

# MONTHLY

An Argus Specialist Publication

APRIL 1986 £1.50

FOR ALL SINCLAIR USERS

# COMPUTING

**NEW**

**=The 128=**  
Is it worth supporting?

**Five 128's to be won**

**QL** Superbasic series plus prize software

**£1000** in prizes — Test the Turbo Esprit

Graphics — In depth reviews  
Art Studio      Mouse Wars



The only cover up you'll find in the new ZX

*Games for the 128*

Rocky Horror    Sweevo    Knight Tyme    Technician Ted

**Crack the Formula — Win a Saga keyboard**







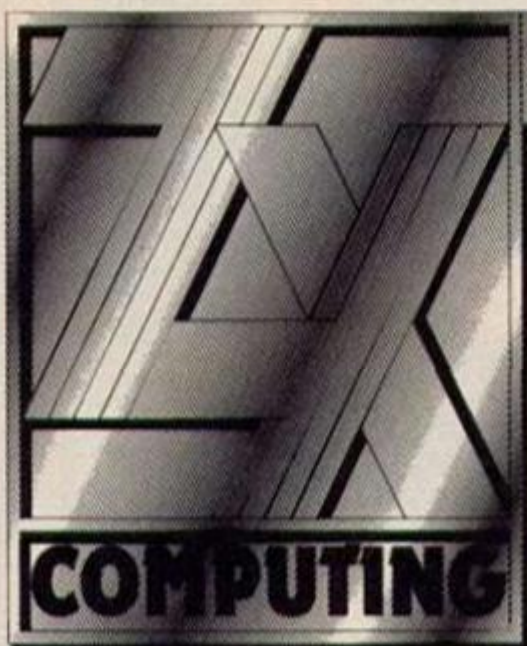

# MONTHLY

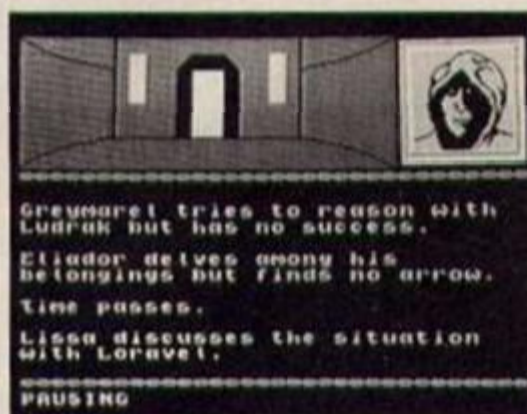

Runestone p47

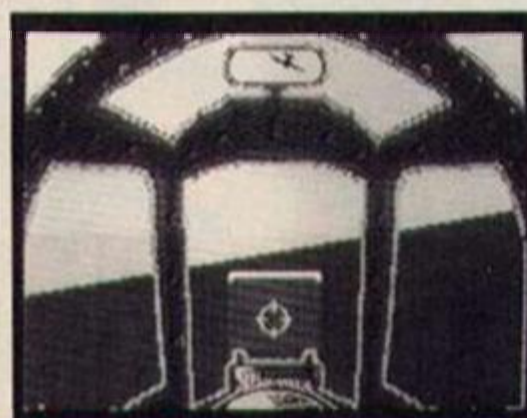

Spitfire 40 p23

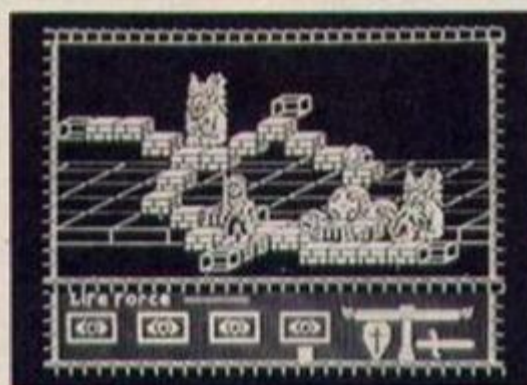

Raspulin p40

## REGULARS

### News

Sinclair launch the 128. 5

### Hardware

A new printer from Citizen. 10  
Mouse Wars: AMX v Kempston. 58

### Crosswires

Your computing problems solved. 85

### Crossfire

Stormy controversy from the letters file. 48

## SOFTWARE REVIEWS

### Spectrum

First 128 games plus Movie, Blade Runner, Skyfox, The Core, Turbo Esprit. 8

### QL

Classic adventures, QL Pawn and new utilities. 68

### Mindplay

A missive from the adventurer's dungeon. 96

## COMPETITIONS

The Flying Formula: Saga keyboards for air aces. 38  
The Great 128 Treasure Hunt. 50  
Cartoon Time. 57  
Experience the Turbo Esprit. 83  
QL Paint and Bounder up for grabs. 85

## PROGRAMMING PROJECTS

Centi: Shoot em up listing. 66  
Light Screen Designer. 74

## FEATURES

Son of Tasword. 19  
Communications: Getting "on line" 28  
Icon Graphics. 32  
Programming the 128. 34  
Laser Basic and now the Compiler. 36  
QL Superbasic: New series. 42  
Quickdraw: Finer points of the Art Studio. 54  
Across the Pond: Sinclair in America. 71  
The 81 Page: Exclusively for ZX 81 users. 81  
Animator: Softcat's new graphics package. 86  
Random Memory: Hints on short cut programming. 93

Editor: **Bryan Ralph**  
Assistant Editor: **Cliff Joseph**  
Consultant Editor: **Ray Elder**  
Advertising Managers: **Mike Segrue**  
and **John McGarry**  
Design: **Argus Design**  
A.S.P. Advertising and Editorial  
No. 1 Golden Square, London W1R 3AB  
01-437-0626



# THE WAY OF THE TIGER

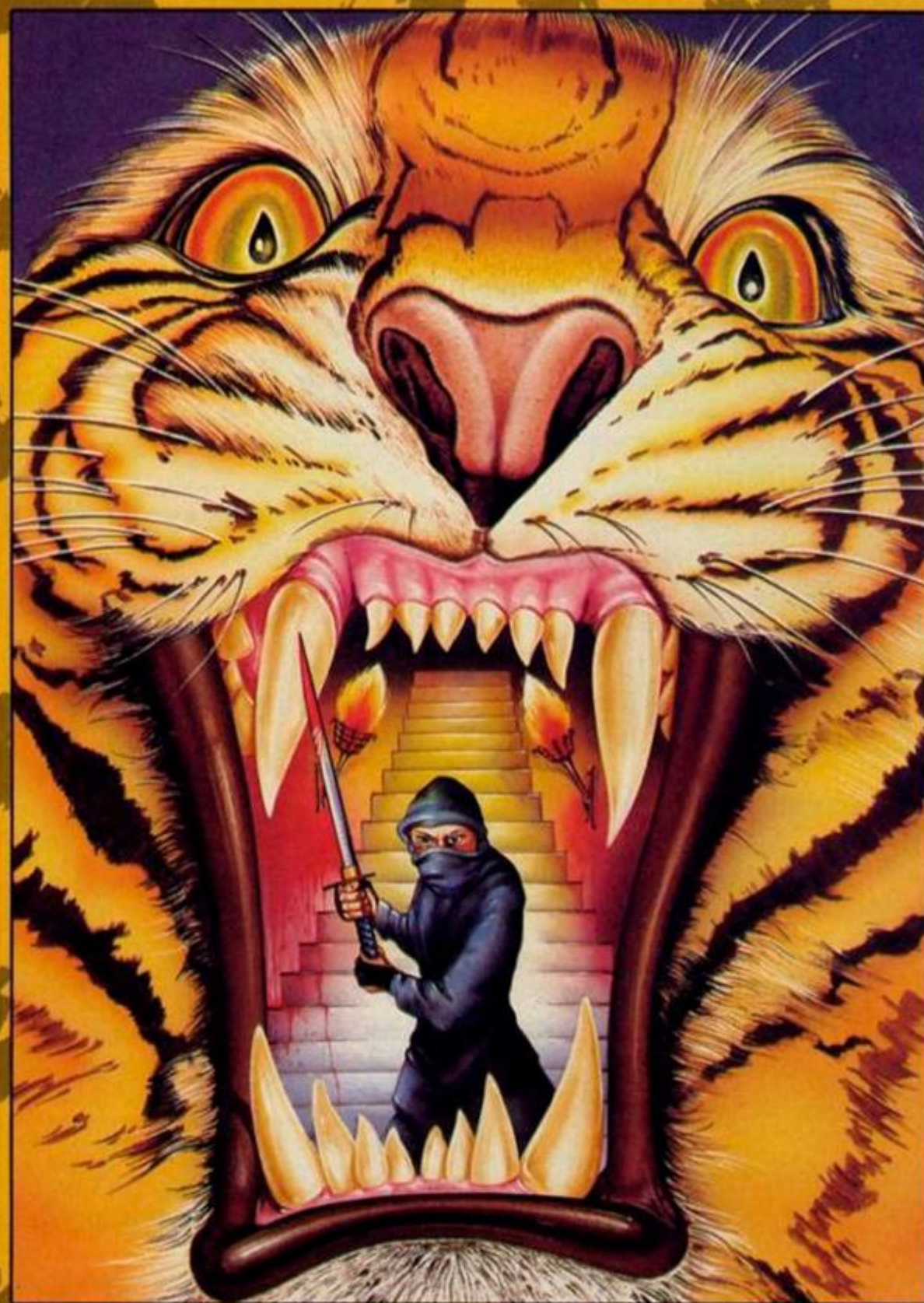

Enter the world of Avenger, a Ninja warrior of unparalleled skills and deadly powers, as he battles the forces of evil in defence of his faith and protection of the weak.

Be calm and stay silent as the outstanding animation and unrivalled combat routines take you to levels of action you'd never have thought possible.

Experience the stunning effects of triple scrolling action as you master the techniques of Hand to Hand combat, Pole Fighting and the skills of the Samurai Sword.

And when you believe you've succeeded in overcoming all the odds, the next in this thrilling series of adventures will beckon you forward to a further challenge of death.

Cassette  
£9.95

MSX 64K Spectrum 48K Amstrad CBM 64/128

Disc  
£14.95

Oremlin Graphics Software Limited, Alpha House, 10 Carver Street, Sheffield S1 4FS. Tel: 0742-753423



TRIPLE-SCROLL  
TRIPLE-SCROLL  
TRIPLE-SCROLL



Screenshots from Spectrum 48K





# NEWS



## Biggles bites your . . .

To coincide with the May release of the Biggles film, Mirrorsoft are planning — wait for it — Biggles The Computer Game. Mirrorsoft promise that the game won't be (yawn) yet another flight simulator, but will be based on a number of sequences from the film. Biggles ETA is 16th May, with an estimated tonnage of £9.95. Chocks away!



The first joint Ultimate and US Gold game is Cyberun which, unfortunately was to be released just a bit too late to get reviewed in this issue. If Ultimate manage to return to form then look out for the review next month.



## Holy software Batman!

Leaping lizards! Arch software house Ocean have acquired the rights to produce a game based on DC Comic's Batman. Their diabolical plan is to produce a 'state of the art' game featuring the dynamic duo and based on the comic strip as it was during the sixties when Adam 'super smoothie' West starred in the high camp TV series.

Personally I'd have preferred a game based on the seventies' Neal Adams/Marshall Rogers strip but there you go. This heinous plot will come to light around April/May. Stay tuned for more Bat News. Holy cliff hangers!



## Nu Wave software

CRL have launched a new games label called Nu Wave. Aimed at people who have 'grown tired of the traditional arcade and adventure game', the label is intended to offer titles that are a little bit different from the norm. The first of these 'different' titles is iD, by Mel Croucher and Colin Jones (and, hopefully, reviewed elsewhere in this issue).

## Quaz was Zig

Hewson's planned Spectrum title Ziggurat has been renamed Quazatron. Similar in style to their C64 hit Paradroid, Quazatron is set in a mechanised underground city, where you struggle against the battle droids that guard the city. The price has yet to be decided, but an early screen shot of the unfinished game looks interesting.

## A touch of the thermals

If anyone out there has a ZX, Timex 2040 or Alphacom 32 printer and is having trouble getting the thermal paper that the printers use, then Dean Electronics can help. Dean have supplies of the paper with a minimum order of £2 for ten rolls. Further information from Dean Electronics on 0344 885661.

## A Fair Cop

" 'Ere what's all this then . . . Gawd blimey it's a fair cop guv'nor . . . Move on my lad". All this and other such cockney drollery will no doubt come in handy when you get your hands on a copy of The Force. Released on the Argus Mindgames label, The Force is a simulation in which you have to clear up all the crime in Middletown. Designed in cooperation with senior police officers, it's meant to be a realistic and challenging game that will take time to master as you go bucking for promotion.

The Force will be with us in March if you're prepared to cough up £9.95.

## A quick Plug

It may not look very thrilling, but LCR Components' new mains filter called The Plug might just come in handy. It's designed to protect home micros from those occasional fluctuations in mains current that can cause your Spectrum to lock up tighter than our Editor's wallet.

The technical details are a bit complicated, but if you contact LCR Components at Woodfield Works, Tredegar, Gwent NP2 4BH, I'm sure they'll be happy to explain it all.







## Advanced S and S

When PSS finally launched Swords and Sorcery it received 'love-it-or-hate-it' reviews, but now they're planning to release an improved version called Advanced Swords and Sorcery. This will contain 'improved graphics and gameplay', a

second dungeon level and detailed map, an Advanced Players Guide, Guide To Monsters, Book of Objects and cassette labels for player characters stored on tape, all for £14.95.

AS&S is due at the end of March, but owners of the original version can upgrade for £4.95 by mail order — contact PSS on 0203 667556 for details.



Domark have gone into the hardware business and will be marketing a monitor produced by French company Eureka. Aimed at Sinclair machines the monitor can amplify your machine's sound output and also expand the game screen so that it occupies the whole of the monitor without the 'dead' border area being visible.

The Eureka monitor should be available in March, costing 'under £250' according to Domark (does that mean £249.95?).

## Incentive's adventures

Incentive Software's Graphic Adventure Creator has received rave reviews on the Amstrad version, and now Incentive are working on a conversion for the Spectrum. Due for release on 1st May the GAC will incorporate full sentence input, text compression, a flexible graphic designer. Looks like The Quill has competition at last. Speaking of which . . .

## 18<sup>th</sup> ZX MICROFAIR

Despite the queue that had been waiting outside London's Horticultural Hall it seemed that the attendance was down compared with previous fairs. I can remember Microfairs where it wasn't possible to see some stands because of the crowds around them, but this time the only stand that consistently pulled in the crowds was Cheetah's where they were demonstrating the Spectrum.

Hardware manufacturers were well represented with Opus, Technology Research, Saga and others plying their wares. Kempston were showing off their Spectrum mouse for the first time (see the review elsewhere in this issue).

Sinclair Research were making a number of special 'once only' offers on both hardware and software. With the QL and Spectrum+ knocked down to £159.95 and £97.50, business was brisk.

Mikrogen were displaying their latest Wally game, Three Weeks in Paradise, as well as Battle of The Planets and Sir Fred. Realtime Software were showing a demo of Starstrike II. This looked impressive, with vector graphics which are shaded and more solid looking than the simple line graphics used in games such as Starion and Elite. We just have to wait until it's finished to see if it's as good as it looks.

QL software was more in evidence than on previous occasions, though standards still vary greatly between the sophisticated business/programming packages that are available and the much less impressive arcade games.

At the last couple of fairs there has been noticeable impatience from people wanting to see some new machines from Sinclair, and on this occasion the disappointment at the non-appearance of the Spectrum 128 was quite apparent. The relative lack of activity from Sinclair has made it difficult to maintain the enthusiasm that has always marked Microfairs in the past. Still, as I sit writing this, the arrival of the 128 is imminent so perhaps the 19th Microfair will have a bit more of the old sparkle . . .

## Infocom for 128?

Along with the news that Activision have 'acquired' American adventure company, Infocom, comes the possibility that Activision may be considering the possibility of converting some of Infocom's games onto the 128.

Infocom's games have all got excellent reputations, but have always been too complex to easily convert for a 48K machine.

Activision's Andrew Wright told us that nothing is definite yet, but that they are thinking about converting the games for a variety of machines, so Spectrum 128 owners may one day experience the famous Zork series, Hitchhikers's Guide and other Infocom classics.



## Starstrike II

Realtime Software are due to follow up their program Starstrike with the innovatively named Starstrike II. A demo of the game was on show at the recent Microfair and looked very promising. It's an Elite style space shoot 'em up, but the graphics are shaded and appeared to be more smoothly animated than in the current crop of space zappers. We don't have a release date yet, but the chaps on the Realtime stand were saying about two weeks (that was a month ago).

## Spectrum Games Top Ten

- |    |                             |            |
|----|-----------------------------|------------|
| 1  | Movie                       | Queen      |
| 2  | Yie Ar Kung Fu              | Imagine    |
| 3  | Commando                    | Elite      |
| 4  | Rambo                       | Ocean      |
| 5  | Computer Hits 10 Volume 2   | Beau Jolly |
| 6  | Daley Thompson's Super Test | Ocean      |
| 7  | Winter Games                | US Gold    |
| 8  | Mikie                       | Imagine    |
| 9  | Saboteur                    | Durell     |
| 10 | Hypersports                 | Imagine    |

(Chart supplied by W. H. Smiths)



## Page Three

Licensing deals reach new heights with the news that Mar-tech plans to release Samantha Fox's Strip Poker and International Seven Card Stud, a twin program cassette due for mid-March release at £8.95 for the Spectrum version.

As well as boasting 'state of the art digitised pictures' Mar-tech also claim to have developed complex artificial intelligence to produce a really challenging game. Not only that, but we got to the end of this item without making a single 'whoppers' joke!

## PSSed again

Falklands '82 from PSS arrived just too late to be reviewed in this issue, but it's available now and priced at £7.95 if you want to rush out and buy it. Or you can wait to see our review next month.

## Global adventures

Global Software have announced the release of one of the first Adventure compilation tapes. Fourmost Adventures will contain Out of the Shadows by Mizar Computing, the graphic Dungeons and Dragons type game that got such a rough deal from distributors and which deserved a wider audience than it got; Galaxias, by Fergus McNeil, author of Bored of the Rings, plus The Mural and The Micro Man, two adventures from lesser known authors but which Global assure us have received 'critical acclaim'.

Fourmost Adventures should be available in early March for £7.95, and may well be worth the price for Out of the Shadows alone.



## Q Comms down

Tandata Marketing has cut the price of its QL communications package by £60. The three modules, Q Connect, Q Mod and Q Call is now available as a package priced £113 plus VAT, though it is still possible

## Timex TV

Sinclair Research have made a deal with Timex which allows Timex to handle the world wide marketing of Sinclair's Flat Screen TV. According to Sinclair, Timex's manufacturing experience now makes possible a cut in price from £99.95 to £79.95, and Timex will be working on developing UHF/VHF models for export.

# NEWS

## Software Turkeys

After Ultimate's Filimation comes Global's Vege-tation. The first of Global Software's series of games based on the world's worst films is on its way. Attack of the Killer Tomatoes and its hero, Wimp Plasboff are due to arrive in late March, priced at £7.95.

If you want to save the nation's supply of tomato puree then this could be just the game for you.



## MAX HEADROOM

### Max Factor

Despite being previewed in just about every games mag in the country over the last few months, Quicksilver's Max Headroom has only recently been completed (and, wouldn't you know it, just too late to be fully reviewed this month). To coincide with the launch of the game ZXC has arranged a nice little freebie: the first hundred people to send stamped and addressed envelopes to Solution P.R. Unit 11, South Block, Riverside Way, Sawbridgeworth, Herts CM21 9PG will all receive free Max Headroom stickers to plaster onto the surface of your choice (windows, budgies, younger brothers, that sort of thing).

## Gilsoft strike back

Gilsoft, creators of the Quill and Illustrator programs are currently working on The Quillustator for the Spectrum 128. As the name implies, this will incorporate the combined facilities of its predecessors. Quillustator should be available towards the end of March for around £25.

In the meantime, for humble 48K owners Gilsoft are providing a bundled Quill/Illustrator Double Pack for just £22.95 (a saving of about £7 compared to the cost of buying the two separately).



## Way of the Tiger

Gremlin Graphics are about to launch the first in a series of games based on the highly popular 'Way of the Tiger' series of role playing adventure books. The series follows the adventures of Avenger the ace Ninja as he battles against evil, and the first game from Gremlin will follow Avenger as he trains to become a master of the martial arts.

The game is in three separate parts which Gremlin say are all complete games in themselves, and deal with the skills of unarmed combat, pole fighting and Samurai sword fighting — all this for just £9.95. The review copy turned up just in time to miss our last deadline, so you'll just have to come back next month for the review.

## Another Mouse

After the arrival of the Kempston and AMX mouse units, Nidd Valley have announced that they too will be producing one for the Spectrum. Or rather two; there will be two versions of the unit, the Digimouse and Anamouse, with the latter being more for professional use. There

will also be two interface available, one which will enable the mouse to be used with joystick driven software, and another which will incorporate a centronics interface and be usable in conjunction with Nidd Valley's own programmable keypad.

The mice will be priced at £34.95, the joystick interface at £14.95, and the 'Professional' interface at £34.95.



## War On Want

The charity compilation tape — WOW Games — intended to raise funds for War On Want is now due to be released on 21st April, and the contents have been finalised.

The tape will sell for £9.95 (all profits going to War On Want) and will include Spectrum Chess II, Pedro, Winged Warrior, Mr Freeze, Headbanger's Heaven, Wizard's Warrior, Hellfire, Hunchback II, Horace and the Spiders, Davior, Rupert and The Ice Palace, Cyber Tanks, Dr Franky and the Monster. Which should total fourteen titles in all.

All concerned (software houses, tape duplicators etc) have given their services without making any profits, so the maximum amount of money will go directly to the charity.



## Lead on

With the launch of the Spectrum 128, Sinclair also revealed their "new philosophy", a commitment to be a "consumer led company". In plain English this means "giving the punter what they want" and Sinclair seem in no doubt that in pitching the 128 as a superior games machine with a £179.99 price tag they are doing just that.

Sinclair are backing the belief that the games boom will continue and to justify their strategy they produced market research figures which showed that in the past two years the percentage of home computers used predominantly by games players has risen from 45 per cent to 62 per cent.

Sir Clive said that "Sinclair Research are dedicated to the Spectrum in the long term and we believe that by taking technical leaps we can keep it in the dominant position it now holds".

"We have taken a big step by introducing better sound and a better picture and want to emphasise compatibility as the 128 will run all the old software".

As for the future, Sir Clive was drawn to reveal some details of the Pandora, the portable computer that is scheduled for "late this year".

"We alone have the technology to produce a light-weight computer that will run off batteries with a display that will work in any light conditions".

Adding that the new computer's screen would be based on the Sinclair flat screen television he said, "The Pandora will not be a compromise and it will be competitively priced and aimed at the world market".

## The Spectrum 128 — The Inside Story

Processor — Z80A running at 3.5MHz  
ROM — 32K (EPROM -27256 chip)  
RAM — 128K (16x64 Kbit dRAM chips)

### Ports

As Spectrum+ (cassette, TV output plus sound and expansion bus)

Added are:  
RS232/MIDI-OUT port (software driven)

RGB/Composite video colour output

Keypad interface (software driven)

### Added features

AY-3-8912 chip giving three channel sound via TV, eight channels via MIDI

Two switchable hardware screens

RAM organised as 8x16K pages  
Enhanced TV picture quality and capability to connect top RGB/composite video colour monitors.

### Software

Includes menu driven calculator, tape loader, tape volume tester and screen editor

TV tuning tester and screen dumper

RAM disc file system, usable by Basic

Spectrum 48 mode

Spectrum Basic converted to multiple key entry

### 128 Add on

Although it came as standard with the Spanish 128, the Numeric Keypad will be sold separately in Britain at a cost of £19.95.

The keypad has 18 numeric and cursor keys and gives extra features for the built in editor when using 128 BASIC. Depending on your preferences it can also act as a calculator or give cursor control during games.

### Graphics, Music . . .

The software houses have not only been developing games to play on the 128, there are also numerous utilities, graphic packages and music software on the horizon.

Art Studio 2 takes the WIMP concept (window, icon, menu, pointer) into new areas of possibility with the 128. Still in the development stage Art Studio 2 from Rainbird will cost £24.95.

Melbourne House are packing some extra Wham! into their Music Box but the 128 music making program will be losing the Wham! from the title and be known simply as The Music Box (£9.95).

Hot on the heels of Tasword 3, Tasman have announced they will be producing Tasman 128 which they say will have 64 characters per line entry and up to 128 characters per line text entry.

Audiogenic's Icon Graphix program (the 48K version is reviewed this issue), is to be enhanced for use with the Spectrum 128. The 128 version will have facilities such as typing text onto the screen, copying areas of the screen and moving them around, flipping the picture horizontally or vertically, mouse control and other features not available on the original 48K version.

Icon Graphix 128 is due for release in March, and will cost £9.95.



The Spectrum 128's that were ghosted into software houses around the country during the past few months came out into the open at the official 128 launch. Programmers have been feverishly preparing games to ensure the machine has credible software support. Despite assurances that 48k games run on the 128, to potential buyers this may seem like fitting a moped engine into a Ferrari.

Compatibility is of course an asset but the machine's viability rests on the utilisation of its added features for games writing.

The software houses have come up with a miscellany of revamped classics using the 128's new capabilities to varying degrees. Games written specifically for the 128 are in the pipeline but the first offerings are reviewed below.

# GAMES

Daley Thompson Super-Test

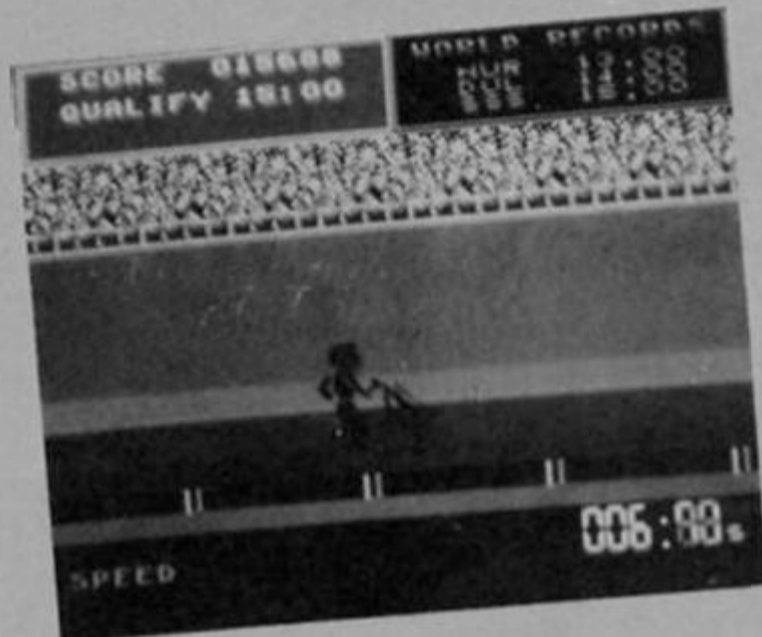
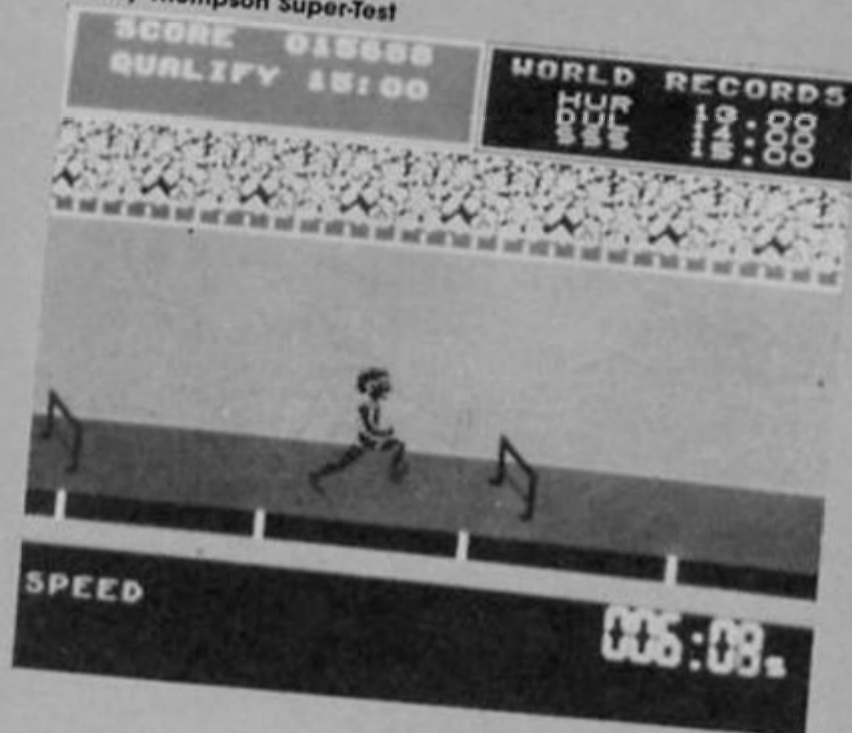

Neverending Story

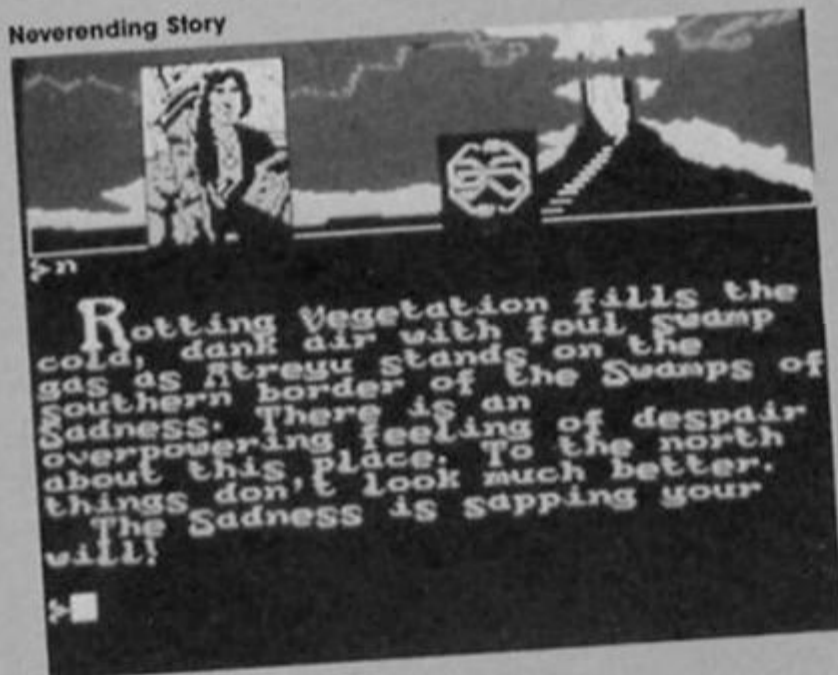

## Neverending Story Ocean £9.95

The first adventure game to appear for the 128 comes bundled with the machine when you buy it. The original 48K version had to be loaded in three sections, but now with the 128's extra memory the whole

game loads in one long chunk.

Set in the land of Fantasia, which is being threatened by the menace of The Nothing, you play the part of the young hero Atreyu, who is the only one that can conquer The Nothing. The characters that Atreyu will come across are all similar to the characters from the film, the huge Rockbiter, Teenyweeny and Nighthob, who will all aid him in his quest, and others like Gmork who is in the service of

The Nothing and will do all he can to stop Atreyu.

The graphics in Neverending Story are cleverly used: as you progress through the game there are pictures of the main locations over which smaller illustrations are superimposed. These show the objects you are carrying and any characters that you may meet, and just for once these graphics do enhance the game rather than just replacing text.

The text input isn't quite as friendly as it could be (and doesn't even seem to accept 'examine'), but I still found it sufficiently flexible to allow me to try most things that I wanted. Neverending Story may not be a classic adventure, but for the 128 owner who's into adventures it will come as a nice extra with the machine.

## Daley Thompson Super-Test Ocean £9.95

To force home the point that the 128 is intended as a games machine Sinclair have included Daley Thompson's Super Test with the machine. To add to the key battering strain of the original Ocean have extended the program to include four more events, 100m Sprint, Javelin, Triple Jump and Hurdles.

As before timing and sustained attacks on the keyboard/joystick are the key to success and with improved graphics and sound effects the 12 event package represents good value even though it costs £2 extra than the 48K version.





**Technician Ted  
Mega-Mix  
Hewson  
£7.95**

Hewson's everyday story of life at a silicon chip factory has been overhauled for the 128 to take full advantage of the sound chip and increased memory.

The Mega Mix contains 100 screens, twice the number of the original and music plays throughout, beginning with a Viennese waltz to accompany

the loading screen and moving onto a rousing march to get you in the mood for Ted's quest to complete his daily tasks.

With so many more locations the gameplay is different so that Technician Ted in the 128 version can be considered almost as a new game rather than just a cosmetic enhancement of the 48K program. Technician Ted, harassed by lethal C5's, floating heads and viciously rotating keys seems set to persuade a new wave of converts to clock on to this addictive platform foray.

**Robin of the Wood  
Odin  
£9.95**

"Can you help Robin in his quest to find the silver arrow?" asks a voice issuing from the Spectrum. Speech on the Spectrum 128 is impressive enough but Odin have gone on to add a number of deft touches to Robin of the Wood that make it a pure pleasure to play.

A jaunty medieval tune plays throughout the game, only interrupted when you have felled one of the Sheriff's men

with your trusty staff. Your reward is a quick burst of the traditional Robin ditty (usually associated with arrows embedded and twanging in a tree) before the theme music smoothly takes over again.

Another nice feature is revealed when Robin is being given a hard time by the Sheriff's men. "Give me a chance," he pleads as another arrow hits him.

With its superior graphics, smooth animation and sound effects Robin of the Wood shows that Odin are among the front runners in using the potential of the 128.



Technician Ted Mega-Mix

**Three Weeks in Paradise**



**Three Weeks in  
Paradise  
Mikro Gen  
£10.95**

Wally's jungle jaunt to rescue Wilma and Herbert from the cannibals has been expanded for the 128 to incorporate some new sequences, improved graphics and music.

The graphics themselves are impressive with each successive screen more crowded

with features and perils than the last. There do however appear to be problems with colour smudge on our copy. The capability for sound has been used to produce a rather weak theme tune which although apt for the game setting will not exactly set the pulse racing.

Despite the quibbles Three Weeks in Paradise is an enjoyable enough Wally adventure and contains enough problems to keep you intent on saving Wilma and Herbert from becoming the cannibals' main course.

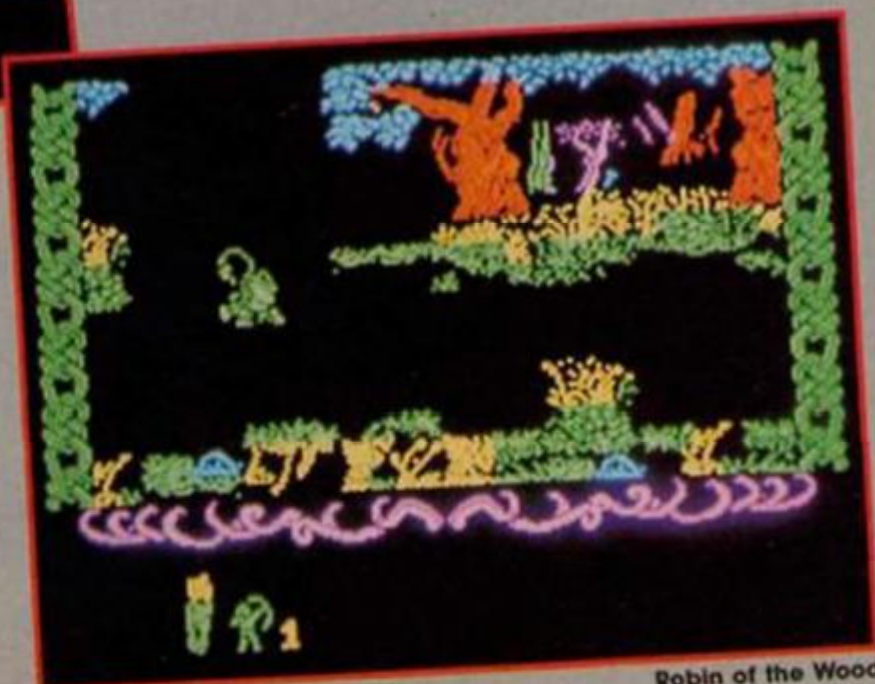

Robin of the Wood





Nodes of Yesod

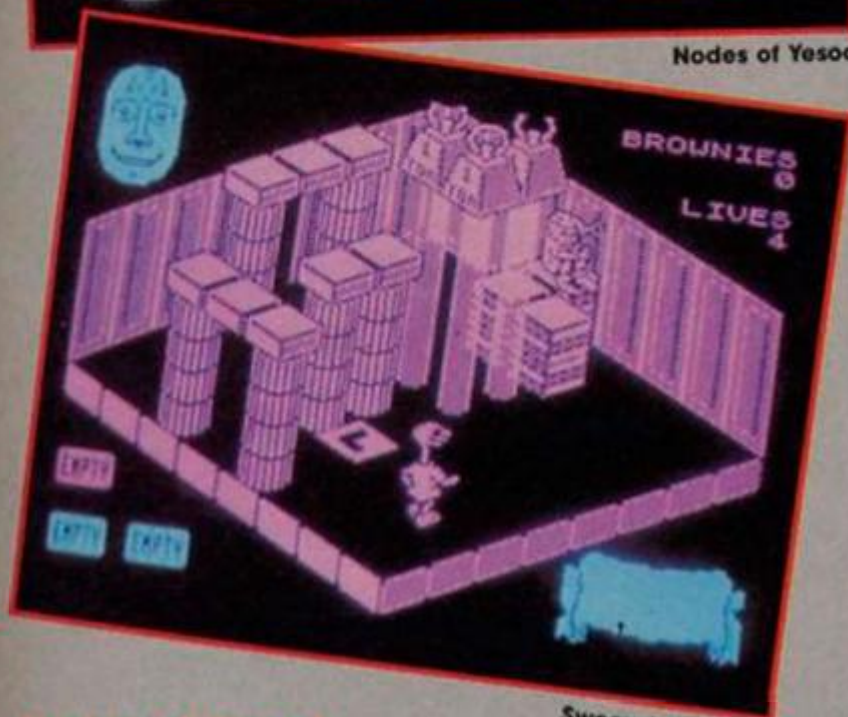

Sweevo's Whirled!

### Nodes of Yesod Odin £9.95

The main difference between this and the 48K version of Nodes is not the size of the game, but the excellent speech synthesis that has been made possible by the 128's new sound chip. The game begins with 'Welcome to The Nodes of Yesod, from the Odin Computer Graphics Team' — speech as good as I've heard on any home computer.

The game itself is the same as the original version, in which you must help Charlie Fotheringham-Grunes locate the eight keys which will allow him to enter a cavern beneath the moon's surface where lurks a great monolith which is sending out signals to potential alien invaders. But now, in addition to the excellent animation and maze of monster infested lunar caverns, the game boasts a continuous and quite atmospheric soundtrack, as well as the occasional spot of speech synthesis such as 'Your energy is running low' or 'Ouch' when you fall from a height.

Like Sweevo's World, this was an excellent and addictive game when released for the 48K Spectrum, and the addition of sound has only improved it. Mind you, it would have been good to see some of the memory used to expand the number of playing screens, which, as far as I can tell remains the same.

### Sweevo's Whirled! Gargoyle Games £9.95

The original version of Sweevo's World would probably have gotten a ZX Monster Hit if they had existed at the time the game was released, so the 128 version starts off with a good pedigree behind it.

The basic plot of the game remains the same; you must guide Sweevo around the rooms of an asteroid inhabited by all sorts of insane creatures, geese and brownies, Horrid Little Girls, deadly fruit and collapsing weights. The humour and strangeness of the obstacles were what made Sweevo's World stand out from the recent spate of Knightlore clones, and of course with an extra 80K of memory to play with it's all still there, plus lots more. The game now contains 250 rooms as well as having enhanced sound.

The number of sections in the game has been increased, so that instead of starting in places like Lonesome Pine and Really Free, you can now add to that list Nobody Nose (a group of rooms inhabited by deadly noses!) and several others. It would have been nice to have continual music rather than just the tune at the beginning, but Sweevo is still one of the most enjoyable games currently available on the Spectrum (48 or 128K).

# THE MONSTER RATINGS

Introducing the Globs — a family of dedicated software reviewers who will be working day and night to bring you the lowdown on the latest games. Each month software is airlifted to the family seat, Globule Towers, where it is rigorously tested for entertainment value, playability and value for money.



**The ZX Monster Hit**  
The ultimate accolade, a surefire hit that's essential for your games collection.



**Globella**  
A special game with addictive features. Miss it and miss out.



**Globert**  
An average game with limited appeal.



**Glob Minor**  
Snooze software — strictly for insomniacs.



**Glob Senior**  
An exasperating game well below the accepted standard.



# MAX HEADROOM

What  
I  
want  
to  
know is...

...why  
would  
anyone  
play  
anything  
else?

**A**vailable for  
the Commodore 64,  
Spectrum and  
Amstrad at a  
recommended  
retail price  
of £9.95.

**QUICKSILVA**

*The most powerful  
games in the Universe*

Quicksilva Ltd.,  
Liberty House,  
222 Regent Street,  
London W1R 7DB.

01-439 0666

© Chrysalis Visual Programming Ltd.





# BLADE RUNNER

**Blade Runner**  
CRL  
£8.95

When I grow up I want to be Harrison Ford, but in the meantime I'll be happy to pass the time playing the part of Deckard (Harrison Ford in the film) in the computer game Blade Runner.

Yet another licensing deal gave birth to this game, but it's not the game of the film of the book, instead this is the game of the soundtrack of the film of the book. I imagine that the film rights were more than CRL could afford, so they got the soundtrack rights instead. Not that it seems to have made much difference because the game looks just as if it were based on the film and only a few names have been changed.

You are cast in the role of a bounty hunter who sets out to eliminate a group of 24 replidroids. These are superhuman artificial beings created by genetic engineering as a form of slave labour for work on other planets. But these 24 have returned to earth to destroy the 'cyberneers' who created them, and it's up to you to stop them.

Because this is the game of the soundtrack you have to sit and listen to a chunk of music before the game starts. This wouldn't be too bad on the 128 which has a decent sound chip, but on the ordinary 48K

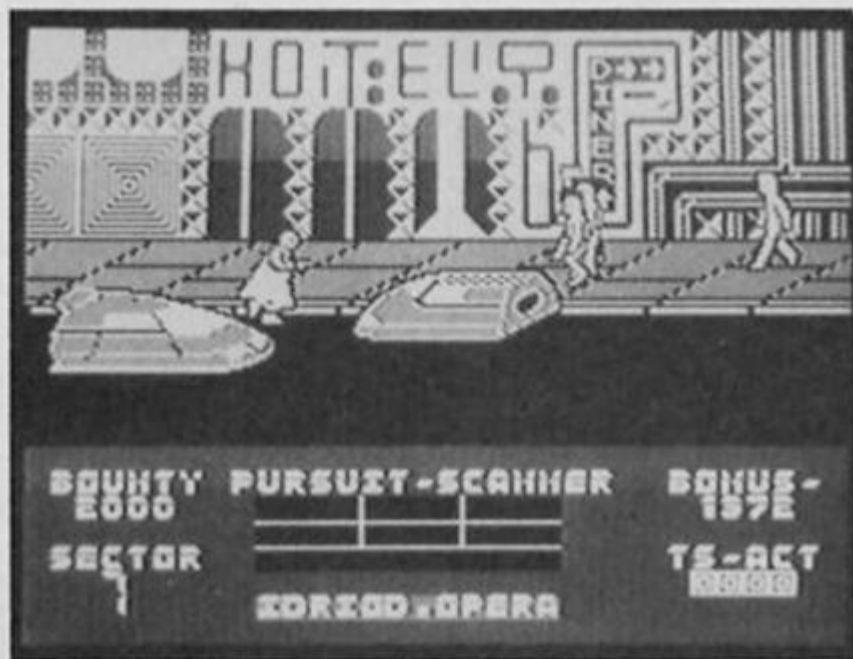
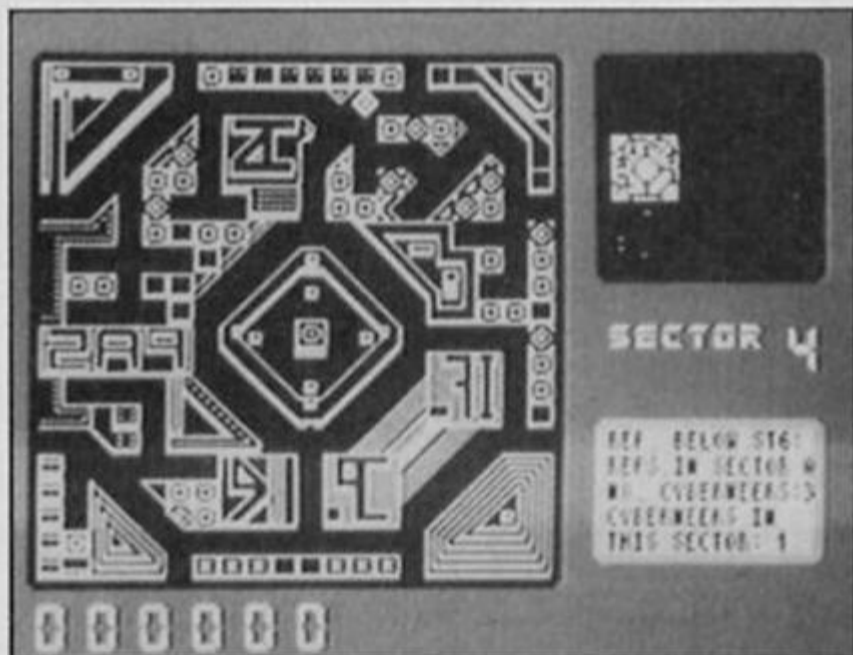

Spectrum listening to its feeble BEEP for more than a few seconds is a bit of a waste of time (though CRL don't seem to have any plans for a 128 version with added sound).

The first part of the game shows you a plan of one sector of the city and the location of any replidroids in the sector. Other sections of the screen contain a map of the whole city, details of your earnings and messages from police HQ.

The main problem on this first screen is deciding which replidroid to go after. The locations of the cyberneers are marked with blue symbols and you have to reach the replidroids before they get to them, but if there's more than one replidroid in a sector and they're all going after different targets then you're going to have to make some quick decisions.

Once you've located a replidroid the screen changes to a view of the city streets. Your jet car hovers down to street level and you have to get out and chase the replidroid in a sequence which is a direct copy of one of the chase scenes from the film.

The graphics in this part of the game are very good, being similar in style to the shaded graphics in CRL's Tau Ceti. The bounty hunter jumps out of his car, and you then have to get him to run along the crowded street in pursuit of a replidroid. The street and pedestrians scroll across the screen from right to left, and Deckard can also move across the width of the pavement in order to avoid colliding with pedestrians. I found catching a replidroid almost impossible, since they seem to run at exactly the same speed as your own character, so the only way to kill them is to get lined up precisely behind them and shoot.

There are six types of replidroid, each type deadlier than the last and harder to pursue as they run faster and dodge in and out of the crowds more.

If you bump into a pedestrian you'll both get knocked down and lose valuable time which may allow the replidroid to get away. If that happens it's back to the first screen and you'll have to track your target down again.

Like the film Blade Runner, the game is visually quite stylish and there are some nice touches such as the heavy raincoat that the bounty hunter wears and which flaps as he runs along. Perhaps I'm feeling generous towards this game as I enjoyed the film so much, on the other hand there are few games based on films or TV programs that manage to do any sort of justice to the original, and I think that Blade Runner is one of the few.





# GAMES

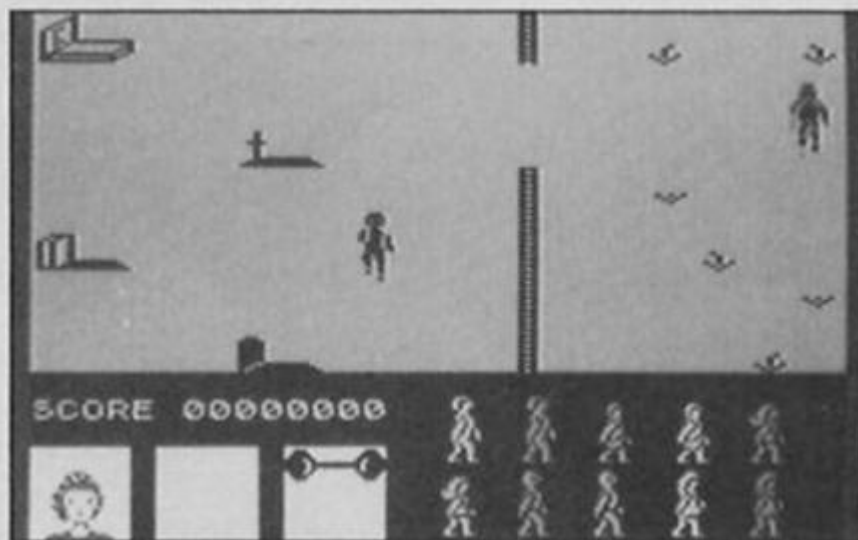
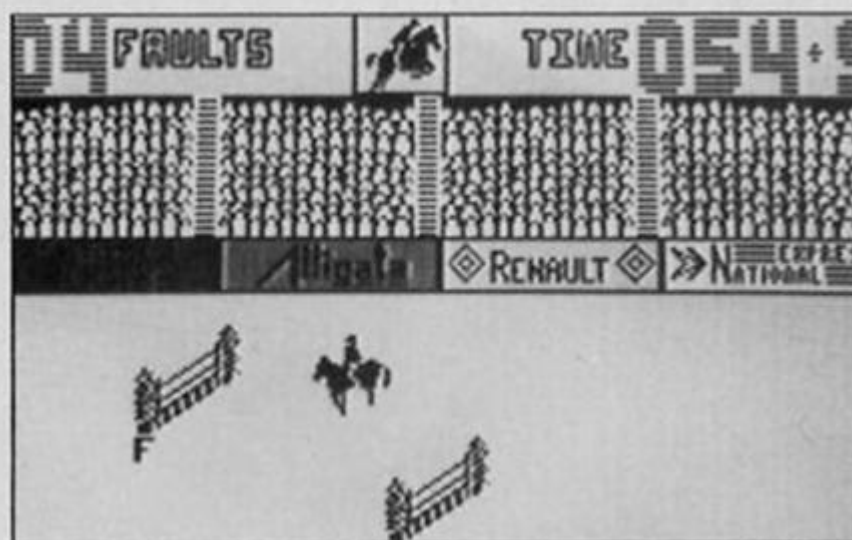

## Showjumping Alligata £7.95

As a spectator sport showjumping has about as much appeal as a snail race for me, but I have to confess that this simulation had me hooked and if you are looking for an engrossing and enjoyable multi-player game this is a real contender.

A simulation like this stands or falls on its animation and the horse movement and jumping in the game are surprisingly good for the Spectrum. The horse has 12 angles of movement which means that subtle control is needed even on a joystick to steer your steed round the course within the 100 second time limit.

Judging the right approach angle to the fence is vital to get a faultless clearance otherwise it's four faults for a fence down and three faults for a refusal. If you forget to jump at the right moment the horse and rider crumple into the fence. Just about the only familiar sight missing from the simulation is the rider spreadeagled over a fence after his mount has made an unscheduled emergency stop.

With six different courses for up to eight players Showjumping makes a compelling competitive game, and if there's a tie the remaining competitors go on to a more difficult jump-off round. Definitely a game where you'll be itching for your next turn.

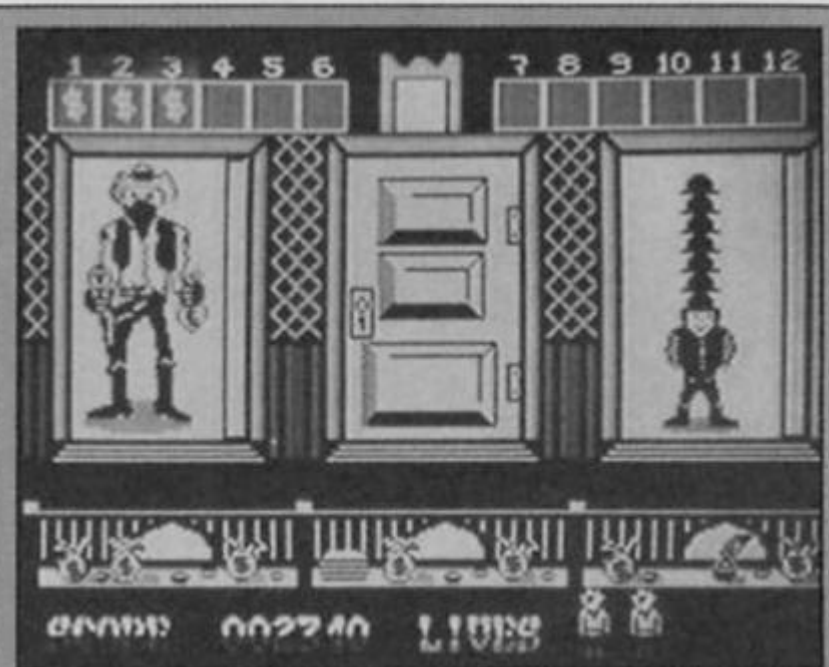

## West Bank Gremlin Graphics £7.95

As a cashier at West Bank you are employed full time to snipe from behind the counter at bandits who want to make a forcible withdrawal.

The difficulty is deciding which are the desperados and which are the depositors. From the three doors that face you there can emerge anything from law abiding citizens to masked bank robbers. There is also a midget wearing six hats, one on top of the other (more common in the Wild West than you imagined), and in between wasting the baddies you can take a second to amass a few points by sharpshooting his hats off. Underneath the last hat is either a bag of money or a bomb which loses you a life if detonated.

There are ten doors to scroll across and when the dollar signs above all ten start flashing that shows that you've taken in sufficient money from your surviving customers and it is time to progress to level two. But first there is a face-on shoot out with three mean lookin' dudes who you have to draw on in the right order or they send you to Boot Hill. On successive levels the doors open and close more rapidly revealing more bandits to pot and fewer customers to accidentally dispose of.

West Bank is really a variation on a shooting gallery game and as such works well, but unless you want to test your reaction time to the limit your reaction might be disappointment.



## Friday The 13th Domark £8.95

I'm no prude, I don't mind a bit of senseless violence from time to time and I wouldn't mind the tacky, tasteless advertising for Friday The 13th if the game itself had a few redeeming features. But it doesn't.

The plot of the game is, of course, based on the Friday The 13th films in which a psycho named Jason hacks his way through a group of young people staying at a summer camp. Having worked on an American summer camp I can sympathise with Jason's feelings, though the game based on his exploits doesn't have a fraction of the excitement that the films generated in their own gory little way.

When first loading, the intro screen is accompanied by a gargled scream that sounds just like Snoopy in the Charlie Brown cartoon series. The instructions tell you that you have to warn all the kids on the camp and lead them to safety before Jason creeps up on them, but that's all they tell you. There doesn't seem to be a way of warning them or of getting them to follow you at all. They all just wander around, apparently at random and there's no way of affecting them — I even tried shoving a chain saw into a few people's ear-holes just to see if it would have any effect, but it didn't.

One of these wandering teenagers is actually Jason and every now and then he'll bump off one of the others, but as he looks just like the rest of them you won't be able to locate him unless he attacks you or he attacks someone else while you're nearby, but that



hasn't happened while I've been playing and I've only ever spotted Jason as he kills me (end of game). And, as it sometimes takes quite a while for Jason to reveal himself, you can be faced with long spells of wandering from screen to screen only to die suddenly when Jason cuts off your head.

The graphics are very poor — your little stick man seems able to walk through tables, he becomes invisible when walking near certain objects but is unable to get close to fences for some reason.

This game has attracted a lot of attention due to the criticism that the advertising has attracted, I just hope that that hasn't led anyone to go out and buy it.



## Gerry the Germ Firebird £7.95

This has to be one of the most infuriating games I've ever played. My initial reaction to the packaging was favourable, as the instructions come on a large glossy sheet in cartoon form, making a small poster.

It was only when I started to play the game that I discovered that the instructions, glossy though they may be, were no use whatsoever in letting me know what was going on.

What I could glean from them was that Gerry is a bit of a failure in the germ stakes, and his ambition is to prove himself as a virulent little microbe by causing some poor sod to have

a coronary. This is done in stages as Gerry progresses from the lungs into different parts of the body, doing his germ business along the way.

Except for one problem — I couldn't work out just what it was Gerry was supposed to be doing. The first screen (the lungs) requires you to avoid white and red blood cells and to collect oxygen cylinders. Fair enough, but the blood cells stick so closely to the oxygen that only on one attempt did I even manage to collect a single cylinder. Failing to collect enough oxygen causes you to be dumped into the bladder, and this screen had me completely baffled.

Here, Gerry is in a little rowing boat, in a lake with an island. There is also a dripping tap, a roll of loo paper, and a

cock and bull (ha, ha) which fly/swim around trying to sink the boat. It took me well over an hour to work out how to complete this screen — not because it was a tough or challenging task, but because I just couldn't see the point of it all. If I hadn't had to stick with it in order to write this review I would have given up.

Once I worked out how to get through the bladder (if you know what I mean) it turned out that the solution was a repetitious task involving rowing the boat to and fro a lot. Then, when I got onto the next screen it was back to square one on another screen that was just as irritating as the first two.

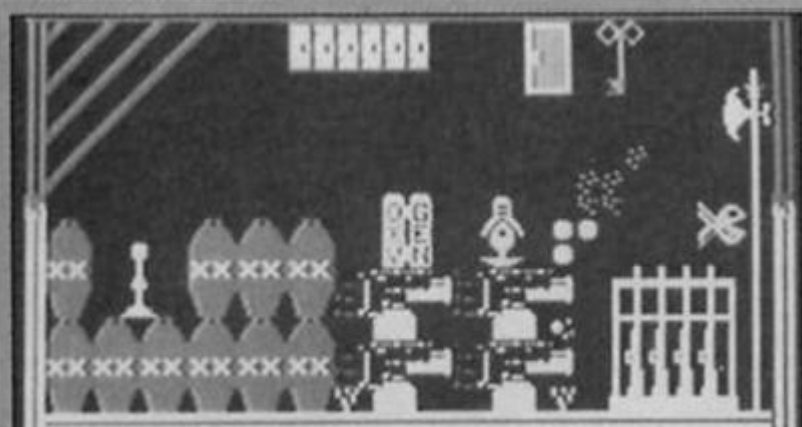

Brews mess, quarter deck carrying a tank of oxygen

## Devil's Crown Mastertronic £1.99

There's a game by the same name floating around for the Amstrad, released by Amsoft and costing £7.99. I hope it's not an Amstrad version of the same game, because while it's a passable budget title it certainly isn't worth more than about £2.

Devil's Crown is an underwater collect-the-objects game, set on board a sunken pirate vessel. You play an archaeologist who, in his little mini-sub, has discovered the ship and now seeks to recover the seven jewels that were on board when it sunk. But before you can locate the jewels you have to find an assortment of other objects and reunite them with their 'flashing' counterparts (so, if you discover a flashing key in one cabin that means there's another key elsewhere that you have to collect and bring together with the flashing one). There are forty screens in all, all drawn in some fairly garish colours, and occupied by killer fish (who drain your oxygen supply) and the ghosts of long dead pirates. Your sub is armed with a limited supply of bullets and there are oxygen cylinders to be found in order to boost your dwindling supply.

The game itself isn't especially challenging since,

apart from avoiding or killing the fish and ghosts, there isn't very much required of you other than to keep on going from cabin to cabin looking for objects. This on its own simply didn't prove challenging or addictive enough to make me determined to see it through to the end, especially since the sub can only carry one object at a time and constantly going back and forth through the same screens time after time eventually became too repetitive to hold my attention.

Perhaps though, I'm expecting too much from a game that costs just £1.99. The loud colours and simple cartoony style of graphics remind me of a children's colouring book, so perhaps this pocket money game is aimed at a very young and relatively unsophisticated audience who might not yet be able to cope with complex arcade and adventure games.

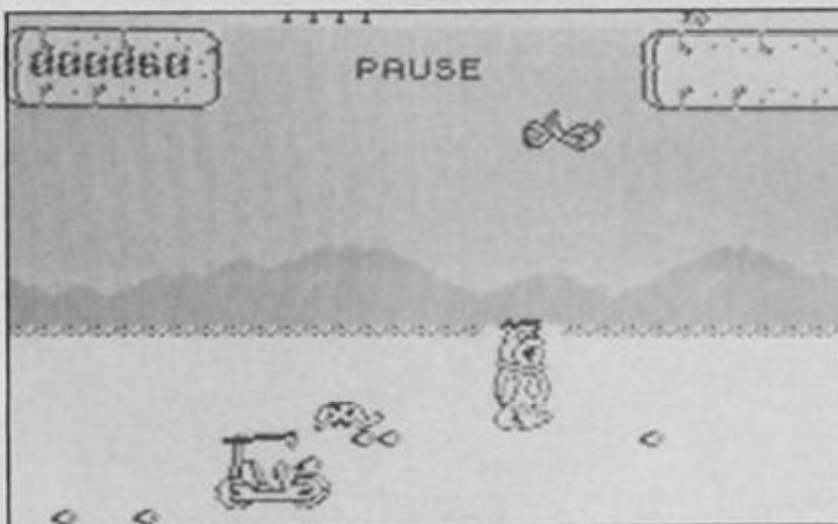

## Yabba Dabba Doo! Quicksilva £7.95

It's the Flintstones, meet the Flintstones... victims of yet another TV licensing deal, Fred and Wilma Flintstone have been turned into a not-terribly-good game which, I am told, is much better on the C64 version than on the Spectrum. The C64 version has been described as 'diabolical', which gives you some idea of what we're up against here.

Fred is attempting to start a thriving stone-age community, the town of Bedrock, and wants winsome Wilma to set up home with him to get things started. But as Fred doesn't yet have a home for them to get set up in, his first task is to build one.

The game begins on a desolate landscape with mountains in the background and loads of rocks scattered around. This screen is where Fred will build his house. There are two types of rock on the ground around him, small ones which have to be collected

and dumped into a quarry to clear the ground, and larger ones which are what Fred uses for building materials. Fred can only carry one rock at a time, so clearing the site of all the small stones means carrying them one after the other to the quarry, a task that isn't at all exciting or challenging (despite the pterodactyls, dinosaurs and turtles that he may bump into and which drain his energy), and which quickly becomes repetitive.

Finding the large rocks isn't much more fun, but since these are scattered over a number of screens you have to do a bit of searching in order to find them. Eventually Fred will have to find a car to help him go looking for rocks, and also to try and find Wilma (who likes to hang out at the Burger Bar, yet still manages to keep that slim figure. How does she do it?).

Controlling Fred's movements is awkward, since he can move onto different pathways either closer to, or further from the mountains, but he can only do so when he's right at the





# GAMES

edge of the screen. And, as all the screens look very similar it's hard to tell which screen Fred's on until you try and retrace your steps and realise that you're lost.

There is also a 'beat the clock' element in the game, as Fred's neighbours are also building their own homes and there's a large score bonus to be had if he beats them to it. Unfortunately this failed to add any excitement to the game as I found the rest of the action so

uninspiring that the possibility of a bonus wasn't enough to get me worked up about it.

The graphics are the best part of the game, smoothly animated and capturing something of a cartoon style, but the game itself has none of the action or fun of the original.

Another licensing deal bites the dust.

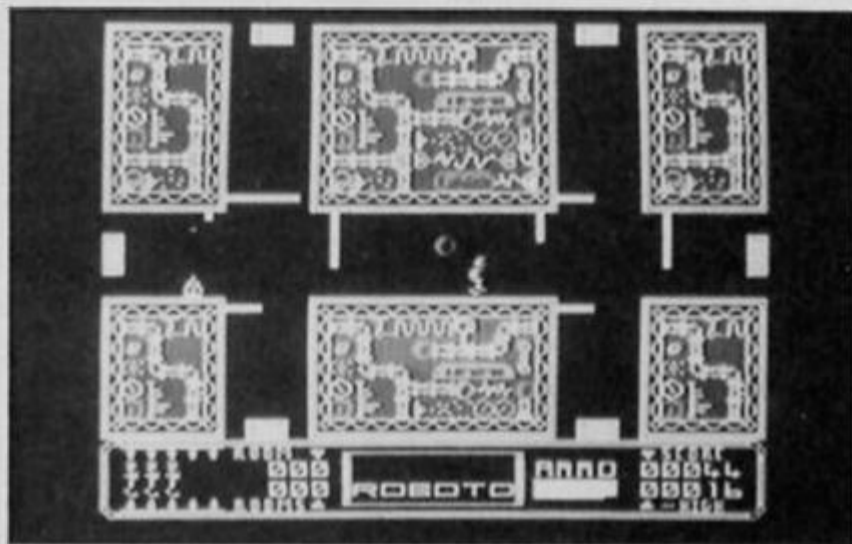

## Roboto Bug Byte £2.95

Bug Byte has released a few simple but fairly enjoyable games since its reappearance as a budget software label, though none of them have been in the same league as the best budget games such as Spellbound from Mastertronic.

Roboto continues that rather average track record, being a 51 screen dodge 'n zap game in which you control a group of robots and must attempt to repair a power plant and save the human race from destruction. The game is set in the year 2086, when the sun has become a weak, dying star unable to sustain life on the earth's surface. The human population has dwindled to a small settlement which relies on the power station for heat and energy.

The trouble is that the automatic components that maintain the plant have gone haywire and are on the rampage. As the only technician in the group it's up to you to take control of the last five droids and guide them through the plant, deactivating each room by destroying the 'power orbs' that you will find.

It's all standard stuff, with deadly sprites and objects out to make life difficult for you, not

to mention a variety of traps that have to be avoided. Your droids are very small figures — about a single character square in size — and the graphics of the game as a whole are small and not very finely detailed, though the animation is smooth and the overall presentation is quite adequate.

Some of the obstacles that you have to get past are quite tricky, and some of the rooms are challenging enough to make you keep on trying to solve them, but in other places the traps and rampaging components are so deadly that they simply become irritating as you lose life after life without making any progress. Many of the gaps that you have to guide your droids through are so small that they require single pixel accuracy in your manoeuvres, but since the graphics are all so small this accuracy isn't really possible unless you've got great eyesight or are sitting right on top of your TV screen.

I suppose that 51 screens for £2.95 is reasonably good value, as long as you don't mind the game looking a bit dated, and are prepared to persevere with some of the really tough screens.

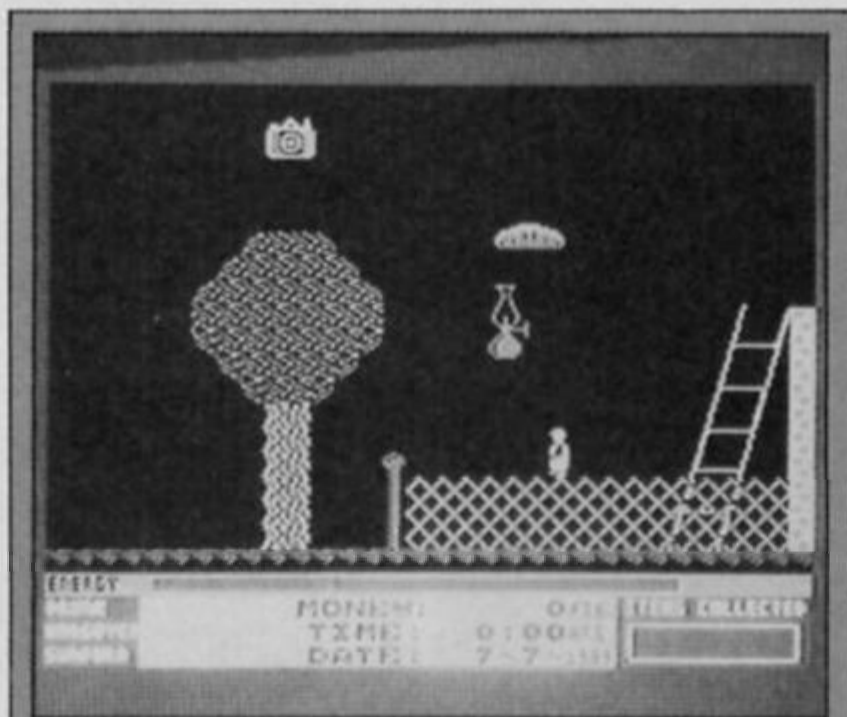

## Costa Capers Firebird £7.95

Costa Capers is the kind of platform game that will either rivet you to the screen or drive you away jabbering hysterically.

Ted Blewitt sets off on a disastrous holiday to sunny Spain and the first thing that happens is that he loses his luggage and money. But the biggest blow is the loss of his Brownie box camera with 36 holiday snaps on film.

So, Ted has to retrieve all his possessions but the items and characters he encounters may help him — alternatively they may not.

An important element in Ted's jaunt is his alcohol intake, massive consumption of lager is likely to render him incapable of some tasks, but on the other hand it's essential to be semi-plastered for others.

Once an item has been collected it can radically effect items in other locations. Don't, whatever you do, let another character stumble on a collected item as it will be taken out of the game never to be seen again until a restart.

The changing variables in the game where items can alternate between hostility and usefulness can be extremely frustrating but of course to the seasoned platformer this sort of whimsy is a challenge to be relished.



# GAMES



# 4

**ZZAP!  
SIZZLERS  
FOR YOUR  
CBM 64/128**

**ZZAP!**

**SIZZLERS**



**WHO DARES WINS II**  
Only the bravest volunteer for the ultimate suicide mission to free last combatants held prisoner by the armies of death, the forces of oppression. Only courage and endurance take up a challenge where intelligence and skill. Competitive. Action packed. Step forward, modern day hero, you'll never know how good you really are until you've tested yourself on the ultimate mission.



**THING ON A SPRING**  
The evil goblin is wreaking havoc on an unsuspecting world, casting spells and banishing its treasures to his underground factory deep in the bowels of the earth. How can he be stopped? What can we do? Who can do it? There's only one saviour - our hero - Thing on a Spring! Complete the magical jigaw and break his fiendish spell.



**WIZARD'S LAIR**  
Is a legend told long ago where dark covers for down below, Enspoking doom and casting spells, If this lair thou dost uncover, Four pieces of lore thou must discover. Only then may you escape Past the lion that guards the gate, So heed this warning and beware Never venture into 'Wizard's Lair'.

**DISK  
£14.95**

**TAPES  
£9.95**

**Who Dares Wins II**

**Wizard's Lair**

**Dropzone**

**Thing on a Spring**



**ALIEN 8**  
Long long ago ... in a distant galaxy, on a distant dying planet, the last of the guardians prepare their starship for its final journey. All of the libraries, records and knowledge have been stored aboard the vessel, along with the very best of their cryogenically preserved race. The planet's final and draws near as the last, most vital piece of equipment is loaded aboard, activated, and the hatchways closed. The ULTIMATE evolution ALIEN 8 cybot whirrs into an artificial cybernetic rash of intelligence. All hatchways are sealed, as the starship prepares for its long uninterrupted journey into theinky void of space.

**SPY HUNTER**  
The official home version of Bally Midway's 7at arcade hit.  
• You control the turbo charged race car/hydro spy boat.  
• You control a deadly arsenal of missiles, machine guns, oil slicks and smoke screens.  
• Sophisticated spy-challenging graphics.  
This is hardly a game. It's a high-speed test of your secret agent skills. Meet the challenge and survive Spy Hunter!



**DUN DARACH**  
It happened that, following a fateful, bloody and largely pointless battle against the Conachta, Cuchulainn the Great was returning home to Muirnebhine in company of his faithful charioter, Loeg, pointless because the enemy was a scouting party and not intent on taking the peak of Beann Ghulban, before which the battle took place; fateful because, amongst their number was Ansoir, a Prince of the Conachta and the darling of his father, who vowed an instant revenge....

**NIGHT GUNNER**  
The air battle where only ones survive! Each of the 30 different missions pushes you to the limit with enemy fighters attacking from all directions, guns blazing! - explosive 3D ground attack sorties, and there's still the right home.



**TAPES  
£9.95**

**Spy Hunter**

**Night Gunner**

**Dun Darach**

**Alien 8**

# 4

**CRASH  
SMASHES  
FOR YOUR  
SPECTRUM  
48K**

**CRASH  
Smashes**





# We thought it was about time we put you in the picture.

When we introduced our AMX Mouse to micro-users, the response was phenomenal.

And no wonder!

Hailed by the press as 'probably the best input device that has arrived recently', the AMX Mouse brings to Spectrum 48K users, the same sophisticated, positive control that has, until now, been the province of more expensive computers - like the Macintosh.

The fantastic AMX Mouse Package opens up an entirely new and exciting world to Spectrum users and comes complete with Mouse, interface, which also includes a Centronics printer interface, and all these fabulous programs.

## AMX ART

This computer aided, drawing program has to be seen to be believed. Making full use of on-screen windows, icons, pull-down menus and pointers, you'll be astonished at the quality of the work you can produce, save and print using either ZX or Epson compatible printers. It's a program ideal for both hours of family fun or for serious professional applications.

## AMX COLOUR PALETTE

The wonderful pictures you create with AMX ART can be brought vividly to life with rich vibrant colours - using AMX COLOUR PALETTE. And with 8 Foreground and 8 Background colours you won't be short of inspiration.

## AMX CONTROL

Now you can create a 'Mouse environment' in your own programs, AMX Control adds 28 commands to normal Sinclair Basic and contains three programs.

1. The machine code program to extend the Basic interpreter, which gives you full use of windows, icons, pull down menus, pointers and also supports AMX printer interface.
2. An Icon designer, an individual program for creating and storing icons for use in your own programs. The number and variety of icons you can create is limited only by your needs and imagination.
3. A demonstration program containing on screen calculator and puzzle.

This fabulous AMX Mouse Package costs only £69.95, a price as remarkable as the package itself and it includes a fully illustrated operating manual.



The software is supplied on cassette and a tape-to-microdrive transfer facility is included. The AMX Mouse package is compatible with the Spectrum 48K and Spectrum +.

Ordering couldn't be easier.

This superb package is available from all good computer dealers or direct using the freepost order form below.

So what are you waiting for?

Get into the picture now!



FOR INSTANT ACCESS OR VISA ORDERS RING (0925) 4130501/2/3

PLEASE RUSH ME POST FREE \_\_\_\_\_ (Quantity)  
 AMX MOUSE SPECTRUM 48K PACKAGE/S  
 AT £69.95 EACH INCL. VAT AND P & P.  
 I ENCLOSE CHEQUE/POSTAL ORDER FOR £ \_\_\_\_\_  
 OR DEBIT MY  ACCESS   
 (TICK AS APPROPRIATE)  VISA   
 CARD NO.   
 EXPIRY DATE \_\_\_\_\_  
 SIGNATURE \_\_\_\_\_  
 NAME \_\_\_\_\_  
 (BLOCK CAPITALS PLEASE)  
 ADDRESS \_\_\_\_\_  
 \_\_\_\_\_  
 POSTCODE \_\_\_\_\_

**AMX MOUSE**  
 IMAGINATION AT YOUR FINGERTIPS  
 SEND TO: ADVANCED MEMORY SYSTEMS LIMITED,  
 FREEPOST, WARRINGTON WA4 1BR.



# SON OF TASWORD

The recent arrival of The Writer and Word Manager have threatened Tasword II's reputation as the best Spectrum word processor, but now Tasman are fighting back with Tasword III.

**Tasword III**  
Tasman Software  
£16.50

Tasword 2 has long been the definitive word processor for the Spectrum, so the arrival of Tasword 3 is quite an event.

Tasword 3 is only supplied, and can only be run, on Microdrive. The reason is that it now has many extra features and in order to accommodate them the program is stored on the microdrive cartridge in sections. When loaded, it goes straight into the text entering mode. When, as with Tasword 2, you use the STOP key to go to the main menu, another section of the program is loaded from the cartridge. This handles text file saving loading and printing, and program customizing and saving. When you return to the text file, the other section of the program is fetched from the cartridge.

## New features

The new Tasword has been given its extra features without sacrificing any of the existing ones. In text entering mode part of the 'help' page is displayed at the top of the screen and the TRUE VIDEO and INV VIDEO keys are used to scroll this, so that the whole of the function key index is available to you as you write your text. If the presence of this prompt window annoys you you can switch it off, or the full 'help' page can be accessed.

There are now 15 ways of moving the cursor: one letter or word in either direction; to the end of the line; to the start or end of the paragraph or page; up or down line by line; to the start or end of the text; fast or slow scrolling through the text. The speed of the cursor movement, which I found painfully slow in Tasword 2, has been speeded up and is much better.

In addition to adjustable margins, Tasword now has full user-definable tabulation and you can move to the next tab in either direction. Deletion options have been extended, so that letter, word, paragraph or block may be deleted. Spaces and blank lines may be inserted into the text, and there is still an insert mode for insertions without over-writing existing text. The useful search and replace mode, which allows you to replace every occurrence of a word with another word or phrase remains, but now you also have the option of stopping at each occurrence and indicating whether or not it is to be replaced. The text formatting and block handling commands are the same as those in Tasword 2.

```
TASWORD THREE
The Word Processor
© Tasman Software Ltd 1986
main menu

Print text file P
Print with Data merge D
Save text file S
Load text file L
Merge text file M
Return to text file R
Customise program C
save Tasword T
catalog/change drive X
into Basic B

@ words @ chars Drive 1
1 lines 20977 chars free
```

A useful new feature is the page switch. When this is on, a line is drawn across the screen at the end of each page, so that you can see the page layout as you write the document. Justification and word wrap may be turned on and off as before.

Text capacity is now measured by the number of characters used, rather than by

```
TASWORD THREE
The Word Processor
© Tasman Software Ltd 1986

start at line (1) _____
finish at line (last) _____
number of copies (1) _____
line spacing (1) _____
continuous/single (C) C/S _____
PF at page breaks (N) Y/N _____
print header (N) Y/N _____
print footer (N) Y/N _____
print page numbers (N) Y/N _____
at top or bottom (T) T/B _____
at middle/sides (M) M/S _____
start page number (1) _____
left print margin (0) _____
PF after printing (N) Y/N _____

Press: ENTER for defaults
OR to start again
RT at any time to print
EDIT to return to menu
```

the number of pages. You can produce 1000 pages or more with only a couple of words on each, but less than 300 if you fill up every line. A word and

character count is now included, and displayed on the main menu, but it is a pity that this is not displayed in text entering mode, since going to the menu and back, involving two program loads from the cartridge, is a chore if all you want is to check the word count.

Some of the major improvements are in the printing. Multiple copies are now available, and the program will number pages, print the number at the top or bottom, in the centre or at the side of the page, and provide a page header or footer as required. The printing margin, which is used to centre the text on the page, is specified at print time.

There is also a mail merge facility, with graphics printer controls entered into the text in the same way as those which indicate underlining or type face change, to indicate where in a document information from the data file is to be inserted. Unfortunately the review copy of Tasword 3 was so hot off the press that the handbooks had not been printed, so I was unable to discover how this feature works or test it. I suspect that, like Tasmerge with Tasword 2, it makes use of Campbell Masterfile files (*actually, a quick call to Tasman confirmed that this is the case, but Tasword 3 is also capable of creating its own free-standing files—Ed.*)

Without the handbook, I could not customize the program to run with the Kempston interface — the method used with Tasword 2 did not work. Having written this review with Tasword 3, I tried to load it into Tasword 2 to print it, only to find that the two programs are not compatible, and all I got was a 'wrong file type' error report. Where Tasword 2 saved the text as a block of code, Tasword 3 saves it as a Microdrive data file.

Being unable to get the printer to work with Tasword 3 meant that I could not test another valuable facility, the alternative character set. These are a useful set of signs, symbols, fractions, diphthongs and foreign letter forms, and they are re-definable if required.

Tasword 3 can rival any word processor, and with it the Spectrum is a serious word processing machine. It is difficult to see where further improvements could be made. Certainly it now has all the features that I ever felt were lacking in Tasword 2. Now all I want is a Wafadrive version — with a handbook! (*the handbook's on its way, honest!—Ed.*)

CAROL BROOKSBANK



# G.A.M.E.S

## Thirty Games Quicksilva £9.95

See the history of Spectrum games programming flash before your eyes with this one score and ten grab bag of games from Quicksilva.

Crammed onto two cassettes and culled from labels such as Bug Byte, Lothlorien, New Generation, Argus Press Software and Quicksilva, Thirty Games is a collection of golden oldies and oddities which will give hours of nostalgic pleasure.

Playing games such as 3-D Tunnel with its onrushing bats, frogs, rats and tube trains may not be state of the art programming but they are still great fun whatever the vintage. It doesn't take a maths genius to work out that even if you hate

half the games it's still great value, especially if you missed them first time around.

And no we don't have space to list them all. Oh all right then... Carpet Capers, Antics, Planet Fall, Grid Runner, Bismark, Meteor Storm, Jet Set Gerry, 3-D Tunnel, Stock Market, Fridge Frenzy, The Valley, Dragons Bane, Demon Knight, Ned's Garden, Space Intruder, Mighty Magus, Fall of Rome, Draughts, Xadom, Detective, 20 Tons, Chess Player, Micro Maze, Tube Cube, Invasion, Escape, Laser Zone, Strontium Dog, Pyromania and lastly and with a title like this probably leastly Blood and Guts.

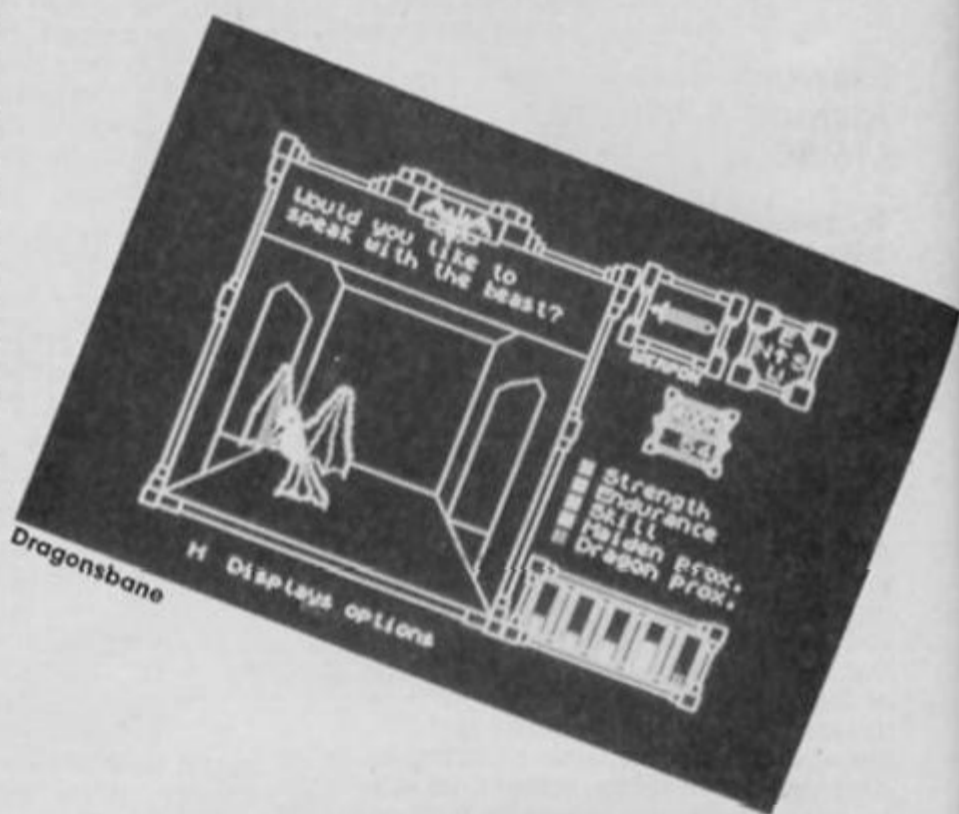

## Sodov the Sorcerer Bug Byte £2.95

Your task as Sodov the Sorcerer is to defend your castle against some very cute looking dragons. By aiming your spell in the appropriate direction you can convert the dragons into gold — ready currency useful even to a Sorcerer.

However this frenetic spell-binding saps your energy which can only be replenished by a quick sprint up the battlements to the tower. The gold is ready and waiting outside the fortress but if you hang about an ostrich will nip in and make off with it.

You also have to avoid spiders who scuttle around your ankles intent on draining your magic powers. If you allow the dragons into the castle they will purloin one of your three YOP apprentices who are looking for an opening in the sorcery trade.

Quick thinking is needed to judge whether you can nip out and grab the loot without losing a fledgling magician.

This game is a conversion of Gandalf the Magician on the C64 and is a welcome addition to the stream of budget software. With its impressive graphics and arcade style action Sodov is well above average for a budget range game with enough features and gaming challenges to make you feel you've got far more than your money's worth.

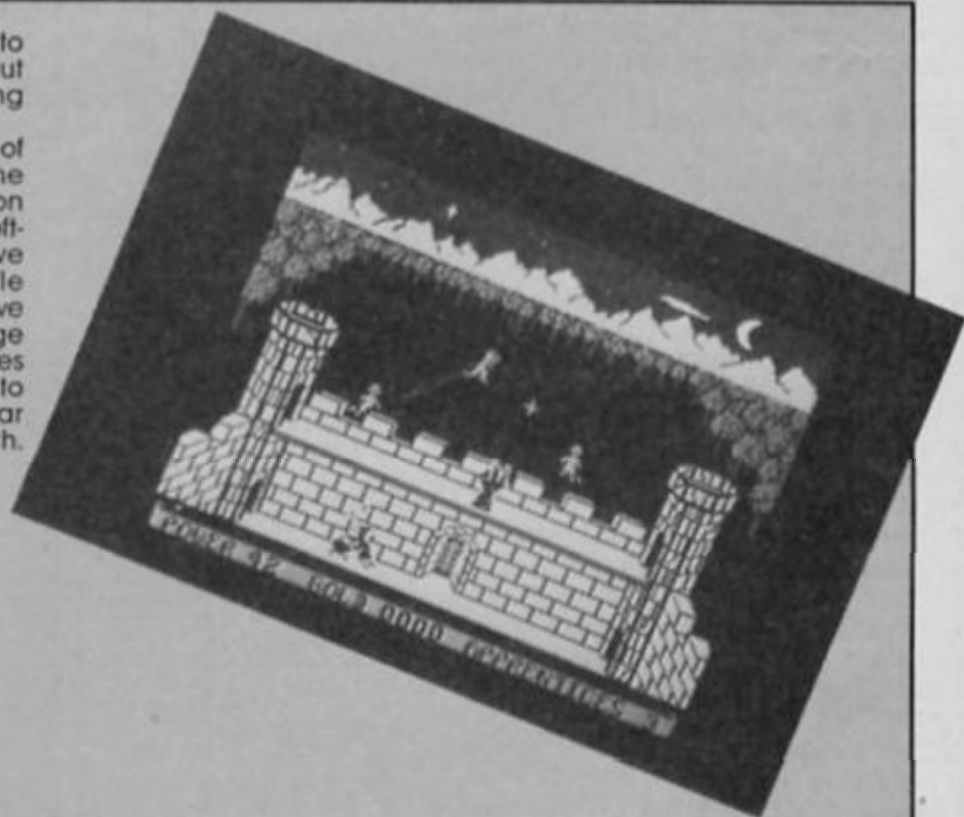



## iD Nu Wave £8.95

If you've always believed that there was someone living inside your computer this game will confirm all your hopes or fears.

iD the new inhabitant has crept inside your Spectrum casing and taken up residence. He has a bad case of split personality, in fact he has seven of them which you must persuade him to reveal.

Winning iD's trust is a major battle and his impatience lurks just under the surface. If you fail to keep his attention he will veer off into pages of rambling text. If you run out of questions to ask iD he will come back at you with some of his own — many of them quite personal but as we are told that iD has been around since the beginning of time he's probably heard all the answers.

Your answers to iD's questions are stored and thrown back into the dialogue in surprising ways. A neat touch

iD's moods are very changeable but he likes compliments and these are often rewarded by iD's revelation that he is feeling scrungy or dribbly (at least I think that means he's pleased).

In order to get anywhere near one of iD's identities you have to build up the trust rating to near 70 per cent which can be a long process if iD's having a bad day. Any clues you may get may be red herrings. At different points in one game I was convinced he was Hitler then Einstein before plumping wrongly for Mussolini.

This game by Mel Croucher will either seem like a fascinating mystery or a complete waste of time. Either way be warned — iD knows how to swear back.

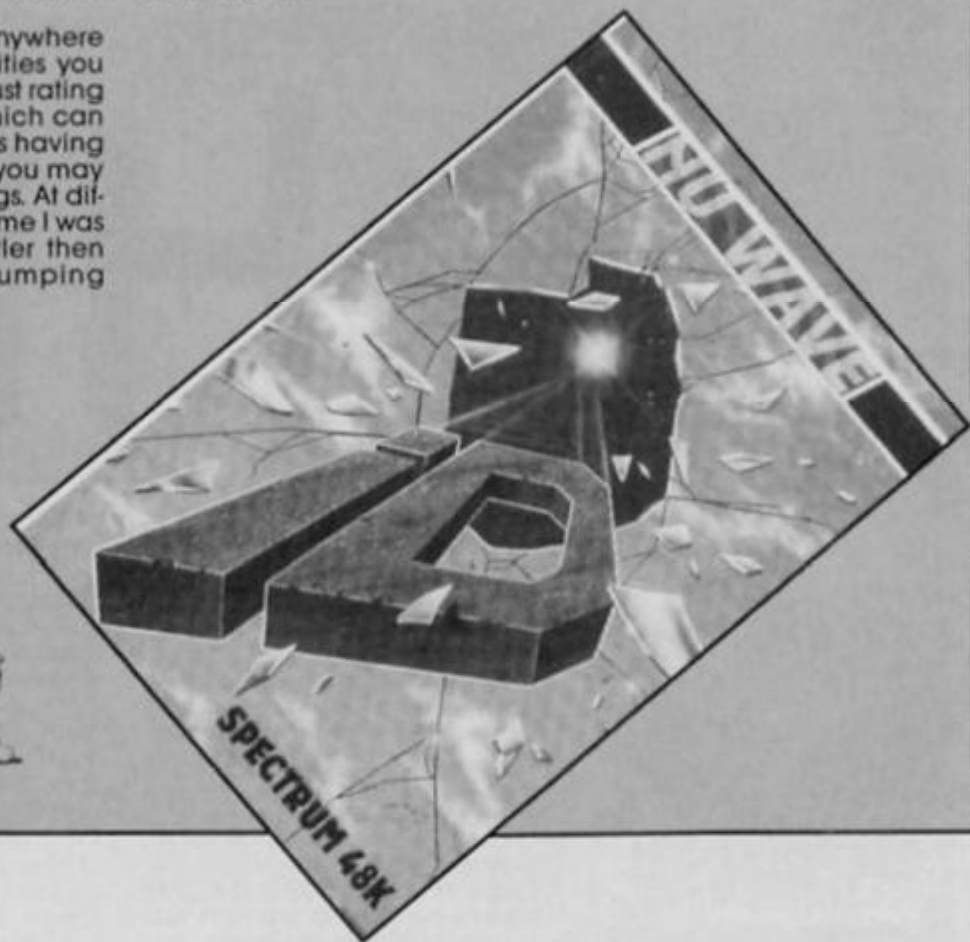

## Desert Rats CCS £8.95

Desert Rats is for those wargamers who put the game aspect above the war. More a version of chess with tanks than a blood and guts confrontation, Desert Rats is played out on smooth scrolling maps with vivid graphics and detailed settings.

The game spreads over six scenarios following accurately the North African Campaign of 1941 to 1942, beginning with Rommel's arrival in Tripoli and culminating in the Battle of El Alamein. Success in this game is all down to the careful deployment of forces and keeping your units fully supplied.

It is not a realtime wargame but uses the order/move system where you plan your moves and then sit back to take the consequences.

My skill as a general did not pose much of a threat to Rommel in the one player option but a game of this kind is perhaps best enjoyed when pushing a friend's forces back into the sea.

The game comes with a comprehensive guide which contains background detail on both the game and the real historical events.

If you are familiar with Arnhem, author Robert Smith's previous game for CCS, then

you'll probably want to rush out (with strategic forethought) and buy it. For the non-wargamer it will provide a good first taste of simulated battle.





# FLYING

All of a sudden there's been a burst of aerial activity on the Spectrum, so let's go for a spin in some new flight simulators.

# HIGH

## Skyfox Ariolasoft £8.95

The Skyfox fighter is a flying arsenal that will give hours of destructive pleasure as you pit yourself against endless waves of tanks and aircraft sent by the mysterious Motherships to destroy your base.

To give you some idea of the scope of the game there are seven different training flights recommended to prepare you for the really tough levels. You can find yourself on the tail of an enemy plane, or nose to nose or virtually any situation you might encounter on a full scale mission.

But first, a guided tour around the cockpit where you find not only a continuous laser cannon at your disposal but also guided missiles and heat seeking missiles to bulk up your firepower. There's also a computer which can be called upon to give your exact

position, score summary, and the locations of the enemy.

A useful feature is an automatic pilot which will fly you to the nearest concentration of tanks and aircraft waiting to be wiped out.

There are enough dials and displays to swamp you with information including radar scanners, co-ordinate monitors and indicators for fuel, speed, altitude and shield strength. The game action proper offers you eight invasion permutations to thwart and the complexity is increased by having to defend your own base which, if destroyed, will rob your computer of vital data on the enemy's strength and positions.

Even in what is called the 'small invasion' you are ludicrously outnumbered but you can inflict heavy casualties before the shield buckles and the screen border flashes red indicating that the joyride has been terminated. Although you have unlimited laser cannons your guided and heat seeking

missiles have to be used wisely. One unwise use is firing a guided missile into a wave of enemy forces while haphazardly flying into its flight path. There is enough to contend with without seeing your own missiles returning on a boomerang course.

It takes dedication to gain the strategic sense and flying technique needed to make a dent in the invasion forces on the higher levels. Even getting a glimpse of the Motherships is cause for celebration and if you opt for the 'Massive Onslaught' invasion the only thing you are likely to see is that by now familiar flashing red border.

The graphics themselves are reasonable, though the perspective shifts when attacking ground forces are confusing. In many cases when flying on a straight course targets that are beginning to loom large suddenly loom left or right for no apparent reason. Alternatively this could be battle fatigue causing the hand to tremble at the controls.

Skyfox is an unashamedly trigger happy game that contains sufficient levels of difficulty to sustain interest past the novelty stage. If you want an all out air war game for the Spectrum this is it.

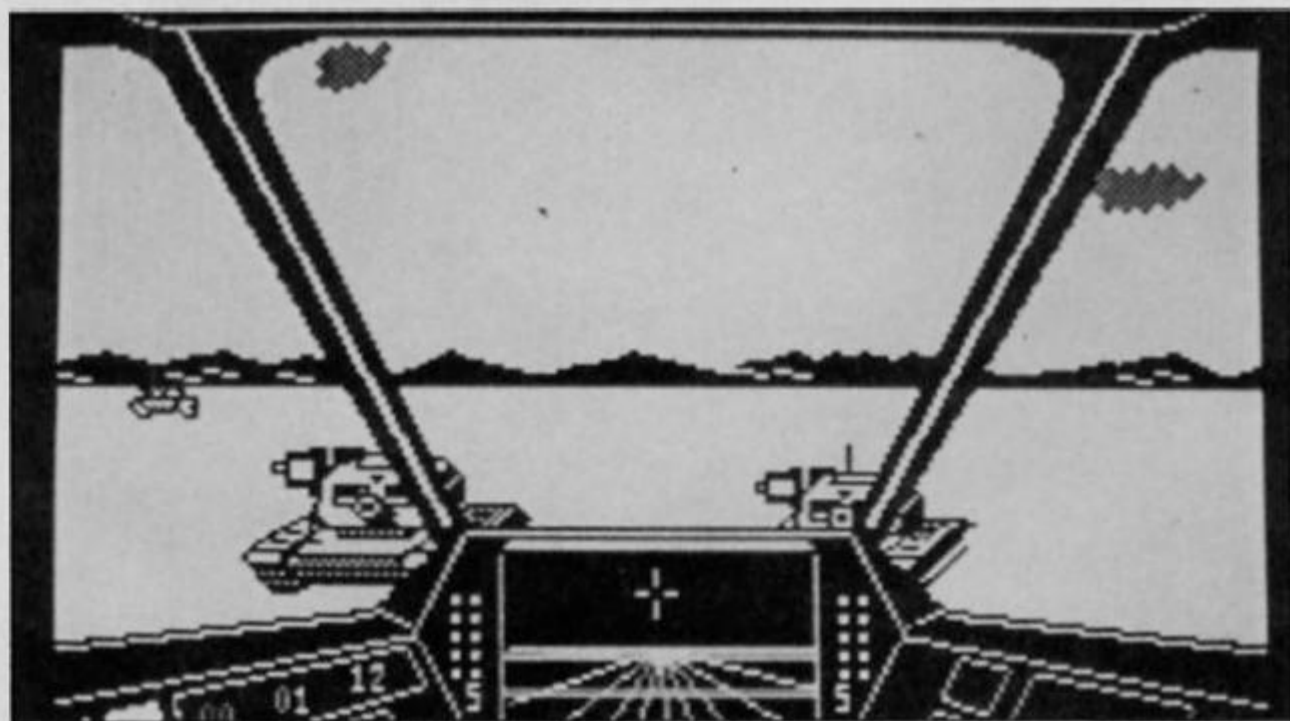



## Flyer Fox Bug Byte £2.95

In this budget sortie you are enlisted to do a bit of Jumbo minding. The aim is to protect a commercial flight flying through "dangerous skies". Sporadically a voice announces "fighters approaching" and a swarm of planes attempts to inflict damage on the lumbering 747. Quite why the passengers are being subjected to this unfriendly treatment is never explained and lends a certain aimlessness to a game that lacks variation and purpose.

Successful protection of the Jumbo is rewarded with an exact re-run with only a few more bandits and extra fuel to add to the game elements.

The combat action is adequate but the need to protect the airliner restricts any interesting clashes. The graphics are basic and the instrument panel merely a token to give the impression of sophistication. Even the Jumbo falls to earth with a measly 'phut' rather than an explosion to be replaced on the next run with another load of doomed passengers.

For those willing to pay £2.95 to escort a Kamikaze airlines jet this game could be mildly diverting but players with flying hours under their belts from other aerial combat games may find it lacking.

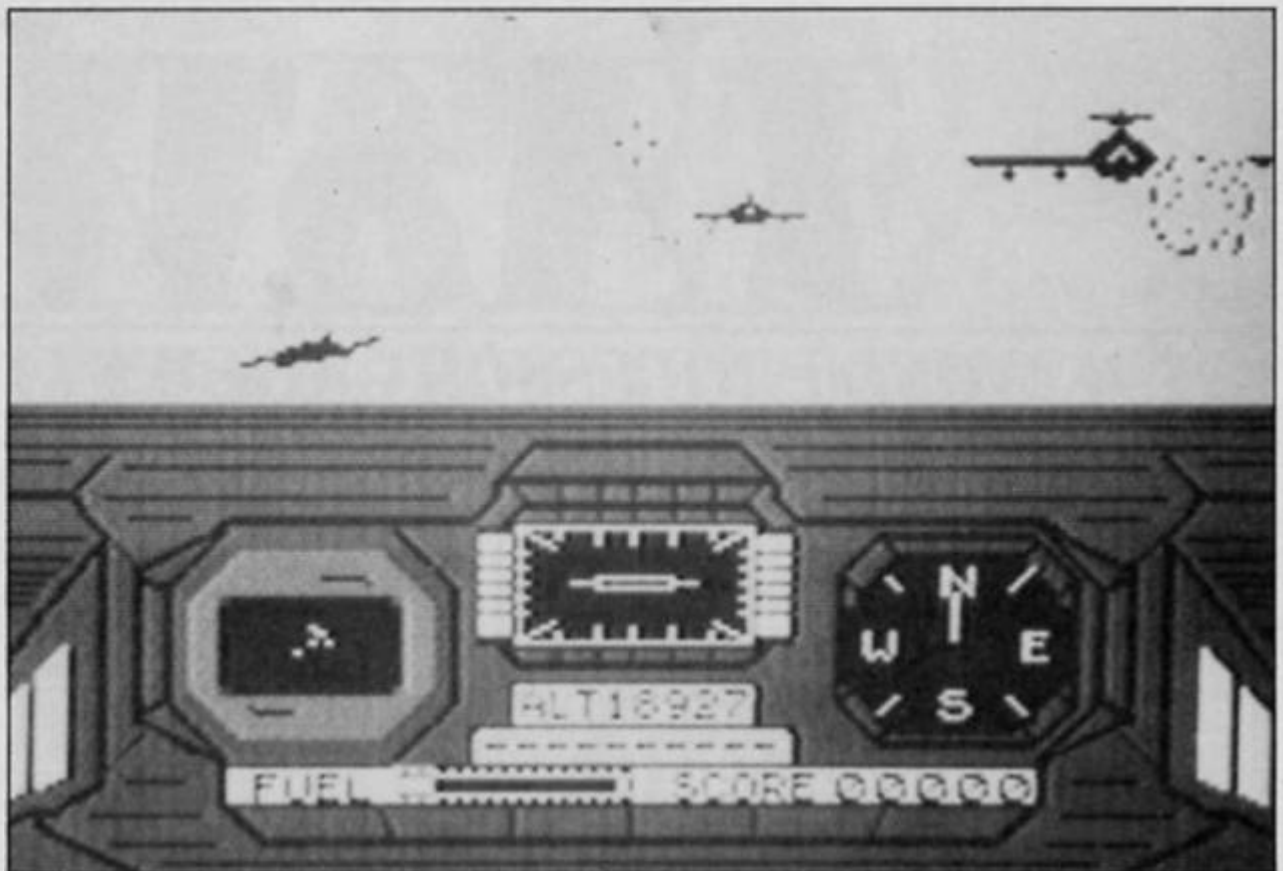

The jumbo takes some flak in this economy flight game.

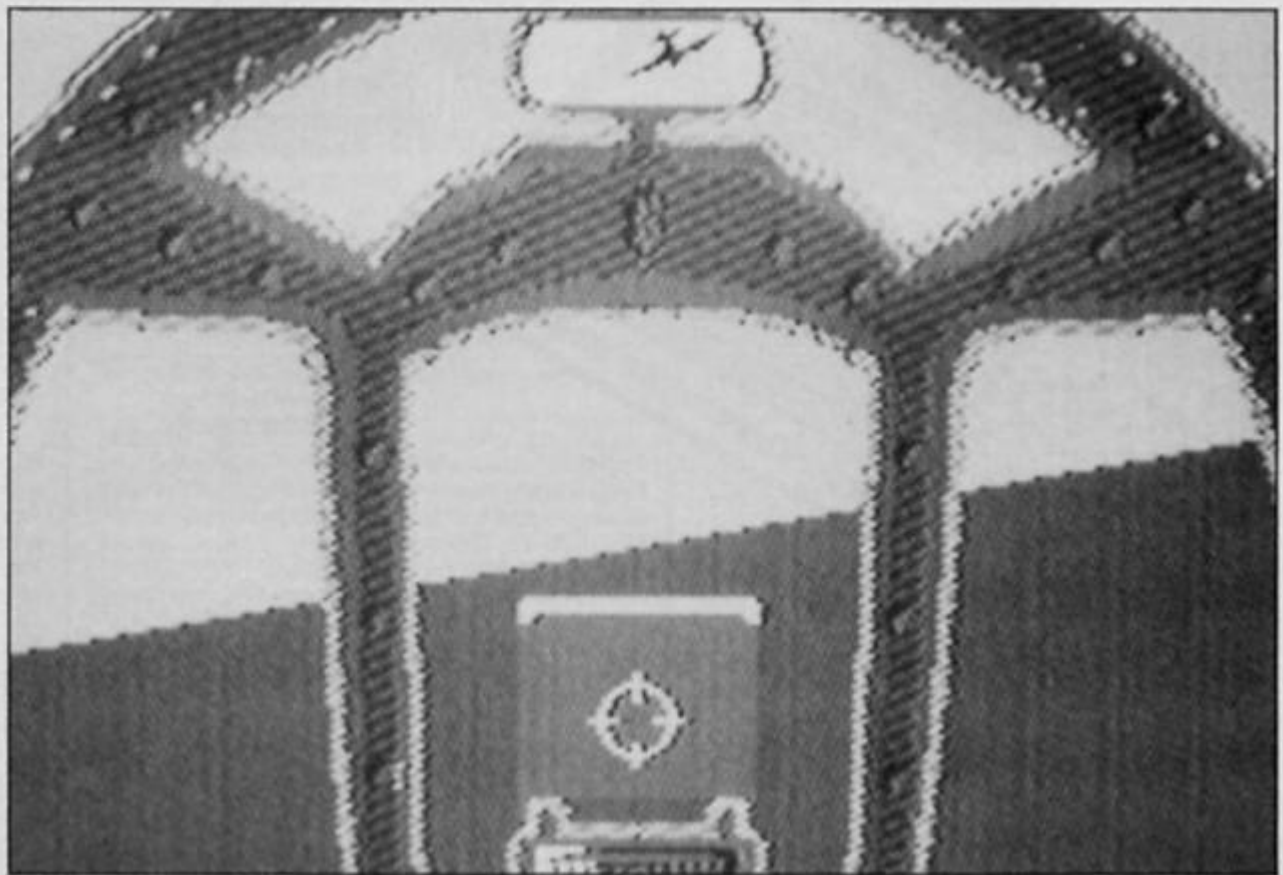

A bandit is on your tail. Time for an evasive move.

## Spitfire 40 Mirrorsoft £9.95

Spitfire 40 is an impressive flight simulator and aerial combat game that gives you the chance to join 'the few' defending South East England against the onslaught of the Luftwaffe. Switching between the authentic looking instrument panel and the cockpit view it is possible to recreate how the war must have looked from an air ace's point of view.

There are three modes, practice, combat and combat

practice. If you want to avoid the complexities of taking off which takes some time to master you can go immediately into a dogfight training scenario at 10,000 feet.

Getting the enemy fighter into your sights is challenging and the dives and turns are simulated by an artificial horizon that unnervingly tends to put the ground above your head quite frequently. This, it must be said, is due to this pilot's inexperience as in the early stages of combat becoming disorientated is unavoidable.

Destroying the enemy while flying upside down at 5,000 feet may lack a little in style but it

is effective. Continued practice shows that the opposition can be brought down with a little more panache and less uncontrollable spinning.

The game comes complete with a very thorough manual that takes you through the principles of fighter flying and gives tips to improve your prowess so that you can progress towards the goal of filling your mantelpiece with medals. Overall, Spitfire 40 has enough variety and difficulty to please 'the few' who are dedicated flight simulator buffs and perhaps the many who have so far shunned the lure of the computer cockpit.





# TASWORD

THE WORD PROCESSOR - A NEW STANDARD FOR THE SPECTRUM

EDITING COMMANDS		
31 start of text	THEN scroll up	35 start of paragraph
31 end of text	TO scroll down	31 end of paragraph
34 start of line	36 fast scroll up	34 next page
34 end of line	3F fast scroll down	3' start of page
30 word left	3E word right	3x start of screen
MARGINS		
30 set left margin	AT delete under	DELETE del. Left
35 clear margins	OR delete word	3X clear text
30 set right margin	3DELETE delete line	3C delete block
REVISION		
3F replace / find text	3 insert line/char	30 auto on/off
MARKING		
<= move text left	3B mark start	5STEP tab right
>= move text right	3U mark end	00T tab left
34 rejustify para (3H)	3M move block	3+ set, 3- clear
3X rejust line (3uu3l)	3N copy block	3I clear all
	3C delete block	3= reset tabs
FORMATTING		
3I form feed	3I insert	3F right justify on/off
37 put header	30 auto	3I help on/off
36 get header	3P	SPACE 2nd char set
38 put footer	3T	3PH printer control
35 get footer	3U	to RETURN TO TEXT

TASWORD THREE  
The Word Processor  
© Tasman Software Ltd 1986  
main menu

Print text file	P
Print with Data merge	D
Save text file	S
Load text file	L
Merge text file	M
Return to text file	R
Customise program	C
save Tasword	T
catalog/change drive	X
into Basic	B

0 words 0 chars Drive 1  
1 lines 20977 chars free



TASWORD TWO led the way in setting a standard for word processing on the ZX Spectrum. TASWORD THREE pioneers the new standard.

TASWORD THREE retains all the features which have made Tasword Two a household name for the Spectrum. With many additional features and enhancements, including a built-in mail merge and up to 128 characters per line, TASWORD THREE is the definitive word processor for the Spectrum and Spectrum+ with microdrive.

## ZX SPECTRUM TASWORD TWO THE WORD PROCESSOR

TASWORD TWO for the ZX 48K Spectrum  
cassette £13.90 microdrive cartridge £15.40

"Without doubt the best utility I have reviewed for the Spectrum"

HOME COMPUTING WEEKLY APRIL 1984

"If you have been looking for a word processor, then look no further"

CRASH JUNE 1984

With 64 characters per line on the screen and a host of useful features TASWORD TWO is the ideal cassette based word processing package for the Spectrum owner.

## TASPRINT THE STYLE WRITER

TASPRINT for the ZX 48K Spectrum  
cassette £9.90 microdrive cartridge £11.40

A must for dot matrix printer owners! Print your program output and listings in a choice of five impressive print styles. TASPRINT utilises the graphics capabilities of dot matrix printers to form, with a double pass of the printhead, output in a range of five fonts varying from the futuristic Data-Run to the hand writing simulation of Palace Script. A TASPRINT gives your output originality and style! The TASPRINT fonts are shown to the right together with a list of compatible printers.

## TASMERGE THE MAIL MERGER

TASMERGE for the  
ZX 48K Spectrum  
cassette £10.90

Transfer data from MASTERFILE to TASWORD TWO! Letters and forms typed on TASWORD TWO can be printed with addresses and data taken from MASTERFILE. The mail merge facility allows, for example, multiple copies of a letter to be printed, each containing a different name and address taken from your MASTERFILE data. To use TASMERGE you must have one or more microdrives as well as TASWORD TWO and MASTERFILE by Campbell Systems (version 9 or later).

## TAS-DIARY THE ELECTRONIC DIARY

TAS-DIARY for the ZX 48K Spectrum and  
microdrives. Cassette £9.90

Keep an electronic day-to-day diary on microdrive! TAS-DIARY includes a clock, calendar, and a separate screen display for every day of the year. Invaluable for reminders, appointments, and for keeping a record of your day. The data for each month is stored as a separate microdrive file so that your data for a year is only constrained by the microdrive capacity. TAS-DIARY will work for this year, next year, and every year up to 2100! Supplied on cassette for automatic transfer to microdrive.

## TASMAN PRINTER INTERFACE

TASPRINT PRINTER INTERFACE for the  
ZX Spectrum £29.90  
RS232 Cable for ZX Interface 1 £14.50

Plug into your Spectrum and drive any printer fitted with the Centronics standard parallel interface. Supplied complete with ribbon cable and driving software. The user changeable interface software makes it easy to send control codes to your printer using the method so successfully pioneered with TASWORD TWO. The cassette contains fast machine code high resolution full width SCREEN COPY SOFTWARE for Epson, Mannesmann Tally, Shinwa, Star, Tandy Colour Graphic (in colour!) printers. TASCOPY shaded screen copy software for this interface (value £9.90) is INCLUDED in this package.

The TASCOPES and TASPRINTS drive all Epson compatible eight pin dot-matrix printers e.g.

AMSTRADDMP2000	NEC PC80238-N	BROTHERM1009
EPSONFX-80	MANNESMANNALLYMT-80	BROTHERHS
EPSONVX-80	STARMP501/515/5610	SHINWACP-80
EPSONMX-80TYPEII	COSMOS-80	DATA-PANTHER
		DATA-PANTHERII

COMPACTA - bold and heavy, good for emphasis  
DATA-RUN - a futuristic script  
LECTURA LIGHT - clean and pleasing to read  
MEDIAN - a serious business-like script  
PALACE SCRIPT - a distinctive flowing font  
TASPRINT output shown at less than half-size.

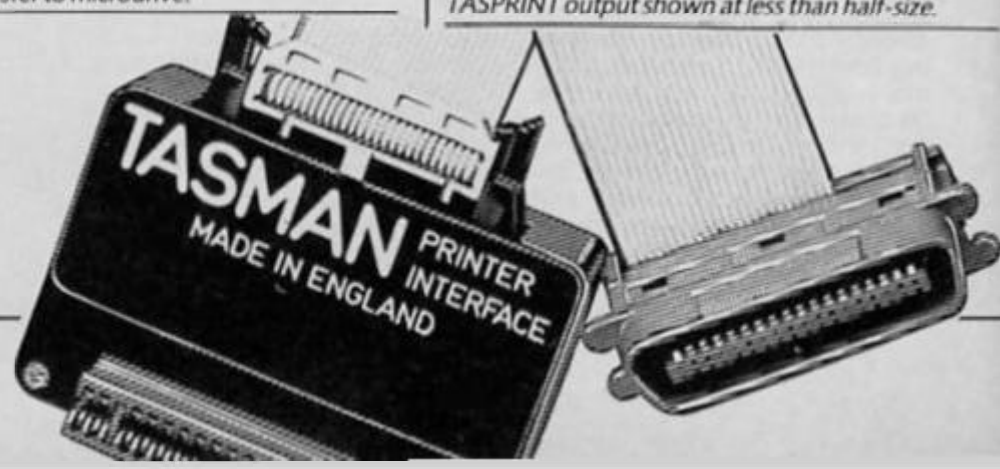







# THE CORE

ZX brings you a sneak preview of the latest game from A 'n F.

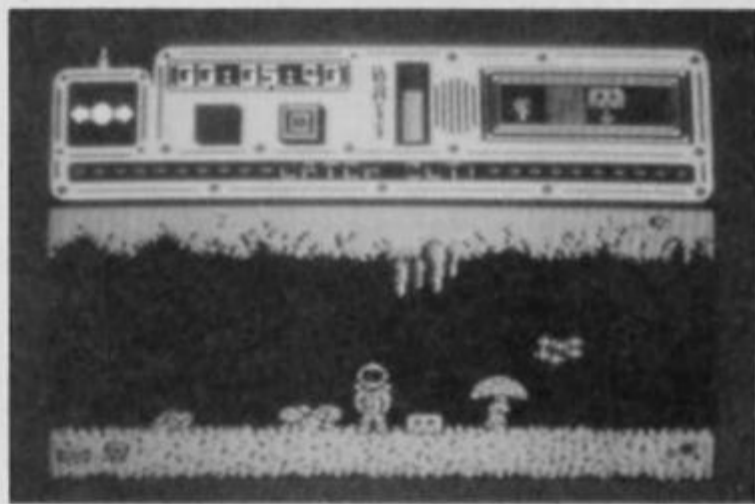
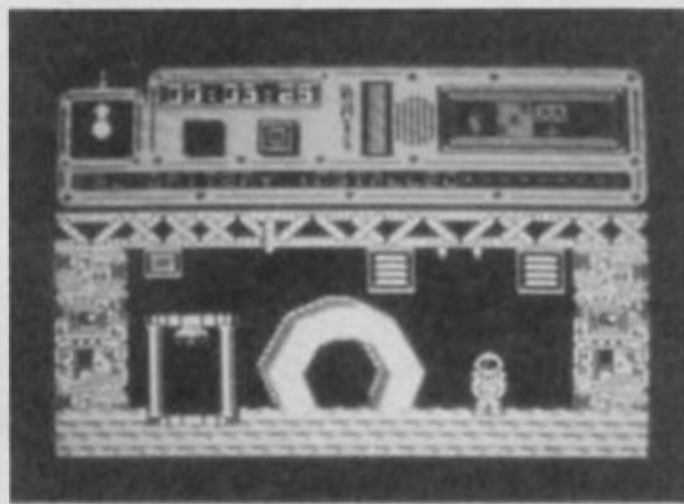
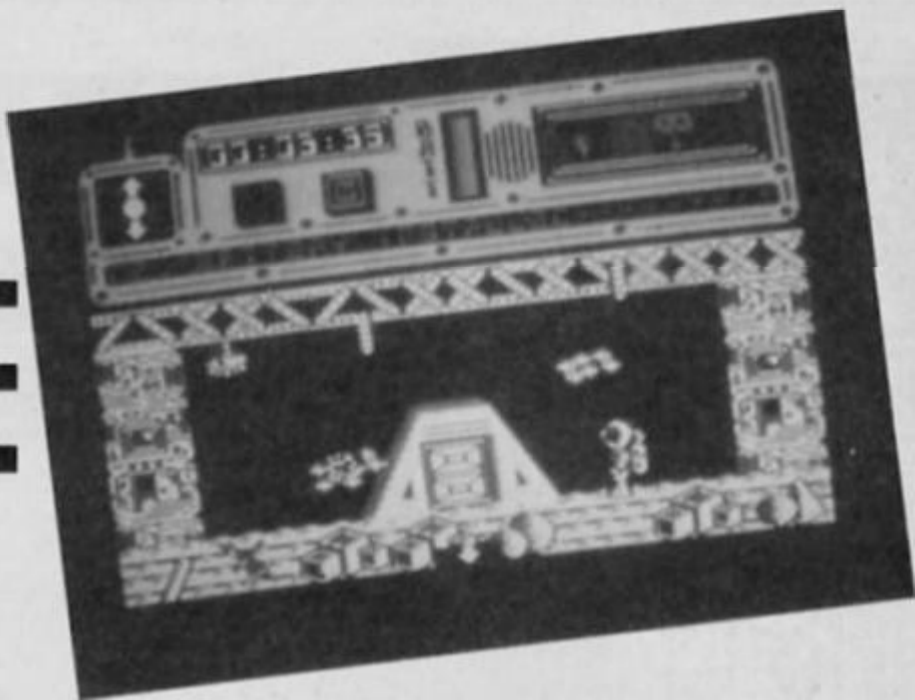

A 'n F Software who will be eternally remembered for their all time Speccy Classic, Chuckle Egg (my hi-score is about 750,000, can anyone beat that?), ran into financial problems a while back and went out of business. But before they went they were working on a new game called The Core, and now that the A 'n F name has been bought by Argus Press Software, The Core is about to be released.

## Core blimey

The Core is an arcade adventure which also incorporates a number of icons that allow you to perform a variety of actions. The game is set in the future when mankind has spread out across the stars, using hollowed out asteroids as colony ships.

In their travels the human colonies have discovered evidence of a number of intelligent races that have been wiped out by some unknown alien threat, and the game begins just after one of the human colony ships has also been attacked and its inhabitants destroyed. During the two day battle the ship's computer recorded everything

that occurred and has stored information that will enable mankind to defeat the aliens.

A last distress signal went out and was received by the game's hero. This character had been named Asteroid Andy during the development of the game, but as everyone at APS hated that name it's going to be changed. Anyway, Andy-as-was arrives on the asteroid and must locate the computer's memory bank which has been split into nine sections and hidden in various locations.

The asteroid is huge, with over a thousand locations and a number of teleport stations linking certain areas, and as well as locating the memory banks you'll have to take on a number of aliens with their robot guards and solve a number of problems in order to reach the deepest levels of the asteroid. Before you can defend yourself from the aliens you'll have to find a gun, and also locate a number of batteries that will be needed to power all your equipment.

Up to this point The Core is a fairly standard arcade adventure in a similar style to games like Nodes of Yesod and Robot Messiah with large, smoothly animated graphics (I particularly liked the way your figure kneels down to pick up objects). But the addition of the

icons allows you to perform actions other than just moving left/right and fire.

There is a Help icon which, just as in a text adventure, can be asked for hints in tricky spots (and just as in adventures hardly ever tells you what you want to know), and an 'actions' menu that allows you to Pick Up, Drop, Use objects and Fire a gun.

There is also a Save Game option (which can only be used when you've found a cassette hidden in one of the caves), and three windows which display the objects you are carrying, the number of batteries you have, and the sections of memory bank that you have found.

When you first teleport into the asteroid you arrive in the mining levels which are relatively simple to get through, but as you go deeper the problems become harder and the aliens deadlier. In the time that I spent playing I didn't even manage to find a gun, so I kept getting killed before I managed to get anywhere. I did manage to find a mysterious scrap of paper and a box of some sort that I couldn't find a purpose for, but with over a thousand locations in the game I've still got about seven hundred and fifty to go, so I'll just have to wait until we're given a final production copy of the game to review.



# Cheetah



## Marketing

are proud to announce  
the arrival of their  
125 Joystick



# SPEED AHEAD

with this  
**NEW JOYSTICK**  
from Cheetah

Compatible with ZX Spectrum, 48K, 128K, Commodore 64, Vic 20, Amstrad, Atari, MSX, etc.

At only £8.95 the features on the 125 are second to none. Besides its unique internal structure, built to withstand immense punishment from even the most vigorous games player, the joystick contains no less than four extremely sensitive fire buttons. Two are housed in the handgrip which has been moulded for extra comfort and ease of operation. The trigger finger fire button provides ease and comfort for your finger and the top fire button is contoured to fit your thumb for sure fire shooting. The base fire buttons are positioned for extra control and two hand firing whether you are right or left handed.

A built in auto-fire switch provides continuous shooting at the touch of a fire button.

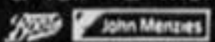
The 125 comes complete with a full 12 months warranty and is available from  John Menzies WHSMITH High Street stores and all good computer shops.

**ONLY**  
**£8.95**

*Price include VAT, Postage and Packing. Delivery normally 14 days.  
Export orders at no extra cost. Dealer enquiries welcome.  
Send cheque/PO now to:*

## Cheetah Marketing Ltd.

1, Willowbrook Science Park, Crickhowell Road, St. Mellons, Cardiff  
Telephone: (0222) 777337 Telex: 497455





Your home computer can open the door into an electronic world full of people with similar interests. A sort of electronic 'club' over the telephone lines which requires no programming skill and a minimum of equipment. A modem and an RS232 interface, plus a program to control them are the key which will open the door to many different computer systems.

The modem is essential as the computer cannot talk over the telephone without it. It usually connects to the telephone via one of those new jack sockets, so if you haven't already got one this is the first thing to get. The only person able to fit one legally in the UK is the telephone company British Telecom. Some modems do not have a socket for the phone, so that two sockets will be needed.

### Modems

To allow you to connect up to the many different sorts of computers a versatile modem is required, preferably one that can operate at PRESTEL (1200/75) and Bulletin Board (300/300) speeds. Some also provide auto-dialing and auto-answer facilities controlled from the computer, which is a definite advantage. Even better are the modems which also come with RS232 interface attached (so that the modem can be connected directly to the computer) as this solves the problems of wiring a special cable up and any incompatibility between modem and the computer's interface.

The VTX5000 is a good example of this type of modem as it fits under the Spectrum computer and plugs directly into the expansion port at the back. The box contains the RS232 and modem and, although it only works at PRESTEL speeds, the only other connection required is to plug the cable into the telephone socket. The modem gets its power from the computer thus eliminating a lot of trailing leads.

### Software

A terminal program is required to use any modem. This divides the computer in half, so that all your keyboard entries go to the

transmitting part of the modem while the screen shows what the receiver in the modem is getting from the telephone line. Most systems reflect back what you are typing down the telephone line, so there is no need for the computer to do that as well. It can also provide extra facilities such as routines for transferring data (pre-recorded programs, machine code or letters) both into and out of the computer, and should also allow you to send control codes (normally excluded from the keyboard) with ASCII codes below 32 so that you can have complete control over any special functions the distant computer may have.

A list of complete systems available for Sinclair computers is given at the end of this article including some manufacturers of RS232s, if you want to be able to choose your own modem (which can be a much cheaper way of starting out).

### Systems to access

Although there are many different computer systems available over the telephone line, PRESTEL is possibly the most famous with its MICRONET closed user group running on it.

PRESTEL is a system that runs on 1K colour pages and by typing in the number of the page that you want you can look at farming advice, letters, News and even book your holiday through an electronic brochure. Pages on the LAW or, for instance, computer swaps are often charged for, and the price of the page is indicated at the top of the page. PRESTEL is a large system with many thousands of pages and it can take sometime to find what you want. Any one registered on PRESTEL can send and receive messages via their own personal (and private) mailbox, free of charge at present.

Much more interesting is the Micronet section (which costs extra to get into). There are free programs to transfer onto your computer and you can also buy some larger commercial programs just by accessing a particular page and transferring it (the charge is automatically added to your bill). There is an electronic newspaper and live

interviews with celebrities on CHATLINE.

Bulletin Boards and message systems mainly operate as electronic mailboxes in which people can leave you letters. Indeed, British Telecom Gold who operate a system for business users make a lot of money doing just this. Mind you, you can access over 30,000 people on this service in 14 different countries! But the humble user of QL or a Spectrum is probably more interested in Bulletin Boards as these also contain programs, hints on the latest games and experts on many different computers. One other advantage is that they are mainly FREE, you pay only the price of a telephone call. There is rarely any subscription to join the system and no time charge as on PRESTEL and other commercial systems.

These also use different software to PRESTEL systems as they scroll up the screen when they reach the last line and use the normal ASCII character codes that are used inside the computer.

### Cost?

So, how much does this all cost? Well, that depends on what equipment you buy (PRESTEL-only modems are cheaper than most, and only the most expensive modems give you auto-dial, auto-answer and more than one speed) and how much time you spend on the phone. Telephone charges can work out very expensive at 6p a minute if you spend several hours on the line several times a week!

The cheapest start is a second-hand modem such as the VTX5000 which can be used to access a few bulletin boards (only 1200/75 ones) as well as PRESTEL. I have seen prices for these as low as £35. It also contains the RS232 and a PRESTEL program on ROM, though User to User and Bulletin Board software can be obtained from Modem House at an extra cost.

A cheap 300 Baud modem will cost you £45 from Display Electronics, though the RS232 and software will have to be obtained elsewhere (see list). Modem House and Miracle



systems do combined systems (Modem House's 'Voyager' for the Spectrum costs about £100). Other modems can cost up to £500 or more depending on what facilities you want.

As for charges you must always add to the cost of the phone call;

- a) the subscription charge to get a password for the system (PRESTEL costs £6.50 and MICRO-NET an additional £12 per quarter).
- b) the cost of any page charge.
- c) Prestel and Telecom Gold also carry a time charge if you use it during the day or on Saturday mornings.

### Complete systems for Spectrum

Modem House — VTX5000, £39 (1200/75)

Modem House — Voyager, approx £100 (300, 1200/75, Auto-dial, Auto-answer)

Miracle Technology — WS2000, £130.75 (300, 1200/75)

Miracle Technology — WS3000, £295 + interface and software cost (300, 1200/75, Auto-dial, Auto-answer under software control)

### Complete systems for QL

Modem House — Brightstar, £199.95 (300, 1200/75 Auto-dial, Auto-answer under software control)

Tandata — QCOM system approx £200 (300, 1200/75, Auto-dial, Auto-answer under software control)

### RS232 interfaces for Spectrum and QL

Eprom Services — one and two port models for Spectrum

Maplin — Spectrum modem interface kit £24.95

Microsource (Spectrum) — printer, 1200/75 and 300 baud interface + Prestel software 295 Guilders

Miracle Systems —

QL modem adaptor

JMV — £33.50

manually settable to 300 or 1200/75 three wire interface

### Other modems sources

Sicon Buzz-Box — £86 300 baud battery operated portable modem

Display Electronics EX BT modems from £45

AnswerCall 300 — £75

Pace Nightingale — £136.85 1200/75 and 300 baud

### Addresses

**Pace Software Ltd**, 92 New Cross Street, Bradford BD5 8BS. (0274-729306)

**Sicon**, Brick Close, Kiln Farm, Milton Keynes MK11 3EJ. (0206-729306)

**AnswerCall**, Kangley Bridge Road, London SE26 5AH. (01-659-1133)

**JMV**, 139 Allington Drive, Strood, Kent.

**Microsource**, Ossenmarkt 25, Postbus 1243, 8001 BE Zwolle, Netherlands. (010-31-38-223698)

**Display Electronics**, 32 Biggin Way, Upper Norwood, London SE19 3XF. (01-679-4414)

**Eprom Services**, 3 Wedgewood Drive, Roundhay, Leeds LS8 1EF. (0532-667183)

**Maplin Electronic Supplies**, PO. Box 3, Rayleigh, Essex SS6 8LR.

**Tandata Marketing Ltd**, Albert Road North, Malvern, Worcs WR14 2TL. (0685-68421)

**Miracle Technology (UK) Ltd**, St Peter's Street, Ipswich IP1 1XB. (0473-216141)

**PRESTEL**, Telephone House, Temple Avenue, London EC4Y 0HL. Freephone PRESTEL (during office hours).

**Micronet 800**, 8 Herbal Hill, London EC1 5EJ. (01-278-3143)

**British Telecom Gold**, 60-68 St Thomas Street, London SE1 3EQ. (01-403-6777)

By Fred Mullins





# HARDWARE

The Citizen 120D is a dot matrix printer with a 6x9 character matrix. It prints at 120 CPS in normal mode and this decreases depending on how many and which of the print styles are used. There is a NLQ print style built in and this operates at 25 characters per second.

The printer is fitted with a Centronics interface as standard and RS232 is available as an optional extra for £28. ASCII characters are standard in both normal and italic and eleven sets of special international characters plus the Epson and the IBM graphics sets are available.

A 4K buffer is fitted and text can be printed in all the usual formats, expanded, compressed, Elite, proportional, emphasised, doublestrike and italics. PLUS underlining, overscoring, reverse (inverse), vertically enlarged, subscript and superscript. Paper feed is either by tractor or friction.

As you may gather, this is a printer overflowing with options. The manual takes the approach that buyers are not computer literate and may simply want to use their printer. It is therefore written in a step by step, easy to understand manner. Although it needs some mental alertness, it is the best printer manual I have seen so far. There are also advanced sections for experts and all the relevant information I could think of seemed to be provided.



Setting up was reasonably easy. I set it to operate with a Spectrum on Centronics, and then on RS232 with a QL. To use it with a Spectrum you will have to have either a Centronics or Sinclair Interface 1 (RS232) attached.

Using Tasword II the printer produced text perfectly, no problems and the NLQ (Near Letter Quality) mode impressed me. The normal mode was great, producing fast checking drafts first, then switching — either by software or from the printer's front panel — to NLQ for the final copy.

Listings were also copied without hitch, the interface switching between Bit Image mode and text mode without difficulty. Screen dumps were

performed without problem.

Using a QL the printer's maximum baud rate of 9600 BPS was slowed by the 120CPS (and slower when in Double strike plus Emphasised mode) however it chuntered away and no unexpected problems arose. Quill text has never looked better and the same system as for the Spectrum was adopted. No problems were experienced.

This printer probably has more features than you'll ever need, but at a price of £235 it is worth every penny and you'll probably never need to buy another.

The design shows Citizen's experience and expertise, rear or bottom paper inlets. Centronics and RS232 interfaces on interchangeable cartridge like boards with DIP switches built in for extremely easy access, front panel front switching and software page formatting. Noise is acceptable and my only adverse comments are that the 4K buffer is not really useful for anything other than a single page, and I wonder why they do not give an initial choice between the Centronics and RS232 cartridge. All round though, this is a superb machine at a very reasonable price.

Citizen UK can be contacted on 0895 72621.

Ray Elder

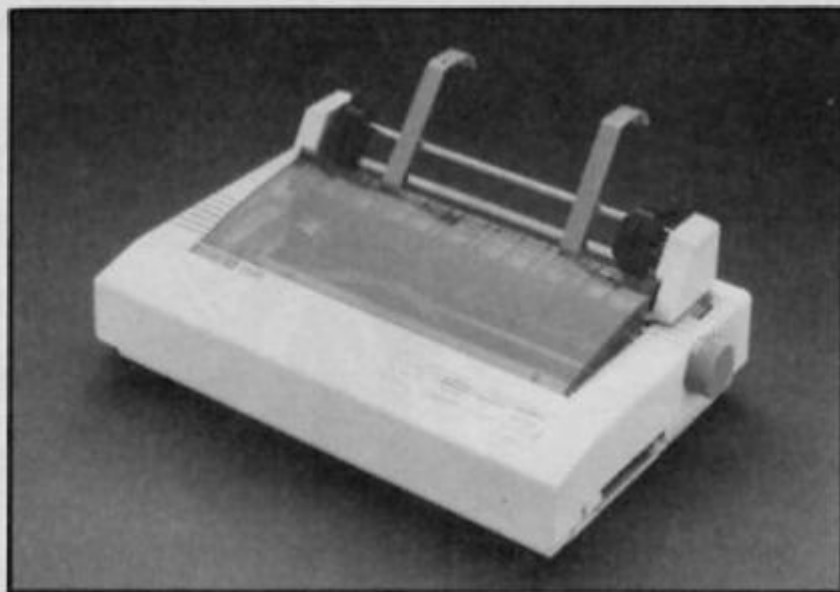



## Joining the Elite

For some reason we didn't review the Saga 3 Elite keyboard when it first came out, but now that the price has dropped from £79.95 to £69.95, and Saga are about to produce a simple add-on which will allow the keyboard to be used with the Spectrum 128, we thought it was high time to have a look at it.

A first glance reveals it to be an impressively sleek unit, constructed of sturdy plastic in a sort of off-white cream shade. The keys are large and moulded with a gently sloping surface that's comfortable to use. The 'action' of the keys as they are depressed is smooth but solid, so that you can be sure when you hit a key that the relevant character will appear onscreen (good for those of us that need to look at the keyboard a lot when typing).

Unlike most add-on keyboards and the Spectrum's own keyboard, the Elite does not have all the various keywords and symbols marked on each key. This makes the keyboard look much tidier and less cluttered than it normally does, but the unit comes provided with a plastic strip that has all the keywords marked on it for use when entering programs. This might be more inconvenient for the BASIC programmer, but for someone like myself who actually uses the Spectrum for wordprocessing it's a real asset.

However, at the left hand side of the main keyboard there are two rows of keys marked with the most often used keywords (Load/Save, List, Run etc), which

really gives the average user the best of both worlds. Back at the main group of keys there's a large space bar, additional keys for the various graphics and extended modes, and two symbol shift keys, one on either side of the keyboard.

Further to the right is what you might call the calculator cluster. This is like the keyboard of a calculator, with an extra set of number keys, cursor keys, and keys for the four main mathematical functions (addition, subtraction, multiplication and division). The overall impression it gives is not unlike one of those hi-tech keyboards on expensive office computers.

If you're only going to use your Spectrum for games that can be played with a joystick, then I don't suppose you need to spend much money on a decent keyboard, but if you do want to use the machine for something like wordprocessing then a good keyboard is essential and the Saga 3 Elite, though not the cheapest, is almost certainly the best.

Available from Saga Systems, 2 Eve Rd., Woking, Surrey GU21 4JT.



## Adapting to monitors

Whenever people write in to us asking about how to connect their Spectrum to an RGB monitor the usual answer is to tell them to get an interface, and one of the more well known companies producing such an interface is Adapt Electronics.

Now, Adapt have released a modified version of their RGB

Output Module which still provides the same monitor facility, but now incorporates a through peripherals port at the back which allows you to connect the machine to further peripherals such as printers (and if you're using it for wordpro that's the obvious choice).

The addition of this port has raised the price to £36.95, though the basic module is still

available for £34.95. I would however, add a reminder that you should always check to see what leads are required when buying such an interface, as Sinclair machines have a habit of using non-standard leads, and not all monitors use exactly the same leads anyway. Though on this point I'm sure that Adapt will be able to advise you if you contact them on 01-504 2840.





# ICON GRAPHIX



Icons controlling the various drawing commands.

would expect are available for drawing standard shapes such as lines, boxes, rectangles, circles and ellipses, although there is no quick way of drawing triangles other than to join three straight lines. A 'push page' command allows you to move the picture around the screen so that you can see the areas normally covered up by the icon area border.

These operations aren't performed as quickly as they are in a program like The Artist, but that's not necessarily a bad thing since I've often found both that and Art Studio getting a bit out of control before I can figure out what I've done wrong. On the other hand, the movement of the cursor around the screen can be irritatingly slow at times and it can also be a bit tricky to control since the choice of control keys (Cap Shift, Z, X, C and V) is a bit odd. Fortunately there is an option for joystick control and, very sensibly, a microdrive compatible version of the program on side two of the tape. Not so sensible is the bug (?) which causes the program to return to Basic whenever you press any of the keys on the bottom row (other than the control keys). Since these are so close to the cursor keys I found myself dropping in and out of Basic like a yo-yo, though this doesn't affect what you've drawn and can be remedied simply by typing RUN.

Other features include the now obligatory Fill and Spray routines with about thirty pre-defined patterns and a facility for defining your own pattern if desired. The Pen option allows you to choose from sixteen types of nib and some of these can also use the standard patterns for shading effects, which can be quite useful.

What is missing is some of the fancier refinements such as being able to Cut and Paste areas of the screen, text handling and reflections. How indispensable you consider these to be is very much a matter of opinion, but at least the lack of frills is reflected in a price that's only about two thirds that of most graphic packages. I think that's about the best way to sum up Icon Graphix — a 'no-frills' package that provides all the basics that you might need if your pocket can't quite stretch to £15 for one of the other programs or if, like me, you're a doodler rather than a dedicated screen designer who really does need a state-of-the-art utility.

There is to be an enhanced version of the program for the Spectrum 128 though, and that could be well worth looking out for.



# UTILITIES

**A.S.L.  
£9.95**

There have been quite a few graphics packages for the Spectrum released in the last few months, what with The Artist, The Art Studio and a mouse each from Kempston and AMS. And with all that graphic activity going on this slightly more modest utility from Audiogenic seems to have been overlooked. Admittedly it's not as sophisticated as some of its recent competition but it's the only one with a price that's not

in double figures which makes it at least worth some consideration.

### Icon do that

The name Icon Graphix is a bit of a giveaway, since it tells you straight away that the program is controlled by a series of icons. These, along with the patterns available for the Fill and Spray options, are very conveniently arranged around the border of the screen so that they surround the drawing area like a frame. Most of the commands that you

UTILITIES



# Q.K. Quiz Time!

- 1 Where can you find over 100 **FREE** software programs a year?
- 2 Who can you go to for **FREE** round the clock advice and help?
- 3 How can you get instant news, views, gossip and "hands on" reviews **24 hours a day**?
- 4 Who gives you **FREE** national electronic mail?
- 5 Where can you "chat" with 70,000 other micro users?
- 6 Who'll help you publish your own database for all to see?
- 7 How can you take part in national multi-user strategy games?
- 8 How can you book a seat on the 3.15 from Euston—at midnight?

**for just 20p a day**

ANSWER

**-Micronet 800-**

*Make the most  
of your micro*

Micronet 800  
8 Herbal Hill, London EC1R 5EJ  
Telephone: 01-278 3143

To: Micronet 800, 8 Herbal Hill, London EC1  
Please send me a brochure on Micronet 800

Name \_\_\_\_\_

Address \_\_\_\_\_

\_\_\_\_\_ Telephone No \_\_\_\_\_

Age \_\_\_\_\_ Micro \_\_\_\_\_

ZX April 1986





# PROGRAMMING

Graeme Devine looks at the programming potential of the new Spectrum 128.

# THE 128

The basic appearance of the 128 is familiar. No drastic changes have taken place, the case is of Spectrum+ type, with a metal heat sink on the right hand end. However the increased number of ports (RS232/midi, RGB, keypad, tape and TV) indicate the scope of the internal changes.

When the machine is powered up, we are presented with a menu, asking us what option we wish to use, these are: Tape Loader, 128 BASIC, Calculator, 48 BASIC and Tape Tester.

The tape option loads a tape as if you had typed LOAD "" from basic. This option saves users' time, and software houses space on cassette inserts explaining how to load a cassette.

128 BASIC has new elements but the first thing that struck me is the loss of single-letter-input, instead to type PRINT, you actually have to type P R I N T. More on this later.

The calculator option turns the Spectrum 128 into a calculator à la Apricot. Personally, I think a calculator is easier to use, but for software and data entry, this is a positive boon.

48 BASIC makes your Spectrum 128 act like a normal 48k Spectrum, and become apparently compatible with the normal Spectrum. However it seems a proportion of 48k titles will not run. More on this in a moment.

The tape tester allows users to set their tape recorders at the proper level to load a program from cassette, this seems a slightly odd function, as I found the Spectrum the most reliable computer for cassette files.

## Programming the 128

The Spectrum in 128k mode has 32k of rom mapped into two 16k pages which occupy 0-3PPPH of the Z80 map. Eight ram pages can be mapped into 0C000H-0FFFFH, making a total of 128k.

The really interesting thing from a programming point of view, is that the 128 has two screens. Most games on the normal Spectrum fill up a screen buffer and then copy it to the screen at a fairly fast rate. Now the programmer can, instead of

copying from one area to another, just swap screens, making the programs' graphics run effectively at twice the rate. This means that games on the 128 will be vastly superior to games on the old Spectrum. This combined with the new sound chip means that the 128 is a very good games machine.

Sound is very well covered in the manual, in fact, it seems to be the only thing covered in the manual. Very few technical details are included, so budding programmers will have to wait for the array of articles and books that always follow a computers' release.

Basically, the computer contains an AY-3-8912 sound chip, this is the same chip that is in the Amstrad and MSX, it has three sound channels, ten envelope waveforms, and a noise generator. Once a note starts, it won't stop until you tell it to, so making background tunes is easy, making good tunes, however, is much harder, as we have seen from the evolution of the Commodore 64.

The sound command is PLAY. BEEP is also available, but mostly for the sake of compatibility. The PLAY command takes the form PLAY A\$, B\$, C\$. For example, to play an A write LET a\$="a": PLAY A\$.

Within the command string, you can change the values of just about anything, for instance "\$" flattens the note following it, conversely, " " flattens the next note. A number in the string changes the length of a note.

This is a most versatile command, and it also controls the MIDI port (for which no main connections are given) and allows the user to control the sound chip very effectively.

The manual makes a nice mess of the MIDI configuration with the note on page fourteen "see page 3" (for pin configuration), while on page three it says "see page 14" (for pin configuration)!

Actually, the pin configuration is as follows, left side to right side.

GND 0 volt line  
 RXD receive data line  
 TXD transfer data line  
 UTR Data Terminal Ready (computer saying "Are you ready yet?")  
 CTS Clear to Send (computer saying "I'm ready!")  
 5 + 12v live



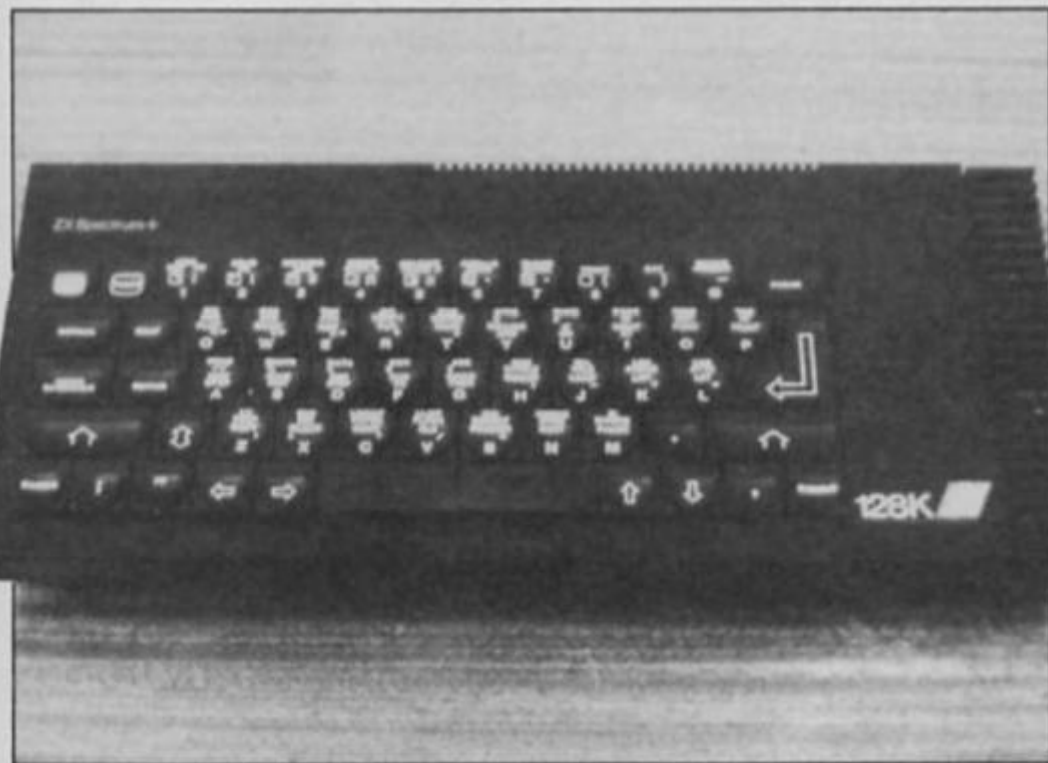

Spot the difference? November 85 saw the launch of the Spanish 128. The Brits had to wait until 86. (Answer: only one machine has Modo Extendido.)

These lines operate at 5 volts.

Built into the new basic is also a ram-disc utility, this allows users developing programs to do a fast save of data to somewhere else in memory, this is much the same as cassette, but the speed is much greater, but as soon as the computer power downs, all that was saved in the ram-disc will be lost. Sony got around this problem with their computer well, by making a battery ram cartridge for their micro. This should be equally possible on the 128, and I am sure someone will bring one out.

The ram-disc uses an exclamation mark after the keyword to activate it, valid commands are:  
**SAVE!** "name" LINE or CODE or DATA or, **SCREENS** — Save a file in the same way a cassette file is saved.

**LOAD!** "name" CODE or DATA or **SCREENS** — Load a file.  
**MERGE!** "name" — Merge a BASIC program.  
**CAT!** — Give a directory of the ram-disk in the same way as a microdrive.  
**ERASE!** "name" — Erase a file.

### Edits

Pressing **EDIT** brings up another menu marked:  
 128 BASIC  
 Renumber  
 Screen  
 Print  
 Exit

Renumber, will alter all the line numbers, gotos, gosubs, restores, and, save "j"line, to units of ten, starting at ten.

Screen, swaps the area of the

screen that you type onto from the main screen to the old two line screen at the bottom. Print lists the current program to the printer, I could swear **LLIST** did the same thing.

**Exit** takes you back to the original menu, you can only recover any data by selecting **128 BASIC** again from the first menu.

Plugging the 128 into an RGB monitor gives astounding results, the picture really is rock steady, using the 128 in this mode is much better than the normal television, only the sound becomes a little tricky to hear. Putting it through your stereo may seem to be a little over the top, but it seems to be the only reasonable way to resolve the problem.

The only problem with the RGB port is that programmers who use it may forget that pictures that look great on a monitor, may look really awful on a television, thus starting a whole new wave of software. This will probably only happen at pre-production level.

### Compatibility?

Is this computer really compatible with the old Spectrum?

There seem to be two problems, but just a single cause. The new machine in 48k mode, has the same rom as the old machine, except at address **3A00H** marked "unused" in the rom disassembly, there now resides a routine to read data in from the keypad. The problem is that software developers in the past used this area to vector mode 2 interrupts to **0FFFFH**, putting **18H** at address **0FFFFH**, and a **JP INTER** at address **0FFF4H**, thus taking up a whole lot less room than a page of memory (a page of memory is 256 bytes).

Other software houses, in an attempt to stop piracy, did a check-sum on the rom before running the program. The checksum has now changed.

Overall the Zx-Spectrum 128 is a nice machine, flawed by its partial non-compatibility with the original Spectrum.

If the machine is promoted and supported by the software industry and programmed to its full potential it could well become another Sinclair success story.



# THE LASER GENERATION

Ocean's utilities label, Ocean IQ, kicks off with the first of their Laser series of programs.

Don't be misled by the titles of these programs, Laser Basic will not give you QL-style BASIC on your Spectrum, and the Compiler is not a rival for BLAST. Laser is an advanced games designing package, for programming top quality screen movement in BASIC. Although Laser Basic supplies four 'toolkit' commands — renumber, remkill, trace and procedure — the other 110 extra new BASIC commands relate to sprite handling, animation, screen window creation, scrolling, attribute handling and the like.

With so many new commands, this is not an easy program to master. It is essential to go through the (excellent) handbook trying out the examples, and you will still need the book beside you while you create your own games. This has enabled Ocean to use an ingenious anti-piracy device. They have produced the handbook in a form which cannot be photocopied and under no circumstances will they supply new copies. Since it is useless without the handbook, they have not built anti-piracy devices into the program. There is a menu option for making Microdrive backups, and I had no difficulty in breaking into it to change the commands to use Wafadrive.

## Zap!

Any doubts about the quality of BASIC-driven movement were dispelled by the demonstration program supplied. One particularly impressive screen has cubes, one with a little man jumping up and down on it, moving across the screen at varying speeds and passing behind and in front of pillars, while at the same time a spaceship antenna whirls and a clock pendulum swings. The movement is smooth and flicker-free. The demo program listing in the handbook shows that all this activity is generated by a 19-line BASIC subroutine!

Movement can be created by scrolling all or part of the screen — the user can define as many windows as required — by moving, animating or scrolling

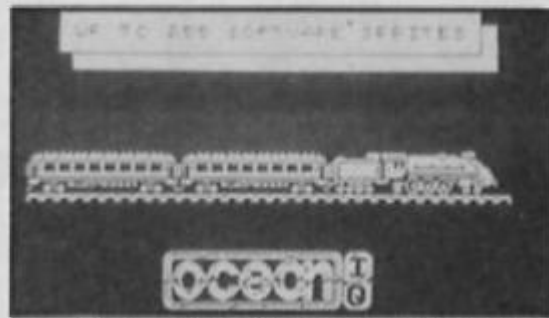

The demonstration program from Laser Basic

sprites, or by a combination of these. You can even define a window within a sprite. Sprites can be moved about the screen without affecting the background, spun, mirrored, inverted, enlarged or scrolled. Scrolling of sprites, screen or windows may be vertical or horizontal, with or without wrap, and the number of pixels to scroll may be specified. Up to 16 SETS of parameters may be used to define windows, to hold sprite numbers and position information, or to hold key codes for keyboard scanning. Using the SETS speeds up the program running, but parameters can also be programmed directly in BASIC.

Up to 255 sprites may be held in memory at once, depending on their size, and there is a separate generator program for designing them. The designer has two screens. One, an 8 x 8 grid, is used for designing one character square of your sprite. You then place this, using cursors to specify the position, on the larger screen which is 15 x 15 character squares in normal size. If you need larger than 15 squares in any direction, you must design two sprites and use them side by side in your game.

I found that the 8 x 8 grid made it difficult to design a large sprite on screen. One character square is too small a window to judge the finished effect and I found it easier to design the sprite on graph paper first. However, this might not be a problem to someone with a surer artistic touch than mine. You can also enter decimal or hex data, which generates your sprite on the larger screen. When the sprite is complete, you specify its height, length and file number and save it in memory. The sprite file may be saved on tape or microdrive in two ways. Option 1 allows reloading to the generator for modification, whilst Option 2 enables you to load in Laser Basic to design your game. I found that you must save them twice, using both options. I designed 25 related sprites to animate a galloping horse, loaded them into the

Basic, and the horse galloped across the screen leaving a trail of disembodied tails and rear legs because I had forgotten to give the sprites a trailing blank square to wipe out the previous position. Because I had not made an option 1 save I couldn't modify them and had to start all over again. (You don't normally use so many sprites in animation — I was experimenting with hi-res movement, which the programme handled impressively).

Designing related sprites is easy. You can rotate, invert, mirror your sprite, move it across its background or make alterations to a small area and save the altered design as a new sprite.

## D.I.Y. games

When your game is complete, you may wish to market it, in which case it must run independently of Laser Basic. This is where the Compiler comes in. You use it to compile your Laser Basic to machine code which, when SAVED with a running code from the Compiler, your sprite file and a loading program, will allow your game to run without Laser Basic being present. While the compiling is going on, the program gives an alarming imitation of a machine code crash, with colours and lines flashing on the screen. This is normal, because the display file is used as a workspace. You can use the Compiler to compile ordinary BASIC programs, but there is little point in it. The time saving is only a factor of two or less, and space saved is lost again to the running code. Also there are limitations on the BASIC program structure that the Compiler can handle.

Ocean place no restrictions on the marketing of programs produced using Laser, and they require no royalties. Laser is expensive, but the games designer or anyone interested in graphics and animation will find it worth every penny.

Ocean place no restrictions on the marketing of programs produced using Laser, and they require no royalties. Laser is expensive, but the games designer or anyone interested in graphics and animation will find it worth every penny.

**Laser Basic £14.95**

**Laser Compiler £9.95**

**CAROL BROOKSBANK**



# OUT OF THIS WORLD!

## SAGA SYSTEMS' HARDWARE

If you want the best for your Spectrum, ensuring it advances with technology, the Saga Systems' collection of keyboards and peripherals is essential. And they are all compatible with the 48K, + and 128K Spectrum.



### THE SAGA 3 ELITE

"Devastatingly smart... the opposition look like toys... the best." - Popular Computing Weekly.  
 "It transforms the humble Spectrum" - Sinclair User.  
 "... will release the full potential of your Speccy... superdooper..." - Your Sinclair.

At its new low price of **£69.95** (Inc. VAT) the Saga 3, with its own number pad, is also ideal for the 128K Spectrum.



### SAGA 1 EMPEROR

"... Good looks... works remarkably well..." - Sinclair User.  
 "... remarkable... value for money..." - Sinclair User Annual 1985.

"... particularly like the extra caps and symbol shift keys... brought the computer to life in quite an unexpected way..." - Primary Teaching and Micros.

PRICE **£39.95** (Inc. VAT)



### THE NEW SAGA 2+

"If I had not already seen the Saga 3 Elite I would have awarded the 2+ a Sinclair User Classic. As it is I'll simply say 'Well done, Saga!'" - Sinclair User.

And the price is only **£54.95** (Inc. VAT).



### THE NEW SAGA 2001

With its infra-red remote transmission, the Saga 2001 can be used while you walk around the room. No wires link it to the Spectrum. It has 101 keys. The Last Word software is available with it free, and it is simply out of this world.

PRICE **£119.95** (Inc. VAT)



### THE SAGA LO PROFILE

With large enter key, full sized spacebar and printed keys, it has go to be good at **£39.95** (Inc. VAT).



## SAGA SYSTEMS' PERIPHERALS



Microdrive extension cable. For use with your Saga 3.

**£9.95** (Inc. VAT)

Sound Boost. To put music in your ears (and television).

**£9.95** (Inc. VAT)

Dust cover. To keep your computer and Saga keyboard clean.

**£4.95** (Inc. VAT)

Centronics Interface. To drive your printer. **£34.95** (Inc. VAT)

## SAGA SYSTEMS' SOFTWARE

If you want to do more than just play games and require serious software with practical applications, then we have "The Last Word".



We believe The Last Word is the most advanced word processing package for the Spectrum. Just look at these outstanding facilities:-

Standard commercial 80 characters on screen, over 60 commands, massive range of printer options, full on-screen help facility, full feature expression evaluator/calculator, over 24K text space in memory, compatible with tape and microdrive, wafar and: KDOS, BETA, Gordon and Opus disc systems.

PRICE: **£13.95** inclusive of VAT  
 Send off now for full catalogue.

FREE WITH THE  
 SAGA 2001

## SAGA SYSTEMS' PRINTERS



### THE NEW SAGA GLP (Great Little Printer)

Only **£199.95**, the Saga GLP is a dot matrix printer with a near letter quality mode, a complete Epson character set, tractor and friction feed, and a centronics and RS232 interface. It is very compact and can print up to 100 c.p.s. Only **£199.95** plus VAT.



### THE CITIZEN 120D

A precision dot matrix printer with a 2 year warranty, the Citizen 120D operates at 120 c.p.s. in fast draft, or 25 c.p.s. in N.L.Q. It has Epson compatible graphics, tractor and friction feed as standard, an optional cut sheet feeder and is very compact. Further features include proportional spacing with many type styles and an exceptional 4K printer buffer. Only **£235** plus VAT.



### THE NEW SAGA DX85

Big and robust the DX85 is a heavy duty dot matrix printer which is made in the U.K. It prints at 120 c.p.s. It has a bi-directional logic seeking print head and centronics interface (RS 232 available). It has a draft quality mode and costs only **£199.95** plus VAT.



### THE LTR1 PRINTER

The LTR1 is a letter quality printer, 12 c.p.s. with centronics and RS232 interface and costs only **£121.70** plus VAT.

- SAGA 1 EMPEROR
- SAGA 2+
- SAGA 3 Elite
- SAGA 2001
- SAGA LO PROFILE
- 128K Keyboard
- up-grade kit
- LTR1 PRINTER
- CITIZEN 120D
- THE SAGA DX85
- SAGA GLP
- MICRODRIVE EXT. CABLE
- SOUND BOOST
- DUST COVER (Please specify which keyboard)
- CENTRONICS INTERFACE
- THE LAST WORD

Quantity	Price	P&P
	£39.95	£1.50
	Available soon.	
*	£69.95	£1.85
	£119.95	Free
	£39.95	£1.50
	£4.99	Free
	£139.95	Free
	£270.25	Free
	£229.95	Free
	£229.95	Free
	£9.95	Free
	£9.95	Free
	£4.95	Free
	£34.95	Free
	£13.95	Free

TOTAL

Please state Spectrum model: 48K, +, 128K (please circle) \*  
 All these products are described in more detail in our Free Catalogue.

SEND YOUR ORDER TO: Dept ZX4 Order Desk Saga Systems Ltd.,  
 2 Eve Road, Woking, Surrey GU21 4JT. Telephone: 04862-22977

Mr/Mrs/Miss \_\_\_\_\_  
 Address \_\_\_\_\_

My Access Card No. is \_\_\_\_\_

Amount enclosed £ \_\_\_\_\_

ACCESS ONLY ACCEPTED

Please tick method of payment: PO  Cheque  Draft  Access   
 If this is confirmation of telephone order, please tick box,

Signature \_\_\_\_\_ Date \_\_\_\_\_

Overseas orders, please deduct 15% VAT add £4 for postage excess.  
 Please allow 28 days for delivery.

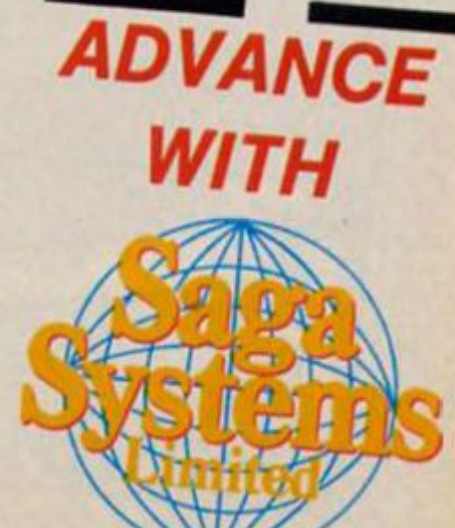

TEL: 04862-22977





**Keys**

**Q** - up

**A** - down

**O** - left

**P** - right

**Space bar** - fire!





**COMPETITION**

**Your do or die mission is to fly across war torn Europe and rescue a team of scientists who hold the key to a lethal new weapon that could change the course of history. Your reward? Unlimited glory and the chance to win a Saga 3 Elite Keyboard.**

# THE FLYING FORMULA

As you strap yourself into the cockpit the fate of Europe is in your hands. Across the Channel there are a team of seven scientists who must be rescued at all costs.

Each scientist has a segment of the vital code that on no account must fall into the hands of the enemy. Your problem is that you only have a two seater fighter and the boffins must be brought back one by one.

Flying out over the Channel you are confronted with a deadly stream of enemy fighters. Once you have eliminated the pride of the Luftwaffe you can land at the secret rendezvous and pick up the first of the precious boffins. Your return trip will be equally hazardous for the enemy has regrouped high over the Channel.

Safely back at home base the boffin is debriefed and reveals his secret part of the formula. The code will be written up on the blackboard in the ops room but for you there is no respite — you must return across the hostile skies to retrieve the remaining scientists.

As the boffins are brought back to base the seven part code will reveal itself but not until the seventh boffin is safely on British soil will the full formula emerge.

The Flying Formula is a hazardous gruelling mission requiring iron nerves and determination but at the end there is a prize in sight.

## The competition

For the first three flying aces to crack the seven part formula there is a Saga 3 keyboard to fly off into the sunset with. As British fliers have a clear time advantage there will be three subscriptions to the new ZX Computing Monthly for the first trio of overseas aces to complete the game.

**The Flying Formula Competition  
Entry Coupon**

Name .....

Address .....

Copy the complete seven part formula on the blackboard above and send this coupon with your name and address, clearly written, to: The Flying Formula Competition, ZX Computing Monthly, No 1 Golden Square, London W1R 3AB.

**COMPETITION**





**Firebird**  
£7.95

Rasputin is one of the first titles to be released in Firebird's new Hot Range, and certainly bodes well for future releases on the label.

Mind you, I'm inclined to

give a slap on the wrists to whoever wrote the incomprehensible waffle that attempts to pass itself off as instructions; not only is it useless in explaining anything about the game, it's also very badly written. That, however, is my only criticism of Rasputin as in all other respects it's a thoroughly classy game.

Rasputin is a cosmic loon intent on wreaking havoc on the universe, but who relies on the sacred Jewel of the Seven Planets for his powers. Your task is to venture into the netherworld, armed only with your magic sword and shield, and to destroy the Jewel. Naturally this isn't going to be easy, and as you set out on your quest you'll be set upon by strange netherworldly creatures, and be faced with a number of tasks that have to be completed before you can reach the Jewel. The main task being to neutralise the eight spells that stand between you and the Jewel.

The netherworld is based around a rather tasteful court-

yard with exits leading off into various dimensions. The courtyard is patrolled by what seem to be the souls of dead warriors who will be reanimated and seek you out if you hang around too long. Once you enter the various dimensions you are faced with Knightlore-style obstacles, presented in highly detailed 3D graphics. But rather than simply being rooms, these dimensions float above the clouds and any wrong moves will send you tumbling down to the clouds below.

Assuming that you manage not to drop over the edge, the task that faces you in each dimension is to locate the stones that carry the mark of Rasputin and step on them in order to absorb their magical powers. To add to your problems, each dimension is occupied by a variety of deadly creatures just waiting to sap your life force; there are mystical spheres which will home in on you if they touch you just once, cyclopean creatures and a sort of ectoplasmic frog, all wandering round and standing between you and your goal. Getting to Rasputin's stones requires a combination of arcade reflexes and strategic planning that could provide a challenge for weeks or even months.

Your troubles don't end there though, for when you've stepped on all the stones in a particular dimension Rasputin will unleash another monster which will probably zap you pretty quickly. But, if you do manage to kill it, the creature will leave behind a rune that will counteract one of the eight spells. To add yet another complication, the dimensions and runes are 'colour coded' and if the dimension you are in doesn't match the colour of the runes you may not be protected when you attempt to neutralise the eight spells.

Yes, it is as complicated as it sounds, and I must admit that, partly due to the gibberish in the instructions, my initial reaction to Rasputin was 'nice graphics but where's the game?', simply because I couldn't work out what on earth it was all about. Fortunately I persevered and gradually the game started to reveal itself. In the end, Rasputin turned out to be one of those games that actually becomes more challenging and addictive the longer you play it, as all its intricate twists become clear.

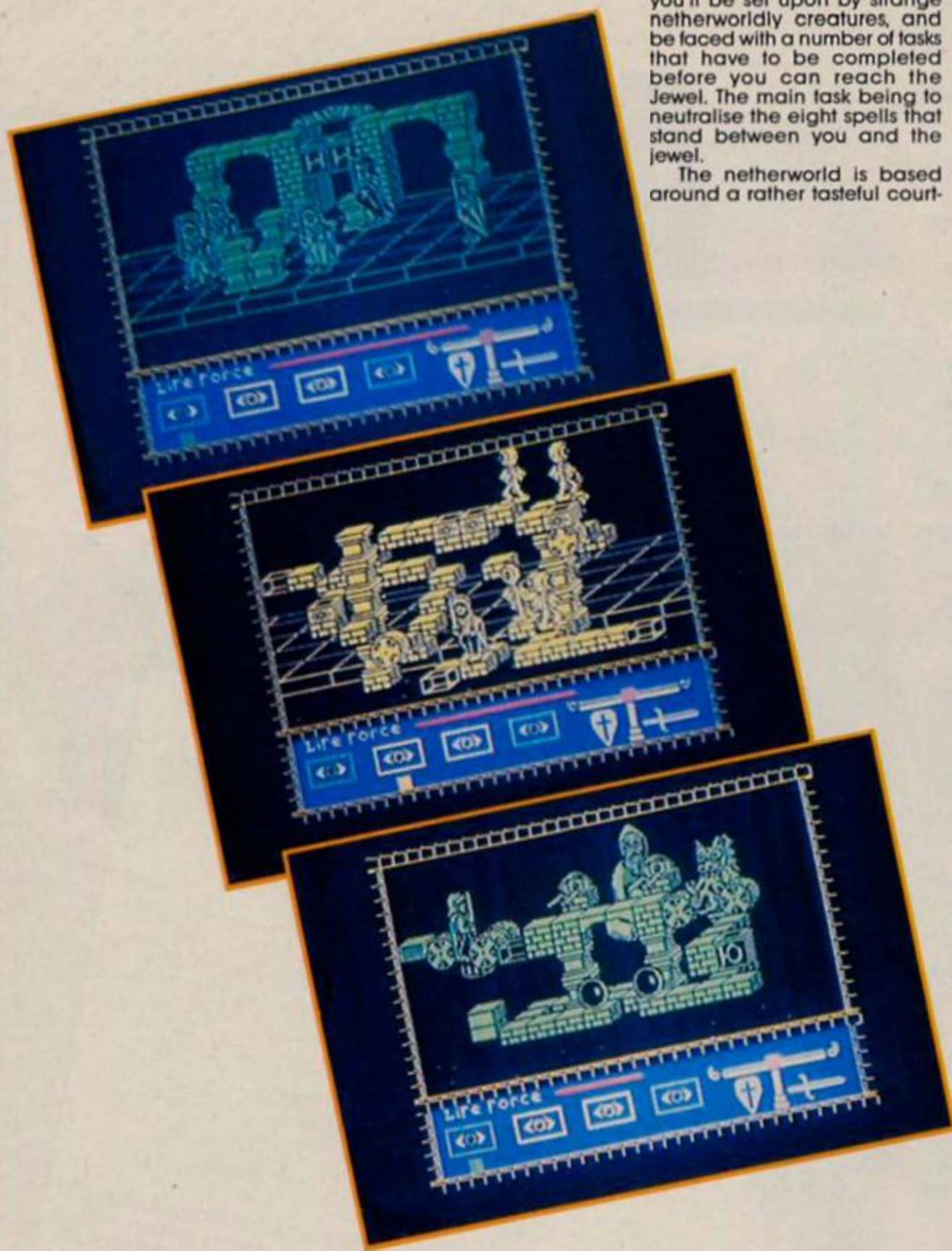

# Rasputin



# Try beating our SpecDrum!



## Spec Drum

Digital Drum System  
for the Spectrum

£29.95

- 8 DIGITALLY RECORDED REAL DRUM SOUNDS
- SIMPLE TO USE — UP AND RUNNING IN ONLY MINUTES
- A TRUE DIGITAL DRUM MACHINE
- 'REAL TIME' OR ON-SCREEN PROGRAMMING
- COMPLETE WITH SOFTWARE
- EXTRA SOUNDS CAN BE LOADED FROM TAPE
- CREATIVE, EDUCATIONAL AND FUN
- THE MOST EXCITING PERIPHERAL EVER DEVELOPED
- DYNAMIC FILING SYSTEM — STORE OVER 1000 PROGRAMMED RHYTHMS
- TAPE SYNC FACILITY
- SONGS CAN BE SAVED ON TAPE
- POLYPHONIC
- COMPREHENSIVE MANUAL
- JUST PLUG INTO YOUR HI FI

AVAILABLE FROM HIGH ST. STORES  
AND ALL GOOD COMPUTER SHOPS  
OR VIA MAIL ORDER.



**Cheetah**  
Marketing

1 WILLOWBROOK SCIENCE PARK, CRICKHOWELL ROAD, ST. MELLONS, CARDIFF  
TELEPHONE: CARDIFF (0222) 777337 TELEX: 497455  
(Export enquiries — contact Cheetah direct)



When Sinclair Research immodestly named the BASIC interpreter on the QL 'Super-BASIC', they inevitably attracted a lot of criticism from users who didn't quite agree with their superlative. But SuperBASIC does possess many attractive features which can make it a pleasure to write programs on the QL. This series will not be a course in programming, but should be of value to beginners as well as those with some previous experience of BASIC. In each part of the series we will examine one aspect of Super-BASIC programming, offering advice, and providing some examples for you to type in and try for yourself. And the subject of this, the first part, will be... WINDOWS.

### Turn on

Turn on your computer and take a look at the screen. What do you see? Straight after power-up, the answer is 'not very much!' But, if you use your imagination, you could be looking through a window into an electronic world where the computer creates images for you to view. With many computers you are looking through one large window, and see a single large image. With many modern computers, the TV screen can be divided up into smaller rectangular units, so that you are given two or more windows to

can enhance both the appearance and user-friendliness of any piece of software. For example, in a complex screen display containing a lot of information, if a certain type of information always appears in one window, the user will quickly recognise that he or she will have to look at a certain part of the screen for that information.

When the QL is first switched on, the user has to select 'F1' for monitor mode or 'F2' for TV. This is simply because the QL's medium resolution display in monitor mode may not be too clear on a TV screen, and the edges of the display in monitor mode may overflow on the TV screen. The choice of 'F1' or 'F2' gives you a selection of two pre-determined window formats. With both you get three windows, as shown in the User Guide. Windows are numbered 0, 1 and 2; window 0 is equivalent to the status window on the Spectrum and QL. Anything you type will appear there. In TV mode, windows 1 and 2 are in exactly the same place, so the screen will look just like a Spectrum display.

Standard BASIC commands like CLS, PRINT, INPUT, etc will operate on window number 1. This is the default window. To get these commands on any other window, the window number has to be specified; e.g. **CLS#2** will clear window 2. So straight away you should see an advantage over the Spectrum; you can

Look closely at the screen and you'll see that the display is made up of lots of dots (called pixels). There are 512 across the screen, and 256 down. A window can be defined by its size, in terms of the number of pixels across and down which make up the window, and the position of the top left corner of the window, relative to the top left point of the screen. The top left of the screen is considered as position 0,0 — so the bottom right pixel is 511,255.

So, the command: **WINDOW 1,400,200,100,20** will alter the size and position of window 1, so that it is 400 pixels wide, 200 deep, and its top left position is at pixel 100,20, relative to the top left of the screen.

To be strictly correct, the QL display will only be 512 pixels wide in one of its display modes. The QL offers eight colours (and flash) in mode 8, but this only allows a screen resolution of 256x256. Mode 4 gives four colours with 512x256 resolution. However, for window definition both display modes are counted as 512x256; each pixel in mode 8 has two 'addresses' — pixel 0,0 is the same as 1,0 in that mode.

You may re-define all of the three original windows in this way. But, if these are still not enough, you can define more windows. In fact, within the limits of the QL's memory, you can have almost as many as you want. To understand how this is done, the concepts of devices

# QL SuperBASIC

view; each window providing you with some specific information.

The ZX81 and Spectrum have two machine-defined windows. These are the main window (32 by 22 characters), and the status and input window (32 by 2 characters) at the bottom of the screen. Intelligent programming can provide more windows, but this cannot be achieved simply. The QL isn't so limited; the user can create any number of windows, in any position, simply through the use of some powerful SuperBASIC commands. Using windows imaginatively

clear any part of the screen (without affecting the rest) simply by clearing a window. In fact, you can clear part of a window using variations on the CLS command; see CLS in the keyword section of your User Guide.

If you ask to LIST a program, this command uses window 2 as default, but you can direct a listing to whichever window you want using **LIST # (number)**. If you should want a different arrangement of windows to those which the QL firmware provides for you on power-up, changing them is very simple. Use the WINDOW command.

and channels need to be appreciated.

### Open channels

The QL thinks of itself as a simple machine, with just a processing unit, memory, and communication links. To allow the QL to work as an effective computer, it must be able to communicate with 'external' devices, such as the screen and microdrives. Communication between the QL and the screen is achieved by means of a channel. This channel has an identifying



number, and it is created using the OPEN command. Thus, **OPEN #3, scr** will open channel number 3 to the screen. Windows 0,1 and 2 use channels of the same number; it is the channel number which identifies the window. Nothing can happen if you decide to use channel 3 after using the above OPEN command, as the window size and position haven't been defined. You can do that with the WINDOW command. Alternatively, you can use a special form of the OPEN command, i.e. **OPEN #4, scr\_200x100a20x30** opens a window (number 4) of size 200 pixels wide by 100 deep, with the top left corner at position at 20,30.

Instead of opening a channel to the 'scr' device, a slightly more powerful variation is to use the console ('con') device. When you use the INPUT command, a flashing cursor appears on the screen; as you type in a letter it appears under the cursor before the cursor moves off to the right. Like PRINT or CLS, the INPUT command can be directed to any window by specifying the channel number, i.e. **INPUT #0, a\$** or **INPUT #2, v** will send the flashing cursor to window 0 and 2, respectively. This will only work if the window was defined as a console device (the QL defines windows 0,1 and 2 as console devices on power-up or reset). In other words, a screen device is for output only, whereas a

## David Nowotnik finds out what's super about SuperBASIC.

### Part One: Windows

console device does everything a screen device does, and it accepts the INPUT command. When defining a console device, a similar OPEN command is used, but an extra parameter can be added, which sets the size of the input buffer (the largest number of characters which will be accepted during the operation of the INPUT command). For example; **OPEN #5, con\_300x200a10x20\_32**. The final '32' is the input buffer size.

Once a screen or console device has been opened, then the window size and position

**Fig1. Window Demonstration Program**

```

10 REMark Window Demonstration
20 REMark ZX Computing
30 REMark
40 REMark Set TV Mode
50 MODE 8
60 WINDOW 512,256,0,0
70 PAPER 0: CLS
80 WINDOW 448,200,32,16
90 WINDOW #2,448,200,32,16
100 WINDOW #0,448,40,32,216
110 PAPER 1: PAPER #1,2: PAPER #0,0
120 CLS: CLS #0
130 INK 7: INK #2,7: INK #0,7
140 CSIZE 0,0: CSIZE #0,0,0: CSIZE #2,0,0
150 REMark Create new Window
160 REMark
170 OPEN #5, con_400x160a56x36_32
180 PAPER #5,4: INK #5,7
190 CLS #5
200 GO SUB 2000
210 CSIZE #5,3,1: PRINT #5\\" Large Print"
220 CSIZE #5,2,1: PRINT #5\\" Medium Print"
230 CSIZE #5,1,0: PRINT #5\\" Small Print"
240 CSIZE #5,0,0: PRINT #5\\" Smallest Print"
250 GO SUB 2000
260 CLS #5
270 BORDER #5,10,200
280 GO SUB 2000
290 BORDER #5, 20,180
300 GO SUB 2000
310 BORDER #5, 30,160
320 GO SUB 2000
330 PRINT #5,"This demonstrates that words are printed
with-in the border."
340 GO SUB 2000
350 AT #5,6,4: PRINT #5,"Now to demonstrate
SCROLL."
360 GO SUB 2000
370 SCROLL #5,-60
380 GO SUB 2000
390 AT #5,6,4: PRINT #5,"And now PAN."
400 GO SUB 2000
410 PAN #5,80
420 GO SUB 2000
430 CLS #5
440 PRINT #5\\"CLS #5 cleared this window, but left
the border intact."
450 GO SUB 2000
460 BORDER #5,0: CLS #5
470 PRINT #5\\"Watch what happens when window #1 is
cleared."
480 GO SUB 2000
490 CLS
500 PRINT \\" As window #5 was within window #1, it was
cleared when CLS was used."
510 GO SUB 2000
520 CLS #5
530 PRINT #5\\"CLS #5 has wiped out that part of
window #1 underneath it!"
540 GO SUB 2000
550 CLS: CSIZE 3,1: PRINT \\" THAT'S ALL"
1990 STOP
2000 a#=INKEY#(-1)
2010 RETURN

```

can be re-defined as many times as you like. If you no longer need a window, then the channel to it can be closed, i.e. **CLOSE #5** disconnects the QL from a device which was using channel 5. You could then connect another device via channel 5. There is nothing to stop you closing channels to the pre-defined windows (0,1 and 2). If you **CLOSE 0**, you'll find that no direct commands will work, as you have closed the console device which the QL firmware has set up to accept this input. So you'll have to press RESET and start again!

### Window commands

Each QL window behaves as if it were an independent screen. To make use of these individual 'screens', there are a range of commands you can use. The listing in fig. 1. will give you a demonstration. Type in the program lines, then RUN the program. Lines 50 to 140 adjust the three original windows to ensure that they are equivalent to TV mode. It is surprising the number of programs which are written for the QL which are otherwise very good, but the writer has forgotten to set the



windows. Many authors assume that the machine is just turned on (or RESET), and TV mode selected, before their program is loaded and run. Often this is not the case, and the windows are all wrong, producing some very odd effects on the screen. So, if you are writing your own programs, make sure that you have a window initialisation routine like that in Fig. 1. at the start of the program.

Having set up the 'original' screen, an extra window is created as a console device (line 170). The INK and PAPER for this window are defined as white and green respectively (line 180), and the window cleared (line 190) so that it is visible on the screen. The program runs through a series of demonstrations; you can move from one stage to the next by pressing any key (GO SUB 2000). You are shown how to adjust the character size in the window with CSIZE (lines 210-240), different border sizes and colours/patterns (lines 270-320), how printing in the window doesn't overlap the border, and how the window itself can be SCROLLED or PANned without effecting any of part of the screen. The effect of clearing window #1 on window #5 is also shown.

Now the principles of windows have been mastered, you should be able to use them to good effect in your programs. One example is shown in Fig. 2. It is simple maths test program for primary school children, allowing them to practise any multiplication table of their choice. The screen display is split into windows, each window having a specific purpose, so that the child should quickly know where to look for any part of the operation. The main window, on the left of the screen, provides the questions, the smaller yellow window on the right hand side provides the response (correct or wrong, or the complete multiplication table, if the child has real problems in getting the answer). The blue window at the bottom of the screen is used for input of answers.

You will notice when running the program that the main window has a 'shadow' to it. This is a popular effect in many QL business programs; it gives the impression that a window is 'standing out' from the rest of the screen, so highlighting to the user which window should be looked at most closely.

If you're not very familiar with SuperBASIC, there may be several constructions within the mathematics program which are confusing. Don't worry, because in the next five issues of ZX Computing most of the QL's special BASIC commands will be featured.

Fig.2. Multiplication Test Program

```

10 REMark Maths test
20 REMark ZX Computing
100 init
110 test
120 AT #3,6,0: PRINT #3,"Any more (y/n)?"
130 a#=INKEY#(-1)
140 IF a#="n" THEN STOP
150 RUN
1000 DEFine PROCedure init
1010 MODE 8: WINDOW 512,256,0,0
1020 PAPER 2: CLS
1030 WINDOW 250,200,45,15: PAPER 255: CLS
1040 WINDOW 250,200,55,20: PAPER 7: CLS
1050 CSIZE 2,1
1060 OPEN #3, scr: WINDOW #3, 180,140, 320,50
1070 PAPER #3,6: INK #3,2: CLS #3
1080 WINDOW #0, 312,20,100,230: PAPER #0,5: CLS #0
1090 INK #0,0: score=0: last=0: prev=0
1100 INK 3: PRINT\ " MULTIPLICATION\ " TABLES"
1110 INPUT #0;" Which table (2 - 12) "; a#
1120 IF NOT check (a#) THEN CLS #0: GO TO 1110
1130 num=a#: IF num<2 OR num>12 THEN CLS #0: GO TO 1110
1140 CLS #0: CLS
1150 END DEFine init
1500 DEFine PROCedure tables (x)
1510 LOCAL i
1520 CLS #3: PRINT #3
1530 FOR i=1 TO 12
1540 IF i<10 THEN PRINT #3," ";
1550 PRINT #3," ";i;" x ";x;" = ";x*i
1560 NEXT i
1570 END DEFine tables
1600 DEFine FuNction check (z#)
1610 LOCAL i
1620 IF z#="" THEN RETURN 0
1630 FOR i=1 TO LEN (z#)
1640 IF z#(i)<"0" OR z#(i)>"9" THEN RETURN 0
1650 END FOR i
1660 RETURN 1
1670 END DEFine check
1700 DEFine PROCedure heading
1710 CSIZE 2,1
1720 CLS: PRINT\ " ";num;" TIMES TABLE"
1730 END DEFine heading
1800 DEFine PROCedure test
1810 LOCAL i,j,h
1820 FOR i=1 TO 10
1830 heading
1840 CSIZE 1,1:PRINT\ " What is:-"
1850 h=random
1860 PRINT\ ". ";h;" x ";num
1870 FOR j=1 TO 3
1880 REPEAT loop
1890 INPUT #0," Answer = ";x#
1900 IF check (x#) THEN EXIT loop
1910 END REPEAT loop
1920 x=x#
1930 IF x=h*num THEN
1940 AT #3,6,4: PRINT #3,"CORRECT"
1950 PAUSE 200: score=score+4-j
1960 CLS #3: EXIT j
1970 ELSE
1980 AT #3,6,4: PRINT #3," WRONG!"
1990 IF j<3 THEN PRINT #3\ " Try again"
2000 PAUSE 200: CLS #3
2010 NEXT j
2020 tables (num)
2030 PAUSE 500
2040 CLS #3
2050 END FOR j
2060 PAUSE 100: CLS #0
2070 END FOR i
2080 CLS: PRINT\ " You got ";score\ " points from\ "
30"
2100 END DEFine test
2200 DEFine FuNction random
2210 LOCAL rd
2220 REPEAT collect
2230 rd=RND(1 TO 12)
2240 IF rd<>last AND rd<>prev THEN EXIT collect
2250 END REPEAT collect
2260 prev=last: last=rd
2270 RETURN rd
2280 END DEFine random

```





CentreSoft  
presents

With over four years experience of providing practical software solutions for business and home applications, Gemini have put together their entire range of famous titles for the Spectrum and Spectrum Plus in ONE special pack, at a VERY SPECIAL price. Whether you're a cassette or microdrive user, this super value pack contains all the serious application software you're ever likely to need for your Spectrum, from home accounts and database management to a complete professional business accounting system. Gemini's OFFICE MASTER is here—put that computer to WORK!

- Database
- Stock Control
- Final Accounts
- Easiledger
- Maillist
- Cash Book
- Home Accounts
- Graph Plot

Each pack contains ALL 8 programs, demonstration data files, and clear and comprehensive manuals for EACH program. Gemini's previous retail price for all these programs individually was £179.60. Now they're all together in ONE COMPREHENSIVE PROGRAM PACK.

### OFFICE MASTER

Tape: £15 Microdrive: £17.50  
includes P&P and VAT.

# Office Master



### Database



Use this program for storing all types of information just the way YOU want to store it. You set up a computerised 'card index' system and add records and data to the file in the format that you choose. Advanced features include sorting and searching for specific records, mathematical calculations, printer routines, data summaries, etc. If you don't have a database, you certainly should!

### Maillist



This is a specially designed database for storing names and addresses, and printing out in label format. Special search routines are included for selecting only names and addresses that conform to your criteria. The famous Gemini 'Searchkey' facility is included with this program, and data entry is simplified by an on screen label painting system. Just type in those names and addresses as though you were using a typewriter!

### Stock Control



One of Gemini's speciality programs, this software will take the drudgery out of keeping stock records. Enter details of part number, description, unit quantity, cost price, selling price, minimum stock level, units in stock, order quantity and supplier details. Detailed reports include totals of stock at cost and sale price, cost of bringing stock up to level specified, gross margin, understocked items, etc. Full browsing facilities to make inventory management a pleasure!

### Cash Book



This is a full and comprehensive cash book accounts system designed to REPLACE your manual ledger entirely. It will take you from the 'shoebox' situation of sheaves of invoices, cheque book stubs, petty cash vouchers and bank statements etc. to a properly constituted trial balance. You may then take your FINAL-ACCOUNTS package and produce profit and loss account and balance sheet ready for audit. A REAL money saver when it comes to your accountancy bill!

### Final Accounts



Using the data file on microdrive or cassette prepared by the cash book program, this software will produce comprehensive end-of-year reports ready for audit by your professional adviser. The Gemini cash book and final accounts system is now in use by many thousands of businesses and as a 'classic' professional program has been translated for a wide variety of micros. Cash-book and final accounts alone warrant the purchase of this OFFICE MASTER program pack.

### Home Accounts



Designed as a complete financial and budgeting package for home affairs, this program allows the user to set up a budget for items of household and family expenditure and compare actual expenditure with budget as often as required. A running total of surpluses and deficits is available both numerically and in bar graph form. A complete bank account routine is included, together with suggested expenditure categories which may be simply altered as required.

### Easiledger



Consists of invaluable routines to allow the creation of any type of financial ledger system. Its usefulness lies in its ability to produce account balances instantly for debtors and creditors together with an audit trail of all entered transactions, with dates and references. A year-to-date summary is included of sales, purchases, receipts and payments over a 12 month period, and most importantly, a completely interactive bank account database is featured.

### Graph Plot



At last, superb graphs, bar charts and pie charts on your Spectrum! With a complete data entry section and the ability to load and save files, this is really one of the fun programs to use. Represent numbers and data in clear diagrams with this package, and print them out on your printer to accompany reports, budgets, etc. Very highly recommended for the office, home and school. Also includes capability to provide mathematical function plotting.

Mail  
Order to:

# GEMINI

To: Gemini Marketing  
Limited,  
Gemini House,  
Exmouth EX8 4RS

Please send me \_\_\_\_\_ Spectrum OFFICE MASTER packs.

Cheques/POs enclosed or please debit my  
Access/American Express No. \_\_\_\_\_

Name: \_\_\_\_\_

Address: \_\_\_\_\_

Signature: \_\_\_\_\_



24 HOUR CREDIT CARD HOTLINE - (0395) 265165 (4 lines)

Sole distributors to the trade: **CentreSoft Ltd.**  
Tel. 021-359-3020



# DURELL

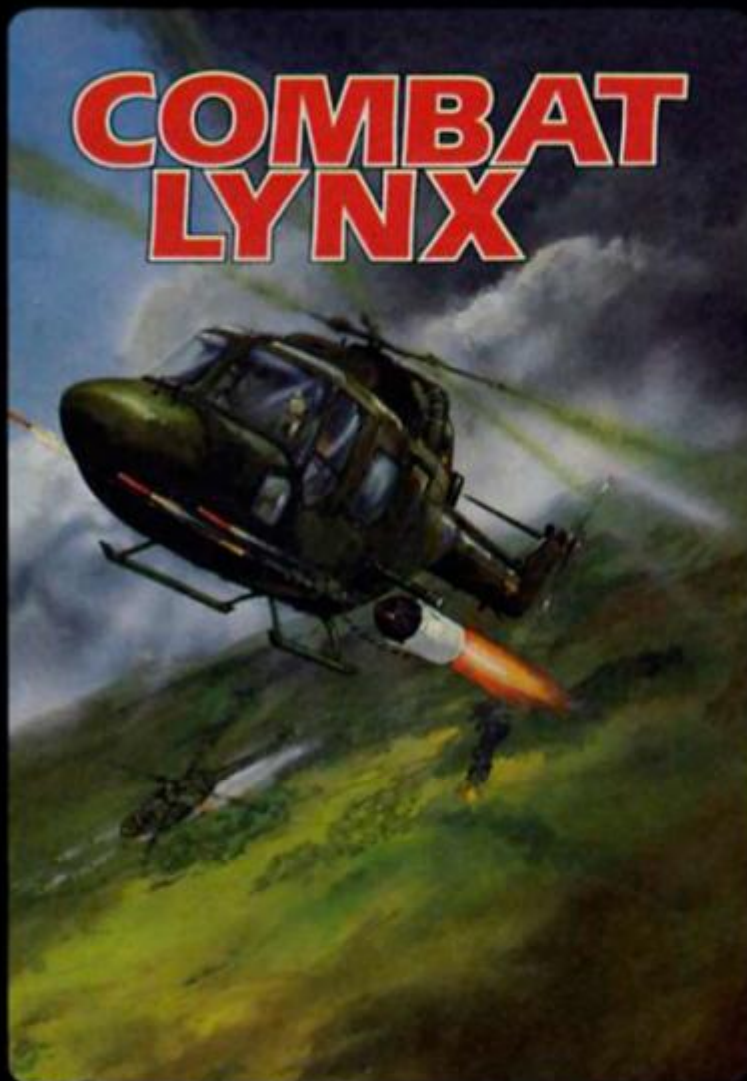

## COMBAT LYNX (Air-to-ground Battle Simulation)

Spectrum 48k	£8.95
Commodore 64	£8.95
Amstrad 464/6128	£8.95
BBC/Electron	£8.95

"Combat Lynx is both simulation and shoot-em-up games in one. The 3D effect created by using contour line graphics tends to give it a more technical feel, so more like a simulation, but on the other hand there are lots of jets and enemy helicopters whizzing around and ground forces shooting at you which gives the game its instant playability appeal. Once you get the hang of coping with everything, it's possible to play a game of high strategy which involves not only arcade skills but those of forward planning. For people who enjoy strategy type games, Combat Lynx should provide hours of fun, while for those who prefer something instant and fast - choose skill level 4 and hang onto your hats! Generally the graphics are most impressive, with a few attribute problems when objects are about to become hidden, but these are minor in what is otherwise an engaging and challenging game."



## TURBO ESPRIT (3D Simulation Car Chase)

Spectrum 48k	£8.95
Commodore 64	£8.95
Amstrad 464/6128	£8.95

You are a special agent equipped with a Lotus Turbo Esprit. An international ring of drug smugglers are about to make a huge delivery of heroin, and must be stopped at all costs. The drugs are stored at a number of houses in the city, and will be taken by cars to an armoured van which will be cruising around the centre. A raid on the van before completion of the delivery would leave some of the drugs in circulation. Similarly a raid on any of the houses would alert them to your squad's activities. You must therefore try and pick-off the cars one by one before they make their drop, and then try to stop the van before it escapes. The delivery cars will be backed-up by 'hit' squads - so watch out!

(Developed with the support of Lotus Cars Ltd)

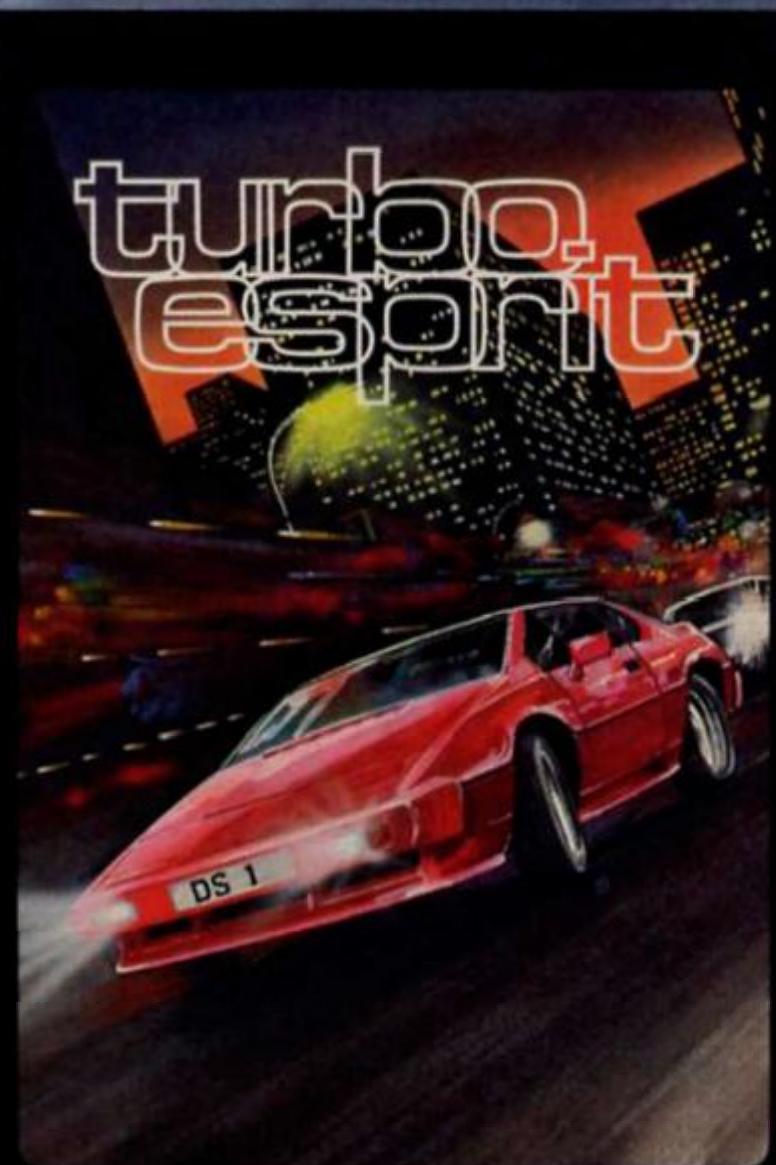





### CRITICAL MASS (Arcade)

Spectrum 48k £8.95  
Commodore 64 £8.95  
Amstrad 464/6128 £8.95

An outlying system of the Terra Federation has set up an advanced anti-matter conversion plant on a centrally positioned asteroid to supply the local colonists with energy. A surprise attack by alien forces has successfully overcome the asteroid's defences and the aliens are now threatening to self-destruct the power plant unless the colonists offer an unconditional surrender. The self-destruction process would effectively turn the power plant into a massive black hole that would wipe out the entire planetary system along with a number of nearby stars. Unconditional surrender offers an equally horrific prospect. Your mission is to infiltrate the enemy position and disable the anti-matter plant before the aliens achieve CRITICAL MASS.

"This is the biz!.....The graphics and playability of this game are superb, making it well worth the money."



### SABOTEUR (Martial Arts Arcade Adventure)

Spectrum 48k £8.95  
Amstrad 464/6128 £8.95  
Commodore 64 £8.95

You are a highly skilled mercenary trained in the martial arts. You are employed to infiltrate a central security building which is disguised as a warehouse. You must steal a disk that contains the names of all the rebel leaders before its information is sent to the outlying security stations. You are working against the clock, both in getting to the disk, and in making your escape. You must enter the building from the sea by rubber dinghy, and will then only be able to leave by the helicopter on the roof. You will have to find your way around the warehouse, making use of the guards' own weapon supplies in your struggle through overwhelming odds.

"Saboteur is without a doubt one of the best arcade games I've seen for a long time and a welcome departure from the plethora of licenced/endorsed product that the industry seems to currently favour. Recommended."



## SABOTEUR!



**DURELL sales dept.,**  
Castle Lodge, Castle Green, Taunton, Somerset, TA1 4AB, England  
Telephone (0823) 54489 & 54029

**software getting harder . . . .**



30 great games from leading software houses including Quicksilver, Bug Byte, Mind Games, Lothlorien, Argus Press Software, Taskset, New Generation and Terminal.

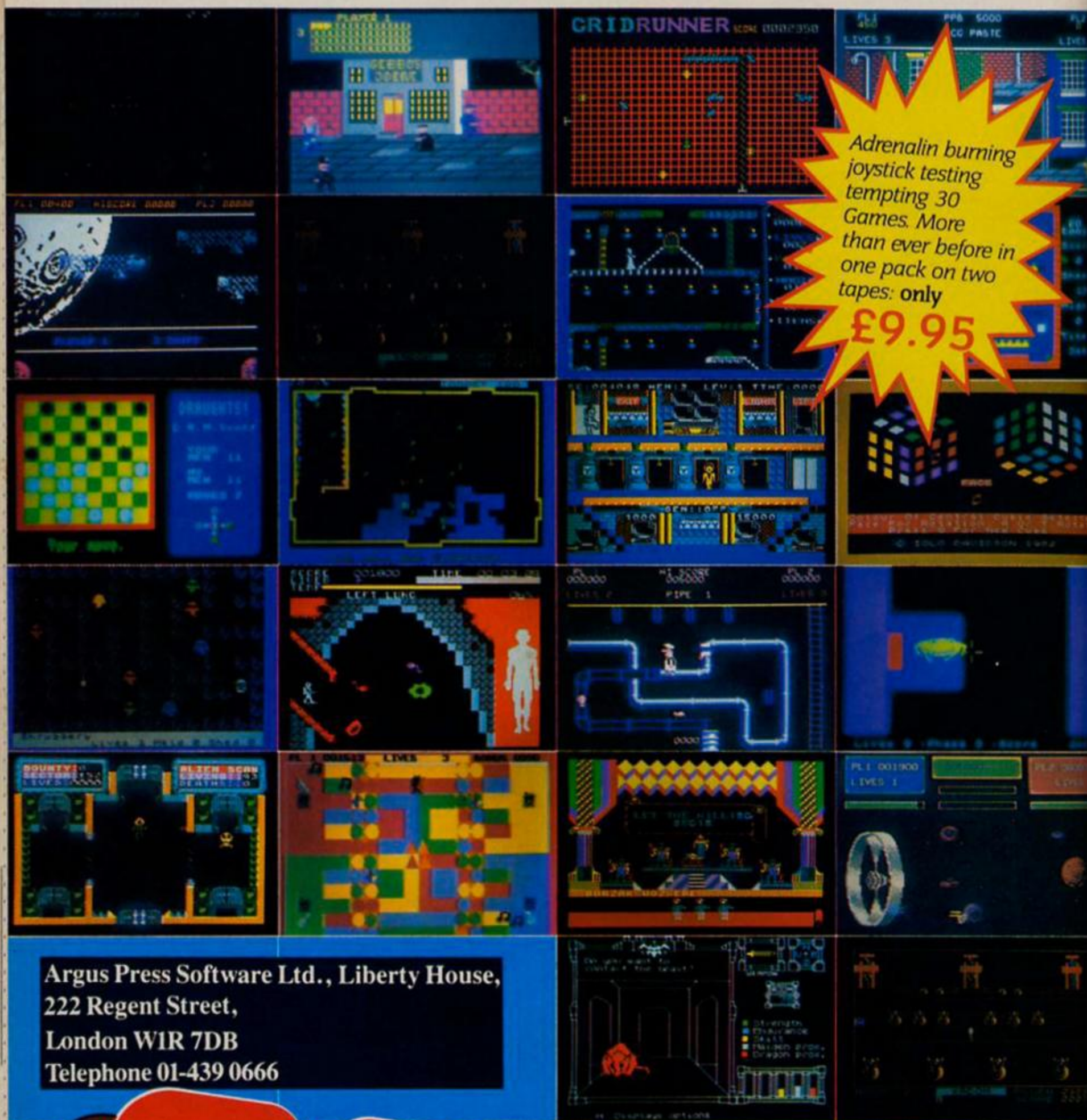

Adrenalin burning joystick testing tempting 30 Games. More than ever before in one pack on two tapes: only **£9.95**

Argus Press Software Ltd., Liberty House,  
222 Regent Street,  
London W1R 7DB  
Telephone 01-439 0666

# 30 GAMES



## Back to school

I would like to point out the time saving advantages of the Spectrum in educational use over the BBC computer. BBC programs always seem to take so long that I decided to make a comparison on the time taken to type in a simple program on the speed of molecules in a gas.

I found the BBC required about 1700 keystrokes to enter the program while the Spectrum did much the same with a 12 line program of 300 keystrokes. Science teachers take note!

Having been one myself I know they are very much pressed for time. There is also the advantage that the Spectrum detects some program errors by not allowing a line to be entered.

With other computers you may not detect the error until in the middle of running the program. Low cost is another strong point in favour of the Spectrum — it enables many more pupils to learn about computing.

In view of all this it seems unfortunate that the BBC seems to dominate the educational field.

Don Hinson, Llanrwst, Gwynedd.

## Printer hints

In the Feb/March issue Mr R. Luxton wrote an article concerning the Kempston E printer interface and the Epson FX80 printer. I have the Kempston E and an RX80 which is similar to the FX80 but without Esc 6 and proportional print.

With the interface, he said that the Spectrum should not have read the information after the REM. What actually happens is that when the Spectrum comes across a COPY command the interface's EPROM pages in. If it is just a plain copy, then the screen is copied, in text, graphics or large size graphics, depending on how the interface is set up. If it is a COPY:REM command, the characters are read by the interface not the Spectrum and the RAM on the interface changes accordingly.

A similar thing happens with micro-divide commands which cannot be used unless Interface 1 or a disc interface is connected.

I hope this clears up the enquiry he had.

Timothy Hunt, Bedford.

## Whys and wafa's

Mr Tyedman in a letter in the Feb/March issue mentioned that when using his Kempston E interface with a Wafadrive there was no screen dump available.

In fact Rotronics who manufacture Wafadrive have issued a number of very useful information sheets, one of which gives the listing to generate machine code to give a screen dump with Epson printers, or non-Epson models which recognise the ESC A and ESC L control modes.

Having used both Kempston and Wafadrive screen dumps, I prefer the Wafadrive, because it has two copy sizes. Another useful feature is that the Wafa copy routine allows you to specify the left margin width so that you have control over where the copy appears on the page.

# CROSSFIRE

**Crossfire is your page to express your opinions on current issues in Sinclair computing and the games scene. We want to hear from you on the problems that bug you and the pleasures of using your computer. And of course we want to know what you think about our first monthly issue.**



The Wafadrive

It is a pity that Rotronics do not publicise their information sheets more as they are reasonable in price and include advice on transferring programs to Wafa to enable you to transfer even long programs which use the Wafa ROM memory area.

I have found Rotronics are quick to reply to problems and very helpful. When I had a faulty wafer they retrieved my files and returned them to me on a new wafer. So full marks for customer service and I would advise anyone with wafa problems to contact them.

Carol Brooksbank, Coventry.

## Hex v Dec

Down with Hex and its mechanical mysticism! I count in tens and if the Creator (or should that be programmer?) meant me to count in sixteens he/she would have given me sixteen toes but at the last count I assure you I had the usual ten. Hex is for the computers' convenience not ours and

let's face it computers are supposed to relieve people of work not create more. Matthew Probert, Basingstoke.

The Hex versus Dec debate certainly seems to bring programmers' passions to the surface. Which side are you on?

## Clubs

From Alexandria to Barnsley Spectrum user groups continue to flourish and look for new members, write to the addresses below for further details.

Spectrum User Club, c/o K. Fox, 23 Caxton Street, Barnsley, Sth. Yorks. S70 2LF (SAE requested).

Club Pen Pal Apartado 364-3007 Coimbra Codex-Portugal. A pen pal group with 600 members around the world swapping information and ideas about the Spectrum.

Egypt Spectrum Users, c/o Waleed M. Hasan, 23 Shity Beck St., Saraya, P.O. Alexandria, Egypt. A growing number of Spectrum owners who wish to establish international contacts.



# 128

# TROASHURQ

This month we start a great two-part competition with five Spectrum 128s to be won.

Legend has it, so they say, that many, many moons ago a band of seafaring software pirates were washed up on a mysterious island and spent the rest of their days marooned with only BBC software to occupy their long empty days. Not surprisingly under the circumstances, they soon lost the will to live and quickly shuffled off this mortal

coil. But, before they went they buried their horde of five Spectrum 128s and threw a map of the island into the sea in a bottle.

Luckily the intrepid explorers at ZXC have managed to locate the map and a series of clues leading to the position of the buried 128s. But just to make things a little tricky for you we're

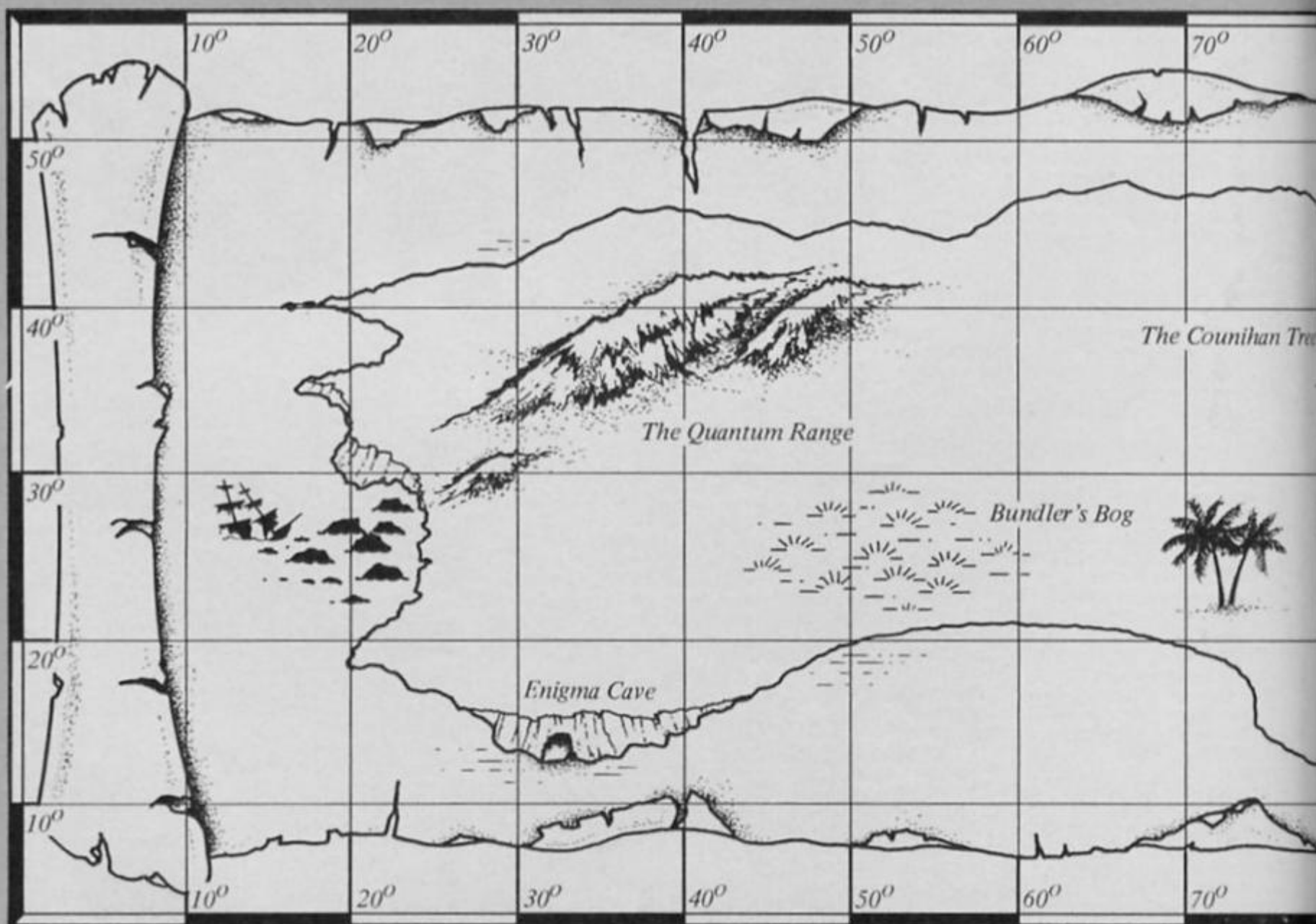



## The questions

- 1) How many Dalmatians were in the title of the Walt Disney film?
- 2) Around The World in how many days?
- 3) How many Thunderbirds were there in the TV puppet series?
- 4) How many years between each Olympic Games?
- 5) How many Dr. Whos have there been in the television series?

Now, take the answer to question 1, subtract the answer to question 2, and then add answer to question 3. That will leave you with a number that you then multiply by the answer to question 4, and if you add to that total the answer to question 5 you get the number that represents the latitude co-ordinate of the buried 128s.

# HWAAT

COMPETITION

only going to give you half the answer this month, and the other half next month.

What you have to do is answer the four questions below: these answers will leave you with four numbers which have to be added, subtracted and generally jiggled around to give you the latitude co-ordinate of the 128s (latitude is the

horizontal axis, marked between 0 and 150 degrees on the map). Next month we'll give you the clues that reveal the longitude co-ordinate and a tiebreaker.

Next month you'll get the second co-ordinate that will allow you to pinpoint them on the map. See you then.

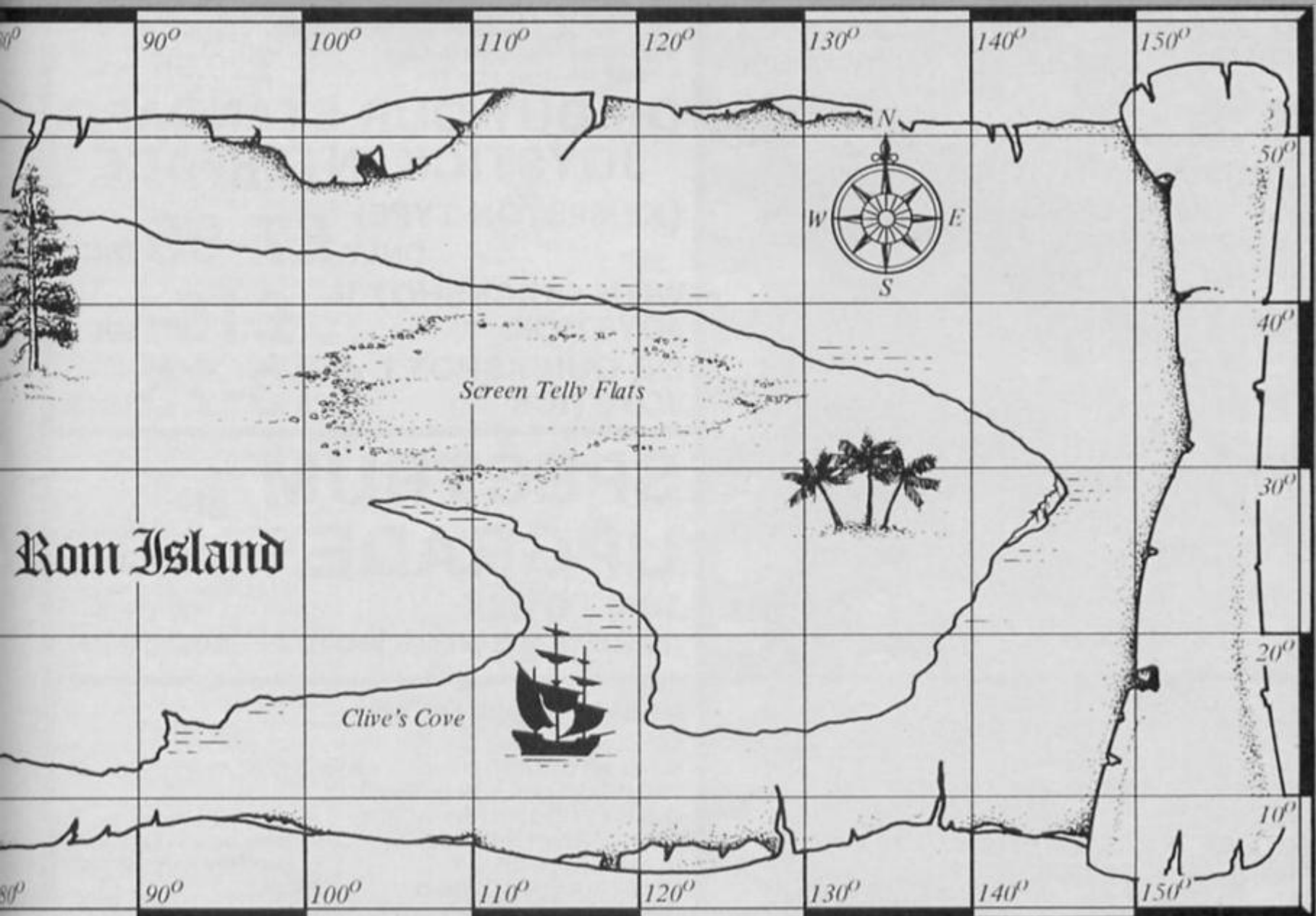

COMPETITION



# KEYBOARDS

## SPECTRUM REPLACEMENT

### THE 68FX2

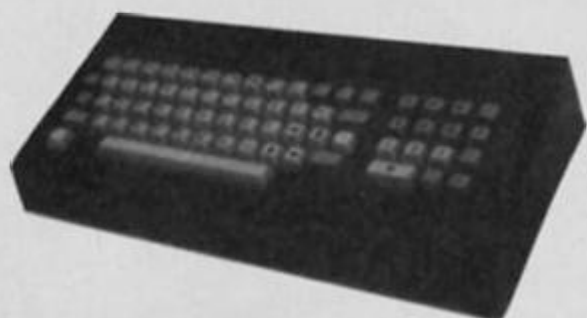

ONLY **£39-95** INCL.

WE ARE NOW ABLE TO OFFER THIS TRULY SUPERIOR KEYBOARD AT THIS EXTRA SPECIAL PRICE **£39-95** THIS KEYBOARD IS FANTASTIC ITS FEATURES INCLUDE:

- \* FULL SIZE SPACE BAR
  - \* INDIVIDUAL GOLD PLATED KEY-SWITCHES
  - \* SINGLE ENTRY KEYS INCLUDE FULLSTOP, SHIFT LOCK, EXTENDED MODE, COMMA, FULL-STOP, EDIT DELETE BREAK, MINUS, \*, RUN DIVIDE AND CURSOR CONTROLS
  - \* 1/4 THICK PLASTIC CASING
  - \* SIMPLE STEP BY STEP INSTRUCTIONS
- ALL FOR THIS UNBELIEVABLE PRICE OF **39-95**

WE STILL HAVE SOME 68FX1 LEFT THESE ARE AS ABOVE BUT WITHOUT EXTENDED MODE, DIVIDE COMMA + MINUS ON SINGLE ENTRY KEYS ONLY

**£29.95**

LIMITED STOCKS

+ 2-00 P&P

SEND NOW TO  
**FOX ELECTRONICS LTD**  
**FOX HOUSE**  
**35 MARTHAM RD**  
**HEMSBY**  
**GREAT YARMOUTH**  
**NORFOLK NR2 94NQ**

# JOYSTICK INTERFACES

## FOR THE SPECTRUM

### THE ULTIMATE

### THE FOX PROGRAMME

### JOYSTICK INTERFACE:-



What the review said...  
 SINCLAIR USER  
 FEBRUARY 1984  
 "Provides the easiest interface on the market to use"  
 SINCLAIR USER ANNUAL 1985  
 "At £28.95 the interface is excellent value"  
 ZX COMPUTING JANUARY 1985  
 "One of the easiest to use, get my approval"

THE FOX PROGRAMMABLE INTERFACE — AN INTERFACE WITH

- \* Complete compatibility with all programs.
- \* In-built memory to store up to 16 different games keysets at one time.
- \* Battery back-up so no loss of memory after power off. (Battery recharge during loss so no replacements are required).
- \* One switch only for simplicity of use.
- \* Full casing.
- \* Through port for further expansion.
- \* Proven compatibility with the microdrive.
- \* Built-in pseudo Rom facility with Rom for personnel tool kit.
- \* Compatible with all Atari-type joysticks.
- \* Compatible with Quickshot II rapid fire.

**SPECIAL OFFER ONLY!!**  
**£24.95**  
 INCL.

THE INTERFACE THAT ONCE PROGRAMMED NEVER NEEDS PROGRAMMING AGAIN!!!

NO TAPES!! NO LEADS TO CHANGE !!  
 JUST FLICK THE SWITCH AND PLAY THE GAME WITH FOX

**SPECIAL OFFER**  
 BUY THE ABOVE INTERFACE WITH THE QUICKSHOT II JOYSTICK FOR ONLY  
**£29.95**

**OR BUY OUR STANDARD JOYSTICK INTERFACE**

(KEMPSTON TYPE) ONLY **£7-95** INCL

WITH QUICKSHOT II JOYSTICK **£15-** INCL

OR QUICKSHOT I JOYSTICK **£13-75** INCL

# SPECTRUM UPGRADE

16K TO 48K  
 (ISSUE 2 or 3 please state)

ONLY **£18.95**  
 INCL.

IN ONE SIMPLE KIT

PLEASE SEND ME:-

- 68FX2 KEYBOARD  Name .....
- 68FX1 KEYBOARD  Address .....
- PROGRAMMABLE INTERFACE
- Q/S II + PROG. INTERFACE
- STANDARD INTERFACE
- STANDARD + Q/S II
- SPECTRUM UPGRADE
- I enclose £ .....  
 or Debit my Barclaycard/  
 Access





# MOVIE

Imagine  
£7.95

The new, revitalised Imagine are continuing to turn out some very good games, the latest being *Movie*, a game set on the streets of New York in which you play the part of Jack Marlow, a *Private Eye* in search of a valuable tape recording.

The style of the game is similar to that of *Knight Lore* and the more recent *Sweevo's World*, giving a slightly overhead 3D view of the streets and rooms that you travel through. But instead of being a cute little sprite, Jack Marlow is a shady looking character in a trench coat and trilby, and as he walks along there's an effective crunching sound effect that sounds as if Jack is walking along the gritty New York sidewalks.

The tape that you're looking for is in the hideout of the gangster Bugs Malloy, but getting there isn't going to be easy. As you scout the area you'll bump into some of Bug's henchmen, and there are more and more of them the closer you get to the hideout. Some of these people may be able to help you, but most of them will try to bump you off with a well placed bullet or a haymaker to the chin. Fortunately you can pack a mean punch as well, and watching the hoods disintegrate after a slugging match is very satisfying. Also, if you can find them there are guns and bombs lying around that will let you shoot your way out of tough spots.

As well as the Ultimate style graphics, *Movie* also features an icon menu that allows you to perform a variety of actions; you can pick up/drop objects which can also be used or simply thrown, you can punch or shoot other characters or even talk to them. This last option is very novel — when you select the 'talk' icon a speech bubble appears over Marlow's head and you can fill the speech bubble by typing text on the keyboard. The level of conversation is fairly basic, but it is sufficient to let you get a password that you will need later on in the game.

The icon menu takes *Movie* a step further than similar games as it allows you a wider

variety of actions (it's interesting to wonder what a version of the game for the 128 might do with the extra memory and sound facilities).

You'll need help to locate Bug's hideout and this arrives in the form of the twin sisters Tanya and Vanya — one of these is on your side and will lead you there, though you'll need to do some quick thinking to follow her all the way. The other sister is a 'plant' and she'll only lead you into an ambush so it's up to you to work out which sister is on your side.

My only quibble with the game is that you only have a single life to play with and it can be very frustrating to reach a late stage in the game only to lose everything by making a single mistake. Even so, the quality of the graphics and the gangster setting make *Movie* stand out from the crowd.







Drawn from a photo



Two faces merged

### Computer Graphic Designer, Neil Strudwick explores the capabilities of Rainbird's Art Studio.

Now there's a piece of software that boosts the graphic potential of the Spectrum and is great fun to use.

The Art Studio (£14.95) is an exciting new graphics package which uses the WIMP environment (windows/icons/mouse/pulldown menus) to create professional looking graphics, and does it as well as the bigger and more expensive micros. The WIMP environment is easy for even a first time operator to use, and has no complicated keyboard sequences to learn. It is also smooth and fast in operation.

By now you may be familiar with all the commands available but may not realise that by using a combination of commands you can create some great effects. So here are some suggestions for getting the most out of the Art Studio.

Start with a simple outline shape, such as a letter or symbol. If you are not artistic, then trace around your image from a photograph or something already drawn, onto a piece of clear acetate. Draw the image as large as possible, but so that it fits in the screen of your

tv/monitor. Trace round the image using the 'Shapes' commands (ie Elastic on/Cont. Lines).

The reason for doing the shape large is so that you have the option of rescaling it smaller (smaller images enlarged become distorted).

Having completed your shape, save it to tape, or microdrive if you have the extended Art Studio. Now you can begin to experiment on it. If there is room on the screen make two copies on it, in case you make a mistake, that way you won't have to reload your original.

You can now fill your shape with various textures, using 'Undo' to experiment, or try out the drop shadow effect mentioned at the back of the manual.

The drop shadow effect uses the 'Windows' commands quite extensively, firstly fill your shape in solid, then copy it using 'Cut & paste window'. Immediately after you have positioned and printed the copy, select a wash texture (halftone) and the shape becomes a halftone. You can then copy and merge your solid shape on top and off centre to give the shadow effect.

You can then put a window around the whole image, clear it using 'Clear window' and then immediately select a further wash texture. You could go on selecting wash texture until your image eventually disappears.

This technique of clearing a shape and washing texture can



be applied to the commands 'Cut, clear & paste' and 'Clear & re-scale', indeed any command that erases a shape.

Try 'Clear & re-scale' without 'merge' and print the rescaled shape over the original, then apply a wash texture. The original shape reappears behind the second shape. Now if you have 'Over' switched on from the 'Attr's' menu, your first image will blend with the second if you merge them. If the 'Over' switch is off pixels merged are unchanged ie black pixel + black pixel = black pixel, but if 'Over' is switched on then the combination is on an XOR basis, this would mean black pixel + black pixel = white space.

The best use of Over (other than a special effect) is when you would like to turn a solid shape into an outlined shape. A simple example would be if you wanted an outline of a square from a solid square. With 'Merge' and 'Over' switched on put a window around the solid square, select 'Re-scale window' and print the re-scaled window directly over the solid square but one pixel smaller all round.

If your shape is a solid and you wish only part of it to be textured, select a brush, pen, or airbrush from the 'Paint' menu with the 'Inverse' switched on, erase part of your shape that you wish textured, then immediately after select a wash texture. The removed part will reappear in the chosen texture. This technique also applies if you use commands from the 'Shapes' menu and 'Text' menu!

Remember that 'Inverse' also has an effect on the 32 textures, with 'Inverse' on you have 32 inverse textures giving access to 64 textures. This 'Inverse' also applies to the 'Text' menu and the 'Paint' menu when using the 'Brush' command. Depending on whether you have inverse on or off it will give the effect of having a solid or outline brush shape.

Returning to 'Windows', I have quite often used this menu if I wanted a larger brush. For example if you wanted to draw a shape made up of large circles, first draw a circle from the 'Shapes' menu, put a window around it, with 'Merge' and 'Multiple' switched on, and then by repeatedly moving and pressing the fire button, you can draw with that shape. Try this technique using the 'Over' switched on, and see what happens.

Finally I will mention the use of colour. I cannot go into great detail about it because of the nature of the Spectrum attribute screen, but a good way to reduce colour/attribute problems is to use 'Windows' to reposition areas of your picture. One way to colour areas of the screen

easily is having selected your appropriate colours, go to the 'Paint' menu selecting 'Brush'. Choose a 'null' brush (ie a blank brush that changes attribute colours, not pixels).

Quite simply you then brush colour onto the relevant areas of your picture. For large areas choose a 'null' texture that will rapidly colour areas of the screen.



The changing face of Sir Clive

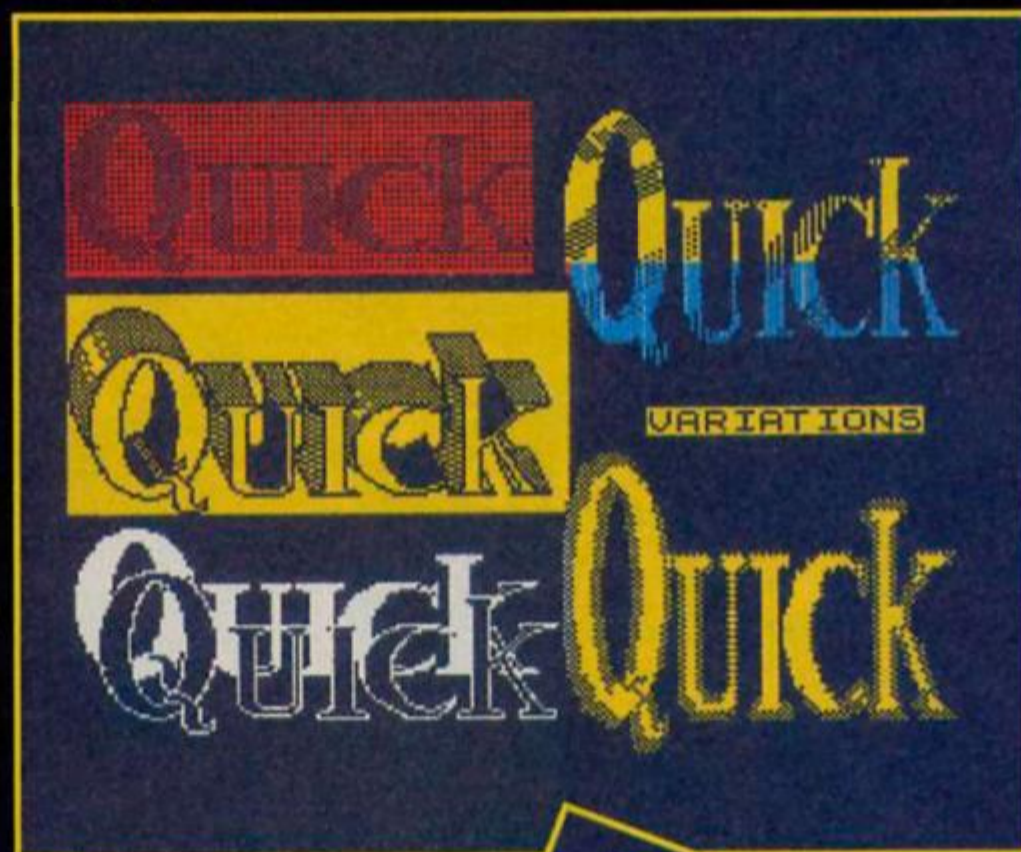

Variations





# THE FORCE

An icon-driven multi-screen strategic simulation of what it's like to take on the most difficult task of all

You may have saved the world from invading aliens many times over - but are you good enough to protect one small town from the criminal element within?

You have at your command around 500 officers, 100 vehicles and a host of other units. All that goes to make up four city police stations in fact. All you have to do is keep the crime rate down . . . and the people happy.



**MIND GAMES**  
Available for the  
Spectrum 48K and CBM64

Argus Press Software Ltd., Liberty House,  
222 Regent Street, London W1R 7DB  
Telephone: 01-439 0666

Designed in consultation  
with  
Britain's Senior Police Officers



ELW 4001



There are five copies of Kipper Williams' new cartoon collection and an original cartoon to be won in this draw if yourself competition.

**COMPETITION**

# CARTOON TIME

Have you ever wondered what your computer is doing when your back is turned? Which computer game do nine out of ten space invaders prefer? These and other vital questions are answered in 'Warning: This Computer Bytes' a hilarious selection of cartoons focussing on the outer limits of obsessive computing.

Kipper, whose cartoons can be seen regularly in Time Out, Smash Hits and Radio Times, says he has avoided the lure of the computer - so far.

"I don't have one and must confess I don't even use one," he said. "I'm certainly not an addict. I always look at it from the point of view of an outsider."

"I think they are fascinating machines but I'm more interested in the people who use them. I find computer users who hide themselves away mildly disturbing and I always get the sense that perhaps it's the machine rather than the man that's in control."

To enter the competition simply dream up and draw a cartoon on any aspect of computing. If you are in control of your computer you might entice it to give you some help with the graphics. Send your entry to Cartoon Competition, ZX Computing, No 1 Golden Square, London W1R 3AB. Be sure to include your name and address.

## Rules

- Entries will not be accepted from employees of Argus Specialist publications, Alabaster Passmore and Sons or Javelin books. The editor's decision is final and no correspondence can be entered into.

- All entries must be received by first post on Friday 16th of May. The winners will be notified by post and the results published in a future edition of ZX Computing Monthly.



The original could be yours.

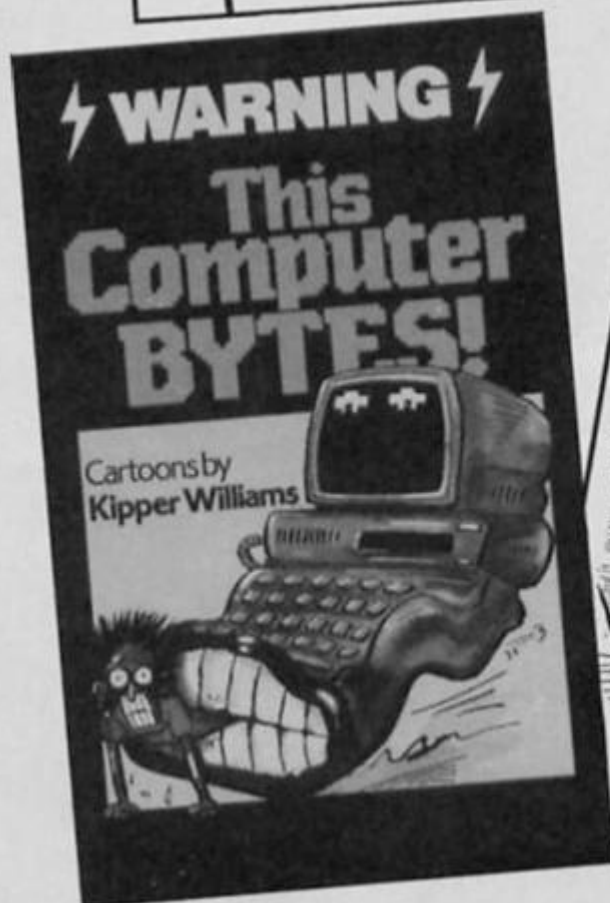

**COMPETITION**



# MOUSE WARS

## AMX MOUSE

Advanced Memory Systems  
£69.95

First past the post with a mouse package for the Spectrum are Advanced Memory Systems, probably the best known to Spectrum owners for the add-on keyboard that they produced some time ago, though the company is also well known as a producer of peripherals for the BBC micro and this mouse is a version of one originally produced for that machine.

I had originally feared that in order to produce a low-cost mouse for the Spectrum AMS might have to cut a few corners in the construction of the unit, but unpacking the mouse revealed it to be a good solid unit constructed out of strong black plastic. Mounted on the mouse's 'head', just below where your fingers would rest when using it, are three large red switches which the manual refers to as 'Execute, Move and Cancel'. These are fairly self explanatory, allowing you to execute a command, move the control pointer to another part of the screen, or to cancel a command in the event of a mistake.

On its underside is a single hard plastic 'ball-bearing' which allows you to move the mouse over flat surfaces and to 'track' the control pointer around the screen in response to that movement.

The mouse is connected to your machine via an interface that plugs into the rear peripherals port. The 'tail' of the mouse, a thin cable running out of the front of the unit, then plugs into the interface. A centronics printer port is also included in the mouse interface (which makes the whole package good value since this is worth up to £30 on its own), and screen dumps to a printer can be controlled directly from AMX Art, the graphics utility that comes as standard with the mouse.

The manual is very well produced and illustrated and, despite one or two fuzzy patches, generally very clear. Where the manual, explaining the IMPORT command, states that it is impossible to load a SCREEN\$ using this command, it should actually say 'possible'

rather than 'impossible' — this confused me for a while since I couldn't see the point of a graphics utility that doesn't allow you to load a screen picture.

The software cassette that comes with the mouse includes AMX Art, AMX Palette, AMX Control, Icon Designer and a demonstration program. AMX Art is an icon and pull-down menu driven graphics designer which, although lacking some of the refinements of The Art Studio is still very sophisticated. The row of icons down the right hand side of the screen which control most of the drawing, painting, and shape commands are marginally faster to use than the Art Studio, which is totally menu driven, though slightly less versatile. AMX Art also allows you to draw a picture that is four times the size of the normal screen area.

The screen that you are presented with when the

program loads is a window allowing you to see the top left-hand quarter of the area that you can draw onto. The rest of this area can be seen either by shrinking the whole thing into the usual size of the screen, or by moving the window around using the icon commands available. If you draw something large enough to fill this entire area, AMX Art allows you to dump the whole picture onto a printer.

The only drawback with this program is that it cannot handle colour at all. You draw pictures in black and white, save them onto tape, then load the AMX Palette program. Your picture then has to be loaded into the Palette program as a SCREEN\$ before you can add colour.

Quite possibly the most

important and powerful of the programs provided with this mouse is the AMX Control program. This is a chunk of machine code that adds 28 commands to the Spectrum's BASIC, all concerned with controlling the mouse. This means, in effect, that you can write your own mouse software, and the Icon Designer program allows you to create your own icons for use with that software.

Obviously, becoming familiar with these commands will require a certain amount of effort but since they open up the possibility of writing just about any sort of mouse-controlled program that takes your fancy the potential of AMX Control is enormous. The demo program that comes on the cassette gives two examples of such programs; a simple sliding block puzzle, and a calculator that are both mouse controlled.

In addition to this write-your-own-software potential, the people at AMS tell me that they hope to produce further mouse software probably along the lines of the 3D Graphics, Database, and Page Maker programs that they have already started to produce for the BBC mouse, so that the potential usefulness of this mouse goes beyond just designing screen pictures.





## KEMPSTON MOUSE

Kempston Micro Electronics  
£69.95

Kempston step into the ring with the reputation of being one of the most well established and successful producers of peripherals for the Spectrum. They can rightly claim to have produced the closest to a universal joystick standard that exists for that machine and so they're in a good position to repeat that success with their mouse system.

Simply handling the Kempston Mouse shows it to be even more soundly constructed than the AMX version. It's smaller but slightly heavier and the tracking ball on the underside is made of rubber, factors which may well give the mouse a firmer grip on your work surface. At the same time, the tracking ball is surrounded by four steel ball-bearings that help to make it move smoothly. Just two buttons are mounted on the mouse's 'head' almost flush with the surface and this, along with the smaller size and white finish, gives it a more stream lined, hi-tech look.

The interface looks exactly like a standard Kempston joystick interface, with a D socket into which the mouse is plugged.

At the moment, the mouse comes bundled with a copy of The Art Studio which, as all good computer magazines will tell you, is the best thing since sliced bread. Its ability to cut and paste areas of the screen is virtually unmatched, except by the harder to use Artist from Softek. It is also very versatile in its shape handling commands, and the fill routine is probably the fastest around.

Art Studio is already compatible with the AMX Mouse, but it requires a few POKES to

make it Kempston compatible (although the microdrive version, Extended Art Studio is already compatible with both). Adding these POKES took a minute or two, but only needs to be done once since Art Studio allows you to make back-up copies of itself with these POKES included.

At the moment the documentation for this mouse isn't completed, though the Art Studio obviously carries its own manual and since there are no other bundled programs to compare with the AMX Control and Icon Designer programs,

there's unlikely to be any need for a large manual. However, Kempston do intend to produce their own graphics utility which, when finished, will replace Art Studio in the package, and the duplicated sheets that came with our review model had brief notes about the ports used by the mouse and the relevant memory locations as well as a short test program and it would be useful to see these expanded on.



### The winner . . .

Well, there isn't one really; this is one of the few occasions when I can't honestly recommend one product over another. £69.96 is quite a lot of money, but I have no doubts about recommending them both as being well worth the price. Both packages are good value since they bring to the Spectrum facilities normally associated with much more expensive machines. And in both cases along with the ease of use that a mouse brings there is also an element of sheer fun.

A mouse gives you much finer control over picture designing than any of the light-pens, graphics tablets or other graphics aids that I've used, and once doodling on screen becomes as easy as doodling on paper it also becomes an enormously enjoyable pass time.

In terms of the actual mice themselves, Kempston have a very slight edge. Though I would never call the AMX Mouse poorly constructed the Kemp-

ton seems a little sturdier, and because of the rubber tracking ball it seems to have a better grip on the work surface. On the other hand, the AMX mouse does include that Centronics port which is both useful and excellent value. And, at the risk of hedging my bets, I can't really criticise the construction of the AMX Mouse: they're both very good, it's just that the Kempston is a little better.

It's also hard to balance the merits of the bundled software. The Art Studio which (at the moment) comes with the Kempston Mouse is without doubt better than any other Spectrum graphics program, including AMX Art. However, the AMX software also includes the AMX Control and Icon Designer programs which open up all sorts of possibilities, and there is also the likelihood of future software support from AMS themselves.

I'm pleased to say that whichever product you decide to buy, this is one of those rare occasions when you're unlikely to regret your choice. Monster hits all 'round.

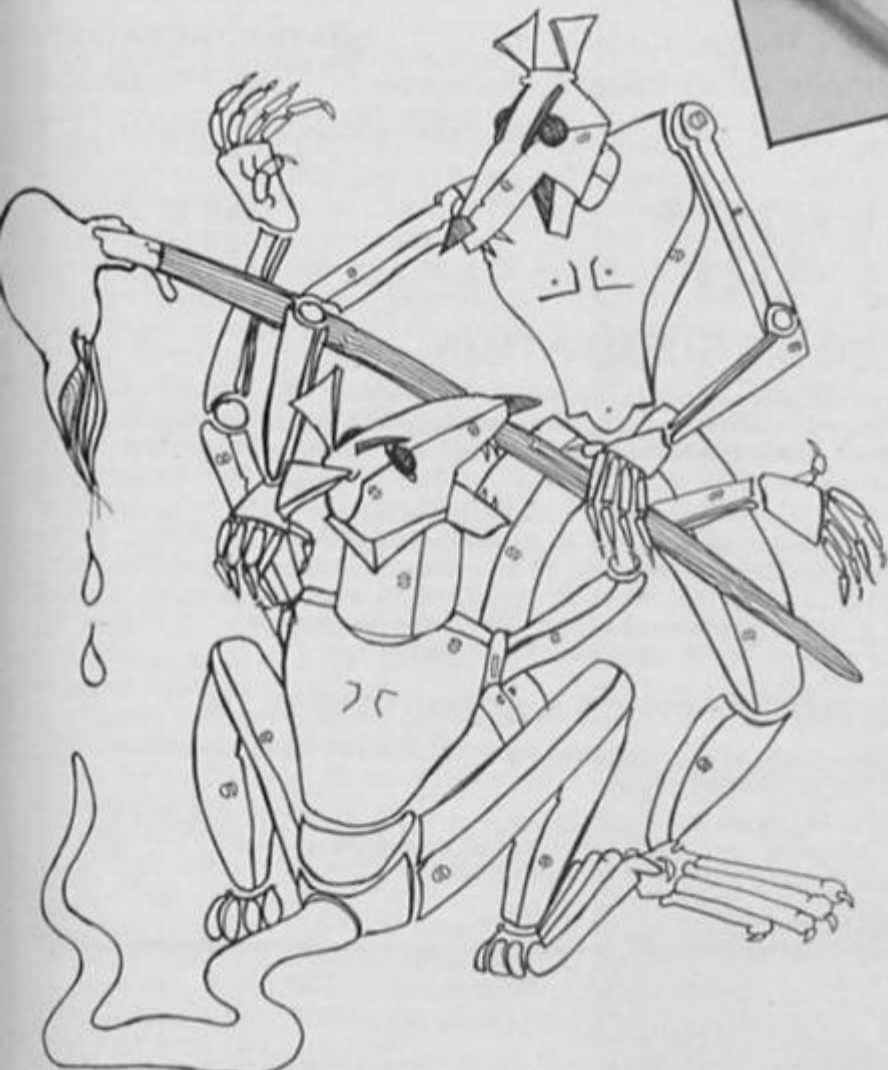



THE  
ADVENTURE  
COMPILATION

TONY BRIDGE'S

## FOURMOST ADVENTURES

Featuring:  
**OUT OF THE SHADOWS**  
A CRASH SMASH

### GALAXIAS

A new graphic adventure from the author of BORED OF THE RINGS.

### THE MICRO MAN

Imagine yourself a tenth your height, but smaller!

### THE MURAL

One of the funniest and most inventive adventures we've yet seen.

ALL FOUR  
GAMES ON  
ONE TAPE  
FOR JUST  
**£7.95**

SPECTRUM 48K

Available from all good software retailers, or in case of difficulty, please send a cheque or postal order to:

 **GLOBAL SOFTWARE**  
PO BOX 67  
LONDON SW11 1BS.

# TROJAN CAD-MASTER™

THE ULTIMATE IN GRAPHICS TOOLS

COMMODORE 64 SUPERB GRAPHICS SOFTWARE PLUS A TOP QUALITY LIGHT PEN SPECTRUM

Discover the exciting world of creating your own graphics on screen.

- FREEHAND DRAW - 5 pen thicknesses incl. Quills
- PAINT BRUSH - for the artistic touch
- FILL ANY SHAPE - use all colours and patterns
- GEOMETRIC SHAPES - circles, boxes, triangles, lines & banding
- DYNAMIC RUBBER BANDING - on all geometric options
- PIN-POINT FUNCTION - for pixel accuracy on all functions

Plus many more too numerous to mention in this ad. All these features in the Program + a top quality Light Pen and an Instruction booklet in one reasonably priced package. Easy to use for creating colourful pictures or technical drawings. Ideal for use by all ages of micro users. Full back-up service from manufacturers. Available at good dealers or direct from Trojan Products. Please state which Micro.

ONLY  
**£19.95**  
per pack.



## TROJAN

Micro Computer Software & Accessories  
Send cheque/P.O. to  
TROJAN PRODUCTS  
166, Derlwyn, Dunvant, Swansea SA2 7PF  
Tel: (0792) 205491.  
TRADE ENQUIRIES WELCOMED

QUAL-SOFT

# THOUGHTWARE

Sports simulations

"A real challenge to the thinking football fan... Bobby Robson could do worse than have a crack at this in his preparation for the World Cup".

AMSTRAD ACTION  
REVIEW Jan '86

QUAL-SOFT COMMENT: At last an INTELLIGENT management game for the knowledgeable soccer enthusiast!

TAPE 1  
QUALIFIERS

## MEXICO '86\*

TAPE 2  
FINALS

### A WORLD CUP MANAGEMENT SIMULATION

Summer 1984 and English International football is at its lowest ebb. We have failed to qualify for the European Nations Cup, and had a string of very poor International results. In a few months we will set out on the '86 World Cup qualifying trail. You have been given the most important job of restoring English pride in their football. You have a match in Paris, the USSR at Wembley, and a South American tour, to assemble a team, first to qualify, and then to beat the world's best in Mexico.

#### TAPE 1 (Qualifiers)

- ★ Current squad of 16 players + 20 user defined players.
- ★ Friendlies in Paris, at Wembley + South American tour.
- ★ ANY team formation you choose. 2 from 5 substitutes.
- ★ In match tactics: any no. of individual player adjustments.
- ★ Your qualification group: full results and table.

#### TAPE 2 (Finals)

- ★ Choose a 20 man squad to take to the finals.
- ★ Group of 4 prelims. 16 to final knockout comp.
- ★ Extra Time, PENALTY SHOOT-OUTS, where relevant.
- ★ Formation and strength information on opposition.
- ★ 2 from 9 substitutes (the FA tells us so).

### ENGLAND'S GAMES: FULL PITCH, 22 MAN, 3D GRAPHICS & SOUND EFFECTS

QUAL-SOFT comments: With 5 levels of play, 12 depths of sophistication, and "fun" graphics, this game can be enjoyed by an 8 year old youngster as a "fun" game, and by the most sophisticated as a tactical/strategy challenge of the highest order.

PACKAGE: Tape 1 plus Tape 2 plus 20 Page Manual in "Video Cassette" style pack. Only £9.95 90K RAM usage. Some would call this a MEGAGAME. YES IT WILL RUN ON YOUR 48K SPECTRUM.

QUALSOFT GUARANTEE: Sent by 1ST CLASS POST on day of the order with P.O., Cheque, Access payment is received. Telephone Access orders accepted.

\* The use of the name MEXICO '86 does not imply any association with FIFA

QUAL-SOFT,  
Dept. ZX  
18 Hazelmere Rd.,  
Stevenage, Herts SG2 8RX.

Tel: 0438  
721936

SPECTRUM  
48K

Name: .....  
Address: .....  
.....  
Access No. (if applicable) .....



# LIFE IN THE FAST LANE

Ray Elder test drives  
Durell's Turbo Esprit.

The building hadn't changed from the last time I visited them two years ago, but the unassuming cars parked outside were less rusty and had more wheels.

Inside, Mike Richardson, programmer of Durell's Spectrum games and occasionally some on other machines, was about to demonstrate the preliminary version of TURBO ESPRIT to Richard White, revered head of the company. I had been invited along to witness this event.

The plot of the game had in fact undergone slight modification from the original concept, and Mike was explaining this to a critical Robert when I arrived. The game is not just another driving simulation. Both Mike and Robert share the belief that simulations tend to become boring, but Turbo Esprit shares the same general concept as Combat Lynx, that of an arcade strategy game. The driving is a skill in its own right, but simplified — ie. this car is fitted with automatic gear change!

The purpose of the game is to foil an international gang of drug dealers who are about to smuggle in a shipment of drugs in an unmarked armoured car. The drugs will be transferred to ordinary dealers' distribution cars where they will be taken to various secret hideouts. Once the drugs have been transferred then it's up to you to stop that supply by either shooting the distributor's car or bumping into it until they surrender. This of course means a high speed chase round the city.

When the armoured car has made four deliveries you can then try to force it to surrender (shooting it has no effect).

The bottom half of the screen is a colourful and well designed area that shows the car's dashboard, revs, speed, fuel and temperature. Messages are also flashed up in this area and you can expect warnings of lack of fuel and engine problems among others.

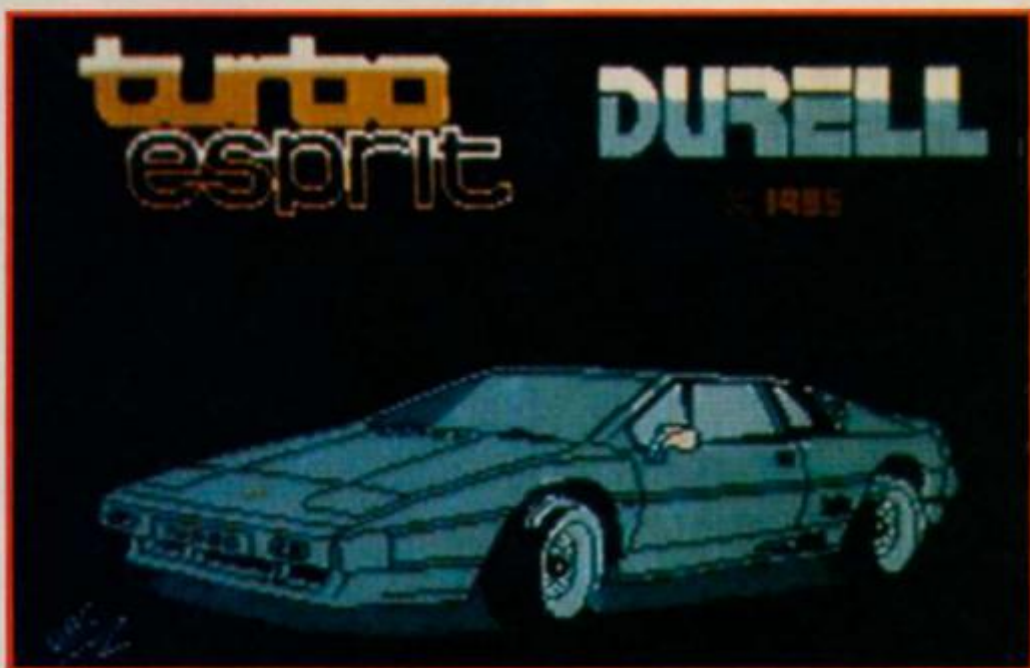

The top half of the screen can toggle between a 3D solid perspective view of the city and your car — rear or side view — and a map. The 3D view is the main driving screen and shows the direction you are travelling in, with the city street scrolling towards you. Though the buildings are featureless blocks, the rest of the detail is superb. Pedestrians, other motorists, traffic lights and roadworks complete with little flashing warning lights are included. This is mainly in black and white with occasional use of colour for enemy cars.

The map screen is for getting your bearings and tracking the movements of the gang's cars. It shows the city to be essentially a 30x30 grid. It also shows a feature which had been at the back of my mind while driving on the 3D screen, the city roads are laid out in straight lines with



right angled intersections. Certainly not like any city I've driven in, but perhaps this is the way it will be in the future?

You gain points for completing each section of the task and lose points for injuring or destroying innocent bystanders and their cars. Oh, and the gang has their own squad of hit cars which roam the streets trying to destroy you!

Mike told me that the game, though nearly complete, may be modified before it reaches the shops, but as it stands the graphics are excellent though sound is minimal. I loved simply driving around the streets and got into some glorious jams.

Chasing the gang's cars was much more difficult, Robert and I were hopeless, though Mike did it with ease (but then, he wrote it). As I left, snatches of conversation floated down the stairs:

"Four difficulty levels?"

"OK, could be the speed of the gang's cars, how about a choice of black gang cars or coloured, that'll make it more difficult?"

"Joystick and user defined keys of course."

"Of course."

"How about having a targetting system when shooting at the enemy cars . . ."





# LOST IN

The Magic Knight from Spellbound has been propelled forward into the 25th Century in Knight Tyme, a sequel written specially for the 128K Spectrum.

The story so far — our hero, the Magic Knight has saved Gimbal the Wizard. Thus Mastertronic author David Jones left him at the end of Spellbound but instead of retiring the Magic Knight has been thrown forward centuries in time to find himself as an anachronistic stowaway on the USS Pisces bound on a trading mission somewhere in a faraway quadrant of space.

The laws of time are protected by the "Paradox Police" who are out to hunt the Magic Knight down and dispose of him. Under your guidance the Knight must find the Tyme Machine before he meets a grim fate.

As with Spellbound, Knight Tyme uses the "Windimation" control system which features animated graphics commanded from a series of window menus. These options depend on where you find yourself on the ship and the objects you have managed to pick up.

Somewhere in sector two is the Tyme Machine and you have to find your way to it in the face of total non co-operation from the ship's inhabitants. Their indifference may stem from the cloak of invisibility which can be turned on and off at will.

Some aid is given by the ship's transporter system Derby IV and you have a blank ID card for which you need to get a picture. With your identity established you can set about controlling the crew members and eventually pilot the ship yourself.

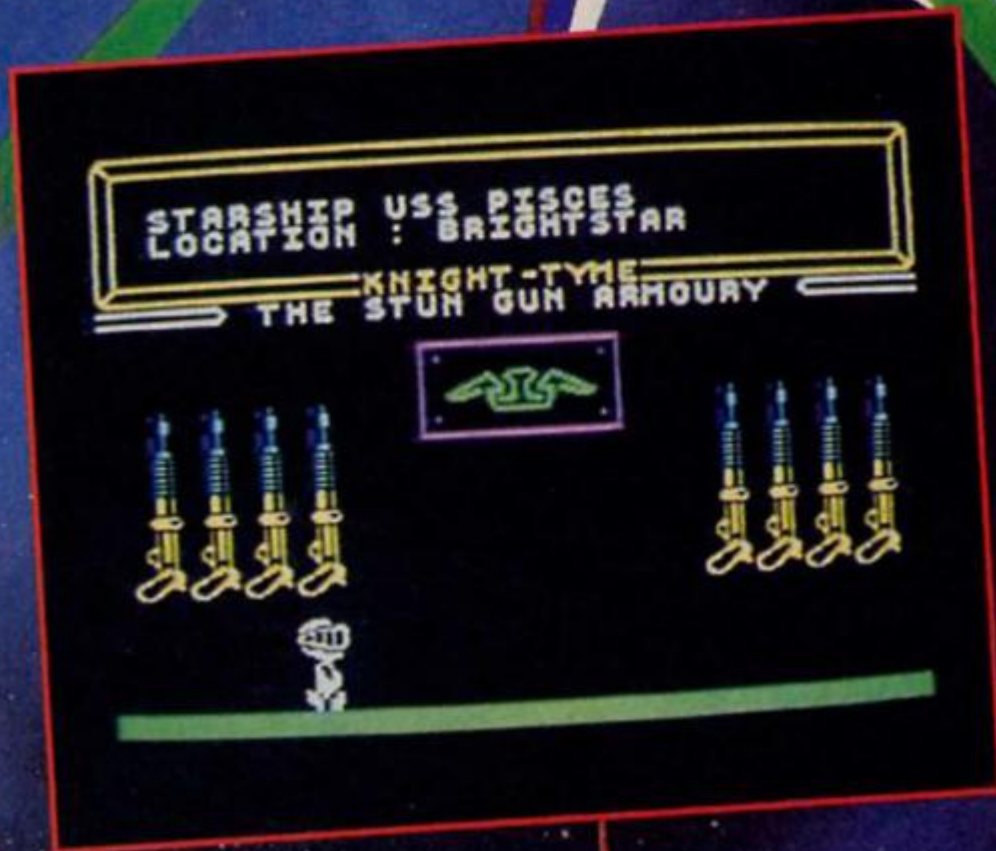
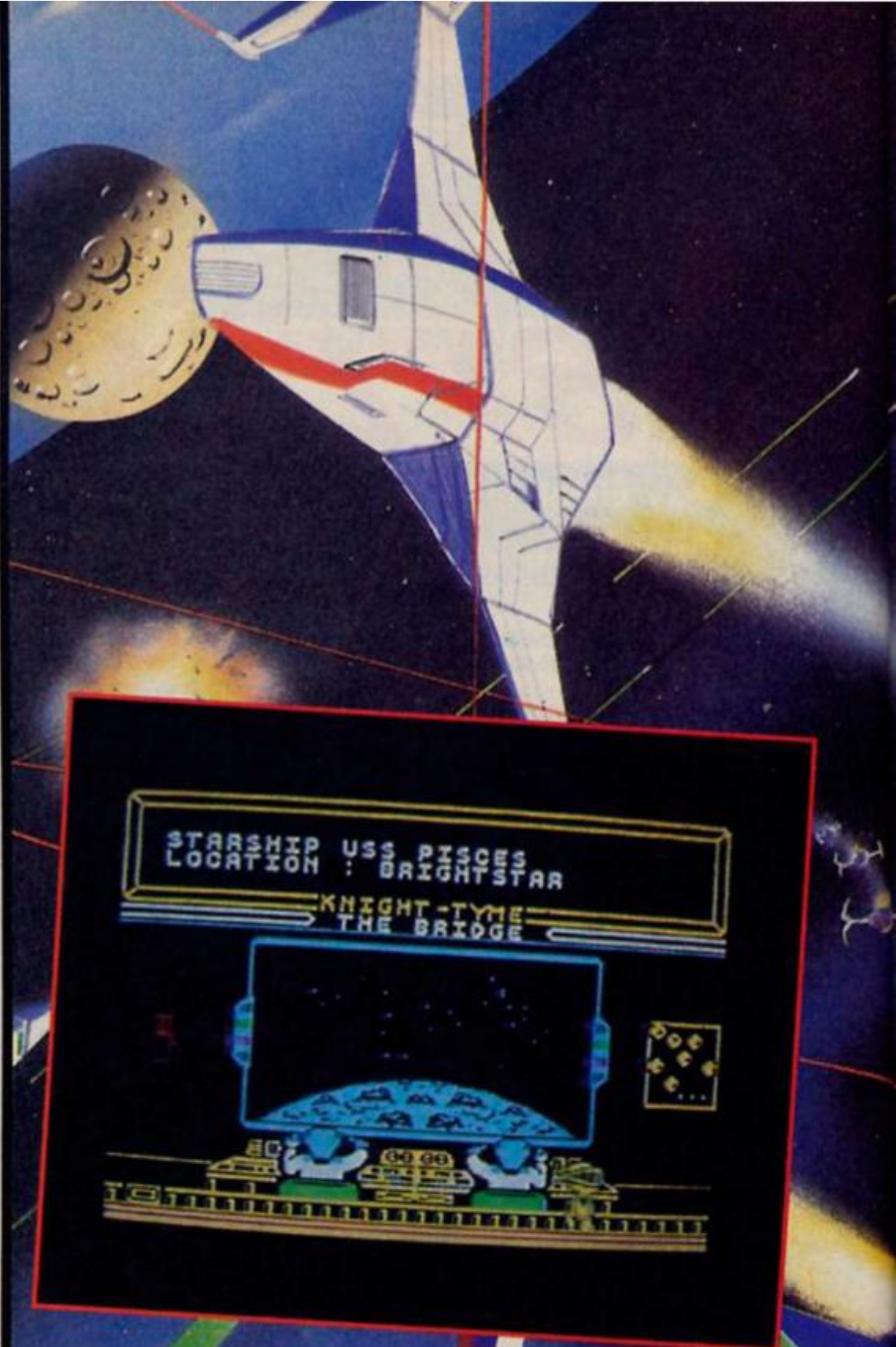





# SPACE

Ports of call in the galaxy include Serendip, Aridia and Pern and slightly more down to earth the dreaded planet of Revenue the collection point for the universe's tax returns.

The ship's transporter must be repaired before you progress and your supply of nutrients dwindles. But if the worst comes to the worst even dying in Knight Tyme is not without compensations — the transporter disassembles your molecules and puts them together in deep space in the shape of a butterfly. It's a nice way to go.

Littered throughout the Pisces are objects of different shapes sizes and uses. And of course on the Pisces there are many red herrings to eliminate before you can find if the objects are a help in your quest.

One tip; don't pick up the pot of glue — you won't be able to put it down again and it restricts the number of objects you can carry around.

Although Knight Tyme has been developed especially for the Spectrum 128 there will be a "concentrated" 48K version available soon.

When playing Knight Tyme you forget that you are becoming addicted to what is technically a budget game. However the only 'budget' aspect of the game is the price which will be £2.99 even for the 128K version. With knockout graphics and animation, the windimation control system, music by Ron Hubbard and an enthralling story line, Knight Tyme puts to shame a lot of games which are three times the price.

Spellbound set a new standard for budget games and Knight Tyme pushes that standard up even further and is a welcome addition to Mastertronic's already impressive catalogue of M.A.D. games.

And to cap it all there is a third Magic Knight game in the pipeline.





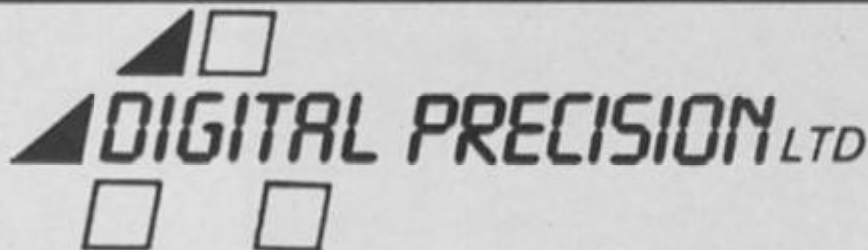

222 THE AVENUE  
LONDON E4 9SE

Please note our  
new address

# DIGITAL PRECISION ANNOUNCES BEST SELLERS FOR THE QL SUPERCHARGE

• Supercharge is a program that translates slow, interpreted superBASIC into fast, flexible 68008 machine code — totally automatically. You need no specialised knowledge at all.

• Supercharge supports the entire syntax of super BASIC. Compiled programs run incredibly fast: Some run over 100 times faster than in the original Super BASIC. Microdrive loading times are accelerated by a factor of up to 30. Multitasking is fully supported, and easy to use.

• ALL Supercharged programs multi-task — you can run any number of them on one QL, simultaneously (RAM permitting)

• Supercharge supports full floating point arithmetic, to an accuracy of NINE digits (SuperBASIC only displays seven decimal places). Arithmetic is breathtakingly fast — integer handling is often 100 times faster than in interpreted BASIC.

• Supercharge allows the entire syntax of QL SuperBASIC: file-handling, multi-dimensional arrays, local variables, procedures and functions (with parameters), turtle graphics, windows, both display modes, all devices (including disk drives, modems etc.), sound, graphics, colour, strings, etc, etc.

• Supercharged programs are reliable on all versions of the QL. Most bugs and restrictions imposed by the SuperBASIC interpreter are corrected or lifted by the compiler. Say goodbye to the integer FOR bug, string and integer SELECT bugs, the CALL bug, the 'too many parameters' bug, the GOSUB in a loop bug, the RESPR bug, etc, etc.

*The arrival of the product is a significant event for the QL and should help many more people produce quality programs with a fraction of the effort machine code programming requires, and many times faster than interpreted Basic.*

Sinclair/QL World March 1986

• Supercharge includes a sophisticated optimiser, which the user can direct to produce either especially compact or fast 68008 machine code, on a line by line basis.

• Supercharge is compatible with virtually all QL add-ons, including disk systems, expansion RAM, and even add-on commands which do not form a standard part of SuperBASIC! 'Toolkit' utilities work beautifully, so long as they don't try to modify interpreter data-structures (which obviously aren't there). Very few commands do this, and Supercharge generates clear warnings where incompatibilities might exist.

• Supercharge issues explicit, plain-English report and warnings, showing the exact position of mistakes. Many 'trivial' errors are automatically corrected!

• Supercharge is fast, device-independent, concise and easy to use — it even compiled itself!

• Supercharged programs may be interactively tested 'in slow motion' using the compatible SuperBASIC interpreter.

• Supercharged programs are protected against unauthorised modification, as they cannot be LISTed. Compiled code loads incredibly fast — for instance, a 75K SuperBASIC program loads 25 times faster once compiled.

• The 105 page Supercharge manual is comprehensive and readable, with tutorial and reference sections, examples, hints and tips, and a full index and glossary

Supercharge costs £59.95; this includes the compiler, code-generator, utility programs, add-on commands for task control and error-trapping, demonstration software and over 100 A4 pages of documentation.

£5 off SUPERFORTH, £5 off SUPERSPRITE and £2 off Super Monitor + Disassembler when these programs are ordered at the same time as SUPRCHARGE

## QL SUPER SPRITE GENERATOR

Version 3.5 is a complete Games Designer system and has been completely rewritten. This classic program is now available in its ultimate refined form, with up to 256 sprites (16 on-screen), up to 256 planes of movement, choice of 2 screens, automatic collision detection/inversion/reversal/freeze frame/background drawing, speed independently variable for each sprite — and guaranteed 100% Flicker Free Operation. Ultra high speed action is possible — and no machine code knowledge is required at all! QL SUPER SPRITE GENERATOR Version 3.5 comes in a full colour cassette library case with detailed instructions and examples (both on-screen and on the inlay card).....£24.9

## SUPER FORTH plus Reversi

Forth is a structured, intermediate-level programming language with a cult following. Forth is a remarkable language which combines the speed of machine-code with high-level control constructs and interactive testing facilities.

Gerry Jackson's SUPERFORTH is a complete, ultra-fast implementation of the Forth '83 standard. In addition to the standard commands SUPERFORTH includes a plethora of extra features to make the best of the QL:

• All the QL's features are supported, including sound windows, graphics, disk systems and other peripherals. Input and Output may be re-directed at will.

• Full 32 bit integer arithmetic, allowing lightning-quick calculations to nine digits of precision. All floating-point arithmetic is also supported, including Logarithmic and Trigonometric functions.

• Incredible speed — much faster than any other QL Forth. A Sieve of Erasthones (the Byte benchmark) runs in just 4 seconds in SUPERFORTH, compared with 3 minutes 30 seconds in QL SuperBASIC (or 3 minutes 10 seconds in IBM PC BASIC).

• Multi-tasking (demo supplied) with full job control for SUPERFORTH and machine-code programs. SUPERFORTH itself runs as a task, so other programs may run at the same time.

• Built in screen-editor for Forth blocks or names files — alternatively you may use Quill to edit Forth source.

The SUPERFORTH package also includes an extremely powerful implementation of the classic boardgame REVERSI. This superb program demonstrates the speed, flexibility and expressive power of SUPERFORTH. REVERSI is written entirely in SUPERFORTH, and the well-written source-code is supplied for you to study or adapt.

REVERSI 1.5 offers nine levels of play, with near-instantaneous response on levels 1 and 2. Many options enable you to exchange sides, retract moves, set up positions, ask for hints or watch the computer 'think'. Moves can be entered by co-ordinate or simply by 'pointing' at the required position.

The latest version of REVERSI — version 1.5 — is better than ever! It is guaranteed to beat Sinclair Reversi every time, when the two are played on similar levels. It beat the Spectrum champion, MOI Othello, 10-0 in a supervised match — in fact we have yet to find any program, for any personal computer, capable of beating REVERSI on equal time — or any human capable of beating it at its top skill level. This is hardly surprising when you consider that REVERSI 1.5 uses state-of-the-art Artificial Intelligence techniques: alpha-beta tree searching with pruning and a killer heuristic.

"Congratulations on an excellent program". E Azzo Pardi, Malta. The Best Forth program H. Heuss Berlin Digital Precision SUPERFORTH & REVERSI cost £29.95. REVERSI 1.5 is available separately, with full rules and an introduction to the strategies of the game, for £12.95.

## SUPER ASTROLOGER DELUXE VERSION

gives you (completely automatically) a full (4 A4 sheets, single-spaced!!) character and personality readout/horoscope, for any location, date and time of birth! It also gives day-to-day personalised predictions (not the over-generalised horoscopes found in the press, but unique to your time + date + place of birth), the facility to compare the detailed personalities of any two persons (ie. for compatibility testing for love or business) and a full graphic printout of the natal chart and all other screens. It comes with everything you need — so for the person who knows nothing of the ancient science of astrology, no extra literature is required... This extremely fast machine code program will also suit the amateur astronomer (it has hosts of features and displays of planetary trajectories and of the solar system, at any point in time), the professional astrologer (because it can be customised by the user to reflect his views on astrological interpretation) as well as the man who just wants an accurate horoscope for himself, his loved ones, friends and famous people. Demonstration files provide.

SUPER ASTROLOGER DELUXE VERSION comes in a full colour wallet, with two microcartridges and a detailed manual .....£24.95

All Digital Precision Software is available now. Software is compatible with ALL versions of the QL, memory expansion and disk interface systems.

Digital Precision Software is available from TBD, Lightning, Creative Sparks, and other distributors of good software. Buyers in Central London can visit Micro-Anvika at 224 Tottenham Court Road.

Supercharge and Superforth are available on 5 1/4 inch 1440 sector disk at no extra charge.

DEALERS: our discounts are generous — phone us now on 01.257 5493.

PROGRAMMERS: We intend to dominate the QL software market, and we pay excellent royalties for good QL software. Send us a disk or cartridge now, for a prompt confidential evaluation of work in progress.

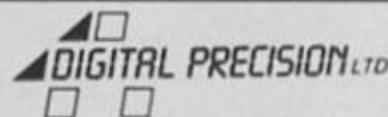

Please rush me.....  
All postage within the U.K. is free but please add £1 (+£2.50 for SUPERCHARGE?) per program for orders from other countries, to cover airmail and packaging. Cheques from abroad should be drawn on a U.K. bank or be Eurocheques — if you are unable to do this, just add £5 to cover cheque clearing charges.

I enclose £..... SIGNATURE.....  
or debit my ACCESS/VISA Acc. No.....  
expiry date.....

\*The quickest response I have experienced from the UK. T. Hansen, Norway

Name.....

Address.....

Postcode.....

Credit Card orders: Tel 01.257 5493



# CROSSWIRES

Our technical wizard Ray Elder unravels your Sinclair computing problems

## Printer Problems 1

**Q** I have recently purchased a Tandy DMP-105 dot matrix printer. I was assured by Tandy that I would have no problems in interfacing the printer to my Spectrum+.

My problem is that I can't find an interface that will drive the printer and I was wondering if you knew of such an interface, preferably with the driving software on hardware rather than software, although this is not essential.

I've been looking for an interface for so long I'll accept anything.  
Robert Miller, Northants.

**A** I do not know this printer so I phoned Tandy who were very helpful and informed me that this printer has both Centronics and RS232 input.

This gives you a wide choice of interfaces, if you intend using Microdrives then your best bet would be Sinclair's Interface 1. This should be readily available and costs around £50 or £99.95 with a microdrive, but you will have to buy a RS232 lead which will set you back another £10.00.

Personally we use a ZX Lprint III Centronics interface from Euroelectronics, 26 Clarence Square, Cheltenham, Glos. GL50 2W and which costs £34.95 and includes on board software and connecting lead. We have used it for over 18 months and had no problems whatsoever.

We also tested the Kempston E interface and this is very similar although we have not used it long term as it had to be returned to them. It costs around £50.00.

## Printer Problems 2

**Q** I am having problems getting my Epsom P40 printer to work with my Spectrum/ZX Interface 1 system. I cannot get COPY, LPRINT or LLIST. What can I do to make this system work? There are eight dip switches at the back, which ones do I use?  
M. A. Conway, Israel.

**A** I am afraid that this letter is rather lacking in details and I am not sure what you have already tried, however if you'll excuse me stating what may appear to be obvious, I'll have a go. First check your printer manual and ensure that the dip switches which relate to the following are set correctly, all the others are probably OK as set by the factory:

1. Parity On/Off set to OFF
2. Number of bits set to EIGHT
3. Number of Stop bits set to ONE
4. Auto line feed set to OFF

5. The baud rate set to the highest rate possible and this rate is set on the Spectrum before printing.

With the RS232 you cannot just use COPY, LPRINT and LLIST, but you have to open a special CHANNEL to send the information to the printer. There are two channels set aside for this, the 'i' channel for normal text and the 'b' channel for control codes and text. Neither will print graphics. Check pages 35/37 of your interface manual.

Briefly use the following lines, either as a program or as separate commands, to test if it is working: (NB. The baud rate is the number which is the rate you found on step 5 on setting the dip switches.)

FORMAT "i";baud rate

OPEN 3;"i"

LPRINT "Testing 1, 2, 3"

CLOSE 3

To LLIST use the same sequence, replacing the LPRINT command, COPY is very complex and we have published routines to do this in earlier issues.

If this does not produce the desired message then there could be a problem with the connecting lead wiring or even with Interface 1 (if it is not unknown), and your best bet would be to take the whole set up to your nearest electrical expert for checking.

## Video Output

**Q** I use my Spectrum (Issue 2) with a video recorder for titling, creative graphics, etc. Could you please advise me how I might get a better composite video output.

I tried jumping the modulator following the procedure suggested by Peter Shaw in the DEC 83/JAN 84 issue and by this means the computer 'monitors' beautifully to the TV via the VCR but degrades considerably when recorded, with a tendency for colours to shimmer and text to ghost.

Is it possible to convert a RGB monitor signal (from say the Ferguson monitor interface) to a composite video signal? Your assistance would be appreciated.  
David Cotton, Leicester.

By sheer chance we received a letter on this subject which I offer to you.

**A** I read Amit Grag's question (and your reply) in the OCT/NOV 85 issue of ZX Computing concerning a monitor connection to the Spectrum.

This is how I solved it with a total cost of £1.00:

1. Open Spectrum case, drill a hole next to the MIC out and place there a co-

axial connector for connecting to the monitor later.

2. Find the shielded HF output stage inside the Spectrum, it has two leads.

3. Add the circuitry as shown in the diagram.  
The transistor can be anything cheap but fast such as the 2N3904 which I used at a cost of 50p, leads being as shown in the diagram.

You can play around with the 200 ohm resistor until the monitor gets a high enough signal. Chassis ground is available almost anywhere inside the Spectrum which is also connected to the ground lead of the co-ax connector.

To do this you do not have to be an expert, just able to use a drill and soldering iron, the costly part is the co-ax connector which is bought to suit the monitor.

I hope this solution can help Amit Grag and Bob Brown.  
Mehmet Erbudak, Greifensee.

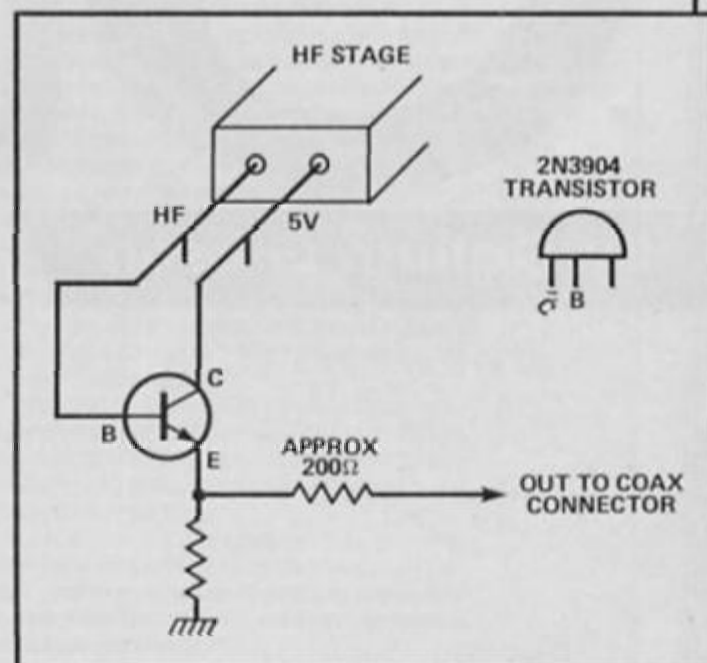

**PS** I must admit not to having time to do this job myself so I can't vouch for it personally, however I see no reason why it shouldn't work. I also checked with a friend who is an electronics engineer and he said it appeared a sound modification.

If you have any doubts then get someone qualified to do this job because I must emphasise that we cannot be held responsible in any way for damage which may be done to your computer through attempting this modification.

Meanwhile Adapt Electronics of 20 Starling Close, Buckhurst Hill, Essex, IG9 5TN do an interface with TTL/Analogue and Composite outputs for £34.95 and will offer advice for specific needs on 01 504 2840.



# Centi

By Callum Gibson

This is a frantic machine-code version of the old classic, Centipede, that also gives you a chance to do a bit of Commodore and Atari bashing! The game should be familiar to everyone, but instructions are included in the game anyway. So, off you go — zap that worm!

## Listing 1

This is the loader program. Type it in, and save it with; **SAVE "CENTI" LINE 1.**

## Listing 2

This is the program that produces the machine code. It has a checksum built in to check for errors when you **RUN** it, so you should be able to correct any mistakes in the code (but make a back-up copy of the program just in case). Save the code onto tape with the command; **SAVE "ZXCCODE" CODE 60000,2688.RANDOMIZE USR 60000** starts the game.

### PROGRAM 1

```
10 CLEAR 59999
20 PRINT AT 9,61:"-----ZX CENTI-----";AT 12,21:"Please wait
loading CODE.*
30 LOAD **CODE: RANDOMIZE USR 60000
```

### PROGRAM 2

```
5 CLEAR 59999: LET add=60000
10 FOR i=100 TO 510 STEP 10
15 PRINT AT 0,011
20 READ a#
25 LET va1=VAL a#(1 TO 4)
30 LET a=0
35 FOR g=5 TO LEN a# STEP 2
40 LET num=(CODE a#(g)-40-(7 AND a#(g))*9*11)*16+(CODE a#(g+1)-40-(7 AND a#(g+1))*9*11): POKE ad
d,num: LET a=a+num: LET add=add+
1: NEXT g
45 IF a<>va1 THEN PRINT "ERRO
R!!!!" line *11: BEEP 2, 10: G
TOP
50 NEXT i: STOP
100 DATA "7509F3AFD3FE32405CFD3
653473E02CD0116DD212DF1DD7700DD7
709CDEACB06DB21D1F37ED72310FBDD5
607DD5E06010000CD6FECDD5609DD5E0
0011900CD6FEC3E"
110 DATA "9026C700DD7E11CDACF40
0007C12CDACF4CD1CECC3EE7DBFE2FE61
F20F73E4700DD7E11CDACF4000DD7E12C
DACF43EF7DBFE1F300CCD01ECCD1CECC
D13ECC37AEA1F30"
120 DATA "600304DD3611021F3004D
D3611031F300ADD3612042101002271E
B1F300ADD36120521D0072271EB3EEFB
DFE1FD220EBE600C29FCADD361206210
0132271EBC39FEA"
130 DATA "7201CD31ECCD13ECCD25E
CCDEACBFD213A5CCD3DEC214BEE06237
ED72310FBDD5E021600011B01CD6FCCD
D5609DD5E00010001CD6FEC010000AFD
DFE2FE61F20050D"
140 DATA "706370B120F3DD5E06DD5
607010001CD6FEC01D0070B70B120FB3
E7FDBFC1F300D3EFCDBFC1F3006FD213
A5CFBC73EBFDBFE6102006CD1CECCD1
3ECCD7E11FE02CC"
150 DATA "960320F2CDA6ECCDA3F2C
D49F3CD7EECF1E433C14CDABEDCB40F1C
364EBFD213A5CCD0EF2E1DD3502C226E
BCDCACBDD5607DD5E06EBDD5609DD5E0
0A7ED52DA7AEA19"
160 DATA "7492EBDD7300DD7209C37
AEA2100401101403600010010EDD0231
30100033642ED00C9CDEACB21E0EF014
D017ED70B2370B120F0C9AFDBFE2FE61
F20F9C9AFDBFE2F"
170 DATA "5011E61F20F0C9113AF22
1F7ED015400EDB0C9112DF1217EECC010
000EDB0C9011F012A705C545D2329291
92929291922705C0C3E20D920070E000
43E15B0C07CFE14"
180 DATA "77013E171E4230043E161
E04CDABED10D1DDE5C5E0605DD219CE
CDD5E00DD56013EFF3CB7ED5230FA195
0C11E42CDABED0CC542DD23DD2310E1C
1DDE1C91027E003"
190 DATA "656064000A000100FD213
AF2DD5605FD4E00FD4601703CCA63ED3
E171E42CDABEDFD7E02FE00203CA7204
679A7200004FD350270FE10207206101
06E00CDE1EDBB20"
200 DATA "509467FE43CABBEBFE462
008FD360200040C1056FD35020C0470F
E10204C06100E0010460470FE102040F
D3602000510390C79FE20200E0DFD340
20470FE10202906"
210 DATA "6567101025CDE1EDBB201
FFE43CABBEBFE4620000D04FD3602001
00E040DFD340270FE10200406100E1FF
D7100FD7001DD7E00B92007DD7E01B0C
ABBEBFD7E031E44"
220 DATA "0005CDABEDFD23FD23FD2
3FD2315C2ADECC9FD213AF2FD7E00B92
00FFD7E01B02009FD3600FFFD3601FFC
9FD23FD23FD23FD2310E1DD4605FD213
AF2FD7E003CC0FD"
230 DATA "040723FD23FD23FD2310F
1A7C9E5D5C5DDE5F526006F292929EBD
D2106EEDD19EB70CD9E0E0600090600D
```



D56007224DD2310F72424D5CD880EEDD  
173F1DDE1C1D1E1\*

240 DATA \*5775C9E578CB2FCB2FCB2  
FC6506770E6070F0F0F016F7EE1C9140  
2FF0E1302FF121202FF0A1102FF13100  
2FF0A0F02FF100E02FF100D02FF120C0  
2FF110B02FF0B0A\*

250 DATA \*440602FF0A0902FF10000  
2FF0D0702FF120602FF110502FF0C040  
2FF110302FF0F0202FF0F0102FF11000  
2FF0B16000073636F726520202020202  
02060692D73636F\*

260 DATA \*302572652020202020202  
06C69766573596F75722073636F72652  
07761733A200F1704000009000000102  
466666624100010305A1010127C00704  
00400705076003C\*

270 DATA \*434042061C46423C00102  
060407E0010007C444070044430003C4  
4407C46663C00006202060C1030003C6  
6663C66663C003C66663E06063C7E010  
DA5A5BD24247E01\*

280 DATA \*792101BDA1A1203C7E010  
505BDA5A53C7E0101BDA109203C7E010  
9019909001C7E0101A5BDA524247E010  
1A5B5BD2C247E010101BDA5243C7E010  
DA5A5BD20247E01\*

290 DATA \*46950191BD91100CF0204  
0F10A040A111010101010101010307  
CFEFED61010000000000000000003C7  
E7E7E7E3C000000000000000000000  
00000000000000\*

300 DATA \*605490900C0F0700000D1  
91931F1E100000F1F3030301F0F00000  
07000700000DD4601DD4E001E423E17C  
DABED3EDFDBFE57E60AFE0A200579A72  
0010D7AE615FE15\*

310 DATA \*603620063E1FB920010C3  
EF00BFE2FE61F20063E10B02001053EF  
DDBFE2FE61F20063E17B0200104CDE1E  
DFE042007DD4601DD4E00C9DD7100DD7  
001FE44C0C3BBEB\*

320 DATA \*392216010210025A50204  
3454E54492E2E2E2E2E43414C4C554  
D20474942534F4E16040210074120766  
57273696F6E204F66202743454E54495  
0454445272C2074\*

330 DATA \*470006052061726361646  
5206661766F75726974652E160000100  
3506F696E74732073636F7265643A160  
A0310074D757360726F66D2E2E2E2E2  
E2E2E2E2E2E2E2E\*

340 DATA \*43732E2E2032351600035  
365676D656E74206F66206D6167676F7  
42E2E2E2E2E203735160003537069646  
5722D4174617269206C6F676F2E2E2E2  
E2E203130301600\*

350 DATA \*424003536E61696C2D436  
F6D6D6F646F7265206C6F676F2E2E203  
23030211610001004436F6E74726F6C7  
33A161201555020202D2027515745525  
427202020202020\*

360 DATA \*35394C454654202D20275  
54F27161301444F574E2D20274153444  
6472720202020202052494748542D202  
759495027161401464952452D20432F5  
32D535041434520\*

370 DATA \*3960202020404F4C44202  
D202740270000000000000000000000  
000000000000205DD7E04A720133E7ED  
BFE2FE61FC8CD16F2DD4601DD4E00100  
D1E423E17DD4604\*

380 DATA \*6409DD4E03CDABED10300  
7352004DD7004C904CDE1EDFE4220101

520EDDD7103DD70043E151E42C3ABEDD  
D5607DD5E06DD360400FE44201BFE452  
044FE0620502119\*

390 DATA \*70060019EBDD7207DD730  
63E171E42CDABEDC9214B0019EBDD720  
7DD73063E161E04CDABEDCD70EDCD93E  
DC0E1DD3402DD7E05FE15CA26EBC603D  
D7705C326EB2164\*

400 DATA \*69430019EBDD7207DD730  
6DD460BDD4E0ADD360B00C334F321C00  
019EBDD7207DD7306DD460EDD4E0D3E1  
71E42DD360E00CDABED0CCDABED063C0  
E96237EE610D3FE\*

410 DATA \*5528511520F00D10F3C90  
60AAF16E6EE10D3FE4A0D20FD141410F  
4C91502FF0E1402FF121302FF0A1202F  
F131102FF0A1002FF100F02FF100E02F  
F120D02FF110B02\*

420 DATA \*4734FF0B0A02FF0A0902F  
F100002FF0D0702FF120602FF110502F  
F0C0402FF110302FF0F0202FF0F0102F  
F110002FF0B2100000E3216147ED3FE4  
610FE231520F60D\*

430 DATA \*606420F1C9DD7E00A7201  
9ED5F2FE679C0ED5FF614E6173DD0770  
BDD360A1EDD360C00C9DD460BDD4E0AC  
D34F379A72005DD360B00C9DD7E0C0DA  
7200D043E17B020\*

440 DATA \*04021205DD360C0010000  
53E10B0200504DD360CFFDD710ADD700  
BCDE1EDFE43CABBEB0CCDE1EDFE43CAB  
BEB04CDE1EDFE43CABBEB0DCDE1EDFE4  
3CABBEB053E191E\*

450 DATA \*067145CDABED0C3CCDABE  
D043CCDABED0D3CCDABEDC91E423E17C  
DABED0CCDABED04CDABED0DCDABED05C  
9DD7E0EA72024ED5FE6F9C03A705C3C4  
73C070F000F0700\*

460 DATA \*592432705CF602E60FDD7  
70EDD360D00470EFF1027DD460EDD4E0  
DDD7E0FA73E171E4220033D1E46CDABE  
D0CDD7E10A73E171E4220033D1E46CDA  
BED0C79FE202005\*

470 DATA \*6795DD360E00C9DD710DC  
DE1EDDD360FFFE422003DD340F3E1D1  
E06CDABED0CCDE1EDDD3610FFFE42200  
3DD34103E1EC3ABED16000053636F726  
53D202020202020\*

480 DATA \*379920202040692D73636  
F72653D2020202020202016020110045  
A502043454E5449202D2043616C6C756  
D20476962736F6E20313930352E10071  
60505302E205374\*

490 DATA \*50626172742067616D651  
60705312E2053656520696E737472756  
374696F6E73160905322E20536F756E6  
4206F6E2D736C6F776572160005332E2  
0536F756E64206F\*

500 DATA \*470066662D66617374657  
2160D05342E204069676020737065656  
4160F05352E204E6F726D616C2073706  
56564161105362E20536C6F772073706  
565641614003C50\*

510 DATA \*332372657373206F70746  
96F6E3E07C605471120002104501910F  
D0E0009011400E5D1130077ED00C9000  
00000000000000000000000000000000  
000000000000000\*



**Hackers' Hints**  
If you feel like delving into the code, here's a few tips for infinite lives and so on.  
**POKE 61056**, number of lives (max 255); **POKE 60511**, frequency of mushrooms (the lower the POKE, the more mushrooms you get); **POKE 62125**, frequency of spiders (as for mushrooms).



## A round up of all thats new for the QL on the games, graphics and utilities scene.

Two years after the launch of the QL much of the games software for the machine is still getting indifferent reviews. Not surprisingly, since, with one or two exceptions, none of it is much more sophisticated than the sort of games that were available on the Spectrum two years ago.

Of course the problem is that few companies are likely to produce megagames for the QL until the size of the user-base justifies the development costs. Even so, there have been a few programs emerging just recently that are worth a second look.

### Chips in Space

**Cuthbert in Space** by Microdeal doesn't do much to push back the frontiers of QL programming, but it is a fairly enjoyable zap game in which you fly a space shuttle around the screen, collecting treasure and blasting the Intergalactic Police Force. It's a pity that the game costs £14.95.

Realtime Software's **Knight Flight** is a version of the arcade game, Joust. I've always had a soft spot for Joust ever since I first played the original arcade game and this is a very good version, with colourful graphics, smooth animation and a two player option which is great fun. Once again though the £14.95 price tag is a bit steep.

### Own brand software

The main supporter of the QL has always been Sinclair Research themselves and they've produced a mixed bag of programs of late. **QL Jabber** is a mediocre zap game that's little improvement on Space Invaders, whilst **QL Quboids** is a colourful version of Digger. Here you face 20 screens full of platforms and hostile germs that you have to destroy by first drilling holes in the platforms for them to fall into, then you sneak up on them and drill holes in their heads. It's reasonably enjoyable for a while, but still not much more advanced than many Spectrum budget titles.

**QL Bounder** is a bit better, being a Jet Set Willy type game in which you guide a character called Quentin Jump through nearly 60 screens' worth of all the usual platform game lunacy. It's not a brilliant piece of programming, but a good platform game is always good for a few weeks' worth of fun,

and the screens are varied enough to make this possibly the best of the current crop of arcade games for the QL. Like all of the Sinclair programs mentioned so far **QL Bounder** costs £9.95.

### QL graphics

The QL is much better served by its utilities than by its games software, and in particular there are a number of good graphics utilities available. Psion have produced some of the best QL software, and their **QL Draw** (£14.95) is based on the utility that they used in developing the graphics for their excellent

Chess and Matchpoint games, which should give you an idea of what it's capable of. The program concentrates on colour handling rather than lots of shape-drawing options, but there is a facility for defining shapes which can then be manipulated in a variety of ways.

Also at £14.95 is **Paint Master** from Shadow Games. This program isn't as easy to use as the Psion package, but it does

# SOFTWARE





have more commands for drawing shapes and also includes a short demonstration program showing how its screen displays can be incorporated into graphic adventures. This feature is particularly useful and makes me wonder why no one has yet produced a graphic adventure for the QL.

## Utilities

Two major complaints about the Sinclair QL soon after its launch were the slow operating speed of SuperBASIC (no better than the 8-bit BBC micro) and the failure to meet the pre-launch promise to allow SuperBASIC programs to multitask (more than one program operating at one time). A new software package aptly named **'Supercharge'** sets out to rectify both faults.

Supercharge from Digital Precision, is a BASIC compiler; this converts SuperBASIC programs into machine code. As such, the programs run much faster, they can multitask, and, in general, they take up less RAM.

The Supercharge package contains a 100 page A4 loose leaf manual, which can be bound in the User Guide, a single cartridge containing the software, and a security device called the 'Lenslok'. The version of Supercharge used in this review was V1.06; at the time of writing, the most recent version.

Using the compiler is simplicity itself. First load the SuperBASIC program to be compiled then load the compiler.

Once into Supercharge, the operator merely has to select a name for the compiled code, and whether or not a compilation listing is required, and a compilation report. Then away it goes. In four passes the code is generated (stored temporarily on the display file) in a matter of minutes, stored on disc or cartridge. The compilation report listing can be viewed on screen, or sent to a microdrive or printer. One of the attractions of the system are the well documented reports.

The type of machine code produced is called 'threaded' code. This is not as fast as code produced with an assembler, but it should be fast enough for most applications. In tests, the claimed speed increase over SuperBASIC of 30 to 1000 times was substantiated, although this applied more to loops and mathematical expressions. The largest gains are made with long programs; SuperBASIC slows down as the program length increases but the speed of Supercharge coded programme is independent of length. The speed increase of the graphics

commands was far more modest. Unlike 'pure' machine code, Supercharge threaded code has the advantage of producing error messages if run-time errors are encountered, rather than crashing!

Supercharge requires 60K of RAM to operate, leaving only 28K as a maximum for SuperBASIC programs (about 250-1000 lines) in the unexpanded QL. However the code produced is more compact than SuperBASIC, and, particularly with long programs, loads far faster with EXEC or EXEC\_W.

The price for this product is rather high (£59.95), so is likely to appeal to the specialist user only. But the extensive claims for the product could not be faulted, and Supercharge will provide an easier alternative to assembly language, or other compiled languages, for those wanting extra speed and multitasking on the QL.

**JOSS** is a new low-price utility for the QL from WD Software which is aimed at the user who is all fingers and thumbs. If you get very annoyed at your QL when, at the slightest mistake, the machine makes you type again a 'load' or 'copy' command line, then help could be at hand.

JOSS stands for 'Joystick Operated Software System'. Using a joystick connected to CTL1 (or the cursor keys), the user can move a cursor around a screen, pressing fire (or space) to select a number of options. Unlike 'GEM'-like systems, words are used instead of icons. By going against the current fashion for symbols, the author of JOSS has created a system which is easier to master.

A six page booklet is provided which takes you on a 'guided tour' of the available facilities. By first selecting a default microdrive, or floppy disc drive, the user can then obtain a directory, load or run any BASIC file (pre-selecting monitor or TV mode), or copy the file to another device — all without touching the keyboard. Other facilities include setting the QL's clock, setting the baud rate to any output device, sending or listing files on the printer, and formatting cartridges the recommended six times.

Using Mode 4, JOSS has a colourful screen display, using colours to highlight commands which may cause problems. But in using the QL's 40 column mode, the screen is rather overcrowded. Also, the cursor was slow to respond, which at times, was frustrating.

At £15 for the microdrive version, and £17 for JOSS on disc, this utility is reasonably priced. The overall conclusion — a poor man's ICE.

# Classic Adventures

Despite the poor showing of the QL's arcade games, adventures on the QL, though few, are generally of a high standard. Sinclair research recently published **The Pawn** (£19.99), written by a company called Magnetic Scrolls. Set in the magical kingdom of Kerovnia, **The Pawn** features an incredibly sophisticated interpreter that allows very complex commands to be used as you attempt to discover the purpose of the game, and the significance of the Roobikyoub Dwarves and Farthington Real Ale Company. The independent characters and quality of the interpreter make **The Pawn** one of the most advanced adventures available on any home computer.

A bit more traditional is Sinclair's latest release, **Classic Adventures**. This is a 'two-pack' containing **The Adventure**, a version of **Colossal Cave**, the original **Crowther and Woods** game that started the whole adventure genre, plus a sequel to this called **Mordon's Quest** (which was originally published for the Spectrum by Melbourne House).

Considering its pedigree, **The Adventure** needs no recommendation from me, and **Mordon's Quest** is a worthy follow-up, containing some really infuriating problems (that always seem obvious once you know the answer) and good location descriptions. Both games use the traditional verb/noun input, but they don't suffer at all from this and as the price of this two-in-one package is just £9.95 it's one of the best bargains available for the QL.





# PROGRAMMERS & ARTISTS

SOLVE ALL YOUR ANIMATION PROBLEMS WITH ONE VERY POWERFUL UTILITY



# ANIMATOR 1

THE ULTIMATE GRAPHICS DEVELOPMENT TOOL FOR  
PROGRAMMERS AND ARTISTS.

USE IT TO PROFESSIONALLY DEVELOP -

**3D ANIMATED SPRITES & MASKS.**  
**ANY SIZE ANIMATED SPRITES**  
**MULTI-COLOURED SPRITES**  
**SCENERY & PROP GRAPHICS**  
**TITLE SCREENS**  
**TEXT LAYOUTS & FONTS**

#### AND IT'S GOT EVERY FEATURE YOU EVER WANTED CRAMMED INTO IT!!!

RE-DESIGNABLE BRUSHES/AIRBRUSHES & HATCHES; FAST TAG & FIXED LINE & CIRCLE MODES (all elastic); AMAZING SHADE PAINT CAPABILITIES (allows you to paint (and erase!) with shading (just the job for 3D work!)); FAST HATCH FILL WITH VERY FAST RE-HATCH (and you can re-design hatches in mid fill!); INDEPENDENT WALK-OVER COLOUR CONTROL (allows you to BRIGHTEN up your graphics without affecting the PAPER/INK or FLASH status etc.); RIDICULOUSLY POWERFUL PRINT FACILITY (allows you to PRINT any size/any shape/anywhere and at any angle (even backwards) over and over again with the same string or graphics (certain companies market less powerful print utilities as a complete package!); STRETCH & COMPRESS THE WHOLE SCREEN (from -100% to +100% horizontally and vertically); MAGNIFICATION WINDOW (allows you to see both real and magnified images as you work!); 25 SCROLLS/ROTATES & MIRRORS (YES 25! and they're all accessed instantly on the cursor keys!); SAVE/LOAD/CAT/LCAT/ERASE & COPY - MICRODRIVE/DISC/TAPE - SCREENS/SPRITES/CHARACTER SETS/UDGs/BRUSHES/AIRBRUSHES & HATCHES. (Machine code programmers will be pleased to know that sprites, graphics and screens can be saved as LINES or CHARACTER SQUARES!); TO DEVELOP YOUR SPRITES YOU HAVE 15k OF MEMORY (the number of sprites depends on their size (up to 255 max). Everything's fully automated - you can STORE/RETRIEVE/ANIMATE (any consecutive sprites at any speed including single stepping)/and CHANGE the size and shape.

#### AND IT'S QUICK & EASY TO USE

ANIMATOR 1 is a completely driven by pop down menus and no nonsense on screen prompts and it's been coded to be very fast to work with indeed! (AND IT'S VERY EASY TO DRAW WITH. So many packages offer a host of features and neglect this most important point! IF IT ISN'T EASY TO DRAW WITH, IT DOESN'T MATTER HOW MANY FEATURES IT BOASTS, YOU STILL CAN'T DRAW WITH IT! That's why we asked lots of users their opinion and the result, we think, is the most controllable free hand draw system around!)

#### WHAT ABOUT THE 128k MACHINES?

ANIMATOR 1 will really come into it's own when the 128k machines become popular enough to code exclusively for - just think of ANIMATOR 1's GIANT SPRITE & LOCATION GRAPHICS capabilities with all that RAM!

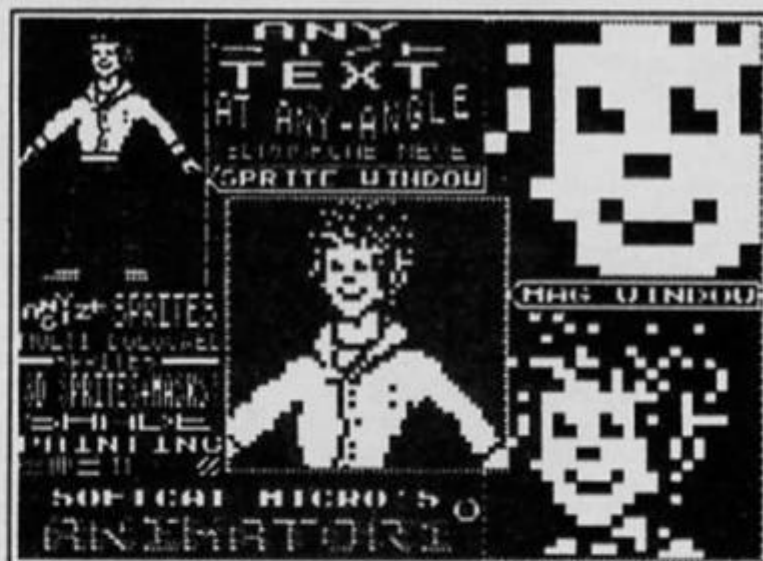

ANIMATOR 1 comes complete in its own ring binder with loose leaf documentation and is recorded on long life high quality chrome cassette.

Please send me \_\_\_\_\_ ANIMATOR 1 PACKS at £14.95 each.

I enclose a cheque/P.O. for £ \_\_\_\_\_  
(UK & EUROPE add £1; OVERSEAS £2)

NAME \_\_\_\_\_

ADDRESS \_\_\_\_\_

POST CODE \_\_\_\_\_ TEL \_\_\_\_\_

Softcat Micros, PO BOX 79, Macclesfield, Cheshire SK10 3NJ.  
DEALER ENQUIRIES WELCOME



# ACROSS THE POND

A stateside view of  
Sinclair computing  
from our American  
correspondent, Mark  
Fendrick.

February 1986 marks the second anniversary of the Timex decision to quit the home computer market. Many of us thought that it would all end then, but, happily, we are still here and stronger than ever. When Timex was still around, there was very little third party development going on, but now it is these independents which continue to support the Timex/Sinclair line. For a while this past summer it seemed as if that support was about to dwindle to nothing, but Zebra Systems has made up for all lost time with a number of very exciting new releases. So to mark this infamous anniversary I present you with these new offerings.

## MSCRIPT

This package is actually a new, updated and less expensive version of MSCRIPT but is not available for the ZX Spectrum. As a wordprocessor it is far superior to Tasword II. In addition to the many advanced features not found on Tasword II, it uses the 64 column display on the T/S 2068, causing every other character to disappear when using a Spectrum, as it lacks the 64 column capability. Yes, I know that Tasword II does claim a 64 column display, but that is with a redefined character set which uses fewer pixels per character. The 64 column T/S 2068 display is much clearer since each character has the same number of pixels as the 32 column display.

The original version was unable to use any alternate mass storage services as the software had its own SAVE to tape routine, with a nonstandard header. This had been a drawback for me since I use the A&J microdrive for all other

storage. This version, allows you to return to BASIC (the original is 100% machine code from which you can not exit) where ZEBRA has added some new features. This particular release is for the A&J microdrives, and the feature which creates a backup copy routes this copy to the drives. SAVES are also made from BASIC and can go to either cassette, microdrive, or with minor modification, any other alternative. This is also done with a standard header, making the procedure for transmitting MSCRIPT files via MTERM (ZXC December/January) much simpler.

## Greetings Card Designer

Similar to a very popular program for that other computer, you can make use of a number of different type fonts and graphics (supplied) to create your own personalized greeting cards for any occasion, using your 80 column printer. The program comes in three parts — a card designer, a library of graphics (I received 22), and a graphics designer for those who want to design their own additions to the library.

The first thing I did was to transfer the card designer and graphics designer to on microwafer, and the library to another. This was very simple to accomplish, and only required minor modifications to the original program. As with all of their software, ZEBRA has provided a back-up option right from the menu, making the transfer simple. (Pressing BREAK during the normal cassette SAVE indicates the line where the SAVE routine exists.) Right now I have 31 graphics on a 35 foot wafer, with room for some more.

To create a greeting card, you LOAD the card designer, and are guided through the procedure. I suggest that the very first thing you do is to set your printer/interface combination, or else you may find that you have designed your card, but are unable to print it.

Next you will choose to design either the cover or inside of your card (the procedure is identical). In designing your card you may choose one of eight borders. For your text you have a choice of sizes (small and large), fonts (filled or open), and justification (right, left or centered). Which of these options you choose depends on the type, size and placement of your graphic. You select the graphic from the menu, choosing from the graphics in your library. Once loaded, you have a choice of two sizes. The small graphic can be placed in any number of compartments within a six by six grid, while the large graphic will fill a three by three grid.

While the package comes with a number of predesigned graphics, you may want to design your own. The graphic designer portion of this software allows you to do just that. When you load this portion of the software you can design your graphic on a 32 by 56 pixel grid. As you turn the individual pixels on or off, you can immediately see your the result in an actual size window on the same screen. You can modify your graphic (or any of the existing graphics) at any time to suit your needs.

If this program proves popular, look for a poster and banner designer to follow. Greeting Card Designer is great for those of us with limited (or nonexistent) artistic talents, since the graphics come with the software.

## ZPRINT-80

The final new offering from ZEBRA is their new ZPRINT-80 Printer Support Package. This supports AERCO, both Tasman, and A&J interfaces with LPRINT output, LLIST output, Normal size screen COPY and full page grey scale color screen COPY. (Screen copy routines support the printers listed above for the Greeting Card Designer. The tape comes with four versions of the driver software; a high memory and low memory version for both the T/S 2068 and Spectrum computers.

For more information and a copy of their latest catalogue write to ZEBRA SYSTEMS INC.; 78-06 Jamaica Avenue; Woodhaven, NY 11421; U.S.A.; (718) 296-2385.



# IT'S 1986 — THE YEAR OF COMMUNICATIONS

Why buy programmes for your Spectrum when a world of free 'telesoftware' is open to you. Discover Prestel, Micronet 800, Viewfax, bulletin boards and open a whole new world. Even user to user.

Everybody's doing it — linking their home computers to giant mainframes and networking to thousands of other micro users via the phone and a modem.

A whole new world of mainframe games, electronic mail, free 'telesoftware', electronic notice boards, real time conversation, armchair shopping and home-banking will be at your fingertips! And at local and cheap rate, phone charges are only around 40p for a whole hour's entertainment.

Spectrum 16k, 48k. Spectrum + The VTX 5000 Modem comes complete with all the software (in ROM) required to access the world of electronic communications, networks, telesoftware and databases (both public and private.)

(User to user software on cassette £3.95 extra)

Terminal Emulation Software Package to link to commercial databases and bulletin boards which use ASCII format on cassette £6.95.

The VTX 5000 requires no external power and fits under your Spectrum to become part of the machine. Only one lead links your computer to the outside world.

FOR THE SPECTRUM 16K, 48K AND SPECTRUM + THE VTX 5000 IS AVAILABLE AT A VERY SPECIAL PRICE  
£29.95 inclusive of VAT and P&P for a limited period only.

**SPECIAL, SPECIAL OFFER**



All modems provide 1200/75 baud, enabling access to Prestel, Micronet 800, BT Gold, Farmlink, Citiservices, Homelink, and some free bulletin boards (some databases and networks require a small subscription). Fully BT Approved.

Simply clip the coupon and send it with a cheque (payable to Modem House) to:

**MODEM HOUSE,**  
70 Longbrook Street,  
Exeter,  
Devon EX4 7AP  
Tel: (0392) 213355



Please send to me:

- Spectrum Modems(s) £29.95
- User to user software £3.95
- PSS Comms/Terminal £6.95

I enclose £ \_\_\_\_\_

Name \_\_\_\_\_

Address \_\_\_\_\_

\_\_\_\_\_

Telephone \_\_\_\_\_

Please allow 28 day delivery Access/Visa No. \_\_\_\_\_

This offer applies only while stocks last.

**GILSOFT**  
INTERNATIONAL LTD.

# The Quill & Illustrator

The Graphic Adventure Writing System  
for The Spectrum, Commodore  
and Amstrad.

Available on cassette and disc.



## The Quill

is also available for the Oric 1/Atmos and shortly for the Atari and BBC B/Electron



Credit Card order line manned  
24 Hours — 0222-41361 ext. 430

~ The Quill without any knowledge of programming will allow you to write high quality text adventures  
From **£14.95**

~ The Illustrator is a companion to The Quill used to create Hi-Resolution pictures for your adventures.  
From **£14.95**

Please rush me details of The Quill & Illustrator and other products in your range for \_\_\_\_\_ (specify Machine). I have enclosed a S.A.E.  
Name \_\_\_\_\_  
Address \_\_\_\_\_

GILSOFT, 2 Park Crescent, Barry  
S. Glam. CF6 8HD Tel. 0446-732765





# Are You Taking Your Spectrum Seriously?

NEW!! ART STUDIO  
(NOT ILLUSTRATED)

NEW

An exciting graphics design program. Features pull down menus, icons and windows — you choose brush, spray, pen, etc. plus host of other features. Also drives most dot matrix printers with suitable interface.

- Art Studio — £12.95   
 Standard Art Studio — £12.95   
 Enhanced Art Studio for Microdrive & Disk — £23.95   
 AMX Mouse Complete — £59.95   
 Mouse Plus Program — £75.00

Your Sinclair Spectrum is a powerful computer, not just a games console. Oxford Computer Publishing unleash that power to make your Spectrum useful and help you perform important tasks. The Manager series of business programs has thousands of satisfied customers over the last three years. Your Spectrum can do jobs normally associated with business computers many times the price. The Utilities were written to create our own application software. They are offered to you



## ZX Spectrum 128

All programs compatible with the NEW 128K SPECTRUM in the 48k mode. "ART STUDIO 2" the 128K version will be available very soon. Further information please contact O.C.P.

as proven reliable programs that have stood the test of our own usage and become industry standards. The classical games are realistic simulations of proven widely played "real" games.

See your local dealer or order direct by indicating the items required, by ticking boxes, complete the coupon and return the advertisement. Alternatively, phone the OCP Hotline on (0753) 888866, stating your Access or Barclaycard Number.

### BUSINESS PROGRAMS

#### ADDRESS MANAGER

A professional address, filing and retrieval system, with full screen editing. Stores up to 350 addresses on cassette and up to 6000 addresses on floppy disk. (In separate files) 32 column format — £8.95  80 column format — £19.95  NEW K-DOS tape/disk cassette — £29.95  SP-DOS floppy disk — £29.95

#### FINANCE MANAGER

Stores and reviews practically all business and domestic accounts. Completely menu driven for ease of use. Stores up to 250 names on cassette and up to 6000 on floppy disk. (In separate files) 32 column format — £8.95  80 column format — £19.95  NEW K-DOS tape/disk cassette — £29.95  SP-DOS floppy disk — £29.95

#### STOCK MANAGER

Features full invoicing, sales totals, price lists and re-order requirements and comprehensive Master File with full breakdown of stock and VAT. Stores up to 600 product lines on cassette and up to 6000 on floppy disk. 80 column format — £19.95  NEW K-DOS tape/disk cassette — £29.95  SP-DOS floppy disk — £29.95

#### VAT MANAGER

Will check gross and nett values of a period's sales plus exempt totals and up to 8 classes of transaction e.g. standard rate, import/export etc. Calculates VAT paid and received and hence the nett tax payable/receivable. 32 column format — £8.95  80 column format — £19.95  NEW K-DOS tape/disk cassette — £29.95  SP-DOS floppy disk — £29.95

### WORD MANAGER

NEW

This word processor has been designed for "user friendliness". The following features should particularly appeal to users of the "Tasword II" program, with which it is text compatible. The software includes an address filing supplement with screen editing. Extra features include:

- ★ Simple "single keystroke" insertion facility.
  - ★ The cursor can be moved on to start a new paragraph by a single keystroke. TAB key also available.
  - ★ The program works with cassette tape, Sinclair Microdrive, Opus and other disk systems.
  - ★ Texts can be printed out on any line length up to 128 characters.
  - ★ Text blocks of any length can be transposed, copied or deleted.
  - ★ The OCP program can print out text while another is being written or edited.
- The Word Manager — £12.95   
 Disk Versions — £19.95

### UTILITIES

#### MASTER TOOL KIT

This versatile program gives you a re-number feature, string — search, a real time clock, a graphics generator and alarm plus many other features that'll change your Spectrum into a 'full spec. machine'. Master Tool Kit — £9.95

#### FULL SCREEN EDITOR/ASSEMBLER

An essential tool for writing Machine Code whether you're a beginner or an expert. Includes full screen input, comprehensive documentation, sophisticated expression

evaluator, SNAKE demonstration mode, extra micro drive facility etc. It also drives 32 and 80 column printer interfaces from the same cassette.

Full Screen Editor/Assembler — £12.95  NEW K-DOS tape/disk cassette — £29.95  SP-DOS floppy disk — £29.95

#### MACHINE CODE TEST TOOL

Test and Display Machine Code instructions as they're written. This versatile program can co-reside in your Spectrum with the Full Screen Editor/Assembler to provide a complete Machine Code environment. Features Hex: Decimal conversion routine, character generator, etc. etc. Machine Code Test Tool — £9.95

### GAMES

#### CHESS-THE-TURK

The ultimate chess challenge. 6 levels of play. 'Blitz' chess, printer output, plus real time clock and alarm. Chess-the-Turk — £5.95

#### CASINO ROYAL

Two way program featuring Roulette and Pontoon. You're allocated money to win — or lose — a fortune. Plug in Microspeech adds realism and both games are fully explained through a comprehensive on-screen menu. Casino Royal — £5.95

#### VIDEO POOL

All the fun and challenge of pool at your fingertips. 1 or 2 people play using joysticks or keyboard. Excellent graphics, sound and colour add to the game's reality. Video Pool — £5.95 (Not Microdrive compatible)

Please send your order to:  
 Oxford Computer Publishing Limited  
 77a Packhorse Road  
 Gerrards Cross Buck. SL9 8PQ



If you would like a copy of our full colour detailed catalogue — please tick box.

Name \_\_\_\_\_

Address \_\_\_\_\_

Amount payable £ \_\_\_\_\_

Please make cheques/postal orders payable to OCP Ltd

Cheque/PO Number \_\_\_\_\_

Access/Barclaycard number (please delete) \_\_\_\_\_

Signature \_\_\_\_\_

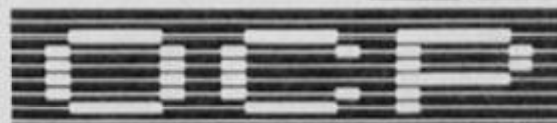

Simply The Best



# LIGHT SCREEN DESIGNER

**Toni Baker brings you her graphics mega-program.**

This month's article is all about COLOURING IN. The general idea is that you should be able to position the cursor in the interior of an outline on the screen and then, hey presto — a touch of machine code and the entire outline is filled with whichever colour you choose.

Having completed the colouring-in program, I subsequently discovered a bug in the earlier LINE DRAWING routine. It turned out that if you used Light Screen Designer to draw a shape composed of straight lines then the line drawing routine would leave 'holes' in the outline at the corners. Of course no colouring-in program can ever fill an outline with holes in it — mine got confused and coloured-in parts of the outside as well as the inside. I realised then that the only way out of the dilemma was to cure the line-drawing bug, so that outlines can be drawn without holes. The solution was to alter the line drawing routine so that an extra point is plotted at the end of a straight line. This means of course alterations to the program. You should amend your program by overwriting the old draw line routine by the new one in figure 1.

Next, it will be necessary to link the colouring bits and the various other parts into the main program. To do this you should enter the following:

```
DBC2 98   DEFB 98
DB76 12 EA
      DEFW EA12, CURSOR_TYPE
DB7A 7A E8   DEFW E87A, FILL
DB8A 70 E8   DEFW E870, PAINT
```

OK — now everything's sorted out we can get on with this month's bit of program.

## Paint away!

The program gives you two new procedures for Light Screen Designer. PAINT, on key 1, and FILL on key 2. Although they perform essentially the same task (i.e. they both effectively

colour-in an area) the two are subtly different.

PAINT is intended for creating colour designs. When an area is filled in this is largely done by altering the attribute bytes. Only at the outline itself is any additional plotting required. This means that it is possible to paint

two adjacent areas in two different colours. Provided that you never try to paint three different colours on the same character square you should be alright. The program will set or reset pixels and adjust attribute bytes automatically.

FILL, on the other hand, is

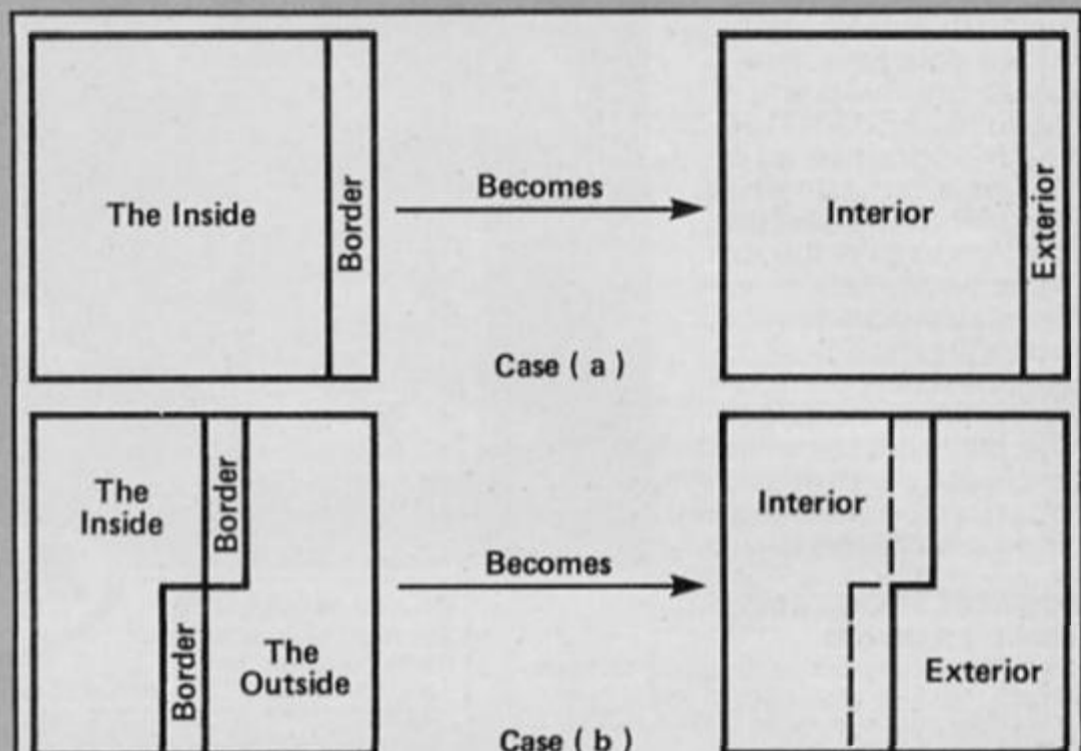

Figure 1.

```

                                ORG DFO4
CDEFDE  DRAW_LINE  CALL DEEF,MOVE_X      Move origin cursor to new position.
CDE6DE                                CALL DEE6,ADJUST_BD  Adjust B and D to ROM convention.
C5                                             PUSH BC              Stack cursor coordinates.
EB                                             EX DE,HL             HL:= previous coordinates.
227D5C                                LD (COORDS),HL      Store as "last point plotted".
110101                                LD DE,0101
78                                             LD A,B               A:=y coord of cursor.
94                                             SUB H                A:= vertical DRAW parameter.
3003                                JR NC,DL_1          Jump if positive or zero.
2F                                             CPL                  A:=ABS(vertical parameter).
16FF                                LD D,FF             D: indicates that vertical parameter
                                                is negative.

47      DL_1      LD B,A               A:= x coord of cursor.
79                                             LD A,C               A:= horizontal DRAW parameter.
95                                             SUB L                A:= horizontal DRAW parameter.
3003                                JR NC,DL_2          Jump if positive or zero.
2F                                             CPL                  A:= ABS(horizontal parameter).
1EFF                                LD E,FF             E: indicates that horizontal
                                                parameter is negative.

4F      DL_1      LD C,A               Draw the line.
CDBA24                                CALL 24BA,DRAW_3
C1                                             POP BC              BC:= cursor coordinates.
18D9                                JR J_PLOT           Jump to plot last point.
```



intended for working in black and white. Unlike PAINT it will fill an area by INKING every point in the interior with the current ink colour. This means that it is not possible to fill an area adjacent to another FILLED or PAINTed area (PAINT does not suffer from this disadvantage). FILL has an advantage, however, which PAINT does not have — if areas are FILLED then every interior point will be SET, so that you can COPY a picture from the screen to the ZX Printer.

The program works by first of all determining which pixels

constitute the interior, and then by changing the colour of these points. The interior is determined as follows:

- (1) The pixel at the cursor position is an interior point.
- (2) Any pixel which is adjacent to, and the same colour as, an interior point is also an interior point.

Thus the 'border' of an outline is not needed in the definition of the interior. To a human it might seem obvious that if you draw a black circle on a white background then the circle itself is a border separating the

'inside' from the 'outside', but to the computer such glaring obviousness is not glaringly obvious. Its own system methodically works each pixel on at a time (actually eight at a time, but that's a minor point). Since the cursor pixel (inside the circle) will be white, then the border (which is NOT white) will be considered by the program to be exterior. It is true that pixels outside the circle will also be white, but none of these are adjacent to true interior points, and so will always remain exterior.

When the program comes to the actual colouring-in-process, it has to do even more thinking (for PAINT anyway). For within an individual character square, the concept of a 'border' may have to be considered anyway. Take a look at Figure 2. In case (a) the so called 'border' is at the edge of a character square. In this case it is relatively easy to colour-in the interior without making any changes to the border. In case (b) however, the 'border' runs down the middle of the character square. Since it is impossible to have three colours on a character square then an alternative solution is necessary. In this program both the inside and the border are recoloured, while the outside is left unchanged.

The program uses the area of memory normally used by Light Screen Designer as the back-up screen memory to store the interior pixels. This is the area of memory called SCR2, which runs from address C000 to D7FF inclusive. I shall now go through each of the subroutines in the program one at a time, and explain them as I come to them:

## Subroutines

**ATTR\_ADDR** at address E76E is very short and very simple. It converts the address of a pixel on the screen (in HL) into the address of the corresponding attribute byte.

**COL\_TEST** at address E778 tests the attribute byte at address (BC) against the known (old) interior colour. It returns

Carry reset/Zero reset if paper and ink are both the required colour.

Carry reset/Zero set if neither paper nor ink is the required colour.

Carry set/Zero reset if ink colour is the required colour.

Carry set/Zero set if paper colour is the required colour. It also returns either 00 or FF in the A register. This value will

Figure 3.

		ORG E76E	
7C	ATTR_ADDR	LD A,H	A:= high part of pixel address.
0F		RRCA	
0F		RRCA	
0F		RRCA	
E603		AND 03	A:= 00, 01 or 02, according to which third of the screen the pixel lies in.
F658		OR 58	
67		LD H,A	HL:= attribute address.
C9		RET	
		ORG E778	
0A	COL_TEST	LD A,(BC)	A:= attribute byte from screen.
1F		RRA	
1F		RRA	
1F		RRA	
E607		AND 07	A:= paper colour.
DDBE08		CP (OLD_COLOUR)	
0A		LD A,(BC)	A:= attribute byte from screen.
280A		JR Z,COLT_PAPER	Jump if paper colour matches search colour.
E607		AND 07	A:= ink colour.
DDBE08		CP (OLD_COLOUR)	
2011		JR NZ,COLT_NO	Jump if neither paper nor ink colour matches search.
37		SCF	Carry flag set. (One match found).
9F		SBC A,A	Zero flag reset; A:= FF. (Ink).
C9		RET	
E607	COLT_PAPER	AND 07	A:= ink colour.
DDBE06		CP (OLD_COLOUR)	
2803		JR Z,COLT_BOTH	Jump if <u>both</u> paper <u>and</u> ink match search.
AF		XOR A	Zero flag set; A:= 00. (Paper).
37		SCF	Carry flag set. (One match found).
C9		RET	
3E0F	COLT_BOTH	LD A,FF	
A7		AND A	Carry and zero flags both reset, indicating paper and ink both match.
C9		RET	
AF	COLT_NO	XOR A	Zero flag set; Carry flag reset;
C9		RET	A:=00, indicating no match found.







always match that of the zero flag (i.e. 00 if zero, FF if non zero).

At E79E is another short, sweet and simple routine. Given the address of a pixel in HL, it will return the address of the corresponding attribute byte in BC, and the address of the corresponding byte from SCR2 in DE. HL will remain unchanged.

**SCAN\_ROW** is where all the tricky bits start. This subroutine lies at address E7AA, and its purpose is to scan one row of the screen — either from left to right, or from right to left. It declares as 'internal' any pixel which is to the right of (or to the left of) a known interior pixel, and is also the same colour. In this way the interior 'field' is extended from a single, or collection of, points, as far as the right (or left) hand interior edge.

**TM\_POP** (E81D) doesn't make a lot of sense on its own. It basically POPs SCR2 from the calculator stack, but see also **TEST\_MEM** (below).

**TEST\_MEM** is at E82E. On entry, BC must contain the maximum number of bytes of memory used by a routine. This must include bytes used on the machine stack, the calculator stack, and the workspace. It doesn't matter if BC is too great, but it must never be too small. Calling **TEST\_MEM** will (a) test the memory, and return immediately if there is not enough room to store an extra copy of SCR2, otherwise (b) PUSH a copy of SCR2 onto the machine stack, and (c) manipulate the machine stack so that **TM\_POP** will be called before returning to the main loop. Control will then be passed to the byte immediately after the **CALL TEST\_MEM** instruction (i.e. like a normal RETURN).

The principal routines, **PAINT** and **FILL** begin here. **PAINT** at E874, and **FILL** at E87E. The first difference between the two is apparent immediately. **PAINT** uses the **MESSAGE** subroutine (listed earlier) to request the required paint colour from the

		ORG E79E	
E5	SR_PTRS	PUSH HL	Stack screen byte address.
CD6EE7		CALL E76E,ATTR_ADDR	HL:= attribute byte address.
44		LD B,H	
4D		LD C,L	BC:= attribute byte address.
E1		POP HL	HL:= screen byte address.
54		LD D,H	
5D		LD E,L	
CBFA		SET 7,D	DE: SCR2 byte address.
C9		RET	
		ORG E7AA	
A7	SCAN_ROW	AND A	Reset carry signals "Not a known interior point".
08	SR_LOOP_1	EX AF,AF'	Store in P'.
1A		LD A,(DE)	A:= byte from SCR2.
A7		AND A	
2850		JR Z,SR_NEXT	Jump if there are no known interior points within this byte.
FEFF	SR_LOOP_2	CP FF	
37		SCF	
284A		JR Z,SR_NEXT_1	Jump if all eight pixels are already known to be interior.
CD78E7		CALL E778,COL_TEST	Search attribute byte for interior colour.
3804		JR C,SR_1MATCH	Jump if one match found.
2005		JR NZ,SR_ALL_BITS	Jump if paper and ink both match.
1841		JR SR_NEXT_1	Otherwise jump with no match.
BE	SR_1MATCH	CP (HL)	
2004		JR NZ,SR_SCAN	Jump unless all eight bits are the required colour.
37	SR_ALL_BITS	SCF	Carry indicates "Known interior point".
9F		SBC A,A	A:= FF (ie. all bits set).
182A		JR SR_STORE	Jump to store FF.
C5	SR_SCAN	PUSH BC	Stack attribute byte pointer.
0608		LD B,08	B:= number of bits in a byte.
AE		XOR (HL)	
4F		LD C,A	C:= byte from screen, with each bit reset for a known interior point, and set otherwise.
08		EX AF,AF'	Carry indicates whether or not last pixel was a known interior point.
1A		LD A,(DE)	A:= byte from SCR2.
DDCB006E		BIT 5,(J_FLAGS)	
200F		JR NZ,SR_SCAN_B	Jump if scanning from right to left.
3006	SR_SCAN_A	JR NC,SR_NBIT_A	Jump unless last pixel was a known interior point.
CB79		BIT 7,C	
2002		JR NZ,SR_NBIT_A	Jump unless pixel is required colour.
F680		OR 80	Set current pixel to show that it is a known interior point.
CB01	SR_NBIT_A	RLC C	Get next bit into bit 7.
07		RLCA	Move new bit into bit 0, and re-assign carry flag accordingly.
10F3		DJNZ SR_SCAN_A	Repeat for all eight bits.
180D		JR SR_NEW	
3006	SR_SCAN_B	JR NC,SR_NBIT_B	Jump unless last pixel was a known interior point.



CB41		BIT 0,C	
2002		JR NZ,SR_NBIT_B	Jump unless pixel is required colour.
F601		OR C1	Set current pixel to show that it is a known interior point.
CB09	SR_NBIT_B	RRC C	Get next bit into bit zero.
0F		RRCA	Move next bit into bit 7, and re-assign carry flag accordingly.
10F3		DJNZ SR_SCAN_B	Repeat for all eight bits.
C1	SR_NEW	POP BC	Restore attribute pointer.
F5	SR_STORE	PUSH AF	Stack carry flag.
C5		PUSH BC	Stack attribute pointer.
4F		LD C,A	C:= new value to store in SCR2.
1A		LD A,(DE)	A:= old value from SCR2.
2F		CPL	
A1		AND C	
2804		JR Z,SR_OLD	Jump unless at least one pixel is a newly discovered interior point.
DDCBOOF6		SET 6,(J_FLAGS)	Signal "Not finished yet".
79	SR_OLD	LD A,C	
12		LD (DE),A	Store new value in SCR2.
C1		POP BC	Restore attributes pointer.
F1		POP AF	Restore carry flag.
08	SR_NEXT_1	EX AF,AF'	Store carry flag.
7D	SR_NEXT	LD A,L	
E61F		AND 1F	A:= column number of character sq.
DDCBOO6E		BIT 5,(J_FLAGS)	
2008		JR NZ,SR_DEC	Jump if scanning from right to left.
FE1F		CP 1F	
C8		RET Z	Return if at right hand edge of row.
03		INC BC	Increment attribute pointer.
13		INC DE	Increment SCR2 pointer.
23		INC HL	Increment screen pointer.
1805		JR SR_CONT	
A7		AND A	
C8		RET Z	Return if at left hand edge of row.
0B		DEC BC	Decrement attribute pointer.
1B		DEC DE	Decrement SCR2 pointer.
2B		DEC HL	Decrement screen pointer.
08	SR_CONT	EX AF,AF'	Retrieve carry flag.
3092		JR NC,SR_LOOP_1	Jump unless last point was known to be interior.
08		EX AF,AF'	Store carry flag again.
1A		LD A,(DE)	A:= next byte from SCR2.
1893		JR SR_LOOP_2	
		ORG EB1D	
01800D	TM_POP	LD BC,0D80	BC:= half number of bytes in SCR2.
2100DB		LD HL,D800	HL: points to the first byte beyond this area.
D1	TMP_LOOP	POP DE	Get next two bytes from stack.
2B		DEC HL	
72		LD (HL),D	
2B		DEC HL	
73		LD (HL),E	Store next 2 bytes in SCR2.
0B		DEC BC	
78		LD A,B	
B1		OR C	
20F6		JR NZ,TMP_LOOP	Repeat for all bytes.
C9		RET	



user, whereas FILL automatically selects the current ink colour. A flag is assigned so that the program knows whether PAINT or FILL is being carried out, and then the two routines merge into one. SCR2 is used to store interior pixels, so this area of memory is cleared, and one pixel set at the cursor position. The primary loop begins at the label PF\_BEGIN. The current row is scanned — first from left to right, and then from right to left. At PF\_CONT the address of the row below (or above) is calculated and any pixels which are directly below (or above) known interior pixels, and which are the same colour, are themselves declared internal.

The process repeats over and over again — alternately up and down the screen until all interior points have been discovered. From PF\_SQ\_LOOP the colouring-in process begins. The screen is scanned one character square at a time and any required pixels are set or reset as needed whilst the attribute bytes are adjusted. When the whole screen has been scanned in this manner the process is complete and control will return to the main loop (possibly via TM\_POP).

Finally the old CURSOR\_TYPE routine has been moved to address EA12, since its previous home (DF24) has now been overwritten with the new DRAW\_LINE routine.

The Light Screen Designer program, in its BASIC form, is now complete. I have spent this article, and indeed every previous article in this series, concentrating on just one tiny segment of the program. My next article will be a special Light Screen Designer Extra — in which I will talk at great length about the whole program (and with no machine code to worry about I'll have more room to waffle!). I'll also be talking about ways to improve or extend the program. See you then.





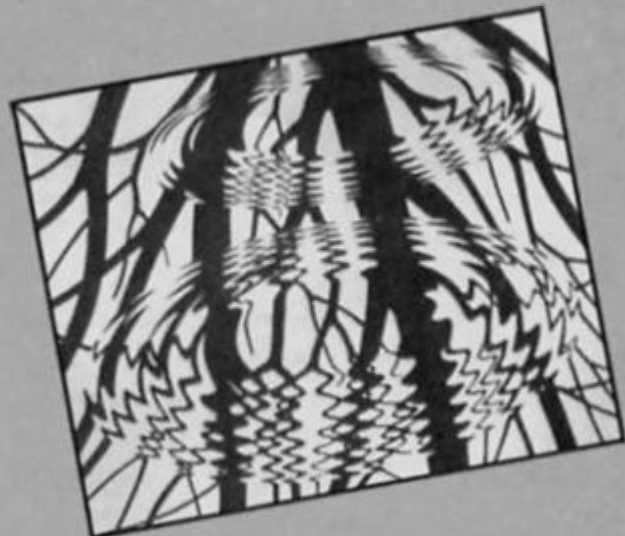

```

2A655C TEST_MEM  ORG EB2E
09              LD HL,(STKEND)
380A           ADD HL,BC
01501B        JR C, TM_NOT      Jump if not enough memory.
09              LD BC,1B50
09              ADD HL,BC      Allow 1B50 bytes for SCR2 and
                                machine stack.
3804           JR C, TM_NOT      Jump if not enough memory.
ED72           SBC HL,SP      Allow for position of machine stack.
381E           JR C, TM_PUSH    Jump if enough memory is available.
DDCBO166 TM_NOT BIT 4,(J_FLAGS hi)
2813           JR Z, TM_
2151EB        LD HL, TM_ESC    Jump if screen memory not being used.
E5             PUSH HL        Load HL with "ESCAPE" address.
CDCCDC        CALL DCCC,MESSAGE
03            DEFB 03         Print message "WARNING Screen Memory
                                Wipe" and await input.
E1            POP HL          Delete ESCAPE address.
FE59          CP "Y"
2802           JR Z, TM_WIPE    Jump if reply was "Y".
F1            TM_ESC          POP AF        Delete return address into subrt.
09            RET            Return to main loop.
DDCBO1A6 TM_WIPE RES 4,(J_FLAGS hi) Signal "Screen memory not in use".
DDCBO1EE      SET 5,(J_FLAGS hi) Signal "SCR2 has been corrupted".
09            RET            Return to carry out procedure.
E1            TM_PUSH        POP HL        HL:= return address.
D9            EXX            HL' := return address.
01800D        LD BC,0D80     BC:= half number of bytes in SCR2.
2100C0        LD HL,C000     HL: points to first byte of SCR2.
5E            TMP_LOOP2     LD E,(HL)
23            INC HL
56            LD D,(HL)      Get next two bytes from SCR2.
23            INC HL
D5            PUSH DE        Store on machine stack.
0B            DEC BC
78            LD A,B
B1            OR C
20F6          JR NZ, TMP_LOOP2
211DEB        LD HL,EB1D, TM_POP
E5            PUSH HL        Force future return into TM_POP.
D9            EXX            HL:= true return address.
E9            JP (HL)        Return to carry out procedure.

```

continued next month



# IT'S A DISCOVERY FROM ALL ANGLES

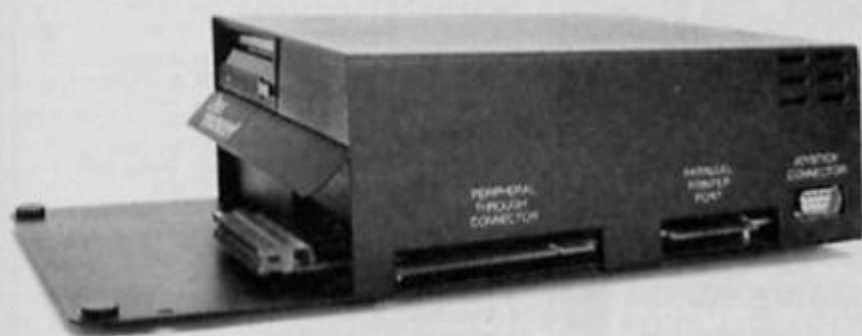

## A FEATURE-PACKED SYSTEM FOR JUST £149.95 INCLUDING:

- 3.5" 250 K disc drive
- Double density disc interface
- Parallel printer interface
- Joystick interface
- Video monitor interface
- Peripheral through connector
- Built-in power supply
- Utilities on ROM including format and verify
- RAM disc facility
- Random access files fully supported
- Connections for second drive upgrade
- Comprehensive user manual



Whichever way you look at it, Discovery – the multi-feature Spectrum disc drive system from Opus – is a lot of hardware for your money, especially now we've made it even more affordable.

At an incredibly low **£149.95** it explodes the myth that you can't buy a full-blooded Spectrum disc drive for under £200. In fact to beat our price you might have to settle for a non industry-standard system – microdrive, waferdrive or even a 2.8" disc drive lookalike. Hardly worthwhile perhaps when for very little more Discovery offers not just an industry-standard 3½" 250 K disc drive but all these amazing features:

- DOUBLE DENSITY DISC INTERFACE
- JOYSTICK INTERFACE
- PARALLEL PRINTER INTERFACE
- COMPOSITE VIDEO MONITOR INTERFACE
- BUILT-IN POWER SUPPLY FOR DISCOVERY AND SPECTRUM
- PERIPHERAL THROUGH CONNECTOR
- RAM DISC FACILITY
- SIMPLE ONE POINT CONNECTION TO THE SPECTRUM

---

## ONLY £149.95

---

Discovery takes no USER RAM from the Spectrum. Random Access Files are fully supported and formatting and back-up routines are included in ROM. You can also choose from a wide selection of 3½" disc software specially written for the Discovery games and business user.

Discovery's price of only **£149.95** even includes VAT, free delivery and a full 12-month warranty.

As you can see Discovery is much, much more than just a simple disc drive and it's available from all good computer stores nationwide. Call 0737-65080 for details of your nearest dealer or to order your Discovery direct.

Opus Supplies Ltd,  
55 Ormside Way,  
Holmethorpe Industrial Estate,  
Redhill, SURREY RH1 2LW.

**Opus.**

---

## NOW A NEW DISCOVERY FOR THE 128K SPECTRUM – CALL 0737 65080 FOR DETAILS

---



**cascade CASSETTE**

**50**

**50 COMPUTER GAMES ON ONE CASSETTE**

**YOURS FOR £9.95**

*including FREE Watch and Postage*

**FREE**

**20 KEY, MULTIFUNCTION CALCULATOR WATCH**

with every order for a Casette 50

- Normal 12 and 24 hour time mode
- Calendar mode
- Alarm mode
- Calculator mode

**WORTH OVER £10**

**PLUS SPECIAL FREE WATCH OFFER...**

**CASSETTE 50 IS AVAILABLE ON**

**BBC A/B ATARI DRAGON ELECTRON**

**VIC-20 ORIC-1 ZX81 Apple Atmos**

**Spectrum commodore 64 AMSTRAD**

**FREE** calculator watch with every Casette 50

**EXPRESS DELIVERY-ORDER NOW!**

**ONLY £9.95**

Name \_\_\_\_\_

Address \_\_\_\_\_

Post Code \_\_\_\_\_

Country \_\_\_\_\_ ZXC/4/86

**Spectrum 16k/48k or +**

'Incredibly frustrating!' - that's the verdict on Casette-50's FROGGER. Satisfied users tell us it's one of the most challenging you'll find it's almost as good as the arcade version!

CARGO has you trying desperately to complete your helicopter mission under attack. Plus 48 other tactical, logical and adventure games featuring multi-coloured and user-defined graphics, scrolling and full use of the Spectrum sound capabilities.

1. Muncher	18. Ski Run	36. Draggold
2. Ski Jump	19. Tanks	37. Space Search
3. Basketball	20. Solar Ship	38. Inferno
4. Frogger	21. Ten Pins	39. Nim
5. Breakout	22. Cars	40. Voyager
6. Crusher	23. Stomper	41. Sketch Pad
7. Startrek	24. Pinball	42. Blitz
8. Martian	25. Cavern	43. Fishing Mission
9. Knockout	26. Laser	44. Mystical Diamonds
10. Boggles	27. Alien	45. Galaxy Defence
11. Alien Attack	28. Cargo	46. Cypher
12. Lunar Landing	29. The Race	47. Jetmobile
13. Maze Eater	30. The Skull	48. Barrel Jump
14. Microtrap	31. Orbit	49. Attacker
15. Motorway	32. Munch	50. Space Mission
16. Labyrinth	33. Bowls	
17. Skittles	34. Raiders	
	35. Field	

*Names and games may vary for each type of computer.*

Delivery FREE to U.K. only, add £1.00 for overseas orders. Free watch and tape will be despatched within 28 days.

I enclose a cheque/  made payable to postal order for £ \_\_\_\_\_ Cascade Games Ltd.

or through any Post Office by **TRANSCASH** (Giro No. 655 6655)

For even faster ordering when charging to Access, Barclaycard and Trustcard Visa use our 24 hour service. (0423) 504663.

AMSTRAD  ATARI  ORIC 1  BBC A/B

SPECTRUM  VIC 20  ZX 81  APPLE

COMMODORE 64  ATMOS  DRAGON  ELECTRON

Cascade Games Ltd., 1-3 Haywra Crescent, Harrogate, North Yorkshire, HG1 5BG, England. Telephone: (0423) 504663. Registered Number 1755554

**ROMANTIC ROBOT** present

56K Spectrum extension? Instant back-up of any program? Joystick & video interfaces? YES! All this & even more with

**NO.1 SPECTRUM MULTIPURPOSE INTERFACE**

**multiface one** Version '86

**UNPRECEDENTED - UNPARALLELED - UNBEATABLE**

**at £39.95!**

- \*Internal 8K ROM and 8K RAM open new concepts in Spectrum computing: 100% reliable saving of anything, anytime and onto all types of peripherals with extra 8K at user's disposal and with a full peek & poke facility covering the entire 56K. MULTIFACE ONE does not take any part of Spectrum RAM & does not need any additional software. Just push a button to freeze a program, save it and restart from the same point next time. Peek/poke facility and 8K RAM (say with a monitor disassembler) are also ideal for studying, modifying, developing programs.
- \*Menu-driven with prompts & one-touch commands: 1) Push button 2) Select function: exit/return/save/poke 3) Input name 4) Save to: tape/cartridge/wafer/opus/beta
- \*Extremely powerful & efficient compressing for fast re-loading & using minimal room on cartridges, tapes, wafers, disks. A 7K screen can be compressed to a few hundred bytes, the whole RAM into a few K (depending on a program).
- \*Option to save a full 24-line screen only
- \*Pressing the button & return can restart a "crashed" computer
- \*Through extension bus for connecting other peripherals
- \*User friendly, fully error trapped, simply magic
- \*Users must ensure the copyright laws are not infringed \* Programs saved with MULTI-FACE 1 Can RUN independently

**Expand your Spectrum to 56K and stretch its capabilities even further with**

**multiface one ESSENTIAL SPECTRUM COMPANION**

I enclose a cheque/PO for £ \_\_\_\_\_ (UK & Europe orders please add £1 overseas £2)

or debit my  No \_\_\_\_\_

Name \_\_\_\_\_ Card expiry \_\_\_\_\_

Address \_\_\_\_\_

Please send me (tick as applicable):

MULTIFACE	£39.95	<input type="checkbox"/>
TRANS-EXPRESS cartridge	£9.95	<input type="checkbox"/>
tape (for m'drive)	£ 7.95	<input type="checkbox"/>
disk (Opus Discovery)	£9.95	<input type="checkbox"/>
wافر (Rotronics)	£ 9.95	<input type="checkbox"/>
MUSIC TYPEWRITER	£7.95	<input type="checkbox"/>
with supplement	£ 9.95	<input type="checkbox"/>
WRIGGLER Spectrum tape	£4.95	<input type="checkbox"/>
or cartridge	£ 6.95	<input type="checkbox"/>
WRIGGLER Amstrad tape	£7.95	<input type="checkbox"/>
or disk version	£ 11.95	<input type="checkbox"/>

**TRANS-EXPRESS**

The software way of transferring Spectrum software. 4 utilities for m'drive, 2 for wafadrive, 2 for Opus Discovery. Invaluable for cartridge/disk maintenance & automatic transfers. Highly professional, user-friendly, versatile and comprehensive. 'An ingenious piece of software.'

\*\*\*\*\* Features \*\*\*\*\* Performance PCN

**TOP SOFTWARE AT BOTTOM PRICE**

**Wiggler**

'One of the best games for any machine I've seen for very long time.'

'Wiggler is a totally original game.' CRASH SMASH STAR GAME PCN

'Great game, good music, well recommended.' What Mirex

'The graphics and sound are excellent and the game is totally addictive. 10/10 value & playability. 9/10 graphics & sound.' C & V Games

'This is a great game.' CAS 'Well worth buying.' ZXC & Crash

'If you've any sense you'll order your copy now.' PCN 'A WINNER' PCN

**!NOW FOR AMSTRAD!!SPECTRUM version at Xmas PRICE!**

**MUSIC TYPEWRITER**

Complete Spectrum music system for writing, editing, playing, printing & storing music. Its real notation graphics and ease of use make it an ideal educational tool. Great fun to play with & a lot to offer in serious use (transposing, dot matrix printout etc).

A very professional piece of programming, easy to use, excellent screen presentation, error trapping & helpful prompts. If you're interested in music and own a computer then get it! ZX Computing

**MIDI compatible with MIDI MUSICIAN package**

**New overlay for Spectrum - Now at Xmas price!**

**ROMANTIC ROBOT** 77 Dyne Road London NW6 7DR 24 hrs orders 01-625 9463



There is something about this machine which makes us users resist the Spectrum's lure of sound and colour or the QL's memory and microdrives.

It doesn't take long before the limitations of Basic cause us to give up or progress into machine code. What I hope to do is give a series of machine code routines which can be used by expert and novice alike to improve the 81's speed and performance.

What I have is a loader program with a massive REM at the start, this Rem contains a suite of programs which perform such essential tasks as a variety of Inputs, Prints, Pauses, Scrolls and screen effects. By keeping careful notes of register values, I then use those which apply to whatever program I am writing.

I hope to give you a similar utility which perhaps other readers may like to contribute to, so building into a program which even QLers will envy!

To simplify for new 81ers, Machine code is operating the computer processor directly by giving it instructions in its own language — numbers.

We have to store these numbers somewhere and the most convenient place is in the first line of the program which is made a REM line. This means that because it is a REM the computer ignores all the characters which follow it until directed there by a specific USR instructions.

The USR function needs to be followed by the memory address where the processor will find the first machine code instruction and this will be an address in the REM.

We know from the manual that the first address that follows the line number and REM code is 16514 and this is often the address at which we begin our machine code.

Unless you have an assembler you have to input the numbers which are usually given in HEX,

**Ray Elder presents a forum of news, hints, tips and advice exclusively for ZX81 users.**

a system of counting in groups of 16, and get them into the memory locations in the REM.

For this we use a LOADER program, a very simple one which I use as the basis of my master program is given in FIG 1, type it and save it.



**FIG 1**

```
9000 PRINT "ADDRESS TO START?";
9010 INPUT A
9020 PRINT A
9030 LET A$=""
9040 LET X=0
9050 IF A$="" THEN INPUT A$
9060 IF A$="S" THEN STOP
9070 IF X=0 THEN SCROLL
9080 IF X=0 THEN PRINT A;" ";
9090 PRINT A$( TO 2);" ";
9100 POKE A,16 * CODE
A$+CODE A$(2)-476
9110 LET A=A+1
9120 LET A$=A$(3 TO )
9130 LET X=X+1
9140 IF X=6 THEN GOTO 9040
9150 GOTO 9050
```



Before we can put numbers into the REM memory we have to claim that memory for our use, and we do that by following the 1 REM by as many characters as we need. Problems arise when you need around 1000 characters as I am about to suggest! One heck of a lot of time, especially as the 81's entry speed slows as the line length increases.

As computers are supposed to make life easy, our first program might as well create our REM for us. We still have to type in a few characters, but typing 1 REM followed by 96 dots is a lot easier than 1000 dots! Add the REM to the loader prog.

Now we can RUN our loader program and it will ask us to enter the start address. This is, surprise, surprise, 16514

The program is now waiting for our numbers, type in each line of FIG 2 one line at a time, pressing ENTER at the end of each line. Note each line consists of 12 characters with no spaces between them.

Finally add the lines in FIG 3 to the loader program and SAVE it. This should become your initial program and will be useful for entering other machine code programs which you may find in these pages or elsewhere.



**FIG 2**

```
D60BCD230F01
06002A8240E5
09444D2A2940
09222940210C
403E095E2356
D5EB09EB722B
7323233D2803
D118EEE1E501
E240A7ED4244
4DE1EDB821E3
403600233602
23C103037123
702336EA0B0B
23110100EB19
EB361BEDB036
7534CD2B0FC9
```

**FIG 3**

```
2 REM
4 PRINT "REM LENGTH ?"
5 INPUT N
6 POKE 16514,N-256 * INT (N/256)
7 POKE 16515,INT (N/256)
8 RAND USR 16516
9 STOP
```



Note 2 REM. This is a safety line and MUST be included even though it has no apparent purpose.

Having Saved the program several times (just in case!) we will now RUN it, and the message REM LENGTH? pops up. We want an all purpose REM and 1000 characters seems plenty, so enter 1000.

If all is well, a flicker and on listing, a massive line of dots...

Delete the lines, one at a time by entering their line numbers, 4, 5, 6, 7, 8 and 9. SAVE this on yet another tape for this will become our master utility program with the first 'real' routine next time.

**Hints**

Mark Baldwin of Barnsley has been squeezing beeping sounds out of his 81. Turn the TV volume up, put the 81 into FAST mode and type in:

```
FAST
RAND USR 821 ( to 829)
The result says Mark is a whole range of different notes.
```

**New Game**

Pooter Games have just brought out Pooter Puzzler No 2 a collection of seven teasing puzzles which sells for £2.95. Information from: Pooter Games, 24 Parsloes Avenue, Dagenham, RM9 5NX.





## SPECTRUM REPAIRS

A Better Deal from Micro-World

REPLACEMENT OF MIC, EAR & POWER SOCKET	7.95
POWER SUPPLIES (Spectrum/Plus/ZX81)	10.95
KEYBOARD - REPLACEMENT (Mat, Membrane & Plate)	12.95
ALL OTHER FAULTS	17.95
KEYBOARD AND REPAIR	25.95
SAGA EMPEROR ONE inc. fitting	39.95
SAGA EMPEROR ONE AND REPAIR	55.00
16-48K UPGRADE (12 months Warranty)	25.95
ZX81 - REPAIRS	17.95
ZX - INTERFACE I - REPAIR	17.95
ZX - MICRODRIVE - REPAIR	17.95

- Prices fully inclusive of VAT & Return P&P
- 48hr turn round on most machines
- 3 months warranty on repairs
- Send SPECTRUM ONLY suitably packed clearly stating fault, your name & address, cheque or postal order to:

### Micro-World Computers (ZX)

25 Hill Top Road, Slaithwaite, Huddersfield HD7 5ES  
Telephone: (Day) 0484-846117 (Evening) 0484-845587

Showroom:  
1006/1010 Manchester Road, Linthwaite, Huddersfield HD7 5QQ  
Open 9 to 5.30, 6 days

## Evesham Micros

### THE UTILITY SPECIALISTS

### MAKE THE MOST OF YOUR MICRODRIVE WITH INTERFACE III

#### THE IMPOSSIBLE HAS BEEN DONE

Yes it's true this fantastic new peripheral will transfer every program available on to microdrive. Yes every one. Yet, believe it or not, it is so easy to use that we are training our pet cat (Clive) to use it. Any one capable of loading and saving a BASIC program can transfer really software programs to microdrive.

Just look at these features . . .

• Consists of hardware and software.

• Transfers all programs available on to microdrive.

• Very, very, easy to use. (If Clive can do it we're sure you can.)

• Makes a "snapshot" of any stage of a program. (Saved as a screen.)

• Transfer can be actuated at any stage allowing "customload" versions.

• All programs reLOAD and RUN once transferred.

WARNING: Unlike competitive products, transferred programs run independently of the utility and occupy the correct amount of artridge space for the program. (This means you can fit two large programs on one cartridge.)

IF YOU HAVE A MICRODRIVE YOU MUST HAVE INTERFACE III

**ONLY £39.95 Inc. P&P**

SIMPLY AMAZING

Trade and distributor enquiries invited, U.K. and overseas

The software can be supplied on cassette for tape users.

This product is in a class of its own. Designed by DRAYSOFT

# The Best

The OCP Art Studio

For  
SPECTRUM & COMMODORE 64/128  
14.95 14.95 or 17.95 disk

"the best available"  
Crash

"extremely powerful"  
Sinclair User

"Without doubt the best"  
Popular Computing Weekly

"comes out shining"  
Your Sinclair

"in short EXCELLENT!!"  
Computer Trade Weekly

NEWSFIELD PUBLICATIONS  
BEST UTILITY 1985



Tel: 01 240 8838



Wellington House, Upper St Martins Lane, London WC2H 9DU

## DOUBLER

HAVING PROBLEMS BACKING UP THE LATEST LOADING TECHNIQUES? **DOUBLER** Will solve ALL your problems

THE tape backup "device".

After spectacular success on the CBM 64 and by public demand we introduced **Doubler** for the Spectrum. Now we have released **Doubler Mk.II**, which is professionally cased and has greater tolerance to the varying types of cassette decks in use.

It includes hardware and software. This superb "device" allows you to make backup copies of software with all types of loader regardless of length and speed. (Includes pulsing headers and different baud rates.) In fact our tests have proved "Doubler" is capable of copying with 100% success.

Requires access to two cassette decks. The software allows you to save a brand new machine copy onto one cassette deck while loading from the other. Fast and easy to use. They said it couldn't be done.

**ONLY £14.95**

PATENT APPLIED FOR

Customers who have the Mk.I Doubler may return it along with £4.95 for the new version.

All prices include P&P and VAT. Send cheque, Postal Order or Credit Card No. Credit Card order accepted by phone. Callers welcome. Wide range of goods stocked. Trade enquiries welcome. European orders send price as advertised. Outside Europe £2.00 for airmail. Mail order to Evesham Shop please.

**EVESHAM MICROS**  
BRIDGE STREET, EVESHAM,  
WORCS., WR11 4RY.  
Tel: 0386 41989

**MICRO CENTRE**  
1756 PERSHORE ROAD,  
COTTERIDGE, BIRMINGHAM.  
Tel: 021 458 4564





# EXPERIENCE THE TURBO ESPRIT!

**Your chance to win a terrifying test drive in one of the world's fastest production cars and a £500 cash prize in a competition run in conjunction with Durell Software.**

There is over £1000 worth of prizes to be carried off in this special competition to mark the release of Durell's Turbo Esprit, but for the first three winners there's an experience they will never forget — a 100mph+ spin

around the track in the capable hands of a Lotus test driver.

The top three prize winners will receive an all expenses paid visit to the Lotus factory and see the Turbo Esprit in every stage of its production. No robots here — the car is completely handbuilt. Then to climax the day — the hair-raising test drive.

In addition the first prize winner will receive £500, a JPS Lotus racing jacket, a Durell T-shirt and a Durell game of their choice. The second and third prize winners will receive all the prizes mentioned above but £100 in cash.

For twenty runners up there's a package containing a JPS Lotus racing jacket, a Durell T-shirt plus a Durell game of their choice.

The competition itself is comprised of six questions and a tie break. The official entry form is also available with the Durell games Critical Mass, Saboteur and Turbo Esprit. Entries must be accompanied by a competition coupon from a Durell advert for Turbo Esprit.

Send your entry form along with the coupon from the Turbo Esprit Advert to: The Durell Competition, Castle Lodge, Castile Green, Taunton, TA1 4AB, Somerset.

The closing date is first post Friday May 30th 1986. The competition is open to all readers of ZX Computing and all purchasers of new Durell games, except for employees of Argus Specialist Publications, Alabaster Passmore and Durell Software.

## OFFICIAL ENTRY FORM FOR THE DURELL COMPETITION

Name .....

Address .....

1. What size are the tyres fitted to Lotus Turbo Esprits?
2. In which year or years did Lotus win the World Championship?
3. Who was the founder of Lotus Cars?
4. Which town is nearest to the Lotus Car factory?
5. Which company manufactures the Combat Lynx helicopter?
6. Answer one of the following —
  - a) In CRITICAL MASS what happens when you successfully prevent the anti-matter plant from blowing up?
  - b) In SABOTEUR what happens when you leave in the helicopter carrying the disk?
  - c) In TURBO ESPRIT what happens when you destroy the armoured car?
7. In not more than fifteen words describe what you think is best about Durell games.

Cut out the COMPETITION COUPON from any Durell advert for Turbo Esprit and send it with this form to: The Durell Competition, Castle Lodge, Castile Green, Taunton, TA1 4AB. To arrive no later than May 31 1986.



**COMPETITION**



# BUG-BYTE



## SODOV THE SORCERER

3D arcade action with magical animation.

**Spectrum 48K**

**£2.95**



### TENNIS

Its 3D arcade centre court action with speech against 5 of the world's best.

**BBC/Electron**



### TURMOIL

Cartoon animation with 26 screens of slippery arcade fun, with Mick and several leaping foreigners.

**MSX**



### OLLO

'First Mission' and 'The Final Assault on Ollo' Ace action, stunning graphics and sonics straight from the arcades.

**CBM 64**



### SOLO

The Di-Planium Wars rage on. 16 alien craft to defeat with fantastic sounds and speed.

**C16**



### JACK ATTAC

A great arcade adventure, 45 screens of action.

**BBC/Electron**



# QL COMPETITION

Why should Spectrum owners get all the good software competitions? Here's a chance for QL owners to win copies of the excellent QL Paint and QL Bouncer from Sinclair Research.

What with all the attention that the Spectrum 128 has been getting lately, it occurred to the generous souls here at ZX that perhaps QL owners might be feeling left out, so we leapt into action and arranged a competition for all the software starved QL people.

Two of the best programs released for the QL recently have been the QL Paint graphics utility, and the arcade game QL Bouncer. These are both reviewed elsewhere in this issue, and we thought it would be a good idea to combine the 'serious' utility with a bit of old fashioned arcade fun, so in conjunction with Sinclair Research we have ten little bundles to win containing both programs. QL Paint alone is worth £25 so there's a tidy little sum to be given away here.

## The tricky bit

All you have to do to enter the competition is to look at the two lists further down the page. One is a list of famous artists and the other is a list of paintings; just match the painter to the painting and then complete the tiebreaker and send the coupon in to us here at ZX (it must be the original coupon, not a photocopy), by April 30th 1986.

### Painters

- 1) Constable
- 2) Da Vinci
- 3) Van Gogh
- 4) Hals

### Paintings

- 1) Mona Lisa
- 2) Laughing Cavalier
- 3) Sunflowers
- 4) The Haywain

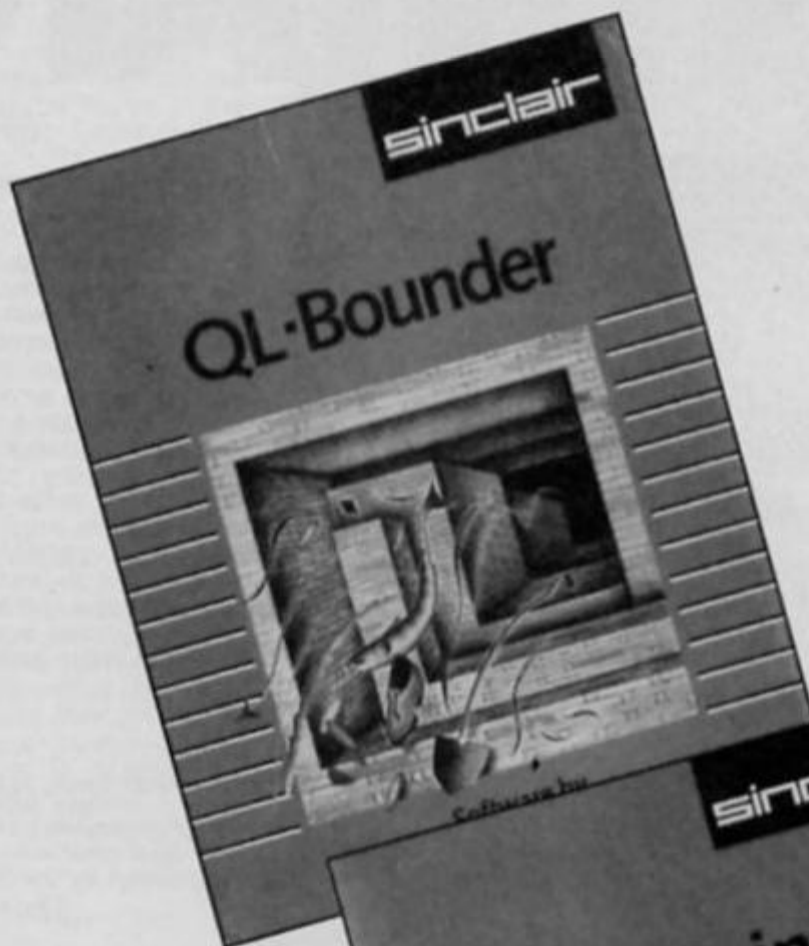

**COMPETITION**

**COMPETITION**

Painter	Painting
_____	_____
_____	_____
_____	_____
_____	_____
Name _____	
Address _____	
Tiebreaker: What would you draw using QL Paint (25 words or less)?	
_____	
_____	

Complete this coupon and send it to: QL Competition, ZX Computing  
Monthly, 1 Golden Square, London W1R 3AB



# ANIMATOR 1

## Softcat Micros £14.95

While wandering around at the last ZX Microfair I came across a stand where a software house that I'd never heard of before was demonstrating an interesting looking graphics utility called Animator 1. One quick chat and an impressive demo later, and we'd arranged for a review copy to be sent in.

Unlike The Artist, Art Studio and other graphics utilities, Animator 1 is not intended primarily as a tool for drawing screen pictures with; instead, one of its main functions is for

developing sprites and animating them to show how they will look when incorporated into other programs.

## Sprite time

When the program first loads you are presented with a pre-defined screen with pictures of a kung fu fighter and the Animator logo. In the top left-hand corner of the screen is the sprite window in which, not surprisingly, you draw your sprites. Next to this in the middle of the screen is the magnifying window which gives a magnified view of the area immediately surrounding the drawing cursor. Having both the magnified and real-size versions of the sprite on view at the same time is a useful idea as it saves switching back and forth between different magnification modes as many utilities require you to do.

The size of the sprite window can be defined according to your requirements, up to the full size of the screen though the

A screen dump of the Camelot picture supplied on the Animator tape, plus a dump of one quarter of that picture expanded by using the Enlarge facility.

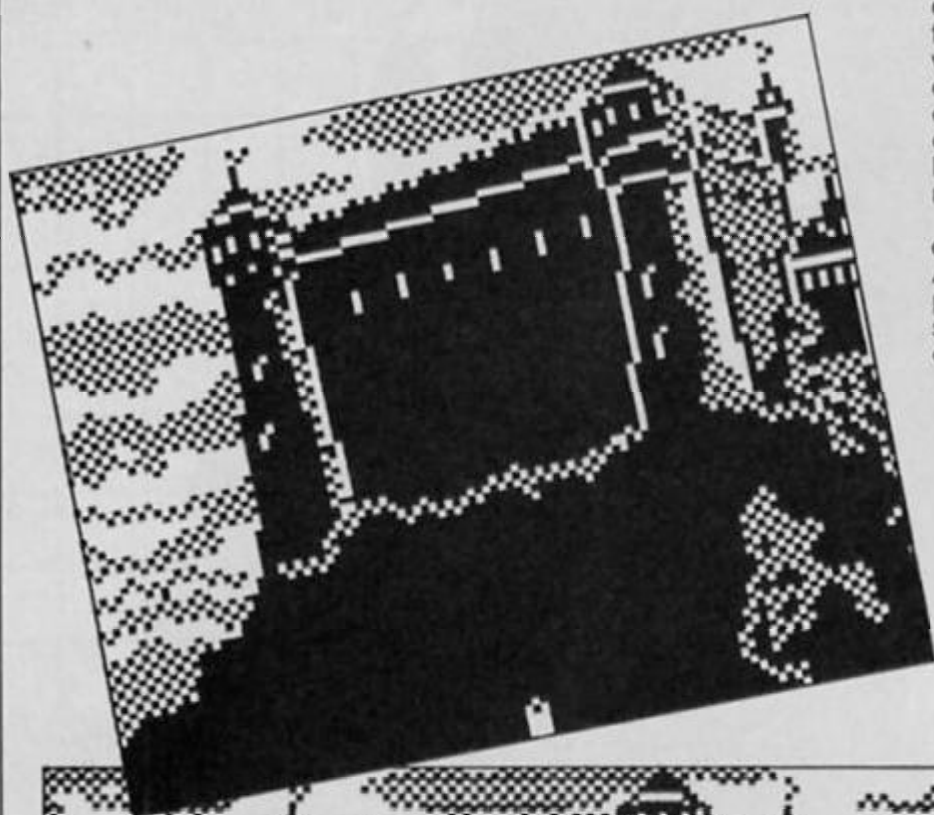



larger the sprite, the fewer the number that can be held in memory. When the program loads the sprite window is set at sixty four pixels wide by ninety six high and up to seventeen of these can be stored in memory.

The magnify window can be moved around the screen or switched off all together if you want to draw on a part of the screen that it normally occupies. If you wish, the sprite window can be done away with, allowing you to draw screen pictures as other utilities do.

The program shares many features that are now standard in such utilities; elastic and fixed line drawing, circles, and



a variety of pen sizes and brush patterns.

It's a mistake to compare Animators 1 to programs like The Art Studio because as an all-round screen designer it's not in the same league. Much of the memory that could be used by drawing routines is given over to sprite storage and animation so there are no fancy Cut and Paste routines and only a few simple shape drawing routines. But, as a dedicated sprite designer it's very good indeed, and there are a number of commands which allow you to manipulate areas of the screen that would be unnecessary in a conventional graphics program, but which could be very useful for instance, for someone attempting to design a series of sprites for an animation sequence in a game.

These commands allow you to rotate, reflect and scroll either the whole screen, the attributes alone, pixels alone or to expand and contract the screen (this turned out to be a surprisingly useful facility which produced some interesting effects, especially when making dumps to a printer and there's an example of this using screen dumps of the Camelot design supplied on the Animators tape).

The control of these commands is cleverly done; the scroll and rotate keys are along the top (numbered) row, and the choice of attributes, pixels and so on is controlled by the bottom row, so to scroll the

attributes you just select the relevant numbered key and press the attributes key (X), or the key relating to whatever part of your picture that needs to be scrolled.

The circle command is also well implemented. Instead of choosing the centre point and then moving the cursor to the radius, Animators 1 places a set of cross hairs on the screen which indicate the position and size of the circle before it is drawn. The cross hairs can be moved around the screen and adjusted to change the size of the circle — a better method than I've seen used by any other graphics program.

Once you've designed your sprites you can FETCH them one at a time to the screen, or there is an ANIMATE option that allows you to animate any combination of sprites at varying speed. The magnifying window remains functioning while this happens so you can have a close look at individual sprites, and there is a frame counter that gives a constant readout of what point in the animation sequence you have reached. This allows you to inspect each sequence in detail and make any changes necessary before SAVING the sprites for future use.

## Print Mode

Animators 1 has some excellent commands for handling text. You can enter a string of up to eighty characters, and using the top row of keys this can be moved around the screen (keys 5-8) or distorted by expanding, contracting or altering the spacing between letters (keys



1-3). When these commands are used together they allow you an enormous number of ways of manipulating text.

My only real criticisms of Animators 1 concern certain aspects of its ease of use. The manual, in its present form, is simply not very well written. It seems to have been written by someone who already knows just what the program is capable of and doesn't really go down to the most basic level that the first time user starts from. It took me a long time of hit-and-miss experimentation with the controls and the various pull down menus to achieve any sort of familiarity with the program's capabilities (though once I had done that I found myself enjoying using the program).

One or two of the menus also get a bit tedious to use, as

they lead you on through a series of sub menus that quite often may not be needed, though you still have to plough through them before getting back into drawing mode. The menu for loading SCREENS into the program only allows you to do so if you enter the name of the screen — you can't tell it to just load the first screen that it comes to on a tape (ie LOAD "" SCREENS), which is inconvenient though not a major drawback.

Still, with one or two reservations about the manual, I nonetheless found Animators 1 a useful and quite enjoyable utility. As I said, it's not the world's greatest all-round graphics program, but with its animation, rotation/reflection and other functions, it is one of the best programs specifically for designing animated graphics.









LOTHLORIEN'S

# ARENA

## ARENA

Following the recent death in combat of the previous champion you have been selected to represent England in the Arena, the 21st Century's warground. Have you the skill and application to prove yourself a champion?

Available for:  
**SPECTRUM 48K**  
**AMSTRAD**  
**£9.95**



Please send me Arena (£9.95 inc P&P) for the

Spectrum .....

Amstrad .....

I enclose a cheque/postal order for £..... made payable to Argus Press Software.

Name .....

Address .....

.....

.....

Post to:  
Argus Press Software, Units 1 & 2, Conlon Developments, Watery Lane, Darwen, Lancs. BB3 2ET  
LOTHLORIEN, LIBERTY HOUSE, 222 REGENT STREET, LONDON W1R 7DB.



# THE ROCKY HORROR SHOW

CRL  
£9.95

'How'd you do, I  
See you've met my  
Faithful handyman.  
He's just a little brought  
down because  
When you knocked  
He thought you were the  
candyman'

Actually it was just Brad and Janet the all-American bores, who dropped by to play The Rocky Horror Show computer game. Based on the stage play rather than the film and approved by Richard O'Brien, the show's creator, this version of the game from CRL was the very first game for the Spectrum 128 to arrive in our offices. It's very similar to the original 48K version in which either Brad or Janet is turned to stone by Frank N. Furter's Medusa machine and the other half of this happy couple has to seek out all the pieces of the De-Medusa machine which are scattered around the house.

You can choose to play either Brad or Janet and as you wander around the house you can collect keys to all sorts of unwholesome and strange rooms, not to mention weird characters like Riff-Raff, Magenta, Fast Eddie and Rocky himself. Magenta has the rather disturbing habit of ripping your clothes off when she bumps into

you, and this prevents you from collecting any pieces of the De-Medusa until you've found them again. Riff-Raff is a little more conventional — he just zaps you with his pitchfork, while Eddie will try and run you down with his motorbike.

The inside of Frank's home is rather chic, with long staircases, old-fashioned cage lifts, four poster beds and so on, all drawn in fine detail. The game itself is more or less identical to the 48K version and the number of screens is the same, though a couple of bugs that were present in the original seem to have been cleared up. The additions are the special effects screen at the end, in which the house takes off, and (drum roll please) the music! At long last Sir Clive has put a decent sound chip into the Spectrum and rather than the usual feeble BEEPs this game is accompanied by a three-channel rendition of 'The Time Warp'. This is a 'funked up' version of the song, also approved by Richard O'Brien, and hearing sounds like that coming from a Spectrum was quite an eye opener (ear opener?) and we've had the game running in the office just to provide a bit of background music. Obviously it's early days for the 128, but if this is an example of the sort of sounds it can create then we've got lots to look forward to.

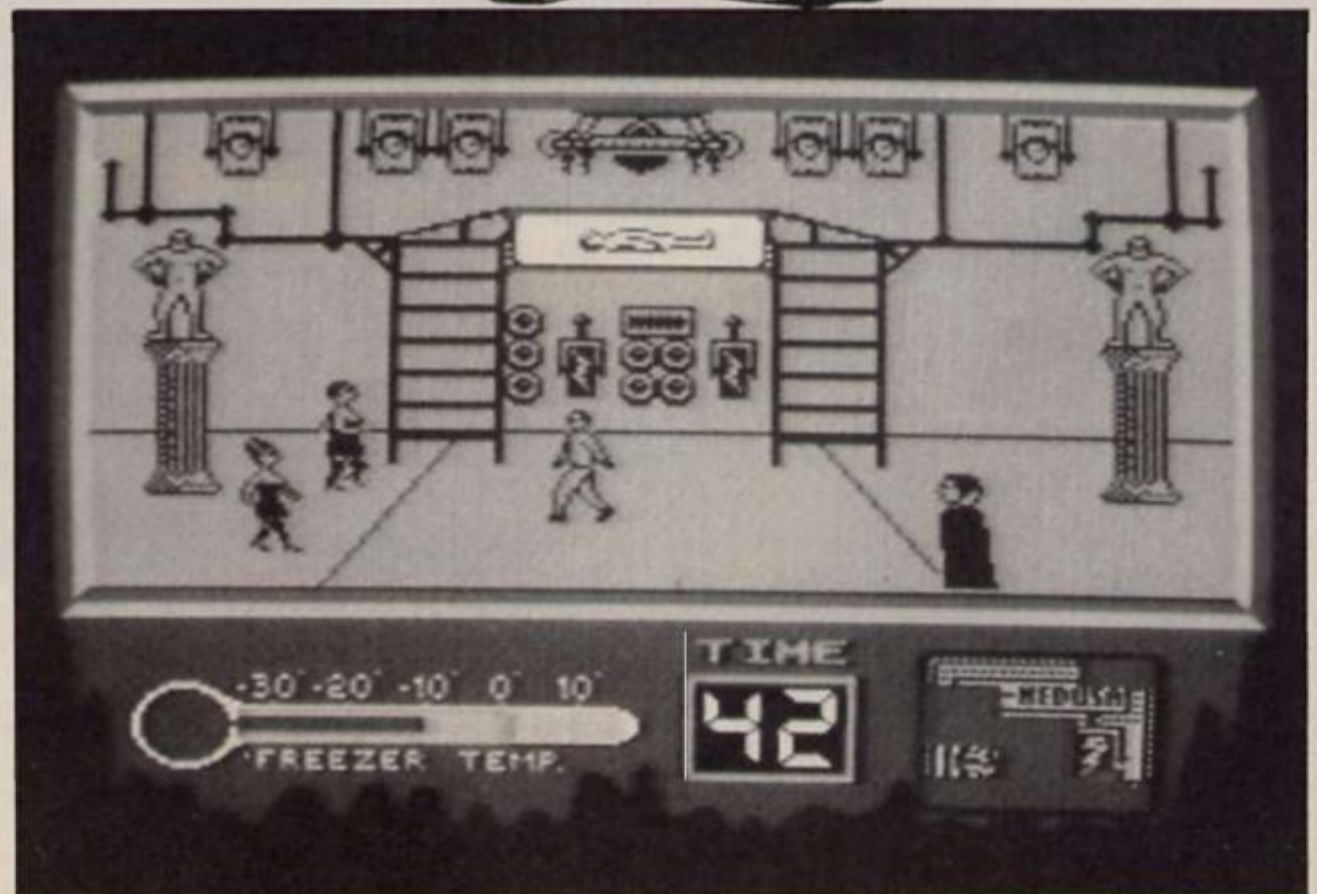







# DYNAMITE!



Ivan the Crusader's epic quest to end Rasputin's evil reign puts this isometric multi room arcade adventure in a world of its own.



The evil Orcs ravage the land of Belorn – you control the only characters who can save it. Stunning landscapes plus intriguing adventure in 'Venturescope'.

## HOT



Crazy multi-screen adventure – failed Germ Gerry proves his worth by laying waste to his victim's body – until he reaches the heart...

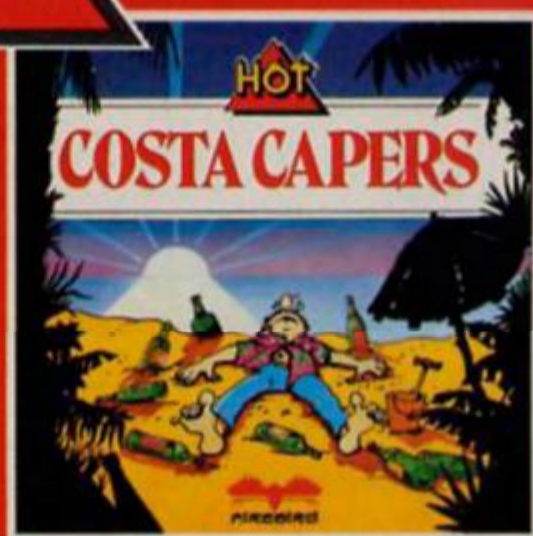

Ted's Great Summer Blow-Out – over 40 whacky screens as he tries to avoid sunstroke, drinks like a fish and blows all his hard-earned money!

Four great, sizzling games from Firebird – the all-new Hot Range. Available for the Spectrum, Commodore 64 and Amstrad – see them at all good computer stores now!



**firebird**

FIREBIRD SOFTWARE WELLINGTON HOUSE  
UPPER ST. MARTIN'S LANE LONDON WC2H 9DL

#### MAIL ORDER

Please state name of game, machine, cassette or disk and quantity required. Enclosed crossed cheque/PO made payable to FIREBIRD SOFTWARE. All offers are subject to availability. Orders are despatched promptly. All prices inclusive of VAT and postage.  
MAIL ORDER: AUNTIE KAY, \*FREEPOST FIREBIRD, WELLINGTON HOUSE, UPPER ST. MARTIN'S LANE, LONDON WC2H 9DL.



# RANDOM MEMORY

Clyde Bish explores the limits of streamlined memory use in the first part of a new series

Hands up those who remember the 1K ZX 81? "Only 1K!" I hear those new to the computer fraternity exclaim. "What on earth could you do with only 1K of memory?". The answer is quite a lot — If you know how to make the most of the bytes available. (Someone even managed to write a chess program in only 1K!)

The 48K Spectrum has about 41K of available RAM for your use, but even this gets used up more quickly than you might think in adventures, databases and elaborate games programs. The purpose of this series is to demonstrate various ways of saving memory to enable you to pack the computer equivalent of a quart into a pint pot.

## Numbers

Let's make a start with those great byte-wasters, numbers. You might think that to hold the number .134 in memory would take up just three bytes, one for each digit, but it doesn't. Type in this short program then press ENTER:

```
10 LET a = .134 : LET p = PEEK
23635 + 256 * PEEK 23636 :
FOR f = p TO p + 17 : PRINT f,
PEEK f : NEXT f
```

Now RUN and you'll see displayed two columns of numbers. The left hand one shows the memory spaces you have used. Opposite each of these is a number which is the code of the character held in each of these bytes. The first eleven of these are the line number and codes for the beginning of your program (LET a = 134). You'll see that six other numbers follow the code for 4 (52) before you come to the 58, which is the code for the colon you typed in. The first of these is 14. This is the code for the number character — see Appendix A in your manual — and is followed by five other numbers. These represent your number 134 in binary. This is the number system your computer actually uses when it runs your program. (It only displays number in decimal for the sake of us 10-digit humans!)

What this means is that storing numbers in a program takes up six more memory spaces than would first appear.

## A few tricks

So, numbers are great byte-wasters. But who needs them any-

way? Here are some tricks which avoid the use of numbers. Each example is followed by a bracket showing; (number of bytes used/number that would be used if an actual number had been included).

The numbers 0, 1 and 3 can be replaced by functions. So, zero can be replaced by: **NOT PI (2/7)** — because NOT with any value equals zero (and the value of PI, 3.142 etc. is built into the machine's ROM). In a similar way the value 1 can be replaced by **SGN PI (2/7)** as the SIGN of any positive value equals 1, and 3 can be replaced by **INT PI (2/7)** as the INTEG of a number removes any digits after the decimal point.

Other numbers can be produced in a variety of ways. If you have already declared a variable, for example by having a statement such as **10 LET L = SGN PI** you can use this value, and subsequent ones to declare others. For example:

```
20 LET z = L + L
30 LET f = z + z (22)
in place of
20 LET z = 2
30 LET f = 4 (30)
```

VAL, the function which evaluates a string, can also be used. For example, **10 LET z = VAL "2" (12/15)** again makes z equal to 2. The VAL trick can be used for any number but there are other tricks which can be used for certain numbers which save even more bytes. For numbers from 32 to 255 the CODE function can be used. For example, **10 LET s = CODE " "** makes s equal to 32, the CODE of the character space. Similarly, **20 LET x = CODE "COPY"** makes x equal to 255, but there's a problem: COPY is a keyword, but the quotes after CODE leave an L cursor, and you need a K. This is how you need to enter that line (ignore the / signs — they are just there as spacers);

```
2/0/LET/x/= /CODE (in E
Mode) / THEN / COPY /
Now cursor left, delete the THEN,
and there you are!
```

## Big numbers

One final trick for large numbers is to use VAL but with the E-form of the number. So, **10 LET t = VAL "4E6"** makes t equal to 1,000,000 (i.e. 1 Extended by six zeros) and take up six bytes less than VAL "1000000" (and seven bytes less than simply using the number value 1000000).

It might not seem that you're saving much memory, after all, what's a few bytes out of 41K? But it is a lot, when you add them all up. Remember, "Look after the bytes, and the K's will look after themselves". A friend, writing a number crunching spread sheet-type program used these tricks and saved 2½K on a 12K listing!

But this isn't the end of the story. You can save even more space with numbers (and other types of variables) if you don't intend to change them while the program is running (or don't mind if they are changed). When you RUN a program, any variables you set are added to what is known as 'the variables area'. This makes them immediately available for the program to use. This means that you have them stored twice, once in the program area, and again in the variables. Why not just store them in the variables area (known as VARS for short.)? Try this. Type in **LET a = 10** with no line number, and press ENTER. "O.K." says the computer. Now type in **PRINT a** and press ENTER. the number 10 appears on screen. Although you don't hold it within your program — you haven't got a program! — the machine knows the value of a because it's held in VARS.

You can prove this by typing in a program similar to the one given earlier, replacing the PEEK values with 23627/8 and missing out the LET a = .134 — the machine already knows what a is! Start your program with GOTO 1, not RUN — I'll explain why in a moment. You should be able to find the code for a, followed by the representation of 10 in five digits.

You must not use RUN with programs where the variables are only held in VARS because RUN clears the VARS area, and so goodbye to your information! The golden rule is SAVE such a program with a line number so that it autostarts (and remember to use GOTO if you BREAK!).

Finally for this month, declare a variable for a number if you intend to use that number more than once in a program, and remember that single letters are much less wasteful than variable names.

Next month I'll turn my attention to the more literary and colourful side of program writing. Happy savings!



# TO ADVERTISE YOUR REPAIRS AND SPARES SERVICE PHONE STUART TAYLOR 01-437 0699

## REPAIRS

### SPECTRUM REPAIRS

- Spectrum repairs £18.95 inc. parts, insurance and p.p.
  - QL repairs - phone for details.
- Send your computer with cheque or P.O. for £18.95 and description of fault to:

#### SUREDATA (ZX) Computer Service

45 Wychwood Avenue, Edgeware, Middx. Tel: 01-951 0124 PL53

### SINCLAIR REPAIRS

New low fixed prices: Just look at these —

Spectrum/Plus	£17.00
Microdrive	£18.00
Interface 1	£18.00
Interface 2	£12.00
ZX Printer	£15.00

Special winter offer 16-48K only £24.00. Please enclose brief description of fault and £1.80 p&p for each item sent to:-  
Micro-Mend, Main St, Farcet, Peterborough PE7 3DB  
Tel: (0733) 241718.

## FREEPOST

### SPECTRUM REPAIRS

Guaranteed Six Months

We have been maintaining all types of computer systems from mainframes to micros for over 15 years and offer you:

- Full overhaul and update with each repair
- Six months warranty on *whole* computer - not only the repair done
- 24hr turnaround on most faults - including soak test
- Returned to you by first class post fully insured
- Freepost - we pay the postage both ways
  - All inclusive price for any fault £20

**MP ELECTRONICS, FREEPOST, DEREHAM, NORFOLK NR19 2BR Z**

Tel: 036287 327

### SINCLAIR COMPUTER REPAIRS

All machines despatched within 72 hours of receipt.  
Spectrum £17.00. ZX-81 £12.50  
Spectrum 16 to 48K upgrade £25.00 (inc. parts, VAT and return postage)  
For a fast and reliable service, send machine, brief description of fault and cheque or postal order to the experts:  
**Capital Computer Services, Unit K2, Cardiff Workshops, Lewis Rd, East Moors, Cardiff CF1 5EG.**  
Tel: (0222) 461801

### SINCLAIR SERVICE CENTRE

Fast repair service for Spectrum, ZX81, Interface 1 and microdrive. All units repaired to original standard by our HNC qualified staff. Average repair cost £15 but for free estimate send your machine with £1.95 (return postage) with a brief description of fault. Turn-around approx 24hrs. Established international Service. Our work is fully guaranteed. Personal callers welcome.

#### QUANTUM

33 City Arcade, Coventry CV1 3HX or phone (0203) 24632 or (0203) 714080

**TO FILL THIS SPACE RING STUART TAYLOR**

### SPECTRUM REPAIRS

£14.95 inclusive of labour parts and p&p. Fast, reliable service by qualified engs., average repair 24hrs. 3 months guarantee. For help or advice ring:  
**H. S. Computer Services, Unit 2, The Orchard, Warton, Preston, Lancashire PR4 1BE. Tel: (0772) 632686.**

### INTERCONTINENTAL SPECTRUM REPAIRS

Spectrum/Plus	£19.95
Spectrum keyboard fault	£12.00
Ram Upgrades	£25.00
Spectrum dust covers	£1.95
QL dust covers	£2.95
Interface 1	£17.50
Interface 2	£12.00
Upgrade 16k to 48k	£30.00

Price including parts, p&p. Send unit & cheque/PO to:  
**P.E.A.K. ELECTRONICS, 32 Clifton Avenue, Hartlepool, Cleveland TS26 9QN. Tel (0429) 272739**  
Overseas please add £3.50 p&p.

### SCOTLAND'S No 1

For home and personal computer repairs  
Specially fast Spectrum service!

- Same day for most faults
- 1 hour if delivered personally
- Open 6 days a week
- Free estimates
- Upgrades, Membranes and P.S.U.'s
- 3 mth. warranty on work done

Also BBC/CBN/ORIC and PERIPHERALS

#### MICRO-SERV

95 Deerdrykes View  
Westfield Industrial Area,  
Cumbernauld G68 9HN  
Scotland  
Tel: Cumbernauld (02367) 37110  
Trade, schools and club discount given.

### SPECTRUM REPAIRS

We expertly repair Spectrums for £17 inclusive of parts and labour and return postage.

Spectrums upgraded to 48K for £34 inc. P&P. All keyboard faults cost only £12.

**R. A. Electronics, 133 London Road South, Lowestoft, Suffolk. Tel: (0502) 66289.**

### COMPUTER REPAIRS

We are the experts, having serviced Sinclair computers since the introduction of the ZX80. Don't waste money on estimates - we repair Sinclair computers at price quoted (inclusive parts, labour, postage, VAT, irrespective of fault. No hidden charges. Repairs guaranteed for 3 months.

Spectrum	£18.75 inc parts
ZX81	£11.50 inc parts
16 KRAM	£9.95 inc parts
Microdrive	£15.95 inc parts
Interface 1-11	£18.75 inc parts
also	
BBC	£22.00 + parts
Electron	£19.95 + parts
XX Memory Expansion Kit	£15.95

Computer Retailers please phone for Special Trade Price.

Call or send with cheque or P.O.  
**T.V. Services of Cambridge Ltd, French's Road, Cambridge, CB4 3NP**  
Tel. 0223 311371

## POOLS

### POOLS PREDICTION

Perfected over 6 seasons. OutPuts best draws, homes & aways. Holds form comparison graphs. Analyses & graphs results. Takes full account of mid week games & "Cup" matches between main league teams. Promotion/ regulation option (can be used from season to season.) Easy to use, even for beginners. 57 wins (356 dividends) received by author so far.

"The best and most scientific of any program I have seen" - Mr R.A.P. Secretary Orpington Computer Club. "Once again, thank you for one of the best investments I have made" - Mr D.L.B. Feltham. "I would like to congratulate you on your excellent service. It is a rare thing these days" - Mr L.G.P. Shrewsbury. "I found your program very professional and user friendly, I am very satisfied with it" - Mr B.D. Spalding.  
Ask for British Pools £11.95  
Australian Pools £11.95  
Allow 7 days for delivery. Cheques, POs payable to ROMBEST or quote ACCESS card number.

#### ROMEST DEPT ZX

2 Welland Croft, Bicester, Oxon  
OX6 8GD Tel: (0869) 248002  
Available for 48K SPECTRUM & COMMODORE 64. Add £2 for Sinclair microdrive or 1541 disk.

## FOR SALE

**SPECTRUM 48K** and **ZX-81 16K**. Morse RTTY and SSTV, RX, TX, PGM's. Output radio into earsocket Spectrum or ZX-81 info. Jerry Holthaus, Iristraat 73, 4542 ED Hoek, Netherlands. Phone: 01154 1591.

**ZX COMPUTING MONTHLY WELCOMES ITS CLASSIFIED ADVERTISERS TO THE NEW STYLE ISSUE**

## ACCESSORIES

**SPECTRUM RGB OUTPUT MODULE**  
adapt electronics

★ Connect a monitor to your Spectrum ★ Super sharp text ★ Superb colour graphics ★

- True TTL/Analogue outputs + comp syncs
  - Monitor quality pictures - no dot crawl.
  - Suits RGB monitors & monitor/ TVs
  - Simply plugs into expansion port.
  - No separate power supply required.
  - New through port version. Allows connection of modems, joy-stick interfaces etc.
- Price £34.95 or £36.95 (through port) + £1 P&P many addons parts & software SAE for details  
20 STARLING CLOSE, BUCKHURST HILL, ESSEX, IG9 5TN. Tel. 01-504-2840

## GAMES

**EXBI PUZZLER**  
No. 2  
7 GAMES only £2.95  
OTHER EXBI TITLES...  
PUZZLER 1 - £2.95  
All software post free - Send 4\*6 S.A.E. for more information.  
GIROBANK ACC. NO. 30-381-7909  
**PUZZLER GAMES 24 PARLOS AVENUE DAGENHAM RM9 5NX**

## BOOKS



Einstein

**We use only 10% of our mental potentials**

These are the words of Albert Einstein, the greatest physicist of recent times.

L. Ron Hubbard's discoveries in the field of the mind prove today that Einstein was right.

In his book "DIANETICS: The Modern Science of Mental Health" L. Ron Hubbard takes one more giant step in this direction.

He reveals how anyone can use his discoveries to isolate the exact barriers that have so far prevented people from using their mental potentials to the full.

More and more people from all walks of life use Dianetics technology today.

The many written reports on their success are the best proof of the quality of this book.

Find out for yourself. Order your copy of this remarkable book today.

Price £3.95 paperback £17.50 hard-back. Make cheques and POs payable to S.H.F. Send to Church of Scientology Saint Hill Foundation, FREEPOST (FYC 1), East Grinstead, Sussex RH19 4ZA (no stamp required).



# ZX COMPUTING

Lineage: 40p per word.

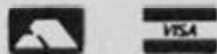

Semi display: £9.00 per single column centimetre. Ring for information on series bookings/discounts.

All advertisements in this section must be prepaid. Advertisements are accepted subject to the terms and conditions printed on the advertisement rate card (available on request).



## 01 - 437 0699

Send your requirements to:  
**STUART TAYLOR**  
ASP Ltd., 1 Golden Square,  
London W1

## UTILITIES

### SPECTRUM TAPE AND DRIVE TRANSFER UTILITIES

ALL SPECTRUM owners need TC7 — our specialist tape utility. Send SAE for FULL DETAILS of this amazing and widely used program.

- Integral header reader.
- includes BAUD RATE (speed) measurer.
- can save high speed/jerky parts in "normal" form for DRIVE transfer.
- so many extra features we can't possibly list them here. Just try it and see. As the market leader we can't afford to let you down.

**COST only £6.50 (or £9.99 on cartridge with MT6 a special m-drive program — £7.50 with MT6 on tape)**

### TAPE TO DRIVE TRANSFER OF RECENT PROGRAMS

Yes SPECTRUM owners now have a **LOW COST** way of transferring many of even the **LATEST** high speed/jerky programs to their drives. You will be amazed! Other methods are expensive or very limited.

Firstly you need our MD1b (for m-drive) or WD16 (for Wafa/or Disc drive. They give you the tools to convert programs so that they will run on your drive. Includes ability to cope with v.long programs, can split/chop bytes in one go, "VAL" creator, REMkill, make Visible, etc, etc. **FULL** manual (highly rated by CRASH) with example transfers. (also need TC7 for latest programs). **MD1b or WD1b cost £6.99** "Manages more programs" — Your Spectrum. (TC7 also needed for latest programs).

### LERM INFORMATION SHEETS

Each sheet gives you the **DETAILED** instructions required to transfer 8 of the more **POPULAR** programs to drive using our software. They cost **£1 each plus SAE**. Up to sheet 5 available.

**TRANSFER PACK** — TC7+MT6+MD1b on **CARTRIDGE** + information sheets 1-3 all for **£15.30** (other drive owners get programs on tape + sheets for same price with WD1b replacing MD1b).

**UPDATE SERVICE:** for latest version on your LERM product send old tape + large SAE to get a **£2 REDUCTION**. **OVERSEAS:** add **£1** Europe, **£2** others for each product. **SAE for enquiries.**

**ALL PROGRAMS CARRY OUR MONEY BACK GUARANTEE (not updates)**

LERM, DEPT ZX, 10 BRUNSWICK GDNS, CORBY, NORTHANTS. NN18 9ER.

## SOFTWARE

**FIVEDICE (48K SPECTRUM)** — a great version of a popular dice game, using well known playing card hands. Only **£4.99 + 50p p/p**. Send Cheque/PO to: Replay Software, Dept Z, 8 Stevenage Rd, East Ham, London E6 2AX.

**SENSATIONAL** postal software bargains for Amstrad, Atari, BBC, Commodore (all formats), Electron, Spectrum. For free list send a SAE or phone Teletex Cleckheaton 0274 875299. 28 Brooklyn Court, Bradford Road, Cleckheaton, W. Yorks.

**ADVENTURES UNITE TO SAVE THE WORLD!** "The Time of the End" is here, an expertly written science fantasy adventure for the 48K Spectrum. Imaginative plot, realistic atmosphere, humour and intriguing problems. Acclaimed as excellent value by top adventurers. **£3.80** from Mandarin Adventures, 14 Langton Close, Woking, Surrey GU21 3QJ.

**ZX81 1K/16K** quality software! B.A.S.I.C. course, and A.Z.U.C. ZX81 users club. For details, send SAE to: ACV, 1 Foxwell Sq., Northampton NN3 5AT, England.

## SOFTWARE

### WD Software

FOR THE QL:

**JOSS** base **£13**

Forget that tedious, time-consuming syntax! Just move the cursor and press SPACE for all your file commands. Cursor keys or your joystick allow you to access microdrives (up to 8) and floppy discs (as many as our interface allows) with up to 150 files on each! Scroll and print directories, COPY, DELETE or PRINT any file, select TV or Monitor mode before LOADING or RUNNING any program. You only use the keyboard to set the DATE or label a device when FORMATTING. Easy to use with Psion and other software. No silly icons to learn — JOSS will TELL you what it's going to do! Programmer's toolkit and mass copying/printing utilities also supplied. Specify microdrive-only, Microperipheral or CST-compatible disc versions.

**Ref QL7** base **£7**

1300 useful QL references with ARCHIVE 2 search/print program. Too long for just one cartridge, so if you have RefQL5 just pay 2 and extra media cost to update.

**Mdv Extension Cable** **£5.50**

Eight inches long, allows addition of extra microdrives to your QL. Twist it to put their slots facing you.

FOR THE QL: SPECTRUM; BBC; ELECTRON

**WD Morse Tutor** base **£4**

Written to teach amateurs, now used by professionals too! Absolute beginner, or stretching your speed to 18 wpm, you won't find anything with more helpful features. What else can offer 100 random sentences as well as all the basics? Disc version unsuitable for BBC B+.

FOR THE SPECTRUM:

**Wordfinder (Microdrive/disc only)** base **£8**

For CHEATING at crosswords. Finds m-ss-ng letters, solves, anagrams. 13,000 word vocabulary, so too long to share a cartridge. 10-letter word ending in ATE? No problem.

**Tradewind** base **£3**

Sailing/trading strategy game with graphic surprises.

**Jersey Quest** base **£3**

Text adventure in time. Background of Jersey folklore from Stone Age to Bergerac.

**For export:**

QL hardware and software from many sources. Ask for list/quotation.

**ORDERING ADD COST OF MEDIUM, POSTAGE £1 OUTSIDE EUROPE.**  
Mdv or 5.25" floppy — £2 3.5" floppy — £4 Cassette — £0

**Payment**

By ACCESS/Eurocard/MasterCard or STERLING (UK bank cheques, Eurocheques, drafts or International GIRO). To:

**WD Software (ZX), Hilltop, St. Mary, Jersey, C.I. tel: (0534) 81392**

## MAKE RACING PAY!

A RETURN OF £180  
Mr. J.G. (Prestwick)

WITH THE BRIMARDON FORMULA.

**AT LAST**, a top class and profitable programme for anyone interested in racing. Much specialised racing knowledge incorporated giving maximum winning potential. This easy to use programme is suitable for computer expert & novice alike and no racing knowledge is necessary to use it. 1985 flat season yielded a 40% profit (after tax). Winners at 20-1, 12-1, 11-2 etc. Excellent Value for money.



Enquiries for this and other racing software to:

**BRIMARDON COMPUTER RACING SERVICE**  
48 PIERREMONT ROAD  
DARLINGTON DL3 6DH

### RACING LEAGUE

If you think that computer games are mostly variations on the same old themes then join the famous personalities in the **RACING LEAGUE!** This refreshing simulation game is for one to four players. Features include buying and selling of horses, betting, jockeys, loans, racing sequence etc. As in real life you will need skill and luck to succeed. Can you become Top Owner? A Save Option keeps the game going as long as you like. For 48K Spectrum and Spectrum Plus and only **£3.50** post free from:

**R.L. Software, "ZX" 22 Lindale Garth, Kirkhamgate, Wakefield, West Yorkshire, WF2 0RW.**

**DATABASE** for ZX81 with Memo-pak 64 new structure. Compact, fast, flexible, stores vast amounts of data **£5**. Johs Lind, Kirkegade 116, 6700 Esbjerg, Denmark.

**TERROR. A GAME** to give you nightmares. Pure graphical brilliance. Horrifyingly original. 48K Spectrum. **£4** Henderson, Kinnear, Wormit, Fife, Scotland.



# REAR-END MI

Greetings from the dark dungeons! Step with me into the mysterious, murky but always exciting world of adventuring. I am kept down here in the gloomy, damp and dripping dungeons, at the bottom of the hideously evil Argus Press towers with only a Spectrum and a few large rats to keep me company (*that's no rat, the Ed.—Asst. Ed.*) solely to tell you informed of what's new in adventures. Some loyal readers may remember this was exactly my task for the late, and much lamented, Home Computing Weekly. When that publication met its untimely demise, I looked forward to being released into the sunlight after many years of silicon slavery. But was freedom forthcoming? No way! A mysterious figure called Bryan brandishes a whip at me and tells me to keep writing for this new magazine. More years of cruel ill treatment to come I fear, and this editor is even more savage . . . (*shut up and get on with it or it's back in the cold custard for you—Ed.*)

More on what Mindplay offers. Each month, along with full reviews of the latest adventures, there will be a helpline service offered to readers. Just fill in the form at the end of this column if you need aid. I also like to join in the celebrations when you complete a game — so if you feel particularly chuffed having solved a tricky adventure, tell me about it! I like to receive your solutions too — unfortunately I just don't have the time to complete every adventure available! At the end of each column I will be listing some of the games a solution would be particularly welcome for, and I am sure you amazingly intelligent readers will be able to provide them.

So, ever onwards. The reviews are all a bit old this month — there seems to be a lack of adventure software at the moment, due to the post Christmas lull, but before those, a little thought.

## 128 Implications

You will probably have read elsewhere in this illustrious journal full details of Uncle Sir Clive's new(ish) baby, but I felt the need to add something on its exciting implications for adventuring. No longer will we have to endure excuses about brief text or dull/absent graphics "because of memory

problems". Now we can have our cake *and* eat it! All the features the adventurer ever dreamed about: imagine Adventure International style graphics with Level 9 quality text — now it's possible. And large vocabularies, with a fully understanding interpreter. The pure text adventure for the 128 could approach the standard set by Infocom on other machines.

At the launch, some 128 versions of 48K titles were promised; these include Never Ending Story, Secret of St. Brides, Adrian Mole, Return To Eden (perhaps with decent graphics?) and Robin Of Sherlock to name but a few. There's also talk of an improved Lord Of The Rings, but not for some time.

But the most exciting new product comes from Gilsoft, and is provisionally called The Quillillustrator. As the more intel-

lectual among you might have guessed, this combines the ever popular Quill and Illustrator, and adds some other very interesting facilities. Built-in will be speedier graphics, a shape function, RAM save/load and, best of all, four word input recognition — at last we can all put TIE ROPE TO TREE in our adventures! With the extra memory, Gilsoft reckon you should be able to have 250 locations with full text and a picture at each. And while we're on the subject of the Quill, good news for 48K owners — a text compressor is on the way, sometime this year.

So, exhilarating times ahead, I hope to look at some 128 adventures, if, that is, I manage to get my hands on one of the machines. Maybe the editor will throw one through the dungeon grating?

# RUNESTONE

Firebird £7.95

I first saw this last May, when Games Workshop were marketing it. When they pulled out of the software industry, Firebird bought the rights to the game, and at last here it is.

The first thing you notice is its similarity to the classic Lords Of Midnight. This is largely due to a technique called 'Venturescope', which produces a similar staggering number of views to the system used in Midnight. But Runestone actually improves on Midnight, which is one of the reasons it's so good.

The once beautiful land of Belorn is being destroyed: hordes of orcs, controlled by Kordomir, the Dark One, have been roaming around and generally being rather nasty. Your quest is to find the Runestone, which will give you the power to destroy Kordomir and return Belorn to its nice old self. You control three different characters: Morval the warrior, Eliador the elf and Greymarel the wizard; there are also various amiable folk of the land to help you. The game has over 2000 locations, 40 different char-

acters and is played in real time. Within the quest are many problems to be solved, plus some wargaming to defeat the orcs, and plenty of treasure to hunt.

The top half of the screen contains the graphics, which are generally very attractive. Since the game was first released, these have been improved with more detail, and like the rest of the game they are slightly faster. There are 8000 different views, all quite similar, made of trees, mountains, various buildings, lakes and so on. They all look rather cold looking, since they are almost entirely in blue.

Where Runestone differs from the Midnight series is in the stylish, lengthy text which appears: location descriptions, battles, conversations and actions. The characters interact with each other, and with you, in slightly random Hobbit style. Plus, your commands are typed. The interpreter is good — a fairly large vocabulary, with fast response and complex sentences allowed.

By Peter Sweasey





Etiador travels north.

Etiador is standing in a beech wood, looking north towards a beech tree.

Etiador is carrying a bow and an arrow.

>PAU\_



Morval is standing on open ground, looking north.

Morval makes pathetic whimpering noises.

Morval is carrying nothing.

PAUSING

## TIME OF THE END

Mandarin Adventures  
£3.95

In contrast to Mindshadow's professionalism comes what can only be called an amateur adventure, not from America but from my home town, Woking. A series of cataclysmic events indicates the end of the world — but they are in fact being caused by evil aliens, playing a demented game to relieve the boredom of their eternal lives. Taken to their planet, you must save earth from destruction.

Time Of The End is an imaginative hotch-potch of ideas. Inspiration ranges from Monty Python and Bob Dylan to the ubiquitous HitchHiker's Guide. At one point you become a bird and fly about; at another you lose your body and need to engage in deep philosophy. There is also a kindly alien called Kilroy. He tried to warn earth of its destruction with his graffiti, but it was misinterpreted!

Description is atmospheric, sometimes lengthy and above average. There is a peculiar offbeat wit — laughs from ideas rather than words. Where the game falls down is in its limited vocabulary; any game which requires USE needs improving. This restrictive vocabulary makes play feel linear, more an effort to find the right word than solve puzzles. Sound is really naff, particularly the death march. The game presentation I found rather unprofessional: a redesigned font, and less long pauses, garish colour and beeping would have improved this.

Generally then, a cheap (four pounds) and cheerful adventure; not bad if you like the idea and don't mind word matching, but hardly competition for Level 9.



A few flaws remain. There is the daft character called Skrimnal who will appear from time to time, steal what you are carrying and grin. Getting it back is laborious. Also, if the computer does not understand you, it prints 'your character

scratches his head and wonders what to do next', rather than say what it does not understand. But these are minor points. Runestone is simply excellent: a high class, polished piece of software. It comes in a well designed square package,

complete with story book, map and other information. It will keep you going for some time, and all for a very reasonable price! Congratulations to Firebird and the author, Alan Davies, for the very first Mind-play Monster Hit!





## MINDSHADOW

Activision  
\$9.95

I thought up an amazingly witty comment about amnesia for this review, but I've forgotten what it was! The reason for that (attempted) witticism is that you start this game not knowing who or where you are, or why you are there. The object of the game is to find this information, which makes a change from searching for lost princesses.

Mindshadow is of American origins, indicated not only by the idiosyncratic spelling (like 'marvelous') but in the extreme professionalism and good design. Whilst British adventures are often innovative they are just as often flawed, and forget the needs of the player. But, like many American games, what Mindshadow lacks in innovation, it makes up for in quality. For example, on the tape is a short tutorial — and this is by far the best introduction to adventuring I have EVER seen. It even guides the player through a

mini-adventure complete with its own illustrations describing almost every command you could think of. The game proper is extremely user friendly, with an unusually wide variety of responses.

The graphics are in an unusual style, as you can see from our screenshots, but are above average and varied. They can be slow to build up but this is offset by the facility to jump straight to a location using a string of movement commands. The puzzles are intelligent and logical, and though Mindshadow is nothing stunning it is entertaining and worth looking at; it's good to see some American software on the Spectrum, even at this slightly expensive price.



# MINDPLAY



# HELPLINE

This being my first issue no pleas for help have yet been dropped into my dungeon. So I've picked some problems which seem to occur quite frequently, in the hope that they may be of use to any struggling adventurers.

First, help for the popular game of the fun film Gremlins. Keep getting snow ploughed? You need equipment from the petrol station pit. The gremlin in

the bedroom can be killed by emptying the kitchen drawer, but it's a remote possibility. Gremlins reproduce in water, so a full swimming pool makes little sense.

Even though it's rather ancient now, Fantasia Diamond still proves popular. To go down the trapdoor, HIT or BREAK it several times. Knock on the brown door — it helps. The sheet of music is in a book in a chest. Take it to the violinist and ask him to play. Tell the robot to open the manhole, but make sure it's fully powered first. Stuck

in the dark cellar? RUB GLASS!

One feature of Ventures, HCW's adventure column, was maze corner. I have never liked mazes; they don't test ability, just slow the player down, frustrate or totally stop him. Once you can solve one, you can solve them all, so experienced adventurers often don't like them either. Maze corner simply gave full solutions to mazes. To those people who don't agree with this idea, I would suggest not reading the next two paragraphs. Maze Corner is hereby reinstated!

Starting then with Witch's Cauldron. From the workshop: OPEN DOOR, S, S, E, E, S, W, W, S, E, N, where you will find the large key, then W, N, E, N to the east door. In the more recent Mindshadow, go north from the Quicksand sign, then E, N, E, E, E, S, S, E, to find another beach.

In Colossal Adventure, you might find your lamp dimming. In which case you need to go and drop the coins by the vending machine to have your batteries recharged. The machine is in the maze of twisty tunnels, all different; from the entrance, go S, CLIMB, E, and E. To return, go N then up. In the same game, to find the orange column in the maze of alike passages, go S, E, S, S, S, N, E. Then, providing you have been robbed, go E and NW to the pirate's chest.

Some Hulk hints. If you have fatal ant attacks, block their entrances — plug your ears with wax, close your eyes and hold your nose. You'll need to be rid of the bees before you can take the wax — so wave the fan at the holes you'll find outside the second dome, on closer examination.

Remember, help is at hand for your adventure problems — just fill in the form. I usually give a personal reply unless a vast amount of mail is received. Next time expect to see a much longer helpline in Mindplay, dealing with all the sticky situations I am sure you will send in! Finally, I'd like to hear from you if you have completed any of the following: Mordon's Quest, Lord Of The Rings, Worm In Paradise or any of the Mysterious Adventures series.

Title: .....

Company: .....

Problem: .....

I can help solve: .....

Name: .....

Address: .....



**REALTIME GAMES SOFTWARE**



# STARSTRIKE II

**SHADED 3D**

**SPECTRUM / AMSTRAD £7.95**

Mail order or Access telephone orders  Tel: 0532 458948  
Cheques, P.O.s payable to: Realtime Games Software Ltd., Prospect House, 32 Sovereign Street, Leeds LS1 4BJ

Send for product list for: **Spectrum \* C64 \* Amstrad \* QL**



THE OFFICIAL

# FA Cup

GAME



R.R.P.  
£7.95

For the first time the Football Association has fully endorsed a computer football game. It is a realistic football simulation which lets you take 10 teams through the competition from the First Round.

Tony Williams, celebrated author of "League Club Directory" and "F.A. Non-League Club Directory" has provided authentic up-to-date home and away form for a total of 124 League and Non-League teams.

You must decide which tactics your teams use throughout the various matches and you must make managerial decisions which may well effect the morale of your team and subsequently the score! You may represent a local team, and if you are lucky enough to receive the benefit of a "giant-killer" your team may even experience a dream cup run!

Above all, **The Official F.A. Cup Football** game comes up with realistic results that's why the Football Association have given it their full approval!

Available for Spectrum 48K, Commodore 64/128 and Amstrad CPC 464/664/6128

Name .....

Address .....

Spectrum 48K  Commodore 64/128  Amstrad CPC 464/664/6128

Tick appropriate Box

All versions of F.A. Cup Football cost £7.95. Please make cheques and postal orders to **Virgin Games Limited** and post to the address on this advertisement.

Please do not post money.

Virgin Games Ltd, 2-4 Vernon Yard, 119 Portobello Road, London W11 2DX