

UPDATE!

Magazine

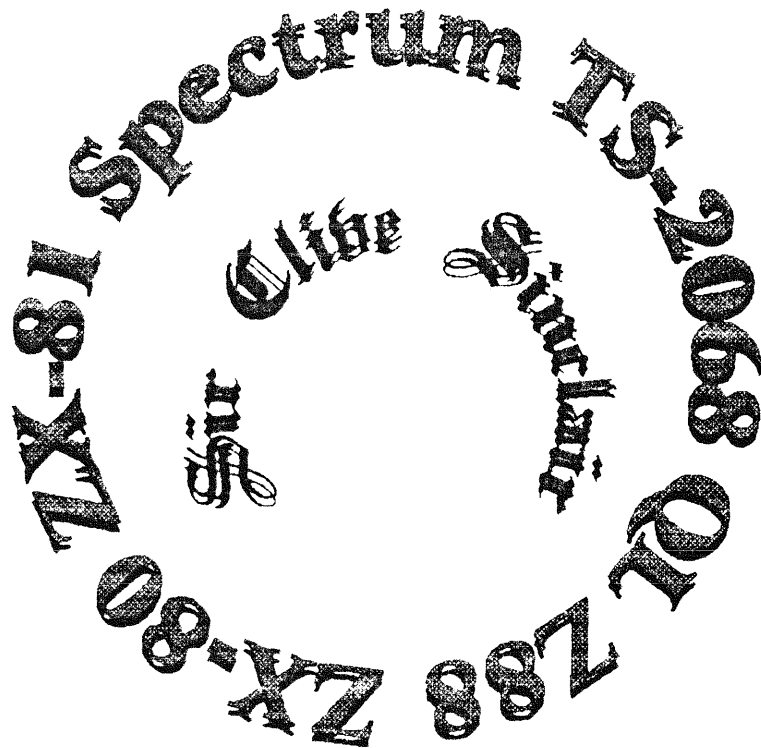

APRIL 1995

P.O. BOX 17, MEXICO, INDIANA 46958
\$5.00 / Issue \$20 / Year

UPDATE COMPUTER SYSTEMS is edited by Frank Davis and published by Carol Davis of P.O. Box 17, Mexico, IN 46958 USA. The phone number is 317-473-8031 for both voice and fax. Normal hours for voice are 6 to 9 P.M. Tuesday thru Saturday. Please use the answering machine if we are not available, and leave a short, concise message with both phone number and address. The hours for faxing are from 11 P.M. to 6 A.M. Monday thru Sunday, and at other times if you let us know that we have a fax coming. Most answers to questions left on the machine will be by mail, as long distance charges are too costly for a small magazine to be expected to bear.

Mailing date of the magazine: all issues will be mailed out near the 20th of the months of October, January, April, and July. All mailings within the USA are by bulk mail and may take a few weeks to reach you at the most. Those wishing to have faster service may pay \$4 extra for First Class Mail. The present rate for North America is \$20 in US\$; and 18 Pounds, or 40 DM in European currency, for a subscription. All issue years run from October to July of the next year, and those who subscribe during a year will get all of the issues for that year. In this way all subscriptions begin and end at the same time. Timely renewals are what keep us in business!

Assistance in publishing this magazine is provided by you the readers, many of whom have contributed news, articles and reviews. We offer you our heartfelt thanks. We are mainly assisted by our longtime friend, Eliad Wannum, Poet, Psychologist, and Sinclair computer user. In addition, regular contributors have been: Bill Cable, Paul Holmgren, Al Feng, Don Lambert, Bob Swoger, Abed Kahale, Peter Hale, A. E. Green, to name just a few. We invite

you to submit material for publication to UPDATE MAGAZINE. Please make all hard copy (printed out) submissions Letter or NLQ; no draft print, or 2040 thermal print. The quality is too poor to print in a readable manner, and we do not have the spare time to re-type an article. If you do not have a printer capable of this, then send the article on disk to us as: Z88, IBM, QL, TS2068 in Oliger or Larken, or in an Amiga file. We can handle these disk formats. We can use 5.25 or 3.5 disks, in DSDD, HD or ED densities. Send two copies of hard copy. Do not submit stuff on audio tape, as we no longer have tape decks for the TS1000 or the TS2068. Try to avoid flowery or hard to read fonts, unless you are showing us sample output from a printer reviewed or a program. If artwork for an article is to be included, please let us know in what order you think it should be displayed. We can accept articles over the fax.

Those wishing to place ads in UPDATE MAGAZINE: We have two ways of handling ads. ONE, we will do reciprocal ads for other publications (generally on a year for year basis) with both of us exchanging copies of the issues the ads are placed in. TWO, the other way, is to purchase ad space from us, with the following rates in effect for now: \$15 per quarter page; \$25 per half page; and \$40 per full page ad. This is per issue. For inclusion in all four issues, you pay for three issues in advance, and get the fourth issue free. For two issues you pay full rate for one ad, and get \$5 off of the cost of the second ad rate. Should you have any questions on this please contact Frank Davis either by phone or mail, as listed above. All checks should be made out to UPDATE MAGAZINE.

We hope to be of service to you. Thank you for your support.

TABLE OF CONTENTS for April 1995

The front cover for this edition was done courtesy of Abed Kahale of CATUG. Thanks, Abed! This is a quarterly, user supported magazine. The inside page covers subscriptions, ad and article submission to UPDATE.

Page 1	--	Directory
Page 2	--	Editorial by Frank Davis
Page 4	--	When Zero Isn't Zero by Bob Hartung
Page 5	--	Repairing the TS2068 by Victor M.S. Acuna
Page 8	--	RMG ad - Rod Gowen
Page 9	--	A New Sinclair BBS by Tim Swenson
Page 10	--	T/SNUG Information
Page 11	--	Sinclair's and the World Wide Web by Tim Swenson
Page 12	--	TS2068 ad by Mechanical Affinity
Page 13	--	Reference Card for the ZX80, ZX81 & TS1000 (part 2)
Page 15	--	Reference Guide for the TS2068 (part 1)
Page 18	--	Use a Mouse on Any Hardware, Implementing the Mouse on a Z80 System by Richard Rodman, submitted by Wm. DesLauriers
Page 21	--	Wanted or For Sale - ads by subscribers to UPDATE!
Page 23	--	Buying a Modem? by Abed Kahale
Page 25	--	QBOX USA - ad
Page 25	--	Computer Classics - ad
Page 26	--	See You In Oak Ridge - Mechanical Affinity - QL ad
Page 27	--	Archive Series Part 20: More on Linking Databases Together and Using Sedit - Cable Column by Bill Cable
Page 30	--	QLerk - ad by Wood & Wind Computing
Page 30	--	Z88 ad - Mechanical Affinity
Page 31	--	IQLR - ad
Page 32	--	The 3rd North American QL Show
Page 33	--	QLUMSi v4.70 by Al Feng
Page 35	--	News and Views on the QL by E. P. Wannum
Page 38	--	Hardware For Your QL by Roy Arwood
Page 39	--	Z88, Machine States from the Developers' Notes
Page 39	--	Notebook Computer Light - ad (useful for Z88)
Page 40	--	Z88, The Serial Interface from the Developers' Notes
Page 44	--	Z88 & QL Source Books - ad
Page 45	--	Timex Publications Index, part 3 by Paul Holmgren
Back Covers -- Information on Issue Disks for the QL & TS2068		

EDITORIAL by Frank W. Davis

Carol has brought it to my attention that it is time for me to take computer keyboard in hand and type out another vastly entertaining and educational editorial for your amusement. At least this is how almost all authors hope their work will be taken. Be that as it may, here I go.

I try to offer a variety of articles, ads, reviews and news in each issue of UPDATE. I would like to have more reviews of programs. I seem to have run across a problem with that, however. I have had several people offer to do reviews, so I sent programs to them. Months later I do not have the reviews, yet I am out the copy of the program. I have never had anyone who ended up doing the review in the 12 times I have sent a program to someone to review. The reviews we have carried over the last five years have been done by people who had bought a copy of the program and either sent it in unsolicited or asked me in advance if I wanted a review of a program. To those people, let me say "Thanks". I am at a loss as to what to say about those who never carried thru for whatever reason. I do not want to say hurtful things, just "to those 12 of you who I have over the years sent a copy of a program and never received a review back from you, please note that you could still do so." No hard feelings on my part, just amazement that it is those who have paid for a copy of a program who ended up doing the review. Enough said on this subject.

Just for myself I feel that over the years I have come a long way with computers. In 1976 when I first started learning to repair what were called mini-computers in those days (PD8s and PD11s) the idea of this much horsepower in the hands of so many was unthought of. Even though the number of Sinclair users is not what it was ten years ago, I find that most of us are quite familiar with what we have and are still interested in getting them to do more. For those who use the TS1000, ZX81 and the TS1500, I have seen no new software out over the last 4 years. I have seen a few articles on new uses and a few type-in programs as well as repair hints. If you still like using them, all I can say is stay with a user group, promote its newsletter, and buy up extra programs, repair parts and hardware every time you get the chance. They still have use left in them, but to put off a purchase may mean that you will never get a chance at that particular item again.

Now for those of you who use the TS2068 we have a bit more movement on the scene. If you have paid any attention at all to the T/SNUG quarterly and to UPDATE Magazine, you will have seen this. At UPDATE we have given many of you ample opportunity to get our Issue Disks at a fair price to both us and the software author. They are usually worth the money. We have seen improvements with an alternative operating system called Logical for the Larken. This is to me the best improvement for the Larken system I have seen since it came out. Ask Bob Swoger of CATUG (the software author), I was never pleased with having to use the Larken system. Now I at least do not find it an objectionable task. Many people find that this makes Larken the ideal system to use for their TS2068. I still prefer the Oliger disk drive system, but not by a whole lot. I think that this has something to do with the fact that I had been using the Oliger for about four years constantly when the Larken came out. I am very comfortable with it.

Also for the TS2068, we have made information and programs available that allow you to do some work with 24 pin printers, offered greatly improved versions of TASWORD 2, and brought back a chance for those who tried to previously obtain Print Factory (DTP program) to get what they had missed out on. We have also recently brought back the chance for you to buy the Print Factory Graphics disks by John McMichael. We, as well as T/SNUG recently published plans to give you the chance to build your own Larken dock board. This can give

you a home brew disk drive system for your TS2068.

We also try our best to let you know where you can get your computers repaired (such as the Computer Classics ad). Add to this the fact that we have usually had at least one type-in program an issue for the TS2068, as well as the occasional one for the TS1000. I hope that most of you feel we are doing a balanced job. It is not easy when trying to cover the TS1000, Spectrum, TS2068, QL as well as the Z88. I often envy Bob Dyl, the publisher of IQLR, as he has only one machine to devote all of his coverage to. Bob does a great job on keeping us up to date on what is going on with the QL world wide. I believe he deserves more support from North American users than he gets. The subscribers he has are good people and contributors; I just think he deserves more North American subscribers.

I am not going to touch too much here on what we have done with the QL; Eliad has sent me a large enough article covering what is new or changed to handle that. Just allow me to say two items.

One is that the QL has seen a lot of growth over the last couple of years in both hardware and software. At its present rate of development, if kept up, it can still be made comparable to the mainstream computers in use, and still offer us an easy to learn and use multi-tasking system that is the envy of many other users, when they take the time to use it. My personal opinion is that right now the only things lacking are: (1) SCSI Interface (2) a good color scanner with software for graphics and OCR (3) software with a graphical interface designed to use the Internet (4) VGA or better graphics, with at least 256 colors available.

The second item concerns the QL Issue Disks. Unlike the sale of those for the TS2068, sales have been darn near non-existent for the last year. If there is no change in this by the next issue, I will be dropping this for future issues. Perhaps that is because Paul Holmgren and I offer so much software for the QL thru Mechanical Affinity that more of the users go that route. Please do not make the mistake of thinking that these issue disks are of inferior quality; they are really quite useful. As in all things in life, the choice is yours.

We have still not had as much coverage on the Z88 as I would like to see. We are limited in this area by what is sent to us, and by the fact that there is still not a lot of commercial software available here in the US for them. At Mechanical Affinity we have brought in some new Z88 users recently by once again offering these fine machines for your public consumption, as well as more peripherals (by the way if you recently bought a program and cable to use the Z88 with your QL and it does not work, it is the cable....return it to one of us and we will set it right). The best place to find some home grown software as well as commercial for the Z88 is to (1) buy a copy of the Z88 Source Book from us (you also get software) (2) check with Mike Fink of Domino Cubes for his software offerings.

I hope I have not bored you with this editorial. It is not meant to be a complaint department, just to keep you up on what is good and to let you know about new products and events. If something bad is mentioned, it is just to let you know the Sinclair scene as it looks from here, as a dealer and as a magazine editor. We do this magazine as an act of affinity for our users and readers, not to make money. There are not enough of you to make any decent money doing this, but it is usually fun. I also particularly like the computer shows. I want to see as many of you as I can at the QL show in Oak Ridge, TN in June, and at the Dayton Computerfest at the end of August. Let us all get together and have fun and share information.

OAK RIDGE HO!!!!

When Zero Isn't Zero

Bob Hartung, 2416 N. County Line Road E., Huntertown, IN 46748

The problem posed by Basil Wentworth (January UPDATE, p. 22) seems to point to a glitch in the floating point algorithm used by Sir Clive -- shades of Intel Pentium! I first became aware of it shortly after the TS2068 came out, but I presume it also existed in the ZX81 ROM I installed in my ZX80, as it does in the Spectrum and QL ROMs. I found that a program branch which depended upon a zero difference between a calculated mixed decimal value and its integer was erratic. It only worked when .00001 was added to the calculated value before the ≤ 0 branching test was applied.

In the listing to the right, this compensation is done in line 150 of Basil's demo. The two right columns of the printout show this produces the desired result. The left column printout shows why the calculations of the variable pg in lines 150 and 250 do not produce a true zero as they should at every tenth result of 0.1 being summed ten times. In fact, repetition of the error and round-down cause greater divergency each time a calculation is based on the one preceding it.

Compensating with +.00001 also produces a divergency, but since it is positive instead of negative, truncation of the calculated values to two decimal places will produce an expected zero result enough times for most practical purposes. STR\$ and VAL (missing on the QL) may be used for this on the TS2068:

```
LET d$=STR$ n1
IF LEN d$<4 THEN LET d$=d$+".00"
LET n2=VAL d$( TO 4)
```

QL coercion allows this method:

```
d$=n1
IF LEN(d$)<4 THEN d$=d$ & ".00"
n2=d$(1 TO 4)
```

A similar error also is produced by the floating point algorithm used by Intel processors preceding the Pentium, but

since the divergency is positive rather than negative, an approximation of zero at the expected places is produced similar to the one demonstrated below. This can be shown in both the GW-Basic and QBasic programs included with Microsoft DOS. Interestingly, spreadsheets such as Abacus for the QL and Quattro Pro 5.0 for DOS handle repeated floating point-integer calculations correctly.

```
TS2068 DEMO LISTING
10 PRINT "Left column shows no
n-zero sums of pg+.1-INT pg. Ri
ght columns show compensation of
page+.00001""
100 LET page=1: LET pg=1
110 FOR f=1 TO 60
130 REM .00001 added to page in
line 150
150 LET page=page+.1+.00001: LE
T pg=pg+.1
160 LET panel=page-INT page
165 LET panel=.1*INT (10*panel)
250 PRINT pg-INT pg;TAB 16;INT
page+panel;TAB 24;panel
1000 NEXT f
```

Regarding a "glitch" of another sort, during the past year my responsibilities as chaplain for a county jail and sheriff department, plus trying to pretend I was a hard-hat construction worker while helping my brother build a Quonset-type machinery storage barn, greatly curtailed the time available for computer-surfing. I'm not complaining but, in fact, am glad that at +70 (non-floating point!) years I could still climb a scaffold and tighten about 8000 bolts. However, during that time I discovered that both disk drives for my TS2068 as well as the two for my QL had become ill and were corrupting disks whenever a write was attempted.

Fortunately, I can now access my backups, thanks to Dan Elliott having replacement drives, although I still need time to restore everything. The moral is backup, backup, backup! By the way, if your floppy drives are repairable, ISR in Leander, TX, does an excellent job at a reasonable cost, phone (800) 458-6778.

Victor M. S. Acuña
Buenos Aires, October 16, 1993

UPDATE MAGAZINE
P.O. BOX 1095
Peru, Indiana
U.S.A.

Dear Frank:

I am sending my subscription fee (in cash because I must pay \$ 10. plus, for a check), and a few tech. notes about my circuits in repairing TS-2068's.

Some words about my curriculum: I am a Superior Electronics Technician (a tertiary level grade), and actually I am a student at CIE (Cleveland Institute of Electronics), in Electronics Engineering course. I work since 1986 in the computers field, and really I am an expert in repairing TSs.

The topics I send in this letter are over repairings of SCLD IC. Evidently the troubles generator in the TSs is the SCLD IC. In the service shop I encountered that about 60% of TS's fails are over it, and like it change cost about \$ 30.- (I have until many of them, and I did a special iron to remove them), when the price of the machine began to fall, an option was design circuits specifically to repair parts of it. Now a working TS 2068 cost around \$ 50. And the TS repair market, practically don't exist. The total number of machines imported to my country was around 5,000.

Principally, the SCLD problems are:

- 1) No Interrupts (every ~17ms) from SCLD to CPU, and then "no keyboard" fail.
- 2) One or more rows of keyboard not work. SCLD not read or it's data lines are "open".
- 3) No cassette. Not read data from the cassette player.
- 4) The refresh circuit build into the SCLD for the high memory bank (32,768-65,535) A7R don't work. The machine initialize, but the programs crash. THIS IS THE MOST "DESTRUCTIVE" FAIL, and commonly only reparable by changing the SCLD. Yes it's my great discovery !!! Thanks, thanks,.....

1) The SCLD provide, via INT signal (Pin 16 Z80) the signal necessary to scan the keyboard. This signal are generated in every field of the screen (1/60th sec.). But if it aren't, the CPU never read the keyboard. More explain about it are in the Technical Manual. Originaly, I tested taking the signal from vertical synchronism, but it don't work well. Then I designed a circuit from a 555 timer, and it worked O.K. The circuit is:

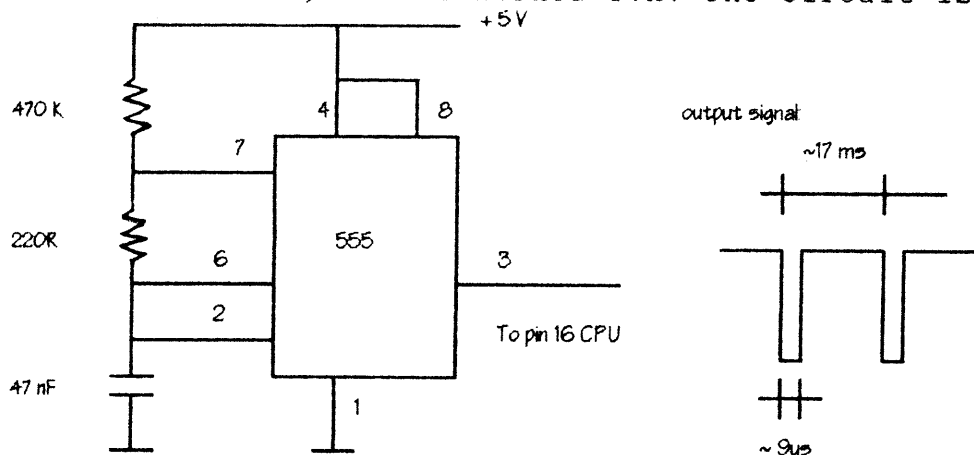

2) If the keyboard fail only in some rows, and one are sure that the problem is in the data lines, (via oscilloscope level test, for example) and not in the keys itself. Then the solution are build a circuit that overlap the SCLD keyboard circuit. To remember you, the keyboard use D0 to D4 to scan the KB0 to KB4 lines, in the port 254. This correspond to A0 = 0. Then the circuit is:

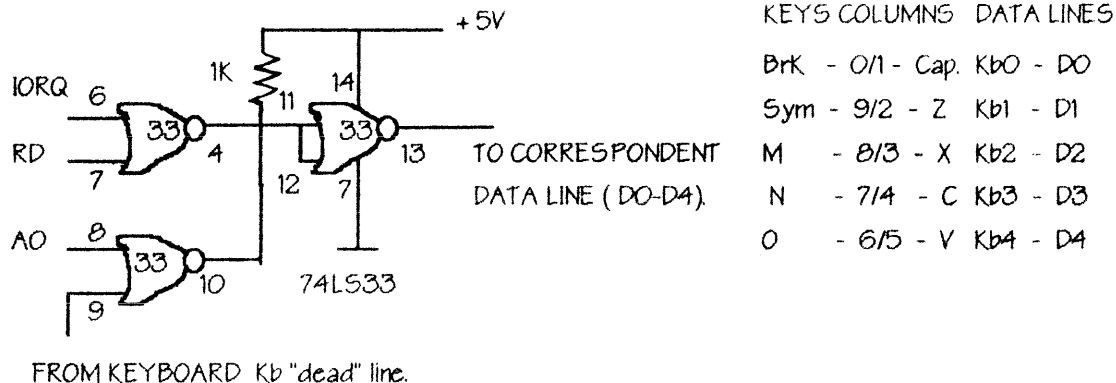

3) The cassette input view from CPU is the same port that the keyboard, but in the D6 bit. All we need to do, is amplify the audio input, decode the 254 port, and accouple it to D6. Then a "dead" cassette TS come to work. The circuit is:

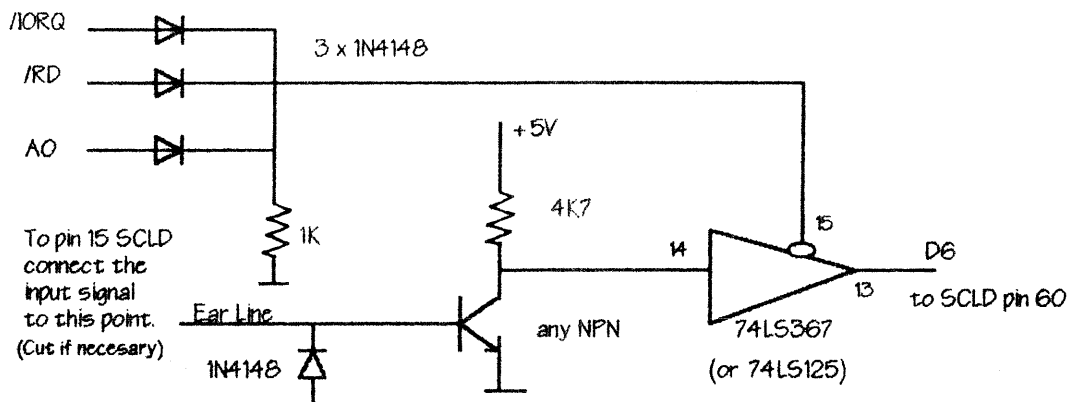

EXTRA :Like some TSs are more deaf than others, and in general all are "hard" to ear (Sure I designed, sold, and made money with a signal improver, LG-02), seeing in the cassette input, Timex put only two diodes to ground -CR25/26- (I don't know why, only two), for bias the input SCLD circuit, to protect the input electronics, and to conform the input signal. The solution I encountered, was to add one diode in series between them. Commonly I desolded one extreme of one diode and add one more between it and the hole in the board, - remember in the same direction -. Conclusion: with three diodes my TS become an excellent machine !!!

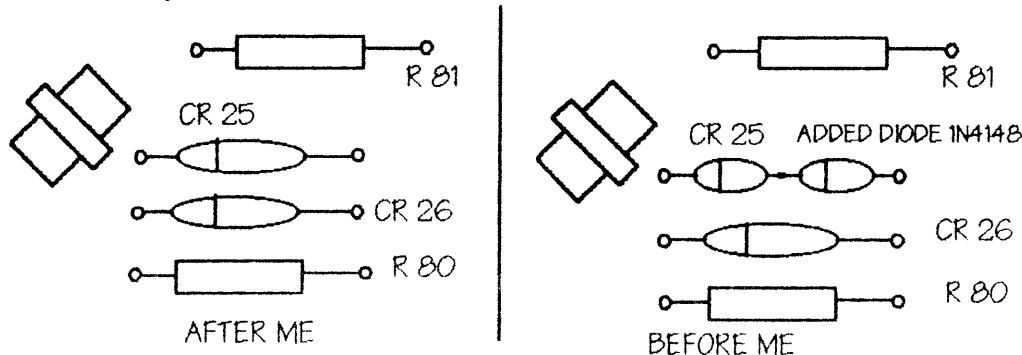

4) The refresh problem was hard to find in the beginning, but with an oscilloscope and understanding of memory and Z80 devices, finally I win. The TMS 4416 was a new chip when it was used in the design of the TS2068. And been the Z80 the best 8 bits micro, than that it have inside, the refresh counter necessary to maintain the data in the dynamic memories, the combination was perfect. But when it was designed, only seven bits was used for this counter. It's O.K. for 4116, 4164 family (it's need only seven bits for refresh all cells), but in the "new" 4416 family eighth bit was needed. In the low memory block, the constantly reading to form the video, make the necessary refresh reading. But in the high memory block the SCLD make the eighth bit necessary for a complete refresh cycle (the A7R). When it fails, the machine can't maintain it's data integrity, and crash.

The first thing to do is confirm that the problem is this, I made a little program that display this problem in the form of lost UDG data, simply making all bits set in UDG, the lost information are see like white dots in them.

First input this program line:

```
10 PRINT "ABCDEFGHJKLMNOPQRSTU" ( all letters in UDG mode)
```

Then input this command line:

```
FOR A = UDG "A" TO UDG "U": POKE A,255: NEXT A (ENTER & RUN)
```

Now all letters must be black boxes, and in the upper left side of the screen you can see a coarse black line, 21 characters long. Every time you type RUN and ENTER you refresh the display area, tacking the UDG information from its original address (high memory block). Running a program every minute, if you can see how the white spots come to appear, you machine have the refresh problem !!!

Second build and install the next circuit:

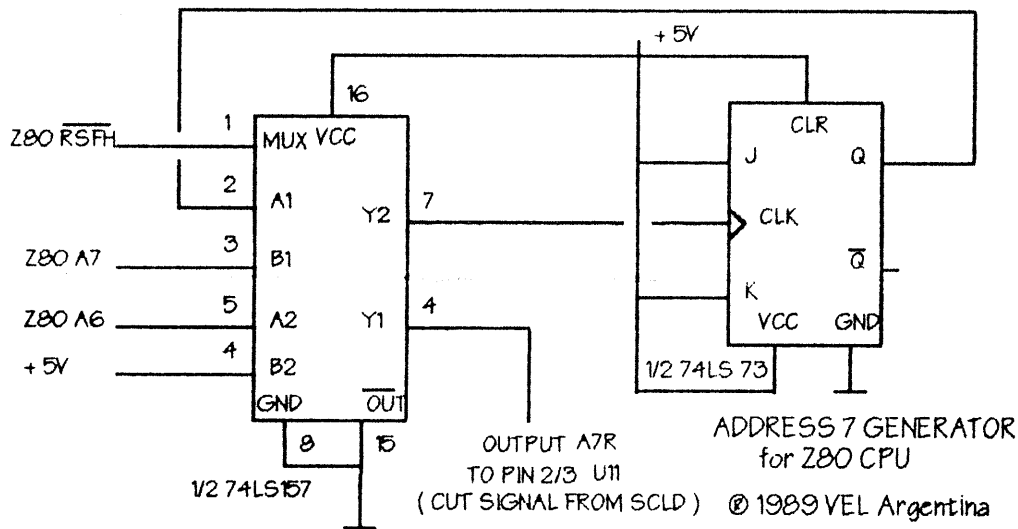

The circuits given represent hours of high tech. research, they are copyrighted to my mind. I send them to you for a help in yours troubles, (and for my TS's USA folks, of course). You should not use them commercially, without my acceptance.

RMG ENTERPRISES

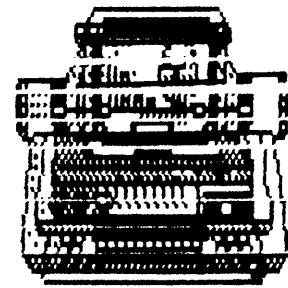

Supports Sinclair/Timex Users!

Send legal S.A.S.E. with request for price sheet. Specify model interest. Send \$4 for GIANT GIFT catalog. (Includes ALL price lists) Phone or FAX for information on prices and availability.

Mail to:

14784 South Quail Grove Circle
Oregon City, OR 97045

503/655-7484 * FAX 503/655-4116

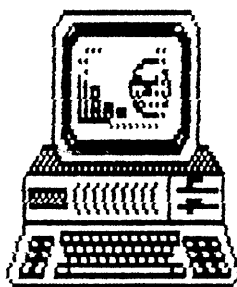

A New Sinclair BBS
By Tim Swenson

Bob Newell of Bismark, North Dakota, has started a BBS called "GlobberNet" that specializes in computer games, including Spectrum Games.

Bob has over 1200 Spectrum Snapshot (.SNA) files available for download. These snapshot files are supported by the Spectrum (on a Spectrum disk) and by various Spectrum emulators. Bob also has a few of the Spectrum emulators available.

As Bob says, "GlobberNet is 100 percent a free service, with no catch or trick. Verified users get 45 minutes and 2.5 Megs of download per day with no download ratios; regular uploaders and helpers get more time and bytes. No money or compensation is ever accepted for any reason."

Since the legal status of old Spectrum games in SNA form is not quite ironed out, Bob has decided to steer clear of any problems by not charging for downloading. Since almost all Spectrum programs are no longer being sold by the software houses, Bob is under the impression that these software houses have not objected to non-profit distribution of these programs. Bob is not the only person making these programs available. The FTP site in Norway is the primary storage site for them.

Besides the Spectrum files, GlobberNet has other classic games, text adventures, and some online games.

The Specs for GlobberNet are: 701-222-0429, 8n1, 1200-14400 /v.32, VT100 emulation, a "rocat" Linux BBS, 24 hrs/7 days, a single line.

Bob is also available on the Internet at bnewell@delphi.com.

QL Hacker's Journal
Supporting All QL Programmers

Timothy C. Swenson, Editor
5615 Botkins Rd.
Huber Heights, OH 45424
(513) 233-2178

swensotc@p2.ams.wpa.fb.af.mil

QL Hacker's Journal
Supporting All QL Programmers

Timothy C. Swenson, Editor
5615 Botkins Rd.
Huber Heights, OH 45424
(513) 233-2178

swensotc@p2.ams.wpa.fb.af.mil

T/SNUG Information

T/SNUG

Here is the list of T/SNUG Chairmen and how to contact them. We wish to support the following SIGs:- ZX-80/81, TS-1000, SPECTRUM, TS-2068, TC-2068, Z88 and QL. If you have any questions about any of these fine machines, contact the:

Chairman

Chief Motivator

Donald S. Lambert (ISTUG)

Vice-Chairmen

Tape & JLO PD Library

D. G. Smith

R 415 Stone St.

Johnstown, PA 15906

814 535-6998

Z88 Library

Dave Bennett (HATSUG)

329 Walton St. Rear

Lemoyne, PA 17045

717 774-7531

ZX-81 PD Tape Library

Ed Snow

2136 Churchill Downs Cir.

Orlando, FL 32825

407 380-5124

RMG Enterprises

Rod Gowen (CCATS)

14784 S. Quail Grove Cir.

Oregon City, OR 97045

503 655-7484 FAX 503 655-4116

TS-2068

Rod Humphreys (VSUG)

10984 Collins Pl.

Delta, BC V4C 7E6 Canada

604 583-2819

QL PD Library

John Donaldson (CATUG)

835 Foxwood Cir.

Geneva, IL 60134-1631

708 232-6147

BBS — GATOR

Bob Swoger (CATUG)

613 Parkside Cir.

Streawood, IL 60107-1647

708 837-7957 work 708 576-8068

Editor/Treasurer

LarKen PD Library

Abed Kahale (CATUG)

335 W. Newport Rd.

Hoffman Estates, IL 60195-3106

ZXir QLive Alive!

Is the newsletter of T/SNUG. the Timex/Sinclair North American User Groups, providing news and software support to the T/S community in a volume of four newsletters per year; beginning with the Spring (March) issue.

T/SNUG's main goal is to keep our Magazine, our vendors and our repair service alive for the benefit of T/S users.

These valuable services shall have free advertising space in this user supported Newsletter that they can see that we are still active out here. We must support their services whenever possible.

Another T/SNUG goal is to unearth titles of all known Public Domain and commercial software available for all Timex/Sinclair machines, building a library and providing lists of that software showing both the source and the availability.

If you feel T/SNUG should perform other tasks, let us know your feelings. If you have solved a problem in one of your software or hardware, please share it with the rest of us.

Treasury Note\$

As of March 1, 1995, we have a balance of \$507.35

You can keep T/SNUG alive by an annual contribution of \$12 for one volume made payable to Abed Kahale. Send check to:-

ABED KAHALE

335 W NEWPORT RD

HOFFMAN ESTATES IL 60195-3106

Phone:- 708 885-4337

Back Newsletter copies are available for \$0.50 each postpaid.

Article Contributions

Send in your articles by tape or disk and your inputs to:-

DON LAMBERT

ZXir QLive ALive! Newsletter

1301 KIBLINGER PL

AUBURN IN 46706-3010

Phone 219 925-1372

Or by hardcopy to:— Abed Kahale.

GATOR's TWISTED PAIR

We have a 24 hour BBS and encourage you to exchange mail and contribute to the Upload Section. Use it and have fun!! (8N1 300-2400 BAUD)

Call 708 632-5558

and Register using your first name, last name and phone number along with a password you won't forget, and *Write It Down!* Do not try to do anything else this first time because all the board options will be locked-out.

When you call-in the next time, you will have Level 5 security and be able to enjoy full user privileges. The BBS has smaller sections called conferences. Select "J" for "Join a Conference" to see the different user groups. Select "TIMEX" to get into the Sinclair Section. The mail you then read will only be from other TIMEX Sinclair users but all SIGs share the same bulletins. Use extension .ART for articles, .ADS for ads and .NWS for news when uploading.

For help, contact the SYSOP by leaving a message, mail, e-mail or phone. Bob Swoger — SYSOP

----GATOR----

You may freely copy any of the material in this Newsletter but, please credit the author(s).

Sinclairs and the World Wide Web

By Tim Swenson

The World Wide Web (WWW) is one of the applications making the Internet into a hot item. WWW is composed on two items, a server and a client. The server takes requests from the client (from across the network) and send the information back to the client. Server software is available for a variety of platforms (Unix, Windows NT, OS/2, etc). Two clients are popular, Mosaic and Netscape.

World Wide Web supports text, graphics, and hyperlinks. Hyperlink is the ability to click on a highlighted word and branch off to another page of information. It functions like a menu system, but with a lot more flexibility.

Well, the World Wide Web has hit the Sinclair world. No, there are no server or client software for any Sinclair computers, but there are a number of web servers (Home Pages) dedicated to Sinclair computers.

Chris Owen of England has created two of the best Sinclair Home Pages.

<http://sable.ox.ac.uk/~tr95006/sinclairtop.html>

<http://sable.ox.ac.uk/~tr95006/sincover.html>

Both cover the same basic information, but the second one is more graphical with lots of 256 color pictures. The sections are:

- The Man and the Company
- The Machines
- The Software Industry
- The Magazines
- The Virtual Spectrum

The Man and the Company covers information about Sir Clive Sinclair and Sinclair Research Ltd. It has as short life story with two early pictures of him. It even has the text of an address he have to Congress in 1984. I did not even know he spoke before Congress.

The Machines covers most of the stuff that Sinclair has created. The Software Industry documents a few Spectrum software houses. The Magazines touches on mostly Spectrum magazines. The Virtual Spectrum provides links to other Spectrum Home Pages and to Spectrum emulators.

Most of the information on each section is only a small portion of the total data available on Sinclair machines. Some articles are taken from the trade press. The graphical layout of these home pages makes them worth looking at.

Another interesting Home Page is the ZX81 Home Page:

<http://www.maths.nott.ac.uk/personal/cpg/zx81>

This is a home page dedicated solely to the ZX81 and it's emulators. It briefly touches on the history of the ZX81, it's technical details, a "touching personal story", and a short listing of stuff on the net. It has links to 4 ZX81

emulators (two for MS-DOS, one for the QL, and one for the Atari ST).

You are not going to find much information at these home pages that you don't know already. But, they are just starting and should expand in the future.

All creators of Sinclair WWW Home Pages are doing this for free. Some do it for the limited fame it brings (this Internet fame can become real big sometimes). Others like to produce something usefull and great looking, and then share it with the world. Of course, the neat thing about the Internet and with World Wide Web, is the low cost of distribution.

MECHANICAL AFFINITY

is the place all of these people are going to find what they need for their TS2068 & TS1000 Computers.

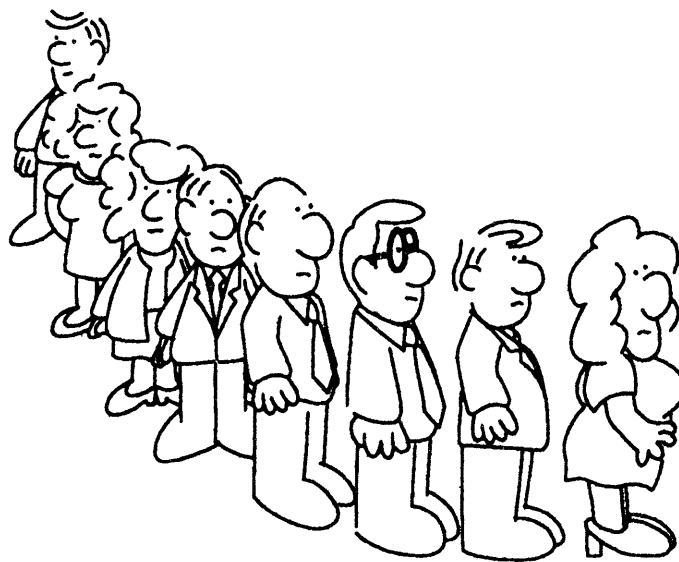

We will soon be out of the last of our TS2068s, and this may be (other than the odd one or two showing up occasionally) your last chance to get one, or to get a backup TS2068.

When they are all gone, that is it. If you have been putting this "off till later", it could be too late by then. The price is \$55, and includes (a) TS2068 Computer with power supply (b) TS2040 Thermal Printer with 3 rolls of paper (c) four TS2068 computer programs on tape (d) one book on programming the TS2068. The programs and the book are of our choosing, so please do not ask for certain ones. We are emptying out as much of this as we can to make room for new items.

**MECHANICAL AFFINITY
513 EAST MAIN ST.
PERU, IN 46970
317-473-8031**

**MECHANICAL AFFINITY
5231 WILTON WOOD CT.
INDIANAPOLIS, IN 46254
317-291-6002**

Please only phone during the times listed, TUES thru SATURDAY, 5-9 P.M. Make all checks or money orders out to F. Davis or P. Holmgren. We will ship C.O.D., and such orders may be faxed at 317-472-0783 during the hours of 11 PM to 7 AM Standard time.

BASIC SPECIAL CHARACTERS AND OPERATORS	
;	Suppress tab after PRINT.
blank	Tab to next column after PRINT. Tab to next line after PRINT.
" "	Double-quote char. in a string. Character-string delimiter.
\$	Identifies character-string variable. (A\$)
blank	Identifies a numeric variable (A)
E	Scientific notation. (1.7E38)
()	Denotes priority in order of operations.
=	Equal or assignment.
+	Addition, concatenation.
-	Subtraction or minus sign.
*	Multiplication.
**	Exponentiation.
/	Division.
>	Greater than.
<	Less than.
>=	Greater than or equal to
<=	Less than or equal to.
<>	Not equal.
NOT	Reverses true/false result.
AND	If both expr are true, result is true.
OR	If either or both expr are true, result is true.
NON-ZERO	True.
ZERO	False.

Order of operations: (), **, - (negation), *, /, +, -, =, >, <, NOT, AND, OR.

SCREEN LAYOUT					
LINE	DISPLACEMENT	Y-COORD	LINE	DISPLACEMENT	Y-COORD
0	0	43	12	396	19
		42			18
1	33	41	13	429	17
		40			16
2	66	39	14	462	15
		38			14
3	99	37	15	495	13
		36			12
4	132	35	16	528	11
		34			10
5	165	33	17	561	9
		32			8
6	198	31	18	594	7
		30			6
7	231	29	19	627	5
		28			4
8	264	27	20	660	3
		26			2
9	297	25	21	693	1
		24			0
10	330	23	22	726	
		22			
11	363	21	23	759	
		20			

DEC	HEX	ZX80	ZX81	DEC	HEX	ZX80	ZX81
0	00	SPACE	SPACE	64	40		RND
1	01	"	"	65	41		INKEY\$
2	02	█	█	66	42		PI
3	03	█	█	67	43		
4	04	█	█	68	44		
5	05	█	█	69	45		
6	06	█	█	70	46		
7	07	█	█	71	47		
8	08	█	█	72	48		
9	09	█	█	73	49		
10	0A	█	█	74	4A		
11	0B	█	"	75	4B		
12	0C	£	£	76	4C		
13	0D	\$	\$	77	4D		
14	0E	:	:	78	4E		
15	0F	?	?	79	4F		
16	10	((80	50		
17	11))	81	51		
18	12	-	>	82	52		
19	13	+	<	83	53		
20	14	*	=	84	54		
21	15	/	+	85	55		
22	16	=	-	86	56		
23	17	>	*	87	57		
24	18	<	/	88	58		
25	19	;	;	89	59		
26	1A	.	.	90	5A		
27	1B	.	.	91	5B		
28	1C	0	0	92	5C		
29	1D	1	1	93	5D		
30	1E	2	2	94	5E		
31	1F	3	3	95	5F		
32	20	4	4	96	60		
33	21	5	5	97	61		
34	22	6	6	98	62		
35	23	7	7	99	63		
36	24	8	8	100	64		
37	25	9	9	101	65		
38	26	A	A	102	66		
39	27	B	B	103	67		
40	28	C	C	104	68		
41	29	D	D	105	69		
42	2A	E	E	106	6A		
43	2B	F	F	107	6B		
44	2C	G	G	108	6C		
45	2D	H	H	109	6D		
46	2E	I	I	110	6E		
47	2F	J	J	111	6F		
48	30	K	K	112	70		⊕
49	31	L	L	113	71		⊖
50	32	M	M	114	72		⊗
51	33	N	N	115	73		⊘
52	34	O	O	116	74	HOME	GRAPHICS
53	35	P	P	117	75	EDIT	EDIT
54	36	Q	Q	118	76	NEWLINE	ENTER
55	37	R	R	119	77	RUBOUT	DELETE
56	38	S	S	120	78		Ⓜ/L mode
57	39	T	T	121	79		FUNCTION
58	3A	U	U	122	7A		
59	3B	V	V	123	7B		
60	3C	W	W	124	7C		
61	3D	X	X	125	7D		
62	3E	Y	Y	126	7E		number
63	3F	Z	Z	127	7F		cursor

ZX80 ONLY: 16-26, 64-212 Not available from keyboard.

DEC	HEX	ZX80	ZX81	DEC	HEX	ZX80	ZX81
128	80	■	■	192	C0		" "
129	81	"	■	193	C1		AT
130	82	■	■	194	C2		TAB
131	83	■	■	195	C3		
132	84	■	■	196	C4		CODE
133	85	■	■	197	C5		VAL
134	86	■	■	198	C6		LEN
135	87	■	■	199	C7		SIN
136	88	■	■	200	C8		COS
137	89	■	■	201	C9		TAN
138	8A	■	■	202	CA		ASN
139	8B	■	"	203	CB		ACS
140	8C	■	■	204	CC		ATN
141	8D	■	■	205	CD		LN
142	8E	■	■	206	CE		EXP
143	8F	■	■	207	CF		INT
144	90	■	■	208	D0		SQR
145	91	■	■	209	D1		SGN
146	92	■	■	210	D2		ABS
147	93	■	■	211	D3		PEEK
148	94	■	■	212	D4	"	USR
149	95	■	■	213	D5	THEN	STR\$
150	96	■	■	214	D6	TO	CHR\$
151	97	■	■	215	D7	;	NOT
152	98	■	■	216	D8	.	**
153	99	■	■	217	D9)	OR
154	9A	■	■	218	DA	(AND
155	9B	■	■	219	DB	NOT	<=
156	9C	■	■	220	DC	-	>=
157	9D	■	■	221	DD	+	<>
158	9E	■	■	222	DE	*	THEN
159	9F	■	■	223	DF	/	TO
160	A0	■	■	224	E0	AND	STEP
161	A1	■	■	225	E1	OR	LPRINT
162	A2	■	■	226	E2	**	LLIST
163	A3	■	■	227	E3	=	STOP
164	A4	■	■	228	E4	>	SLOW
165	A5	■	■	229	E5	<	FAST
166	A6	■	■	230	E6	LIST	NEW
167	A7	■	■	231	E7	RET	SCROLL
168	A8	■	■	232	E8	CLS	CONT
169	A9	■	■	233	E9	DIM	DIM
170	AA	■	■	234	EA	SAVE	REM
171	AB	■	■	235	EB	FOR	FOR
172	AC	■	■	236	EC	GOTO	GOTO
173	AD	■	■	237	ED	POKE	GOSUB
174	AE	■	■	238	EE	INPUT	INPUT
175	AF	■	■	239	EF	RAND	LOAD
176	B0	■	■	240	F0	LET	LIST
177	B1	■	■	241	F1		LET
178	B2	■	■	242	F2		PAUSE
179	B3	■	■	243	F3	NEXT	NEXT
180	B4	■	■	244	F4	PRINT	POKE
181	B5	■	■	245	F5		PRINT
182	B6	■	■	246	F6	NEW	PLOT
183	B7	■	■	247	F7	RUN	RUN
184	B8	■	■	248	F8	STOP	SAVE
185	B9	■	■	249	F9	CONT	RAND
186	BA	■	■	250	FA	IF	IF
187	BB	■	■	251	FB	GOSUB	CLS
188	BC	■	■	252	FC	LOAD	UNPLOT
189	BD	■	■	253	FD	CLEAR	CLEAR
190	BE	■	■	254	FE	REM	RETURN
191	BF	■	■	255	FF		COPY

ZX81 - SELECTED ROM CALLS		
TO USE, POKE BYTES INTO ANY SAFE RAM, AND CALL VIA USR FUNCTION (LET A=USR(addr)). RESULTS RETURNED AS FUNCTION VALUE, AND IN BC REGISTER.		
TO SCAN KEYBOARD FASTER THAN INKEYS		
HEX	DEC	CODE
CD BB 02	205 187 2	CALL 02BBH
7C	124	LD A,H
C6 02	198 2	ADD A,2
38 09	56 9	JR C,+9
44	68	LD B,H
4D	77	LD C,L
CD BD 07	205 189 7	CALL 07BDH
06 00	6 0	LD B,0
4E	78	LD C,(HL)
D8	216	RET C
01 00 00	1 0 0	LD BC,0
C9	201	RET
TO MOVE CURSOR TO A ROW, COLUMN		
01 cl rw	1 cl rw	LD BC,row col
CD F5 08	205 245 8	CALL 08F5H
C9	201	RET
TO OUTPUT A CHARACTER TO SCREEN		
3E nn	62 nn	LD A,nn (nn=character)
D7	215	RST 0010H
C9	201	RET
TO OUTPUT CHARACTER STRING TO SCREEN		
11 dd dd	17 dd dd	LD DE,addr of string (low byte first)
01 dd dd	1 dd dd	LD BC,length of string (low byte first)
CD 6B 0B	205 107 11	CALL 0B6BH
C9	201	RET
TO PLOT		
01 xx yy	1 xx yy	LD BC,yyxx
3E 9B	62 155	LD A,9BH
CD B2 0B	205 178 11	CALL 0BB2H
C9	201	RET
TO UNPLOT		
01 xx yy	1 xx yy	LD BC,yyxx
3E A0	62 160	LD A,A0H
CD B2 0B	205 178 11	CALL 0BB2H
C9	201	RET
TO SET "FAST"		
CD 20 0F	205 32 15	CALL 0F20H
C9	201	RET
TO SET "SLOW"		
CD 28 0F	205 40 15	CALL 0F28H
C9	201	RET

REFERENCE GUIDE NOTATIONS AND FORMAT CONVENTIONS

This reference guide employs a standard scheme for presenting the general format of BASIC language statements. The capitalization, punctuation and other conventions are listed below:

- [] Brackets indicate that the enclosed items are optional. Brackets do not appear in the actual statements.
- { } Braces indicate that a choice of one of the enclosed items is to be made. Braces do not appear in the actual statements.
- ... Ellipses indicate that the preceding item may be repeated. Ellipses do not appear in the actual statements.
- Italics* Italics indicate generic terms. The programmer must supply the actual value or wording required. See *Generic Terms and Abbreviations*.

BASIC PROGRAMMING MODES

IMMEDIATE Statement entered without a line number will be immediately executed by BASIC. Also known as "command" mode.

PROGRAM Statement(s) entered with line numbers will be executed by RUN and ENTER in numerical order.

BASIC STATEMENT FORMAT

Maximum line length is 704 characters on 22 physical lines of 32 characters per line to include the line number.

Immediate Mode format: `statement[; statement]`
 Program Mode format: `line number[; statement]`

GENERIC TERMS, ABBREVIATIONS AND DEFINITIONS

array A set of variables that has the same name and that are distinguished by a number known as the subscript written in parentheses after the name. An array can have as many values as there are elements, with each element of the array having a separate value.

border The edge of the screen.

concatenation The joining together of two strings in a specified order.

cursor A moveable display marker that indicates how the computer is going to interpret the next key entered or if a syntax error has occurred.

element The value assigned to a subscript.

expr Any valid expression.

expr\$ Any valid string constant, variable, or expression.

exprm Any numeric constant, variable, or expression.

format The structure of the BASIC command or statement.

INK The color of the printed characters and symbols printed on the screen. Also known as foreground.

letter Any one of the 26 alphabetic characters.

letters Any one of the 26 alphabetic characters followed by a dollar sign (\$) which signifies a string name.

line A BASIC program line number between 1 and 9999.

list A list of constants, variables, or expressions.

m A column on the screen between 0 and 31 used to position where characters and graphic symbols are to be displayed. The value can be expressed as a numeric value, variable, or expression.

memory A memory address referenced by a numeric expression, variable, or constant.

n A line on the screen between 0 and 21 used to position where characters and graphic symbols are to be displayed. The value can be expressed as a numeric value, variable, or expression.

PAPER The color of the screen. Also known as background.

program name An identifying name given to a program that can be up to 10 characters long to include spaces.

radius The radius of a circle expressed as a numeric value, variable, or expression.

scalar A variable that has only one value at a given time.

scroll? Is a question the computer asks you when the screen has all lines filled and you decide whether to stop or continue the execution of the program.

slicing Operation to obtain a substring from a string.

statement A BASIC language equivalent of an English sentence.

string A group of characters beginning and ending with quotation marks that is treated by the computer as a single item.

subscript A number or numeric expression

GENERIC TERMS, ABBREVIATIONS AND DEFINITIONS (continued)

which, when evaluated, identifies a particular element in an array.

x-coordinate The position of a pixel with respect to the left-hand column of the screen. The specified value must be between 0 and 255.

CURSOR DISPLAY MODES

- K** Keyword (token) mode: indicates that the computer is expecting a keyword command or number located on the key.
- L** Letter mode: means the computer will interpret any key pressed as the main letter or number (large symbol) on the key. If unshifted, the key will be interpreted as a lowercase letter. If shifted, the key will be interpreted as an uppercase letter.
- C** Capital mode: means that all letters will appear as capitals. CAPS LOCK causes a change from **L** mode to **C** mode or back again.
- E** Extended mode: means that a key gives a token above it if unshifted, and another token below it if pressed together with either shift key. A digit key gives a token if pressed with SYMBOL SHIFT, otherwise it
- S** gives a color control sequence. **E** mode occurs after CAPS SHIFT and SYMBOL SHIFT keys are pressed together and lasts for one key depression only.
- G** Graphics mode: permits graphics characters on the digit keys and user defined graphics on all letter keys except V through Z to be displayed. The Graphics mode is entered by pressing CAPS SHIFT and 9 key and lasts until the two key sequence is pressed again.
- P** Syntax error marker: denotes an unacceptable format for the data that was entered.
- █** Program cursor: indicates the line most recently entered or accessed.

KEYBOARD UTILIZATION

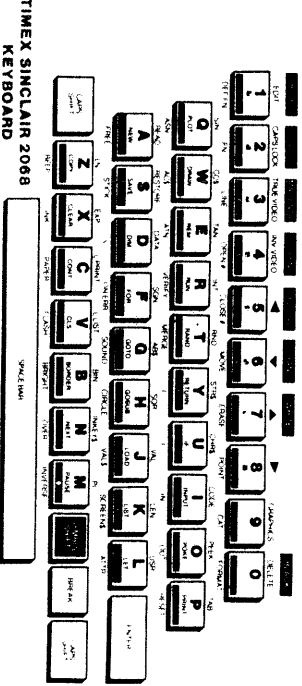

TIMEX SINCLAIR 2068 KEYBOARD

KEY FORMAT

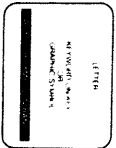

DATA ENTRY

FUNCTION or COMMAND Pressing CAPS SHIFT and SYMBOL SHIFT at the same time causes the cursor to change to **E** for extended mode. When in this mode, the function or command written on the keyboard above each key can be entered by pressing the key. The function or command written on the keyboard below each key can be entered by simultaneously pressing either shift key and the desired key when in extended mode.

LETTER English alphabet (A through Z) and numerics (0 through 9) can be entered as individual characters when

the **L** or **C** cursor is displayed. All alphabetic characters entered in lowercase unless CAPS SHIFT held down or **C** cursor is displayed when entering character. Pressing CAPS SHIFT and alphabetic character when **L** cursor is displayed or when **C** cursor is displayed results in a capital letter being entered.

KEYWORD ON KEY A BASIC statement entered by pressing the appropriate key when **K** cursor is displayed. After keyword is entered, the cursor will automatically shift to **L**

DATA ENTRY (continued)

GRAPHIC SYMBOL The graphic symbols on the number keys in the top row of the keyboard can be entered by first pressing CAPS SHIFT and the 9 key simultaneously to obtain graphics mode. Then typing any of the keys with a graphic symbol on them will cause that

DATA ENTRY AND CURSOR DISPLAY MODES

CURSOR	MODE	OPERATION	DATA ENTERED/MODE EFFECT	RESULTING CURSOR
█	Keyword	Press numeric key(s)	Line number	█
█	Keyword	Press key	Keyword on key	█
█	Letter	Press key	Numeric or lowercase letter	█
█	Letter	Press CAPS SHIFT	Numeric or uppercase letter	█
█	Uppercase	plus 2 then key	Uppercase letter	█
█	Uppercase	Press numeric key	Letter mode	█
█	Letter	Press CAPS SHIFT plus 2 then key	Graphics mode	█
█	Graphics	Press numeric key	Graphic symbol	█
█	Graphics	Press 9	Letter mode	█
█	Graphics	Press CAPS SHIFT	Inverse graphic symbol	█
█	Letter	Press CAPS SHIFT and SYMBOL SHIFT	extended mode	█
█	Extended	Press key	Words written on keyboard above key	█
█	Extended	Press SYMBOL SHIFT and key	Function or command written under key	█
█	Extended	Press CAPS SHIFT and SYMBOL SHIFT	Returns to previous mode	█

DISPLAY INDICATORS

█ Last line entered (program line) or line being edited

█ report of current line work area

Last Line Entered Previous program line ENTERed by pressing ENTER key.
Current Line Program line you are entering
Once ENTERed, current line becomes last line entered.
Report A code that reports success or failure of an operation.

DISPLAY CONTROL

KEY OR KEY COMBINATION OPERATIONAL RESULT

CAPS SHIFT and 0	Deletes the character or keyword immediately to the left of the cursor when the █ or █ cursor is on the screen
CAPS SHIFT and 1	Moves the (program line) pointed to by the cursor into the work area at the bottom of the screen for editing
CAPS SHIFT and 2	Turns CAPS LOCK on or off
CAPS SHIFT and 3	Changes the display to TRUE VIDEO where characters are printed in the ink color on a paper color background
CAPS SHIFT and 4	Changes the display to INVERSE VIDEO where characters are printed in paper color on an ink color background
CAPS SHIFT and 5	Moves the cursor to the left one position
CAPS SHIFT and 6 (when editing)	Moves the cursor > down one position
CAPS SHIFT and 7 (when editing)	Moves the cursor > up one position
CAPS SHIFT and 8	Moves the cursor > left one position
CAPS SHIFT and 9	Moves the cursor > right one position
ENTER	Causes graphic mode entry or exit
LIST (line)	Enters present line into memory, retrieves program listing on screen or indicates end of input
SPACE BAR	Causes the program in memory to be listed at the first line of from the specified line number. If screen filled, the query SCROLL? will appear at the bottom of the screen. If any key other than n (for No), BREAK, or STOP entered, the next 22 lines will be displayed
	Causes cursor to move to right one position each time this bar is pressed

VARIABLE NAMING CONVENTIONS

Scalar Variable format $F\{S\}$ where:
First character must be a letter;
Second character must be a dollar sign (\$) if string variable; otherwise may be a letter or digit.
Name length: one letter and dollar sign (\$) if string variable; any number of letters and digits if numeric variable.
Array Variable formats
NUMERIC ARRAY format

Letter (exprm1, exprm2, ...)
STRING ARRAY format
Letter (exprm1, ..., exprm_n)
where: exprm_n defines the length of the string array in characters

Note: all array subscripts start at 1
Example: AS(5) specifies 3rd letter of AS(5) or a string array of 5 elements, each 3 characters in length.

ARITHMETIC OPERATORS

Operation	Operator	Symbol Shift	Priority	Example	Operational Result
ARITHMETIC					
Exponentiation	^	H	10	A^B	
Unary Minus	-	J	9	-B	
Multiplication	*	B	8	A*B	
Division	/	V	8	A/B	
Addition	+	K	6	A+B	
Subtraction	-	J	6	A-B	
RELATIONAL					
Equal	=	L	5	A = B	
Not equal to	<>	W	5	A <> B	
Less than	<	R	5	A < B	
Less than or equal to	<=	Q	5	A <= B	
Greater than	>	T	5	A > B	
Greater than or equal to	>=	E	5	A >= B	
BOOLEAN					
Logical complement	NOT	S	4	NOT A	0 if A is non-zero 1 if A is zero
Logical AND	AND	Y	3	A AND B	1 if B is non-zero 0 if B is zero
Logical OR	OR	U	2	A OR B	0 if B is non-zero 1 if B is zero

STRING OPERATORS

Slicing Obtains a substring from a string.
Format: $exp\{S\}(start) TO (finish)$
Example: "ABCDEF"(2 TO 5) = "BCDE"

Concatenation Joins together two strings.
Format: $exp\{S\} + exp\{S\}$
Example: "BUG" + "OFF" = "BUGOFF"

Parentheses Defines slicing operation result.
Examples: "ABC" + "DEF"(1 TO 5) = "ABCDE"
("ABC" + "DEF")(1 TO 2) = "AB"

STRING AND NUMBER VALUED BOOLEAN RELATIONS

X\$ AND Y X\$ if Y is non-zero
 ... (empty string) if Y is zero.

CASSETTE OPERATIONS

- PROGRAM LOADING**
- Obtain **█** cursor on your screen and insure tape is rewound to the beginning of program.
 - Make sure both recorder & computer are EAR to EAR.
 - Press LOAD "... " or LOAD "program name"
 - Start cassette recorder by pressing PLAY on recorder and then press ENTER on your computer.
 - Receive report of 0 OK, 0 1 or a little screen and/or user
- PROGRAM SAVING**
- Position tape in recorder.
 - Connect MIC socket of computer to the microphone socket of recorder.
 - Press SAVE "program name" or Save "program name" line number and press ENTER. If line specified, the program will automatically begin execution at the specified line number.
 - Computer displays message "Start tape then press any key..."
- VERIFYING A SAVE**
- Rewind the recorder to the place where SAVE began
 - Be sure the EAR sockets on the computer and recorder are connected
 - Press VERIFY "program name" or VERIFY "..."
 - Start cassette recorder and press ENTER in PLAY mode
 - If the program is verified, the report code 0 OK will appear on the screen.

- Program Loading (cont'd)**
- Instructions when loading completed successfully.
 - Stop recorder.
 - Press RUN and ENTER to execute program if program is not specified to run automatically.

- Program Saving (cont'd)**
- Start the recorder on RECHRD and PLAY then press any key on the keyboard.
 - Receive report code @ OK @ 1 on screen when saving successfully completed.
 - Stop recorder.

- TIMEX COMMAND CARTRIDGE™ OPERATIONS**
- Turn off the T/S 2068.
 - Lift the cartridge door.
 - Insert the Command Cartridge with the label side up.
 - Close the cartridge door.
 - Turn on the T/S 2068.
 - The program will begin.

SYSTEM COMMANDS

These commands result in the computer performing an operation at the system level. The commands are normally entered without a line number; however, they can be used in a program by preceding the command with a line number.

BREAK Can be used as a space bar for editing or to suspend program execution. Resume execution by pressing SPACE bar or CONT.

Format: BREAK

NOTE: BREAK only works when the program is not waiting for input. Has to have CAR'S SHIFT pressed with it to break the program.

CLEAR Deletes all variables, freeing the space they occupied, but leaves the program in the computer.

Format: CLEAR (exprm1)

CONT CONTinues execution at the next in situation following a BREAK or STOP; restarts a program or lets you continue when the screen is full.

Format: CONT

COPY Prints the contents of the top 22 lines of the display to the printer; if attached, otherwise does nothing.

Format: COPY

DELETE Erases the specified range of lines from the program.

Format: DELETE (line₁, line₂)

Note: If line₁ not specified, all lines through line₂ deleted; if line₂ not specified, program lines from line₁ to end of the program are deleted.

LIST Displays up to twenty-two lines of a specified portion of the program currently in memory, starting at the indicated line, or the beginning of the program, and makes the first line or indicated line number the current line.

Format: LIST { line }

LIST Lists all or starts from a specified portion of the program currently in memory on the printer, starting at the indicated line.

Format: LIST { line }

LOAD Loads the first program or a specified program on cassette in memory.

Format: { LOAD ... }
{ LOAD "program name" }

Note: LOAD can be used to load variable information.

Format: LOAD expr/\$ parameter

parameter	result of loading/saving
DATA ()	numeric array
DATA \$ ()	string array
CODE m, n	n bytes, starting at address m
CODE m, n	n bytes starting at address m
CODE m	bytes back into the address where they were saved from
SCREENS	screen of information

Example: LOAD "TABLE", DATA A () loads array named A from tape stored under the name TABLE.

MERGE Merges the specified program with the program currently in memory.

Format: { MERGE "program name" }

NEW Starts the basic system of deleting the current program and all variables from memory.

Format: NEW

RUN Clears all variables and executes the current program in memory. If a line number is specified, execution commences at that line number, otherwise execution begins at the first line in the program.

Format: RUN (line)

SAVE Saves the program currently in memory on cassette with the designated program name.

Note: SAVE can be used to save variable information. See table under LOAD.

Format: SAVE "program name"

Example: SAVE "TABLE", DATA A () saves array named A on tape under the name TABLE.

VERIFY Compares a program on cassette previously saved with the version in memory.

Format: VERIFY "program name"

BASIC LANGUAGE STATEMENTS

These statements result in the computer performing an operation when the program is executed. They are normally entered with a preceding line number; however, a statement may be used as a command by entering it without a line number.

BRANCHING

GOSUB Results in a branch to the subroutine at a specified line number. A RETURN statement causes a branch back to the instruction following the GOSUB.

Format: GOSUB exprm

Example: line GOSUB 500

GOTO Causes an unconditional branch to the line number, or if there is none, to the first line after that.

Format: GOTO exprm

Examples: line GOTO 500

Note: When used in immediate mode, GOTO starts a program at any line you choose without clearing the variables.

ERROR CONTROL

ON ERR GOTO Causes a transfer to the specified line number when an error occurs in the program.

Format: ON ERR GOTO line

Example: line ON ERR GOTO 5000

Note: Error number obtained by PEEKing location 23738. Line number where error occurred obtained by PEEKing location 23736-23737.

ON ERR CONT Causes the program to resume execution at the statement in which the error originally occurred.

PROCESSING STATEMENTS

CLS Clear Screen clears the display file that is the memory copy of the television picture. The program remains in memory.

Format: CLS

Example: line CLS

DATA Creates a list of numeric and string constants to be assigned to variables through the use of the READ statement.

Format: DATA constant (, constant)

Example: line DATA 5, 25, "ART"

DEF FN Allows user-defined function definitions.

Format: DEF FN letter ((letter) = exprm)

Example: line DEF FN A (N) = X13 + 4 * X + 2

DIM Deletes an array or string that has the indicated name if it previously existed and sets up an array of numbers or characters in bytes.

Format: { DIM letter (n₁ n₂) }

Example: { DIM letters (n₁ n₂) }

Examples: line DIM A (10,5)

line DIM C \$(5,10)

FOR Initiates a loop that repeats execution of all instructions bounded by the NEXT statement until the automatically incremented or decremented "step" variable attains the value exprm₂.

Format: FOR letter = exprm₁ TO exprm₂

Example: line FOR A = 50 TO 100 STEP 10

IF-THEN Causes the execution of a statement if the indicated expression is true; if not true, the rest of the line is ignored and the program moves onto the next line.

Format: IF expr THEN statement

Example: line IF K = 41 THEN GOTO 200

RETURN Results in a program branch to the statement immediately following the most recently executed GOSUB statement.

Format: RETURN

Example: line RETURN

Note: RETURN appears as RETRN on the keyboard.

ON ERR CONT

Format: ON ERR CONT

Example: line ON ERR CONT

ON ERR RESET Disables the ON ERR CONT statement which causes the program to resume reporting errors and terminate in the usual manner.

Format: ON ERR RESET

Example: line ON ERR RESET

Note: If STEP omitted, exprm₁ assumed to have a value of 1.

LET Assigns a value or a string to the specified variable.

Format: LET var = expr

Example: line LET X = 4 * A + 3 * B

NEXT Terminates the loop initiated by a FOR statement.

Format: NEXT letter

Example: line NEXT X

PAUSE Stops computing and displays the display file for n frames (at 60 frames per second) or until a key is pressed.

Format: PAUSE exprm

where: 0 ≤ exprm ≤ 65535

Example: line PAUSE 500

POKE Writes the value exprm to the byte in storage at the indicated memory address.

Format: POKE memadr, exprm

where: 0 ≤ exprm ≤ 255

0 ≤ memadr ≤ 65535

Example: line POKE 16514, 102

RANDOMIZE Statement that controls the randomness of the RND function by starting RND off at the denoted place.

Format: RANDOMIZE (exprm)

where: 1 ≤ exprm ≤ 65535 starts RND off at a definite place

when exprm = 0 RND starts based upon how long the television has been on.

Example: line RAND 35

Note: RANDOMIZE appears as RAND on the keyboard.

Use a Mouse on Any Hardware

Implementing the Mouse on a Z80 system

by Richard Rodman

The Logimouse® R7 and C7 mice (Logitech, Inc., 6505 Kaiser Dr., Fremont, CA 94555, (415) 795-8500) are widely available and interface via a standard RS-232 serial port. It seemed that this mouse could be easily used with my Z-80 system. After some experimentation, this proved to be true.

The Logimouse R7, which I used, has an external power supply connecting to a DB-25 female connector. Data comes out on pin 3; pin 7 is grounded. I'm not sure if it's necessary to drive DTR on pin 20, but I did. The Logimouse C7 does not require an external power supply.

The mouse is held in the hand with the cord proceeding away, in the opposite direction from the arm. The palm rests on the flat area on the top of the mouse, and the fingers operate 3 buttons on the far end of the mouse. This is important—the directions "up," "down," "left" and "right" below depend on this orientation.

The mouse sends data in 5-byte packets at 1200 baud. The first byte of the packet has bit 7 set, and bits 0, 1, and 2 set or reset according to the status of the 3 mouse buttons. Bit 0 will be 0 if the right button is down, or 1 if it is up. Bit 1 contains the status of the middle button, and bit 2 that of the left button. Bits 3 through 6 are all zero.

The second and fourth bytes are movement values in the horizontal or X direction (left to right). A value which is negative indicates motion to the left; a value which is positive indicates movement to the right.

The third and fifth bytes are movement values in the vertical or Y direction (up and down). A value which is negative indicates motion downward (toward the user); a value which is positive indicates motion upward (away from the user).

The program given in the Listing is written in Software Toolworks C for CP/M. It tracks the movement of the mouse with the cursor of a video terminal, and displays the status of the three buttons in the lower right corner of the screen. The program has in-line assembly code for a Z80-CTC and a Z80-SIO working together. To modify for other serial port

```
/* --- MOUSE.C --- Read serial Logimouse on arbitrary hardware
   Implementation given is for Software Toolworks C.
   Hardware port logic is for Z80 SIO f CTC.
```

By Richard Rodman. Any use whatsoever of this code is heartily encouraged.

Usage:

If a command line parameter is used, it will simply display the bytes received in hex. Otherwise, the cursor will track movement of the mouse, and the button status of each button will be displayed.

Press esc to stop.

Mouse data packet structure:

```
First byte: 10000LMR   L = 0 if left button down, else 1
                  M = 0 if middle button, else 1
                  R = 0 if right button, else 1
Second byte:  delta x, negative = left, positive = right
Third byte:  delta y, negative = down, positive = up
Fourth byte:  Another delta x value
Fifth byte:  Another delta y value
```

The entire packet is sent if anything changes.

History:

```
870706 rr orig version */
```

```
#include "tprintf.c"      /* for debugging only */
```

```
int cursx, cursy;        /* cursor location */
```

```
main( argc, argv )
```

```
int argc;
```

```
char *argv[];
```

```
{
```

```
    int i, byte[ 5 ];
```

```
    char butstr[ 4 ];
```

```
    minit();              /* init serial port for mouse */
```

```
    clrscr();             /* clear the terminal screen */
```

```
    butstr[ 3 ] = '\\0'; /* terminate string for display */
```

```
    cursx = 40;
```

```
    cursy = 12;           /* center the cursor */
```

```
    goxy( cursx, cursy ); /* and display it */
```

```
    while( 1 ) {         /* do forever */
```

```
/* Check local console for press of ESC key. */
```

```

        if( bdos( 6, 0x00FF ) == '\033' ) break;

/* Check the mouse for a character */

        if( mstat() ) {

/* If command line parameter was present, just display it. */

                if( argc > 1 ) printf( '%02x ', minput() );
                else {

/* Read the 5-byte packet from the mouse */

                        for( i = 0; i < 5; ++i ) {
                                while( ! mstat() ) /* wait */ ;
                                byte[ i ] = minput();
                        }

/* Process buttons in byte 0 */

                                butstr[ 0 ] = butstr[ 1 ] = bjtstr[ 2 ] = ' ';
                                if( ! ( byte[ 0 ] & 0x04 ) ) butstr[ 0 ] = 'L';
                                if( ! ( bste[ 0 ] & 0x02 ) ) butstr[ 1 ] = 'M';
                                if( ! ( byte[ 0 ] & 0x01 ) ) butstr[ 2 ] = 'R';
                                goxy( 75, 23 );
                                printf( butstr );

/* The cursor movements are signed characters. Process these. Use a
   slew of 256 as full-screen. The Y movement needs to be negated. */

                                        cursx += 80 * ( extend( bste[ 1 ] )
                                                + extend( byte[ 3 ] ) ) / 256;
                                        cursy -= 24 * ( extend( bste[ 2 ] )
                                                + extend( byte[ 4 ] ) ) / 256;

/* Make sure the cursor stays on the screen */

                                                if( cursx < 0 ) cursx = 0;
                                                if( cursx > 79 ) cursx = 79;
                                                if( cursy < 0 ) cursy = 0;
                                                if( cursy > 23 ) cursy = 23;

                                                goxy( cursx, cursy );
                                        }
                                }
        }

/* extend sign on integer */

int extend( c )
int c;
{
        if( c > 128 ) c -= 256;
        return c;
}

/* clear the terminal screen */

clrscn()
{
        printf( '\033E' );
}

/* go to x, y */

goxy( x, y )
{

```

hardware, modify the routines `minit()`, `mstat()` and `minput()`.

Since I couldn't determine the reason for the two movement values in each direction, I simply added them. This gives values in each direction of -256 to $+254$. This value, once calculated, needs to be scaled to the resolution of your display, so that moving the mouse produces proportional movement on the screen. Because I was using a normal 80 by 24 video terminal, I scaled the horizontal values by multiplying by 80 and dividing by 256, the vertical values by multiplying by 24 and dividing by 256. The resulting movement values are added to the current X and Y cursor position.

If you use a graphics display, multiply by your actual horizontal and vertical resolutions instead. Remember to insure that the X and Y values don't exceed the dimensions of the display.

You may desire to divide by a value less or greater than 256. Smaller values make the mouse respond with greater movement; larger values with less movement. The "best" value would be a value which allows accurate positioning of the cursor anywhere, without requiring the user to constantly "row" the mouse (repeatedly rolling the mouse, then picking it up and moving it back without rolling).

Since you have control of this parameter, you can make your targets large and your divisor small, and eliminate the rowing for all but the most crowded of desks.

Another point to remember: The mouse is a *relative* movement device. It does not keep track of its absolute position. Therefore, your program can only follow it when it actively examines the serial port. I suggest checking for characters periodically, and processing the mouse movement whenever a packet is waiting. This can be done by converting the `main()` in the listing into a function, and removing the `while(1)` loop. This function then should be called periodically to update the mouse position while other program activity is going on.

```

    }
    printf( "\\033Y%c%c", y + 32, x + 32 );
}
#asm
;Z-80 SIO and CTC routines - IMS 740 slave board
CTC EQU 28H
SIO EQU 2CH
UART EQU 1 ;uart number on SIO
CHAN EQU 1 ;channel number on CTC
DATA EQU SIO+UART
STAT EQU SIO+UART+2
; Baud Rate Divisor
B1200 EQU 16 ;baud rate divisor
#endasm

minit()
{
#asm
; Initialize SIO
MVI A,18H ;Channel Reset
OUT STAT
MVI A,4
OUT STAT
MVI A,11000100B ;8 bits xmit, *64 Async
OUT STAT
MVI A,5
OUT STAT
MVI A,111101010B ;set DTR on, RTS on
OUT STAT-
MVI A,3
OUT STAT
MVI A,11000001B ;8 bits recv
OUT STAT
MVI A,1
OUT STAT
MVI A,0
OUT STAT
;no interrupts

; Set Baud
MVI A,01000111B ;Counter mode, free-run, value follows
OUT CTC+CHAN
MVI A,B1200
OUT CTC+CHAN
}

#endasm
}

/* check serial port status */
mstat()
{
#asm
IN STAT
ANI 1
MOV L,A
MVI H,0
#endasm
}

/* read serial port data */
minput()
{
#asm
IN DATA
MOV L,A
MVI H,0
#endasm
}

#include 'stdlib.c' /* include code for bzos() and other functions */
/* end of mouse.c */
)ry 6eMUX5-4 BAK -yZeMUX5-1 DWG hqy . pLeMUX5-2 BAK [y 8 6eMUX5-3 BAK n[y ?

```

WANTED OR FOR SALE

These ads, for sale or wanted, are available free for those who subscribe to UPDATE Magazine. They must be of a Sinclair or Z88 nature or a peripheral that may be used for them. Use these ads to solicit help on a project, or to help you sort out a hardware or a software problem. They are for your use. They offer a good resource for the Sinclair and Cambridge community of users. Please inquire to the magazine for commercial ad placement.

(1) FOR SALE: TS2040 printer with adaptor. Has a roll of paper. Works good, for \$20.00. TS1016 Memory Pack. Not tested, for \$7.00. One QSAVE, a fast loading device for the TS1000, with program tape. Not tested, for \$5.00. One TS1500 Computer, with adaptor, its own Sinclair case, TV switch. May be good for parts to fix up another TS1500, for \$25.00. One TS1000 Computer, with no adaptor, nor TV switch. Not tested, for \$7.00. Please write to William DesLauriers, 9926 Kramer Ct., Indianapolis, IN 46236-1647.

(2) WANTED: Interested in buying new or used Larken disk interfaces for the TS2068. Contact Bob Swoger, 613 Parkside Circle, Streamwood, IL 60107. Also contact me if you are interested in joining a TS user group that has been around for a number of years and is still growing. We even have our own BBS and newsletter.

(3) TS CONSULTING AVAILABLE: Contact Rod Gowen, for professional (fee charged) help with your computer problems (use his experience to your advantage and keep this valuable resource available). Rod Gowen of RMG, phone 503-655-7484.

(4) FOR SALE: Miracle Hard Drive for the QL, 30 Meg. This is a complete system ready to hook up to the ROM cartridge port on the back of the computer. Price is \$150 and includes shipping. Also want to sell approximately 70 back issues of QUANTA Magazine. Price is negotiable. Contact Paul Holmgren, 5231 Wilton Wood Ct, Indianapolis, IN 46254.

(5) FOR SALE: Foote Printer Interface that fits in the dock port of your TS2068 and gives you access to a parallel printer. No driver with it, but works fine with my Tasword 2 and MSCRIPT. Also 2 Aerco Printer Interfaces, one for the TS2068 and one for the TS1000, for \$25 each. Also for sale a JLO kit for making a 4 slot motherboard for the TS2068. It fits on the back of the TS2068, and is for sale for \$30. I also have for sale a SPEM (Italian made) full page scanner for the QL. This is already set up on a serial printer body so it easily connects to your QL. It comes with software. The price is \$90. All prices include US shipping, but for foreign throw in a few extra dollars for large items and an extra \$2 for the small items. Contact Frank Davis, 513 East Main St., Peru, IN 46970, or call evenings Tues thru Sat from 5-9 P.M. at 317-473-8031.

(6) FOR SALE: Small tape cartridges that work in the A&J 1000, A&J 2000, and the Rotronics Wafadrive. Some are brand new, still sealed in package, while some are used, but good. They are hard to get, whereas I no longer have the equipment they are for, so I am offering them for sale to those who can use them. One for \$3, or two for \$5, and I will mail them for free. I also still have for sale a Falkenberg Hard Disk Interface, with RLL card and Bus Expansion Board for the QL. Make me a good, reasonable offer on this and it is yours. I use one, as well as a QUBIDE IDE Interface and like both, but have only so much room in my place. Write to me : Eliad Wannum, c/o UPDATE Magazine, P.O. Box 17, Mexico, IN 46958.

(7) HELP WANTED: It is now possible for a lot of people to access the Internet. What we as Sinclair users now need is a graphical interface that will allow us to easily navigate the Internet. This requires a program that allows us to be able to access many common tools for the Internet such as SLIP, FINGER, ICP or TCP, ARCHIE, GOPHER. Has anyone out there given any thought or actual work in this area? If so, please take the time to share your work, or ideas with the rest of us. We here at UPDATE Magazine would be glad to help if we can, or to help you make your work, efforts, or problems in this area known. We have gotten this far as a group of users by helping and sharing. This is just another area we can shine in. If you think it is not possible, check out the QFAX software, QEM, and QTPI to see how far we have come in comm software. It could be done. Your help is wanted.

(8) ADDITIONAL HELP WANTED: We are also in need of some much improved terminal communications programs for the TS2068. MTERM and MTERM2 are way too elementary and lacking in features to be of great use on most BBSs of today. SPECTERM and a few like MAXCOM were at least improvements over the above. But we need to face the fact that they also are not up to the speed and ease of use that today's BBSs demand of you, much less able to upload and download programs with any speed. Because of no local access numbers, many of our users in out of the way places can develop large phone bills with the software now available for the TS2068. Anyone out there got any new ideas or solutions? If so, let us know at UPDATE Magazine. Another good place to pass on this information is to the QBOX BBS. What better way to make it known!

(9) A TIP FOR QL USERS OF SERIAL MOUSE: This comes from A. E. Green of Tampa, Florida. "I think it was the QL Report that I saw this, a gender changer for the IBM serial mouse to the QL. After reading the article I thought that there must be a better way and there is: First: cut the mouse's tail off about an inch from the female plug. Second: strip off the insulation of the 4 wires and using an OHM meter check out what color wire goes to what pin of the plug and write it down. Third: Cut the end that goes into the male socket flush then remove what is left of the metal pins. Fourth: Mark the outline of the plug with a felt tip pen and using a Dremel tool (or similar) with a 1/8" router bit hollow out the plastic just deep enough to insert a 9 pin male socket. By this time you can remove what is left of the remaining tail and replace it with the other end and solder the wires by color code according to the QL pin out, a drop of super glue on both ends of the socket will hold everything together quite well."

A second bit of useful information from Mr. Green is: "I found two power supplies for the TS2068 that are much better than the original. Both are switchers type, one is from a Zenith data system #150-308 16.5 volts at 2 amps, the other is from COMPAQ Computer #129827-001 18 volts at 2.5 amps. Need a plug that will fit the TS2068 try an 8bit ATARI, the plug and not the power supply. It's 9 volts AC and won't work. Remember that the center pin on the TS2068 is negative."

A.E. Green ends off by asking "Has anyone found a better power supply for the QL?"

Editors note: one thing those who attended last years Dayton Computerfest saw, but I forgot to tell the rest of you was a little something that A.E. Green made for us here at UPDATE Magazine. He took a TS1000, and installed an LCD clock in it. He cut out a place above the keypad part for the display to show through, and wired it in so that the time and date could be adjusted from the keyboard and made it so it hangs on the wall. It is above the computer I am using at this moment. The work was really well done and much appreciated. Mr. Green seems to have a knack for these things.

Buying a Modem?

by *Abel Kahale* CATUG - T/5NUG

They are doing it to us again. Just when you may have thought you had a handle on understanding modems — those devices that let computers connect to other computers and to on-line services over telephone lines — the computer industry has introduced a new, and particularly confusing, standard for these gizmos. So, if you are looking for that fast modem, read on.

So this is a good time to look into the new standard, and to go over the whole process of buying a modem, whether it's an add-on to a computer or built into a new machine.

The easiest way to think of a modem is as a telephone for your computer. Regular phones — the entire telephone system, in fact — are designed to carry voices. Modems are mainly designed to transmit and receive computer data over this voice-based network. The material transmitted by modem can range from simple text-based documents such as electronic mail messages, to program types that contain spreadsheets, sounds, pictures, video and more. Nearly every modem today also has the ability to send documents from a computer's screen to a fax machine (facsimile) and to receive on the computer's screen documents faxed from a fax machine.

When you look at a modem in a store, the box is crawling with techno-terminology that hardly anybody understands. But there really are only two basic characteristics of a modem that will mater to most people. The first is its physical

configuration — Is it an internal (for PC's) or external model? The second is the speed at which it is capable of sending and receiving data, a crucial issue since many on-line services charge by the hour or even the minute.

External modems are easy to hook-up, they have lights that give you positive confirmation that you are still connected and that a download or other transmission is proceeding. These little lights have cryptic labels, but they're useful anyway.

Speed is the other key factor. Modem speeds are measured in *bits per second* or bps (a bit being the smallest unit of computer-data). This is sometimes called BAUD, but that's actually a different measure, as explained in my last article, so bps is the one to use.

Modems usually have one speed for computer data and another for faxing. The fastest modem speed that's widely supported today by commercial and corporate networks you might dial into is 14,400 bits per second, usually called 14.4, fourteenfour or fourteen-dot-four. These 14.4 V.32 modems usually have a faxing speed of 9,600 bps. They now cost around \$100 to \$150 (\$70 - \$110 for internal modem). Older modems with data speeds of 2,400 bps or 9,600 bps are cheaper (\$30 - \$70) but they are just too slow for long distance or for going on-line.

Here's where that new industry standard comes in. Many modem companies have just brought out models that claim to work at a high speed of 28,800 bps.

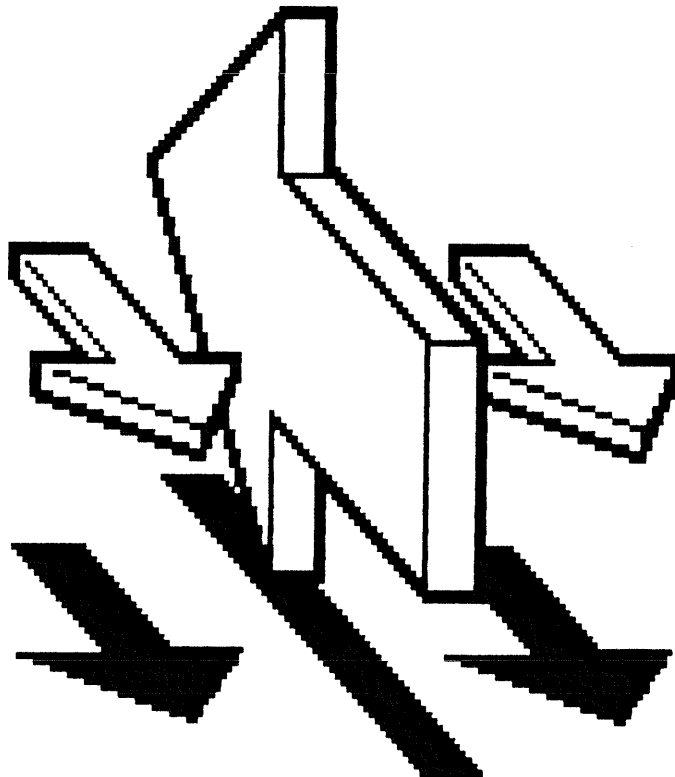

These 28.8 bps modems promise great benefits, but for most people, they aren't a good choice now for several reasons. First, none of the leading on-line services can handle data at this new speed, few other computers with the 8251 UART can either. (A 16550 UART or its equivalent is required) Second, even when the on-line services can handle the new speed, in a year or so, they're likely to charge a premium for that faster service that will partly or wholly wipe out any cost savings the speed increase brings. Third, the 28.8 bps modems are roughly twice as expensive as 14.4 bps models—about \$230 - \$300.

Many modems on store shelves can't be relied upon to connect at full speed to other 28.8 bps modems because they don't meet the international standard for modems of that speed. This standard is set by an international panel of engineers (ITU formerly CCITT) and covers lots of technical matters too dense and boring to enumerate here, *even if I could*. But all you need to know is that the standard is called V.34. If you insist on buying a 28.8 bps modem, make sure it says on the box that it complies with the V.34 standard. Don't buy a modem that supports a standard called V.FC or V.Fast or any other V that's not V.34. These are unofficial standards cooked up by impatient modem companies while waiting for the slow-moving international committee to define the official standard.

The only exception is a few nonstandard 28.8 bps modems that can be cheaply upgraded to the official V.34 standard. One example is the best-selling US Robotics Sportster, which now comes in an official V.34 version (\$235). Older Sportsters (\$125) that met only the V.Fast standard can be upgraded to V.34 by popping in a chip the company will send you for \$29. Same as with V.Everything that can be upgraded to any forthcoming standard by just downloading a file from US Robotics's BBS free of charge.

Sorry for all the jargon, but you'll need to look for it on the box if you absolutely must have the fastest modem, no matter how impractical it is.

For the rest of us, 14.4 bps V.32 will do just fine.

On-Line Security

Computer security experts have discovered a new weakness that could leave more than half of the "host" computers on the INTERNET vulnerable to hacker break-ins.

The Computer Emergency Response Team, a federally funded center based at Carnegie Mellon University, issued a public warning and said that the security lapse could let hack-

ers commandeer INTERNET computers that use the UNIX operating system, specifically a program that manages electronic mail. UNIX is the basic system software that runs more than two million of the roughly four million main *host* computers connected to the global network.

The CERT warning is the latest in a spate of security problems to emerge recently. A notorious hacker was arrested and charged with pilfering records on 20,000 credit-card accounts and breaking into myriad computer systems on the INTERNET. In the wake of publicity about the case, a new "hole" was discovered that could let hackers shut down electronic-information sites that hundreds of companies have set up on the World Wide Web, a multimedia portion of the INTERNET.

The vulnerability allows a hacker to penetrate a *hole* in nearly 20 commonly used, electronic-mail programs and then read any file on the system, overwrite or destroy files according to an advisory that went out on the network.

The security risks are growing as the INTERNET adds record numbers of new users, many of them businesses. More than 30,000 businesses have registered INTERNET addresses, and more than 2,000 newcomers join each month. The latest disclosures underscore that their data may not be as secure as they thought.

Vinton Cerf, a vice president at MCI and one of the INTERNET'S original architects, said security problems will continue to plague the network, despite the arrest of fugitive hacker Kevin Mitnick. "One could hardly credit him with all of the security incidents.", Cerf said. All too often, he added; "security concerns are ignored because they have annoying side effects." such as increased costs and time-consuming procedures.

A senior scientist at computer security firm TISI, said the persistent security problems are partly the result of an immature software engineering industry, in which security concerns fall by the wayside. "We also have all these hackers who don't seem to have anything better to do than breaking into these systems.", he said. "It doesn't help that the government restricts the export of robust security methods known as cryptography."

Eugene Spafford, a professor of computer science at Purdue University, said that if consumers made greater demands on software manufacturers for better security features, the vendors would justify the increased cost of including them "Are we going to continue seeing problems? You bet.", He said

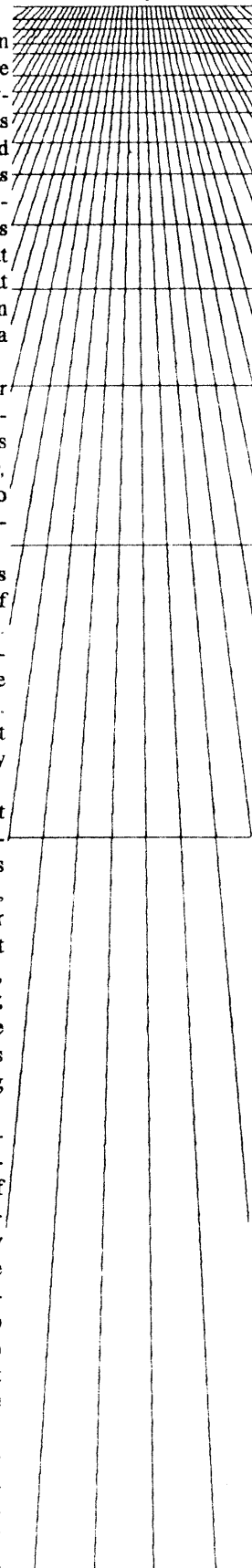



QBOX - USA



24 hours

810-254-9878

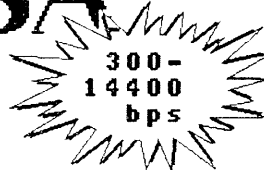

300-
14400
bps

Now running with a QUBIDE interface and a hard drive!

We're expanding! Lots of new files! New message and file areas will be added soon. Give us a call and let us know what you want to see here. We still have the following areas available:

MESSAGES

- Local
- Private
- International QL
- Minerva
- Quanta
- QBox Sysop
- Spectrum
- Netmail

FILE AREAS

- General
- Utilities
- Communications
- Archivers
- Pointer Stuff
- Emulators
- Spectrum/2068
- Private

If you like the 2068 but use a PC, we have a Timex 2068 emulator available for download.

```

*****
*
*      COMPUTER CLASSICS
*      RT 1, BOX 117
*      CABOOL, MO 65689
*
*      Repair Service for America's
*      Favorite Home Computers
*      and their accessories
*
*-----*
*      ADAM      ATARI      COMMODORE
*
*      IBM       OSBORNE    SINCLAIR
*
*      TIMEX     TI         TRS-80
*
*-----*
*      BUY - SELL - TRADE - UPGRADE
*
*      Write for prices
*      SASE appreciated
*
*      Ph. (417) 469 - 4571
*
*
*      COMPUTER CLASSICS
*      *** FOR SALE ***
*
*      IBM XT COMPUTER $200 +shipping
*      Includes 10 MEG hard drive, 640K
*      RAM, 360K floppy, serial port and
*      parallel port, monochrome monitor,
*      and keyboard.
*
*      IBM 286 COMPUTER $350 +shipping
*      Includes 20 MEG hard drive, 1MB
*      RAM, 1.2MB & 1.44MB floppies,
*      serial & parallel ports, keyboard,
*      and monochrome monitor.
*
*      QUAD DENSITY 5 1/4 in. (720K)
*      half height floppy drives
*      $25 each or 10 for $150
*
*      IBM HARD DRIVES, CONTROLLERS,
*      and RGB COLOR MONITORS
*      Write for prices
*
*****

```

SEE YOU AT OAK RIDGE!

MECHANICAL AFFINITY
513 EAST MAIN ST.
PERU, IN 46970 USA
317-473-8031 Tues - Sat
5 to 9 P.M.

MECHANICAL AFFINITY
5231 WILTON WOOD CT
INDIANAPOLIS, IN 46254 USA
317-291-6002

We accept checks, cash,
money orders, or will
send C.O.D. All returned
goods need prior okay.



We will be at the IQLR and Miracle QL show June 10 at Oak Ridge and invite all of our customers to join us there for the festivities and the chance to socialize. PLUS!!! you will have the chance to purchase some of the best software in the world for your QL. We will have QLs, Gold Cards, Super Gold Cards, QXLs, Trump Cards, Hermes, Qubide AT/IDE Interfaces, parts, chips, membranes, tons of the latest software for the QL, Z88s to use as a portable for your QL. Take our word that the trip will be worth the while. An excellent vacation with European and UK dealers as well as us. Also UPDATE Magazine, IQLR and QBOX will be there. Hope to see you soon. In the meantime if you need anything, call!

Frank Davis and Paul Holmgren

SINCLAIR QL
QL TECH GUIDES \$12
QL SERVICE MANUALS \$10
QL POWER SUPPLIES 110 VOLT \$15
QL REPLACEMENT MEMBRANES \$20
512K EXPANDERAM FOR QL \$25
QL INTERNAL ROM BOARD \$12
INTERNAL QL BATTERY BACKED CLOCK \$15
QL COMPUTER USA VERSION W/POWER SUPPLY \$75
MINERVA MK1 ROM \$58, MK2 \$85
HERMES , 8049 replacement co-processor \$42
QUBIDE , QL AT/IDE HARD DRIVE INTERFACE \$120
FALKENBERG MFM or RLL HARD DRIVE INTERFACE \$ 185
QL KEYBOARD 90 INTERFACE, add IBM keyboard to computer \$90
QL GOLD CARD \$ 195
QL SUPER GOLD CARD \$395
QL TRUMP CARD \$90
QL SERIAL to PARALLEL PRINTER INTERFACE \$40
QXL Card for PC, 4 Meg QL board \$415
Ask us about SMSQ/E, the new QDOS compatible operating system!



CABLE COLUMN

By Bill Cable

ARCHIVE SERIES

PART 20 : MORE ON LINKING DATABASES TOGETHER AND USING SEDIT

CREATING ADDRESS2_DBF and SUBSCR2_DBF

The desired fields for an address database were listed last time and now we need to create it and add a few addresses. We will call it 'address2' because it is an address database and the '2' will make it easy to identify with our country database, gazet2. We create address2 at the ARCHIVE prompt just like we did gazet2. Flp1_ will be used as our device throughout :

```
create 'flp1_address2' logical 'a'<ENTER> {start create}
acode$<ENTER>
date$<ENTER>
name$<ENTER>
fname$<ENTER>
street1$<ENTER>
street2$<ENTER>
city$<ENTER>
stcypv$<ENTER>
postcode$<ENTER>
ccode$<ENTER>
phone$<ENTER>
note$<ENTER>
<ENTER>                                {end create}
display<ENTER>                          {show it}
{we will add some made up addresses just so we have
some in the database to play with}
insert<ENTER>                            {add first address}
smith,b<ENTER> 95/05/15<ENTER> Smith<ENTER>
Bob<ENTER> PO Box 92<ENTER> <ENTER>
Cornish<ENTER> NH<ENTER> 03745<ENTER>
usame<ENTER>(603) 675-4211<ENTER><ENTER>

wilson,r<ENTER> 95/05/15<ENTER>          {next one}
Wilson<ENTER>Robert<ENTER>
20 Mow Barton<ENTER><ENTER>Yate<ENTER>
Bristol<ENTER>BF17 5GF<ENTER> uking<ENTER>
(01434) 882 206<ENTER><ENTER>

baum,u<ENTER> 95/05/15<ENTER>           {next one}
Baum<ENTER>Ursula<ENTER>
Im Stillen Winkel 12<ENTER><ENTER>
Duisburg<ENTER><ENTER>12133<ENTER>
germa<ENTER>0201-511247<ENTER><ENTER>

Ward,r<ENTER>95/05/15<ENTER>Ward<ENTER>
Roger<ENTER>Old Valley Road<ENTER><ENTER>
Aukland<ENTER><ENTER>32145<ENTER>
nzeal<ENTER><ENTER><ENTER>
```

{enter some of your own, the more the better}

```
<F4>                                     {end address entry}
order acode$,a<ENTER>                    {set order by address code}
close<ENTER>                              {done with this for now}
```

Notice the Addresses were given an Address Code consistent with the rules mentioned last time and is our Key for looking up an Address. The Country Code field (ccode\$) in Address2 matches values of the Country Code field (ccode\$) in Gazet2 which is our Key for looking up Country. Now we have our Country Database (gazet2_dbf) and our Address Database (address2_dbf). We need to create our final database which will be a Subscription Database. It will keep track of subscriptions for three different newsletters we will pretend to sell - macworld, pcworld, qlworld. Creating databases containing real data is a lot of work. We just want enough data to realistically illustrate the linking of the Databases and even that is a fair amount of work. We will pretend we are in charge of keeping subscription information for these 3 newsletters. We will define the following fields in the subscription database :

Field #	Field Description	Field Name
0	Newsletter name	newsletter\$
1	Subscribers address code	acode\$
2	Starting Date	sdate\$
3	Ending Date	edate\$
4	Issues left	issues
5	Amount Paid	amt

We will call our database subscr2 to go along with gazet2 and address2. From the ARCHIVE prompt type :

```
create 'flp1_subscr2' logical 's'<ENTER> {start create}
newsletter$<ENTER>
acode$<ENTER>
sdate$<ENTER>
edate$<ENTER>
issues<ENTER>
amt<ENTER>
<ENTER>                                {end create}
display<ENTER>                          {display record}
{we will add some pretend subscriptions}
insert<ENTER>                            {begin adding}
qlworld<ENTER>smith,b<ENTER>
95/05/15<ENTER>96/04/15<ENTER>
12<ENTER>15<ENTER>

pcworld<ENTER>smith,b<ENTER>             {next one}
95/02/15<ENTER>96/01/15<ENTER>
12<ENTER>20<ENTER>

qlworld<ENTER>wilson,r<ENTER>           {next one}
94/09/15<ENTER>96/08/15<ENTER>
24<ENTER>30<ENTER>

macworld<ENTER>baum,u<ENTER>
95/02/15<ENTER>96/01/15<ENTER>
```

```

12<ENTER>25<ENTER>
qlworld<ENTER>baum,u<ENTER>
95/05/15<ENTER>96/04/15<ENTER>
12<ENTER>15<ENTER>
pcworld<ENTER>ward,r<ENTER>
95/01/15<ENTER>95/12/15<ENTER>
12<ENTER>20<ENTER>
<F4>                                {end adding}
order newsletter$a,sdate$a<ENTER>
close<ENTER>

```

Notice that the Address Code in the Subscription Database matches the Address Code we set up in our Address Database. So the Address Code in the Subscription Database points to and Address in the Address Database which points to a Country in the Country Database and our Linking is complete. Now that we have our databases we need to be able to see information in all three databases at once.

CREATING A SCREEN FOR 3 DATABASES

ARCHIVE has several commands that can be used to print information to the screen but it also has a special Screen Builder which allows you to visually construct a screen layout using a Screen Editor (SEDIT) and then save it to load and use as needed. Although limited in power and not especially user friendly it is an example of visual programming so much the rage these days. Instead of writing code you actually move around the screen putting labels and variable values where you want them to be and then save it to use. Using an ARCHIVE Screen is probably the easiest way to display information from 3 databases simultaneously.

The instructions below will give a brief description of how SEDIT works plus exact key presses to create the screen we want. We will display the subscription database on the left and the address database in the center and the country database on the right. I will use RA to indicate right arrow. So (14RA) will mean press 14 right arrows. The arrow keys move the cursor around the screen. Typing text will enter the text exactly where the cursor is. You can't push text around you can only overwrite places on the screen. Different colors can be used but I won't get into that now. Pressing <F3> allows you to access the screen editing commands which includes defining areas where variable values will go. So putting the cursor where you want the variable to start and pressing <F3> and v will cause ARCHIVE to prompt for the variable name. Enter it then press the RA (right arrow) until you have defined enough space for the variable value to be displayed. You will see periods (.) fill that area. Then <ENTER> will end defining that variable area. Variables can include fields of accessed databases. I will use a special ARCHIVE technique to exactly define database field names when more than one database is accessed at once. Notice that

above and when we access files below we will use logical names "g" for gazet2 and "a" for address2 and "s" for subscr2. This allows us to precisely refer to which field in which file we want. So a.ccode\$ refers to the country code field in the address database and g.ccode\$ refers to country code field in the country database. If more than one file is accessed at one time then only one will be active. Which is active can be switched by using the Use command (use "s" or use "a" or use "g"). The active one will not need the "." prefix to refer to a field but all the others will. In defining the screen I will make the subscription database active and so its fields will be referred to on the screen without any prefix but the Address fields will have an "a." prefix and the country fields will have a "g." prefix. If you are not familiar with SEDIT I suggest you also read over that section of your ARCHIVE manual and keep it handy.

Below I will give the key presses to set up the screen. Reading them will not make much sense but as you enter them on your QL you will see on the screen what is happening and it will make sense. Basically a line at a time I am setting up 3 columns (one for each database). Each column will have a label and a field (variable). All the extra RA (right arrows) are to line up the columns or define the variable areas. Rather than carefully counting you will be able to see visually where to move to. This is a challenging exercise but if you suffer through it you will learn a lot about the screen editor before you are through.

```

new<ENTER>                                {clear things out}
sedit<ENTER>                               {start screen editor}
(2RA)SUBSCRIPTION(11RA)ADDRESS(18RA)
COUNTRY<ENTER><ENTER>

```

```

(2RA)Newsletter(1RA)<F3>vnewsletter$<ENTER>
(9RA)<ENTER>(3RA)Addr Code(1RA)<F3>v
a.acode$<ENTER>(14RA)<ENTER>
(2RA)Cntry Code(1RA)<F3>vg.ccode$<ENTER>
(15RA)<ENTER><ENTER>

```

```

(2RA)Addr Code(2RA)<F3>vacode$<ENTER>
(9RA)<ENTER>(3RA)Date(6RA)<F3>va.date$
<ENTER>(14RA)<ENTER>(2RA)Country(4RA)
<F3>vg.country$<ENTER>(15RA)<ENTER><ENTER>

```

```

(2RA)Start Date(1RA)<F3>vsdate$<ENTER>
(9RA)<ENTER>(3RA)Name(6RA)<F3>va.name$
<ENTER>(14RA)<ENTER>(2RA)Continent(2RA)
<F3>vg.continent$<ENTER>(15RA)<ENTER><ENTER>

```

```

(2RA)End Date(3RA)<F3>vedate$<ENTER>
(9RA)<ENTER>(3RA)Frst Name(1RA)<F3>va.fname$
<ENTER>(14RA)<ENTER>(2RA)Capital(4RA)
<F3>vg.capital$<ENTER>(15RA)<ENTER><ENTER>

```

```

(2RA)Issues(5RA)<F3>vissues<ENTER>
(9RA)<ENTER>(3RA)Street1(3RA)<F3>va.street1$

```

```

<ENTER>(14RA)<ENTER>(2RA)Languages(2RA)<F3>
vg languages$<ENTER>(15RA)<ENTER><ENTER>

(2RA)Amount(5RA)<F3>vamt<ENTER>
(9RA)<ENTER>(3RA)Street2(3RA)<F3>va.street2$
<ENTER>(14RA)<ENTER>(2RA)Currency(3RA)
<F3>vg.currency$<ENTER>(15RA)<ENTER><ENTER>

(25RA)City(6RA)<F3>va.city$<ENTER>
(14RA)<ENTER>(2RA)Population(1RA)<F3>vg.pop
<ENTER>(15RA)<ENTER><ENTER>

(25RA)St/Cy/Prv(1RA)<F3>va.stcypv$<ENTER>
(14RA)<ENTER>(2RA)GDP(8RA)<F3>vg.gdp
<ENTER>(15RA)<ENTER><ENTER>

(25RA)Postal Cd(1RA)<F3>va.postcode$<ENTER>
(14RA)<ENTER>(2RA)Area(7RA)<F3>vg.area
<ENTER>(15RA)<ENTER><ENTER>

(25RA)Cntry Cd(2RA)<F3>va.ccode$<ENTER>
(14RA)<ENTER><ENTER>

(25RA)Phone(5RA)<F3>va.phone$<ENTER>
(14RA)<ENTER><ENTER>

(25RA)Note(6RA)<F3>va.note$<ENTER>
(14RA)<ENTER><ENTER>

```

```

<ESC>                                {done}
ssave "flp1_sub2"<ENTER>             {save it}
screen<ENTER>                        {look at it}

```

look "flp1_subscr2" logical "s"<ENTER>
Do all the subscription fields show up? If not sed it again and make corrections where subscr2 variables are. If you have misspelled a variable name you first have to delete it by moving to it then <F3><ENTER> and then reenter it as described above. Exit and look it over again. After it is okay save it and :

```

look "flp1_address2" logical "a"<ENTER>
Do all address fields with values show up. If not then correct as with subscr2 and save and then :
look "flp1_gazet2" logical "g"<ENTER>
Do all country fields show up. If not then correct as with subscr2 and then :
ssave "flp1_sub2"<ENTER>
close "s": close "a": close "g"<ENTER>

```

PLAYING WITH 3 LINKED DATABASES

We have our databases and screen defined. Now we will write a little procedure that will allow us to access and view all 3 together and they will be linked so whatever address is specified for the subscription will appear as the address and whatever country is associated with the address will appear as the country. To be really useful a more involved user interface needs to be built up but our

```

purpose is only to illustrate how linking can work. You
saved everything as suggested up to this point right?
new<ENTER>                                {clear everything out}
edit<ENTER>                                {start ARCHIVE editor}
subview<ENTER>                             {call procedure subview}
mode 0: error close_all<ENTER>
look "flp1_subscr2" logical "s"<ENTER>
look "flp1_address2" logical "a"<ENTER>
look "flp1_gazet2" logical "g"<ENTER>
sload "flp1_sub2" : screen<ENTER>
use "s"<ENTER>
while not eof()<ENTER>
use "a" : locate s.acode$<ENTER>
use "g" : locate a.ccode$<ENTER>
use "s" : sprint<ENTER>
print "<ENTER> to view next subscription : ";<ENTER>
input ans$<ENTER>
next<ENTER>
endwhile<ENTER>
error close_all<ENTER>
mode 1: print "Done"<ENTER>
<ESC>                                       {finished with subview procedure}
<F3>nclose_all<ENTER>                       {add close_all procedure}
while 1 : close : endwhile<ENTER>
<ESC>                                       {finished with close_all procedure}
<ESC>                                       {all done adding procedures so exit editor}
save "flp1_subview"<ENTER>                 {save procedures}

```

We have our procedure 'subview' which will step through the subscription database and display the proper address and country for each subscription. Let us try it out.

```

subview<ENTER>                             {start it}
<ENTER>                                     {continue to <ENTER> until end}

```

If you have no errors you will see the linked data correctly displayed. It is an interesting exercise and you can see that ARCHIVE's multifile capabilities coupled with the ability to link databases together and efficiently display them makes for powerful data handling only limited by your imagination. In fact you will find no other structure on the QL that can do this with such relatively little programming effort. Being able to link data together and efficiently display it is a necessity for any sophisticated data handling system. Although this exercise was long and tedious most of the work involved setting up data to play with. The actual programming effort was very small. Can you imagine trying to do this with SuperBASIC. You would have to invent a complete ARCHIVE-like subsystem and why bother since has already been done.

Any of you who will be coming to the 3rd North American QL Show in Oak Ridge Tennessee on June 10th be sure to bring examples of your favorite ARCHIVE problems or solutions. I will be there and will happily discuss all things related to ARCHIVE. Next time more fun with ARCHIVE. Any suggestions are welcomed. Until then, Happy Archiving!

QLerk

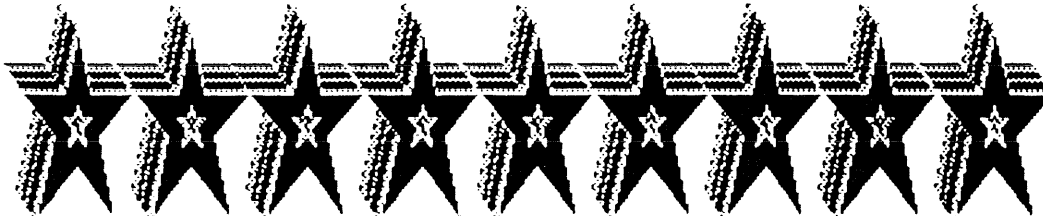

A FINANCIAL PROGRAM FOR THE SINCLAIR QL

By
Wood and Wind Computing : Bill Cable : RR3 Box 92 . Cornish NH 03745 : USA
Phone : (603) 675-2218

For the first time you have the capability of keeping complete and accurate financial records for the Home or Small Business with your QL. A friendly Financial Clerk to serve you. The code is written in the ARCHIVE Programming Language and is completely accessible to the user. All functions are selectable from standardized menus. No knowledge of ARCHIVE is required. The program works from a common sense point of view without imposing accounting theory on the user. Although it has many powerful features the user can use only those features desired, ignoring the rest. Recommended minimum system is a Trump Card with 2 DD Drives. It works much faster on Gold Cards and Super Gold Cards. Latest Version is 3.21. Great for Tax Records. Order it today so you have plenty of time to be ready for the IRS on April 15.

PRICING

Public Domain Demonstration Version of QLerk (refundable with QLerk order)	\$5.00 US/Canada	\$7.00 Elsewhere
QLerk Program on Disk with Tutorial Doc File	\$29.00 US/Canada	\$31.00 Elsewhere
QLerk Manual (150 pages of details)	\$29.00 US/Canada	\$34.00 Elsewhere
QLerk Program with Tutorial and QLerk Manual	\$50.00 US/Canada	\$57.00 Elsewhere

Z88 COMPUTERS

AVAILABLE FROM US AT THE FOLLOWING PRICES THRU JUNE 10, 1995

Basic Z88 Computer, with carrying case and manual, new. \$175
Z88 Computer, plus 128K extra RAM, soft case, new. \$220
To use all of the features on your Z88 you need blank EPROM Cartridges to store your most frequently used programs. 32K \$25, 128K \$55, and 256K for \$85. We also have extra RAM available, 32K TO 512K.
MACLINK to Z88 for \$50 PCLINK to Z88 for \$45 QLINK to Z88 \$30.

MECHANICAL AFFINITY

**513 EAST MAIN ST
PERU, IN 46970**

**5231 WILTON WOOD CT
INDIANAPOLIS, IN 46254**

Cash, checks, money orders, or COD. Payable to F. Davis or P. Holmgren.

Do YOU Require the very latest information on software and hardware developments within the International QDOS/SMSQ Community ? **Then you need a subscription to:**

IQLR

International QL Report

Do YOU Want to Know what QLer's really think about the products they buy and do they live up to the suppliers claims? **Then you need a subscription to:**

IQLR

International QL Report

Do YOU Need up-to-date information on show events, hints and tips, who is doing what and why, communications, PD and Shareware software developments and plenty of adverts to help you make that important decision? **Then you need a subscription to:**

IQLR

International QL Report

Is it Important to YOU to have your QL magazine delivered to you ON TIME, EVERY TIME, without ever missing an issue? **Then you need a subscription to:**

IQLR

International QL Report

IQLR

HOW to SUBSCRIBE: Send the appropriate amount listed below in the form of a Postal, Bank, Euro or Personal cheque to our North American or European office.

IQLR

International QL Report

Please Note: Personal cheques in £ MUST be drawn on a UK bank. Personal cheques in US\$ MUST be drawn on a US bank. Please make ALL cheques payable to IQLR.

IQLR

International QL Report

Credit Card Users may subscribe by either calling or sending their Credit Card number and Expiry date to: MIRACLE SYSTEMS LTD - 20 Mow Barton - Yate, Bristol BS17 5NF - UK Telephone/Fax: (01454) 883 602

IQLR

International QL Report

SUBSCRIPTION RATES: To the US the rate is \$24.00 - To the British Isles and Europe the rate is \$34.00 or £25.00 or DM70 - To Canada the rate is \$27.00 - To Central and South America the rate is \$34.00 - To the Rest of the World the rate is \$40.00 or £30.00 or DM80.

IQLR

International QL Report

IQLR • P.O. Box 3991, Newport, RI 02840-0987 • USA

Telephone/Fax: +1 401 849 3805

IQLR • 23 Ben Culey Drive, Thetford, Norfolk • Great Britain IP24 1QJ

The 3rd North American QL Show

An Open Invitation to All QDOS/SMSQ Users

Come, join with us, as we celebrate the QL's eleventh year and Jochen Merz Software's tenth year at the 3rd annual North American QL show. The show will be held on Saturday the 10th of June 1995 in OAK RIDGE, TENNESSEE, USA. Those who have attended in the past, will tell you that the show is really secondary to the real event, the GREAT OLD-FASHIONED GOOD TIME to be had by all. Many of us arrive two days in advance and stay one or two days afterwards, others stay a day or two while still others arrive the day of the show. No matter how long your with us, you will have a great time.

Traders expected to attend include: Stuart Honeyball of Miracle Systems (UK), Tony Firshman of TF Services (UK), Bill Richardson of W N Richardson and Co (UK), Jochen Merz of Jochen Merz Software (GERMANY), Frank Davis of Mechanical Affinity (USA), Carol and Frank Davis of Update Magazine (USA), Bill Cable of Wood and Wind Computing (USA) and while not traders, John Impellizzeri and Don Walterman of QBOX-USA (USA) will be demonstrating their QL Bulletin Board.

New Products and Old are expected to abound, including: the Masterpiece Enhanced Graphics Card - Super Gold Card - QXLs from Miracle Systems, Super Hermes - Minerva - I2C interfaces from TF Services, and Mechanical Affinity will have Qubide hard disk interfaces and just about anything else you might want.

Jochen Merz will be demonstrating SMSQ/E plus a number of his PE compatible programs including some new products. Wood and Wind Computing will be demonstrating their state of the art financial package QLerk along with their other products and Mechanical Affinity if they are true to form, will have just about every program currently available for the QL plus plenty of spare parts. For the first time we'll have a table set up for Trade and Sale, so bring those excess items you have with you, people are always looking for good buys.

The Show Registration Fee will be \$3 (US) per person in advance and \$5 (US) at the door. To register for the show (not the motel) contact IQLR at our North American office. As has been our practice, a Dutch Treat Dinner (you pay for your own meal) will be held following the show.

Base of Operations will be the SUPER 8 MOTEL 1590 Oak Ridge Turnpike Oak Ridge, TN, USA. The room rates are \$37 for a single and \$41 for a double plus local taxes. Room rental includes the use of their outdoor swimming pool, 25" color television (in each room) with multi-channel Cable, and a FREE Continental Breakfast. For RESERVATIONS Telephone: US 615 483 1200 or Fax: 615 482 9834

Please Note: The room rates listed above **"Are Special Show Rates"** and will only be honored for reservations made by 9 May 1995. After that date rooms will be on a first come basis at rates 16% higher. **YOU MUST** state that you will be attending the **"3rd North American QL Show"**.

The venue of the show (with plenty of free parking) will be just down the road from the motel at : FAITH LUTHERN CHURCH, 1300 Oak Ridge Turnpike, Oak Ridge, TN . Show hours will be: 10 am (EST) to 4pm (EST).

Travelling Info If your flying to the show, we recommend that you book your flight to Knoxville, TN (McGhee-Tyson Airport) there is then a short 20 minute ride to Oak Ridge. Shuttle service is available from 'ABC Airport Limo Service' at very reasonable rates (they have a counter at the Airport). For those of you driving (motoring) to Oak Ridge and require additional information and/or directions, please contact:

Mel LaVerne
103 Endicott Lane
Oak Ridge, Tennessee 37830-4117 USA
Telephone: +1 615 483 4153

International QL Report

P. O. Box 3991 Newport, RI 02840-0987 Tel/Fax: 401 849 3805

QLuMSi
by Al Feng

QLuMSi/QL.using.M'cr*S'ft.interface (yes, it's pronounced "clumsy") is a front-end program, an MS-DOS simulation, and a learning tool. QLuMSi is a TURBO-compiled program can be EXEC(_W)'d on any QL which has TK2_EXTensions and is MINERVA and QXL/SMSQ compatible.

For individuals who move between QDOS and DOS, QLuMSi allows for a smoother transition when invoking command line input -- QLuMSi will convert the delimiter for you. Either an 'underscore'/'_' (the QDOS's standard delimiter) or a 'period'/'dot'/'.' (the standard DOS delimiter) may be used within filenames.

For individuals whose spouse may not want to use their QL because they use a DOS system at work, this allows them the comfort of the standard prompts and commands. For example, typing "quill" at an 'A:\>' prompt will instruct your QL to "EXEC_W flpl_quill" and load the Quill program if it is present on the disk in flpl_.

For individuals who are not familiar with "standard" DOS commands, it gives them an opportunity to easily familiarize themselves while allowing them to continue to use standard QL programs.

CHANGES FOR v4.70

The most prominent change for *version 4.70* is in the DIRectory displays.

An implicit '/p'(for "pause") is now presumed. In addition, the standard DIR display now more closely matches the DOS display:

```
A:\> dir
      Volume in drive A is @ PLATYPUS
      Directory of A:\

Quill           60614 04-02-95 19:33
Archive         52814 04-02-95 19:33
- - - - -
misc ->
turbo ->
printer_dat      85 04-02-95 19:37
GPRINT_PRT      510 04-02-95 19:37
QLAMBer         32330 04-02-95 19:37
QLUSTER         32470 04-02-95 19:37
```

Press any key when ready ...

The number of files that are displayed on the screen is dependent on whether the "banner" is displayed ("CLS" vs. "SHOW").

If you want the DIRectory of another PATH, then type:

DIR [path_letter]:

To see a DIRectory data displayed in four columns, type:

```
DIR /W
or,   DIR [path_letter]:/W
```

Extra spaces may return a "Bad command or file name" message.

COMMANDS

The following COMMANDS are supported (Typing "HELP" will display this list):

CD \	CLS	COPY	DATE
DEL	DIR	FORMAT	FREE
MEM	PRINT	RENAME	STAT
TIME	TYPE	VER	VIEW

'RD \' & 'MD \' are also supported.

Since 'MD \' accesses the MAKE_DIR keyword {QXL, (Super)GOLDCARD, and FLP/RAM}, **QLuMSi_COMn** (i.e., COMn == common) is amongst the versions provided for systems lacking the MAKE_DIR keyword. This is also the only version included which supports mdv():

```
Y: == mdv1_           Z: == mdv2_
```

Typing "HELP ..." (where '...' is the name of a supported command) will reveal more detailed information.

The **COMMAND_COM** program is the same as the "full" **QLuMSi_COM** program except that it lacks the additional HELP beyond the HELP screen which shows the COMMANDS and PATHS which are supported. **COMMAND_COM** has the advantage of being "smaller" than the "full" program. **COMMAND_EXE** is the **COMMAND_COM** program which begins with a 'C:\>' prompt (i.e., 'win1_').

SBasic/MINERVA QUIRKS

Every attempt has been made to ensure QLuMSi compatibility with the demands of the MINERVA ROM code as well as the variations found in the SMSQ's SBasic code.

THE BOTTOM LINE

This remains as an *UPDATE! issue disk* (see back cover).

Previous users [*direct(CATUG/ZQA!)/EMSoft/UPDATE!*] may acquire an upgrade from me (\$5/specify disk size).

HAPPY TRAILS,
AND COMPUTING, TO YOU ...

News and Views on the QL by E.P. Wannum

Once again we find ourselves looking to see just what is new for the QL, as well as why I firmly believe that it is a computer system well worth staying with and expanding its capabilities. Take this as the straight skinny from someone who spends a great deal of time listening to the problems of other people. I would not like to sound like a commercial for a product, but "I have seen personal computers actually provide therapy for many of the people that use them. This goes as well for hand and eye co-ordination as well as the sense of mental accomplishment people can get by mastering computers as a skill." The QL or QDOS system is great for this. With its built-in SuperBasic and an extendable operating system, it is a computer that can be easily learned. Even better is the fact that you do not need to learn "all there is to learn" in order to start using it, even from SuperBasic programming. A few years back most computers (except IBM types) had Basic as a language built right in. Look around and you see that is not the case now. The forms of Basic for the computers now are something you buy separately and need several large tomes (books of learned lore) to even start to come to grips with. I will grant you that the QL system is more difficult to learn than say the TS1000, Spectrum or the TS2068; yet we have much more in the way of mature software for those who just want to use it instead of program it. For those who want to program it we also have excellent software for that use. If you disagree with this, all I can say is you have not paid attention to IQLR, UPDATE and the Mechanical Affinity catalog. Check it out for yourself.

Now to bring you up to speed (some of you are probably already aware) on things in the realm of the QL. For those who do not already know, DJC (Dilwyn Jones Computing) the largest software retail house in the UK, is no longer in business. The owner, Dilwyn, after much soul searching closed it down. At the time of closure it was at its busiest and most profitable he had seen. Lack of customers was not the reason. Last year they suddenly lost their two year old child, and were very grieved by this. They are once again trying to bring a child into this world and wish to devote more attention to this. The decision is quite personal and well within the realm of their right to decide. We wish them only the very best of luck in all future ventures in life. Dilwyn has said he will not be totally absent from the QL scene.

The products that were carried by DJC have not been dropped by the wayside. The CARE Electronics items of Tool Kit 2, QPAC1, QPAC2 and I presume QTYPE2 have all been picked up by Miracle Systems of the UK. The Pointer Environment based programs have mostly been picked up by Jochen Merz of Germany. A great deal of the rest of these programs have been picked up by Bruce Nichols of QREVIEW magazine. A few of the not so popular programs have been placed into the public domain; if I find out just which ones, I will try to tell you in a future column.

Now for the good part for those here in North and South America. Frank and Paul of Mechanical Affinity in Indiana, full knowing what was happening with DJC, took the time and invested a lot of money to stock up on a lot more of DJC software than usual. They also added a dozen or so pieces of DJC software that they had not carried before. They did this to increase the size of their business, offer you more titles, and to get them at the old price, as they did not know if some of the prices by the new retailers would increase or not. Frank is now slowly going about contacting some of the software authors personally to see about directly carrying their software. I realize he is

a little cautious on this, as it does him and Paul no good to invest thousands of their personal dollars in software and hardware that you, the customers do not buy. Give them some support, so we can continue to see their presence.

I now shall try to do a number of mini-presentations on some of the new software that Mechanical Affinity has taken on. Call Frank if you need more detailed information on a particular item. First I will discuss some new items of entertainment.

The first item is THE OPEN GOLF, by Oliver Neef and Rich Mellor. It is a golf playing simulation, with 50 courses. Each course has 18 holes. It runs on QL's with 384K of memory, disk based, and a color monitor is recommended. A nice item in this game is that you can load an old high score table at the beginning of the game. At this point you are offered the option of choosing which of the 50 golf courses you wish to play upon. Throughout the game you have the choice of club to use. Try this for a bit of relaxation and fun.

The next game is a text based adventure game called THE FUGITIVE. Do not confuse this with the old '60s American TV show or the recent movie. The game was designed by DI-REN. The scenario is "You are working for the British Embassy in Russia. After several years a problem arises. It becomes essential you leave as quickly as possible. You are -THE FUGITIVE!" The author says that the game has 140 different locations and has been designed to be a complex adventure that will require a lot of patience and thought. It has not been designed to be gimmicky or easy. Sounds like it could be lots of fun and kill a lot of time.

The next is one that was formerly offered by Peter Hale of EMsoft, and written by Robert Schubel. In fact I believe that DJC still had been obtaining these from Peter Hale. It is called SOLITAIRE for the Sinclair QL. It will run on an unexpanded QL. It is not copy protected, but if you are using the Minerva ROM from version 1.92 on, use the Minerva bodge on your Minerva disk. It is not an easily won game, so it will challenge you and improve your skill.

The last of the new games Mechanical Affinity is offering is called GREY WOLF and is a simulation of World War Two submarine warfare. It was written by Oliver Neef and Rich Mellor. It needs a minimum of 256K of memory and an 85 column screen, RGB. In this game you are a WW2 German commander and are fighting the Allies in the year 1943 in the North Atlantic. It is possible if you do not like this scenario to pretend that the "baddies" are other than the allies. As the author was German, it was written from his perspective. All in all, it is a good war simulation. I had not done a war simulation since Sharps "War In The East" of years ago.

Now for the more serious, or utility side of the new software Mechanical Affinity is offering.

They have brought in more clipart to be used in art, CAD and DTP programs. One set is three disks of imported (from other computer systems), compressed clipart specially for LineDesign. Some of it is even double-compressed. This has hundreds of more screens that you can easily put to use.

The next clipart collection newly offered is the seven disk set of FAMILY/RELIGIOUS CLIPART. Frank says they had several requests for a collection just like this. It should be great for the children, or to do up a bulletin or brochure for your church group. They can also be used in any one of the major DTP programs, as well as LineDesign.

The last new addition for clipart is called MINICLIPS. These are small pieces of

clipart that you can use in newsletters, brochures, posters, banners, etc. A lot of what has previously been available was larger than you needed for some uses. This helps fill this previously empty space in your set of software tools.

For those looking for utilities that they can use in an unexpanded microdrive based QL, they now have MDV TOOLKIT. This is a collection of SuperBasic extras concerned with the reading and writing of microdrive sectors, HEX and ASCII displays like in machine code monitors, and memory and sector editors. It has a large manual (disk file) that can be read on screen at any time.

Also new to their inventory is FILEMASTER by Joe Hafke. It is a file handling utility that will give you: batch copying of files, batch deletion of files, ordered directory (printed to screen or printer), formatting, view or print files, and simple, fast disk labeling. It needs at least 256K extra memory and a RAMdisk system.

The next one I want to mention is one I found extremely useful (I have not tried all of those I am mentioning, some I only loaded up and looked at the manuals) when it came to transferring and setting up of programs on my two hard drive systems. I use both the Falkenberg and the QUBIDE disk drive interfaces. Both are on Super Gold Cards. This is an easy to use utility, pointer driven, to make QL software run from the hard disk and from subdirectories. It will also work for on disk driven systems. If you use ED disks and want several programs on a single disk, all with their own directories and subdirectories, then this will cut way down on the work needed to do this. It can even work with older software like QUILL or EXchange. I am also told that it will work with the Miracle Hard Drive System of a few years ago. It does require expanded memory, and will work with the Gold Card or Trump Card with the FLP/Level 2 RAM eprom, as well as the Super Gold Card.

An updated version of SIDEWRITER is now in their inventory. It is a spreadsheet and text file printing utility. It has simple pointer driven operation, yet it can be used on the unexpanded QL by simple keyboard operation.

THE PAINTER from PROGS of Belgium is now back in stock. It is a nifty pointer driven art program that is perhaps the best so far for the QL. If you have added a mouse over the last year or so, this is the program that really puts it to use. I just upgraded my version of this program.

One program they have new that I was unable to see how it worked was RPM, an EPROM programming utility for the QL. As I do not have an EPROM programmer, all I could do was read the manual. For those with a programmer it looks to be quite useful to design and check to see if a certain program on EPROM would work prior to burning.

Next to last of the new programs was SCREEN ECONOMISER, a screen blanking utility. It will turn off the screen display on your QL after a set number of minutes if no keyboard use is detected. Without a blanking utility like this you run the risk that when a monitor is left on for a long time with no screen movement that you will end up with burn points on your screen. This is the destruction of the phosphor pixels used to coat the screen.

The very last of the new programs I had time to check out at least some, was SCREEN DAZZLER by Bruce Nichols. This is another screen saver program, but with a few twists. It is a two disk set that will automatically save the current QL screen display if no key has been pressed within a set (configurable by you) period of time. It will then release a program that will either manipulate the screen, or produce a new graphical display so as to prevent a stationary image from burning spots on your screen.

HARDWARE FOR YOUR QL by Roy Arwood

In a recent trip to the States I found that we have much the same things in common when it comes to the types of hardware we should be keeping our eyes out for. With many of the new and exciting things coming up for the QL, we can tend to overlook those we have taken for granted.

Check your local telly and you just seldom see ads for upcoming computer shows. There are not as many of them going on for the hobby user as there was 5 to 10 years ago. Check with your chums on that and see if they don't agree. That used to be the places many of us went to find disk drives, monitors, cases, etc. Instead we have many more professional shows that expect you to spend thousands for a Pentium or a full blown Mac with thousands more for a full complement of software. I want to still use my QL, I rather am fond of it, and it does the trick for me.

Take a good look around and you will notice that RGB monitors are about as rare as hens teeth, or even composite ones. I realize that we should soon (hope!) have a Graphics card out from our friends at Miracle, but that will leave us only VGA and SVGA monitors, and they do cost more. If you are not planning to go that route, then the next time you get a chance to buy an RGB, you best do so! Should you have trouble getting it hooked up to your QL, check with QUANTA, or TF Services BBS here in the UK, or with T/SNUG or the QBOX BBS in the States. They should be of help. Perhaps even your local QL fixer, or QL club.

Another scarce item these days is ED drives. Many of us have gone the way of the Gold Card and the Super Gold Card, which lets us use the ED drives to get 3.2 meg of data on a 3.5 disk. This is great, but all of the local computer magazines that had plenty of ED drives for sale in them a year ago have dried up. The mags are still there, but no ED drives, or their disks listed. If you have thought of getting one, or a spare, you best get one the next chance you get. And if you have them, then by all means buy up a goodly supply of disks for them.

While on the subject of disk drives and hard to find items, here in the UK we never quite got into the 360K disk drives (720 sectors) that used to be so popular in the West; instead we went with a 5.25 720K disk drive (1440 sectors). For years that was the standard on the QL. No one ever gave us a bit of hardware that would let us use 5.25 1.2 meg disks on our QLs. Well take a look around. These are also more than a bit hard to find. Should you find a new one, snatch it up for a spare or to use. A good used one is also a good idea. See Dennis at Ad-man for one or information about. Get on TF Services or a similar BBS and put out the word on what you want. Get them while you can. I saw in the States during my visit that many users there also used these disks as well as 3.5 on the QL. Frank at Mechanical Affinity, told me he carried some, but that Classic Computers, a repair facility in the Midwest had a bunch of them.

The subject of disk drives leads to another quite close. To use disk drives with our QLs you need an external case with a separate power supply. They can not just lay on the table and work. These too are on the endangered species list for the Continent, UK and the West. Should you want to, you could go the route of many and put your machine in an IBM tower or desk top case. Or you might just buy up a spare external disk drive case. These will both work. Frank Davis recently showed me on my visit, his own little use, done quite well and on the cheap. He took a desk top IBM case. He put 4 disk drives inside it (using its power and drive holders) and ran the disk drive cable out from it to his Super Gold Card. He also put his monitor on top of it. The last bit of work on it was that he used its power, IDE connector and holding slot to put his IDE hard drive, and once again brought the cable out to his QL using Qubide.

I hope these observations are of help. Let me know if you want more. Bye, bye.

Machine States

One of the interesting features of the Z88 is its ability to selectively shut down parts of the internal circuitry when it is not required and thus maximise battery life. There are four operational states:

- 1) Active The Z80 clock is running and the display is on. ie. the Z80 running program instructions.
- 2) Snooze The Z80 clock stopped but the display still on. eg. the Z88 waiting for keyboard input. This state can be achieved by executing a HALT instruction. (This must only be done by the operating system, never by the user.)
- 3) Doze: The Z80 clock running and the display off. eg. programming an EPROM.
- 4) Coma: The Z80 clock stopped and the LCD display off. eg. Z88 shut down.

The maskable interrupt, INTL, is used by the BLINK chip to attract the processor's attention. The Z80 will read the interrupt register in BLINK to determine the source. There are two other cause of INTL which are to indicate battery low condition and a keyboard scan request.

The non-maskable interrupt, NMIL, this interrupt will cause the machine to enter the coma state, by saving the current state of the machine and then executing a HALT instruction. NMIL is generated by when the timeout counter in BLINK (as set by the Panel) expires, when the the flap at the front of the machine is opened, or when in response to the SNSL signal. The SNSL signal flags a power failure or the plugging in of a memory card or device on the expansion port.

The RSTL usually needs to be pulled low twice. The first action starts the processor clock if, as is the case most of the time, the machine is in the snooze (or even coma) state and the second which actually initiates the reset process. The BLINK chip is also reset by this line. The reset button on the side of the machine simply brings RSTL low, and subsequently the button generally needs to be pressed twice.

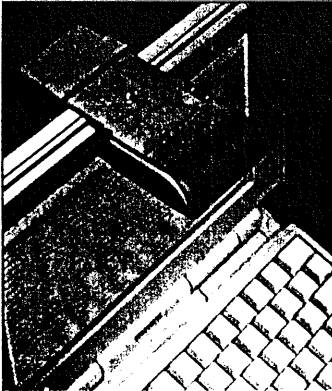

Introducing

The Best Solution for Portable Computing in Dim Light!

Notebook Computer Light® evenly illuminates your keyboard, display & work area!

NEW light lets you work anywhere, anytime!

- Allows productive use of time in dim planes, trains, hotels, meetings
- Improves lighting without disturbing others and reduces eyestrain
- Top-quality, patented design fits *any* NoteBook/Laptop
- Installs quickly—easy to use—great tool for the mobile professional
- Sleek, compact, lightweight (just 7.8 oz.)
- Comes with cost-effective, rechargeable AA NiCads & slim AC Adapter/Charger
- **FREE** — Travel Case (6" x 2-1/2" x 7/8") + 2 spare Ektron® bulbs
- **Only \$39.95 + \$3 USA shipping/handling — 30-day, money-back guarantee**

To order, call: 800-771-3600 8:30 a.m. - 4:30 p.m. EST M-F
MC/Visa/Amex

Visit us March 9 & 10
Lap & Palmtop NY 95
Booth 133

ASF Assoc. Ltd • The Personal Portable Lighting Experts
Box 625 Merrick NY 11566 • Fax: 516-868-6897

Dealer Plan Available

The Serial Interface

The Z88 has a single serial port which has to be shared by all applications, so it is important that applications use the system to access the port to avoid interfering with the correct operation of other applications running in the machine. The system runs the serial port using interrupts and buffering, so most of its operation is transparent, but there are certain operations, such as directly controlling the RTS line (required for auto-dialling by some modems), which the system calls do not support and in these cases the hardware is accessed more directly (see section 2.19) The serial port specification is reproduced here for convenience:

Baud rates:	75, 300, 600, 1200, 2400, 9600, 19200, 38400
	Send and receive rates are independent.
Parity:	None, Odd, Even, Mark, Space
	Note the Z88 generates the appropriate parity, but will ignore, but not strip, the parity of incoming data.
Flow control:	Hardware handshaking or XON/XOFF.
Timeout	This defaults to 10 minutes. (ie. the Z88 will wait for input for 10 minutes before giving up.)

Using the Serial Port

The serial port is accessed by opening the device :COM, using gn_opf, and then using the standard file i/o routines: gn_gb, gn_pb, gn_gbt, gn_pbt and os_mv. The device should be closed after the operation is complete. For most applications this level of access should be sufficient, however, it may be necessary to change the serial port parameters from within an application. This is done by writing new values to the Panel, using the os_sp call, and then issuing a 'Soft Reset' command to the serial driver. Changing the Panel setting may affect other software in the machine, so should not be undertaken lightly. It would be appropriate to reset the Panel to its original setting after serial operations are complete. This can be achieved by first reading the Panel settings with os_nq. os_sp and os_nq are covered in detail in section 2.18.

The 'Soft Reset' operation is carried out by using the os_si call. This call also provides other serial operations, which might be useful for some applications.

os_si - serial interface

RST &20
DEFB &8D

In:

L - reason code

The reason codes are as follows:

SI.HRD (&00)	Hard reset the serial port
SI.SFT (&03)	Soft reset the serial port
SI.INT (&06)	Interrupt entry point. DO NOT USE!
SI.GBT (&09)	Get byte from serial port
SI.PBT (&0C)	Put byte to serial port
SI.ENQ (&0F)	Status enquiry
SI.FTX (&12)	Flush Tx (transmit) buffer
SI.FRX (&15)	Flush Rx (receive) buffer
SI.TMO (&18)	Set timeout

SI.HRD

No parameters. This resets the UART in the gate array and performs a soft reset (see below). This call should not need to be used.

AFBCDEHL/IXIY	same
...../.....	different
afbcdehl	different

SI.SFT

No parameters. This call should be used to install new panel settings or to when starting low level (ie. using SI.GBT, SI.PBT etc.) serial operations. It carries out the following:

- 1- Empty receive and transmit buffers
- 2- Reset the XON and XOFF flags
- 3- Reset baud rates, parity and flow control settings according to the PANEL values.
- 4- Assert RTS
- 5- Resets the serial port timeout to its default of 10 minutes.

SI.INT

This should not be used.

SI.GBT - Get byte from serial port

In:
BC - timeout in centiseconds

Out if call succeeded:
Fc=0
A - byte received
BC - remaining time

Out if call failed:
Fc=1
A - RC.TIME (if no data available before timeout)

....BCDEHL/IXIY	same
AF...../.....	different
afbcdehl	different

SI.PBT - Put byte to serial port

In:
A - byte to send
BC - timeout in centiseconds. If BC=&FFFF then default timeout is used.

Out if call succeeded:
Fc=0
BC - remaining time

Out if call failed:
Fc=1
A - RC.TIME

....BCDEHL/IXIY	same
AF..... /.....	different
afbcdehl	different

This call will return immediately if there is space in the transmit buffer, otherwise it will wait until there is space for as long as the timeout. If the timeout is exceeded it will return with an error.

SI.ENQ - Status enquiry

In:

-

Out if call succeeded:

D - number of full slots in the Tx (transmit) buffer
 E - number of empty slots in the Tx (transmit) buffer
 B - number of full slots in Rx (receive) buffer
 C - number of empty slots in Rx (receive) buffer

A7 - Rx shift register full
 A6 - DCD interrupt
 A5 - CTS interrupt
 A4 - Tx register empty
 A3 - undefined
 A2 - Rx register full
 A1 - DCD level (inverse of the value on the D-connector)
 A0 - CTS level (inverse of the value on the D-connector)

.....HL/IXIY	same
AFBCDE...../.....	different
afbcdehl	different

Notes:

A slot, in this context, is the set of bits required to transmit one character. This will include 8 data bits plus start and stop bits.

SI.FTX - Flush transmit buffer

In:

-

Out:
 Fc=0

AFBCDEHL/IXIY	same
...../.....	different
afbcdehl	different

SI.FRX - Flush receive buffer

In:

-

Out:

Fc=0

AFBCDEHL/IXIY	same
...../.....	different
afbcdehl	different

SI.TMO - set default timeout

In:
BC - new value for default timeout

Out:
Fc=0

AFBCDEHL/IXIY	same
afbcdehl	different

If you set the default to &FFFF then when the default is used (by setting a timeout value of &FFFF in get and put routines) then the system will wait forever. A soft reset sets the default timeout to 10 minutes. This timeout is completely independent of the system timeout, which is set by the Panel.

Flow Control

Flow control can be controlled either by software or hardware. The hardware handshaking is always active, so if you want to use software exclusively you will need to wire a cable to set the handshaking lines high at all times. (Tie pins 5, 8 and 9 together on the Z88 D-connector.)

An external device can ask the Z88 to stop sending by either sending an XOFF character or by de-asserting (bringing low) the CTS line. With software flow control transmission can only stop when the XOFF character has been processed, so there is potentially a slight delay in response, while previously sent characters are read. With hardware control transmission stop on the next character boundary. Transmission is resumed on the receipt of an XON character, in the case of software control, or by re-asserting CTS ie. bringing it high. The output buffer is around 95 bytes long.

If software control is used the Z88 will send an XOFF to an external device once the receive buffer is more than half full. Characters will continue to be received until there are only 15 character spaces left in the buffer. At this point an XOFF will be sent for every character subsequently sent by the external device. If the receive buffer overflows then data is lost forever. The Z88 will send an XON when the receive buffer has been cleared to less than a quarter full. Under hardware control, the Z88 will de-assert (bring low) RTS when the receive buffer is less than half full and the re-assert (bring high) when it has become less than a quarter full. The input buffer is around 127 bytes long.

Serial Port Lines

1 -	unswitched +5v at 10 uA	output
2 TxD	transmit data	output
3 RxD	receive data	input
4 RTS	ready to send	output
5 CTS	clear to send	input
6 -	reserved for future use	
7 GND		
8 DCD	data carrier detect	input
9 DTR	switched +5v at 1mA	output

WHERE ELSE IN THE WORLD?

WHEN YOU WANT TO KNOW WHERE CAN YOU FIND A CERTAIN ITEM OF SOFTWARE OR HARDWARE FOR YOUR QL, WHERE DO YOU GO? WHEN YOU HAVE A BASIC QUESTION ON YOUR Z88 ON HOW TO HOOK IT UP TO ANOTHER TYPE OF COMPUTER? HOW TO MAKE A CABLE FOR IT? WHERE DO YOU GO? WHERE DO YOU FIND PUBLICATIONS THAT WILL



SUPPORT YOUR COMPUTERS? SO MANY QUESTIONS! FIND THE ANSWERS FROM UPDATE MAGAZINE, P.O. BOX 17, MEXICO, IN 46958.

QL SURVIVORS SOURCE BOOK

FOR ONLY \$8.00 POSTAGE & HANDLING INCLUDED

Z88 SOURCE BOOK AND IBM OR QL DISK OF PROGRAMS.

FOR ONLY \$7.00 POSTAGE & HANDLING INCLUDED

TIMEX PUBLICATION INDEX, part 3, by Paul Holmgren

<p>HIGHWAY ROBBERY SYN 4-1</p> <p>HI-RES Sum 3-10 2068 SWN 3-2 2068 Pix-Fix " 3-3 1500 " 3-4 1500 " 4-2 1000 TD 1-6 see Pablo Pixel-O " 3-4 1000, Blackjack pt1 " 3-5 " " pt2 " 4-1 " " pt3</p> <p>HORIZONTAL BAR CHART TD 4-5 2068</p> <p>HOT-Z SWN 1-5 1000 fix " 2-6 patch " 3-6 2068 trick " 5-4 patch 1000 & MEMOTECH CIF</p> <p>HOUSE OF HORRORS SYN 2-5 ZX80</p> <p>HOW MANY BLOCKS SYN 2-5 for kids</p> <p>HURKLE SYN 1-1 ZX80 " 2-5 8K update</p> <p>INTERP SYN 3-1 interpreter</p> <p>INTERRUPTS SWN 3-6 1000</p> <p>INVADERS SYN 2-4 ZX80-Galaxy, ZX81-Micro</p> <p>INVENTORY Sum 4-7 SYN 1-6 ZX80/ZX81 " 2-1 " " fix (2) " 2-2 fix for above " 2-4 " " " " 2-6 mod for above</p>	<p>soft game</p> <p>soft</p> <p>soft</p> <p>soft</p> <p>soft game</p> <p>soft game</p> <p>soft game</p> <p>soft</p> <p>soft</p> <p>soft game</p> <p>soft</p> <p>soft game</p> <p>soft</p>	<p>I/O (PORTS) SWN 1-4 1000 paging control " 2-2 " LEDs SYN 1-6 ZX80 " 3-2 using Byte Back BB-1 " 3-4 ports, add counter " 4-1 connect a BSR X-10 TD 1-4 article, 1000 " 4-6 4 port expansion decoder 1000 TSU 1-7 1000 control card</p> <p>JOYSTICK TMZ 366 2068</p> <p>KALEIDOSCOPE TD 3-1 1000 TSU 1-6 1000</p> <p>KEYBOARD Sum 3-7 fix 2068 " 3-9 interface & add 2068 " 4-1 mods " 4-5 mods SWN 1-1 1000 add joystick " 1-2 " bug alert " 1-4 1000 add joystick " 2-6 TI99 mods " 3-5 " " " 4-3 Kempstonize 2068 SYN 1-3 key click " 2-3 2 switch for disabled, add keyboard " 2-5 repeat key option " 3-1 strong signals " 4-1 add full size TD 2-4 joystick, adapt TI99 keyboard " 2-5 external buffer 1000 " 2-6 one-key mods " 3-2 Sinclair to 2068 mods " 3-5 for the 1500 TMZ 101 Trakball 2068 " 134 wire Trakball " 233 possible 1500 bug TSH #1 Repeat Key " #2 Reset Switch " #14 wire for 1000 " #15 mods " #18 Extra Shifted keys TSU 1-5 1000 & joystick " 1-6 " " " IF</p> <p>KEYBOARD SYN 1-4 MC scanning ZX80 " 1-5 " " " " fix " 2-6 keyboard learning game " 3-1 MC scan keyboard " 3-4 add joystick 1000 " 3-6 " " " " fix</p>	<p>hard</p> <p>soft</p> <p>soft</p> <p>hard</p> <p>soft</p> <p>soft</p>
---	---	---	---

TD 14 2068, joystick & MC
 " 1-6 BASIC stick control
 " 2-2 stick algorithm

KINGDOM soft game
 TSU 1-4 1000
 " 1-5 " fix

KNIGHTS MOVE soft game
 TSU 1-2 1000

KNIGHTS TOUR soft game
 SYN 4-2

KNITTING soft
 SWN 5-4 1000/2068

LABEL soft
 SWN 4-2 2068 label maker
 TD 2-2 make
 " 2-5 Video tape
 TMZ 133 tape labels 2060
 " 166 " " 1000/1500
 " 193 big printer
 " 278 mailing labels
 TSH #17 make
 " #18 mods for #17

LANDER soft game
 TSU 1-7 1000

LASER CANNON soft game
 TSU 1-2 1000

LEMONADE soft game
 TSU 1-1 1000

LETTER SCRAMBLE soft game
 SWN 5-5 1000, 2068

LIFE soft game
 SYN 1-2 ZX80
 " 1-4 fix for above
 " 2-1 ZX80 MC version
 " 2-2 fix for above
 " 2-3 " " "

LIGHT SHOW soft
 TD 2-6 2068

LIST LEARNING soft
 SYN 2-5 education
 " 2-6 fix for above

LIST SCANNER soft
 SWN 1-5 originally for 1000

LIST, ADDRESS/PHONE soft
 TMZ 113 2068 names & numbers
 TSH #8 1000

LLIST soft
 TMZ 267 format LLIST

LOAD/SAVE hard
 SWN 1-2 plug guard
 " 1-3 good 1000 tips
 " 1-4 aid circuits load amp
 " 2-3 Fix 2068
 " 2-5 " " load amp
 " 2-6 " " diodes
 " 3-1 " " " clearer
 " 3-5 " " , notes
 " 3-6 1500 & Z-XLR8
 SYN 1-1 LED load monitor
 " 1-6 " " " ZX80
 " 2-2 " " "
 " 3-1 program LOAD function
 TD 2-3 add amp
 TMZ 128 2020 recorder, hearing aid
 TSH #3 Load Aid

LOAD/SAVE soft
 SWN 2-2 1000 & recover bad load
 " 4-2 2068 SAVE vars trick
 SYN 1-5 ZX80 MC load/save blocks
 " 3-1 Multisave, backup MC pro
 " 3-2 fix for above
 " 3-4 " " "
 " 3-6 " " "

LOAD/SAVE/VERIFY soft
 SWN 5-3 loading test
 TD 4-5 2068 Turbo loader
 TMZ 339 1000 verify
 " 355 " " " fix
 " 455 load/save all progs

LOLLIPOPS soft game
 TD 2-3 fix for 2-2

LONDON BRIDGE soft game
 TSU 1-1 1000

LOTTO	soft		
SWN 3-3		2068 pick no.s	
TD 3-6		generate numbers	
" 4-1		" "	
TMZ 383			
LOW-RES	soft		
SWN 3-1		1000	
LSCROLL	soft		
SYN 2-2			
" 2-4		fix	
LUNAR LANDER	soft game		
SYN 2-1			
" 2-6		mods	
MACRO PHOTO	soft		
SYN 3-2			
MAGIC BIRTH DAY SQUARE	soft game		
TMZ 293		2068 lucky no.	
MANDEL PLOT	soft		
SWN 3-5		1000,1500 math art	
" 4-2		mods	
MAPS	soft		
SYN 2-5			
MASTERMIND	soft game		
SYN 1-3		ZX80	
" 3-1		8K update	
MATH	soft		
SWN 5-3		1000 geometry plotter, MULTIPLICATION TUTOR	
TD 4-4		primes	
MATH	soft		
Sum 4-2		accuracy for 1000	
" 4-5		Tutor, func Graph 1000	
SWN 1-2		Simulate linear equation 1000, using same in electronics	
" 1-3		Development prog, Algebra, convert Polar/Rectangular	
" 1-4		Integration, Polynomials Integration, RMs, Arbitrary functions	
" 1-5		differentiation	
" 2-2		Dec - Hex 2068	
" 3-3		Tri-base	
" 3-5		Mandelplot, math art	
" 4-2		Advanced calculator	
SYN 1-1		Multiplication tables	
" 1-2		fix for above BOTH ZX80	
" 1-4		bisection iteration	
" 1-5		prime numbers	
" 2-1		floating point math, linear regression	
" 2-2		floating point pt 2	
" 2-3		least squares	
" 2-4		2 to the 420th power, floating point pt 3	
" 2-5		math with a smile, Quiz, implicit functs, Degrees Grads, Radians, rounding	
" 3-2		rounding mods, math support	
" 3-4		fix for 3-2	
TD 2-2		Linear programming	
TMZ 47		precision tests	
" 188		cancellations	
" 192		Dec to Frac	
" 207		" " Bin	
" 210		Dec HEX BIN table	
TSH #1		Simulate Liner Equation 1000	
" #2		Matrix Inversion 1000	
" #3		Diff Equations 1000, Simpson's Rule 1000	
" #5		Least Squares 1000	
" #6		Linear Boundary Value	
" #19		Quadratic Equations	
TSU 1-4		Flash cards	
" 1-5		Kwikplot	
MAZE	soft game		
SYN 1-6		ZX80	
MC IN HIGH MEMORY	hard		
SWN 2-5		MemoTech 64K mods, Byte-Back 64K mods	
" 3-5		fix for above	
MC TUTOR	soft		
SWN 2-1		1000 pt 1 (progtop)	
" 2-2		" " 2 (renum), good writing practices	
" 2-3		1000 pt 3 (fun)	
" 2-4		" " 4 (block delete)	
" 2-5		" " 5 (find line), LDIR routines (move it)	
" 2-6		1000 pt 6 (renum aid?)	
" 3-3		" " 7, list & guides	
" 3-5		" " 4 revised	
" 3-6		" " 8 (MEGA-REM)	
" 4-1		" " 9 (math)	
" 4-2		" " 10 (when, why)	
" 4-3		GO TO/GO SUB	
" 4-4		decisions	
" 4-6		FOR..NEXT	
" 5-1		PEEK/POKE	
" 5-4		1000/2068	
SYN 1-6		intro to MC	
" 2-2		Safe MC routines ZX80	
" 2-3		ROM calls (Parser) pt 1	
" 2-4		ROM calls (Parser) pt 2	
" 2-5		ROM calls (Parser) pt 3, Block transfers pt 1,	

side scrolling
 " 2-6 fix for above, block transfers pt 2, move variables
 " 3-1 easy as 2+2
 " 3-2 fix for move variables, looping
 " 3-4 MC & screen
 " 3-6 " " fix
 " 4-1 bit testing
 TD 2-3 Beginning Z80 MC pt1
 " 2-4 pt 2
 " 2-5 " 3
 " 2-6 " 4
 " 3-1 " 5
 " 3-2 " 6
 " 3-3 " 7
 " 3-4 " 8
 " 3-5 " 9
 " 3-6 " 10
 " 4-1 " 11
 " 4-3 " 12 (end), & part of 9?
 TMZ 4-2 undoc instructions
 " 2-62 totally safe storage
 TSH 2-1 totally safe storage
 TSU 1-6 & 7, see Programming game

MEDCARE soft
 Sum 4-6 2068 medical records

MEMORY soft
 SWN 1-2 savings
 SYN 1-2 Memory display ZX80
 " 1-3 " " fix
 " 3-4 adjust RAMTOP
 " 3-5 save program memory
 " 4-2 way BASIC is stored, using extra memory, ROM & RAM addressing
 TD 2-4 savings
 TMZ 1-7 RAM test
 " 2-22 memory map

MEMORY ADDS hard
 SWN 2-3 Oliger 64K to 2068
 " 2-6 Gladstone 64K mods
 " 3-3 mod 16K to 8-16 range
 " 3-5 fix for above
 " 4-1 add NVM to 1000
 SYN 1-6 ZX80
 " 2-4 ZX81
 " 3-1 ZX80
 " 3-4 2K to 4K
 " 4-2 rescue RAM
 " 4-3 MemoTech 64K to 2068
 TD 2-6 convert 16K to 64K 1
 " 3-1 " " " 2
 " 3-4 internal 64K for 1000
 " 3-6 add 64K inside 1000
 TMZ 7-6 Cheetah 64K mods
 " 1-14 AERCO & Spectrum ROM, convert 1016 to 64K
 TSH #14 16K to 2068

" #19 Hunter board mods, DIY Spectrum ROM add
 TSU 1-7 build 64K for 1000

MEMORY MAP soft
 TD 3-5 for 1500
 " 4-1 " "

MEMORY TRACE soft
 TD 3-6 2068 using Z80 IM2

MEMOTECH 1000 hard
 SWN 1-1 CPI bug?
 " 1-2 " " & 64K
 " 1-4 " LPRINT, examine memotext, other 64Ks,
 " 1-5 1-1 & 1-2 add report
 " 2-2 convert M-text to tape
 " 2-6 make 2040 & 16K work
 SYN 3-4 HRG & demo program

MENU soft
 TD 2-5 Mac type menu
 " 4-3 2068 drop down menus
 TMZ 1-16 for 1000

MERGE 1000 soft
 TSU 1-5

METEORS soft game
 SYN 4-2

MICROACE hard
 SYN 1-1 build, LED load monitor
 " 1-2 fix for above, add 8K ROM
 " 2-3 fix " "
 " 2-5 hardware tips

MINI-BILLBOARD soft
 SYN 1-4 ZX80
 " 1-5 " with 8K ROM, fix for above
 " 2-1 fix for above

MINI-BREAKOUT soft game
 TSU 1-7 1000

MINOTAUR soft game
 SYN 3-2
 " 3-3 fix for above
 " 3-4 tips
 TSU 1-4 1000

MONEY soft
 SYN 1-1 ZX80 Dollars & cents, Basic accounting
 " 1-3 fix for above
 " 3-1 Personal management sys, checkbook
 magement sys, loan amortization,
 " 3-4 " " mods
 " 3-6 figure loans
 " 4-1 Tax shelter time bomb, hatch your nest egg
 " 4-2 fix for tax shelter
 TD 1-3 total cost of loans
 " 2-1 Interest
 " 3-2 see Tax calculator
 " 3-4 car cost analyzer
 " 4-2 Loan Analyzer
 TMZ 79 2068 loan amortization
 " 192 make coin rollers
 TSH #2 Rule of 78
 " #16 Quick - Balance 1000

MONITOR CIRCUIT hard
 Sum 3-5 convert tv
 " 3-7 convert 1000
 SWN 1-5 convert 1000 & tv
 " 2-1 total video upgrade 1
 " 2-2 " " " 2
 " 3-5 reverse video & 1500
 " 3-6 poss fix for 2068, 1000 video upgrade update
 " 5-6 TS1500 to TTL
 SYN 1-2 reverse/direct vid ZX80
 " 1-5 " " fix "
 " 1-6 fix for above
 " 2-1 inverse video
 " 3-1 add UHF
 " 3-4 mod for 1000
 " 3-5 " " " fix
 TD 1-6 convert for 1500
 " 4-4 1000

MORSE CODE soft
 SWN 4-3 using sound

MOTORCYCLE RACE soft game
 SYN 1-5 ZX80, & fix

MOUSE hard
 TD 2-2 use mouse with Tech Draw

MULTIPLICATION BINGO soft game
 SYN 14 ZX80

MULTI-TASKING soft
 TMZ 268 2068 using mode 2
 " 277 " correction tips

MULT STEPS soft game
 SWN 4-6 math game

MUSIC soft
 Sum 3-11 Santa 2068
 SWN 3-6 2068 Music Maker
 " 4-4 2068 piano
 SYN 1-2 with ZX80
 " 1-3 mods
 " 1-5 with ZX80
 " 3-6 see Audisyn Defmag, Staff
 TD 3-1 Simply Music
 " 3-2 2068
 " 3-6 MoTSart for 1000/1500
 TMZ 148 synchronize
 " 178 2068 Xmas
 " 307 Star Spangled Banner
 " 343 Christmas
 TSH #10 Xmas Music
 TSU 1-1 1000
 " 1-3 Note tester 1000
 " 1-7 Maker 1000

MYSTERY PROGRAM soft
 SWN 4-5 ??, for 1000, no1
 " 5-1 ??, for 1000, no2

M * 5 soft game
 SWN 4-6 astronomy tutor

NATIONAL LANDMARK soft game
 SWN 5-6 2068

NEW CAR SHOPPER soft
 TD 3-4 2068

NICOMACUS soft game
 SYN 1-1 ZX80
 " 1-2 fix
 " 2-5 8K update

NIM soft game
 SWN 1-1 1000

NOTE PAD soft
 TMZ 409 2068

NUMBER BASE CONVERTER soft
 TD 3-4

NUMBER MADNESS

TD 3-3 1000

soft game

OBJ

SYN 1-3 ZX80 disassemble ROM?

" 1-6 " fix for above

soft

OBSTACLE RUN

TD 2-1 2068

soft game

OHMS LAW

SYN 2-5

soft

OP-AMP

TD 4-3 1000, design circs

soft

PABLO PIXELO

TD 1-6 hi-res to printer, 1000 & 2068

soft

PARADOX OF THE TWINS

TSU 1-7 1000

soft game

PAYROLL

SYN 3-2

" 3-4 fix for above

" 3-5 changes

" 3-6 fix for above

soft

PHASOR

TSU 1-1 1000

soft game

PHONE HOME

TD 4-5 1000, words from phone no.

soft

PIGSKIN PICKS

TD 3-1 try predict game winners

soft

PLOTTER

Sum 4-3

hard soft

PLOT 1000

SWN 1-1 Greyplot, dual display, TriPlot

" 1-2 Greyplot improvements

soft

POKER

TD 4-5 2068

soft game

POWER SUPPLY

hard

Sum 4-1 2068 changes

" 4-4 2068

SWN 1-2 1000 U.P.S. & heat

" 1-3 " " adds

" 3-4 affecting screen

SYN 1-2 Micro juice

" 2-4 mod to clean video

" 3-2 regulated voltage adapt.

TSH #1 1000 U.P.S.

" #7 " protection

PRINTER INTERFACE

hard soft

Sum 3-1 build a CPI 2068 pt 1

" 3-2 build a CPI 2068 pt 2

" 3-3 build a CPI 2068 pt 3

SWN 5-1 JLO CPI & MSCRIPT

SYN 1-4 CPI for ZX80

TD 2-3 CPI & Tasprint, 2050 to RS232

" 2-4 AERCO & TXP-1000

TMZ 266 CPI interface tips

" 286 convert 2050 to RS232

PRINT DRIVER

soft

SWN 1-3 1000 pt1

" 2-6 " UPD, customize graphics, EPROM notes,
relocate

" 3-1 UPD extra patch

" 4-2 word wrap utility

" 4-5 inkjet plotting

" 5-2 Spectrumized 2068

SYN 2-6 word wrap in BASIC for text

TD 4-2 serial port driver

TMZ 276 print sideways

PROBABILITY

soft game

TSU 1-1 1000

PROGRAMMING CONCEPTS

soft

TD 3-2 1000, better basic

" 3-3 " " "

" 3-4 " " "

" 3-5 examine why a prog works

PROGRAMMING GAMES

soft

TSU 1-5 1000 pt 1

" 1-6 " " 2

" 1-7 " " 3, fix for pt 1

PROGRAM CRASHING

soft

SWN 4-1 screen crash effect 1000

PRO/FILE TIPS

soft

SWN 2-1 convert Memotext file to PRO (1000)

* TS2068 UPDATE ISSUE DISKS *

These disks contain a program, suite of programs, or a set of utilities that have either been presented in UPDATE, or sponsored by. This is done in the hopes of encouraging and sponsoring the authoring of TS2068 or Spectrum software by North and South American programmers. They are guaranteed to be worth the money. At times vacant space left on these disks is also filled with particularly appealing Public Domain or Shareware programs for the TS2068 or Spectrum. We also welcome programs from our other readers anywhere in the world. We support at this time Larken and Oliger disk formats for the TS2068. Contact us for other formats. Please let us know what size, interface format and density of disk you wish the program in. Half of the funds received go to the author of the program. Please feel free to offer a program for inclusion in our Issue Disk Series.

- 1) THE JOHN McMICHAEL GRAPHICS COLLECTION- This is a six disk set of IBM clip art graphics converted for use with Print Factory, the desk top publishing program for the TS2068. Can also be used with Pixel Print, by Lemke. They are offered in Larken and in Oliger disk format. Each disk is \$7, or \$40 for the entire collection. The best ever for the TS2068.

- 2) LOGICALL PROFESSIONAL V5.2- This is the Auxiliary Operating System and Integrated Software Package that completes your Larken multi-drive system. It allows you to move in and out, and around your system and programs with usually two keystrokes or less. No need to turn off your machine. The best Larken improvement yet. Soon to be available for the Oliger sytem. Authored by Bob Swoger. \$15 for the program.

- 3) THE WIDJUP COLLECTION- This contains some of the most popular programs formerly offered by WIDJUP. They are not Public Domain, all were commercial and given to UPDATE for distribution by Bill Pedersen with his passing. This is a two disk set, and does not contain his CAD program. It has editors, printer drivers, games, TS2068 tutorials, etc. In Oliger or Larken format. Priced at \$20.

- 4) WIDJUP'S CAD PROGRAM- This is a long time favorite for Larken and Oliger users. It will give you professional results from your TS2068 in the area of computer aided design and the development of printed circuit boards. Bill used to even use it to make disk labels and DTP. Let us know which format and whether it is for either an IBM compatible printer or an Olivetti Inkjet printer. The price is \$20.

- 5) OLIGER DISK DRIVE BBS PROGRAM- This will create a single user BBS program, with several message bases, E-mail, and SYSOP chat area. The rest of this disk is chocked full of other programs either by, or enhanced by, Paul Holmgren (program author). In Oliger format only. The price is \$20.

- 6) 24-PIN BIT IMAGE GRAPHICS FOR 24 PIN OR BUBBLE JET PRINTERS- This program, by Larry Crawford, is for Epson emulation modes on your printer. It takes the mystery out of graphics when used with some of the newer printers out there on the market. We have also included some extra software with this one, and all of this for \$15. It is available in either Larken or Oliger format disks.

Needless to say we are always interested in a new issue disk we can present here for our readers. If you are out there writing programs, or know someone who is, give us a chance to present your software to the users, and perhaps make a bit of change in the bargain. This way we all win. We make royalty payments twice a year based upon the sales. Sales are not guaranteed, but we do our best!

* QL UPDATE ISSUE DISKS *

These disks contain a program, suite of programs, or a set of utilities that have either been presented in UPDATE, or sponsored by. This is done in the hopes of encouraging and sponsoring the authoring of QL programming by North and South American programmers. They are guaranteed to be worth the money. At times vacant space on these disks is also filled with particularly appealing Public Domain or Shareware programs for the QL. We support all know disk formats for the QL. Please let us know what format you wish yours in when you order. The prices are as listed and do already include postage and handling. Half of the funds received go to the author. Please feel free to offer a program for inclusion in our Issue Disk Series.

1) HARTUNG UTILITY ISSUE DISK- Here we have some excellent programs for the QL, such as a stand alone database, an Address and QSO file program, etc. It also gives lots of programming hints and tips for QL programmers. All are in SuperBasic. The Address file can also be used as an inventory program, or use it to print out labels. Both screen and printer output can be alpha-sorted, or done by last name. The price is \$15.

2) CABLE ARCHIVE ISSUE DISK- Written by Bill Cable, perhaps Americas best known programmer for Archive. Contains many useful ARCHIVE programs that work on any Archive database. Titles include: DIR (directory within Archive), SCAN (quick database display and print), FREQ (frequency distribution of a field), SPLIT (split 1 database display and print), JOIN (join 2 databases into 1), REFIELD (redefine field names), REPLACE (replace text within a database), MATCHER (find dupes within a database), WINDEX (word index any text file), GROUP 1 to 3 (useful procedures from UPDATE articles), QUERY (interrogate any database). Also includes extensive DOC files about the programs and ARCHIVE in general. Commercial Quality! The price is \$20.

3) QLUSTER 5s109 ISSUE DISK- A great program from AI Feng to provide you with many utilities to handle and unclutter your disks and MDVs (and it now supports sub-directories such as in Level 2 devices such as FLP LEVEL 2 ROM for Trump Cards and Gold Cards). Some of the features concern COPY, DELETE, FORMAT, VIEW, as well as extended use of some of the TK2 commands (TK2 needed for this program). The program is TURBO compiled for a speedy program. It is MINERVA compatible, multi-tasks, and allows you to use minimal keypresses to do the job. The price is \$15.

4) QLUMSI DOS 4.30 ISSUE DISK- The latest version of AI Fengs extensively updated MSDOS simulator (not emulator) and front end program for the QL. Other programs on the disk enhance file management and cloning of other programs. Educational and useful. The price is \$20.

5) QLAMBer ISSUE DISK- AI Fengs latest issue disk and it is even compatible with the QXL now! He calls it A_Moving_Box/enhancedrelease! This greatly extends the selective file management capabilities of the QLUTfer program by additionally accessing six TK2 keywords, while reducing CODE size, easily supports sub-directory access, and easily multi-tasks within QRAM or Taskmaster. TK2 must be on ROM or loaded prior to start up of program. The price is now \$20.

6) COMMS & COMPRESSION COLLECTION- Eliad Wannums collection of the best P.D. and shareware fax, telecommunications, and file compression and decompression programs available for the QL. This is a four disk set that is extremely useful, and all the disks are fairly loaded. The price is \$20.