

UPDATE!

\$4.95

April 1989

Annual Subscription: \$18.00



Computer Systems



CATS FEST EDITION

SUPPORTING

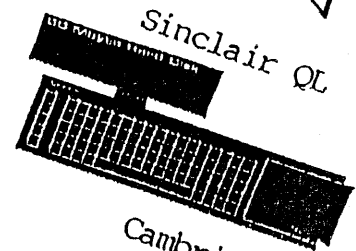
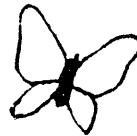

Cambridge Z88

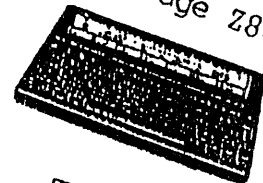

Timex TS-2068

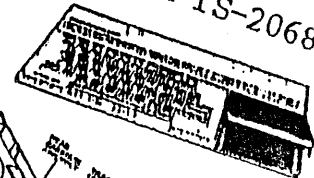

SEE INSIDE COVER FOR INFORMATION

UPDATE SUPPORTS

Sinclair QL---Cambridge Z88---TS-2068
and DISK DRIVE SYSTEMS

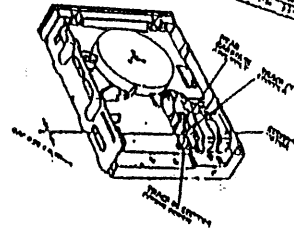

UPDATE Magazine
1317 Stratford Ave.
Panama City, FL 32404

Tel 904 871 3556

NEWS AND NEW PRODUCTS

CAPITAL AREA
USERS GROUP

MAY 5 6 7

1989

Capital Fest

Timex Sinclair

The Biggest T/S Party of the Decade

THIS IS A SHOW FOR THE:

ZX 80 ZX81 T/S 1000
TS 1500 TS 2068 Z 88
Z 89? Sinclair PC

Psion Organizer & Amstrad
Projected Program.

Friday:

Program Registration
Hotel Registration
Limited-seating Banquet

Saturday:

8 AM - Set Up Tables
9 AM - Swap Shop Intake
9 AM to 5 PM - Open Floor
10 AM to 5 PM - Speakers
10 AM to 8 PM - Videos
7 PM to 10 PM - Hospitality Suite

Sunday:

9 AM to 3 PM - Open Floor
10 AM to Noon - Speakers
10 AM to Noon - Videos of Saturday's Presentations
3 PM to 5 PM - Wrap-up/Clean-up

FEST IS TO BE HELD AT HOWARD JOHNSON'S
ROUTE 450 & 95, EXIT 20B, NEW CARROLLTON,
MD.

TICKETS ARE \$7.00 FOR 2 DAYS IN ADVANCE
\$10.00 AT THE DOOR

HOTEL IS \$62.00 PLUS 10% HOTEL TAX. (SPECIAL)

FRIDAY NIGHT INFORMAL BANQUET WILL ^{RUN} AROUND
\$17.00. EVERYONE IS INVITED. LIMITED SEATING

VENDOR TABLES ARE \$25.00 EACH.

USERS GROUP TABLES ARE \$10.00 EACH.

ONE FREE ADMISSION TO SHOW WITH HOTEL
RESERVATION FOR FIRST 50 ROOMS RENTED.

ADVANCE TICKETS AND HOTEL RESERVATIONS
SHOULD BE MADE BEFORE 4/1/89.

CHECKS SHOULD BE MADE OUT TO:
CATS CAPITAL FEST
BOX 24
GARRETT PARK, MARYLAND 20896
Audrey Curnutt
301-439-8756

It CAN Work!!

It CAN Work!!

We have a central location on the East coast.

We are accessible, with a 24 hour
bulletin board for fest

information; (301)588-0579.

We are going after the biggest names for our seminars.

We can offer non-computerist spouses and children a variety of
alternate diversions.

We are doing our homework - Two preliminary mailings to 5000
known QL owners and over 5000, 2068 and 1000 owners.

AND YOU CAN BE HERE TOO!!

Indianapolis worked!

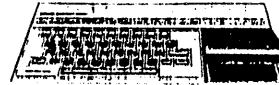
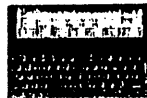

I N D E X

GENERAL INFORMATION

Advertising	49
BOSlug	4
Publishing Data	3
QZX	4
S.N.U.G.	4
Sinc Link	4
Update Library	5,52
ZX Appeal	4

SINCLAIR QL

CAPS Multitask	36-39
CAT Print	40
Cable Column	29-31
Issue Software	53
LINK the Z88	41
LLIST Utility	43
Loop Printer	20
Mallfile Hints	42
Quirks	9-11
Repairs	4,11
Software Review	25
Styles, Macros	24

CAMBRIDGE Z88

Link with QL	41
New Items	3,41,51
Review	6-8

TS-2068 ARTICLES

Bob's Notebook	44-46
CATS Library	4
FD-68 Update	21-23
INPUT Utility	12-17
Issue Disks	52
LKDOS Catalog	32
LKDOS Track 0	34-35
Profile Names	40
ReNum to 10 Grand	44
Sincus Library	4
T.O.S. Serial Print	18-19
TASORT	45-46
TOS Vars Save/Load	41
Voice Recognition	26-28

ADVERTISEMENTS

CATS FEST	1
Club Z88	51
Domino Cubes	51
EMSOFT	48
Grey Enterprizes	Back Cover
Larken Electronics	47,50
Personal Ads	35,40,46,53
RMG Enterprizes	50,54
Update Library	52,53
Wood and Wind	48

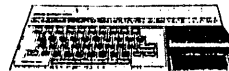
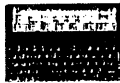

*** UPDATES ***

THIS ISSUE and NEXT: Guess you've noticed the 17 point print size of this issue. This resulted in 35% more (BEEF) content, but this print is about as small as we dare go. A very painful task was to keep the page count down to 50. Some 65 pages of good articles had to be held for coming issues. LOOKING AHEAD- The next (JULY) issue will be the last of this issue year and all subscriptions will end with the July issue. So, PLEASE start thinking "RENEWAL", and dont be a straggler! Prompt renewal will assure Magazine Size, Quality, and Timeliness.

TRUTH IN CIRCULATION can hurt advertising potential, but build reputation. Update circulation level is at around 500 and building. All 50 U.S. States and all Canadian Provinces, plus three foreign Countries are represented. The breakdown of population is; 50% TS-2068, 50% Sinclair QL, 12% Cambridge Z88. About 70% use two or three of these Computers, and express their intent to continue to do so. Sinclair QL users are evenly divided between having Disk Drive or just MDV, and having extra memory or not. 95% of TS-2068 users have Disk drive and are divided; 47% Oliger Disk, 47% LKDOS, 19% FD-68, 8% TOS Zebra, 4% Ramex, with 30% having Dual DOS capability. This is a very good mix of Sinclair Users, but we need MORE. Update will hit Computer Shopper with a promo ad soon. You can help by "arm twisting" other Sinclair Users to subscribe. Shame them to subscribe if they are reading your copy. (or a club copy)

The quality of the next issue is assured by a full issue of articles on hand. Due to space limits this issue wont have much hype about the ISSUE DISKS. If you want some EXCELLENT ensembles of Disk and MDV software and utilities, refer to the January 89 issue of UPDATE to see what is available in the ISSUE DISK Library. These disk and mdv ensembles are excellent values for \$20 and cannot be found elsewhere for near the price. We are working on broadening the TS-2068 disk series to include TOS Zebra systems. Next issue will add at least one more Issue Disk/MDV for both the TS-2068 and the QL. This issue concentrates upon Key-In projects. You can be assured that these key-in projects DO WORK, and each will add something useful and NEW to your computing capability.

----BJ

Cambridge Z88 New Stuff

Z88 to Sinclair QL Link: to transfer files back and forth and use QL Disk/MDV.

Z88 Cassette Recorder intfc. Load/Save data & prog to cass.

Z88 Disk Intfc and 3 1/2" DD. Runs on batteries.

Z88 Tech Reference Guide.

Check price with your Dealer.

Publishing Data

UPDATE MAGAZINE is a publication that is devoted to the support of the users of Sinclair Computers which includes the Sinclair QL, the Cambridge Z88, and the Timex TS-2068. Update is published quarterly on the first day of January, April, July, and October. The emphasis is upon PERMANENT INFORMATION content to build a User Library of Programming and Operational references. The standard issue is 50 pages.

The subscription year is October through July. Subscription is \$18.00 per issue year. Back issues are available in year packs of four issues for \$16.00 (1987 and 1989).

Advertising rate schedules are published in the back page of each issue. Subscribers may insert free line ads for the sale of their own surplus computer products. Article participation is encouraged.

UPDATE Magazine Tel: 904 871 3556
1317 Stratford Ave. 904 871 4513

Panama City, FL 32404

*** Renew your subscription before July and the rate increase **
\$16.00 now -- \$18.00 after July 1.

*** SINCLAIR COMPUTING ***

S.N.U.G. (Sinclair North American User Group)

Update Magazine has withdrawn its offer to allow SNUG to take over publishing the magazine. This was because of two reasons: 1. It did not appear that SNUG was yet sufficiently organized to take on the responsibilities. 2. Strong opposition to SNUG publishing a magazine developed from other sources.

Other Developments: SNUG membership is at approximately 60 members. An election of SNUG officers has been conducted via letters. The results of this election are not available as this issue goes to press.

Update subscribers are advised to watch for news about SNUG, its plans, activities, and membership benefits offered, in future issues and in other publications. The growth and success of SNUG seems to hinge upon their development of an attractive membership benefits package. We wish them success and will report their progress.

**** The Event of the Year ****

The CATS FEST! Just in case you glossed over the announcement on the inside cover page- This will be the biggest and the bestest Sinclair Timex convention of this year. See you there--

THE SINCUS TS-2068 LIBRARY of DISK PUBLIC DOMAIN

SINCUS has devoted a lot of work into purifying public domain programs and re-working the programs to operate in two disk formats, Oliger SAFE, and Larken LKDOS. Update bought the Four Disk Oliger Library a few months past and rates the disks as an OUTSTANDING library (More than 120 programs!). Now it is available in LKDOS format. Send \$2.00 to cover costs of receiving an index of Disk programs to: John Colona (SINCUS), 28 Guilfoyle Ave., Binghamton, NY 13903. SINCUS also publishes a good newsletter that is worthy of subscribing to.

SINCLAIR QL FIX- A source for Repairs and Up-grades

Dan Elliott, RR-1 Box 117, Cabool, MO 65689, says that he is now ready to receive QL Computers to install his "Outside Power Supply and Regulator". He says that this up-grade completely eliminates the LOCK UP

caused by un-stable QL power. This fix costs around \$50 (+ or - a few). A "Coleco Power Supply and dual regulator" with ON OFF switch is supplied. Keep your QL power module to run your electric train or mustatche trimmer, as you wont need it for the QL anymore. Update's spare QL is receiving this power mod. It had the "S.L.S." (Sudden Lock Up Syndrome).

GOOD QL SOFTWARE-- WOOD AND WIND COMPUTING, RR-2 Box 92, Cornish, NH 03743, is Bill Cable's Software Development House. Bill has at least six more excellent softwares for the QL, all for either Expanded QL's or Standard QL's. Dont wait for his programs in Update. Send SASE for a program list and pricing. We need to keep this outstanding programmer working for us.

TS-2068 Cassette Public Domain Library: CATS, PO Box 467, Fairfax Station, VA 22039, has one of the largest cassette libraries for the TS-2068. CATS also is one of the largest TSUGS and produces an excellent newsletter. A \$2 check for information is well spent.

ONTARIO CANADA has one of the largest and most active TSUGS. Last issue Update mentioned that SINC LINK, the newsletter of this group, is one of the best sources for Larken Disk LKDOS information. That slighted some of the Ontario group's members. SINC LINK and the Ontario Club has a well rounded membership consisting of users of all Sinclair computers. The Sinc Link newsletter covers all systems. Two of their members, Bob Mitchell and George Chambers, are foremost LKDOS programmers and have built up one of the most complete libraries of LKDOS Disk Software and utilities. This library also contains programs on cassette and is available at nominal cost to members and subscribers to SINC LINK. SINC LINK, 14 Richome Court, Scarborough, Ontario, Canada, M1K 1Y1.

ZX-APPEAL is the newsletter of the Vancouver, Canada TSUG. This newsletter has good coverage of both the QL and the TS-2068. Membership is \$15 and includes a subscription to ZX-APPEAL. ZX-Appeal, 2006 Highview Place, Port Moody, BC, Canada, V3H 1N5.

Pony Express galloped through the Indian Territories and opened up the West for communications. Western Sinclair Communications is via "THE PLOTTER", a

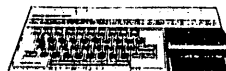

newsletter published by CCATS, in OREGON. PLOTTER always has good article support for the QL and TS-2068. Pony express operates a bit faster now a days, making it both practical and beneficial to make them bring you an issue of PLOTTER each month. SASE to THE PLOTTER, 655 N.W. Territorial Road, Carby, OR 97013.

ELECTRONIC MEDIA and Newsletter: This quib may contain some errors. There are several TSUGS in the San Francisco area that cooperate to publish Sinclair programs and utilities. There is a written newsletter TIMELINEZ, PO Box 1312 Pacifica, CA 94044, and another thrust at information propagation via BBS for modem download. Update receives the Timelinez newsletter. Timelinez is invited to send in a re-write of this epistle, explaining WHAT and HOW they do it. Other TSUGS are also invited to send in brief announcements of their repertriore.

BOSTUG Sinclair/TimeX Newsletter is a very informative newsletter published by BOSTUG, which is one of the largest and most active TSUGS. The newsletter is always well done and has a wealth of programming information for the Sinclair QL and TS-2068. BOSTUG, PO Box 8763, Boston, MA 02114-8763. Peter Hale is the Editor.

Q.Z.X. is a newsletter that covers Amateur Radio and Sinclair Computers. QZX has international readership and is likely the best source for PACKET information. QZX, 2055 O'Donnell Drive, Las Cruces, NM 88001.

TS-2068 and Sinclair QL Support

The UPDATE PROGRAM LIBRARY. Current support includes Sinclair QL Micro Drive and 80 track Disk. TS-2068 Larken Disk, Oliger Disk, and Aerco FD-68 Disk Formats are supported. We are working on establishing FDD (Zebra-TOS) support. Called "Issue Disks", this is an ensemble of programs and utilities, listed or documented in Update Magazine.

The purpose of the Issue Disk program is to provide the users with useful and inexpensive programs and utilities, and to provide incentive for programmers to support us. The Issue Disks are bargain priced at \$20 each, and the modest profits go to the programmers.

Each magazine issue will have a listing and discription of the Issue Disks offered. Each disk or MDV is stuffed to capacity with

useful programs. Update urges subscribers to participate in the Issue Disk/MDV program to improve their program library and to help build North American Programming Support. An added incentive to participate is the disks and mdvs are Guaranteed to Please, or full refund.

TS-2068: Larry Kenny, Larken Electronics, still BUSY!

Larry's RAM DISK hardware board was selling like hot cakes to lumberjacks until the price of 43256 chips shot up. This is one of the best additions to the TS-2068 that has come down the pike. R.M.G. Enterprises, (Tel: 503 655 7484) still has some. R.M.G. also carries a full line of QL and TS-2068 support items.

Now Larry has just released "MAXCOM", a most impressive Communications software package for Modem Com. See his ad in this issue for this and still more new software. Ed Grey Enterprises (213 759 7406) handles LKDOS, Oliger DOS, Modem Communications software and equipment, plus a good catalog of other TS-2068 and Disk Drive Support.

SINCLAIR PUBLICATIONS NEWS

By now SyncWare News subscribers should have received the ending issue of SYN. We wont have an obituary or even a funeral, as SyncWare News will be absorbed into the Quantum Levels magazine pages. Subscribers to SYN will receive the magazine under the QL's name. Jeff Moore continues to be the Publisher. (This, according to the information published in the final edition of Syncware News.)

TIME DESIGNS MAGAZINE

Update received a lengthy news release from Tim Woods, publisher of TDM. For the sake of brevity it will be put into a nut shell. Tim promises to get back on schedule with Time Designs after a problem period that included the joyful addition of one "David Anthony Woods" to the family. Tim invites postcards if issues have been missed or make your problem calls to 503 824 2658.

NEW CAMBRIDGE Z88 PUBLICATION

PIPE LINE is the name, and is being published jointly by Time Designs and Paul Bingham. Subscribe through Time Designs Magazine.

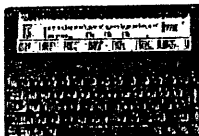

The Cambridge Z88 Computer

A Sinclair Portable from England
A first impression Mini Review

By: Bill Jones

Upon returning from a vacation in Tuscon a UPS carton was waiting with a new "Cambridge Z88 Computer" inside. Un-packing a new computer brings a mixture of trepedation, eagerness, and anxiety. As the Z88 was lifted from the box my first impression was that it is not a "tiny" computer as the ads would lead one to believe. Later measurement revealed that its desk space occupied is only slightly less than the keyboard of the IBM AT, the Sinclair QL, or the TS-2068. It is about seven inches less in width than the IBM and the QL, but about 3 inches deeper, and only an inch in thickness. Strange, that a different shape makes so much difference in portability! The Z88 will fit into the smallest of briefcases and leave room for sox, underwear, a spare shirt, and still more necessities.

The keyboard of the Z88 is full size and has seven extra function keys. The keys are very sensitive and has an adjustable repeat rate, which also seems to adjust for touch sensitivity. It also has "chirp on or off", allowing silent operation.

The first operation after un-packing is to install the four AA cell batteries, which bring the computer on line, via a touch of both SHIFT keys. This turns on the computer and presents a SOFTWARE MENU. Since this data base that you are reading was begun about 20 minutes after un-packing the Z88, by a new user, I will shift into REAL TIME, and give you my impressions as this evening's operation continues.

First, fingers must rest very lightly upon the keys. They are sensitive to the touch. I am amazed that the "Pipe Dream" software menu just popped on screen and let me "begin typing imediately". I haven't even read the user manual!

By the way, I am doing this at the dining room table, and absolutely nothing is attached to the computer- no power supply- no monitor- nothing.

Just as I typed the last sentence a report came on bottom screen, "End of Text". I assumed that this meant that FREE MEMORY had been used up, which was not the case at all. But believing that it was, I consulted the

index of the manual to find out how to install the "128K Ram Cartridge" that I bought with the computer. With that done I had to read a bit more to find out how to "transfer the data already typed" into the Ram Cartridge. This proved to be very easy and I will discuss that a bit.

The Z88 manages its 64K "home ram memory", plus three cartridge memory slots. Each of the cartridge slots can have up to 1 mega byte of RAM. The third slot can have up to 512K of EPROM memory. Keyboard control allows the computer to control one of the Mega Byte cartridge banks at a time. Or, programming control within an operating program can, in effect, control up to 3 Mgbts of RAM Memory! Since I am a cheap skate, I bought only a 128K RAM Cartridge and a 32K EPROM Cartridge. When Ed McMann pays me the promised million bucks, then I'll buy some more cartridges. Anyway, the data file that I started in "home ram" transferred easily into Cartridge slot #1, and I'm continuing to build the file. If I can do it with only a cursory glance at the manual, then I feel that Cambridge must have this Bank Switching scheme perfected for idiot operation. My son's IBM AT will only address 1 Mgbts, so this 3 mgbts capability of the Z88 is impressive, even if I cannot afford the cartridges right now.

The Next Day

After some zzzzz's the Jet Lag has disappeared. Last evening I turned the Z88 OFF by simply touching both SHIFT keys at the same time. This morning I scanned through the manual and found out that I didn't need to turn it off, because after a few minutes of NO KEYS touched, the Z88 shuts itself off. The Z88 User Guide is 137 pages and 2/3 of it is devoted to the "Built in Software". There are two Software Ensembles, PIPE DREAM, and DIARY. We will discuss this software separately. I was more interested in the Programming Aspect. The 66 pages devoted to programming is enough for beginners but is not adequate for the serious programmer. So, I put in a call to Sharps' INC (804 746 1664), a Z88 Dealer. Before the call was over there were two advanced Z88 books on the way. We will review these books in a later article.

THE Z88 BUILT IN SOFTWARE

PIPEDREAM is a Data Base Software, a Word Processor, and a Calculator. Calculations

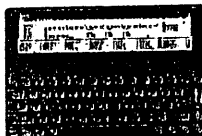

can be integrated within the data base as it is being generated. This is a very complete software ensemble, and one that must be learned in stages. I cannot begin to review the software at this early stage of proficiency, but I have already found that it is very friendly, has many pop down menus, and has an extensive HELP file. It also has a very comprehensive "Printer Set Up" section, which allows the user to change set-ups to use any and all printers. After scanning the manual and beginning to use the data base, I would say that PIPE DREAM is about the equivalent of WORD PERFECT for the IBM, or the two QL programs "Quill" plus "Archive". Word Perfect retails locally for around \$800, which could be the comparison to establish the value of PIPE DREAM.

DIARY is another Built-In software ensemble. To get the best mental picture of this software, we must remember that the Z88 "holds its data in RAM even when turned off". DIARY is a Filing System, a Calendar Appointment schedule, a Data Organizer, and has functions that are similar to a Spread Sheet. One of the many features is a "Data Sort By Type". Example: Sort Mail Files, etc. There is a similar "Look Up" feature.

The data files created by both Pipe Dream and Diary are FILED in memory that "does not forget" when the computer is OFF. Already I have four 'stages' of this document filed in Pipe Dream 'suspended activities'. These are automatic 'file saves' done as one quits to another computer mode. While handy and safe to protect from data loss, these files must be eliminated from time to time to conserve filing space. Since I have only a 128K Ram cartridge, filing space is limited to about 40 written pages of data. But suppose that there were three "megabyte" cartridges installed. Then the filing space would be about Three Thousand Written Pages of Text! We must chew upon that for a while, as all of us are accustomed to LOSING all Computer data when we turn OFF the computer. Ordinarily, we start up and search for a file in disk to resume working with.

It is difficult to compare DIARY with another existing software, as its concepts are for "permanent memory" files storage and manipulation. But I'll take a stab at it by saying that an IBM software having similar total functions would retail for around \$600...

The questions comes to mind: "Did I buy a Computer and get \$1400 worth of free software?". Or, "Did I buy the software and get a FREE Cambridge Z88 Computer to run the

software with?"

THE DISPLAY

The display is a "supertwist liquid crystal", having 8 lines of 80 characters each. Last evening I found that the display was quite readable if one positions the computer on a table at about the same distance as reading a newspaper. But you don't have to worry about the KGB spying over your shoulder. One must be "in range" for reading. This morning the sun is shining through the window directly upon the Z88 and against the side of my RGB monitor which is connected to the QL Computer. The sunlight does not affect the Z88 display. Actually it seems to be enhanced. But I had to make adjustments of the other computer's RGB monitor to read it. I am not comparing the Z88 display with a RGB monitor, but simply saying that it seems to be satisfactory.

The 8 lines of the Z88 display seems to be adequate for orientation of data being generated. The UP CURSOR pulls down earlier lines as needed. I believe that the Z88 display will be completely adequate for portable use. I hope that, eventually, an interface will be available for use with a monochrome monitor for desk top operations, mostly to design pretty graphics, charts, and spreadsheet operation.

DISK DRIVE Versas CHIP STORAGE

Can you do without disk drive for portable operation? Cambridge makes it very practical to do without disk drive "on the road" by providing permanent SAVE of data or programs in EPROM. While my EPROM cartridge holds only 32K, other 128K and 256K EPROM cartridges are available, and Cambridge Direct promises a 512K EPROM cartridge for the future. Now I believe that this may be confusing. "Don't you have to have a EPROM programmer to put data or programs into EPROM?" "YES, you do". The Z88 computer is also a EPROM programmer.

Data or programs are SAVED to EPROM in much the same manner as to RAM or to Disk Drive. This is a NEW concept for portable computers. One may leave town with a dozen or more special programs in EPROM cartridges to use during out of town operations. These cartridges are small and may be carried in the same briefcase with the Z88. OR, BLANK EPROM cartridges may be carried in order to install and SAVE programs or data. When these or the RAM cartridges are installed, they

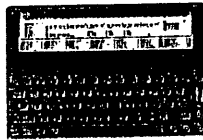

disappear into the Z88 cartridge ports. The plastic door closes and the physical dimensions of the Z88 is unchanged.

As my Wife and I were departing for vacation, a man at the airport had a "portable computer". While waiting we struck up a conversation. His job involves visiting and calibrating Hospital Electronics equipment. The computer he was carrying had a 3 1/2 inch disk drive and a package of floppy disks calibration programs. His computer was the size of a medium size luggage piece, but thicker. I hefted it and would say that it weighed about 40 pounds. A similiar capability with the Z88 would be in a small briefcase and would weigh less than 8 pounds (including underwear and shaving kit).

COMPATABILITY With IBM XT/AT

(Also Apple Mac- Sinclair QL- AND Disk Drive)

Cambridge Direct makes available two "LINK" Software cartridges, "PC Link", and "Mac Link". With each is supplied a floppy disk for the "linked computer". Sinclair QL Dealers have "QL Link". These software programs allows data and programs to be transferred between types of computers. The software also provides the Link needed to use Disk Drive. For example; a Z88 file is transferred to a IBM computer with "PC LINK". Then the file is saved to floppy. Or, a Word Perfect file is transferred to the Z88. Or, a Z88 file is transferred to a Apple Mac computer with the "Mac Link" software, etc.

The Z88 Operating System

There has not been a personal computer developed within the past ten years that did not use some form of BASIC Language as its programming language. The Z88 uses "BBC" Basic. A quick glance through the manual shows BBC Basic to be a nice adaptation of Dartmouth Basic, which allows the abbreviation of key words and commands. For example, DELETE is abbreviated with "del", and LIST with just L. Most of the BBC Basic terms are already familiar to us and can be entered with from one to three characters. I will save PROGRAMMING for another article and conclude by saying that a quick review of BBC Basic indicates that the structure looks to be easy to learn and rich in functions. Our TS-2068 programmers will be at home here.

The Z88 as a EPROM PROGRAMMER

Normally a good EPROM Programmer costs in the range of \$150 to \$3000. These are devices that transfers "organized programs or files one byte at a time" to an EPROM. Each byte transferred requires eight tiny fuzes in the EPROM to be burned out with applied voltage. As the process continues, and thousands of fuzes are blown, the EPROM is "programmed with the data supplied by a computer". The EPROM then is a device that contains PERMANENTLY STORED DATA. To erase the data in an EPROM it is subjected to a strong ultra violet light for a period of time. This has the effect of reorganizing the fuses so that the electrical lines to the storage cells are again connected. Then the EPROM can be programmed again. The Z88's operating system provides for easy operator SAVE of Data or Programs to EPROM, an amazing capability for a portable computer!

PROGRAMMING SUPPORT

It appears that Z88 Software programs will appear in two forms, Z88 EPROM Cartridges and Floppy Disks to be "LINK LOADED" from either a IBM AT/XT, a Apple Mac, or a Sinclair QL. The latter concept will be the least expensive, but will require the support of another computer system for transferring the Z88 program on disk to the Z88 RAM, upon which the user can SAVE to EPROM for independant program operation.

Now to figure out how to FORMAT and PRINT this file with my old Daisy Wheel printer. A Parallel interface cable was purchased with the Z88. The cable is small enough to carry in the same briefcase, or in a pocket.

SUMMARY: It took me about 3 months to get this far with the TS-2068 when I first started with it. The QL required about a month of study. That I could begin this data base the same day as receiving the Z88, then finish it in a few days following, attests to a very User Friendly computer and its software. The whole kit and kaboodle cost less than \$800, which is less than similiar software would cost for most computers. This Z88 is a true PORTABLE, where I haven't seen another that really is portable. I believe that I will be happy with the Z88 for both Portable and Desk Top use.

More details will come in follow on reports.

BJ-----



>> Q. L. QUIRKS <<

John E. Juergens
18 Bryce Canyon Way
Pacifica, CA 94044

Bill Jones
c/o UPDATE Magazine
1317 Stratford Avenue
Panama City, FL 32404

Dear Bill,

The article on page 17, UPDATE, Jan '89, by Oscar Sensabaugh (another of your nom de plume's?), R. O. C. (Regular Old Cumudgeon?) presents a problem which has a solution. I am referring to the statement that Oscar uses TWO QL "work copies" in order to implement two printing devices, a QL and a Smith-Corona printer AND he has to make his choice of printing devices BEFORE starting.

With four devices to output to (Star Gemini 10X, Panasonic Penwriter, Silver-Reed typewriter and QL Talker) Oscar's solution, in our case, would prove a bonanza for the microdrive cartridge manufacturer(s). As a plank-owner in DMUG (Dedicated Microdrive Users' Group) I would like to suggest a less cartridge-intensive option.

1. Delete QLWP_hob (The HELP file) from your QLWP backup/"working copy" to give yourself some room. When the choice is a \$3.00+ cartridge or punching up Help on F1, we opt for looking up the answer in the manual and using that valuable media space for things like extra printer drivers and often-used forms. Printer drivers consume 1 sector apiece and forms (a blank QLWP page with Margin, Tab, Design, Header and Footers set to our liking) consume 5 sectors each.

2. Make all of the different printer drivers you need via the installation program. The only problem here is that each driver has to be made with a separate run-through of that program - which takes a lot of time. After each driver run-through what you end up with is: (1) An updated install dat file which has all of the information about each driver you have made to date, and, (2) A file called printer_dat which is the new printer driver you have just configured.

a. Before going on to the second/next driver configuration copy the just-configured printer_dat file under the file_name you wish to use; eg. Copy mdv1_printer_dat to mdv1_QLPrinter_dat or copy mdv1_printer_dat to mdv1_SmCorPtr_dat and go on to the next driver configuration.

b. Do as many of these as you have need for and then make a copy of your QLWP "working copy" copy in order to spare you all of the agony you just went through when your original "working copy" gives up the ghost. Deleting the HELP file (QLWP_hob) from your "working copy" gives you about all of the room you may need.

3. When you next bring up QLWP with your "working copy" AND before you send anything to the printer select your driver of choice (SmCorPtr_dat for example) and do the following: F3, (O)ther, (F)iles, (D)elete mdv1_printer_dat, ENTER. ESC, (B)ackup, mdv1_SmCorPtr_dat, ENTER(to mdv1_printer_dat, ENTER, ESC, ESC. Yes, you CAN copy a file FROM mdv1 TO mdv1!

The net result of these "exercizes" is to allow you to have your choice of printing devices WHEN, WHERE and HOW you choose; a full range of options without having to reset and re-load if you later change your mind and ALL on one cartridge.

re: (S)udden (L)ock (S)yndrome, page 11, UPDATE, Jan/'89

If I can extrapolate from your SLS experiences as well as my own there are probably a great number of QL users out there who were relieved to hear your voice that particular problem; we/they are not alone!



If the problem is what I believe it to be - momentary powerline interruption or sudden voltage drop to the QL caused by a/several high load appliances turning on - the generic fix is obvious: Attach the QL to a non-interruptible power source. Notice that I did not say the fix was easy or inexpensive.

A few blocks away from us live a family with a large (spell it "expensive") Apple investment. If they are "computing" when the furnace blower turns on, immediately thereafter they are NOT computing. I haven't touched base with them recently but unless they switched power supply circuits wintertime computing is either out, very risky or they are cold.

As the power supply requirement to the ZX81/TS1000 is relatively simple, one nine/ten volt DC supply at less than 1 amp, seven AA ni-cads in series, diode paralleled to and trickle-charged by the supply adaptor worked very well for me; no SLS thereafter (at least none caused by the power supply.)

With the QL things are not that simple: Two supplies, 9 VDC, unregulated, at 1.8A and 15.6 VAC at 200 ma vitalize the computer according to the specs glued to my power supply.

On the face of it one solution would be to plug the QL power supply into a 75 watt (min. AC output) DC to AC converter operating from a 12 volt gel-cel, motorcycle or vehicle battery.

A quick look at my pile of catalog sources reveal that (besides the fact that things have never been the same since Allied Radio, Lafayette and Olsen stopped sending out catalogs) Tripp Lite will sell you their SB-200 (not including the battery) for \$240 through Fordham, 260 Motor Parkway, Hauppauge, NY, 11788 (516) 435-8080. The literature claims computer use but it also mentions a 10 ms switch-over time which seems a bit slow to me.

A non-generic but less expensive fix is to backup your deathless prose often and regularly to MDV or disk. It wont eliminate resets but it will eliminate a lot of time and re-writing from scratch.

As now may be expected, there is a problem with often and regular backups to MDV as well: If there is a power outage, as opposed to a momentary dip, and if you have left the backup cartridge in the MDV there is a good chance that the outage kapooted the cartridge as well.

Have you noticed how problems beget fixes which beget problems ...! Therefore take the cartridge out after each of the often and regular backups remembering to replace before the next. As we do not have a disk drive I do not know whether the same caution may apply.

I have experienced two other types of problems one of which LOOKS like SLS. When working in QLDB with a large program and data base a call to SELECT, UPDATE or APPEND at times will produce SLS symptoms. Many the times in days long gone I thereafter reset and started over again; that is, until I accidentally stumbled upon the fix of just W A I T I N G, up to two minutes in some instances, and the program in its own sweet time continues.

I don't know for certain what happens but guess that at certain memory-used-points Archive must re-write or re-arrange itself somehow and waiting it out works 99% of the time. To solve that problem I added a couple of dummy procedures full of REM statements to the program and when the problem occurs (always after I have modified the program) to go back into EDIT and either add to or delete a dummy, then run it and see if the wait still occurs. This cut and paste method is neither very scientific nor high tech but it does work.



The other problem occurs with QLSS: Our tax program occupies 150 sectors and during the initial LOAD, at about the 75 sector point, LOADING stops with an "Out Of Memory" error message. As our QL has a 512K external Miracle board, Out-of-Memory is simply not consistent with reality - I hesitate to call our computer a liar as I am dependent upon it and have to work with it and in my secret heart know it reads my vibes and reacts in a mean, vicious and totally amoral fashion to real and fancied slights (including calling it a liar!)

The QL Manual and the Miracle installation sheet, as far as I have ever been able to determine, are simply silent on that state of affairs - well, not exactly: The Error Handling section in Concepts does say that that message means that QDOS and/or SuperBasic has insufficient free memory which of course is what one would gather from the error report in the first place which of course is simply not true in our case. And, before I get into an endless loop, I just wish to say that the fix is simple: Press Space to get rid of the error message, then F3, (L)oad file_name again just exactly as you did at the initial start.

Strangely, once the double-LOADing is successful (which it inevitably is) a re-LOAD of the same program occurs without the interruption encountered in the initial LOADING. This impels the thought that the re-starting of the initial LOAD probably had something to do with memory re-allocation. What is puzzling is why a manual re-start is required when an automatic software re-start could have been implemented?

You might, Bill, consider christening a new column entitled QL Quirks. It just might turn into a book.

Commento: Har har! 'ole Tex'll get a kick outa this-un! His hide is the thickness of a smitty's aporn, so he wont be offended. Oscar (R.O.C.) began computin in the country with a ZX-81, then a TS-1000, then a TS-2068, and a couple of X'mas trees ago his stocking had a QL in it. So, he has 'curmudgeoned' most of Sir Clive's stable of critters. As he discovers something he tells us bout it with a mix of Morse Code and Texas twang. He has fun a dunning at it and we most of us enjoy deciphering the code to get at the message. Couple 'o years past ole Tex almost left us for the happy hunting grounds of devout curmudgeons. He musta think that he was endowed with the ability to fly. Anyway, he crash landed on the tarmac from 12' atop an 18 wheeler and nearly kilt hisself. Took mor'n a year of laying low letten the energy flow back into his vittals afore he could take up curmudgeoning agin. Whether you dig his style or not there is always a tip in there for some who are streevin and strainin to learn it durn it. By the way, beginners flying lessons should start from the door steps first and graduate to higher altitudes as skills develop.

About "QL Quirks": I do dig that family's problem with their Apple. S.L.S. is a quirk not confined to the QL and whose genealogy traces back to Mr. Franklin's kite flying adventure. Electricity comes and goes. When it goes, S.L.S. grabs us. Should say "when it waffles or waivers". Funny that a respectable Engineer will neglect to account for a non-perfect world of pure sine waves, unaffected by power loading, lightening, buss switch over, neon lights switching on and off, and yes birds alighting upon the power lines.

Since Florida is where most of the birds fly for the winter, and they are always lighting upon the power lines, and that causes S.L.S. with some QL computers, I am happy to report that Dan Elliott has a guaranteed fix for the syndrome. Dan has my back up QL now to do the "Outside Power Regulator Job" on it. He says that the Power supply is so effective that one can do a quick OFF and back ON without the QL dumping. Also, an ON-OFF switch comes with the fix. So dont buy that \$350 AC/DC converter, or that \$900 constant AC Back Up supply. Let ole Dan do it for about \$50 plus or minus a few. Dan Elliott, RR-1 Box 117, Cabool, MD 65689.

OPINION: Somebody needs to revise the Quill Proc to stop that automatic MDV save when Quill decides to do it. At least it should give you a warning and let YOU decide. This Big Bad Suprise comes when operating without extra memory and you get about three pages into a data file generation.

John, thanks for the Quirks. Dig the Header afore your letter. This could be the place to confine our varying forms of humor, as well as Quirk Quacking. You started it, and now others can join in. To Tex: I apologize for putting you under the Quirks Column. Did'ja ever learn to fly?

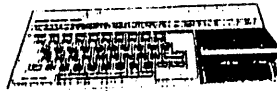

TS-2068 DATA INPUT

-a utility for:

Data Base Generation
 Keyboard Reading
 Character Concatenation
 Screen Display
 Full Editing

This is an audacious attack upon the most famous weaknesses of the TS-2068, slow data input and poor screen editing. The result is a INPUT SECTION of programming that can be used for many purposes. Programmers have overcome the problems mentioned by developing their own independantly running Machine Code in RAM. Such softwares as Mscript, Tasword, and ProFile, do a nice job of Display Control and Data generation, but at great cost of FREE memory. These code utilities are proprietary. Even if their use were free, they would lack the flexibility for user applications.

Generally, there has been a tenancy by programmers to NOT use the inherent abilities of the TS-2068 for DATA MANAGEMENT. The "TS-2068's way" is to control data in the Variable area of memory". Most programmers develop an independant control system for data, using machine code to place the data into high ram, edit the data, etc. While this may be somewhat faster, and more efficient for 'some' functions, it is redundant and FREE Memory is reduced by the amount of code used.

We TS-2068 users have never had a flexible, easy to use utility for "Input Data Control". Look back all you want into Sync, Syntax, and existing magazines. The cupboard is bare.

TS-2068 DATA INPUT is a utility that does all of the functions listed in the above title. Moreover, these functions are done "the TS-2068 way", using the Variable file. This allows easy flexibility for using the utility in almost any Basic Program to enhance typing input and editing.

DATA INPUT takes advantage of the ROM routine "K-STATE" for fast keyboard reading. The display management is done using Systems Variable SPOSEN, which stores the X,Y coordinates of the "next print position" in two addresses. Then each key touched is printed to screen and concatenated to a typing buffer. The typing buffer is the simple string "U\$".

We will now take a look at the "Nucleus" of the Data Input utility, which are two routines in Basic.

The SPOSEN ROUTINE: The purpose is to display the last 148 characters of U\$ to screen and to establish tracking variables. A=vert print position. B=horiz print position. Al=LEN U\$ in the beginning and will be changed to track the cursor so that Al=the U\$ chr

number to the left of the cursor. The SPOSN routine needs to be used only once upon entry of the PEEK K-STATE typing input routine.

SPOSEN

```
100 IF LEN U$ <= 148 THEN PRINT AT 0,0;U$;
102 IF LEN U$ > 148 THEN PRINT AT 0,0;U$(LEN
U$-148 TO);
104 LET A=24-PEEK 23689: LET B=33-PEEK 23688:
IF B=32 THEN LET B=0: LET A=A+1
106 LET Al+LEN U$
```

Lines 100 and 102 in the above routine is for a 32 column screen. Replace "LET A=24-" with "48", and "LET B=33-" for an implemented 64 column screen.

Next, the PEEK K-STATE routine to read the keyboard. K-STATE is first POKED to its active status. Then the ROM routine reads the keyboard until a key is touched, then the Character code is assigned to var "c". If the chr code is less than 32 the key read loop is escaped from to line 158 (EDIT). If not, the character is concatenated to U\$, printed on screen, a Cursor is printed, and the SPOSEN vars are incremented. GO TO 150 gets the next character.

K-STATE Routine

```
150 POKE 23611,220
151 IF PEEK 23611 < 221 THEN GO TO 151
152 LET C=PEEK 23560: IF C < 32 THEN GO TO 158
153 LET U$=U$+CHR$ C:PRINT AT A,B;CHR$ C;" ";
154 LET B=B+1:LET Al=Al+1: IF B=32 THEN LET
B=0:LET A=A+1
155 GO TO 150
158 STOP:REM See the program TS-2068 DATA
INPUT for the complete, ready to use, utility.
```

While the above two routines are fairly fast, and I have used them for years in the Smart Text software, a typing speed greater than about 40 words per minute can over-ride the input. The K-STATE loop is slowed by the basic programming to concatenate, the LETS, and the IF THEN escape. So, I ask Mr. Don Lamen, SINCUS, to provide a Machine Code clone of these two basic utilities. The next 4 pages comprise Don's MC utility and it's documentation. Don's MC utility "Concat" does everything that the SPOSEN and K-STATE Basic utilities do; using only 196 bytes of code. So, we put the code in the printer buff area, starting at adr 23296. This left me the task of developing a FULL EDIT function to begin at basic line 158. After Don's code is explained, the whole BASIC utility "TS-2068 Data Input" will be listed and commented upon. Once Don's code is installed in the Print Buff, just one Basic line is needed to replace all of the lines of programming of the SPOSN and PEEK K-STATE routines. That line will be <150 RANDOMIZE USR 23334>

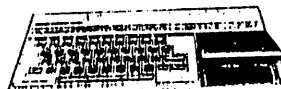

**** CONCATENATION ****

Dear Bill,

Here is the machine code routine that I came up with in response to your letter of Nov. 30, 1988.

On the B side of this tape is a Demo program containing the actual machine code routine, support sub-routines and supporting BASIC lines. I have put several STOPS in the BASIC to allow you to follow the various steps.

This text file consists of five parts as follows:

1. The BASIC support.
2. The Machine Code Entry Points.
3. The Assembly Listing.
4. A HEX Dump of the Machine Code.
5. A DEC Dump of the Machine Code.

BASIC SUPPORT

```

1 REM * CONCATENATION * V.1.0
  by Don Lamen, SINCUS 12-14-88

2 REM ** DO NOT USE PRINTER **

3 REM * For a Demo GO TO 998 **

150 REM ** CONCATENATE **
151 RANDOMIZE USR 23399
152 STOP
153 REM
157 REM * EDIT AND/OR PRINT VARIABLES *
158 STOP: LET A = PEEK 23299: LET B =
PEEK 23298: LET C = PEEK 23300: LET A1 =
PEEK 23296 + 256 * PEEK 23297: STOP
159 PRINT "A (LIN): ";A;"B (COL): ";B'
"C (CHR): ";C;" (" ; CHR$ C;)"'"A1 ( LEN
U$): ";A1: STOP
160 GO TO 151
996 REM
997 REM ** INITIALIZE U$ **
998 LET U$ = ""
999 REM ** CLS AND PRINT LAST 148 CHRS.
**
1000 RANDOMIZE USR 23334
1001 STOP
1002 LOAD "Concat" CODE
1003 LIST
    
```

MACHINE CODE ENTRY POINTS

```

(23296) 5B00    VAR1 ; LEN U$
(23298) 5B02    VAR2 ; (SPOSN) LO: COL / HI: LIN
(23300) 5B04    VAR3 ; CHAR. CODE

          09          ADD HL, BC          ; End of U$
          A7          AND A              ; RES Carry Flag
          ED52        SBC HL, DE          ; Go back 148
          EB          EX DE, HL          ; DE -> 1st Char.
          44          LD B, H            ; to be printed.
          4D          LD C, L            ; 148 bytes
(23367) 5B47    CDDB21    PRINT: CALL 21DB, PR-STRING
          ED4B885C    LD BC, (SPOSN)
          3E18        LD A, 18           ; 24 dec.
          90          SUB B
          47          LD B, A
          3E21        LD A, 21           ; 33 dec.
          91          SUB C
          4F          LD C, A
          FE20        CP 20              ; New line?
    
```

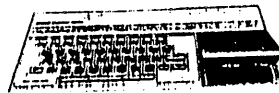

```

                2003          JR NZ, STORE
                0E00          LD C, 00      ;
                04            INC B
(23389) 5B5D ED43025B STORE: LD (VAR2),BC ; Store Param.
                CD185B      CALL 5B18, PR-AT
                3E5F          LD A, 5F      ; Cursor
                D7            RST 10        ; Print Cursor

                                65 bytes

ENTRY POINT 2: (CONCATENATE)

(23399) 5B67 3A3B5C CONCAT: LD A, (FLAGS)
                FEED          CP DD        ; 221 dec.?
                38F9          JR C, CONCAT ; Wait for Key
                3A085C        LA A, (LAST K)
                5F            LD E, A      ; Save Char. in E
                3EDC          LD A, DC     ; 220 dec.
                323B5C        LD (FLAGS), A
                7B            LD A, E      ; Char.
                FE20          CP 20       ; Is it < 32 dec.
                300A          JR NC, CONT  ; No! It is OK
                219E00        LD HL, 009E  ; If < 32 dec. GO
                                TO Line 158 in
                                BASIC.

(23423) 5B7F CDD616          CALL 16D6, LINE-ADDR
                22555C        LD (NXTLIN), HL
                C9            RET
(23430) 5B86 32045B CONT:  LD (VAR3), A ; Save Char.
                CD055B        CALL 5B05, FIND-U$
                23            INC HL
                4E            LD C, (HL)
                34            INC (HL)
                23            INC HL
                46            LD B, (HL)
                2001          JR NZ, ADVAN
                34            INC (HL)
                09            ADVAN: ADD HL, BC ; HL -> Last Char
(23448) 5B98 CDB812          CALL 12B8, ONE-SPACE
                3A045B        LD A, (VAR3) ; Get Char.
                23            INC HL
                23            INC HL
                77            LD (HL), A ; Add it to U$
(23454) 5B9E ED4B025B PR-2: LD BC, (VAR2)
                CD185B        CALL 5B18, PR-AT
                3A045B        LD A, (VAR3) ; Get Char.
                D7            RST 10      ; Print it to the
                                Screen.
                3E5F          LD A, 5F    ; Cursor
                D7            RST 10      ; Print Cursor
(23468) 5BAC 2A025B        LD HL, (VAR2)
                2C            INC L
                7D            LD A, L
                FE20          CP 20       ; Is it 32 dec.?
                2003          JR NZ, UPDATE
                2E00          LD L, 00
                24            INC H
(23480) 5BB8 22025B UPDATE: LD (VAR2), HL ; 'AT' Parameter
                2A005B        LD HL, (VAR1) ; LEN U$
                23            INC HL
(23487) 5BBF 22005B        LD (VAR1), HL
(23490) 5BC2 18A3          JR CONCAT

                                93 bytes
    
```

TOTAL NUMBER OF BYTES = 196

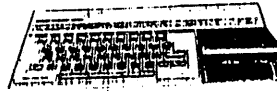

HEX DUMP

CONCAT									CHECKSUM
(23296)	00	00	00	00	00	2A	4B	5C	D1
(23304)	7E	FE	55	C8	CD	20	17	EB	88
(23312)	18	F6	CD	A6	08	01	00	00	8A
(23320)	21	3B	5C	CB	8E	21	3C	5C	CA
(23328)	CB	86	CD	B2	05	C9	CD	12	7D
(23336)	5B	CD	05	5B	23	4E	23	46	62
(23344)	ED	43	00	5B	23	EB	21	94	4E
(23352)	00	A7	ED	42	09	30	08	EB	02
(23360)	09	A7	ED	52	EB	44	4D	CD	38
(23368)	DB	21	ED	4B	88	5C	3E	18	6E
(23376)	90	47	3E	21	91	4F	FE	20	34
(23384)	20	03	0E	00	04	ED	43	02	67
(23392)	5B	CD	18	5B	3E	5F	D7	3A	49
(23400)	3B	5C	FE	DD	38	F9	3A	08	E5
(23408)	5C	5F	3E	DC	32	3B	5C	7B	19
(23416)	FE	20	30	0A	21	9E	00	CD	E4
(23424)	D6	16	22	55	5C	C9	32	04	BE
(23432)	5B	CD	05	5B	23	4E	34	23	50
(23440)	46	20	01	34	09	CD	B8	12	3B
(23448)	3A	04	5B	23	23	77	ED	4B	8E
(23456)	02	5B	CD	18	5B	3A	04	5B	36
(23464)	D7	3E	5F	D7	2A	02	5B	2C	FE
(23472)	7D	FE	20	20	03	2E	00	24	10
(23480)	22	02	5B	2A	00	5B	23	22	49
(23488)	00	5B	18	A3					16

Total BYTES = 196

DEC-DUMP

CONCAT						CHECKSUM
(23296)	0	0	0	0	0	0
(23301)	42	75	92	126	254	589
(23306)	85	200	205	32	23	545
(23311)	235	24	246	205	166	876
(23316)	8	1	0	0	33	42
(23321)	59	92	203	142	33	529
(23326)	60	92	203	134	205	694
(23331)	178	5	201	205	18	607
(23335)	91	205	5	91	35	427
(23341)	78	35	70	237	67	487
(23346)	0	91	35	235	33	394
(23351)	148	0	167	237	66	618
(23356)	9	48	8	235	9	309
(23361)	167	237	82	235	68	789
(23366)	77	205	219	33	237	771
(23371)	75	136	92	62	24	389
(23376)	144	71	62	33	145	455
(23381)	79	254	32	32	3	400
(23386)	14	0	4	237	67	322
(23391)	2	91	205	24	91	413
(23396)	62	95	215	58	59	489
(23401)	92	254	221	56	249	872
(23406)	58	8	92	95	62	315
(23411)	220	50	59	92	123	544
(23416)	254	32	48	10	33	377
(23421)	158	0	205	214	22	599
(23426)	34	85	92	201	50	462
(23431)	4	91	205	5	91	396
(23436)	35	78	52	35	70	270
(23441)	32	1	52	9	205	299
(23446)	184	18	58	4	91	355
(23451)	35	35	119	237	75	501
(23456)	2	91	205	24	91	413
(23461)	58	4	91	215	62	430
(23466)	95	215	42	2	91	445
(23471)	44	125	254	32	32	487
(23476)	3	46	0	36	34	119
(23481)	2	91	42	0	91	226
(23486)	35	34	0	91	24	184
(23491)	163					163

Total number of bytes = 196

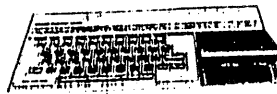

TS-2068 DATA INPUT, TYPING INPUT TO SCREEN WITH FULL EDIT

-NOTES-

100 REM * TS-2068 DATA INPUT *

Donated to Public Domain by---

UPDATE Magazine and Don Lamen, SINCUS.

140 INK 7: PAPER 0: BORDER 0: CLS : RANDOMIZE US
R 100: OPEN #4,"dd": RANDOMIZE USR 100: LOAD "con
cat.C1"CODE : RANDOMIZE USR 100: OPEN #3,"lp": RA
NDOMIZE USR 100: POKE 16096,0: RANDOMIZE USR 100:
POKE 16092,0: LPRINT : LET u\$=""

INITIALIZE LKDOS - LOAD CODE -
INITIALIZE LKDOS VERSION 3 PRINTER
POKE NO LINE FEED - POKE AERLO OR
OLIGEN INTERFACE -
INITIALIZE U\$ - THE TYPING BUFFER

150 RANDOMIZE USR 23334 - Turbo Typing
158 LET a=PEEK 23299: LET b=PEEK 23298: LET c=PE
EK 23560: LET a1=PEEK 23296+256*PEEK 23297
159 IF c<>12 THEN GO TO 230
160 LET b=b-1: LET a1=a1-1: IF b=-1 THEN LET b=
31: LET a=a-1: IF a=-1 THEN LET a=0
162 LET u\$=u\$(TO a1)+u\$(a1+2 TO)
164 IF LEN u\$>a1-b+1-a*32+404 THEN PRINT AT a,0
;u\$(a1-b+1 TO);

Run CODE til BREAK out to Line 158
- GET BASIC VARS FROM CODE
- IF NOT DELETE Chr 12
- IF Delete Chr 12

166 IF LEN u\$>a1-b+1+403 THEN PRINT AT a,0;u\$(a
1-b+1 TO 404);
167 RANDOMIZE USR 23334
230 GO TO (c>31)*300+(c=7)*390+(c=8)*290+(c=9)*2
75+(c=10)*265+(c=11)*255+(c=12)*370+(c=13)*150+(
=14)*2926+(c<7)*2926

- BACK TO Turbo SPEED TYPING After Delete Last Chr.
10-IF THEN BRANCHES IN Boolean Logic

235 POKE 23611,220
238 IF PEEK 23611<221 THEN GO TO 238
240 LET c=PEEK 23560: POKE 23611,220
250 GO TO 230

PEEK K STATE TO Read Keyboard
IN BASIC

255 LET a=a-1: LET a1=a1-32: IF a<0 THEN LET a=
0: IF a1<b THEN LET a1=b
256 IF LEN u\$<a1-b+1+404-a*32 THEN PRINT AT 0,0
;u\$(a1-b+1-a*32 TO);
257 IF LEN u\$>a1-b+1+403-a*32 THEN PRINT AT 0,0
;u\$(a1-b+1-a*32 TO a1-b+1+404-a*32);
258 PRINT AT a,b; INVERSE 1; OVER 1;"_";: GO TO
235

CURSOR UP Arrow Action

265 LET a=a+1: LET a1=a1+32: IF a1+128>LEN u\$ TH
EN PRINT AT a+2,0; FLASH 1;"To edit here Touch E
NTER " : PAUSE 0: RANDOMIZE USR 23334
266 IF a>11 THEN LET a=12: PRINT AT 0,0;u\$(a1-b
+1-384 TO a1-b+96);
270 PRINT AT a,b; INVERSE 1; OVER 1;"_";: GO TO
235

CURSOR Down Arrow
action

275 LET a1=a1+1: LET b=b+1: IF b=32 THEN LET b=
0: LET a=a+1: IF a>21 THEN LET a=a-1: LET b=31:
LET a1=a1-1

MOVE CURSOR Right WITH
Right Arrow KEY

280 IF A1>LEN U\$ THEN LET A1=A1-1: LET B=B-1: I
F B=-1 THEN LET B=31: LET A=A-1
285 PRINT AT a,b; OVER 1;"_";: GO TO 235
290 LET b=b-1: LET a1=a1-1: IF b=-1 THEN LET b=
31: LET a=a-1: IF a=-1 THEN LET b=0: LET a=0: LE
T a1=a1+1

MOVE CURSOR LEFT WITH
Left Arrow KEY

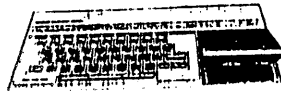

```

295 PRINT AT a,b; OVER 1;"_"; GO TO 235
300 LET u$=u$( TO a1)+CHR$ c+u$(a1+1 TO ): LET b
=b+1: LET a1=a1+1: IF b=32 THEN LET b=0: LET a=a
+1
301 IF LEN u$<a1-b+1+VAL "404"-a*32 THEN PRINT
AT a,0;u$(a1-b+1 TO );
302 IF LEN u$>a1-b+1+403-a*32 THEN PRINT AT a,0
;u$(a1-b+1 TO a1-b+1+404-a*32);
305 PRINT AT a,b; INVERSE 1; OVER 1;"_"; GO TO
235
370 LET b=b-1: LET a1=a1-1: IF b=-1 THEN LET b=
31: LET a=a-1: IF a=-1 THEN LET a=0
372 PRINT AT a,b;" "; LET u$=u$( TO a1)+u$(a1+2
TO )
374 IF LEN u$<a1-b+1-a*32+404 THEN PRINT AT a,0
;u$(a1-b+1 TO );
376 IF LEN u$>a1-b+1-a*32+403 THEN PRINT AT a,0
;u$(a1-b+1 TO 404);
378 PRINT AT a,b; OVER 1;"_"; GO TO 235
390 PRINT AT 19,0; INVERSE 1;"BLOCK INSERT"; INV
ERSE 0;" Type String, ENTER": INPUT z$: CLS : LET
u$=u$( TO a1)+z$+u$(a1+1 TO ): RANDOMIZE USR 233
34

```

*INSERT TYPING IN MIDST
OF TEXT*

*INTERIOR
DELETE IN MIDST OF
TEXT*

*BLOCK INSERT WITH EDIT KEY
AT THE CURSOR POSITION.*

TS-2068 DATA INPUT

"DATA INPUT" provides a fast TURBO typing speed and data presentation on screen. The typed characters are collected in "U\$" and called "the typing buffer". The data length of the typing buffer is un-restricted. Any "un-printable" character entry, such as the arrow keys or EDIT will escape TURBO mode and enter the EDIT mode. If just a single character DELETE is done with the DELETE key, TURBO is re-entered. Otherwise, after EDITING, touch the ENTER key to re-enter TURBO mode.

Each time that TURBO is re-entered, the last 148 characters of the typing buffer (U\$) is presented, giving 4 1/2 lines of text for orientation. The Arrow keys move the cursor up through the screen text for interior EDITING. UP ARROW will pull down earlier typed lines of text all the way to the first data line for editing.

The TURBO mode uses Don's code by RANDOMIZE USR 23334 at line 150. During EDIT mode the second "PEEK K-STATE" (in BASIC) is used at line 235. The edit mode is slowed by the large number of IF THEN Conditionals in line 230. There are 10 IF THEN logicals expressed in Boolean for its faster CPU evaluation. Though the K-STATE loop is slower than the same loop in Machine Code, the EDIT mode does not need such speed.

For fast lengthly INSERTS within the text, a touch of EDIT provides BLOCK INSERT. Block insert uses the standard TS-2068 INPUT at screen bottom. This allows the INSERT of a string of typed characters, or one may erase the Quotes and enter a simple string or character array cell to BLOCK TRANSFER segments of other data bases. Example: To BLOCK INSERT data contained in "H\$(3)" character array, just run the cursor up to the place to insert, then touch EDIT. Then erase the input quotes and enter H\$(3). The BLOCK INSERT mode also allows the entry of graphics characters, which would not be possible to enter in any other mode.

In line 230, one of the conditionals is for the use of CAPS and SYM SHIFT together to ESCAPE and GO TO line 2926, which is not present. This line number is the QUICKIE MENU of the Smart Text Software. For Aerco FD-68 and LKDOS Smart Text owners, this DATA INPUT utility may be used to replace all program lines of Smart Text from 150 through 399. Oliger DOS owners need to re-locate the code to either high RAM or to the unused SYSCON addresses. For other uses, the line number for ESCAPE may be changed from 2926 to the appropriate program line number.

Line number 140 is given only to allow the utility to work as stand alone. This line may be omitted when DATA INPUT is used with another program that initializes a DOS with a printer driver. Somewhere early in the program the "concat.B1"CODE must be loaded. This code is SAVED at address 23296 <SAVE "concat.B1"CODE 23296,196> and is 196 bytes in length. This is in the TS-2040 Print Buffer area.

The code in the print buff will be wiped out by the command LPRINT if there is no Centronics Printer Driver code resident in the system. However, after printing data with the TS-2040, the code may be re-loaded by <LOAD "concat.C1"CODE>. Then <GO TO 150>. The only requirement for the code is that U\$ must either be initialized or already contain data. <LET U\$=""> will do it.

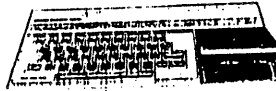

The connectors are available at Radio Shack:

- Female 9 pin #276-1538 \$2.49
- Hood 9 pin #276-1539 \$1.99
- Male 25 pin #276-1547 \$1.99
- Hood 25 pin #276-1549 \$1.99

Any three wire cable up to 50 feet long can be used. You may wish to use a joystick extension cable available from Radio Shack, cutting off and discarding the male connector. The wire colors on the one I have are Pin 2-red, Pin 5-green, and Pin 7 is grey. To be safe you should check them.

Now that you have your cable made, plug the 9 pin connector into the A channel serial interface of the FDD 3000. As you look at the back of the unit, it is the one on the right and is labeled. Making certain that all power is off, plug the other end into the EP-22 printer or into the serial input of the Messenger Module.

Are you ready to use your printer? Not really as you must first configure the interface driver program for your printer. This is done in TOS using the FORMAT * command, so you should be sure that the disk is protected by the write protection tab. After powering up the computer and then the FDD 3000, insert the DEMO disk in the A drive. When the drive light goes off, type in the following command:

```
FORMAT *":CH_A"
```

then press ENTER. You will be prompted to key the required answers for your printer. The EP-22 has only the choice of 75 or 300 Baud rate. The character bits are eight and one stop bit. No parity check. The Messenger Module has dip switches for optional settings. Using the configurations as set by the factory you would answer the questions as follows:

QUESTION	EP-22	MODULE
1. Text or Bytes?	T	T
2. Auto line feed?	N	N
3. XON / XOFF?	N	N
4. Input with wait	N	N
5. Baud rate?	G	I
6. Parity?	N	E
7. Stop bits?	A	A
8. Bits/char?	D	D

After all the questions have been answered you are back in BASIC. Type in:

```
GO TO *":DEMO:UTIL"
then press ENTER
```

There are three utility programs on the TOS DEMO disk that can be used by a serial typewriter printer. "TYPE" (no extension), a keyboard echo program. "LPRINT" (no extension), a BASIC loader for the machine code LPRINT and LLIST support program for the SCP CH_A, named "LPRINT.COD" CODE 23297.

Power up the typewriter. With the EP-22, use the CP mode, change from the typewriter to printer mode, and press the CONT button. You should now see in the printer display "ON LINE 300 BAUD".

With the Messenger Module and the Smith-Corona typewriter, set the pitch desired, turn on the keyboard, hold down the CODE key and press the "P" key. The red program light should come on.

Type into the computer:

```
LOAD *"TYPE"
```

Then press ENTER. When the program has loaded, the prompt "Do You Have a Printer (Y/N)?" will appear on the screen. Answer with a Y and when the cursor appears press ENTER. You should now be able to use the computer keyboard and both the screen and printer will echo the key that is pressed. The ENTER key acts as a carriage return/line feed. If the program hangs up, the typewriter was not on line, the connections are bad, or the cable is wired incorrectly.

If all goes well, break out of the program using the BREAK key. Type in:

```
CLOSE # *1
```

Then press ENTER. Type in:

```
LOAD *"LPRINT"
```

Then press ENTER. When the program has loaded, type in:

```
RUN
```

Then press ENTER. You should now be able to use the normal LLIST or LPRINT commands.

You can now avoid reconfiguring the SCP CH_A by FORMATTING new disks. The DEMO disk also has a utility program named "LOSYS" that will allow you to change the default setting on existing disks, after configuring a SCP, without losing the data on your disks.



Jean-Claude Touzin
 C.P.41 La Sarre Prov. Québec
 Canada J9Z 2X4 Tél. (819)333-2175

 To: UPDATE MAGAZINE
 1317, Stratford Ave., Panama City, FL 32404
 #####
 9.2.89

Dear Bill,

UPDATE jan. 89 was my second issue and I like the open spirit and warm feeling that you put in this mag.

As a small contribution, I send you a new listing for the QL index program that appeared on page 61, with some commentaries.

Concerning the way to terminate a loop in superbasic, the standard is to use END FOR or END REPEAT. NEXT is used when you want to terminate a FOR loop for ex. before the END FOR. In this case, QDOS will jump from the NEXT to the FOR statement.

You can also use EXIT to jump after the END FOR or END REPEAT statement (see listing for example of this).

Concerning the linefeed, I removed the c of SER1, which make my printer always print on the same line. As is, I do not have to change dipswitch for going to and from QUILL.

Another thing to note is that you don't need to repeat the DIM statement for each variable that you define. Also notice how powerful is the INPUT statement in Superbasic: you can concatenate(?) all sort of thing in the prompt, plain text, numeric variable, string variable and even loop control variable(see listing).

Lastly, when you want to repeat something in Superbasic, the easy way is to englobe everything in a REPEAT END REPEAT loop, instead of GOTO. That's what I have done to your small program.

I hope that my "Frenchlish" is not too hard to decipher...

QLy Yours,

Jean-Claude Touzin.

See "INDEX PRINTER" in the January 89 UPDATE - SAME ALGORITHM BUT THIS IS BETTER.

BJ Thanks J.C.!

```

5 REPEAT index
10 CLS:CLS#2: LIST
20 INPUT "Number of index' titles? ";a
30 DIM a$(a,28),b$(a,12)
100 FOR n=1 TO a
110 INPUT\ "Enter index' title no " & n & " (x to end):"\a$(n)
120 IF a$(n)="x": a=n-1: EXIT n
130 INPUT"Enter pages ";b$(n)
140 END FOR n
500 INPUT "Enter first tab ";tb
510 OPEN#4,ser1: BAUD 9600
520 FOR n=1 TO a
530 PRINT#4;TO tb;a$(n);TO (tb+28);b$(n)
540 END FOR n
550 INPUT"Number of linefeed ";x
560 IF x>0: FOR n=1 TO x:PRINT#4;\
570 CLOSE#4
580 END REPEAT index
    
```

Freebie

Need a QL Power Supply Module?
 - Since having a "Outside PWR Sup" installed, and I don't have a mustache trimmer - you can have my old QL pwr supply for shipping cost of about \$5.00. FIRST call gets it.
 - CAN I UPDATE. - BJ
 (ideal for running a mustache trimmer)
 (OR even a QL)

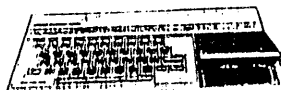

The FD-68 Update

— By Sid Wyncoop —

Last issue, we learned little bit about CP/M. We now have the important system addresses and the function calls that are common to most all CP/M systems. We will explore the use of these items in subsequent issues so, keep this information close at hand.

Also, I mentioned CP/M public domain software last issue. The public domain software is generally very good. There are application programs for any use you can imagine and generally the source is included, as well as documentation! There are also utilities, games, languages and virtually anything you can imagine. The best source is the original CP/M user group, SIG/M. SIG/M have over 300 CP/M disks full of public domain software. You will not find any 'Shareware' on these disks, everything is truly public domain. SIG/M can be contacted at:

SIG/M-Amateur Computer Group of New Jersey, Inc.
P. O. Box 97
Iselin, N. J. 08830

On a more local basis, there are still many active CP/M user groups, most of which have the SIG/M library available. Contrary to the PC Cloner's opinion, CP/M is not dead. CP/M has matured so there is not much new being developed but many of the old programs are constantly being improved. Also, there are many bulletin boards that cater to CP/M by having the latest revision of the more popular programs available for download. Many of these boards are free but the small access fees charged by the others are cheap, compared to the price of good software.

The following list is just a few of the programs I find indispensable and which I strongly recommend you obtain. It is certainly not exhaustive, but are a few that I use almost daily.

- | | | |
|------|------|--|
| SD | .COM | Super Directory is much improved over the CP/M internal command DIR. SD.COM allows complete control over the output of the disk directory information. |
| DU | .COM | Disk Utility allows editing of individual disk sectors. The control DU gives you is similar but much greater than SEKTOR which, is written for the FD-68, Timex mode, by Mowgli Assor. |
| NSWP | .COM | New Sweep is a user friendly replacement for CP/M's PIP.COM and does much more. NSWP contains abilities that would otherwise require several utilities. I consider NSWP to be indispensable. |
| Z8E | .COM | Z8E is an interactive debugger/disassembler that will run circles around CP/M's DDT.COM. If you are an assembly language programmer, this is a must have. |

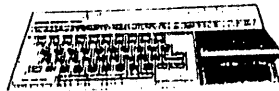

- UNERASE .COM UNERASE will recover erased files. Great for accidental erasures.
- MODEM7 .COM There are many updates to this original version but, it remains the best generic communications program, particularly the updated version MEX.COM.
- NULU .COM New Library Utility is needed as your number of files grows and you need to conserve disk space. It combines several files into one which recovers the excess space that your system requires for its smallest disk file. For Example, a normal DSDD drive will have a minimum file size of 2048 bytes (2K). This is true even if the file is only one byte. NULU reduces the minimum file size to CP/M's 128 byte record size

I should explain filenames for those of you that unfamiliar with CP/M file naming conventions. All programs, text, data, etc. are called a file. Each file name has two parts, the individual filename which is 1-8 characters and an optional file extension of 1-3 characters. A generic file name is often used which is "filename.ext".

Like the Timex mode of the FD-68, the CP/M file extensions have definite meanings however, CP/M does not require a file extension. The recognized meanings are listed below. Again, this is not an exhaustive list but they are the most often used file extensions.

<u>Ext Type</u>	<u>Ext Meaning</u>
COM	COMmand files are your programs. This file type is automatically loaded into the TPA and executed by typing its filename, without the extension, at the CP/M prompt.
BAS	These are BASic program files. They cannot be directly executed. You must first load MBASIC.COM in order to be 'in Basic.' The MBASIC interpreter will load and execute the Basic program. Note: This is not the very user friendly Sinclair Basic that you have become accustomed to but, is the MicroSoft Basic-80 interpreter.
SUB	These files are Ascii text files which contain several CP/M commands. Use SUBMIT.COM to execute these files.
DOC	DOCumentation files are rather obviously the instructional files for the .COM file of the same filename. This extension is also used by several wordprocessors to designate the working DOCument.
TXT	TeXT files are simply Ascii text files of any nature.
ASC	ASCii is an alternate for TXT or DOC.

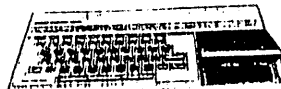

BAK BAcKup files are copies of other files of the same filename. Most wordprocessors use these files to retain the integrity of the original DOCument file.

HLP HeLP files are special Ascii text files that are used by HELP.COM to provide help for many programs and CP/M instructions.

ASM ASseMbly files are Ascii text source files. These files must be assembled by ASM.COM to produce executable .COM files.

C These are extensions which are Ascii text source files that are used by that language's compiler.

FOR

PAS

REL RELocatable object code files are output by the MicroSoft assembler.

DAT DATA files are in various formats and they contain.

LBR LiBRary files are collections of files that usually related and written to the disk in a compressed format. See NULU.COM explanation above.

HEX HEX files are Ascii files that are in the Intel Hex format which is very similar to a standard hex dump.

You will find file extensions that have a letter 'Q' for the second letter. These are 'squeezed' files and you must unsqueeze these files prior to use. Lastly, many applications use an extension that is unique to them. For example, .CAL is used by the SUPERCALC spreadsheet (not public domain).

Let's stop there until next issue. Next time I'll give a couple routines to move files between Timex mode and CP/M, as a means to demonstrate the use of a CP/M function call.

Syd Wyncoop
15951 Rosalita Drive
LaMirada, Ca 90638

The Printer Revolution

Just as the year 1989 gets into full swing the printer industry is going through an evolution. The 24 pin dot matrix printers are driving the 7 and 9 pin printers from the market. Some dealers may get hurt if there are stocks of 7 and 9 pin printers on hand.

These older printers that sold from \$300 to 900 just last year are now being dumped for as low as \$150, a good buy for those willing to settle for "NLQ".

The 24 pin printers started before Christmas at high prices, but as we enter March, we see the Epson LQ-500 offered at

\$299.00! a \$200 drop in price in just three months. The Seikosha SP-1000 that I bought two years ago for \$325.00 can now be found for \$150.

The prices of Daisy Wheel printers could be affected also. Until now, the difference in print quality between Dot Matrix NEAR Letter Quality, and the output of a Daisy Wheel printer was as night and day. The Daisy should still maintain an edge because of the "bleeding" characteristics of dot matrix print. Ink bleed is caused by the tiny wires of the dot matrix printer actually puncturing the paper. This shows up markedly in copies made of the two products.

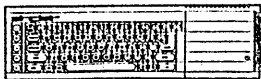

Style Sheets, Formats and Macros

by Peter Hale

The other day I demonstrated **TASKMASTER** to my QL user group. As bug eyed as all were over **TASKMASTER**, the hit of the show was my use of style sheets in Quill and Abacus.

There's a lot about Formats, Style Sheets, and, most commonly, Macros in the computer press. What few at the meeting realized is that the QL has them all, although you need Toolkit II or KeyDefine to make macros.

STYLE SHEETS are most common in word processing. I dislike Quill's default page design, particularly the footer which is inappropriate in correspondence.

I create a document of my letterhead with design, margins, footer, justification and tabs the way I like them. I have both my box number and my street address, together with a dummy date and salutation. I include a reminder of the control codes I use in Quill to make the printer do double-wide and elite type faces. I save that as `flpl_setup_doc`.

Now when I power up in Quill, I load `flpl_setup`, position the cursor to delete whichever lines of my return address I am not going to use, go into **OVERWRITE** mode to enter the correct date and salutation, and I am off and running, knowing that the letter will have my desired design and format.

Among my dozen or so style sheets I have one sheet with the correspondence parameters called `close_doc`. This has my 'Sincerely yours,' etc. I position the cursor at the bottom and merge `close_doc`.

FORMATS are commonly mentioned in the context of spreadsheets and databases but are really nothing more than style sheets.

As far as Abacus is concerned, it need be nothing more than a template that you have saved as `flpl_setup_aba`, with the design features, grid, numerical and text justification, and units you prefer on startup. You may have `setup1`, `setup2`, etc. for different applications or column headings.

Archive isn't so amenable, unless you have a suite of procedures that you commonly use in your programs, such a might permit single key movement around a database or search for records to delete.

MACROS, too, are most commonly mentioned in the context of spreadsheets and databases. The definition of a Macro tends to depend on whom you ask. It seems to refer to style sheets and formats that can be loaded with only one or two key strokes.

With Toolkit II or KeyDefine operating in your QL you can dedicate certain key combinations to perform a desired sequence of instructions.

With Toolkit II have a line in the boot:
`ALTKEY "s",chr$(240)&"sflpl_setup"&chr$(10).`

While in Abacus, press `ALT+s`. The template `setup` will be automatically loaded from `flpl_`.

Within Quill the same `ALT + s` will load `flpl_setup_doc`.

If you commonly work without the prompt window, avoid the need to press F2 on startup by including `chr$(236)&` just prior to `chr$(240)` in the `ALTKEY` example above.

Similarly, having the line: `ALTKEY "g",chr$(240)&"gw?","b","f"&chr$(10)` in the boot will let `ALT + g` set the grid width to 7 in columns B through F in Abacus.

With KeyDefine a similar series of `ALTKEY` functions can be created.

KeyDefine lets you create chains of commands (formats) that will sequentially set parameters. That is, you can set a given `ALTKEY` combination to invoke a series of KeyDefined functions. (Not possible with Toolkit II.)

Only your imagination limits the possible applications but note a few realities.

Long `ALTKEY` and KeyDefine strings proceed only as fast as the characters can be sent to the screen. There is a point at which it is quicker to load a file from medium.

Any QL character, no matter how awkward the key combination, can be set to an `ALTKEY` under Toolkit II. Thus `ALT A` and `ALT a` can have separate functions attached to them.

If operating under a multi-tasking front end such as **TASKMASTER** that also uses `ALT` functions, be sure to restrict dedicated `ALTKEY`'s to characters that are not used.

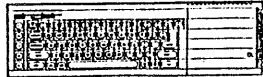
**QLAND_LORD**

A Review By Roy Arsenault

VERSION REVIEWED: V. 1.0

REQUIREMENTS: 256k RAM and Archive V. 2.0 or later

SOFTWARE PUBLISHER: EMSOFT DIV., ESTATE MANAGEMENT SERVICES,
P.O. Box 8763, Boston, MA 02114-8763, (617) 889-0830

OVERALL PERFORMANCE: Excellent

DOCUMENTATION: Very good

ERROR HANDLING: Very good

EASE OF USE: Excellent

SUPPORT: Very good (phone support 9AM-6PM Eastern)

PRICE: \$19.95 5 1/4 Disk or \$21.95 Micro Cartridge

I obtained a copy of QLAND_LORD because of my interest in Financial and Data Base software. QLAND_LORD as the name implies is designed to aid in the management of real estate. It provides complete detailed record keeping for all financial transactions, prints rent receipts, provides quarterly reporting and prepares the data required for IRS Schedule E tax reporting. A future release will provide for check printing.

The software is easy to use and menu driven. I had to refer to the manual only once during my initial usage. Some other features are:

- * Manages up to 99 units in a single file.
- * Records can be ordered by unit, date, or type of transaction.
- * Security and key deposits are maintained separately from cash flow.
- * Procedures for opening and closing the books for varying reporting periods are supported.
- * The program code is unprotected for easy editing and enhancing.

QLAND_LORD represents an excellent value and is at least two cuts above the boring blue world.

-- See EMSOFT Ad, page 48 this issue.

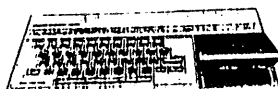

Low Cost Voice Recognition For the TS-2068

By: John McMichael

With a new chip recently offered for sale through Radio Shack distributors and a few other parts, a speaker-independent word recognition circuit can be easily and inexpensively built. This article will describe how to build the circuit and interface it to a TS2068 via a joystick port.

The new VCP200 chip has two speech recognition modes: Command Mode and Yes-No/On-Off Mode. In the Command Mode, the chip can recognize five motion related commands: GO, STOP, LEFT TURN, RIGHT TURN, and REVERSE. In the Yes-No/On-Off Mode, it recognizes two sets of commands: either YES and NO or ON and Off. When a command is recognized, the associated output for that command is latched at a logic low. In addition to the two outputs for the yes-no/on-off mode, there is also a "command not recognized" output. The VCP200 chip comes with Radio Shack's own technical data sheet, application info., theory of operation, and a diagram for a circuit in which one of five LED's will light in response to a spoken command. I modified Radio Shack's circuit by replacing the LED's with optoisolators. The output sides of the optoisolators are wired to a standard 9-pin female joystick plug for mating with either of the TS2068's two joystick ports. By using the BASIC "STICK" command, the status of the VCP200's command output latches can be read and used as spoken input to a program. Among other applications, the circuit can be used as a voice controlled joystick. While limited to recognizing just a few fixed words, the beauty of this circuit is that NONE of the TS2068's RAM is required. To use it is as simple as plugging it in and turning it on.

BUILDING THE CIRCUIT

The circuit can be built on a general purpose pre-punched .100" X .100" grid board by soldering wires from point to point, or by etching a single sided copper-clad board using the layout pattern shown in the solder side diagram. In either case, the minimum size board you'll need is 3 3/4" X 2". The circuit is designed to operate at 5 volts DC and draws about 50 ma. If you don't have a 5 volt DC power supply, you can use a 9 volt DC supply (such as a TS1000 or 2050 modem uses) and a LM7805 voltage regulator IC (U3). If you are comfortable with the reliability of battery power, a 9 volt battery may be used. If you have a regulated 5 volt DC supply, you can omit the LM7805 regulator and solder a wire

jumper from U3's "IN" pad to U3's "OUT" pad and make the 5 volt supply connections to the pads labeled "9V. DC". The circuit can be turned on and off independently of the TS2068. A SPST toggle or slide switch can be soldered to the pads labeled "PWR SWITCH". If you do not want a power switch, install a wire jumper between the "PWR SWITCH" pads. I soldered a cannibalized joystick plug wires to the p.c. board as shown in the hook-up diagram.

The following table shows how the vocalized commands for each mode correspond to a joystick's directions and fire button:

VOCALIZED COMMAND		JOYSTICK DIR./FIRE BUTTON
MODE 1	MODE 2	
"GO".....	"NO"/"ON".....	UP
"REVERSE".....	(no recog.).....	DOWN
"TURN RIGHT"...	"YES"/"OFF".....	RIGHT
"LEFT TURN".....		LEFT
"STOP".....		FIRE BUTTON

As some programs require the "fire" button to be activated while a cursor is being moved, a normally open pushbutton can be wired parallel with the optoisolator's output associated with the "STOP" command. The optoisolator IC (U5) can be eliminated for manual pushbutton "fire" only. Wire this pushbutton to the pads marked "FIRE SWITCH".

You may also find that a second normally open pushbutton for resetting the VCP200 to be very useful. Because a recognized spoken command results in a latched output, problems can arise when the voice actuated joystick is used with certain programs. For example, when used with TECH-DRAW JR, the command "TURN RIGHT" will cause the cursor to move right across the screen. Vocalizing a command not recognized by the VCP200 such as "SIT" will stop the cursor, but even speaking the words as fast as possible, in the time it takes to say "TURN RIGHT" and "SIT" the cursor can traverse a large part of the screen. By using a pushbutton to reset the VCP200, the "unlatching" of a spoken command can be done as fast as you like. Wire this pushbutton to the pads labeled "RESET SWITCH" on the p.c. board.

Selection between the two speech recognition modes is done with jumper (J1). The five motion commands are selected with (J1) installed and the second yes-no/on-off mode is selected with (J1) removed. A SPST toggle or slide switch can be wired in place of (J1) for facilitating mode switching.

Parts List

- C1 = .22 uf
- C2 = 47 pf
- C3,C4,C12 = .01 uf
- C5 = 4.7 pf
- C6,C7,C11 = .1 uf
- C8 = 10 to 22 uf tantalum
- C9,C10 = 27 pf
- R2,R5 = 1 K
- R3,R6,R13 = 10 K
- R4 = 470 K
- R7 = 470 k to 750 K
- R8 = 10 Meg
- R9 = 15 K
- R10 = 5.6 K
- R11 = 4.7 K
- R12 = 100 K
- R17 = 470
- U1 = LM324 quad op-amp IC (R.S. cat.# 276-1711)
- U2 = VCP200 word recog. IC (R.S. cat.# 276-1308)
- U3 = LM7805 5-volt req. IC (R.S. cat.# 276-1770)
- U4 = quad optoisolator (D.K. part # PS2501-4NEC)
- U5 = single optoisolator (D.K. part # PS2501-1NEC)
- Y1 = 10 MHz crystal (D.K. part # X057)
- MIC = Electret mike element (R.S. cat.# 270-092)
- SWITCHES = 2-n.o. pushbutton; 2-SPST toggle/slide
- PLUG = Replacement ATARI joystick plug w/wires
- MISC.: 2-20 pin and 1-14 pin IC sockets
- * = Optional depending on configuration - see text

Parts Suppliers

- R.S. = RADIO SHACK
- D.K. = DIGI-KEY CORP., 701 Brooks Ave. South, P.O. Box 677, Thief River Falls, MN 56701-0677

TESTING THE CIRCUIT

The VCP200 voice recognition test program will allow you to test your circuit by indicating on the screen which word is spoken for either of the two voice recognition modes. Accurate and consistent pronunciation of command words is very critical. The VCP200 test program will give you a visual confirmation that your pronunciation is correct. The data sheet that comes with the VCP200 chip has many helpful suggestions for optimizing voice recognition reliability - be sure to read it!

While the VCP200 voice recognition circuit can be used as a substitute for a joystick with some programs, it does not have the response speed and accuracy required by some joystick oriented software. I'm certain that some interesting programs can be adapted to or written specifically for voice input. I would very much like to hear from anyone who experiments with the VCP200 circuit. Address

your letter to: John McMichael, 1710 Palmer Dr., Laramie, WY 82070. I would also like to thank M.D.M. Enterprises for developing the super p.c.b. designer program "PC-DRAW" which was used to draw the circuit diagrams for this article.

```

1 REM *****
*****
2 REM * VCP200 TEST PROGRAM *
3 REM *****
4 REM ** by John McMichael **
10 CLS : PRINT AT 0,2; INVERSE 1;"VCP200 WORD RECO
GNITION TEST": INPUT "Using recognition mode 1,2? ";
a$: IF a$(">"1" AND a$(">"2" THEN GO TO 10
20 LET rp=7: PRINT AT 5,5; INVERSE 1;"MODE 1";AT 5
,22;"MODE 2"; INVERSE 0;AT 7,1;"not recognized";AT 8
,1;"STOP";AT 9,1;"GO";AT 10,1;"REVERSE";AT 11,1;"LEF
T TURN";AT 12,1;"TURN RIGHT";AT 5,22;AT 9,18;"NO or
ON";AT 10,18;"not recognized";AT 12,18;"YES or OFF"
30 LET s= STICK (1,1)
40 IF STICK (2,1)=0 AND s=0 THEN LET r=7+(3 AND a$
="2"): GO SUB 100: GO TO 30
50 IF s=0 THEN LET r=8: GO SUB 100: GO TO 30
60 LET r=8+s-(s=4)-(4 AND s=8): GO SUB 100: GO TO
30
100 PRINT AT rp,0+(17 AND a$="2");" ";AT r,0+(17 AN
D a$="2"); INVERSE 1;">": LET rp=r: RETURN
    
```

ED NOTE: John says that if as many as 15 folks want a READY to USE circuit board that he will make one available. Letters to: John McMichael, 1710 Palmer Drive, Laramie, WY 82070.

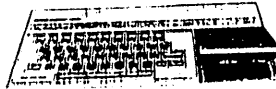

HOOK-UP DIAGRAM

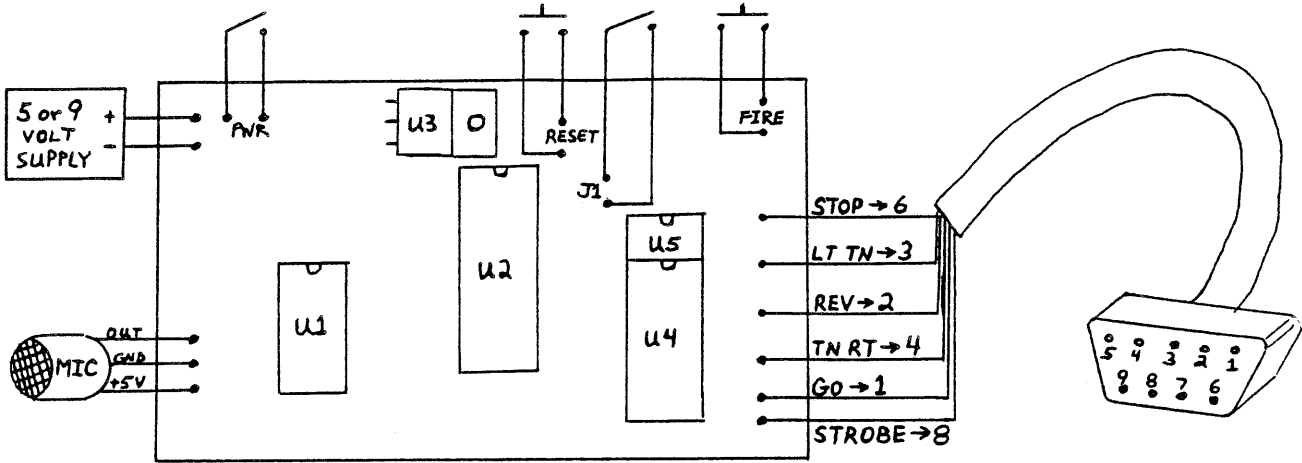

M D M Enterprises PC-DRAW 3.0 12/18/88
SOLDER

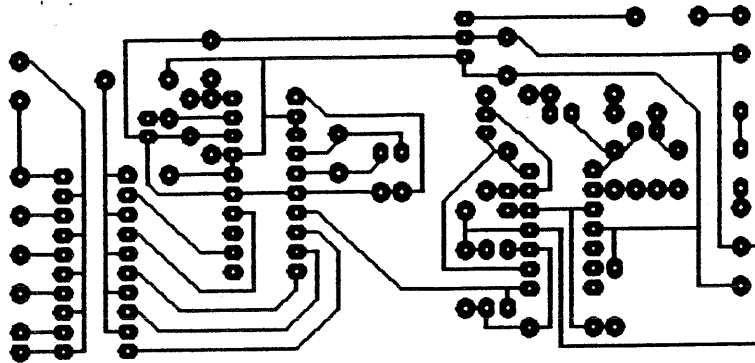

M D M Enterprises PC-DRAW 3.0 12/18/88
COMPONENT

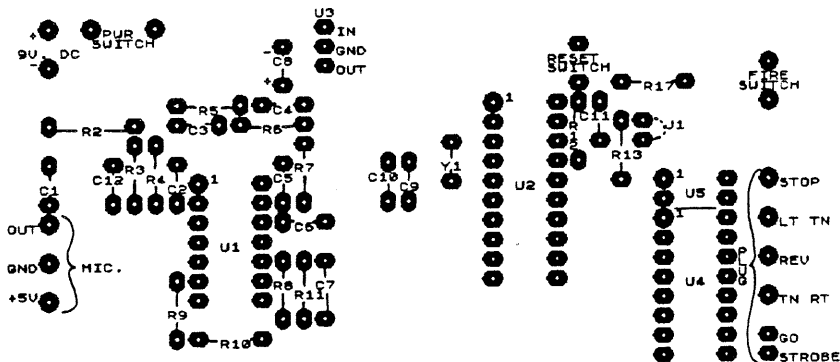



The CABLE COLUMN

WOOD AND WIND COMPUTING

Bill Cable : RR 2 Box 92 : Cornish, NH 03745 : 603 675 2218

PROGRAMMING IN ARCHIVE

In the last 2 issues of UPDATE you were introduced to ARCHIVE, the excellent database program supplied with every QL. You were encouraged to try it if you haven't already because almost every computer user has applications that involve the storage and retrieval of information. When you load ARCHIVE, your QL becomes a powerful information handling machine. The IBM version of ARCHIVE (PC-FOUR for \$99) is just like our QL ARCHIVE. In fact these articles can be used as tutors for IBM clone users who have it and these programs will work on their IBM machines. So ARCHIVE can be used on millions of machines.

You will find that although ARCHIVE is very powerful it is not convenient to use unless you put the tasks you want to accomplish in programs so you can quickly call them up and execute them. What a drag you say. Well you can purchase quality ARCHIVE based programs for specific applications that don't require knowledge of ARCHIVE programming. But have you tried the language? It is a very nice language and its implementation on the QL is very efficient and well behaved. The ARCHIVE language is a procedure oriented language like SUPERBASIC but without line numbers. When you write a program in ARCHIVE you make a series of procedures. These are blocks of code with a name. When you need the task done that the procedure provides you simply use its name. That part of the program will be executed and you will return to where you were.

How can you keep track of your program without line numbers you ask? ARCHIVE has a nice built-in program editor (think of it like a word processor for writing programs) just for that purpose. It does it all for you automatically. When you enter the program edit mode any loaded procedures are listed alphabetically on the left side of the screen. The procedure being edited is in bold face and its lines appear on the right. You change which procedure to edit by pressing <TAB> or <SHIFT><TAB>. You choose your edit location within the procedure's lines (on the right) by the up arrow and down arrow keys. You do your editing at the bottom of the screen. It very convenient and much easier than SUBPERBASIC program editing. The editor automatically indents conditional statements and loops for easy reading. Because the language has very good error messages, giving procedure name and the line where the error occurs and the editor is so quick at hand you can debug very fast.

So let's try entering a small program called 'e' which allows us examine a database with single key presses. You can try it on the gazet database provided with ARCHIVE. You can easily customize it for your own purposes. This exercise will introduce you to ARCHIVE programming. We won't worry about how the program works but rather the more basic skill of how you enter and edit a program. Have the ARCHIVE section of your user's manual open. You can look up the commands and functions there for more detail. At the end of the article is a list of the the commands you should be familiar with for program editing in ARCHIVE. Keep it handy as a quick reference.

ENTERING AN ARCHIVE PROGRAM

Below I will go through all the keystrokes necessary to enter a short but useful program that consists of 2 procedures. One procedure is called 'e' for examine and the other 'sfind' for string find. What you should type in will be in bold and my comments with be in (), <ENTER> means press the ENTER key. Most of the editing takes place at the bottom of the screen. If you make a detectable typo the editor will reject your line and force you to redo it. Otherwise correct mistakes after you enter the procedures.

Start up ARCHIVE by resetting and putting the DATABASE (ARCHIVE) cartridge in mdv1_ and pressing <F1>. ARCHIVE loads and we are in command mode. Put a formatted cartridge in mdv2_ to save the finished program to. We will activate the program editor, enter our 2 procedures, save the program, and run it. Watch the top screen boxes as they tell you what to do also.



edit<ENTER> (activate the program editor)

The editor activates. No procedures are loaded and the editor prompts for the name of our procedure. Type in its name and then the lines of the procedure.

e<ENTER> (name of this procedure)

```
cls<ENTER> (lines of the 'e' procedure)
input at 2,1;"Look at which database [device_name] : ";ans$<ENTER>
look ans$<ENTER>
mode 0<ENTER>
display<ENTER>
let c$=""<ENTER>
while c$<>"e"<ENTER>
  sprint<ENTER>
  print at 14,58;"KEY OPTIONS ";recnum();" "; at 15,60;"b back";<ENTER>
  print at 16,60;"n next"; at 17,60;"f first"; at 18,60;"l last"<ENTER>
  print at 19,60;"s string find"; at 20,60;"c continue"<ENTER>
  print at 21,60;"e exit";at 23,58;"** press a key **"<ENTER>
  let c$=getkey()<ENTER>
  let c$=lower(c$)<ENTER>
  print at 23,50;rept(" ",30)<ENTER>
  if c$="b": back : endif<ENTER>
  if c$="n": next : endif<ENTER>
  if c$="f": first : endif<ENTER>
  if c$="l": last : endif<ENTER>
  if c$="s":sfind: endif<ENTER>
  if c$="c": continue : endif<ENTER>
endwhile<ENTER>
close<ENTER>
mode 1<ENTER>
```

We are done with our first procedure. To end it press :

<ESC> (end entering first procedure)

We will now make one more procedure. To create a new procedure type :

```
<F3>n (edit command for new procedure)
sfind<ENTER> (new procedure name)

print at 23,50;rept(" ",30)<ENTER> (lines of the sfind procedure)
input at 23,50;"Find what : ";i$<ENTER>
if i$<>"": find i$: endif<ENTER>
print at 23,50;rept(" ",30)<ENTER>
if not found(): print at 23,60;"Not found": endif<ENTER>
```

We are done entering the 2nd procedure so let's exit from inserting

<ESC> (exit from inserting lines)

Now let's exit from the program editor and save our program and print it out.

```
<ESC> (exit from the program editor to ARCHIVE command mode)
save "mdv2_eprog"<ENTER> (actually saved as mdv2_eprog_prg)
l1ist<ENTER> (do only if you have a printer and put if online)
```

Now let's run it.

```
e<ENTER> (activate the e procedure)
mdv1_gazet<ENTER> (our program prompts for a database, let's use gazet)
```

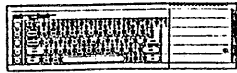

Now play with the menu options. If everything works well you have done good. If you get an error, note where it occurred and the error message and type :

```
close<ENTER>           (close database if left open by the error)
mode 1<ENTER>         (mode 1 has upper display box visible)
```

Check you printout against the instructions above for typos. When you determine the problem use the editor to correct it and rerun it. Program structure fault means if-endif or while-endwhile don't pair up. Below are the basic commands needed. Don't forget to save your corrected version.

ARCHIVE PROGRAM EDITING COMMANDS

1. When in ARCHIVE Command mode (not in the ARCHIVE program editor)

```
Start the editor      edit<ENTER>           (from within ARCHIVE)
Load a program       load "()"<ENTER> (where ()=device_name, ie. mdv2_prog)
Save a program       save "()"<ENTER> (where ()=device_name, ie. mdv2_prog)
Start a procedure    ()<ENTER>         (where ()=procedure name)
print a program      llist<ENTER>      (list out loaded procedures)
```

2. When in the ARCHIVE program editor (not in ARCHIVE command mode)

```
Stop the editor      <ESC> or <ESC><ESC> (returns to ARCHIVE command mode)
Make a new procedure <F3>n<ENTER> (new procedure command)
                   ()<ENTER> (where ()=name for procedure)
                   <enter lines of procedure>
                   <ESC> (when done)
Move to a procedure  <TAB> or <SHIFT><TAB> (until its name is in bold)
Move to a line       <up arrow> or <down arrow> (until it is in bold)
Insert new lines     {move to line just above where they go}
                   <F4> (insert command)
                   {now insert lines}
                   <ESC> (when done)
Edit a line          {move to the line to be edited with arrow keys}
                   <F5> (now edit line at bottom of screen, use arrows)
                   <ENTER> (when line is okay)
Cut (Delete) line(s) {position on 1st line to be deleted with arrow keys}
                   <F3> c (cut command)
                   {use up or down arrow to mark those to be deleted}
                   <ENTER> {delete marked lines or <ESC> to abort)
Paste (copy) Lines  {Cut them as above}
                   {move to procedure & line to put them}
                   <F3> p <ENTER> {they will be pasted in place}
Delete a procedure  {Move to procedure to delete by <TAB> & <SHIFT><TAB>}
                   <F3> d <ENTER> (its gone)
```



 Customized Catalog Command for LKdos by Larry Kenny

This is an alternative Catalog command that can be added to your programs or to use when modifying an existing program for disk. It only prints the selected filenames in a single column without any other info such as disk name or disk parameters. It works very well with windows such as the ones in LKdos or in a program like Art Studio that uses pulldown menus.

This machine code routine is relocatable and is 120 bytes long. You can use an assembler to enter the assembly language source code on the next page or just enter the decimal values into memory at almost any address (40000 is ok) then save the code.

It will also fit into the printer buffer at address 23300. The syntax for the command is the same as the Cat command in the dos and it supports selected searches and wild card character '^' the same as the dos on eprom. When using the new command, the USR call is to the address where you loaded the code.
 EG: RAND USR 40000: CAT "", (or CAT".C", etc)

Further Customizing - You can change the first command from LD A,2 to any channel number eg: LD A,3 will send it to printer or LD A,5 can be used for a window attached to chanel 5 Also you can modify the width of the cat listing by changing the return added on line 770 of the assembly listing to printing a few spaces instead which will let you print up to 3 file names per line. If you want to run entirely from machine code then remove the lines 210 to 260 and transfer your search string directly to program terminated by a ".".

The Basic program below is a demo to show the Cat command being used with Windows. If you are using a version 2 eprom be sure to load a narrow character set for the windows.

```

5 REM -- WINDOW CATALOG DEMO --
10 RANDOMIZE USR 100: OPEN #4,"dd"
20 PRINT #4: CLOSE #2
25 CLS : PRINT INVERSE 1;"BASIC FILES","CODE FILES"
30 IF INKEY$="b" THEN GO TO 100
40 IF INKEY$="c" THEN GO TO 200
50 GO TO 30
100 PRINT #4: OPEN #2,"w0"
120 PRINT #4: INPUT #0,1,0,20,20
130 RANDOMIZE USR 40000: CAT ".B",
150 PAUSE 0: GO TO 20
200 PRINT #4: OPEN #2,"w0"
230 PRINT #4: INPUT #0,1,16,30,20
240 RANDOMIZE USR 40000: CAT ".C",
250 PAUSE 0: GO TO 20
    
```

Decimal Dump of Custom Catalog

62	2	205	48	18	243	205	98	0	175
50	29	32	205	126	0	205	123	0	231
205	156	0	235	121	254	0	32	3	33
34	32	54	34	205	141	0	33	136	32
35	126	254	250	202	186	0	254	255	32
245	35	126	254	254	40	239	34	176	92
6	9	17	34	32	26	254	34	40	31
254	94	40	8	190	40	8	35	16	241
24	214	19	24	236	26	254	94	40	7
254	34	40	7	190	32	199	19	35	24
240	42	176	92	6	9	126	35	229	197
215	193	225	16	247	62	13	215	24	176

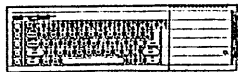

Customized Catalog Command

by Larry Kenny

```

00010 ORG 40000 - Can be anywhere
00020 wrkspc EQU 8220 - Work area in cartridge
00040 data EQU wrkspc +108 - Address of data block in Lkdos
00050 curtrk EQU wrkspc +1 - Holds the current block number
00060 progmn EQU wrkspc +6 - Buffer in Lkdos for String$
00070 LOADBF EQU 123 - Dos call to load disk to buffer
00080 TRACK EQU 126 - Move drive head to (curtrk)
00090 ENDLN EQU 141 - Move CHAD to end of Basic line
00100 GTFIL EQU 156 - Get file name or string from command
00110 JPOUT EQU 186 - Exit the cartridge
00120 ;
00130 CAT LD A,2 - Open channel 2 (or any channel)
00140 CALL #1230
00150 DI
00160 CALL 98 - Turn on cartridge
00170 XOR A
00180 LD (curtrk),A
00190 CALL TRACK - Move head to Track 0 side 0
00200 CALL LOADBF - Load disk Catalog to buffer
00210 RST 32
00220 CALL GTFIL - Evaluate String$ in Cat command
00230 EX DE,HL - and place result at progmn
00240 LD A,C
00250 CP 0 - If length of string = 0 then
00260 JR NZ,QUOTE
00270 LD HL,progmn - put end quote right at start
00280 QUOTE LD (HL),34 - of the string buffer
00290 CALL ENDLN - move Basic pointer to next command
00300 LD HL,data - set HL to start of Catalog
00310 FNDNAM INC HL - Look for start of next name cell
00320 LD A,(HL)
00330 CP 250 - If 250 then end of Catalog
00340 JP Z,JPOUT - and exit cartridge
00350 CP 255 - 255 means the start of a name cell
00360 JR NZ,FNDNAM
00370 INC HL
00380 LD A,(HL)
00390 CP 254 - 254 means Cell not used or deleted
00400 JR Z,FNDNAM
00410 LD (23728),HL - Store the start address of the Cell
00420 LD B,9 - Length of file name
00430 LD DE,progmn - Point to search string$
00440 First LD A,(DE) - Find first char of search string
00450 CP 34 - end of search string ?
00460 JR Z,Print - If so then print it
00470 CP 94 - Is Wild card first character ?
00480 JR Z,Wild1
00490 CP (HL)
00500 JR Z,Match - Start of search string found ?
00510 INC HL
00520 DJNZ First
00530 JR FNDNAM
00540 Wild1 INC DE - Move past the wild card character
00550 JR First
00560 Match LD A,(DE) - Check if entire string matches
00570 CP 94
00580 JR Z,Wildc - If Wild card then dont check it
00600 CP 34
00610 JR Z,Print
00620 CP (HL) - If string doesnt match then
00630 JR NZ,FNDNAM - go and find next name cell
00640 Wildc INC DE
00650 INC HL
00660 JR Match - Check next character
00670 Print LD HL,(23728) - Print the file name
00680 LD B,9 - print 9 characters
00690 Pnext LD A,(HL)
00700 INC HL
00710 PUSH HL
00720 PUSH BC
00730 RST 16 - send to current channel
00740 POP BC
00750 POP HL
00760 DJNZ Pnext
00770 LD A,13 - Print carriage return
00780 RST 16
00790 JR FNDNAM
    
```

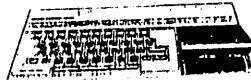

LARKEN DIRECTORY (Track 0) REPAIR
by G. Chambers

The track directory for the Larken disk system is located on track 0. This directory stores the data that is required by the system to locate and load the chosen file. On occasion the system, for obscure reasons, is prone to corrupting the directory track, thus effectively causing the loss of all programs on the disk. This problem is more apparent on the first vintage of the system, nevertheless it could occur on any system. This program is designed to restore the track directory to its pristine newness!!

The program is able to do this because of the design of the LARKEN system whereby the program name (also it's starting address, and length) is stored at the beginning of each track.

The program commences by working it's way through the disk, track by track, picking the program name off each track. It stores this information in a string array, then using this information it reconstructs a new directory in memory and saves it to track 0.

Although the program does a very effective job there are a couple of points to be aware of. The program will restore to the directory track a record of every program file that it finds on the disk. This includes any programs which may have been erased in the original state. Now, this in itself does not present a problem. A problem can arise however, if the erased program is not complete, i.e. some of it's tracks have been reused with by a subsequent SAVE. In this case a program will be shown as recovered, but in fact it has been only partially recovered. The solution is to do a manual erase of any such programs.

The program listing here is for LARKEN systems which hold 5090 bytes/track. This is the system which is currently being marketed by Larken Electronics. I have provided a list of the program lines which need to be changed to make the program suitable for the earlier LARKEN systems which hold 1960 bytes/track.

100 REM Disk Directory
Repair for the LARKEN system

110 REM By G. Chambers
14 Richome Court Scarbo
rough, Ont. CANADA M1K 2Y1

120 REM Use to reconstruct a dama
ged Directory(Track 0)

130 REM Data statements contain
the"RHMDOS.C2" Code.

136 REM For use with the OSK400 syst
em of 5090 bytes/track using DD drives
i.e.80 tracks

140 GO TO 160

```

150 RANDOMIZE USR 100: SAVE "repair.01" L
INE 160
160 RESTORE 210
170 FOR n=63000 TO 63104
180 READ a: POKE n,a
190 NEXT n
210 DATA 195,43,246,195,72,246,195,104,24
6,243,205,98,0,201,58
220 DATA 100,0,251,201,205,33,246,58,176,
92,50,29,32,205,126
230 DATA 0,205,123,0,33,112,32,17,156,224
,1,0,20,237,176
240 DATA 195,38,246,205,33,246,58,176,92,
50,29,32,33,156,224
250 DATA 17,112,32,1,0,20,237,176,205,150
,0,205,126,0,205
260 DATA 120,0,195,38,246,205,33,246,205,
129,0,205,123,0,33
270 DATA 112,32,17,156,224,1,0,20,237,176
,195,38,246,201,0
290 DIM a$(79,9): DIM c$(79,9): DIM b$(9)
: DIM d$(256)
300 LET trac=23728: LET nexttrack=63006:
LET loadbuf=63000: LET savebuf=63003
310 LET 0=79: LET e=1: LET f=1: LET buffe
r=57500: LET name=57688: LET trackno=5769
8
312 BORDER 1: PAPER 1: CLS
320 PRINT AT 2,7: INK 2: PAPER 6:"LARKEN
DISK UTILITY": PAPER 1:,,TAB 2: PAPER 6:"
Directory (Track 0) Recovery": PAPER 1,,T
AB 7: PAPER 6:"By George Chambers"
325 INK 3: PLOT 0,108: DRAW 0,62: DRAW 25
5,0: DRAW 0,-62: DRAW -255,0
326 INK 6: PLOT 8,114: DRAW 0,50: DRAW 23
8,0: DRAW 0,-50: DRAW -238,0: INK 7
340 POKE trac,0: RANDOMIZE USR loadbuf
350 PRINT AT 10,0;d$:AT 14,2;"Insert your
defective disk""TAB 2;"and press any ke
y to start": PAUSE 0
360 REM Picking program names off
each successive track
370 POKE trac,1: RANDOMIZE USR loadbuf
380 PRINT AT 10,0;d$
390 PRINT AT 10,0;d$:AT 10,1;"Lifting nam
es off disk tracks";AT 13,8;"Track Prog
ram"
400 PRINT AT 14,9;"No. Name"
410 FOR n=1 TO 79
415 IF n>1 AND PEEK 57500=0 AND PEEK 5750
1=0 THEN LET n=79: GO TO 490
420 LET d=n
430 FOR m=1 TO 9
440 LET a$(n,m)=CHR$ PEEK (57501+M)
450 NEXT m
460 PRINT AT 16,9;n;" ";a$(n)
480 IF n<79 THEN RANDOMIZE USR nexttrack

490 NEXT n
500 REM Placing Used/Free track reco
rd in buffer (Track 0)
    
```

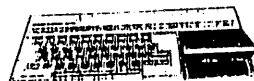

```

501 PRINT AT 10,0;d$;AT 14,1;"Install a n
ewly-formatted disk""TAB 6;"and press an
y key": PAUSE 0
502 POKE trac,0: RANDOMIZE USR loadbuf
503 PRINT AT 10,0;d$;AT 14,1;"Now re-inse
rt defective disk""TAB 2;"and Press any
key to continue": PAUSE 0
520 FOR n=0 TO d
530 POKE 57524+n,245
540 NEXT n
550 REM Compile the program
names into C$ array
560 PRINT AT 9,0;d$;AT 9,0;"Reconstructio
n of the directory will take a couple of
minutes""TAB 10;"Please wait""TAB 4;"Co
mpiling program names"
570 LET c$(1)=a$(1)
580 FOR n=2 TO d
590 LET b$=a$(n)
600 LET f=0
610 FOR m=1 TO e
620 IF b$=c$(m) THEN LET f=f+1
630 NEXT m
640 IF f=0 THEN LET e=e+1: LET c$(e)=b$
650 PRINT AT 16,11;c$(e)
660 NEXT n
670 REM Poke pgm names into
buffer(Track 0)
675 PRINT AT 13,0;d$;AT 14,0;"Putting tra
ck names in directory"
680 FOR n=1 TO e
685 PAUSE 30
690 FOR m=1 TO 9
700 POKE name+m,CODE c$(n,m)
710 NEXT m
720 LET name=name+34
730 PRINT AT 16,11;c$(n)
740 NEXT n
750 REM Poke track numbers in
to buffer (Track 0)
760 LET f=1
770 PRINT AT 13,0;d$;AT 14,0;"Putting Tra
ck No's in Directory"
780 FOR n=1 TO e
790 LET f=1
800 FOR k=1 TO 79
810 IF c$(n)=a$(k) THEN POKE trackno+f,k
: LET f=f+1: POKE trackno+f,249
820 NEXT k
830 LET trackno=trackno+34
840 PRINT AT 16,11;c$(n)
850 NEXT n
860 PRINT AT 9,0;d$;AT 10,1;"The director
y has been rebuilt"" PAPER 5; INK 2;"R
emove WRITE-PROTECT label from defective
disk and install. "" Press a key to
save to track 0 ": PAUSE 0
870 POKE trac,0: RANDOMIZE USR savebuf
880 PRINT AT 11,0;d$;AT 13,9;"JOB COMPLET
ED": PAUSE 0
    
```

```

890 STOP
1000: SAVE "repair" LINE 10
    
```

The following lines should replace those in the "REPAIR.B1" listing to make the program suitable for the LARKEN systems that format to 1960 bytes per track i.e. the earlier systems.

```

135 REM For disks made prior to the Larke
n cartridge DOS, modify lines 720 and 830,
replacing the 34 in each line with a
33.
136 REM Use only with the LKDOS system
i.e. 1960 bytes/track.
240 DATA 195,38,246,205,33,246,50,176,92,
50,29,32,33,16,248
250 DATA 17,112,32,1,192,7,237,176,205,15
0,0,205,126,0,205
270 DATA 112,32,17,16,248,1,192,7,237,176
,195,38,246,201,0
310 LET D=79: LET e=1: LET f=1: LET buffe
r=63500: LET name=63600: LET trackno=6361
8
415 IF n>1 AND PEEK 63610=0 AND PEEK 6351
9=0 THEN LET n=79: GO TO 490
440 LET a$(n,m)=CHR$ PEEK (63505+m)
480 IF n<79 THEN OUT 84,8: PAUSE 3: RAND
OMIZE USR nexttrack
530 POKE 63527+n,n+127
810 IF c$(n)=a$(k) THEN POKE trackno+f,k
+128: LET f=f+1: POKE trackno+f,249
    
```

UPDATE'S LETTER QUALITY PRINTERS FOR SALE

(Going to fast 24 pin Dot Matrix). Two Daisy Wheel (Centronics Parallel) printers for sale. Both exc cond, takes standard ribbon carts and print wheels available everywhere. Both have immaculate typewriter quality print. Both have WIDE 15" carriage. Single sheet feed and friction feed- no tractor. Both have built in data buffers of 1.5K. Manuals. Hook up to any QL or Z88 with in line Parallel intfc, or TS-2068 with Aerco, Oliger, Tasman intfc. Both prints at 17 CPS speed. Add \$10 for U.S. or \$20 Canada Shpg.

- 1 Printer Queme Compatable (TIOWA)- \$125.00
- 1 Panasonic KXP3131 Diablo Comp----- \$165.00

These printers require very little software commanding. Print styles changed by quick change of print wheels. Both have Shadow, underline, Bold styles for whatever print wheel installed. Call UPDATE to reserve. 😊

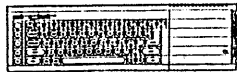

A Capslock indicator for the QL
By Harold Jastrzembki

As a professional applications programmer, I generally work on either an IBM XT/AT or a UNIX workstation. When several years ago Sinclair USA offered me a great deal on some new QLs, I jumped at the chance to own a machine capable of multitasking and I ordered several. After some experimentation, I added 512K of extra memory, disk drives, and a suitable user interface. Given the wide range of languages available and the ability to remove a program gone bad without having to re-boot the machine, made the QL an excellent machine to develop and test new software on. One thing that I found to be a minor annoyance was the lack of a capslock indicator. I was forever having to re-enter code that was typed in the wrong case, simply because I forgot which state the capslock was in. The program in the listings below was written to correct this situation.

The program CAPS is presented in two formats, an assembler listing for those with a 68000 assembler and a SuperBASIC program for those who don't. Listing 1 is the assembler listing and was written for the METACOMCO (r) MACRO ASSEMBLER. I have kept away from the macro function or special assembler directives, so the program should port easily to other assemblers. CAPS takes advantage of the systems multitasking ability to monitor two of the systems variables, SV_ARBUF(the autorepeat buffer) and SV_CAPS(the capslock flag), and control a text message to a small window. The program is written in four sections, the first being the program header. This header starts with a branch to the start of the program followed by an illegal op-code used by the system to identify the location of the job name. Lastly this is followed by the job name and if needed a pseudo-op to align the code to a long word boundry.

The next section is program initialization, first setting job priority to 1(the lowest available) so the job runs in the background. Next we open a window one character high by 4 characters long in the upper right side of the screen. Finally we set the character size to the smallest (0,0).

The next two sections are a pair of interconnected loops. The first loop starts by clearing the window and then checks SV_ARBUF, the autorepeat buffer, to see what the last key pressed was. If the last key pressed was ^Q (CTRL Q) the program then exits, removing itself from the job scheduler. Next the program looks at SV_CAPS, the capslock flag, and if flag is cleared then branch to LOOP and clear the window again. If SV_CAPS is not cleared, then the cursor is set to the first print position and write the word CAPS in the window. The program then branches back to LOOP2 and checks SV_ARBUF and SV_CAPS.

LISTING #1

```

*
*   CAPS -- A program to monitor the capslock key and print
*           an indicator message to the screen when the
*           capslock is set....
*
*   Copyright 1988 H. J. MicroSystems. All Rights Reserved.
*
*   License is granted for all non-commercial use of this
*   program.
*
MYSELF    EQU        -1
MT_FRJOB  EQU        $05      ;remove job
MT_PRIOR  EQU        $0B      ;set priority
SD_POS    EQU        $10      ;position cursor
SD_SETSZ  EQU        $2D      ;set character size
SD_CLEAR  EQU        $20      ;clear screen
UT_SCR    EQU        $C8      ;setup window
UT_MTEXT  EQU        $D0      ;write text

```

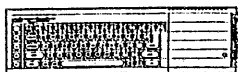

```

SV_CAPS    EQU    $28088    ;capslock flag (word)
SV_ARBUF   EQU    $2808A    ;autorepeat buffer (word)
*
*   Program header
*
        BRA.S    CAPS        ;branch to program start
        DC.L    0
        DC.W    $4AFB        ;program locator code
        DC.W    4
        DC.B    'CAPS'      ;program job name
        CNOP    0,4          ;align to long word
*
CAPS:
        MOVEQ   #MT_PRIOR,D0    ;set priority to lowest
        MOVEQ   #MYSELF,D1
        MOVEQ   #1,D2
        TRAP    #1
*
        LEA    SCR,A1            ;create window in upper
        MOVE.W UT_SCR,A2        ;right corner of screen
        JSR    (A2)
        BNE    ERROR            ;if D0 not equal to 0 error
*
        MOVEQ   #SD_SETSZ,D0    ;set char size to
        CLR.W   D1                ;smallest size
        CLR.W   D2
        MOVEQ   #-1,D3           ;no timeout
        TRAP    #3
*
LOOP:
        MOVEQ   #SD_CLEAR,D0    ;clear window
        MOVEQ   #-1,D3
        TRAP    #3
*
LOOP2:
        MOVE.L  #SV_ARBUF,A1    ;fetch last key pressed
        MOVE.W (A1),D2
        CMPI.W #17,D2           ;exit if ^Q
        BEQ.S  BYE
        MOVE.L  #SV_CAPS,A1     ;fetch capslock flag
        MOVE.W (A1),D0
        BEQ.S  LOOP            ;if clear, clear window
*
        MOVEQ   #SD_POS,D0      ;set cursor to 0,0
        CLR.W   D1
        CLR.W   D2
        MOVEQ   #-1,D3
        TRAP    #3
*
        LEA    MESS1,A1          ;write indicator message
        MOVE.W UT_MTEXT,A2
        JSR    (A2)
*
        BRA.S  LOOP2            ;loop and test
*
BYE:
        CLR.L  D0                ;no error
*

```



```

ERROR:
      MOVE.L   D0,D3           ;remove THIS job
      MOVEQ   #MT_FRJOB,D0
      MOVEQ   #MYSELF,D1
      TRAP    #1
*
SCR:
      DC.B    0               ;no border
      DC.B    0
      DC.B    0               ;paper color black
      DC.B    7               ;ink color white
      DC.W    30              ;window dimentions
      DC.W    12
      DC.W    448             ;window location
      DC.W    0
*
MESS1:
      DC.W    4               ;indicator message
      DC.B    'CAPS'
      END

```

Listing 2 is a SuperBASIC program to generate the program CAPS and is presented for those readers who don't have access to an assembler. This program reads the code (in word format) in the data statements and pokes it into a section of reserved memory. Then if the checksum matches, the program is then saved as a transient program.

To use the SuperBASIC version, you must reset or turn on your QL and type in the program in listing 2. After saving the code, run the program with a tape in mdv1 (line 280 may be changed for a different drive or filename). If an "ERROR IN DATA STATEMENTS....." error occurs, add up the numbers in each line with a DATA statement and compare with the checksums listed below:

```

LINE 290 110252
LINE 300 130401
LINE 310 168020
LINE 320 108718
LINE 330 152682
LINE 340 118648
LINE 350 129694
LINE 360 38274

```

CAPS runs in 4 color (monitor) mode only as written, but the assembler version may be modified to run in any mode and any position. Feel free to experiment with it. To run CAPS enter exec mdv1_caps into your boot file or load whenever you need a capslock indicator. To deactivate CAPS, press <CTRL Q>. A note to QRAM users, this program makes use of destructive windows and to operate correctly with QRAM you will have to run the unlock utility on it. Have fun and happy computing.

H. F. Jastrzembski

LISTING #2

```

100 REMark ***** CAPS_BAS *****
110 REMark A BASIC program to provide a capslock indicator.
120 REMark
130 REMark Copyright 1988 H. J. MicroSystems
140 REMark License is granted for all non-commercial use of this program.

```



```

150 REMark
160 baseaddr = RESPR(200)
170 addr = baseaddr:checksum = 0
180 RESTORE 290
190 FOR inx = 1 TO 64
200   READ a
210   POKE_W addr,a
220   checksum = checksum + a
230   addr = addr + 2
240 END FOR inx
250 IF checksum <> 956689 THEN
260   PRINT#0,"ERROR IN DATA STATEMENTS.....":STOP
270 END IF
280 SEXEC mdv1_caps,baseaddr,128,32
290 DATA 24590,0,0,19195,4,17217,20563,28683:REMark 110252
300 DATA 29439,29697,20033,17402,84,13432,200,20114:REMark 130401
310 DATA 26112,66,28717,16961,16962,30463,20035,28704:REMark 168020
320 DATA 30463,20035,8828,2,32906,13329,3138,17:REMark 108718
330 DATA 26400,8828,2,32904,12305,26594,28688,16961:REMark 152682
340 DATA 16962,30463,20035,17402,32,13432,208,20114:REMark 118648
350 DATA 24786,17024,9728,28677,29439,20033,0,7:REMark 129694
360 DATA 30,12,448,0,4,17217,20563,0:REMark 38274
370 STOP

```

ED NOTES: Here is how I made this program work. 1. Typed in listing 2. 2. Saved it to mdv1 by <save mdv1_caps bas>. 3. Ran the program with <RUN ENTER>. 4. A program was automatically SAVED. Later investigation revealed the saved program name was "caps".

Looking at the listing of the caps bas program, line number 280 does the SAVE of the code generated in the data statements. The <SEXEC MDV1_caps> command is on page 54 of the KEYWORD Section of the user manual. The short CODE program may be run with the EXEC command. Page 21 of the manual says that EXEC will execute a series of stored programs "IN PARALLEL" (hmmm).

EXPERIMENT: I have a disk that I put all four of the PSION softwares in for faster boot up in FLPL. The QUILL boot program was re-named "QBOOT". The other PSION boot programs were saved as "Dboot, Sboot, and Gboot. So much for the scenario. So, the next series of steps were accomplished: The objectives will become apparant soon.

5. <copy mdv1_caps to flpl >. 2. <load flpl Qboot> This loaded in the Quill Boot program (without running it). 3. <EDIT 1>. This brought line 1 of the Quill boot program to screen bottom, where the line was changed to: (1 CLEAR: flp_use mdv: EXEC MDV1_caps >. The modified line was re-entered.

6. <DELETE flpl Qboot> then <SAVE flpl Qboot>. This eliminated the Quill boot program in disk so that the amended Quill boot program could be saved. (without a toolkit). Then it was saved.

7. <lrn flpl Qboot>
Paydirt! When Quill came up running, a little black box appeared in the upper right hand corner of the screen. Toggling Caps Lock during Quill operation fills the block with "CAPS", a running indicator of the CAPS Lock switch. Maybe this is not so useful in Quill, but I can see where it would be for the other three PSION programs, and many others.

While Hal's Caps Lock indicator was designed to aid programmers while keying in code, it can be useful to have on a flp or mdv for use in programs. All we need do is edit a program line of any program and install <EXEC mdv1_caps> in the line of programming.

But I believe that "caps" gives us something else of importance as well. Isn't this an excellent demonstration of "multitasking" and how to achieve it? Here we have the Quill software working, and all the time the "caps" program is also working, checking for Caps Lock condition and displaying the status on screen. For more on Multitasking see page 41 of the Concepts section of the QL manual. Want to multi-task another program with Quill? If so, do the Clock program on page 42.

(The PSION disk arrangement works well for me, but the <flp_use mdv> locks out Micro Drive until the reverse programming is used <flp_use flp>.)

THANKS HAL, and get off of that IBM as often as you can to do more neat utilities for us!! We appreciate! _BJ-

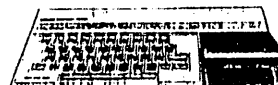
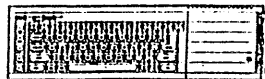

CAT PRINTS ON YOUR QL

Bob Hartung

No, this isn't about feline graffiti on the hood of your QL, but is a way of making hard copies of the file directories on your microdrives. It is an adaptation of a screen-print only utility provided by Mike Lloyd in the May 1987 QL World. It also demonstrates the use of a defined string for device parameters to avoid syntax errors that otherwise occur. I don't have a QL DOS but I think with appropriate changes in SAVE/LOAD syntax it should work with one and also RAMdisk. Note that the MDV or disk being cataloged cannot be write-protected as the temporary cat_dat file is stored on it, then deleted.

CATPRINT

```

10 MODE 8
20 INPUT 'Left margin: ';lm: lm$='': lm$=lm$ & FILL$( '
,lm)
30 OPEN #7,ser1
40 PRINT #7,CHR$(27) & 'E';CHR$(27) & 'B';CHR$(27) & '!
:CLOSE #7
50 INPUT 'Drive no. ';drive
60 CLS
70 OPEN #7,ser1
80 d$='mdv' & drive & '_'
90 OPEN_NEW #3,d$ & 'cat_dat'
100 DIR #3,d$: CLOSE #3: CLS
110 OPEN_IN #3,d$ & 'cat_dat'
120 INPUT #3,line$: PRINT 'CATALOG: ';line$: PRINT #7,lm
$;'CATALOG: ';line$
130 REPEAT loop
140 FOR x = 1 TO 18
150 INPUT #3,line$
160 IF line$ (<) 'cat_dat_' THEN PRINT line$: PRINT #7
,lm$;line$
170 IF EOF(#3) OR KEYROW(1)=8: EXIT loop
180 END FOR x
190 PRINT 'More >': PAUSE
200 AT 2,8: CLS 3: CLS 2
210 END REPEAT loop
220 PRINT #7\
230 CLOSE #3: CLOSE #7: DELETE d$ & 'cat_dat'
240 GO TO 50
250 DEFINE PROCEDURE sv: SAVE mdv1_catprint: END DEFINE
    
```

NAMES IN PROFILE

Bob Hartung, 2416 N. Co. Line Rd., Huntertown, IN 46748

Unless a last-name-first printout is done when this excellent data base program is used for mail files, a sort by last names requires they be entered on a separate line from the title and first name. The following addition to the Basic listing does a character by character scan of line one, which may be up to 30 characters long, then prints the last name from line two next to the first. The sort is done by line two. There may be no more than one space between title and first name(s) in line one entries. The PAUSE and LPRINT in line 7206 assumes the P/F printer driver is in use and not one on EPROM such as used with the JLO I/F. This line may be adjusted to your own needs for continuous printout, roll labels, or envelopes in a web carrier.

```

7205 IF Z$(<)"0" THEN FOR X=1 TO LEN C$: PRINT E$(X):
NEXT X
7206 IF PEEK 26703 THEN LPRINT : PRINT #0;AT 0,0;"Key
0 TO SKIP/ANY CHR$ TO LPRINT ": PAUSE 0: IF INKEY$="0"
THEN GO TO 7226
7207 FOR X=1 TO LEN C$
7208 IF X=1 THEN FOR R=X TO 31: IF E$(X,R TO R+X)="
THEN LPRINT " ";: NEXT X
7209 IF X=1 THEN LPRINT E$(X,R);: NEXT R
7210 IF CODE C$(X)=0 THEN LPRINT
7220 IF X(<1 AND CODE C$(X) AND E$(X))W$ THEN LPRINT E$
(CODE C$(X))
7225 NEXT X
    
```

BREAK-IN FOR CATS

When a CAT directory contains more than one screenful of file titles, keying BREAK with the following routine will halt the display at the desired screen and go to the title-input for SAVE or LOAD. The SDOS syntax as given will need to be adapted to that used by your DOS.

```

10 ON ERROR GO TO 20: CAT
20 ON ERROR RESET: INPUT "Title to LOAD: ";t$
30 LOAD /t$: REM Or SAVE /t$
    
```

Encl

FOR SALE: TS-2068, ZX81, TS-2020 Rcdr, Alph Comm 32 Ptr, Flt Sim Cart, VU-3D Tape, 2068 Tech Man, ZX-81 Manual, 2068 Light Pen w/tape, SYNC Issues, TS-2068 Sftwr. All Exc cond. -- All \$250, or want C-64 and Disk drive. Call Days: 505-325-0291- nite: 505-326-7551. Jack Strong.

Packeteers: Joe Wilkerson (W6JPB) wants contacts with others interested in Packet. 73 Joe W6JPG, 11453 Moreno Ave, Lakeside, CA 92040. Also reach thru BBS N6CQW.



Z88 TO Sinclair Transfer Link

Link Up Software by Sector Software Ltd.
Now available at your QL Dealer

Want to use your QL to SAVE Z88 files? To print Pipedream files? To move files between Pipedream, Quill and Archive (either way)? To dump a whole batch of files from Z88 Memory to QL Disk Drive, and back again? To read Z88 files on the QL monitor screen?

Update has received the QL-Z88 Link software, and it is incredibly easy to use. Z88-QL Link consists of a single MDV cartridge for the QL. Also needed and available from the QL dealer is a serial cable to connect between the serial port of each computer.

There is no device needed at all for the Z88, just the serial cable. One can make up a serial cable, but there is a slight difference in the thickness of the pins in the connectors for the two computers which prevents a QL serial connector from being used at the Z88 end.

All of the documentation for using the Link software is contained in two "Read-me" Quill doc files in the mdv. The two files loads to Quill for reading or for print out. The instructions are seven pages in length and seem to be quite adequate.

Now for some jesting. Wouldn't you think that literary material coming from England would be couched in immaculate English prose? Dig the dangling infinitudes and split geraldoses in the following exact quote, including punctuation, and which adds a bit of technical detail to this report: (QUOTE) "When the file is being transfered as each carriage return is sent a display at the bottom of the screen will show the number of lines sent, this is for your information only and is not used or remembered by the program. A '*' star may be used in the filename as a wild card, this means that if you give the name 'flp inv*' then the QL will send all files on flpl that begin with inv to the Z88, eg. invoice, inv bas, and inventory are all files that would be transmitted, if your are using a wildcard name which may send a few files across to the z88 then the z88 will have to be in batch receive mode, after sending all of the files files press 'E' from the main menu on the QL to send a 'Endbatch' signal to the z88 to terminate the batch receive mode on the z88." (end quote)

I had to resort to the ole high school sentence block diagram to decipher that piece of the King's English, but never the less if you read kinda fast the meaning grabs you fairly well. -And from England yet!! And here I thought that I was the Champeen particycle dangler of the 21st century! Iff'n Cornwallis had had that guy to confuse the enemy, we'd still have Brit agents collecting

tea tax in Boston.

And did you know that the Canadians have 999 different meanings of the two letter word "eh", eh? The differences are translated by inflection and only two can be expressed in writing (with a question mark or exclamation).

This software is 'version 2' which transfers both Quill and Archive files to the Z88 Pipedream. The writer explains that another version will be coming out soon, and a free exchange of mdv carts will be made upon receipt of the old one. I dont know how that will work from across the Atlantic. This looks like a "must have" for owners of both the QL and Z88. -----BJ _____

TS 2068 VARS SAVE AND RELOAD
TOS DISK SYSTEM VERSION
Program by Bill Jones
Modified for TOS by Dunnington

```

9900 LET ELIN=1: LET VARS=1: LET
H80=1: LET X$="111": LET Y$="11
1": LET Z$="11111.COD": LET L$="
11111"
9910 LET VARS=PEEK 23627+256*PEE
K 23628: FOR N=1 TO 1: NEXT N
9915 LET ELIN=PEEK 23641+256*PEE
K 23642
9920 LET X$=STR$ (PEEK 23627): L
ET Y$=STR$ (PEEK 23628)
9925 IF LEN X$<3 THEN LET X$=STR
$ 0+Y$: GO TO VAL "9925"
9930 IF LEN Y$<3 THEN LET Y$=STR
$ 0+Y$: GO TO 9930
9935 LET L$=STR$ (ELIN-VARS-1)
9940 IF LEN L$<5 THEN LET L$=STR
$ 0+L$: GO TO 9940
9945 LET Z$=L$+" .COD"
9950 LET H80=PEEK 23641+256*PEEK
23642-1
9965 PRINT "ELIN=";ELIN;TAB 12;"
EADR=";PEEK 23641+256*PEEK 23642
""VARS=";VARS;TAB 12;"VADR=";PE
EK 23627+256*PEEK 23628""LENGTH
=";L$;"LENGTH VERIF=";(PEEK 23
641+256*PEEK 23642)-(PEEK 23627+
256*PEEK 23628)-1""ULSB=";X$;TA
B 14;"VMSB=";Y$""ULEN=";Z$;TAB
15;"IS SER # OF SAVE""H80=";H
80;TAB 14;"VERIF=";PEEK (PEEK 23
641+256*PEEK 23642-1)
9970 PRINT ""ENTER WHEN READY":
PAUSE 0: SAVE *Z$CODE VARS,VAL
L$
9972 REM PAD*****
9980 CLEAR : CAT #
9985 DIM K$(9): INPUT "INPUT 9 C
HR TITLE OF VARS CODE ";K$: DIM
V$(VAL K$( TO 5)-9)
9990 POKE 23297,INT (VAL K$( TO
5)/256): POKE 23296,(VAL K$( TO
5)-PEEK 23297*256): LOAD *K$CODE
(PEEK 23627+256*PEEK 23628):
9995 LET N=PEEK 23627+256*PEEK 2
3628+PEEK 23296+256*PEEK 23297:
POKE N,128: LET N=N+1: POKE 2364
2,INT (N/256): POKE 23641,N-PEEK
23642*256: POKE N-1,128

```



QL MAIL FILE HINTS

Bob Hartung, 2416 N. Co. Line Rd., Huntertown, IN 46748

I received from Dick Wagner some comments and questions about the UPDATE listing and the issue disk/mdv version which suggested that the info I sent him might be helpful to other users also. Because it was written with the intention of demonstrating some elementary Super Basic programming concepts which can be modified and enlarged upon by the user it obviously lacks many of the refinements and features of Archive, which can be used for mail files and much, much more.

Perhaps I should also mention that the listing and the accompanying text in the October UPDATE were both typed into TASWORD on my 2068 because at the time I didn't have a printer hook-up with my QL that would produce a decent master for Bill to copy. Also, I only had a QL that was working properly or at all about 2 months of the 14 preceding last Christmas. The rest of the time it was either down or away for replacement or repair. I finally sent it to Dan Elliott who did the repairs right for me and also made some changes in the power supply so all voltages are pre-regulated outside the computer. This has eliminated about 90% of the heat build-up inside the case as well as the power surge, RFI, and oscillation problems. The display now is steady as a rock, even in TV mode.

The listing in the issue disk/mdv program is correct as is, but in the process of translating a Beta Basic version of the program to Tasword, I missed lines 160 and 170 in the UPDATE listing. They should have been:

```
160 CLS
170 IF C# INSTR F$(N,1 TO 115) THEN GO SUB 200: PAUSE
```

It is interesting--and also can be very frustrating--that a definition such as F\$(N) will work sometimes in a situation such as this and sometimes will not, so a full definition of all the parameters is the only sure way to go.

In the process of de-bugging the issue MDV/disk version which allows user-defined and named fields of any length and number (within RAM limitations, of course!) I noted a quirk in the sort routine which sometimes keeps it from a correct sort with an even number of file-items. This was corrected by adding a counter (cnt) to lines:

```
30 LET n=last: LET s=n: LET cnt=0
40 LET s=INT(s/2): IF S<1 AND NOT cnt THEN RETURN
70 LET j=n: cnt=0
80 IF F$(j,21 TO 40)>F$(j+s,21 TO 40) THEN LET x=F$(j,1
  TO 115): LET F$(j,1 TO 115)=F$(j+s,1 TO 115): LET F$(j+
  s,1 TO 115)=x: LET j=j-s: LET cnt=cnt+1: IF j>0 THEN GO
  TO 80)
```

A printer formatting routine was purposely not included in the program as given because practically every kind has different command-sequences. For example, to set a 45th column left margin for addressing envelopes on my C. Itoh 8510 this sequence would be needed at line 1300:

```
1300 OPEN #7,SER1: PRINT #7,CHR$(27);"L045": CLOSE #7:
GO TO 500
```

A universal left margin setting may be provided by the following, using lm\$ as PRINT #7,lm\$;f\$(n, slice):

```
1300 INPUT "Left margin col: ";lm: lm$="": lm$=lm$ & FIL
L$( " ",lm): GO TO 500
```

The prompt in line 980 of the printed listing would probably be less confusing if made "Key ENTER to Keep, \$STOP, or % to delete item LINE # to EDIT". The entire file-item is deleted and the last-item counter is decremented by one if % is entered as the very first input. An item-line to be edited is selected by a first-input of a single digit, 1-6. The re-definition of F\$(n,21 TO 40)="zzzzzzzzz" during a delete is used to properly re-order item(s) to be deleted to the bottom of the file instead of to the top where they would otherwise go if sorted after F\$(n,1 TO 115)="". A full definition is needed here instead of just F\$(n)="".

One of the drawbacks of using arbitrarily-defined fields for data such as this is that the ones that work fine for me may not meet your requirements. To enlarge the sizes of the respective fields beyond the total of 114 characters (plus the one in 115 for first-name length) the DIM F\$() statement must be changed in line 770 in the printed listing. Then every line must be changed that defines F\$(n,1 TO 20) for first-name field, F\$(n,21 TO 40) for last-name field, etc. With a 400-item dimension of the F\$ array the sorting time takes several minutes when the file is filled to this size so you might want to do sorts only after an EDIT and from the menu instead of following every set of new entries.

The "y/n" options as given accept only lower-case inputs which may be changed in lines like 350 in the printed listing to: IF y\$="y" OR y\$="Y" THEN . . .

Those who have the issue disk/mdv version also have two versions of a menu-loader routine which resides in the BOOT file and displays up to 36 file names. Unlike the auto-directory 2068 users have with their SDDS routine this one requires manual input of each name in the menu, but only a single key-stroke then is needed to LRUN the file selected. The one version saves and loads as data this user-entered directory and the other version brings down into edit mode a string-definition line into which a file name is entered. The latter loads more quickly since all the data is contained in the listing itself rather than in a separate data file.

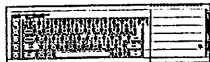

A QL LLIST UTILITY

Bob Hartung, 2416 N. Co. Line Rd., Huntertown, IN 46748

This routine may be of particular interest to those such as Bill and myself who do QL listing printouts in column format as master copies for publication. A simple OPEN #n,ser1: LIST #n: CLOSE #n will send a listing to the printer but unless your printer has right-margin setting or column/line setting, long listing lines will splatter the full width of the page. If the left margin is set far enough over to allow only the desired number of columns to be printed before the printer does an end-of-line CR/LF the listing lines will be done properly but will require a cut-and-paste job to prepare a copy master containing more than one column of listings.

Of course, anyone who paid close attention to Bill's tutorial in the January UPDATE on importing files into QUILL no doubt has figured out how to do this with listings. Once in QUILL, they may then be edited, have margins re-set, and be printed out as any other QUILL file. However, since QL command-words are treated as real words the printed right-hand margins will either be unjustified, with no word wrap-around, or if justified will have spaces inserted so the printout will not quite correspond with the on-screen listing. Also, there is a considerable amount of footwork involved in all this.

All we actually need is to somehow get each line of the listing into a string which can then be sliced any way we want it. The following LLIST was done by reading each line of the Basic listing as data for input into p\$. The command codes to set line-spacing, font, etc. may be inserted into line 20 for your printer or else that line may be omitted if you elect to use the pre-set ones or use panel settings.

The routine begins with the selection of the drive no. containing the program to be LLISTed, then displays a directory of the files in that source drive. Key F5 for more than one screenful. An error repeats drive and title entries, or Q (or q) to quit. The entire Basic file is loaded into RAM as data and the printout then is done from a succession of p\$ definitions obtained by accessing this data from RAM.

After the data is loaded, the first prompt asks for the number of lines to be printed in this pass (including a title line and one space-line if the title option is selected). An input of 0 at this first prompt allows the program to be aborted with all channels properly closed. This is done automatically if an end-of-file (EOF) takes place before the selected number of lines is printed.

The second and third prompts ask, respectively, for the desired column-width and left-margin settings. Since these are done with string-slices and string-spaces instead of command codes they will work with all printers.

Repeat passes allow re-inserting a page and changing these settings to print side-by-side listing columns that begin with the next line after the last previous one which was printed from the same file-loading.

QLLLIST

```

10 REMark Enter YOUR printer codes in line 20 or omit 20
   if not needed
20 OPEN #7,ser1: PRINT #7,CHR$(27);'Q';CHR$(27);'T11';CHR$(27);'A';CHR$(27);'!': CLOSE #7
30 WHEN ERROR : PRINT #0,y$;' not found--check entry': PAUSE 200: GO TO 30: END WHEN
40 CLS: CLS #0: INPUT #0;'Q to quit'\'\LLIST program in drive #';drv$: md$='mdv' & drv$ & '_': IF drv$='q' OR drv$='Q' THEN STOP: END IF
50 PRINT 'Key F5 TO SCROLL DIRECTORY': PAUSE 100: DIR md$
60 INPUT #0;'File Name? ';y$: md$=md$ & y$
70 CLS #0: curln=0: remln=0: REMark current line; remaining line
80 OPEN_IN #8,md$
90 OPEN #7,ser1
100 CLS: INPUT 'Enter zero to cancel ';(y$)\'\No. lines this page-column: ';lines: IF lines=0 THEN CLOSE #7: CLOSE #8: GO TO 30: END IF
110 INPUT 'Columns per line: ";col
120 INPUT 'Left-margin setting: ';lm: lm$='': lm$=lm$ & FILL$( ' ',lm)
130 INPUT 'Key ENTER to skip title-print any chr to print ';t$: IF t$ <>' THEN t1$='': t1$=t1$ & FILL$( ' ',INT((col/2+lm)-INT(LEN(y$)/2)): PRINT #7,t1$,y$: PRINT #7: END IF
140 cnt=0: IF t$ <>' THEN cnt=2: END IF : REMark count print-lines
150 IF remln < 0 THEN cnt=cnt+curln-remln: GO TO 250
160 IF EOF(#8) THEN CLOSE #7: CLOSE #8: GO TO 30: END IF
170 INPUT #8,p$
180 lp=LEN(p$): IF p$(lp)=' ' THEN lp=lp-1: END IF
190 IF lp <= col THEN PRINT #7,lm$,p$: cnt=cnt+1: IF cnt=lines THEN GO TO 100: ELSE GO TO 160: END IF : END IF
200 curln=INT(lp/col)
210 DIM lin$(curln,col)
220 FOR n=0 TO curln
230 lin$(n,1 TO col)=p$(col*n+1 TO lp)
240 END FOR n
250 FOR k=remln TO curln
260 PRINT #7,lm$,lin$(k,1 TO col)
270 cnt=cnt+1: IF cnt=lines THEN remln=k+1: IF remln > curln THEN remln=0: END IF : GO TO 100: END IF
280 END FOR k
290 remln=0
300 GO TO 160
310 DEFine PROCedure sv: SAVE mdv1_QLLLIST: END DEFine

```

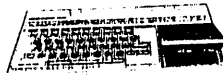

BOB'S NOTEBOOK

Let's get back to some programming for a change. I have two interesting utilities from my notebook.

1. RENUMBER TO 10000+

When you are faced with using the MERGE command to join one of your utilities with another program, the first problem is whether there will be a clash of line numbers. Keeping your utilities (the ones written in BASIC) above line 9000 or so is helpful but there is no guarantee that some programs have not gone into this area. What to do? First, if the utility can be written in machine code or compiled via Timachine, that is an obvious way out. But if BASIC is the only way, then here is the solution.

Renumber the utility starting at line 10000. Right, that's what I said: ten thousand! Then there will be no danger of a line number conflict of interest. Type in the program below and SAVE it.

```

1000 REM Renumber to 10000 plus
1005 REM Bob Mitchell 1988
1010 REM Do not leave out lines 1000 and 1005. Change them is OK
1015 CLS : PRINT "This utility allows renumbering to lines higher
than the usual 9999." "" "The current start line is set at 10000
. Line numbers increment by five."
1020 PRINT "" "To set a different start line use <GO TO 10040> now.
Now, MERGE the program to be renumbered."
1025 PRINT "" "DELETE the lines of this utility by using <DELETE 10000,10095>."
1030 PRINT "" "Change all GO TOs etc manually calculating them carefully in
respect to the new start line." "" "When ready, use <RANDOMIZE USR 32000> to renumber."
1035 STOP
1040 INPUT "Start line # ? ", line
1045 LET line=line-5
1050 RANDOMIZE line
1055 LET hi=PEEK 23671: LET lo=PEEK 23670: POKE 32004,lo: POKE 32005,hi
1060 STOP
1065 RESTORE 1070: FOR i=32000 TO 32030: READ a: POKE i,a: NEXT i: GO TO 1015
1070 DATA 42,83,92,17,11,39,237,75
1075 DATA 75,92,167,237,66,200,9,6
1080 DATA 5,19,16,253,114,35,115,35
1085 DATA 78,35,70,9,35,24,231,0
1090 RANDOMIZE USR 100: SAVE "re#10+.B2" LINE 1065
1095 STOP

```

Try this program on itself. GO TO 1065 then RANDOMIZE USR 32000 and LIST. All the line numbers now start with a colon (<:>) which is the next character after <9> in the TS2068 character set. Thus it represents <10>. If you choose 11000 as the start line, the first "digit" in the line numbers would be a semicolon (<:;) and so on.

Now MERGE this program with your favourite short utility. Change all your GO TO and GO SUB numbers to the line numbers they will represent after the renumbering is done, noting that the line numbers increment by five (5) only. I have deliberately chosen a renumber routine that does NOT renumber GO TOs and GO SUBs because those that do will not handle line numbers over 9999.

Once the renumbering is done, it is impossible to edit the lines, hence the need to change these GO TOs etc manually.

DELETE my utility as indicated in line 1025 above. Then, use <RANDOMIZE USR 32000> now to renumber your utility and SAVE it.

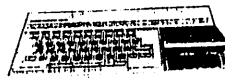

2. TASORT- A TASWORD UTILITY TO SORT LISTS

As the title infers, this utility will sort Tasword lists of up to 240 lines or 15360 bytes. Each record in the list must be only one line long, but with 64 characters per line there is room for a lot of material in any list (eg, birthdays and anniversaries, long play records, telephone numbers, things to do, diaries, program descriptions on disk or tape).

You may sort all or part of a list, or just the list in a longer Tasword file. When your list is saved in the usual Tasword manner, ensure you have noted the file text length (variable <a> gives this), list's start and end line numbers and the column number to sort on. The program prompts will walk you through the operation and when finished, the program along with its newly sorted list will have been saved ready for loading into Tasword. Respond to all <scroll ?> prompts with a <y>.

The program is set up for compiling via Timachine and there is a short loader/manager program to go with it. Type in the two listings, compile the main program and save it in the usual way and save the loader. The utility is then ready for use.

Try it on your favourite Tasword list, bearing in mind the limitations explained above. It should only take a few short minutes to get the job done.

One thing more: the display of the lines in the list uses Tasword's companion piece, Taswide, to present it in a 64 cpl format. If you do not have Taswide, change line 230 to read:

```
CLS: FOR i=n TO e: PRINT d$(i): NEXT i
```

and remove <RANDOMIZE USR 100: LOAD "taswi.Cx"CODE> from line 8 of listing 2.

Listing 1. Tasort

```
40 REM !USR 28000
50 REM ! LPRINT
60 REM ! LIST
70 REM !LEN h#<=64
80 REM !INT +oa,ob,sf,a,b,c,e,s,n,i,J,t
90 REM ! OPEN #
100 CLS
110 LET oa=SGN PI: LET ob=2: LET sf=64: LET a=47615: DIM d$(240,64)
120 INPUT "length of text? (<=15360)" b: IF b>15360 THEN GO TO 120
130 LET c=INT (b/sf)
150 INPUT "start line? " s
152 INPUT "end line? (0=last)" e
153 IF e=NOT PI THEN LET e=c
154 LET ei=a+((e-1)*sf)
157 CLS : PRINT "loading text from" "line " s ";" " to line " e ";" ".
"
160 LET n=s
170 FOR i=a+((s-1)*sf) TO ei STEP sf
180 FOR j=NOT PI TO 63
190 LET d$(s,j+oa)=CHR# PEEK (i+j)
200 NEXT j
210 LET s=s+oa: IF s>e THEN GO TO 230
220 NEXT i: STOP
230 CLS : RANDOMIZE USR 64300:FOR i=n TO e: PRINT CHR#3;d$(i):
NEXT i
240 BEEP oa,10: INPUT "1=sort 0=save? " ;ss: IF NOT ss THEN GO
TO 440
255 INPUT "sort on which col.? (1-63) " ;t
260 CLS : PRINT "sorting on col. " ;t: GO SUB 300: GO TO 230
290 REM shell-faulk sort
300 LET sn=e
310 LET sn=INT (sn/ob)
320 IF sn<oa THEN CLS : RETURN
330 IF sn/ob=INT (sn/ob) THEN LET sn=sn+oa
```

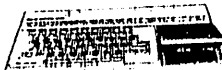

```

340 FOR i=n TO e-si
350 LET m=i
360 IF d$(m,t TO ) <= d$(m+i,t TO ) THEN GO TO 420
370 LET h=d$(m)
380 LET d$(m)=d$(m+i)
390 LET d$(m+i)=h
400 LET m=m+i
410 IF m>0 THEN GO TO 360
420 NEXT i
430 GO TO 310
440 CLS : PRINT "storing sorted file for SAVE...": LET s=n: FOR
i=a+((s-oa)*sf) TO e1 STEP sf
450 FOR j=NOT PI TO 63
460 POKE (i+j),CODE d$(s,j+oa)
470 NEXT j
480 LET s=s+oa: IF s>e THEN GO TO 492
490 NEXT i
492 STOP
495 REM ! CLOSE #
550 CLEAR : RANDOMIZE VBR 100: SAVE "tasort.Bp" LINE 100

```

Listing 2. The loader

```

5 CLS : PRINT INVERSE 1;"TASWORD SORT": INVERSE 0;" by Bob M
itchell."'"This utility will sort Tasword lists of up to 240 l
ines (15360 bytes)."'
6 PRINT '"Have the following parameters ready from SAVED li
st:"'"1. text length"'2. start line number"'3. end line numbe
r if not last"'4. column # to sort on (1-63)."'
7 PRINT '"Install disk containing list to be sorted: then,
press a key.": PAUSE 0
8 RANDOMIZE VBR 100: LOAD "tasw1.Cx"CODE : RANDOMIZE VBR 100:
LOAD "tasort.Cc"CODE 28000
10 INPUT "TASWORD SORT "'list name? max 6 ": LINE n#: RAND
OMIZE VBR 100: LOAD n#+".CT"CODE 47615
20 ON ERR GO TO 25: RANDOMIZE VBR 28000: GO TO 30
25 ON ERR RESET: POKE 23607,60: GO TO 55
30 LET b=PEEK 30078+256*PEEK 30079: REM see note 1.
40 INPUT "list name? max 6 ": LINE n#: RANDOMIZE VBR 100: SAVE
n#+".CT"CODE 47615,b
50 CLS : PRINT "Sorted file has been saved and is ready for l
oading into Tasword"
55 INPUT "1=more 0=quit "Im
56 IF m THEN GO TO 5
57 IF NOT m THEN STOP
60 CLEAR : RANDOMIZE VBR 100: SAVE "tasort.Bb" LINE 5

```

NOTE 1. Line 30. This gets the value of in the compiled program. The PEEK addresses may change depending on your compilation list of variables.

NOTE 2. The listings above have been entered into Tasword using the Sequential File routine in the Larken Version 3 LK008 EPROM. This was covered in my article in the Sep-Oct issue of Binc-Link page 10.

Bob Mitchell Willowdale Ont BB1115

- WANTED -

Notice!

HUGE list of TS-2068, QL, TS-1000, Tandy 1000 items for sale: SASE or Compu Serve 75036,616. Barry Carter, PO Box 614, Warren, MI 48090. (313 537 8559).

A Corrected Listing of "Train Dispatcher" published in "The Ins and Outs of Timex TS-1000" by Don Thomasson. Want either a TS-1000 or a QL Version. Arnold Nieuwenhoff, 16 Heritage Rd, Sutton, MA 01590

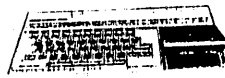

LKDOS SOFTWARE



MAXCOM 300/1200 baud Terminal/BBS

This full feature modem software lets you effectively link the modem to the disk, so you can upload or download files larger than 100K. This lets you send NMI saves and large text files as well as Basic or Code files, which other modem programs couldn't send because of memory limitations. Also files can be sent with or without a Information header (Spec-term compatible).

It also has a 64 column display and is the only 2068 modem program that will run at full 1200 baud without missing characters. Other features of the terminal mode are IBM graphic characters, auto-dialer, macro keys, 110K disk buffer for captured text, auto repeat keys.

The BBS is the most elaborate available for the 2068 and allows the remote user full access to the disk drives similar to a CPM BBS. Features of the BBS are - 300/1200 baud, operation with fast reponce even at 1200 baud, Passwords, priority levels, Use time limits, Multiple Message Bases, Uploads and Downloads are not limited by Memory, Dual Window Monitor screen, Interupt driven time out and Hangup protection, Also Keeps a User log of callers Names and Activity on disk so a printer isnt needed and its easily customised and expanded.

MAXCOM can be used with the 2050 modem or with the Z-SIO RS232 interface and a 300/1200 baud modem. (a version for the Aerco RS232 is in the works).

PRICE: \$24.95

LARKEN DISK EDITOR

This program lets you examine or change any byte on a LKdos disk. It is useful in repairing damaged or glitched disks, changing the disk Name or head speed etc. You can also examine the track map and disk info headers.

The documentation for the disk editor also includes information on how to access LKdos from Machine Code and information on the structure of the disk catalog and data blocks.

PRICE: \$15.00

SEQUENTIAL/RANDOM Access FILES

This utility is a ram resident extension to the LKdos operating system and lets you create, read from, or write to very large data files kept on disk. It uses the commands OPEN#, CLOSE#, PRINT#, INPUT#, and INKEYS# to access the files from BASIC. There is also a high speed search command for finding a text string within the data file. Using the TAB command, you can randomly access directly any record in a file.

The utility is easily used within your basic programs and has a lot of uses, from storing large data files, creating large spell checker dictionarys or even converting you basic programs to an ascii text file.

This utility lets you take the limits off of the data capacity of the 2068. Files on disk can be huge!

A simple data base program is included on the disk to demonstrate the utility.

PRICE: \$ 15.00

Coming Soon from Larken Electronics

** The Larken Desk Top Publisher ** Produce high quality printing (like this page) with an Epson compatible printer and LKdos. The entire Hi-res graphic page is kept on the disk and scrolling though the page is as easy as clicking the joystick or mouse on the Icon type menu. Text and Graphic editing with multiple sized fonts will also be featured.

** Spell Checker for Tasword and M-Script ** This utility program will let you have your wordprocessor text files be checked by a 350K dictionary.

All Prices \$US - Specify type of drive when ordering.
LARKEN ELECTRONICS RR#2 NAVAN, ONTARIO CANADA, K4B-1H9
(613)-835-2680



WOOD AND WIND COMPUTING

Bill Cable : RR 2 Box 92 : Cornish, NH 03745 : 603 675 2218

QL SOFTWARE AND INFORMATION

HELPER

A Special Group of Tool Kit functions that work with both expanded and standard QL's to provide complete MDV and Disk Management of files and programs. Ideal for use as a BOOT program to manage an entire MDV or Floppy Library.

DB-PROGS

A 22 Page Manual that describes Six Wood and Wind "Archive Related" programs, what they do, and how to use them.

SPLIT

A program that splits Data Base Files into two distinct parts for management and re-save.

JOIN

A program that Joins two Data Base Files.

DB-TUTOR

A 25 page manual and 256K Floppy that comprise a "Learning Shell" for the Archive Data Base Software.

REFIELD

A large program that greatly expands the Archive Software.

Each of the above programs are on MDV or Disk and are supplemented with a manual, plus stored "read-me" files. Other business application software are available. Send \$6.00 for a package of manuals. Then selectively order the programs that interests you. Or send \$2.00 for a complete listing of all products, and brief discriptions. (Address above).

EMSoft

Software for the QL that really works

We have business and technical software to do real (tax deductible) work. Prices range from \$9.95 for QLUtter or QLUster, resident boot utilities, to \$2850.00 for a CAD site license to design circular cams and generate CNC code to a vertical mill controller.

Others include TAX-I-QL, an ABACUS template for your income tax; MAILBAG, the, best address database we've seen; QLAND_LORD, a property management application; TRUST_FUND, a portfolio and asset manager; and RECIPES for the cook - all at just \$19.95 each.

DBTutor is a handy flash-card program to teach yourself anything you need to know, including Spanish and QDOS, which are provided; DBProgs has 5 useful Archive utilities. The_Transfer_V3 laser prints desk top publishing files. There is other good stuff, too.

Generally, prices (post paid) are under US\$20.00 on DSQD Disk, but like CAM MASTER, some are a bit more. For microcartridge add \$2.00.

Please send for our latest catalogue which explains our offerings in greater detail than is possible here. It has a demo disk for the CAD program, CAM MASTER at only \$6.95.

Look for our table at the CATS CapitolFest with show specials.

EMSoft, P.O. Box 8763, Boston MA 02114 (617) 889-0830

UPDATE!

\$4.95 per copy

April 1989
Issue

\$18.00 Year Subscription



Computer Systems



OF SINCLAIR COMPUTERS

ADVERTISING RATE SCHEDULE

effective until July 1989

UPDATE MAGAZINE is published quarterly each January, April, July, and October in support of the users and suppliers of the SINCLAIR QL, SINCLAIR Z88, AND SINCLAIR-TIMEX TS-2068.

The following Ad sizes are based upon a page size of 8 1/2 inches by 11 inches. Ads are black and white only. Reduction and enlarging capability exists for ads that are off size. Camera ready copy should arrive at least 15 days before publishing date.

DISPLAY ADVERTISEMENT RATE SCHEDULE

AD SIZE	PRICE	
2 pages	\$220.00	
1 page	120.00	
2/3 page	90.00	(vertical or horizontal)
1/2 page	65.00	(vertical or horizontal)
1/4 page	35.00	(vertical or horizontal)
1/8 page	20.00	(vertical or horizontal)

Special placement of full page or double page ads, add 10% and call for reservation (inside front cover, first page, inside back cover, back cover).

Line ads: 78 characters per line across page, 1 line minimum, \$6.00 per line. Will be type set to Elite 12 Chrs per line.

Your existing Ad copy for other publications is fine. Just send copy with instructions for sizing (up, down, or same). Enhancement of legibility is usually possible. Draft quality dot matrix print is not so good.

TERMS: Check Payment with order 10% discount, or billing on publication date. (no credit cards).

Send Ad copy to: UPDATE MAGAZINE, 1317 Stratford Ave., Panama City, FL 32404. Tel 904 871 3556 or 904 9871 4513

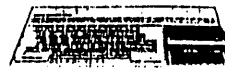

McBrine Computer Products announcement:

Update received a letter from Mr. William J. McBrine (McBrine Computer products, 514 S. Jackson St., Salisbury, NC 28144). Bill announces that he is suspending the activities of his software company and converting all of his software, both past and future to SHAREWARE. Users are encouraged to distribute the software to "all and sundry". Those receiving are ask to contribute "what they deem it to be worth" to Bill at the above address. Bill has served the Sinclair community well with good software and and we hope that he continues to PRODUCE. Update will communicate to offer assistance to that end.

Spullink: I apologize to Mr. Confucius for referring to Abacus as "Abascus". Wonder how many Chinese can spell licorice, or lickerish?

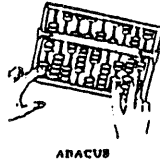

*** LKDOS SOFTWARE ***

- MAXCOM -- 300/1200 baud Terminal / BBS
- Complete communications B/W for the LKDOS-2068
- 300 baud with the 2050 or Full 1200 baud with no missed characters. (1200 requires 7-810)
- 64 column Terminal Mode with IBM Graphics
- Auto dial, Macros, direct to disk buffer.
- Powerful Remote user BBS with fast response
- Auto answer, Xmodem 128/312,1024, Message bases Multi window, Direct access to drives and more.
- Direct 'modem to disk' Xmodem lets you transfer files over 100K in length (eg: NMI saves etc)
- Price : \$19.95

Sequential / Random Access Files

- This ram based LKdos extension allows you to create / access large disk based data files
- OPEN# CLOSE# PRINT# INPUT# and INKEY# basic commands are used.
- Price : \$9.95

LARKEN DISK EDITOR

- Edit any byte on a disk, Reformat single tracks
- Read disk headers , Change disk parameters etc.
- Price : \$24.95

LKDOS SHARE-WARE DISK (Original programs required)

- MULTI-TASKING Taskword. Lets you be printing one file from disk while working on another. Arco GPI
- ART-STUDIO patch for LKdos. MC cassette routines converted to disk.
- Spec-term 64 LKdos overlay. Save Basic or Code
- Transfers to disk with no messing about.
- Price : \$6.00
- (All software requires LKDOS cartridge Price: \$65)
- (Prices \$UB) (Send cash for values less than \$20)
- LARKEN ELECTRONICS, RR#2 NAVAN ONTARIO, CANADA K9B-1H7

LARKEN Hardware products, including LKDOS Disk Interface, RAM DISK MEMORY, and Software Utilities, are sold by two Dealers: RMG ENTERPRISES, 1419 1/2 7th St., Oregon City, OR 97045 (503 655 7484, -- Arnd: ED GREY ENTERPRISES, PO Box 2186, Englewood, CA 90305 (213 759 7406). Both of these dealers have extensive support listings of other products. See Ads in this issue.

Z88!

The Z88 imports/exports work files from both IBM and Macintosh

We Support the Z88!

We just wanted you to know that we will be supporting the Z88 to the best of our ability! If there is anything that you would like for your Z88 computer, be sure to let us know! As more and more products become available for this fine new portable computer, RMG will have it for you. If we don't, let us know and we will do our best to get it for you—FAST!

For more information or prices, contact us at the address or phone given below:

VISA **RMG ENTERPRISES** MasterCard
 1419 1/2 7TH STREET
 OREGON CITY, OREGON 97045
 503/655-7484 * NOON-10 TUE-SAT

NEED A PRINTER? WE CAN HELP!

RMG can supply many top brands at low prices. Names like: CITIZEN-STAR-ALPS PANASONIC-OKIDATA-EPSON-SEIKOSHA BROTHER AND MORE!

*** CHECK THESE OUT! ***

STAR NX 2400 24 PIN	ONLY \$324.95
BROTHER H 1109	ONLY \$164.95
STAR NX1000 MULTI-FONT	ONLY \$180.00
STAR NX1000 RAINBOW	ONLY \$239.95
STAR NX2400 24-PIN	ONLY \$339.95
SEIKOSHA SP-180AI	ONLY \$159.95
CITIZEN 1200	ONLY \$159.95
CITIZEN 1800	ONLY \$175.00

Please add \$15 each for sh. & ins. We also have MANY used printers in stock-write or call!

RMG ENTERPRISES
 1419 1/2 7TH STREET
 OREGON CITY, OREGON 97045
 503/655-7484 * NOON-10 TUE-SAT

THIS AD, IS PRINTED WITH MY ■ DOT,
9 PIN #300 PRINTER - DRIVEN BY
THE Z-88 WITH 4 AA BATTERIES

XX

IT IS HARD TO BELIEVE THAT THEY HAVE JUST BUILT A COMPUTER WITH A NOISELESS TYPEWRITER KEYBOARD, POWERED BY 4 AA BATTERIES!!! AND CONTAINING ALL THE PROGRAMS FOR SERIOUS BUSINESS AND WORD PROCESSING APPLICATIONS! PERMANENTLY LOADED INSIDE THE COMPUTER! AND IT WILL FIT IN A SMALL BRIEFCASE OR A LADIES PURSE!

PLUG IN THE PORTABLE CABLE AND IT WILL PRINT TO ANY PRINTER IN MANY DIFFERENT TYPE SHAPES AND SIZES USING THE EASIEST AND BEST WORD PROCESSING PROGRAM AROUND!!!



HERE ARE SOME EXAMPLES

1. CAN ADD UP TO 3 MEGABYTES MEMORY Italic
2. PLUG IN YOUR MODEM TO THE WORLD Underline
3. WILL TALK TO ANY COMPUTER SERIALY Bold
4. E-NC" ♦ ♦ ♦ ♦ -INVISIBLE- Superscript
5. H=O ♦ ♦ ♦ ♦ -FANTASTIC- Subscript
6. IN EEL ME II LWY MY RTINE Condensed
7. REACH IBM OR APPLE Double Width
8. AC ADAPTER AVAILABLE Dubl-Width-Italic
9. BINARY INCLUDED ! Underline-Superscript
10. SILENT KEYBOARD! Bold-Italic
11. BASIC INCLUDED Bold-Dubl-Width
12. FULL 80 CHAR. SCREEN Italic-Subscript-Dubl-Width
13. CASSETTE ADPTOR INCLUDED Subscript-Italic
14. AT LEAST 50 MORE PRINT VARIATIONS AVAILABLE.....

Nice print with Mike's battery cell powered printer that fits in a small briefcase with the Z88. Print is reduced 75% from common Pica for the ad.

Late Breaking News!

Storage Media for the Z88:

Both a new DISK INTERFACE and Audio Cassette Intfc are being released for the Cambridge Z88. Also, a battery cell powered Disk Drive is now available. Check with your dealer for the prices and expected time of delivery. These new storage media will enable inexpensive software to be marketed in support of the Z88.

SUGGESTED EXTRA OPTIONS:

- | | |
|--|-------|
| A. PARALLEL PRINTER CABLE | \$45 |
| B. A.C. ADAPTER (WALL) | \$15 |
| C. A.C. ADAPTER (CAR) | \$15 |
| D. MY INSTRUCTION MANUAL "A" FREE WITH Z-88 PURCHASE | FREE |
| E. Z-88 COMPUTER | \$500 |
| F. MIKE FINK'S LOTTO PROGRAM | FREE |
| G. MODEM | \$205 |

IMMEDIATE DELIVERY! PAID FOR BY ME! BY UPS! UPON RECEIPT OF MONEY ORDER, OR CLEARING OF CHECK MADE OUT TO DOMINO CUBES

TO ORDER: SEND MONEY TO: DOMINO CUBES
355 W. 39 ST
N.Y. CITY 10018-1401

FOR INFORMATION CALL: 212 971 5638
LEAVE NAME AND NO. MIKE FINK

Join The Club Today!

PIPELINE
TECHNICAL HOTLINE
FREE CLASSIFIED ADS!

CLUB Z 8 8
DON'T MISS OUT!

NEWS EXCHANGE!
SOFTWARE LIBRARY!
CLUB Z88 BBS!

<input type="checkbox"/>	ONE YEAR CLUB Z88 MEMBERSHIP (includes six issues of PIPE*LINE)	\$24.95
<input type="checkbox"/>	SPECIAL \$19.95/year INTRODUCTORY TWO-YEAR MEMBERSHIP (includes twelve issues of PIPE*LINE)	\$39.90
<input type="checkbox"/>	SAMPLE INTRODUCTORY PIPE*LINE ISSUE	\$3.00
<input type="checkbox"/>	PAYMENT ENCLOSED	
<input type="checkbox"/>	BILL MY CREDIT CARD	
<input type="checkbox"/>	VISA	
<input type="checkbox"/>	MASTERCARD	

CARD # _____ EXP: _____

NAME: _____ PHONE # _____

ADDRESS: _____

CITY/STATE: _____ ZIP: _____

CLUB Z 8 8

TIME

designs

29722 Hull Road
Collon, Oregon 97017
(503) 824-2658

Make checks payable to: CLUB Z88/TIME DESIGNS

Add \$2.00 for orders to Canada. Add \$8.00 for all other foreign countries.

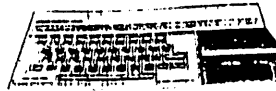

** TS-2068 **

D I S K S O F T W A R E L I B R A R Y

Each of these DISK ENSEMBLES have at least one major software and many utilities. All are NEW programming designed especially for DISK DRIVE. In fact, they are such bargains the each ensemble is guaranteed TO PLEASE, or your money back. There is such an assortment in each disk that several are bound to appeal to you and be more than worth the price.

Formats: Larken LKDOS, OLIGER SDOS, AERCO FD-68 DOS: 40 Track or 80 Track DSDD. Please specify Type DOS, and Type Drive, 40 or 80 Track. Price \$20.00 per disk. 5% discount for two or more in same order.

OCTOBER 88 Smart Text Disk
For All Disk Systems

A complete Administrative Software: This is the ONLY Data Base software for the TS-2068 that was designed for Disk Drive. It is a HUGE software that is MENU DRIVEN to guide you. No print or Command codes are mixed in with text, which allows full management without hassle. Some features: Data Base Manager - Disk Manager - Word Processor - Mail Merge - Automatic printing - Selectable Column print - Label print from Mail list - Selectable RETURN label with each out label -- Letter addressing from Mail List - Multiple automatic Letters - Print coupled files from disk in letters or manuscript. The only limit to the length of print out is the number of data files in the disk library!. Automatic centered Headers - Automatic Letterheads and Sign Off - Completely compatible with all Centronics Parallel Printers, Dot Matrix and Daisy Wheel. Start printing immediately. Smart Text is the Largest and most comprehensive software ever put together for the TS-2068. Has a 3 hour running TUTOR in disk to let you get going in a day. Smart Text comes on TWO 40 track disks or one 80 track disk. \$20.00

OCTOBER 88 "Hartung" Disk for Oliger DOS ONLY.

This is the most complete set of DISK MANAGEMENT Utilities for any computer. Called "The DOSDEX Series", the utilities allows you to do anything that is possible to do with Disk Files and Programs, including FULL COPY, FORMAT, Single file copy, Index and Manage a library. The "DOSDEX MGR" utility operates as a MASTER MENU program to load in and use as a selective MENU for individual disks. There is No better Disk Management for ANY Computer. Surprises fill the disk. \$20.00

April-July "Mitchell Disk"

For ALL DISK SYSTEMS. Two issues of Update Magazine were devoted to the documentation of this excellent HOUSEHOLD BUDGET Software. Also included are all of the other utilities and programs given in the April and July 88 issues of Update Magazine, plus some exciting surprises thrown in to FILL UP the disk. Budget is worth the price. The Utilities are worth the price. And the surprises ice the cake. \$20.00

OCT 87-Jan 88 Issue Disk - For All DOS

The Feature software of this disk is the "Mail Merge" Data Base and Printing Software. This is by far the most useful TS-2068 Mailing List, and the easiest to use. Update Magazine uses it to keep the Subscriber data base, to keep records of your equipment, and to print out the labels for mailing. Use with ANY Centronics Printer and ANY Interface. Mail Merge is a DISK DRIVE software. Also included are two ancillary Mail File Manager programs, "List Locker" and "Purity". The products of these three programs "integrate" with the Smart Text software for automatic letter addressing. But this Mail Merge software does its own printing also. Mail Merge can also be used for other data base purposes, such as Inventory. Additionally, this disk contains a set of utilities for managing EXTRA MEMORY, another set called "J-Utilities" which includes one to perform "mixed math" with mixed number bases. (Multiply FAFF Hex times 425 decimal and the answer pops up in HEX, Decimal, and Binary!). MORE- 20 Sound and utilities are given. No more room on the disk to put in anything else! \$20.00

Please specify your TYPE Disk INTERFACE,
and either 40 or 80 Track DSDD.



***** SINCLAIR QL *****

DISK and MICRODRIVE SOFTWARE LIBRARY

Both 80 Track Floppy Disk and Micro Drive are supported. 3 1/2 inch 80 track support will come later. The "Issue Disk/MDV" program is designed to accomplish two goals: 1. To encourage Programmers to WORK for us by disseminating their good software through Update Magazine.... 2. To provide you with inexpensive, North American, software. The proceeds of disk/mdv sales, after expenses, go to the Authors of the centerpiece software in the disk/mdv.

Most of the disks and mdv carts will contain the software and utilities that are documented in the pages of Update Magazine. Some of the programs are given in Listings, but mostly a printed listing of a major QL software is too long to be published. So, in most cases the documentation in Update will be in the form of a "Mini Manual".

Orders for the Issue Programs on Micro Drive cart must be accompanied with a Cartridge from the user. Some Issue Series will require two cartridges. Each issue listing will say "one or two mdv's". All of the Issue series are for both Unexpanded and Expanded QL Systems. Some may have extensions for use with extra memory systems.

Presently, there are only two QL Issue Series. Another will appear in the July issue of Update, then more as Programmers participate. These are such bargains that they are offered with a GUARANTEE to PLEASE, or return for full refund. All Issue Series are priced at \$20.00.

OCTOBER 88 "CABLE A" Series

The Cable A series comes on one 80 track floppy or two MDV carts. Orders for MDV should be accompanied with two MDV carts. This series contains the four softwares by Bill Cable, given in the October issue. "HELPER" is a super-basic group of TOOLS to manage Micro Drive and Floppy Disks, and to incorporate functions not otherwise possible to do. You can read files directly to screen from any medium, FULL COPY from one medium to another, COPY OVER, Format, Delete, and completely manage 2 floppies and 2 micro drives plus ram disk. Split screens are used to see the directories of two elected mediums. I use HELPER as a boot program to completely manage my entire floppy and mdv library.

"REFIELD" is a major software that uses Archive. Some would call this "Archive Doublor", an apt name because it just about does that.

"SCAN" is Archive Utility that lists Archive Fields and sums up their numeric content, prints if desired.

"ARITHMETIC" is a neat Super Basic program for the kids, or for you to use as a Super Basic Tutor to help learn to program in Super Basic.

To give an idea of how massive this series is, REFIELD alone takes up one whole mdv cartridge. Then the other three can be squeezed into another cart. An outstanding value at \$20.00!

OCTOBER "HARTUNG A" Series

Bob Hartung gave a Super Basic program "ADDRESS FILE" in the Oct. Update. This was a Key-in project. The program provides a "stand alone" mail file data base and printing capability. Address File is easy use, and can be used for other purposes such as Inventory. It can also print labels. Screen or paper print outs can be by Alpha sort, or by Last

name sort. Individual names can be searched out. More disk and mdv tools are presented in this (April) issue. These utilities are also included in the Hartung A Series.

The Hartung A series comes on one 80 track disk or One Micro drive cartridge. Please send a formatted mdv cart if for that medium. Price is \$20.00.

CAMBRIDGE Z88 ISSUE DISK SERIES

UPDATE intends to support the Z88 with the Issue Disk series. With the release of both Disk and Cassette storage interfaces, we will likely choose the disk medium for its faster utilization. We should see programming support developing rapidly. The Z88 uses the "Z80 CPU" which is familiar to our TS-2068 and TS-1000 programmers. So, there is already a wealth of skills to be put to work developing software for the Z88. We anxiously await.

W A N T E D : QL Disk Interface, (CST or Cumana). Also want a "Miracle 512K Ram Expansion. Kenton Garrett, PO Box 127, Lansing, KS 66043 (phone 913 727 3344).

Kenton ask about The Fountain of Youth, his chart shows as being in N. Florida. Yep Ken, it's at Ponce DeLeon, Fla, named for the explorer. We go every qtr to wade in the spring. One hour zeroes out a qtr of aging. Stay too long and you get receding whiskers. Kinda like in-growing toe nails.

There are some old locals around Ponce De Leon. One lady says that she is 242 (contrary to femme tenancy to deny age). They say she has 46 children, none yet of child bearing age. One graduated from grade school four times. You see, the stream crosses her farm, and they take stream baths. They had to fence off the stream else the pigs would'nt grow.

One 88 yr old moved in from Ohio. Nobody ever saw any moving activity since, and now a young feller lives there and courts the pretty native girls.

Me? I moved here after Lee surrendered. I like the area for its mild Winters and good fishing. Could tell more, but Ponce De Leon would end up being the biggest metropolis in North America. Keep this under your hat. ---BJ

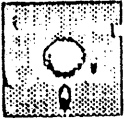

DISK DRIVE SYSTEM SPECIALS

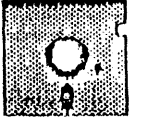

Looking for a disk drive system? LOOK NO FURTHER!



RMG ENTERPRISES
 1419 1/2 7TH STREET
 OREGON CITY, OREGON 97045
 503/655-7484 * NOON-10 TUE-SAT



<h2>SYSTEM #1</h2> <p>LKDOS SINGLE DRIVE UNIT Here is a GREAT starter setup! If you are just getting into disk drives, this one will allow you to expand later-Includes items below: LARKEN DISK I/F - CABLE LKDOS CARTRIDGE-DEMO DISK 1-MITSUBISHI 3.5" 400L DD UTILITY PROGRAMS-FULL DOCS STEEL CASE W/POWER SUPPLY Send copy of ad w/ck or MO for ONLY \$240.00 + \$8 PH Order either system this ad and get 5 FREE DISKS! RMONP102</p>	<h2>SYSTEM #2</h2> <p>LKDOS DUAL DRIVE SYSTEM This system is READY-TO-RUN! Just plug it in and go! Includes ALL of the following items: LARKEN I/F & DOS CARTRIDGE 2- MITSUBISHI 400K 3.5" DD STEEL CASE W/ POWER SUPPLY CABLE & DEMO/UTILITY DISK FULL LKDOS DOCUMENTATION All this AND after sale support! Send copy of this ad w/ ck or MO You SAVE 10% off regular low price ONLY \$265.00 + \$8 PH RMONP107 (Offers end 6/30/89)</p>
--	--

QLQLQLQLQLQLQLQLQLQLQLQLQLQLQLQLQL

DISK SYSTEMS!
 WE'RE THE LARGEST-

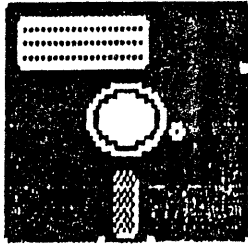

LARKEN dealer in the U. S.! That's why we can offer more 2068 systems than any one at better prices!! This is our lowest priced system-- they start here - many more of these COMPLETE DISK SYSTEMS! Start with this one for only--
\$180.00!
 (Plus \$12 P&H)
 System includes 2-3" SSD drives case/power supply/cable AND the LARKEN LKDOS I/F with s/w. WHERE HAVE YOU SEEN SUCH A DEAL? System is also compatible with the new LARKEN RAMDISK. Don't wait! OFFER ENDS 5/15/89 - POSITIVELY!

RMG ENTERPRISES
 1419 1/2 7TH STREET
 OREGON CITY, OREGON 97045
 503/655-7484 * NOON-10 TUE-SAT

READ ANY GOOD QL BOOKS LATELY?
 HOW ABOUT A USERS GUIDE FOR ARCHIVE THAT'S COMPLETE AND WRITTEN IN PLAIN ENGLISH FOR A CHANGE!

HERE IT IS! JUST FOR YOU!

ARCHIVE MASTER

Our new book will shipping out shortly after the 1st of March, 1987. We don't think that there is anything about ARCHIVE that we have forgotten to cover. We may have missed some small detail, but we can't find it!

The book covers ALL COMMANDS and ALL FUNCTIONS in detail! We step you through each of these and then go on to show you how to create the 'PERFECT FILE'. After that, we show you how to add NEW FIELDS to an existing file.

The next step is to show you, IN DETAIL, the SEDIT or SCREEN EDIT function. Have you ever turned off your QL without closing a file and tried to open it again only to get 'CANNOT OPEN FILE'? If so, we have included a fix for the corrupted file. THIS ONE ALONE IS WORTH THE PRICE OF THE BOOK! And if that's not enough, we even give you the listings for all of our business software!
 All of this at a price of ONE PROGRAM!

ONLY \$44.95+\$3ph

Over 200 8 1/2"x11" pages in a quality 3 ring binder.

ANOTHER SUPERB EXECUTIVE WORKSHOP PRODUCT FOR YOUR QL!

AVAILABLE EXCLUSIVELY FROM:

RMG ENTERPRISES
 1419 1/2 7TH STREET
 OREGON CITY, OR 97045
 503/655-7484

QLQLQLQLQLQLQLQLQLQLQLQLQLQLQLQLQL

New Lower Prices and NEW PRODUCTS!

SPECTERM-64(TS-4.1)

300/1200 Terminal Software for T/S2068
On JLO, AERCO, Larken disk or tape.
Compatible with 2050 modem or standard
RS-232c modem with Z-SI/O (below).
Only \$17.50 + \$2.50 S&H

Z-SI/O Bare Boards

RS-232c Serial Interface for T/S2068.
With FREE 2050 card! Easy to assemble.
Only \$24.50 + \$2.50 S&H

MAX-COM Software

300/1200 Terminal/BBS Software for the
T/S 2068 with LARKEN (v.3) Disk System.
Only \$25.00 + \$2.50 S&H

LARKEN Disk Hardware:

LARKEN Disk System

Includes LARKEN Floppy Disk Interface, LKDOS (v.3)
Cartridge, Operating Manual and LKDOS Utilities' Disk.
Only \$125.00 + \$5.00 S&H

LARKEN "Turnkey" System

Includes everything above plus one disk
drive, with case, power supply and drive cable.
It's Ready to Run, just connect to the T/S2068.
Only \$225 & up + \$15 S&H
Design YOUR OWN system! CALL

LKDOS Cartridge for OLIGER System

Specially configured LKDOS (v.3) Cartridge that
works with your JLO SAFE Disk hardware. Includes
Operating Manual and LKDOS Utilities' Disk.
Only \$65.00 + \$3.50 S&H

Announcing: PIX-FX

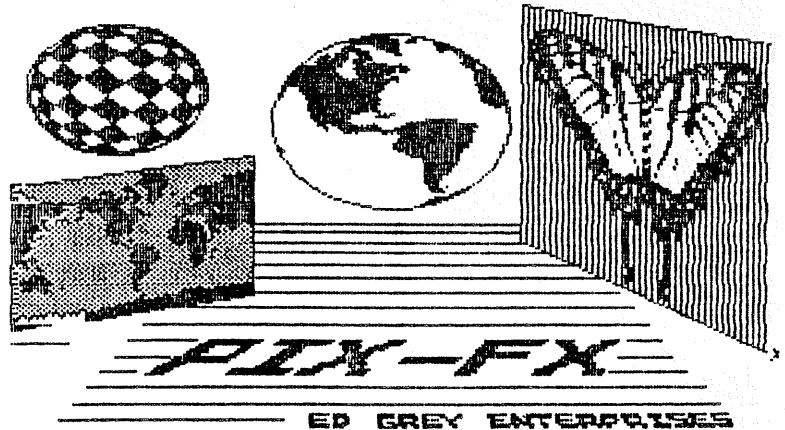

Now YOU can take a T/S2068 screen\$ and
create all sorts of SPECIAL EFFECTS. Wrap
your SC\$ around a globe, change perspective,
magnify, reduce, and merge SC\$ plus more. Pull
Down Menus, use keyboard or joystick. Disk drive
compatible. Excellent documentation.

On tape: \$25.00 + \$2.50 S&H
On disk: \$30.00 + \$2.50 S&H

Modems, Printers and...

- Avatex 1200<E> (300/1200).....\$69
- Seikosha 180AI (100/20)..\$159
- Seikosha SL80AI (24 pin)..\$335
- Wordstar3.3 (CP/M)..\$40 + \$5 S&H
Incl. Deluxe MicroPro WS manual, upgradable.
- PC-Draw(v.3)...\$12 + \$2.50 S&H
Circuit Bd design pgm for T/S2068
- DD Power Supply..\$12.50 + \$3 S&H
110/220 AC : DC +12V 2.6A, +5V 1.6A
- 5.25" Diskettes..25/\$12.50 + S&H
Used once, PREMIUM QUALITY, guaranteed.

S&H CHARGES> MINIMUM: \$3.00, ea. modem: \$4.00,
ea. printer: \$11.00, ea. software: \$2.50. (COD add
\$3.50, CA add sales tax, Canada double S&H)

Continued Timex/Sinclair Support is brought to you by:

Ed Grey Enterprises

P.O. Box #2186, Inglewood, CA 90305
Info >> 213-759-7406 << Order

Call The Grey Matter BBS & RCP/M (213-971-6260)