

PRIMA'S OFFICIAL STRATEGY GUIDE

MULTIPLAYER TIPS AND TRICKS!



THE SUM OF ALL FEARS™

Based on Tom Clancy's *New York Times* best-seller



primagames.com

Now a major motion picture
from Paramount



TOM CLANCY'S
THE SUM OF ALL FEARS™

PRIMA'S OFFICIAL STRATEGY GUIDE

MICHAEL KNIGHT

Prima Games
A Division of Random House, Inc.

3000 Lava Ridge Court
Roseville, CA 95661
1-800-733-3000
www.primagames.com





The Prima Games logo is a registered trademark of Random House, Inc., registered in the United States and other countries. Primagames.com is a registered trademark of Random House, Inc., registered in the United States. Prima Games is a division of Random House, Inc.

The Sum of All Fears: Prima's Official Strategy Guide ©2002 by Ubi Soft Entertainment. All rights reserved. No part of this book may be reproduced or transmitted in any form or by any means, electronic or mechanical, including photocopying, recording, or by any information storage or retrieval system without written permission from Ubi Soft Entertainment.

Product Manager: Jill Hinckley
Project Editor: Terri M. Stewart
Editorial Assistant: Teli Hernandez
Design and Layout: Cathi Marsh

©2002 Paramount Pictures Corp. Software ©2002 Ubi Soft Entertainment. All Rights Reserved. Red Storm and Red Storm Entertainment are trademarks of Red Storm Entertainment, Inc. Red Storm Entertainment, Inc. is a Ubi Soft Entertainment company. Tom Clancy's The Sum of All Fears is a trademark of Jack Ryan Enterprises, Ltd. under license to Ubi Soft Entertainment. Ubi Soft Entertainment and the Ubi Soft logo are registered trademarks of Ubi Soft Entertainment. All other trademarks are the property of their respective owners.

All products and characters mentioned in this book are trademarks of their respective companies.

Please be advised that the ESRB rating icons, "EC", "K-A", "E", "T", "M", "AO" and "RP" are copyrighted works and certification marks owned by the Interactive Digital Software Association and the Entertainment Software Rating Board and may only be used with their permission and authority. Under no circumstances may the rating icons be self-applied or used in connection with any product that has not been rated by the ESRB. For information regarding whether a product has been rated by the ESRB, please call the ESRB at 1-800-771-3772 or visit www.esrb.org. For information regarding licensing issues, please call the IDSA at (212) 223-8936. Please note that ESRB ratings only apply to the content of the game itself and does NOT apply to the content of this book.

Important:

Prima Games has made every effort to determine that the information contained in this book is accurate. However, the publisher makes no warranty, either expressed or implied, as to the accuracy, effectiveness, or completeness of the material in this book; nor does the publisher assume liability for damages, either incidental or consequential, that may result from using the information in this book. The publisher cannot provide information regarding game play, hints and strategies, or problems with hardware or software. Questions should be directed to the support numbers provided by the game and device manufacturers in their documentation. Some game tricks require precise timing and may require repeated attempts before the desired result is achieved.

ISBN: 0-7615-3955-7

Library of Congress Catalog Card Number: 2002104890



Acknowledgments

I would like to thank my wife Trisa for her support and help in making this book a reality. I know my playing games and writing at all hours of the day is a challenge for her, especially during pregnancy. I love you very much and thank you for three wonderful children and a fourth to arrive shortly.

I would also like to thank Terri Stewart, Sara Wilson, Jill Hinckley, and Teli Hernandez at Prima Games for all their help in making this guide as good as it is. I would also like to acknowledge Heather Maxwell at Red Storm Entertainment and Tena Lawry at Ubi Soft for their assistance as well.

This book is dedicated to Sharry Colnar—excellent teacher, wonderful Academic Decathlon Coach, and good friend. She pours much of her life and time into helping create a better world one student at a time. I am also grateful for her introducing me to the work of Tom Clancy at the very beginning of his writing career with his inaugural novel, *The Hunt for Red October*. I hope that I can be as influential in the lives of others as she has been in mine.

Contents

INTRODUCTION	VI	CHAPTER 3: CLOSE-QUARTERS BATTLE TACTICS ..	46
CHAPTER 1: BASIC TRAINING	1	Commanding Your Team	47
Controlling Your Character	2	Indoor Tactics	50
Commanding Your Fire Team	6	Outdoor Tactics	54
The Training Mission	7	Night Ops	56
T01: Movement	7	Preparing for the Mission	57
T02: Small Arms	9	Mission-Ready	58
T03: Grenades	11	CHAPTER 4: THE CAMPAIGN	59
T04: Objects	12	Mission 01: Hostage Rescue Operation	60
T05: Squad	14	Maps	63
T06: Indoor Ops	15	Mission 02: Agent Recovery Operation	71
T07: Killhouse	15	Maps	73
CHAPTER 2: THE ARMORY	18	Mission 03: Barren Garden	82
SMGs	19	Maps	85
Carbines	23	Mission 04: Janus Knife	93
Assault Rifles	25	Map	95
Sniper Rifles	28	Mission 05: Tiger Shell	101
Shotguns	30	Maps	103
Pistols	32	Mission 06: Jagged Hammer	112
Grenades	34	Maps	114
Equipment	36	Mission 07: Glacier Rift	120
Team Kits	36	Maps	122
		Mission 08: Lightning Field	129
		Maps	131
		Mission 09: Hollow Serpent	140
		Maps	143



Mission 10: Broken Chain	149	CHAPTER 6: MULTIPLAYER MISSIONS	207
Maps	152	Types of Multiplayer Missions	212
Mission 11: Razor Scythe	159	General Multiplayer Tactics	215
Maps	162	The Cardinal Rules of Team	
CHAPTER 5: QUICK MISSIONS	170	Close-Quarters Combat	219
Tactics for Quick Missions	171	Multiplayer Weapons Kits	221
The Maps	172	The Maps	222
M01: TV Station	172	M01: TV Station	222
M02: Militia Compound	175	M02: Militia Compound	226
M03: Warehouse	177	M03: Warehouse	228
M04: Weapons Facility	180	M04: Weapons Facility	231
M05: Prison	181	M05: Prison	232
M06: Mercenary Compound	183	M06: Mercenary Compound	234
M07: Diamond Mine	184	M07: Diamond Mine	235
M08: Olson's Estate	186	M08: Olson's Estate	237
M09: Investment House	188	M09: Investment House	239
M10: Corporate HQ	191	M10: Corporate HQ	242
M11: Dressler's Estate	194	M11: Dressler's Estate	245
MP01: RSE Offices	196	MP01: RSE Offices	247
MP02: Athlete	197	MP02: Athlete	248
MP03: Killhouse	199	MP03: Killhouse	250
MP04: Parking Garage	201	MP04: Parking Garage	252
MP05: Reservoir	202	MP05: Reservoir	253
MP06: Art Gallery	204	MP06: Art Gallery	254
MP07: Training	205	MP07: Training	255

Introduction

The Sum of All Fears, Red Storm Entertainment's latest release, is based on Paramount's movie by the same title and the book by Tom Clancy. Players take part in a campaign that runs parallel to the storyline from the movie and even intersects it at some points. All of the missions are based on counterterrorist operations; objectives include rescuing hostages, infiltrating enemy bases, neutralizing terrorists, and planting explosive devices.

What's New?

If you've played *Rainbow Six*, *Rogue Spear*, or any of the related titles, the premise of this game will be familiar. However, while those games required a lot of detailed planning prior to a mission, *The Sum of All Fears* lets you quickly get into the action. Read the briefing, see what your objectives are for the mission, choose a kit of weapons and equipment for your team, and you're ready to begin. HQ plans lead you to your objectives, and support teams provide assistance without orders from you.

Veterans of *Ghost Recon* will notice that the engine and interface of the game are very similar. However, you now engage terrorists (referred to as tangos) instead of enemy soldiers. Also, many of the missions require close-quarters battle (CQB) tactics and take place inside buildings and other structures. This requires different strategies.

How to Use This Guide

This strategy guide helps you become an expert counterterrorist operative proficient in the tactics and strategies associated with close-quarters battle. The guide contains what you need to know to complete the game without frequently getting killed. This guide contains six chapters.

Chapter 1 covers the basics of the game, teaching you about movement, how to use weapons, and the different ways to control your character. It culminates with a walkthrough of the training missions. Chapter 2 provides information on the diverse weapons and equipment available and instructions on how to use them. For tips on CQB and the tactics you need to complete the missions you are assigned, read Chapter 3.

Chapter 4 provides walkthroughs for all 11 campaign missions, complete with maps. Special Forces Tips cover playing the missions with all of the challenging Special Forces options selected. *The Sum of All Fears* also includes quick missions where you individually can play on all of the maps in the game. Tips and tactics for the quick missions, with specifics for each map, can be found in Chapter 5. Chapter 6 covers the multiplayer game. It contains a listing of the individual weapons kits, tactics and strategies for playing multiplayer missions, and tips for each of the maps.

Now, don't just gaze at this page—turn to Chapter 1 and begin your training. You have a lot of work to do. Good luck, soldier!





1

Basic Training

Welcome to the FBI Hostage Rescue Team. As a member of the HRT, you will be assigned important and dangerous missions to apprehend or neutralize criminals. These missions require you not only to rescue hostages, but also to engage in reconnaissance missions to find evidence and assault missions to take down terrorists and other hostiles. You take command of a three-man team. Your team may work alone or with other teams in support.

You won't be unprepared. This training course has been designed to sharpen your skills for combat. It begins with the basics of controlling your character and team, then concludes with a training mission where you can practice what you've learned.

WHAT IS A TANGO?

During the course of the game, and throughout this book, you'll come across the word tango. Tango represents the letter "T" in the phonetic alphabet. As a result, tango is used by counterterrorism operatives as a radio shorthand for terrorist.

Controlling Your Character

During a mission, you directly control an individual operative and indirectly control two other operatives who make up your team. Master the control of your character because you have to guide the operative through dangerous areas filled with tangos.

Movement

The Sum of All Fears uses a combination of the keyboard and mouse for controlling your character. Moving the mouse changes the direction and angle of your character's view. To move your character, use **W** and **S** to move you forward and backward, respectively, while **A** and **D** strafe left and right.

By default, your character walks when ordered to move. Holding down the right mouse button while moving makes your character run. Running is louder than walking, so tangos are likely to detect you when your team is running down a hallway. If you want to sneak around, shuffle by holding down **Alt** while you move. This is the quietest way to move.

There is no command for jumping. Don't worry; you won't need to jump during a mission.

You may have to get over or under obstacles. To crouch to move under something, press **C**. Crouching also makes it harder for the enemy to detect and hit you because you present a smaller target. You move slower than when you are standing, but you can move faster by holding down the right mouse button, or shuffle by holding down **Alt**. To stand up again, press **C** a second time.



To climb over an object, such as a short wall, or onto a platform, walk up to it and press **[Spacebar]**. This is the default “Use” key; it also opens doors and manipulates your environment. Objectives may include disabling security systems, planting or disarming bombs, or picking up documents. To do all of these, walk up to the object, press **[Spacebar]**, and hold it down until the icon over the reticule cycles all the way around. If you release the **[Spacebar]** before this happens, you must repeat this.

HOSTAGES

During some missions, you have to rescue hostages or secure the area around them without killing them. In *The Sum of All Fears*, the tangos won't harm the hostages under their control. When your team rushes into a room with hostages, the only bullets the hostages need to worry about are yours.

In some missions, you must secure a hostage. To do this, eliminate all of the hostage's captors. The hostage remains in place for the duration of the mission. To keep your mission from failing, use extreme caution to ensure the hostages are not inadvertently killed. In this game, the tangos don't execute the hostages.

In one of the campaign missions, you must take a captive. To do this, walk up to and bump into the person to capture him. He then follows you around. Also, in the multiplayer SAR mission, you must bump into each hostage so they follow you about the level.

Using Weapons and Equipment

Guns

The basis of the game is combat, so you carry weapons and other equipment. Chapter 2 discusses each type of weapon available while Chapter 3 provides tactics for using them effectively.

The middle of the action screen, which is also the center of your view, contains a targeting reticule. The shape of the reticule varies with the type of weapon you are using, but each reticule has four short lines extending from it. As you move or turn, these lines move away from the center of the screen, then converge on the center again when you are still. The four lines represent the spread area of your bullets. When you are still, your aim is more accurate; when you are running or turning, shots are less accurate and your bullets spread out much more. Firing a weapon on full-automatic also decreases your accuracy with each additional round fired. Fire at a wall, then observe the pattern of bullet holes created to see how this works.

TIP

To increase your weapons accuracy, do the following:

- Stand still.
- Take a second to aim before firing.
- Walk when advancing.
- Strafe around corners; don't turn.
- Use semi-automatic or three-round burst selections rather than full-automatic.

To fire a weapon, click the left mouse button. Some weapons allow you to select a rate of fire. There are three choices—semi-automatic, three-round burst, or full-automatic. In semi-automatic mode, the weapon fires one round each time you click the mouse. In three-round burst mode, the weapon fires three rounds for each mouse click. Finally, in full-automatic mode the weapon continues to fire as long as you hold down the left mouse button or until the current clip is empty. To change between different rates of fire, press [X].

When you run out of ammo, or if your clip is getting low, press [Z] to change clips and reload. There is an auto-reload option (the default for the Easy difficulty setting), which automatically reloads your weapon when the clip is empty. For most shotguns, each time you press [Z] you load only a single shell, not an entire clip. However, an entire clip is reloaded for the auto shotgun (as well as for all shotguns on the Easy difficulty setting).

Grenades

Grenades are a bit different; you throw them instead of firing them (except for the M203 grenade launcher). When you select either a frag grenade or flashbang, the reticule changes to a large circle. To throw a grenade, select it as your active weapon, then press the left mouse button and hold down until the icon is full. When you release, the grenade is thrown. To roll the grenade only a short distance, left click and release before the icon fills. Rolling is a good way to drop a grenade over a balcony, or to get one just to the other side of a doorway.

The nice thing about frag grenades and flashbangs is that you have three seconds from the time you release until they detonate, so you can throw them around a corner or bounce them off of a wall so they land out of sight before they go off. Be careful they do not come back at you—they kill friend and foe alike. Grenades from the launcher explode on contact, so don't try bouncing them.

Heartbeat Sensors

The heartbeat sensor is useful. When you select the heartbeat sensor, the scanner locates other people in the area on the same level as yourself. Their positions are plotted on the map. Red dots represent tangos while friendlies such as your team, support teams, and hostages appear as green dots.



Team Kits

You carry four items as part of a kit. The primary weapon is your default and consists of a rifle, submachine gun, carbine, or such. The secondary weapon is usually a pistol. You have two equipment slots that can carry frag grenades, flashbangs, or a heartbeat sensor. To select a weapon or item during a mission use the appropriate key listed below.

- ① Primary weapon
- ② Secondary weapon
- ③ Equipment slot 1
- ④ Equipment slot 2

Weapons Status

Monitor the status of your weapons with the weapons display in the screen's bottom right corner. This lists your selected weapon, the number of rounds in the clip, how many clips you have remaining, and how many grenades you have. On the Easy difficulty setting, you have an unlimited number of clips of ammunition, so the clip display shows a dash. Also, grenades never have clip numbers. Instead, the number of grenades is listed in the display for number of rounds.

Night-Vision Goggles

Each of your operatives carries a pair of night-vision goggles (NVGs). These are useful for night missions or while operating in dark areas. To activate the goggles, press **[V]**. The screen changes to a black and green display with an oval view area. When using NVGs, you lose

part of your peripheral vision, but the goggles let you see the enemies in conditions where they most likely cannot see you. NVGs can also be used with weapons sights, so if you are using a sniper rifle or other weapon with a zoom capability, you can still operate in the dark.

TIP

Night-vision goggles are useful during the day. Tangos sometimes hide in shadows, in dimly lit corners, or tunnels. Even though the lights are on, use your NVGs to get a better view of the situation.

TIP

If you change out a clip before it is completely empty, your character does not throw it away. It still is counted in the number of clips remaining. During a mission with a lot of shooting, you may load a new clip to find out it is half empty, because you have used all your full clips and have only the partially filled clips remaining.

The Maps

The maps are very useful tools. The mini-map appears at the screen's bottom. It plots the locations of your team, your support teams, and any detected tangos.

Use the heartbeat sensor to show tangos' positions on the map, even if none of your team has a visual to them. This allows you to “see” through walls and doors without exposing yourself to enemy fire.

The map can be zoomed in and out by pressing **[+]** and **[-]**. The mini-map's size makes it difficult to see the entire level at one time. Pressing **[Tab]** brings up the map full-screen, allowing you to plan ahead.

Maps also plot HQ plans forming a path in a white line on the map. This path leads your team to the objectives. Only the HQ plans to the current objective are shown, beginning with the first. Once you have accomplished an objective, a new of HQ plan illustrates the route to the next objective.

HQ plans usually represent an ideal path for your team to follow. At times you may want to take an alternate route because of enemy resistance. Once you intersect the path again, the HQ plan up to that point disappears and you continue on from where you intersected.

TIP

Messages periodically appear in the upper left corner of the screen. Keep an eye out for this information. It lets you know if your team or other support teams are taking casualties and also whenever a team takes out a tango. This is useful if you are throwing a grenade around a corner or into a room. After the grenade detonates, if you do not get a “tango down” message, the tango is still alive and ready to shoot you.

Commanding Your Fire Team

While you have direct control over your character, you have only indirect control over the rest of your team. They follow you and engage tangos that come into their sights. Give them orders through the Command Interface to make them more useful. To bring up this interface, press **[Ctrl]**, and a window appears in the screen's lower left corner.

During a campaign mission, if the Command Interface is opened, the game pauses. This allows you to give your orders without having to worry about tangos gunning you down while you are occupied. The game does not pause in a multiplayer mission.

The Command Interface has two parts. The upper tells your team how to act with respect to formation, movement, and rules of engagement (ROE). The lower gives your team specific orders, such as clear the room, open a door, or throw a grenade into a room. During the training mission, try out the Command Interface and see how your teammates respond to your orders.



Quickly toggle instructions to your team using hot keys, as listed below.

- T** Formation—open or close
- R** Movement—follow me or hold position
- F** ROE—recon or assault

The Operative Panel

In the lower left corner of the screen, the Operative Panel shows three silhouettes. The large one represents your character while the other two indicate your teammates. These silhouettes show whether your team is standing or crouched, as well as the operatives' health status. When an operative is wounded, his or her silhouette turns yellow. If it turns red, the operative is dead. The three ovals on this display show your current formation, movement, and rules of engagement. A glance at the Operative Panel gives a quick update of your team's condition.

The Training Mission

The training mission is divided into seven areas. Select the first area, T01—Movement, then continue through each area in succession. If you want to practice a certain skill, go back to that training ground.

T01: Movement

In the first area you practice moving your character around the level. Follow a red line from section to section to receive instruction along the way. At the obstacle course, your first task is to crawl under some barbed wire.

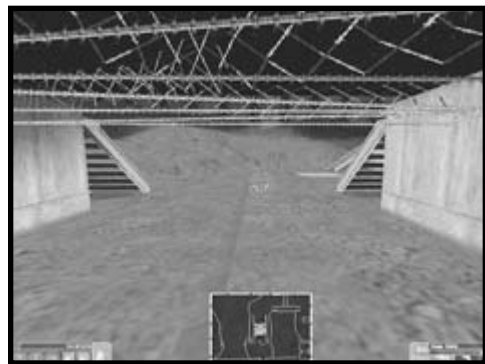

Crawl under the barbed wire.

Press **[C]** to crouch, then **[W]** to move forward under the wire. When you get to the other side and out from under the wire, press **[C]** again to return to a standing posture.

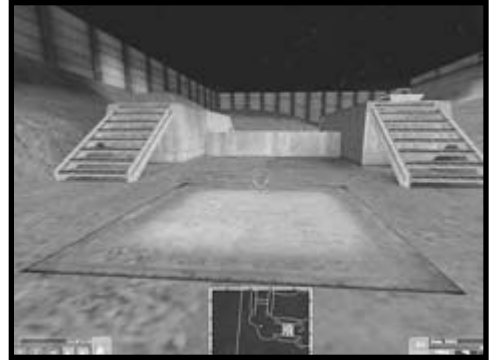

Follow the red line to the next task.

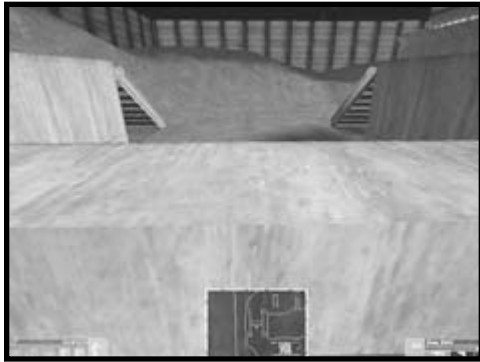

Climb over this short wall.

Follow the red line to the next task. Climb over a short wall. Walk up to it and press **[Spacebar]** to climb to the top, then move forward until you drop down on the other side.

Move to the tall wall. Instead of climbing it, peek around it. Stand next to one edge and press either **[Q]** or **[E]** to lean left or right, respectively, and see around the wall. This allows you to shoot around a corner without exposing your entire body. It's more difficult for a tango to detect you when you're peeking, and tougher for him to hit you. After peeking, practice strafing around a corner by pressing either **[A]** or **[D]**.

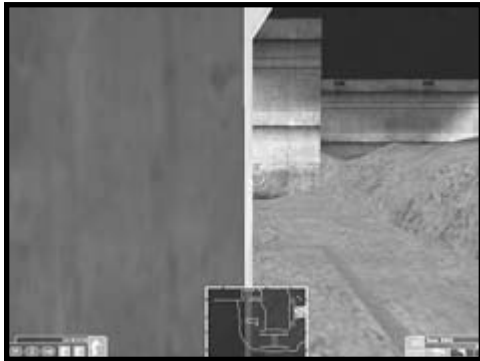

Peek around this wall.





Find this first door and go through it.



Locked doors take longer to open because you must first pick the lock.

When you are through peeking and strafing, follow the red line to a door. To open it, walk up to it and press **[Spacebar]**. Try to open the second door, and the reticle shows an image of a padlock, indicating that the door is locked. Your character automatically begins picking the lock. It may take a couple of seconds to get through a locked door, so hold down **[Spacebar]** until the task is complete. If you let up on **[Spacebar]**, you will have to start over. Some doors can't be opened; see the training session T04—Objects.

T02: Small Arms

At the small-arms range, you learn how to fire weapons, reload, switch weapons, select rates of fire, and use a scope.



This is the small-arms shooting range.



Practice with the SMG to begin with.

Once you are comfortable with the SMG, move to the next range area on the right. This is the sniper rifle, which has only one rate of fire—semi-automatic. Press **[Shift]** to zoom in the scope and see what makes sniper rifles special. Though your rate of fire is much lower, long-range accuracy increases dramatically. Take out all of the targets on the far building using the sniper rifle's scope.

DEVELOPER TIP

Be careful when going around corners. Turning makes it harder to aim, and you're a good target for a stationary gunman who's covering that opening. A good tactic is to line up the angle you want to look around the corner with, then sidestep through the opening. This will improve your chances of getting the drop on your opponent.

Walk over to the first range area on the left to try out the SMG. Take out all of the green targets downrange. As you move side to side and turn, notice how the reticule lines move apart and then come back together.

Practice changing your rate of fire by pressing **[X]**. If you run out of ammo, press **[Z]** to change clips.

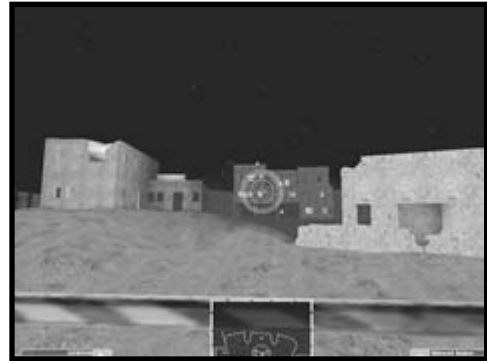

The sniper rifle view seems similar to that of the SMG...



...until you zoom in the scope.





The pistol range is much shorter than the other two.



Continue to the next training area.

After sniper training, it's time for target practice with your secondary weapon—the pistol. Walk over to the third range, where the targets are much closer. Press **[2]** to select your pistol and pick off the green targets. Pistols have a shorter range than the other small arms, but they can be necessary in a bind, and a silenced pistol helps maintain stealth. After you feel comfortable with the pistol, head to the door leading to the next training area.

T03: Grenades

Walk up to the first range on the left and throw frag grenades. These grenades have a delayed fuse, detonating three seconds after you release them. To throw a grenade, left-click the mouse. The longer you hold down the left mouse button before releasing it, the farther you will throw the grenade. Practice throwing frag grenades at the close targets. Then try to take out the targets at the more distant building. Since grenades travel in an arc, you have to aim quite a bit higher than where you want the grenade to land to get it through a window or on top of the building.



For long-distance throws, aim high over the target area.

Fire a grenade launcher at the next range. These grenades explode on impact rather than on a delayed fuse, so fire them directly at a target. These grenades travel faster than hand grenades, and they arc less. For longer shots, aim lower than you did before.



Flashbangs do not take out the target.



Use the grenade launcher to attack tangeros at a distance.

The final grenade range is for flashbangs. These grenades do not kill a target. Instead, they create a bright flash of light and loud sound that momentarily blind and stun the target. Flashbangs are thrown just like frag grenades. To get a better understanding of how

a flashbang affects a tango, throw one short, right in front of you. When it detonates, your view is obscured for a few seconds. It is during that short time of disorientation that you can rush into a room and take out a stunned tango before he has a chance to return fire.

T04: Objects

The field operations training range teaches how to perform specific actions in a mission. Many of these actions accomplish mission objectives, so it is important to learn how to do them.



Field ops is next.



The first task is to try to open the door marked “Authorized Personnel Only.” Walk over to it and press **[Spacebar]**. It doesn’t open, and a message in red text at the top left of the screen states “You cannot use this door; find a different path.” Not all doors can be opened. If you receive this message, find another way in or out.



This door cannot be opened.



Rig a demolitions kit on the weapons crate.

The next task is to plant a demolitions kit on a weapons crate. Follow the red line to the crate, walk up to it, then press and hold down **[Spacebar]** until the icon cycles around to full. For missions requiring a demolitions kit, one is automatically provided. It doesn’t appear in your inventory, but when you approach an objective and press **[Spacebar]**, you automatically plant the explosive.



Pick up the attaché case.

As you may have figured out by now, all actions in this area require you to press **[Spacebar]** to complete a task. Walk over to the desk and pick up an attaché case. Approach the bomb and disarm it the same way. No matter what the task, use **[Spacebar]** to manipulate objects.



Disarm the bomb.

T05: Squad

On your way to the next training area, you must move through a dark passageway. Press **[V]** to activate your night-vision goggles. After exiting the passage, deactivate your NVGs by pressing **[V]** again.



The night-vision goggles allow you to see in the dark.



Watch your squad as you give commands.



Order a teammate to open the door for you.

This is the squad control range, where you learn to command your team effectively. Press **[Ctrl]** to bring up the Command Interface to change the team's formation, movement, and ROE. Walk backward to see what effect each command has on your operatives. Continue to the next area. When you come to the door, order one of your teammates to open it via the Command Interface.

DEVELOPER TIP

In Tom Clancy's novel *The Sum of All Fears*, the championship game is held in Denver. In the Paramount film, it is held in Baltimore; the actual scene was filmed in Montreal. However, none of these cities is likely to host such a game in the near future, since none of their stadiums are domed, and all have the possibility of inclement winter weather.



T06: Indoor Ops



An operative clears out the hall, following your order.



After throwing a grenade into a room, one of your team rushes into clear it.

The next area is the indoor training range, where you learn how to instruct your team to clear indoor spaces. Practice giving your operatives specific orders. When you get to the first door, order your team to “clear.” A teammate automatically opens the door and quickly enters to clear the room. There are more doors inside where you can practice clearing and throwing frag grenades or flashbangs into rooms.

T07: Killhouse

Your team is now ready for the final training area. This is a test of all the skills you have learned in the other training areas and consists of a two-story killhouse. Five tangos and one hostage wait inside. Your job is to take out all five tangos and secure the hostage.



Real people inhabit the killhouse.

What makes this training exercise tougher is that there are real people inside who shoot back at you—using simulated ammunition, of course.

TIP

During this training exercise, the map shows all tangos as red dots. This is similar to how a heartbeat sensor works. Use the mini-map to plan your advance through the killhouse.



Order your operatives to clear rooms and watch how they do it with a tango inside.



Head up the stairs once the first floor is clear.

Open the front door and take down the first tango in the hallway. There are two more on the ground floor—one in each room to the side of the hallway. Order your team to clear these rooms to see how they do. Then go upstairs to the second floor.

DEVELOPER TIP

Lone Wolf mode places you as a single operative in a level full of enemies; your challenge is to make it to the extraction zone alive. For an added challenge, try eliminating all enemies in the level.





Order your team to throw a frag grenade into a room.

Order your team to throw a frag grenade and take out the tango in the upstairs hallway. The last tango is near the hostage, so use a flashbang on the next room. Rush into the room immediately after the grenade detonates to neutralize the tango before he recovers. When this tango is down, the mission is complete. However, you can try escorting a hostage, which is similar to the leading of a captive that you must do in a campaign mission and in the multiplayer SAR mission. Open the door to the room containing the hostage. Walk over to her and she automatically follows you; you've secured the hostage. Lead her downstairs and exit the killhouse. Good work.



The tango is stunned by a flashbang.



The hostage is secured.



2

The Armory

Your team goes up against dangerous terrorists and criminals. To complete your objectives without getting killed in the process, arm your team with appropriate weapons and equipment. The first part of this chapter individually covers each weapon and piece of equipment. The second section contains information about the team kits with which you can outfit your team prior to the start of a mission.

SMGs

Submachine guns are larger and more unwieldy than handguns, but they deliver more firepower because of their ability to quickly fire multiple rounds. At close range, this provides ample stopping power.

SMGs are best for interior operations where most targets are at close to medium range. Because of the guns' short barrels, the rounds from SMGs have less muzzle velocity than those fired by a carbine or assault rifle. This means that SMGs have less penetrating power against targets wearing body armor. When going up against a well-armored enemy, fire more than one round to ensure a takedown. Fire off two or three rounds in semi-automatic, use a three-round burst, or let loose a short burst on full-automatic. Most SMGs can be fired at all three rates of fire, but a few lack the three-round burst option.

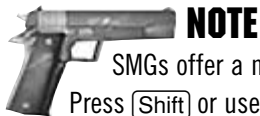

NOTE

SMGs offer a magnification to their sights.
Press **[Shift]** or use the mouse wheel to zoom in on your targets.

9mm SMG

The 9mm SMG lacks the firepower of the M4. This deficiency is compensated for by better control when firing on automatic and when turning and shifting aim.



Rates of Fire

- Semi-automatic
- Three-round burst
- Full-automatic

Notes

The 9mm SMG is your standard submachine gun for missions. It is used by many counterterrorist and SWAT organizations for interior operations. The three rates of fire make this SMG versatile and effective in different types of situations. The 9mm SMG is the most accurate SMG in the game.

9mm SMG SD

The silenced variant of the 9mm SMG sacrifices firepower for a quieter operation. This makes it an ideal weapon when stealth is crucial.



Rates of Fire

- Semi-automatic
- Three-round burst
- Full-automatic

Notes

The 9mm SMG SD is one of two silenced primary weapons in the game and the one you use for all stealth missions. When stealth is key to the success of a mission and you need heavier firepower than a pistol can provide, choose a kit that offers this weapon. During the campaign, several missions call for this SMG.

5.7mm SMG

The 5.7mm SMG is a bullpup design, making it more accurate than most guns its length. Because of the short length, use this weapon in tight quarters.

Rates of Fire

- Semi-automatic
- Three-round burst
- Full-automatic



Notes

When you need an SMG for a mission, but stealth is not important, choose a kit containing the 5.7mm SMG. With its 50-round clip, you can use the full-automatic rate of fire for sustained periods of time without worrying about running out of ammo in the middle of a firefight. It's also a "room broom." To clear a room containing more than one tango, rush in and lay down a stream of lead. As with all SMGs, the 5.7mm is best for close-quarters battle situations where all targets are at short range. It is less effective at medium range and poor at long range.



0.45 Auto Pistol

Firing a heavier pistol round than the 9mm, this automatic pistol is effective at short range. However, the light weight and lack of a second hand-hold make the gun difficult to control in automatic-fire mode.

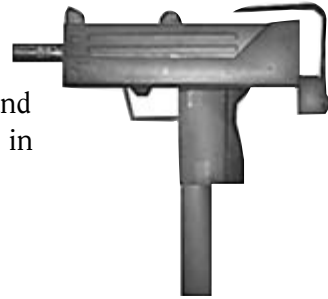

Rates of Fire

- Semi-automatic
- Three-round burst
- Full-automatic

Notes

The 0.45mm Auto Pistol is available in multiplayer kits. It fires the largest, heaviest round of any of the SMGs and provides good penetration at short range. Because of its short barrel, accuracy is not as good as some of the other SMGs, especially on full-automatic for sustained bursts.

9mm Auto Pistol

This lightweight machine pistol fires the 9mm pistol round in a rapid automatic-fire mode. It is difficult to control this weapon when it is firing fully automatic.



Rates of Fire

- Semi-automatic
- Full-automatic

Notes

The 9mm Auto Pistol is available in multiplayer kits. It is similar to the 9mm SMG, but not as accurate. If you have a choice between the two, go for the 9mm SMG rather than the 9mm Auto Pistol.

9mm Compact SMG

The compact SMG trades overall length and accuracy for a higher rate of fire. The shorter length makes it as controllable as a pistol when you're moving.

Rates of Fire

- Semi-automatic
- Three-round burst
- Full-automatic

Notes

The 9mm Compact SMG is available in multiplayer kits. Based on the same design as the 9mm SMG, this weapon has a collapsible stock and a shorter barrel, making it easier to conceal and handier in confined situations. It is less accurate than its larger brother, though, and is best used at close range.



5.45mm SMG

This weapon is a scaled-down variant of an assault rifle. It fires a less lethal round than the M4, but the lighter round allows for better control when firing on automatic.

Rates of Fire

- Semi-automatic
- Three-round burst
- Full-automatic

Notes

The 5.45mm SMG is available in multiplayer kits. It is one of the most powerful SMGs in the game because it fires a rifle-type round rather than a pistol round like most SMGs. This gives the bullet good penetration capability; it goes through most body armor without problems.



Carbines

Carbines are heavier versions of submachine guns, using a larger ammunition type. They deliver more firepower because of their ammunition type and are favored in more combat-oriented situations.

If you will be operating at medium range and stealth is not a concern, choose carbines. In addition to their heavier firepower as compared to SMGs, their size makes them more effective than assault rifles for close-quarters battle situations. Also, carbines can zoom in the view more than SMGs, making it easier to target enemies at longer range.

M4 Carbine

This weapon has a good blend of firepower and size. It combines the firepower of a rifle round with a smaller size, making it a versatile weapon useful in open spaces and CQB (Close-Quarters Battle) situations.



Rates of Fire

- Semi-automatic
- Full-automatic

Notes

The M4 is the standard carbine for the early campaign missions. Unless you need the silence of a suppressed SMG, choose the M4 for operations until you unlock more effective weapons. It allows you to engage targets at longer range and with more penetrating power than an SMG.

Spec Ops M4

This modified M4 has several attachments that make the weapon easier to control while moving and firing.



Rates of Fire

- Semi-automatic
- Three-round burst
- Full-automatic

Notes

The Spec Ops M4 is one of the best weapons available. With its selectable rates of fire, it offers versatility. What makes this weapon an excellent choice is its scope. It zooms in on distant targets with as much magnification as a sniper rifle. This ability makes the Spec Ops M4 more accurate than other carbines and some assault rifles.

M4/Shotgun

The combination of an M4 with a shotgun makes this weapon an ideal choice for CQB situations where noise is not an issue. The shotgun allows for quick room entry, while the M4 provides excellent firepower.



Rates of Fire

- Semi-automatic
- Full-automatic

Notes

The M4/Shotgun is a better choice than a standard shotgun for missions requiring breaching operations. The weapon not only can get through locked doors, but it also has penetrating power and range for engaging enemies.



5.56mm Carbine

This carbine is equivalent to the M4. It fires the same round but is more compact, resulting in lower overall accuracy but better control over aiming when moving.



Rates of Fire

- Semi-automatic
- Three-round burst
- Full-automatic

Notes

The 5.56mm Carbine is available in multiplayer kits. Choose this weapon when you want the firepower of a carbine but the handling of an SMG.

Assault Rifles

Assault rifles combine the fully automatic firing capabilities of the submachine gun and carbine with the greater range and firepower of a rifle. They are not typical equipment for HRT teams, as they are more military in design and application. However, certain missions call for a more military approach, so assault rifles are available.

For most missions in the campaign, you use either SMGs or carbines. There is one assault rifle in the team kits for campaign and quick missions. When you need heavy firepower, the assault rifle delivers.

DEVELOPER TIP

Additional “Special Forces” modes are available for campaign play. These impose special conditions like not being able to save or load games mid-mission. Can you complete the entire campaign without a single save? Special medals can be earned through playing with these settings enabled.

M16

Firing the same round as the M4, the M16 has moderate firepower. The longer frame of the weapon allows for greater accuracy, but reduces control when moving in tight quarters.



Rates of Fire

- Semi-automatic
- Three-round burst

Notes

Unlike other assault rifles, the M16 cannot fire full-automatic bursts. Studies by the U.S. Army showed that after the first three rounds of a burst, all subsequent rounds were off-target. So the full-automatic rate of fire selection was replaced by the three-round burst. The M16 is available in multiplayer kits.

M16/203

This weapon combines the power of the M16 with an underbarrel 40mm grenade launcher, making a formidable assault weapon. Take care when using the grenade launcher if civilians are in the area.



Rates of Fire

- Semi-automatic
- Three-round burst

Notes

The M16/203 is the only assault rifle available in the team kits for the campaign and quick missions. You do not unlock it until later in the campaign. Of all the weapons available to you in the game, the M16/203 packs the most firepower, allowing the operative to fire rifle rounds or grenades as needed.



7.62mm AR

The heavier firepower of this assault rifle makes it more effective than an M16 when it hits a target, although each shot produces more recoil, and the weight of the weapon makes it harder to control while moving.



Rates of Fire

- Semi-automatic
- Full-automatic

Notes

The 7.62mm AR is available in multiplayer kits. It is the most powerful assault rifle in the game, with excellent penetration and accuracy. However, its accuracy decreases when fired on full-automatic. Select the semi-automatic rate of fire. One round is sufficient to neutralize any enemy you come across.

Bullpup AR

The bullpup configuration of this assault rifle makes it easier to control while moving than the M16. The forward handgrip makes it easier to control the recoil from each shot, but the base accuracy of the gun suffers.



Rates of Fire

- Semi-automatic
- Three-round burst
- Full-automatic

Notes

The Bullpup AR is available in the multiplayer kits. It is the least effective assault rifle. If you need the smaller size, you are best served by a carbine such as the M4.

7.62mm LMG

The combination of the heavier firepower of a sniper round with automatic fire capabilities makes the LMG a dangerous weapon. However, the automatic fire comes at the cost of reduced accuracy.

Rates of Fire

- Full-automatic



Notes

The 7.62mm LMG is available in multiplayer kits. Though not an assault rifle, the 7.62mm LMG provides a good fire base for a team. With its full-automatic rate of fire, this weapon saturates an area with a hail of bullets, forcing the enemy to take cover if you don't take him or her out first. Because of its mode of fire, the 7.62 is less accurate than other assault rifles or carbines.

Sniper Rifles

Sniper rifles are a special class of weapon, designed for long-range engagements. Because of the length of their barrels, they are unwieldy in CQB situations but accurate and deadly at range.

There are few instances within the campaign missions where you need a sniper rifle. For the quick missions and multiplayer games, though, sniper rifles allow you to get a hit at long range.

7.62mm Sniper Rifle

The 7.62mm Sniper Rifle fires a powerful round with excellent firepower at even long range. Its length and weight mean you use it best from a stationary position, as it is hard to control while moving.

Rates of Fire

- Semi-automatic



Notes

The 7.62mm Sniper Rifle is the standard sniper rifle available to you as part of the team kits. While it is great for long-range shots, use your secondary weapon while moving around during a mission.



Silenced Sniper Rifle

Trading firepower for quieter operation, the Silenced Sniper Rifle is an ideal candidate for medium-range shots that require noise discipline.



Rates of Fire

- Semi-automatic

Notes

The Silenced Sniper Rifle is less accurate and powerful than the 7.62mm Sniper Rifle, but it trades in that for stealth. With this weapon, you can engage enemies at long range without them knowing you are around. It is great for multiplayer games where you can pick off several enemies before they know what's going on.

SVD

The SVD sniper rifle fires a round with more power than most assault rifles. The long length of the gun makes it difficult to control when maneuvering, but you only need a single careful shot.

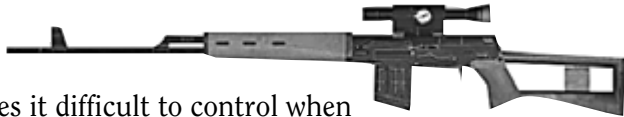

Rates of Fire

- Semi-automatic

Notes

The SVD is available within multiplayer kits. It functions like the 7.62mm Sniper Rifle.

Shotguns

Shotguns fire different types of rounds than other guns; rather than standard, one-piece bullets, they use “shot,” a collection of small round pellets similar to BBs. This gives them effective firepower at short range, though the dispersal of the “shot” makes the gun ineffective at longer range. Shotguns can breach doors.

12ga Pump Shotgun

The 12ga shotgun does tremendous damage at close range, but the lead shot is easily stopped by body armor. The most common use of this weapon in CQB situations is for a quick breach of locked doors.

Rates of Fire

- Single shot

Notes

Shotguns are useful for breaching doors. They are less effective for taking out tangos, especially those wearing body armor, at long range. The 12ga Pump Shotgun has a slow rate of fire, making it a poor choice for a mission because you rarely take out an enemy with a single shot and the tango will shoot you before you can pump and fire again.



12ga Auto Shotgun

This automatic shotgun clears rooms. The immense short-range firepower is accompanied by noisy operation. This is not a weapon for stealthy missions.

Rates of Fire

- Semi-automatic
- Full-automatic

Notes

Though the 12ga Auto Shotgun can fire on full-automatic, it takes several shots to kill enemies and is useless at medium range. It quickly clears a room full of close-packed tangos, however. The nice feature about this shotgun is that you reload it with a clip of shells, rather than one shell at a time.



12ga UB Shotgun

This underbarrel-mounted shotgun sacrifices accuracy for the sake of combining the effectiveness of two weapons. Because you primarily use the shotgun for opening doors, this weapon is an excellent choice for CQB operations.



Rates of Fire

- Single shot

Notes

Attached to an M4 carbine, this is the most useful shotgun in the game because you can use it to breach doors, then switch to the M4 for dealing with tangos.

Sawed-Off Shotgun

This shortened shotgun retains the short-range capabilities of most shotguns. However, because the shot spreads faster, its effective range is reduced, but the user does not have to be as accurate with each shot to hit a target.

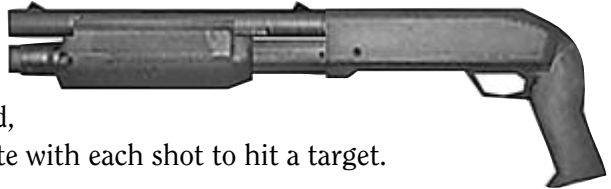

Rates of Fire

- Single shot

Notes

The Sawed-off Shotgun is available only in multiplayer kits. It is effective at close range against unarmored targets.

Pistols

While less powerful than some of the weapons available to operatives, a pistol (or sidearm) is standard as a secondary weapon in most equipment schemes. While pistols do not have the range or firepower of other weapons, they are useful for many CQB situations.

If everything goes well during a mission, you will rarely rely on your pistol. You should know how to use it. When firing a pistol, always shoot two or three rounds to make up for the lower accuracy and penetrating power.

9mm Pistol

Firing a light pistol round, this weapon has decent firepower at close range, but its effectiveness drops beyond that. It makes a good secondary weapon.



Rates of Fire

- Semi-automatic

Notes

The 9mm pistol is the standard pistol assigned as a secondary weapon for most kits. It is the least effective of all pistols.

9mm Pistol SD

The silenced version of the 9mm pistol sacrifices firepower for quieter operation. The increased length makes the weapon more accurate, but less wieldy.

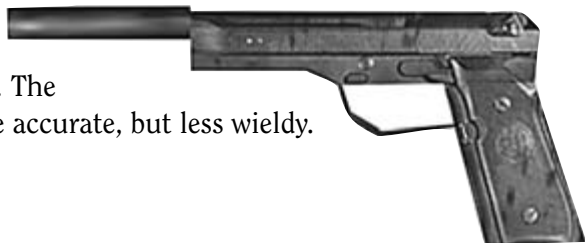

Rates of Fire

- Semi-automatic

Notes

The 9mm Pistol SD is one of the most useful pistols in the game, especially when combined with non-silenced primary weapons. Use the 9mm Pistol SD for stealthy infiltration, then rely on your primary weapon when you get into trouble and need more firepower.



0.357 Pistol

This pistol fires a more powerful round than the 9mm. It is less accurate, but the heavy frame reduces recoil effects when the gun is fired rapidly.

Rates of Fire

- Semi-automatic

Notes

The 0.357 Pistol packs more power than the 9mm Pistol and is available in some team kits.



9mm Automatic

This variant of the 9mm Pistol is capable of firing a three-round burst. Each round has the same firepower as the 9mm Pistol, but the increased number of rounds fired makes this an effective sidearm.

Rates of Fire

- Semi-automatic
- Three-round burst

Notes

The 9mm Automatic is the only pistol that can fire a three-round burst. It is usually assigned in a kit with a sniper rifle, giving the sniper a good secondary weapon for advancing through a mission and close-quarters fighting.



DEVELOPER TIP

Grenades and flashbangs can be thrown through windows and bounced off walls. This is a great way to neutralize enemies in a room before you walk into it.

M1911

The M1911 fires a heavier round than the 9mm Pistol. This improves its firepower at the cost of greater recoil with every shot.



Rates of Fire

- Semi-automatic

Notes

The M1911 is available only in multiplayer kits. It is the most powerful pistol in the game and has a lot of penetrating power, making it useful against armored targets.

Grenades

Grenades are small explosive devices thrown by hand or shot out of a launcher. Their destructive power comes from explosions and shrapnel.

Frag Grenades

The fragmentary hand grenade explodes after three seconds, sending shrapnel in a deadly radius. Scaled down for CQB work, these hand grenades have a lethal radius of five meters.



Notes

Unless you are in a mission where hostages or friendlies are a concern, frag grenades are the best type of grenade to take. When they detonate, they take out tangos—and anyone else too close. They have a delayed fuse, so you can throw frag grenades around corners, bounce them off walls, and take out tangos without exposing yourself to danger.



Flashbangs

The flashbang hand grenade emits a loud sound and bright flash. Together, these effects stun a person for a couple of seconds without doing any permanent damage. This makes the flashbang an ideal item to toss into a room just before entering it.

Notes

Flashbangs are great when hostages are involved in a mission since they do not kill. After throwing a flashbang into a room with a tango, switch to another weapon and wait for the flashbang to detonate. Rush in and neutralize the tango before he recovers.



M203 Grenade Launcher

This weapon is an underbarrel grenade launcher. It fires individual grenades that explode on impact, as opposed to the timer in the hand-held grenades. The M203 can hold only one grenade at a time, and must be reloaded after every shot.



Rates of Fire

- Single shot

Notes

Attached to an M16 assault rifle, the M203 allows you to take out tangos at a distance. It is especially useful, even at close range, for taking out groups of tangos with a single shot. Remember to take cover after firing since you must either reload the launcher or switch to the M16 to continue the fight.

Equipment

Heartbeat Sensor

The heartbeat sensor is a radar device that picks up the unique electromagnetic signature of the human heart. All enemies within its range are displayed on the mini-map.

Notes

The heartbeat sensor is useful. Not only does it allow you to see where tangos on the same level as you are located, but it also allows you to set up shots prior to opening doors. Look at the mini-map to get into position, switch to your weapon, then open the door and fire. Use it to plan a grenade throw around a corner, or through a doorway, so that the grenade lands near the targeted tango.



Team Kits

Before you begin a mission, you select a kit for your team. A kit consists of all the weapons and equipment carried by your team, and each kit is designed for specific requirements for different types of missions. There are 15 different team kits to choose from. At the beginning of the campaign, you have access to only a few kits. As you complete missions and advance through the campaign, you unlock more kits. A kit can be used in both the campaign game and the quick missions.

Each kit consists of a primary weapon, secondary weapon, and two equipment slots for each operative in the team. In most kits, the weapons and equipment are identical for all operatives. A few kits assign the team leader a different assortment of weapons and equipment than the rest of the team. These kits are usually for sniping or breaching. As the team leader, if you do not want to use the primary weapon for the duration of the mission, take control of another member of the team—and their weapons and equipment.

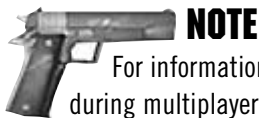

NOTE

For information on the individual kits available during multiplayer missions, see Chapter 6.



HRT Stealth

The silenced weapons in this outfit allow for a stealthy execution of the operation. Be warned; flashbang detonations can alert enemies to your presence.

WEAPON ASSIGNMENTS

CHARACTER	SUPPORT 1	SUPPORT 2
9mm SMG SD	9mm SMG SD	9mm SMG SD
9mm Pistol SD	9mm Pistol SD	9mm Pistol SD
Flashbangs	Flashbangs	Flashbangs
Heartbeat Sensor	Heartbeat Sensor	Heartbeat Sensor

Notes

Both the primary and secondary weapons in this kit are silenced, making the HRT Stealth kit good for operations where you have to keep things quiet. You also have flashbangs to stun tangos when necessary. Flashbangs are loud and will alert tangos in the area to your presence. This may increase their alert level or set off an alarm.

HRT Assault

The primary weapon assigned is the M4, with a 9mm pistol as a secondary. Flashbangs are provided to suppress enemies, and a heartbeat sensor should help locate them.

WEAPON ASSIGNMENTS

CHARACTER	SUPPORT 1	SUPPORT 2
M4	M4	M4
9mm Pistol	9mm Pistol	9mm Pistol
Flashbang	Flashbang	Flashbang
Heartbeat Sensor	Heartbeat Sensor	Heartbeat Sensor

Notes

The HRT Assault kit is a good choice when you need some firepower and are expecting a fight. The M4 carbine provides enough power to drop any tango you face, while the flashbangs give you an edge by stunning tangos and allowing you to take them out with your carbine before they can return fire.

HRT Breach

The team leader carries a shotgun to quickly enter doors. Other team members have an assault package. This outfit is ideal for quick, dynamic entries. It is noisy and will alert the enemy to your location.

WEAPON ASSIGNMENTS

CHARACTER	SUPPORT 1	SUPPORT 2
12ga Pump Shotgun	M4	M4
9mm Pistol	9mm Pistol	9mm Pistol
Flashbang	Flashbang	Flashbang
Heartbeat Sensor	Heartbeat Sensor	Heartbeat Sensor

Notes

The HRT Breach kit assigns the team leader a shotgun while the rest of the team carries carbines. The shotgun is good for getting through doors but less effective against enemies—especially those wearing body armor or those at medium to long range. If you use this kit, control one of the operatives with the carbine as you advance through the mission. Switch to the operative with the shotgun only when needed.

HRT Recon

This package combines the firing power of a submachine gun with a silenced pistol, giving flexibility to move between stealth and assault modes.

WEAPON ASSIGNMENTS

CHARACTER	SUPPORT 1	SUPPORT 2
9mm SMG	9mm SMG	9mm SMG
9mm Pistol SD	9mm Pistol SD	9mm Pistol SD
Flashbang	Flashbang	Flashbang
Heartbeat Sensor	Heartbeat Sensor	Heartbeat Sensor



Notes

The HRT Recon kit provides a balance between firepower and stealth. The only difference between it and the HRT Stealth kit is that the SMGs are not silenced—rarely a good choice for a mission. If you want stealth, take the HRT Stealth kit, and the HRT Assault is best if you are going to get into a firefight and are not concerned about noise.

HRT Sniper

The team leader carries a sniper rifle. Other team members carry CQB weaponry to prevent enemies flanking while the lead is concentrating on his targets.

WEAPON ASSIGNMENTS

CHARACTER	SUPPORT 1	SUPPORT 2
7.62 Sniper Rifle	9mm SMG	9mm SMG
9mm Automatic	9mm Pistol SD	9mm Pistol SD
Flashbang	Flashbang	Flashbang
Heartbeat Sensor	Heartbeat Sensor	Heartbeat Sensor

Notes

The HRT Sniper kit gives your team long-range firepower and the ability to protect itself in close-quarters combat. The sniper rifle is semi-automatic, so move through a mission with the 9mm Automatic as the selected weapon for quick fire. Take control of one of the other operatives to increase your short-range firepower and takedown ability. Switch to the sniper when the need arises. This tactic works well in most missions because you need only a few shots from the sniper rifle.

DEVELOPER TIP

Additional sets of equipment for use in Quick Mission mode can be unlocked by playing through the missions in Campaign mode.

Spec Ops Assault

All team members carry the Spec Ops M4. Stealth is not an option with this package, but good firepower quickly can be brought to bear on targets.

WEAPON ASSIGNMENTS

CHARACTER	SUPPORT 1	SUPPORT 2
Spec Ops M4	Spec Ops M4	Spec Ops M4
9mm Pistol	9mm Pistol	9mm Pistol
Flashbang	Flashbang	Flashbang
Heartbeat Sensor	Heartbeat Sensor	Heartbeat Sensor

Notes

After you complete the first two campaign missions, you have access to some heavier firepower. You get a modified M4 carbine with a much better scope for accurately targeting tingos at long range.

Spec Ops Recon

All team members carry the Spec Ops M4. The addition of a silenced secondary pistol allows for more versatility by offering a quieter option.

WEAPON ASSIGNMENTS

CHARACTER	SUPPORT 1	SUPPORT 2
Spec Ops M4	Spec Ops M4	Spec Ops M4
9mm Pistol SD	9mm Pistol SD	9mm Pistol SD
Flashbang	Flashbang	Flashbang
Heartbeat Sensor	Heartbeat Sensor	Heartbeat Sensor

Notes

This kit is a better choice than the Spec Ops Assault kit. You have the same carbine, but with a silenced pistol. This kit allows you to infiltrate an area silently, then gives you the firepower to take on the enemy if you are detected.



Open Assault

This combination provides maximum versatility in a firefight. A rifle, flashbangs, a heartbeat sensor, and frag grenades from the grenade launcher allow an operative to deal with almost any situation.

WEAPON ASSIGNMENTS

CHARACTER	SUPPORT 1	SUPPORT 2
M16/203	M16/203	M16/203
M203	M203	M203
Flashbang	Flashbang	Flashbang
Heartbeat Sensor	Heartbeat Sensor	Heartbeat Sensor

Notes

The Open Assault kit contains a lot of firepower. In addition to an assault rifle (the only one in the team kits), you also have a grenade launcher for destruction at a distance. This is not a stealth kit, but nothing comes close in terms of raw firepower.

Covert Assault

Both primary and secondary weapons are silenced. This allows for a stealthy execution of missions at the cost of some firepower. However, the loss of firepower is offset by the kit's frag grenades. Don't use these grenades near civilians.

WEAPON ASSIGNMENTS

CHARACTER	SUPPORT 1	SUPPORT 2
9mm SMG SD	9mm SMG SD	9mm SMG SD
9mm Pistol SD	9mm Pistol SD	9mm Pistol SD
Frag Grenade	Frag Grenade	Frag Grenade
Heartbeat Sensor	Heartbeat Sensor	Heartbeat Sensor

Notes

This kit is very similar to the HRT Stealth kit. The difference is the substitution of frag grenades for flashbangs. If you need a stealth kit and do not need to worry about hostages or friendlies being hurt by the frags, take this kit.

Military Breach

An ideal combination of speed and firepower. The underbarrel shotgun in this outfit allows speedy entry through locked doors. The attached carbine provides excellent firepower in CQB situations.

WEAPON ASSIGNMENTS

CHARACTER	SUPPORT 1	SUPPORT 2
M4/Shotgun	M4/Shotgun	M4/Shotgun
12ga UB Shotgun	12ga UB Shotgun	12ga UB Shotgun
Frag Grenade	Frag Grenade	Frag Grenade
Flashbang	Flashbang	Flashbang

Notes

This kit provides the best assault kit with the best breach kit. You can use the shotgun for shooting open doors, then switch to the carbine deal with tangos. You also have both types of grenades, giving you greater flexibility to deal with tangos around corners or in adjacent rooms. This kit lacks heartbeat sensors. Whenever you head around a corner or enter a room, be ready to shoot.

CQB Assault

The 5.7mm SMG allows for maneuverability and control when heading around corners, so it's a great weapon for CQB situations. An automatic secondary makes a good backup if you run out of ammunition.

WEAPON ASSIGNMENTS

CHARACTER	SUPPORT 1	SUPPORT 2
5.7mm SMG	5.7mm SMG	5.7mm SMG
9mm Automatic	9mm Automatic	9mm Automatic
Frag Grenade	Frag Grenade	Frag Grenade
Heartbeat Sensor	Heartbeat Sensor	Heartbeat Sensor



Notes

The CQB Assault kit is excellent for interior missions where you face lots of tangoes at short range. With its 50-round clip, the 5.7mm SMG can easily clear a room without reloading. Use the frag grenades to begin an attack, then mop up with the SMG.

CQB Breach

The team leader carries a shotgun for quick door entry. All other team members have the firepower of the 5.7mm SMG. All team members have an automatic secondary weapon.

WEAPON ASSIGNMENTS

CHARACTER	SUPPORT 1	SUPPORT 2
12ga Pump Shotgun	5.7mm SMG	5.7mm SMG
9mm Automatic	9mm Automatic	9mm Automatic
Frag Grenade	Frag Grenade	Frag Grenade
Heartbeat Sensor	Heartbeat Sensor	Heartbeat Sensor

Notes

Similar to the CQB Assault kit, the CQB Breach kit provides the team leader with a shotgun. As with other breach kits, you should take direct control over an operative with an SMG for most of the mission, only switching to the shotgun-carrying operative when needed.

DEVELOPER TIP

On Easy difficulty, you can have the heartbeat sensor active without having to carry it in your inventory by selecting this option in the options menu. This feature allows you to get more information on enemy positions without sacrificing equipment options.

CQB Recon

The 5.7mm SMG combined with a silenced pistol allows for the firepower versatility and the option for a silent takedown.

WEAPON ASSIGNMENTS

CHARACTER	SUPPORT 1	SUPPORT 2
5.7mm SMG	5.7mm SMG	5.7mm SMG
9mm Pistol SD	9mm Pistol SD	9mm Pistol SD
Flashbang	Flashbang	Flashbang
Heartbeat Sensor	Heartbeat Sensor	Heartbeat Sensor

Notes

Unlike other CQB kits, this one provides a silenced pistol for stealthy infiltration. It swaps out the frag grenades for flashbangs, decreasing your team's firepower.

Field Sniper

The team leader carries a Silenced Sniper Rifle for quiet, precise shots. Other team members pack the 5.7mm SMG and a silenced pistol for defending the leader.

WEAPON ASSIGNMENTS

CHARACTER	SUPPORT 1	SUPPORT 2
Silenced Sniper Rifle	5.7mm SMG	5.7mm SMG
9mm Compact SMG	9mm Pistol SD	9mm Pistol SD
Frag Grenade	Flashbang	Flashbang
Flashbang	Heartbeat Sensor	Heartbeat Sensor

Notes

The Field Sniper kit provides the team leader with a Silenced Sniper Rifle, allowing for long-range attacks without exposing the team's position. The other team members have SMGs. Switch to an SMG operative to get through the mission since they carry the heartbeat sensors. Switch back to the sniper for long-range attacks and to use frag grenades.



Full Assault

The ultimate in firepower and speed. The leader carries an automatic shotgun for quick room entry. Other team members wield more precise weapons for situations involving civilians.

WEAPON ASSIGNMENTS

CHARACTER	SUPPORT 1	SUPPORT 2
12ga Auto Shotgun	Spec Ops M4	Spec Ops M4
0.357 Pistol	0.357 Pistol	0.357 Pistol
Frag Grenade	Frag Grenade	Frag Grenade
Frag Grenade	Heartbeat Sensor	Heartbeat Sensor

Notes

The Auto Shotgun is excellent for breaching and taking on tingos without body armor at close range. You will want to switch to a team member with a carbine while advancing through the mission, using the Auto Shotgun only when needed.

STEALTH AND SILENCED WEAPONS

Enemies come to investigate if they hear shots fired. Therefore, un-silenced weapons cause more swarming behaviors (enemies in groups who are actively searching you out) and more difficult encounters. This effect is particularly noticeable in M03, M05, M06, and M08, and when playing in Firefight mode. Use silenced weapons to “get a drop” on enemies, and to take them down without alerting other enemies in the level.

DEVELOPER TIP

You can edit missions, guns, kits, outfits, and objectives using the internal editor included with the game. However, it is recommended that you not overwrite the existing files, as this may cause problems with the standard campaign and require you to reinstall the changed game files.



3

Close-Quarters Battle Tactics



Most of your missions take place in and around buildings or other structures.



Close-quarters battle is the military term for street or city fighting. Rather than fighting out in the open in forests or on plains, your team operates almost entirely within or around structures. Many powerful armies that were victorious on the battlefield met utter destruction when they were forced to fight within the confines of a city. Fighting within buildings requires different tactics.

Commanding Your Team

Besides the character you directly control during a mission, you also command a fire team of two additional operatives. They follow you through the mission, adding their fire support when needed, and helping to cover your back. While you learned how to give orders to your team in Chapter 1 and during the training mission, it is important to understand when to give orders and how to use your team effectively during a real mission. Let's look at the different commands you can issue to your fire team.



The Command Window appears at the bottom left corner of the screen during a mission and allows you to give specific orders to your team.

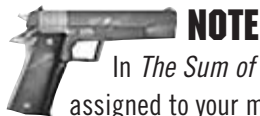

In *The Sum of All Fears* you may have one or more support teams assigned to your mission. However, you have no control over them. Their actions depend on specific actions your team takes, such as opening a certain door or entering an area. When you give orders, they apply only to your team members.

Formations

There are two formations your team can assume: “close” and “open.” Close puts your team in what is called a stack, with each operative immediately behind another. While advancing, you lead with your two team members right behind—one covering to the left, the other the right. This keeps your team close together so that you have three weapons covering roughly a 180-degree arc. Use close formation indoors to keep your firepower concentrated.



Close formation.

Open formation works better to maneuver in wide areas—outside or in large rooms where your team could be attacked from several different directions. As the name implies, open formation keeps your operatives at a distance from each other. This helps to prevent losing your entire team to a burst of enemy machine-gun fire.

Movement

You order your team either to “follow me” or “hold this position;” the default and most common command is for the team to follow you. At times you may need to advance on your own, perhaps to reconnoiter an area where one person would be less noticeable than an entire team. You may want to leave your team at a crucial position, like an intersection, to cover the area and prevent enemies from sneaking up on you from behind while you disarm a bomb or perform some other task. Just remember to order your team to follow you when you are done, or you may find yourself all alone in a big firefight while the rest of your team is unable to support you.

Rules of Engagement

As with the other types of commands, there are two different rules of engagement (ROE) you can issue to your team: “assault” and “recon.” The default ROE, assault, orders your team to fire at will. In most cases, you should keep your ROE set to assault, especially within buildings and during daylight operations, since enemies will shoot as soon as they see you. When ordered to assault, your teammates automatically fire at any tango that comes into sight. This may help keep you alive if you don't see a tango as you advance through an area.

Recon orders your team to hold their fire until they are fired upon. This restriction may get you or your teammates killed, so give it only under certain circumstances. In some night operations it is often better to maintain stealth and avoid contact while you infiltrate the objective area. Recon prevents your teammates from neutralizing tangos along the way, leaving bodies that may alert other enemies and sound an alarm. You may



Open formation.



want to get your team into a specific position to ambush or surprise the enemy before you let the bullets fly. Before you begin the attack, or if you are engaged, switch the ROE to assault so your teammates will support you with their own weapons.

Specific Orders

There are four specific orders you can give to your team. “Open” orders a teammate to open a door targeted with your reticle. This can be helpful if you are lining up a shot by use of the heartbeat sensor and need someone else to open the door for you.

“Clear” orders your team to move through an area and neutralize all tangos. If you point to a closed door while giving this order, your team will first open the door and then enter the room to clear it out. This order works well when you are carrying a shotgun to breach doors, but are facing enemies with body armor. Let your teammates with the full metal jacket ammo take care of the tangos.



A teammate throws a flashbang into a room following your orders.

“Flashbang” and “grenade” order a teammate to throw either a flashbang or frag grenade into an area. If you point to a closed door while giving this order, the teammate will open the door, then throw the grenade.

TIP

When it comes to throwing grenades, it's generally best to do it yourself. Your teammates usually open a door and stand right in the doorway as they throw the grenade. This leaves them open to enemy fire from inside and often results in an unnecessary casualty. Also, your teammates don't try to bounce grenades off of walls or around corners.

Switching to a Different Operative

At times, you may need to take control of one of the other operatives. Pressing **[Pg Up]** or **[Pg Dn]** cycles through your teammates. Use this order when you need a different primary weapon for a specific task, or when you run out of ammo. If you are killed, press the Fire button to take control of another operative in your team.

TIP

Keep an eye on the weapons display at the bottom right corner of the screen. This tells you how many clips you have left for each weapon and how many rounds are in the current clip. As a general rule, keep your current clip at least half full. You do not want to run into a group of tangos with only a couple of rounds left. While you reload, the tangos will try to kill you!

Advance Cautiously

One of the first rules for indoor operations is to move with caution. Rarely is there a reason to blitz through a place to get quickly to the objective, as such actions get you and your team killed. Take your time. Another good tactic is to remain crouched while you move. This slows you down somewhat, but it also makes it more difficult for the enemy to see and subsequently hit you.

Clear as You Go

One of the worst things that can happen is to have a tango sneak up behind your team and gun you all down because you didn't clear all the enemies along the way. Always make sure each room or hallway is clear as you advance. This also corresponds to multistory buildings. Clear each floor before advancing to the next. The only time you

Indoor Tactics

Maneuvering through confined hallways, rooms, and doorways requires caution and special tactics, since structures provide the means for tangos to ambush your team.



Indoors, watch out for tangos hiding behind furniture or other obstacles.



would not want to clear as you go is if you are on a recon mission where you must avoid contact with the enemy. One exception to this rule is the first mission where you want to approach the studio from the third floor while your support team comes in from the second. If you try to clear the studio before going to the third floor, you will fail the mission.

Corners and Doorways

Buildings are dangerous locations. Most new operatives get killed going around a corner because they don't use the correct tactic for the job. When a person normally goes around a corner, he or she walks out past the corner, then turns. In the time it takes for that person to turn and aim at a tango, the tango may have already got off several shots. To safely turn a corner, halt before you get there. Turn to face the wall, then strafe toward the corner. Once you get to the edge, either peek around to see if anyone is there or continue strafing out past the edge. If there are enemies around the corner, you are already facing the correct direction and need only aim and fire to get the drop on them.

Doorways are another hazardous spot. If they are open, treat them just like corners. If they are closed, you must first open them. As a general rule, never position yourself directly in front of the door you are opening. That is exactly where the tangos expect you to be, and when they hear the door opening, they get ready to shoot. Instead, stand off to one side of the door. Once it is open, strafe into the doorway while maintaining your aim into the next room. There are other ways to open doors, but they are covered a bit later, under Breaching.

Stairways

Stairways are almost as deadly as corners and doorways—especially those stairways that turn halfway up, such as in a stairwell. The key to moving up or down stairs is to keep your weapon aimed at where a threat may exist. For example, if you are advancing up a stairwell,



Peek around corners to get the drop on tangos.



Keep your weapon aimed toward the top of the stairs.

strafe up the stairs while aiming as far up the stairs as possible. About halfway up the flight, turn and walk backward to keep the top in your sights.

Avoid throwing grenades up a stairway—they have a tendency to bounce back down toward your team. If you are descending, throwing a frag grenade or flashbang ahead of you can be a good idea.

Heartbeat Sensors

This radar-like gadget detects the electromagnetic emissions of a person's beating heart and is available in most kits. To use the heartbeat sensor, you must make it your active equipment, meaning you are unable to shoot while using it.

A heartbeat sensor can be one of your most important tools. When activated, it shows the locations of all people in the surrounding area on your mini-map. Before you open a door or go around a corner, you can see what is on the other side. You can even use the heartbeat sensor to set up shots before you open a door.

Bring out the heartbeat sensor every so often to check the area for hostiles—especially before going around a corner or through a doorway. Remember to switch back to your weapon before trying to engage.

CAUTION

Heartbeat sensors detect only people at your elevation. They won't show you if there is a tango at the top of the stairs.



Locked doors can be picked or breached with a shotgun or grenade.

Breaching

Some of the doors you come across may be locked. Not to worry—you are trained to pick locks. It can take several seconds to pick a lock, so if you are in a hurry, or you want to surprise the tangos on the other side of the door, breach it. The most common way to breach a door, locked or unlocked, is with a shotgun. Aim at



the doorknob and fire. This throws the door open quickly, often surprising the tangos and giving you a split second advantage to aim and neutralize them before they can return fire. Another way to breach a door is with a frag grenade. Step back and throw a grenade toward a door and then take cover. Not only will it blow in the door, it will also take out anybody near it on the other side.

Flashbangs and Frag Grenades

Your team can carry two different types of grenades. Frag grenades are similar to military grenades in that they spread shrapnel around a blast area when they explode. Your grenades are not as powerful as military grenades, making them more effective indoors.

Flashbangs emit only a loud bang and a flash of light when they detonate. Instead of killing anybody nearby, flashbangs disorient targets. For a few seconds, those affected cannot see and their accuracy is severely reduced. Even though flashbangs won't kill you, keep back from them or you won't be able to see and react.

Grenades are great for engaging tangos in adjacent rooms or around a corner. With a little practice, you can throw grenades so they bounce off of an opposite wall and around a corner, out of your sight, and toward tangos. A good tactic is to throw grenades into rooms before moving in to clear them out. Disoriented or dead tangos can't shoot at you. Even if a frag grenade isn't lethal, it still disorients enemies like a flashbang.

You can also throw grenades through windows. This takes some practice, especially throwing at anything but short range. Grenades usually go through the glass, but if you can, shoot out the window first so you don't risk the grenade deflecting off of the glass and bouncing back toward your team.

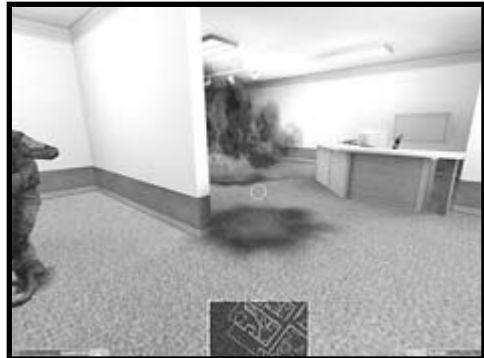

Grenades are a great way to engage tangos around a corner or in another room without exposing yourself.

Outdoor Tactics

When outdoors, your team is often susceptible to long-range fire from several different directions—you could be gunned down without ever seeing who was shooting at you. Order your team to spread out as they move to prevent losing two team members to a burst of fire. Several other tactics apply specifically to outdoor operations.

Cover and Concealment

Unlike indoors, where there are walls, doors, and furniture to hide behind, outside is wide open. You must make a conscious effort to find and use terrain or objects for cover. If cover is not available, try for concealment—cover will stop a bullet. Both hide you from the eyes of the tangos, and they can't shoot what they can't see.

When your team is outside, always try to move along some object that will protect you, such as a wall, hedge, or side of a building. This ensures you are safe from at least one direction.

Moving Across Open Areas

Cover or concealment is not always available. If you have to move across an open area, be cautious. Before you move, check out your route, and try to ensure that there are no tangos along the way. Also, check the surrounding area for enemies and neutralize all that you can see. Pick your destination to be someplace with concealment where you can stop and regroup. Once everything is clear, move fast. Don't worry about crouching—just run. As your team advances, don't stop to return fire. If you halt to take aim, you present an easier target to the tangos. Instead, concentrate on getting to your destination or other semi-safe area before stopping to shoot.

If the enemy is in your path, keep moving as you fire, but slow down to a walk to improve your accuracy somewhat. Remember, moving out in the open is a last resort. Only do it if there is no other way.

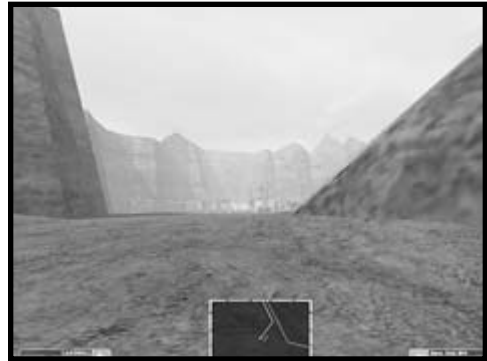

You must watch for enemies all around you when out in the open.



TIP

During some missions, your HQ plan may take your team out in the open. Unless there is an objective out in the open, find another route if there are threats around. The HQ plans are not required. They only offer a suggestion of how to move from objective to objective. If there are support teams involved, be sure to move through the doors and rooms as shown by the HQ plan, or the support teams may not activate to help you out.

Windows

Many buildings have windows through which tangos can observe you. Always take note of any windows overlooking your area of operation and make sure the room on the other side is clear. If there are tangos inside, neutralize them. You can fire through a glass window. Fire a three-round burst or a couple of shots in case the first round deflects as it shatters the window. If you are accurate at throwing grenades, throw a frag through a window to clear out a room in a hurry. When firing through a window, be sure to quickly take out all tangos inside because the breaking glass will alert everyone in the room, and they will be gunning for your team.

Sniping and Long-Range Fire

The wide-open outside not only allows tangos to attack you at long range, it also lets you do the same. For long-range fire, the sniper rifles and the Spec Ops M4 both offer magnifying sights that zoom in on tangos.

Any type of long-range fire is referred to as sniping—even if you are not using a sniper rifle.



Shoot through windows to take out the tangos inside.



Sniping allows you to shoot at tangos at long range so they can't fire back at you as easily.

In most cases, sniping allows you to attack enemies at a distance so they cannot return fire. When sniping, find a good position that makes it hard for the enemy to see you yet provides a good view for yourself, and crouch down if possible. Leave the other members of your team somewhere else where they can provide cover and prevent tangos from sneaking up on you.

Grenades

Grenades can also be used outdoors. Flashbangs are less effective outside than indoors, but they still distract enemies enough to buy you a couple of seconds. Choose frag grenades outdoors. Use them to take out tangos clustered together, or to attack enemies indirectly by throwing the frags over a hill or wall. Don't forget to use the heartbeat sensor to locate hidden tangos and line up a grenade toss.

Night Ops

Missions that take place during the night or in darkened buildings give you a great advantage over your enemies. Your team is trained and equipped to operate in the dark; the tangos you are up against are not. Let's take a look at how to win in the dark.

Night-Vision Goggles

Each team member carries night-vision goggles. Using ambient light, they allow you to see in the dark as if it were day. The goggles narrow your vision so you can see only what is in front of you. Also, the image is black and green, so be cautious if there are friendlies nearby—don't shoot them by accident.

Stealth

During night ops, use stealth to infiltrate an area. Choose a kit with silenced weapons. The recon kits, which contain silenced pistols, are a good choice in that they give you a silent option as well as heavier firepower if you need it. To maintain stealth, don't use grenades unless you have been detected or are ready to announce yourself to the enemy. Maintaining stealth makes a mission much easier



Night-vision goggles restrict your field of view somewhat but allow you to see and fight in the dark.



because you advance through an area with the enemy unaware of your presence. If tangos hear shots, they are alerted and come after you. However, if you keep quiet and use silenced weapons, you can bypass some tangos and sneak up on others while they are distracted or disinterested.

Patience and Observation

A major problem during night ops is failing to detect a tango patrolling a dark area. To avoid this, find a safe place and observe before advancing into an area. At night, the enemy often assigns tangos to patrol areas. Take a few minutes to see where the tangos go and how many there are. When you are ready to infiltrate, avoid them or neutralize them before they detect you and alert the rest of the enemies.

Hiding in the Darkness

The darkness itself can provide concealment during night ops. Use it to your advantage by avoiding lighted areas. It is safer to cross open areas in the dark than during the day, so instead of running, crouch and advance carefully. Try to avoid being detected instead of running to avoid being hit. When possible, seek cover in case you have a firefight on your hands. When you fire a weapon in the dark, enemies can see your muzzle flash and take aim at it even if they can't see you. If you must fire, keep moving until you can get behind some cover.

Preparing for the Mission

Before you jump right into a mission, you must make preparations. The Pre-Mission Screen gives you specific information to help you get ready. The briefing provides an overview of the mission, telling you what has happened, why you are there, and what you are expected to do. Read this carefully; it may contain tips to help you complete the mission successfully.

Next, you are given objectives. Click on each objective to get specific information about that objective. There often is a graphic that shows



The Pre-Mission Screen is where you learn about the mission and assign a weapons kit for your team.

you the specific object to manipulate or the specific target to neutralize. Also, you must complete some objectives in a certain order. Therefore, they are numbered 1 through 3 or 1 through 4. There may also be an objective marked with an “X”—this is a special objective. The mission automatically ends once all of the numbered mission objectives have been completed, so make sure you complete the special objective before the last mission objective or you won't have a chance to later.

The Pre-Mission Screen also contains an intelligence briefing. The intel is often background information on the tangos you face or the area where you will be operating. It is not essential to the mission, but it does help provide the storyline.

After reading up on the mission, check out your team. The team window lists the three operatives that make up your team. The operative at the top is the one you will take control of at the start. Here you can see the status of each operative as well as campaign statistics and awards.

The team window also allows you to select a kit for the mission. Rather than outfitting each operative individually, you select from a number of team kits. These kits provide each operative with a primary weapon, a pistol, and additional equipment. For most kits, each operative carries the exact same things, but for a few kits, the team leader gets a different primary weapon, such as a shotgun or sniper rifle. It is important to choose the right kit for the mission. The briefing should help you determine the type of firepower you need and whether you need silenced weapons to maintain stealth during the mission.

Mission-Ready

Now that you have familiarized yourself with the tactics necessary to complete the missions, you are ready to begin the campaign game. Good job, soldier. You are now classified as “Mission-Ready.”

DEVELOPER TIP

You don't need to be right next to a door to open it. If you're not sure how close you need to be, hold down the Action key (default: `Spacebar`) and move toward the door. The door opening icon will appear as soon as you are in range. This also works for manipulating other objects.



4

The Campaign

The Sum of All Fears campaign comprises 11 missions. Each is progressively more difficult and challenging. The following walkthroughs contain briefing material regarding each mission, including a suggested team kit, what support you can expect, and some brief notes. Maps show the locations of all objectives and tangos as well as your route through the mission area. Finally, the mission strategy sections take you step-by-step through each mission.

The walkthroughs are written for the Medium difficulty level. However, Special Forces tips have also been included for those looking for a real challenge. These tips are based on the Hard difficulty level with all three Special Forces options selected—no in-game saves, fail on team casualties, and no support teams.

Note that the pathway shown on the maps follows the HQ plan.

Mission 01: Hostage Rescue Operation

Briefing

Heads up, everyone. Sorry to pull you out of your New Year's celebrations, but we've got a touchy situation out in West Virginia, and the local boys need our help.

At approximately 19:00 hours this evening, a militia group known as the Mountain Men stormed a television station in Charleston, taking the station personnel hostage. Most of the hostages have been released, but they kept a few as insurance. Now the group is broadcasting live from the news studio and threatening to kill the hostages if their demands are not met.

One of the hostages they released says that he saw the Mountain Men fiddling with the station's security system. Our best guess is they've re-programmed it to alert them if any attempt is made to breach the building. However, we've been in touch with the security company that owns the system, and they've given us the master access codes that will get us in without tipping our hand.

Gold team, you're on point for this one. Get into the station, disarm the security system from the lobby control panel, then head up to the roof to disconnect the broadcast feed. Once you've taken them off the air, put the militia down and bring the hostages out. Blue team and red team will back you up.

Be careful. If any of the hostages are killed, especially on a live broadcast, we're going to catch hell for it. Let's show the world what the HRT (Hostage Rescue Team) can do.



The two hostages are being held in Studio A.



Objectives

1. Disarm the Security System: Your first task is to disarm the security system so you can exit onto the roof without setting off any alarms. The security controls are located at the reception station in the lobby on the first floor. Disarm the system there.
 2. Cut the Satellite Feed: The standoff in Studio A is broadcasting live by antenna and satellite. Cut this feed before attempting to take down the militia members in the studio; otherwise, the firefight is going out live on international television. To cut the feed, exit onto the roof from the third floor; there is a junction box there where you can cut the cable without disrupting the internal feed, so the militia members won't know they've been taken off the air.
 3. Rescue the Hostages: The militia is holding hostage two news anchors in Studio A. Approach the studio from the third floor control room. Your support teams will move in from the second floor and the catwalk to give you support. If either of the hostages is killed, or if there's a firefight before the satellite feed is cut, the mission will be a failure.
- X. No Team Casualties: No one is expendable on this squad; bring everyone back alive.

Intel

The group calling itself 'The Mountain Men' was founded in 1986 in West Virginia, and it's existed in some form in the state ever since. A right-wing militia organization with strong racist tendencies, the group has been involved with several shoot-outs with West Virginia state police, and have been implicated in connection with a series of armed robberies throughout the state.

The group's central belief is that the American government has become decadent and depraved, catering exclusively to special interest groups and willing to sell out its citizens in a heartbeat to any corporation or foreign power with ready cash. In response, the militia's members have done their best to be independent of the government; paying no taxes, stockpiling arms and protecting their property as sovereign territory.

While both the FBI and the ATF have been dogging their trail for years—their fingerprints are all over several illegal arms deals, in addition to the other incidents—this is the first time they've been known to take hostages. Our analysts feel that the trigger for this escalation was the recent arrest of the group's leader, Jeremiah Tanner, on tax evasion

charges. Tanner's sitting in federal prison without bail, and the first round of demands broadcast from the television station included a call for his immediate release.

Suggested Team Kit

HRT Stealth

Support

Two support teams

Notes

On your inaugural mission, your two support teams go in to rescue the hostages. Your job is to clear the way by taking care of the security system and shutting down the TV station's transmission ability. Although you don't have to worry about the Mountain Men tangos killing the hostages (unlike in the *Rogue Spear* series), work stealthily. Silenced weapons allow you to infiltrate the building, clearing out as you advance, without alerting the tangos in other rooms or on the upper floors. However, at times it is a good idea to flashbang a room to stun the tangos inside so you can enter without getting killed.

TV STATION FIRST FLOOR

T = Tango
● = Objective

NOTE: The pathway on these maps shows the HQ plan. The numbers connect the maps between floors; match them up.

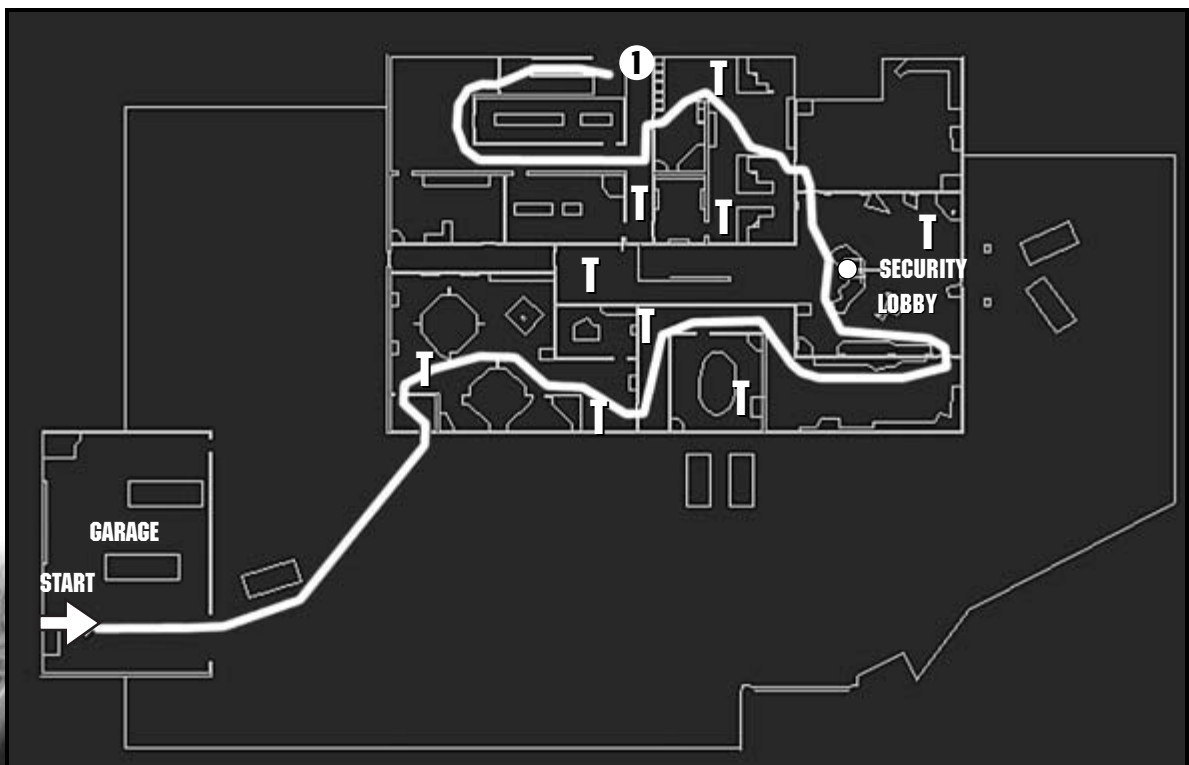

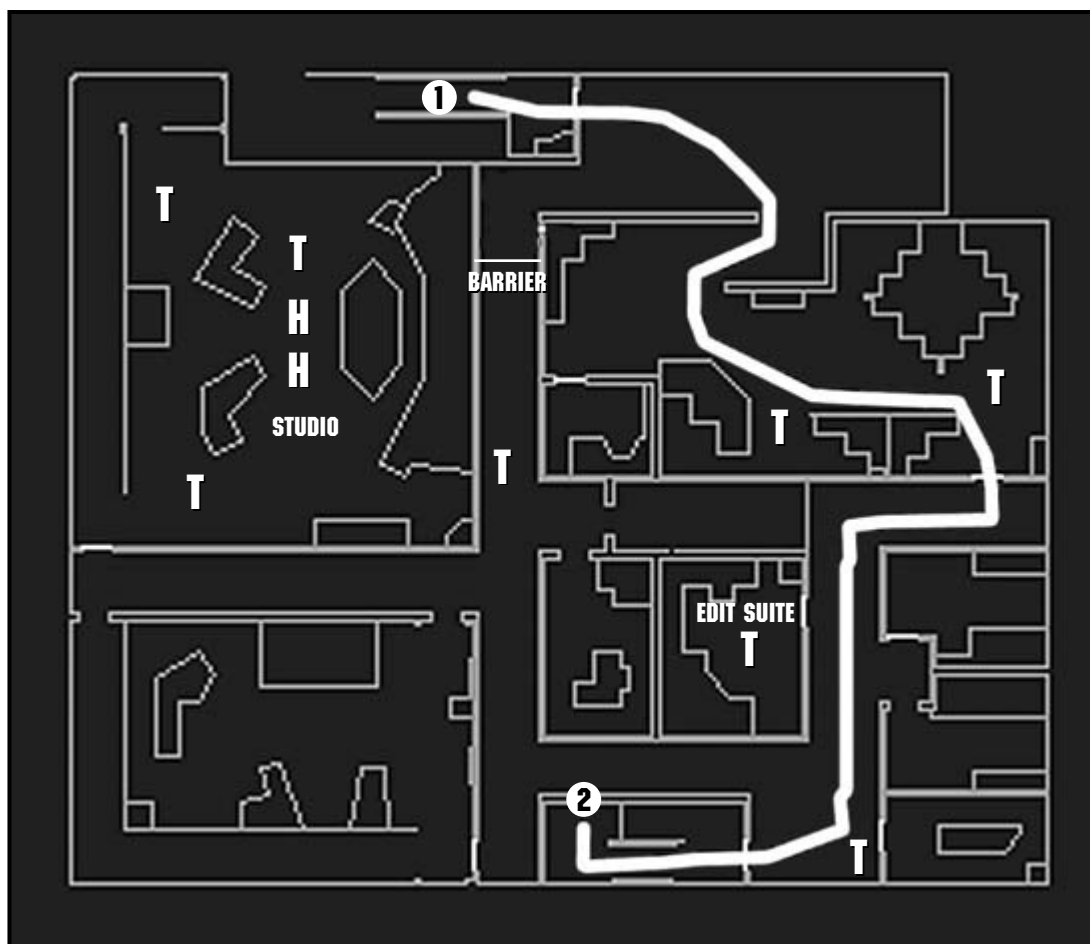
**TV STATION SECOND FLOOR**

T = Tango
H = Hostage

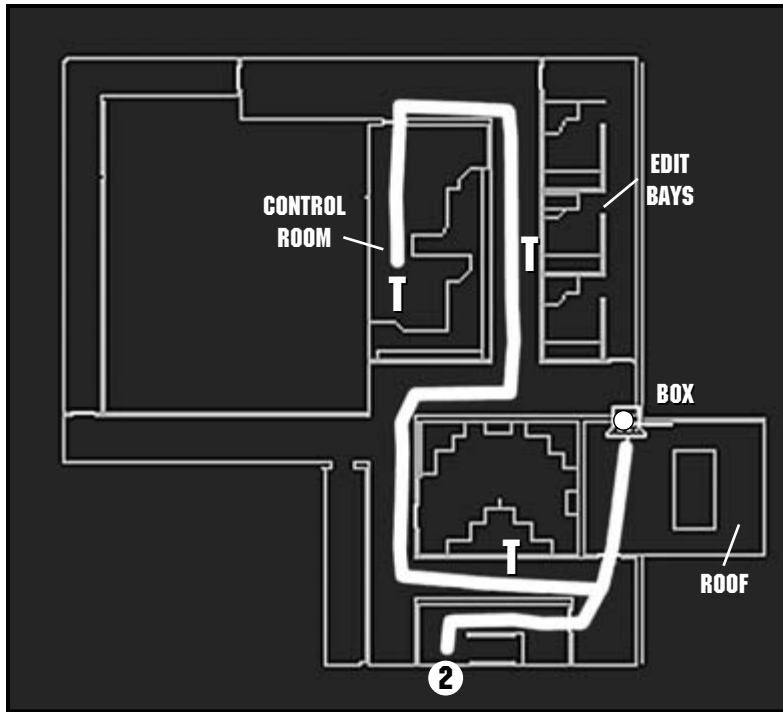

TV STATION THIRD FLOOR

- T = Tango
- = Objective

Mission Strategy

All three teams begin in the television station's garage. Follow your HQ plan to the side door as shown on the mini-map. The other two teams move to the front and rear doors. After you get to the side door, take out the heartbeat sensor and expand your map to full screen by pressing [Tab]. The red dots on the map represent the tangos on the first floor. By following along your HQ plan, you can see where tangos are. After you complete your radar reconnaissance, switch to your primary weapon, crouch, and open the first door.



Your team enters through the side door.





Take out this first tango after you enter.



If you maintained stealth, this second tango won't know you're in the room.



Wait until this tango walks away before entering the hallway.



Shoot through the glass.

The outer side door is unlocked and easily opens. The inner door is locked. Open it. (Your operative automatically picks the lock.) After it opens, take out the first tango to the right of the door. Continue into the room to dispatch the second tango by the door on the other side of the room. After you reach this door, whip out the heartbeat sensor to check on the location of the tango patrolling the hallway. Wait until he is either walking away or around the corner before opening the door and stepping into the hallway. Wait

for the patrolling tango and take him out as he comes around the corner. Face the window and strafe left until you have a shot at the tango in the room on the other side: Fire through the glass to drop him. Continue down the hallway to the door leading to the lobby.



Don't hit your support team as it enters the lobby.



The other tango is by the desk.



Deactivate the security system.

Make sure your clip is full before opening the door. When you open this door, the other two teams rush into the lobby. Without your help, they may take some casualties. Therefore, use the heartbeat sensor to line up a shot on the tango across the lobby from your door. Open the door and drop him. Turn left and strafe right through the doorway to take out a second tango standing by the lobby desk. Advance to the desk and deactivate the security system by aiming at the computer and pressing the Use key (the default is the Spacebar). This completes your first objective.





Drop this tango when you open the door.



Throw a flashbang over this cubicle wall...



...then rush around and take out the tango on the other side.

With the security system deactivated, you are given another HQ plan. Follow them to the next door, pick the lock, and enter the room. Crouch to the left of the next door as you open it so you can drop the tango at the far corner of the room. A second tango hides behind an office cubicle wall. Throw a flashbang over the short wall, then neutralize him. Watch out for another tango who may enter the room from the hallway. If he doesn't enter the office area, follow the HQ plan to the hallway and take care of him. With this tango down, the first floor is secure. Time to head up to the second floor.

DEVELOPER TIP

On the After Action Report screen, you can toggle between seeing your operatives' mission stats or their career stats by clicking on the button underneath the stat display.



Strafe around the corner to get the drop on this tango in the hallway.



Flashbang the tango crouched at the rear of the office.

Your HQ plan leads to a staircase. The other two support teams hold at the central staircase until you cut the satellite feed. Head upstairs to the second floor. Once at the top, pull out the heartbeat sensor and study the map. Switch to your primary weapon. Instead of following your HQ plan to the next room, veer to the right and eliminate the tango in the hallway near the central stairs. If you don't, he may shoot up your support teams as they enter the hallway. Right-strafe around the corner by the barricade and take him out. Continue following your HQ plan.



Clear out the tango in the edit suite.

The next room contains two tangos. Take out the first by right-strafing around the corner. Throw a flashbang to the far side of the room to stun the second tango crouched and hiding. Switch to your primary weapon. When the flashbang detonates, rush toward the tango and neutralize him before he recovers. Exit these offices and head into the hallway. There is a tango at the far end of the hallway, so right-strafe or peek around the corner to take him out. Before you go down the hallway, deal with the tango in the room containing the large window—the edit suite. Throw a flashbang



through the window, then rush in; or line up your shot through the door with the heartbeat sensor, then open the door and fire. Either way, you have cleared your section of the second floor and can head to the stairway to the third floor.



Watch out for the tango around the corner from the stairway on the third floor.



Cut the satellite feed to the junction box.

When you get to the top of the stairs, use the heartbeat sensor to locate all enemies on the third floor. Wait until the closest tango is walking away from the door, then open it and move around the corner to eliminate him. Follow your HQ plan onto the roof and to the junction box. Press the Use key to cut the satellite feed. That takes care of your second objective.



The tango by the edit bays is quick on the trigger. Throw a flashbang around the corner before taking him on.

You are provided a new HQ plan. Follow them through the hallways to take out the tango standing by the edit bays. Continue to the door leading into the control room. By the time you get here, the two support teams will be in position to rush into the studio where the militia is holding the hostages. They are waiting for you to open the door to the control room. When you do, take out the tango inside. Move



Neutralize the single tango in the control room.



If you help the other teams clear out the studio, do not hit the hostages or the other teams

into the control room and fire through the glass. At the same time, assist the other two teams in dispatching the three remaining tangos guarding the hostages. Do not hit a hostage. After you neutralize all tangos, the mission is complete.

SPECIAL FORCES TIPS

This first mission is not difficult. However, when playing at the Hard level with all Special Forces options, it is tougher. There are a few more tangos to deal with and you have to do it on your own.

In the first room you enter from the side entrance, a third tango faces the door you open, so line up your shot before you open the door. Enter and take out the remaining two tangos. The next extra tango is in the storage room leading into the lobby. Take out the tango behind the central stairs after you clear out the lobby. The rest of the mission is similar to the regular walkthrough until you get to the third floor.

A tango hides in the edit bays, so open the side door, north of the junction box, and take him out. Since it is dark inside, consider activating your night-vision goggles prior to opening the door. Continue on to take out the tango in the control room. Because your team is going solo, you have to take out the three tangos in the studio below. To do this, exit the control room and either turn left and take the catwalk overlooking the studio to take your shots or head down to the second floor. Once there, enter the studio through a side door and clear it. Do not hit a hostage.



Aftermath

The FBI rang in the New Year in an exciting fashion, as members of its hard Hostage Rescue Team stormed a television station to rescue hostages taken by a local militia group. None of the hostages were harmed, and all were home to celebrate the holiday with their families.

At roughly 7 o'clock P.M., members of a militia group calling itself the Mountain Men seized control of the station building, herding the staff onto a sound stage and broadcasting their demands live. It is believed that the recent arrest of the group's leader on tax evasion charges was the impetus for the hostage situation. The live television feed was cut early in the rescue attempt, but station spokesman Maxwell Heatherton reports that there were no civilian casualties, and that all militia members in the building had been either killed or taken into custody by the HRT.

Mission 02: Agent Recovery Operation

Briefing

OK, pay attention. Two squads of FBI agents were ambushed yesterday when they tried to serve papers on the remaining Mountain Men at their compound. Four are dead, and two more are being held hostage. It's our job to go in and get those agents out of there alive.

This is going to be extremely difficult because we know they're expecting us. They've got snipers positioned in all three of the site's buildings, which lets them cover every approach from the road. And because we don't know where the hostages are being held, a full-scale assault is out. At the first sign of action on our part, those agents are likely to be killed. That doesn't leave us with a lot of options. You're going to have to do a night insertion over the top of the mountain and down into the militia's backyard.

The good news is that overflights with ground-penetrating radar show that there's a bunker and tunnel system beneath the compound. This should allow you to move from building to building without alerting the lookouts. Your assignment is to move in, take out the snipers, and secure the hostages.

All right, saddle up. I want you over that mountain in two hours. We move in at sunrise.

Objectives

1. Eliminate Hostiles in the Barn: Militia members in the barn are keeping us from moving more squads into the bunker system. Clear them out so the support teams can move in.
 2. Eliminate Hostiles in the Trailer: This is another vantage point for the militia to cover our entrance. Take them out so we can move in.
 3. Secure the Hostages: The militia is holding the hostages in one of the bunker rooms. Eliminate the enemies who are guarding them, but do not shoot the hostages.
- X. No Team Casualties: No one is expendable on this team. Bring everyone out alive.



The Mountain Men are holding hostage a couple of federal agents in the tunnel complex.

Intel

The Mountain Men's compound is southeast of the town of Weston, in the Mountain Lakes part of the state. There's a few small towns and a couple of run-down tourist resorts nearby, but that's about it. They don't have any near neighbors, and the only access to the site is via either dirt road or helicopter.

The compound itself looks deserted, but that's because the bulk of it is below ground, in a complicated bunker and tunnel system. Aboveground you'll find a barn, a trailer, some outbuildings and that's about it. The trailer and the barn are the most important surface objectives, and every building on the compound is linked to the tunnel network.

The best guess as to where the agents are being held is in the bunker at the end of the tunnel system. That's also where the Mountain Men keep the bulk of their weapons and ammunition, and as a result it's likely to be heavily defended.

Suggested Team Kit

HRT Assault



Support

Two support teams

Notes

Though minor parts of this mission take place aboveground, the majority of it requires your team to move through subterranean tunnels where there are few objects to hide behind. The tangos are spread out enough that the great firepower of the HRT Assault kit makes it a good choice.

For this mission you have two support teams to help you. One begins the mission with you and advances with you through the first part of the mission. It later helps you clear a room, then comes to your aid for the final room, along with the second support team.

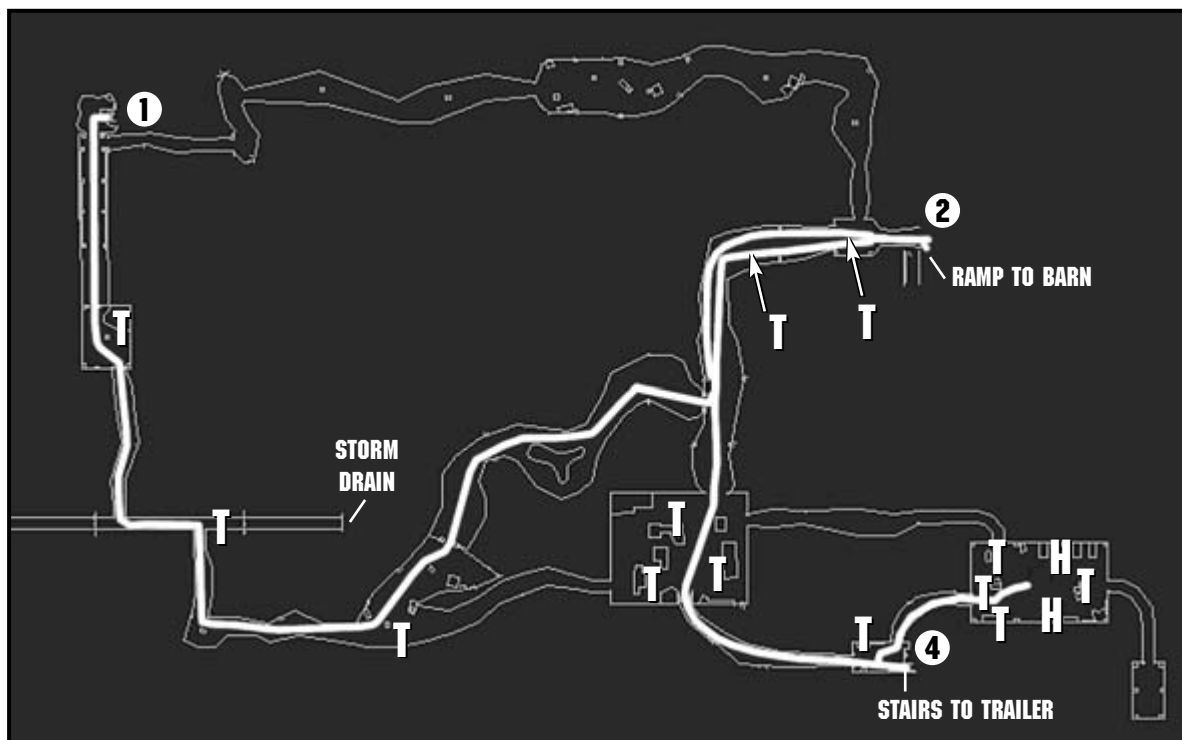

MOUNTAIN MEN COMPOUND UNDERGROUND

T = Tango

H = Hostage

MOUNTAIN MEN COMPOUND ABOVE GROUND

T = Tango

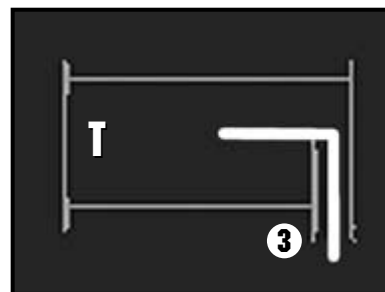
BARN SECOND FLOOR

T = Tango





This cabin provides access to the tunnel complex.



Two tangos are the only resistance in the cabin.



The kitchen stairs lead into the tunnels.

TIP

Though the tunnels are illuminated, tangos hide in shadows, making them difficult to spot. If you get shot at before you can see the enemy, use your night-vision goggles. They work well in some of the dimly lit rooms where multiple tangos congregate.

Mission Strategy

Your team begins the mission a short distance away from the cabin along with one of the support teams. At the start, move your team toward the cabin. Use the heartbeat sensor as you approach to locate the two tangos in the first room. As you open the door, shoot. To clear the cabin, move quickly. Otherwise, the support team will rush in and do the job for you. With these first two tangos down, it's time to head down into the tunnels. A flight of stairs in the cabin's kitchen takes you into the subterranean passages. The area around the base of the stairs should be clear. Follow your HQ plan and move into the tunnel system.



Move through the tunnels.



The first tango is near the first room you come across as you advance.



The tango by the storm drain patrols back and forth. Wait until he walks into your sights.

When you advance through the tunnels, you come across the first tango. Focus straight ahead so you can get the first shot. Because you are in no hurry, keep your team crouched so you present a smaller target for the enemy. The second tango is near the first bend in the tunnel, where it intersects a storm drain. As you approach, use the heartbeat sensor to see where the tango is before you round the corner. Wait until he is walking away, then strafe around the corner to neutralize him while his back is turned.

DEVELOPER TIP

Pressing the Leaderboard key (default: **B**) in multiplayer brings up a wealth of information: who is on what team, kill and respawn counts, and the current score, where applicable.





This ramp leads into the barn where the sniper is.



Take out the tango on the first floor of the barn.



The tango sniper perches in the barn's loft.

With these two tangos eliminated, check your heartbeat sensor and continue. Advance through the complex, following the HQ plan to the left when you come to the fork. Near the fork is another patrolling tango. Take him down and continue. Watch out for another tango patrolling the tunnels. You eventually arrive at a small room with a ramp into the barn. A tango guards it; take him out. As you approach the ramp, turn to the right and strafe left up the ramp. Activate your night-vision goggles so you can locate the tango, who is hiding in the shadows downstairs. Take him out, then right-strafe up the stairs until you have a shot at the sniper in the window. He may have heard your shot at the other tango and be looking at you. Shoot first to clear the barn, thus completing your first objective.



These large doors lead into a central room containing three tangos.



Clear this central room of tangos. Do not hit the support team entering through another door.

With the barn cleared, a new HQ plan leads to your second objective. Head into the tunnel system, making sure that the other operatives in your team are following. You come to two large doors. Before you get close to them, halt and pull out your heartbeat sensor. There are three tangos inside. Note their positions. One of your support teams is poised to assault the room from a door to your right. It enters as you approach the doors, so open them and shoot as you advance. Do not shoot the other team members. They move from right to left, so use aimed shots to clear the room.



There is always danger behind a door in the tunnels.



Drop this tango guarding the stairs to the trailer.





There are two tangoes in the trailer by the top of the stairs.



Take out the tango in the back room to finish clearing out the trailer.

Advance across the room and through more tunnels until you come to a single door. Make sure your weapon clip is loaded and do a quick check with the heartbeat sensor. A tango lurks in a room on the other side. Line up your shot and switch to your primary weapon. Open the door and fire. Advance into the room and to the foot of the stairs. They lead into the trailer. Select a flashbang and throw it so it lands at the top of the stairs and to the left. Switch to your primary weapon and charge upstairs after the flashbang detonates. Dispatch the two tangoes at the top of the stairs and continue to the rear of the trailer, following the HQ plan. The last tango in the trailer is in the back room. The door is closed, so approach it safely. However, the tango may have heard the flashbang and opened the door to take a look. Therefore, use caution as you head down the trailer's hallway. Neutralize this tango to finish clearing the trailer and complete your second objective.

DEVELOPER TIP

You can change your weapons selection on the pre-mission screen from the team tab. Simply click on the "Change Equipment" button underneath the team picture and select the equipment you want to use.



At the bottom of the stairs, go through this door.



Fire down the length of the tunnel to take out as many militia men as you can see.



Rush to secure the hostages.

With the barn and trailer secure, it's time to go after the hostages. Head downstairs into the tunnels and follow your new HQ plan. At the bottom of the stairs, turn right and go through a closed door. Activate your night-vision goggles and zoom in your view as you cautiously advance toward the room where the militia is holding two hostages. Shoot tingos when they come into view. It is best to take out as many as possible while you are still in the tunnel passageway; this prevents attacks from your flanks. Move forward to clear the room. While you move in, one support team comes in from your left while the second support team enters from across the room. Do not hit the other teams or the two hostages kneeling on the floor. When the room is clear and the hostages secure, the third and final objective is completed and the mission ends.



SPECIAL FORCES TIPS

This mission is tough playing at the Hard level with all of the Special Forces options. Plan on more tangos throughout the mission. Use the HRT Stealth kit for the more challenging version of this mission because it allows you to move through the tunnels without alerting groups of tangos, who run toward the sounds of your weapons. When entering the cabin, take out the two tangos in the first room. Watch for a tango who might come up the stairs from the tunnels below. If he doesn't, watch for him as you descend the stairs. There is also a tango hiding in one of the cabin's rooms.

The tunnel passageways are crawling with tangos. Use night-vision goggles and zoomed-in view so you can see them well and at a distance. Watch your ammo because you will quickly deplete your clips with all of the targets you have. Occasionally check your heartbeat sensor to locate tangos on the map, but be quick and only do so in a safe location. If a tango comes at you while you have the sensor in your hand, you have a hard time switching to a weapon to fire before he kills you.

When you get to the barn, expect an extra tango downstairs. The central room also contains more tangos, as does the room containing the hostages. What makes these rooms even tougher is that you have to clear them by yourself, without any support teams. The trailer is tougher because the tangos are ready for you, especially the one in the back room. During this mission, you will wish you had some frag grenades instead of the flashbangs.

Aftermath

Authorities are still looking for answers in the wake of Sunday evening's devastating terrorist attack in Baltimore, Maryland. Over a hundred thousand people are presumed dead in the wake of a massive explosion at the site of Sunday's championship game, with tens of thousands more still unaccounted for.

High radioactivity counts at the bomb site have hampered rescue efforts, as emergency gear has been rushed to Baltimore from all over the country. "The bomb was definitely a nuclear device," said FBI spokeswoman Joanna Sleighton. "This is our worst nightmare come true." Authorities estimate that it will be several weeks, if not longer, before the full extent of the damage is known.

Sympathetic responses have poured in from around the world, as world leaders have expressed their solidarity with the American people in this time of crisis. The President offered words of sympathy to a grieving nation as well as a promise to punish those responsible for the bomb. "There is no doubt in our minds about that. This was a terrorist attack on American soil. We are going to find whoever did this and we are going to make them pay."

Mission 03: Barren Garden

Briefing

Welcome to the CIA, ladies and gentlemen. We're glad to have you on board. My name is John Clark, and you're going to report to me for the duration of your assignment. It's an honor to be working with you, and I was impressed by your work in West Virginia. That being said, listen carefully, because we do things a little differently around here.

As you're all aware, a nuclear device was detonated in Baltimore two days ago. What people don't know is that we almost went to war with Russia over it, as certain evidence pointed in that direction. It turns out that they weren't responsible, and you can thank your lucky stars cooler heads prevailed. If they hadn't, we could very easily have had a full-scale exchange on our hands.

As our people on the ground have sorted through the evidence, we've turned up a few new leads. The bomb was brought in through Baltimore by way of a shipping facility in Haifa. Intelligence suggests that this isn't the only weapons trafficking that's been happening through that site, and we need you to go in and find out who's been shipping what where. The Israeli government is backing us up on this one, but we need to go in fast and quiet so that the people running this operation don't get wind of it and destroy their records.

Your assignment is to get two pieces of information. First, we need copies of the shipping manifests for everything that's moved off that dock in the last month. Second, we need to track where they're getting their supplies from, and that means a list of serial numbers for what's in the warehouses.

Keep your heads down, and if they raise an alarm, get out fast. We don't need a public spotlight on this mission.



Objectives

1. Collect Documents from the Office: Go to the office building in the northwest corner of the complex and collect shipping documents related to manifests bound for Baltimore.
 2. Get Weapons Info from Warehouse: One of the supervisor's stations in one of the warehouses should have serial numbers for the weapons stored at the complex. Get this information so we can trace the shipments.
 3. Return to Extraction Zone: Get your team to the extraction zone on the dock.
- X. Don't Set Off the Alarm: If the alarm goes off, you'll have to finish up fast and get out before the police arrive, and there are bound to be embarrassing questions. Avoid their involvement.



Your mission is to retrieve evidence from this dockside warehouse complex.

Intel

In the wake of the events in Baltimore, the CIA has formed a new task force. Its mandate is to track down and bring to justice those responsible for the bombing. The task force is partially comprised of former members of the FBI's Hostage Rescue Team, yourself included. You and the other HRT members were selected because of your training in close quarters combat and operations in civilian areas.

The field commander for the task force is John Clark; you'll be taking orders from him now. Clark is an experienced CIA field agent, and he has a military background as well. He will be briefing you about the details of operations and will provide your mission objectives.

CIA analyst Jack Ryan, who was instrumental in defusing the tension between the U.S. and Russia, will be running the intel side of things. As he tracks down more data on the situation, he will feed you additional operational information.

The entire free world is looking to you for results. Good luck.

Suggested Team Kit

HRT Stealth

Support

None

Notes

Unlike the two previous missions, this time you're on your own. Because your objectives are to obtain two objects—documents and weapons info—neutralizing tangos is secondary. Therefore, engage only those tangos who pose a threat to your team or are in your way. For example, you can leave the tangos in the security posts alone as well as those in buildings you do not need to enter.

Because you want to avoid setting off the alarm, silenced weapons are a must. Also, be careful when taking long-range shots. If you miss, you will alert the tango you were targeting and possibly send him to set off the alarm. Use the darkness for concealment and move in the shadows. If you set off the alarm, you have only a set number of minutes until the Israeli police show up. The time depends on the difficulty level you are playing. For Easy and Medium levels, you have five minutes. For the Hard level, you have only three minutes. Furthermore, setting off the alarm releases several tango reinforcements that will spread out on the buildings looking for your team.

DEVELOPER TIP

You can save your campaign from the After Action Report screen once you've completed a mission by selecting this option from the menu dialog. The campaign also saves automatically each time you move on to a new mission.



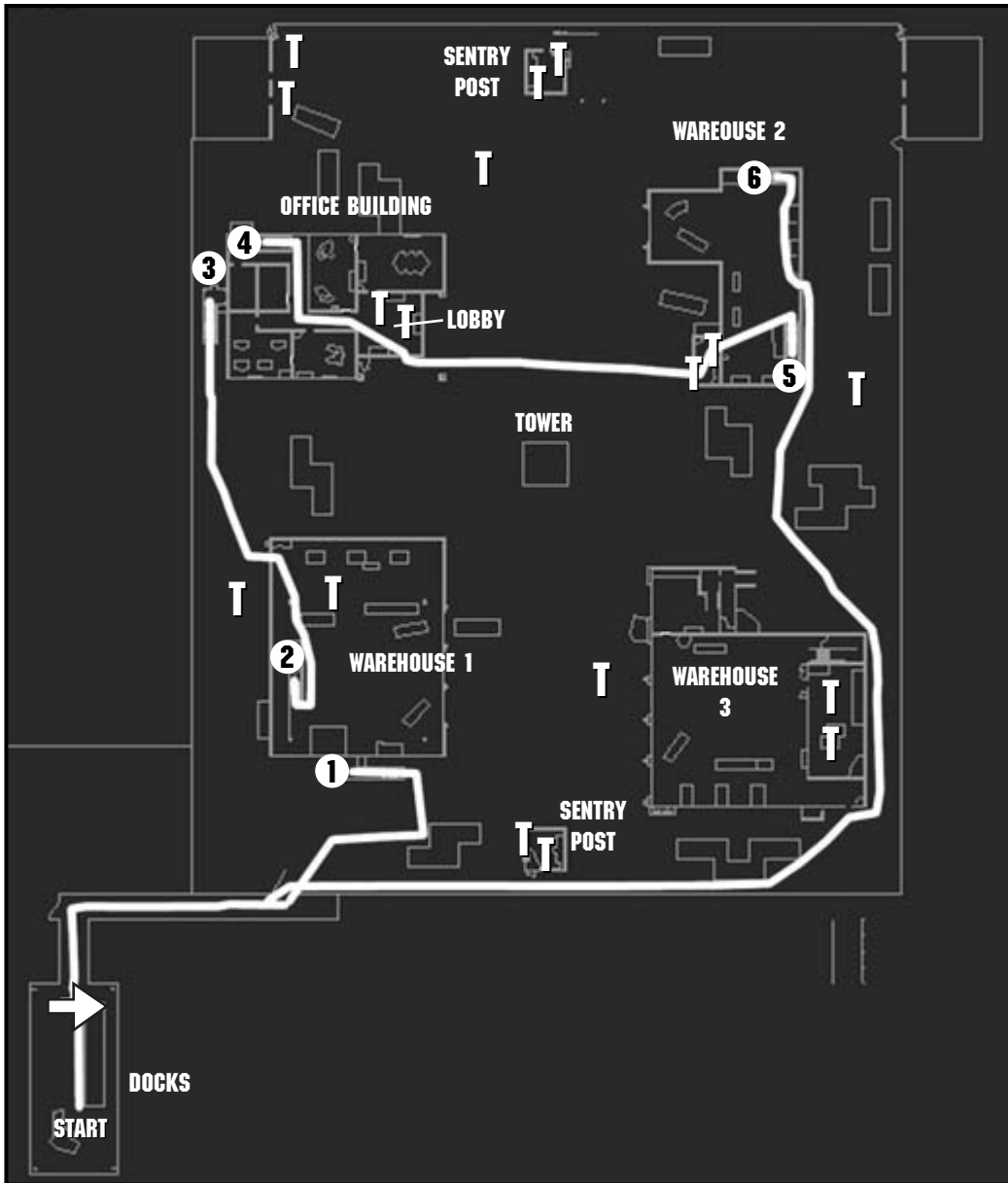

WAREHOUSE COMPLEX FIRST FLOORS T = Tango

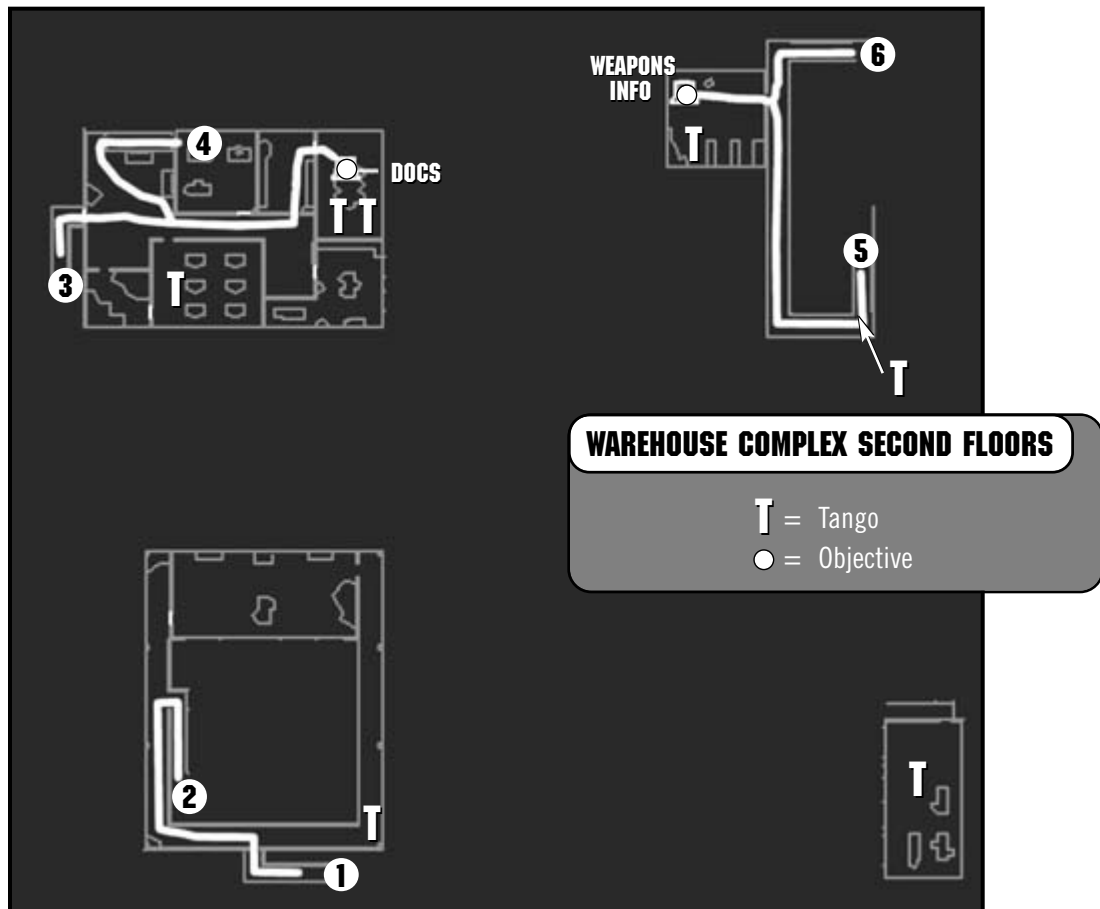

Mission Strategy

This mission is straightforward. You begin on the docks and must infiltrate a warehouse complex, collect your objective materials, then return to the dock for extraction. In addition to two tangos in each of the two sentry posts, six tangos patrol the warehouse grounds. The remainder are within the buildings. At the start of the mission, activate your night-vision goggles. You'll need them to see while your team is outside in the dark. Also order your team to assume the Recon ROE rather than Assault. You want to avoid trouble—Recon will keep them from shooting at every enemy they see.





Take out tingos patrolling around the warehouses.

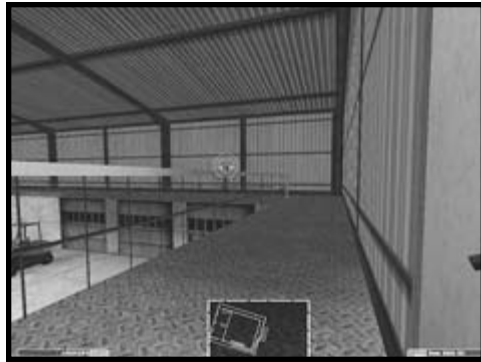

This tango is on the catwalk.



The second tango is below.

Follow your HQ plan to the open gate in the chain-link fence. While advancing, watch for tingos patrolling to your north and northeast. If you have a good shot, take it. The HQ plan leads you to the exterior stairway of the first warehouse. Head up the steps and do a quick heartbeat sensor check to locate the tango on the catwalk inside. After you fix his position, switch to your primary weapon and open the door. Take him down, then aim to the warehouse floor to neutralize a second tango. With the warehouse clear, descend the interior stairs to the door indicated by your HQ plan.

TIP

While the HQ plan advances you through the first warehouse, there is no need to do so. Instead, move around the outside of the warehouse to the office building.



Watch out for more patrolling tangos outside.



Take these stairs to the second floor of the office building.



This tango patrols around the office.



Drop these two tangos next to the objective.



Grab the documents to complete your first objective.



Take out the heartbeat sensor to check for nearby patrolling tangos. Advance out the door and toward the exterior stairway of the office building. Along the way, notice the spotlights of the tower in the middle of the warehouse complex. Shooting out the lights will set off an alarm, as will walking in their beams. So keep away. Continue to the stairs and ascend them to the door. Pick the lock and enter the second floor of the office building. A check of the heartbeat sensor shows one tango in a side office to our right and two tangos in the room containing the documents you need. Deal with the lone tango first. Approach the door, which may or may not be open, and strafe left to bring the tango into your reticule. Take him down and continue to your objective. Two tangos guard the documents. Follow the HQ plan to the office door. Line up your shots with the heartbeat sensor and position yourself to the left side of the door, facing right. Open the door and drop both tangos. Move in and pick up the documents to complete your first objective.



Lead your team to the first floor of the office building.



Neutralize these two chatting tangos in the lobby.



This tango between the offices and the security post shoots at you as you head for the second warehouse.

A new HQ plan appears, guiding you to the second objective. Follow them down the interior stairs of the office building to the lobby. Two tangos guard the lobby. Take them out and continue to the door. Before exiting, pull out the heartbeat sensor to check for patrolling tangos. There is one between the office building and the sentry post and possibly others about the central spotlight tower. Activate your night-vision

goggles and step outside. Avoid the spotlight. It will set off the alarm if it shines on anyone in your team. Instead, take out all tangos you can see, then continue to the second warehouse.



You can shoot through the window to dispatch both of these tangos.



This tango patrols the warehouse ground floor.



Follow the catwalks to the upstairs office.



Fire through the window.





Grab the weapons info on the desk.



There are two tingos in the security post.

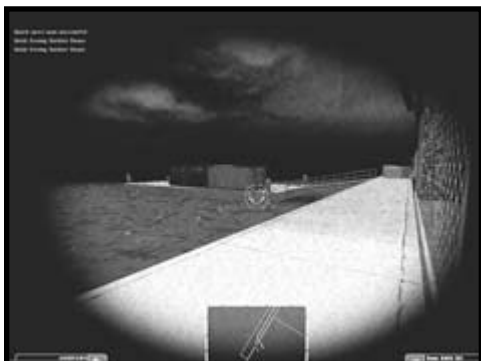

Get to the docks to complete the mission.

The small office through which you must enter this building contains two tingos. Shoot them through the window and enter the small office. Before entering the warehouse, check it with the heartbeat sensor. There may be a tingo on the ground floor. Switch to your primary weapon and rush in. Take out the tingo if he is there, then follow the HQ plan upstairs to the catwalk. It leads you to another office where the weapons info is. The tingo inside has his back to you, so shoot through the window before entering to retrieve the info.

With the second objective complete, it is time to get back to the dock. Your new HQ plan shows you a route to take. Follow them downstairs to the door of the warehouse. Do a heartbeat sensor check, then continue through the door and out into the dark. Move toward another warehouse and past it. There are three tingos inside, but because you have what you came for, let them be. As you approach the sentry post, you see two tingos inside through the windows. Neutralize them. Continue to the extraction zone on the dock to complete the mission.

SPECIAL FORCES TIPS

When playing with the difficulty maxed out, this mission is tough. There are more than twice as many tangos patrolling the grounds of the complex as well as extra ones in each of the buildings. Also, if you set off the alarm, you have only three minutes to complete the mission as well as tango reinforcements to deal with. While the HRT Stealth kit is probably your best choice, for more firepower try taking the Spec Ops Assault kit. The modified M4 carbines give you excellent accuracy for long-range shots with a good zoomed-in view. The only drawback is the noise.

No matter which kit you choose, the key to this mission is to engage tangos when you get to the chain-link fence. Take out as many patrols as you can at long range. Watch out for a tango who advances along the fence from the security post. He is difficult to see. After it is clear, head to the side of the first warehouse. Use the dumpster as cover and strafe from behind it to take out patrolling tangos headed your way. Check the heartbeat sensor occasionally to make sure tangos are not sneaking up behind you. After you deal with the tangos on patrol, the interiors of the buildings will not pose much problem. Get the materials and get out.

Aftermath

Israeli police report this morning that an overnight raid of a shipping facility in the port of Haifa was a dramatic success. Police spokesman Ari Shimron announced the seizure of stockpiles of illegal weapons destined for a variety of terrorist groups.

While no details are officially available at this time, a government source speaking under a guarantee of anonymity claimed that weapons seized ranged from assault rifles and grenades to surface-to-air missiles. A search is currently on for the owners and operators of this facility.

DEVELOPER TIP

You can change the zoom level on the mini-map by using the **[+]** and **[-]** keys on your keyboard. This is useful for getting the lay of the land. You can also get a full-screen version of the mini-map by pressing the **[Tab]** key.



Mission 04: Janus Knife

Briefing

Alright, settle down. We're onto something here. The documents we gathered from the docks have given us a lot to go on. It looks like most of what came through that warehouse started out in Lebanon. Our analysts have been able to back up the shipping records with satellite surveillance of the area, and we've located a facility in the Bekaa valley that's a likely source for a lot of the smugglers' traffic.

This place is built into the side of a mountain out in the middle of nowhere. We've got some evidence that suggests that they're working on weapons of mass destruction: chemical, biological, hell, maybe even nuclear. We know for sure that they're manufacturing conventional weapons there and sending them out to terrorist groups around the world. Even if they weren't tied into what happened in Baltimore, we'd want them put out of business.

And that is exactly what you get to do. You've all been given demolitions kits, and if you place these in their storage area, you should be able to pull the house down around their ears. At the same time, we don't want any trace of their research to survive, so be sure to rig any labs you may find. Finally, get any records you can. I have a feeling this isn't the only operation the group is running, and if we're going to start taking them out, we need to finish the job.

There are no civilians at this facility. Take no prisoners. Get in, clean up, and get out.



The weapons research and production facility is filled with tangos.

Objectives

1. Get Intelligence from Office: We need to know who is running this operation; check the computers in the office section.
2. Plant Explosives in the Storage Area: Intelligence indicates that high explosives are being stored on-site. Plant a demolitions kit in the storage area; that should set off an explosion big enough to collapse the caves.

3. Plant Explosives in the Research Lab: It is imperative that you destroy any materials used for researching weapons of mass destruction. Plant a demolitions kit in the research lab; we don't want any traces of useful information left after we're done.
- X. No Team Casualties: This is an assault on a hostile facility. Take it in stages, and bring everyone out alive.

Intel

The weapons making facility has apparently been carved out of a series of natural caves that were briefly mined for saltpeter back in the 1950s. Without the recent intelligence recovered in Haifa, we never would have suspected that it was a production facility. It's been marked as a mine on our maps for years.

According to our overflight radar scans, there are three wings to the facility, surrounding one large, central room. That's where you're likely to encounter the stiffest resistance.

We've also managed to confirm an interesting detail. The reason the mine was abandoned in the first place was that the rock formations on the north and east sides of the facility are highly unstable. That situation hasn't gotten any better with time, and a judicious application of explosives will make the entire complex collapse in on itself. Just make sure you get clear before detonating the charges, or you'll be buried in there when the place blows.

Suggested Team Kit

Spec Ops Assault

Support

Three support teams

Notes

This is a full assault mission. The Spec Ops Assault kit features the Spec Ops M4 with its excellent scope for long-range shooting. There are two main parts to the mission— infiltrating the compound, then clearing out the caves to complete the objectives.

The first part requires careful shooting at long range to clear out the entrance to the compound. There is little cover during this stage, so shoot quickly and accurately. When you are in the cave network, the mission requires interior tactics against tangos hiding behind doors or grouped together in large rooms. Use your heartbeat sensor to locate tangos and avoid ambushes.



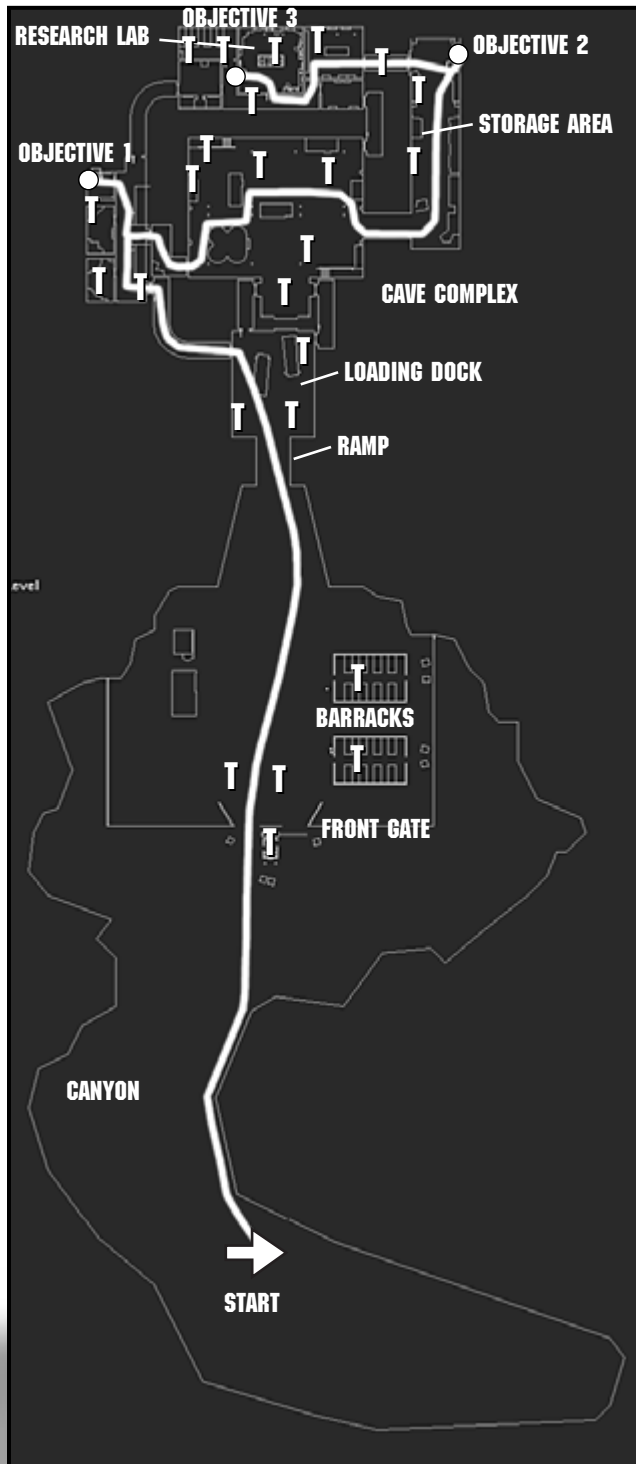

You have three support teams for this mission. They help when you clear out the entrance to the compound after you get started, then again when you're clearing a large central room containing lots of tangos. Keep ahead of the other teams to get the secondary objective. The other teams get shot up if your team is not participating in the firefights.



Snipe at the tangos by the gate.

Mission Strategy

Your team and the three support teams begin in a desert canyon. Around a bend in the canyon wall is the weapons research and production facility. Advance cautiously until you have the front gate in sight. Crouch and zoom in your view using the M4's scope.

WEAPONS FACILITY

- T = Tango
- = Objective

Snipe at the tangos guarding the entrance. There is one in the gatehouse with two more walking behind it. Wait until they are all in sight and neutralize each in succession before they take cover. After all three are down, advance to the gate. As you do, keep your sights toward the two barracks. A tango comes out of each one as you approach. Take them out and the outside entrance is secure.



Watch for the tangos who come out of the barracks.



Take out one tango down the ramp from a distance.

Move toward the ramp that leads into the cave complex. While keeping your sights zoomed in, advance until you can take out the three tangos in the loading dock area. With them down, all teams can enter the facility. Your team's HQ plan takes you through the door on the left side. Open it and follow a tunnel that curves to the right. You come to a door. Before opening it, check the heartbeat sensor to locate the tango patrolling the hallway on the



Rush to get the second.

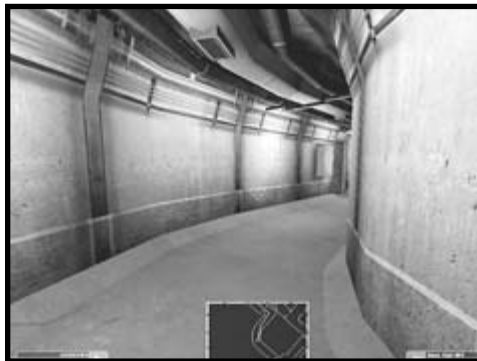

Follow this passageway.





Drop this tango in the hallway.



Only one foe guards the first computer.

other side. When he has his back to you or is walking away, open the door and take him out. Head down the hallway to the last door on the left. Open the door and take out the tango inside. Walk to the computer and use it to gather information. Doing so completes your first objective.

Exit the room and follow your new HQ plan down the hallway and into a passage. When you arrive at the door to the large central room, hold and bring out your heartbeat sensor to scan for tangos inside—there are six of them. However, your scan will only show five because one is on the catwalk above the room. When you open the door, two support teams enter from the south. However, if you do not assist, they often get slaughtered in the process. Therefore, shoot as you open the door. A tango stands in front of you across the room. Take him out, then turn



Get the info off of the computer.



Neutralize this tango before he shoots up the other teams.

left and strafe right to neutralize the tango in the northwest corner of the room. Work with the other two teams to finish clearing the room.

TIP

When clearing the large central room, use the heartbeat sensor to locate tangos hiding behind obstacles, then throw frag grenades over the obstacles to take them out.



This tango waits to ambush you as you enter the large room.



Take out the tango behind the chain-link gate first.



Strafe right to get the close tango.

When the large central room is secure, follow your HQ plan to the storage area. A chain-link gate divides this room. There is one tango on your side of the gate and another on the other side. Take them both out. Use flashbangs thrown over the obstacles to stun





Open the gate like you would a door.



Place the demolitions kit on the crate of explosives.

the tangos, then move around to take them out. With the storage area secure, go through the gate and to the crate of explosives. Press the Use key to plant a demolitions kit on the crate and complete your second objective.

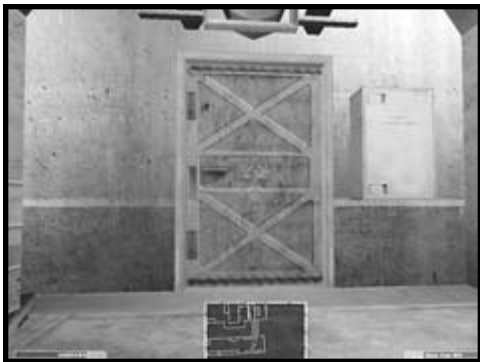

This door leads to the lab.



Watch for this tango hiding behind the shelves of boxes.

As usual, you receive a new HQ plan, which leads your team to their final objective. Be ready for the tango in the short passageway leading to the next room. After you take him out, stop and do a heartbeat scan. Locate the tango in the next room. Open the



Two teams converge on the lab.



Drop the tango behind the lab table.



The second demolitions charge goes on the lab computer.

door and take him out. Continue into a hallway leading to the research lab. A tango waits in the hallway. Do not take out a support team coming toward the lab from the other direction. Position yourself in front of the door. When you open it, fire and take out the single tango across the room. That secures the lab. Now walk to the computer and press the Use key to place a second demolitions kit on it. That final action completes the mission, which ends there. You don't have to return to an extraction point.

SPECIAL FORCES TIPS

The Special Forces hardcore version of the mission is not much harder than the Medium difficulty version. There are a few more tangos and you have to clear out the complex on your own. Because there is no need to go through the central room containing several tangos, after getting info from the computer take the northern passageway to the lab and complete objective three. Head to the storage area to complete objective two. You don't have to do them in order.





The mission ends when you complete the third objective.

Aftermath

Scientists are scrambling to explain a small earthquake that disturbed southern Lebanon yesterday. The quake, registering just 2.2 on the Richter scale, was centered in an area not usually known for seismic activity. Edouard Haddad, a geologist who teaches at the American University of Beirut, said that while it is not uncommon for Lebanon to be shaken by earthquakes originating in the Mediterranean, it is rare for quakes to originate in the country itself. No aftershocks were recorded.

Mission 05: Tiger Shell

Briefing

It looks like we found what we were looking for in the Bekaa. According to the computer records from the weapons facility, the headquarters for this group is located at an abandoned prison not too far away from their manufacturing site. Given the amount of traffic going back and forth between the two locations, it looks like they're probably storing the rest of their arsenal there. The prison facility is likely to be extremely well-guarded, so we're giving you some heavier equipment to make the job easier.

It looks like the main living quarters are in the center of the prison, which is still relatively intact. We can infer from this that the weapons are being stored out in the old cell blocks. Your first job is to plant explosives on those weapons caches, because we don't want anyone else getting their hands on that stash. Once you do that, take out whoever's in charge of this operation. According to the blueprints, there's a group of offices up on the second floor, so you'll probably find him—and his bodyguards—up there.

After you take care of business, get clear as fast as you can. There's going to be one massive fireworks show in Lebanon tonight.

Objectives

1. Plant Explosives in Cell Block A: The smuggling ring has acquired a stockpile of illegal weapons, ranging from assault rifles to surface-to-air missiles (SAMs). You need to use a demolitions kit to rig these for destruction. According to our surveillance, one of the caches is located in the southern cell block. Place explosives there.
2. Plant Explosives in Cell Block D: There is a second weapons cache in the eastern cell block. Place explosives there.
3. Eliminate the Group's Leader: The head of this organization keeps his offices here on the second floor in the old warden's office. Find him and kill him.
4. Return to the Extraction Zone: After you clean up the place, get clear. You don't want to be hanging around when those explosives go off.



This mission takes place in a Lebanese prison.

Intel

The complex the smuggling ring uses as a base of operations is actually an old prison that dates back to the French colonial days. It was rated maximum security, and was used as a storage facility for people the government wanted to forget about. It stopped official operation under Gemayel, and some time during the mid-Eighties the weapons smuggling ring set up shop there.

The actual prison construction is mostly concrete and barbed wire, and it's stood up to repeated shellings. On the inside, the complex is a maze. It's easy to get lost in there, and easier to be ambushed.

Suggested Team Kit

Covert Assault

Support

Two support teams



Notes

Your engagements will be at fairly close range, so you don't need a carbine or assault rifle. However, you also need to maintain stealth so you don't have tangos swarming toward you. Therefore, the Covert Assault kit is a great choice. The frag grenades in this kit come in handy.

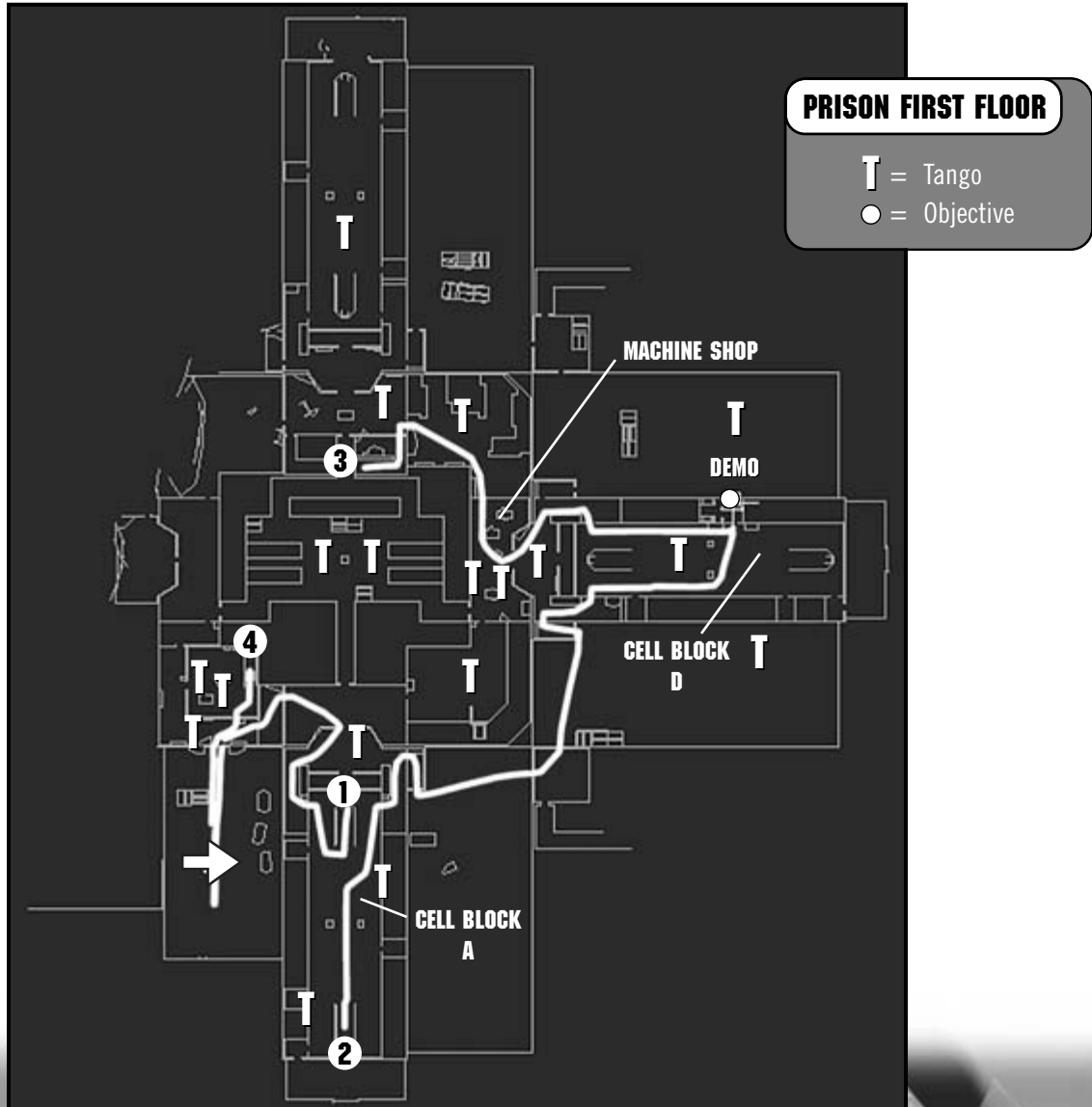

The prison has two levels, and in several places the second level looks onto the lower level. As you move through the prison, be mindful of tangos above you firing down on your team. These tangos don't show up on your heartbeat sensor, so use caution.

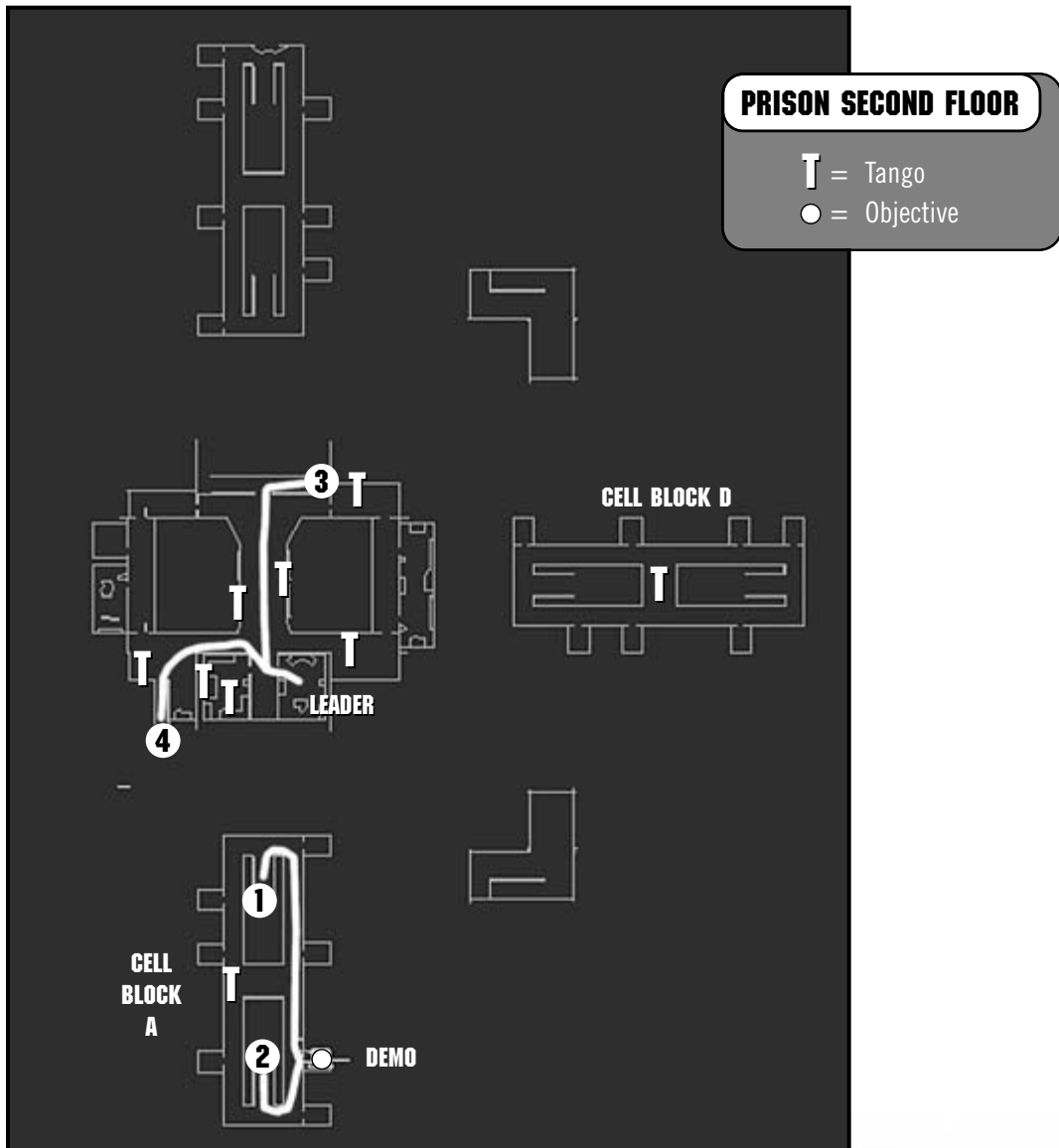

Mission Strategy

Your team begins outside the prison building. Follow the HQ plan to the door into the prison. Pull out the heartbeat sensor and scan the other side of the door for tangos. There are three in the first room with a fourth on the second level. Switch to your primary weapon and position yourself to one side of the door. Open it and begin firing. Let loose with automatic fire and take out the tango on the second level as well. Keep an eye on the messages in the upper left corner of the screen. When it shows that you have eliminated four tangos, you know the area is clear.



Open the door to the first room and let loose with the bullets.



Clear the way to Cell Block A.

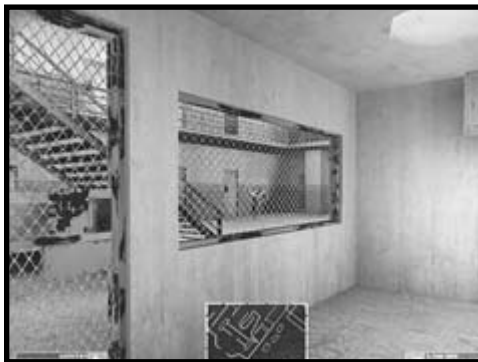

Take out the tango on the lower level of the cell block.

Now you can enter the prison building. Go through the gate on the right and advance through the HQ plan. In the next room, you may find some tangos, so do a heartbeat scan before opening the door. Clear this area, then continue on to Cell Block A. Through the window, take out one tango in the lower level of the cell block, then left-strafe through the door to eliminate the tango at the far end.

DEVELOPER TIP

You can give your squadmates orders by pressing the Command key (default: **Ctrl**) and selecting a command. You can also use hotkeys to give the same orders to your team.

Be careful because a support team is entering the cell block at this end; don't shoot them. A tango patrols the walkways above, so pick him off before moving out in the open.



Watch out for the tango on the upper level.



Place the first demolitions kit.

With Cell Block A secure, head upstairs and move to the cell where some crates of weapons are stored. Place a demolitions kit on the crate by pressing the Use key to complete the first objective.



Exit the cell block.

Follow your new HQ plan downstairs and out of the cell block. Ensure that all members of your team are together. Sometimes the tail end operative gets stuck behind a door. Switch control to another teammate to bring him up to the rest. Give the team the "hold this position" order so the other teammates don't run to the trailing operative. Continue out of the prison building to a yard area. There is a single tango patrolling here, so find him and take him out.





These tangos are guarding outside Cell Block D.



Take out the tango patrolling the lower level of the cell block.



Place another demolitions kit on this crate of weapons.

Then continue through a couple of gates and into the building. A couple of tangos patrol outside Cell Block D, so locate them with the heartbeat sensor before opening the door into the building. With these tangos neutralized, head into Cell Block D. There is one tango on the lower level and one above. Also, another support team enters from the far end of the cell block, so exercise caution. After the cell block is secure, advance to the cell on the lower level where the Lebanese are storing more weapons. Place another demolitions kit to complete your second objective.

DEVELOPER TIP

If you enjoy *The Sum of All Fears*, be sure to check out *Ghost Recon*, *Rainbow Six*, and *Rogue Spear*.



Neutralize the tango in the machine shop.



Watch out for this tango overlooking the machine shop.



Drop this tango so you can get to the stairs.

Gather your team together, then follow your new HQ plan. Exit the cell block and move through the room where you cleared the tangos. Before heading into the next room, a machine shop, scan it for tangos. There is only one, so open the door and take him out. When you move into this room, watch out for the tango on the level above. Throw a frag grenade on the platform to blow him up. Watch for the message to ensure that it is clear. Then head for the opposite door. Scan to locate the tango in the next room, then open the door and drop him. Follow the HQ plan to the stairs and go up them.

DEVELOPER TIP

Shotguns can be used to open doors, even locked ones, by firing at the handle. This can save time when trying to get in or out of a building in a hurry.





Take these stairs to the central upper level.



Clear out the two tangos in the main corridor.



A third tango comes along.

As you approach the top, crouch, turn left, and strafe right until you can see down the corridor. A couple of tangos patrol there. Take them out, then wait to see if a third shows up at the far end. If he doesn't, scan quickly to locate him, then advance toward your third objective. Hug the wall to the right. Take out the third tango if he does not come to you and continue to the two rooms ahead.

TIP

If you run out of frag grenades or ammo during the mission, switch to another operative in your team to be ready for action.



Throw a frag grenade into the room on the right to take out the two tangos inside.



The leader in the next room is tough to kill by rushing the room...



...so throw in a frag grenade to take him out.

The room on your right contains two tangos while the room on the left holds the group's leader—your objective. Advance cautiously and throw a frag grenade into the room on the right to take out the two tangos there. Move to the room on the left. Throw another frag grenade so that it bounces off the back wall and to the right. It should land near the leader. Rush in after it detonates. If the frag grenade didn't kill him, it stunned him, so finish him off to complete the third objective.

DEVELOPER TIP

In missions, you have two ways to switch what equipment you're using. You can press the  key to cycle to the next item in your inventory, or you can use buttons 1–4 to go directly to the first through fourth items you are carrying.



All that remains is to get your team to the extraction zone. The path is clear, so follow the HQ plan down the stairs and out the door where you first entered. When all members of your team arrive at the extraction zone, the mission is complete.



Get your team to the extraction zone.

SPECIAL FORCES TIPS

As with most hardcore versions, this mission is tougher because there are more tangos to take out. Use the CQB Assault kit and scan frequently to locate tangos before entering rooms. As a variant, instead of heading for Cell Block A at the beginning, go through the gate on the left in the first room and upstairs. Clear out the central upper area and take out the tango leader. While you are doing this, be ready for other tangos rushing up the opposite stairs to investigate what is going on. By doing this, you not only help prevent tangos from firing down on you from the central upper level, you also help clear out the lower level as the tangos leave their posts to come to you.

Once the upper level is clear, continue with the mission, planting the two demolitions kits in the cell blocks and then returning to the extraction zone. Since there are no support teams, fire at will, laying down a hail of bullets as you clear the prison.

Aftermath

Mysterious explosions rocked the Bekaa Valley last night as local authorities scrambled to provide an explanation. No terrorist group has claimed responsibility for the blasts, and there are no reported injuries. This morning, the Lebanese government issued a statement denying that it had any connection to the blasts. One theory offered was that a supply dump abandoned by Israel in the wake of its pullout from Lebanon had detonated, though there was no evidence to support that claim.

Mission 06: Jagged Hammer

Briefing

Good morning, people. I hope you got some rest on the flight in because this is going to be a long day. Our original analysis of the shipping records seized in the Haifa operation indicated that a number of shipments were made to a group here in South Africa. Follow-up from the boys back at Langley shows that the financing for shipping the nuclear device also came from this neck of the woods.

The South African government has been tracking the recipients of those weapons for a while. They're mostly hard-line right-wing Afrikaners, the kind of people who used to find work on the death squads. All the signs indicate that they've been gearing up for an open revolt, shipping in as many weapons as they can get their hands on. Intel suggests that they were just waiting for the international scene to get caught up in the war between the U.S. and Russia before making their move.

Since things didn't go according to plan, they're scrambling, and the South African government has given us approval to go in and take them down. They've given us some intercepted radio transmissions that suggest one of their financial backers is going to be on-site today at their main training facility, placing some orders and making payment for services rendered.

You're going to go in, disrupt the weapons sale, take out the backer, and destroy whatever weapons they have on-site. These are trained military men you'll be going up against, so take advantage of the equipment you have and the element of surprise. Hit them hard, and don't let up until you've taken them down.

Intel

The mercenary group running the training camp calls itself something that roughly translates to "Loyal Boer Sons of the Transvaal." They date back to the apartheid era, when their precursors operated as a freelance terror squad putatively working against the ANC. In reality, they were heavily armed, highly trained thugs, and nothing much has changed.



It's time to take out this terrorist training camp.



In the past few years, the group has reinvented itself as a mercenary operation, hiring itself out to various brushfire wars all over the continent. Their real game, however, is toppling the current South African government and installing themselves as the new regime, bringing back the bad old days in the process. They've been recruiting heavily and taking every contract that comes along, and that's how they got involved in the Baltimore operation.

Our best guess is that they facilitated the purchase and transfer of the bomb, and that means there's some serious money behind them. If nothing else, the size of their operation and their weapons stockpile indicates a sizeable bankroll.

Objectives

1. **Disrupt Weapons Sale:** We have to stop the mercenaries from getting their hands on any more weapons. They're in the middle of a transaction right now, so raid the main office building to disrupt it.
2. **Neutralize VIP Backer:** One of the group's backers is on site, probably seeing what his money is paying for. Best guess is that he'll be in the training facility in the SE corner. Find him and take him down.
3. **Clear the Barracks:** There will probably be reinforcements in the barracks area. Clear the barracks so the South African army doesn't get any nasty surprises.
- X. **Neutralize All Enemies:** There are no innocents here. Take out everyone if you can.

Suggested Team Kit

Open Assault

Support

One support team

Notes

This mission is tough. There are a lot of tingos to take out: either positioned to ambush your team, clustered together, or difficult to engage without totally exposing yourself. All of the tingos have body armor, so you need M16/203s because they have enough power to penetrate the tingos' armor.

You must neutralize all enemies to meet the secondary (X) objective, but if you follow the HQ plan, the mission ends when you complete the third objective and you can't take out the rest of the tangos. After taking out the VIP (Objective 2), detour away from the barracks and clear out the grounds around the camp, making sure that everyone around the barracks is neutralized. Now continue the mission where you left off. The VIP is the last enemy as well as the third objective.

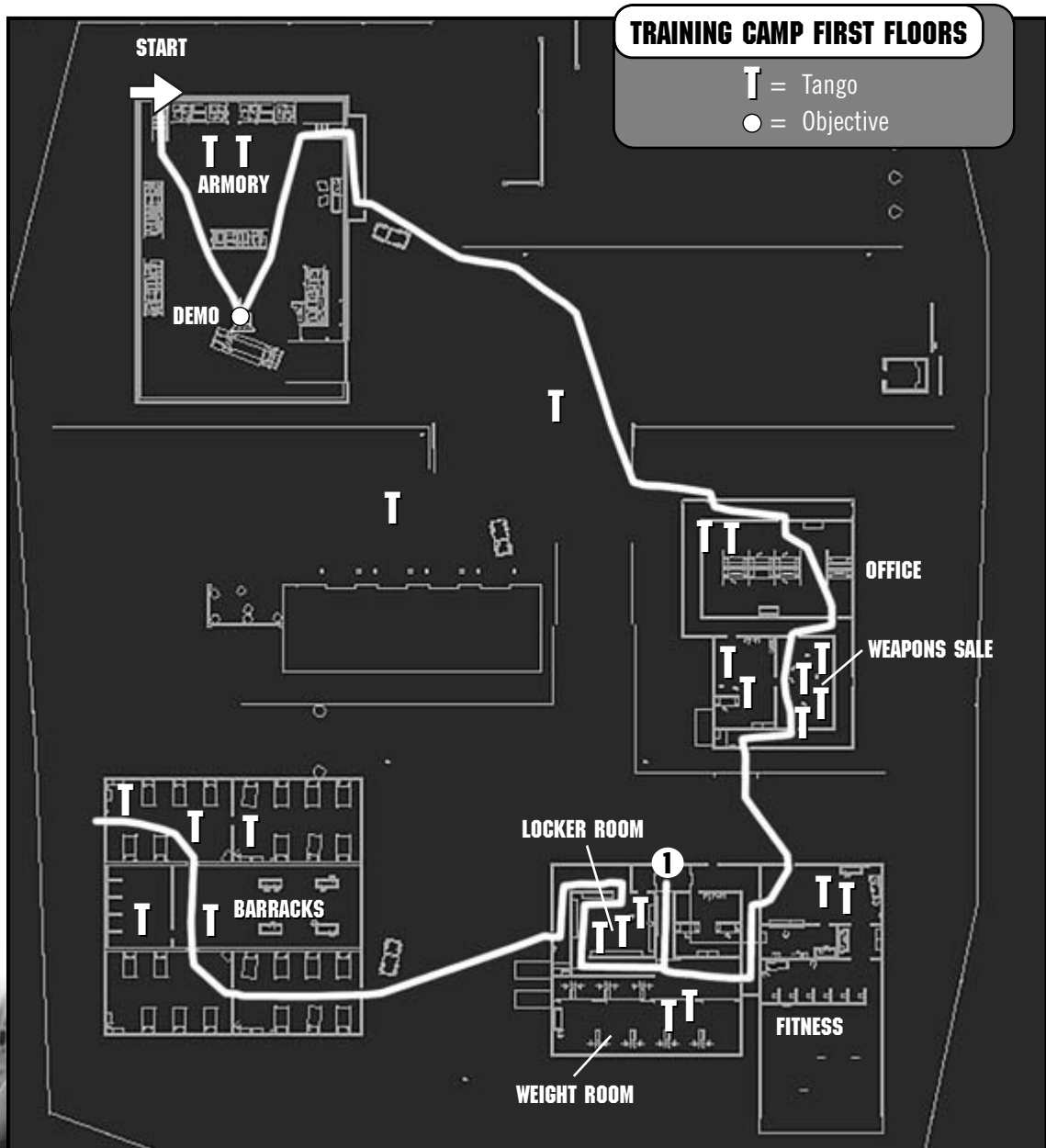

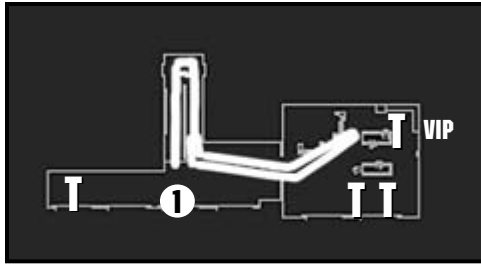

TRAINING CAMP SECOND FLOOR

T = Tango



Take out these two tangos in the armory.

Mission Strategy

Your team begins in the northwest corner of the map, near the armory you need to rig for your first objective. Follow the HQ plan to the door and bring out the heartbeat sensor for a quick scan. Locate the two tangos inside. Switch to your primary weapon, pick the lock, then right-strafe through the door. Throw a flashbang toward the tangos or keep strafing until they are in your sights.

DEVELOPER TIP

In multiplayer, character models and team bases are assigned based on team color. If you want to vary up the starting positions for the platoons you're using, just change their team colors in the edit server window.

With the armory secure, gather your team and follow your new HQ plan out of the armory. A couple of tangos patrol the yard area, but the support team enters the compound from the east and usually takes care of them. Do a heart-beat scan to ensure neither is hiding, waiting to ambush you. Go to the office building.



Watch for tangos waiting to ambush you outside.



Before you open the door, position yourself so you are ready to shoot.



Launch a frag grenade to break up the terrorist meeting.

Pass through a door into a hallway. Follow your HQ plan to a door that opens into an office. Position yourself to the left of the door and face it at an angle to have the drop on a couple of tangos when you open the door. Cross the office to where the meeting is being held. Stand centered on the door, open it, and launch a frag grenade. Quickly switch to your primary weapon and rush in to mop up any of the four tangos that survived the blast. This accomplishes the first objective. Watch out for a couple tangos in the adjacent room who may come out to attack you after the grenade goes off.





Stand to the right of the door into the fitness building.



A quick burst takes out both tangos.



These tangos try to flank you.



The other group waits in the hallway.

The HQ plan leads to a door into the fitness building. However, be careful as you exit the office building. The gunfire may have attracted tangos from the fitness building that may now be waiting to ambush you. Use the heartbeat sensor to check for them, then continue to the next building. If they were not alerted, stand to the right of the door and face toward the two tangos on the other side—to the left of the door. Open the door and fire. Five more tangos hide in the building on this level—two in the weight room and three in the locker room. A quick check of the heartbeat sensor shows if they're headed your way. If so, move to the door west of the one you opened and wait for the three from the locker room. They open the door and try to flank you. Ambush them. The last two tangos come down the other hall. When they stop, launch a frag grenade to take them out.



Cross the weight room to the stairway.



Take out the VIP to complete the second objective.

After all tangos on the lower level of the fitness building are neutralized, go for the VIP. Follow the HQ plan upstairs. Use the heartbeat sensor to locate the VIP and the three other tangos on this floor. One is located in the hallway, while the other two are in the room with the VIP. Take out the hallway tango, then go after the VIP and his guards. Depending on where they are located in the room, launch a frag grenade or strafe through the doorway.



Head over to the barracks.



The first tango is in the third room.





The tango in the bathroom is to the right of the door.



The next room contains three tangos.



The last tango hides behind the door, waiting for you to enter the room.

To complete the additional objective, you will need to detour from your plan. Instead of heading to the barracks, patrol around the grounds and neutralize all tangos outside the barracks. Use the Heartbeat Sensor to locate some that might be hiding. When it is all clear, follow the plan again and advance to the barracks. Enter through the eastern door, shooting the first tango, who is directly in front of you. Go to the next room and do the same. Continue through all six rooms, neutralizing a total of six tangos. After the barracks are clear, the mission ends.

TIP

The tangos in the barracks wait to ambush you. Before you open any door, do a quick scan with the heartbeat sensor. Plan your shots to fire or throw a frag grenade as soon as you open the door. When a tango is near a door, throw a frag grenade so it lands by the door. When it detonates, it takes out the door and the tango behind it.

SPECIAL FORCES TIPS

This mission is slightly more difficult with the hardcore settings. There are a few additional tangos, and no support teams. You can use the same tactics and strategy as you would for the Medium game.

Aftermath

South African officials are touting the roundup of members of a militant organization as a triumph for peace and democracy. The organization, calling itself the Loyal Boer Sons of the Transvaal, has been linked in the past to acts of violence across the country, and several of the organization's leaders were wanted for questioning in connection with the disappearance of journalist Matthias Parsival in 1997.

The arrests, made in the wake of information that the militia was planning an attempted coup, took place at the group's compound. While the militants put up spirited resistance, South African troops were able to storm the compound quickly and with few casualties. Inside, authorities discovered stockpiles of weapons and ammunition, as well as several million dollars in uncut diamonds that the group had apparently been using to finance its operations.

"This is a great day for democracy in South Africa," said government spokesman Piet Reihana. "The efficient work of our police and military to foil this planned assault on peace will serve as a lesson to those who do not understand that there is no room for hatred or violence in our country."

Mission 07: Glacier Rift

Briefing

It looks like we've got a new problem on our hands. Apparently, some of our mercenary friends weren't at the base yesterday. They may be running scared, but they're not done causing trouble yet.

A group of transports was spotted heading from one of their rural bases to a diamond mine on the western coast, near the Namibian border. Our analysis indicates that they're going to try to make off with a fortune in uncut gems, then start all over again. Even worse, when the local authorities went in to clean up the base, they found several crates of high explosives, some of which were half empty. It doesn't take a genius to figure out where those explosives have gone.

The government has asked for our help, and we're going to give it to them. You are going to go into the mine complex and stop the mercenaries in their tracks. Make sure none of the workers get killed and that no bombs go off, and most importantly, that none of the mercenaries escape.

Also, our analysts suspect this target wasn't picked randomly. This mine is owned by a shell corporation, and no one knows who's holding the real purse strings. Get into the vault while you're there and get any information you can about why this place was targeted.



Intel

The Port Christopher diamond mine is located about ten miles south of the Namibian border, on the west coast of South Africa. It's a maritime diamond mine, which means that it operates by sifting gems out of sand both above and below the waterline. This means that by necessity the site's a bit more open than anything you'd find in Kimberly or otherwise inland, and that's what makes it such an inviting target to the Loyal Boer Sons.

The compound at Port Christopher is fenced in and has a residential operations crew. That means that you've got barracks in addition to the sorting and appraising facilities, as well as the mine's main offices and diamond storage area. There's also a massive fuel storage facility on site, which makes any operations there trickier than they might be otherwise. The storage tanks are very close to the barracks, and anything that sets them off is liable to take the work crew with them.



The tangos hold two workers hostage in the barracks.

Objectives

1. Secure Intelligence Documents: There should be transaction documents in the safe. Pick them up so that intel can track down the money that's been moving through this facility.
 2. Clear the Barracks: The mercenaries have taken some workers hostage in the barracks. Clear that building out so we can extract the civilians safely.
 3. Defuse the Bomb: There's a bomb on-site. Defuse it before the whole place goes up in smoke.
- X. No Team Casualties: No one is expendable. Bring them back alive.

Suggested Team Kit

Open Assault

Support

Two support teams

Notes

This mission is another assault. The two support teams come in handy and nearly complete your second objective for you. The Open Assault kit provides you with good takedown power and long-range firepower. As in some of your previous missions, tangos respond to your attacks. When you clear a room, don't consider it safe. When you return, tangos may have investigated the sounds of the gunfire and be waiting to ambush you. Because it's dark outside, use your night-vision goggles.

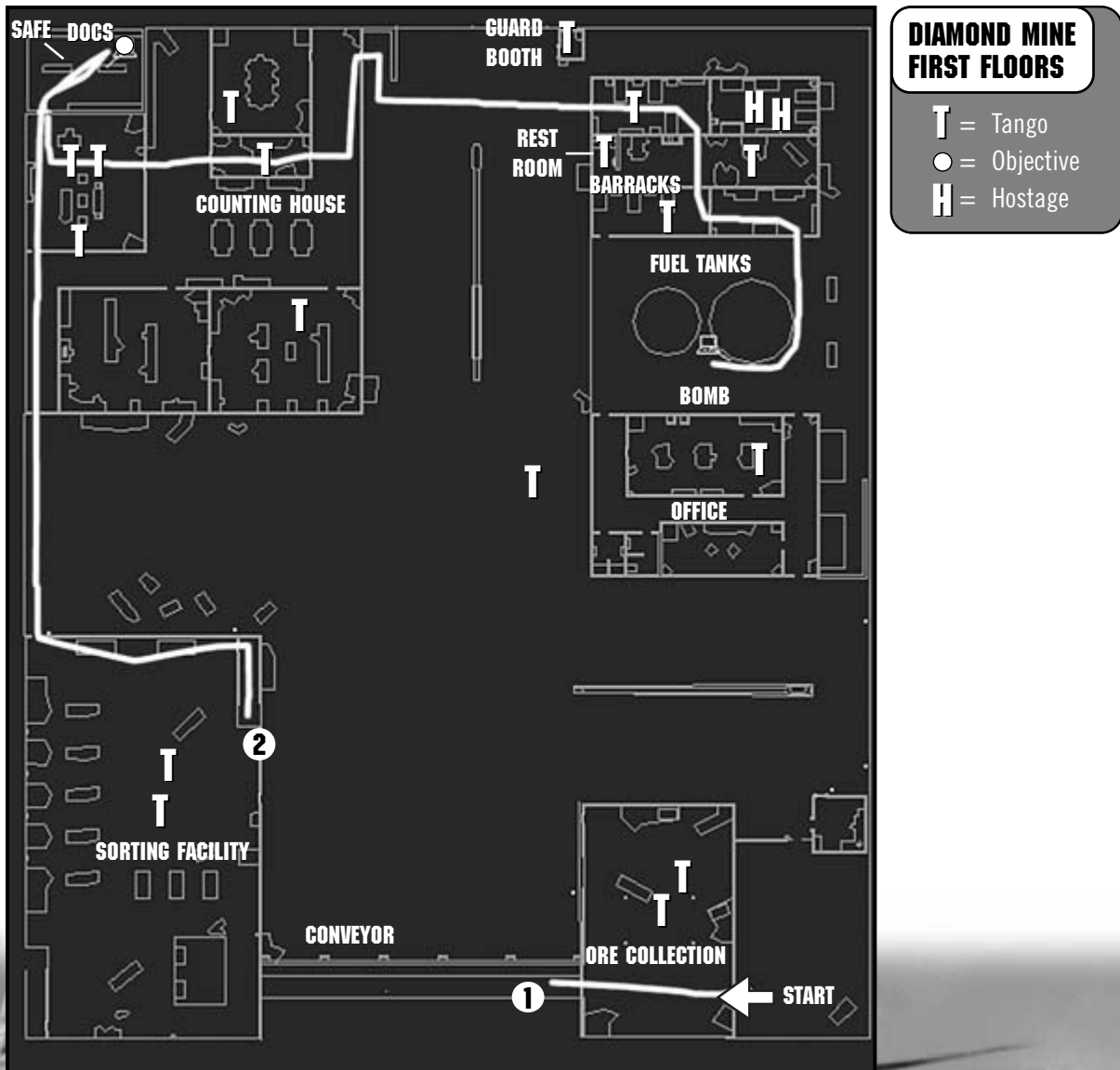



Your team begins outside the ore collection facility.



Take out both tingos to clear the building.



The conveyor belt takes you to the next building.

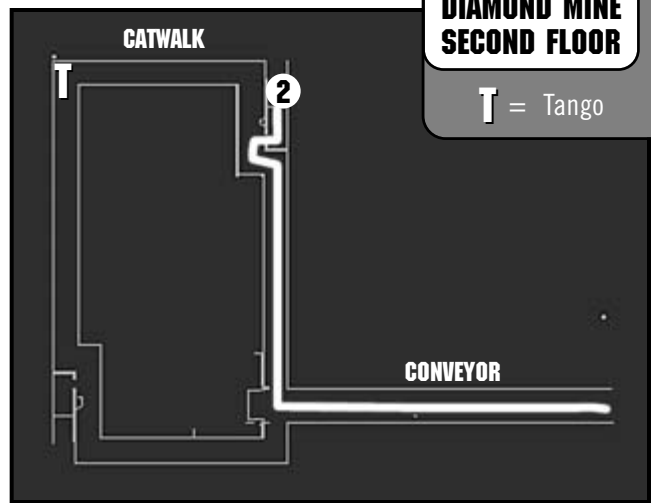

**DIAMOND MINE
SECOND FLOOR**

T = Tango

Mission Strategy

Your team begins in the southeast corner of the map. Move to the door of the ore collection facility and use your heartbeat sensor to locate the two tingos inside and line up a shot. Open the door and drop both to clear the building. Follow your HQ plan onto a conveyor belt that takes you into the next building.

DEVELOPER TIP

Multiplayer maps can also be played in Lone Wolf and Firefight modes. Simply go to the Quick Mission menu and select the Lone Wolf or Firefight option, then scroll down to the multiplayer map you want to play.



Zoom in for a good shot at both targos on the ground level of the sorting facility.

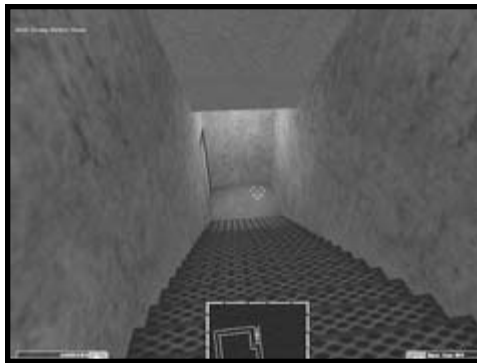

Head downstairs to the ground level.



One of the support teams helps you secure the sorting facility.

The conveyor belt ends on the second level of the sorting facility. To your right, there are two targos on the floor area below and a third on the catwalk level with you. They don't know you're there, so zoom in and take your shots. By the time you shoot, one of the support teams rushes in on the lower level. Help your backup clear the sorting facility from your perch on the end of the conveyor belt, then follow the catwalk to the right and down a flight of stairs to the ground floor. Move across the building to the far door and then outside.





Go to the counting house.



Drop these two tangos.



A third tango waits to ambush you.

The support teams take care of the lone tango patrolling the grounds to your right, but move cautiously until you confirm the kill either with the heartbeat sensor or a visual on the body. Continue to the counting house.

Before you enter, perform a heartbeat scan. All six of the tangos should be in rooms with none roaming the hallways. Enter the building and follow your HQ plan to the first room. Position yourself directly in front of the door. Open the door and take out the two tangos in your sights, then give a frag grenade a short toss to the right. Strafe to the right side of the doorway to miss the blast, switching to your primary weapon. After the grenade detonates, rush in to confirm the third tango to the right of the doorway is down.

DEVELOPER TIP

Every time you start a campaign, the default settings for the difficulty level you selected are used. You can change these settings from the options menu while in the campaign.



Move to the safe.



Pick up the documents to complete your first objective.



Watch out for tangos who catch you leaving the safe.



Take out this tango in the hallway.

With this room secure, you have a clear path to the safe. Lead your team inside to retrieve the documents and complete your first objective. Before you leave the safe, use your heartbeat sensor to see if the other three tangos in the counting house have converged on the room adjacent to the safe. Shoot them if they are in sight, or use frag grenades to neutralize them if they are hiding around a corner or doorway, waiting to ambush you as you exit. Take care of all three tangos before following the new HQ plan to an exit.

TIP

Before you enter the counting house room with the three tangos, order your team to hold this position outside the door. Your teammates take care of any tangos who emerge from the rooms where they begin the mission to come after you.





Watch for tangos leaving the barracks.



Neutralize the tango in the guard booth.



Enter the barracks and clear them.



Don't rush the tango in the restroom; he's deadly.

When you exit the counting house, use your night-vision goggles. Watch for tangos exiting the barracks. One of your support teams may have roused them. Take out the tango in the guard booth. With the route to the next building secure, move to the barracks.

As usual, hold at the door and use the heartbeat sensor to see where the tangos are positioned and locate the two hostages in the northeast room. They are marked on the mini-map with green dots. The barracks originally held four tangos. The number remaining and their locations depend on the efforts of the support team. Count on the tango in the restroom to still be there. He guns you down if you come into his sights, so throw a frag grenade to blow him away.

You receive a message when you have neutralized all the tangos from the barracks. If you have been in every room and still have not completed this objective, check around the outside of the barracks. Sometimes the tangos flee.

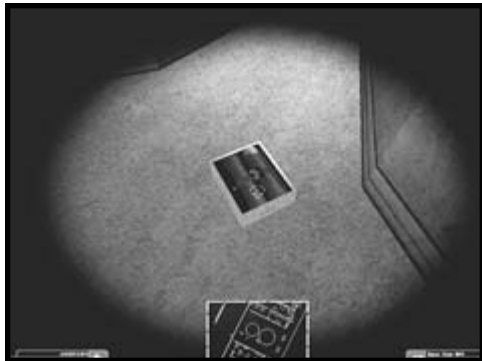

The bomb is by the fuel tanks. Disarm it to complete the mission.



The support team helps clear the barracks.

After you clear the barracks, the rest of the mission is downhill. Follow the HQ plan to the fuel tanks and disarm a bomb to complete the mission.

SPECIAL FORCES TIPS

While this mission isn't easy on the Medium level, the hardcore Special Forces version is downright deadly. The ore collection facility is the same, but when you arrive at the sorting facility, you face a tough fight. There is an extra tango near the two on the ground level, and another in the southeast corner. This latter tango is your worst worry: He waits to ambush you when you expose yourself. Use a frag grenade or line up your shot and fire as you strafe out from the conveyor belt to take him out.

After the sorting facility is clear, deal with three tangos patrolling the grounds outside, then clear the barracks on your own. The rest of the mission is the same.



Aftermath

South African police were able to foil a daring raid on the Port Christopher diamond mine late last evening, rescuing both the mine complex and workers who were being held hostage by the thieves. Police arrived at the scene shortly before midnight and engaged in a fierce gun battle with the robbers, who were attempting to break into the facility's storage vault.

Several staff members, including mine workers and security personnel who live on site, were taken hostage by the thieves. After a tense standoff, police were able to dispatch the hostage-takers without any civilian casualties.

The mine, which is located near the Namibian border, produces nearly \$17M per year in uncut diamonds. It has been in operation since 1983, and in 1997 was purchased by an Austrian consortium.

Mission 08: Lightning Field

Briefing

That was some good work in the mining operation. The documents you secured from the diamond mine have led us right to the man responsible for buying and rebuilding the nuclear bomb. His name's Olson, and he's been dealing arms to groups around the world for 30 years. I suspect it won't surprise you to hear that he had extensive dealings with the crowd you took out in Lebanon, but he's always been an independent operator. Based on the information you gathered, we've been able to track him down. His operation is centered on an estate on the island nation of Mauritius.

Your assignment is to go in, clear out any resistance you find, and get Olson's private records. He may have supplied the bomb, but chances are someone paid him to do it, and we want to know who that was. Surveillance indicates that Olson's private secretary is on the grounds as well. Olson himself is elsewhere right now, but we want you to find the secretary and bring him out alive. We've got a lot of people who want to talk to him.

I'm sorry I can't be there with you today, but there's another aspect to this operation that I need to take care of in Damascus, personally. Don't worry. It shouldn't take me too long.



Assault a mansion filled with tangos.

Intel

The money behind the Loyal Boer Sons belonged to a man named Derek Olson, a South African arms dealer. Olson first shows up on the CIA's radar supplying weapons to UNITA in Angola back in the late 1980s. Since then, he's been linked to deals in Chad, Zaire, Uganda, and South Africa, and he's supplied terrorist organizations all over the globe. There's evidence of his having moved everything from handguns up to helicopters.

Olson's involvement in the Baltimore incident is twofold: as a procurer and as a source of funding. He's the one who arranged the initial purchase of the weapon and arranged for its reconstruction, and he connected the buyer and the seller. He also worked through the Loyal Boer Sons of the Transvaal to transport the bomb to Lebanon, from whence it went to Haifa and then Baltimore.

The man himself moves between homes in Damascus, Mauritius, and Salzburg. The bulk of his records, however, are kept at the estate on Mauritius. For that reason it is still heavily defended, though Olson himself is not in residence at this time.

Objectives

1. Capture Olson's Secretary: The most important man in that house is Olson's secretary. Get in there, track him down, and make sure he's secured. We need him alive so we can interrogate him.
 2. Seize Documents from Vault: The money trail leads straight to Olson. The question is where it goes from here. Olson's got a small vault in the cellar of his house; collect up his records so we can get a better handle on who he's working with.
 3. Neutralize Enemies in Pool Area: Olson's secretary was apparently meeting with some of Olson's business partners; well, you can call them that if you consider murder to be business. They are staying in the guest house out behind the estate. Make sure these guys don't make it out; we'd hate for them to tip anyone off that we're on their trail.
- X. No Team Casualties: No one is expendable. Bring them back alive.



Suggested Team Kit

CQB Assault

Support

Three support teams

Notes

In this tough assault mission, fight your way through a mansion swarming with tangos, clearing the mansion and meeting your objectives. You definitely need frag grenades and heartbeat sensors. The larger 50-round clip of the 5.7mm SMG wins out over the penetrating power of the larger caliber Spec Ops M4 rounds: Choose the CQB Assault weapons kit.

The tangos have turned several parts of the mansion into kill zones. In addition, some of the tangos try to flank you or attack you from behind while you concentrate on other threats. Getting through to your objectives requires skill, planning, and firepower.

To help you, three support teams assault the mansion from different spots. You use lots of frag grenades during this mission; switch control to a different teammate whenever you run out. Amongst the three operatives on your team, you have 12 frag grenades—you'll use most of them.

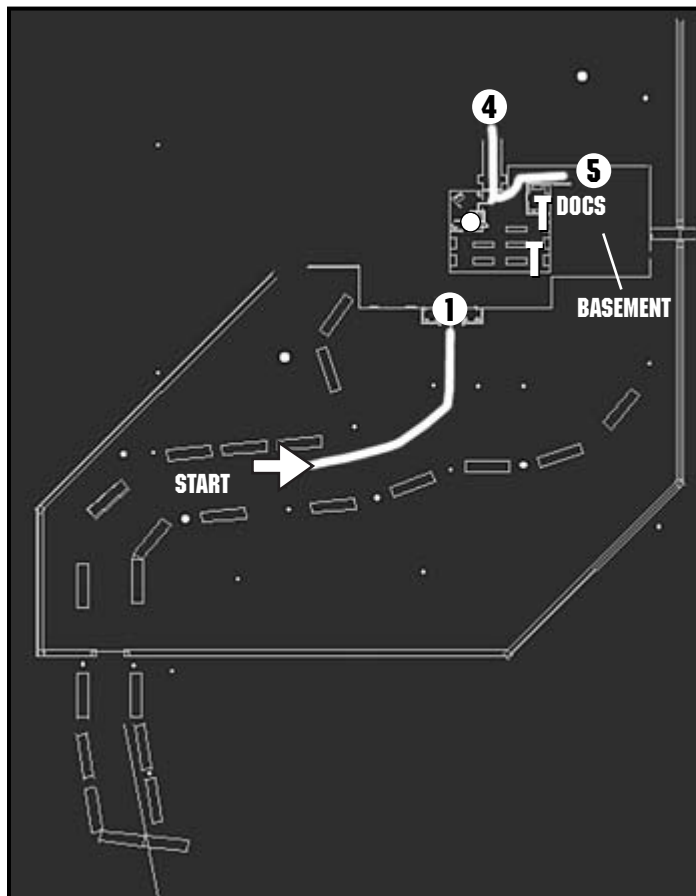

MANSION DRIVEWAY

T = Tango
○ = Objective

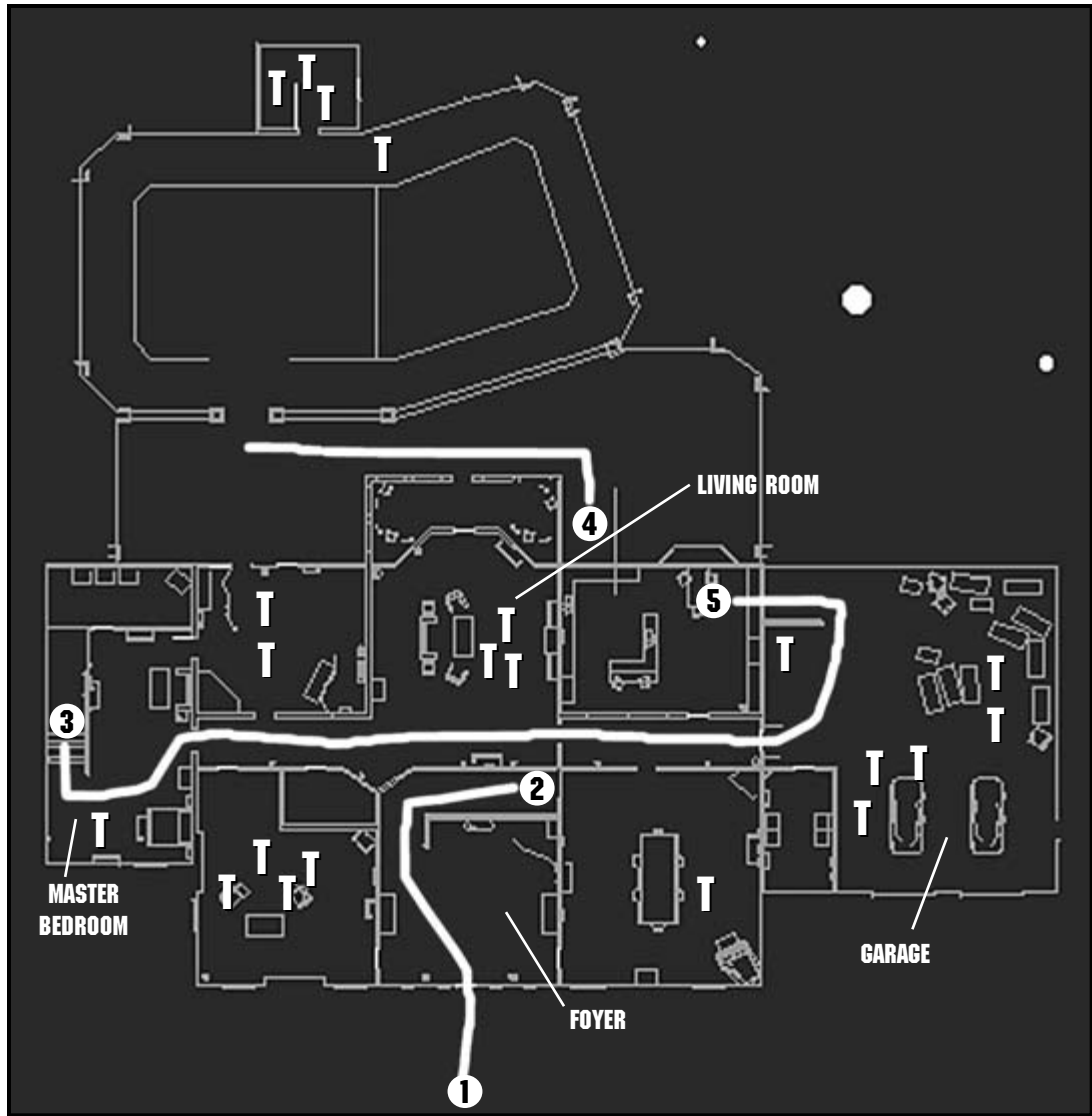
**MANSION FIRST FLOOR**

T = Tango

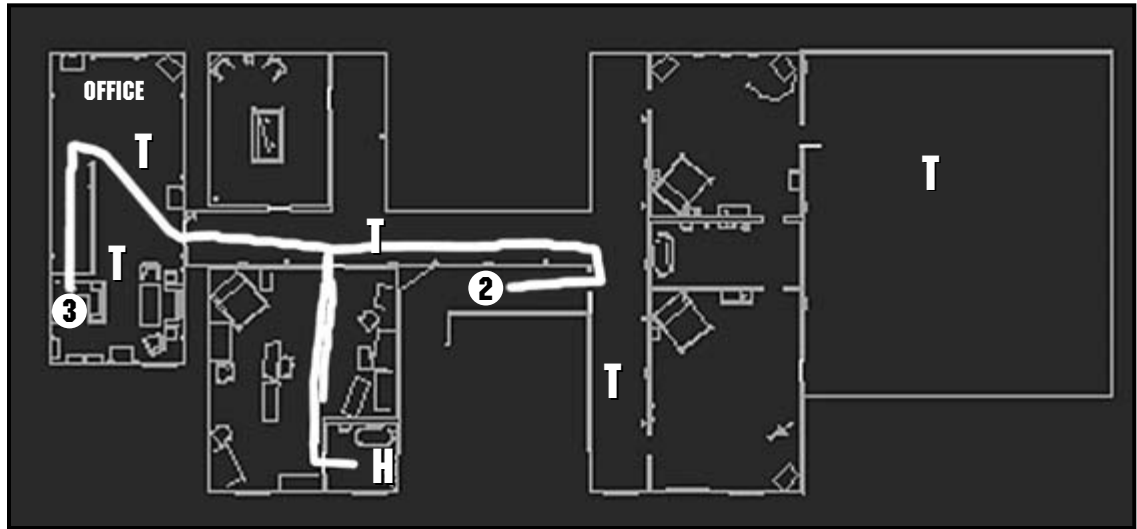

**MANSION SECOND FLOOR**

T = Tango
H = Hostage

Mission Strategy

Your team starts on the driveway to the mansion with orders to go in through the front door. There are no tangos outside on the front lawn, so walk right up to the front door. Use your heartbeat sensor to locate tangos on the first floor. Pick the lock and enter.



Clear out the entrance foyer.

Your plan leads you upstairs. At the top, check your heartbeat sensor to locate tangos on the second floor. One patrols near the door. When you find him, open the door, rushing through to take him down. From here, turn right and head toward the front of the house.

Turn and face your HQ plan. It leads down a long hallway to your left—this hallway is a kill zone. Two or three tangos wait at the far end and additional tangos downstairs fire up at you. Do a Quicksave here in case you get killed.

Inch your way toward the hall, facing the enemies at the end as you right-strafe. Crouch so the tangos below can't see you, then strafe out enough to get the tangos in your sights and let loose with a hail of lead. Be quick on the trigger to take them all down.

TIP

Another way to engage the tangos at the end of the hall is to go through the southeastern bedroom to the northeastern bedroom and take position in the side hallway to throw frag grenades. Bounce them off the wall so they land near the tangos at the other end.



Gun down the tango at the top of the stairs after you open the door.



Eliminate the tangos at the far end of the hall.



Now take care of the tangos below. Watch for them near the back door in the room below. Pick them off with your SMG and throw frag grenades over and through the banister. Watch the messages in the upper left corner of the screen to track your tango hits. Use short throws that drop straight down to take out the tangos below the walkway. Order your team to hold their position at a distance in case the grenade does not make it over the edge and you have to run.



Throw grenades through the banister at the tangos in the living room below...



...or they'll gun you down as you advance down the hall.



Lead your team down the hall.



The secretary hides in a bathroom.

When it is clear below, lead your team down the hallway to the bedroom indicated by your HQ plan. Go into the bathroom and capture the secretary by walking up to him to complete your first objective. Once he's captured, he will stay put. Just leave him and continue.

TIP

If you operate quickly, there is an alternate strategy. After taking out the tangos by the front door, rush up the stairs and through the door, taking a position covering the hallway. Take out the tangos at the other end as they come into view, before they have a chance to ready an ambush. You must move fast to do this; there's no time for heartbeat scans.

This strategy, though riskier, makes getting through the upstairs kill zone simpler. You must still watch out for tangos below, but that's easier with the second floor clear.



Head to the office.



Then go downstairs to the master bedroom.

Follow your new HQ plan out of the bedroom, through the office, and down to the first floor. The tangos below are dangerous. Crouch down, then right-strafe down the stairs. Keep your sights on the doorway and the hallway beyond, tangos at the far end of the hallway shoot.

DEVELOPER TIP

The default setting for an Easy campaign uses full auto-aim. If you want more of a challenge, try turning auto-aim off from the options menu within the campaign.



When you are in the room below, move to the right of the doorway and scan with the heartbeat sensor. Locate tangos on the first floor. They may be in rooms adjacent to the master bedroom you are in, or farther away. For those close to you, throw frag grenades through the doors to take them out. If a tango is near the other side of a closed door, toss the frag grenade so it lands next to the door. When it blows, it takes out both the door and the tango.



Watch out for tangos in the hallway or living room as you go down the stairs.



Clear out adjacent rooms with frag grenades.



Advance toward the living room.

If the door at the far end of the hall is open, tangos from the garage take shots at you. Neutralize as many as you can, then advance toward the garage. Watch for tangos still alive in the living room. This is the room into which you dropped frag grenades. Work your way to the garage, clearing as you go.

When you are close to the garage, throw frag grenades inside. Hopefully a support team cleared the garage for you. If the team was ambushed, however, you must do it on your own. Scan with your heartbeat sensor to check whether you got them all. If not, rush in and clear out the few diehards with your SMG.



A frag grenade takes out a tango hiding behind a door.



The vault is in the basement.



Grab these documents.

When the garage is clear, lead your team through it and downstairs into the basement. Two tangoes are down there, so be cautious as you enter. Clear the basement, then advance to the vault and retrieve the documents located on a table to complete your second objective.





Take out the tango patrolling around the pool.



Neutralize the tangos in the pool house.

Once you have the documents, head up the other stairs and exit the basement out into the backyard. Your final objective is to take out the tangos in the pool house. There is one tango patrolling around the pool. Take him out and then throw a frag grenade next to the door of the pool house. When it goes off, it will take out the door as well as some of the tangos behind it, if not all. Neutralize the rest with your SMG to complete the mission.

TIP

Clearing out the garage is dangerous. Instead of rushing to get to the basement, exit the house through the door in the living room and turn right, advancing to the exterior basement stairs. If the door is closed, you can't unlock it, so step back and throw a frag grenade down to the door. The blast blows in the door, letting you access the basement and get the documents.

Then clear the garage from the basement stairs.



Then clear out the garage from the basement stairs.



You can also reach the basement by blasting open the outside door.

SPECIAL FORCES TIPS

Since the mission is tough to begin with, the good news is that the Hard version is not much worse. You just face a few more tangos but with the same challenges. However, this time you are on your own. The HQ plan for the mission leads you to the first objective—the secretary. But since the mission ends successfully once you neutralize all tangos, change your strategy to terrorist hunt and forget the HQ plan.

After entering the mansion through the front door, head into one of the side rooms and clear out the first floor. The tangos don't always behave the same way each time you play, so monitor their movements with the heartbeat sensor and ambush them as they come for you. Liberally use frag grenades to take out tangos in hard-to-shoot-at areas or when they are grouped together.

When you're ready to go upstairs, use the stairs in the master bedroom, but first throw a frag grenade into the office above to blow up any tangos waiting for you at the top. Mop up any remaining tangos upstairs, outside, and in the basement to complete the mission.

Aftermath

Noted international financier and philanthropist Derek Olson was found dead in his Damascus home this morning, the victim of a heart attack. Olson, 48, was found by his housekeeper shortly before eight, having apparently died in his sleep.

Olson, described by peers and friends as 'an energetic, gentle man' was well-known for his work with charities in both his native South Africa and his adopted homeland of Mauritius. A frequent visitor to Damascus, he owned several small businesses there, as well as an import-export firm in South Africa and a textile factory in Mauritius. He is survived by his former wife, Greta.

Mission 09: Hollow Serpent

Briefing

Good to see you again. You'll be happy to know that the Olson situation has been taken care of, and so has Olson. I don't think I need to say anything more about my trip to Damascus.



We're getting close to the source now. The financial transactions surrounding the bomb have been traced back to a private bank here in Austria. While it looks like a normal financial institution, our research shows that it's actually a front. A careful look at the records shows that it only does business for a group of corporations that are all a part of the same conglomerate, some of which have what I'll call questionable political ties. Neofascist groups, historical revisionists, international gunrunners—you know the type.

We need you to go in and get the documents that will tie the bank back to whoever's behind the entire operation. These will probably be in the president's office. Since we don't want our bomb-loving friends to know that we're on their trail, you should ransack the bank's vault as well—make it look like a robbery. You'll need to get the security codes first to open it up, but for you, that should be a piece of cake.

Bear in mind that the people you are going to be up against are not the Vienna Boys Choir. Anyone you find on the grounds is associated with the group that put that bomb on the ground in Baltimore. You have my permission, no, my encouragement to show no mercy.

Intel

The First People's Investment Firm of Vienna is a fairly awkward name for a very streamlined operation. Founded in 1948 with money that goes back to the Germans' ODESSA operations, it's essentially a shell corporation that deals with all sorts of unsavory transactions. In 2001 alone it handled over \$310M in fund transfers, investments, land and equipment purchases, and arms and narcotics deals for various right-wing organizations around the globe.

The firm operates out of Vienna, though it has branch offices in three cities across Austria, and two more in the GDR. Our interest is in the main branch, however, which is where the firm's records are kept. The building itself is fairly unassuming, but the company employs extensive and heavily armed security forces, many of whom have served time in various skinhead or other neo-fascist groups before graduating to security work.

One other thing: One of the firm's best customers was Olson, the South African arms dealer. The payments tied to the Baltimore bombing were all routed through Vienna.



An FBI operative doesn't often get to rob a bank.

Objectives

1. **Recover Financial Documents:** The documents recovered at Olson's estate lead here, but we need the investment firm's transfer records to verify the connection. The papers we need should be in the president's office up on the second floor. Get in there and get those papers.
2. **Secure Vault Security Code:** In order to make this look like a robbery, you're going to need to get into the vault, which means disabling its security. There's a security center upstairs; you should be able to get the codes you need to get the vault open there.
3. **Ransack Vault:** We don't want to tip off the people running this operation that we're onto them, so make a mess in the vault; they're never going to believe it's a robbery if everything's in order.
4. **Go to Extraction Zone:** Once you've got the papers and covered your tracks, get out the front door as quickly as possible. We don't want to have to explain this one to the local police.

Suggested Team Kit

HRT Stealth

Support

None

Notes

After the previous mission, this one is a piece of cake. There are two ways to go about this mission: guns blazing or with stealth. We recommend the latter. If you opt for heavy firepower, you face a big firefight in the bank lobby. While you can complete your objectives this way, the quieter approach is easier and less dangerous. You have no support teams, so your operatives are on their own.

Mission Strategy

Your team begins outside the bank's front entrance. There is no other way in, so move to the front doors. Take out your heartbeat sensor to scan the ground floor.



Take out the tango by the front door quietly, so the others don't know you're in the bank.



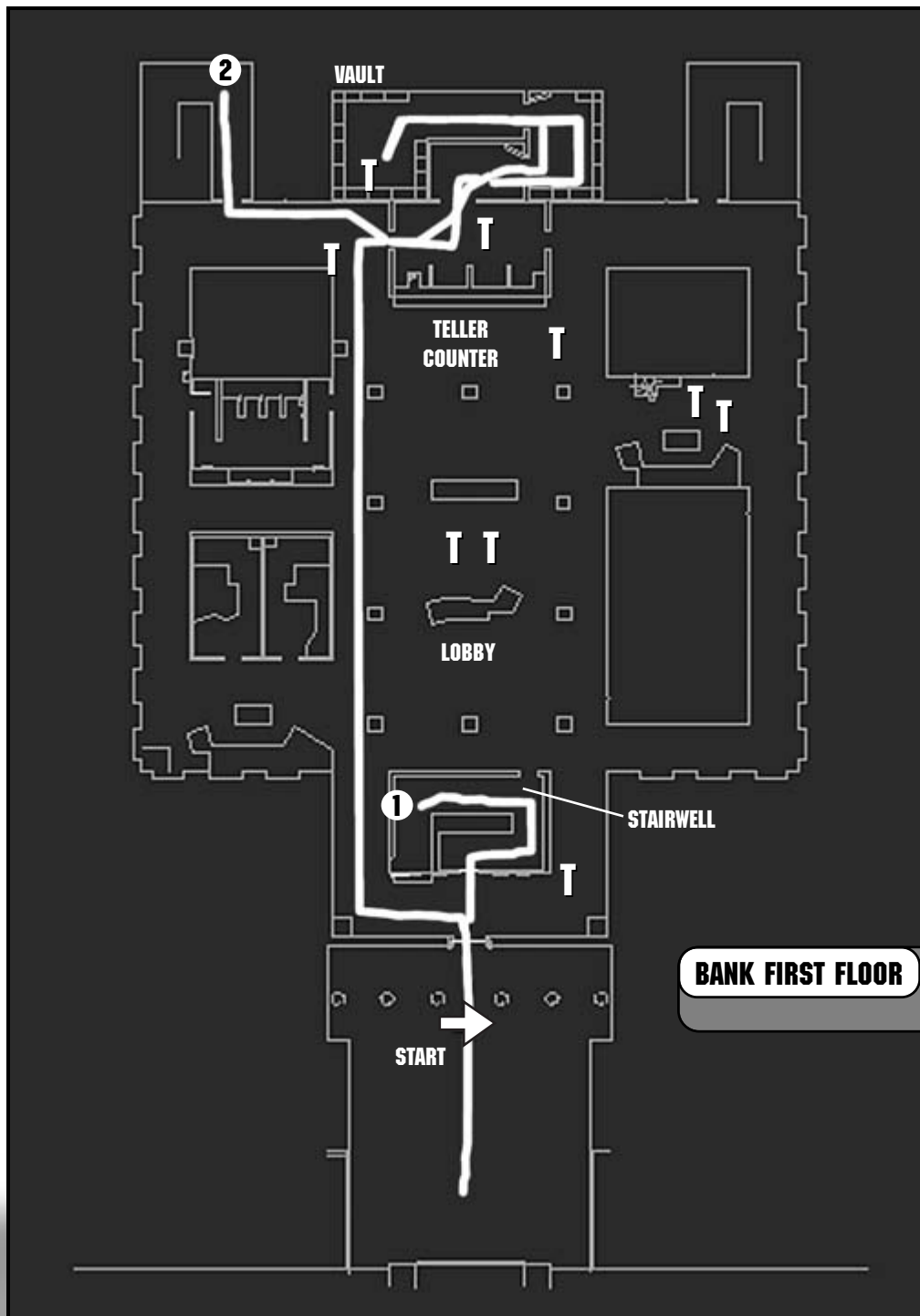

BANK FIRST FLOOR T = Tango

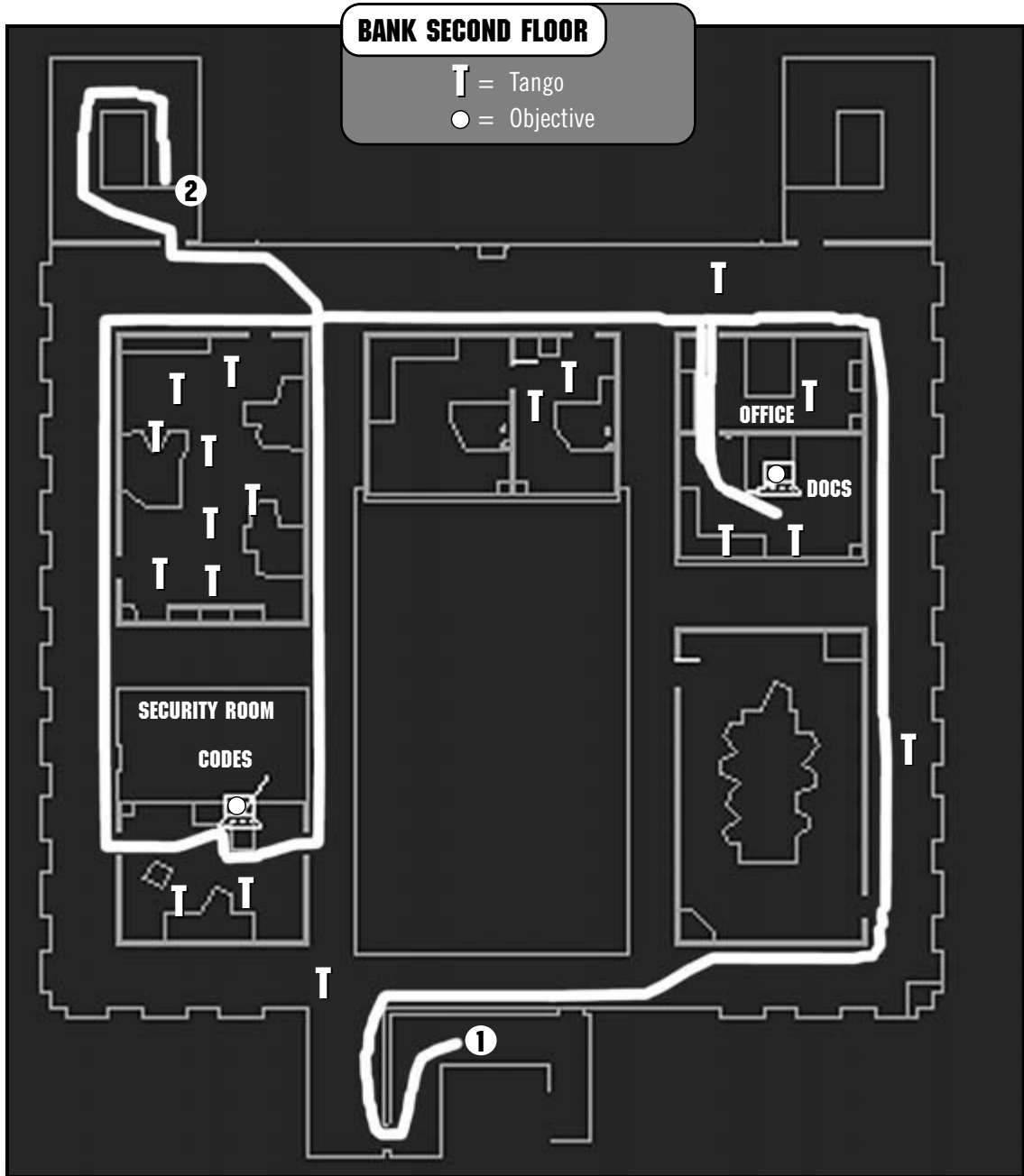



Head upstairs to the second level.



Neutralize this tango on patrol.



The heartbeat sensor helps you set up an ambush.



This tango walked right into your sights.

Your only concern is the tango who patrols the front door. Wait until he is near the doors, then open them and shoot. Silence him before he gets off a shot and no one else will know you're there.

Follow the HQ plan into the stairwell and ascend to the second floor. Crouch down and exit the stairwell, then take a right. Hold just outside of the door and pull out your heartbeat sensor. Use it to find the tango patrolling this area. Switch to your primary weapon and wait. As soon as the tango walks past the corner, silently kill him.

Stay low and follow the HQ plan down the hallway. Use the heartbeat sensor to locate the second patrolling tango. He usually is on the other side of the building, so move past the open area looking down on the lobby below, and hold at the corner before turning left. Again wait to ambush. After you neutralize him, the hallways are clear—for now.



Quietly take out this tango in the front office...

Move down the hallway, following the HQ plan to the office. Scan the rooms for tangos. One is in the front room and two in the back. Set up your shot, then open the door and fire on the first tango. Work quietly so you don't alert the others. Repeat this again at the next door: Line up your shots with the heartbeat sensor, then open the next door and wipe out the two tangos inside. With the room clear, enter and grab the documents to accomplish your first objective.



...and the tangos in the back office won't shoot when you open the door.



Grab the documents on the table to complete the first objective.

TIP

There are more tangos on the second floor—avoid them. Two are in one room while eight are in another. The eight respond to gunfire or an alarm if you are detected. Therefore, remain quiet while upstairs so you don't have to fight off a lot more tangos. You can't see these tangos during the mission since they only respond to the alarm. However, after you enter the vault, the alarm is automatically triggered and they will come after you.



The security tangos concentrate on the monitor screens. They won't ever know what hit them.

The HQ plan now leads to your next objective—the security room. Before leaving the office, scan for tangos in the hallway. When it's clear, head to the security room. Both tangos have their backs to the door, so stand slightly to the left of the door, facing right, to set up your shot. Open the door and mow them both down. Move to the computer and press the Use key (**Spacebar**) to obtain the security codes.



This computer holds the security codes.

Check the second floor with the heartbeat sensor before leaving the room. A tango from downstairs may come upstairs to patrol. Watch for him and eliminate the threat if he is present. Follow the HQ plan to a stairway in the rear of the bank. Descend to the ground floor and scan the area for nearby tangos. One or two are near the tellers' counter, two are out in the lobby, and one is in the vault. If you did not take out the tango who patrols both floors, he may be there too.



Stay low as you follow the HQ plan to the rear stairs.

DEVELOPER TIP

Firing single shots gives the best accuracy when using guns, but using burst or full auto provides more stopping power. You can set the option you prefer to have when starting a mission in the “Gameplay” tab of the Options menu.



Watch out for a tango who comes upstairs to patrol.

Exit the stairway and take out the tangos by the tellers' counter. Be stealthy—do not let them get off a shot. Cautiously advance toward the counter. The tangos in the lobby face away from you, so either shoot them with your SMG or throw a frag grenade between them.

Follow the HQ plan into the vault. Rather than rushing in to shoot the tango hiding there, throw in a frag grenade. Enter the vault to ransack it for the third objective. All that remains is to get your team safely out of the bank. However, when you entered the vault, it set off an alarm. Therefore, you can expect a lot of tangos to be coming after you. Since they are on the second floor, either wait for them and take them out as they enter the stairwell, or make a run for the entrance.

SPECIAL FORCES TIPS

The hardcore version of this mission is not much tougher than the medium. A few more tangos are on patrol and in the lobby. Use the same strategy and tactics as provided in this walkthrough and you'll have no trouble.



Clear out the tangos behind the counter.



Throw a frag grenade at the two tangos in the lobby.



Head into the vault.



Blow up this tango with a frag grenade or he guns you down.



Aftermath

A prestigious investment firm was the scene of an armed robbery this evening, as gunmen broke into the First People's Investment Firm of Vienna and emptied several dozen safe-deposit boxes. The losses have been estimated as being in excess of three million Euros, mostly in gems and jewelry. Several security guards were injured in the robbery, two of them seriously.

According to police reports, the gunmen entered the building after the close of business hours and proceeded to open fire without even issuing a warning. Bystanders said they heard sporadic gunfire from inside the building. The robbers fled, however, before police arrived.

"They were heavily armed," said one witness. "They had guns like they were going to war."

Mission 10: Broken Chain

Briefing

We've found the hornet's nest. Based on the information we have, we've been able to track down the man who ran the financing through the bank. He's a VIP at a local tech company, a firm that has some suspicious ties to a neo-fascist group that's been agitating for more autonomy in the region. Intel suggests that their plan was to start the war between Russia and the U.S. and then step into the resulting power vacuum. Whether or not it would have worked is debatable, but that doesn't change the fact that these people are the ones behind what happened at the Super Bowl. If we take this guy down, we'll be one step closer to the top.

Your target is Bernhard Wernecke. One of our agents in the field has set up a breakfast meeting with him, a meeting that he won't have to show up for, since you're going to take Wernecke down first. However, we want to track this guy back to whoever's pulling his strings, so before you hit him, you need to sneak into the building and plant a tracer on his laptop. Our analysts project a near certainty that the group behind this will try to recover the laptop after you take out its owner. If we bug it first, this will lead us to the man in charge.

You're sure to be detected if you walk in the front door, so your first objective is to disarm the security system in the basement. Once you've done that, plant the tracer, then take down Herr Wernecke over his coffee. We'll be waiting for you when you're done.

Intel

Bernhard Wernecke is the Chief Executive Officer for Steincgebirgscdynamik, or Stone Mountain Dynamics. It's a consulting firm based just outside of Vienna, and its entire board of directors consists of heavy investors in the First People's Investment Firm. Based on that alone, there's reason to suspect there's something fishy at the company.

Wernecke is the one who handles all of the tricky assignments. In essence, he's the controller for all of the dirty ops sponsored by the firm's backers, and that includes Baltimore. He's the one who makes the contacts, approves the wire transfers, and greenlights the operations once all the pieces are in place.

In this particular instance, he recruited Olson to handle the transfer of the bomb and brought the weapons smuggling ring on board. He's not the mastermind of the operation. Instead, he lets someone else make the plans, and then carries out their orders, flawlessly.

Objectives

1. **Cut Power to the Security Grid**To get into the offices without being detected, you're going to have to shut off the security system. Your best bet is to head to the basement and cut the power to the system. Make sure no one raises the alarm or the plan will fail.
2. **Plant Bug in CEO's Laptop:** We don't want Wernecke; we want the people behind him. The phony breakfast meeting we've set up should get him out of his office and up to the rooftop garden. Get to his office and plant a tracer in his laptop. His backers will come to pick it up soon enough if something happens to Wernecke. Make sure no one spots you on the way to his office. If there's even a hint of what we're really up to, it could blow the whole thing.
3. **Neutralize the CEO:** This guy is no saint. He's up to his neck in the bomb plot, and it's time for him to pay for what he's done. When he goes down, the people pulling his strings will come and collect his computer, and we can track them down once and for all.
4. **Go to Extraction Zone:** Once you've taken down Wernecke, get out. There's nothing more for you to do here.



The CEO is your main target for this mission.



Suggested Team Kit

Covert Assault

Support

One support team

Notes

While this mission doesn't appear difficult, it requires finesse. The key is to use stealth to infiltrate the building and to complete your objectives without alerting the enemy. You must complete the objectives in their assigned order. If an alarm is raised before you turn off the security grid, or if your team is detected before you bug the CEO's laptop, the mission fails. After you complete the first two objectives, alarms send lots of tangos to protect the CEO, making him a difficult target.

Your one support team begins on a flight of stairs just below the second floor patio where the CEO begins the mission. As you approach, the operatives rush up the stairs and help you clear the patio.

Mission Strategy

The first part of this mission is the toughest and may take you a few tries. Your team begins on a ramp leading into the basement, which holds three tangos. You must neutralize them before they set off an alarm that causes the mission to fail.

Set the fire selection of your SMG to full automatic and run along the HQ plan. The first tango is near the point in the basement where your HQ plan makes a 90-degree right turn. Take him out before he gets off a shot. After turning the corner, slow down and wait for the second patrolling tango to come into view. Drop him.



Quickly take out the first tango in the basement.



Wait for the second tango to come around the corner.

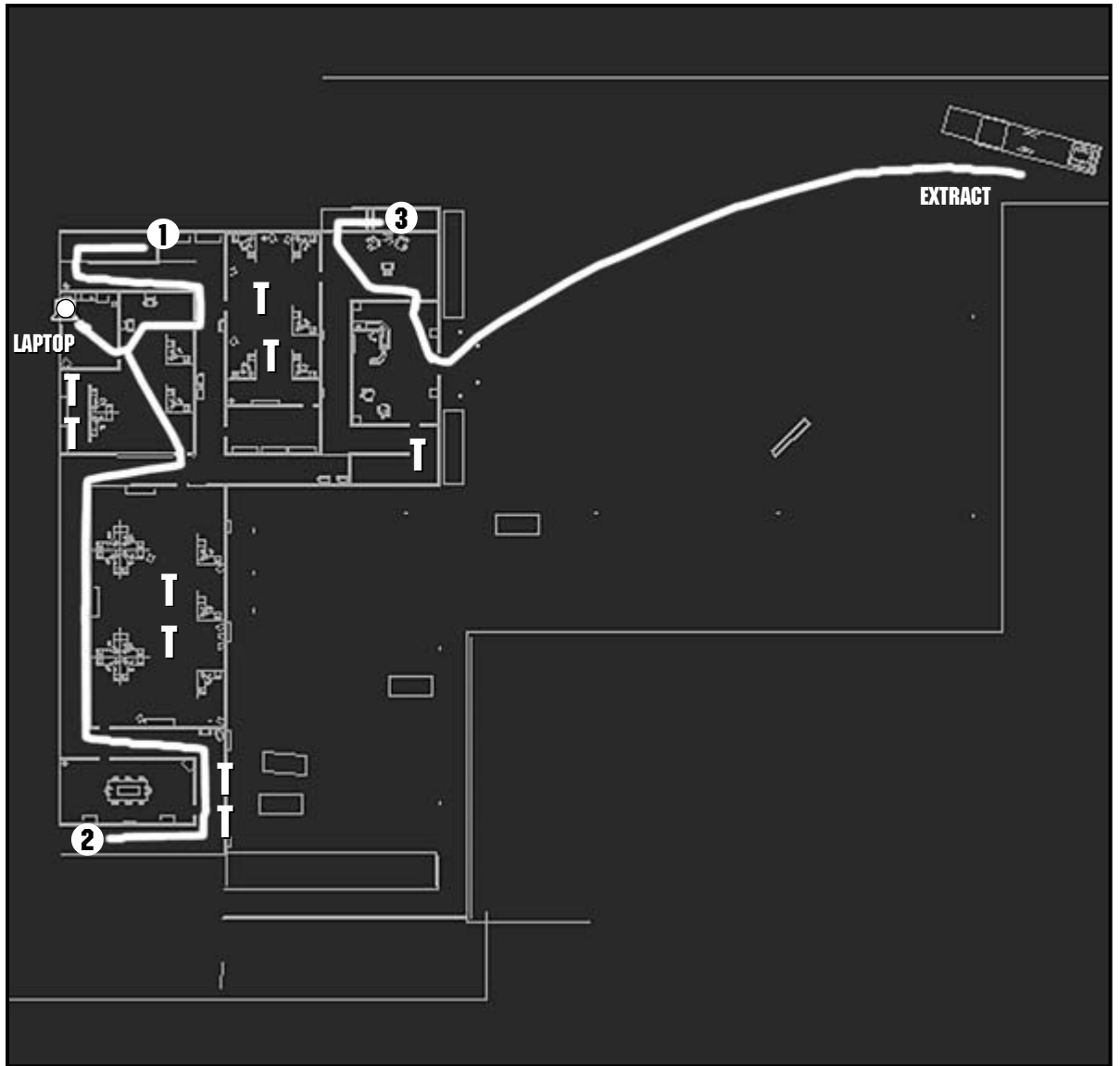

STONE MOUNTAIN DYNAMICS FIRST FLOOR

- T = Tango
- = Objective

STONE MOUNTAIN DYNAMICS SECOND FLOOR

T = Tango

● = Objective

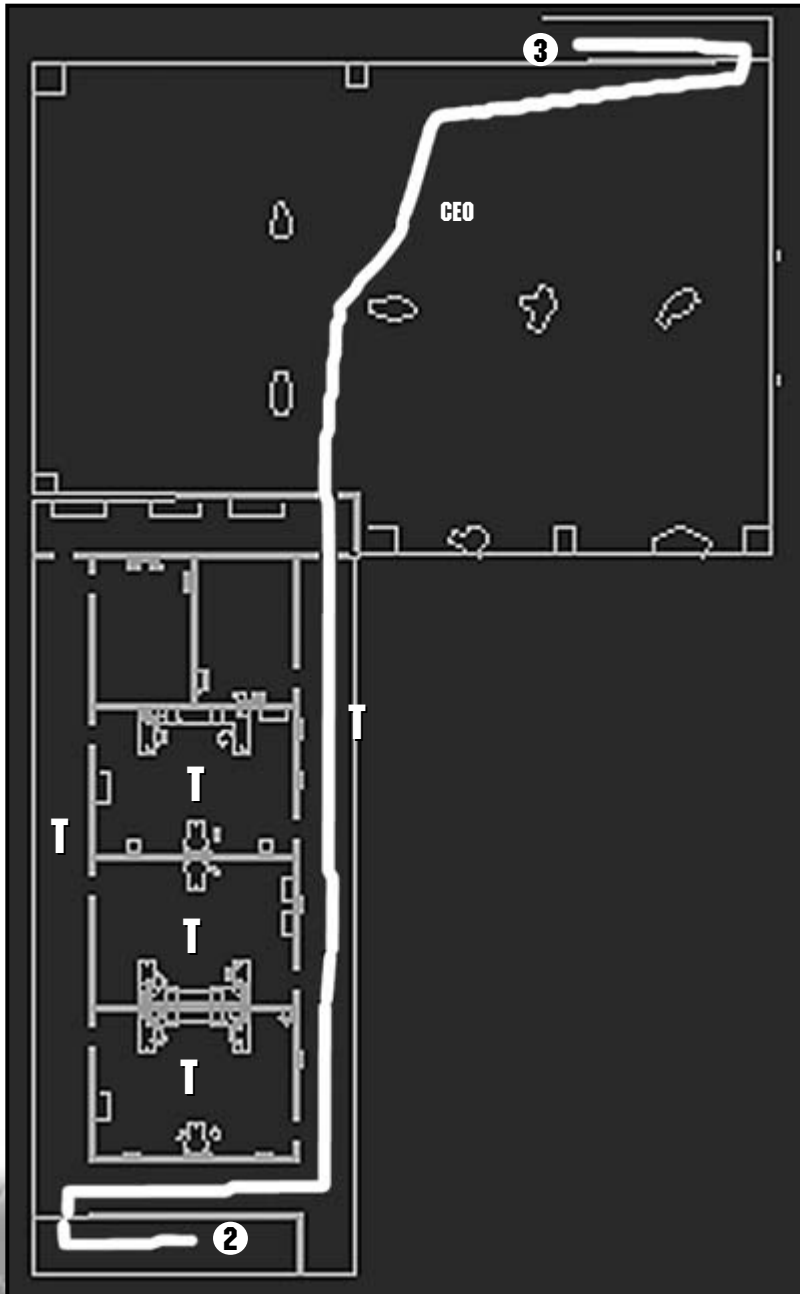



The tango in the power room may come out to investigate.



Flip the switch to turn off the security power grid.

Move to the room containing the security grid power control. If the tango inside does not come out on his own, open the door and quickly neutralize him. With all three tangos down, the basement is secure. Walk over to the power switch and deactivate the power grid. Your first objective is complete, and you no longer need to worry about the alarm.



Head up the stairs to the first floor.

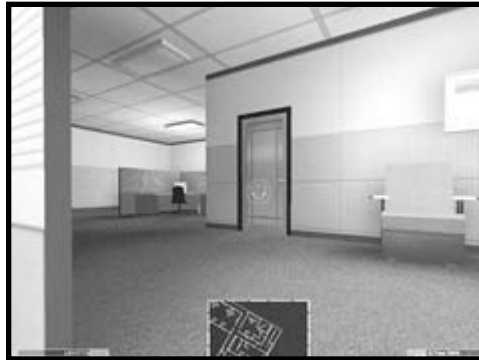

Shuffle through the hallways to maintain stealth.

Follow the new HQ plan out of the power room and upstairs to the first level. Be very quiet on this level; when you advance, shuffle. This is the stealthiest way to move. To do this, hold down **[Alt]** while moving forward. Don't run or the tangos hear you and alert the CEO.



This is the CEO's office.



Plant the bug on the CEO's laptop computer.

Follow the HQ plan to the first room on your right. Order your team to hold position in the hall while you go into the room by yourself. Keep shuffling because two tangos are behind a partition. Enter the office and move to the laptop. Press the Use key to plant the bug and complete the second objective. Shuffle out the door to join your team.

TIP: If you stay very quiet, the support team may eliminate the CEO for you. If that happens, make your way to the exit and on to the extraction zone.

Shuffle down the hallway; it's slow, but it makes your mission easier. Pull out your heartbeat sensor and monitor the actions of the tangos as you advance. If they don't move around, you remain undetected. If they head for the doors, however, get ready because someone heard you. At the end of a long hallway, and around the corner to the left, wait a couple of tangos. If you've remained stealthy, they have their backs to you. Drop



These two tangos don't know you're in the building. Take them out quickly and quietly.



Climb the stairs to the second floor.

a flight of stairs to the second level.





This tango patrols one of the hallways on the second floor.



You may see the CEO out on the patio if the doors are open.

As you approach the top of the stairs, turn to the right, crouch down, and left-strafe up the rest of the steps. A tango patrols the hallway in front of you. Drop him silently, then continue to the top. Follow the HQ plan to the next hall, where a second tango patrols. Observe his movements with the heartbeat sensor. Wait until he walks away, then strafe out past the corner and take him down.

TIP: If the alert is raised, several tangos rush to the patio to protect the CEO. Shoot down the hallway that leads to the patio to pick them off as they come into your sights. Advance down the hallway, and when you are close enough, throw frag grenades to clear the patio. The CEO may escape. If you sweep the patio and do not complete the third objective, you must search the building for the CEO to complete your assignment.



These stairs take you to the first floor.

You now have a clear route to the CEO. Walk down the hallway to the patio. Scan to locate the CEO, then open the door and eliminate him. With your third objective complete, get your team to the extraction zone. Follow your new HQ plan down the stairs by the patio to the first floor. As you open the door, watch out for

a patrolling tango or an open door on the right side of the hallway. Take out the tango on patrol. If the door to the room on the right is open, you must also clear out the tangos inside.

Return to the main entrance of the building. Open the doors and exit. Lead your team toward the truck near the extraction zone. When your entire team is there, you complete the fourth objective and successfully accomplish the mission.



A tango patrols the hallway; be ready to deal with him.



Exit the building through the front doors.



Get your team to the extraction zone to complete the mission.

SPECIAL FORCES TIPS

The hardcore version of this mission is very tough, especially the first part where you must clear the basement without setting off the alarm. As an alternate strategy, take the Field Sniper kit. Use the silenced sniper rifle to take out the tangos near the shelves by shooting through the gaps in the boxes. You can only see their waists, but two or three rounds in each tango take them down. The first floor has a few more tangos, but if you remain quiet, you have no trouble getting past them. The third floor is the same.

After planting the bug, because you do not have a support team, head up the exterior stairs to the patio, rather than using the interior stairs. This puts you near the CEO and allows you to make a quick getaway to complete the mission.

Aftermath

At least one man is dead and others wounded as a result of a shooting spree at an Austrian office park. At approximately 8 AM local time, the gunman, whose name has not yet been released, arrived at the suburban Vienna offices of Steincgebirgscdynamik, a well-respected consulting firm, and opened fire. Police believe the shooter was a disgruntled former employee, though the exact reasons behind the rampage are not known.

The one confirmed victim of the shooting has been identified as Bernhard Wernecke, CEO and co-founder of the firm. His body was found, riddled with bullets, in the building's rooftop garden.

"This is a terrible tragedy," said firm president Hans Rödl in a prepared statement. "Bernhard was a hard and talented worker, and his loss will affect the firm tremendously."

Mission 11: Razor Scythe

Briefing

This is it. Just as we thought, one of our fascist friends picked up the laptop yesterday afternoon and took it to the mansion of one Richard Dressler. Our researchers say this man is up to his neck in the neo-fascist movement and has been financing their work for a long time. The conglomerate that worked through that bank you hit? His. The seed money for the South African mercenaries? His. And now, all signs point to him as the man responsible for organizing the whole plot.

Dressler keeps an impressive mansion here in Vienna. We've caught a break, though, in that it's currently undergoing renovation. That means there are repairmen and equipment everywhere, which gives us a cover we can use to get on the grounds. Once you get there, we've got a little surprise we want you to attach to Dressler's car. Don't worry about finding him and taking him out yourself. No matter what, he's not getting far.

However, a number of his elite bodyguards are likely to be on the premises. Deal with them, permanently. We don't want this hydra growing any more heads after we're done with it. Finally, collect any records of Dressler's you can find. If he's been working with anyone else, we want to know about it.

That's all. You've done a lot of good work to get this far. Now I know you can finish it, and when you do, a lot of good people are going to be able to sleep easier at night.

Intel

Richard Dressler is the man behind the bombing of Baltimore. A self-made billionaire, he was born in the Danube city of Linz in 1930. His family benefited tremendously from Anschluss, and they emerged from World War II with their fortunes unscathed. In 1957, he took over the family investment business and, with steady infusions of capital from various backers—many of whom were later discovered to have connections to escaped war criminals from the Second World War—amassed a fortune.



Dressler's mansion is filled with tangos.

Beginning in the late 1970s, Dressler began to spend some of his hard-earned wealth through dummy corporations, trusts and anonymous donations to charities and academic institutions that supported his political views. Much of the money from these donations went to supporting neo-fascist militias across the globe, bankrolling one side or another in various small wars and establishing funding for groups fond of firebombing immigrant neighborhoods.

In the wake of the cold war, Dressler turned his attentions to re-igniting tensions between the United States and the former Soviet Union. Believing that a war between the two old rivals would enable a united Europe—under his guidance, of course—to emerge as the dominant world power. The opportunity to purchase the nuclear device and detonate it on American soil was a dream come true for him, his best chance to kick-start a full-scale exchange between the United States and Russia.



Objectives

1. **Plant Car Bomb:** We want to make sure Dressler doesn't get away. Rig a bomb in his car before you move into the mansion. That way, if he runs, we'll be waiting.
2. **Neutralize Elite Guards:** Dressler's bodyguards are scattered throughout the mansion. They're vicious, professional, and deadly. Take them down.
3. **Recover Dressler's Records:** Grab Dressler's records while you're in the mansion so we can track down anyone else he's been working with and put a stop to any other plans he's cooked up.
4. **Go to Extraction Zone:** Once you've taken care of business, get back to the van, and we'll all go home.

Suggested Team Kit

Covert Assault

Support

None

Notes

The Dressler estate is large. Without your HQ plan, it's easy to get lost. Dressler's car is on the ground level, which swarms with tangos. The elite guards can be found on both levels. Because the second level is divided into two wings that do not connect, the HQ plan takes you upstairs, down, and then back up again rather than have you clear out an entire level at a time.

Because you don't need long-range or heavy firepower for this mission, the Covert Assault kit is best. Stealth allows you to sneak up on tangos and take them out—often while they have their backs to you. Remember, these bad guys nuked Baltimore. They have no honor and don't deserve a fair fight. Frequently check your heartbeat sensor to locate patrolling tangos and to set up shots prior to opening doors. Move cautiously and keep quiet to complete this mission without the tangos ever getting off a shot.

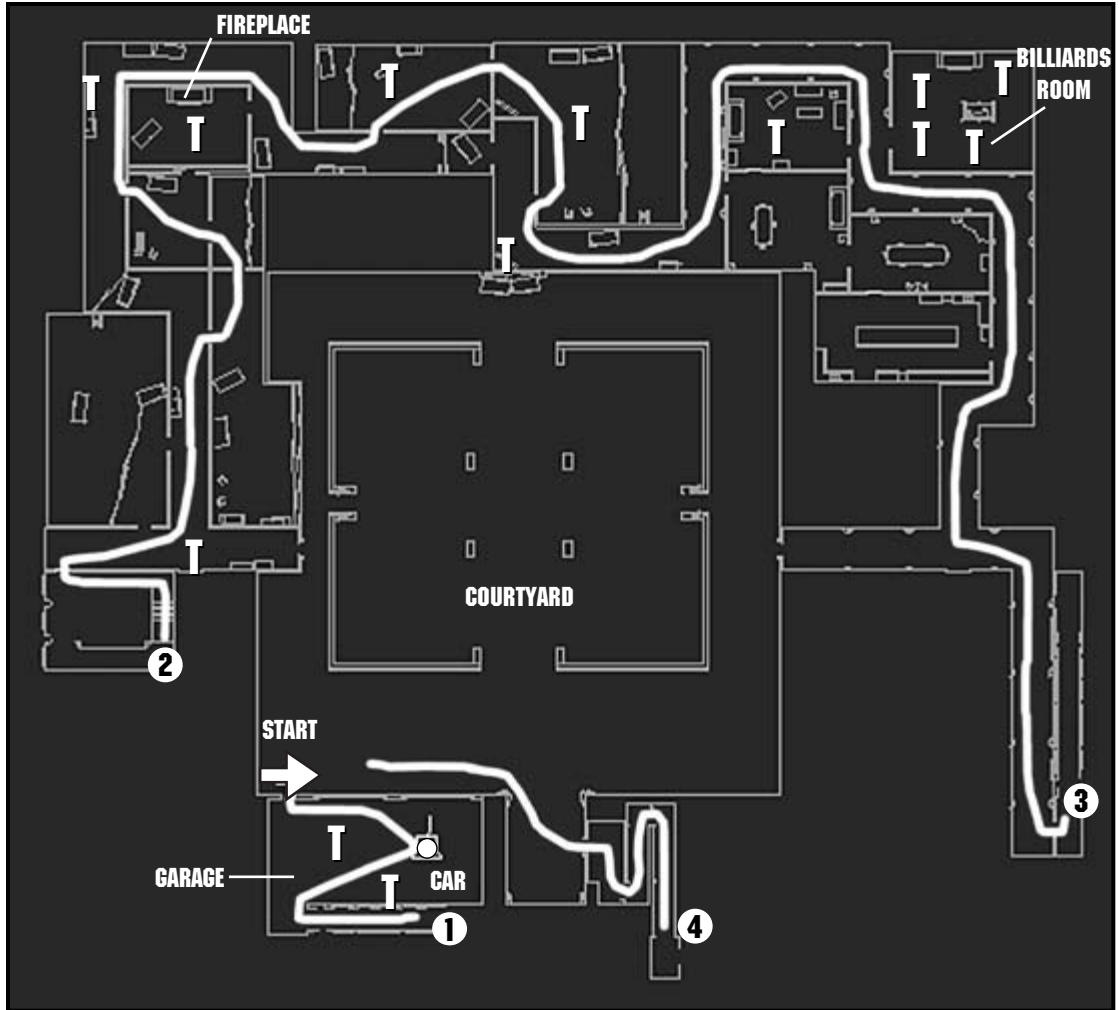

DRESSLER ESTATE FIRST FLOOR

- T = Tango
- = Objective



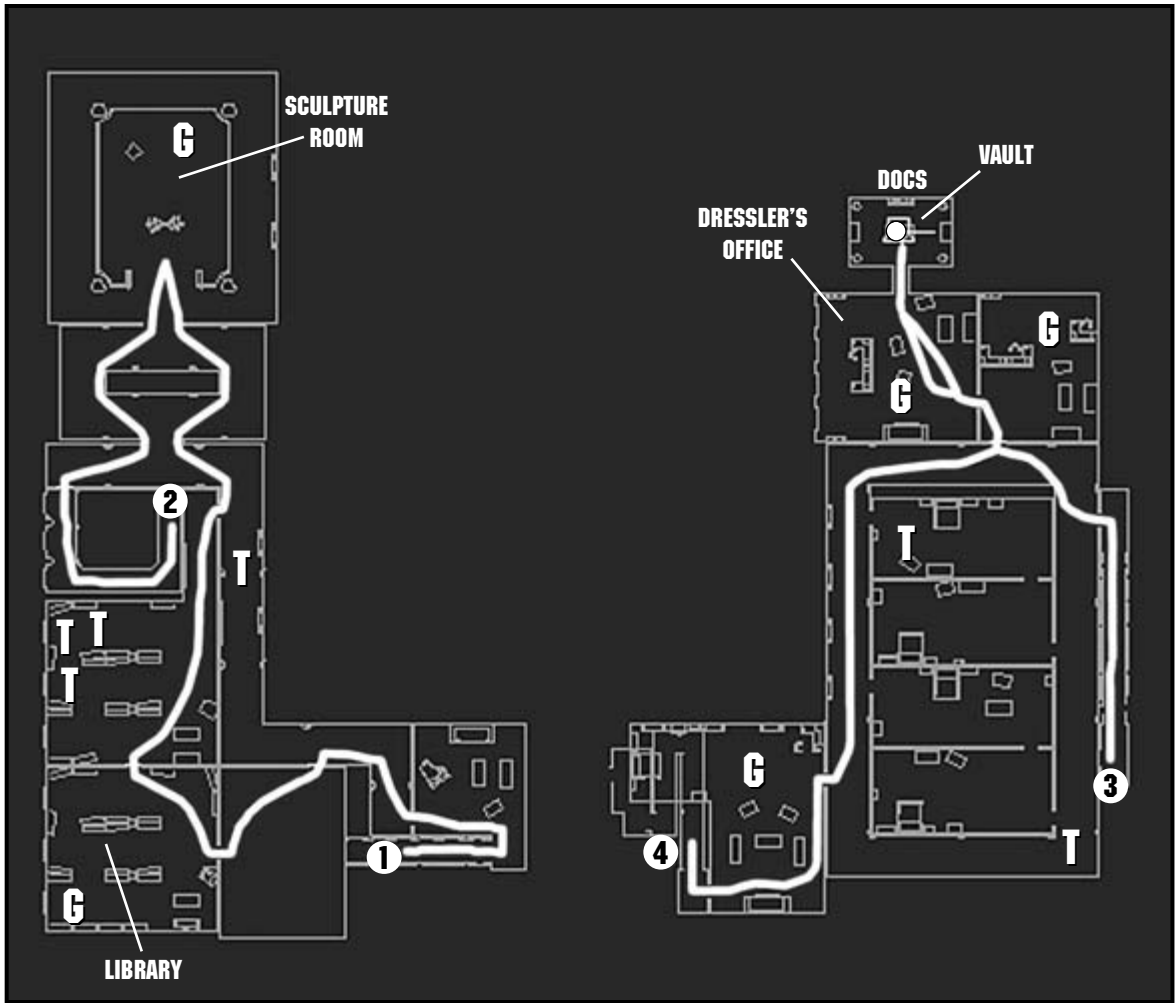

DRESSLER ESTATE SECOND FLOOR

- T = Tango
- = Objective
- G = Elite Guard

Mission Strategy

Your team begins outside in the estate courtyard. The HQ plan immediately leads you to Dressler's garage. Walk to the door and perform a heartbeat scan. Two tangos protect Dressler's car. Line up your shot using the sensor, switch to your SMG, open the door, and take out both tangos. They are busy admiring the car, and won't even see you.

With the garage clear, enter and move to the car. Press the Use key (**Spacebar**) to plant a car bomb. This completes your first objective and ensures Dressler's



Two tangos guard the car.



Plant the car bomb to complete the first objective.

imminent demise. Follow your new HQ plan around a corner and up a long flight of stairs to the second level.

The room you enter is clear. Approach the door and scan the level for heartbeats. A tango patrols the hallway, but he is at the other end and won't bother you. Open the door and follow the HQ plan through the hall and into another room. This too is empty, as is the next room, a library.



Climb these stairs to the second level of the mansion.



The first library is empty.



Follow your HQ plan to another library room. Three tangos wait in a corner. Neutralize them and move to a door. Scan the hallway to locate the patrolling tango. It's his turn. Wait until he moves away from the door, then exit and take him out.



It's time to deal with this patrolling tango.



The second elite guard admires the sculpture.

One person remains in this wing of the upper level—a second elite guard. Follow the HQ plan to the sculpture room. Before rounding the corner, use the heartbeat sensor to locate the tango and set up your shot. Strafe out around the corner and put him down... three more to go. Return to the ground level. The HQ plan leads to a large secure stairway; don't worry about an ambush at the bottom.



Descend this large staircase to the ground level.

DEVELOPER TIP

You can toggle on and off individual portions of the user interface in missions by using the **[F6]**, **[F7]**, and **[F8]** keys. **[F9]** toggles the entire interface on and off, except for the targeting reticule.



Eliminate this tango in the hallway.



Shoot through the plastic.



Shoot another tango through the plastic.



Set up your shot, then execute.

At the bottom of the stairs, pull out the heartbeat sensor, check for tangos, then follow the HQ plan. You must remove a tango in the hallway. This area is under renovation. Plastic covers some doorways, but you can see and shoot through it. When you come to a doorway framing a fireplace, wait for the tango within to walk by. Neutralize him and continue.

Run another sensor scan to pinpoint a tango patrolling the northwest hallway, another in the northeast hallway, and two in separate rooms in the north center. There is also an elite guard in the northwest. Follow the HQ plan and first pick off the tango patrolling in the northwest, followed by the elite guard. Keep going, but hold before you enter the first room with a tango. See through the plastic ahead, into the next hallway.

Wait here until the patrolling tango walking comes into view. Eliminate him. Check the heartbeat sensor to locate the tango in the first room and set up a shot. Open the door and take him out, repeating this procedure in the next room.





Take out another elite guard.



This elite guard likes to hide.



Aim your throw so the frag grenade bounces off the wall and flies over to the billiards table.



Strafe around the corner to finish off any surviving tangos.

There are two tangos, each in separate rooms in the northeast. The one in the southern room is an elite guard. Watch out as he often crouches behind the table if he has heard you coming. There is only one more occupied room on the ground level—the billiards room in the northeast. However, your plan will allow you to bypass it. To neutralize all enemies, pull out a frag grenade and throw it so it bounces off the wall of the room and lands by the group of tangos. Watch the messages in the upper left corner of the screen to confirm how many the grenade took out. If you killed at least two, strafe out into the doorway and finish off the rest. Otherwise, throw another grenade using a different bounce angle.

TIP

While your HQ plan lets you avoid the billiards room, you can clear out the tangos inside if you want.



Head up these stairs.



This room contains another elite guard.

After taking out all of the elite guards, go down the hallway to the stairway and ascend to the eastern wing of the second level. Follow the HQ plan to a room. Before opening the door, locate the elite guard inside with the heartbeat sensor. Set up your shot before you open the door, or use a frag grenade. Either way, be quick, because this tango is fast and will gun you down if you aren't careful.



This is Dressler's office.



Grab the records in the vault.

After the elite guard is dead, move into Dressler's office. Go through a closet door, which leads to a security door. Open this, then step into the vault. The records are on a table in the middle. Pick them up to complete your second objective.



All that remains is to eliminate the last elite guard. Follow the HQ plan down the hallway to the room he occupies. Scan the room to set up your shot, open the door, and fire to complete your third objective. If you've eliminated the tangos on both levels, the mission ends. Otherwise, you must get your team to the extraction zone in the courtyard where you began the mission. Once there, the mission is complete and a cutscene concludes not only your mission, but the campaign, as well. Good job, operative.



Take out the fifth and final elite guard.

SPECIAL FORCES TIPS

The hardcore setting of this mission is not much tougher than the Medium version. Three tangos guard the car and five are in the billiards room. An extra tango is also in one of the rooms on the ground level. Follow the same strategy and tactics for a successful mission.

DEVELOPER TIP

You can customize the keyboard layout by going to the "Input" section of the Options menu. You can even save multiple configurations if different people are playing on the same machine.



5

Quick Missions

In addition to the campaign, *The Sum of All Fears* offers quick missions played on the campaign maps and multiplayer maps. Lone wolf missions pit a map full of tangos against your single character. To win, get to the extraction zone safely or neutralize all the tangos. Firefight missions challenge your team of three operatives to clear the map of all tangos. You can also play each of the campaign missions as a quick mission.

Tactics for Quick Missions

Quick missions are different from campaign missions. The objectives are basic, and the tangos are randomly scattered about the map.

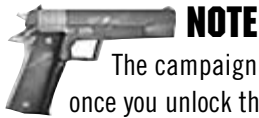

The campaign maps and team kits are available once you unlock them by advancing through the campaign.

Lone Wolf

In lone wolf missions, you have no teammates. Avoid attracting attention; the Covert Assault kit is a good choice. It allows you to neutralize tangos quietly as you encounter them, but also provides frag grenades for getting out of a bind or clearing out a group of enemies. A heartbeat sensor is a must since it allows you to locate tangos and plan your route to the extraction zone. In missions where you must move through wide-open areas, take a kit containing the Spec Ops M4, which provides good firepower at long range. Taking shotguns is suicidal.

The extraction zone appears on your mini-map as a yellow square, as long as you and the zone are on the same level. Use the maps in this chapter to plan a primary and alternate route to the extraction zone.

Firefight

In firefight missions, you want to seek out enemies rather than avoid them. Stealth is not important. Create noise so that the tangos come to you—especially if your team is positioned to ambush them.

In addition to a good primary weapon and frag grenades, choose a kit that includes a heartbeat sensor. Without one, you have to search every room and location on the map to find all the tangos. The only friendlies on the map are your team, so feel free to frag first and ask questions later.

TIP

As you advance through a lone wolf mission, look for dead-end hallways, rooms, and corners to use as safe locations to reload, scan the area with your heartbeat sensor, or set up an ambush. Once you are detected, use these spots to pause, locate your pursuers, and prepare to take them out.

The Maps

Now that you have a feel for how to get through the quick missions, let's take a look at the maps. We have included tips for both lone wolf and firefight missions to help you survive and complete your objectives.

M01: TV Station

Lone Wolf

The stealth capability of the Covert Assault kit allows you to move through the TV studio without attracting much attention. You begin on the third floor and must get down to the garage. Stay away from large concentrations of tangos as you move to the stairways and out of the building. In some of the hallways, tangos surround and come at you from two different directions.



TV STATION, FIRST FLOOR

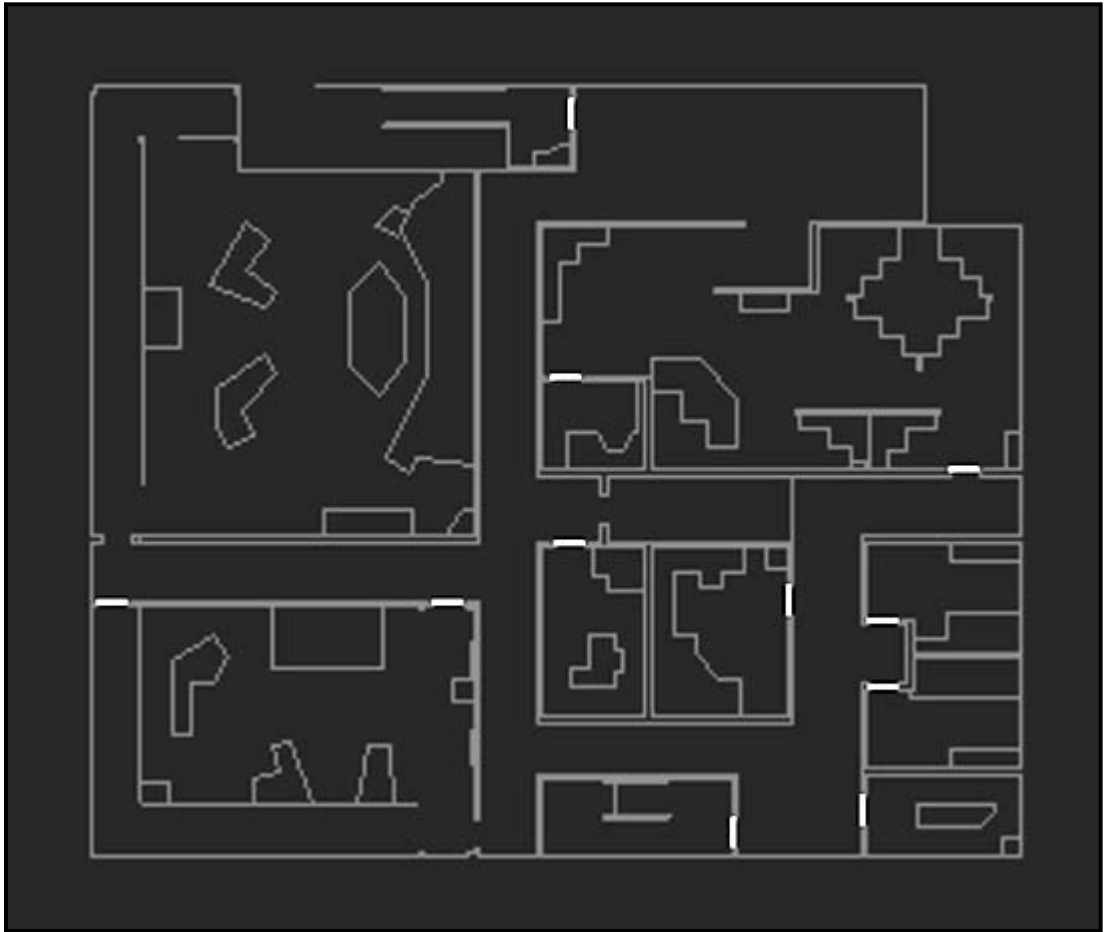

TV STATION, SECOND FLOOR

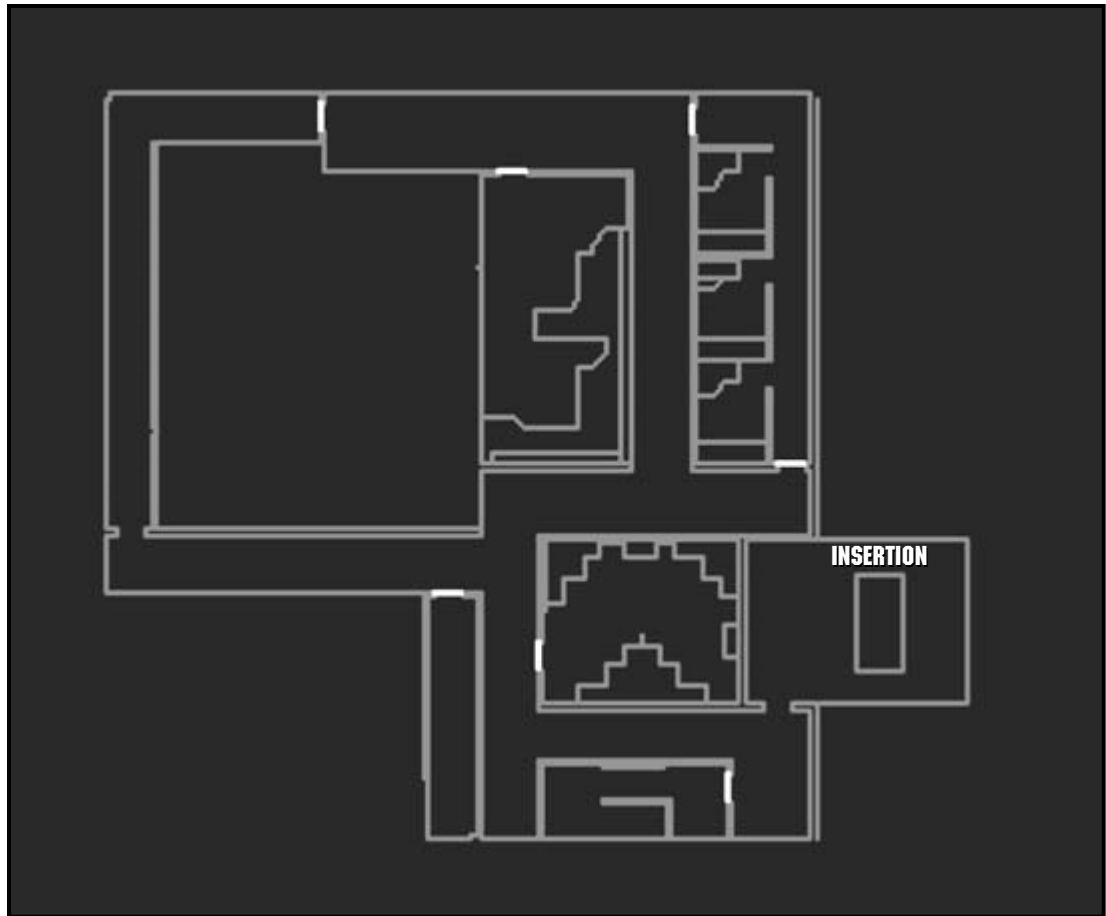

TV STATION, THIRD FLOOR

Firefight

You also begin on the third floor. Stealth is not as important, so take whichever kit you like. When clearing out the TV station, begin at the top and clear out each floor before descending the stairs to repeat the process. Keep your team in close and watch out for tangos.



M02: Militia Compound

Lone Wolf

You must travel through the tunnels to the cabin and make your way to the boat dock on the lake. The tunnels are filled with tangos, and other foes patrol the ground level outside of the structures. Once you get to the cabin, take some long-range shots to make sure you can get to the boat safely. Otherwise, go up to the trailer and barn to clear them out, and take care of any tangos patrolling around outside of them.

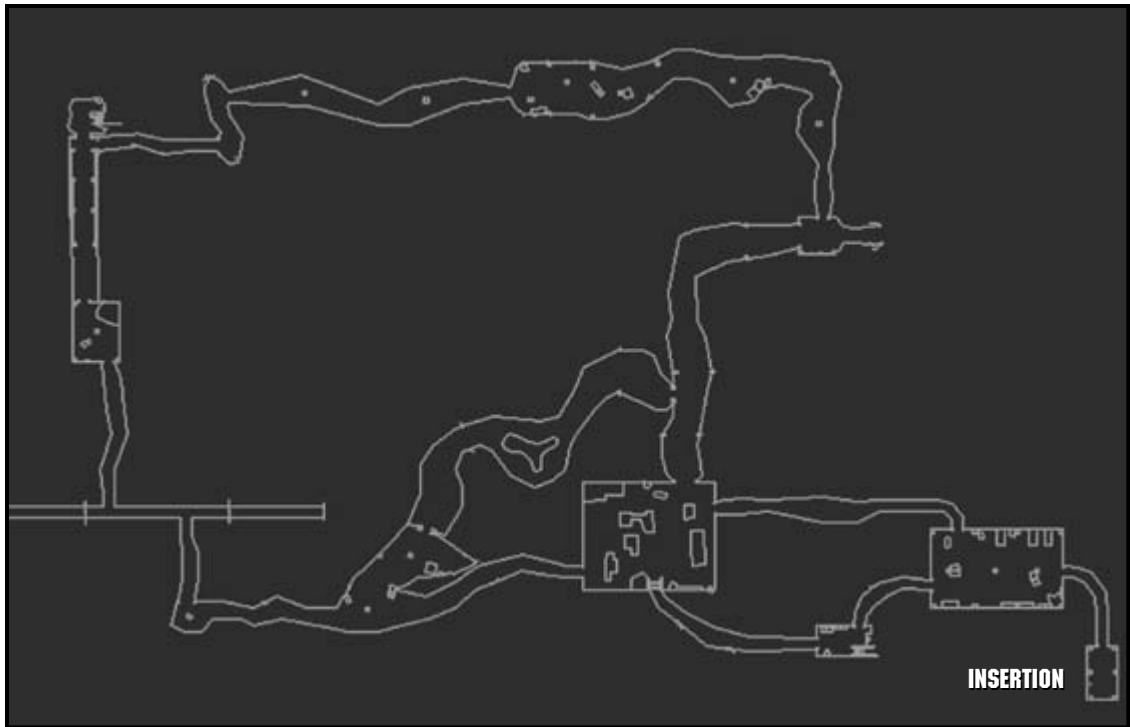

MILITIA COMPOUND, UNDERGROUND



MILITIA COMPOUND, ABOVE GROUND

Firefight

You must visit each of the structures and clear out all passages in the tunnels. Note that one passage that is closed during the campaign mission can now be entered and does contain tangos. Use the Open Assault kit—the M203 grenade launcher does a great job clearing out the tunnels.



MO3: Warehouse

Lone Wolf

This mission is almost entirely outdoors. You have to get from the dock to the opposite side of the warehouse complex. Stealth is key. Remain on the periphery, following the fence line to avoid the tangos patrolling near the middle of the map with the help of the spotlights on the central tower. You need your night-vision goggles. Move quickly and take out any tangos you come across before they can alert others.



DEVELOPER TIP

You can make a quick save by pressing the **(F11)** key during a mission. Pressing the **(F12)** key will load your last saved game for that mission.

DEVELOPER TIP

The server can save replays of multiplayer matches. These can be useful for sorting out bragging rights afterwards.

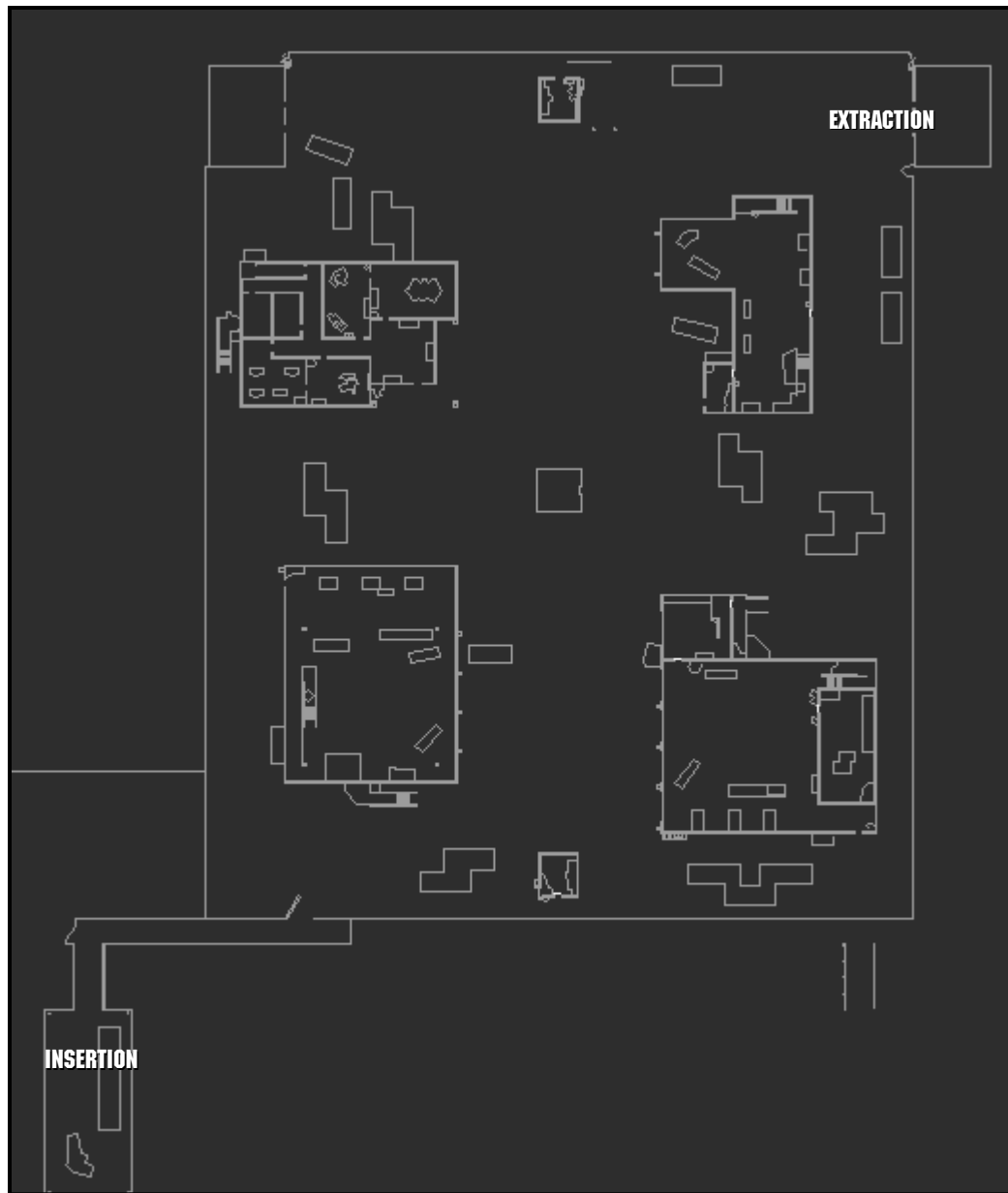

WAREHOUSE COMPLEX, FIRST FLOOR



Firefight

Clear out all of the tangos patrolling the warehouse grounds, then move into the buildings and sweep them out one at a time. In the warehouses, watch out for tangos on the catwalks. You cannot detect them with your heartbeat sensor while you are on the ground level, but they can snipe down at you as you enter the building. Take out the lights on the central tower at the beginning of the mission to give your team the advantage—the tangos don't carry night-vision goggles.

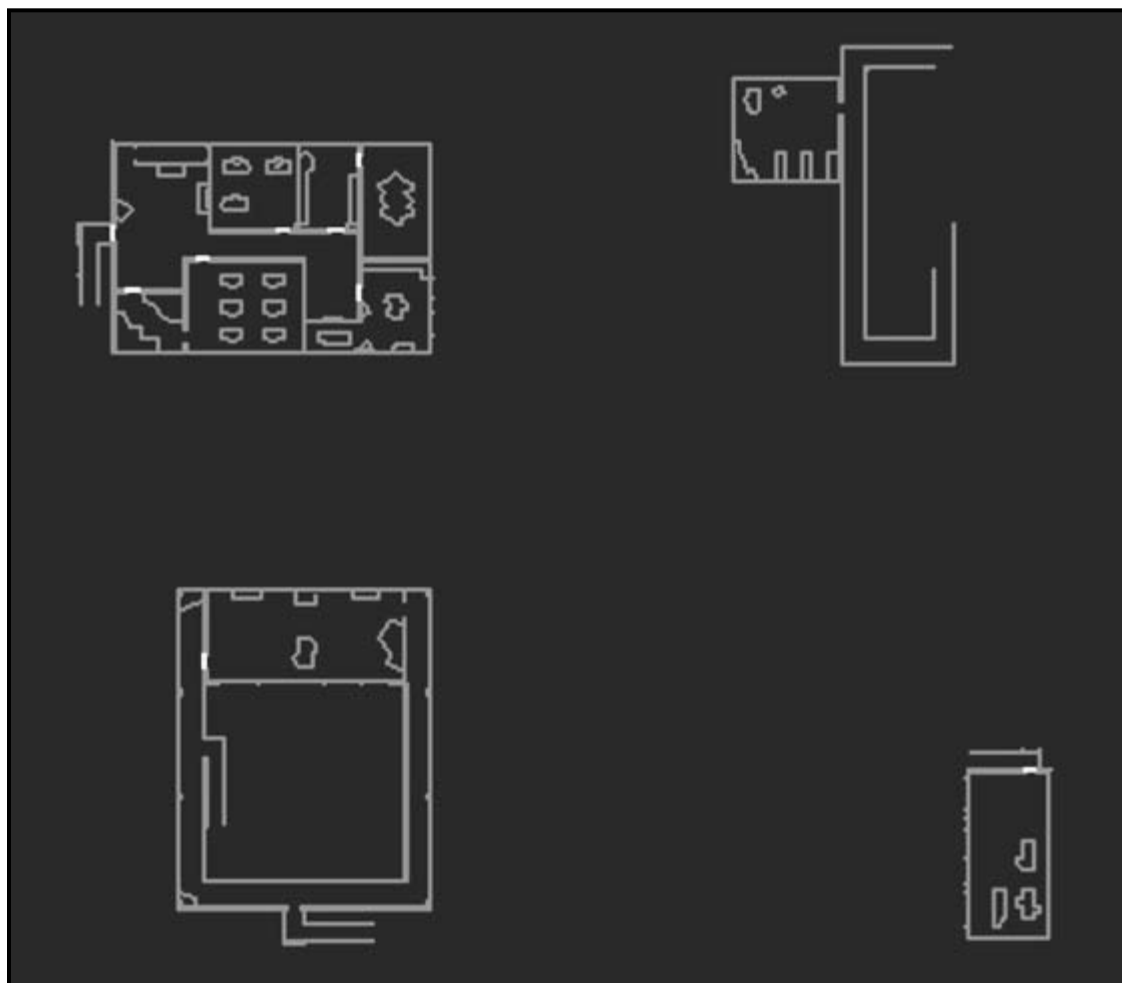

WAREHOUSE COMPLEX, SECOND FLOOR

M04: Weapons Facility

Lone Wolf

You begin deep inside the underground facility and must make your way to the outside and exit the compound to complete the mission. Use the Spec Ops Recon kit—the 9mm Pistol SD is best for clearing your way through the tunnels. Avoid the large central room. Once you get to the loading dock, switch to the Spec Ops M4 and clear your way to the gate and the extraction zone.



Firefight

You also begin in the underground facility. Work your way through the tunnels, clearing rooms as you go. Use caution when entering the large central room since tangos may fire down on you from the overhead catwalks. Only once the underground facility is clear should you exit and mop up any tangos around the bunkers and gatehouse.

WEAPONS FACILITY

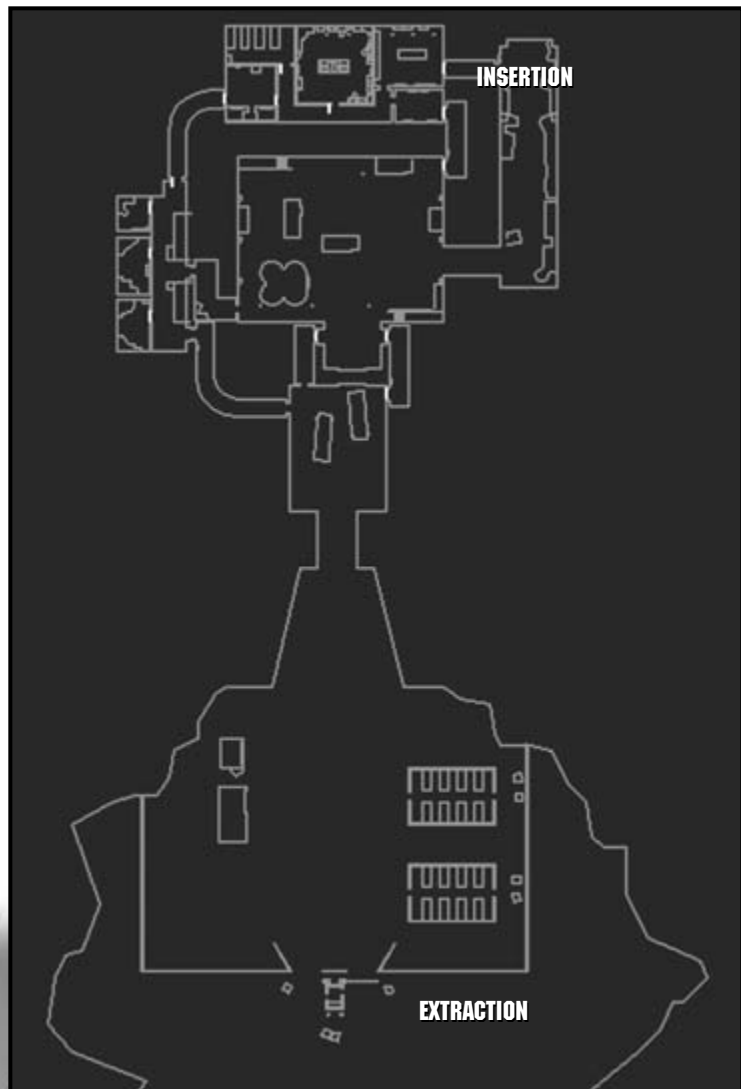

M05: Prison

Lone Wolf

The route to the extraction zone allows you to bypass several tangos. Head downstairs to the entrance area, then through the hallway leading to the first cellblock. Stay out of the cellblock and exit to the outside. Head over to the guard tower and take out any tangos along the way, at the top of the tower, and inside it. Rush to the tower roof where the extraction zone is located.



PRISON, FIRST FLOOR

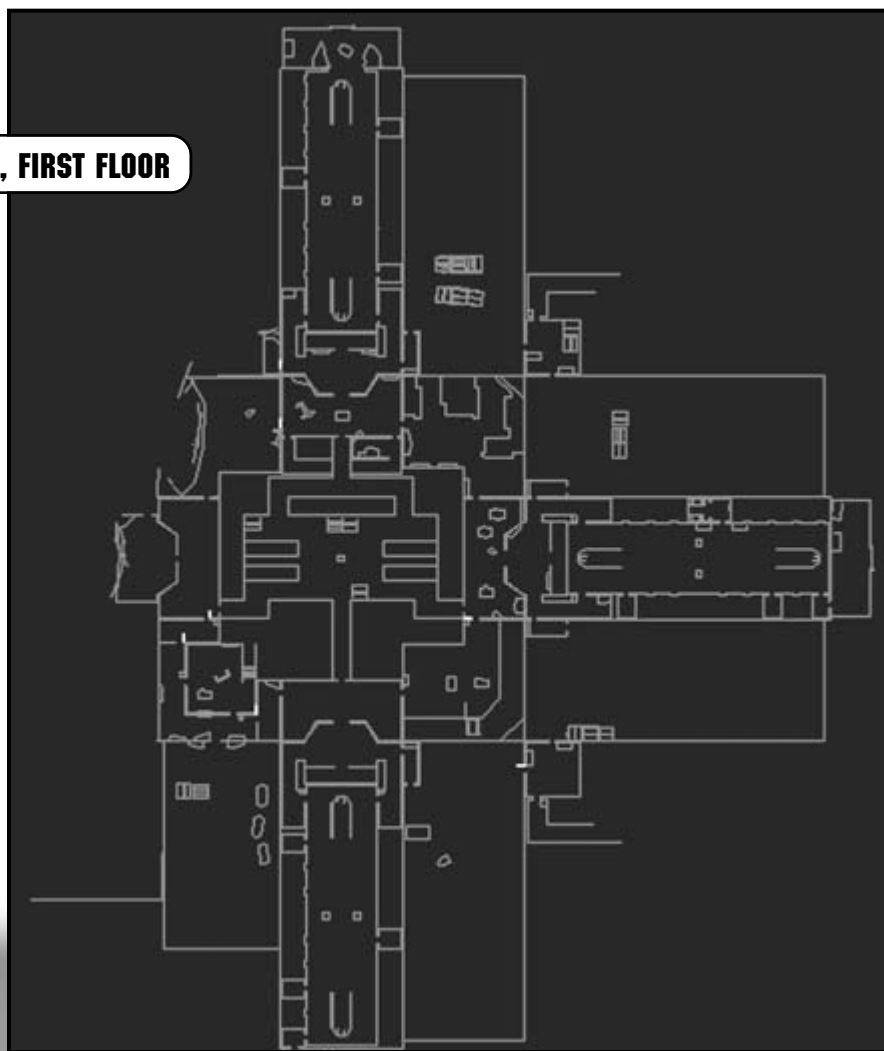

Firefight

Your team has a lot of territory to cover in this mission. Use the heartbeat sensor to locate hidden tangos. Be careful in the cellblocks where tangos can lurk on the level above, firing down on you. There are three cellblocks as well as the guard towers outside, all containing tangos. Scout them out from a distance before advancing; tangos like to snipe from these towers.

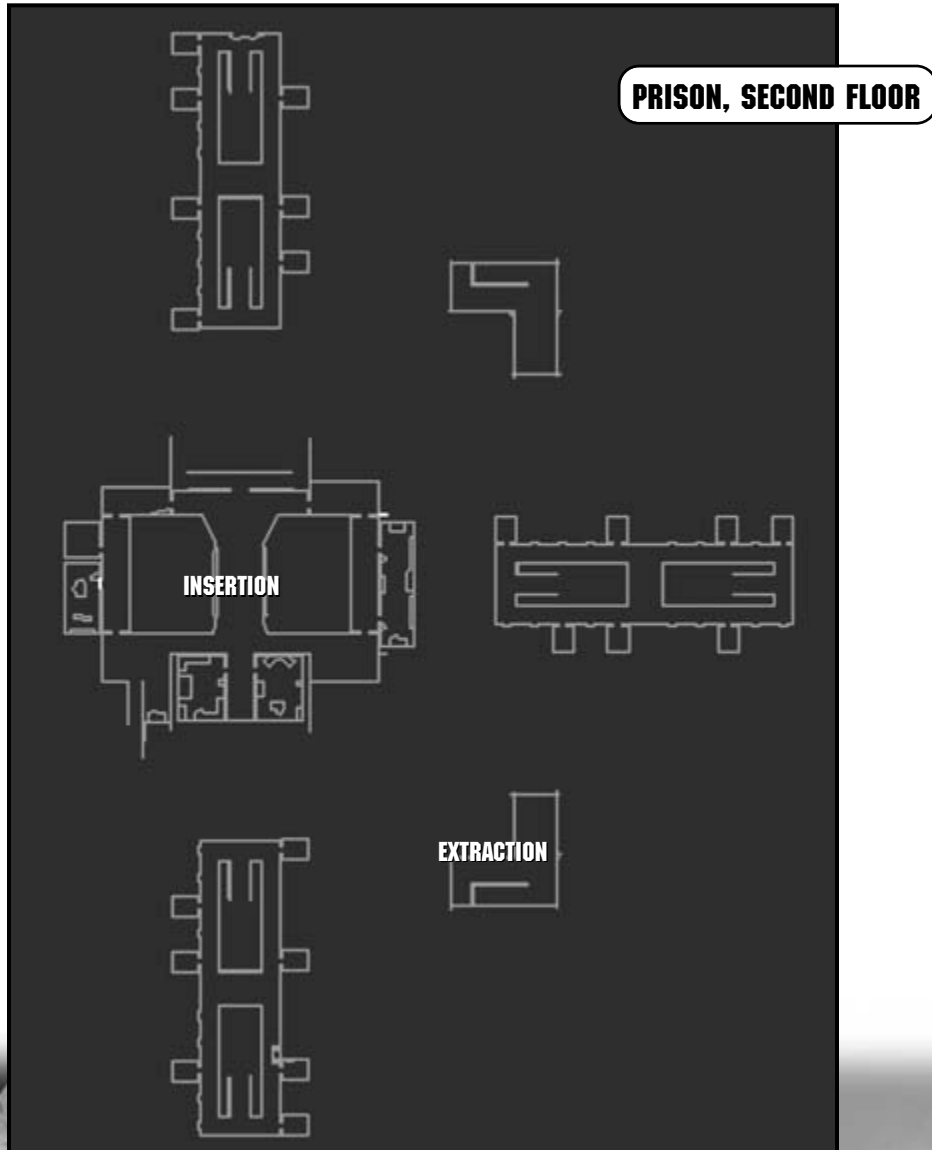

MO6: Mercenary Compound

Lone Wolf

This mission combines indoors CQB with outdoor medium- and long-range combat. You begin upstairs in the recreation building and must make your way to the northwest corner of the compound. Watch out for a tango either in the room where you begin or nearby. Descend the stairs. Avoid a firefight in the first building since the tangos inside will try to flank you. Once you exit, clear out the tangos patrolling the grounds as you make your way to the extraction zone. Use buildings and vehicles for cover. Use the Field Sniper kit for this mission—the 9mm Compact SMG allows you to clear the first building, while the Silenced Sniper Rifle lets you take out the tangos outside without alerting other tangos to your location.

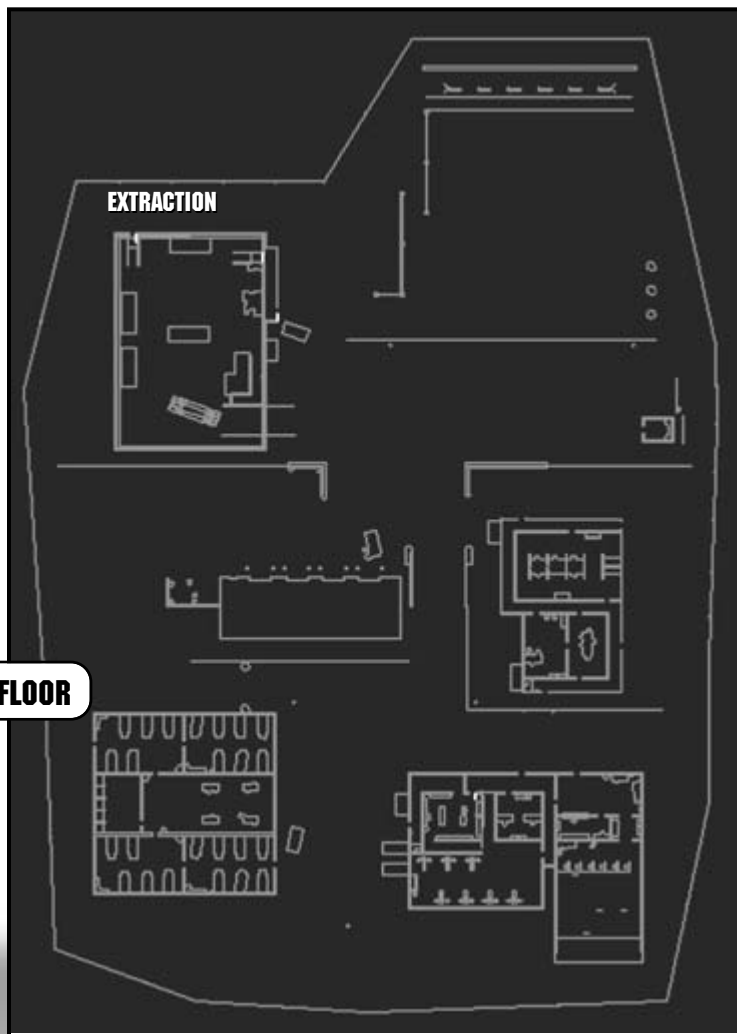

MERCENARY COMPOUND, FIRST FLOOR

Firefight

This mission requires you to clear four buildings as well as the tangos on patrol outside. Start with the recreation building where you begin. Once it's clear, take out all tangos outside. Empty the rest of the buildings one at a time until all tangos have been neutralized. Go for heavy firepower rather than stealth.

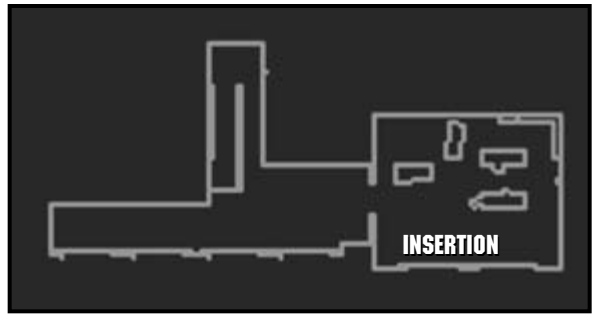

MERCENARY COMPOUND, SECOND FLOOR

M07: Diamond Mine

Lone Wolf

This mission combines indoor and outdoor combat. You begin inside the diamond vault. Exit the building as quietly as possible and make your way across the yard in the dark to the extraction zone on the opposite side of the facility. Crouch down and move cautiously, but be ready to take out any tangos near the extraction zone.



Firefight

Start by clearing out the building in which you begin the mission. Move outside and take out any tangos patrolling the grounds, then sweep the remaining buildings to make sure you get each and every tango.



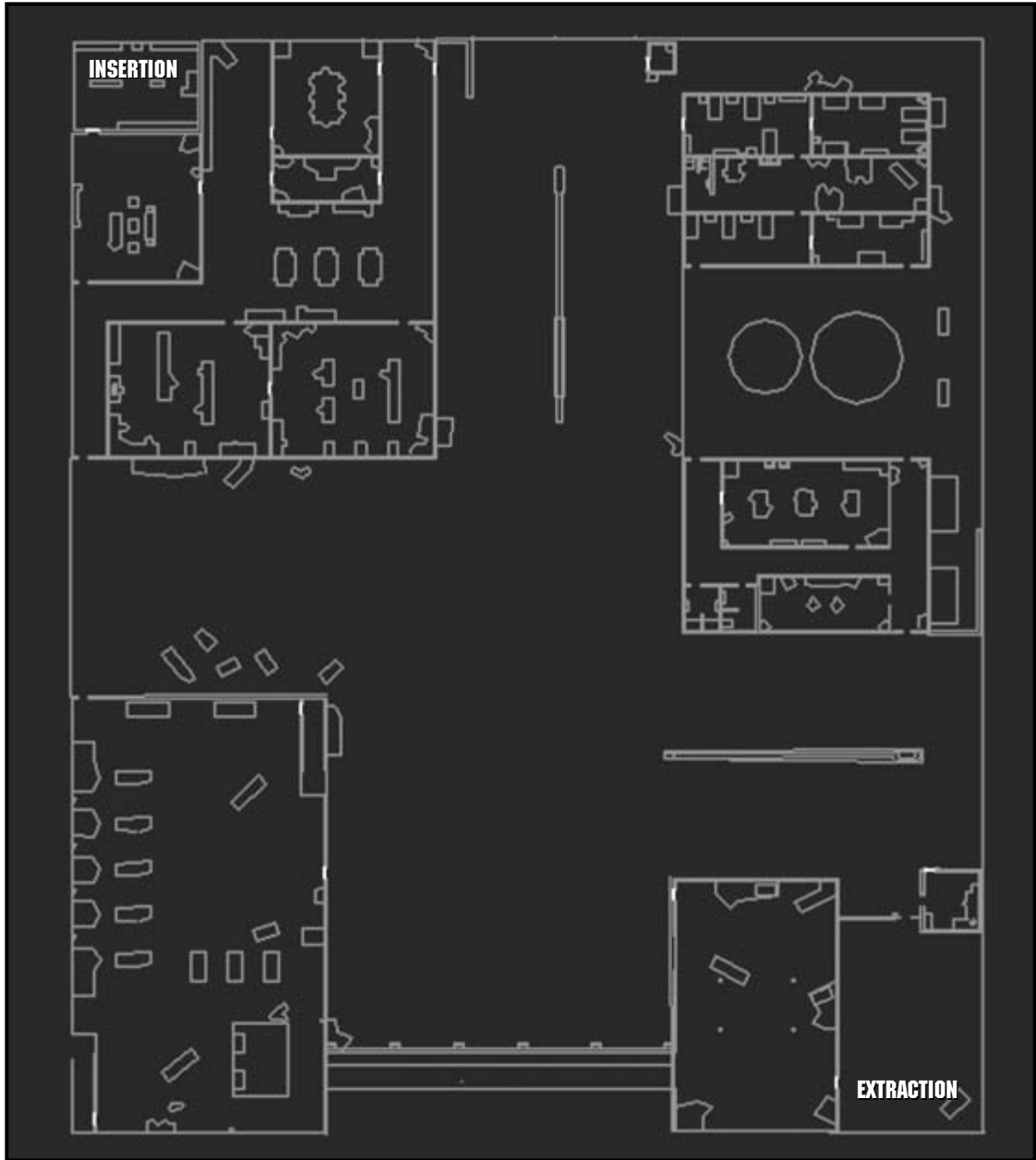

DIAMOND MINE

M08: Olson's Estate

Lone Wolf

This mission can be tough depending on where the tangos are located. You begin in the wine cellar. The best route is through the garage, then into the house. Head for the staircase by the main entrance and ascend to the second floor. It is a quick sprint through the bedroom to the balcony where the extraction zone is. Watch out for the tango in the living room below. You may need to take him out as you head for the bedroom.

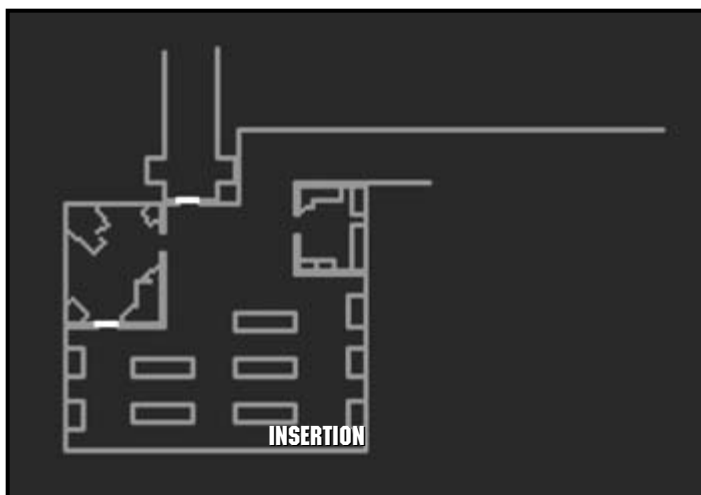

OLSON'S ESTATE, BASEMENT



Firefight

Your team begins in the wine cellar. Take out any tangos down there, then wait to see who comes to investigate. The cellar offers great ambush locations. Enter the house through the garage and clear out the first floor before continuing to the second floor. Avoid the living room since tangos upstairs can shoot down on your team. Climb the stairs in the master bedroom to the office, then clear out the second floor. Finally, mop up any remaining tangos in the back and front yards.

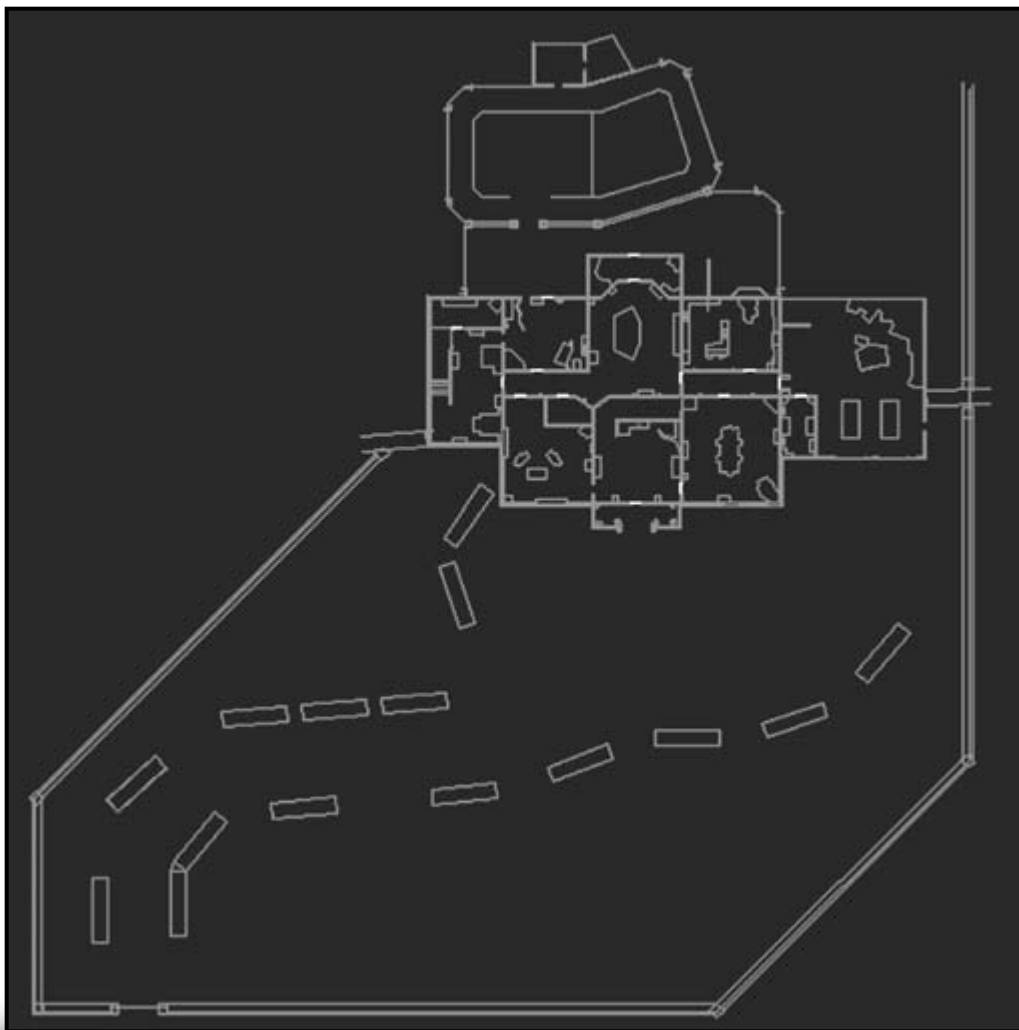

OLSON'S ESTATE, FIRST FLOOR



OLSON'S ESTATE, SECOND FLOOR

M09: Investment House

Lone Wolf

You begin in a room on the second floor of the building. There are two ways to complete this mission. Either head down the stairs nearest you to the ground floor, then make your way along the outer hallway to the front where you can exit, or advance along the second floor to the staircase near the front of the building and descend directly to the exit. The latter plan is safer, but it risks a fight on the upper level. Once you exit the bank, watch out for tangos patrolling the grounds as you make your way to the extraction zone.



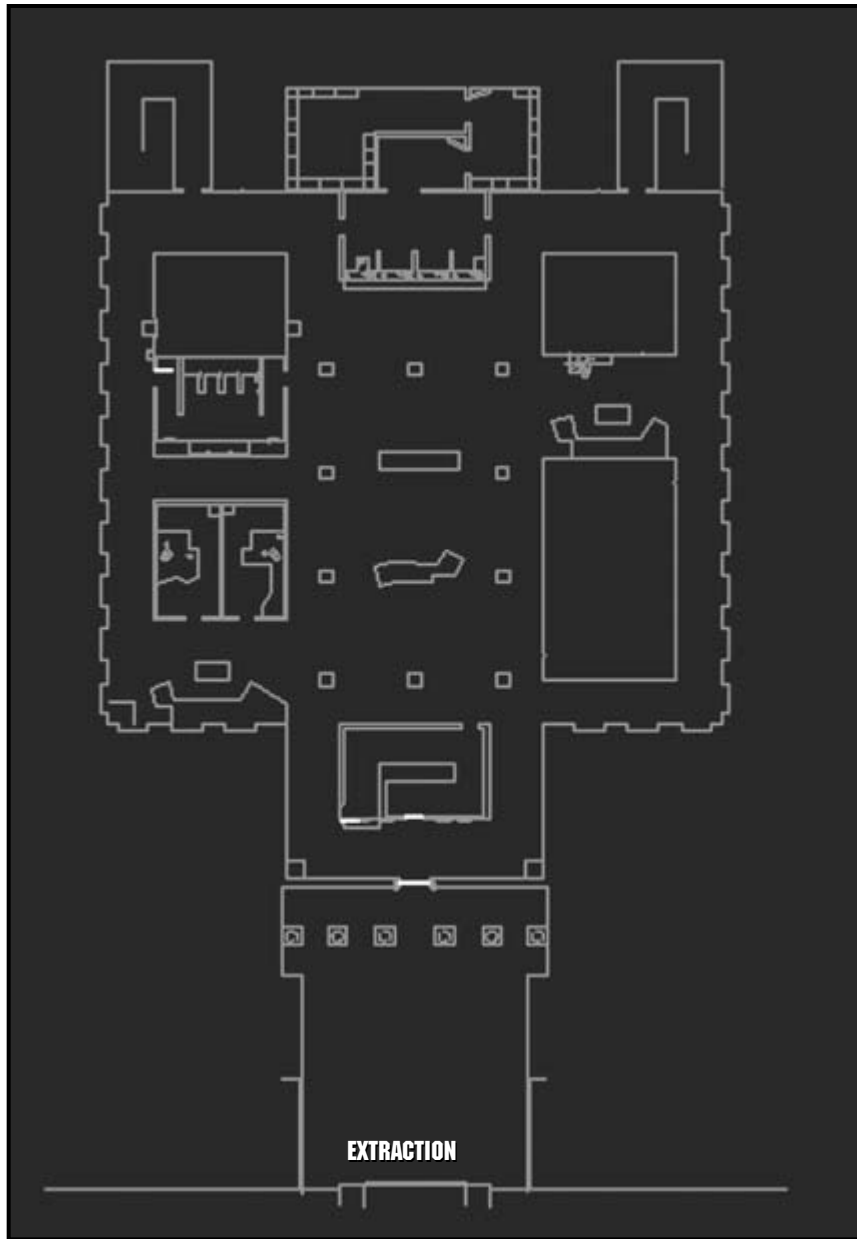

INVESTMENT HOUSE, FIRST FLOOR

Firefight

Clear out the second floor, then head downstairs to finish the job. Use the heartbeat sensors to locate tangos hiding in the numerous rooms throughout the investment house. After the building is clear, check outside for any remaining tangos.

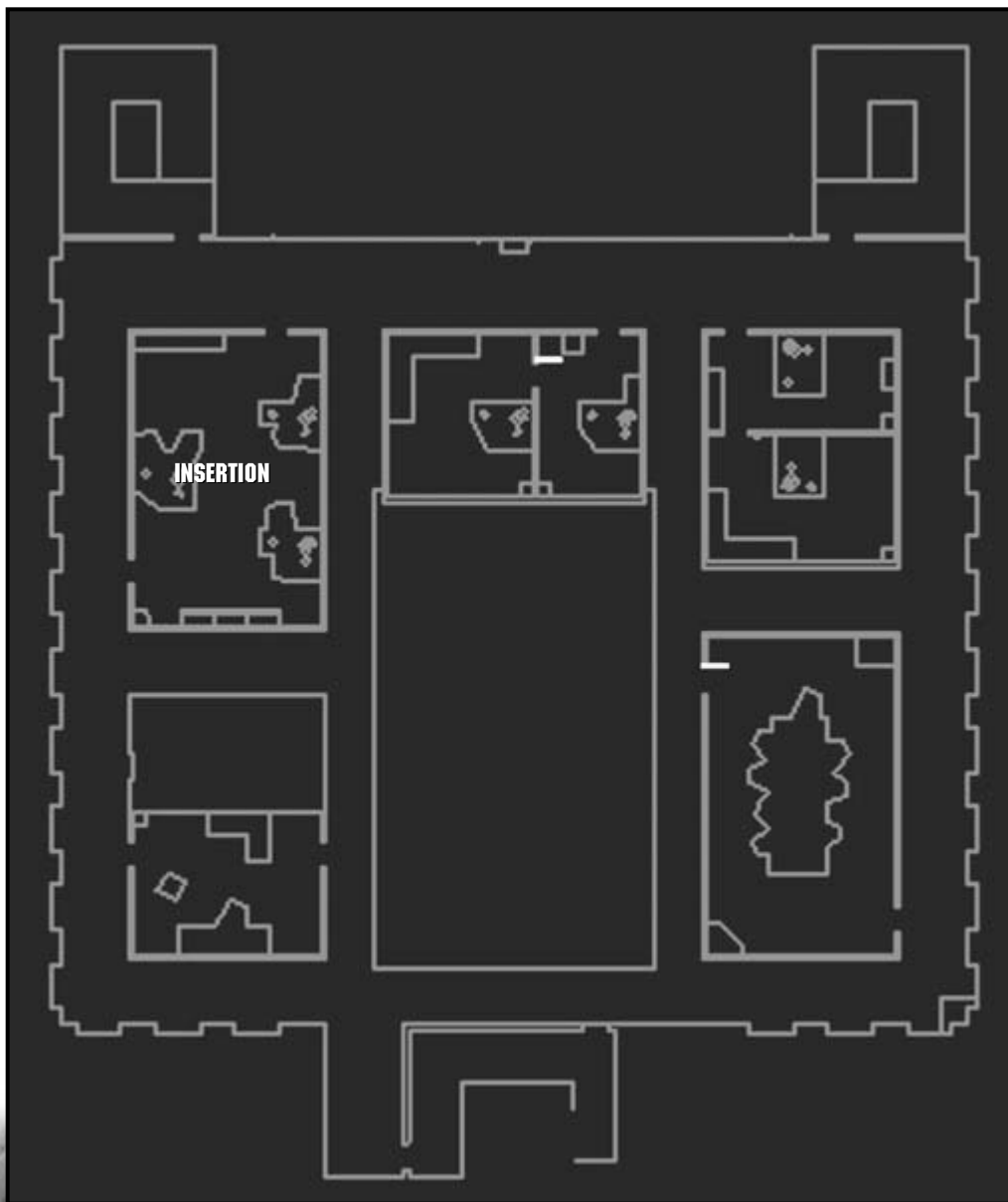

INVESTMENT HOUSE, SECOND FLOOR

M10: Corporate HQ

Lone Wolf

This mission isn't as tough as it seems. You begin on the patio area on the top floor. Instead of going directly into the building, head down the exterior stairs to the second level. Watch out for a tango that might be guarding these stairs. Enter the building and make your way to the main entrance just to the right. Be alert for tangos patrolling the hallways. Once you exit the building, turn right and rush through the parking lot and downstairs to the trucks near the extraction zone. Don't forget to scan the parking lot for hidden tangos before running across.



CORPORATE HQ, BASEMENT

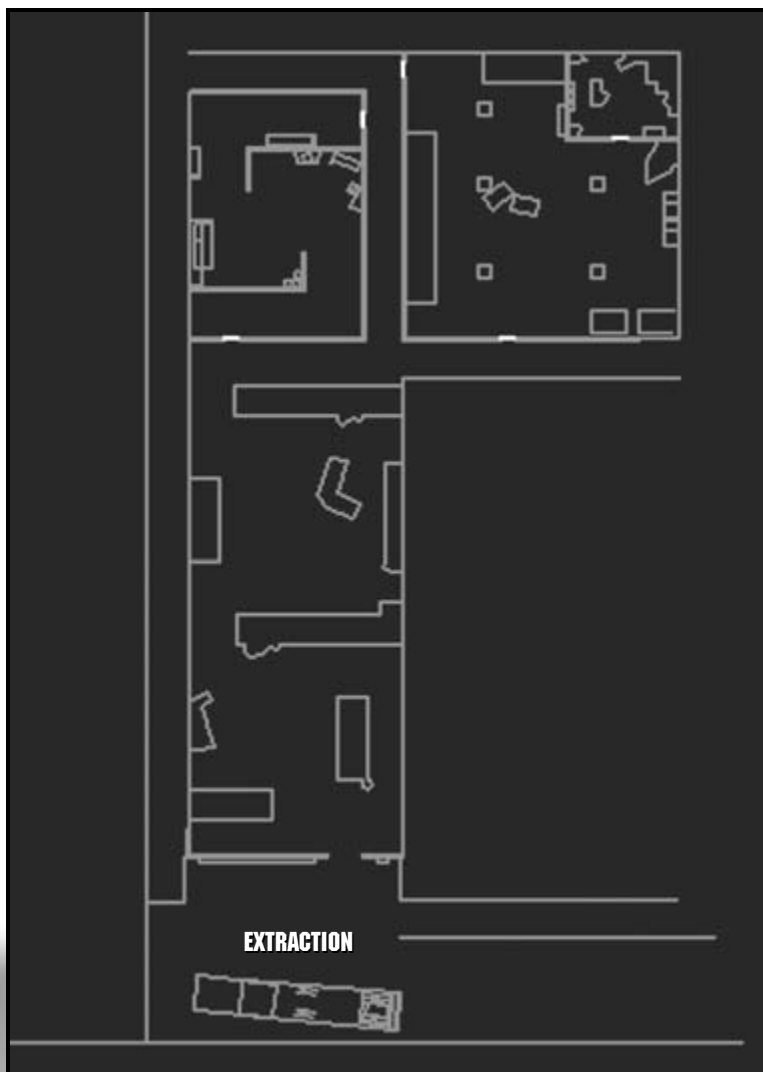

Firefight

Since you want a fight, start off by entering the building on the third floor after checking for a tango by the exterior stairs. Clear out the entire third level before descending to the second level. Repeat the process on the second and first levels. If the mission does not end, check outside for more tangos.



CORPORATE HQ, FIRST FLOOR



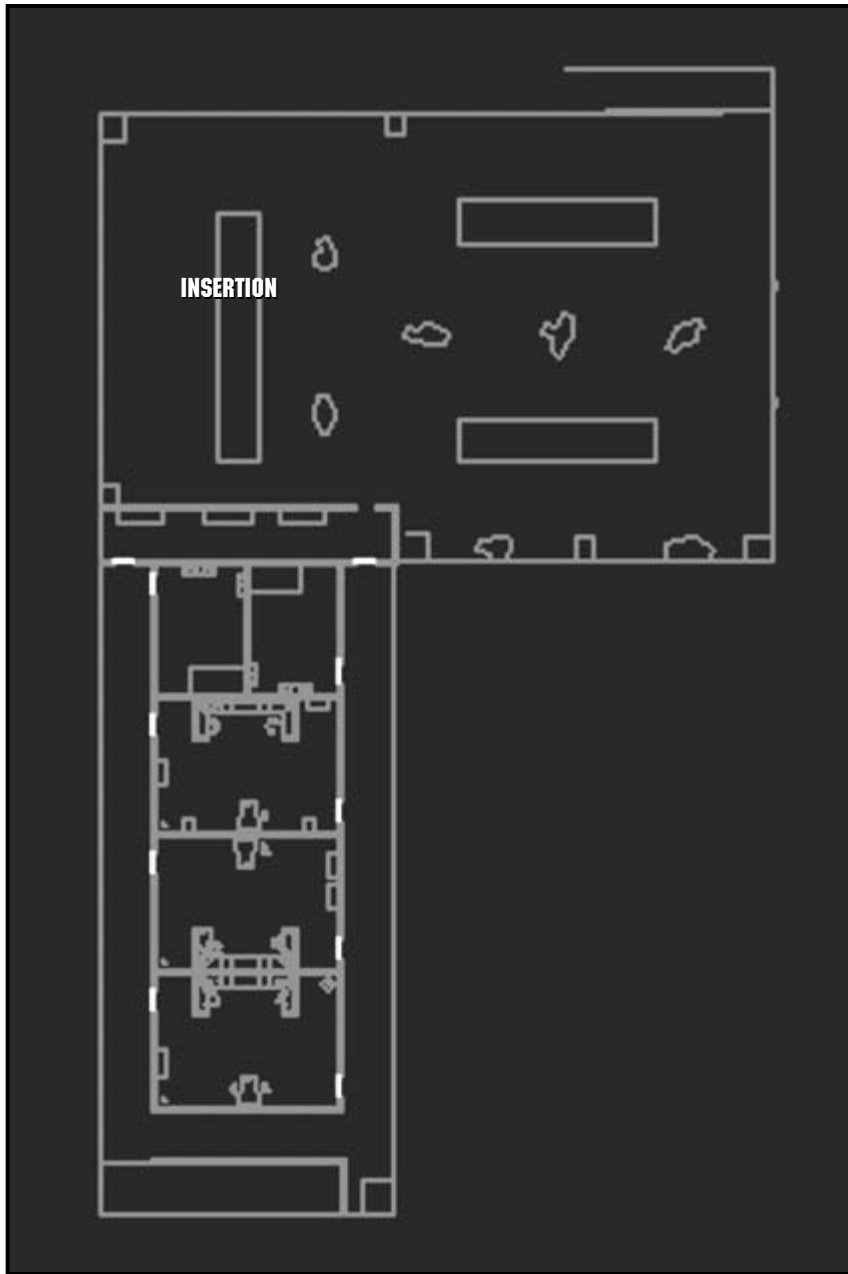

CORPORATE HQ, SECOND FLOOR

M11: Dressler's Estate

Lone Wolf

This mission can be tough because there are numerous ways in which to approach it. You begin on the first floor with the extraction zone on the second floor of the opposite wing. You can advance through the building to the stairs in the southeast corner, then head directly up to the room containing the zone. Or, you can make your way to the courtyard and then head upstairs to the east wing. Neither route is much easier than the other. Be sure to watch out for tangos in the stairways—they won't show up on your heartbeat scanner.

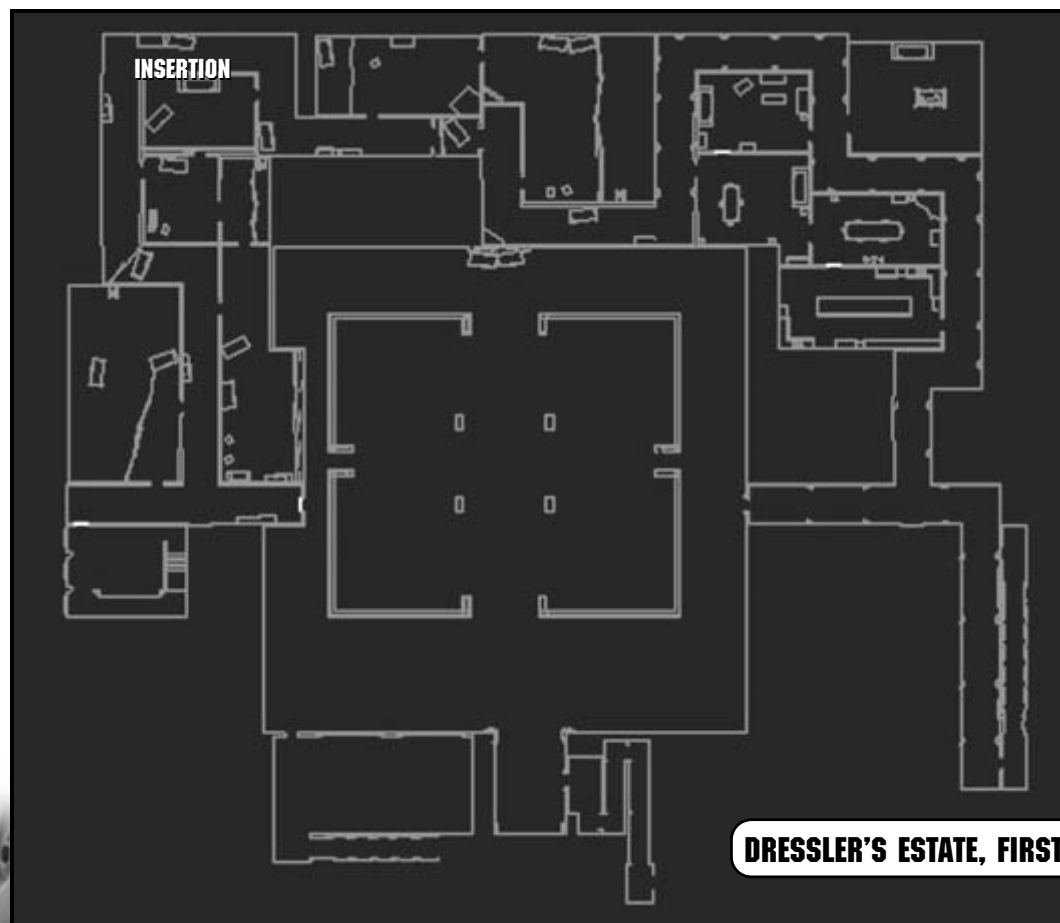

Firefight

The fact that the upper floor comprises two wings adds complexity to this large map. Clear out the ground first. Be sure to check the courtyard and garage for tangos as well. Climb upstairs to one wing and take out all tangos, then head back downstairs and across to another staircase to the second wing. There are two staircases for each wing. Two lead directly into the mansion while the other two descend into the courtyard or garage.

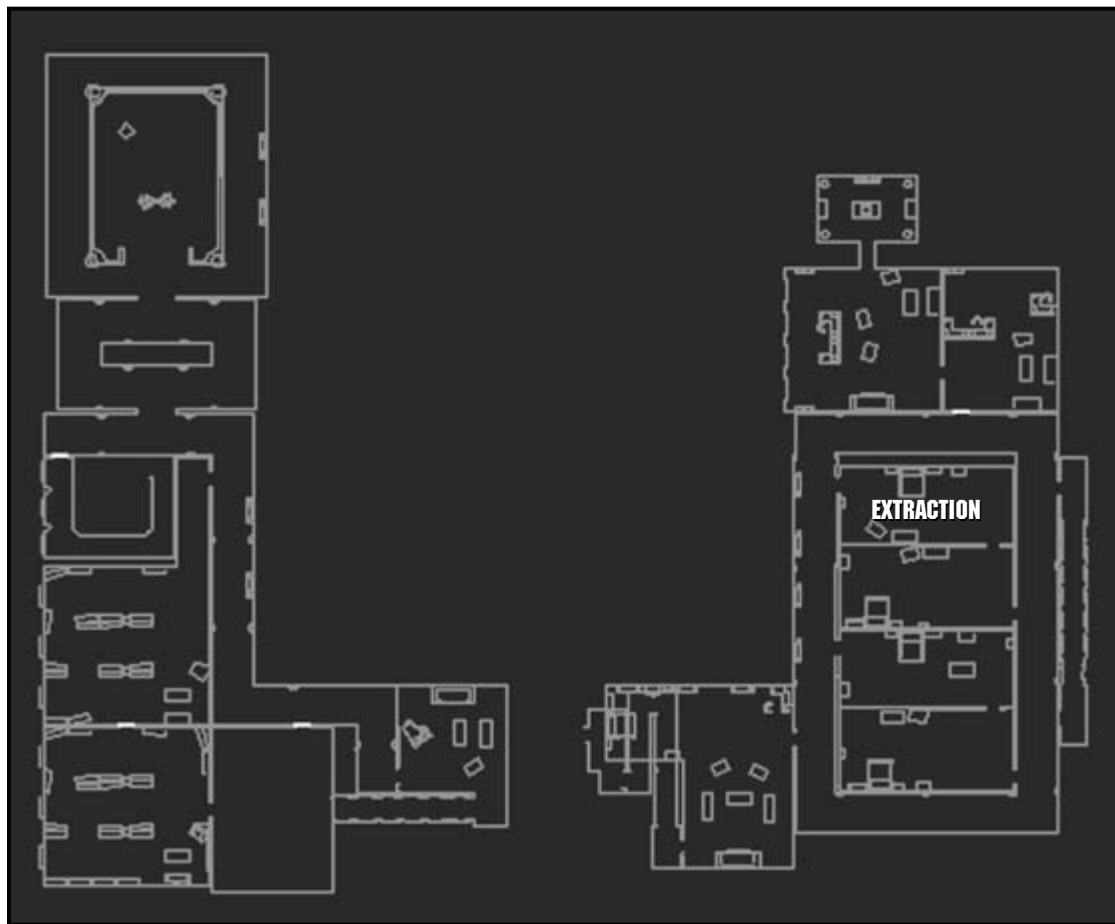

DRESSLER'S ESTATE, SECOND FLOOR

MP01: RSE Offices

Lone Wolf

Some of the rooms in this level are like mazes of cubicles, so use the heartbeat sensor to find tangos before they find you. You begin at the front of the office and must get to the back. To do so, go through the building. If you stay along the western part of the map, you can avoid tangos in other areas. Get in and get out before the enemy even knows you're there.



RSE OFFICES

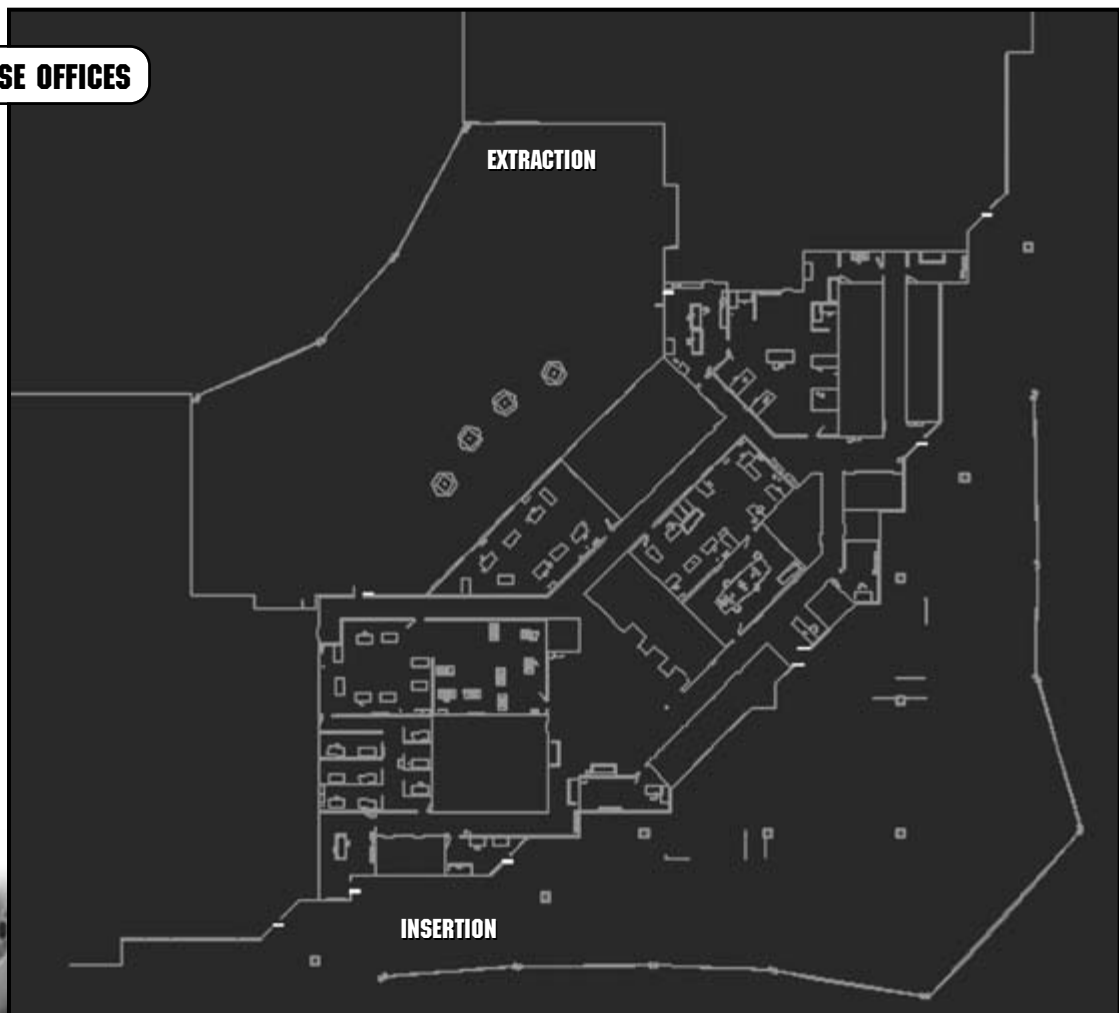

Firefight

This map is all one level, and most, if not all, tangos are inside. Make your way through the building, clearing as you go. Maintain stealth for this mission since the layout of the office allows tangos to rush around your flank and hit your team from behind if you aren't careful. Consider ordering your teammates to hold in a hallway and cover your flank as you clear. By ordering the team to hold position, you can take control of the operatives and position them to cover certain areas.

MPO2: Athlete

Lone Wolf

You begin in the gymnastics room. Head toward the main hallway and take a right. Enter a room that leads to the stairway down to the lower level. Follow it to the extraction zone in the far corner. As usual, if you are quiet, you can avoid most tangos and get to where you need to be without alerting many enemies.

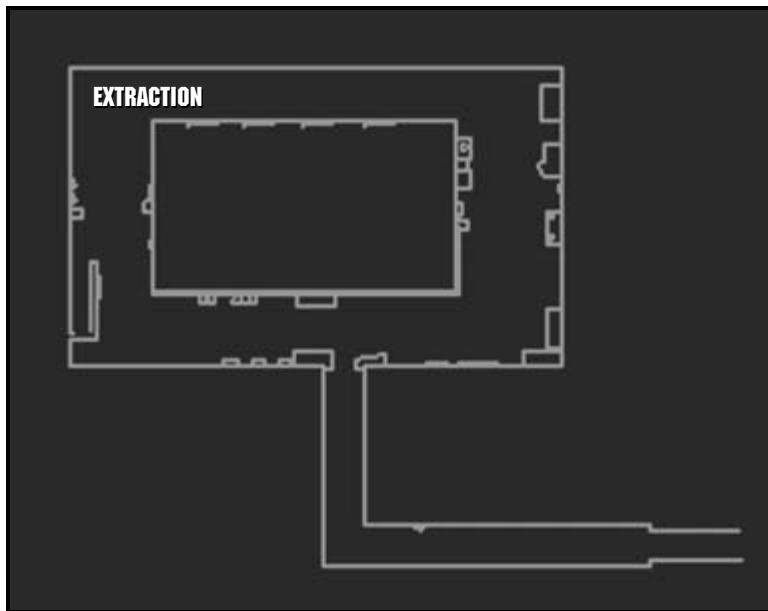

ATHLETIC COMPLEX, FIRST FLOOR

Firefight

Your team begins on the main level at one end. Advance through the level, taking out all tangos as you go. Be sure to check the restrooms—some tangos like to hide in the corners and try to ambush you. Use frag grenades. Once the main level is clear, head down to the lower level and mop up any remaining tangos.

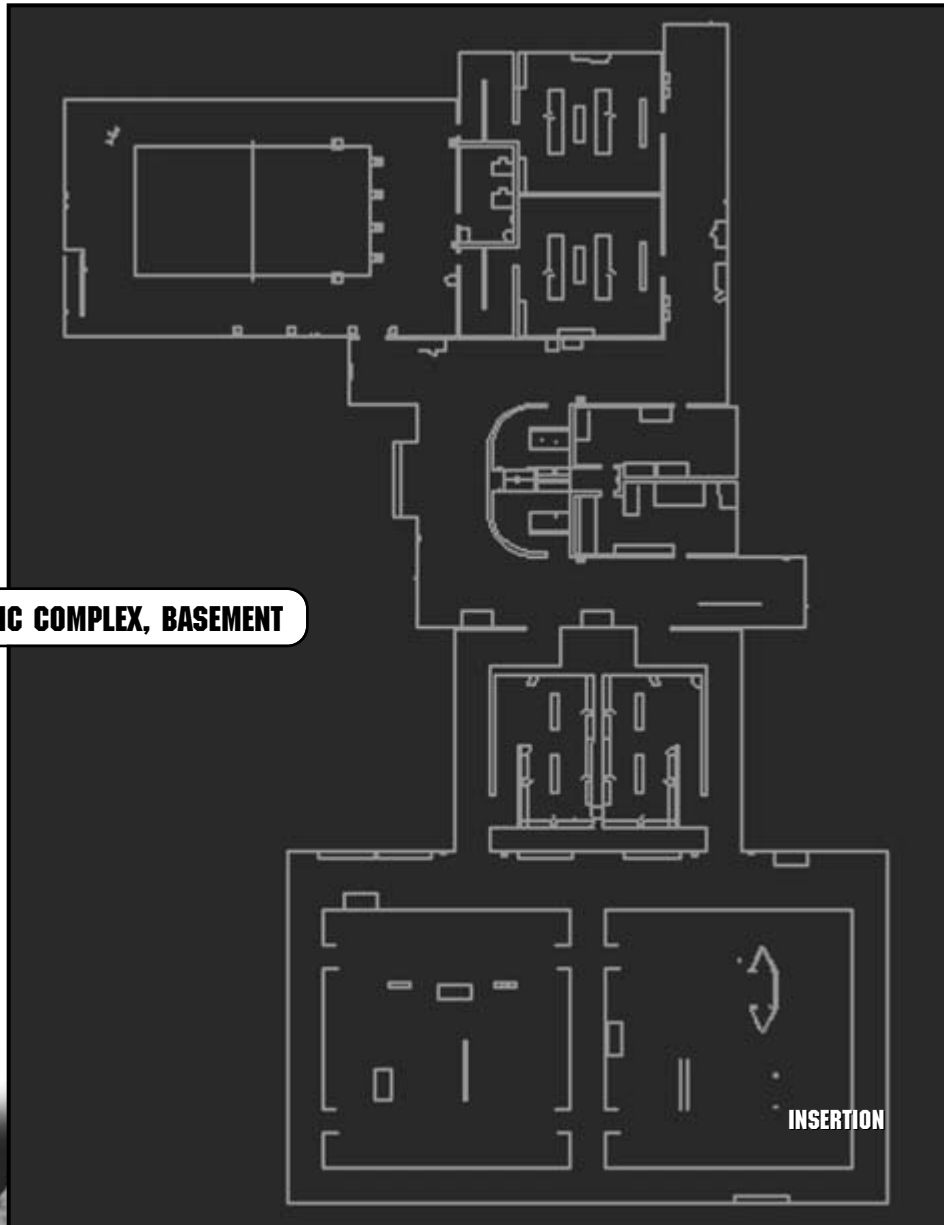

MP03: Killhouse

Lone Wolf

You begin upstairs on one side of the map. You must then go downstairs, cross to the other side, and go back upstairs to the extraction zone. The map has lots of windows and obstacles, so be careful that enemies cannot see you or ambush you. This is one of the few lone wolf missions where stealth may not be your best bet. Instead, take along heavy firepower—like the M16/203—and snipe out of the window where you begin. Then wait to see who comes after you. When it is clear, head downstairs, crouch down, and cross to the other side of the map and the extraction zone.



KILLHOUSE, FIRST FLOOR

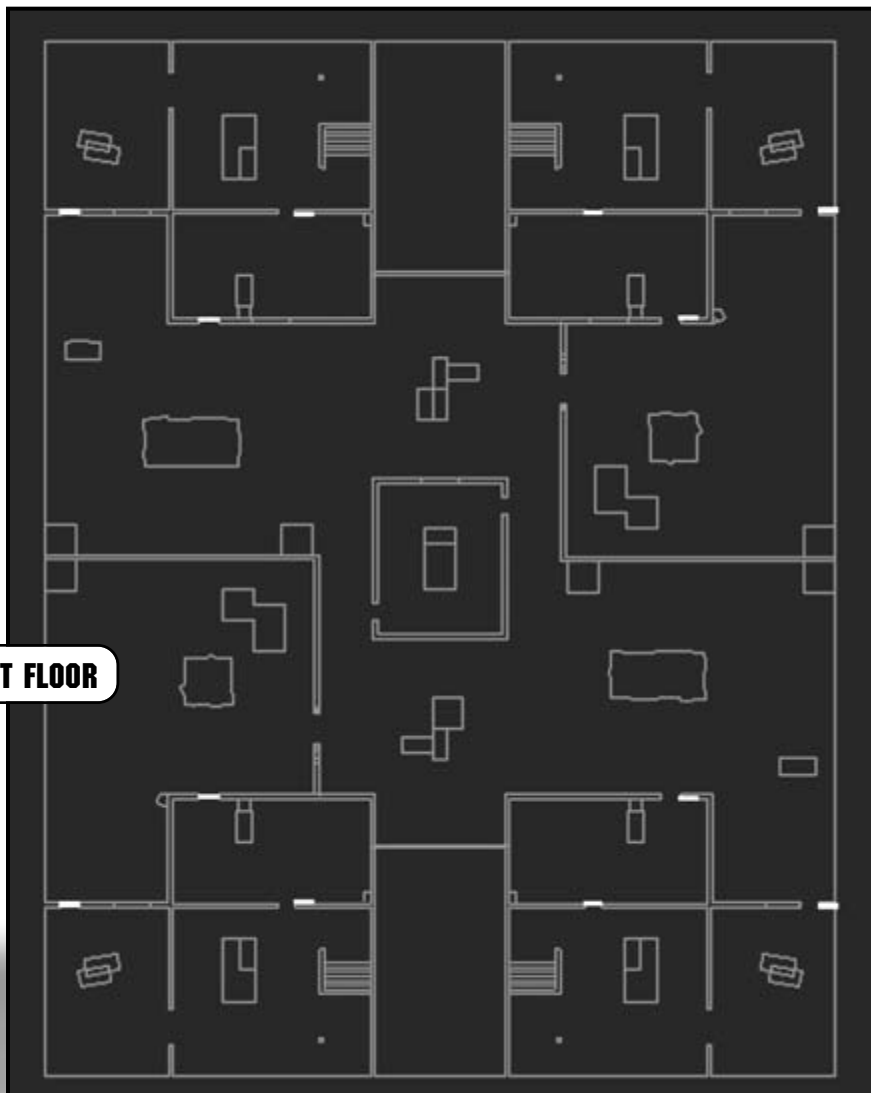

Firefight

Be sure to carry heavy firepower for this mission. Since you begin in one corner of the map, secure the building on your side after picking off tangos patrolling outside by shooting through the windows. Make extensive use of the heartbeat sensor to locate tangos in cover or concealment, then throw frag grenades to take them out. Once one side is secure, make your way across the map to clear out the middle and then the opposite side.

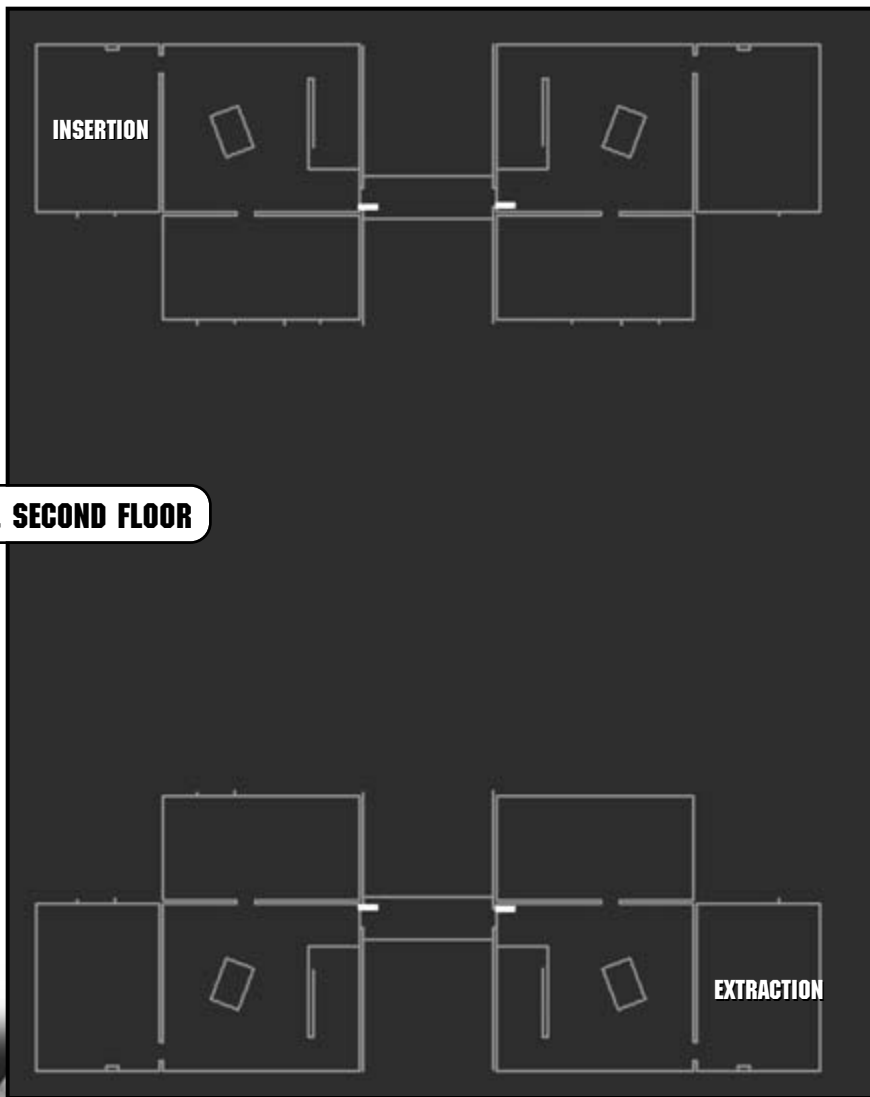

MP04: Parking Garage

Lone Wolf

You begin in one corner of the garage. Quickly scan around, looking for tangos, then make for the cover of a stairwell. Scan the level with the heartbeat sensor to locate tangos and the extraction zone, then clear a path to the extraction zone. Advance along the edges of the level so you don't have to worry about tangos coming at you from all directions. Watch out for tangos hiding behind cars.



Firefight

The key to this mission is heavy firepower. Target and engage enemies at long range. Use vehicles and other objects for cover as you clear one area at a time. Position operatives at strategic locations to both provide cover and protect your rear and flanks as you hunt for tangos.

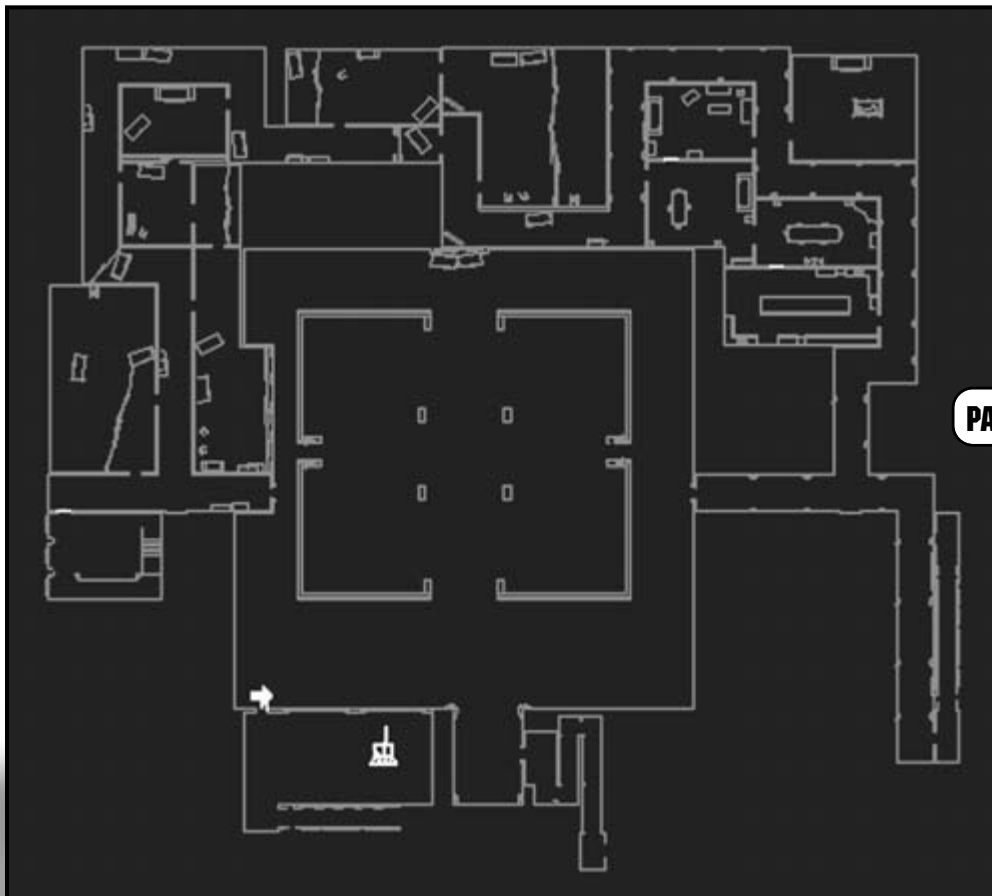

MP05: Reservoir

Lone Wolf

This very big map encompasses buildings, tunnels, and large open areas. From where you begin, head into the tunnel in the rock wall. As you enter a large chamber, stay to the left and take out any tangos you come across. Several lurk behind walls, waiting to ambush you. Use the heartbeat sensor as needed. Maintain stealth as long as you can. Frag grenades are effective. The passageway leads to the extraction zone.

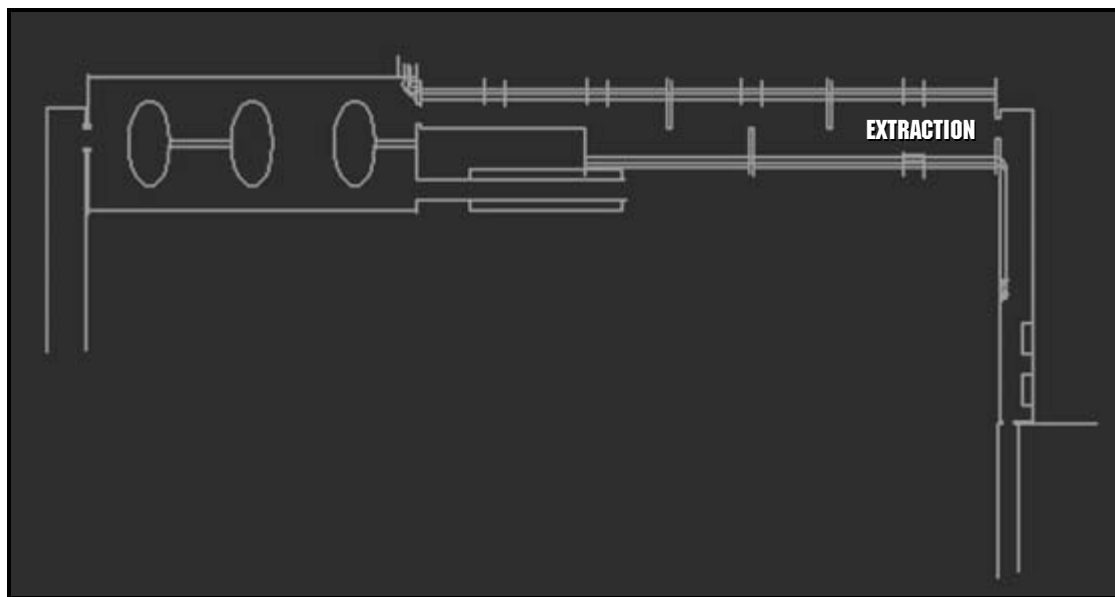

RESERVOIR, LOWER LEVEL



Firefight

Take along some heavy firepower, such as the Spec Ops Assault or Open Assault kit for this mission. Head into the tunnel by where you start. At the split, take the tunnel to the right—you end up overlooking the area. Clear as you go. As an alternate plan, try taking the Field Sniper kit. Then, at the insertion zone, snipe at all the tangos you can see from across the bridge. When it appears clear, advance across the bridge and clear out the buildings before heading into the tunnels.

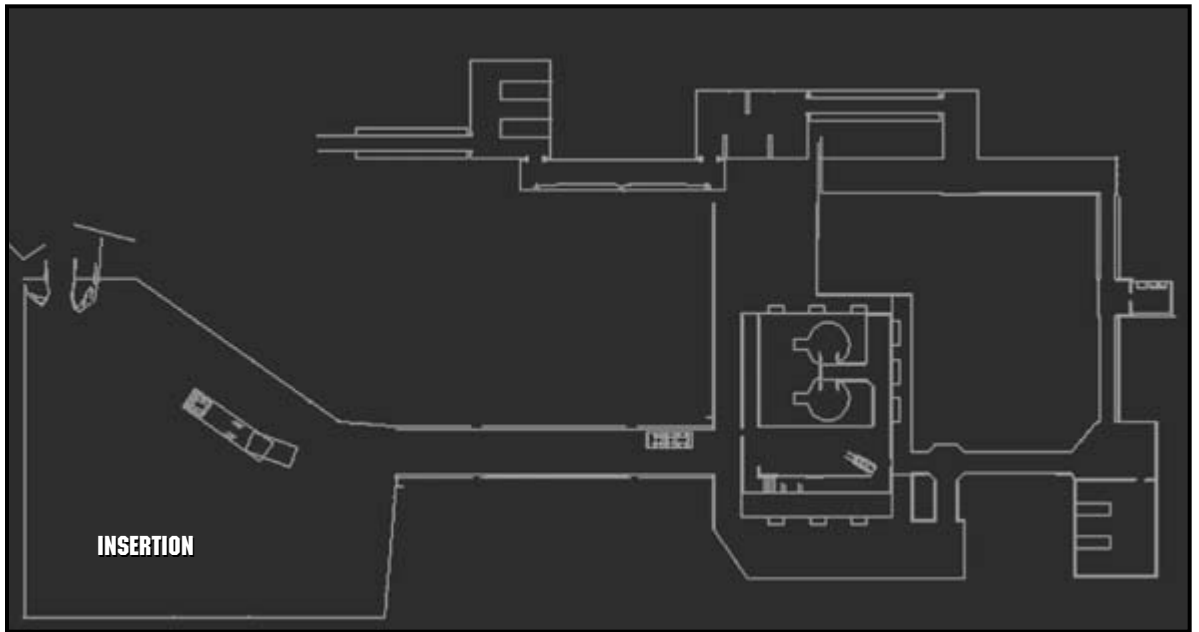

RESERVOIR, UPPER LEVEL



MPO6: Art Gallery

Lone Wolf

Right at the start, get ready to shoot and move. Avoid the large rooms as much as possible, advancing down the outer hallways when you can. If necessary, pick a side room as a hiding place from which you can ambush passing tangos. Whether to use stealth or not is a toss-up. However, since this mission often begins with a gunfight, the CQB Assault kit is a good choice since you can sweep a room with a single clip.



Firefight

The action starts right away. Find a room or corner where your rear and flanks are secure so you can focus your firepower down one hallway or doorway through which the tangos must come to get you. Detonate frag grenades to clear out the building. Start at one end and advance to the other, clearing as you go.

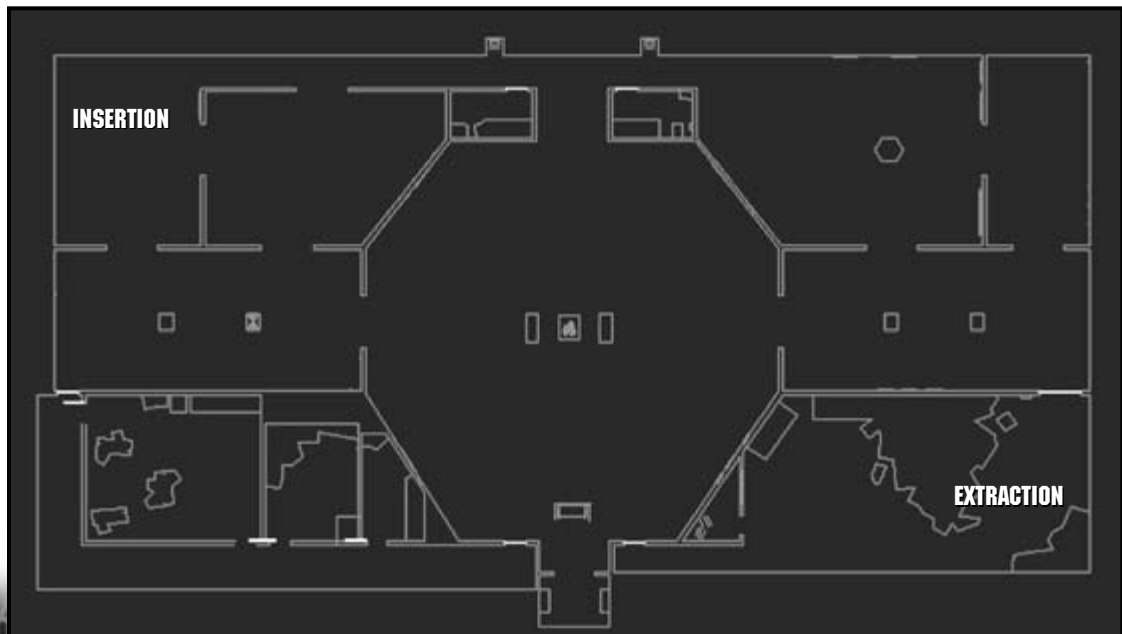

ART GALLERY

MP07: Training

Lone Wolf

You begin in the two-story killhouse in the middle of the map. Your first task is to get downstairs and exit the house. Scan the area to locate tangos. Once you are out of the killhouse, follow the red line into the main building and through the hallways. You have to take out several tangos along the way.

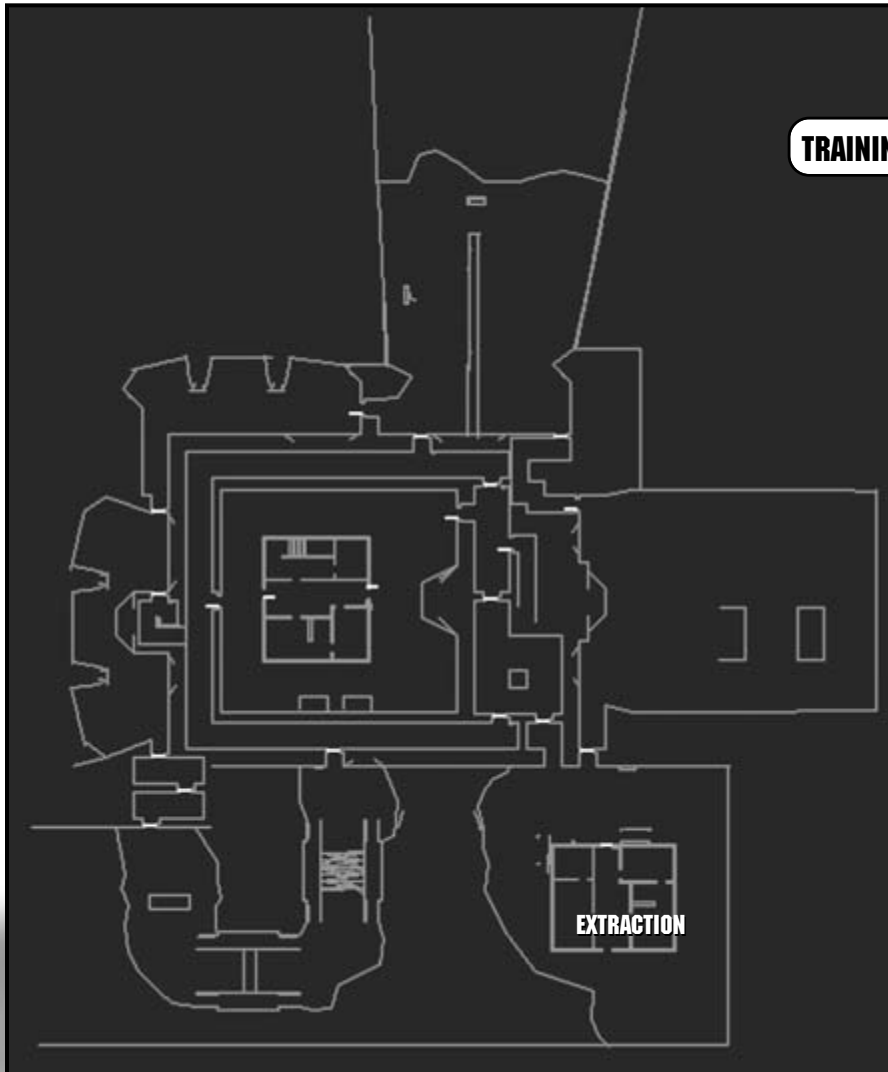
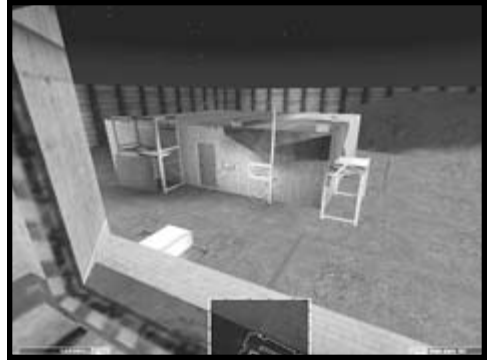

TRAINING, FIRST FLOOR

EXTRACTION

Firefight

The firefight mission is not as easy as the lone wolf for the training area. After exiting the killhouse and heading into the main building, open the door marked for authorized personnel only and head upstairs. From the second level, shoot down on the training ranges through the windows and take out several tangos. Watch out for the floor grates—tangos sometimes fire up through them as your team passes by. Clear the second level and as much of the ranges below as possible, then head back downstairs to clear out the lower level of the building and mop up any remaining tangos.

TRAINING, SECOND FLOOR

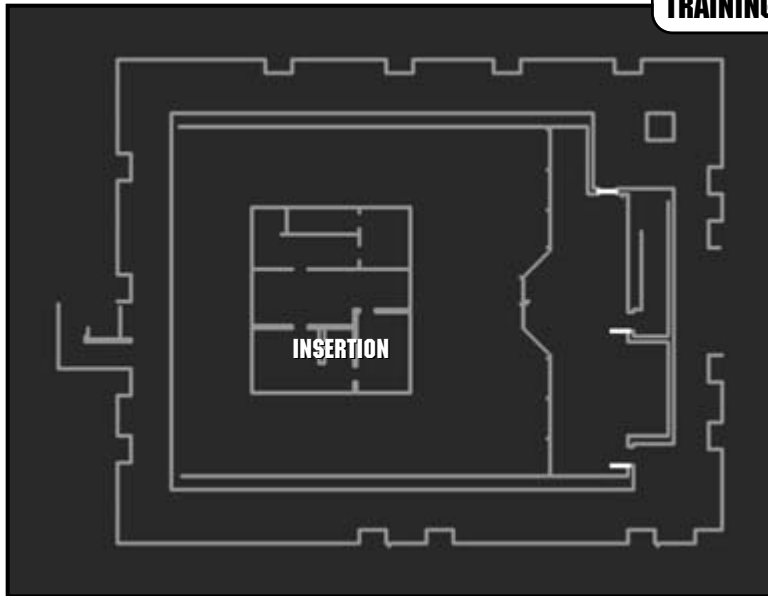

DEVELOPER TIP

Crouching and peeking are good ways to line up targets without becoming one yourself.





6

Multiplayer Missions

The Sum of All Fears contains one of the best multiplayer systems available using the same realistic model as the single-player game. Plus, you can play on any of the carefully crafted campaign and multiplayer maps. During the single-player missions, you move quickly through the maps to your objectives. In multiplayer games, you can explore each room, corner, and balcony.

The multiplayer games match your skills against or with other players over a LAN or on the Internet. If you are looking for other players, connect to *Ubi.com* through the game.

You can join a game or create one yourself. The player creating the game is the host. The host determines the type of game played and several options. At the setup screen, you can divide into teams and equip your operatives.

Types of Multiplayer Missions

There are three main categories of multiplayer games: co-op, solo, and team. Each category comprises several game types.

Co-Op

Co-op games pit human players against AI-controlled tangos. You can have up to three in a team or, depending on the number of players, divide into separate teams all working toward the same goal. Co-op games are great practice for teams preparing to go up against other human teams.

Firefight

Objective: The players win if all enemies are eliminated.

This mission is similar to the firefight quick missions except that human players control all operatives. Use the same tactics for each map as provided in chapter 5.

Recon

Objective: Reach the extraction zone without casualties.

The recon mission is similar to the lone wolf quick missions, except you work with your teammates to get everyone to the extraction zone.

Mission

Objective: Complete the objectives as listed in the campaign mission.

The campaign missions are a lot of fun. Now you can try them with other human players creating your team as well as the support teams. If you don't have enough players, the support teams will be AI-controlled. The HQ plan to the mission objectives appears on your map, but you're not required to follow it.



Solo

In the solo missions, it's every player for him- or herself. There are no teams and anything goes. While this can make it tough, you don't have to worry about friendly fire—no one is your friend.

Cat and Mouse

Objective: All players start as cats. The first player to score a kill becomes a mouse. The mouse's kit is replaced with just a pistol, and the mouse is highlighted by fire. Whenever a mouse scores a kill, he or she gets a point. If a cat kills a mouse, the cat becomes the mouse and can score points. The winner is the player with the most kills as a mouse.

This unique game moves quickly. To make it more interesting, restrict the kits to pistols only so the mouse and all the cats have the same level of firepower (see the sidebar Kit Options in the Multiplayer Weapons Kit section later in the chapter).

King of the Hill

Objective: The winner is the player who spends the most time alone in the central base.

On some maps, the base can be defended while behind cover. However, in most cases there are several ways to access the base, so the solo defender has to respond quickly to any enemy infiltration. The defender is also a good target for grenades.

Last Man

Objective: The last soldier alive is the victor.

This is the standard death match type of game. It is best to play with the respawn option off. Or keep the number of respawns to a minimum.

Sharpshooter

Objective: Accumulate the most kills before time runs out or only one soldier remains.

This is like a death match, but you put a notch in your gun for every kill. Try this one with infinite respawns and a specific time limit.

Team

For team games, you need enough players to create at least two teams. You can have up to four teams, which makes for a big battle. Many of the team games are similar to the solo games, except that you work as a team to win rather than as an individual.

Domination

Objective: Secure key map locations for your team by eliminating nearby enemies. Team points are earned for control over time. Control is not lost by abandoning a zone. The surviving team with the highest score wins.

This interesting game requires some strategy. Often the team that thinks and plans ahead beats the team with the better shooters. You don't have to camp out at a location to maintain control of it; you just have to be the last team to have entered the location. Therefore, position snipers or a player with an M16/203 to cover the access points to the locations from a distance while other members of your team go after the other locations.

King of the Hill

Objective: Teams score points by being the only team within the central area. Points accrue over time. The team with the highest score at the end is the winner. If two or more teams are in the central area, no one scores points.

For this game, you must occupy a location. But that doesn't mean your entire team has to be in one spot. Consider keeping some operatives to hold a location while others take up firing positions overlooking the access points to it. These players can also act as observers, warning the players inside of pending attacks.

Last Man

Objective: The side with the last survivors wins.

This is a death match—team style. Stick together in a group and hunt down the enemy rather than going off solo. Support one another.

SAR (Search and Rescue)

Objective: Be the first to find all three hostages and secure them in your base.

Luckily, the hostages cannot be killed, although the escorting operatives can. Don't hurry to the tangos first. Instead, wait for other teams to grab the hostages, then steal the hostages from them. Assign one member of your team to hostage escort duty. When you come across a hostage, have this teammate go up to the hostage to get him or her to follow. Then guard that player. If he or she gets killed, another teammate must gain control of the hostages before another team steals them.



Siege

Objective: The smallest company must prevent all enemies from entering their base. An attacker can capture the defenders' base by surviving five seconds in the base zone. The defenders win if they kill all the attackers or time expires.

This is a challenging game, especially if you are the defending team. Stay away from windows or doorways through which the attacker can lob a grenade. Remember, the attackers must be in the base zone for five seconds to win. Take cover behind objects and wait to ambush the foes as they enter. Five seconds is a long time and gives you enough opportunities to take them out.

As the attacker, rush the base from different directions—use of grenades. The LMG is effective for keeping the defenders' heads down as other team members rush in.

General Multiplayer Tactics

While all the tactics for the single-player missions still apply, multiplayer games require additional strategies.

Communications

One of the most important parts of team play is communicating with the other players on your team. Although you can type out messages using the chat function, *The Sum of All Fears* is a fast-paced game, and the time it takes to type a message is often too long—you may be killed while typing. Use the chat keys. They allow you to pre-program 10 different messages that can be sent with a press of a key—all on the numeric keypad. Plan out the game before it starts and use the various chat messages to report in or order an assault to begin.

The best way to communicate is through an external voice program that allows players to talk over the Internet while playing the game. Several of these programs are available on the Internet—many for free. Go to www.rogerwilco.com or www.gamevoice.com.

Teamwork

Teamwork is among the most important tactics in *The Sum of All Fears*. If you have enough players, group them in pairs or larger teams. Two people see twice as much and can accomplish different tasks, making the team more effective.

An effective tactic involves using the heartbeat sensor: the leader carries a weapon while another team member locates enemies. The operative with the heartbeat sensor can tell the team where the enemies are.

A multiperson team also is useful for breaching a door or clearing a room. One opens the door as the other tosses a frag grenade or flashbang, and the rest cover the first two. All run through the doorway and spread out. This prevents anyone from getting shot in the back because he or she looked left when the tango was right. (Practice will develop the good timing such tactics require.) Other players can help prevent surprises from the rear.

Spacing between team members is also important. You want to stay close enough to support one another, but not so close that a single automatic burst takes both of you out. Outdoors, space team members far enough apart that they can support one another without a single grenade killing both.

Every team must have a leader. In this game, you lead from the front, so the leader acts as point. In large games, where each side has multiple teams, an overall commander should coordinate the teams.

Movement

When outdoors, it's important to spread out and cover all the angles of threat: An open window, door, corner, upstairs balcony, or any other place an enemy could hide. Spreading out the team while in the open provides fewer targets of opportunity for the enemy.

When indoors, keep your teammates close so you don't get lost. If you get lost, then everyone behind you is lost. Confusion sets in, and you die. If you're in position #2, keep the leader in sight. If you're in the #4 position, keep the #3 player in sight. Staying close to the person in front of you does have its disadvantages, though. For instance, frag grenades thrown by the enemy or a burst of automatic fire can kill all of you.

When you cross a narrow choke point, move fast and get through as quickly as possible. The same goes for large open areas. If you cannot cover all angles of threat, run as fast as you can to minimize the chance of attack.

TIP

When moving through a map, whether you have two or more players in your team, the last player in line should always cover to the rear. Walk backward and use the mini-map to keep track of the rest of the team. This may keep your team alive if the enemy sneaks up from behind.



When going upstairs, face the direction where the enemy could be. This may mean ascending stairways sideways or backward. Stairs can be dangerous choke points. Since your heartbeat sensor only works on the level you are on, there is no way to see if a tango lurks at the top until you get there.

GIM

The standard fire team consists of three operatives. As you advance, the lead faces forward and engages any tangos in your path. The tail walks backward covering the rear. But what does the GIM (guy in middle) do? When moving through an open area, the GIM should help the lead and watch for enemies on the flanks. When moving through hallways and such, the GIM should use the heartbeat sensor to monitor the location of the enemy and let the lead and tail know if they need to be ready to engage an approaching threat.

If you are not using a voice program for communication, configure the chat keys for warnings:

[7], [8], and [9] can tell the lead to watch for enemies to the left, center, or right, respectively, while [1], [2], and [3] do the same for the tail.

Fire Discipline

In multiplayer games, ammo can run out quickly. It's important to use it sparingly. Since a single shot often kills and a three-round burst always does, avoid using full-automatic fire. Firing while moving is inaccurate. Missing a target not only lets the tangos know you are there, but also gives them the opportunity to fire back. As a general rule, you should "stop, drop (crouch), fire"! This increases your accuracy and minimizes the chance of your being detected if you miss.

In some instances full-automatic fire and movement are acceptable. If you have to get through a choke point or a large open area, running and firing wildly at the enemy forces them to keep their heads down and fire inaccurately.

Attacking

To attack the enemy advance slowly and carefully as a team, using good fire discipline and covering each other. However, sometimes rushing the enemy has its benefits.

Some players refer to this as “Ramboing.” It works well on small maps. At the beginning of the mission, your team blitzes toward the enemy with guns blazing. Catching the tingos before they have a chance to set up gives you the element of surprise, and you can win a game in a minute or two.

The best strategy for advancing is “Bound and Overwatch.” This tactic divides a team into two parts. While one advances, the other covers. When the first group gets to some cover, it halts and covers the second group as it advances. Practice this tactic so everybody understands what to do.

Defending

Defending a position entails setting up firing positions, ambushes, and snipers. Since this takes time, at the start of a mission each player should assume a defensive position in case the enemy tries blitzing you right from the start.

For firing positions, choose locations with cover and at a distance from an entrance. This increases your ability to survive grenade attacks and makes it harder for the enemy to shoot you.

Locate the choke points and set up your defenses near them. It’s hard to defend a large area, so concentrate on the narrow spots through which the enemy must advance. Use frag grenades to blast a hole in an enemy’s attack.

REMEMBER THE ALAMO!

In most multiplayer games, especially the co-op and team games, always find an Alamo where you can put up a stand when the enemies come after you. An Alamo can be a room or a hallway with only one or two access points. Players should each cover an access point to protect against enemy attacks. You can slowly advance out of the Alamo as the situation clears; it’s also a place to fall back on for regrouping. If you have enough players, one who is not covering an access point should scan the area with a heartbeat sensor and let the other players know when enemies are approaching.



The Cardinal Rules of Team Close-Quarters Combat

1. Move decisively and with purpose. You are the hunter, not the hunted. Move like a victim, and you'll soon be one. Move with purpose as a hunter, and you will attack your enemy with confidence.
2. Put your opponent under duress—if you see your opponents, open fire. With rounds coming at them, they'll panic, giving you or preferably your partner the chance to take a good kill shot.
3. Teamwork! You have to trust your teammates to cover their zones and do their jobs. Everyone has to do their part even if it's watching a locked door miles from the action. It could save your whole team from being wiped out from behind.
4. Never assume a room is cleared simply because you've "already been in there."
5. Choose a weapon with stopping power, not just because it looks cool.
6. Use short, controlled bursts. It doesn't matter how many rounds you fire, just where they land.
7. If you are not using auto-aim, aim for the crotch. The head is harder to hit and the chest is usually covered by body armor.
8. Never leave your back to an open window or door.
9. The enemy can't hear a suppressed submachine gun firing, but if you are 500 yards away, it won't matter since you won't hit them.
10. When yelling "cover me," make sure someone on your team responds before making your move.
11. As a team, secure all doorways coming into your location as quickly as possible. You should do this every time you enter a new room during an advance so you are not surprised by the enemy.
12. Grenades cannot break through all windows. At times they bounce right back at you. Shoot out the window first. However, you can use frag grenades to take out windows and doors—as well as enemies standing too close to them.
13. Peek around corners! It saves your life. It's harder to hit half a head than it is to hit half a body.

14. Don't investigate a pile of your teammates' bodies lying next to a window or door. Choose life.
15. If you peek around a corner and someone nearly shoots your head off, don't stick your head back around. You may or may not get them in a shootout, but isn't it better to leave them thinking you're there and then go flank them, or get some teammates and set up an ambush?
16. Remember the golden rule: When in doubt, FRAG OUT!!!
17. Teamwork is essential. Find each member of your team's special skill or ability and work on those strengths. If you have players who are quick shots and accurate, have them play as snipers and develop tactics around them to utilize their skills. They can always move to a high spot or provide covering fire for your assaulters.
18. When you move across an area that you're sure the enemy is covering, lay down plenty of scattered rounds where you think they could be hiding while part of your team moves. You may not know for sure where they are, but if dirt clouds are hitting near them, they are less likely to poke their guns around the corner and see what the commotion is about.
19. Though covering fire and other noisy tactics are discussed, don't discount stealth. More often than not, it's the sneaky operative who gets the kill. A good mix of playing styles and working together with plans that capitalize on your team's talents goes a long way to make your team victorious.
20. Develop standard operating procedures and break contact drills. That way, everyone knows what to do when the bullets start flying. Often the best tactic is to get out of there (break contact) and set up an ambush somewhere else on your own terms.
21. When patrolling, stay in formation. Only move as fast as your slowest man, which is your rearguard. The slowest should be your point man so he doesn't get too far ahead and end up by himself.
22. Not all maps provide for planned slow movements. Some are small and you need to move decisively and quickly. Develop plans for each map, as you won't have time to once the game starts. Once again, each team member should know his or her job and be able to count on their teammates to do theirs!



23. Practice, practice, practice! As a team, play co-op firefight missions on each map until you master it. By the time you go up against another team, you should know exactly where to go for cover and all of the best spots for ambushes.

Multiplayer Weapons Kits

During the campaign and quick missions, you select team kits that are unlocked as you progress through the campaign. Multiplayer games offer 22 individual kits. Some contain weapons not included in the team kits. Multiplayer games allow you to experiment with different types of weapons and see their effects. You often have to choose between stealth and firepower with the answer dependent on the map, the type of game, and your personal and team tactics. The following lists all of the multiplayer kits. For more information on each weapon, see Chapter 2.

KIT OPTIONS

The host of a multiplayer game selects kit options as he or she edits the server. These restrictions make a game more interesting. Let's look at the options.

No Restrictions: The players can choose any multiplayer kit.

No Sniper Rifles: Kits containing sniper rifles are not available. Tired of getting sniped at by the enemy? Even up the odds and get rid of those pesky sniper rifles.

Pistols Only: The number of kits is reduced and each contains only one or two pistols. There are no primary weapons, grenades, or heartbeat sensors. This makes the game challenging since you have to get close to your enemy and aim well.

Primaries Only: The available kits contain only a primary weapon. You cannot rely on a backup pistol, grenades, or heartbeat scanners.

Grenades Only: Each player is issued 16 frag grenades divided between four slots. This makes for an interesting and fun game because the grenades have a three-second fuse and take time to throw.

No Explosives: Twenty-one kits are available, but there are no frag grenades or flashbangs. Also, the M16/203 kit cannot be selected. Try this on maps where there are a lot of low obstacles such as cubicle walls and such. You have to see your target to kill it.

No Heartbeat Sensors: None of the kits contain a heartbeat sensor, making things tougher. You actually have to look around a corner to see if someone is on the other side.

Kit 1

- M16
- 9mm Pistol
- Frag Grenades
- Frag Grenades



Kit 2

- 9mm SMG
- 0.357 Pistol
- Frag Grenades
- Flashbangs



Kit 3

- 9mm SMG
- 0.357 Pistol
- Frag Grenades
- Heartbeat Sensor



Kit 4

- M4
- 9mm Pistol SD
- Frag Grenades
- Heartbeat Sensor



Kit 5

- 5.45mm SMG
- 9mm Pistol SD
- Frag Grenades
- Flashbangs



Kit 6

- SVD
- 9mm Automatic
- Frag Grenades
- Frag Grenades



Kit 7

- M16/203
- M203
- Flashbangs
- Heartbeat Sensor



Kit 8

- 12ga Auto Shotgun
- M1911
- Frag Grenades
- Frag Grenades



Kit 9

- 5.56mm Carbine
- 9mm Pistol
- Frag Grenades
- Flashbangs



Kit 10

- 7.62mm LMG
- 0.357 Pistol
- Frag Grenades
- Heartbeat Sensor



Kit 11

- 7.62mm Sniper Rifle
- 9mm Automatic
- Frag Grenades
- Heartbeat Sensor



Kit 12

- 12ga Pump Shotgun
- M1911
- Frag Grenades
- Flashbangs



Kit 13

- 7.62mm AR
- 9mm Pistol
- Frag Grenades
- Frag Grenades



Kit 14

- 9mm Compact SMG
- 0.357 Pistol
- Frag Grenades
- Frag Grenades



Kit 15

- Sawed-off Shotgun
- M1911
- Frag Grenades
- Heartbeat Sensor



Kit 16

- Silenced Sniper Rifle
- 9mm Automatic
- Frag Grenades
- Flashbangs



Kit 17

- Bullpup AR
- 9mm Pistol
- Frag Grenades
- Heartbeat Sensor



Kit 18

- 5.7mm SMG
- 0.357 Pistol
- Frag Grenades
- Flashbangs



Kit 19

- Spec Ops M4
- 9mm Pistol SD
- Frag Grenades
- Frag Grenades



Kit 20

- M4/Shotgun
- 12ga UB Shotgun
- Frag Grenades
- Frag Grenades



Kit 21

- 0.45mm Auto Pistol
- 9mm Pistol SD
- Frag Grenades
- Flashbangs

Kit 22

- 9mm Auto Pistol
- 9mm Pistol SD
- Frag Grenades
- Heartbeat Sensor

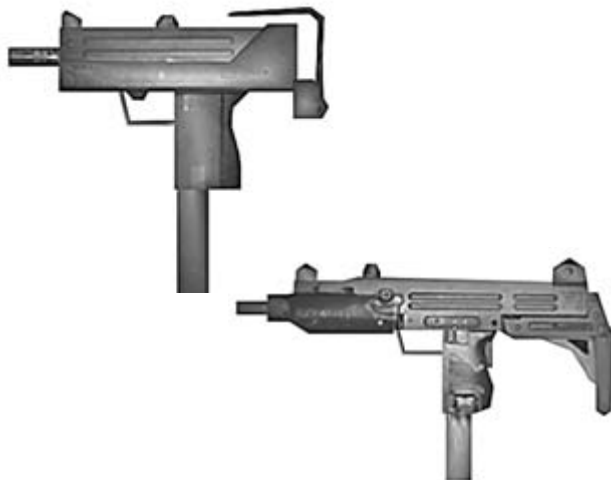

The Maps

For the multiplayer missions, you can access all of the campaign maps and seven additional multiplayer maps. Since you can also play on these maps for the quick missions, use the quick missions as practice for multiplayer games. You'll learn each map and find good places for ambushes or hiding.

M01: TV Station

The television station contains three levels with only one stairway to the third level and two between the first and second levels. That means the stairways are major choke points and should be defended. Instead of defending right at the stairway, choose a position down the hall so you can take out enemies as they emerge but stay out of grenade range. The two studios are the only rooms where you can fire between levels, so be careful around them. The garage is a good spot to defend because it allows distant attacks against enemies as they emerge from the main building.



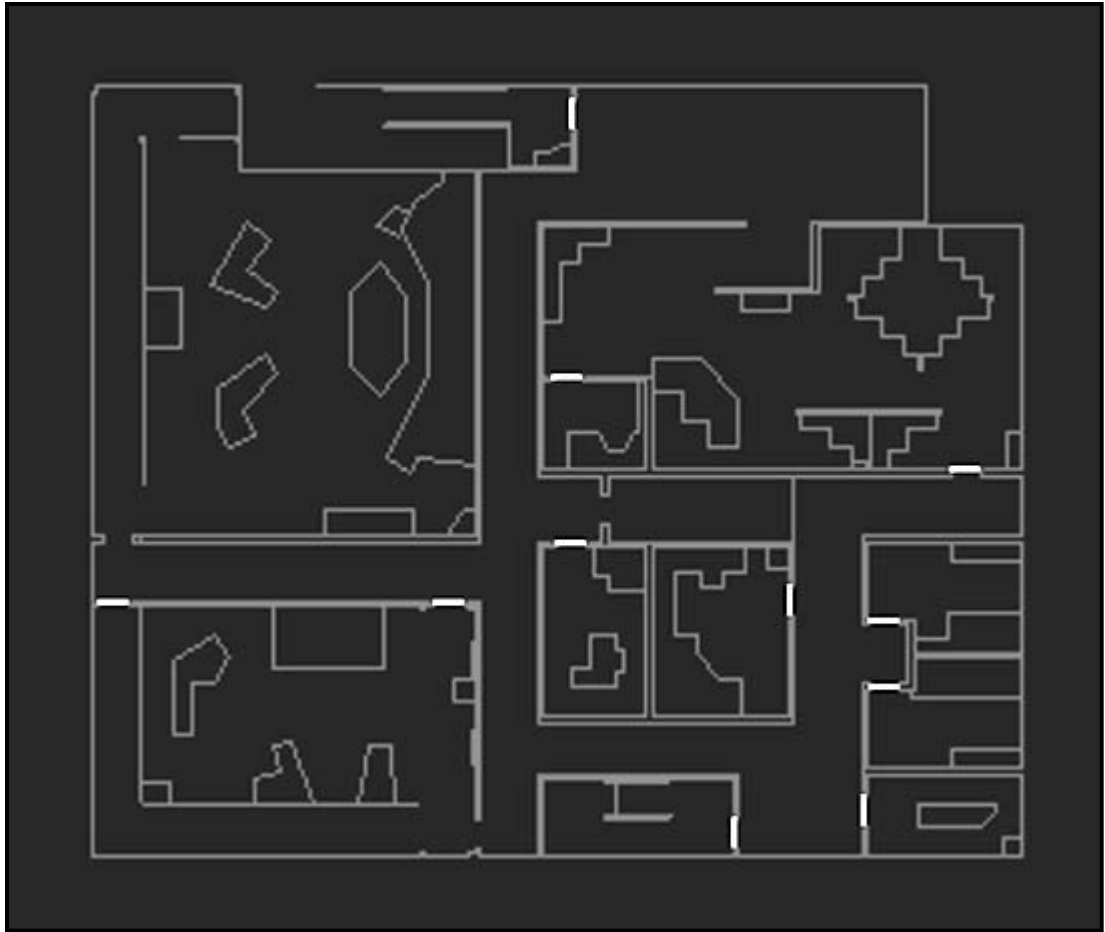

TV STATION, FIRST FLOOR

**TV STATION, SECOND FLOOR****DEVELOPER TIP**

If you want to check on which objectives you've completed during a mission, simply hit the **[Esc]** key at any time.



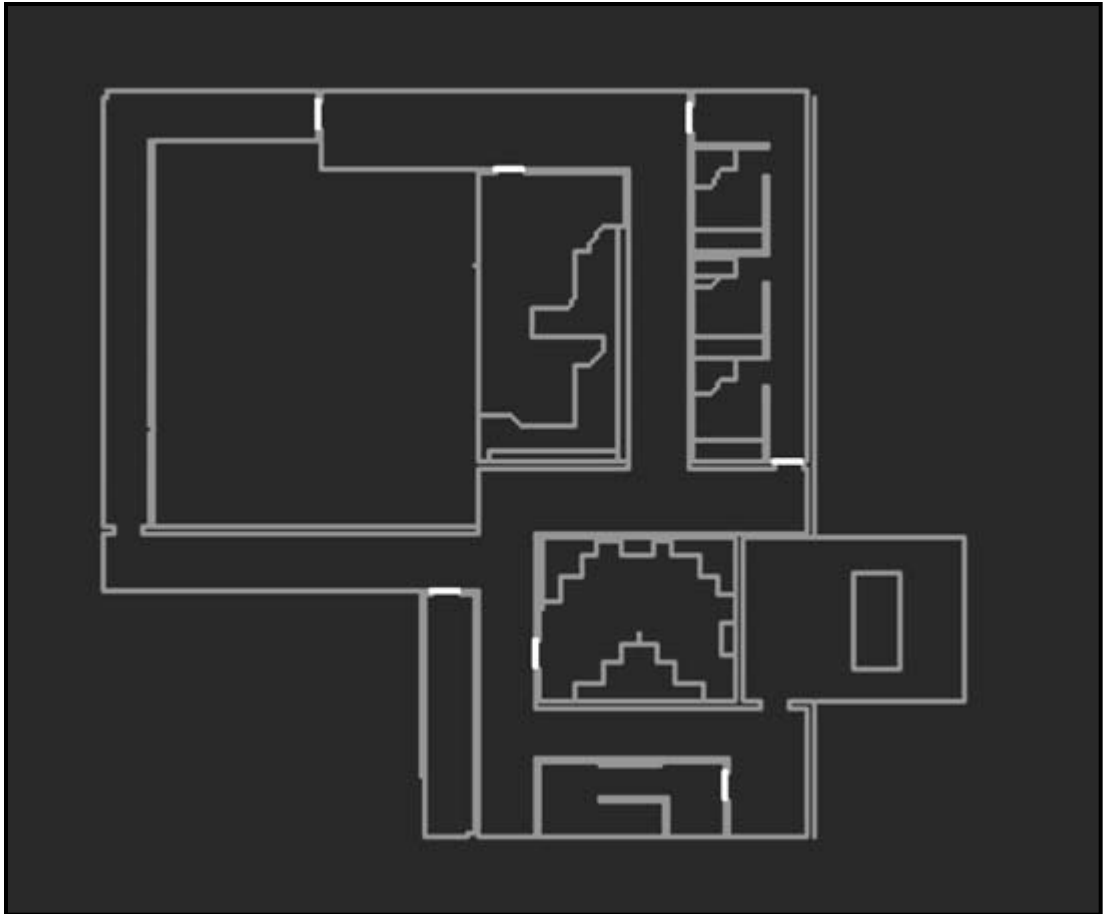

TV STATION, THIRD FLOOR

M02: Militia Compound

While most of the combat takes place in the tunnels, you also stay busy on the open ground above. The barn and trailer can be accessed by the open field between them. You cannot get to the cabin—fences and the lake block your path. The M16/203's grenade launcher is excellent for clearing out tunnels. Wear the night-vision goggles when down in the tunnels to avoid being ambushed by an enemy crouched down in the shadows.

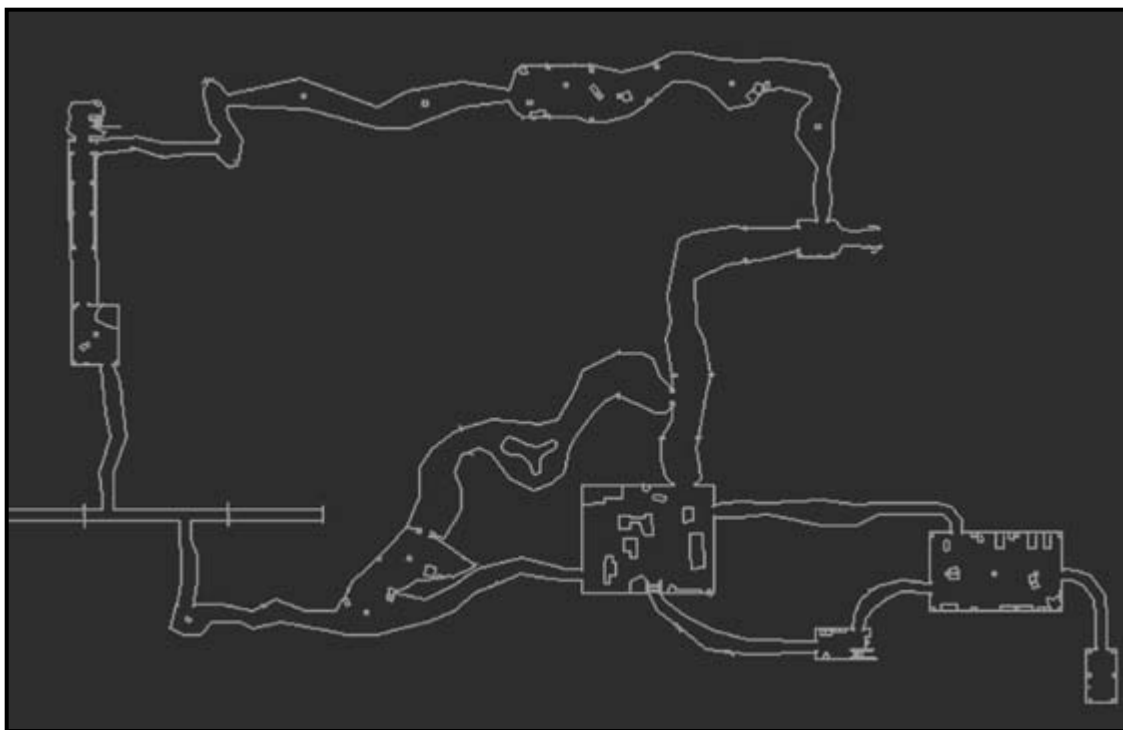

MILITIA COMPOUND, UNDERGROUND



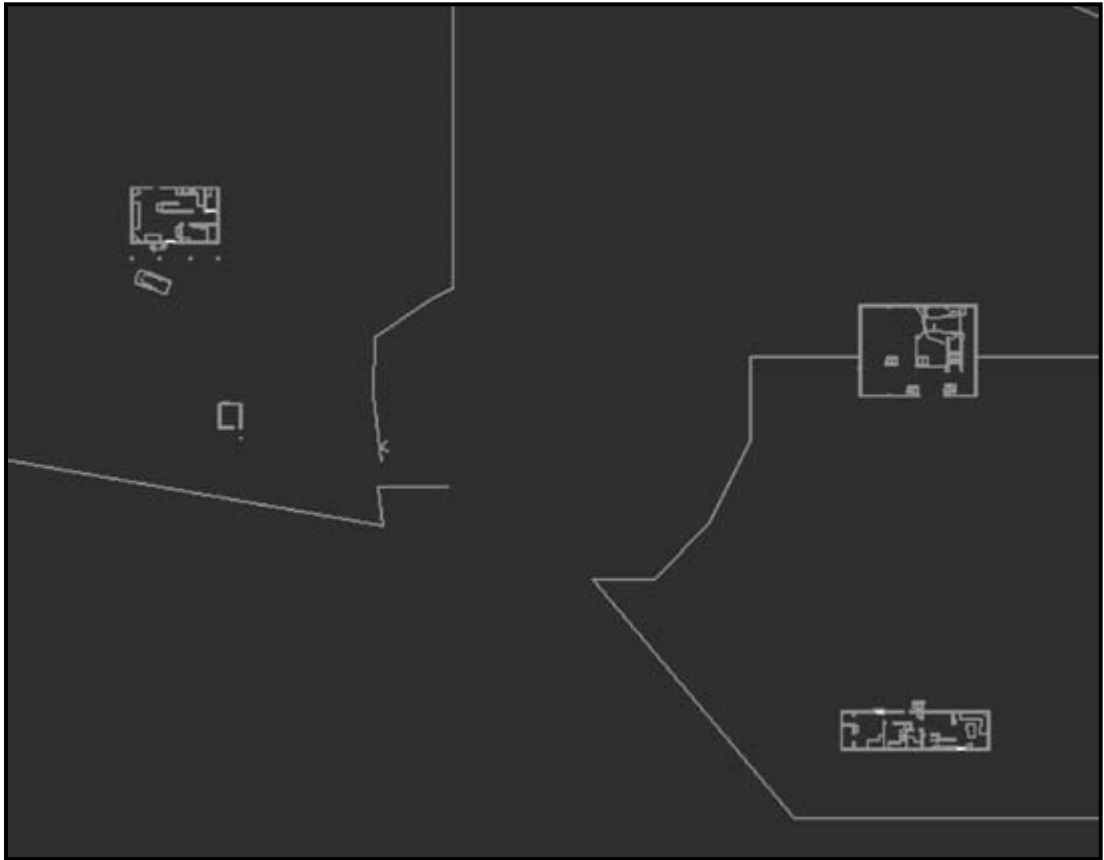

MILITIA COMPOUND, ABOVE GROUND

M03: Warehouse

The three warehouses and the office building offer good places for defense. Large windows in the office building look out on the central area of the facility, providing good sniping positions. You need night-vision goggles while outside in the dark. If you have to defend a building, consider sending part of your team outside to take cover behind crates or other objects and create a fire lane perpendicular to the route the enemy will take to get to your building. They often don't expect to take fire from their flanks. Be sure to watch your own flanks. Assault rifles are a must for this map, and an LMG can be great for covering the outside area.



DEVELOPER TIP

If the reticule moves too quickly for you to aim, you can change your mouse sensitivity in the Options menu.

DEVELOPER TIP

Winning all five gold medals for one character in a campaign is an extraordinary feat. Can you do it?



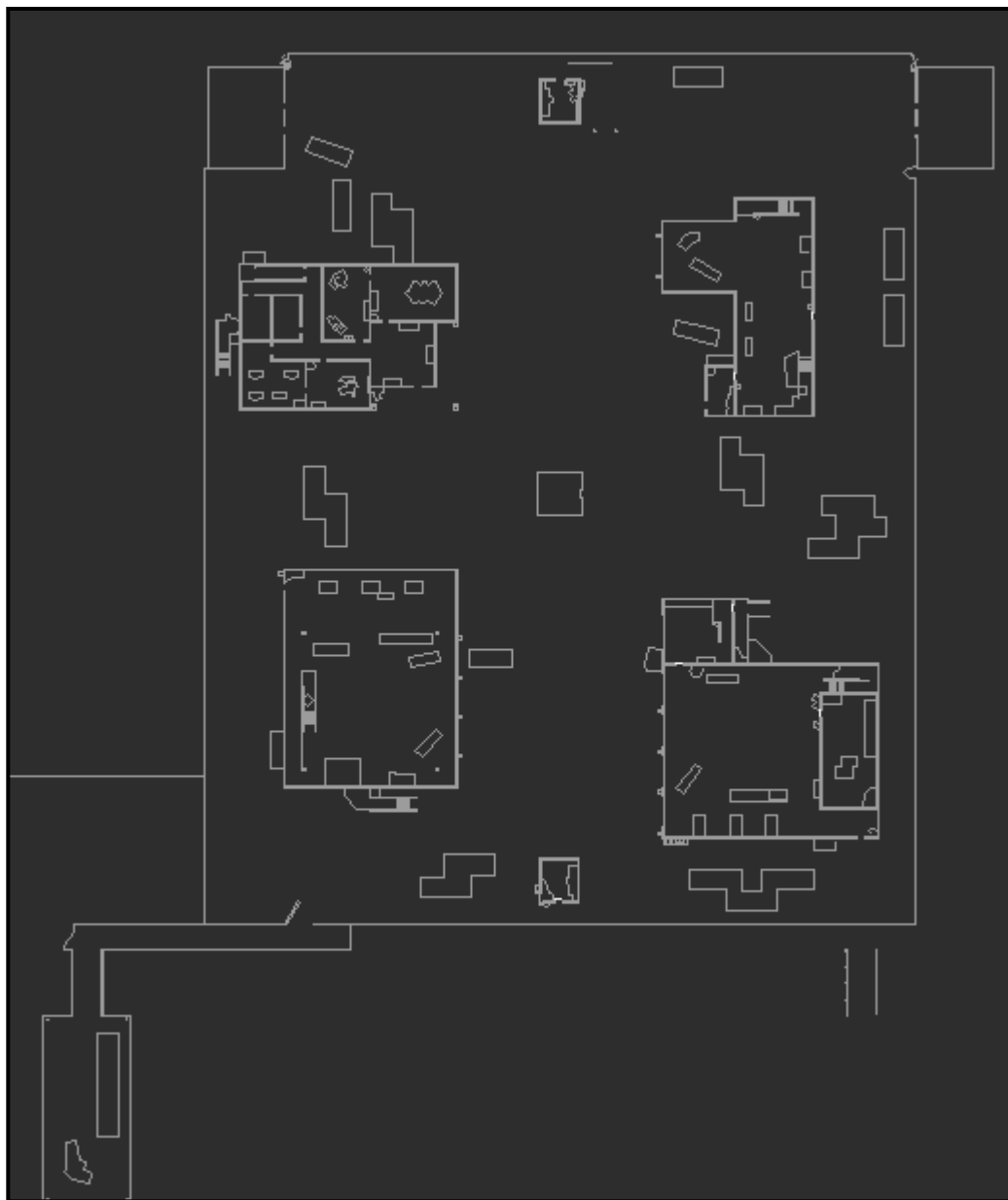

WAREHOUSE COMPLEX, FIRST FLOOR

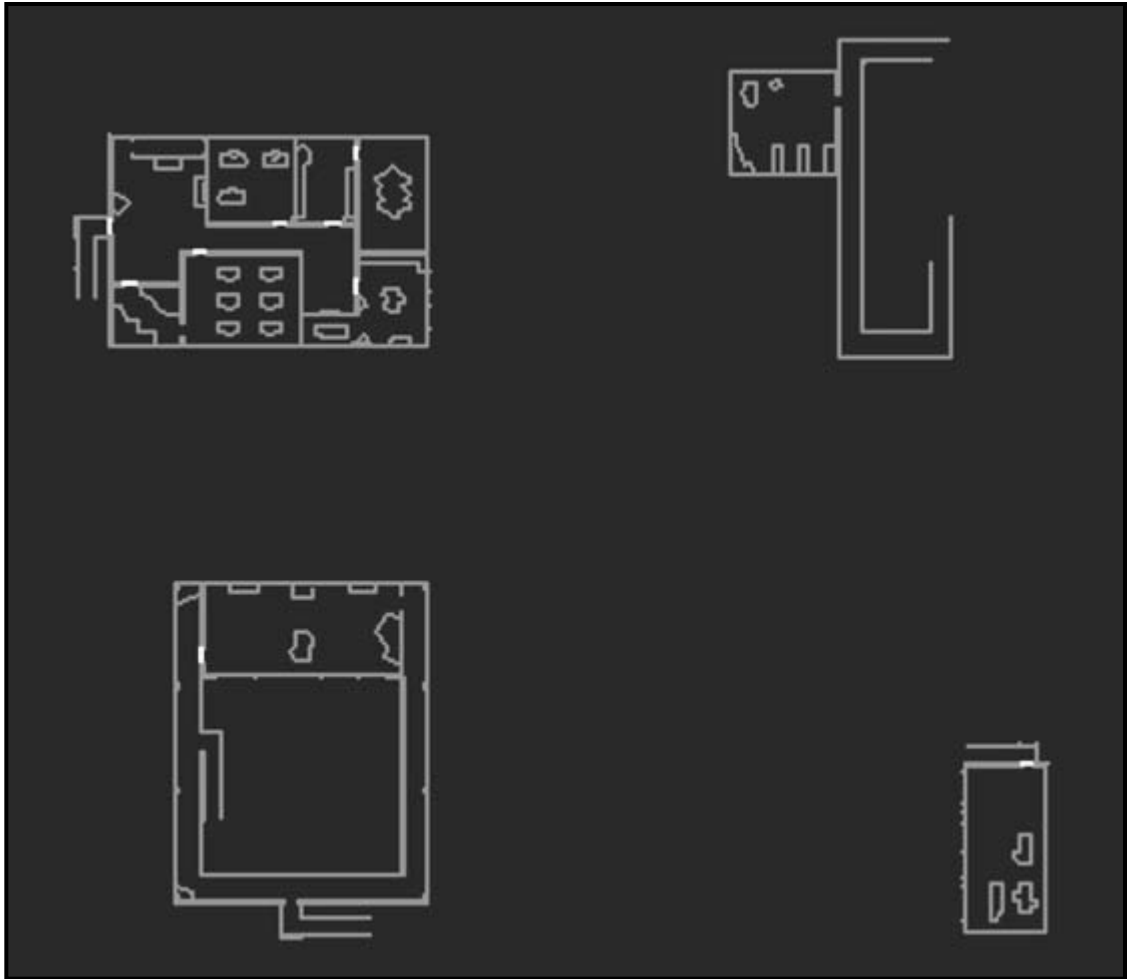

WAREHOUSE COMPLEX, SECOND FLOOR



M04: Weapons Facility

The weapons facility offers an outdoor area, several narrow passageways, lots of objects to hide behind, and a large central room. A catwalk runs around the edges of the central room, so position players up high where the enemy cannot detect them with heartbeat sensors. From the catwalk, all of the access points can be covered, and three or four players can hold this room indefinitely. The automatic doors slide open, so don't worry about standing back so the door doesn't block your shots. The loading dock is the choke point between the underground complex and the ground level; a defensive strategy should take this into account.



WEAPONS FACILITY

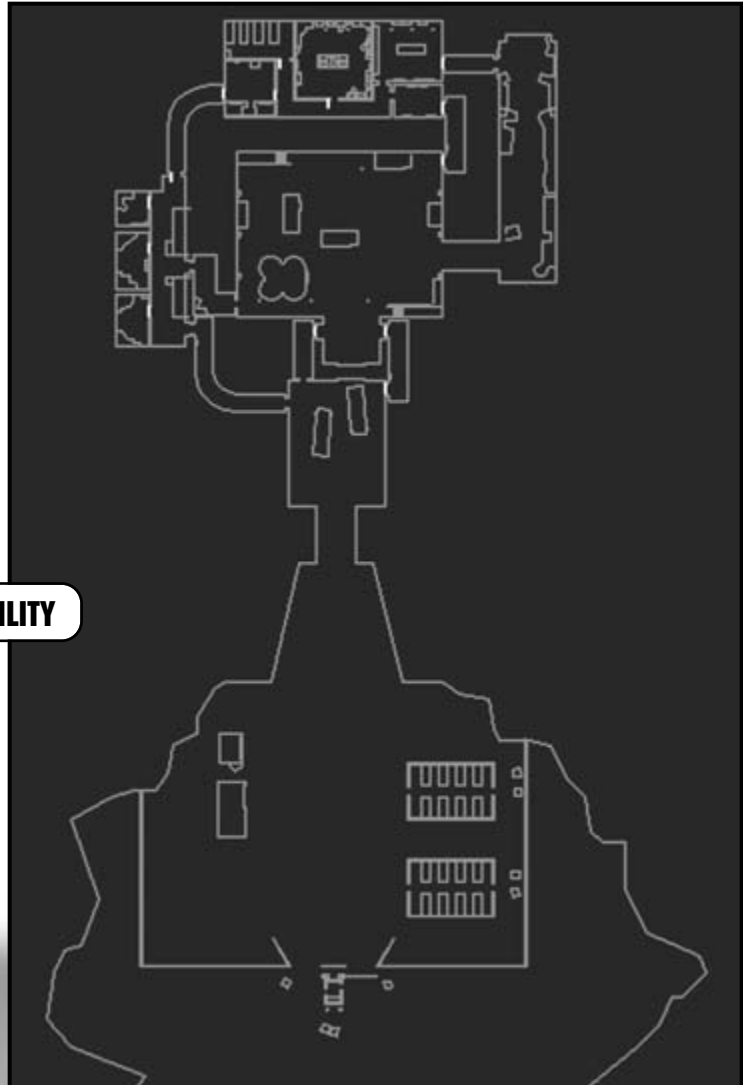

M05: Prison

The prison is a dangerous map. In the central area and the guard towers, second-level sniping perches let you fire down on your enemies. The guard towers make good defensive positions.



PRISON, FIRST FLOOR

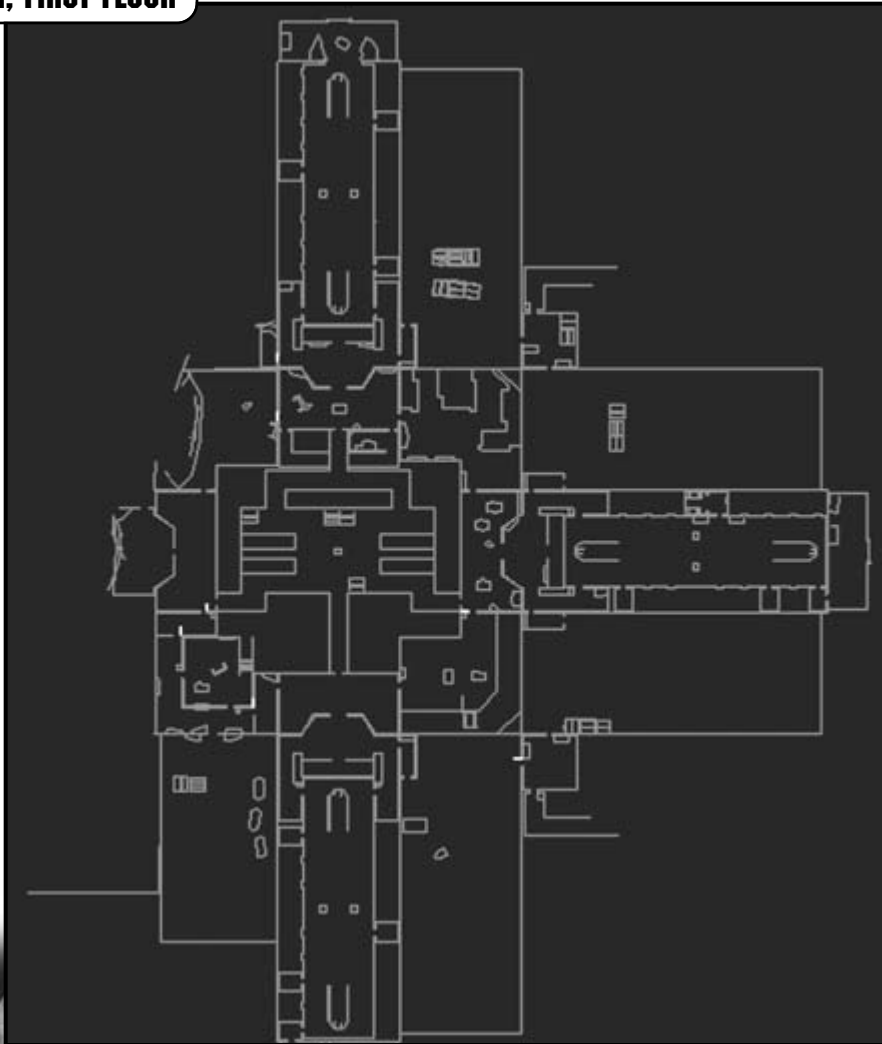

Be careful in the cell blocks, where only a few entrances can be covered from a distance. When defending a cell block, position your team on the catwalks so the enemy below can't detect you with heartbeat sensors. If you have enough people on your team, keep one player in a safe place on the ground floor, such as in a cell, to act as a spotter. He or she should monitor attackers with the heartbeat sensor and warn the players above.

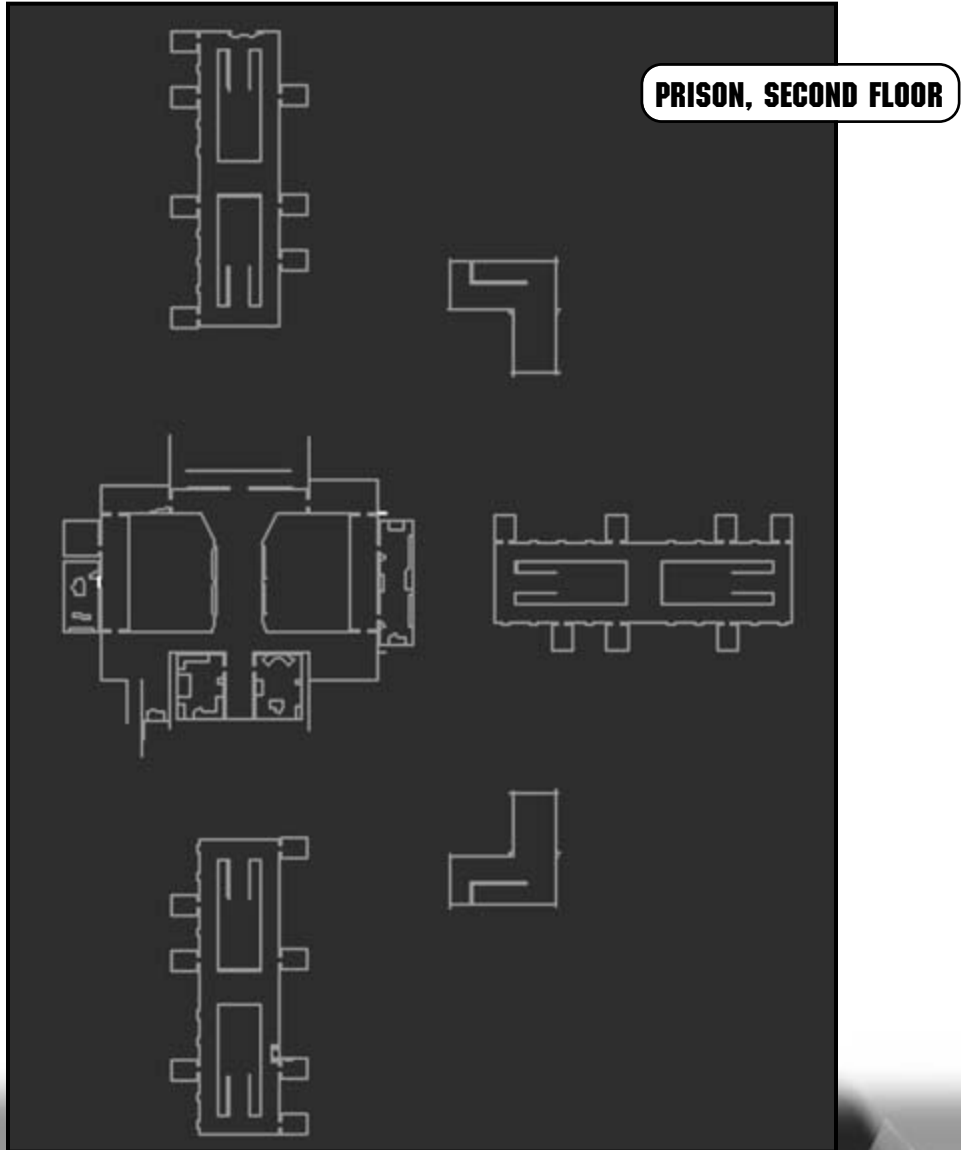

M06: Mercenary Compound

This is another map with several buildings and wide-open areas between them. The limited number of exits makes it easy for a sniper to keep a team shut up in a building. If you are defending a building, send players outside behind cover to guard the entrances.

Only the recreational building has a second floor; it consists of a large room and a hallway. A single player positioned at the far end of the room can cover the hallway from a distance. An operative wielding an LMG can deny access to an entire team and make an assault a bloodbath.



MERCENARY COMPOUND, FIRST FLOOR

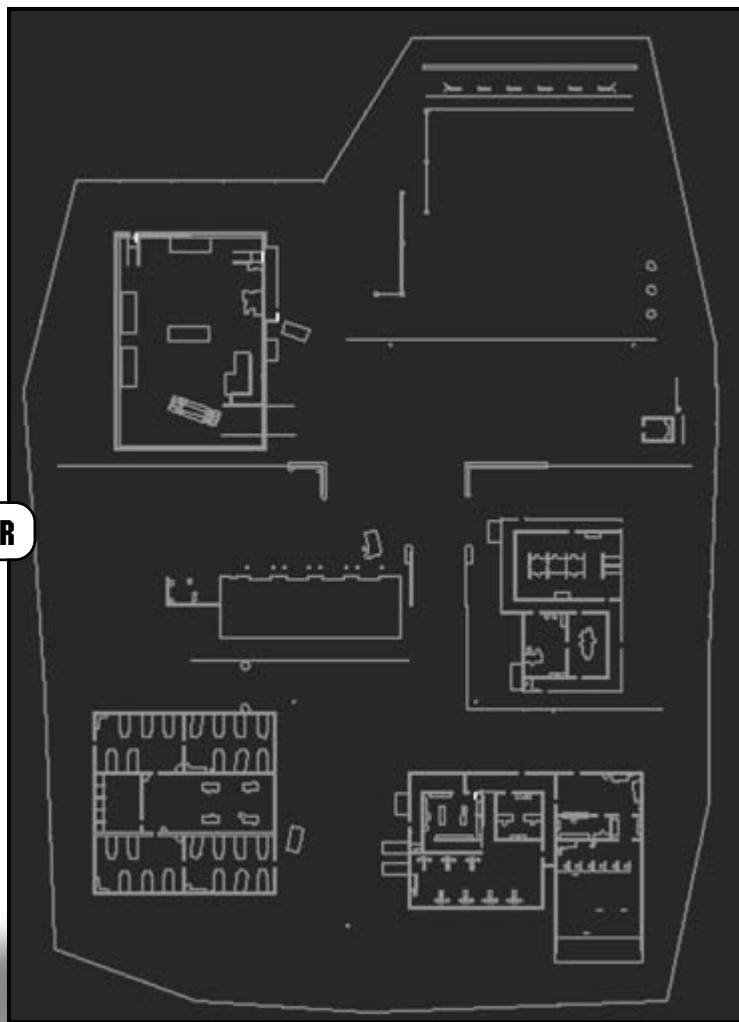

To defend the barracks, open all doors, then position your team to cover the doors to the outside from inside. Select positions in rooms adjacent to the entrances. This keeps you far enough away so the enemy can't throw grenades at you, but close enough to get a good shot at whoever steps through the doorway.



MERCENARY COMPOUND, SECOND FLOOR

M07: Diamond Mine

Here you have five different buildings and the open grounds at night. Wear night-vision goggles while outside and set up sniping or covering positions outside to cover the building entrances. The catwalk at the large processing facility works great for covering the entrances from the inside. Also, the conveyor belt connects it to an adjacent building. If you have to defend both buildings, use the conveyor belt as a protected passageway between the two.

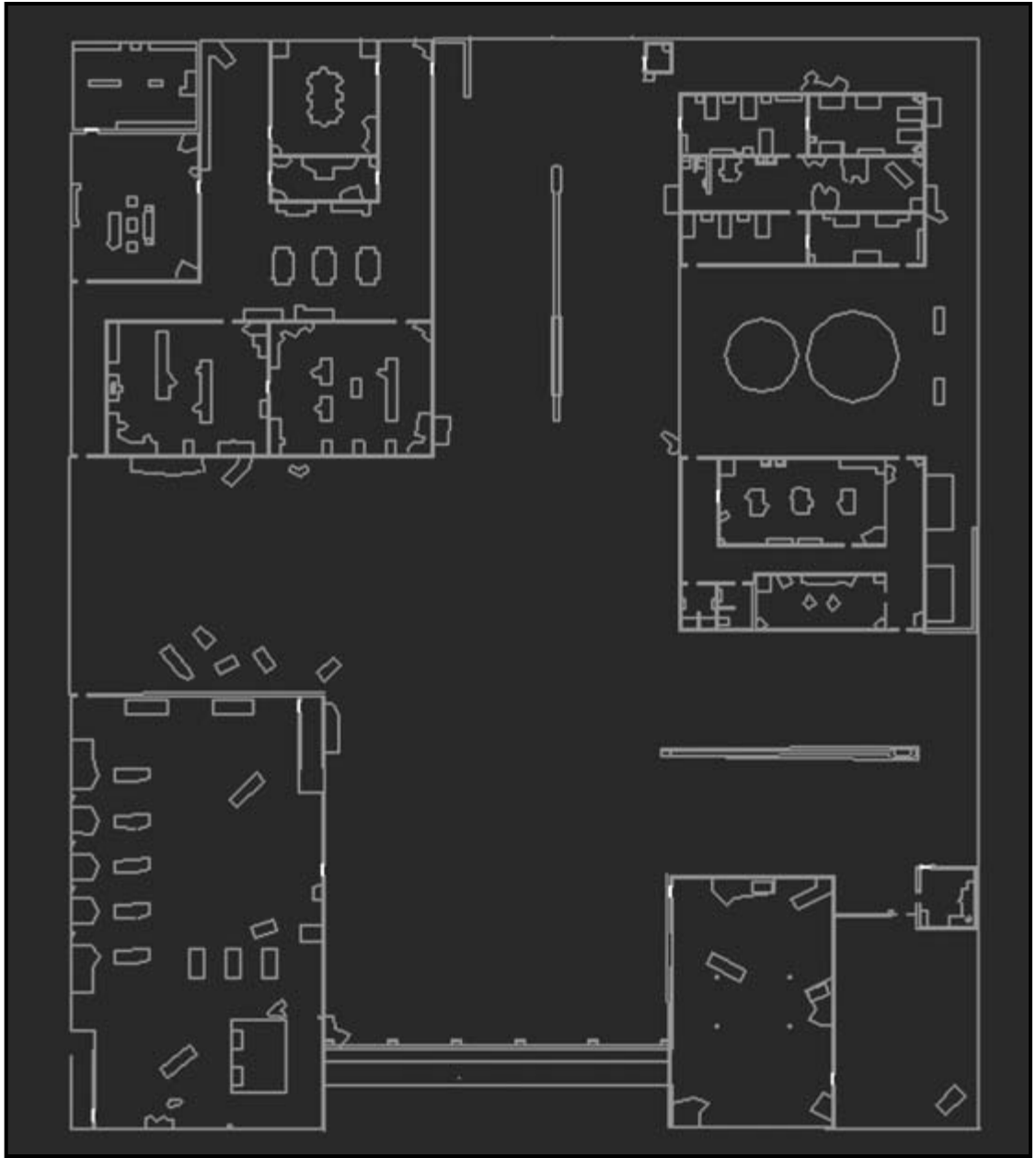

Defend the building with the vault from inside, too. Open the doors and position a player in the vault to cover one entrance while another player is out in the large central area, covering the doorway to the room with the second exit. The tangos can enter this first room but will be killed if they go any farther.

**DIAMOND MINE**

M08: Olson's Estate

The fast-paced games on this small map involve a lot of grenades and close-quarters fighting. The pool house's single entrance is hard to defend; it can be covered from the house. The primary kill zones are the long upstairs and downstairs hallways; the living room provides line of sight to the central sections of both hallways.

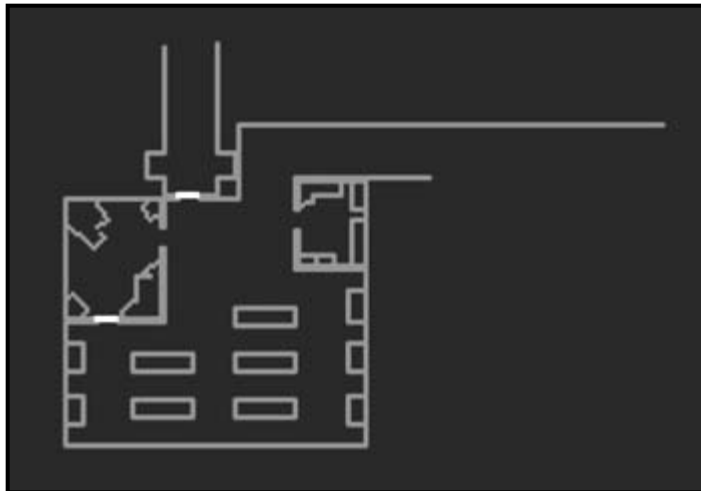

OLSON'S ESTATE, BASEMENT

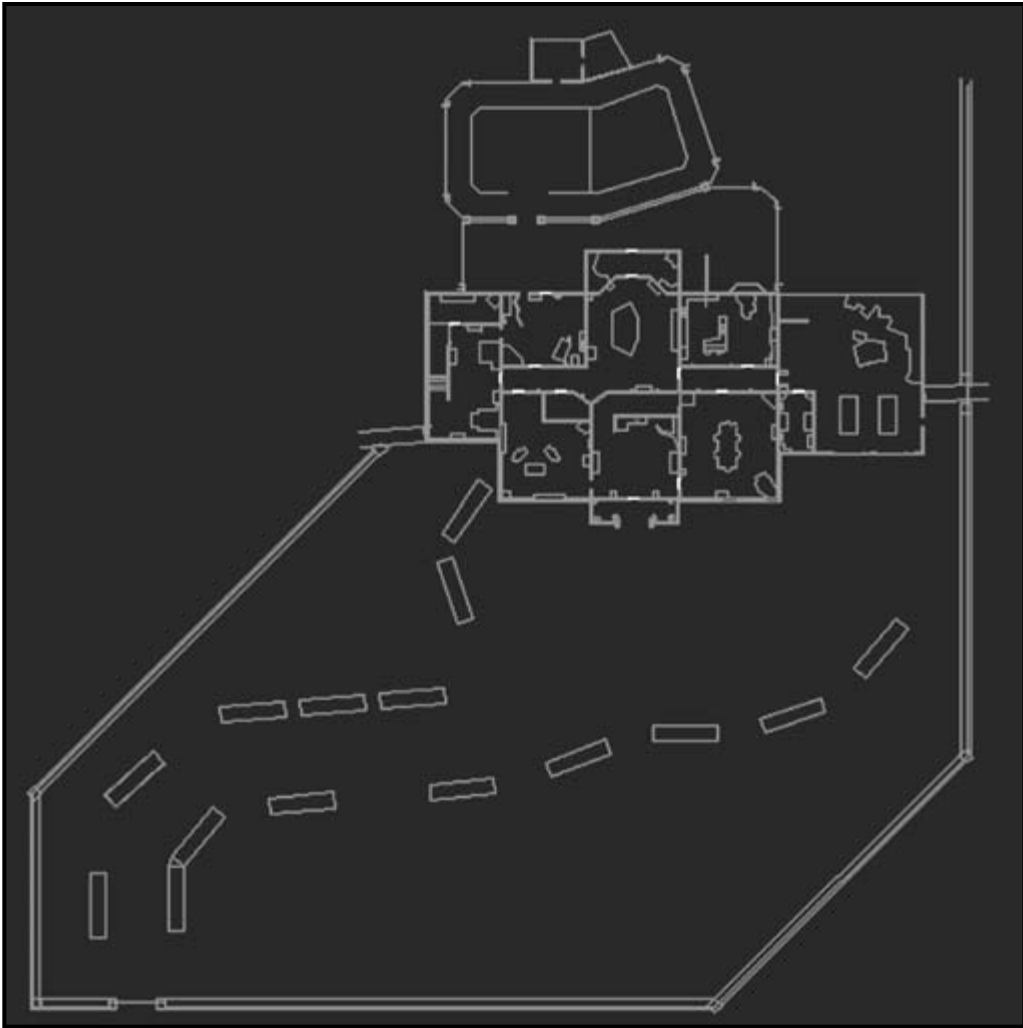

OLSON'S ESTATE, FIRST FLOOR

The cellar's plentiful cover comes in handy if the enemy starts throwing grenades down the stairs. From the large office upstairs you can cover the upstairs hallway and the stairway to the bedroom below.

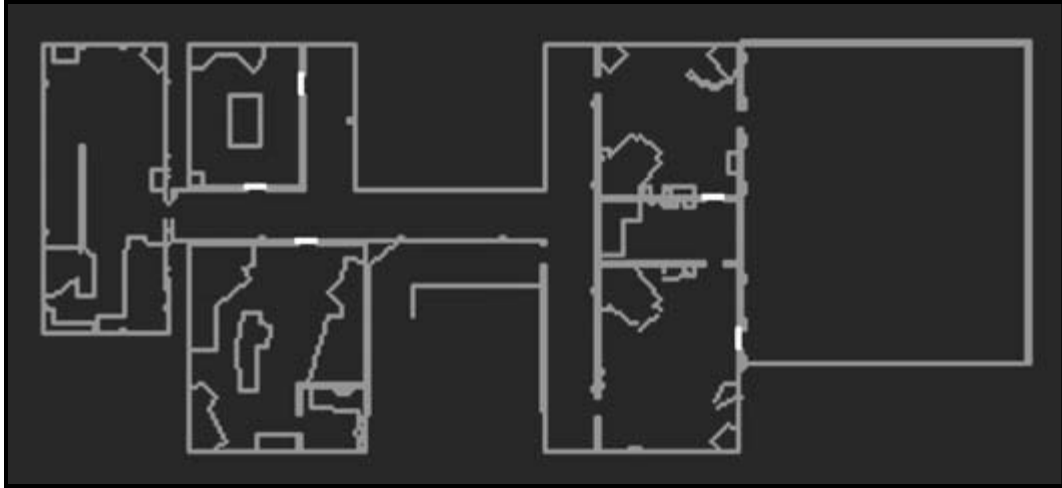

**OLSON'S ESTATE, SECOND FLOOR**

M09: Investment House

A large opening in the main building allows those upstairs to look down on the lobby, but a short wall blocks the line of sight, making this area a poor choice for a sniper position. However, the long hallways running down the side of the building, both upstairs and downstairs, are great kill zones. They are easy to defend. There are only three stairways between the floors, and the doors to them can be covered at a distance, making them dangerous. Some players use the vault as a last stand, but it is susceptible to grenade attacks. Don't get yourself cornered in the vault area.



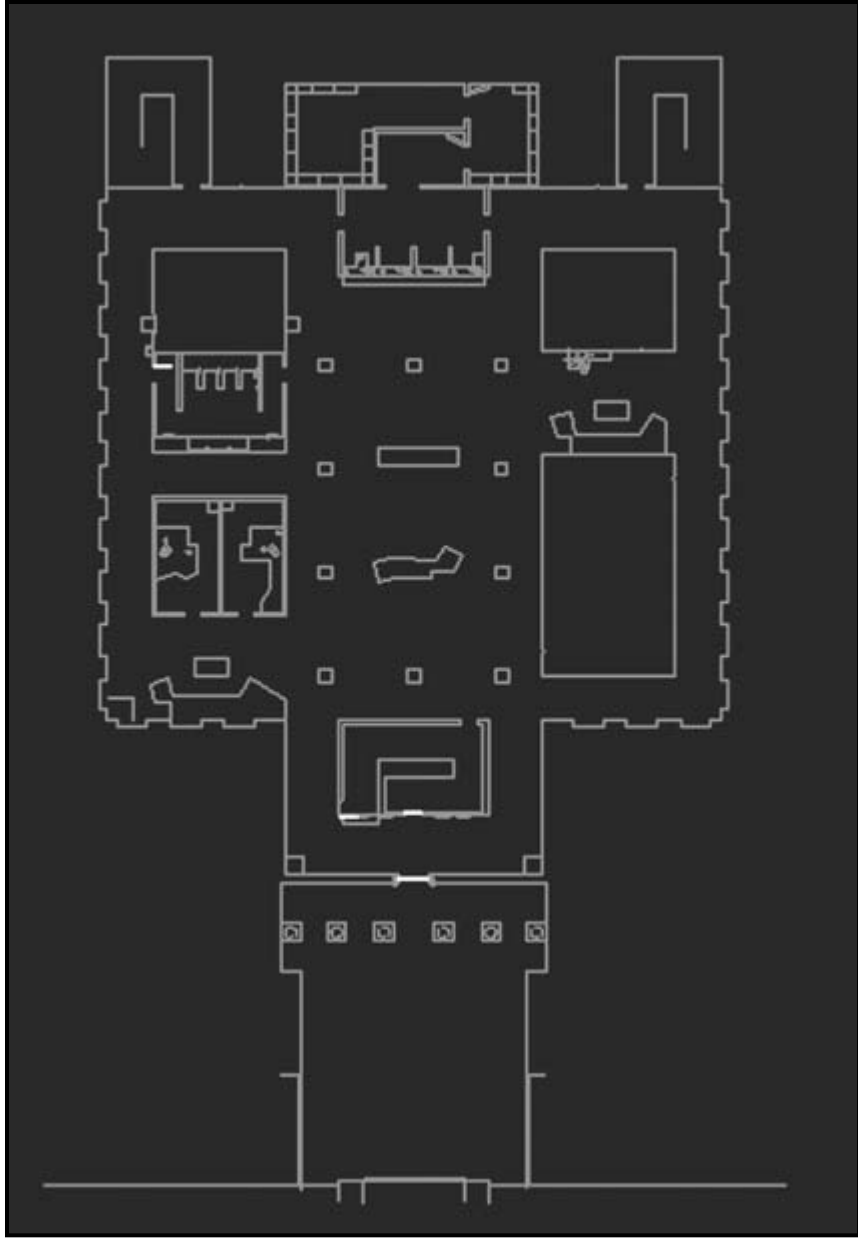

INVESTMENT HOUSE, FIRST FLOOR



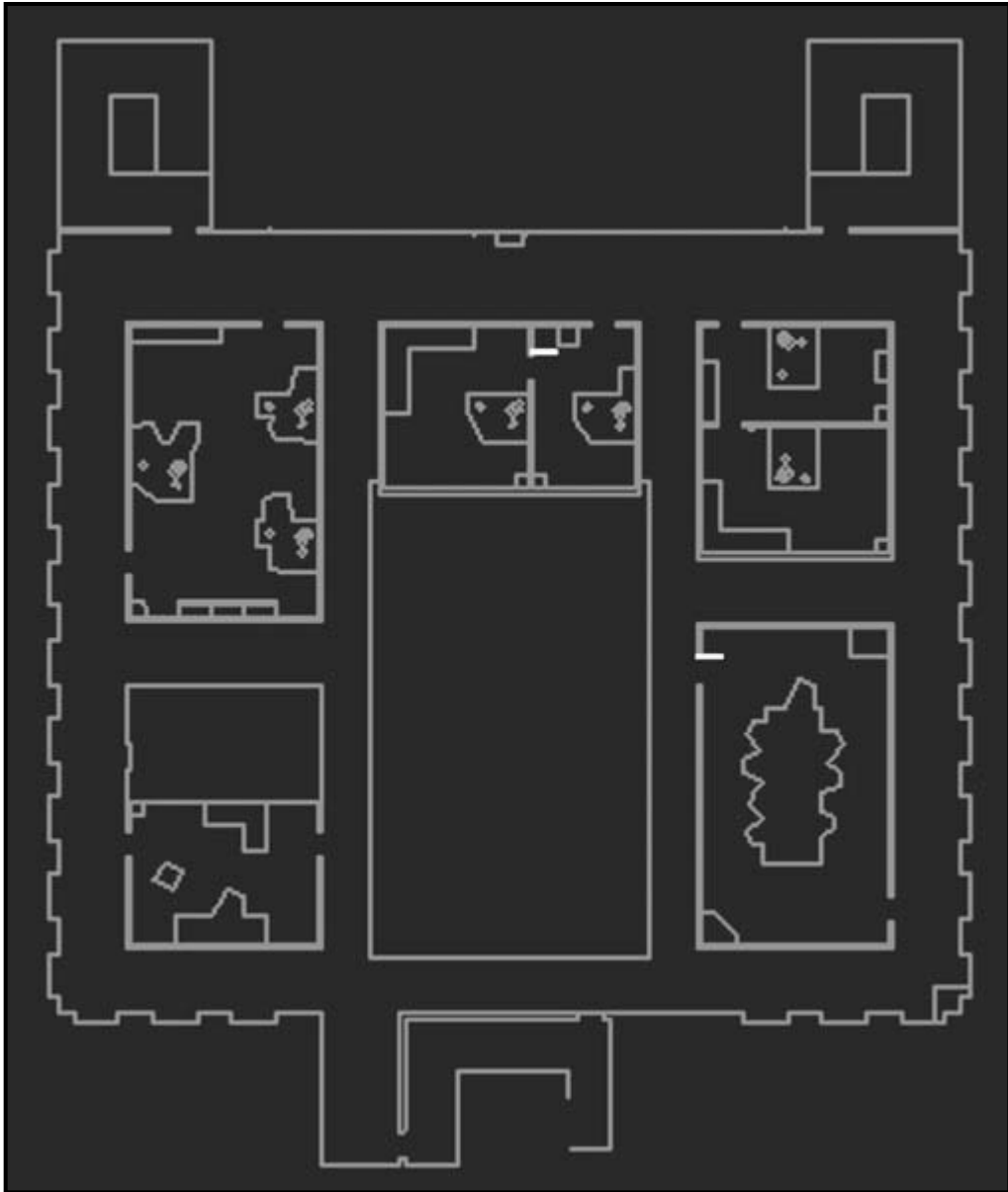

INVESTMENT HOUSE, SECOND FLOOR

M10: Corporate HQ

The headquarters building comprises three floors inside and three outside levels. Dead-ends are few, so flank your opponents and get to their rear. Set up the long hallways as fire lanes and position snipers or players with assault rifles outside to cover the entrances.



CORPORATE HQ, BASEMENT

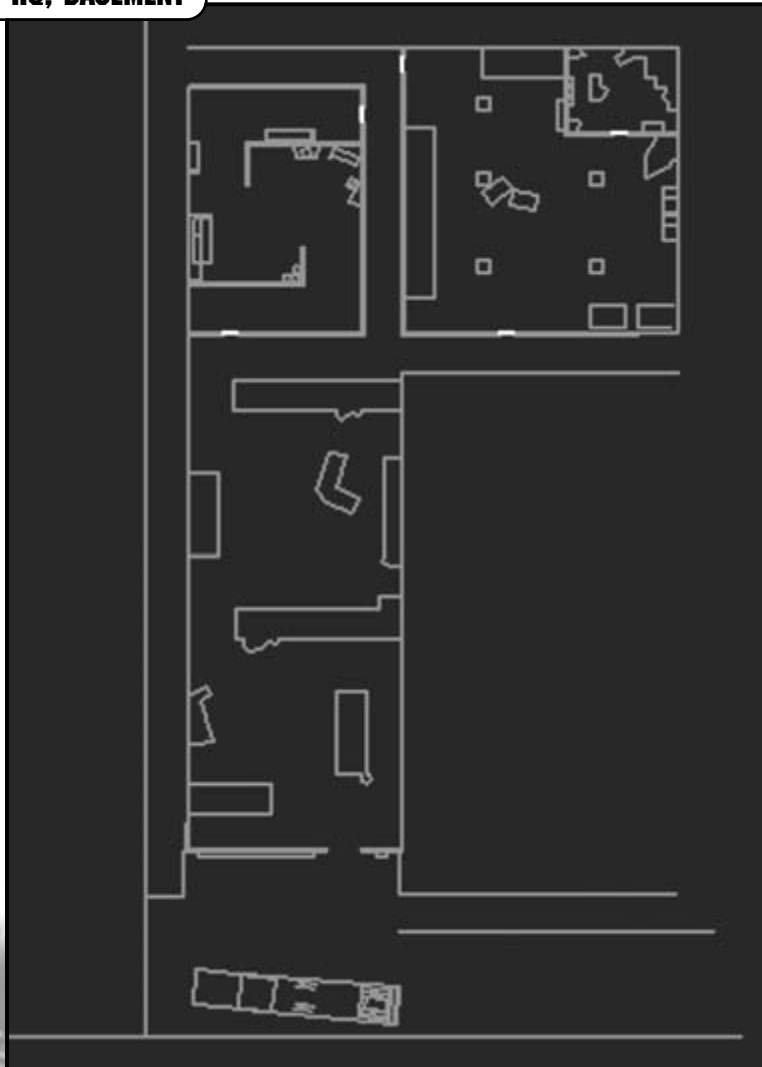

The third floor patio area is an excellent spot to hole up. Cover the single doorway leading out to the patio from a distance. Some external stairs form the only other access. You can cover the top of the stairs from a distance or position a player at the top and gun down anyone who tries to come out the door below. Throw a frag grenade down the stairs as an enemy opens the door. The challenging basement level requires resourcefulness to defend or assault.



CORPORATE HQ, FIRST FLOOR

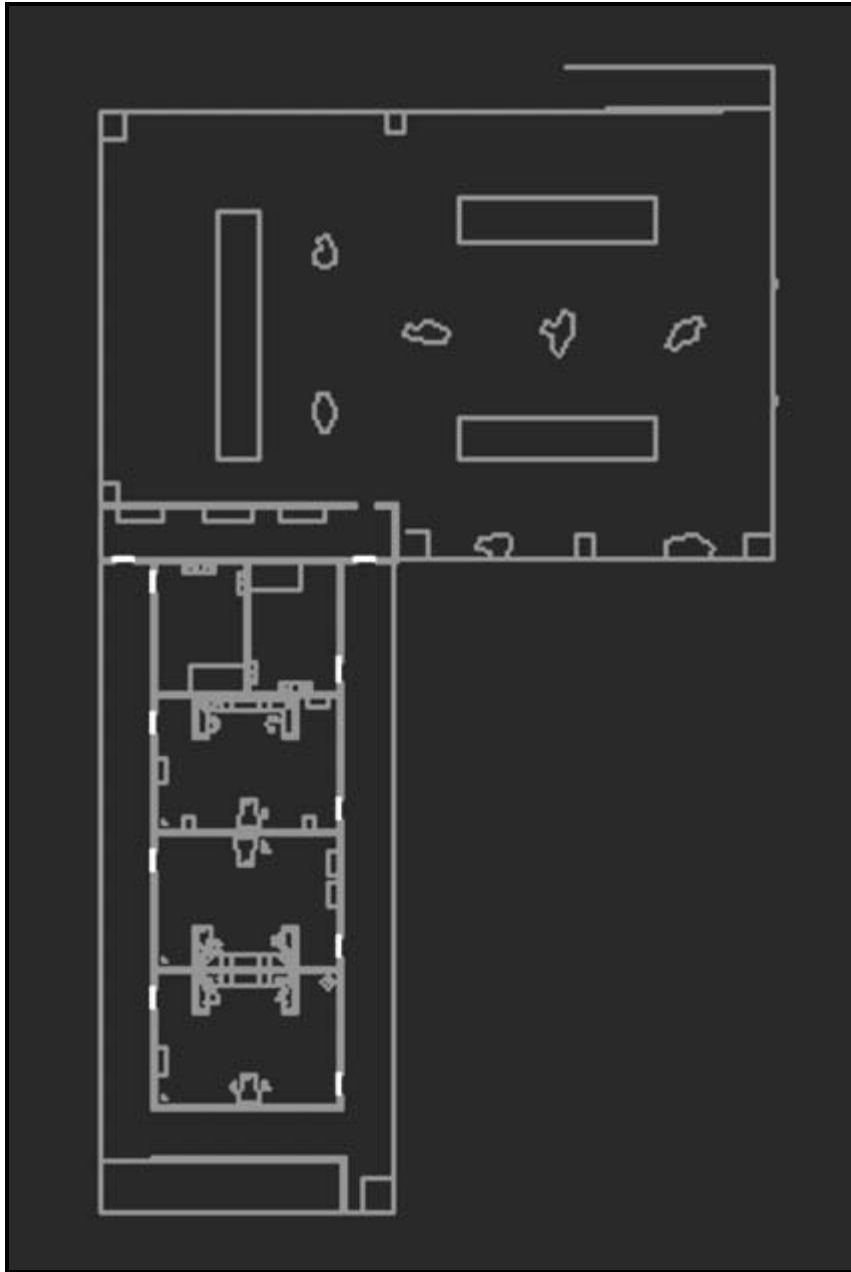

CORPORATE HQ, SECOND FLOOR



M11: Dressler's Estate

This mansion consists of a lower floor, an outside area, and two upstairs wings, which are not connected to one another. Each wing has two staircases that are the only access points. The large stairway on the west wing is best defended from the top, while the other stairways can be covered from a distance or through an adjacent room.

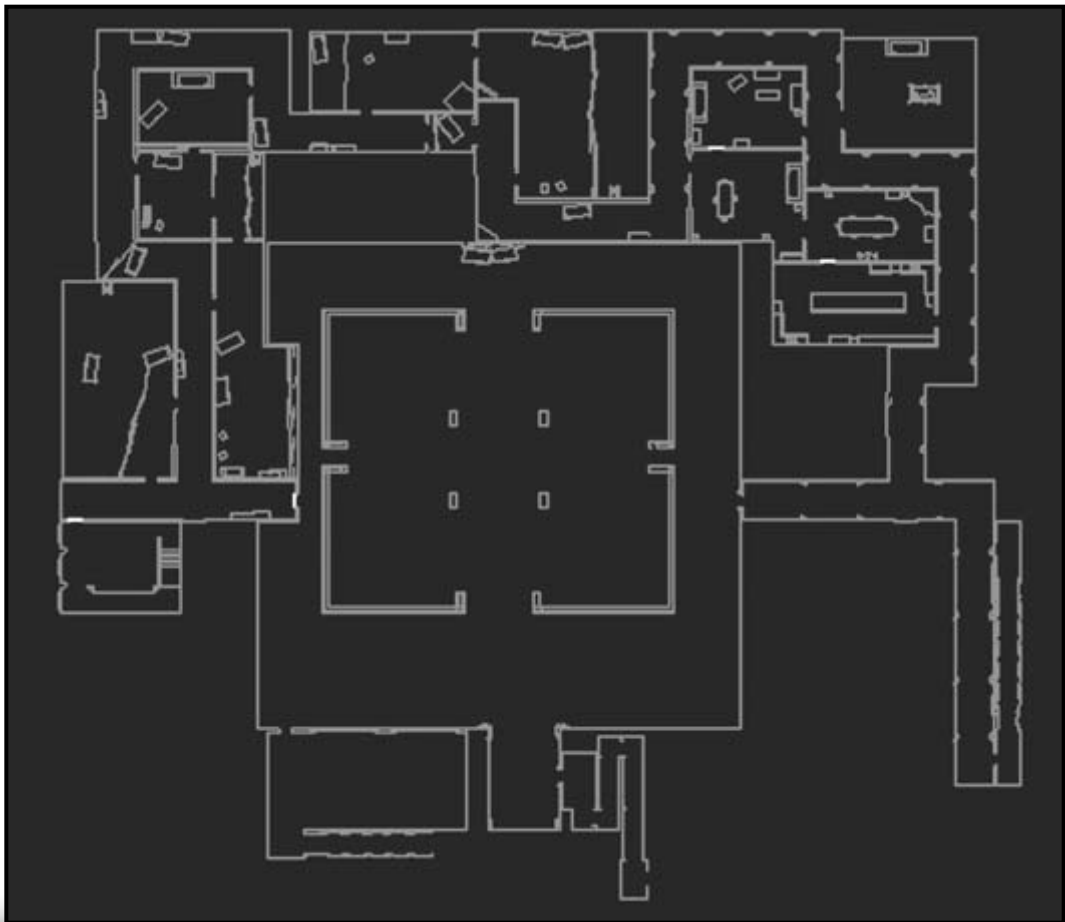

DRESSLER'S ESTATE, FIRST FLOOR

Parts of the mansion are undergoing renovation. Scaffolding and plastic partitions block doorways and force you to detour. However, you can see and shoot through the plastic. Take advantage of this fact to set up ambushes.

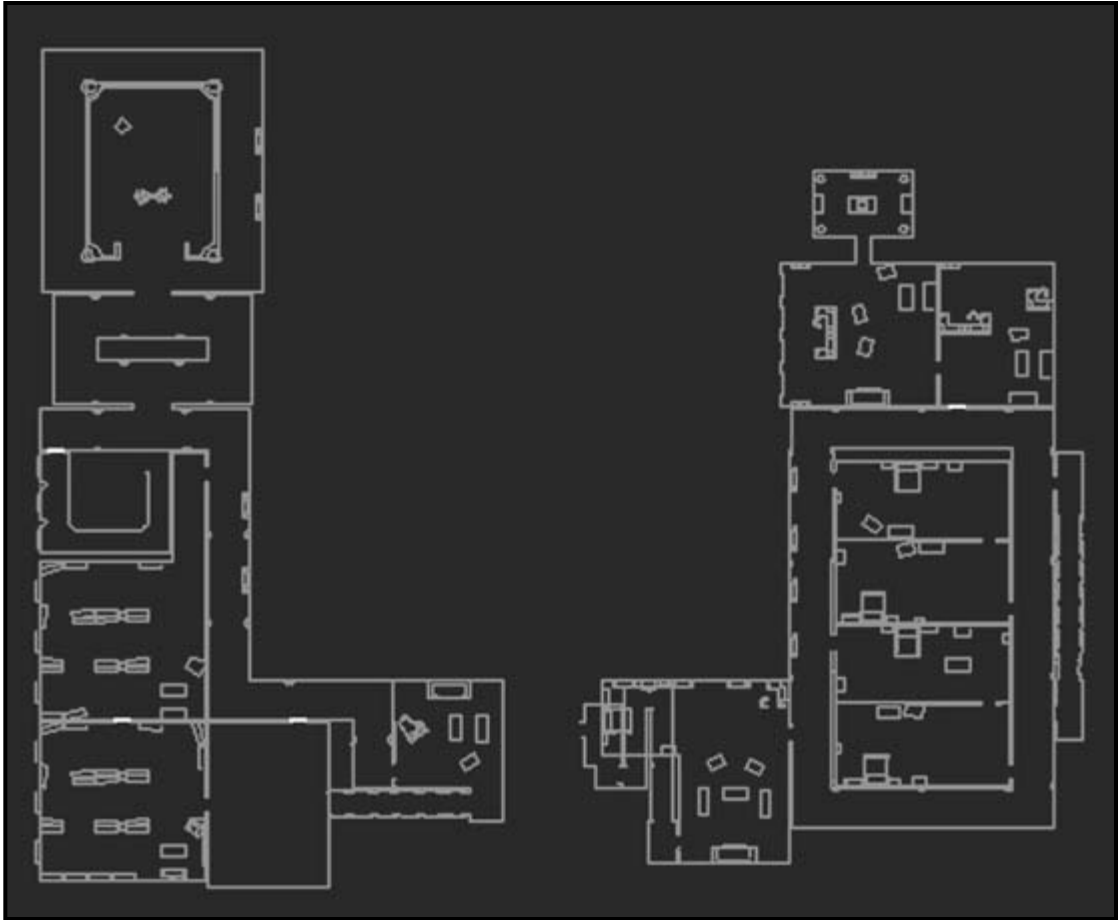

DRESSLER'S ESTATE, SECOND FLOOR



MP01: RSE Offices

The single-level office building presents a big challenge. The hallways become kill zones when they are used for fire lanes to cover all of the doorways along them. Grenades and the grenade launcher work well on this map. Exit the building to get around choke points or to flank the enemy. Put on night-vision goggles for outdoor operations and in the dimly lit offices. The high cubicle walls make throwing a grenade over them difficult—it might bounce back toward you.



MP02: Athlete

The athletic complex is primarily all one level with a small basement that surrounds the pool. Two stairways access the basement, making it fairly easy to defend. The swimming pool area and the gymnastics room are the two main rooms. The gymnastics room contains an elevated platform you can crouch behind for cover. These large rooms have at least two access points. The turns and corners of the restroom and locker rooms present a challenge. But the main hallways offer good clear lines of fire, allowing you to keep enemies boxed into one area.

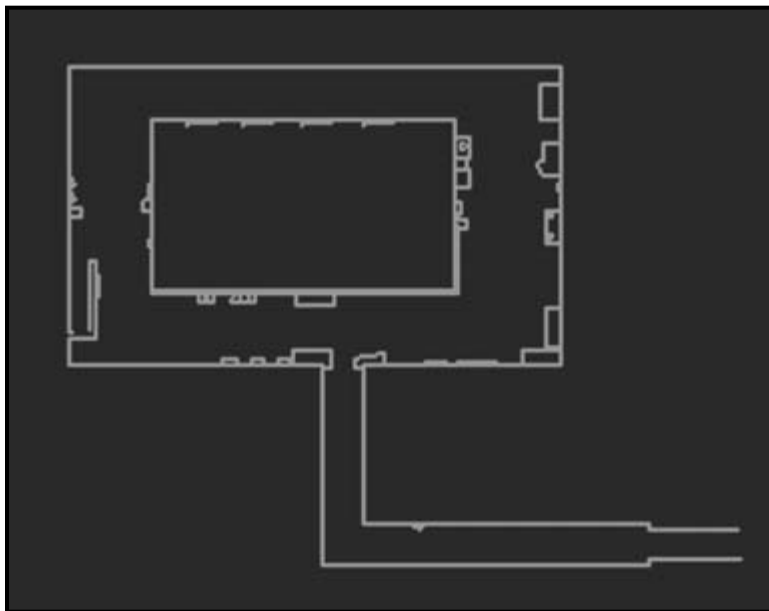

ATHLETIC COMPLEX, FIRST FLOOR



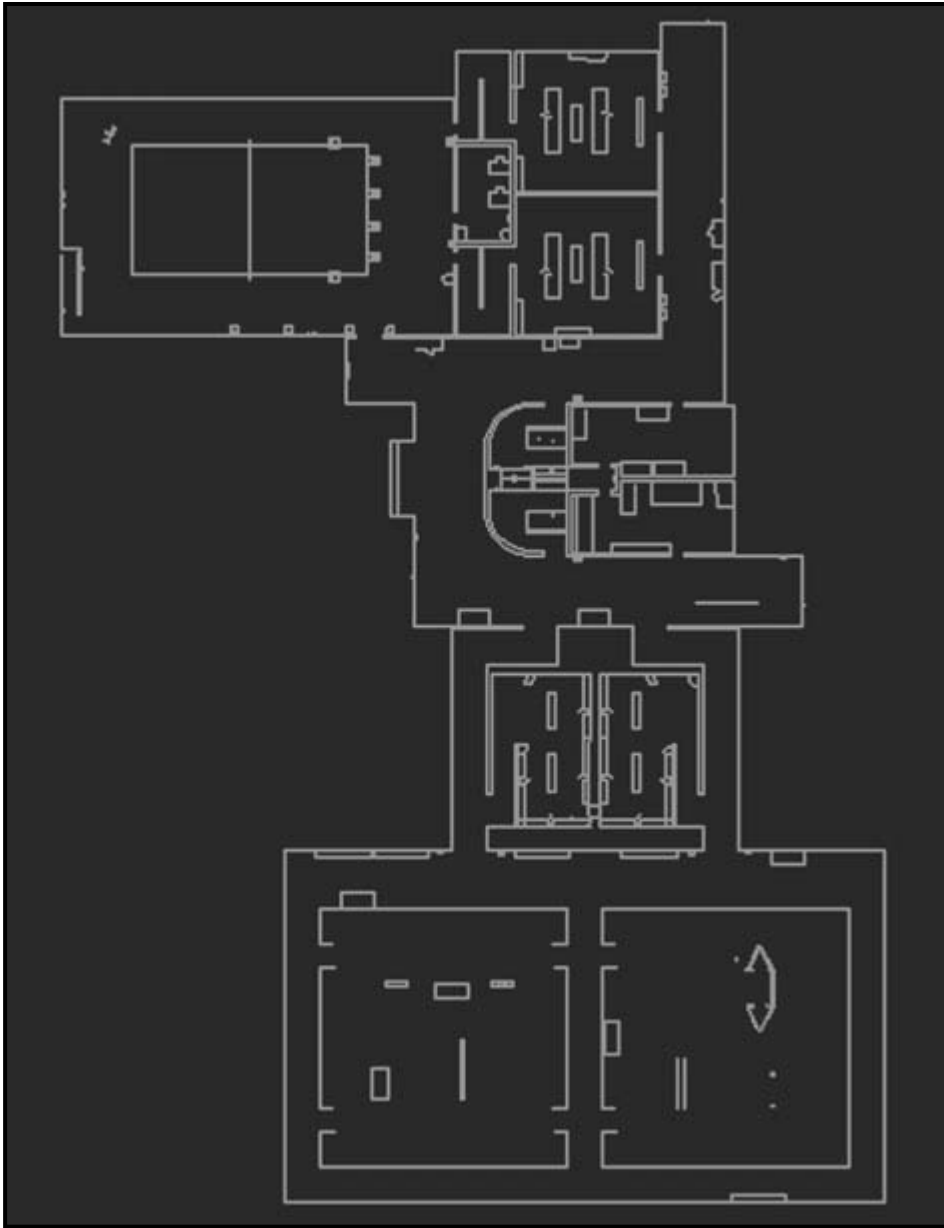

ATHLETIC COMPLEX, BASEMENT

MP03: Killhouse

The killhouse complex comprises two main fortresses that can be divided into four mini forts. Access between the two forts is across an open area with lots of walls and crates to provide cover. A small building in the middle of the map serves as a holding position, but it's tough to defend and vulnerable to grenades. To control this map, secure one corner and slowly expand. Be careful to cover all paths to your secured area so enemies cannot get in behind you.

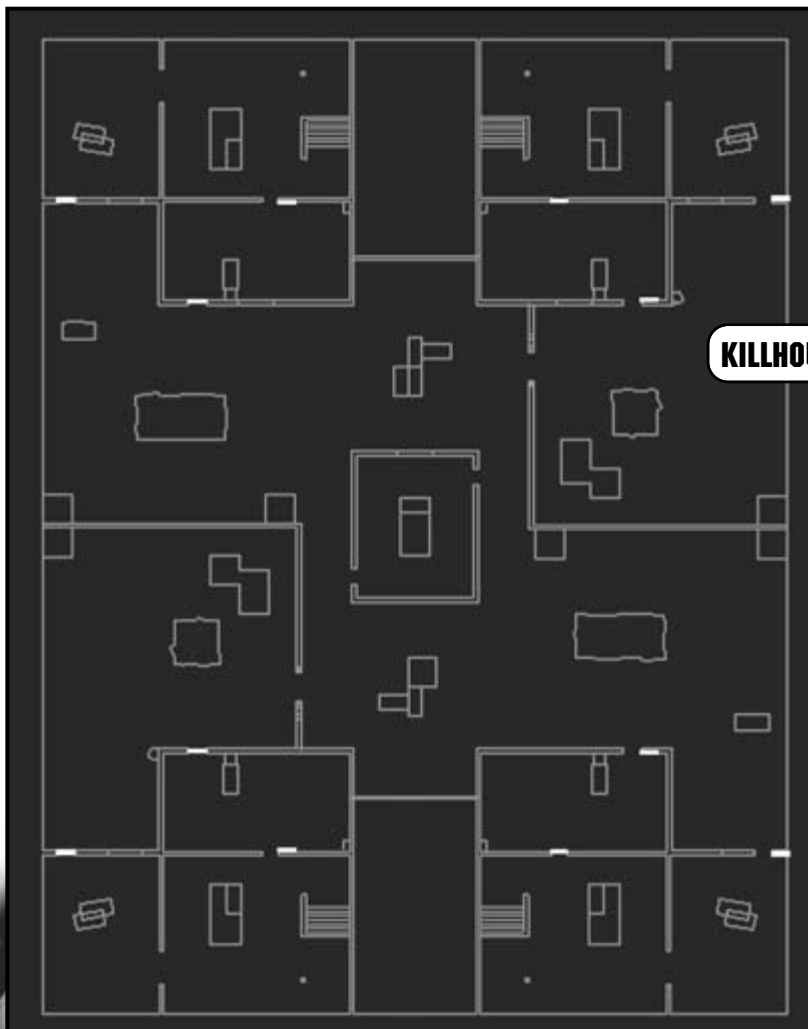

KILLHOUSE, FIRST FLOOR

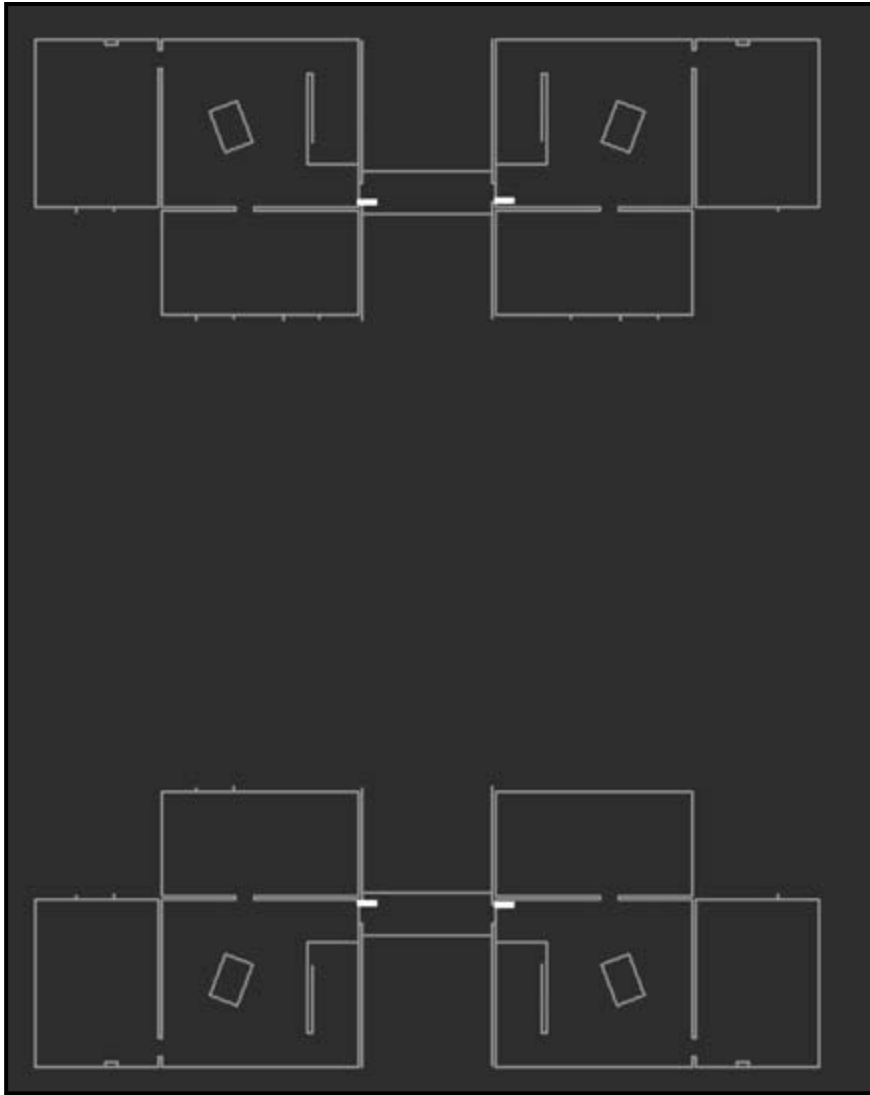

KILLHOUSE, SECOND FLOOR

MP04: Parking Garage

This is a tough map. To move through the wide-open level, use vehicles and other objects for cover. Carry carbines or assault rifles because most fighting takes place at medium range. Set up fire positions near cars and other types of cover. Frag grenades work great on this level since you can throw them right over obstacles to take out enemies on the other side. Just be careful—frag grenades work against you as well. Keep moving, and don't camp behind a car—you'll just invite a fragging.



PARKING GARAGE

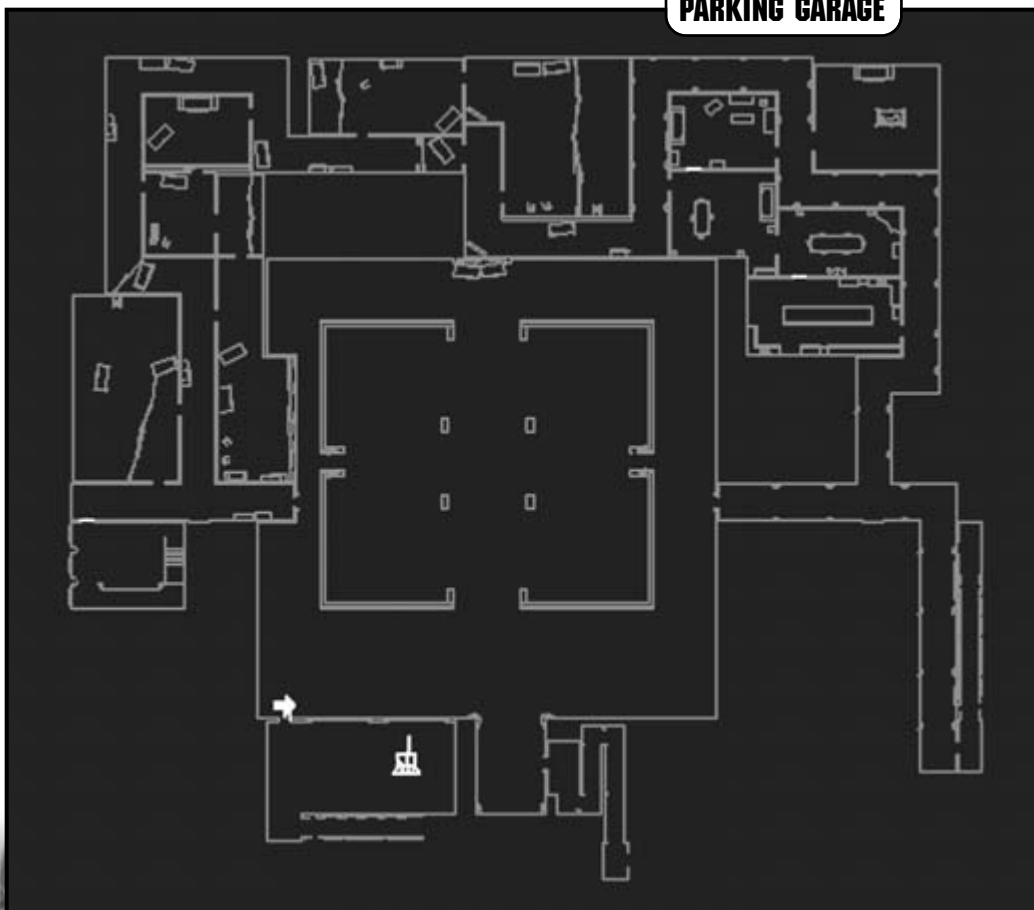

MPO5: Reservoir

The reservoir map contains open outdoor areas, buildings, and tunnels. Some of the stairways and ramps are long. The tunnels are the easiest to defend; some long straight passages provide good fire lanes. However, a sniper positioned at the top of the dam structure can dominate the area below. Position players in the buildings and shoot through the windows at anyone crossing the bridge.



RESERVOIR, LOWER LEVEL

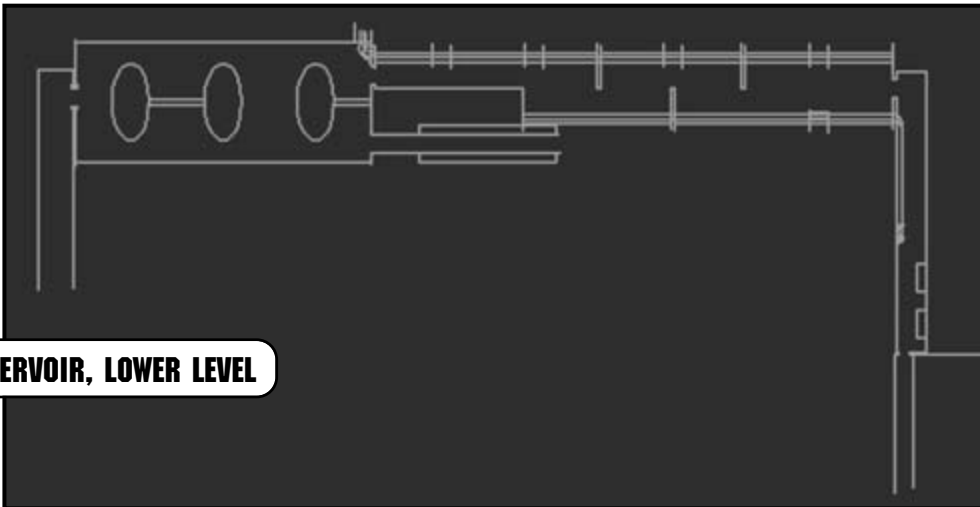

RESERVOIR, UPPER LEVEL

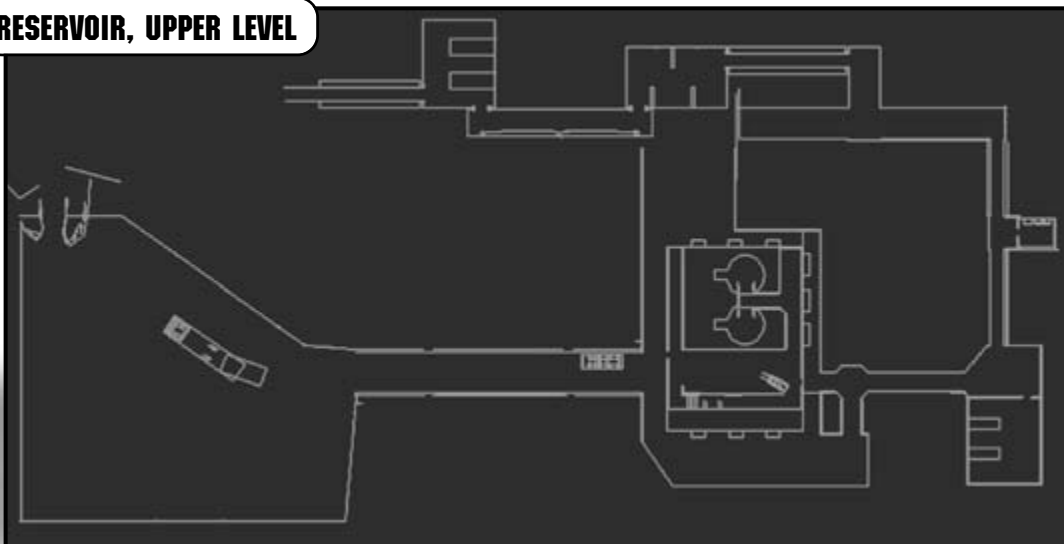

MPO6: Art Gallery

The art gallery, one of the smallest maps in the game, provides fast and deadly missions. Large openings expose every room. The only safe places are the corridors along the front of the building that access the office rooms. The offices may seem safe, but they sometimes have only one entrance, becoming death traps. To assault enemies in an office, blast in the door with a frag grenade, then send more grenades through the doorway.

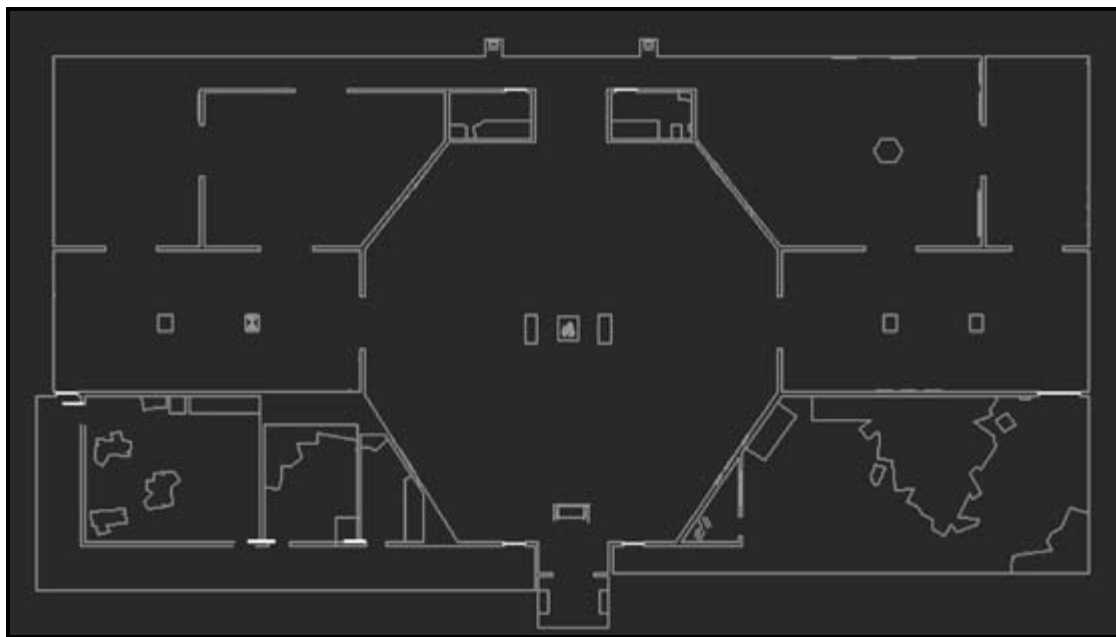

ART GALLERY



MP07: Training

The training center map is a lot of fun. It combines the outdoor range areas with small structures and the main building. The downstairs hallways surround the central killhouse and provide access to the ranges. Upstairs, you can fire through the windows and even shoot down through the grates in the floor at enemies below; they can't detect you until you start firing. The long hallways are easily covered from a distance.

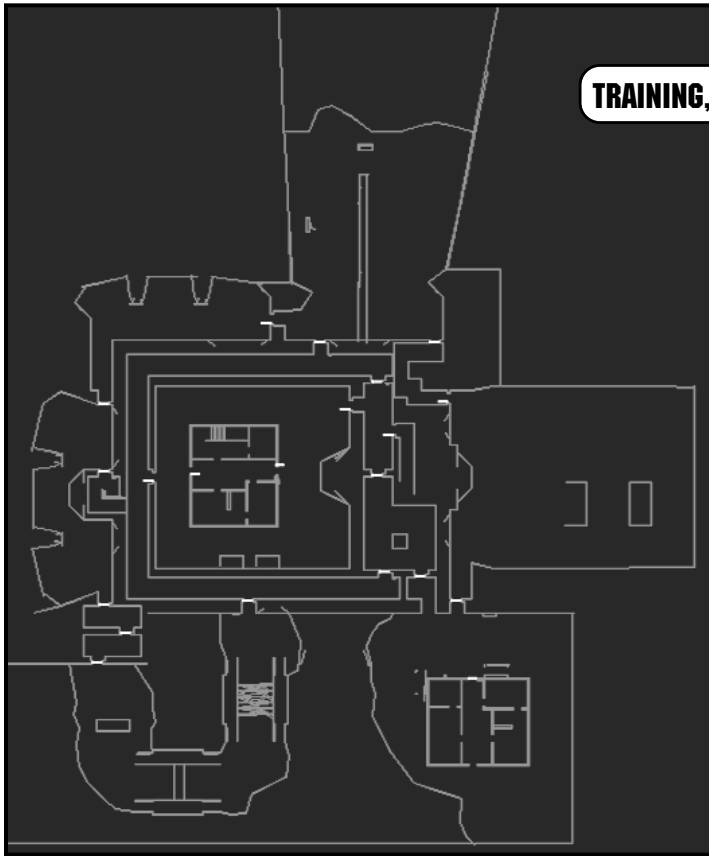

TRAINING, FIRST FLOOR

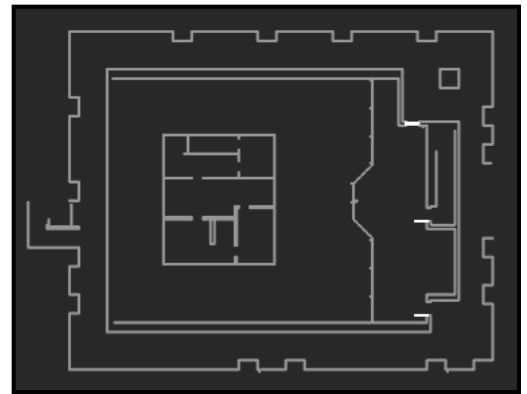

TRAINING, SECOND FLOOR