

**PRIMA'S OFFICIAL STRATEGY GUIDE**

**DETAILED  
RAINBOW  
OPERATIVE  
STATS**

Tom Clancy's  
**RAINBOW SIX™**  
**ROGUE SPEAR™**  
**-BLACK THORN-**



Michael Knight

[primagames.com](http://primagames.com)®



# Tom Clancy's RAINBOW SIX™ ROGUE SPEAR™ -BLACK THORN-

## PRIMA'S OFFICIAL STRATEGY GUIDE

MICHAEL KNIGHT



The Prima Games logo is a registered trademark of Random House, Inc., registered in the United States and other countries. Primagames.com is a registered trademark of Random House, Inc., registered in the United States.

© 2001 by Ubi Soft Entertainment. All rights reserved. No part of this book may be reproduced or transmitted in any form or by any means, electronic or mechanical, including photocopying, recording, or by any information storage or retrieval system without written permission from Prima Games. Prima Games is a division of Random House, Inc.

Senior Product Manager: Sara E. Wilson  
Project Editor: Michelle Pritchard  
Editorial Assistant: Etelvina Hernandez

© 2001 Red Storm Entertainment, Inc. Rogue Spear Black Thorn is a trademark of Red Storm Entertainment, Inc. Red Storm and Red Storm Entertainment are trademarks of Red Storm Entertainment, Inc. Red Storm Entertainment, Inc. is an Ubi Soft Entertainment company. All Rights Reserved.

All products and characters mentioned in this book are trademarks of their respective companies.

### Important:

Prima Games has made every effort to determine that the information contained in this book is accurate. However, the publisher makes no warranty, either expressed or implied, as to the accuracy, effectiveness, or completeness of the material in this book; nor does the publisher assume liability for damages, either incidental or consequential, that may result from using the information in this book. The publisher cannot provide information regarding game play, hints and strategies, or problems with hardware or software. Questions should be directed to the support numbers provided by the game and device manufacturers in their documentation. Some game tricks require precise timing and may require repeated attempts before the desired result is achieved.

ISBN: 0-7615-3699-X

Library of Congress Catalog Card Number: 2001095001

### PRIMA GAMES

A Division of Random House, Inc.

3000 Lava Ridge Court  
Roseville, CA 95661  
1-800-733-3000  
[www.primagames.com](http://www.primagames.com)

### ACKNOWLEDGEMENTS

I would like to thank Patrick Naud at Ubi Soft for his support as well as Michelle Pritchard and Sara Wilson at Prima Games for making this book possible. Special thanks to my wife and children for their love and support which is greatly appreciated.

# TABLE OF CONTENTS

<b>Introduction</b> .....	1	Operation: Spirit Clasp .....	100
Back In Action .....	1	Mission Orders .....	100
<i>Black Thorn</i> —The Strategy Guide .....	2	Team Assignments .....	101
<b>Section 1: Basic Training</b> .....	<b>3</b>	Strategy .....	103
Close Quarters Combat Tactics .....	4	Notes .....	108
Basics of Close-Quarter Battle .....	4	Operation: Golden Song .....	110
Multiple Teams and Coordination .....	8	Mission Orders .....	110
Heartbeats and Hostages .....	11	Team Assignments .....	111
Stealth .....	12	Strategy .....	114
Noncombatants .....	13	Notes .....	119
Sweepers .....	13	Operation: Blunt Scroll .....	120
The Rainbow Operatives .....	14	Mission Orders .....	120
Attributes .....	14	Team Assignments .....	121
Specialties .....	15	Strategy .....	123
The Rainbow Arsenal .....	31	Notes .....	128
Firearms .....	31	Operation: Broken Sceptre .....	130
Ammunition .....	46	Mission Orders .....	130
Equipment .....	47	Team Assignments .....	131
Uniforms .....	52	Strategy .....	134
Planning A Mission .....	55	Notes .....	140
Briefing .....	55	Operation: Empty Cloud .....	141
Intel .....	56	Mission Orders .....	141
Roster Selection .....	56	Team Assignments .....	142
Kit .....	56	Strategy .....	144
Team Assignment .....	57	Notes .....	150
Plan .....	57	<b>Section 3: Other Missions</b> .....	<b>151</b>
Execute .....	58	The Custom Missions .....	152
Planning a Mission .....	58	Assault .....	152
<b>Section 2: The Black Thorn Campaign</b> .....	<b>63</b>	Lone Wolf .....	153
Operation: Desert Dragon .....	64	Terrorist Hunt .....	154
Mission Orders .....	64	Hostage Rescue .....	155
Team Assignments .....	65	Defend .....	155
Strategy .....	67	Recon .....	156
Notes .....	72	Multiplayer Missions .....	157
Operation: Silent Ace .....	73	Cooperative Games .....	158
Mission Orders .....	73	Adversarial Games .....	158
Team Assignments .....	74	Additional Equipment for Multiplayer Games .....	161
Strategy .....	76	Tactics for Multiplayer Games .....	161
Notes .....	82	More Tips and Hints for Multiplayer Games .....	166
Operation: Copper King .....	83	The Maps .....	168
Mission Orders .....	83		
Team Assignments .....	84		
Strategy .....	85		
Notes .....	91		
Operation: Course Blade .....	92		
Mission Orders .....	92		
Team Assignments .....	93		
Strategy .....	94		
Notes .....	99		

# BACK IN ACTION

In 1998, a fairly new company released a new type of game. Red Storm Entertainment developed a first-person shooter that incorporated teamwork with computer-controlled operatives and a realistic combat engine. This game was based on Tom Clancy's novel *Rainbow Six*.

Unlike other games of the genre, *Rainbow Six* focused on counterterrorist operations with unprecedented realism. Mistakes didn't just cost your character a small chunk from the life bar, if the enemy hit you, you were down. A complete planning phase was also incorporated into the game, allowing a player to control up to four teams at once by giving orders to each team in advance. In addition to interesting and challenging missions, *Rainbow Six* included a multiplayer format that allowed players to work as teams to accomplish an objective. In early 1999, the *Eagle Watch* mission pack was released, adding five new missions to those in *Rainbow Six*.

Red Storm Entertainment listened to their customers, and in the fall of 1999 they released the sequel to *Rainbow Six*—*Rogue Spear*. This was a new game rather than an add-on, and it had a new engine. The game incorporated many of the aspects asked for by loyal fans of the original. *Rogue Spear* included several new weapons and abilities that made it easier to give orders to computer-controlled operatives. Then, in early 2000, the *Urban Operations* mission pack was released, adding five new missions and five original *Rainbow Six* missions that had been updated for *Rogue Spear*.

Continuing to build on the series, *Covert Ops Essentials* was a stand-alone game using the *Rogue Spear* engine. It offered several new missions and a CD-ROM training guide on counterterrorism.

Now Red Storm Entertainment has produced *Black Thorn*. This stand-alone game has a new campaign of nine linked missions involving an unknown enemy that draws the RAINBOW team into a trap.

I have had the opportunity to work with the *Rainbow Six* series since the beginning when I wrote the strategy guide for the original and also have been able to work with Red Storm Entertainment first-hand. Through all of this *Rainbow Six* immersion, I've enjoyed playing the games, both individually and with other players, and I hope that you will enjoy this newest installment as much as I have.

# BLACK THORN— THE STRATEGY GUIDE

This guide contains hints, tips, tactics and strategies to help you become a proficient counterterrorist operative, capable of taking on the worst the world throws at you. Many missions in *Black Thorn* require careful planning and coordination of various teams, plus sound tactical skills and a quick trigger finger. Don't expect to get through these missions using the same strategies you would for a standard first-person shooter. *Black Thorn* requires careful thought and quick reflexes.

This guide is organized into three main parts. Section 1 provides the basics for the game. Chapter 1 covers the tactics of Close-Quarters Battle. Chapters 2 and 3 provide detailed information on each of the RAINBOW operatives and their equipment. Chapter 4 guides you through planning a successful mission.

Section 2 provides a walkthrough for each mission in the *Black Thorn* campaign. The walkthroughs offer advice on which operatives you should use, what weapons to equip them with, how to plan the mission, and the best way to execute the mission.

Section 3 covers the other types of missions in *Black Thorn*. Chapter 14 discusses each of the Custom Mission types and gives tips for each, while Chapter 15 discusses the multiplayer missions.

Good luck and good hunting!





SECTION

1

BASIC TRAINING

# CLOSE-QUARTERS COMBAT TACTICS

Going up against terrorists is a dangerous business. In many missions, your life and the lives of your operatives are not the only ones on the line. You must protect hostages, as well. Sloppy assaults and poor planning result in body bags filled with good guys, not bad ones. It's vital to acquire the skills to complete the missions you face as a counterterrorist operative.

This chapter serves as a tutorial for close-quarters and other types of combat. Study each lesson, then go to the game's training missions and apply what you've learned.

## BASICS OF CLOSE-QUARTERS BATTLE

Most missions, such as those that take place in building interiors, force you to fight at close range around obstacles. This section helps you maneuver your operative, fire weapons, use grenades, and breach doors. By the end of this lesson, you will be ready for the first training mission and be able to enter and clear a room with a single team.

During any mission, you directly control one team member. The others act on orders you issue. Control involves handling movement and weapons smoothly and simultaneously. To achieve this, first master them individually, then put them together.

### MOVEMENT

In *Black Thorn*, you choose how to control your team members. Although you can use a joystick or other game controller, the keyboard-and-mouse combination gives you greater control and finer targeting.

Use **W**, **S**, **A**, and **D** to move forward and backward and to strafe left and right. The mouse controls the direction your operatives face and their line of sight elevation. Move the mouse forward to look down and backward to look up. Move it left and right to turn in the corresponding direction. Hold down the right mouse button to run as you move. To peek around corners, use **Q** to peek left and **E** to peek right.

To avoid exposure, press **C** to crouch. Use **Spacebar** to manipulate your environment—open doors, climb ladders, surmount obstacles, and the like. Jumping is an uncontrolled movement: after you're in the air, you can't stop or change direction until your feet hit the ground again. Elite units such as RAINBOW avoid uncontrolled movements. Their missions are difficult and deadly enough without introducing more variables. None of the training or combat missions require jumping.

### STRAFING AND PEEKING

Strafing and peeking are powerful skills. Using them during a mission can mean the difference between life and death. Tangos wait in ambush as you move around corners. Therefore, strafe or peek around corners so you can get in the first shot.

Strafing consists of sidestepping left or right without changing the direction you face—moving laterally while maintaining a facing. When rounding a corner or obstacle, face toward the threat, then strafe *away from* the obstacle. For example, if you must round a corner to the right, face the wall on your right, then strafe left. If a tango waits around the corner, you should have the enemy in your sights. This saves precious time and gives you a better chance at a first shot. If you walked to the corner and then turned to face the threat, the time it took you to turn would give the tango a chance to fire first.

Peeking is better than strafing for corners and obstacles such as trees. Rather than move into the open and expose your whole body, peeking exposes only your head, shoulders, and weapon. You can peek far more quickly than you can strafe in one direction and back toward another. Tangos are less likely to notice a peeking operative than one strafing into view, and you offer a smaller target.

### FIREARMS

The weapons in *Black Thorn* are realistically modeled after weapons counterterrorist groups use. (Chapter 3 covers weapons in detail.)

During missions, a targeting reticle (a red circle with four lines extending in the four compass directions) is always in the center of your view. The reticle indicates where your rounds will hit. Although the center remains the same, the four short lines moving out from the circle reflect the area where your bullets will strike as your accuracy changes. Keep this area as small as possible.

Factors affecting accuracy include fatigue, health, distractions, and taking hits. As your operative tires or becomes wounded, his or her accuracy decreases for the rest of the mission. Distractions such as flashbangs, seeing a teammate or hostage go down, or hearing an alarm temporarily decrease accuracy.

To fire a gun, left-click the mouse. You may select a rate of fire—that is, the number of rounds you fire each time you click the mouse—for any gun. Each gun has a safety and a



single-shot setting. When the safety is on, the weapon won't fire. The single-shot setting fires one round each time you pull the trigger (click on the mouse). Most submachine guns and assault rifles have two additional settings—three-round burst and full-automatic. Three-round burst fires three rounds and stops each time you click on the mouse. Full-automatic continues firing as long as you hold down the fire button, or until the clip is empty. To change a weapon's rate of fire, press **[B]**.

Each firearm affords its own level of accuracy. A pistol is less accurate than a rifle because of its shorter barrel. Rate of fire affects accuracy, as well. For example, when firing at full-automatic, the first few rounds will hit the target, but remaining rounds will scatter. This is the reason for the three-round burst setting: Accuracy decreases dramatically after three rounds are fired. When a gun fires once, its recoil alters a weapon's aim. Multiple recoils in a short amount of time during full-automatic firing can significantly change the aim. All rounds of a three-round burst should hit the target, then allow the shooter to correct the aim and fire again. Full-automatic is suited only for spraying a lot of bullets into an area when accuracy and ammunition aren't concerns. Remember, a round that misses its target will still hit *something*. Take care that hostages and team members aren't on the receiving end of your stray bullets.



The three-round burst is the ideal rate of fire for missions. It's as accurate as single-shot, yet it packs a punch that will knock down a target. Use full-automatic only when you want to hose down an area with lead and you have ammunition to spare.

A shooter's motion also affects accuracy. It's harder to keep your firearm trained on a target when you're walking than when you're standing still; running increases the difficulty. When you move, your weapon moves up and down and side to side with your body. Forward and backward motion decrease accuracy, but turning impacts it most. Avoid turning and sidestep when you fire.

At times, especially when shooting at medium to long range, you want to get a closer view of your target to help you aim better. Most weapons (except pistols and some subma-



While zoomed in, your peripheral vision is decreased by the tunneling effect.

chine guns) allow you to use a zoomed-in Sniper view. Press Left-**[Shift]** to zoom the view in and out. Sniper rifles have two zoom levels. Use Left-**[Shift]** twice to zoom in to the maximum.

## GRENADES

Grenades help when it comes to safely entering a room or building. RAINBOW operatives have two types at their disposal—flashbangs and fragmentation grenades. Flashbangs explode with a loud noise and a bright flash of light. They're also called stun grenades, because they briefly stun people nearby. The effect lasts only a few seconds, but that can be long enough for your team to enter a room and kill the terrorists within.

Fragmentation grenades are those the military uses in combat. When they explode, they send shrapnel flying in all directions, killing those close by and wounding others farther away. Take care when using fragmentation grenades; the blast radius may be greater than the distance your character can throw them. Make sure you have cover to hide behind after you throw them.

To throw a grenade, select it as your current weapon. Then aim the reticle toward where you want to throw it, and press the mouse button. Release it to throw. The longer you hold the button, the farther you throw the grenade. If you're too near a flashbang when it goes off, the screen goes black briefly and spots appear in your sight: you've stunned yourself. If you're too near a frag grenade, you may kill yourself. To avoid this, throw grenades around corners or take cover after you throw.

Grenades offer an efficient way to attack tangos without exposing yourself to fire. Throw a grenade at an angle to bounce off a wall (and hopefully out of your sight) toward the tango.

Frag grenades kill good and bad alike. Therefore, do not use them near hostages. When hostages are at risk, toss a flashbang into the room to stun the tangos, then enter the room after it goes off.

## BREACHING

Some missions involve combat in urban environments, and nearly all require your teams to enter buildings. It's important, therefore, to learn how to enter buildings using breaching devices and explosives.

When you confront a closed door, you must choose how you want to open it. To open a door normally, walk to it and press **[Spacebar]**. It takes a few seconds to open. If it doesn't open, it's locked. If silence is key to a mission, let your character pick the lock. You do this the same way you open the door; it just takes longer. A lockpick kit—either your character's or another team member's—shortens the time it takes to pick a lock.

When stealth isn't a factor, you have more choices. Blasting a door's lock with a shotgun opens it easily. Or use a breaching charge. This involves placing small amounts of explosives around a door, then detonating them to blow it in, removing the door and briefly stunning those beyond it.

To use a breaching charge, select it as your active item. Move to a door and click the mouse. It takes time to place a charge. Step back and click the mouse to detonate it. Quickly switch to a gun before you run into the room. The blast often kills or incapacitates anyone next to the door on the other side of a charge, so use care when you breach a room containing hostages.



In a pinch, use a frag grenade to blast open a door. Unlike the breaching charge, however, a grenade explodes in all directions. Take cover after you throw a grenade at a door.

## GIVING ORDERS TO OTHER OPERATIVES

Because a single operative can't always carry all the equipment necessary for a mission, sometimes you'll order teammates to toss grenades or breach doors.

To give such orders, face toward where you want the action to occur. Press the Orders mode key (U) to bring up a menu over the action bar and lock your mouse (to control a cursor instead of your view). Click on the order you want to issue, then press U again to return to action mode.

## MULTIPLE TEAMS AND COORDINATION

In the first training mission, you need only one team to complete your objective. In many missions, however, you need to coordinate up to four teams. You can't control them all at once personally, so you must prepare their orders in advance during the planning phase. Then, during the mission's action phase, you can coordinate the timing of various orders using Go Codes.

## PLANNING A MISSION

Real-life counterterrorist units spend a lot of time preparing for each mission. They never rush into action. Instead, they study maps and blueprints of the operational area. If time allows, they configure a "kill house" training facility to resemble the area where the unit will operate. If time doesn't allow for this, they'll make a "glass house"—tape laid on the ground to represent walls and other solid structures in the building or area they'll assault. The team will go over the plan several times until their timing is perfect and everyone knows exactly what's supposed to happen. Most successful operations take only minutes, so there's no time to figure out what you should do as you go.

In *Black Thorn*, you spend most of your time preparing for missions. After you choose the operatives and their kits and organize them into teams, you come to the Plan screen. From there, go to the box in the lower left and select Recon to learn the actual or probable locations of hostages and terrorists in the mission area. The Landmarks category provides important information about terrain and structures—whether a trellis is climbable or an entrance barricaded, for example. Learn as much as you can about what you face. Then decide how many teams you need and what their tasks will be.

## SETTING WAYPOINTS

To set waypoints, change the Recon box to Orders, select a team, and plot. Waypoints tell a team where to move and which path to take. The first point must be within an insertion zone, and the last within an extraction zone if one is available (some missions don't have extraction zones). Then you'll determine where the team enters a building, their route to that spot, how they'll reach their objective, and how they'll get out.

## GO CODES

Use Go Codes to coordinate team activity. For example, you want to have all teams enter a building at the same time. But in some cases, one team may have to complete a task before another team can continue. Go Codes act as stop gates to a team's progress. A team will move through each waypoint until it reaches one with a Go Code. It will halt there until a Go Code is given.



Each of the four Go Codes has a corresponding key: Alpha **[J]**, Bravo **[K]**, Charlie **[L]**, and Delta **[M]**. You can use each Go Code more than once.

For example, you may want to assign all Alpha codes to Blue Team, Bravo codes to Green, and so forth.

## ORDERS

You can also issue orders at each waypoint. For example, you can order the team to use a flashbang or frag grenade, or even a breaching charge. These require a waypoint near a doorway. Such orders are important, because computer-controlled teams won't do these things unless you instruct them to.

Set orders for your own team, as well. If you want a demolitions specialist on your team to breach a door a certain way, order it at that waypoint. Otherwise, you'll have to do it yourself using the equipment you're carrying, or issue an order to your team in Order mode during the mission.

You also can order teams to disarm bombs, deactivate security systems, and perform other mission-related tasks.

## COVER AND DEFEND

When you assign a Go Code to a waypoint, you can tell the team how to act at that point. Defend orders the team to set up a 360-degree defensive perimeter around the point. This is good if your team is stopped in an open area. Cover limits the defensive arc to 180 degrees in the direction you choose. This is better than Defend because each team member covers a narrow arc. Use this when your team can back up against a wall or when it doesn't have to worry about being attacked from a certain direction.

At each Go Code, give some order for the team. Usually it will be Cover, to direct where they watch for tangos.

## SNIPE

Although you'll usually issue the Snipe order to a team containing a sniper, you can give it to any team. The sniper (or team member with the best sniper skill) will aim at the point you designate on the planning map with Sniper view activated. This is a narrow arc, so don't expect a sniper to cover a large area. Meanwhile, the other team members assume a posture similar to Defend to protect the sniper.

## RULES OF ENGAGEMENT

Rules of Engagement (ROE) tell your teams how to behave as they advance to the next waypoint. There are two types of ROE—speed and mode.

Speed tells the team how fast to move and how careful to be when targeting and firing weapons: Blitz speed instructs the team to move as quickly as possible and fire at anything that moves; use it only when there are no friendlies in the area. Normal speed is a basic walk; the team exercises more caution before firing. Teams assigned Cautious speed move slowly, pausing every so often, and take deliberate aim at well-identified targets before firing, perhaps even risking their own safety. When approaching areas where hostages are, change the speed to Cautious.

Mode tells a team how to act and react. Teams with the Assault order move along their path while attacking targets. If possible, such as in small rooms, they'll clear the area before advancing to the next area. Recon orders a team to move stealthily and only return fire. They use silenced weapons. Heartbeat sensors are used only by teams with Recon orders.

Infiltrate orders a team to move quickly and quietly. If the operatives encounter enemies, they fire, using silenced weapons. Their main task is to reach a given point rather than to clear areas of terrorists. After the team rescues a hostage, it must escort the hostage to safety. If a team approaches a hostage in any other mode, the hostage stays put. Escort mode tells the hostage to follow the team. When escorting a hostage, the team should follow a secure route (cleared of tangos) to the end point. Securing and escorting hostages is covered in greater detail later in this chapter.

## HOLD AND OTHER COMMANDS

At times you need to halt a team before it reaches a Go Code. Or you may need to stop all teams for a moment. Use Hold commands to do this: **[R]** orders the team you're leading to hold in place. This allows you to keep them in one spot while you move ahead on your own; **[H]** orders all teams to hold at their positions. Press the Hold keys again to release the teams. These keys also release teams that were ordered to Cover or Defend using Orders mode.

### TIP

After setting waypoints for all teams, make a few notes on what each Go Code does so you can refer to it later.

When a unit gets an order to Snipe, that unit covers a certain area. However, the operatives won't fire until you release them. This allows you to have a sniper wait until other teams are in position before shooting. To order your snipers to fire, press **[Y]**. Press it again to order them to hold fire.

At times, you'll want to control different teams during a mission, particularly if they need your expert guidance to get through a certain spot. Use **[Page Up]** and **[Page Down]** to switch between teams. Remember, the team you leave continues to the next waypoint and executes any given orders while you control another team. If you want the team you're not controlling to stay put until you get back, issue the Team Hold command **(R)**.

Finally, it is helpful to know what the other teams are doing during a mission. Look at the Teams Status display in the lower-right corner of the screen or press **[7]** to request a status report. Each team reports in by name and states its current order.

## HEARTBEATS AND HOSTAGES

In many of your missions, the primary objective is to rescue hostages. The presence of hostages makes a mission more difficult, because the need to protect them limits the types of force you can use. To help locate hostages (as well as tangos), equip your operatives with a heartbeat sensor.

### THE HEARTBEAT SENSOR

RAINBOW's arsenal includes cutting-edge technological devices. One such device is the heartbeat sensor. This handheld item can "see" through walls to locate tangos and hostages. To use it, select it as your active item. Tangos and hostages within range show up on your Map view. Tangos appear as purple circles, hostages as white ones. The line extending from the center of each circle indicates the direction the target is facing.

Heartbeat sensor detection range is greatest in the direction the user is facing, so when you pull it out, rotate in place to scan in all directions. Because you're always a team leader, it's a good idea to assign heartbeat sensors to leaders. When you need both slots in the kit for other items, assign the sensor to the operative in the rear of the line. To order the operative to pull out the heartbeat sensor, change ROE mode to Recon. (Don't assign everyone sensors, or they'll all pull them out when you use this ROE.) Remember that when an operative uses a heartbeat sensor, he or she isn't holding a weapon. If you need other team members to cover and provide support, change the ROE from Recon; otherwise they only observe.

### SECURING AND ESCORTING HOSTAGES

Counterterrorist units are trained to enter a location, neutralize tangos, and rescue hostages unharmed. If it weren't for hostages, any elite military unit or SWAT team could perform the RAINBOW missions.

When you undertake a hostage rescue mission, study the map during the Plan phase. Note the hostages' positions and work your way backward to the insertion zone to plan your approach. The key is getting a team to the hostages as quickly as possible. After you secure the hostages, maintain a clear route to the extraction zone. If the extraction zone lies near the insertion zone, clear the route on the way in. After the route is clear, a team must change its ROE mode to Escort. This orders the hostages to follow the team as it moves. If you want the hostages to stay put while the escorting team moves ahead, change the ROE to another mode; the hostages will halt in place until a team comes near them with the Escort ROE.



**TIP**  
 When extracting hostages, have another team lead the escorting team to clear any tangos who moved to block the route after the teams went in. Also position other teams to cover the route and order them to return to the extraction zone only after the hostages pass by.

Be careful when assaulting a room or area containing a hostage. Never use frag grenades; they kill everyone in the area. Also, don't hose down an area with automatic fire: A stray round may hit a hostage. Given their spread, the same goes for shotguns. The best way to enter and clear a room with hostages, especially if a tango is covering them, is to

use a flashbang. Toss one into the room so it lands away from the hostages, then rush in after it blows, while the tangos are still stunned. Set weapons to single-shot or three-round burst. After a tango is in your sights, wait to shoot until the reticle shrinks down to ensure that your shot is true and on target.

You can't always throw a flashbang, however. When you must get through a closed door to enter a room, the tango may open the door and shoot at you or the hostages. To prevent that, use the heartbeat sensor to locate tangos and hostages. Face the tango as you open the door. The tango should be in your sights when the door opens. You haven't moved, so your reticle is small: *Fire!* In other circumstances, you need to move into the room to fire. For those times, position your operative so he or she can strafe into the room and take out the tango.

Hostages are unpredictable, and may get up and run out the door when you enter firing. Even a flashbang may cause this reaction and hostages may end up in your line of fire (or the tangos'). There's really no way to prevent this, but by being alert and ready, you can avoid shooting the people you're supposed to rescue. Aim at a tango before you shoot. The positions of the people inside may change after you open the door, and you may have to reacquire your target.

## STEALTH

Tangos are dangerous to both teams and hostages. Some are so desperate that they may kill the hostages if they realize your teams are assaulting them. In these instances, use stealth to reach the hostages before the tangos execute them. Stealth also may be necessary when you go after tangos that threaten to use bombs or other lethal devices.

To keep your teams stealthy during their approach is to use silenced weapons. You can equip several submachine guns and pistols with silencers. Silencers allow you to shoot without the report alerting other tangos in the area. In some cases, however, you may need the heavier firepower of an assault rifle. For those times, use a silenced pistol during the stealthy part of the mission, then bring out the rifle.

Uniforms also affect stealth: Light uniforms are stealthiest; medium and heavy uniforms are progressively noisier. Running makes more noise than walking, and the surfaces your operatives walk on (metal floors, for example) can also make noise. Each operative has a stealth attribute level. The higher the rating, the quieter an operative moves. Recon specialists are the stealthiest operatives.

To maintain stealth, don't use grenades. The noise of their explosions travels far and alerts everyone in the area.

Unless you need the firepower, use stealth. The longer you can stay quiet, the easier your mission will be. As soon as tangos hear shots, they become more alert. When you employ stealth, you can approach inattentive tangos before they know they're under attack.

## NONCOMBATANTS

During some missions, your teams may encounter civilians who, although they're not hostages, must still be protected. Most of the time, these civilians are moving about.

To prevent your teams from accidentally shooting one of these people (and failing the mission), use heartbeat sensors to check for noncombatants in the area you're about to assault. Take care using frag grenades during missions with noncombatants, and limit automatic fire to cleared areas.

## SWEEPERS

You'll encounter hostages early in some hostage-rescue missions. Don't waste time escorting them to safety with your assault teams. Nor should you leave them where they are, lest they get hit during a firefight. Instead, form a team or two to use as "sweepers."

Sweepers come into an area after you clear it, and escort hostages to the extraction zone while your assault teams continue with the mission. A sweeper team may consist of only one operative, and you can arm the team however you choose. Back at the extraction zone, give an order to Defend or Cover toward the threat, in case a tango comes after the hostages.



# THE RAINBOW OPERATIVES

This chapter covers each RAINBOW Operative—providing background, personal information, attributes, and suggestions for how best to use him or her.

## ATTRIBUTES

Attributes fall into two categories—profile and skill. Profiles are inherent or learned attributes that demonstrate psychological make-up and physical endurance. Skills, on the other hand, are learned attributes that relate to using equipment or to movement.

### PROFILE

**Aggression:** An Operative's basic nature. Comes into play only when an Operative “snaps,” or loses self-control. Aggressive Operatives may use extreme force when they snap, endangering hostages and teammates. In similar circumstances, a passive Operative may freeze, or panic and run away.

**Leadership:** Teamwork and self-control attributes. Leaders with low leadership ratings reduce the values of those under their command. The higher the value, the better the bonus. Leadership applies whether the team leader is player- or computer-controlled.

**Self-Control:** Likelihood that a nonplayer Operative will snap during combat. After an Operative snaps, his or her aggression level determines the outcome.

**Stamina:** How many wounds it takes to incapacitate an Operative. This attribute also affects fatigue levels at the end of missions.

### SKILL

**Assault:** Operative's base accuracy with pistols, shotguns, submachine guns and rifles, and how actions such as movement and firing affect that accuracy.

**Demolitions:** How long it takes an Operative to place a Demolition Kit, Breaching Charge or disarm a bomb, and how many shots it takes to breach a locked door with a shotgun. High demolition value means faster time and fewer shotgun blasts.

**Electronics:** Time it takes an Operative to place bugs, pick locks, bypass security systems, and splice video.

**Grenades:** Operative's fragmentation grenade and flashbang accuracy and throwing time.

**Sniper:** Operative's base accuracy when using a sniper rifle or a rifle in Sniper view or mode.

**Stealth:** How much noise Operatives make as they move. The higher the value, the quieter the Operative. Those with low stealth values can be heard walking slowly on normally quiet surfaces.

## SPECIALTIES

Each Operative has a specialty—an area of expertise reflecting additional training and experience—and shows values for related attributes.

**Assault:** Operatives with the assault specialty have good firearms values. Use them for taking out terrorists and performing other combat actions.

**Demolitions:** Operatives with this specialty are great for breaching doors and creating access for teammates. Use them for defusing bombs and other explosives. They have high demolitions and grenade values.

**Electronics:** Electronics specialists are trained to plant bugs, deactivate security systems, etc. Keep them out of firefights; only two Operatives have this specialty.

**Recon:** Use recon Operatives for surveillance and scouting. Their job is to locate the enemy without being detected, so their stealth values are high. They usually have high firearms values as well, but keep them out of the fray when you can.

**Sniper:** These Operatives are especially skilled at sniping and have high stealth values. Use them only for sniping tasks, and always give them a good sniper rifle.

## ARNAVISCA, SANTIAGO



### PERSONAL INFORMATION

IDENTIFICATION NUMBER: RCT0031-A1044

**NATIONALITY:** SPANISH

**DATE OF BIRTH:** 01 JANUARY 1968

**SPECIALTY:** ASSAULT

**HEIGHT:** 186 CM

**WEIGHT:** 81 KG

**HAIR:** BROWN

**EYES:** BLUE

**GENDER:** MALE

### ATTRIBUTES

**AGGRESSION:** 72

**LEADERSHIP:** 81

**SELF-CONTROL:** 94

**STAMINA:** 83

**ASSAULT:** 100

**DEMOLITIONS:** 24

**ELECTRONICS:** 34

**GRENADES:** 65

**SNIPER:** 49

**STEALTH:** 82

### BACKGROUND

Born in Málaga, Spain. Although the family's holdings shrank considerably under Franco's rule, the Arnaviscas still control large tracts of farmland around Córdoba and the Guadalquivir River valley. The second in a family of eight, Arnavisca's elder brother is a deputy in the Adalucian parliament. Attended University of Seville, 1983–88. Joined the *Guardia Civil* after graduation. Brigade commander 1994–96 in the Western European Union (WEU) administration of Mostar in Bosnia, where he was instrumental in rebuilding the local police force. *Guardia Civil's* counterterrorism unit, the *Unidad Especial de Intervención* (UEI) recruited him in 1997 as part of its focus on the growing threat of terrorism within the European Union by former citizens of Yugoslavia.

Arnavisca is an expert marksman, having participated in shooting competitions since childhood. In addition to his native Spanish, he speaks English, German, and Italian fluently and can make himself understood in most other European languages. Despite his aristocratic bearing, he is more comfortable acting as lieutenant and advisor than team lead. Tenacious in combat, he remains calmly detached in the tensest situations.

### NOTES

Arnavisca is a superb marksman and one of the two best Operatives with firearms. You can use him as team leader in a pinch, but he serves far better in a supporting role. He stays cool during the hottest firefights. Arnavisca is a perfect inclusion to your team.

## BECKENBAUER, LARS



### PERSONAL INFORMATION

IDENTIFICATION NUMBER: RCT0031-A1044

**NATIONALITY:** GERMAN

**DATE OF BIRTH:** 21 AUGUST 1953

**SPECIALTY:** DEMOLITIONS

**HEIGHT:** 176 CM

**WEIGHT:** 87 KG

**HAIR:** BLOND

**EYES:** BLUE

**GENDER:** MALE

### ATTRIBUTES

**AGGRESSION:** 55

**LEADERSHIP:** 78

**SELF-CONTROL:** 77

**STAMINA:** 81

**ASSAULT:** 76

**DEMOLITIONS:** 100

**ELECTRONICS:** 91

**GRENADES:** 80

**SNIPER:** 31

**STEALTH:** 72

### BACKGROUND

Born on a farm near Chemnitz on the Czechoslovakian border in the former German Democratic Republic (East Germany). Drafted into the East Germany Army, 1970. Specialized in bomb disposal and demolitions. Assigned to East German Border Patrol, 1971–76. Arrested by the GDR State Security Service (Stasi) in 1976 under suspicion of involvement in high-profile defections. Released for lack of evidence and discharged from the army in 1977. Movements and activities from 1977–84 unknown. The current German government will neither confirm nor deny rumors that he was a member of the *Libellen*, an underground group responsible for bombings of East German governmental offices in and around Berlin in the summer of 1981. Resurfaced in 1985 and granted asylum by West Germany after a risky crossing of the Baltic Sea in a small sailboat. Opened Pyrotechno GmbH, a security consulting firm, in 1989. Since then, he has acquired a reputation as Germany's leading expert on explosives and demolitions. Married 1995. Two children.

Beckenbauer has an encyclopedic knowledge of explosive devices. His years of working with bombs make him extremely meticulous. He overlooks no detail and leaves nothing to chance. Because he focuses completely on the job at hand and considers personal interactions dangerous distractions, the rest of the team may perceive him as cold and distant.

### NOTES

Bechenbauer is RAINBOW's demolitions expert, and is also proficient in electronics. His other attributes are normal or low. He is not a leader and prefers to work alone. Put him in a team that has a strong leader and will engage in minimal combat.

## BOGART, DANIEL



### PERSONAL INFORMATION

IDENTIFICATION NUMBER: RCT0047-A1109

NATIONALITY: AMERICAN

DATE OF BIRTH: 12 OCTOBER 1954

SPECIALTY: ASSAULT

HEIGHT: 188 CM

WEIGHT: 82 KG

HAIR: BLACK

EYES: BLUE

GENDER: MALE

### ATTRIBUTES

AGGRESSION: 89

LEADERSHIP: 96

SELF-CONTROL: 93

STAMINA: 97

ASSAULT: 98

DEMOLITIONS: 20

ELECTRONICS: 20

GRENADES: 50

SNIPER: 51

STEALTH: 73

### BACKGROUND

Born in Keokuk, Iowa, USA. Father is a local deputy sheriff, mother a homemaker. Two brothers. Attended University of Iowa on a track and field scholarship, 1972–76. Graduated with honors with a degree in law enforcement. Patrolman with Keokuk Police Department for three years. Hired in 1980 by the Federal Bureau of Investigation. Member, FBI Hostage Rescue Team, 1987–97. Married 1979. Wife and two teen-age children live in Maine, USA.

Bogart makes an excellent team leader. He has exceptional tactical skills and situational awareness from his years with HRT. Cool under fire, he is a crack shot, and won marksmanship awards during his tenure at the FBI. His low-key demeanor and laconic sense of humor make him well-liked among RAINBOW team members.

### NOTES

Bogart is a good choice for team leader. He is highly proficient with firearms. Use him for your main assault teams.

PRIMA GAMES.COM

## BURKE, ANDREW



### PERSONAL INFORMATION

IDENTIFICATION NUMBER: RCT0049-A2267

NATIONALITY: BRITISH

DATE OF BIRTH: 12 JANUARY 1968

SPECIALTY: ASSAULT

HEIGHT: 176 CM

WEIGHT: 72 KG

HAIR: RED

EYES: BLUE

GENDER: MALE

### ATTRIBUTES

AGGRESSION: 91

LEADERSHIP: 85

SELF-CONTROL: 75

STAMINA: 94

ASSAULT: 93

DEMOLITIONS: 75

ELECTRONICS: 53

GRENADES: 67

SNIPER: 36

STEALTH: 78

### BACKGROUND

Born in Manchester, England. Whereabouts of father unknown. Mother is a secretary at a plastics processing plant in Leeds. Three siblings—two brothers and a sister. Joined Royal Marines, 1986. Two tours with British Special Air Service (SAS), 1989–91 and 1996–99. Received Military Cross, 1998. Has taken part in SAS actions in 22 countries on four continents. Further service record details are sealed. Unmarried.

Burke is a seasoned veteran of numerous covert operations. Although not reckless, he has a strong can-do attitude and confidence in his abilities. As a leader, he is decisive and demanding. He has a quick sense of humor and often uses jokes to relax his team before a mission. He maintains contact with his immediate family, but he considers the service to be his home.

### NOTES

Burke is a well-rounded Operative. He has experience in most areas, but excels in none. A poor choice for team leader, he serves well in a support role for assault or other teams needing his firearms skills.

## CHAVEZ, DING



### PERSONAL INFORMATION

IDENTIFICATION NUMBER: RCT0047-X0566

NATIONALITY: AMERICAN  
 SPECIALTY: ASSAULT

DATE OF BIRTH: 12 JANUARY 1968  
 HEIGHT: 176 CM  
 WEIGHT: 72 KG  
 HAIR: BLACK  
 EYES: BROWN  
 GENDER: MALE

### ATTRIBUTES

AGGRESSION: 95  
 LEADERSHIP: 100  
 SELF-CONTROL: 92  
 STAMINA: 97  
 ASSAULT: 100  
 DEMOLITIONS: 71  
 ELECTRONICS: 67  
 GRENADES: 74  
 SNIPER: 63  
 STEALTH: 100

### BACKGROUND

Born in Los Angeles, California, USA. Joined U.S. Army, 1983. Served with the 7th Infantry Division (Light), 1984–87. Achieved rank of staff sergeant before the American Central Intelligence Agency (CIA) recruited him in 1987 for narcotics interdiction operations in South America. Discharged, 1988; became a full-time CIA employee under John Clark the same year. Service records for years 1989–99 are sealed. Earned B.S. degree in political science, George Mason University, 1995. M.A., international relations, from the same institution, 1999. Married.

Chavez is an excellent light infantry soldier with an exceptional grasp of small-unit tactics and close-quarters battle. Although small in stature, he is powerfully built and agile, a formidable opponent with a wide range of weapons and in hand-to-hand combat.

### NOTES

Chavez is operational leader of RAINBOW. Put him in command of the team with the most important objectives. He is expert at firearms and stealth, with good experience in several other areas. His high leadership value boosts other team members with lower self-control and teamwork attributes. Put less-experienced Operatives on his team. You will probably want to control Chavez, but because he will follow your orders better than anyone else, you should leave him under AI control.

## DUBARRY, ALAIN



### PERSONAL INFORMATION

IDENTIFICATION NUMBER: RCT0013-A5436

NATIONALITY: FRENCH  
 SPECIALTY: ELECTRONICS

DATE OF BIRTH: 27 SEPTEMBER 1967  
 HEIGHT: 174 CM  
 WEIGHT: 66 KG  
 HAIR: BLACK  
 EYES: BROWN  
 GENDER: MALE

### ATTRIBUTES

AGGRESSION: 72  
 LEADERSHIP: 81  
 SELF-CONTROL: 76  
 STAMINA: 91  
 ASSAULT: 84  
 DEMOLITIONS: 76  
 ELECTRONICS: 100  
 GRENADES: 81  
 SNIPER: 66  
 STEALTH: 73

### BACKGROUND

Born in Chantilly, France. Father is manuscript curator at a local museum, mother a journalist. Four sisters, two brothers. Second-oldest sister is a prominent professor of mathematics at the University of Paris. Attended *l'École Supérieure d'Ingénieurs en Electrotechnique et Electronique* (ESIEE) in Paris, 1984–89. Graduated with degrees in electronics engineering and computer science. Joined the *Gendarmerie Nationale* in 1990 as an officer in their computer crime division. Instrumental in thwarting a 1994 attempt by Algerian nationals to bring down the French Minitel computer network using a virus spread by telephone switching software. *Groupe d'Intervention Gendarmerie Nationale* (GIGN), France's elite counterterrorist unit, recruited him in 1996 as a specialist in telephony and electronic surveillance. Unmarried.

DuBarry is expert in computers and computer nets, and in more conventional forms of surveillance. Although his role in CT actions is usually intelligence-gathering and communications, as a veteran of GIGN's extensive combat training, he is fully qualified to participate in armed operations. Introverted, thoughtful, and an excellent tactician, he often makes connections other team members miss. Off duty, he is an avid amateur scuba diver and an officer in the *Confédération Mondiale des Activités Subaquatiques* (CMAS).

### NOTES

DuBarry is RAINBOW's electronics expert. He's also proficient in the use of firearms and grenades. He'll do well in a team with a good leader. Keep him out of combat when you can, because he is one of only two RAINBOW electronics specialists. His death can seriously hamper future missions.

## FILATOV, GENEDY



### PERSONAL INFORMATION

IDENTIFICATION NUMBER: RCT0069-A1772

**NATIONALITY:** RUSSIAN  
**SPECIALTY:** ASSAULT

**DATE OF BIRTH:** 12 FEBRUARY 1964  
**HEIGHT:** 1.83 CM  
**WEIGHT:** 84 KG  
**HAIR:** BLOND  
**EYES:** HAZEL  
**GENDER:** MALE

### ATTRIBUTES

**AGGRESSION:** 82  
**LEADERSHIP:** 82  
**SELF-CONTROL:** 87  
**STAMINA:** 83  
**ASSAULT:** 91  
**DEMOLITIONS:** 62  
**ELECTRONICS:** 36  
**GRENADES:** 85  
**SNIPER:** 59  
**STEALTH:** 70

### BACKGROUND

Born in Pskov, Pskovskaya Oblast in the former Soviet Union. No information on family. Served in army of former Soviet Union, 1981–85, including one tour in Afghanistan. Recruited by *Alfa* counterterrorist group, 1987. Operated in all major territories of the former Soviet Union and eastern Europe. Resigned from *Alfa* in 1991 in response to that organization's ambiguous response to the failed Soviet coup. Director of operations for private security firm, 1991–96. Returned to *Alfa* during its 1997 restructuring under the Russian Federal Security Service. Married, no children.

Filatov is a solid counterterrorism Operative. His training and background are unorthodox by western standards, but he has a wealth of real-world experience from his years in the security forces of the former Soviet Union and numerous contacts across eastern Europe and Asia. His steady nerves and methodical approach to threats make him particularly valuable in combat situations. Do not let his world-weary manner mislead you; he is no pessimist, but, rather a realist, and he prides himself on being the voice of reason and conservatism in any debate.

### NOTES

Filatov is an average Operative with good values in all attributes except electronics. Although he is not a leader, he does well in a support role.

PRIMA-GAMES.COM

## GALANOS, KURE



### PERSONAL INFORMATION

IDENTIFICATION NUMBER: RCT0031-A1044

**NATIONALITY:** GREEK  
**SPECIALTY:** SNIPER

**DATE OF BIRTH:** 25 JULY 1975  
**HEIGHT:** 1.67 CM  
**WEIGHT:** 58 KG  
**HAIR:** BLACK  
**EYES:** BROWN  
**GENDER:** FEMALE

### ATTRIBUTES

**AGGRESSION:** 100  
**LEADERSHIP:** 88  
**SELF-CONTROL:** 90  
**STAMINA:** 90  
**ASSAULT:** 50  
**DEMOLITIONS:** 45  
**ELECTRONICS:** 22  
**GRENADES:** 83  
**SNIPER:** 96  
**STEALTH:** 99

### BACKGROUND

Born in Nicosia, Cyprus. Galanos was thrust into the ethnic tensions on Cyprus from an early age, when her family lost their homes during widespread clashes between Turkish and Greek rioters. The Galanos family, while never physically harmed by the tensions, continued to suffer difficult times for many years due to the unrest. Eventually they fled the city, and Galanos' father, an ex-ELDYK sniper, taught her his trade in extended hunting trips through the center of the island. Galanos attempted to join the Greek MYK force, but was denied due to her gender. Instead, she joined the civilian police force and quickly rose to prominence as a sniper with a reputation for precise shooting in less than optimal conditions.

Galanos is, at times, a sheer force of nature. What she cannot achieve by skill alone, she often completes by force of will. Teammates claim her piercing gaze does more damage than her bullets. She displays no antipathy toward any nationality or criminal. She treats assignments as problems to be solved, and solves them with a single, clean trigger pull.

### NOTES

Galanos is one of the best snipers, and she stays cool no matter what. This attribute is important to snipers because excitement ruins their accuracy.

## HAIDER, KARL



### PERSONAL INFORMATION

IDENTIFICATION NUMBER: RCT0007-A3709

NATIONALITY: AUSTRIAN

DATE OF BIRTH: 10 SEPTEMBER 1975

SPECIALTY: ASSAULT

HEIGHT: 196 CM

WEIGHT: 117 KG

HAIR: BLACK

EYES: BLUE

GENDER: MALE

### ATTRIBUTES

AGGRESSION: 100

LEADERSHIP: 75

SELF-CONTROL: 71

STAMINA: 96

ASSAULT: 89

DEMOLITIONS: 42

ELECTRONICS: 55

GRENADES: 71

SNIPER: 61

STEALTH: 74

### BACKGROUND

Born in Graz, Austria. Father is a petroleum distributor, mother a homemaker. Two siblings, a brother and a sister, both still in school. Joined the regular Austrian army in 1992. Transferred to *Gendarmerieeinsatzkommando Cobra* (GEK Cobra) in 1996. Trained with Germany's GSG-9 and Israel's *Sayeret Mat'Kal*. Participated in GEK Cobra raid on Deissenmayr GmbH headquarters in Vienna in 1998, single-handedly saving the lives of seven hostages. Married 1999. No children.

In combat situations, Karl is unstoppable. He is extremely aggressive and will use any methods necessary to complete his mission. He is fanatical about protecting hostages and innocent bystanders, to the point of jeopardizing his own life. Off the job, he is soft-spoken and private, but has an iron determination.

### NOTES

Haider is one tough soldier, but he needs a strong leader. He provides good support for Chavez's team.

## HANLEY, TIMOTHY



### PERSONAL INFORMATION

IDENTIFICATION NUMBER: RCT0005-A1299

NATIONALITY: AUSTRALIAN

DATE OF BIRTH: 14 APRIL 1965

SPECIALTY: ASSAULT

HEIGHT: 187 CM

WEIGHT: 85 KG

HAIR: BLOND

EYES: BROWN

GENDER: MALE

### ATTRIBUTES

AGGRESSION: 93

LEADERSHIP: 86

SELF-CONTROL: 84

STAMINA: 100

ASSAULT: 91

DEMOLITIONS: 75

ELECTRONICS: 65

GRENADES: 84

SNIPER: 43

STEALTH: 85

### BACKGROUND

Born in Margaret River, Australia. Father is a winery foreman; mother is a homemaker. Two siblings, a brother and a sister. Attended Australian Defense Forces Academy in Canberra, 1983-87. Upon graduation, the Special Air Service Regiment (SASR) recruited him into its newly formed 1st squadron; he remained with this unit when it was reorganized into the Australian Tactical Assault Group (TAG) shortly thereafter. He has served his entire career with TAG, except one tour with the Australian Intelligence Corps (AustInt), 1993-96. Has led counterterrorist teams on three continents and cross-trained with both U.S. Delta Force and British Special Air Service. Unmarried.

Hanley is a career CT officer. He is a veteran of dozens of assaults and approaches even the most dangerous missions with easygoing good humor. Off duty, he is an experienced backpacker and mountaineer who has taken part in amateur expeditions to many of the world's major peaks. He is in superb physical condition and has demonstrated an ability to endure even the most extreme physical hardship.

### NOTES

Hanley is another good support operative with good values across the board. In a pinch, you can use him even for demolitions work.

## JOHNSTON, HOMER



## PERSONAL INFORMATION

IDENTIFICATION NUMBER: RCT0047-B0381

NATIONALITY: AMERICAN

DATE OF BIRTH: 23 AUGUST 1972

SPECIALTY: SNIPER

HEIGHT: 183 CM

WEIGHT: 73 KG

HAIR: BLOND

EYES: BROWN

GENDER: MALE

## ATTRIBUTES

AGGRESSION: 89

LEADERSHIP: 83

SELF-CONTROL: 87

STAMINA: 98

ASSAULT: 42

DEMOLITIONS: 55

ELECTRONICS: 50

GRENADES: 70

SNIPER: 100

STEALTH: 100

## BACKGROUND

Born in Boise, Idaho, USA. Father logger, mother secretary at lumber mill. Brought up in true mountain-man fashion. Shot his first deer at age 10. Former Green Beret and Delta Force member. Part of 101st AirMobile, Fort Campbell, Kentucky. Found his way into Black Ops by 1989. Definitive distance runner. Relies on stealth and speed to set up his sniper locations. Expert with all rifle types. Spends free time hunting with Weber and visiting his parents. Unmarried.

## NOTES

Johnston is one of RAINBOW's snipers. As such, he has great firearms and stealth skill levels. With the PSG-1 rifle, he's deadly at long range. Assign Johnston to a team that must pick off tingos from a distance. He'll give you a new understanding of the sniper motto, "One shot, one kill."

PRIMA GAMES.COM

## LOFQUIST, ANNIKA



## PERSONAL INFORMATION

IDENTIFICATION NUMBER: RCT0030-A3224

NATIONALITY: SWEDISH

DATE OF BIRTH: 02 NOVEMBER 1966

SPECIALTY: ELECTRONICS

HEIGHT: 179 CM

WEIGHT: 68 KG

HAIR: BLONDE

EYES: BLUE

GENDER: FEMALE

## ATTRIBUTES

AGGRESSION: 80

LEADERSHIP: 92

SELF-CONTROL: 77

STAMINA: 82

ASSAULT: 85

DEMOLITIONS: 61

ELECTRONICS: 97

GRENADES: 69

SNIPER: 58

STEALTH: 69

## BACKGROUND

Born in Göteborg, Sweden. Father was a retired admiral in the Swedish Navy, now deceased. Mother is professor of Romance languages at Göteborg University and is active in *Miljöpartiet de Gröna*, the Swedish Green Party. Three brothers. The entire family sails avidly. Attended Stockholm University, 1984-87; earned a B.S. in physics. After a stint as engineer with the Swedish semiconductor giant *Microelektronik AB* (1988-92), Lofquist joined the Stockholm police force as an expert of electronic surveillance. *Ordningens Nationella Insatsstyrka* (ONI), the national rescue unit of the Stockholm police force, recruited her in 1994. From 1997 to 1999, she led ONI intelligence and surveillance teams in more than a dozen counterterrorist actions, including the high-profile 1998 Red Cell occupation of the trading floor of the Stockholm futures exchange. Unmarried.

Lofquist is an electronics genius. Her name is on 14 patents held by *Microelektronik*, her old employer, and she continues to consult with their engineers while serving as a member of the RAINBOW team. Most of her innovations are in the area of electronic eavesdropping. She is confident and courageous, but at times her lack of military training can lead her to overestimate her ability to handle a situation. Off duty, she keeps to herself, and lives alone on a sailboat in Saltsjobaden, outside Stockholm.

## NOTES

Lofquist is proficient in electronics and makes a good team leader. She is good with a gun, but as with DuBarry, keep her safe.



## LOISELLE, LOUIS



### PERSONAL INFORMATION

IDENTIFICATION NUMBER: RCT0013-B5928

NATIONALITY: FRENCH

SPECIALTY: ASSAULT

DATE OF BIRTH: 06 JUNE 1968

HEIGHT: 178 CM

WEIGHT: 68 KG

HAIR: BLACK

EYES: BROWN

GENDER: MALE

### ATTRIBUTES

AGGRESSION:	90
LEADERSHIP:	85
SELF-CONTROL:	100
STAMINA:	85
ASSAULT:	94
DEMOLITIONS:	49
ELECTRONICS:	70
GRENADES:	70
SNIPER:	50
STEALTH:	78

### BACKGROUND

Born in Paris, France. Married to Elaine, three years. Father former commercial pilot, mother a clerk at local department store in Avignon. Former member, French Parachute Division. Detailed to DGSE. Part of action group Service 7. Involved in tactical espionage and counterespionage throughout Europe. Began training DGSE recruits in 1985. On assignments, he's a utility player and doesn't disturb easily. He's a marksman with pistols and rifles, but is experienced in all forms of counterterrorism. He spends most free time reading and with his wife.

### NOTES

Loiseau is a good choice for an assault team in the support role. He'll do a great job covering your back during a mission, and will stay calm, even in hectic situations. Place him in a team's second slot.

## MALDINI, ANTONIO



### PERSONAL INFORMATION

IDENTIFICATION NUMBER: RCT0023-A2009

NATIONALITY: ITALIAN

SPECIALTY: RECON

DATE OF BIRTH: 14 OCTOBER 1966

HEIGHT: 179 CM

WEIGHT: 68 KG

HAIR: BLOND

EYES: BLUE

GENDER: MALE

### ATTRIBUTES

AGGRESSION:	50
LEADERSHIP:	60
SELF-CONTROL:	80
STAMINA:	95
ASSAULT:	90
DEMOLITIONS:	65
ELECTRONICS:	65
GRENADES:	50
SNIPER:	38
STEALTH:	100

### BACKGROUND

Born in Milano, Italy. Father manages a textile factory; mother is a homemaker. Five siblings. Attended *Università degli Studi di Ferrara*, 1984–88. Degree in chemistry. Joined *l'Arma dei Carabinieri* in 1989. On completion of training, he was assigned to the *Comando Carabinieri Antidroga*, the Carabinieri's antinarcotics agency. Transferred in 1995 to the *Gruppo Intervento Speciale* (GIS), Italy's elite counterterrorism team. Married since 1990. Three children.

Maldini's attribute is stealth. At GIS, his ability to occupy positions undetected by the enemy earned him the nickname "Invisible Man." He is in excellent physical condition and is quick on his feet. His demeanor is calm and somewhat aloof. Although a solid team member, he is too introspective to be a truly effective commander. Off duty, he is an amateur marathoner and has competed in races throughout Europe. Extremely intelligent and well-spoken.

### NOTES

Maldini is extremely stealthy and can sneak up on enemies undetected. Use him for quiet strikes and to gain intelligence on enemy locations. He is no leader, but is useful in a support role or alone.

## MCALLEN, ROGER



## PERSONAL INFORMATION

IDENTIFICATION NUMBER: RCT0011-A1932

NATIONALITY: CANADIAN

DATE OF BIRTH: 06 JUNE 1964

SPECIALTY: DEMOLITIONS

HEIGHT: 185 CM

WEIGHT: 95 KG

HAIR: BROWN

EYES: HAZEL

GENDER: MALE

## ATTRIBUTES

AGGRESSION:	70
LEADERSHIP:	70
SELF-CONTROL:	70
STAMINA:	98
ASSAULT:	96
DEMOLITIONS:	97
ELECTRONICS:	71
GRENADES:	100
SNIPER:	65
STEALTH:	70

## BACKGROUND

Born in Toronto, Ontario, Canada. Father is a senior officer with the Royal Bank of Canada. Mother deceased. He has one sister, who resides in Toronto. Joined Canadian Army as field engineer, 1981. One tour, 1981–85. Received advanced training in combat diving and explosive ordnance disposal. Upon discharge, joined the Royal Canadian Mounted Police (RCMP) and, in 1988, became a member of the Special Emergency Response Team (SERT), the RCMP's elite counterterrorism unit. When SERT was disbanded in 1993, he helped coordinate the transition of counterterrorist responsibilities to the Canadian Armed Forces' newly formed Joint Task Force Two (JTF-2). McAllen reenlisted in 1994 and became a full member of JTF-2 the same year. He has participated in counterterrorist actions on three continents, including JTF-2 extended operations against war criminals in Bosnia, 1996–97. Married 1984; divorced, 1992. One child, a daughter, born 1986, lives with her mother in London, Ontario, Canada.

McAllen specializes in several areas. He is an excellent shot and is aggressive in combat situations, and so makes a good assault team member, but he also has extensive experience with bomb disposal and demolitions. He is an amateur power-lifter and his strength and stamina make him a formidable opponent. Team leads should be warned that he performs better as a subordinate than in a command position. He has a hearty, good-natured manner and spends his off-duty time socializing with a wide circle of friends, most military or ex-military men.

## NOTES

McAllen is proficient in demolitions and firearms and expert with grenades. Although he is not a leader, he is helpful as support when breaching doors and for additional firepower.

PRIMA GAMES.COM

## MORRIS, GERALD



## PERSONAL INFORMATION

IDENTIFICATION NUMBER: RCT0047-A0781

NATIONALITY: AMERICAN

DATE OF BIRTH: 24 DECEMBER 1965

SPECIALTY: DEMOLITIONS

HEIGHT: 186 CM

WEIGHT: 96 KG

HAIR: BLACK

EYES: BROWN

GENDER: MALE

## ATTRIBUTES

AGGRESSION:	40
LEADERSHIP:	72
SELF-CONTROL:	80
STAMINA:	79
ASSAULT:	80
DEMOLITIONS:	99
ELECTRONICS:	54
GRENADES:	97
SNIPER:	63
STEALTH:	71

## BACKGROUND

Born in Birmingham, Alabama, USA. Father is a retired furniture salesman; mother is a homemaker. Two younger sisters, both still living in Birmingham. High school valedictorian; National Merit Scholar, 1982. Attended Rice University in Houston, Texas, 1983–87; earned a B.S. in material science and a B.A. in Russian literature. Joined the American Bureau of Alcohol, Tobacco, and Firearms (BATF) in 1988 as an agent in their explosives division. Earned an M.S. degree in inorganic chemistry from the University of New Orleans during leave of absence from BATF, 1992–94. His thesis, "Applications of Micro-stress Analysis in Accelerant Identification," is considered a landmark in the forensic analysis of bomb debris. Upon his return in 1995 to active duty in the BATF, he was assigned to their International Response Team (IRT). Since 1998, Morris has been on extended assignment in South Korea with the Korean counterterrorism task force, the National Police 868 Unit, training them in bomb detection, bomb disposal, and post-bombing investigation techniques. His wife and two daughters live in Seoul, South Korea.

Morris is a team player who likes his operations run strictly by the book. His primary specialty is forensics, but he is also expert at setting and disarming all types of explosive devices. Although he is experienced in conducting counterterrorist assaults from his years working with the 868 Unit, he prefers to take an indirect approach in hostage situations. Morris likes to spend his off-duty hours with his family. In his spare time he collects antique blues recordings and memorabilia.

## NOTES

Morris is very good with demolitions and grenades. Use him for support, much as you would McAllen.

## MURAD, JAMAL



### PERSONAL INFORMATION

IDENTIFICATION NUMBER: RCT0031-A1044

NATIONALITY: EGYPTIAN

DATE OF BIRTH: 03 APRIL 1971

SPECIALTY: ASSAULT

HEIGHT: 170 CM

WEIGHT: 74 KG

HAIR: BLACK

EYES: BLACK

GENDER: MALE

### BACKGROUND

Born in Bani Suwayf, Egypt. Murad is the son of an influential moderate Muslim cleric, and grew up learning a great deal about both the religious and secular worlds. To the dismay of his pacifistic parents, Murad joined the Egyptian armed forces rather than continue his scholarship. Privately upset by the reputation of Egypt's Unit 777, Murad set out to change the organization from within. His contacts with US, British, and German training units convinced him there was a better way, but that Egypt would not be taking that path soon enough for him. His exceptional linguistic and military skills landed him a frequent cross-training position with the SAS, where he came to the attention of RAINBOW.

In combat, Murad is a swift and lethal presence. Once he has committed a plan to memory, nothing stands in his way. Prior to the mission, Murad questions every detail of every plan, often infuriating the planning officers but ensuring that every possible consequence and complication have been well thought out. His insistence that there is a right way has won him many admirers, if few friends

### ATTRIBUTES

AGGRESSION: 99

LEADERSHIP: 86

SELF-CONTROL: 99

STAMINA: 65

ASSAULT: 87

DEMOLITIONS: 16

ELECTRONICS: 50

GRENADES: 78

SNIPER: 42

STEALTH: 88

### NOTES

Murad is great as an assault team member. However, his leadership skills are not as high as others, so put him in second or third position in a team.

## NARINO, EMILIO



### PERSONAL INFORMATION

IDENTIFICATION NUMBER: RCT0031-A1044

NATIONALITY: COLOMBIAN

DATE OF BIRTH: 12 JANUARY 1967

SPECIALTY: SNIPER

HEIGHT: 164 CM

WEIGHT: 82 KG

HAIR: BLACK

EYES: BROWN

GENDER: MALE

### BACKGROUND

Born in Cartagena, Colombia. Narino's early activities are shrouded in mystery, a situation he enhances with conflicting stories regarding his training and upbringing. At various times, Narino has claimed to be the nephew of a Colombian drug lord, a failed university professor, an ex-police officer, and a freedom fighter. Most team members believe that he learned his trade as a CIA assassin, a belief that Narino alternately encourages with outrageous stories or flatly denies with cold stares. Regardless, everyone agrees that Narino is a cool and composed marksman with a disquieting ability to sneak into exposed positions without being seen.

Narino is a study in unpredictable mood swings. One minute joking and talkative, the next tight-lipped and silent. This never interferes with his professionalism on the job, but it has kept Narino at arm's length from the easy camaraderie pervading most of the team. This distance is especially noticeable during planning sessions, where he doesn't contribute unless it is to point out an unorthodox sniping position.

### ATTRIBUTES

AGGRESSION: 95

LEADERSHIP: 80

SELF-CONTROL: 54

STAMINA: 84

ASSAULT: 39

DEMOLITIONS: 60

ELECTRONICS: 56

GRENADES: 67

SNIPER: 97

STEALTH: 90

### NOTES

Narino is a good and capable sniper. Use him if the other snipers need to rest because they are fatigued by the last mission.

## NORONHA, ALEJANDRO



### PERSONAL INFORMATION

IDENTIFICATION NUMBER: RCT0009-A1538

NATIONALITY: BRAZILIAN

DATE OF BIRTH: 08 JUNE 1959

SPECIALTY: ASSAULT

HEIGHT: 175 CM

WEIGHT: 70 KG

HAIR: BROWN

EYES: BROWN

GENDER: MALE

### ATTRIBUTES

AGGRESSION:	91
LEADERSHIP:	91
SELF-CONTROL:	91
STAMINA:	82
ASSAULT:	94
DEMOLITIONS:	50
ELECTRONICS:	32
GRENADES:	75
SNIPER:	56
STEALTH:	73

### BACKGROUND

Born in Belo Horizonte, Brazil. His late father ran an import business. His mother is a homemaker. One older brother, two younger sisters. Attended college at the Brazilian military academy, *Colégio Militar do Rio de Janeiro* (CMRJ), 1977–81. Served two terms of duty with the regular Brazilian army before recruitment into the CounterTerrorist Detachment (CTD) of the 1st Special Forces Battalion in 1987. Since 1995 he has commanded one of CTD's three squadrons. He has cross-trained with the U.S. Delta Force, Chile's *Unidad Anti-Terroristas* (UAT), Argentina's *Brigada Especial Operativa Halcon*, and Columbia's *Agrupación De Fuerzas Especiales Urbanas* (AFEU). In 1997, he was one of a group of senior Brazilian CTD operators who assisted the Peruvian armed forces in ending the occupation of the Japanese embassy by the Tupac Amaru Revolutionary Movement (MRTA). Married 1985. His wife and two daughters live in Rio de Janeiro.

Noronha has spent most of his military career as a CT operator. He is well known in the CT community, particularly in North and South America, and has a reputation as a stern taskmaster. Although he has conducted actions in a variety of terrain and circumstances, he is particularly proficient in jungle operations and long-range intelligence-gathering. In combat situations, he is extremely aggressive and expects the same from any team that serves under him. He has no sense of humor and considers it unprofessional in others. His only passions (aside from work and family) are classical music and opera.

### NOTES

Noronha makes a good team leader. Although he is an assault specialist, you can assign his teams to other objectives, such as electronics or demolitions actions. He provides good leadership and protection for other types of specialists.

PRIMAGAMES.COM

## NOVIKOV, ARKADI



### PERSONAL INFORMATION

IDENTIFICATION NUMBER: RCT0031-A1044

NATIONALITY: RUSSIAN

DATE OF BIRTH: 24 MAY 1966

SPECIALTY: ASSAULT

HEIGHT: 201 CM

WEIGHT: 125 KG

HAIR: BLACK

EYES: BROWN

GENDER: MALE

### ATTRIBUTES

AGGRESSION:	74
LEADERSHIP:	99
SELF-CONTROL:	80
STAMINA:	83
ASSAULT:	94
DEMOLITIONS:	32
ELECTRONICS:	85
GRENADES:	60
SNIPER:	75
STEALTH:	70

### BACKGROUND

Born in Minsk, in what is now Belarus. Novikov is the son of a career army officer; his family is politically very well connected, and has made the transition from the USSR to the CIS very well indeed. Novikov enjoyed the finest education and living standard available, including an engineering degree from the University of Moscow. He spurned the regular army to take a prized field position in the enforcement arm of the KGB, only to find it disintegrating beneath him. When his co-workers joined the forming Russian Mafias, Novikov left the city to return to Minsk, where the newly independent Belarus army offered him a chance to lead a CT team of his own creation. A series of low profile but well-planned and executed missions brought him to the attention of RAINBOW, which Novikov gladly joined.

Novikov combines the broad build of the Russian athlete with an incisive mind and stern leadership. He is capable of working much higher in the organization, but prefers field duty, even if it means taking more orders than he gives. Other team members feel comfortable with Novikov in charge, as his personal bravery combines with sharp planning to virtually guarantee success.

### NOTES

Novikov makes an excellent leader, nearly on par with Chavez. Use him to lead one of your assault teams.

## PAK, SUO-WON



### PERSONAL INFORMATION

IDENTIFICATION NUMBER: RCT0031-A1044

**NATIONALITY:** SOUTH KOREAN    **DATE OF BIRTH:** 12 DECEMBER 1973  
**SPECIALTY:** RECON    **HEIGHT:** 159 CM  
**WEIGHT:** 45 KG  
**HAIR:** BLACK  
**EYES:** BROWN  
**GENDER:** MALE

### ATTRIBUTES

AGGRESSION:	60
LEADERSHIP:	70
SELF-CONTROL:	88
STAMINA:	100
ASSAULT:	89
DEMOLITIONS:	25
ELECTRONICS:	67
GRENADES:	65
SNIPER:	51
STEALTH:	99

### BACKGROUND

Born in Kangnung, South Korea. Pak is a member of a large family of fishermen; he has four brothers and three sisters. He entered the South Korean army at the youngest age he could, hoping he would not have to serve on a boat ever again. Despite (or perhaps because of) his slight build, Pak developed a reputation for physical prowess, particularly endurance. He was accepted into the 707th Special Mission Battalion, making battalion history by being the only inductee to exceed every one of the punishing physical tests exacted upon the battalion during training. He further built his reputation by succeeding at lengthy solo infiltration missions behind North Korean lines, often in disguise for extended periods of time.

Pak is cheerful and optimistic at all times. While recon Operatives are not used in all missions, Pak manages to be in the center of the planning and discussion stages all the same.

### NOTES

Pak is an average recon specialist. Even though he can move without making a sound, his firearms and leadership skills are only average for a RAINBOW Operative.

## PETERSEN, EINAR



### PERSONAL INFORMATION

IDENTIFICATION NUMBER: RCT0031-A1044

**NATIONALITY:** NORWEGIAN    **DATE OF BIRTH:** 14 SEPTEMBER 1970  
**SPECIALTY:** SNIPER    **HEIGHT:** 189 CM  
**WEIGHT:** 73 KG  
**HAIR:** BROWN  
**EYES:** BROWN  
**GENDER:** MALE

### ATTRIBUTES

AGGRESSION:	88
LEADERSHIP:	75
SELF-CONTROL:	100
STAMINA:	98
ASSAULT:	36
DEMOLITIONS:	24
ELECTRONICS:	49
GRENADES:	75
SNIPER:	99
STEALTH:	89

### BACKGROUND

Born in Hamar, Norway. Parents owned and operated a ski resort high in central Norway. Began skiing at an early age; soon added hunting and shooting, to become an accomplished biathlete. Attempted and failed to win entry to Norway's Olympic Biathlon Team in 1988 and 1992, missing by fractions of a point each time. Joined *Beredskapstroppen* in 1990, after sister traveling in the Middle East was wounded in a terrorist attack.

Petersen is a nearly unstoppable sniper if allowed the proper setup time. He projects an air of icy calm at all times, prompting teammates to devise various pranks and embarrassing situations to disturb that calm. All attempts so far have failed. While aloof, his unerring accuracy has endeared him to the rest of the team. When not on duty, Petersen often embarks on lengthy solo cross-country skiing trips, disappearing into dense terrain for days at a time.

### NOTES

Petersen is an excellent sniper. He is extremely accurate and patient, waiting for hours for the perfect shot.

## PRICE, EDDIE



### PERSONAL INFORMATION

IDENTIFICATION NUMBER: RCT0049-B4197

NATIONALITY: BRITISH

DATE OF BIRTH: 21 SEPTEMBER 1958

SPECIALTY: ASSAULT

HEIGHT: 186 CM

WEIGHT: 84 KG

HAIR: BROWN

EYES: GREEN

GENDER: MALE

### ATTRIBUTES

AGGRESSION: 80

LEADERSHIP: 95

SELF-CONTROL: 90

STAMINA: 87

ASSAULT: 96

DEMOLITIONS: 71

ELECTRONICS: 63

GRENADES: 77

SNIPER: 52

STEALTH: 89

### BACKGROUND

Born in London, England. Father deceased, mother living in Cambridge, retired nurse. Price is a former color sergeant, serving in the 22nd SAS at Hereford. Spot-promoted to Sergeant Major. Spent time in Northern Ireland for the 14th Intelligence Company. Highly trained in techniques including CQB, IR photography, and covert surveillance, "the Company" performs in Northern Ireland, monitoring known IRA terrorists and preemptively striking terrorist targets. Involved in hostage rescue, Colombia, 1984. Extremely physically fit and an expert marksman. Enjoys reading, smoking his pipe, and working out with Weber. Unmarried.

### NOTES

In the Tom Clancy novel *RAINBOW Six*, Price is the first sergeant of Chavez's team. With more experience than any of the other Operatives, Price makes a great team leader. He has great leadership skills, and he's very proficient with firearms.

PRIMGAMES.COM

## RAKUZANKA, KAZIMIERA



### PERSONAL INFORMATION

IDENTIFICATION NUMBER: RCT0027-A2057

NATIONALITY: POLISH

DATE OF BIRTH: 29 FEBRUARY 1964

SPECIALTY: ASSAULT

HEIGHT: 165 CM

WEIGHT: 61 KG

HAIR: BLONDE

EYES: BROWN

GENDER: FEMALE

### ATTRIBUTES

AGGRESSION: 85

LEADERSHIP: 85

SELF-CONTROL: 60

STAMINA: 96

ASSAULT: 96

DEMOLITIONS: 50

ELECTRONICS: 52

GRENADES: 70

SNIPER: 73

STEALTH: 80

### BACKGROUND

Born Kazimiera Koziol in Gdansk, Poland. Her father and brothers worked in the shipyards and she was active from an early age in the movement later known as *Solidarnosc*. In 1981, when she was 17, she was beaten seriously enough by police to require hospitalization; in 1982 she was arrested during a street demonstration and spent the following year in jail. Upon her release in 1983, she resumed activity in the Solidarity underground while working odd jobs in and around Gdansk. Married in 1986 to fellow activist Andrzej Rakuzanka. With the shifting of political winds in 1989 and the founding of the Republic of Poland, she was able once again to make public her affiliation with Solidarity. In 1990, she joined the reconstructed Gdansk police force and quickly moved into undercover work to battle the growing organized crime problem in the newly liberated country. In 1993 she joined the *Grupa Reagowania Operacyjno Mobilnego* (GROM), Poland's newly formed counterterrorist unit. Initially involved purely in intelligence-gathering activities, in 1994, when her unit took part in Operation Restore Democracy, the American-led invasion of Haiti, she was promoted to full-fledged CT operator. She led her first assault team in 1998 and has since cross-trained with the U.S. Delta Force, Norway's *Beredskapstroppen*, and Finland's *Osasto Karhu*. Her husband and two daughters reside in Gdansk.

Rakuzanka is a survivor. Despite her unassuming appearance, she has an iron constitution and can endure extreme hardship. She is a strong team player and an excellent shot. She can be sarcastic, but reserves her sharpest barbs for the rich and powerful. Friends and family call her "Kazi," colleagues "Kamikazi" (but never to her face).

### NOTES

Rakuzanka is a good assault specialist in a support role. She is best at firearms, and average in other areas.

## RAYMOND, RENEE



### PERSONAL INFORMATION

IDENTIFICATION NUMBER: RCT0047-A1342

NATIONALITY: AMERICAN

DATE OF BIRTH: 30 MARCH 1968

SPECIALTY: ASSAULT

HEIGHT: 172 CM

WEIGHT: 64 KG

HAIR: BLACK

EYES: BROWN

GENDER: FEMALE

### BACKGROUND

Born in Kansas City, Missouri, USA. Father is a retired U.S. Army colonel; mother is a homemaker. Two older brothers. Attended University of Oklahoma, 1986–89, under Reserve Officers Training Corps (ROTC) program, majoring in political science. Entered regular U.S. Army upon graduation. Served in Kuwait, 1991. Recruited into U.S. Special Operations Psychological Operations (PSYOPS), 1992. Served in Bosnia, 1996–97. In 1998, participated in U.S. Army trial introduction of women into special operations ground combat forces. Trained with 1st Special Forces Operational Detachment-Delta (1st SFOD-D, "Delta Force"). Married 1993. Husband is a lieutenant in U.S. Army, stationed in Frankfurt, Germany. One child, a daughter, born 1995.

Raymond is self-reliant and resourceful. An excellent combat soldier, she is also well-versed in psychological warfare, and understands how both soldiers and civilians react under the stress of combat. Although she is an experienced officer, she is too much of a loner to be at her best as team lead. Use her to maximum advantage in a support role. She talks little and weighs her words carefully when she does speak.

### ATTRIBUTES

AGGRESSION: 75

LEADERSHIP: 79

SELF-CONTROL: 90

STAMINA: 91

ASSAULT: 97

DEMOLITIONS: 30

ELECTRONICS: 23

GRENADES: 85

SNIPER: 68

STEALTH: 96

### NOTES

Raymond is excellent in combat, with great firearms and grenades attributes, and her great stealth renders her useful for reconnaissance. Keep her in the support role; other team members are better leaders.

## WALTHER, JORG



### PERSONAL INFORMATION

IDENTIFICATION NUMBER: RCT0017-A1615

NATIONALITY: GERMAN

DATE OF BIRTH: 17 MAY 1974

SPECIALTY: ASSAULT

HEIGHT: 190 CM

WEIGHT: 105 KG

HAIR: BROWN

EYES: BLUE

GENDER: MALE

### BACKGROUND

Born in Saarbrücken, Germany. Father is a safety engineer with Lufthansa German Airlines; mother is a homemaker. Three younger siblings—two sisters and a brother. Amateur archer, competing in Germany junior national championships, 1990. Entered the German Federal Border Police Force (*Bundsgrenzschutz*) in 1994, at the top of his cadet class. Stationed at Saarbrücken, 1994–98. Recruited into Germany's elite counterterrorist force, *Grenzschutzgruppe 9* (GSG-9) in 1998. Completed GSG-9 training in record time, again at the top of his class. Temporarily attached to GSG-9/1, the group's primary CT strike unit, before reassignment to RAINBOW. Married 1996. No children.

Walther is the youngest member of the current RAINBOW team. His extraordinary drive and determination compensate for his inexperience in the field. He learns quickly and makes an exceptional team member who follows every order without hesitation or question. Although trained primarily in assault, he is well-versed in wiretapping and electronic surveillance. *Bundsgrenzschutz* command clearly is grooming him for advancement; his assignment to RAINBOW reflects the German government's long-term commitment to international CT collaboration.

### ATTRIBUTES

AGGRESSION: 76

LEADERSHIP: 97

SELF-CONTROL: 90

STAMINA: 96

ASSAULT: 96

DEMOLITIONS: 71

ELECTRONICS: 89

GRENADES: 83

SNIPER: 71

STEALTH: 97

### NOTES

Walther makes a great team leader. He is good with firearms, and useful for electronics work, as well.

## WEBER, DIETER



### PERSONAL INFORMATION

IDENTIFICATION NUMBER: RCT0017-B7682

NATIONALITY: GERMAN

DATE OF BIRTH: 09 JULY 1971

SPECIALTY: SNIPER

HEIGHT: 191 CM

WEIGHT: 98 KG

HAIR: BLOND

EYES: BROWN

GENDER: MALE

### ATTRIBUTES

AGGRESSION: 93

LEADERSHIP: 73

SELF-CONTROL: 84

STAMINA: 100

ASSAULT: 45

DEMOLITIONS: 53

ELECTRONICS: 61

GRENADES: 72

SNIPER: 95

STEALTH: 96

### BACKGROUND

Born in Munich, Germany. Father ironworker, mother deceased. Graduate of German Army's *Berger Fuhrer* (Mountain Leader) schools, one of the world's toughest, physically. Came from GSG-9 team, part of the former Border Guards, the Federal Republic's counterterrorism team. Fluent in English and German, his marksmanship is matched by only a few team members. Spends free time hunting, working out with Price, and practicing taekwon do. Unmarried.

### NOTES

Weber is another one of RAINBOW's snipers. Although he has great firearms and stealth levels, he's not the best leader. You may want to control him, however, since he is an excellent sniper. Either put him in charge of a small team, or keep him alone at a distance from the action to supply fire support.

PRIMAAMES.COM

## WOO, TRACY



### PERSONAL INFORMATION

IDENTIFICATION NUMBER: RCT0047-A2715

NATIONALITY: AMERICAN

DATE OF BIRTH: 14 JULY 1971

SPECIALTY: RECON

HEIGHT: 155 CM

WEIGHT: 44 KG

HAIR: BLACK

EYES: BROWN

GENDER: FEMALE

### ATTRIBUTES

AGGRESSION: 50

LEADERSHIP: 5

SELF-CONTROL: 85

STAMINA: 96

ASSAULT: 80

DEMOLITIONS: 30

ELECTRONICS: 85

GRENADES: 50

SNIPER: 61

STEALTH: 98

### BACKGROUND

Born in Los Angeles, California, USA. Father is a doctor, mother a lawyer. No siblings. Amateur gymnast, competing in West Coast regional championships 1987-88. Attended UCLA 1989-92; graduated with a B.A. in psychology. Joined Los Angeles Police Department in 1992; transferred to Metro Division Special Weapons and Tactics (SWAT) team in 1994, specializing in surveillance and negotiation. Commended for bravery for her role in ending the New Millennium occupation of Los Angeles City Hall in 1999. Unmarried.

Woo is expert in reconnaissance and surveillance. She moves quickly and quietly through terrorist-controlled areas, and is skilled in the installation and removal of a variety of electronic intelligence-gathering devices. She handles command well, but has an independent nature and has been known to argue with superiors. Her combat skills are average. Outspoken and self-reliant.

### NOTES

Woo is a good support Operative in recon missions. Although she is very stealthy, her combat and other skills are below average, (except for electronics, in which she is fairly proficient).



## YACOBY, AYANA



### PERSONAL INFORMATION

IDENTIFICATION NUMBER: RCT0022-A4242

NATIONALITY: ISRAELI

DATE OF BIRTH: 03 MARCH 1973

SPECIALTY: RECON

HEIGHT: 163 CM

WEIGHT: 57 KG

HAIR: BROWN

EYES: BROWN

GENDER: FEMALE

### ATTRIBUTES

AGGRESSION: 95

LEADERSHIP: 65

SELF-CONTROL: 70

STAMINA: 95

ASSAULT: 97

DEMOLITIONS: 30

ELECTRONICS: 86

GRENADES: 60

SNIPER: 54

STEALTH: 97

### BACKGROUND

Born in Tel Aviv, Israel. Father is a greengrocer; mother died when she was three. One younger brother, professional soccer player, *Beitar Jerusalem*. Joined regular Israeli army, 1992. Transferred to *Sayeret Mat'kal* in 1995, where she served in the general staff reconnaissance unit. Mossad recruited her in 1997. Specializes in infiltration and intelligence gathering. In addition to her native Hebrew, speaks fluent English and Arabic. Unmarried.

Yacoby is master of the silent kill. Her training enables her to move stealthily into hostile territory and neutralize any threats. She is extremely intelligent, with little tolerance for fools. The quintessential professional, she has complained about the "cowboy mentality" of some other team members. Ruthless in combat, in nonmilitary situations she may err on the side of excessive force.

### NOTES

As with most recon specialists, Yacoby is no leader. However, she is an expert in firearms and stealth. Her relatively low self-control value means you should use her in support of good leaders.



# THE RAINBOW ARSENAL

An important part of preparing for any mission is putting together kits for your operatives. A kit is the equipment you issue to help an operative accomplish the mission objectives. Each kit includes a uniform, primary and secondary weapons, and two slots you can fill with your choice of a number of different items.

When assembling kits, tailor each to the individual operatives and their unique roles in the mission. For example, a sniper's kit will differ from an assault operative's kit. Even operatives within a single team may need different items, depending on their duties.

When planning a mission, first assign the operatives to teams and give them their orders; then return to the Kit screen and issue the appropriate equipment.

## FIREARMS

Firearms in the RAINBOW arsenal are selected based on accuracy, firepower, and reliability. Each team member carries a primary weapon and a pistol. The mission and its objectives determine which weapons you assign. Sometimes stealth and silence are paramount, while other circumstances call for long-range firepower. Give your team members the best weapons for their tasks.

## PRIMARY WEAPONS

Primary weapons comprise four categories: submachine guns, assault rifles, sniper rifles, and shotguns. Read on for a look at each and the situations for which they're best suited.



Statistical information is provided for each firearm. Ammunition lists the size and caliber of the round fired; Rounds per Magazine lists how many rounds are in magazine; Magazines lists how many magazines are issued with the weapon; and Fire Selection lists how the weapon can be fired. SA represents semi-automatic,

where each pull of the trigger fires a single shot. TRB is three round burst, where each pull of the trigger fires three rounds. FA is full-automatic, where the weapon continues to fire as long as the trigger is pulled or until the weapon's magazine is empty.

## SUBMACHINE GUNS

Submachine guns are best used in close-quarters battle (CQB) when you need a smaller weapon with a high rate of fire and good maneuverability. Because their shorter barrels render submachine guns less accurate at medium and long ranges, Sniper mode view is limited or nonexistent for these weapons. They're also the only primary weapon you can fit with a sound suppressor for stealthy operations.



### 9MM MP5 A4 SMG

AMMUNITION: 9MM

MAGS: 6

ROUNDS PER MAG: 30

FIRE SELECTION: SA, TRB, FA

The preferred submachine gun of counterterrorist operatives around the world, the 9mm MP5 A4 SMG is known for its reliability and accuracy, even when firing on full-automatic. RAINBOW uses this submachine gun fitted with single, triple, and full-auto trigger group.

#### Notes

This is the standard RAINBOW firearm, and it's one of the most accurate firearms available to your operatives. Unless you need long-range fire, greater stopping power, or stealth, this is the weapon to use.



### 9MM MP5 SD SMG

AMMUNITION: 9MM

MAGS: 6

ROUNDS PER MAG: 30

FIRE SELECTION: SA, TRB, FA

Terrorists throughout the world fear the 9mm MP5 SD SMG. Its integral silencer is so effective that the bullet's report is minuscule compared to the click of the bolt. RAINBOW uses the 9mm MP5 SD SMG whenever accuracy and stealth are essential.

#### Notes

The 9mm MP5 SD SMG is essentially a silencer-equipped 9mm MP5 SMG. Use this weapon when you must take out enemy units while maintaining stealth and secrecy. It's the only primary weapon with a silencer. Assign it to your recon teams. Other submachine guns have silencers, but the 9mm MP5 SD is the quietest.



### 10MM MP5 10A2 SMG

AMMUNITION: 10MM

MAGS: 5

ROUNDS PER MAG: 30

FIRE SELECTION: SA, FA

The 10mm MP5 10A2 SMG is an improved variant of the venerable 9mm MP5 SMG chambered for a 10mm round. The heavier round's increased stopping power is offset by increased recoil. It comes equipped with a single and full-auto trigger group.

#### Notes

This is a good weapon if you want the ease of use of the 9mm MP5 A4 SMG, but need a little more punch. If you expect the terrorists to be wearing light body armor, this is a good choice.

## 10MM MP5 SD10 SMG

AMMUNITION: 10MM      MAGS: 5  
 ROUNDS PER MAG: 30      FIRE SELECTION: SA, FA



A 10mm MP5 SD10 SMG equipped with a sound suppressor provides a nice balance of power and silence. Because the suppression isn't integral (as it is with the 9mm MP5 PDW SMG), it is not quite as complete.

### Notes

It's always best to use silenced weapons. This one gives you more takedown power than the 9mm MP5 SD SMG, but makes a bit more noise.

## 0.45CAL UMP SMG

AMMUNITION: 0.45      MAGS: 5  
 ROUNDS PER MAG: 25      FIRE SELECTION: SA, TRB, FA



The stopping power of its .45 caliber round comes at the price of increased recoil and a lower rate of fire.

### Notes

This weapon fills the gap between submachine gun and assault rifle. Its size makes it a bit more difficult to handle in close quarters, but it's still much better than a rifle. This is a good choice when the enemy is wearing medium body armor. After you fire the first couple of rounds of a burst, the recoil will cause the rest to go wild. Therefore, use the three-round burst selection or don't hold the trigger down long when on full-automatic, especially when hostages are nearby.

## 0.45CAL SD UMP SMG

AMMUNITION: 0.45      MAGS: 5  
 ROUNDS PER MAG: 25      FIRE SELECTION: SA, TRB, FA



A 0.45cal UMP SMG equipped with a sound suppressor. Of course, the suppression isn't as complete as the integral suppressor of the 9mm MP5 SD SMG. This weapon is a good choice when you need a balance between power and silence.

### Notes

This weapon is the largest caliber silencer-equipped primary weapon. If you need stealth with all the takedown you can get, use this weapon.

## 9MM MP5 PDW SMG

AMMUNITION: 9MM      MAGS: 6  
 ROUNDS PER MAG: 30      FIRE SELECTION: SA, FA



The 9mm MP5 PDW SMG is a compact version of the classic 9mm MP5 SMG. Its folding stock and light weight make it an ideal choice when a full rifle or submachine gun is unmanageable and a handgun is a poor compromise. It comes equipped with the single and full-auto trigger group.

### Notes

The PDW is RAINBOW's close-quarters submachine gun. Although not as accurate as the 9mm MP5 A4 SMG, it's good for clearing rooms with full-automatic bursts. Use caution with this weapon around hostages. During a long full-automatic burst, the rounds can go wild.

PRIMAGAMES.COM



### 5.7MM P90 SMG

AMMUNITION: 5.7 X 28MM      MAGS: 3  
ROUNDS PER MAG: 50      FIRE SELECTION: SA, FA

The 5.7mm P90 SMG is a blowback-operated, selective-fire weapon. It's fed from 50-round box magazines made of translucent polymer. The 5.7mm P90 SMG was developed in the late 1980s, and is the forerunner of the PDW (Personal Defense Weapon) concept.

#### Notes

This is a great weapon for operations within buildings where long-range accuracy is not as important as raw firepower. The 50-round magazine provides plenty of shots before you have to reload.



### 5.7MM P90 SD SMG

AMMUNITION: 5.7 X 28MM      MAGS: 3  
ROUNDS PER MAG: 50      FIRE SELECTION: SA, FA

A 5.7mm P90 SMG equipped with a sound suppressor and uses a special subsonic variant of the 5.7 x 28mm cartridge.

#### Notes

This weapon has all the same features as the 5.7mm P90 SMG, plus a silencer. This is a great weapon for interior operations.



### 9MM TMP SMG

AMMUNITION: 9MM      MAGS: 3  
ROUNDS PER MAG: 30      FIRE SELECTION: SA, FA

The 9mm TMP SMG is a modern compact submachine gun. It is blowback operated, and has a locked breech design with a rotating barrel. It fires 9mm rounds with a magazine capacity of 30 rounds. The TMP is very controllable and comfortable to fire.

#### Notes

This weapon is small and easily concealed. However, it's only accurate at close range. Experiment with it, but there are other submachine guns that can do the same job better than the 9mm TMP SMG.



### 9MM M12 SMG

AMMUNITION: 9MM      MAGS: 3  
ROUNDS PER MAG: 40      FIRE SELECTION: SA, FA

The 9mm M12 SMG is a recoil-operated, select-fire firearm, firing the 9 x 19mm round of ammunition from an open bolt. It has a low rate of fire compared to other submachine guns, and it's a little less accurate but its small size and weight make up for it.

#### Notes

Its small size makes the 9mm M12 SMG easy to conceal, but this is not necessary for RAINBOW operations. Try this gun, but the 5.7mm P90 SMG is a better choice if you want something small.

**7.65MM SKORPION SMG (MULTIPLAYER ONLY)**

AMMUNITION: 7.62MM    MAGS: 8  
 ROUNDS PER MAG: 20    FIRE SELECTION: SA, FA



This is a true machine pistol. It's not much larger than a pistol, and it fires pistol ammunition. Terrorists favor this submachine gun for its ease of concealment and its firepower. Due to its short muzzle, the 7.65mm Skorpion SMG is best used at close range. The small round and low muzzle velocity don't pack much of a punch, and limit its takedown power. For the best results, fire in bursts.

**Notes**

This weapon comes with eight magazines, and you will need them all. Don't waste your time with single-shot mode. Instead, when you see a target, let loose with full-auto. Also, you cannot use Sniper mode with this weapon. The 7.65mm Skorpion SMG is only available during multiplayer missions. It is also used by some tangos during the campaign missions.

**9MM UZI SMG (MULTIPLAYER ONLY)**

AMMUNITION: 9MM    MAGS: 6  
 ROUNDS PER MAG: 32    FIRE SELECTION: SA, FA



The 9mm Uzi SMG was designed in response to the need for a quality firearm that could be produced domestically for the Israeli Defense Force. It entered service in 1950. Because the magazine is loaded into the pistol grip, the point of balance is above the grip, allowing this weapon to be shot one-handed. The 9mm Uzi SMG was the premier submachine gun until the MP5 series. This weapon is only available during multiplayer missions. It is used by some tangos during the campaign missions.

**Notes**

The 9mm Uzi SMG is a good submachine gun. Like the 7.65mm Skorpion SMG, you cannot use Sniper mode for long-range shots.

**ASSAULT RIFLES**

Military forces use assault rifles on the battlefield. They're more accurate at medium and long ranges, and the view in Sniper mode is quite good. Rifles also have more stopping power because many of them fire a larger, more powerful round. Use assault rifles for outdoor missions where firing range can be long, and for interior missions where you need the additional firepower and stealth isn't necessary. Give assault rifles to your teams that provide fire support for other teams.

**5.56MM M4 AR**

AMMUNITION: 5.56MM X 45MM    MAGS: 5  
 ROUNDS PER MAG: 30    FIRE SELECTION: SA, FA



A compact version of the 5.56mm M16 AR, the 5.56mm M4 AR is appropriate when you want the firepower of an assault rifle without the weight and size. It's commonly used by U.S. and Israeli Special Forces. It comes standard with a single and full-auto trigger group.

**Notes**

Issue the 5.56mm M4 AR to firepower support teams. It functions best outside, but its compact size allows it to be effective inside buildings, as well.

PRIMAEMISS.COM



### 7.62MM G3A3 AR

AMMUNITION: 7.62MM X 51MM

MAGS: 4

ROUNDS PER MAG: 20

FIRE SELECTION: SA, FA

The 7.62mm G3A3 AR is a standard assault rifle. It fires the powerful 7.62mm NATO round. This is the most accurate assault rifle in RAINBOW's arsenal.

#### Notes

This is your best choice for long-range, non-sniper shooting. Give it to teams providing cover from a distance when you need more firepower than a sniper rifle can offer. Because of its size, it's not as good as the 5.56 M4 AR for close-quarters battle.



### 5.56MM G36K AR

AMMUNITION: 5.56MM X 45MM

MAGS: 5

ROUNDS PER MAG: 30

FIRE SELECTION: SA, TRB, FA

The 5.56mm G36K AR is their latest assault rifle entry. Its compact design makes it useful in close quarters, and its 5.56mm round will penetrate most body armor.

#### Notes

Firing the same round as the 5.56mm M16 AR, the 5.56mm G36K AR gives added punch to assault teams working at short range with little room to maneuver. Use this against tingos wearing body armor when you must advance through narrow corridors or other such areas. This assault rifle functions a lot like a submachine gun (with various firing options), but packs the punch of rifle.



### 5.56MM L85A1 AR

AMMUNITION: 5.56MM X 45MM

MAGS: 5

ROUNDS PER MAG: 30

FIRE SELECTION: SA, TRB, FA

The 5.56mm L85A1 AR is the standard infantry weapon of the British Army. Its bullpup design trades accuracy for maneuverability.

#### Notes

With the magazine built into the stock, the 5.56mm L85A1 AR provides a longer barrel in a shorter gun. Similar to an 5.56mm M16 AR in firepower, it is much easier to use in close quarters where accuracy is less important.



### 5.56MM AUG AR

AMMUNITION: 5.56MM X 45MM

MAGS: 5

ROUNDS PER MAG: 30

FIRE SELECTION: SA, FA

The standard weapon of the Austrian Army, the 5.56mm Aug AR is a futuristic-looking assault rifle with a compact bullpup design. It's well-suited for missions requiring the maneuverability of a submachine gun and the punch of an assault rifle.

#### Notes

A bit more accurate than the 5.56mm L85A1 AR, the 5.56mm Aug AR is a good choice for both indoor and outdoor missions.

## 5.56MM M16 AR

AMMUNITION: 5.56MM X 45MM  
 ROUNDS PER MAG: 30

MAGS: 5  
 FIRE SELECTION: SA, TRB



When they need extra range or firepower, RAINBOW turns to the 5.56mm M16 AR. Tried and true, its 5.56 caliber easily pierces level 2 body armor and has the longest range of any of RAINBOW's standard weapons. It comes standard with a single and three-round trigger group.

### Notes

The 5.56mm M16 AR is RAINBOW's heavy firepower. Although it's the standard infantry weapon of the U.S. military, it's quite large by RAINBOW standards. This weapon functions best for support-fire teams and is best used outside, where range is a factor. It's difficult to use in room-to-room combat because of its size. Also note that this is the only assault rifle that can't be fired in full-automatic mode; the A2 version instead uses the three-round burst. U.S. Army studies found that after the third round in a full-automatic burst, remaining rounds fired were off-target by quite a bit. Therefore, to maintain accuracy and save ammo, this fire mode was removed. If you like to hose down an area with lead, this is not the weapon for you.

## 7.62MM M-14 AR

AMMUNITION: 7.62MM X 51MM  
 ROUNDS PER MAG: 20

MAGS: 4  
 FIRE SELECTION: SA, FA



The direct descendant of the classic WWII M1 semiautomatic rifle, the 7.62mm M-14 AR fires a 7.62mm round with extreme accuracy. The U.S. Army has used it since 1957.

### Notes

The 7.62mm M-14 AR fills the gap between assault rifle and sniper rifle in both accuracy and firepower. This is definitely an outdoor weapon. It fires a larger round than any of the assault rifles at a longer range, but its rate of fire is slower.

## 5.56MM FAMAS G2 AR

AMMUNITION: 5.56MM X 45MM  
 ROUNDS PER MAG: 25

MAGS: 3  
 FIRE SELECTION: SA, TRB, FA



The 5.56mm FAMAS G2 AR fires 5.56 x 45mm NATO rounds, and its 950-rounds-per minute rate of fire is the highest among RAINBOW's assault rifles.

### Notes

The 5.56mm FAMAS G2 AR assault rifle is comparable to the 5.56mm G36K AR or the 5.56mm L85A1 AR in that it has three modes of fire selection. The 5.56mm FAMAS G2 AR is the best of these three weapons, and a great choice for missions requiring firepower heavier than a submachine gun.

## 5.56MM FNC AR

AMMUNITION: 5.56MM X 45MM  
 ROUNDS PER MAG: 30

MAGS: 3  
 FIRE SELECTION: SA, FA



Once called the "free world's assault rifle," the 1980 assault rifle design inherited the best ideas and characteristics of the Israeli Galil, the Soviet AK, and the Belgian FAL. It uses 5.56 x 45mm NATO rounds with a magazine capacity of 30 rounds.

### Notes

Although not as good as some of the other assault rifles, the 5.56mm FNC AR is a decent choice for operations requiring this type of weapon.

PRIMAEMIA





### 7.62MM FAL AR

AMMUNITION: 7.62MM X 51MM    MAGS: 3  
 ROUNDS PER MAG: 20    FIRE SELECTION: SA, FA

This light automatic rifle is one of the most widely used battle rifles of the 20th century. Due to its heavy recoil in full-auto mode, it's often issued in semi-auto mode. It uses 7.62 x 51mm NATO rounds with a 20-round magazine.

#### Notes

The 7.62mm FAL AR has been around for decades. While it has some stopping power thanks to its large-caliber round, its poorer accuracy during full-automatic fire can be detrimental during RAINBOW operations.



### 7.62MM AK-47 AR (MULTIPLAYER ONLY)

AMMUNITION: 7.62MM X 39MM    MAGS: 4  
 ROUNDS PER MAG: 30    FIRE SELECTION: SA, FA

The 7.62mm AK-47 AR was the standard infantry weapon of the Soviet Red Army and many Soviet satellite countries. Based on the German MP-44 assault rifle, this weapon gave the Soviet soldier a high rate of fire with a rifle-caliber round and a large magazine. Because it was manufactured by most Soviet Bloc countries, it is the most widely used military firearm in the region. Due to the massive quantities in these nations' stockpiles, 7.62mm AK-47 ARs have been exported around the world, and are easy for terrorist groups to obtain. It has a low muzzle velocity, making the range of accurate shooting only 300 meters.

#### Notes

This is a fun weapon to try. However, it is loud and you only have four magazines. It knocks the target down when it hits. This weapon is only available during multiplayer missions. It is also used by some tangos during the campaign missions.



### 5.54MM AK-74 AR (MULTIPLAYER ONLY)

AMMUNITION: 5.45MM X 39MM    MAGS: 5  
 ROUNDS PER MAG: 30    FIRE SELECTION: SA, FA

The 5.54mm AK-74 AR is a revision of the successful 7.62mm AK-47 AR. It uses a smaller-caliber round, thus giving the rifle longer range and more accuracy. It was first fielded by the Red Army in 1974. Although not as widely available as the 7.62mm AK-47 AR, it is commonly used by Russian terrorist groups and Russian mercenaries.

#### Notes

The 5.45mm AK-74 AR is more accurate than the 7.62mm AK-47 AR, and has one more magazine. The 5.45mm AK-74 AR can be identified by its brownish-orange plastic magazines. This weapon is only available during multiplayer missions. It is also used by some tangos during the campaign missions.



### 5.56MM GALIL ARM AR (MULTIPLAYER ONLY)

AMMUNITION: 5.56MM X 45MM    MAGS: 3  
 ROUNDS PER MAG: 35    FIRE SELECTION: SA, FA

This Israeli-made assault rifle is based upon the successful Soviet AK design.

#### Notes

This weapon is only available during multiplayer missions. It is also used by some tangos during the campaign missions.

**5.56MM M82 AR (MULTIPLAYER ONLY)**

AMMUNITION: 5.56MM X 45MM

MAGS: 3

ROUNDS PER MAG: 30

FIRE SELECTION: SA, FA



This futuristic-looking assault rifle is similar to the 5.56mm Aug AR. It is smaller than some of the other assault rifles, making it easier to use in close-quarters combat.

**Notes**

This weapon is only available during multiplayer missions.

**SNIPER RIFLES**

Sniper rifles are intended for use at long and very long ranges. They can be extremely accurate, especially in the hands of an operative with a high sniper skill level. These rifles are single-shot. Of course, most snipers need only a single round to drop the tango in sight. Due to the weapon's length, snipers usually carry their secondary weapon when they move around.

When under the control of the AI, snipers on your team will use their sniper rifle only when they receive the order to Snipe. For Cover and Defend orders, they use their pistol. Also, snipers will not fire in Snipe mode until you release them by pressing **[Y]**. When you take direct control of a sniper, be sure there are no tangos nearby. When you are zoomed in on a target, your peripheral vision is nil and it's easy for tangos beyond your narrow field of vision to approach and attack.

**0.50CAL M82A1 SR**

AMMUNITION: 0.50 BROWNING

MAGS: 2

ROUNDS PER MAG: 10

FIRE SELECTION: SA



The 0.50cal M82A1 SR was the first .50 caliber sniper rifle to achieve widespread use. Its massive length (1.55m) and weight (13.4 kg) make it the most accurate sniper rifle in RAINBOW's arsenal. Use extreme care when employing this weapon. Its high-powered .50 Browning round can tear through multiple targets just as easily as it can through an engine block.

**Notes**

This sniper rifle is definitely an outdoor weapon. Its very long barrel makes it hard to use indoors. With a range of over a mile, you can position your snipers away from the terrorist fire and still have plenty of stopping power.



### 7.62MM PSG-1 SR

AMMUNITION: 7.62MM X 51MM  
 ROUNDS PER MAG: 5

MAGS: 4  
 FIRE SELECTION: SA

Arguably the most accurate off-the-shelf sniper rifle available and a favorite of police forces around the world, the 7.62mm PSG-1 AR comes standard with a 6x sight and fires the NATO 7.62 round.

#### Notes

This will be your standard sniper rifle for most missions. It fits between the other two sniper rifles in terms of range and maneuverability.



### 7.62MM WA2000 SR

AMMUNITION: 0.300 WINCHESTER  
 ROUNDS PER MAG: 6

MAGS: 5  
 FIRE SELECTION: SA

The shortest sniper rifle used by the RAINBOW team, the 7.62mm WA2000 SR's bullpup design and light weight make it a favorite among snipers who must move stealthily into difficult positions. Its powerful .300 Winchester round has more punch than the more common 7.62 NATO round.

#### Notes

This sniper rifle is a good choice for indoor missions. Its length and weight allow it to be carried in close quarters, although it should still be used for long-range shooting.



### 7.62MM AW COVERT SR

AMMUNITION: 7.62 X 51MM  
 ROUNDS PER MAG: 10

MAGS: 4  
 FIRE SELECTION: FA

The 7.62mm AW Covert SR is a silenced sniper rifle firing the 7.62 x 51mm subsonic round. This round is less powerful than the standard 7.62 x 51mm round, making the AW Covert slightly less powerful and accurate than other sniper rifles. This reduced effectiveness is offset by the silencer. The subsonic round does not produce the sonic crack as it leaves the barrel, which allows a sniper to get closer to the target and still avoid detection.

#### Notes

This weapon is the best of both worlds—it provides the long-range firepower of a sniper rifle with the silence of a submachine gun. This gives you new options when planning a mission, and allows you to position your sniper in more threatening positions, where they can strike without being detected. If you need to take out tangos at long range, consider taking along a sniper armed with the 7.62mm AW Covert SR. This weapon also offers awesome benefits for multiplayer missions.



### 7.62MM SSG 3000 SR

AMMUNITION: 7.62 X 51MM  
 ROUNDS PER MAG: 5

MAGS: 3  
 FIRE SELECTION: SA

This sniper rifle fires the powerful 7.62mm NATO round. This very accurate weapon has a magazine capacity of five rounds.

#### Notes

You can use the 7.62mm SSG 3000 SR in any situation where you would use the 7.62mm PSG-1 SR. The two weapons have similar accuracy, but the PSG-1 allows you to carry an extra five-round mag.

### 7.62MM DRAGUNOV SR (MULTIPLAYER ONLY)

AMMUNITION: 7.72MM X 54MM      MAGS: 2  
 ROUNDS PER MAG: 10      FIRE SELECTION: SA



The Snayperskaya Vintovka Dragunova, known as the 7.62mm Dragunov SR, was the chief sniper rifle of the Red Army and Soviet Bloc countries. Because of the open buttstock, the rifle is lighter than most sniper rifles. In fact, the 7.62mm Dragunov SR is more like a sharpshooter's rifle than a sniper rifle. After the Cold War, the 7.62mm Dragunov SR became available in greater numbers. Most terrorist snipers will be armed with this weapon.

#### Notes

The 7.62mm Dragunov SR only comes with two magazines, for a total of twenty shots. If you plan on using it extensively, bring along some extra primary mags. This weapon is only available during multiplayer missions.

## SHOTGUNS

Shotguns can be useful when used in the correct situations. They're effective at close range against tangos lacking body armor, but it will take several shots to neutralize a tango equipped with a helmet and other protection. In most cases, shotguns are great for breaching doors. Issue a shotgun to a team member (usually not the team leader) who must get through obstacles that require breaching.



**When reloading a shotgun, you load a single shell at a time. The bottom number in the weapons display represents how many shells the operative is carrying, not the number of magazines. Whenever you get a chance, top off a shotgun so it will have a full load when you need it.**

### 12G M1 SG

AMMUNITION: 12 GAUGE BUCKSHOT, SLUGS, OR RUBBER BATONS      ROUNDS TOTAL: 35  
 ROUNDS PER MAG: 7      FIRE SELECTION: SA



Whether used for door breaching or highly lethal close-quarters combat, a good tactical shotgun is essential in any antiterrorist team. RAINBOW uses the 12g M1 SG largely because its superb recoil characteristics enable a skilled operator to fire five rounds accurately in less than a second. This is the only shotgun that can utilize slugs.

#### Notes

Although the 12g M1 SG is a good weapon, it is usually best to take the 12g SPAS-12 SG on missions requiring a shotgun. The only advantage the 12g M1 SG has over the 12g SPAS-12 SG is its ability to fire slugs. If you want to fire slugs, take the 12g M1 SG.

### 12G SPAS-12 SG

AMMUNITION: 12-GAUGE BUCKSHOT OR RUBBER BATONS      ROUNDS TOTAL: 36  
 ROUNDS PER MAG: 9      FIRE SELECTION: SA, FA



The 12g SPAS-12 SG is a fully automatic combat shotgun capable of emptying its clip in 2.25 seconds. This makes it ideal for quickly clearing a room of all hostiles.

#### Notes

This is an excellent weapon for close-quarters combat against terrorists that are wearing no body armor. If stealth and range aren't factors, give this shotgun a try. You'll be impressed.

## MACHINE GUNS

Machine guns are heavy weapons that put out a lot of firepower. Often they have a magazine containing 100–200 rounds of ammunition. Machine guns fire the same ammunition as assault rifles. These rounds have a lot of stopping power, and are capable of penetrating any type of body armor. The main drawback to using machine guns is their poor accuracy while moving. To improve accuracy, an operative should be in a crouched position. Machine guns are best used as fire support for the other teams and teams should be positioned in a spot with a good field of fire over an open area. They are usually a poor choice for interior operations or when stealth is a factor.



### 5.56MM M249 LMG

AMMUNITION: 5.56 X 45MM  
 ROUNDS PER MAG: 200

MAGS: 1  
 FIRE SELECTION: FA

The 5.56mm M249 LMG is a light machine gun firing the 5.56 x 45mm round. It is the standard U.S. Army squad support weapon. This gun comes with a 200-round box magazine, and fires only in full-automatic mode. It packs tremendous firepower, but is only accurate from a crouched, stationary position. Used this way, it is an effective covering weapon.

#### Notes

This weapon packs a lot of firepower and helps keep the heads of tingos down, if not take them out altogether. The only drawback is that the firing operative must be crouched and stationary to be accurate. Give this weapon to a team that can position itself, then cover an area. Since this weapon is not effective while moving, don't assign it to a team leader. Have the other operatives in the team carry weapons for protection while moving into position.



### 7.62MM 21E3 LMG

AMMUNITION: 7.62 X 51MM  
 ROUNDS PER MAG: 100

MAGS: 2  
 FIRE SELECTION: SA, TRB, FA

Based on the 7.62mm G3A3 AR framework, the 7.62mm 21E3 LMG is a light machine gun firing the 7.62 x 51mm round from a 100-round box magazine. This round packs more punch than the 5.56 x 45mm round. In addition, the 7.62mm 21E3 LMG has single-shot and three-round-burst options. It is more accurate than the 5.56mm M249 LMG, but harder to control when moving. As with the 5.56mm M249 LMG, this weapon is best used from a stable firing stance.

#### Notes

If you need accuracy and heavy firepower, this is a better choice than the 5.56mm M249 LMG. Although its magazine only holds 100 rounds, you begin with two magazines, so you have the same total number of rounds as the 5.56mm M249 LMG. Use the 7.62mm 21E3 LMG in the same manner as you would the 5.56mm M249 LMG.



### 7.62MM M60 LMG

AMMUNITION: 7.62 X 51MM  
 ROUNDS PER MAG: 100

MAGS: 3  
 FIRE SELECTION: FA

The 7.62mm M60 LMG machine gun was designed in the late 1940s, and its initial design strongly borrows from World War II German developments. The 7.62mm M60 LMG was adopted by the U.S. military in 1950. It has a belt of 100 rounds firing 7.62 x 51mm rounds at 550 rounds per minute.

#### Notes

The 7.62mm M60 LMG was the main squad-based machine gun during the Vietnam War and is the most powerful machine gun in the game. As with all machine guns, it is best used by a crouched operative in a secure location with a good field of fire. If your teams need heavy fire support, the 7.62mm M60 LMG is the weapon for the job.

### 7.62MM RPD LMG (MULTIPLAYER ONLY)

AMMUNITION: 7.62 X 39MM  
 ROUNDS PER MAG: 100

MAGS: 2  
 FIRE SELECTION: FA



The 7.62mm RPD LMG is a Russian light machine gun that dates back to World War II. It is a common light support weapon. It fires the 7.62 x 39 mm round from a 100-round drum magazine, and only fires in full-automatic mode. This weapon is less accurate than either the 5.56mm M249 LMG or the 7.62mm 21E3 LMG. It is, however, lighter than either of the other two, and therefore returns to an accurate state after firing more rapidly.

#### Notes

This is a terrorist weapon, and is only available during multiplayer missions.

## SECONDARY WEAPONS (PISTOLS)

Your team members will use their pistols rarely—usually only if a primary weapon jams or runs out of ammo. Pistols are inaccurate at medium or long range. If you must use one, fire several times at your target; they allow only for single shots and it may take more than one to drop a terrorist, especially one in body armor.

### 9MM 92FS PISTOL

AMMUNITION: 9MM  
 ROUNDS PER MAG: 15

MAGS: 4  
 FIRE SELECTION: SA



The 9mm 92FS Pistol is RAINBOW's 9mm pistol of choice. Its primary advantages are low recoil and a large magazine compared to the bulkier .45.

#### Notes

The 9mm 92FS Pistol fires a smaller-caliber round than the 0.45cal M23 Pistol, so its magazine can hold more ammunition. If you're going to use a pistol a lot during a mission, this is a good choice. The 9mm 92FS Pistol is the standard sidearm of the U.S. military.

### 9MM 92FS SD PISTOL

AMMUNITION: 9MM  
 ROUNDS PER MAG: 15

MAGS: 4  
 FIRE SELECTION: SA



The specially designed sound- and flash-suppressor on this 9mm 92FS SD Pistol minimizes weight and length to maintain accuracy while boasting an impressive 32 decibels of sound reduction. It's the favored pistol of RAINBOW's recon specialists.

#### Notes

This is a great pistol for recon teams or any team that needs a silenced sidearm to supplement a nonsilenced submachine gun or assault rifle. Some missions may demand stealth at first and tremendous firepower later on. Use this pistol for the early kills.



### 0.40CAL USP PISTOL

AMMUNITION: 0.40  
ROUNDS PER MAG: 13

MAGS: 3  
FIRE SELECTION: SA

The 0.40cal USP Pistol is preferred by operatives who need a balance of size and firepower.

#### Notes

Although similar to the 0.45cal M23 Pistol, this pistol fires small-caliber ammunition and so is a little lighter. It's usually a better idea to take an 0.45cal M23 Pistol because of its greater punch.



### 0.40CAL USP SD PISTOL

AMMUNITION: 0.40  
ROUNDS PER MAG: 13

MAGS: 3  
FIRE SELECTION: SA

This Knight Armament Corp. Silencer provides excellent sound suppression to the 0.40cal USP Pistol.

#### Notes

If you need a silenced pistol, the 0.45cal M23 SD Pistol is a better choice.



### 0.45CAL M23 PISTOL

AMMUNITION: 0.45  
ROUNDS PER MAG: 12

MAGS: 3  
FIRE SELECTION: SA

The extreme ruggedness, reliability, and match-grade accuracy of the 0.45cal M23 Pistol makes it the handgun of choice for all U.S. Special Forces.

#### Notes

The 0.45cal M23 Pistol is one of the best pistols available to RAINBOW operatives. The weapon is accurate and the .45 round has the necessary stopping power.



### 0.45CAL M23 SD PISTOL

AMMUNITION: 0.45  
ROUNDS PER MAG: 12

MAGS: 3  
FIRE SELECTION: SA

The specially designed suppressor on this 0.45cal M23 Pistol virtually eliminates muzzle flash and provides more than 35dB of sound reduction. It's essential to any RAINBOW mission requiring both firepower and discretion.

#### Notes

The 0.45cal M23 SD Pistol is nearly as accurate as the standard 0.45cal M23 Pistol, and its silencer allows your team to kill without alerting others to your presence.

### 0.50CAL DESERT EAGLE PISTOL

AMMUNITION: 0.50 AE  
 ROUNDS PER MAG: 7

MAGS: 2  
 FIRE SELECTION: SA



The 0.50cal Desert Eagle Pistol is a very powerful handgun, capable of punching through body armor. It has a limited seven-round magazine.

#### Notes

Although the 0.50cal Desert Eagle Pistol has only a seven-round magazine, this shouldn't be a problem given the limited use a secondary firearm gets. Besides, with a .50 caliber round, it takes only a single shot to drop your target even if you don't hit the tango in the head. Unless you must stay quiet, take one of these pistols along. If you must resort to your secondary weapon, this is one you can count on. This is a good pistol to assign a sniper for personal protection.

### 0.357CAL DESERT EAGLE PISTOL

AMMUNITION: 0.357  
 ROUNDS PER MAG: 9

MAGS: 3  
 FIRE SELECTION: SA



The smaller cousin of the 0.50cal Desert Eagle Pistol, the 0.357cal Desert Eagle Pistol round can punch through body armor at close range. It carries a limited nine-round magazine.

#### Notes

This pistol is a bit smaller and easier to handle than the 0.50cal Desert Eagle Pistol. It also carries an additional round in the magazine along with an extra magazine.

### 5.7MM BELGIAN PISTOL

AMMUNITION: 5.7 X 28MM  
 ROUNDS PER MAG: 20

MAGS: 2  
 FIRE SELECTION: SA



Designed as an Army pistol with high armor-piercing capabilities. Low recoil and high magazine capacity make this handgun a good defensive firearm against personnel in bulletproof jackets or in unarmored vehicles.

#### Notes

The 5.7mm Belgian Pistol fires a smaller-caliber round than any of the other pistols. However, it carries more rounds in the mag than most.

### 9MM P-228 PISTOL

AMMUNITION: 9MM  
 ROUNDS PER MAG: 13

MAGS: 4  
 FIRE SELECTION: SA



The 9mm P-228 Pistol is one of RAINBOW's favorites, and a popular law enforcement handgun used by police departments across the United States by the FBI, the Secret Service, and the DEA.

#### Notes

This pistol is very similar to the 9mm 92FS Pistol.





### 9MM SPP PISTOL

AMMUNITION: 9MM

MAGS: 1

ROUNDS PER MAG: 30

FIRE SELECTION: SA

First appeared in 1989. The 9mm SPP Pistol is bigger and heavier than most pistols, but it's a little more precise, making it a great option for RAINBOW's operatives.

#### Notes

This pistol is like a mini-submachine gun, except that it can only fire in semi-automatic mode. It has a 30-round mag, but it only comes with one mag. However, it is quite accurate for a pistol, and an excellent choice for a secondary weapon when silence is not an issue.

## AMMUNITION

*Black Thorn* allows you to select the type of ammunition your operatives use in their firearms during a mission. All firearms (except shotguns) can fire either full-metal jacket or jacketed hollow-point rounds. Shotguns can fire buckshot, slugs, or rubber batons.

### FULL METAL JACKET (FMJ)

This is the common military round. The soft lead projectile is covered, or "jacketed," by a harder metal. This prevents the round from breaking up when it hits something, allowing the full impact to strike at a small point. This increases the round's penetrating power.

Full-metal jacket ammunition has a longer range than jacketed hollow-point, and is better against body armor. It's the default selection for all weapons.

### JACKETED HOLLOW-POINT (JHP)

This round is often used by law enforcement. Similar to the full-metal jacket round, the jacketed hollow-point surrounds a lead center with a harder metal jacket. However, instead of the round coming to a pointed tip, it has a cone-shaped depression at the tip. When this round strikes a target, it flattens, creating a larger surface and causing a lot more damage. As the round flattens, it also becomes less able to penetrate body armor, because the force is spread across a larger area.

Because of the shape and ballistics of the round, jacketed hollow-point bullets have a shorter range, so don't use them for long-range firing. However, they're very effective for short- to medium-range firing and serve best against terrorists wearing no body armor.

## .00 BUCKSHOT

This is the standard load for RAINBOW's shotguns. The shell contains a number of small, round projectiles that separate and spread out after leaving the barrel. Although ineffective for penetrating body armor at medium and long range, buckshot is great for unarmored targets in close-quarters combat. The spread increases the chance of hitting the target. It is also effective for shooting out locks and breaching doors.

## SLUGS

A shotgun shell can also contain a single large projectile. Ineffective against body armor, slugs will still knock targets off their feet. Although buckshot is often a better choice, slugs are great when you must avoid hitting nearby hostages with the spread of buckshot.

## RUBBER BATONS

This round allows the operative to fire a shotgun with non-lethal force. The shell contains a rubber slug-like projectile. As such, it won't kill or even penetrate the skin of the target. Rubber batons are used mostly for training missions, but can be useful when you must attack a tango and are concerned about hitting a hostage. Use a shotgun with rubber batons to get the tango to move away from the hostage; then use lethal force to neutralize the enemy. Also try using rubber batons in adversarial multiplayer games when you're just training. Players will know when they've been hit, but they won't be taken out of the game.

# EQUIPMENT

## DEMOLITIONS KIT



This kit speeds explosives placement and disarming. It contains basic electrical diagnostic equipment along with the essential mechanical tools you need to perform the job. Extra primer, detcord, and a variety of adhesives complete the kit.

### Notes

Take this along only if explosives will be placed or disarmed. Assign it to a demolitions specialist.

## ELECTRONICS KIT



This kit speeds up electrical tasks such as placing bugs and rewiring security cameras. It contains a high-precision multimeter, miniature power supplies, a “breadboard,” and a digital analyzer. A full complement of jumpers, clips, and miscellaneous electrical parts rounds out the kit.

### Notes

This kit is essential for getting through security systems. Assign it to electronics specialists.

## LOCKPICK KIT



This kit's primary component is a highly sophisticated autopick capable of opening most mechanical locks in a few seconds. Electrical keycard or swipe locks are handled using a classified system containing presets for all major keycard variations.

### Notes

Your team will need lockpick kits to get through some doors quickly and quietly (as opposed to a shotgun breach or breaching charge). Although your operatives can pick locks without a kit, doing so takes much longer.

## FRAG GRENADE



The M61 fragmentation grenade is the standard-issue offensive grenade used by infantry throughout the world. Although its blast radius is small, it still takes an overhand throw to safely clear the blast radius in the open.

### Notes

Frag grenades can clear a small room with a single blast. Take care when you use them during hostage rescues, unless you're certain that the targeted room contains no hostages. Try to bounce them off of walls to round a corner. Should this grenade detonate in view of the operative who launched it, it stuns and often wounds the operative (if it doesn't kill the operative outright).

## FLASHBANG



Capable of stunning observers with its bright flash and loud report, flashbangs are commonly tossed in to “prepare” rooms prior to entry. The valuable seconds gained while potential hostiles recover from the stun effects can mean the difference between life and death to a tactical team. These are also known as distraction devices or stun grenades.

### Notes

At least one member of each team should carry flashbangs. Better, all should carry some, because clearing a large building may require a number of these devices. As a rule, use a flashbang if there's a chance an enemy occupies any room you're about to enter.

## BREACHING CHARGE



Breaching charges are used to remove doors explosively for rapid entry. You needn't use flashbangs in conjunction with a breaching charge; the breaching charge will stun, wound, or even kill anyone that is very close to it.

### Notes

These are great for entering a room quickly. Use them when breaching a door to a room containing both hostages and terrorists. Often, terrorists will move to kill hostages as soon as a door is opened. The breaching charge stuns them, giving your team valuable seconds to enter and take down the hostiles. They're also effective when a tango waits on the other side of the door and is aiming, waiting for you to enter. You can breach the door and neutralize the tango at the same time.

## HEARTBEAT SENSOR



The heartbeat sensor can track a human heartbeat even through thick layers of concrete. It works by detecting the characteristic ultra-low-frequency electric field given off by a beating heart. In use, the heartbeat sensor scans in a small circle around the user and in a larger cone straight ahead.

### Notes

The heartbeat sensor is very valuable. If the character you control carries one, select it as the active item. Then, when you hold down the mouse button, the sensor will scan at a longer range down a narrow arc instead of the standard short range in all directions. Terrorists show up on the mini-map as red dots, and hostages as white dots. Use this sensor to see if a room is occupied before you enter it and to help determine the piece of force or restraint to use.

At least one operative on each team should carry a heartbeat sensor. Avoid assigning it to the leader unless you'll be in control and using it yourself. Instead, issue it to the rear-most operative. If you want to use the sensor but you aren't carrying it yourself, give the team a Recon ROE; the appropriate operative will pull it out and begin using it. The shortcoming with this is that you can't always choose which direction the operative faces. However, it leaves you an extra slot for another type of equipment.

## BINOCULARS



These compact, lightweight binoculars are specially constructed to withstand the rigors of CT operations. A built-in range finder and choice of 4x and 8x zoom factors make these the item of choice for RAINBOW recon missions.

### Notes

Binoculars are great for recon teams. They allow you to scout an area from long range and observe the enemy from out of view. You won't need them for indoor missions, but they're a must for most outdoor missions.

## PRIMARY MAGS



Extra magazines for your primary weapon.

## SECONDARY MAGS



Extra magazines for your secondary weapon.

## HB (HEARTBEAT) JAMMER (MULTIPLAYER ONLY)



This handheld device prevents other players from picking up HB sensor information in a radius from the player holding it. To activate it, make it the current item.

This item can be very useful in setting up ambushes. Some players consider the heartbeat sensor cheating, so the jammer is a cheat against a cheat. Only one member of a team needs to carry the jammer because it operates over a small radius. As long as your team stays together, all are invisible to enemy sensors.

## SA (STAND ALONE) HB JAMMER (MULTIPLAYER ONLY)



An HB jammer that can be placed on the ground, and does not need to be carried. This item can be destroyed. To use it, make it the current item and press the fire key to place it on the ground.

This item is useful for defender roles. Place them around an ambush point to prevent the enemy from detecting your defenders. Bear in mind that once you place it, you cannot pick it up and move it.

## C-4 (MULTIPLAYER ONLY)



You can place this small (less than 1kg) block of C-4 plastic explosive with radio detonator anywhere on the ground and detonate it from anywhere in a level. It functions like a frag grenade, but with a smaller radius. To plant the C-4, make it the current item and press the fire key.

You can then change to another item. To detonate the planted explosive, make the C-4 your current item again and press the fire key.

Think of C-4 as a landmine you can remotely detonate. It is great for ambushes and other defensive tasks. Place it along the path you expect the enemy to use, and hide. You can monitor the kill zone with heartbeat sensors or visually. Don't place it in the middle of a hall, where the enemy might spot it. Instead, place it alongside of a wall or around a corner. Because the blast radius is smaller than a frag grenade's, wait until the enemy is right next to the C-4 before detonating it.

## SA HB SENSOR (MULTIPLAYER ONLY)



This is similar to the handheld device, but this one is placed on the ground, and detects within a radius of its location. This item can be destroyed. To use this item, make it the current item, then press the fire key to place it on the ground.

This item is useful for defensive missions because it frees a team member from having to use the handheld sensor. Since it can be destroyed, place it out of sight of the enemy.

## FALSE HB PUCK (MULTIPLAYER ONLY)



Drop this item on the ground, and it produces an HB signature that mimics that of the person who dropped it. This item can be destroyed. To use this item, make it the current item, then press the fire key to place it on the ground.

This is another useful item for defensive tasks, especially if your opponent relies on heartbeat sensors. Place it away from your operatives, but within their sight. Use it in conjunction with a heartbeat jammer. When the enemy detects the false heartbeat, they will enter the room or throw a grenade at it, thinking it's you. While they go one direction, you can hit them from the other.

## SMOKE GRENADE (MULTIPLAYER ONLY)



Throw this grenade just like any other. Instead of exploding, it releases a cloud of smoke that reduces visibility. The smoke is hard to see through, and night vision goggles cannot see through it any better than the naked eye.

Use smoke grenades to create artificial and temporary concealment. Before running across an open area, throw a few out to conceal your movement. However, don't ever rely on smoke to cover you. Even if enemies can't see you, they may fire into the smoke hoping to get a lucky hit.

Try throwing smoke grenades toward enemies, especially if they are defending an area or camping out. Nothing ticks off a sniper in a good spot worse than to have that spot compromised by a thick cloud of smoke.

## UNIFORMS

RAINBOW operatives have access to seven uniform patterns, each designed for a certain environment or lighting condition. The patterns help make the team as inconspicuous as possible so they can take down the enemy before they're seen.

Each pattern is available in three weights. Light uniforms are basically for recon or other teams uninvolved in firefights. They're quieter and allow the wearer to move about stealthily. Heavy ("breaching") uniforms incorporate the most body armor. However, they're bulky and make some noise, limiting wearer mobility and stealth. Breaching and demolitions teams should wear these. The medium-weight uniform is the standard. It's appropriate for assault and other teams that need a balance of protection and ease of movement.

As the commander, you must outfit your team members appropriately for the tasks they must perform.

## UNIFORM CLASSES



### LIGHT

This class is perfect for nighttime missions and recon specialists. It consists of a lightweight level IIa tactical vest capable of stopping low-powered pistol rounds, and is rounded out with the standard soft-soled rubber boots, Nomex balaclava, and Nomex/Kevlar gloves.



### MEDIUM

This class consists of a level II waist-length tactical vest and a Kevlar helmet, soft-soled rubber boots, Nomex balaclava, and Nomex/Kevlar gloves. The vest can stop most pistol fire and some submachine-gun fire.



## HEAVY

This class consists of level III body armor extending to the groin; it can stop all but the highest-powered rifle rounds. This is the preferred uniform of demolitions experts, because the faceplate on the Kevlar helmet offers excellent protection from flying debris. The desert, camo, and woods heavy uniforms don't include the helmet with faceplate, and the body armor extends only to the waist because you'll use these uniforms mainly for outdoor missions.

## UNIFORM PATTERNS



### ARCTIC 1

This all-white uniform is great for missions in the snow.



### DESERT 2

This darker desert camo uniform is good for low-light operations.



### ARCTIC 2

An alternative arctic uniform, this one has dark splashes on white and is best used when your team must operate in snow and brush, where an all-white uniform would stand out.



### BLACK

This black uniform is perfect for nighttime missions.



### DESERT 1

This desert camo uniform is issued to RAINBOW operatives for desert-type operations.



### BLUE

This blue uniform provides a good alternative to black for nighttime missions.





### EURO

An excellent uniform choice for those operating in mixed forest environments, it uses a European woods camouflage pattern.



### STREET 1

This grayish street camo uniform is one of RAINBOW's choices for urban assault operations.



### GREEN

This uniform provides a good blend of protection and ease of movement. It's used primarily in general outdoor environments.



### STREET 2

This pattern resembles street 1, but it contains more earth tones and less gray. It's useful when operating in smaller towns that have more dirt and vegetation.



### GRAY

This gray uniform is standard for urban operations.



### WOOD

This uniform is useful for operations in forests and rural areas. You'll use it most in European and North American operations. Wood uniforms are a personal favorite of Santiago Arnavisca.



# PLANNING A MISSION

The adage “If you fail to plan, you plan to fail” applies to this game more than to any other. The planning stage is the most important, and it’s where you’ll spend the most time during operations. Most missions only take a few minutes to execute, but often takes an hour or more to plan and fine-tune. The planning stage is broken down into seven screens. Each screen contains important information or requires you to do something to prepare for the mission. In the following sections, we’ll look at each screen, then go over mission-planning basics.

## BRIEFING



The Briefing screen

This is the first screen in the planning stage, where you receive valuable information regarding your missions. Your objective lies in the center of the screen.

In Recruit campaigns, you only need to achieve the primary objective. Veteran campaigns require you to accomplish a secondary objective, and Elite campaigns require a third. The higher the level of gameplay, the more terrorists you face, and the harder they are to kill.

On the left side of the screen are quick briefings from Mission Control, and other useful information. Your mission orders are below the briefings. Study them carefully.

## INTEL



The Intel screen

Although the Intel screen isn't vital for completing your mission, it provides the background story for the campaign. It displays your past mission success and shows how it affects the campaign. This screen displays four categories of information: people, organizations, newswire, and miscellaneous.

## ROSTER SELECTION



The Roster Selection screen

Choose operatives for your missions using the Roster Selection screen. It displays background information on the members of RAINBOW, including their abilities and health status. When you select your operatives, you needn't pick them in order or by team. You can organize them later.

## KIT



The Kit screen

Arm your team using the Kit screen. For each operative, you can select a primary and secondary weapon, additional items to carry (these fit into slots one and two), and a uniform. Although you can assign everyone the same things, you'll need to customize individual kits for specific jobs.

# TEAM ASSIGNMENT



The Team Assignment screen

You organize your operatives into teams from this screen. You can take only eight people with you, divided into a maximum of four teams. Teams can comprise no more than four operatives each. You can create two teams of four, four teams of two, or any other combination of your eight operatives.

# PLAN



The Plan screen

You spend the most time at the Plan screen. It provides a recon report of probable locations of hostages, terrorists, and landmarks. Plot waypoints for each of your teams here, and give them special orders or commands. After the action starts, you control only one of the teams at a time. At each waypoint, you can change the Rules of Engagement

regarding speed and mode—how fast the team moves to the next waypoint and how they respond to others on the way. You can also give breaching instructions at waypoints.

You can acquire some control over other teams using Go Codes. There are four in all. When a team reaches a waypoint with a Go Code, it waits for you to issue that code before advancing. This way you can synchronize your teams' activities. The "Planning a Mission" section covers the Plan screen in greater detail.

# EXECUTE



The Execute screen

Use the Execute screen to choose a team to control and start the mission.

## PLANNING A MISSION

Mission planning can be difficult and time-consuming. If you fail a mission or are unhappy with the results, return to the planning stage and try it again. Rarely will you execute a perfect mission your first time through, but the better your plan, the better the execution.

Take the following steps when you plan a mission (not necessarily in this order).

### BRIEFING

First, read through all of the briefings to learn about the situation and determine the purpose of your mission. You'll find the latter in the mission orders and objective. Listen to Control, John Clark, and Kevin Sweeney. They may offer some insights. Next, go to the Intel screen to get background information on the mission.

### RECON

At the next screen, pick a team member at random. (You must select one to advance to the next screen.) Continue past the Kit screen, assign the operative to a team, then move on to the Plan screen. It doesn't matter which team you place your operatives in—you'll reassign them later.

At the Plan screen, go to the box in the lower left and select Recon to learn the actual or probable locations of hostages and terrorists in the mission area. The Landmarks category provides



The walkthroughs of each mission contain detailed maps illustrating the location of all tingos, hostages, and other mission-related items such as bombs and security systems. Use these maps to help plan your mission.

important information about terrain and structures—whether a trellis is climbable or an entrance barricaded, for example. Learn as much as you can about what you face, then decide how many teams you need to accomplish the mission, and what their tasks will be.

## SET WAYPOINTS

Change the Recon box to Orders, select a team, and begin plotting waypoints. The first waypoint must be within an insertion zone and the last one within an extraction zone. Determine the team's entry into a building, their route to that area, how they'll reach their objective, and how they'll get out.

## GO CODES

Use Go Codes to coordinate team activity. For example, it's usually a good idea to have all teams enter a building at the same time. But in some cases, one team may have to complete a task before another team can continue.

How you use Go Codes depends on your preferences and the mission. You may choose to assign each team a unique Go Code (for example, Blue Team uses Code Alpha, Red Team uses Code Bravo, and so forth) or use the same Go Codes for all teams sequentially throughout the mission (Alpha is the first code, Bravo is second, and so forth).

Go Codes act as stopping points for a team during a mission. Teams move through their waypoints until they come to a Go Code. Then they halt, assume a posture if assigned, and wait for the code to be issued. Only those teams actually waiting for a certain code are released when that code is given. If another team arrives at a Go Code waypoint after you give the code, they must wait until the code is given again.

Assigning Go Codes throughout a mission allows teams to better work together. For example, a good time to use a Go Code is when entering a structure. The code allows all of the teams to get into position, then rush in at the same time to maximize the element of surprise. When using multiple teams to rush into rooms with hostages, Go Codes help coordinate the action so you can get the maximum amount of firepower into the area in the least amount of time. Finally, use Go Codes to order teams escorting hostages to wait until the pathway to the Extraction Zone is clear and safe.

You need several teams for each mission. Since you cannot control all of them at once, use Go Codes to maintain order during a mission.



Each of the four Go Codes has a corresponding key: Alpha **Q**, Bravo **W**, Charlie **E**, and Delta **R**. You can use each Go Code more than once.

## ORDERS

You can also give teams orders at each waypoint. For example, you can order them to use a flashbang or frag grenade, or even a breaching charge. Those orders require a waypoint near a doorway. Giving orders is important, because computer-controlled teams won't do these things unless they're instructed to. Set these orders for your own team, as well. If you want a demolitions specialist on your team to breach a door a certain way, order it at that waypoint. If you don't, you'll have to breach it yourself using the equipment you're carrying, or issue an order to the team during the mission. You can also give orders to disarm bombs, deactivate security systems, and perform other mission-related tasks.

## COVER AND DEFEND

When you assign a Go Code to a waypoint, you can also give an order instructing the team how to act at that point. "Defend" orders the team to set up a 360 degree defensive perimeter around the point. This is good if your team is stopped in an open area. "Cover" limits the defensive arc to 180 degrees in the direction you choose. This is better than Defend, because each team member covers a narrow arc. Use Cover when your team can back up against a wall, or when they don't have to worry about being attacked from a certain direction.

## SNIPE

"Snipe" is the final order you can assign with a Go Code. Usually you should issue the Snipe order to a team containing a sniper, but you can give it to any team. The sniper (or the team member with the best sniping skill) takes aim at the point you designate on the planning map with Sniper view activated. Do not expect a sniper to cover a large area. Meanwhile, the other team members assume a posture similar to Defend, providing protection for the sniper.

## RULES OF ENGAGEMENT

Rules of Engagement tell your teams how to behave as they advance to the next waypoint. There are two types of ROE—speed and mode.

## SPEED

Speed tells the team how fast to move and how careful to be when targeting and firing weapons. Blitz instructs the team to move as quickly as possible and to fire at simply anything that moves. Use Blitz only when there are no friendlies in the area. Normal is a basic walk; the team exercises a bit more caution before firing. Teams assigned Safety move slowly, pause every so often, and take deliberate aim at well-identified targets before firing—perhaps even risking their own safety. When approaching areas where hostages are located, change the speed to Safety.

## MODE

Mode tells a team how to act and react. Teams in Assault mode move along their path while attacking targets of opportunity. Whenever possible, they attempt to clear the area before advancing to the next area. Recon mode makes the team move stealthily, only return fire, and use silenced weapons if available. Only teams in Recon mode use heartbeat sensors. Infiltrate mode orders a team to move as quickly and quietly as possible. If they come across enemies, they will fire, preferably with silenced weapons. Their main task is to get to a specific point rather than clearing areas of terrorists. After the team rescues a hostage,



**After planning waypoints for all teams, make a few notes on what each Go Code does for quick reference later.**

switch to Escort mode to escort the hostage to safety. If a team approaches a hostage in any other mode, the hostage will stay put. Escort mode tells the hostage to follow the team. When escorting a hostage, have the team follow a secure route that is clear of tangos.

## BUILDING TEAMS

You've created your teams and assigned them tasks. Now it's time to choose operatives from the Roster Selection screen.

Delete the members you chose earlier and start from scratch. First, choose one operative with good leadership ability for each team. Assign specialists, such as electronics or demolitions, if the mission calls for them. Finally, fill in the teams with assault specialists. Team up operatives that have poor self-control values with stronger leaders. Now that you have the operatives and their assignments fresh in your mind, go to the Team Assignment screen and place them into teams, with the leader at the top of each list.



**Consult the mission walkthroughs for suggestions on which operatives to choose for a mission.**

## PASS OUT THE AMMO

Distribute firearms and equipment to your assembled teams. RAINBOW is well funded, so take as many weapons or items as you need. Equip your teams appropriately. For example, if they must breach a door with a charge, at least one member of the team must carry a breaching charge. The same rule applies to flashbangs and frag grenades.

Remember to issue the correct types of weapons. If your mission requires silence, all operatives must have a silenced primary weapon so you don't prematurely reveal your presence to the tangos. Carry a silenced secondary weapon unless stealth is completely unnecessary.



After you have all the required items for a mission, fill up any remaining slots. It is usually good for each team to have at least one heartbeat sensor. Assign it to the second or third member of the team rather than to the leader, who must be armed at all times. Flashbangs are a good choice when the mission involves hostages. Otherwise, take along some frag grenades. If you expect a sniper to have lots of targets, take some additional Primary Ammo.

Finally, suit your operatives in appropriate uniforms. Choose inconspicuous patterns, and weights appropriate for the task. Breachers should wear heavy uniforms and recon teams should don light ones to stay quiet. Most team members should wear medium-weight uniforms that provide a balance of protection and mobility.



The mission walkthroughs suggest weapons and equipment for each mission.

## START THE MISSION

Your teams are ready, so go to the Execute screen. You've invested a lot of time in planning this mission, so save it here. This way, if you fail the mission, you can make small adjustments to your plan instead of going back to the beginning. Finally, select the team you'll lead, and begin the mission.

## MISSION FAILURE?



A failed mission can be an excellent learning tool.

If you fail a mission or get a lot of your people killed in a successful mission, go back to planning and try again. Study who got killed and where to determine the changes you need to make. For example, if a team was massacred when they entered a room, order them to throw a frag grenade before going through the doorway. You may also need to change a team's ROE for a certain waypoint. Think of each failure as a learning experience.



After every mission, whether it was a success or a failure, watch the replay to see how the operatives followed the orders you gave them. Study what worked well and what needs improvement. No mission is perfect, but the more you learn, the smoother future missions will go.



Consider replaying the mission even if only one team member dies, especially in the early missions. Losing one member per mission early on will leave you short of experienced professionals for later missions.



SECTION

2

# THE BLACK THORN CAMPAIGN

# OPERATION: DESERT DRAGON

## MISSION ORDERS

An unknown terrorist group has taken over the Japanese Embassy in Caracas, Venezuela during a party for visiting Japanese dignitaries. Your mission is to subdue the terrorists and rescue the hostages.

The embassy is a two-floor building with a basement and an enclosed backyard garden. Terrorists are holding hostages in the basement and the Japanese ambassador is being held separately on the first floor. Their locations are marked on the map. Because of the potential repercussions of this matter, it is especially important not to alert the terrorists.

05.26.04 0600  
JAPANESE EMBASSY, CARACAS

## INTELLIGENCE BRIEFING

Welcome back to the field, though I wish it were under better circumstances. The situation here is delicate. Neither the Venezuelan nor the Japanese government wants the other to handle it solo, so they've agreed to let RAINBOW take it on, instead.

The terrorists have separated the hostages into two groups. It's important to take out the terrorists guarding both groups at the same time, so they won't be able to alert each other. These hostages are all prominent political leaders, so be careful. Losing any one of them would cause all sorts of trouble.

The requests we've gotten have been fairly standard ones. They want money, a flight out, and the release of a handful of political prisoners whom both countries have a problem turning loose. To tell you the truth, this mission reminds me of the operation at the Japanese embassy in Peru back in '97, when the site was held for four months. With luck, this will be resolved a lot faster than that.



Get the Japanese ambassador and two other hostages to safety.

# TEAM ASSIGNMENTS

**OBJECTIVES**  
 1. RESCUE THE JAPANESE AMBASSADOR  
 2. RESCUE ALL HOSTAGES

## BLUE TEAM

Operative	Primary	Secondary	Slot 1	Slot 2	Uniform
Chavez	0.45cal SD UMP SMG	0.45cal M23 SD Pistol	Frag Grenade	Flashbang	Green Medium
Raymond	0.45cal SD UMP SMG	0.45cal M23 SD Pistol	Heartbeat Sensor	Flashbang	Green Medium

## RED TEAM

Operative	Primary	Secondary	Slot 1	Slot 2	Uniform
Novikov	0.45cal SD UMP SMG	0.45cal M23 SD Pistol	Frag Grenade	Flashbang	Green Medium
Hanley	0.45cal SD UMP SMG	0.45cal M23 SD Pistol	Heartbeat Sensor	Flashbang	Green Medium

## GREEN TEAM

Operative	Primary	Secondary	Slot 1	Slot 2	Uniform
Bogart	0.45cal SD UMP SMG	0.45cal M23 SD Pistol	Frag Grenade	Flashbang	Green Medium
Maldini	0.45cal SD UMP SMG	0.45cal M23 SD Pistol	Heartbeat Sensor	Flashbang	Green Medium

## GOLD TEAM

Operative	Primary	Secondary	Slot 1	Slot 2	Uniform
Price	0.45cal SD UMP SMG	0.45cal M23 SD Pistol	Frag Grenade	Flashbang	Green Medium
Walther	0.45cal SD UMP SMG	0.45cal M23 SD Pistol	Heartbeat Sensor	Flashbang </td <td>Green Medium</td>	Green Medium

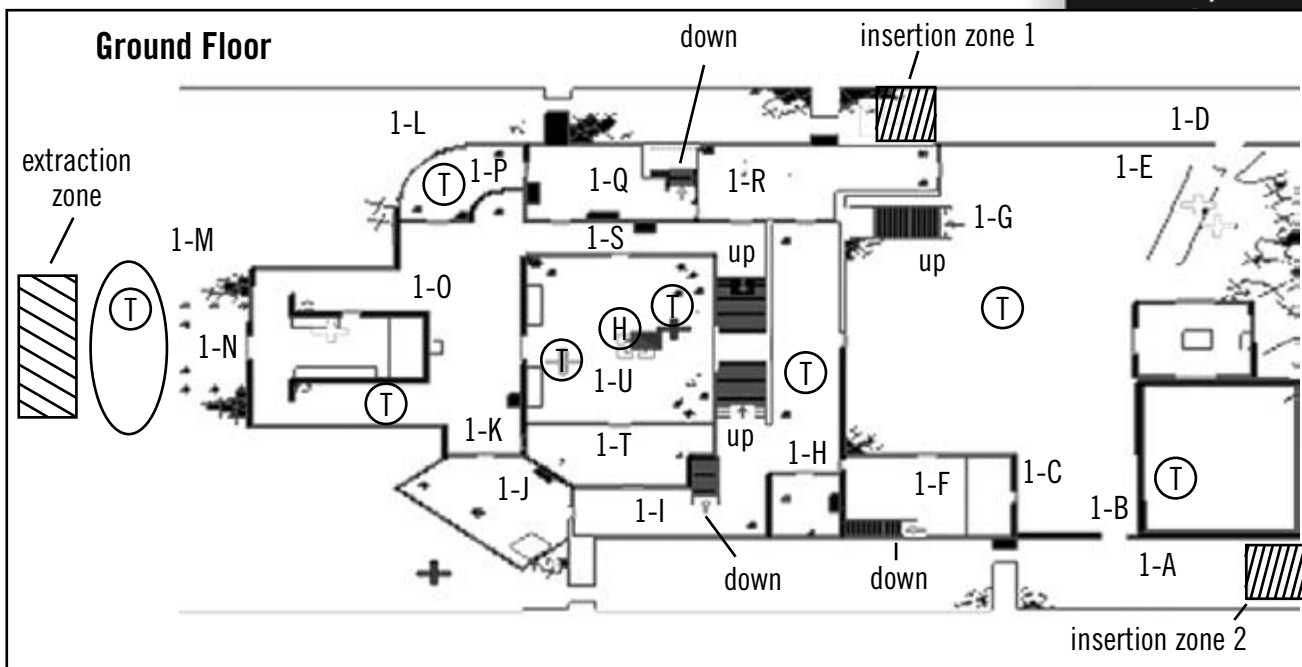

Map 6-1. Ground Level, Japanese Embassy

Map 6-2. Upper Level

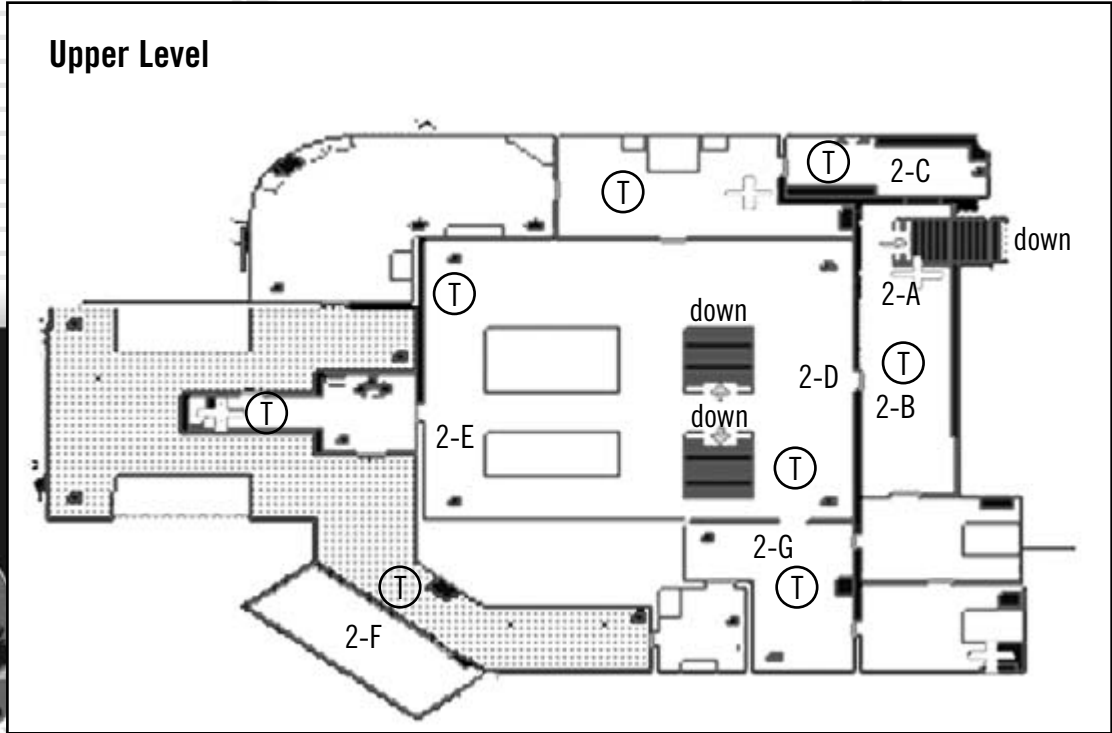

Map 6-3. Basement

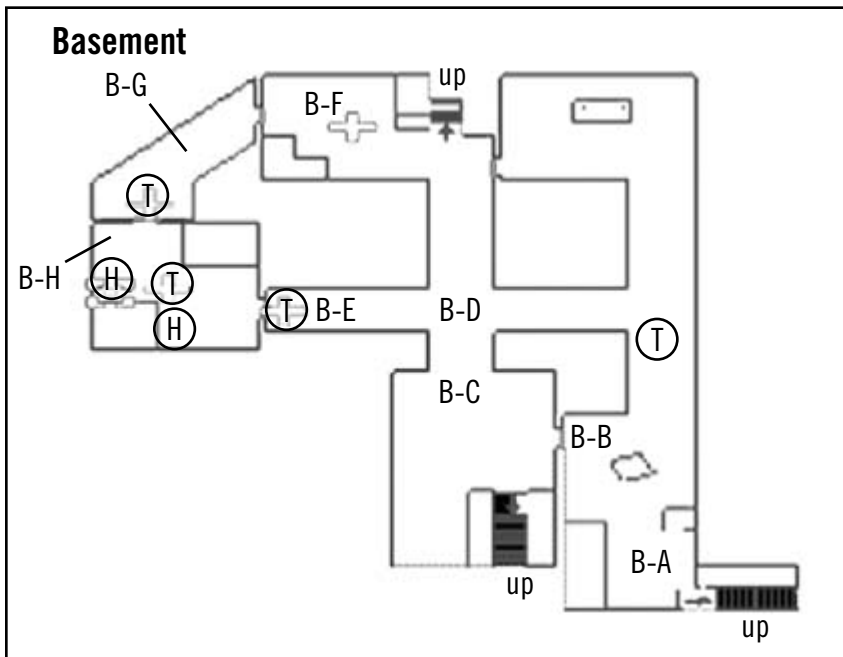

# STRATEGY

Although the terrorists are holding hostages in two different locations, you must assault both places at the same time to prevent either group from being killed by the tangos.

You need four assault teams for this mission. Two are assigned to clear the ground floor and rescue the Japanese ambassador. The third assault team will clear out the basement level and rescue the two hostages there. The fourth assault team will clear the area of the upper level that looks down on where the ambassador is being held. All four teams must coordinate their actions and strike at the same time so the tangos don't have a chance to execute the hostages.

Since stealth is a major factor while getting your teams into position, take along silenced weapons. Heartbeat sensors help you set up your shots before you blitz into rooms with hostages. Avoid any loud noises until you are ready to rescue the hostages so the tangos have no warning.

## BLUE TEAM

Blue Team is one of the two ground level teams who will rescue the Japanese ambassador. It will also help clear out the ground level to extract the hostages.



Blue Team covers and clears out the front of the embassy grounds.

Blue Team begins at Insertion Zone 1 and immediately heads along the side of the embassy to point 1-L. Once there, assume a Cover posture facing toward 1-M and hold for code Alpha. Two tangos patrol the front

of the embassy. From this position, Blue Team can neutralize both as they come into view. When code Alpha is given, Blue Team advances toward the front doors of the embassy at 1-N and enters. Continue to point 1-O and hold for code Bravo while covering toward 1-S. One or two tangos patrol the hallways here. Take them out before they can alert the tangos guarding the ambassador in 1-U.



Unlike in some of the other missions, you do not need to clear the entire embassy of tangos. You must only

clear the paths to the hostages and a path to the extraction zone. If you choose, you can clear out all of the tangos before assaulting the rooms where the hostages are being held. However, the more time you spend clearing (especially in the second level), the more likely one of the tangos will get off a shot and alert those guarding the hostages. After they start shooting the hostages, the mission is over.



Blue Team covers the hallways of the ground level.

At code Bravo, move through 1-P, 1-Q, and 1-R, taking care of any tangos along the way. Then continue to 1-S and hold for code Charlie. Assume a Defend posture here.

Blue Team blitzes in to secure the ambassador.

When you receive code Charlie, blitz through the door into 1-U and drop the two tangos before they can shoot the ambassador. Be careful not to shoot Red Team, who will be blitzing in through the opposite door. With this room clear and the ambassador secure, Blue Team proceeds out through the double doors to 1-O, then to 1-M, and finally to the extraction zone, ensuring that the way is clear for the teams escorting the hostages.



## RED TEAM

Red Team is the second assault team assigned to clear out the ground level, then assist in securing the Japanese ambassador. Red Team works with Blue Team during this mission.



Red Team clears out the back courtyard.

At the start, position Red Team at Insertion Zone 2. It must then advance to 1-B and hold for code Alpha. Assume a Cover posture here, facing toward 1-G. Two or three tangos patrol the back courtyard area. Neutralize them all.

## OPERATION: DESERT DRAGON

At code Alpha, advance into room 1-F. Then continue on through 1-H, 1-I, and 1-J. Hold at point 1-K for code Bravo. While waiting, maintain a Cover posture while facing 1-O. This gives the team some time, and puts it in good position to take out any remaining tangos patrolling the ground level.



Red Team clears the ground level of the embassy.

After receiving code Bravo, Red Team must advance to 1-T and hold for code Charlie. Assume a Cover posture facing the door into 1-U. At code Charlie, blitz through the door into 1-U, neutralizing both tangos before either one can harm the ambassador. After the area is clear, move next to the ambassador and Defend the room while awaiting code Delta.

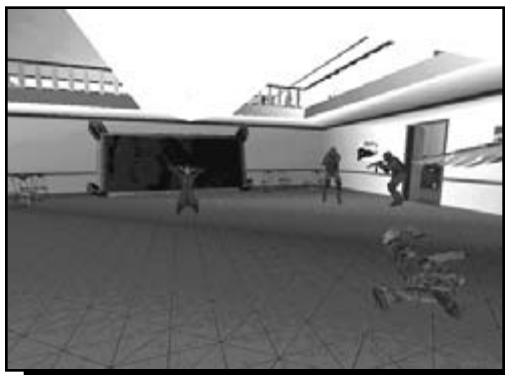

Red Team blitzes in with Blue Team to rescue the ambassador.

Code Delta is the signal to escort the ambassador out through the front doors of the embassy, past 1-M, and on to the extraction zone.

## GREEN TEAM

Green Team has a limited role in this mission. However, it is extremely important, primarily to the ambassador and the teams ordered to rescue her. Green Team must clear the area above the room where the ambassador is being held and make sure no tangos fire on your people below.

Green Team begins at Insertion Zone 1 and immediately advances through 1-D to 1-E. Hold here for code Alpha while maintaining a Cover posture facing toward 1-C. While here, Green Team assists Red and Gold teams in clearing out the back courtyard.



Make sure all of your teams move through 1-M on their way to the extraction zone. This allows them to avoid the tango that patrols the balcony at 2-F, who might take shots at the hostages or your operatives as they are leaving the area.





Green Team blitzes up the outside stairs to the upper level.

When code Alpha is given, Green Team moves toward the stairs at 1-G, then up them to the second level to 2-A. Hold here for code Bravo and assume a Defend posture. Watch out for a tango in 2-C that may walk past the window that looks out toward Green Team's position.



Watch out for tangos that appear and shoot out of this window.

At Bravo, move to 2-B and hold again—this time for code Charlie. Cover the nearby door leading into the embassy building. When Charlie is issued, blitz through the door and hold at 2-D for code Delta. Cover toward a point halfway between 2-E and 2-G, and neutralize any tangos that come into view.

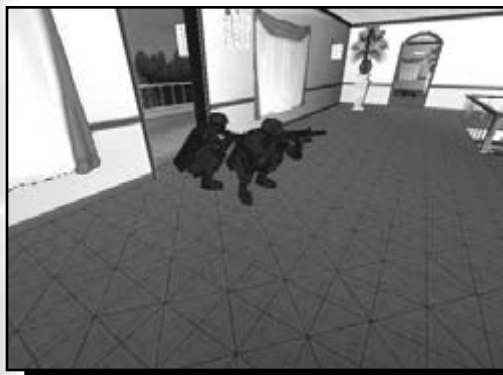

Green Team covers the area above the ambassador's room.

After code Delta is given, blitz down the stairs near 2-D, then out through the front doors on the ground level to the extraction zone.

## GOLD TEAM

Gold Team must clear the basement level and secure the two hostages being held there. This is one of the toughest assignments, but Gold Team is more than capable of executing it flawlessly.

## OPERATION: DESERT DRAGON



Gold Team heads down to the basement.

Gold Team begins at Insertion Zone 2 with Red Team, and immediately moves to point 1-C. Hold there for code Alpha and Cover toward 1-G. After the back courtyard is clear and Alpha has been issued, enter the embassy through room 1-F and descend the stairs in this room to the basement level.



Clear out the tangos in the basement level.

Hold at point B-A for code Bravo. While waiting, assume a Cover posture facing toward B-B. A tango patrols the basement level, and this position gives you a good opportunity to shoot him. When code Bravo is given, advance through B-B to B-C. If you didn't take out the tango patrolling the level yet, you get him along the way. Continue to B-D and take out the tango guarding the door at B-E. Keep things quiet, and continue to B-F. Be ready to fire as soon as you open the door to B-G so you can quickly take out the tango inside. If you don't, he may rush into room B-H and begin killing hostages.



At code Charlie, Gold Team blitzes in to secure the two hostages being held in the basement.

Hold at the door to B-H for code Charlie. When this code is given, blitz into B-H and take out the final tango on this level, thus securing the hostages. Assume a Defend posture while holding for code Delta. At Delta, escort the hostage up the stairs by

B-F, then through the ground level to the front doors and out to the extraction zone.

PRIMAGAMES.COM



Gold team escorts the hostages to the extraction zone.

## NOTES

Coordination and silence are vital to the success of this mission. Take control of more than one team during the course of the operation. Here is what works best.

At the start, control Blue Team. Lead it to 1-L and take out the two tangos patrolling the front of the embassy. When both are neutralized, switch to Green Team, make sure the back courtyard is clear, then give code Bravo. Take Green Team up the stairs at 1-G, keeping an eye on the window to the left at 2-C. Order your teammate to check the room with the heartbeat sensor by switching the ROE to Recon. This lets you know if anyone is in there. Wait until all of the other teams are in position and have cleared their areas.



code Charlie.

**Charlie is the code to assault the rooms where the hostages are held. Keep things quiet until you give code Charlie.**

Now switch to Gold Team and give code Bravo. While in control of Gold Team, you can peek around corners to clear out all of the tangos in the basement except for the one guarding the hostages. When you have cleared the tangos and all other teams are in position, switch to Green Team.

Switch to Recon ROE to check the large room at 2-D for tangos. Set up your shot, give code Charlie, then open the door. Fire through the doorway so you are covered on the

flanks. When the large room is clear, move to 2-D and cover the doorway at 2-G, taking out any tangos that appear.



very difficult to get the timing correct if you are in control.

**Although you may think it a good idea to take control of Red or Blue Teams during the assault to secure the ambassador, it is better to let the AI handle both teams at this critical time. This way, both teams enter the room at the same time. It is**

When all hostages have been secured, and Red and Gold Teams are holding for Delta, give the code and blitz down the stairs to the ground level. Go to the extraction zone to complete the mission.



# OPERATION: SILENT ACE

06.13.04  
NAPLES, ITALY

0125

## MISSION ORDERS

An unknown terrorist group has seized an Italian cruise ship anchored just off Naples, Italy. High explosives have been detected on board, and two passengers have been taken hostage. A night assault is RAINBOW's only chance to extricate the hostages safely. Your mission is to disarm the bomb and liberate the captives.

The assault team will infiltrate the harbor next to the cruise ship under cover of darkness. The liner has three entry ramps, which can then be used for boarding. The terrorists on the deck should be vulnerable to snipers. Make sure you synchronize your attacks on the three objectives since the terrorists are making frequent radio checkups. The hostages must be escorted back to the rendezvous area without casualties.

## INTELLIGENCE BRIEFING

The *Rei di Tutto* is a 100-meter luxury cruise ship designed for an elite clientele. We've located two bombs aboard the ship. Both have been placed on the third deck, with one in the ship's casino and the other in the bar at the other end of the vessel. They're both well guarded. The hostages—both high-ranking government officials—seem to be held somewhere below the main decks of the ship. Get in, disable the bombs, and then get those hostages out alive. The terrorists have started posting their ransom demands for each passenger, and if we don't wrap this up quickly, matters could get extremely complicated.

With the information we've got, the resemblance between a previous cruise ship attack



and the one we're looking at now can't necessarily be ignored. We still don't know who these guys are or what they want, but they're well organized and well equipped, and they seem to have done their homework on how to tackle a ship like this one.

Tangos are holding hostages on this ship, and threaten to blow it up if their demands are not met. It is up to you to save the hostages and the ship.

### OBJECTIVES

1. RESCUE ALL HOSTAGES
2. PREVENT TERRORISTS FROM ACTIVATING CASINO BOMB
3. PREVENT TERRORISTS FROM ACTIVATING BAR BOMB

# TEAM ASSIGNMENTS

## BLUE TEAM

Operative	Primary	Secondary	Slot 1	Slot 2	Uniform
Bogart	0.45cal SD UMP SMG	0.45cal M23 SD Pistol	Frag Grenade	Flashbang	Grey Medium
Arnavisca	0.45cal SD UMP SMG	0.45cal M23 SD Pistol	Frag Grenade	Flashbang	Grey Medium
Burke	0.45cal SD UMP SMG	0.45cal M23 SD Pistol	Heartbeat Sensor	Flashbang	Grey Medium
Filatov	0.45cal SD UMP SMG	0.45cal M23 SD Pistol	Frag Grenade	Flashbang	Grey Medium

## RED TEAM

Operative	Primary	Secondary	Slot 1	Slot 2	Uniform
Walther	0.45cal SD UMP SMG	0.45cal M23 SD Pistol	Frag Grenade	Flashbang	Grey Medium
Loiselle	0.45cal SD UMP SMG	0.45cal M23 SD Pistol	Frag Grenade	Flashbang	Grey Medium
Rakuzanka	0.45cal SD UMP SMG	0.45cal M23 SD Pistol	Heartbeat Sensor	Flashbang	Grey Medium
Raymond	0.45cal SD UMP SMG	0.45cal M23 SD Pistol	Frag Grenade	Flashbang	Grey Medium

Map 7-1. Level 1, Cruise Liner

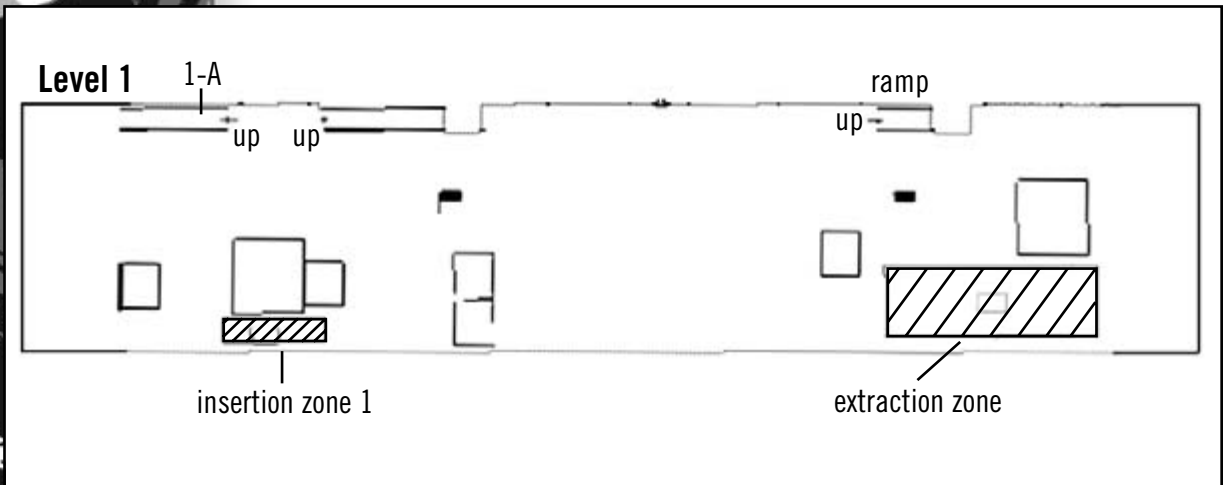

Map 7-2.  
Level 2,  
Cruise Liner

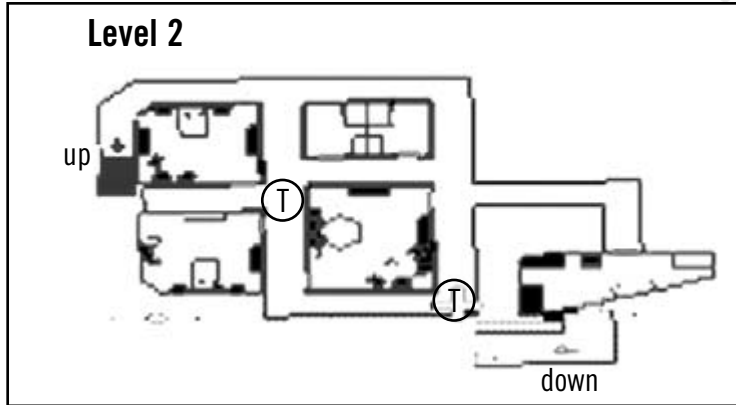

Map 7-3. Level 2, Cruise Liner

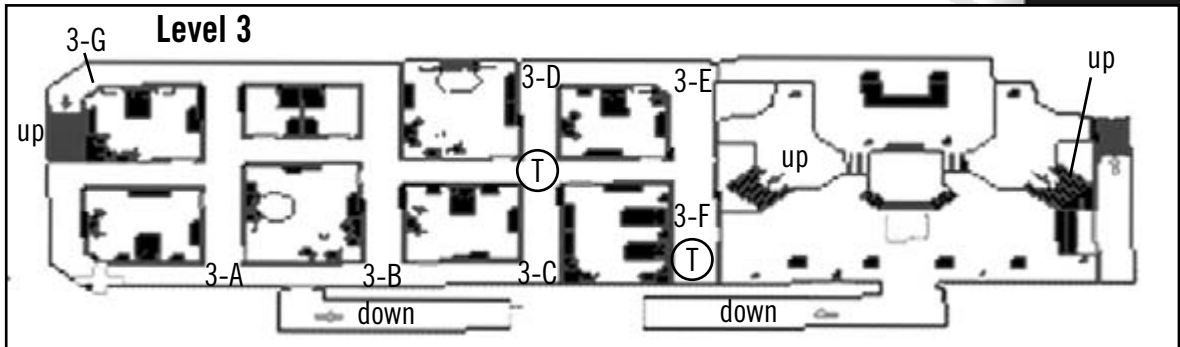

Map 7-4. Level 4, Cruise Liner

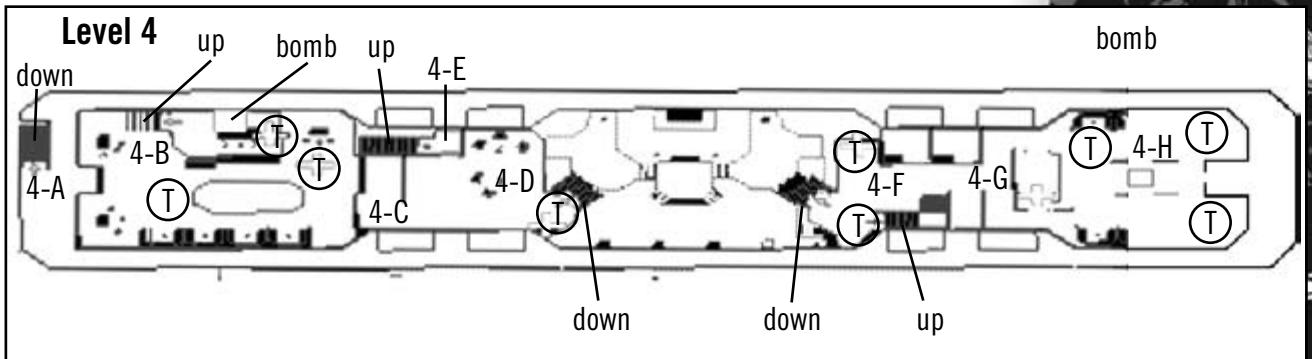

Map 7-5. Level 5, Cruise Liner

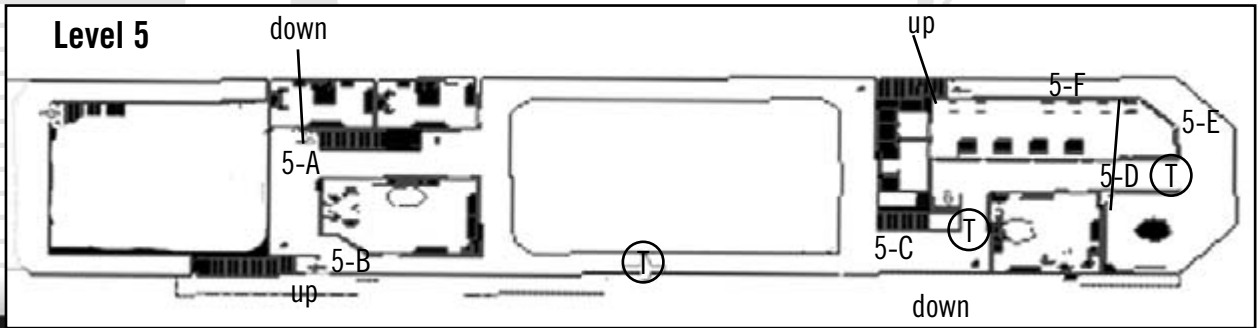

Map 7-6. Level 6, Cruise Liner

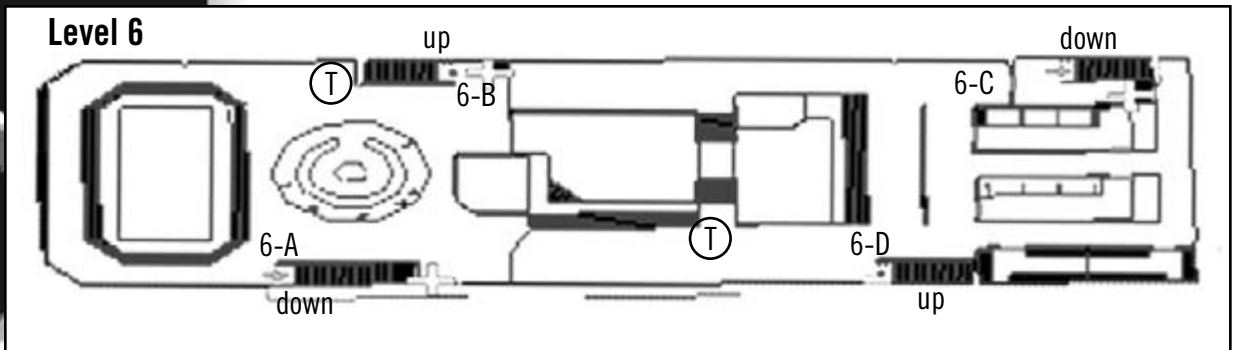

Map 7-7. Level 7, Cruise Liner

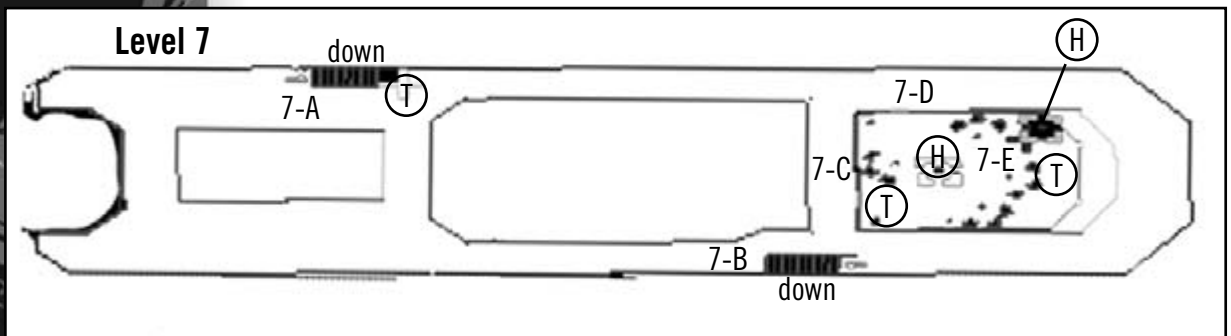

## STRATEGY

Although this mission can be tough, you can make it a bit easier by concentrating on the objectives. You need two assault teams. Together they will prevent the tangos from detonating the two bombs, then they'll assault the ship's bridge and rescue the hostages there.

As with the previous missions, stealth is essential. If the tangos learn of your presence, they may detonate one or both of the bombs or kill the hostages.

The key to the mission is to avoid blitzing into wide-open areas where your teams can be shot at from several locations. Instead, work from the stern of the ship and gradually head toward the bow as you ascend to the upper levels. You do not need to clear out every tango—only those you come across while achieving the objectives.



This walkthrough uses only two teams. The extra firepower of having four operatives in each team can be a bonus while moving around the ship. You can use more teams, but two is all you really need. In fact, with some experience, you can even accomplish the mission with a single team.

## BLUE TEAM



Blue Team is the first assault team. Their assignment is to clear the casino area and prevent the bomb there from being detonated. Then, Blue Team assists Red Team in securing the hostages on the bridge of the ship.

Blue Team leads the way up the ramp.



At the start of the mission, Blue Team moves up the ramp at 1-A to the third level of the ship. Continue to 3-A and hold there for code Alpha. Assume a Cover posture while facing toward 3-G. Hold here while both teams get organized onboard the ship. Take out the patrolling tango if he comes into view.

Securing the bomb in the casino is the first objective.

When Alpha is given, head to 3-G. Hold here for code Bravo. After code Bravo is issued, blitz up the stairs to 4-A and through the doors into 4-B, neutralizing all of the tangos in



sight. Watch out for a tango that might be on the ledge overlooking the casino area. Another one may be crouched near the bomb. When the room is clear, the first objective is complete. Hold near the bomb for code Charlie.

At code Charlie, advance through 4-C to the stairs at 4-D. Take them down to level three, then back up to 4-F. Hold here for code Delta. When you receive Delta, blitz through 4-G, taking a right turn into 4-H. After the bar is clear and you've prevented the tangos from detonating

the bomb, your second objective is complete.



Blue Team must climb a lot of stairways in this mission.

With the bar clear, advance to the stairs at 4-F and take them up to 5-C. Continue to 5-B and hold at the base of the stairs for another code Alpha. When Alpha is given, head up the stairs to 6-A, then on to 6-B, taking out any tangos along the way. Also watch out for the tango patrolling on level 7; he will look down and shoot at your teams if he can see them.

Hold at the base of the stairs by 6-B for code Bravo.



Watch out for tangos near the pool area.

When Bravo is issued, move up the stairs to 7-A and then on to 7-D. Hold by the door for code Charlie. At Charlie, blitz in to 7-E and neutralize both tangos before they harm the hostages. When the bridge is clear, wait for code Delta.



Blue Team is prepared to assault the bridge.

## OPERATION: SILENT ACE



Blue Team blitzes in to secure the two hostages.

At code Delta, return to the stairs at 7-A and take them down to 6-B. Continue to 6-A, then down the stairs to 5-B. Next, move to 5-A and take the stairs down to 4-E. Continue to the stairs at 4-A, which take you down to 3-G. Head down the ramp near 3-A and make your way to the extraction zone.

## RED TEAM

Red Team is the second assault team. Their assignment is to secure the bar area and prevent the tangos from detonating the bomb. They also work with Blue Team in securing the hostages on the bridge of the ship.



There is a tango patrolling level 3.

At the start of the mission, Red Team follows Blue Team onto the ship by boarding the ramp near 1-A. Continue to 3-B and hold for code Alpha while Covering toward 3-D. Take out the patrolling tango before proceeding.



Peek around the corner to take out this tango at 3-F.

At code Alpha, advance through 3-C and 3-D toward 3-E. Use caution at the corner. There is a tango standing guard at 3-F. Take him out before he can get off a shot at your team. With this tango down, Red Team must head to the stairs at 3-G. Hold behind Blue Team for code Bravo.

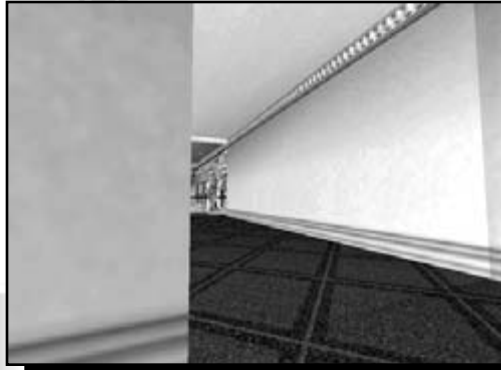

Red Team clears a path to the lobby.

At code Bravo, Red Team blitzes into the casino area at 4-B and helps Blue Team clear the area. Instead of staying here after clearing the area, Red Team advances to 4-C and then on to 4-D. Between these two points, Red Team can take out tangos near 4-D and 4-F, and even some on level 5. Hold at 4-D for code Charlie. Assume a Cover posture aimed toward 4-G.

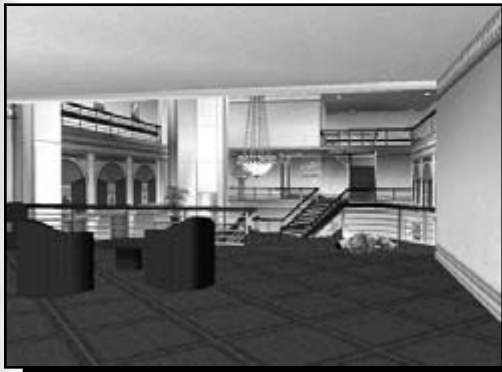

Take out several tangos on the opposite side of the lobby.



Watch out for the tango patrolling the walkway on level 5. Drop him as soon as he comes into view.

After code Charlie has been issued, Red Team heads to the stairs at 4-E and takes them to level 5. Advance through 5-A and 5-B to 5-C. Take out the tango near the exercise center at 5-D, then descend the stairs to 4-F. Hold here for code Delta.

## OPERATION: SILENT ACE



A single tango patrols near the exercise center.

At code Delta, blitz through 4-G, taking a left turn before entering the bar area at 4-H. Neutralize all tangos here and prevent them from detonating the bomb in the bar. With the area clear, return to the stairs at 4-F and take them to 5-C. Continue around through 5-D, 5-E, and 5-F to the stairs to

level 6. Hold at the base of the stairs for code Alpha while Covering toward the top of the stairs, at 6-C.

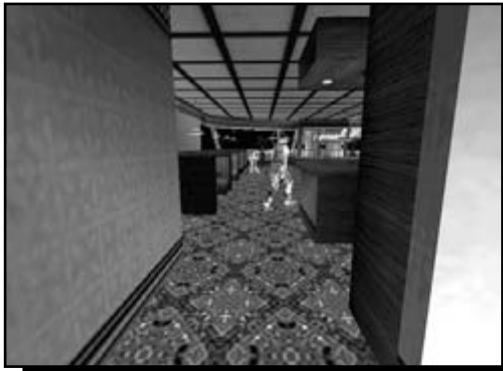

Red Team assaults the bar area to secure the bomb.

Code Alpha sends Red Team up the stairs to 6-C, then to the next flight of stairs at 6-D. Hold at the base for code Bravo. When you get the code, advance up to 7-B, then to the door to the bridge at 7-C. Hold here for code Charlie.

At code Charlie, blitz into the bridge area at 7-E, neutralizing both tangos before they have a chance to kill the hostages. With the room clear, hold for code Delta. After you get it, round up the two hostages and escort them to the stairs at 7-A, down to 6-B, then across to the next stairs at 6-A. Continue down to level 5 and descend the stairs at 5-A. From 4-E, advance to the stairs at 4-A, which lead down to level 3. Exit the ship via the ramp near 3-A and take the hostages to the extraction zone to complete the mission.





Red Team escorts the hostages down the ramp to safety.



You may have noticed that both teams use only the left-hand ramp onto the ship. That's because the ramp on the right leads into the cargo area on level 2. There are a couple of tangos here, but they don't cause any trouble. The center ramp takes you into the main lobby, where tangos can fire down at you from several angles.

## NOTES

This mission is not as difficult as other missions. Start off in control of Red Team and lead them up the ramp to 3-B. While holding here, switch to Recon ROE so one of your teammates will use the heartbeat sensor. Locate the patrolling tango on level 3. Once he is down, give code Alpha and lead Red Team around to 3-E. Before you go around the corner, face toward 3-F, crouch, and then peek around the corner to the left to take out the tango at the end of the hall. Then move to the stairs at 3-G.

Switch to Blue Team and give code Bravo before rushing into the casino area. As soon as all tangos are down, switch back to Red Team and use them to take out the tangos overlooking the large lobby area near 4-D. When all is clear, give code Charlie and take Red Team up the stairs at 4-E, across to 5-E (clearing the level along the way), then down the stairs at 5-C to 4-F.

When both teams are holding at 4-F, give code Delta and blitz into the bar.

After it is clear, move back to 4-F, climb the stairs, and advance to the stairs at 5-F. Wait until both teams are holding, then give code Alpha. Advance to 6-C, then 6-D, taking out any tangos on level 6. Hold at the base of the stairs until Blue Team is ready, then give code Bravo.

Move up the stairs to 7-B, take out any tangos still patrolling the decks, then continue to 7-C. When Blue Team is ready, give code Charlie and blitz into the bridge, careful to take out both tangos before they can get off a shot at the hostages or your teams. When it's clear, give code Delta and escort the hostages to the stern of the ship, down the stairs to level 3, and out through the ramp you used to board. After the hostages are safely at the extraction zone, the mission is complete.



# OPERATION: COPPER KING

## MISSION ORDERS

Terrorists have crossed into a town on the Malawi-Zambia border and captured a school bus full of soldiers being transported to a new assignment. You must stop the terrorists without any casualties among the hostages. Your mission is to prevent the bus from crossing the border.

06.24.04 1.21.5  
MALAWI, ZAMBIA BORDER

Intelligence reports there is a single terrorist and an unknown number of hostages on board the bus. You will be inserted at the edge of town and must make your way to a good lookout position in the bell tower, which is located on the map. Some hostiles may be encountered along the way. Because the terrorists are all using radios, the bus will leave as soon as gunfire is heard. You can, however, neutralize the terrorists before they report you in. Stealth and protecting the sniper are key to this mission. Once the lookout position has been reached, stop the bus by taking out the terrorist on board.

## INTELLIGENCE BRIEFING

This mission requires absolute stealth, followed by quick, decisive action. The terrorists must be stopped before they can get the bus into Zambian territory. Once it crosses over, it's going to be impossible to get it back without a major international incident. Reports indicate that the hostages have been tied up in the back of the vehicle. We're also told that only one of the terrorists is on board driving the bus and there appear to be others in the surrounding area running interference.

We're starting to get a picture of what's going on here. We believe the current situation may be a recreation of a historic rescue made in Djibouti by the French. Coincidence? I doubt it. We don't have hard evidence to back up our theory, but it seems to fit the available data, and if so that means we'll be dealing with another aspect of the same terrorist organization.



Watch out for the many tangers patrolling the town.

If the terrorists successfully get the bus across the Zambian border, the risk to the hostages' lives will be greatly increased. We don't want to start a border war over this one, so you're going to have to move fast. And just to make things more interesting, the hostage-takers are demanding, not money this time, but weapons. If the government of Malawi gives in, odds are that we'll see those guns again the next time our terrorist hits.

## OBJECTIVES

1. PREVENT THE BUS DRIVER FROM ESCAPING THE TOWN

# TEAM ASSIGNMENTS

## BLUE TEAM

Operative	Primary	Secondary	Slot 1	Slot 2	Uniform
Chavez	9mm MP5 SD SMG	0.45cal M23 SD Pistol	Primary Ammo	Heartbeat Sensor	Desert 2 Light
Maldini	9mm MP5 SD SMG	0.45cal M23 SD Pistol	Primary Ammo	Heartbeat Sensor	Desert 2 Light

## RED TEAM

Operative	Primary	Secondary	Slot 1	Slot 2	Uniform
Johnston	7.62 SSG3000 SR	0.45cal M23 SD Pistol	Primary Ammo	Heartbeat Sensor	Desert 2 Light
Pak	9mm MP5 SD SMG	0.45cal M23 SD Pistol	Primary Ammo	Heartbeat Sensor	Desert 2 Light

Map 8-1. Lower Level, Malawi-Zambia Border

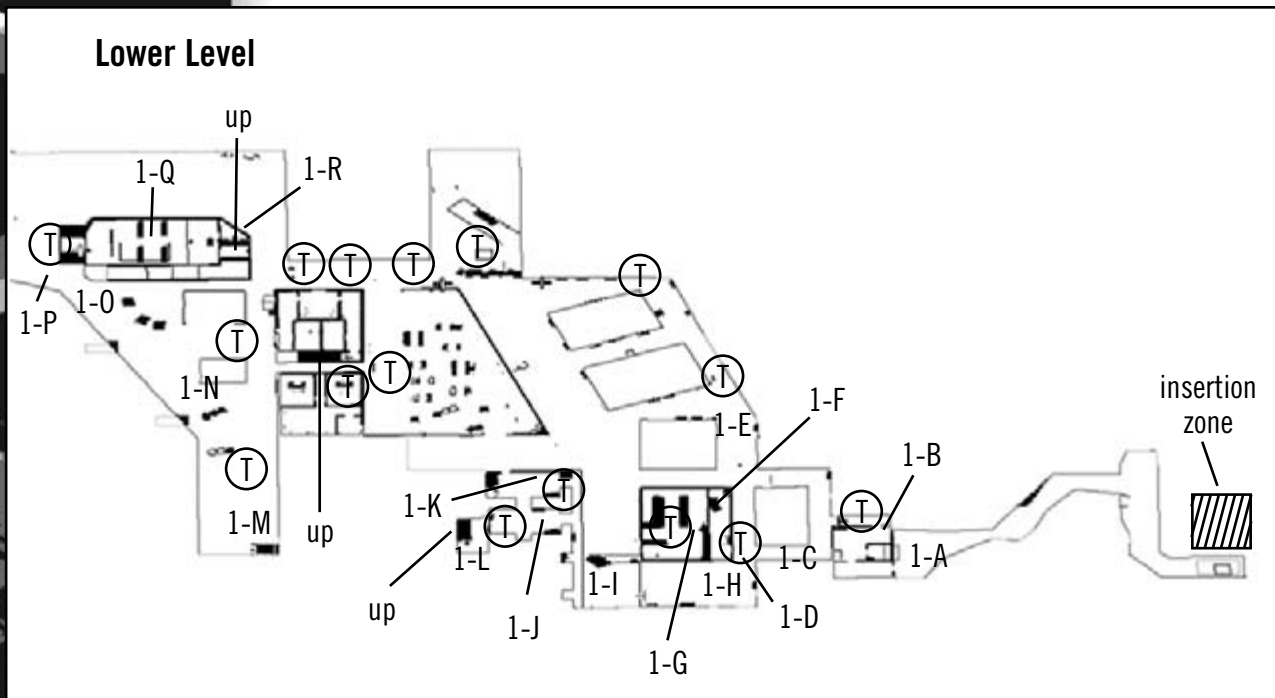

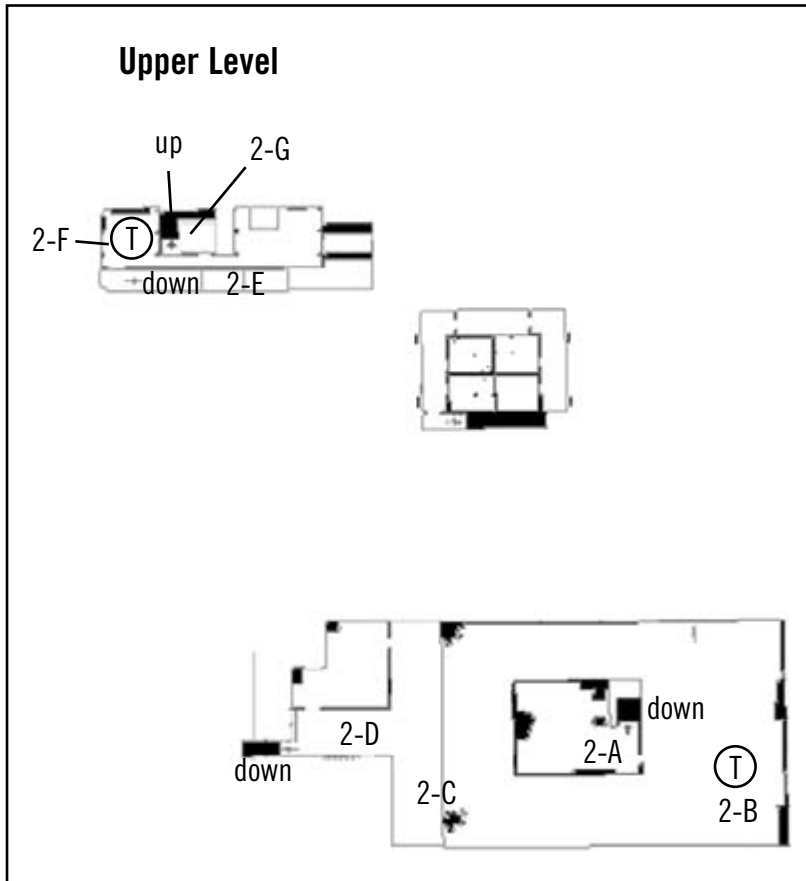

Map 8-2.  
Upper Level,  
Malawi-Zambia Border

## STRATEGY

This mission is unlike any you have ever been assigned. The objective is to get your sniper team to the church tower without alerting any of the tangos in the town of your presence. Then, your sniper must take out the tango driving the busload of hostages before he crosses the border into Zambia.

There is no way for your teams to get near the road the bus is traveling, so the sniper is the only way to complete this mission. The tangos are carrying radios and are in constant contact with the bus driver. If they see your teams or hear gunshots, they will inform the driver and he'll drive away. Therefore, stealth is extremely important. Take only silenced



**TIP**

The key to this mission is to find the path of least resistance. Rather than clearing out all of the tangos in the town, try to avoid large concentrations, and neutralize those who may see your teams or are on your way to the church.

weapons (except for the sniper rifle), and neutralize all tangos you come across.

For this mission, you need two teams—an assault team and a sniper team. Choose operatives with high stealth ratings so your teams can move about undetected.



## BLUE TEAM

Blue Team is your assault team. Their assignment is to clear a path to the church for the sniper team, silently eliminating all tangos along the way. Since many of the tangos are patrolling, you must find good spots from which to ambush the hostiles.



This walkthrough contains a lot of Go Codes Alpha and Bravo. Because there are several places the teams must hold and Cover, each is assigned its own Go Code. Blue Team uses Alpha and Red Team uses Bravo. Both teams use Delta at their final waypoint.



Blue Team sneaks up behind the first tango.

From the insertion zone, move along the stream to the narrow pathway leading to 1-A. Crouch down and cautiously enter the small building, making your way to 1-B. There is a tango just outside the door. If you have kept quiet, you can sidestep out the door and take him out while his back is turned. Hold at 1-A for code Alpha. Assume a Cover posture while aiming into the alleyway.



Cover down this alleyway until you take out at least two patrolling tangos.

Take out the heartbeat sensor and scan for the next tango patrolling around 1-D. Sometimes he comes into your sights at 1-B, but usually you have to move to 1-C and wait for him to come around the corner toward 1-D. Hold at 1-C for code Alpha. Drop the tango as soon as he comes into your sights and before he can get off a shot.

After Alpha is given, move to 1-D and hold again for another code Alpha. Cover toward 1-E. There are a couple tangos patrolling down the alley. Press Left **[Shift]** to activate Sniper mode and zoom in your view. Take out both tangos as they come into view.

## OPERATION: COPPER KING



Eliminate the tango on the rooftop or he will shoot at your teams.

When both tangos are down and Alpha is given, move silently into 1-F and scan room 1-G with the heartbeat sensor to locate the tango inside. At the door into 1-G, line up your shot using the sensor, then open the door and eliminate the tango before he can warn others.

This tango in the shop causes problems unless you take him out from the back door.

Move back through 1-F to 1-H and hold for another code Alpha. This time, Cover toward 2-B. A tango patrols this upper level and will fire on your teams if you do not neutralize him. After he is down and Alpha is given, move carefully toward 1-I. Cross the street using the boxes for cover, then hug the wall as you continue to 1-J. Use the heartbeat sensor to locate the tango near 1-K, then move into 1-J and position yourself to drop the tango.



If you have moved quietly, you can easily take out this tango without him even knowing you are there.

With this area clear, head to the stairs at 1-L and take them to the upper level. Move through 2-A to 2-C, while facing toward 2-D for the entire movement. Watch out for a tango that often patrols the area between 2-D and the lower level. Hold at 2-D while Covering toward 1-M until code Alpha. After you take care of the tango in this area, continue down the stairs to 1-M.



Move across the rooftop carefully, watching for a patrolling tango to appear.

Be careful as you descend these stairs, always keeping your weapon aimed toward possible threats.

A couple of tangos patrol the area near 1-N. Carefully move toward 1-N, neutralizing any tangos that come into your sights. Continue through 1-O to 1-P and drop the tango at the entrance to the church. Then, immediately enter the church and advance through 1-Q to the stairway at 1-R. Another tango runs at you between 1-R and 2-E, so take him out quickly. Continue to 2-F and hold for a final Go Code—this time Delta—while covering the doorway to 2-E. Remain here until the mission is complete.



Drop the tango in front of the church doors.



Blue Team holds in the church and covers the doorway to the tower.

## RED TEAM

Red Team is the sniper team. If Blue Team does its job correctly, Red Team just has to follow and take the final shot at the tango driving the bus. However, you should also use Red Team to cover Blue Team's rear so they are not surprised by unexpected tangos.



Red Team follows Blue Team along the stream.

At the start of the mission, Red Team follows Blue Team along the stream and up the narrow path to 1-A. Hold here for code Bravo. Then advance through the small building to 1-B and hold again for code Bravo while Covering toward the alleyway.

### Red Team covers Blue's rear.

When the code is given, continue to 1-C and hold again for Bravo. Assume a Cover posture facing toward 1-D. After Blue Team has cleared out the surrounding area and Bravo is given again, advance through 1-H and 1-I to 1-J. Then head up the stairs at 1-L to hold at 2-A for another code Bravo.





With the way cleared by Blue Team, Red advances to the two-story building.

When this last code Bravo is given, move through 2-C and 2-D, down the stairs to 1-M, and then through 1-O to the church. Continue through 1-Q, 1-R, and 2-E to the stairs at 2-G. Take them to the very top and

hold at the window for code Delta. Assume a Snipe posture aiming out the window toward the distant roadway. By the time you get to the top of the church tower, the bus is in motion. Zoom in all the way, aim at the tango in the driver's seat, and fire. After you neutralize him, the mission is a success.

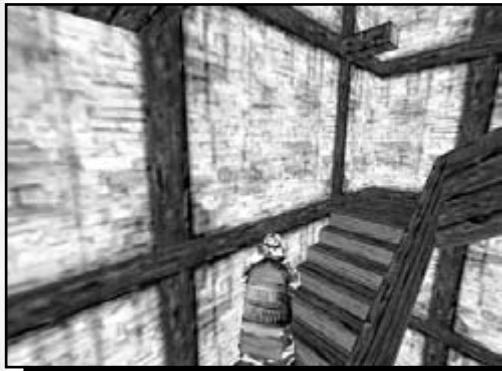

Red Team rushes to the top of the church tower.



The sniper aims out through the window.

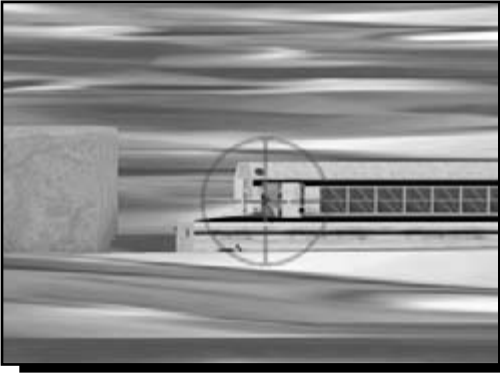

Place the crosshairs over the driver, and fire to save the hostages.

## NOTES

As mentioned earlier, this mission requires a lot of holding and covering as the teams advance toward the church. Silence is imperative. If any of the tangos get off a shot, others radio the bus driver and he begins moving. Since you only have 10–15 seconds to neutralize the driver once he is moving, the mission will end in failure.

Start off in control of Blue Team. All of their Alpha codes are just reminders to hold at specific positions and use Covering fire to take out patrolling tangos that can cause problems later. The Bravo codes are used to move Red Team forward after Blue Team has cleared an area.

After Blue Team is moving from 1-B to 1-C, give the first code Bravo to move Red Team to 1-B. After Blue Team clears 1-G and is at 1-H, give the second code Bravo to move Red Team to 1-C. When Blue Team is headed up the stairs to 2-A, give the third code Bravo to get Red Team headed to 2-A. Finally, as Blue Team is just about to the church doors, give the last code Bravo so Red Team makes their way to the church.

After Blue Team neutralizes the tango inside the church, switch to Red Team and lead them to the top of the tower. Shoot the driver of the bus, and the mission is complete.



You can play this mission with a third or even fourth team to help provide cover. Just leave them at key positions with Covering orders. This mission can also be accomplished with just one team. Take along the AW Covert sniper rifle for the team leader, a good silenced pistol, and a heartbeat sensor. If you really want a challenge, use only a single operative for the mission. Just be sure to watch out for tangos creeping up behind you!



To help keep track of where Red Team is during the mission, press **G** to toggle the

Map view to show both teams' respective maps.

# OPERATION: COARSE BLADE

## MISSION ORDERS

07.06.04  
 JUNGLE OF NIGERIA

0650

An unknown terrorist group has captured United Nations peacekeepers in Nigeria and is holding them hostage in their jungle-based camp. The terrorists are heavily armed and well prepared, and they are most likely expecting an assault from foreign forces. Your mission is to neutralize their anti-aircraft weapons, liberate the hostages, and capture the group leader alive so that he can be interrogated.

Rainbow teams inserted on the southern bank of the river will have to secure the anti-aircraft artillery and rescue the hostages while two other teams will capture the leader and escort him back to the rendezvous point, where a rescue helicopter will be waiting. From the reports of the hostage-taking operation, we can expect these terrorists to be well armed. Heavy fire is expected.

### INTELLIGENCE BRIEFING

It seems that our terrorist group has gotten comfortable in Africa. All of their other attacks have been extremely clean, and this one looks like no exception. We need information on these people and we need it now. A recon team located the most likely candidate for leader of this particular group. We need to capture him alive: A thorough interrogation should reveal what these terrorists actually want—as opposed to the rather scattershot demands we've been getting.

This operation will need to be an all-out assault on the revolutionaries' jungle base camp. The terrorists are heavily armed and their base is well protected. We'll need to get the hostages out by air, so taking out their anti-aircraft emplacements is extremely important.

Peacekeeping convoys in this area are often attacked for their vehicles and weapons, but it's rare for the guerillas to take hostages. The motivation behind this and the other attacks remains a complete mystery, though this looks a bit like an incident back in Sierra Leone. Our only hope is that if we get our hands on their leader, we can get some answers.



**Capturing the terrorist leader is one of your objectives for this mission. Be careful not to shoot him.**

# TEAM ASSIGNMENTS

## OBJECTIVES

1. SECURE THE ANTI-AIRCRAFT GUN
2. CAPTURE THE TERRORIST LEADER
3. RESCUE ALL HOSTAGES

### BLUE TEAM

Operative	Primary	Secondary	Slot 1	Slot 2	Uniform
Chavez	5.56mm FAMAS G2 AR	9mm SPP Pistol	Frag Grenade	Primary Mag	Euro Medium
Yacoby	5.56mm FAMAS G2 AR	9mm SPP Pistol	Frag Grenade	Heartbeat Sensor	Euro Medium

### RED TEAM

Operative	Primary	Secondary	Slot 1	Slot 2	Uniform
Novikov	5.56mm FAMAS G2 AR	9mm SPP Pistol	Frag Grenade	Primary Mag	Euro Medium
Filatov	5.56mm FAMAS G2 AR	9mm SPP Pistol	Frag Grenade	Heartbeat Sensor	Euro Medium

### GREEN TEAM

Operative	Primary	Secondary	Slot 1	Slot 2	Uniform
Bogart	5.56mm FAMAS G2 AR	9mm SPP Pistol	Frag Grenade	Primary Mag	Euro Medium
Burke	5.56mm FAMAS G2 AR	9mm SPP Pistol	Frag Grenade	Heartbeat Sensor	Euro Medium

### GOLD TEAM

Operative	Primary	Secondary	Slot 1	Slot 2	Uniform
Price	5.56mm FAMAS G2 AR	9mm SPP Pistol	Frag Grenade	Primary Mag	Euro Medium
Raymond	5.56mm FAMAS G2 AR	9mm SPP Pistol	Frag Grenade	Heartbeat Sensor	Euro Medium

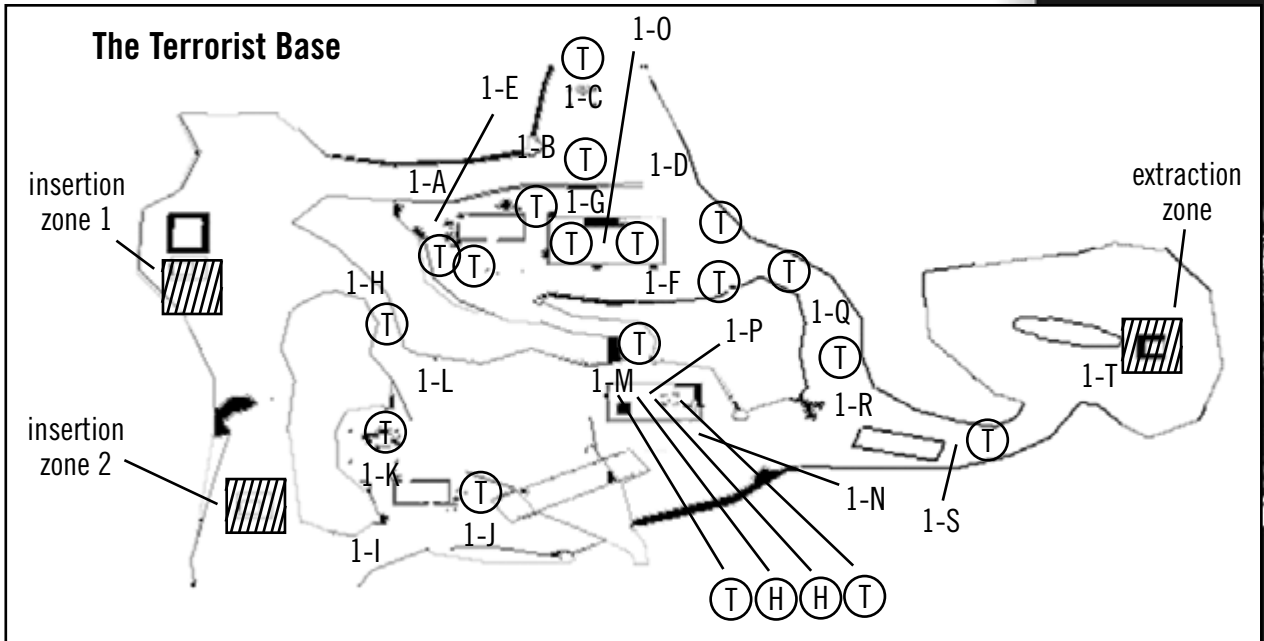

Map 9-1. The Terrorist Base



# STRATEGY

This mission is a bit different than previous ones. You still have to rescue hostages, but there is no need to stay quiet. Equip good assault rifles and use grenades when necessary. Capturing the terrorist leader is just like rescuing a hostage: Clear the area around him and assign a team to escort him to the extraction zone. To secure the anti-aircraft gun, simply neutralize the tangos nearby.

You will use four teams for this mission. Three begin at the first insertion zone, and the fourth begins at the second one. The first two teams work together to clear half of the base and capture the terrorist leader while the second two teams secure the anti-aircraft gun and rescue the hostages. The coordination for this mission is not as critical as in some of the previous missions, and you concentrate on achieving one objective at a time rather than all of them at once.

## BLUE TEAM



Several tangos patrol the area near the guard tower. After the first shots, they usually come toward you to see what's going on. Take them out before they can harm your teams.

Blue Team is the lead team, assigned to capture the terrorist leader. Begin at Insertion Zone 1 and immediately head toward 1-A. Take out any tangos near 1-D, as well as one who may fire down at you from 1-E. After the path is clear, throw a frag grenade toward 1-E, then continue toward 1-B. Take it easy and watch for patrolling tangos. As you approach 1-B, crouch and turn toward 1-C, where a tango sniper is in a guard tower. Zoom in your view, aim up at the tower, then slowly sidestep until you can peek around the foliage and take out the hostile before he can shoot at you. Remain at 1-B for code Alpha, while covering toward 1-D.

Throw a frag grenade like this, and you might take out a tango on the other side of the small building.



## OPERATION: COARSE BLADE



Move carefully and shoot quickly to take out the tango sniper in the tower. If you miss, he ducks. Stay put and wait for him to stick his head up again.

At Alpha, advance through 1-D and 1-F toward 1-E, making sure there are no tangos still alive in the area. If the grenade you threw didn't take one out, he may be near 1-F. Hold near 1-E for code Bravo while Covering toward 1-F. At code Bravo, return to 1-F and hold in front of the door to 1-O, covering toward the door until code Charlie.



Blue Team blitzes in to clear the building. Watch for the tangos on the stairs.

After Charlie, blitz through the door and mow down any tangos in the building. Watch out for hostiles on the stair leading to the upstairs office. After the building is clear, exit and advance toward 1-G. Hold

here for code Delta and assume a Cover posture facing toward 1-R. When Delta is issued, make your way through 1-R and 1-S to the extraction zone, clearing the way for the follow-up teams with the hostages and the prisoner.

## RED TEAM



Red Team crosses the river to reach its initial position.



Try fragging building 1-O before blitzing inside. To do this, stand to the left of the door and open it, then

throw a frag grenade inside so that it bounces off of a wall toward the center of the room. After it detonates, give code Charlie and blitz in.

Red Team works with Blue Team to capture the terrorist leader. Start at Insertion Zone 1 and send them toward 1-A right away. Hold at this point for code Alpha. Assume a Cover posture while facing toward 1-D. Red Team provides cover for Blue Team as it attacks the sniper in the tower.



Red Team covers Blue Team while they go after the sniper in the tower.

At code Alpha, advance toward 1-D and hold there for code Bravo. Cover toward 1-G, and eliminate any tangos patrolling the area within your sights. After Bravo, move to the door at 1-G and hold again—this time for code Charlie. When you get the signal, blitz into the building at 1-O and clear it of tangos. Continue up the stairs to the office.

Open the door and introduce yourself to the terrorist leader. Hold in the office for code Delta.



Red Team clears the building before capturing the terrorist leader.

After Delta, escort the terrorist leader down the stairs and out of the building. Move through points 1-G, 1-R, and 1-S as you advance to the extraction zone, where the helicopter is waiting.



If you decide to control Red Team, be careful not to shoot the terrorist leader. He is the only person in the upstairs office within building 1-O.

Although he looks like a tango, he is not carrying a weapon.

## GREEN TEAM



Green Team holds in the stream.

Green Team is tasked with rescuing the hostages. They begin at Insertion Zone 1, but work with Gold Team. Immediately head toward 1-H. Take out the tango patrolling the waterway, then hold at 1-H for code Bravo. Assume a Cover posture facing toward 1-L. While you wait, drop the tango near the bridge at 1-J.

Zoom in and take out the tango by the bridge.

At code Bravo, advance through 1-L to 1-M. Neutralize the tango on the narrow walkway opposite the building at 1-P, then hold at 1-M and Cover toward the door until code Charlie. When Charlie is issued, blitz through the door and take down both tangos inside, being careful not to hit the two hostages. When the room is clear, hold for code Delta.



Green Team blitzes in to secure the hostages.

After code Delta, escort the hostages out the door at 1-N, through points 1-R and 1-S, then to the extraction zone where the helicopter is waiting to take you to safety.



Get the hostages  
to the helicopter.



## GOLD TEAM

Gold Team is assigned to help rescue the hostages and to secure the anti-aircraft gun. It is the only team that begins the mission at Insertion Zone 2. Immediately head toward 1-I and hold for code Bravo. Assume a Cover posture facing toward 1-J, and take out any tingos that come into your sights.



Gold Team covers the bridge.

At code Bravo, move forward toward 1-K and take out the tango near the anti-aircraft gun. Continue across the bridge to 1-N. Hold for code Charlie near the door, facing the building.

Take out this tango by  
the anti-aircraft gun to  
complete an objective.





Gold Team assists in securing the hostages.

After Charlie is issued, blitz into 1-P and take out the tangos guarding the hostages. When you're clear, exit the building through the door you entered and advance to 1-R. Hold there for code Delta and Cover toward 1-S. Finally, at Delta, continue through 1-S to the extraction zone, making sure the path is clear for the follow-up teams.



## NOTE

By the time you capture the terrorist leader and rescue the hostages, you may have taken care of all the tangos on the map. If so, the mission ends without you having to get everyone to the extraction zone.

## NOTES

This mission is fairly simple to execute. Take control of Blue Team at the beginning, and stay with them the entire time. At the start of the mission, all four teams advance toward their initial holding positions. Stay with Red Team as they move to 1-A, and watch for tangos above you at 1-E. Shoot any that come into sight, then lob a frag grenade or two over the embankment to take out any tangos on the other side of the small building.

As you approach 1-B and the tower, press **[R]** to order your teammate to hold. Otherwise, he or she may run ahead of you and get hit by the sniper as you are inching around the foliage to shoot that sniper.

When the tower is clear, give code Alpha to bring Red Team with you. When they are waiting at 1-D, give code Bravo to send all teams toward their assault points—Blue and Red to capture the terrorist leader, and Green and Gold to rescue the hostages. When all teams are ready, give code Charlie and take out the tangos in building 1-O. Then exit and head to 1-G. After the terrorist leader is in Red Team's custody and the hostages have been secured, give code Delta to send all four teams to the extraction zone. Neutralize any tangos along the way that might shoot at your teams

or the hostages. When everyone reaches the helicopter, the mission is a success.



## TIP

This is a fun mission to go back and play again. Try it with different number of teams or with different weapons and equipment. Because the tangos do not kill the hostages at the first gunshot, you can experiment with frag grenades, flashbangs, and assault rifles.

# OPERATION: SPIRIT CLASP

## MISSION ORDERS

07.19.04  
PATTAYA, THAILAND

1620

Terrorists have taken control of a military Hospital in Pattaya, Thailand and are threatening to execute their hostages one by one if their demands are not met. Your mission is two-fold. First, you must intercept a communication link from the terrorists to their home base before they have a chance to break the connection. Second, you must eliminate the terrorists and liberate the hospital.

A stealth team must enter the hospital through the roof and reach the terrorist carrying the mobile unit without alerting him. The location of the unit is indicated on the map. Any team member may retrieve the signal information from the digital interface next to the unit. A team member with an electronics kit will be able to do this in less time. The hostages are scattered throughout the hospital. Rounding them all up and extricating them may be difficult.

## INTELLIGENCE BRIEFING

The Intel team is just now catching up with our real enemy's maneuvers. It seems he has been one step ahead of us the whole time. We may be able to locate the figure behind the assaults—if we can pull the connection data from one of the mobile communication units the terrorists use to contact him. Our targets will break the connection at the first sign of hostilities, so the team going after the device must be as stealthy as possible. Gunplay will alert the terrorists, and they'll likely sever the link immediately. There are still some medical personnel in the hospital, so watch your step.

The Thai government has expressed a wish that RAINBOW handle this operation, perhaps because there are still repercussions from the 2000 hospital seizure in Ratchaburi. Furthermore, the top of the terrorists' list of demands is that the Thai government turn over a pair of officials implicated in some of the recent violent crackdowns on protesters, and they don't want to get anywhere near that situation.

We have learned from Kautingu Safaniya, the captured leader from the Nigerian mission, that there is, in fact, one man orchestrating all of these terrorist reenactments. Our target supplied Safaniya with arms and cash to perform a very specific task. Safaniya was paid handsomely to capture the peacekeeper convoy and hold the hostages at his camp until further instruction. He was also told to expect RAINBOW intervention. Safaniya also claims that he was told that his people could keep anything they managed to capture, either from the U.N. Peacekeepers or from downed RAINBOW team members. Apparently his employer didn't care about the hostages or the loot; he just wanted to test RAINBOW, and perhaps to expose it.

Safaniya also informed us that the man he was working for communicates with his hired mercenaries prior to every attack through a mobile communications unit. The terrorists deactivate the communicator at the first sign of assault and the connection is lost. The mobile unit will have to be intercepted while still active so that we can trace the signal back to its source.

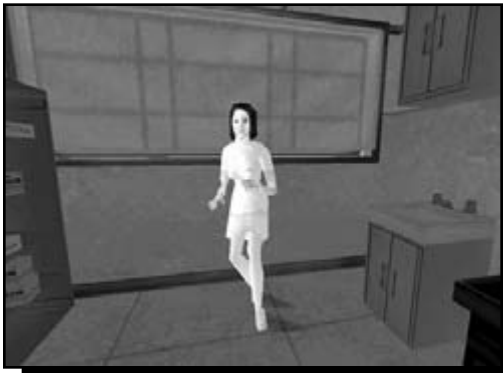

## OBJECTIVES

1. PLANT BUG
2. NEUTRALIZE ALL TERRORISTS

There are hostages spread out on levels 1 and 2. Use caution to avoid harming them while going after the tangos.



Because all of your shooting will be at close range, the P90SD is a great choice. Its

50-round mag allows your teams to clear out an entire floor without having to reload.

# TEAM ASSIGNMENTS

## BLUE TEAM

Operative	Primary	Secondary	Slot 1	Slot 2	Uniform
Chavez	5.7mm P90 SD SMG	0.45cal M23 SD Pistol	Frag Grenade	Primary Mag	Street 1 Medium
Arnavisca	5.7mm P90 SD SMG	0.45cal M23 SD Pistol	Frag Grenade	Primary Mag	Street 1 Medium
Rakuzanka	5.7mm P90 SD SMG	0.45cal M23 SD Pistol	Heartbeat Sensor	Primary Mag	Street 1 Medium

## RED TEAM

Operative	Primary	Secondary	Slot 1	Slot 2	Uniform
Walther	5.7mm P90 SD SMG	0.45cal M23 SD Pistol	Frag Grenade	Primary Mag	Street 1 Medium
Loiselle	5.7mm P90 SD SMG	0.45cal M23 SD Pistol	Frag Grenade	Primary Mag	Street 1 Medium
Raymond	5.7mm P90 SD SMG	0.45cal M23 SD Pistol	Heartbeat Sensor	Primary Mag	Street 1 Medium

## GREEN TEAM

Operative	Primary	Secondary	Slot 1	Slot 2	Uniform
Yacoby	5.7mm P90 SD SMG	0.45cal M23 SD Pistol	Frag Grenade	Primary Mag	Street 1 Medium

## GOLD TEAM

Operative	Primary	Secondary	Slot 1	Slot 2	Uniform
Lofquist	5.7mm P90 SD SMG	0.45cal M23 SD Pistol	Electronics Kit	Primary Mag	Street 1 Medium



Map 10-1. Hospital, Level 1

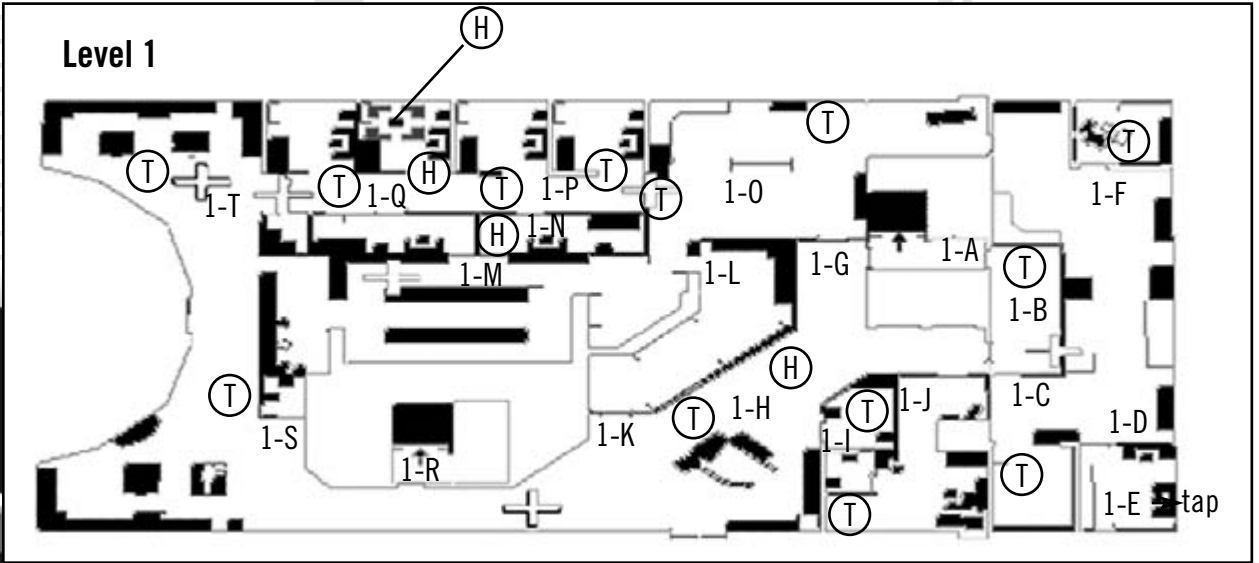

Map 10-2. Hospital, Level 2

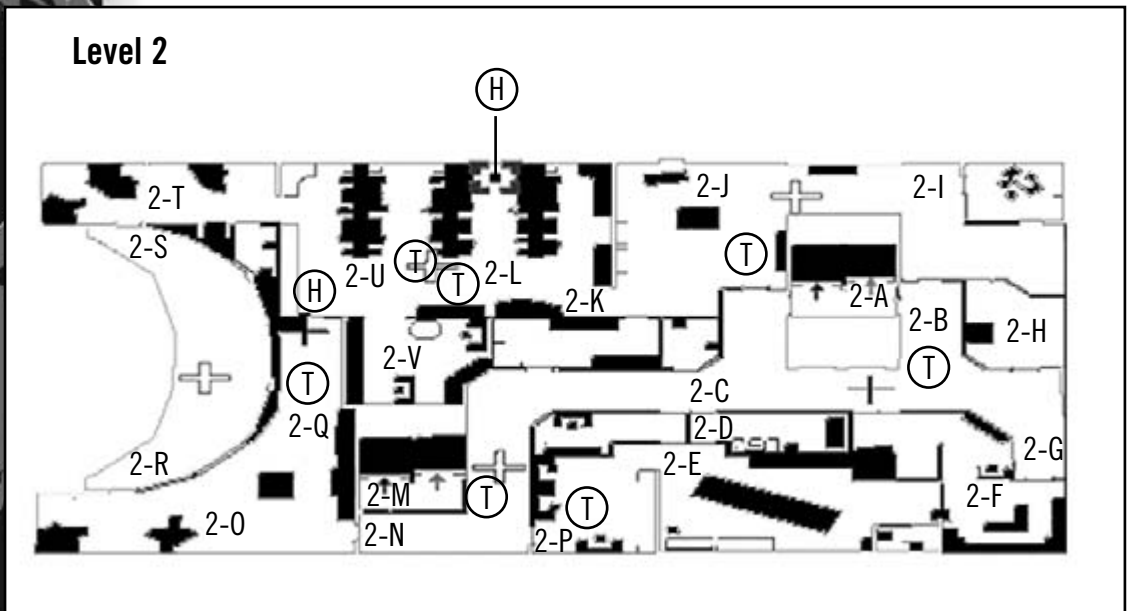

Map 10-3. Hospital, Roof

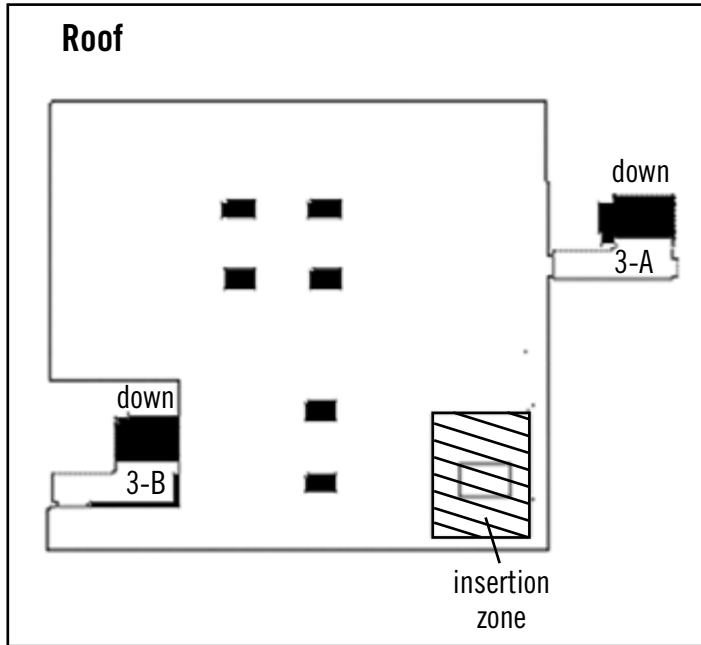

## STRATEGY

This mission combines reconnaissance with hostage rescue. The first part entails getting to the communications terminal and bugging it before the tangos can destroy the link. The communications terminal must be defended for the duration of the mission. The second part of the mission is to neutralize all of the tangos within the hospital. Since several hostages are scattered about, it is not feasible to extract each of them to safety. Instead, your teams must remove the threats.

For this operation, you need two assault teams, an infiltration team, and an electronics team. The infiltration team will clear a path to the communications terminal, then guard it while the electronics team bugs the device. Meanwhile, the assault teams will clear out the tangos.

As with many missions, stealth is vital. As soon as your teams are detected, tangos begin running toward the communications terminal to destroy it. Remember that the tangos guarding the hostages may kill them if they hear gunshots, so keep as quiet as possible.



**TIP** Because many of the tangos patrol rather than stay in one spot, your teams must be constantly alert in case one appears around a corner. Also, watch out for hostages. They are scattered throughout the hospital, and although most are in the same locations each time you play this mission, some will be in different spots.

## BLUE TEAM

Blue Team is the first assault team, and will work with Red Team to clear all tangos from both levels of the hospital. All of the teams begin on the rooftop. When the mission starts, have Blue Team advance to the stairway at 3-A and take it down to 2-A. Hold by this door for code Alpha.



Blue Team encounters their first tango in this mission on the other side of the door.

At Alpha, open the door and move toward 2-B. Take out the tango patrolling this area, then continue on to 2-C. A second tango patrols the area, so be on the lookout. Enter room 2-D, then 2-E to ensure there are no other tangos. Then, move through 2-F, 2-G,

and 2-H to 2-I. Hold here for code Bravo and Cover toward 2-J. Take out the tango in this room before he can alert the others.

While holding at 2-I, watch out for the tango patrolling around the area.

When code Bravo is given, blitz through 2-K and into 2-L. Drop all of the tangos in here, careful not to harm any of the hostages. After it is clear, return to the stairs at 2-A and take them down to 1-A. Hold here for code Charlie.



Blue Team blitzes in to secure the first group of hostages.



After code Charlie is issued, move out into 1-G and on to 1-H. Be alert for tangos in the area as you make your way to 1-K. Crouch and carefully advance toward 1-L. Keep your sights toward 1-M. Peek around the corner of the counter and take out the tango at 1-M. If he sees you, he will run to 1-N and execute the hostage there, so make your shot count. Hold at 1-L for code Delta.

## OPERATION: SPIRIT CLASP



Peek around the corner and drop this tango before he executes a hostage.

At code Delta, blitz to 1-P, then 1-Q, taking out all tangos along the way. Move and shoot fast before they can begin gunning down the hostages here. By the time you get to 1-Q, the mission should be complete.

After this area is clear, the mission is complete.



## RED TEAM

Red Team is the second assault team, assigned to work with Blue Team in clearing the hospital of tangos. Red Team begins at the insertion zone on the roof, then immediately advances to the stairs at 3-B and descends to level 2, holding at 2-M for code Alpha.

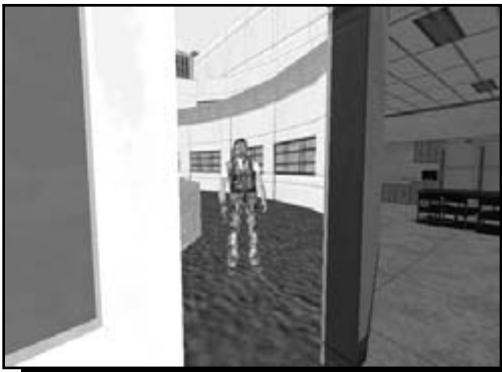

Watch out for the tango in the balcony area.

After receiving Alpha, Red Team moves out to 2-N, checking 2-0 before moving to 2-P. Neutralize all tangos you come across. Return to 2-N and continue toward 2-Q to eliminate the tango by the door before advancing to 2-R. Carefully open the door and take care of any tangos on the balcony. Move to 2-S and hold for code Bravo.



Check this small room adjacent to where the hostages are being held. Often, a tango hides here and you have to come back later to get him.

At Bravo, blitz into 2-T and then on to 2-U, careful not to hit the hostages as you take down the tango guards. Also check 2-V for hostiles before exiting through 2-Q and returning to the stairs at 2-M. Descend to 1-R and hold for code Charlie.

While clearing this lobby, watch out for tangos coming out from small rooms.

When code Charlie is given, advance toward 1-H. Check rooms 1-I and 1-J for tangos before backtracking toward 1-R. Edge around the corner and take out the tango near 1-S, then hold there for code Delta.



Eliminate this tango waiting to ambush you.

After Delta is given, blitz to 1-T, then on to 1-Q, neutralizing all tangos along the way. Blue Team meets you at 1-Q and the mission is a success.

Blitz in to secure the final group of hostages.



## GREEN TEAM

Green Team is the infiltration team, assigned to clear a path to the room where the communications terminal is located. Green Team begins on the roof, then heads to the stairway at 3-A. Descend the stairs to the bottom and hold at 1-A for code Alpha.



Green Team takes out the tango guarding the room next to the stairway.

When code Alpha is issued, blitz through 1-B, dropping the tango in this room, then out to 1-C. By this time, another tango is running to destroy the communications terminal. Eliminate him, then advance to 1-D. Hold here for code Alpha and assume a Cover posture. Aim toward 1-F and take out the tango in the room near that point.

Drop this tango before he destroys the communications terminal.

Green Team remains at 1-D for the rest of the mission. Other tangos may run down here to destroy the communications terminal, so Green Team must stand guard.



Green Team covers the hallway until the end of the mission.



Both Green and Gold teams contain only one operative each. By limiting them to one operative, they can move faster and not worry about stacking problems going through doorways. Also, instead of combining the two operatives into one team, one operative can guard while the other bugs the communications device.

## GOLD TEAM

Gold Team is the electronics team. Its job is to get to the communications terminal and plant a bug on it so Intel can try to track down the main terrorist leadership.

Gold Team begins on the roof with the rest of the teams. Immediately head to the stairway at 3-A and descend all the way to level 1. Hold for code Alpha at 1-A.



Gold Team plants the bug on the communications terminal.

When code Alpha is given, follow Green Team through 1-B and 1-C to room 1-E. Walk to the communications terminal and plant a bug. Do not touch the console on the wall—this will destroy the communications terminal and end the mission. Once your

teams have planted the bug, return to the doorway and hold for code Alpha. Aim toward 1-C while Covering. Remain in this position until the mission is complete.



Green and Gold teams guard the room with the communications terminal. Every now and then, they report that they have a tango headed their way.

## NOTES

This mission can be tough. However, with careful planning, you can get through it successfully without any of your operatives being wounded or killed.



While walking around the hospital, occasionally change the team's ROE to Recon. The rear teammate pulls out a heartbeat sensor and give you

a heads-up about any tangos that might be hiding in rooms nearby.

## OPERATION: SPIRIT CLASP

Although you might be tempted to take control of Green or Gold teams during the initial, critical part of the mission, the AI can control them well as they bug the communications terminal guard it against the tangos. You do better by taking control of Blue Team.

Lead Blue Team down the stairs to level 2. After all four teams are ready and holding, give code Alpha. This sends Green and Gold teams on their way, and orders Blue and Red to begin clearing level 2. Follow the waypoints for Blue Team listed above, then hold at 2-I. Wait for Red Team to get into position, then give code Bravo. Blitz into the room with the hostages and take out all of the tangos. When it is clear, return to the stairs and descend to level 1.

Hold by the door until Red Team is in position at the other stairway. When both teams are ready, give code Charlie and advance to the center of the floor at 1-K. Crouch and enter the office area. Switch to Recon ROE to your teammate pulls out the heartbeat sensor as you slowly head toward 1-L. Locate the tango at 1-M. Wait until he is walking away from you, then peek around the counter and drop him. He is the most trigger-happy of the bunch, so take him out early.

Hold by the counter and switch back to Assault ROE. When Red Team is in position at 1-S, give code Delta and blitz into room 1-P, where more hostages are being held. Neutralize the tangos quickly before they harm the hostages. When this area is clear, the mission should end. If it does not, there are still tangos remaining in the building. Switch Blue Team's ROE back to Recon, and begin walking around level 1, trying to locate any remaining tangos. After you check level 1, go back up to level 2 and repeat the process until the mission ends.



PRIMAGAMES.COM



# OPERATION: GOLDEN SONG

## MISSION ORDERS

07.30.04 0535  
ENSHEDE, NETHERLANDS

Terrorists have seized a Dutch High Speed Train (HST), taking its passengers as hostages. The train is currently halted in a small station near the German border, and the local authorities are trying to negotiate with the hostage-takers, who have refused all attempts so far. Your mission is to free the hostages and escort them to safety.

The train is stopped at the station, surrounded by terrorists either standing guard or working to restore power to the train. The hostages are being kept on the top floor of both two-story wagons. Your first priority is to clear the way so you can easily extract the hostages. Once it is done, get the hostages out. Synchronize your attack on both primary wagons for a better chance of success.

## INTELLIGENCE BRIEFING

Our opposite number is at it again. He's not as smart as he thinks he is, though. We were monitoring his communications, so we already had the team in place when they made their demand for RAINBOW. We can be sure they weren't expecting us to respond so quickly, and we'll use this to our advantage. We have already pinned them by cutting power to the rail line.

As I noted previously, the terrorists are demanding that RAINBOW and only RAINBOW be dispatched to the scene. Fortunately, this demand was made only through channels, which is a win for us. The world at large simply knows about their ransom demands. The Dutch government has therefore requested us, and it behooves us to move quickly before the terrorists decide to share the news of RAINBOW's existence with a wider audience.

Just to make sure we know they're serious, they've already shot the engineer. No one else has been hurt so far, but the clock is ticking.

They have people stationed inside the station, as well as in and around the train. Getting on board without being noticed is going to be difficult, but there's no other way to do this. If they find out you're there, they won't hesitate to execute hostages and we're going to have a lot of explaining to do.

Let me reiterate this: These guys are extremely professional. They clean up after themselves, they don't leave clues, and we don't have a handle on why they're taking this approach. It can't be for the money. With the firepower and expertise they've got, they could have picked easier ways to cash in. What we do know is that these people are pros, they're experienced, and they're good. If I had to hazard a guess, I'd say they're mercenaries hired to play terrorist. I can't think of another scenario that makes sense.



Each hostage is guarded  
by three tangos.

**OBJECTIVE**  
1. RESCUE ALL HOSTAGES

## TEAM ASSIGNMENTS

### BLUE TEAM

Operative	Primary	Secondary	Slot 1	Slot 2	Uniform
Chavez	0.45cal SD UMP SMG	0.45cal M23 SD Pistol	Frag Grenade	Flashbang	Street 2 Medium
Arnavisca	0.45cal SD UMP SMG	0.45cal M23 SD Pistol	Heartbeat Sensor	Flashbang	Street 2 Medium
Rakuzanka	0.45cal SD UMP SMG	0.45cal M23 SD Pistol	Frag Grenade	Flashbang	Street 2 Medium

### RED TEAM

Operative	Primary	Secondary	Slot 1	Slot 2	Uniform
Price	0.45cal SD UMP SMG	0.45cal M23 SD Pistol	Frag Grenade	Flashbang	Street 2 Medium
Loiselle	0.45cal SD UMP SMG	0.45cal M23 SD Pistol	Heartbeat Sensor	Flashbang	Street 2 Medium
Raymond	0.45cal SD UMP SMG	0.45cal M23 SD Pistol	Frag Grenade	Flashbang	Street 2 Medium

### GREEN TEAM

Operative	Primary	Secondary	Slot 1	Slot 2	Uniform
Johnston	7.62 SSG3000 SR	0.45cal M23 SD Pistol	Primary Mag	Flashbang	Street 2 Light

### GOLD TEAM

Operative	Primary	Secondary	Slot 1	Slot 2	Uniform
Galanos	7.62 SSG3000 SR	0.45cal M23 SD Pistol	Primary Mag	Flashbang	Street 2 Light



Map 11-3. The Train Station, Second Level

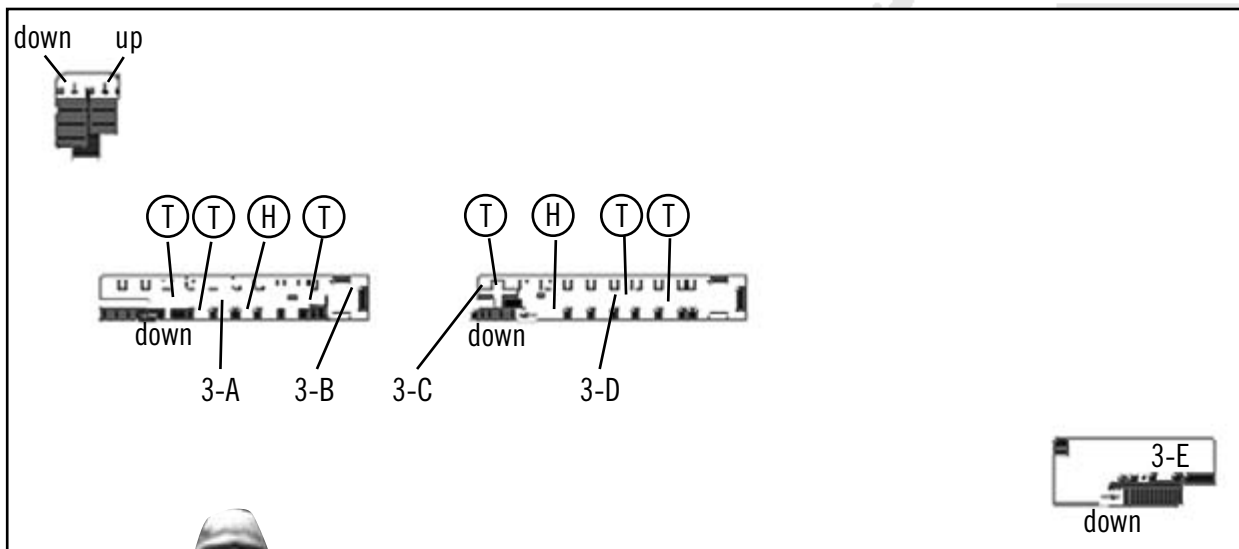

Map 11-4. The Train Station, Third Level

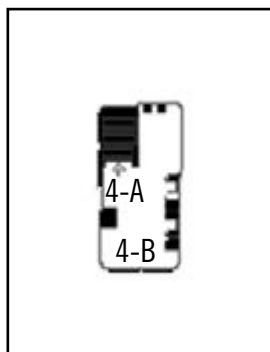

# STRATEGY

This mission is not too difficult, because most of the tangos are spread out and can be taken down one at a time. The hardest part of this mission is the timing for the final assault. All four teams must carefully coordinate their movements so the hostages can be secured before the tangos have a chance to kill them.

For this mission, you will use two assault teams and two sniper teams. The first part of the mission entails getting your teams into position for the final assault. After all of them are ready, the two assault teams rush up to the second floor of the rail cars while the snipers assist by taking out some of the tangos guarding the hostages, giving the assault teams a bit of an advantage. Timing is critical. The assault teams have to move at the same time the snipers begin firing.

## BLUE TEAM

Blue Team is one of the two assault teams, assigned to clear out the train station and assist in the main assault to secure the hostages. They should begin the mission at Insertion Zone 1 in the sublevel of the train station.



Take out this tango as you open the door.

At the start of the mission, advance out the door near 1-A and into room 1-C. Continue to room 1-D and take out the tango inside as soon as you open the door, then move to 1-E. Open the door and take out the tango patrolling 1-F as he walks by.

Drop this tango as he walks by.

With the sublevel clear, move to the stairs at 1-G. Climb them slowly and take out the tango at the top near 2-A. Turn left and slowly strafe to the right. There are two more tangos walking around in the lobby of the train station, near 2-B and 2-C. Drop them and a third tango behind the counter with his back to you. Hold at 2-A for code Alpha.



## OPERATION: GOLDEN SONG



Watch out for this tango  
at the top of the stairs.

Neutralize the other three tangos  
one at a time as they come into  
your sights. Slowly strafe to the  
right as needed.

When Alpha is issued, change your ROE to Recon and advance to the doors by 2-C. Open the door and exit the train station. Quickly open the door to the end rail car at 2-P and enter. Continue to 2-Q and hold for Charlie.



Your ROE must be set to Recon as Blue Team leaves the station for the rail car. If not, your teammates may fire at the tango with his back to the window, which prompts the other tangos to kill the hostages. The mission will end in failure.

Be careful not to hit the  
hostage as you blitz up the  
stairs to the upper level of  
the rail car. Watch out for the  
tango hiding behind a seat.

At code Charlie, blitz up the stairs to 3-A, taking out the two remaining tangos there. Hold here for code Delta, then escort the hostage down the stairs and out of the rail car. Take the hostage to the extraction zone to complete the mission.

## RED TEAM

Red Team is the second assault team. Their job is to clear the area alongside the rail cars and take out any tangos patrolling inside them, then help in the main assault. Red Team should begin at Insertion Zone 2.



Red Team covers near the rail car.

When the mission begins, send Red Team to 2-E and hold there for code Alpha. Assume a Cover posture with your operatives aimed toward 2-H. Take out any tangos that come into your sights.

Patrolling tangos exit the rail cars every now and then. Drop them as they appear.



When going through the rail cars, some of the doors are locked and cannot be opened. Those with green handles can be opened, and those with red handles cannot.

Take out the tango near the small building and any others on the other side of the train from where you began.

At Alpha, open the door to the nearby rail car and continue to 2-F. Move through the car to 2-G by the other door. Open it and advance toward 2-M. Neutralize any tangos along the way, watching especially for the one near 2-J. When you get to 2-M, hold for code Bravo.



## OPERATION: GOLDEN SONG

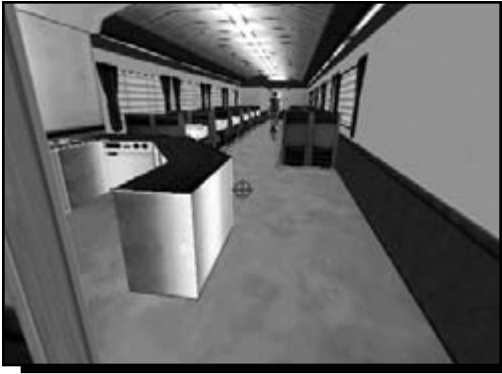

Wait until this tango is walking away, then strafe around the corner to eliminate him.

Red Team secures the second hostages.

After code Bravo, enter the rail car. Turn left and strafe to the right around the wall to take out the tango patrolling inside the rail car. Advance to 2-0 and hold for code Charlie. When you receive Charlie, blitz up the stairs to take out the two remaining tangos on the upper level before they kill the hostage. Hold at 3-D for code Delta.



At Delta, escort the hostage down the stairs and out of the rail car. Take her all the way to the extraction zone to complete the mission.

## GREEN TEAM

Green Team is the sniper team that assists Red Team during the final assault. This team should begin with Blue Team at Insertion Zone 1.



Stand along the right side of the window.

After the mission starts, remain at the insertion zone for code Alpha. When it is given, advance through the door at 2-B and up the stairs at 2-G. Continue up the stairs all the way to 4-A. Then walk to 4-B, stand



to the right side of the window, and hold for code Delta. Assume a Snipe posture. Aim your sights toward 3-C and put the tango next to the window of the rail car in your sights. When the Sniper Release order is given, fire!



Keep this tango in your sights until you are ordered to fire.

At code Delta, return to the main level of the train station. Exit through the doors at 2-B and advance to the extraction zone.

## GOLD TEAM

Gold Team is the sniper team assigned to work with Blue Team during the final assault. It should begin the mission at Insertion Zone 2 with Red Team.

Gold Team covers at the end of the train.

When the mission begins, advance to 2-D and hold for code Bravo. Assume a Cover position, and aim your weapon toward 2-F. Eliminate any tangos that come into view.

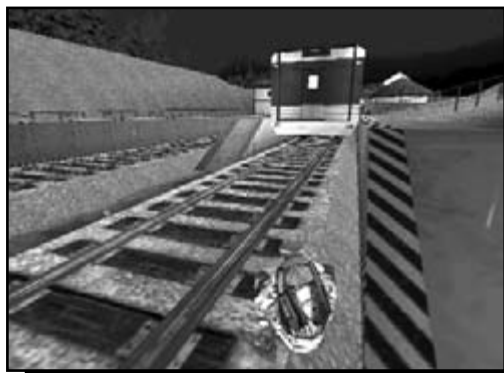

Position Gold Team on the right side of the window.



Make sure your sniper has a good view of the tango and is ready to shoot before you begin the main assault to secure the hostages.

At Bravo, head toward the small building at 2-J. Climb the stairs at 2-K and hold at 3-E for code Delta. Assume a Snipe posture here. Aim your sights at 3-B and target the tango next to the window. When the Sniper Release order is given, fire!

After the hostages are secure and code Delta is given, head back down the stairs and to the extraction zone.

## NOTES

Although the final assault is very tricky, the rest of this mission is not too bad. Take control of Blue Team at the start. If you switch your ROE to Recon, one of your teammates will pull out a heartbeat sensor so nearby tangos appear on your mini map. After you have taken out both tangos on the sublevel, get ready to clear out the train station. Switch your ROE back to Assault so your teammates help out.

Once the train station is clear of all tangos, take control of Red Team. By this time, Red Team should have already taken out at least one, maybe two, tangos from their covering position. Give code Alpha, then lead Red Team through the first rail car to the door at the opposite end. Hopefully Gold Team has taken out another tango or two by now. Before opening the door, switch your ROE to Recon and look around on the Map view. There are four tangos to look for. See how many are already down, and if any live ones are near your door.

Open the door and take out any remaining tangos. Keep an eye on the mini map to see if any tangos are still patrolling the interiors of the rail cars as you advance. When you get to 2-M, give code Bravo to send Gold Team into position for the main assault. Enter the rail car and take out the tango there.



The timing for the main assault can be tricky. If you lose a hostage, make small adjustments to your plan until you get it right. You might also want to let the computer control the assault teams while you take control of a sniper. Even better, go to Watch mode and give code Delta and the Sniper Release order; your operatives will do the rest.

Now switch back to Gold and Green teams to make sure they are aimed at the right spot. Then take control of Blue Team. Once all teams are in position, give code Charlie, the Sniper Release order, and blitz up the stairs to take out the tangos guarding the hostage. If the timing is right, you'll succeed. However, if it is off just a bit, one of the hostages may be killed.

After both hostages are secure, give code Delta to send all four teams and the hostages to the extraction zone.

# OPERATION: BLUNT SCROLL

## MISSION ORDERS

08.03.04 2320  
CAPE TOWN, SOUTH AFRICA

Terrorists have seized control of a bus station outside of Cape Town, South Africa. After arriving in a series of vans, the mercenaries stormed the bus terminal and took a group of parks and conservation officers as hostages. Your mission is to rescue the hostages and escort them back to the extraction zone.

Teams will be inserted on both sides of the terminal. Clear those areas before going for the hostages. Once the area has been cleared, you must rescue the hostages being held in the main terminal. Escort them back to the main entrance as quickly as possible.

## INTELLIGENCE BRIEFING

It seems we may have discovered who our mastermind is. A news helicopter surveying the operations in the Netherlands spotted someone in a nearby abandoned building observing the scene. We were able to identify him from stills taken from the news footage. His name is David Newcastle, and he's a former member of the top UK counter-terrorism unit. He cashiered following an incident in 1998 in which he tortured and killed captured terrorists, and interestingly enough, at one point he wanted to join RAINBOW. Intel's looking at his dossier right now.

Newcastle must have figured out we were monitoring his communications and changed his system. That means we're in the dark again. We never saw this one coming. The mercenary team that has taken control of the terminal is extremely well armed. They have body armor, and they've got sentries placed at all access points to keep anyone from getting close.

David Newcastle was an assault specialist for the National Crime Squad when he was recruited by the SAS. He is a real professional and was one of the best soldiers in his unit. From the file we retrieved, he knew about RAINBOW's existence and wanted badly to become a RAINBOW team member. After a hostage rescue mission in Gibraltar resulted in the capture of three terrorists, Newcastle proceeded with their interrogation solo. Afterwards, two of the terrorists needed emergency hospital care for everything from broken bones to severe lacerations. The third was already dead due to blunt trauma to the head; an autopsy revealed multiple broken ribs, a collapsed lung and several suspicious-looking burns. A subsequent psychological exam on Newcastle revealed aggressive tendencies bordering on psychosis, and he was relieved of duty. Shortly thereafter we lost track of him, and didn't see him again until the Netherlands ops. He's had intense counter-terrorism training and is now using it against RAINBOW.

## OPERATION: BLUNT SCROLL

We do have a present from our friends in Psych: a profile on Newcastle. From his actions, they've concluded that he's bitter about not having been selected for RAINBOW, and he's intent on seeking revenge for his perceived humiliation. He's not a copycat in the strict sense. Rather, he's trying to eliminate feelings of inadequacy by taking what he's learned—operations and tactics he studied—and putting it to use. This, he thinks, will show conclusively that he is good enough. It sounds a bit odd to me, but it fits his style, and as such, you might want to keep it in mind.

**OBJECTIVE**  
1. RESCUE ALL HOSTAGES



Securing these two hostages located in the large open area is the toughest part of your assignment.

## TEAM ASSIGNMENTS

### BLUE TEAM

Operative	Primary	Secondary	Slot 1	Slot 2	Uniform
Price	9mm MP5 SD SMG	0.45cal M23 SD Pistol	Flashbang	Heartbeat Sensor	Street 1 Medium
Murad	9mm MP5 SD SMG	0.45cal M23 SD Pistol	Flashbang	Heartbeat Sensor	Street 1 Medium

### RED TEAM

Operative	Primary	Secondary	Slot 1	Slot 2	Uniform
Bogart	9mm MP5 SD SMG	0.45cal M23 SD Pistol	Flashbang	Heartbeat Sensor	Street 1 Medium
Burke	9mm MP5 SD SMG	0.45cal M23 SD Pistol	Flashbang	Heartbeat Sensor	Street 1 Medium

### GREEN TEAM

Operative	Primary	Secondary	Slot 1	Slot 2	Uniform
Chavez	9mm MP5 SD SMG	0.45cal M23 SD Pistol	Flashbang	Heartbeat Sensor	Street 1 Medium
Arnavisca	9mm MP5 SD SMG	0.45cal M23 SD Pistol	Flashbang	Heartbeat Sensor	Street 1 Medium

### GOLD TEAM

Operative	Primary	Secondary	Slot 1	Slot 2	Uniform
Johnston	7.62mm AW Covert SR	0.45cal M23 SD Pistol	Primary Mag	Heartbeat Sensor	Street 1 Medium
Galanos	7.62mm AW Covert SR	0.45cal M23 SD Pistol	Primary Mag	Heartbeat Sensor	Street 1 Medium

Map 12-1. Level 1, Bus Station

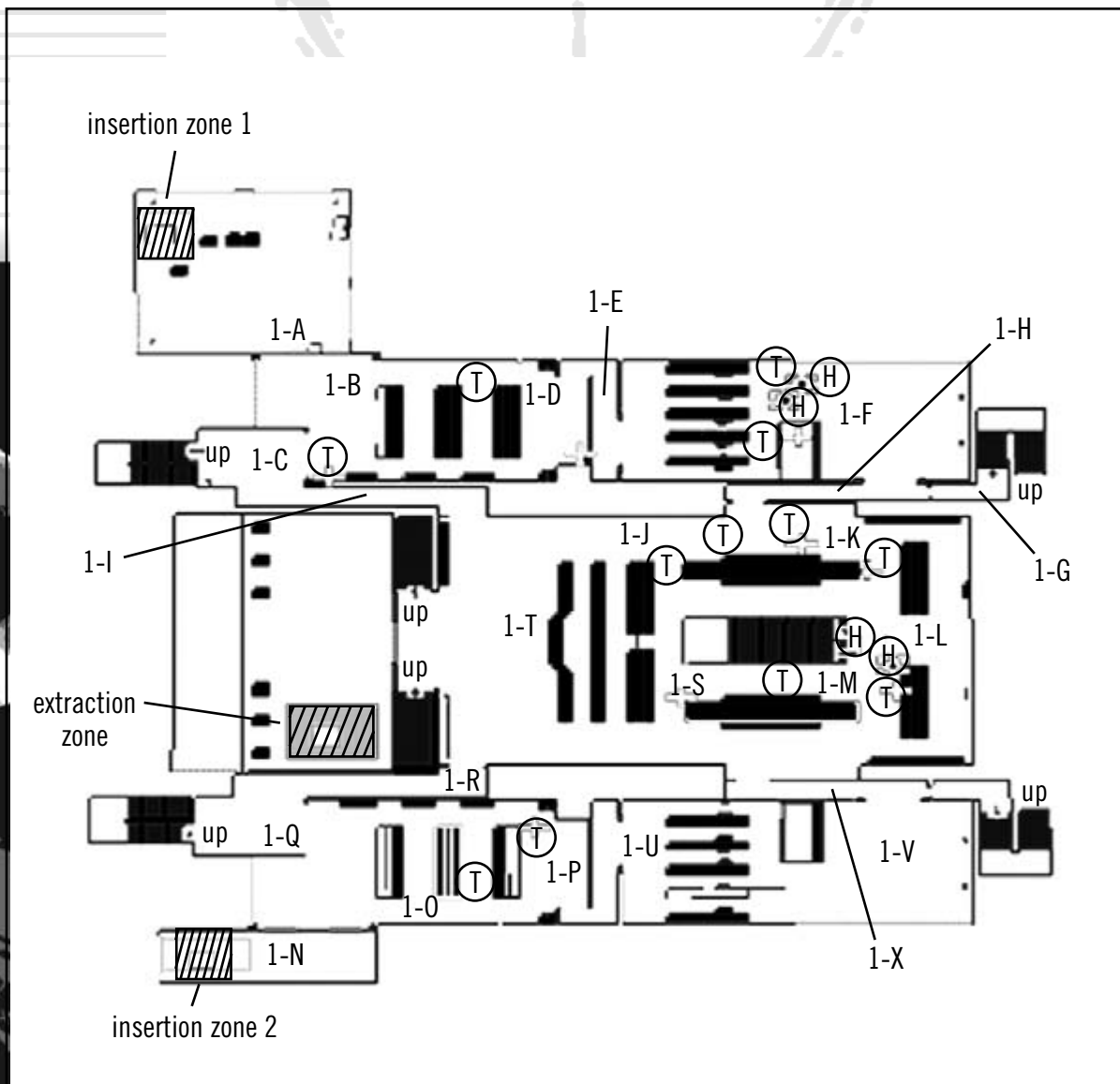

Map 12-2. Level 2, Bus Station

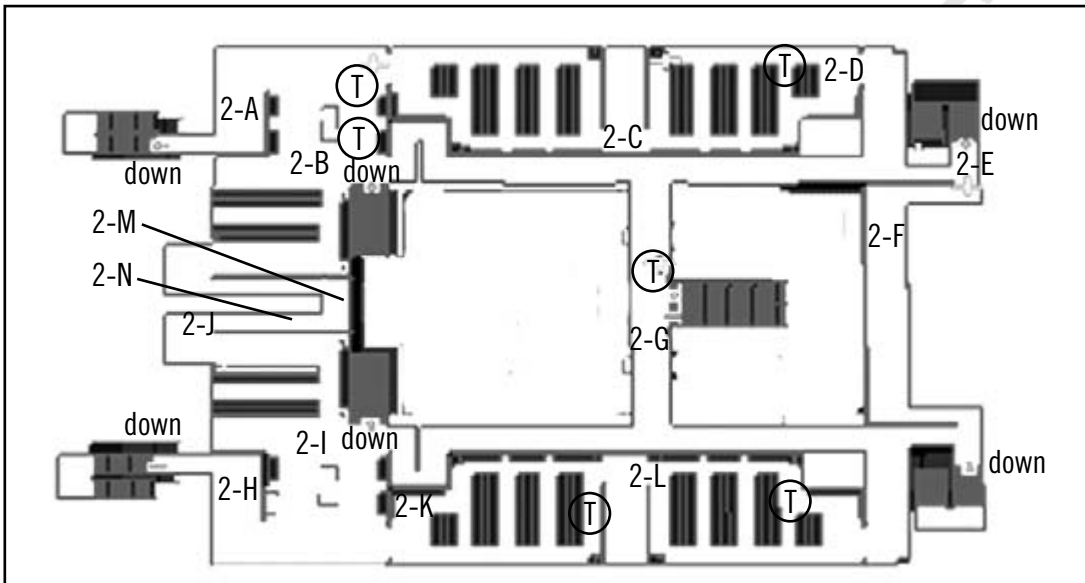

## STRATEGY

This mission is difficult, and even with perfect planning, you may have to execute it more than once to get through without any casualties. The hostages are in two different areas on level 1. The two hostages off to one side of the terminal are not too hard to secure, but the two in the main concourse are another story. There are eight tangos nearby who will execute the hostages as soon as shooting begins in the concourse.

For this mission, you need three assault teams and a sniper team. Two assault teams start on one side of the bus station and clear out the ground floor while securing the first set of hostages. The sniper team and the third assault team start on the other side of the bus station, clear the ground floor, then set up for the main assault on the concourse. The key to this assault is coordination. You need all three assault teams to blitz the concourse at the exact same time the sniper begins picking off tangos next to the hostages.

Because you must be concerned for the safety of the hostages, stealth is extremely important. Use only silenced weapons, and neutralize tangos before they can shoot. Also, use caution when your teams are near the concourse area. If the tangos there see any of your operatives, they immediately begin killing hostages.



You may have to make minor changes to your planning if you cannot get the mission to go just right. Don't worry—this one takes a lot of fine-tuning. Also, order your teams to blitz into the concourse area so that they move quickly.

## BLUE TEAM

Blue Team is the assault team assigned to enter the bus station with the sniper team. They must clear one side of the airport before setting up for the main assault.



Blue Team enters the bus station and begins clearing out tangers.

Begin at Insertion Zone 2 and immediately move to the doors at 1-N, then hold for code Alpha. Cover with your sights aimed towards 1-P. At Alpha, blitz through the doors into 1-0 and take out both tangers in this room as you move through 1-P to 1-U, then on to 1-V. Continue to point 1-X and hold for code Bravo.

Blue Team holds in preparation for the main assault.



If the tango on the upper walkway is still alive, drop him on your way to the hostages.

## OPERATION: BLUNT SCROLL

When code Bravo is issued, blitz out into the concourse and head toward 1-M, near the two hostages, and hold here for code Charlie. Maintain a Defend posture to protect the hostages while the other teams complete their assignments. After code Charlie is given, escort the hostages to the extraction zone.

Blue Team reaches the hostages before they are executed.



## RED TEAM

Red Team is one of the assault teams assigned to clear out the opposite side of the bus station, secure the hostages in the side terminal, then take part in the main assault. Red Team begins at Insertion Zone 1. At the start of the mission, move to the doors at 1-A and hold for code Alpha.



Red Team enters the bus station.

At Alpha, blitz through the doors into 1-B and take out the tangos in this room. Next, head to 1-L and hold there for code Bravo.





Red Team blitzes toward the hostages in the concourse area.

At code Bravo, blitz toward 1-J and then 1-K, dropping all of the tangos before they harm the hostages. Hold there for code Charlie and maintain a Cover posture, with your sights aimed towards 2-M. At Charlie, head toward the extraction zone.

## GREEN TEAM

Green Team is the assault team assigned to assist Red Team in clearing out half of the bus station. Start at Insertion Zone 1. When the mission begins, move to the doors at 1-A and hold for code Alpha. Wait in front of one of the doors while Red Team waits in front of the other.



Green Team helps clear out the room near their entry.

At code Alpha, blitz into 1-B, then toward 1-D, neutralizing any tangos along the way. With the room clear, advance to 1-E and blitz into 1-F and take out the tangos guarding the hostages. When the hostages are secure, leave them here and continue to 1-H. Hold here for code Bravo, just out of sight from the tangos in the concourse.

Green Team secures the first group of hostages.



## OPERATION: BLUNT SCROLL



Green Team blitzes into the concourse area.

At code Charlie, blitz into the concourse toward 1-K and on to 1-L, taking out as many tangos as you can while moving toward the hostages. Then return through 1-H to the hostages at 1-F and hold for code Charlie. Assume a Defend posture while waiting. Finally, when code Charlie is

given, escort the hostages out through 1-H to the extraction zone.

## GOLD TEAM

Gold Team is the sniper team. If everything goes according to plan, their assignment is fairly easy, but vital. Gold Team starts off at Insertion Zone 2. Hold here for code Alpha.

Gold Team enters the bus station and heads up to level 2.

At code Alpha, follow Blue Team into the bus station at 1-N. Advance up the stairs near 1-Q to level 2. Continue through 2-H and 2-I to 2-J. Hold here for code Bravo. Assume a Snipe posture with the target set at point 2-G, where a tango is patrolling the upper walkway.



Gold Team settles into position.

When the Sniper Release order is issued, take out both tangos and any other targets of opportunity. Shoot quickly and accurately to neutralize the tangos before they harm the hostages, all the while being careful not to hit the hostages.



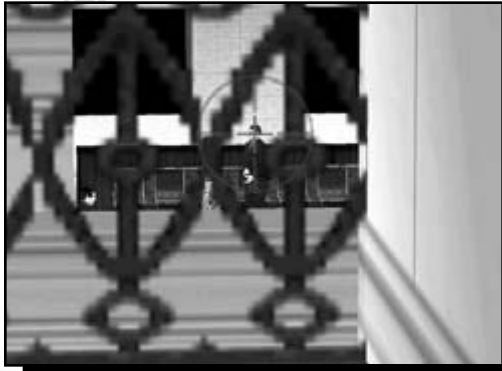

Target this tango first...

... then the tango  
right next to him.

### CAUTION

Certain tangos start executing hostages as soon as your teams are detected. The tango with the lighter hair standing next to the hostages has an itchy trigger finger. Take him out first.



At code Bravo, move forward to 2-N and hold for Code Charlie. Cover with your sights aimed at 2-J. Then at code Charlie, move to the stairs by 2-I and take them down to the concourse. Continue on to the extraction zone.

## NOTES

As mentioned earlier, this mission can be quite tough. Don't worry if it takes you more than once to get through it successfully. The tangos guarding the hostages in the concourse area have itchy trigger fingers, and everything has to come together just right to neutralize them before they execute the hostages.

Control Gold Team for the entire mission. The game's AI can control each of the three assault teams, but getting the sniper into just the right position without being spotted requires a human touch.

When the mission begins, wait until all three assault teams are ready near their doors and Blue team has neutralized both tangos in 1-0, then give code Alpha. This sends all four teams into the bus station, where they begin clearing the ground floor wings of the terminals. Lead Gold Team up the stairs to level 2.

## OPERATION: BLUNT SCROLL

As you approach 2-J, switch to your pistol and crouch. Carefully advance until you see the heads of the tangos at 1-M. You must switch to your sniper rifle to check the view, then back to the pistol to move while you're crouched. You need to target two tangos. Make sure both are visible on the screen at the same time so you can take them out in quick succession. Center your sights on the one with the lighter hair; he will start shooting hostages first.

With the tango in your sights, wait until the three assault teams are holding for code Bravo. Then give code Bravo, followed by the Sniper Release order when the tangos on the ground begin to respond. Quickly take out the first two tangos, then any others that come into your sights. Quickly get ready for tangos to come at you from 2-J as well as 2-M. Red Team should take out those by 2-M, but you will have to cover 2-J.

When all the shooting stops and the concourse is clear of tangos, give code Delta to send everyone to the extraction zone to complete the mission.



PR1MAGAMES.COM

# OPERATION: BROKEN SCEPTRE

## MISSION ORDERS

08.11.04  
MILAN, ITALY

1105

After arriving in Milan, Italy for a conference, the United Nations' Secretary-General, Lord Nigel Cameron, was taken hostage by operatives believed to be working with Newcastle. Cameron was captured in the small hotel where he was staying just prior to leaving for the conference, and is being held there along with some of his personal staff. Your mission is to rescue the UN Secretary-General and the other hostages.

Teams will be inserted from both sides of the hotel, so that the two buildings can be taken simultaneously. The hotel employees are being kept on the third floor in the primary building, while the Secretary-General has been taken to the second floor of the secondary building. Presumably, he is well guarded. Watch for guards patrolling the corridors and especially for gunfire between the two buildings.

## INTELLIGENCE BRIEFING

Newcastle is getting desperate. An operation like this is extremely risky, and four Italian police officers have already been shot. This has the local government howling for blood. We're going to have to move fast before someone decides to take matters into their own hands. The only reason the Italians haven't already made an assault is that the UN is holding them back. The Italians did a nice job of extracting Brig. Gen. Dozier from that apartment building in Padua a few years back, but this situation is a lot touchier, especially with the local casualties and the reduced operating space we've got.

Make sure the Secretary-General survives without injury. He has been the key factor in the current round of talks between the United States and China, and losing him would be a major setback. You don't need to be reminded how fragile those talks are. The bad news is that Newcastle himself doesn't seem to be on the premises, but odds are that he sent some of his very best people to handle this. Getting Cameron out past them would be a slap in the face to Newcastle.

Further research on Newcastle's activities has come up with a fairly accurate picture of what he's been up to since washing out of the SAS. He's been working as a mercenary, taking contracts from around the globe. The bulk of his work has been in the Middle East, but he's taken work from all comers. Our best guess is that he's been using the work to bankroll his attempts to stockpile weapons and resources in order to take revenge on Rainbow. Now, it seems, he feels like he's in a position to stop preparing and to act instead. I don't need to tell you how high the stakes are now. A blunder on this one and Rainbow could be exposed, discredited and disbanded—and that's exactly what Newcastle wants. He's forcing us into these high-profile situations, and it's not a tenable place for us to be. If we don't catch Newcastle soon, the odds just might catch up to us.

## OPERATION: BROKEN SCEPTRE

As for UN Secretary-General Lord Cameron, he's been mediating the current round of conflicts between the American and mainland Chinese governments, trying to maintain peaceful relations. His efforts have kept a bad situation from getting worse, and without him, we might well be headed for another Cold War.

### OBJECTIVE

1. RESCUE ALL HOSTAGES

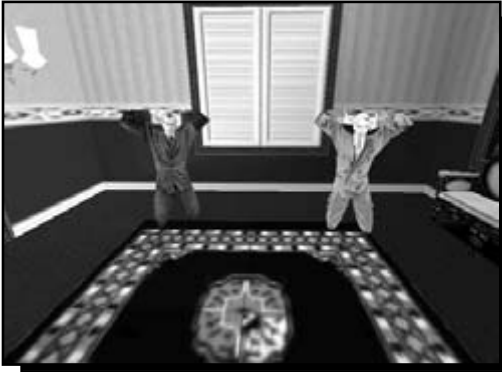

You must rescue four hostages. Three are in the main building, and the Secretary-General is in the second building.

## TEAM ASSIGNMENTS

### BLUE TEAM

Operative	Primary	Secondary	Slot 1	Slot 2	Uniform
Chavez	10mm MP5 SD10 SMG	0.45cal M23 SD Pistol	Flashbang	Frag Grenade	Blue Medium
Yacoby	10mm MP5 SD10 SMG	0.45cal M23 SD Pistol	Heartbeat Sensor	Primary Mag	Blue Medium

### RED TEAM

Operative	Primary	Secondary	Slot 1	Slot 2	Uniform
Walther	10mm MP5 SD10 SMG	0.45cal M23 SD Pistol	Flashbang	Frag Grenade	Blue Medium
Loiselle	10mm MP5 SD10 SMG	0.45cal M23 SD Pistol	Heartbeat Sensor	Primary Mag	Blue Medium

### GREEN TEAM

Operative	Primary	Secondary	Slot 1	Slot 2	Uniform
Price	10mm MP5 SD10 SMG	0.45cal M23 SD Pistol	Flashbang	Frag Grenade	Blue Medium
Arnavisca	10mm MP5 SD10 SMG	0.45cal M23 SD Pistol	Heartbeat Sensor	Primary Mag	Blue Medium

### GOLD TEAM

Operative	Primary	Secondary	Slot 1	Slot 2	Uniform
Novikov	10mm MP5 SD10 SMG	0.45cal M23 SD Pistol	Flashbang	Frag Grenade	Blue Medium
Raymond	10mm MP5 SD10 SMG	0.45cal M23 SD Pistol	Heartbeat Sensor	Primary Mag	Blue Medium

Map 13-1. Level 1, Hotel

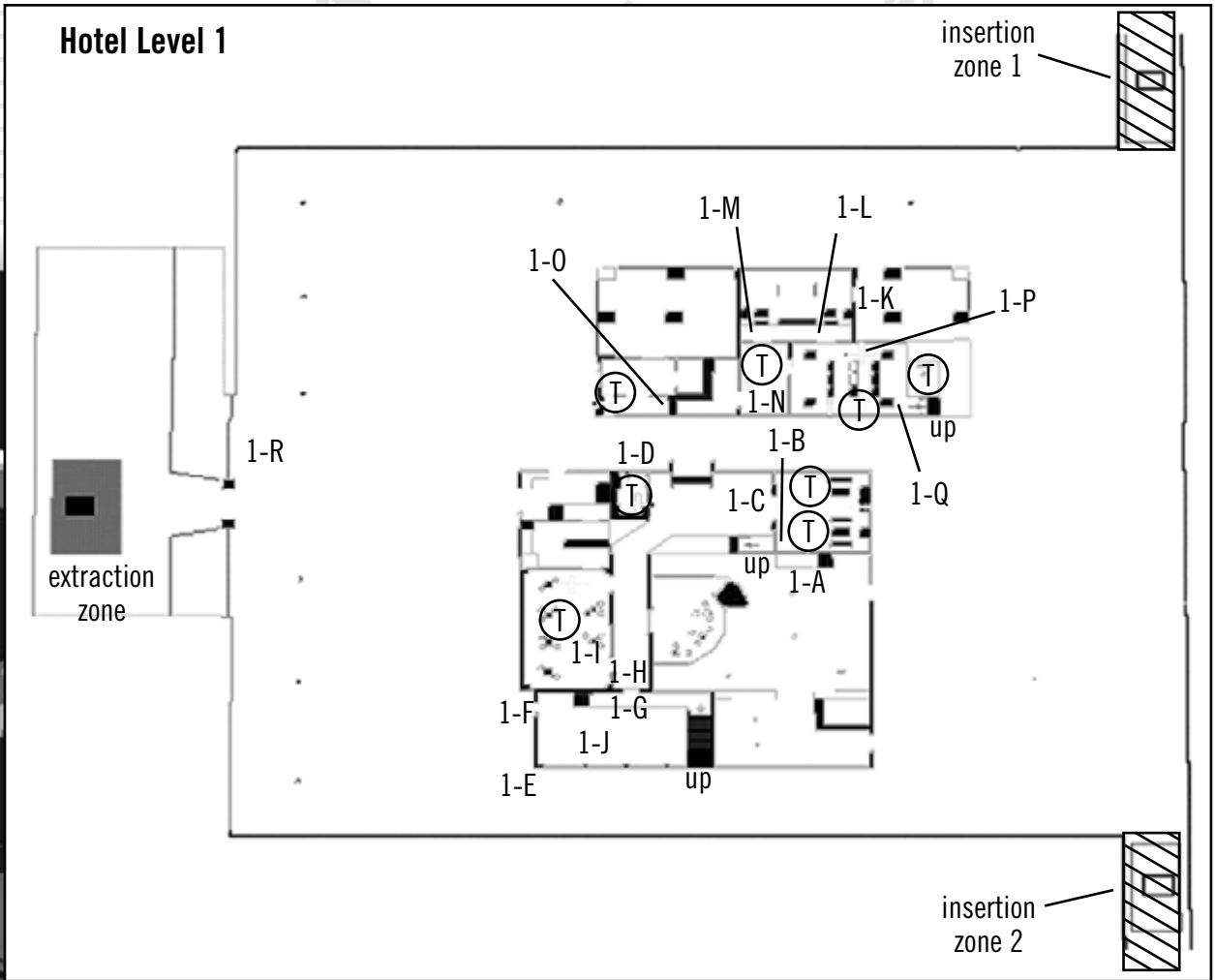

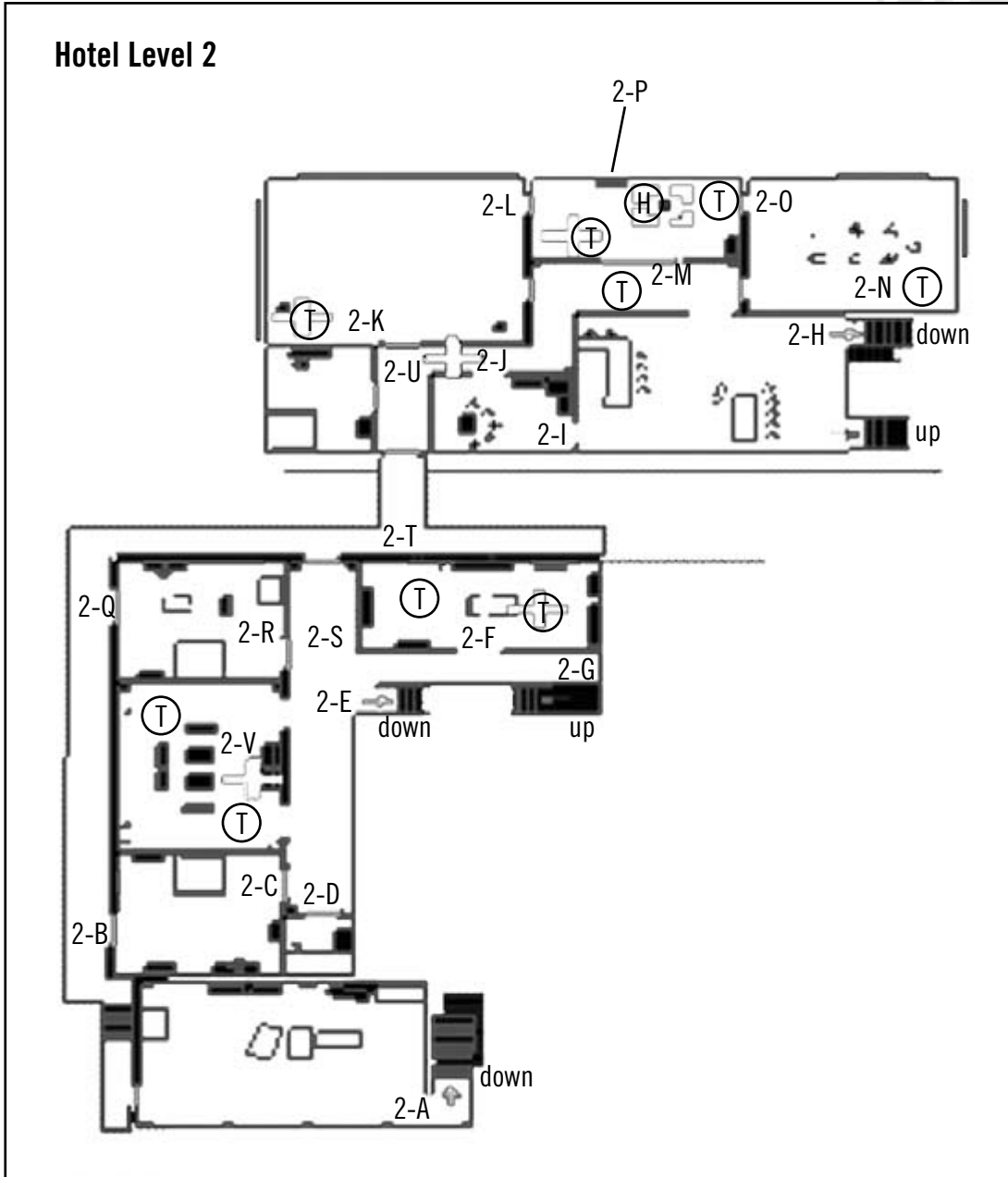



Map 13-3. Level 3, Hotel

### Hotel Level 3

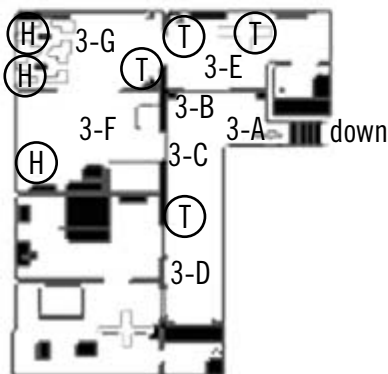
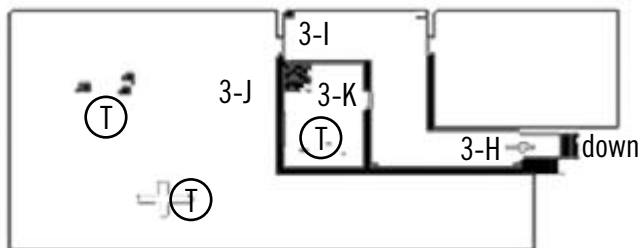

## STRATEGY

This hostage rescue mission presents your teams with some unique challenges. There are lots of tangos crammed into two medium-size buildings. Many of the tangos patrol around rather than standing in one position, making planning for the mission a bit tougher. Order your teams to hold in positions where their rear and flanks are covered, such as at the end of a hallway, then take out tangos as they come into view.

For this mission, you need four assault teams. Two will operate in the first building, and two in the second building. The key is to use discretion and take your time advancing through the buildings, clearing each floor of all tangos so your rear is secure. The only time you need to use speed is when rushing into the rooms where the hostages are held.

Since both groups of hostages are being guarded by tangos that will execute them at any sign of trouble, use stealth and remain as silent as possible. Only take silenced weapons, and neutralize all tangos before they can shoot at your teams, alerting the tangos on guard duty.

The two sets of assault teams operate independently for most of the mission. However, toward the end, they must cooperate to secure the hostages on the third level of the main building.

## BLUE TEAM

Blue Team is the lead assault team for the main building. They clear a path to the third level, secure the three hostages there, then escort them to the extraction zone.

Start the team at Insertion Zone 2 and immediately advance to the door through 1-E to 1-F. Head up the stairs to 2-A and continue to 2-B. Enter the hotel and hold near the door at 2-C for code Alpha. When the Go Code is given, open the door and move through 2-V, taking out the two tangos in this first room. Hold near 2-E for code Bravo. Assume a Cover posture while waiting and aim toward 2-F.



Take out both tangos in room 2-V.

Holding on level 2.



Clear out this room before heading up to level 3.



At code Bravo, advance to room 2-F and clear it of any tangos waiting to ambush you. Continue to 2-G and take the stairs to level 3. Silently take out any tangos in the hallway before moving to 3-B and holding by the door for code Charlie.

You must fire fast to take out all of the tangos in 3-E before they harm the hostages.



After code Charlie, open the door and take out the tangos in 3-E. Continue on to 3-G, clearing out any tangos. After the rooms with the hostages are clear, escort all three hostages to 3-A, down the stairs to 2-S, through 2-R, along the walkway from 2-Q to 2-A, then down to the garage area, holding at 1-J for code Delta. When this final Go Code is given, lead the hostages to the extraction zone to complete your objective.

## RED TEAM

Red Team assists Blue Team in clearing the main building of all tangos and securing the hostages on level 3. Because of the layout of the main building, it is important for the two teams' actions to be coordinated.



All teams head towards the garage of the main building.



Head through the attic to get to level 2.

Red Team begins the mission at Insertion Zone 2. Head directly to 1-E. Continue on through 1-F to the stairs 1-J. Move through 2-A, out onto a walkway, and reenter the building at 2-Q. Hold by the door at 2-R for code Alpha.

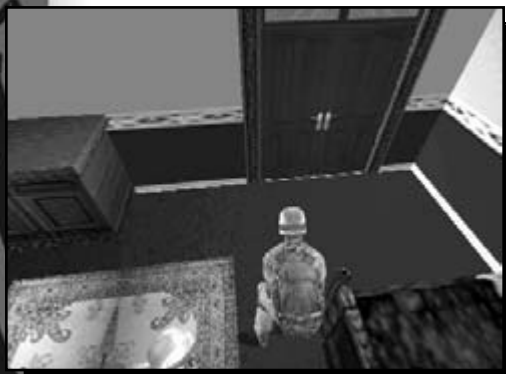

Hold by the door at 2-R.

At Alpha, go through the door and hold at 2-S for code Bravo. Cover toward 2-E, neutralizing all tangos patrolling in the hallway area and preventing them from attacking Blue Team.

## OPERATION: BROKEN SCEPTRE



Red Team rushes in to secure the hostages.

After code Bravo, advance through 2-E to the stairs at 2-G. Take them to level 3 and hold by the door at 3-C for code Charlie. When you receive this Go Code, blitz into 3-F and 3-G, eliminating all tingos before they harm the hostages. Continue through 3-E back to 3-A, and take the same

way you came in back down to the garage at 1-J. Make your way to 1-R and hold for code Alpha. Cover while aiming at the hotel. At this last Go Code, move to the extraction zone.

Red covers the hotel while the other teams extract the hostages.



## GREEN TEAM

Green Team is the lead assault team assigned to clear the second building and secure the hostage on the second floor. They start the mission at Insertion Zone 2. When the mission begins, they must advance along with the other teams to the garage at 1-J. Head up the stairs to 2-A, then follow the outside walkway past 2-B and 2-Q to 2-T. Hold there for Code Alpha.



Hold at 2-T until all teams are in position.

When code Alpha is given, head to the other building and enter the hallway at 2-U. Take out the tango patrolling here before continuing through 2-J, 2-I, and then hold at 2-M for code Bravo. Assume a Cover posture, with your sights aimed toward 2-H.



Drop the tango near 2-U.

After code Bravo, blitz into room 2-P and take out the two tangos guarding the Secretary-General. After the room is clear, escort the hostage back across the walkway to the main building and back the way you came to the garage at 1-J. Hold here for code Delta. When Delta is given, escort the hostage to the Extraction Zone.

Take out this sniper on the patio so your teams can safely get to the extraction zone.



Rush in to secure the hostage.



## GOLD TEAM

Gold Team assists Green Team in clearing the second building and securing the hostage on level 2. After this, they help out the teams in the main building during their assault to secure the hostages by clearing the tango snipers on the rooftop of the second building.

Gold Team hold with Green Team at 2-T.



## OPERATION: BROKEN SCEPTRE

Gold Team starts the mission at Insertion Zone 2, and immediately heads to the garage at 1-J. Climb up the stairs and follow the outside walkway through 2-B and 2-Q to 2-T. Hold here for code Alpha. After Alpha is given, enter the second building and advance through 2-U to 2-K, taking out the tango sniper on this patio area. Continue to the door at 2-L and hold here for code Bravo.



Gold Team covers the stairway of the second building.

At Bravo, rush into room 2-P to help secure the hostage before the tangos execute him. Then advance to 2-Q and head up the stairs

to level 3. Move through 3-H to 3-I, and hold for code Charlie. Assume a Defend posture while waiting.

Neutralize the snipers on the rooftop before they can fire through the windows of the main building.



At code Charlie, rush out through the door to 3-J, taking out all tangos on the rooftop before they shoot at Blue Team or the hostages in the main building. Hold at 3-J for code Delta while maintaining a Defend posture. When Alpha is issued, return to 3-H and head back down the stairs to level 2, along the outside walkway to the garage and then on out to the extraction zone.



Before Green Team gets to 3-I to hold for code Delta, take out the tango in 3-K to prevent him from sneaking up on your team from behind. Only do this when you are in control of Green Team, because the AI will have trouble following the procedure correctly. Stand to one side of the door to 3-K and open it. When the tango inside comes to investigate, quickly take him out, then continue to 3-I and hold.

## NOTES

This mission is fairly quick. Take control of Blue Team for the majority of this mission, because this team requires finesse that only a human can provide. Lead the team to their position on the second floor of the main building. Wait until all teams are ready, then give code Alpha. Open the door and take out the tangos in 2-V and then holding near 2-E. Watch for tangos coming up the stairs from level 1.



### TIP

When clearing the second floor of the main building, try using a few frag grenades. At 2-D, move Blue Team so you can just throw one into 2-V, then try throwing one from 2-E to 2-F. You can also switch to Red Team and throw one so it bounces off the stairs and into 2-F instead.

Watch the Team Status display on the lower right side of the screen to view the progress of the other teams. Wait for Green and Gold Teams to get into position, then give code Bravo. This sends both of these teams in to secure the Secretary-General. Lead Blue Team toward 2-F and neutralize the tangos you located earlier. Continue up the stairs to 3-A. Usually the doors to 3-E are closed. Hold by the door until Red and Gold Teams are in position before giving code Charlie and rushing in to secure the hostages. However, if for some reason the doors are already open, quickly give code Charlie and rush in to take out the tangos in 3-E before they kill the hostages.

When the room is secure and all three hostages are safe, escort them down to level 1 and hold in the garage until all four teams are in position. Red Team will provide cover for the escorting teams. Give code Alpha and lead the hostages to the extraction zone to complete the mission.



If the doors at 3-B are closed, you may want to take control of Gold Team to eliminate the tango in 3-K as outlined in Gold Team's walkthrough.



# OPERATION: EMPTY CLOUD

## MISSION ORDERS

08.24.04  
ATHENS, GREECE

1435

Intel projections indicate that Newcastle's mercenaries planned to mount a last-ditch operation at an auto show in Athens, Greece. Local security forces were informed of the attempt and were able to prepare for the assault. While this allowed them to keep the guests and exhibitors safe, the terrorists discovered the trap and took security personnel hostage instead. They then retreated to the old Convention Center next to the show site. Your mission is to rescue the hostages and neutralize Newcastle himself. It would seem he is personally taking part in this operation.

There are hostages scattered on all three floors, all of them extremely well guarded. You must clear every room to ensure the safety of the hostages. Once all three floors have been cleared, proceed to the Exhibition Hall. That's where the last hostages are being kept. Your teams cannot succeed unless they synchronize their attacks. If one team goes in too soon, Newcastle's people will be alerted and the hostages will most likely be executed. Also, keep an eye open for snipers.

## INTELLIGENCE BRIEFING

Rescuing Secretary-General Cameron was more successful than we had hoped. While being held by the terrorists, Lord Cameron was able to overhear a couple of them discussing details of their next move. Furthermore, he was able to confirm that Newcastle did in fact take part in the kidnapping. Intel was able to piece together what Cameron overheard with Newcastle's modus operandi, and came up with a logical projection of what he was going to do next. He intended to hit the upcoming auto show in Athens, which routinely draws dignitaries from all over Europe, and we were in the process of setting up on site when everything hit the fan.

Unfortunately, site security surprised the terrorists before we were ready. Newcastle and his men took security personnel prisoner, then fell back and locked themselves in the closest building, the old Convention Center next door to where the show is being held. We now have a situation in which the terrorists are trapped in the Convention Center with an unknown number of hostages. Because of RAINBOW's record and experience in dealing with Newcastle's group, we've been asked to neutralize him and rescue the hostages. This mission will take exceptional teamwork and absolute precision. We need to stop Newcastle for good, and this is the best chance we're going to get.

The good news is that only security was involved in the firefight. None of the show guests, exhibitors or other employees were involved, and most didn't even know something was going

PRIMAGAMES.COM



## OBJECTIVES

1. NEUTRALIZE NEWCASTLE
2. NEUTRALIZE ALL TERRORISTS

on. The bad news is that two of them were killed, and an unknown number taken hostage.

Newcastle himself is in on this one, which makes things a little more difficult. His record with SAS was dirty, but what he did, he did very well. The guy is sharp, fast and good, and he knows how to place his people. Watch your back on this one. He's a sneaky son of a gun. We won't get any better chance to take him down.



Your teams must work together from the beginning of the mission.

## TEAM ASSIGNMENTS

### BLUE TEAM

Operative	Primary	Secondary	Slot 1	Slot 2	Uniform
Chavez	0.45cal SD UMP SMG	0.45cal M23 SD Pistol	Frag Grenade	Flashbang	Street 1 Medium
Arnavisca	0.45cal SD UMP SMG	0.45cal M23 SD Pistol	Flashbang	Heartbeat Sensor	Street 1 Medium

### RED TEAM

Operative	Primary	Secondary	Slot 1	Slot 2	Uniform
Bogart	0.45cal SD UMP SMG	0.45cal M23 SD Pistol	Frag Grenade	Flashbang	Street 1 Medium
Burke	0.45cal SD UMP SMG	0.45cal M23 SD Pistol	Flashbang	Heartbeat Sensor	Street 1 Medium

### GREEN TEAM

Operative	Primary	Secondary	Slot 1	Slot 2	Uniform
Price	0.45cal SD UMP SMG	0.45cal M23 SD Pistol	Frag Grenade	Flashbang	Street 1 Medium
Loiselle	0.45cal SD UMP SMG	0.45cal M23 SD Pistol	Flashbang	Heartbeat Sensor	Street 1 Medium

### GOLD TEAM

Operative	Primary	Secondary	Slot 1	Slot 2	Uniform
Novikov	0.45cal SD UMP SMG	0.45cal M23 SD Pistol	Frag Grenade	Flashbang	Street 1 Medium
Rakuzanka	0.45cal SD UMP SMG	0.45cal M23 SD Pistol	Flashbang	Heartbeat Sensor	Street 1 Medium

OPERATION: EMPTY CLOUD

Map 14-1. Level 1, Convention Center

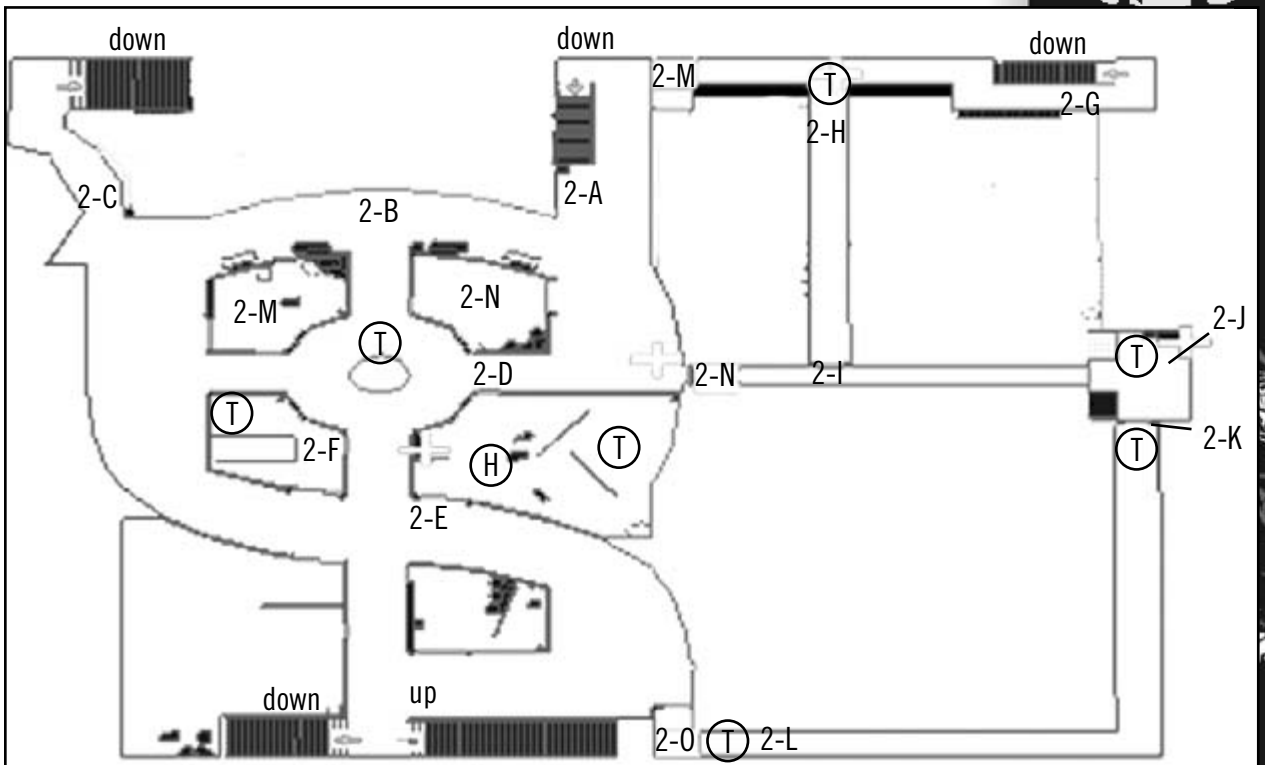
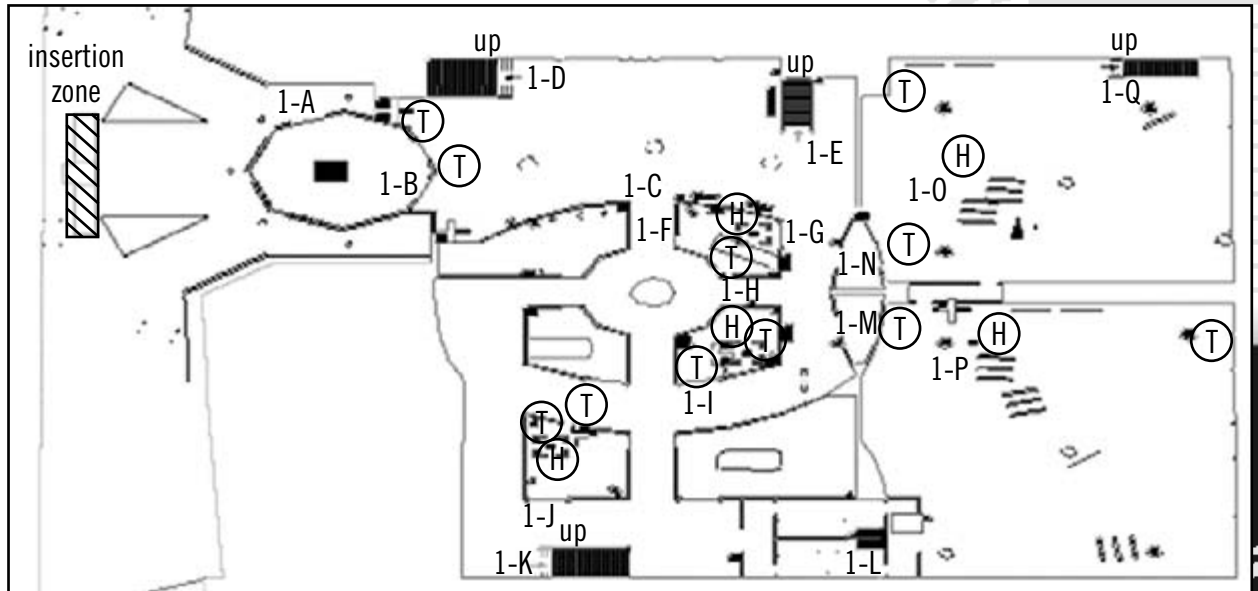

Map 14-2. Level 2 Convention Center

Map 14-3. Level 3, Convention Center

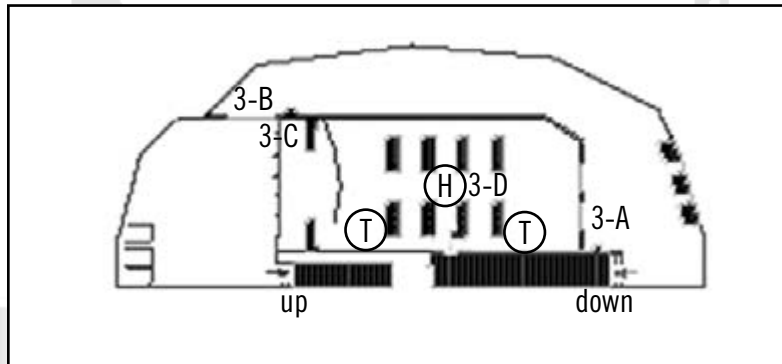

## STRATEGY

This is the most difficult mission in the campaign. The first part of the mission is rather routine, but the final assault to secure the last two hostages and take out Newcastle is frustrating.

For this mission, you need four assault teams that will work together in pairs. All four teams clear the front area of level 1. Have one pair of teams clear level 2 while the other pair takes care of level 3. After these areas are clear and the hostages there are secure, all four teams return to level 1 for the final assault. Coordination and timing are critical.



**TIP**

There are cameras at 2-M, 2-N, and 2-O. If you enter these small rooms leading to the catwalks, Newcastle—located in room 2-J—moves to 2-K and begins killing hostages. If you plan on sending teams through these rooms, have other teams rush

into the rooms where the hostages are at the same time to cover them.

Stealth is vital to this mission. If Newcastle or the other tangos hear gunfire or detect your team, they begin executing the hostages. Your teams must keep things quiet. Take silenced weapons for everyone, as well as a heartbeat sensor for each team. There are a lot of rooms where tangos can hide, so check each one.

## BLUE TEAM

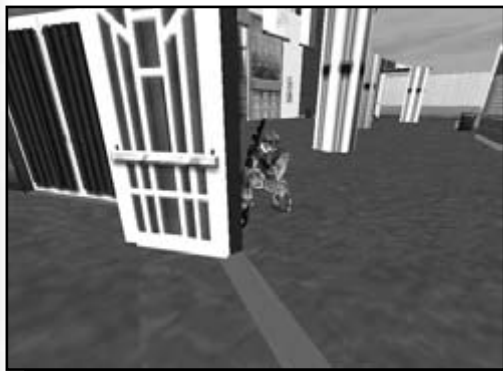

Take out this first tango near the door.

Blue Team is the lead team for this mission. At the start, lead the rest of the teams from the insertion zone, through 1-A, to 1-B. Hold by the doors for code Alpha.

## OPERATION: EMPTY CLOUD

When the Go Code is given, open the door and clear the lobby as you enter. There is a tango near the door and one off to the left. Get both of them before they gun down your teams. Continue through 1-C to 1-I and hold by the door for code Bravo. Watch out for the tango patrolling the hallways.



Blue Team clears the first room where there's a hostage.

After code Bravo is issued, open the door and rush into the room, taking out the two tangos guarding the hostage. Watch out for Red Team entering through the other door. With the room clear, exit and advance to 1-J. Open the door and take out the tango next to the hostage. After making sure the room is

clear, move to point 1-K at the base of the stairs and hold for code Charlie.

You clear 1-J without the help of Red Team. Go through the right door so you have a perfect shot at the tango.

At Charlie, move up the stairs to level 3. Continue around the corridor to 3-B, open the doors, and hold at 3-C for code Delta. After this Go Code is given, rush out toward 3-D, taking out the two tangos guarding the hostage in this theater. With level 3 clear, get ready for the final assault. Head back down the stairs to level 1 and move through the restrooms to 1-L. Hold here for code Alpha.



Clear out the theater on level 3.

When you receive code Alpha, blitz into room 1-P and take out the tangos near the hostages. Watch for the sniper at 2-K and hold near 1-P for code Bravo. Assume a Cover posture with your sights aimed up at 2-K. Remain here until the mission is complete.





Make sure you have a full magazine of ammo in your weapon before rushing out during the main assault.

Watch for Newcastle to appear with his sniper rifle, then neutralize him quickly.



## RED TEAM

Red Team is the assault team assigned to work with Blue Team. Together they blitz the same rooms to secure the hostages before the tangos execute them.

### TIP

When planning orders for each of your teams, spread them out within the entry area around 1-B. Then, when you give code Alpha, the teams

don't get bunched up trying to enter the lobby area.

At the start of the mission, advance through 1-A to a position just short of Blue Team's. Hold there for code Alpha. At this Go Code, rush into the lobby area and head toward 1-C. Hold by the door at 1-H for code Bravo.

Red Team helps clear a room on level 1.

At code Bravo, rush into the room and take out the tangos guarding the hostage. Leave the room and move to 1-K at the foot of the stairs. Hold there for code Charlie.



## OPERATION: EMPTY CLOUD

After this Go Code is issued, advance up the stairs to level 3. Hold near the doors at 3-A for code Delta.



Take out the two tangos in the theater.

After code Delta is given, rush into room 3-D and neutralize all tangos. Then head back down the stairs to level 2. Move to the door leading to 2-O and hold for code Alpha.

Red Team rushes into room 1-P to secure the hostage.

After you receive code Alpha, rush through the doors and take out the tangos near 2-L. Then, continue toward 2-K, taking out any Tangos that come into your sights.



## GREEN TEAM

Green Team leads the second pair of teams. When the mission begins, advance through 1-A to room 1-B and hold for code Alpha. At this Go Code, rush into the lobby area, moving toward 1-E. Hold near the door at 1-G for code Bravo.



Green team does not have much of a shot at this tango on level 1. However, Gold Team can get him.

At code Bravo, rush into the room and take out the tango guarding the hostage. Once the room is clear, exit and advance to the stairs at 1-E. Hold here for code Charlie while assuming a Cover posture. Aim toward the upper level at 2-B.

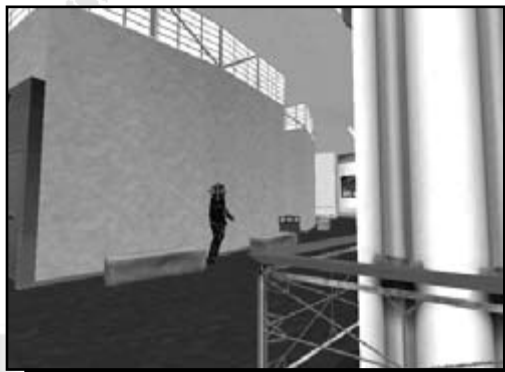

Watch out for patrolling tangos on level 2.

Be careful not to shoot the hostage when you go after the tangos.

After code Charlie, head up the stairs and advance to 2-D. Hold by the door for code Delta. At Delta, rush into the room and take out the tango, careful not to hit the hostage or Gold Team as they enter through the other door. With this room clear, advance to room 2-N and enter to make sure there are no tangos hiding there, then return toward the stairs at 2-A. Head to the door leading to 2-M and hold for code Alpha.



Watch for the tango on the catwalk when rushing.

As soon as code Alpha is given, open the door and blitz through 2-M and on to 2-H, taking out the tango on the catwalk. Then continue on to 2-I. Take a left and rush into room 2-J, clear it, and hold here for code Bravo and the completion of the mission.



Neutralize this tango hiding in the office at 2-J.

## GOLD TEAM

Gold Team assists Green Team in securing hostages and clearing the building of all tangos. At the start of the mission, move through 1-A to room 1-B and hold for code Alpha. At Alpha, blitz into the lobby area and then to 1-F. Hold by the door for code Bravo.

Gold Team secures a room on level 1.

At Bravo, rush into the room to neutralize the tango inside. Then go to 1-D, at the base of the stairs and hold for code Charlie. Assume a Cover posture. Keep your sights aimed up toward 2-A.



Clear out this room on level 2 with the help of Green Team.



advance through rooms 2-F and 2-M to ensure that no tangos are hiding there. Then head down the stairs at 2-A to level 1. Continue to 1-N and hold for code Alpha.



A tango hides out in one of three rooms on level 2. Depending on his random start position, he'll be in room 2-F, 2-M, or 2-N. Therefore, when planning for the mission, have the teams move through these rooms to make sure you get all of the tangos so the mission will end after you make your main assault.

At code Charlie, head up the stairs to level 2 and advance to 2-E. Hold by the door for code Delta. At Delta, rush into the room to take out a tango guarding a hostage. With the room clear,





Shoot fast to take out the tingos before they harm the hostage in room 1-0.

At code Alpha, blitz into room 1-0 and take out any tingos you see before they harm the hostage. Hold at point 1-0 for code Bravo, and Cover with your sights aimed up toward 2-H to take out the sniper on the catwalk if he shows himself. Remain here until the mission is complete.

## NOTES

The hardest part of this mission is getting the planning just right. All of your teams must use coordinated movements to maximize the element of surprise. This is especially true of the final assault to get Newcastle and rescue the last two hostages. If the planning is well done, the execution for the mission is not all that hard.

For this mission, take control of Blue Team. Lead them into the main entrance and up next to the doors. Quickly change the ROE to Recon to locate the tingos on the other side of the door, then change it back to Assault. Give code Alpha and open the door when you're ready. Take out the first tango near the door, then turn left and sidestep right to get the second tango to the left of the doors. This tango usually guns down the AI teams.

Lead the teams toward the small rooms with the hostages, taking out any tingos patrolling the hallways. When you are at 1-I, and all of the other teams are in position, give code Bravo and rush into the room. Next, secure the hostages in the room near 1-J before heading to the stairs at 1-K. Change the ROE to Recon again and quickly walk around the other rooms in this area, making sure they are all empty. They are usually clear, but it never hurts to check. Switch the ROE back to Assault.

At the stairs, wait for the other teams to get into position, then give code Charlie. This sends all four teams upstairs—Green and Gold to level 2, Blue and Red to Level 3. Follow the waypoints to the rear of the theater, and wait for the rest of the teams to get ready. When they are all holding, give code Delta and rush in to clear level 3. After each team clears their assigned areas, they all prepare for the main assault.

When all four teams are ready, give code Alpha and rush into room 1-P. Take out the tingos on the ground, then be ready to take out Newcastle as he comes out of the office at 2-J. He moves to 2-K and snipes down at the hostage. Neutralize him as soon as he shows his face. Also watch out for another tango at 2-L. Remain here until the other teams take out any remaining tingos to complete the mission.



SECTION

3

OTHER MISSIONS

# THE CUSTOM MISSIONS

The training and campaign missions are a major part of *Black Thorn*, but the action does not end there. *Black Thorn* also allows you to create your own custom missions, choosing from a variety of maps and mission types.



Custom missions let you play different types of missions on each map.

The Custom Mission screen presents numerous variables that you can choose from to create scores of different missions. You can choose the map or level you want to play on, the difficulty of the mission, and even the number of tangos (for some missions).

In addition, you can choose from six mission types. These determine your objectives and how many operatives can go on the mission. You may play on any multiplayer map, and also those from the campaigns as long as you've unlocked them by playing them during a campaign.



You can play all custom mission types (except Lone Wolf) cooperatively for multiplayer games.

## ASSAULT



Take out all the tangos you can find.

The Assault is the basic counterterrorist mission, where you must assemble a team and neutralize all tangos on the map. The difficulty level you set determines the number of tangos in an assault mission. During the planning phase, select up to eight operatives and give them orders to

cover all parts of the map looking for tangos. The tangos may be anywhere, but usually they congregate around or inside the main structures.

## LONE WOLF



You're on your own. Either get to the extraction zone safely, or eliminate all the tangos on the map.

This mission type differs from the others. Other mission types rely heavily on teamwork, but the Lone Wolf missions test your individual skills. There are no hostages to rescue or bombs to disarm. Your only objective is to get from the insertion zone to the extraction zone

alive. Tangos are scattered about the map to try and stop you. During setup, you may choose to fight from one to fifty tangos. You're free to kill as many as you want. If you get them all, the mission will end without your having to reach the extraction zone. You can play Lone Wolf missions on any training or campaign mission map, although some campaign maps may be locked until you complete those missions in the single-player campaign.



When you begin a Lone Wolf mission, go through the planning stage as you would any other mission. However, you can only choose one operative. Pick one with good assault and stealth ratings, such as Chavez. These are the two skills you need most. As for weapons, it's usually best to go with silenced submachine guns. Because you're outnumbered, you want to maintain the element of surprise for as long as possible. A heartbeat sensor is essential. Finally, take along either frag grenades or an extra primary mag. Because there are no hostages, you don't need flashbangs. Go with a light- or medium-weight uniform; light is quieter, but medium offers a bit more protection.

After outfitting your operative, go to the Plan screen and assign waypoints. You should be somewhat familiar with the map already, because you've probably completed a mission on it. First, note your starting and ending points. Select a path that minimizes moving through open areas where multiple tangos can fire at you from several angles. Find back routes that provide a lot of cover on your way to the extraction zone and look for small side rooms that you can duck into to ambush patrolling tangos.

The key here is to use caution and take your time—there's no rush. Use your heartbeat sensor as much as or more than you use your weapons. Always use it to check the next room before you round a corner or go through a doorway. The room may have been clear a few seconds ago, but a tango could have entered in the meantime. Peek around corners to take out tangos after you pinpoint their positions and facings with the heartbeat sensor. Use grenades sparingly—the noise can summon more tangos to your position. A frag grenade, however, is a great way to clear a room of multiple tangos, especially if you're getting close to the extraction zone.



## TERRORIST HUNT



Tangos could be hiding anywhere.

After you complete a campaign mission, you can use the map for Terrorist Hunt missions (as in Lone Wolf missions). Your objective is to neutralize the tangos scattered throughout the map. Similar to Lone Wolf missions, you can choose how many tangos your team faces, from one to fifty. Unlike Lone Wolf, you can take along eight operatives.

Plan this mission type as you would a campaign mission, but don't worry about hostages being killed or bombs. Divide your operatives into teams and assign each team waypoints in order to cover every inch of the map; tangos appear in the most unlikely places. You may go through a mission that won't end because a single tango is holed up in a closet or the corner of a shack.

For Terrorist Hunt missions, you can choose to be stealthy with silent weapons, or noisy with large assault rifles. One good tactic is to use the Cover posture. Order your teams to move to a waypoint, then hold for a Go Code while they cover a hallway or open area. Leave them there for a bit to catch any patrolling tangos, then move to the next Cover position and repeat the process.

You have to get every tango to complete the mission successfully, so use a sweep strategy: from one position, move out and clear every room or structure as you advance. Don't leave any tangos behind you or allow any to sneak past you into the area you already cleared. A good way

to do this is to have two teams work. One team covers a hallway or other access point while the other team searches and clears all of the rooms. This prevents tangos from moving past a team while it clears a room.

## HOSTAGE RESCUE



The mission briefing reveals the hostages' positions. However, you still have to get them out safely.

This is the standard RAINBOW mission. Assemble a team of up to eight operatives, locate the hostages, then secure them and escort them to the extraction zone. The difficulty level determines the number of tangos you face. This mission type allows you to use campaign maps that did not have hostage rescue objectives.

## DEFEND

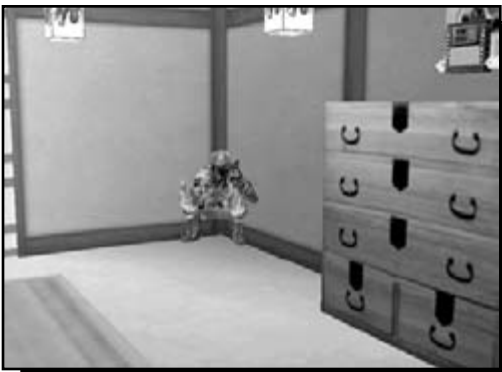

The switch may be in an area that forces you to cover two or three approaches at once.

This is another solo mission. However, this time your operative must defend an area by preventing tangos from triggering a switch. As if that weren't enough, you must also neutralize all tangos on the map. Take along a weapon with a lot of firepower.

At the start of the mission, find a position from where you can cover the switch and be partially protected from enemy fire. One more challenge—the tangos in this mission type can throw grenades. Make sure you can duck behind an object to protect yourself from the shrapnel.

This type of custom mission is difficult because of the position the switch. There are often two or three approaches to the switch, and you must cover them all. Use a heartbeat sensor to help locate tangos before they get too close.

## RECON



Get to the objective, bug it, and get out without getting caught.

Recon missions can be some of the most challenging ones you face. The objective is to plant surveillance devices at certain spots on the map, then get all of your operatives back to the extraction zone. The tough part is that if any of your operatives are detected by the enemy, the mission fails. In addition, you cannot attack any tangos. Some of the maps can be very tricky for this type of mission. Take along a heartbeat sensor and an electronics kit.

The key to this type of mission is to find a position where you can hide, then use the heartbeat sensor to study tango patrol routes. It helps to use more than one team. Positioned one team at a distance to observe the enemy through binoculars and tell the other teams when to make their move.



# MULTIPLAYER MISSIONS

*Black Thorn* contains one of the best multiplayer systems available, using the same realistic model from the single player game. Plus, you can play on any of the carefully crafted maps. During the single player missions, you usually move very quickly through the maps to your objective. However, in multiplayer games, you can use every little room, corner, and balcony.

Multiplayer games allow you to use your skills against or with other players over a LAN or on the Internet. *Rogue Spear* also includes the option to go to the MSN or Ubi.com sites and find games. Additionally, many *RAINBOW Six* and *Rogue Spear* clans will be now playing *Black Thorn*. Red Storm Entertainment's website, [www.redstorm.com](http://www.redstorm.com), provides links to some of these, or you can use an Internet search engine.



The host sets a number of options for a multiplayer game.

You can join a game or create one yourself. The player creating the game is called the host. The host determines the game type and several game options. Team and equip your operatives at the Setup screen.

Unlike other multiplayer games, death here is final. When your operative is killed, he or she doesn't respawn. Instead, you must wait until the game ends and a new one begins to get back into the action. You can still observe the game in progress, but you can't communicate with the living operatives.

There are two types of multiplayer games: adversarial and cooperative. In adversarial games, players are divided into teams that play against each other. Cooperative games put all players on the same team to complete single-player missions.



## COOPERATIVE GAMES



Work with other players to complete mission objectives during cooperative missions.

As you might expect, players work together in cooperative multiplayer games. The choice of mission types is the same as for the custom missions. Choose from Assault, Terrorist Hunt, Hostage Rescue, Defend, and Recon missions.

The host selects from several options. Players can choose to be any of the RAINBOW operatives, but there can be only one of each personality. A chat window on the Game Creation screen facilitates mission planning. Use it to ensure that team operatives carry appropriate equipment and know their roles. For cooperative missions, you can even add partners for each player. When everyone's ready, the host can start the mission.

## ADVERSARIAL GAMES

There are 11 adversarial game types, each with its own objectives. They vary from last-player-standing to last-team-standing, or even offense vs. defense. Each has different objectives and requires a different style of gameplay. Try them all.



You may be playing against a friend, but that doesn't mean you have to play nice.

## SURVIVAL

Survival games are free-for-alls in which the objective is to be the last person left alive in a level.

## TEAM SURVIVAL

Team Survival games resemble Survival games. Each person joins one of two teams (Blue or Gold). The winning team is the last one with at least one team member left alive.

## SCATTERED TEAMS

Scattered Teams is like Team Survival, but instead of starting out together in team bases, the teams are scattered all over the map. Bases are visible, as in standard Team Survival, and the game ends when only one team has members still active (or if neither team has an active member).

## TERRORIST HUNT



In Terrorist Hunt, the terrorists are scattered throughout the level. In addition to the Team Survival victory condition of being the last team with a member standing, your team can win if it kills more than half of the terrorists on the level (kill 16 terrorists, because there are 30 on the level). The terrorists are randomly placed on the level.

## SCATTER HUNT

Scatter Hunt is the Terrorist Hunt game where members of a team start out scattered over the map.

## ASSASSINATION

In the Assassination Team Survival variation, each team must defend a general from the other team. To win, kill all of the opposition, or kill the other team's general.

## SCATTER ASSASSINATION

In Scatter Assassination, teams start spread out over the map and must find and defend their general.

## SAVE YOUR BASE

Save Your Base is another Team Survival variation. In this version, each team must race to its base and disarm a bomb before the opposing team finds its own base and disarms a bomb.

## DOUBLE BLUFF

Double Bluff is a Team Survival game with the added objective of trying to get both hostages back to your base. Each team starts at its base with a hostage. If either team kills a hostage, that team loses.

## STRONGHOLD

In Stronghold games, Gold Team must stop Blue Team from entering its base. If Blue Team gets a member into Gold Base for three seconds or more, Blue Team wins. If either team eliminates all members of the opposition, that team wins.

## DOUBLE STRONGHOLD

In Double Stronghold games, both sides must defend their bases. In addition to the Stronghold victory conditions, if Blue Team can get a person into Gold Team's base for at least three seconds, it wins.

## LONE WOLF

This is a new type of game for *Black Thorn*. One player is the lone wolf, and he or she can choose any type of weapon from the RAINBOW arsenal. The rest of the players are the hunters, and must neutralize the lone wolf before he or she gets to the extraction zone. However, to help even out the odds, the hunters are only allowed to carry pistols.



# ADDITIONAL EQUIPMENT FOR MULTIPLAYER GAMES

*Black Thorn* includes some additional equipment for use only in multiplayer games. These can add a new twist on games against other players. In addition, you can use several new terrorist weapons. For more information on these weapons and equipment, see Chapter 3—The RAINBOW Arsenal

# TACTICS FOR MULTIPLAYER GAMES

All the tactics that work in single-player missions work in multiplayer games. Several additional tactics are particularly effective against other human players, however.

## COMMUNICATIONS

A critical component of team play is communication with your teammates. Although you can type messages using the chat function, *Rogue Spear* is a fast-paced game and the time it takes to type a message is often too long. (You may be killed while you're typing.)

The “Bound Keys” function allows you to preprogram 10 different messages, which can be sent with the press of a single key. The messages are sent audibly so your teammates don't have to shift their eyes from their gun sights to read them. Plan the game before it starts and use the various Bound messages to report in or to order an assault.



Customize Bound messages on the Options screen.



Your operative signals with his hand while giving a Go Code.

## TEAMWORK

Teamwork is among the most important tactics in *Rogue Spear*. If you have enough players, pair them or create even larger teams. Two people see twice as much as one, and can accomplish different tasks, making the team more effective.

One team member checks the other side of the door with the heartbeat sensor while the other covers the door in case the enemy comes through.



My favorite Teamwork tactic involves using the heartbeat sensor: the leader carries a weapon while another team member uses the heartbeat sensor to locate enemies. Everything the sensor picks up is relayed to all team members, rendering it unnecessary for them to use their own sensors.

A multi-operative team is useful for breaching doors and clearing rooms. One operative opens the door, another tosses a frag grenade or flashbang, and the rest cover the first two. All then run through the doorway and spread out left and right. This prevents anyone from getting shot in the back because he or she looked left when the tango was right. (Practice helps teams develop the precise timing such tactics require.) Other players can help prevent surprises from the rear.



Each team should have one heartbeat sensor. Only one team member will use it, and all team members can benefit from what it detects.



While one team member opens a door, the rest of the team gets ready to fire at the enemy on the other side.

Think about spacing between team members. You want to stay close enough to support one another, but not so close that a single automatic burst could take you both out. Outdoors, space team members far enough apart that they can support one another without allowing a single grenade to kill them both.

Keep a sufficient spread between team members. They should be close enough to support one another, but not so close that a single grenade could kill them all.



Every team must have a leader. In this game, you lead from the front, so the leader is usually the point man. In large games, where each side has multiple teams, an overall commander coordinates the teams' actions.

## MOVEMENT

Outdoors, it's important to spread out and cover every angle. Open windows, doors, corners, balconies—any place an enemy could hide—represent points of threat. Watch them. Spreading out in the open provides the enemy with fewer targets.

Indoors, keep your teammates close together so they don't lose their way. If you get lost, everyone behind you is lost. Confusion sets in, and you usually die. If you're in position 2, keep the point man in sight. If you're in position 4, keep the number 3 operative in sight. Staying close to the person ahead of you can have disadvantages, though. Enemy frag grenades or automatic fire can be very effective if your team is bunched up.

When you must pass through a narrow choke point, do so as quickly as possible. The same goes for open areas. If you can't cover all angles of threat, run as fast as you can to minimize the chance that the enemy will hit you.



Blitz through open areas to make it harder for the enemy to hit you.

If you must climb stairs, face toward where the enemy could be. This may mean going up sideways or even backwards. Stairs can be dangerous choke points. Because your heartbeat sensor only works on the current level, there is no way to see if there is a tango at the top until you get there.

## FIRE DISCIPLINE

You can quickly run out of ammo in multiplayer games. Therefore, it is important to use it sparingly. Because a single shot often kills, and a three-round burst nearly always does, avoid using full-automatic fire. Firing while moving is highly inaccurate. If you miss a target, you alert the enemy to your presence and you give them the opportunity to fire back. As a general rule, stop, drop, and fire! All of this will increase your accuracy and minimize your chance of being detected if you miss.

Take time for a good a shot—if the enemy lets you.

There are some instances where full-automatic fire and movement are acceptable. If you have to get through a choke point or a large open area, running and firing wildly at the enemy may force them to keep their heads down and prevent them from firing accurately at you.



## ATTACKING

There are several different ways to attack the enemy. In most cases, you should advance slowly and carefully as a team, using good fire discipline and covering each other. However, there are also times when rushing the enemy has its benefits.

Some players refer to this as “Rambo-ing.” This strategy can be very effective on small maps. At the beginning of the mission, your team blitzes toward the enemy with guns blazing. By catching the enemy before they have a chance to set up or get organized, you gain the element of surprise, and can win a game in a minute or two.

The best way to advance is by using “Bound and Overwatch.” This tactic divides a team into two parts. While one advances, the other covers them. When the first gets to some cover, they halt and cover the second group as it advances. Practice this tactic so everyone on your team understands their role.

## DEFENDING

Defending a position can entail setting up firing positions, ambushes, and snipers. This can take time, so at the start of a mission, each player should assume a defensive position in case the enemy immediately tries to rush your position.



Snipers are great for defending if there is a good location at a distance from the action where they can cover a narrow passageway such as a bridge.

For firing positions, choose locations with cover and at a distance from an entrance. This increases your ability to survive grenade attacks, and makes it harder for the enemy to shoot you.

Set up a HB sensor jammer and an HB sensor near where you will defend.

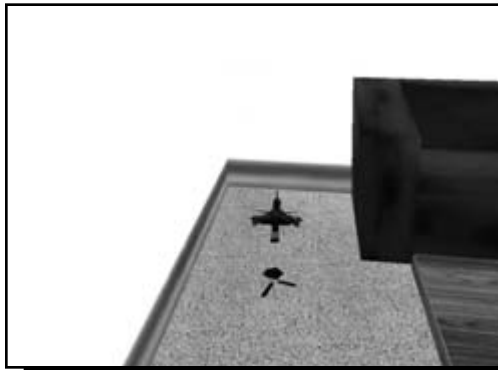



Locate choke points and set up your defenses near them. It's hard to defend a large area, so concentrate on narrow spots through which the enemy must advance. Use C-4 to blast a hole in an enemy's attack. Grenades also come in handy. Set up heartbeat sensors and jammers to locate the enemy and conceal your position.

## MORE TIPS AND HINTS FOR MULTIPLAYER GAMES



Use smoke grenades to conceal yourself and keep the enemy in the dark.

- Move decisively and with purpose! You're the hunter, so attack your enemy with confidence. If you move like a victim, you'll soon be one.
- Put your opponent under duress—if you see your enemy, open fire! With rounds flying, the enemy will panic, giving you (or preferably your partner) the chance to take a good kill shot.
- Teamwork! Trust your teammates to cover their zones and do their jobs. Everyone must do their part. Just watching a locked door far from the action can save your whole team from being wiped out from behind.
- Never assume a room is cleared simply because you've already been in there.
- Choose a weapon because it has stopping power, not just because it looks cool.
- Remember—short, controlled bursts. It doesn't matter how many rounds you fire, just where they land.
- If you are not using auto-aim, aim for your opponent's crotch. The head is harder to hit and the chest is usually covered by body armor.
- Never put your back to an open window or door.
- Most quiet weapons can't hit enemies from long range. Silenced weapons have their advantages, but the standard ones are better for long range.
- When you yell "Cover me," make sure someone on your team responds before you make your move.

- As a team, secure all entries into your location as quickly as you can. Do this every time you enter a new room during an advance so the enemy doesn't surprise you.
- Grenades can't break through all windows. If you try to throw them through thick durable windows, they bounce right back at you. As a general rule, shoot out the window before tossing a grenade. You can use frag grenades to take out windows and doors, however.
- Peek around corners before rounding them! This will save your life again and again. It's harder to hit half a head than it is to hit a half a body.
- If your teammates' bodies were piled near a window or door in real life, would you go there to see what killed them? Why do it the game?
- Along the same lines, if you peek around a corner and the enemy nearly shoots your head off, don't stick your head around again. It's better to let them think you're there, then flank them or get some teammates and set up an ambush.
- Remember the golden rule: When in doubt, *frag out!*



Frag grenades are great to throw around corners. They are hard to defend against and cause a lot of damage. If they don't kill, they at least wound and/or stun the enemy. After tossing one, be ready to move in to finish off survivors.

- Teamwork is essential. Find each team member's special skill or ability and work on those strengths. For example, if you have quick, accurate shots among your players, cast them as snipers and develop tactics to take advantage of their skills. They can always move to a high spot or provide cover for your assaulters.
- When you must move across an area that enemies are covering, throw smoke and lay down plenty of scattered rounds where you think they're hiding as part of your team moves. They'll be less likely to poke their guns around the corner.
- Don't discount stealth. More often than not, it's the sneaky operative who gets the kill.
- Develop standard operating procedures and break contact drills. That way, everyone will know what to do when the bullets start flying. Often, the best tactic is to get out of there (break contact) and set up an ambush somewhere else, on *your* terms.
- Learn to use formations and overlapping fields of fire. The map is a helpful tool. With the diamond formation, your rear guard walks backward most of the time, covering your "six." This operative can keep an eye on the map to stay in position relative to the rest of the team and still do the job.

- When patrolling, stay in formation. Move only as fast as your slowest operative—usually your rear guard. (It should be your point man if he wants to live a long time.)
- Not all maps provide for slow, deliberate movements. Many are small, forcing you to move quickly and decisively. Plan ahead for each map type. You won't have time to plan once the game starts. Again, team members should know their jobs and be able to count on their teammates to do theirs!

## THE MAPS



### ALASKA DEPOT

Alaska, USA

Map 16-1. Sublevel

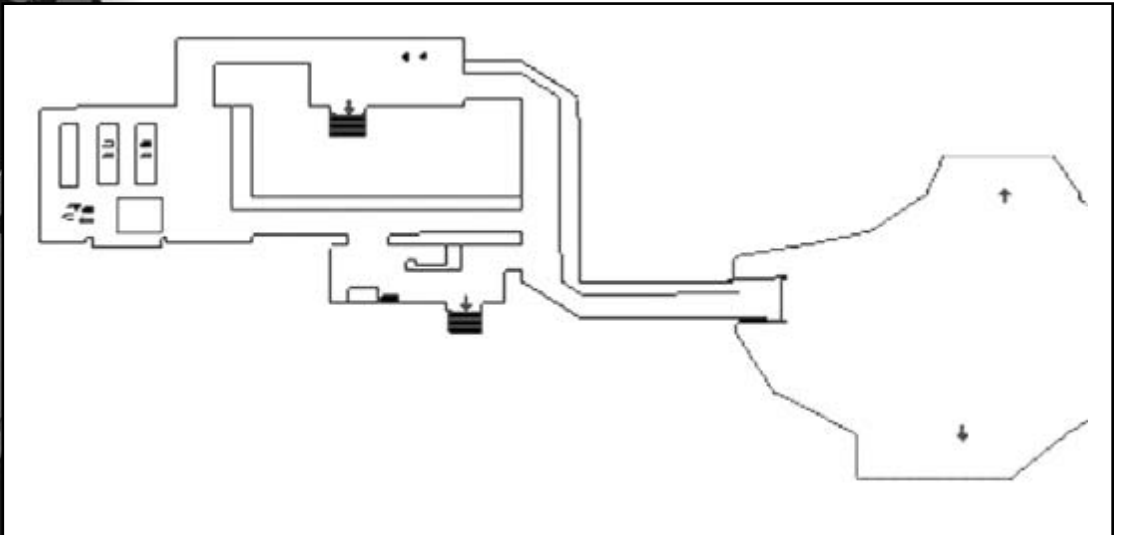

Map 16-2. Level 1



Map 16-3. Level 2

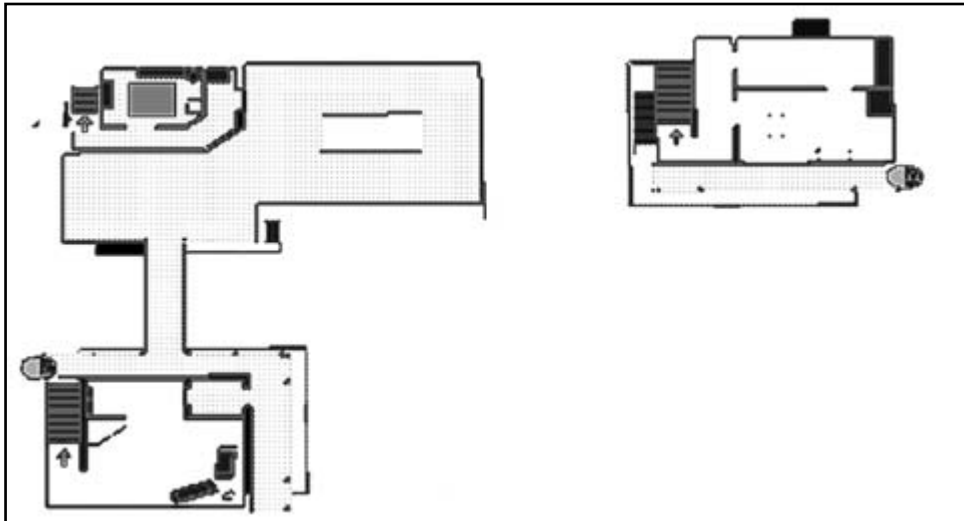

This map contains an outdoor main level with several small buildings. Some have a second floor. There is also a subterranean level that connects most of the buildings, allowing you to avoid going out in the open.



## CHOP SHOP

New Jersey, USA

Map 16-4. Level 1

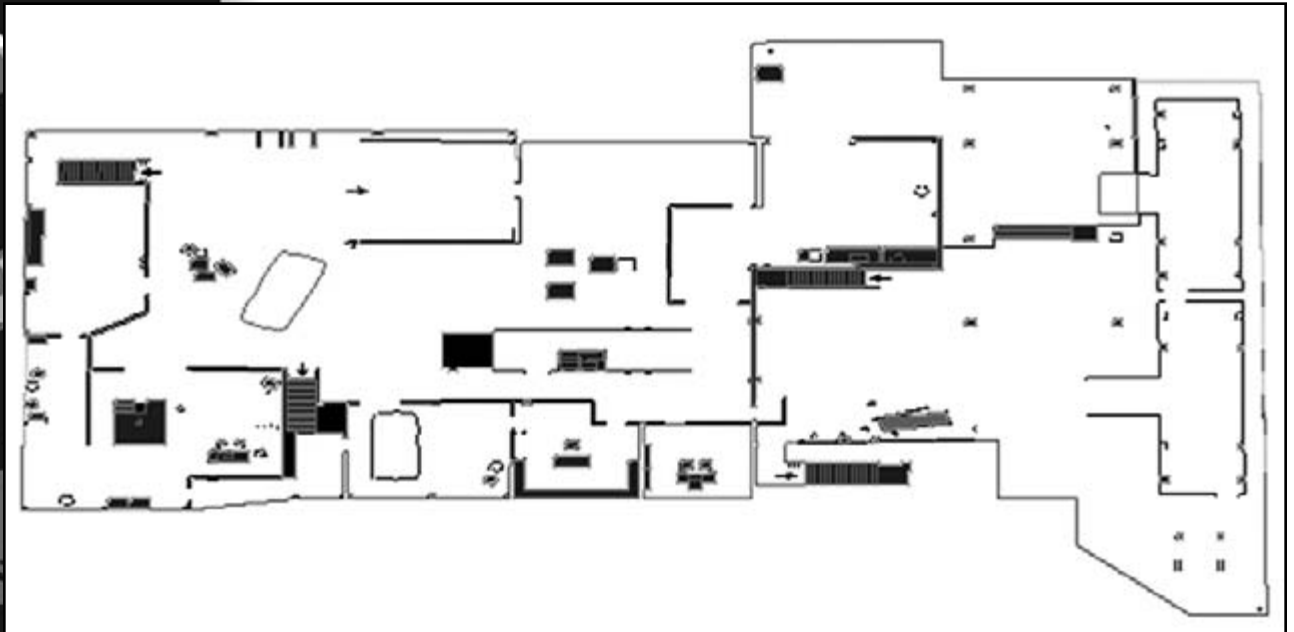

Map 16-5. Level 2

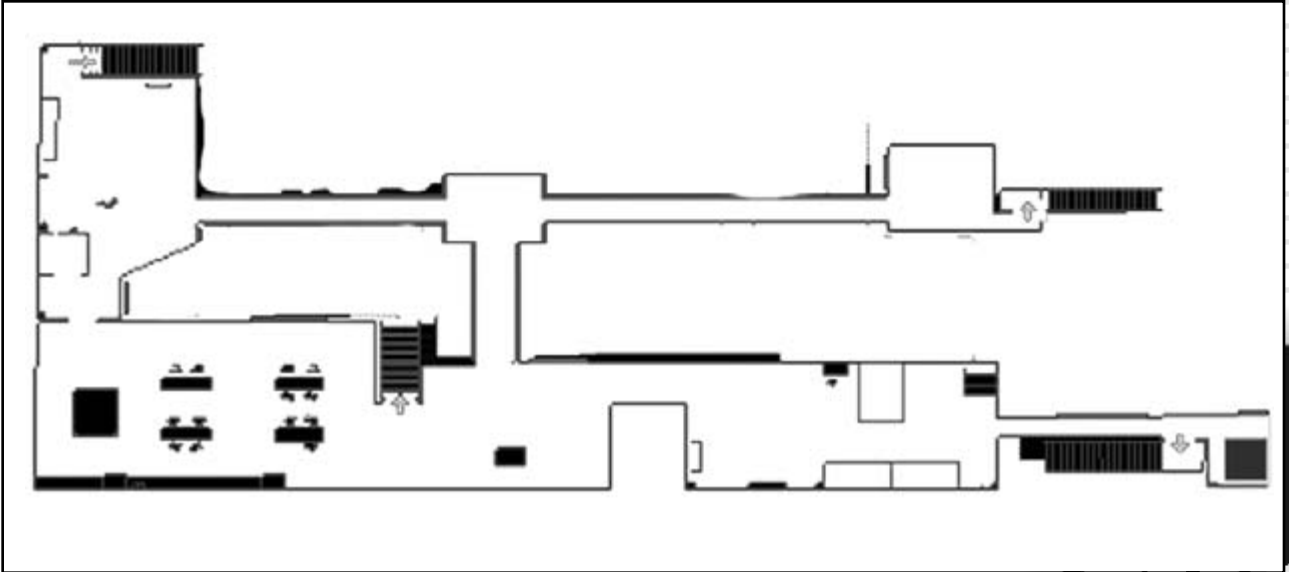

Map 16-6. Sublevel

The main level of this map consists of an outside area and the inside of a large building. The second level contains some great sniper positions overlooking the outside area. You can also climb inside the semi truck trailer and the railroad cars.

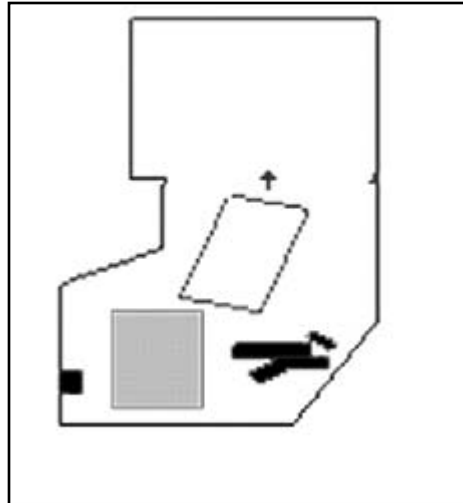

Try shooting the gas cylinders inside the building. They release a gas that functions like a smoke grenade.



## CITY STREET SMALL

London, UK

Map 16-7. Level 1

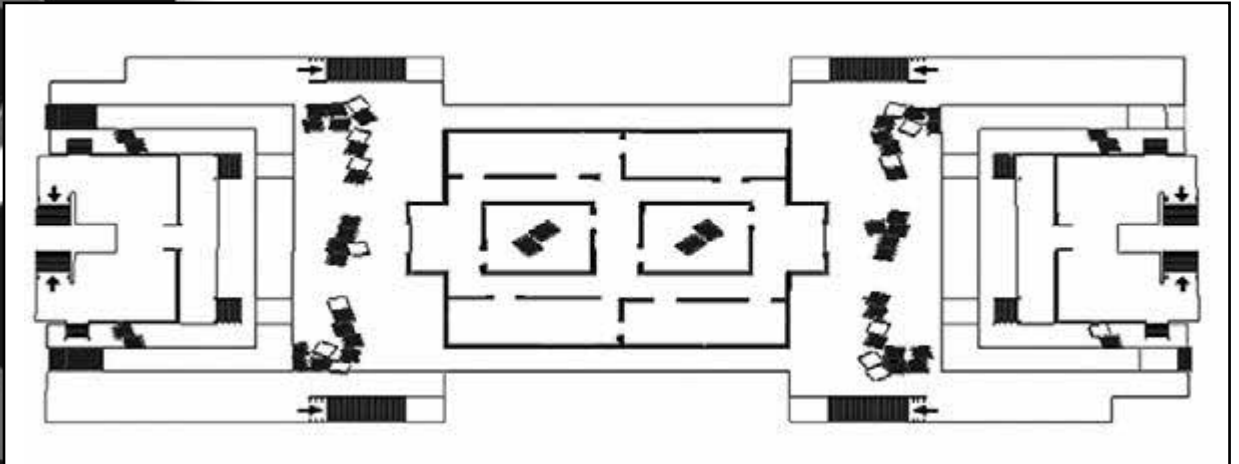

Map 16-8. Level 2

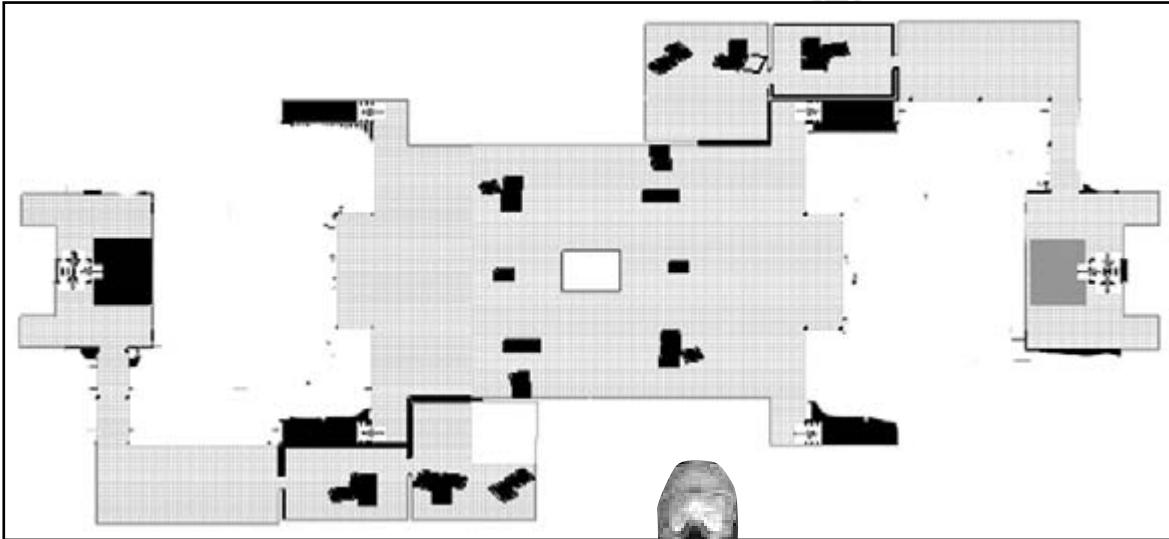

This is a great map for adversarial games using headquarters. Both sides have great defensive positions with good spots for snipers. There is a main level with a building at each end and one in the center, with catwalks providing connections between the upperfloors of the buildings.





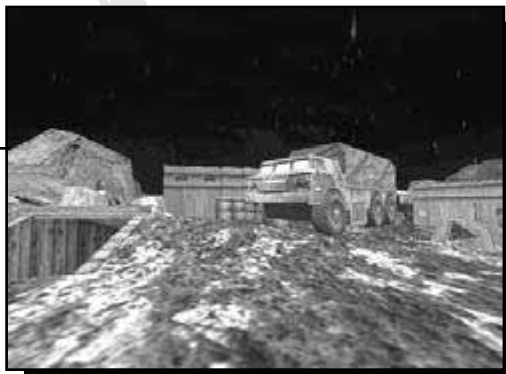

## HIDDEN CAMP

Sivas, Turkey

Map 16-9. Level 1

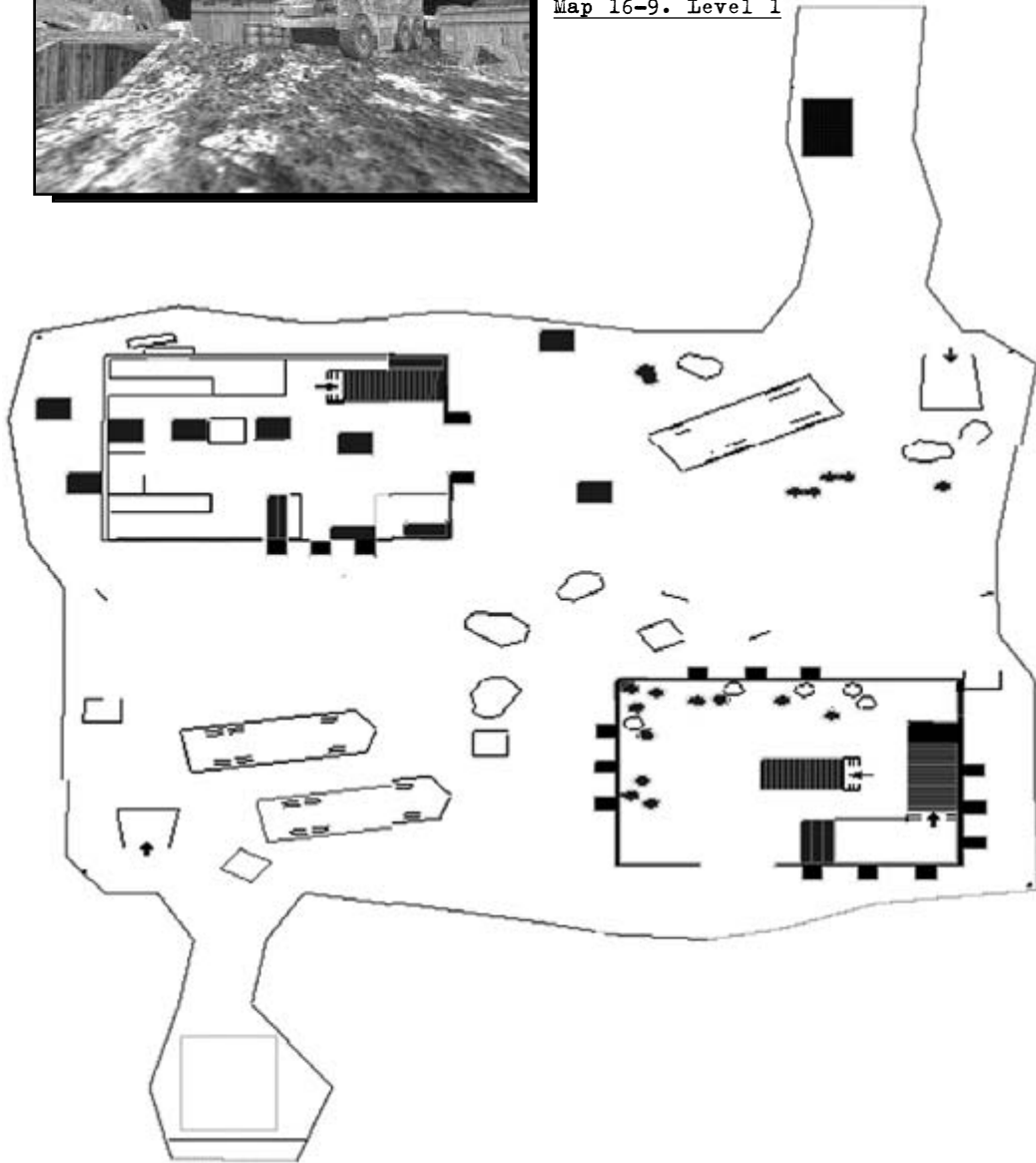

Map 16-10. Sublevel

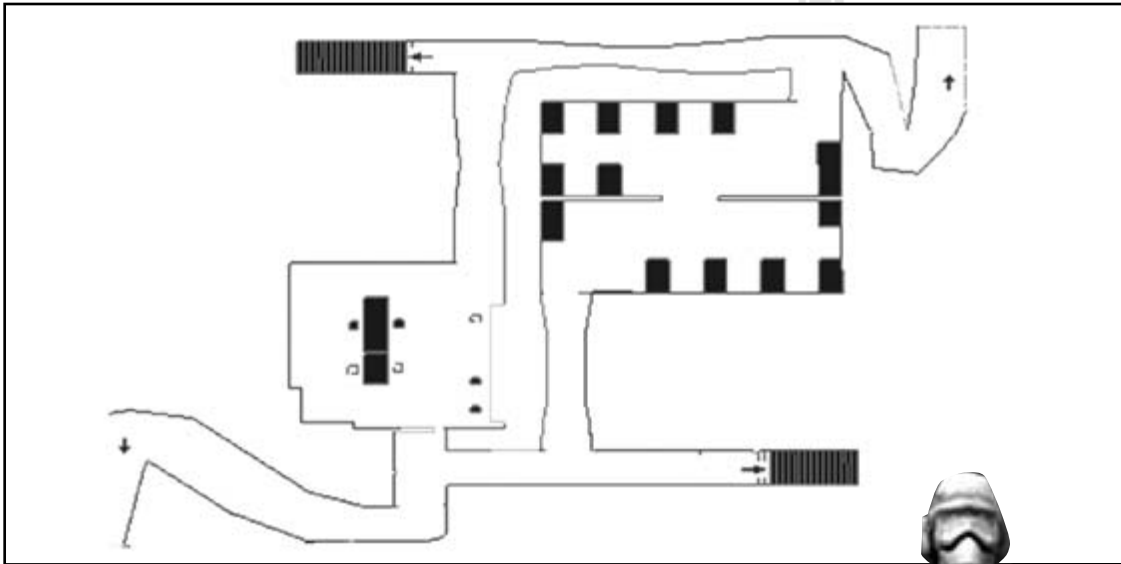

PRIMAGAMES.COM

Another good map, with building for headquarters. Each one has an excellent sniper spot that covers access to the building. There is also a subterranean level that fosters interesting fire fights.





## OFFICE BUILDING

Montreal, Canada

Map 16-11. Level 1

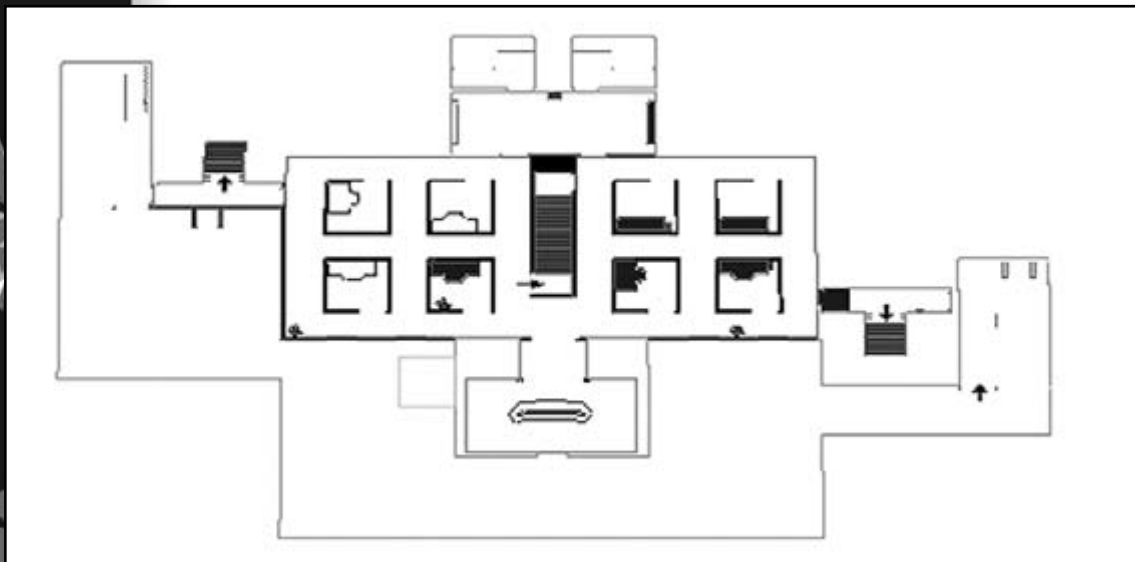

Map 16-12. Level 2



This map is almost all indoors, and covers two floors of an office building. It consists of open areas broken up by cubicles and small offices. If you crouch, you can hide behind the walls of the cubicles. Bring a lot of frag grenades—they're great for throwing over cubicles and at office doors to open them and blast whoever is inside.





**PAGODA**  
Achinoe, Japan

Map 16-13. Level 1

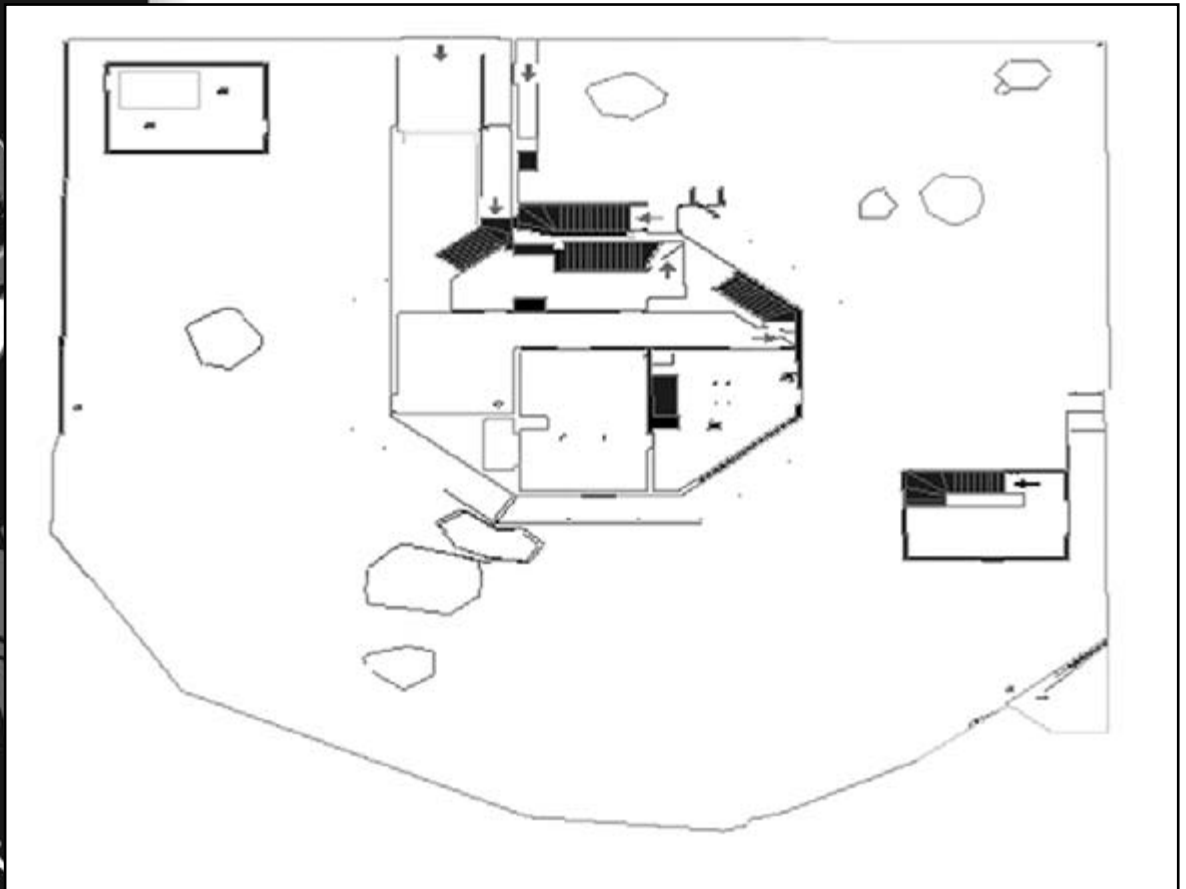

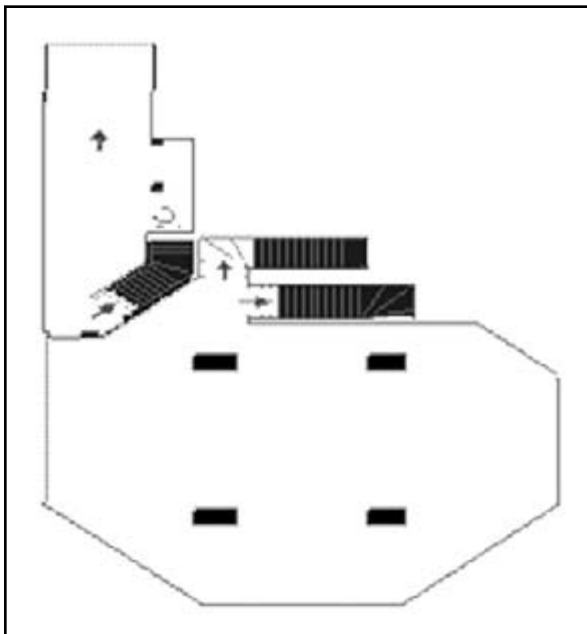
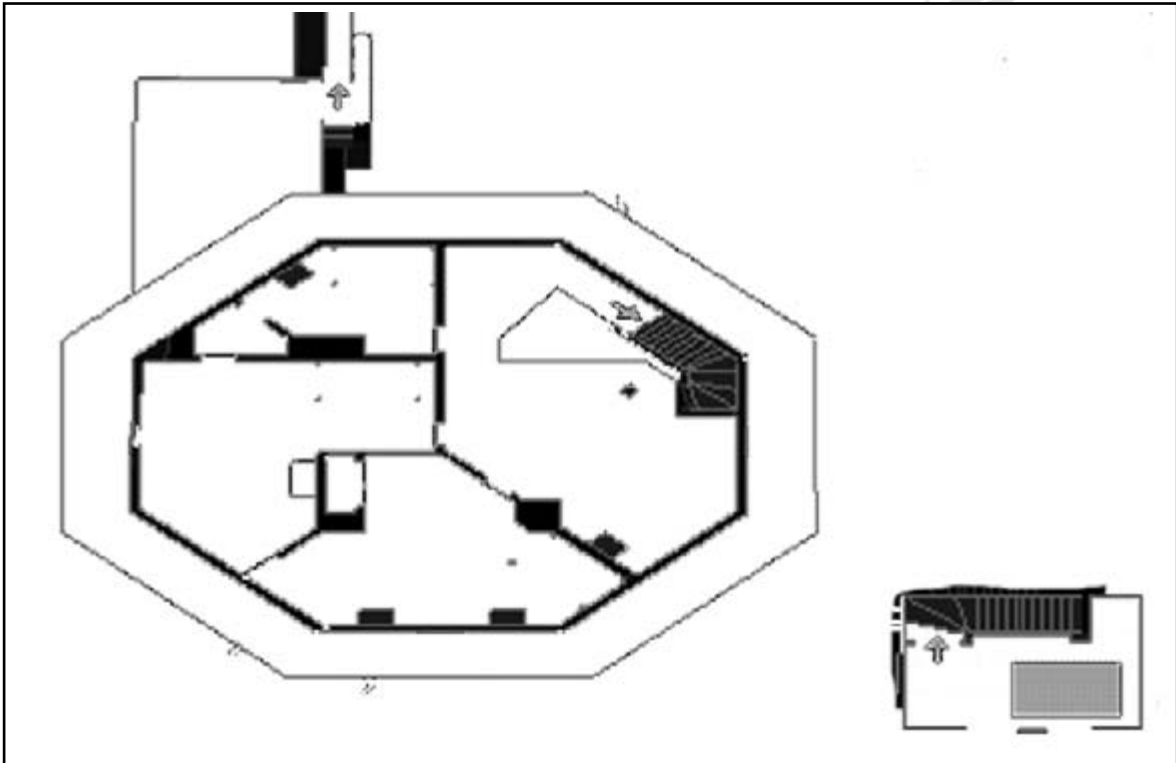
Map 16-14. Level 2Map 16-15. Sublevel

This map consists of a large building in the center and two small buildings in opposite corners. The outside area has some obstacles that provide cover. The large pagoda in the center provides a few sniping spots through windows on the second floor.