

The independent monthly magazine for users of Timex Sinclair computers

48516

Volume 1 # 4

U.S. \$2.95

Canada \$3.50



Bulk rate  
U.S. Postage  
paid  
Permit # 527  
Norwood, MA

# timex sinclair user

Print banners  
with your 2040

FORTH  
explained

Contest #1  
winners

Announcing  
the T/S2068  
and T/S1500  
from  
Timex



**PLUS: Software, hardware  
& book reviews, 8 pages of prog  
and much more!**



# TIMEX MAKES THE COMPUTER, BUT WE MAKE IT TICK.

If you own a TS-1000 or ZX-81 computer and want to bring out the power within it, you'll want Memotech. From easier input to high quality output and greater memory, Memotech makes the add-ons you demand. Every Memotech peripheral comes in a black anodized aluminum case and is designed to fit together in "piggy back" fashion enabling you to continue to add on and still keep an integrated system look.



**MEMOPAK RAM** All Memopak RAMs are directly addressable, user transparent, are neither switched nor paged and no additional power supply is required. You can also choose the Memopak RAM which is just right for your needs. From economy to power. **16K RAM** The Memopak 16K RAM is the most economical way to add memory to your TS-1000. It is fully compatible with the Timex or Memotech 16K RAMs to provide you with up to 32K of RAM. The 16K RAM also offers additional add-on capabilities through its "piggy back" connection. **32K RAM** The 32K Memopak enables you to execute sophisticated programs and store large data bases and like the 16K RAM is fully compatible with Timex's or Memotech's 16K RAMs to give you a full 48K of RAM. **64K RAM** The 64K Memopak is powerful enough to turn your TS-1000 into a computer with capabilities suitable for business and educational use. It accepts such BASIC commands as 10 DIM A (9000). **MEMOCALC** Memocalc, our spreadsheet analysis

software, enables TS-1000 users to perform complex number crunching routines with ease. With the 64K RAM a table of up to 7000 numbers with up to 250 rows or 99 columns can be specified. Quick revisions can be achieved by entering new data to your formula.

**MEMOTECH KEYBOARD** For ease of operation, the Memotech keyboard is a high quality standard typewriter keyboard, with TS-1000 legends. The keyboard is cable connected to a buffered interface which is housed in a standard Memopak case and plugs directly into the back of the



TS-1000 or other Memopaks. **MEMOPAK HRG** The Memopak High Resolution Graphics, with up to 192 by 248 pixel resolution, enables display of high resolution "arcade game" style graphics through its resident 2K EPROM, programmed with a full range of graphics subroutines.

### CENTRONICS PARALLEL AND RS232 INTERFACES

Memotech's Interfaces enable your TS-1000 to use a wide range of compatible printers. The resident software in the units gives the

complete ASCII set of characters. Both Memopak Interfaces provide lower case character capabilities and up to 80 column printing. The RS232 Interface is also compatible with modems and terminals.

**SEIKOSHA GP 100A PRINTER** The Seikosha GP 100A uses a 5x7 dot matrix printing format with ASCII standard upper and lower case character set. Printing speed is 30 characters/second with a maximum width of 80 characters. The printer uses standard fanfold paper up to 9-1/2 inches wide. The GP 100A is offered as a package including cable and

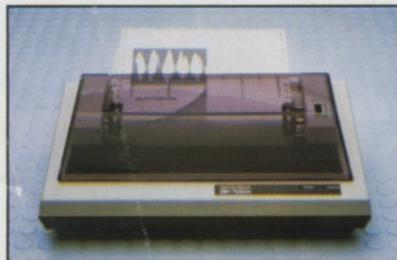

interface. Other printer packages are also available through Memotech.

**ORDER AT NO RISK.** All Memotech products carry our 10 day money back guarantee. If you're not completely satisfied, return it within ten days and we will give you a full refund. And every Memotech product comes with a six month warranty. Should anything be

defective with your Memotech product, return it to us and we will repair or replace it free of charge. Dealer inquiries welcome. To order any Memotech product use the order coupon or call our toll-free number **800/662-0949**.

TS-1000 is a registered trademark of Timex Corp.

**MEMOTECH**  
CORPORATION

7550 West Yale Avenue, Denver, Colorado 80227, 303/986-1516, TWX 910-320-2917

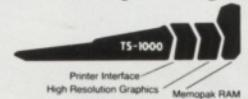

Mail To: Memotech Corporation, 7550 West Yale Ave., Denver, CO 80227

Code: **TS-07**

|                               | Price*   | Qty. | Total   |
|-------------------------------|----------|------|---------|
| 16K RAM                       | \$ 49.95 |      |         |
| 32K RAM                       | 99.95    |      |         |
| 64K RAM                       | 149.95   |      |         |
| Memocalc                      | 49.95    |      |         |
| Keyboard with Interface       | 99.95    |      |         |
| High Resolution Graphics      | 99.95    |      |         |
| Centronics Parallel Interface | 74.95    |      |         |
| RS232 Interface               | 99.95    |      |         |
| Printer Cable                 | 19.95    |      |         |
| GP 100A Printer Package**     | 399.00   |      |         |
| Shipping and Handling         | 4.95     |      | \$ 4.95 |
| Tax (Colorado residents only) |          |      |         |
| TOTAL                         |          |      | \$      |

\*All prices quoted in U.S. dollars. Prices and specifications subject to change without notice.  
\*\*Please add an additional \$5.00 for printer shipping charges.

Check  MasterCard  Visa

Account No. \_\_\_\_\_ Exp. \_\_\_\_\_

Name \_\_\_\_\_ Phone number \_\_\_\_\_

Address \_\_\_\_\_

City \_\_\_\_\_ State \_\_\_\_\_ Zip \_\_\_\_\_

## Expands the use of your TIMEX SINCLAIR COMPUTERS

### Softbox™\*

- Expands the expansion port of your Timex Sinclair computer
- Has 4 gold plated, fully buffered ports
- Software selectable, any desired port/ports
- Longer life to your computer console and program cartridge
- Has LED indicator, on/off switch and DC power input jack
- Provides power to your computer and peripherals
- Eliminates the computer overloading and peripheral connection problems

#PL7012      \$59.95

### INTERCONTROLLER™\*

Makes Your Life a Little Easier

- Puts your Timex Sinclair computer to work around the clock at home, office or your laboratory
- Does any number of tasks for you automatically (turns on/off your lights or motors, waters your lawn . . . . .)
- Contains 4 programable socket outlets, each of which supplies up to 6 Amps at 110 Volts and 60 HZ
- Controls from fractions of seconds to days
- If SOFTBOX is used, up to 4 intercontroller units can be connected to your computer

#PL7013      \$59.95

\* Needs flexible ribbon connector; will be available for TS1500 and TS2000 computers



### MCODER (16K RAM)

- The first real integer BASIC compiler for the TS1000 computer
- Give your BASIC program the speed of MACHINE language programs
- 75 times and in some cases up to 900 times speed improvement
- Very simple to use:
  1. Load MCODER
  2. Write your BASIC program according to the manual and compile it through the MCODER by using a single PRINT USR command
- BASIC programs can be compiled and

### QSAVE

A Reliable Fast Loading System

- Operates 16 times faster than the Sinclair system (i.e. Loads/Saves 8K in 10 secs; 48K in 110 secs)
- Operates with any memory and on any program length
- Works equally well with AUTORUN programs, BASIC or MACHINE CODE
- This is what you get:
  1. A cassette interface to improve the signal quality. To make loading most reliable an AUTOMATIC LEVEL CONTROL, an OVERLOAD WARNING LIGHT, a SAVE/LOAD SWITCH, an ON/OFF SWITCH are also built into this unit.
  2. Highly sophisticated, superbly easy to use 1/2K software

#PL7001      \$37.95

mbly language  
imes and other  
needs SOFT-  
M and Ribbon

\$34.95

Computers

SOFTWARE  
NAGEMENT

SPECTRUM/

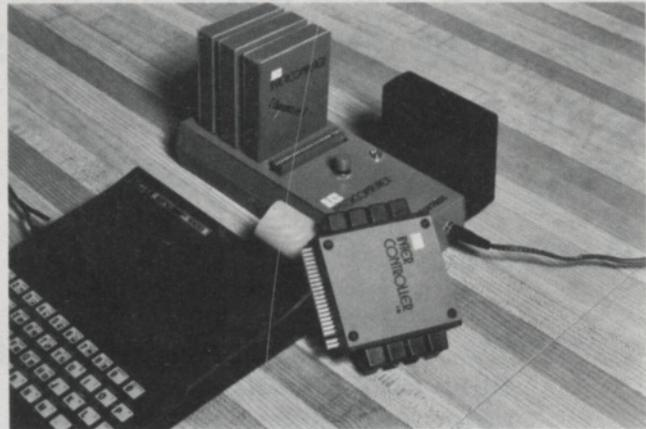

### FLEXIBLE RIBBON CONNECTOR

No More System Crashes

- Connects any RAM expansion to your TS1000
- Prevents usual system crashes caused by the computer or the RAM movement
- 7 inches long flat ribbon cable

#PL7016      \$17.95

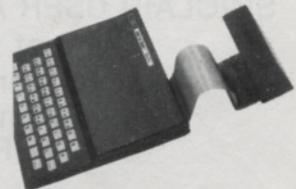

### STOPPER

- Enables you to break through any machine code software, list it on the screen, save it on another tape, or print it out
- Very simple to use, load STOPPER into your TS1000 and follow the simple instructions on the screen

#PT4002      \$18.95

### DEALERS/DISTRIBUTORS PACKAGE AVAILABLE.

Phone orders: (617) 437-1190 7 days a week.

Mail to: Intercomputer, Inc., P.O. Box 90  
Prudential Center, Boston, MA 02199  
Tel: (617) 437-1190  
Telex: 951141COFAR

| PART #                | QTY.        | UNIT U.S. \$                        | TOTAL |
|-----------------------|-------------|-------------------------------------|-------|
|                       |             |                                     |       |
|                       |             |                                     |       |
|                       |             |                                     |       |
|                       |             |                                     |       |
|                       |             |                                     |       |
|                       |             |                                     |       |
|                       |             |                                     |       |
|                       |             |                                     |       |
|                       |             |                                     |       |
|                       |             |                                     |       |
|                       |             |                                     |       |
| Shipping and Handling |             | 4.95                                |       |
| Mass. Residents Tax   |             | 5%                                  |       |
|                       |             | <b>Total</b>                        |       |
|                       |             | <input type="checkbox"/> Check      |       |
|                       |             | <input type="checkbox"/> Mastercard |       |
|                       |             | <input type="checkbox"/> Visa       |       |
| Account No. _____     |             | Exp. _____                          |       |
| Name _____            |             |                                     |       |
| Address _____         |             |                                     |       |
| City _____            | State _____ | Zip _____                           |       |

# SPECIAL OFFER

★★★★★★★★★★★★★★★★★★★★

Get the best of British Sinclair with ...  
The Sinclair User Annual

NOW — the best programs, advice and features from the top Sinclair computer magazine in the U.K. are available in North America in Sinclair User Annual!

SINCLAIR USER ANNUAL — from the home of the Sinclair (Timex) computer comes the best of the top-selling magazines, Sinclair User, Sinclair Programs and Sinclair Projects!

TIMEX SINCLAIR COMPUTERS — originated in the U.K. three years ago where there are now over one million users. Sinclair User Annual gives you the cream of their programs, projects and ideas!

T/S1000,ZX81 — get more fun, more knowledge, more programs, practical projects, hints and tips from other enthusiasts. Take advantage of their experience to get more from your computer.

YOU GET — 116 pages including exciting software and hardware reviews, graphics ideas, 19 pages of program printouts, a Spectrum (T/S2000) preview, technical information, programming help ... and much more!

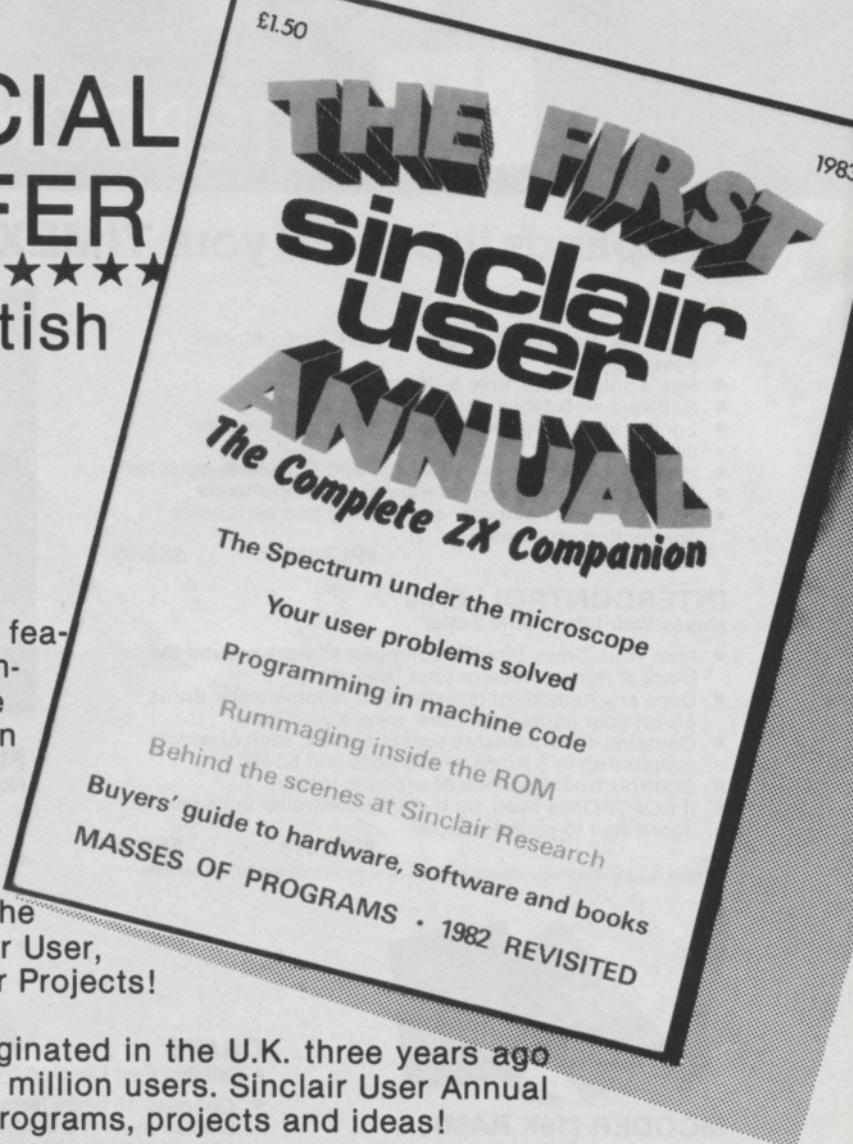

U.K. price ..... \$4.00  
(including handling & shipping)

**SAVE 30%**

MAIL THIS COUPON TODAY!

**ONLY \$2.75**

# Contents

## timex sinclair user

### President

Terry Cartwright

### Editor-in-Chief

John Sterlicchi

### Managing Editor

Joseph Gladstone

### Art Director

Vladyana Krykorka

### Production Editor

Bill Gladstone

### Associate Artists

Gwen Egan

Don Kletke

Katarina Altrichter-Raksany

### For SUBSCRIPTIONS

Phone 800-543-3000

Operator 243

### Editorial Assistant

Becky Ashwell

### Chairman

Richard Hease

Timex Sinclair User is published monthly by ECC Publications Inc. in conjunction with C.W. Communications/Inc.

If you would like to contribute to Timex Sinclair User, please send programs, articles or ideas for hardware projects to:

**Timex Sinclair User**  
49 LaSalle Avenue  
Buffalo, N.Y. 14214

Programs should be on cassette and articles should be typed and double spaced. If you wish your material returned, enclose a stamped, self-addressed envelope.

We pay \$20 for each program published and \$100 per 1,000 words for each article used.

© Copyright 1983  
Timex Sinclair User  
ISSN 0737-0881

Typesetting by  
International Typesetting  
Printing by  
Clark Franklin Kingston Press

**Advertising Sales**  
Bill York  
Hajar Associates  
(617) 444-3946



Software reviews, page 5.



News from Britain, page 59.

|  |           |
|--|-----------|
| <b>SOFTWARE</b> _____  | <b>4</b>  |
| Seven new reviews and a new feature — "Previously Reviewed"                |           |
| <b>NEWS</b> _____  | <b>8</b>  |
| A computer museum, libraries that loan T/S computers, and more             |           |
| <b>TIMEX EXPECTATIONS</b> _____  | <b>11</b> |
| Timex creates confusion as well as computers                               |           |
| <b>COVER</b> _____   | <b>12</b> |
| Chuck Durang on two new arrivals from Timex                                |           |
| <b>CONTEST</b> _____   | <b>18</b> |
| Ten winners of our first contest announced and their 2K programs described |           |
| <b>FEATURE</b> _____   | <b>20</b> |
| The Binary Banner: a great new 2000-series program by Fred Blechman        |           |
| <b>HOW TO PROGRAM</b> _____  | <b>26</b> |
| Part four in John Gilbert's five-part series                               |           |
| <b>PROGRAM PRINTOUT</b> _____  | <b>29</b> |
| Treasure Hunt, 3-D Tic-Tac-Toe, Hampson's Plane and more programs listed   |           |
| <b>LETTERS</b> _____   | <b>38</b> |
| Our readers have their say   |           |
| <b>IN-DEPTH</b> _____  | <b>42</b> |
| Bill Payne explains the computer language known as FORTH                   |           |
| <b>HARDWARE</b> _____  | <b>48</b> |
| This little gizmo is a must for every T/S user                             |           |
| <b>HINTS &amp; TIPS</b> _____  | <b>51</b> |
| Learn why you are your computer's worst enemy                              |           |
| <b>USER GROUPS</b> _____   | <b>53</b> |
| The Boston Computer Society's Cliff Danielson built an octopus             |           |
| <b>U.K. WINDOW</b> _____   | <b>59</b> |
| The creator of the computers that bear his name is knighted                |           |
| <b>BOOKS</b> _____   | <b>61</b> |
| Despite flaws, David Lien's new BASIC primer is irresistible               |           |
| <b>BULLETIN BOARD</b> _____  | <b>63</b> |
| Product information, upcoming events and other items of interest           |           |

## Next month

- Build a color board for your Timex computer
- How to program arcade games and much more!

## Amusement for Brainy Types

### THE NOWOTNIK PUZZLE

Reston Associates, 16K

If you ever tried Rubik's Cube or the many similar games and puzzles which followed it, you'll love this one. It operates in two dimensions and the graphics are excellent.

Here's what happens. In level one the screen is divided into four squares which move at random up, down, left and right. Then all you have to do is reassemble the original design pattern. It sounds simple. The movement is fast and the game is user-friendly.

There are five levels available. I spent my time in levels one and two. I looked at five, but I just couldn't afford more psychiatric help and my bartender was on vacation. It is amazing. The design in level five consists of an 8 x 8 grid which moves at random as well.

Although I have yet to do well on it, I like the game. My children (as usual) are better at it than I. The whole family, plus miscellaneous visitors, guests and relatives (even my mother-in-law) shared my enthusiasm. Depending on your attitude to a challenge, this could be great!

### MEGA MIND

Orbyte, 16K

It takes a long time to load (almost six and a half minutes), so start it up, then go make a pot of coffee because this one is fairly addictive and you'll need to stay awake and alert. In fact, while you play one game against the computer on half of the screen, the computer is solving your problem on the other half.

The graphics are inventive as the screen is "painted" black very neatly in two different ways. Be sure to read the directions and, if you can, sketch the

possible shapes. The play of the game is similar to the popular game called Mastermind. You guess what shape is in which position. The computer tells you only that you have a number of shapes in the right place, or in the wrong place, or the wrong shapes all together.

It's not a game for everyone, but I liked it, especially since I blew it on level one (easiest) and solved the level five (most difficult) in three guesses! I know it's just luck, but it was enough to hook me and keep me going for one pot of coffee!

### THE CUBE GAME

Timex, 16K

This is a computerized version of Rubik's Cube. It loads easily but slowly in five minutes and thirty-seven seconds. Then you are faced with your first decision: your cube — will it be a solid, two-dimensional (unfolded), or a see-through three-dimensional cube?

The movements are fairly complex as you are faced with choosing one of eight axes to move. However, only the X, Y and Z axes refer to rows, the others are commands to list moves, store the game, start again, and so on.

After choosing your axis, you pick a number to move the chosen row the right direction. There are nine choices here.

The graphics make the best use of the machine, but I found them difficult to get used to, particularly with the see-through cubes. The movements are fairly slow but acceptable.

On the whole, I prefer the graphics and play of the Nowotnik Puzzle over the Cube Game. The directions are simpler, the play is faster, and although I've yet to become an expert (heck, I'm not even good enough to be mediocre at it) I enjoy the puzzle. — George Miller

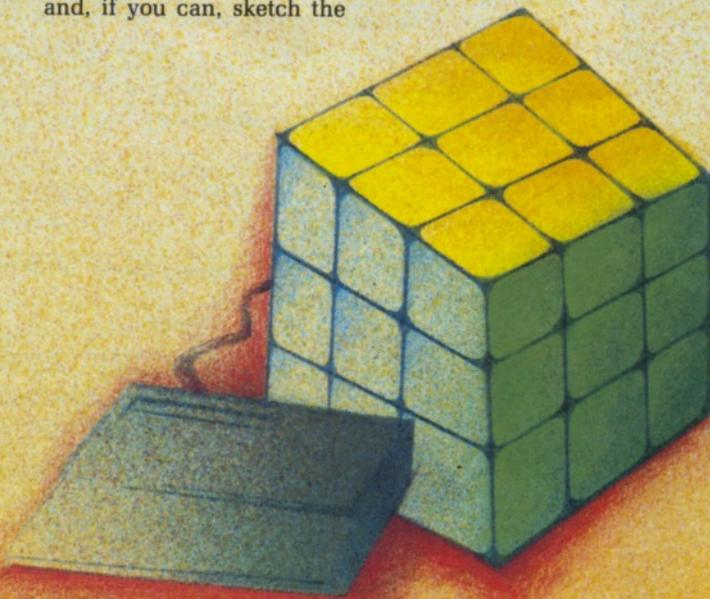

### TSU Rating

All three games load and play well. The graphics for the Nowotnik Puzzle and Mega Mind are clearly superior to The Cube Game. I also find the play of Nowotnik slightly preferable.

| Name      | Publisher | Graphics (1-10) | Play (1-10) | Directions (1-10) | Service Card No. | Rating |
|-----------|-----------|-----------------|-------------|-------------------|------------------|--------|
| Nowotnik  | Reston    | 9               | 8           | 9                 | 3                | ★★★★   |
| Mega Mind | Orbyte    | 8               | 8           | 8                 | 4                | ★★★    |
| Cube Game | Timex     | 7               | 6           | 6                 | 5                | ★★     |

## 3 in 1

### MIXED GAME BAG 1

Timex, 16K

The Mixed Game Bag 1, as the name suggests is actually three games on one tape. Since each is a separate program, they are reviewed individually, followed by a final evaluation.

Bowling is a graphic game which simulates ten-pin bowling. The player bowls ten frames, controlling the ball's direction with the up and down arrows. As in real life bowling, the player attempts to achieve the highest score possible. If your aim is true you can bowl strikes; there are two balls per frame so if you miss a strike you can try for a spare. After each frame is bowled, the score is tallied and displayed, and at the end of the game you are given your total pin count and final score. Bowling is fun, easy to play, and requires no special skill.

In Bingo you are given a card. The computer calls out numbers randomly from 1 to 75 and posts them under their corresponding letters. The screen is your card and the letters B I N G O are printed across the top of it.

It is very easy to cheat at this game by simply typing in Bingo. The computer does not confirm whether you have indeed won, and will accept your claim without checking. Bingo is slow-moving and rather dull, and would be noticeably improved if (a) the computer verified your claim of Bingo, and (b) you had the option—as in real Bingo, of playing more than one card.

Robot Wars is an intriguing take-off of the game *Mastermind*. In *Star Wars* fashion you receive instructions to defend your galaxy



against the evil robot Korkon. You do this by matching exactly (within ten rounds) Korkon's randomly picked, four-digit number.

Certainly the most challenging of the three games, *Robot Wars* requires exacting thought and cold logic. After you enter your four-digit number a short animated spar, complete with lasers and laser shields, is fought between your robot ("our boy") and Korkon. If you misjudge Korkon's number altogether you will end up in chains, but if you pick any correct digits you will be told how many are correct and how many are in the proper sequence. From this information you can plot your next move. The instructions are clearly and humorously presented, and the graphic effects in this game have a distinctly professional touch.

The Mixed Game Bag 1 is an entertaining assortment of three games, which are all, in their fashion, rather amusing and well done. The player should find many hours of entertainment in this software package, particularly with *Robot Wars* and *Bowling*. On its own, *Bingo* leaves much to be desired, but coupled with the other two

it helps to create a well rounded package.

★★★

3-star rating

For more information, circle 6 on the reader service card.

## Flying High

PILOT

Mindware, 16K

In *Pilot* you are in the cockpit of a small aircraft and must bring it to a safe landing.

*Pilot's* main menu lists seven possible modes of play, including final approach, take off and automatic pilot. Twelve control keys give you control of such things as direction, speed of climb and descent, and flap and landing gear. The realistic cockpit panel measures and displays your heading (in degrees), air speed, altitude, wind velocity, r.p.m., landing gear and flap positions, and distance to the runway. It also has a fuel gauge, automatic direction finder and an artificial horizon which allows you to 'see' your position. Landing is extremely difficult but you can always switch to automatic pilot for safe-

ty. At the end of each flight the computer tallies up your navigation and flying skills, and also charts out the correct landing path.

★★½

2½-star rating

For more information, circle 7 on the reader service card.

## Lazy Monster

3D MONSTER MAZE

Melbourne House, 16K

*3D Monster Maze* brings Tyrannosaurus Rex to the 20th century and sets him loose in a graphic maze of seemingly endless corridors which often lead nowhere. The player enters the maze and must avoid Rex while at the same time seeking escape through the maze's one exit. Points are accumulated by avoiding Rex when he is tracking you, and you win by escaping the maze altogether.

*3D Monster Maze* has good graphic effects and you really do get the impression of being inside a huge maze. The computer informs you when Rex is hunting you, when he gets close ("footsteps approaching") and when he is just lying in wait. If you encounter Rex you will be instructed to run, and you can easily outrun him. When Rex lies in wait you have the opportunity to explore the maze and find the exit, but you should be careful as you can accidentally run into him.

*3D Monster Maze* could be an 'amazing' experience, but I found that Rex spends more time lying in wait than he does tracking. This tends to slow down what would otherwise be a fast paced, exciting race.

— M.K. Wilson

★★

2-star rating

For more information, circle 8 on the reader service card.

## Softsync kit enhances graphics

FOR many Timex Sinclair owners, the low-resolution graphics are the computer's sole limitation. It is not that the selection between black, gray and white shapes is so offensive, but rather that the pixel size is so large and available only in squares — no circles or curves. So any device purported to enhance the graphics is sought after like the Holy Grail.

**Graphics Kit**, a 16K graphics toolkit distributed by Softsync, occupies 2K at the top of the 16K RAM and is compatible with their Programmers' Toolkit. Through various combinations of POKE and USR instructions, it offers 23 machine language routines and enables your T/S1000,ZX81 to DRAW/UNDRAW multi-character shapes, which you define in a REM statement; REVERSE all characters to their inverse video; BORDER/UNBORDER around the screen; SEARCH and REPLACE any character you indicate throughout your program; FILL in lines with the character of your choice; SCROLL in four directions; and use FOREGROUND on/off to create the illusion of graphic characters moving in front of and behind one another.

Other machine language routines include square and rectangle drawing, plus left, right, up and down print position controls. But *caveat emptor!* The machine language routines are stored in RAMTOP and are not accessible for external study and application. Whatever is gleaned from the information can be ap-

plied only privately without violating copyright laws. What good is this to anyone who wishes to sell programs? The user is handcuffed and unable to apply these techniques elsewhere.

The packaging is disappointing; instructions begin on a piece of heavy card, then transfer to a slick, three-page booklet. Why two parts? Also, our tape would only load from one side: typographical errors and unclear instructions equally prevented us from fully enjoying Graphics Kit.

But the demonstration program is informative and entertaining. If every Timex Sinclair retail outlet continuously ran the Graphics Kit in their stores, owners-to-be would sooner realize the power packed into the tiny black box, and sales would soar.

We approached Graphics Kit with hopes of creating beautiful graphics for our games and of more fully understanding the capabilities of our T/S1000,ZX81. But when we attempted to reproduce the functions contained in the Kit for use elsewhere, we found the program listing locked and the documentation poor. We were able, however, to obtain the listing of the DEMO program from which we learned a bit about how to use the program. If you program for your own entertainment and you'd like to spice up your graphics, then Graphics Kit is recommended. (For more information, circle 9 on the reader service card.)

— Julie Knott  
and Dave Prochnow

## Previously Reviewed

All tapes are 16K unless otherwise noted.

**Chessmaster — Chess.** Allows you to save unfinished games for later, change sides, resign, and choose one of seven levels of difficulty. Of all chess programs, our reviewer gave this one top marks. ★★★

**Intercomputer — Demolisher.** Drop bombs on an increasing mass of blocks beneath you. Our reviewer called this game a sleeper. ★½

**Intercomputer — Missile Launcher.** Target practise. This slow, simple game does not make good use of its 16K, and allows you to participate only in the firing of missiles. ★½

**International Computers — Galactic Invasion.** Choosing the velocities of your 15 rockets also determines their directions; you fire them to save Earth from invaders. Also on the tape are three action games, a solitaire and a drawing program. None are very fast or really engaging. ★½

**International Publishing & Software — Flashcard.** In the classroom, a flashcard has a problem on one side and an answer on the other. This program lets you input the problems and answers, poses questions at random, and gives a score at the end. ★★★

**International Publishing & Software — Galactic Invaders.** Seven alien ships fly over your laser base; when you destroy them, the next regiment appears. You get to choose the speed. Annoyingly, some of the aliens take long rests on the ground, but the game is still a must for the video game connoisseur. ★★★

**International Publishing & Software — Galaxia.** You must protect Earth from hostile Thargons in this Invaders-type game. Dive-bombing aliens, smooth action, fast machine response and good graphics make it fast and challenging. ★★★

**International Publishing & Software — Home Money Manager.** Lets you keep track of your finances on a monthly basis, then do a month-by-month or full year balance sheet. Well-documented, well-conceived, user-friendly. ★★★½

**International Publishing & Software — 1K Chess.** Limited-option game suitable for beginners on an unexpanded ZX81. Does not allow castling or en passant moves. ★★

**International Publishing & Software — 2K Chess.** Allows castling and en passant moves but will not let you change sides, resign, or save a game for later. Suitable for intermediate players using an unexpanded T/S1000. ★★½

**International Publishing & Software — ZX Assembler.** Occupies 7K at the top of the memory. Programming in machine language is much more difficult than in BASIC, but programs such as this offer aid by allowing you to enter and edit machine language using mnemonics. With the clear, detailed, 26-page manual and a good book on Z80 machine language, a beginner will find this program easy to use. ★★★½



# Software

**International Publishing & Software — ZX Scramble.** Hit enemy installations before they hit you, while maneuvering to avoid crashing into treacherous terrain. The game is slow, and the terrain repeats itself like a chase scene in a poorly animated cartoon. ★★

**Melbourne House — Combat Flight.** Fly through mountainous terrain and shoot at alien ships. An unexceptional invaders-type game. ★★

**Melbourne House — 3D-Orbiter.** As they approach, the alien ships grow and display increasingly fine detail; when you shoot them, they explode with wonderful realism. Besides the superb visuals, this game is very exciting and will provide hours of fun. ★★★★★

**Mindware — Cosmos.** Avoid hitting your own convoy and alien space mines as you fly through space looking for alien ships to destroy. Fast, fun and challenging. ★★

**Mindware — The Fast One.** A "computerized filing cabinet," ideal for setting up lists of phone numbers, recipes, addresses, inventories, and any other listable information. Excellent documentation. ★★½

**Mindware — Gulp.** You move around any of six mazes at any of nine speeds eating dots while a hunter pursues you. The keys that control movement are too close together, and after you eat the last dot you have to be captured before the game ends, but it's still enjoyable. ★★

**Mindware — Labyrinth.** You may choose to see an overview of the complex, 3D-style maze before you wander through it, and if you get lost and give up you get to see the whole picture again. With practise, the trek becomes simpler. An interesting game but not a classic. ★★½

**Mindware — Multiple Choice.** This so-called "educational" program asks questions like "What is the capital of New York state?" and "What is the square root of 2?" but isn't really anything more than an information drill. As such it works well, though, and lets you create tests of your own. ★★

**Orbyte Software — Home Budget.** Its 39 categories (which you can alter) help you organize your spending habits. After analyzing proposed and real budgets, this program compares them in graph form; and despite poor documentation, does a good job. ★★

**Psion — Flight Simulation.** Land your plane successfully on the runway, taking flying speed, wind speed, altitude, fuel and other variables into account. You win by not crashing. ★★★★★

**Quicksilva — Munchees.** From one to four ghosts (you get to choose) chase you around a well-constructed maze. The movement keys are too close together, causing difficulty at high speeds, but this game is still fun to play — repeatedly. ★★

**Reston Publishing — Invasion Force.** Shoot lasers through a moving force field to destroy alien ships, and watch out for bombs. The game is fun, the graphics distinctive. ★★½

**Reston Publishing — Math Series.** This full-fledged math program is divided into six sets corresponding to grades one to six, each with 32 lessons, a 64-page workbook, a vinyl storage case, and a hefty price tag. ★★½

**SoftSync — Computer Tutor.** This series includes Math Raiders and Alpha/Vowel Tutor, which really don't teach, but rather ask questions and correct wrong answers. For fun, it rates high; for educational value, it rates low. ★★½

**SoftSync — The Financial Manager and Record Keeper.** This well-designed program has 19 categories to help you keep track of your dollars, tells you what per cent of your income each of your expenses constitutes, and makes other sundry financial calculations. A good budget planner. ★★

**SoftSync — Night Gunner.** You are the pilot of an airplane in an aerial dogfight with four others, and must shoot them down before they shoot you. The game is fun, the action fast, the graphics not outstanding. ★★

**SoftSync — Starblaster.** One of a six-pack of 2K games marred by poor instructions but enjoyable for those who own machines with unexpanded memories. ★★

**SoftSync — TS Destroyer and Space Raid.** Fast action duo in 2K. In TS Destroyer, you must dodge or destroy floating objects as a spaceship takes potshots at you; in Space Raid, you must shoot a hole through a spaceship and hit the left foot of an alien. Neither game prints a score. ★★½

**SoftSync — Superchess.** Plays a mean game at ten different levels of difficulty. Recommends moves, plays itself, but doesn't let you save games for later. Packaging adequate but not great. ★★½

**Thomas B. Woods — ZX Data Finder.** This storage and retrieval system offers some very advanced title and word search features, and helps you keep track of everything from correspondence to car repairs. Comes with a complete listing and a thorough explanation. ★★

**Timeware — Chess.** Offers six levels of play, recommends moves, allows you to save unfinished games for later but not to resign. ★★

**Timex — Ator, the ABC Gator.** Eye-catching graphics, great pacing, and sound make this educational tape of great value to children just learning their ABCs. An adult is needed to synchronize the sound with the visuals and to help the youngster read the instructions. ★★½

**Timex — Chess.** Doesn't recommend moves, play itself, change sides or allow you to save or print games. Offers six levels of difficulty. ★★

**Timex — The Coupon Manager.** Before you go shopping, you can flip through your file of coupons and pick out the ones you need. Keeps track of amount, store and expiry date. A must for the compulsively organized. ★★

**ZX-Panding — Checkbook, Tax and Budget Organizer.** Helps you manage your finances. Comes with a clear, four-page booklet but gives no clear instructions on how to get going after loading. An excellent save frame lets you return to the menu in case of error. ★★



## World's First Computer Museum One Year Old

On June 10, 1983 the Computer Museum in Marlboro, Massachusetts celebrated its first anniversary. As far as we've been able to discover, this is the only independent computer museum in the world. It is a non-profit organization supported through corporate and private membership. Its purpose is to chronicle the evolution of information processing from the abacus to the silicon chip.

"Because computer history is continually being made, we're always changing," says museum director Gwen Bell. "Our exhibits and collection evolve as the technology moves forward."

The museum was founded by Digital Equipment Corporation. The Museum became independent with its own board of directors in June, 1982. Its next big move is planned for later this year when it will move to a new location on the Museum Wharf in Boston.

Museum programs include gallery talks on the lighter side of computing history. Such talks have featured a computer poet, the inventors of the first video game (Space War), and the designer of the world's largest computer sculpture ... a two-ton Easter egg in Alberta, Canada.

As well as lectures the Museum has a permanent display open to the public, guided tours, a computer store, library and viewing room. It is open to the public Sunday through Friday from 1:00 to 6:00 PM. Admission is free. For more

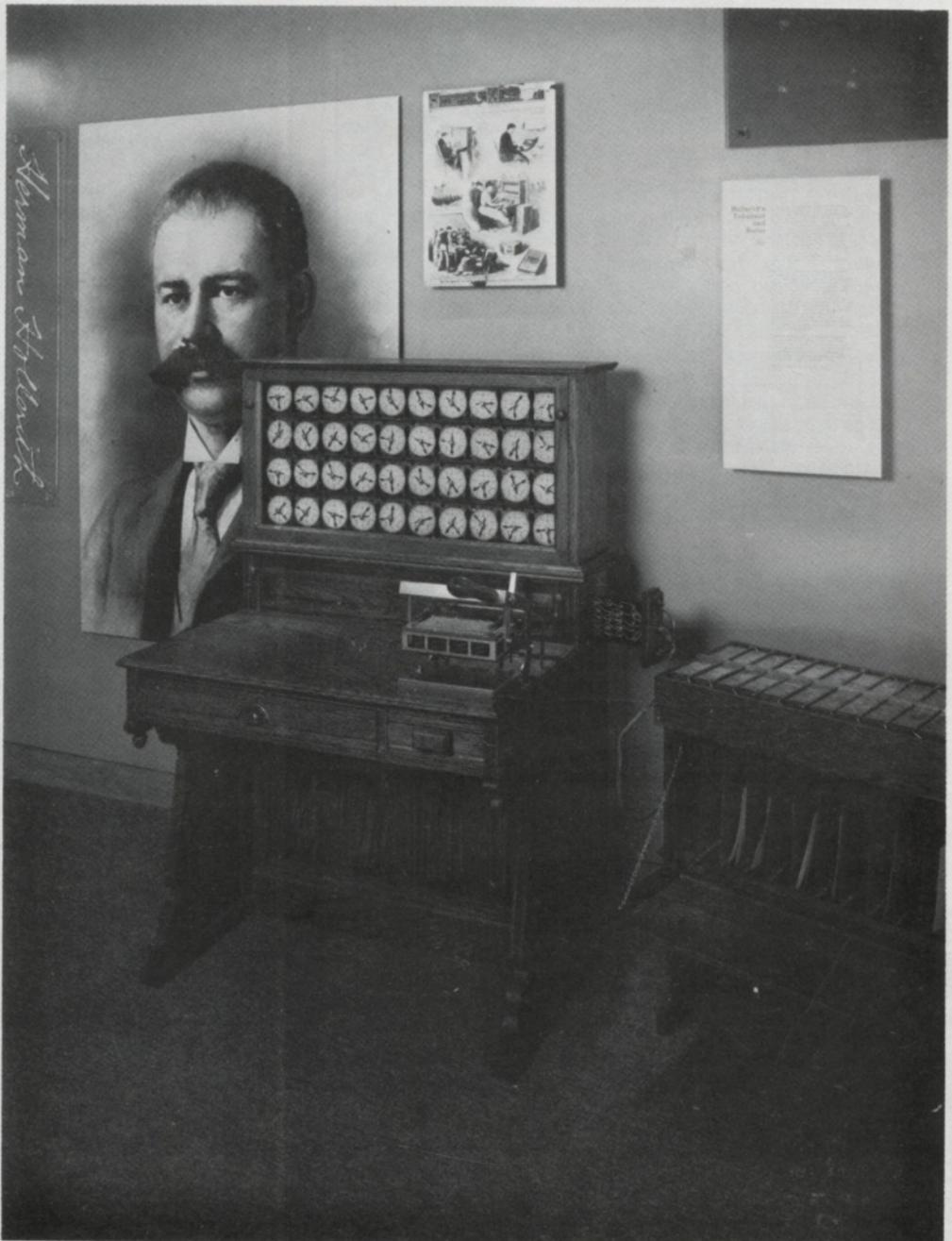

information you can write to the Museum at One Iron Way, Marlboro, Massachusetts 01752.

This exquisite full-scale model of a Hollerith tabulator was designed and built for the museum by a model maker in New York. The Hollerith punch-card computing device invented by Herman Hollerith to tabulate the 1890 United States census, cut calculating time from seven to three years.

Photo courtesy of Computer Museum.

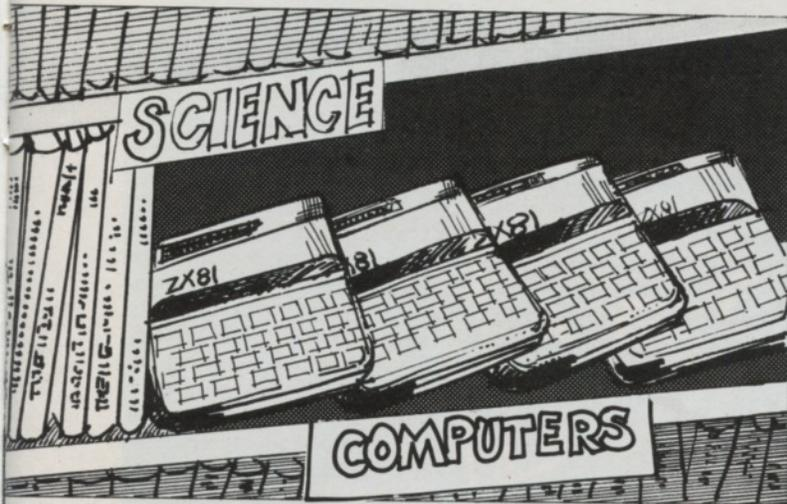

## T/S Goes to the Library

"Fantastic! A great idea! I can think of no better way to show people what a great machine the T/S1000 is." This excitement was generated when Greg Melko of Timex Computers of Canada discovered that two library systems in the Toronto area were allowing library users to become T/S users by borrowing a machine. The Oakville and Burlington library systems have introduced a computer lending program using the T/S machines exclusively.

While many libraries have computers for "in-house" use, this is the first program to allow the user to take the computer home to be established in Canada. Users and library officials agree that it is a very inexpensive way to let people learn about personal computers. Because of its portability and low initial cost, the T/S machine is ideal for programs of this sort.

Each library system

develops its own user fee. These fees range from free one week loans to a high of \$6 per day.

It is estimated that at present over 150 libraries across the United States have a computer-lending program. Many systems are "actively studying" the program with the goal of establishing one soon. The main problem seems to be simply a matter of funding. Again the T/S1000 with its under \$50 price tag appears to be the right machine for the job. P & J Educational Associates of New Jersey have established a unique business. They rent T/S computers to libraries, including a service contract so the libraries can loan them to users.

Many people fear computers. The take-home systems being established by libraries will help these people explore computers without having to make a commitment. The program is very popular wherever it

TIMEX SINCLAIR USER

## Busyness

Business/Professional Applications for Timex/Sinclair users.

Busyness is the only publication geared to professional & business applications for Timex/Sinclair users. Six times yearly Busyness presents Feature articles, New Products Information, Resource Listings . . . and more

Enclosed is my check for \$12.00 to cover a one year subscription. Make check payable to **Busyness**

Name \_\_\_\_\_

Address \_\_\_\_\_

City & State \_\_\_\_\_ Zip \_\_\_\_\_

Busyness P.O. Box 421773 S.F., CA 94101

For more information, circle 10 on reader service card.

## Synchro-Sette

The Subscription Magazine for the  
**SINCLAIR ZX-81 / TS-1000**  
**MICRO COMPUTERS**

Games, Educational,  
Business, Graphics, Tutorial, Etc.

12 Month Issues —  
6 Bi-Month Cassettes  
At Least 6 Programs Each

**\$39.50**

Illinois residents add \$2.07 Tax

Outside U.S.A add \$10.00

**24 HOUR HOT LINE:**  
**(800) 543-1300**

Ask For Operator 383.

**THE S & S COMPANY**

388 W. Lake Street

Addison, Illinois 60101

**(312) 628-8955**



For more information, circle 11 on reader service card.

**WANT TO BUILD  
YOUR LITTLE  
TIMEX/SINCLAIR  
INTO A REAL COMPUTER?**

*Try our plug-together systems.*

**MEMORY TO  
1M BYTE  
HI SPEED TAPE  
CHARACTER  
GENERATOR  
TRANSISTOR  
DRIVER  
RELAY DRIVER  
A/D CONVERTER  
FLOPPY DISC  
POWER SUPPLY  
CENTRONICS**

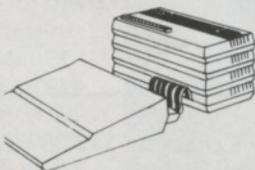

**SOFTWARE  
KEYBOARDS  
I/O PORTS  
SWITCHES  
CONTROLS  
JOYSTICKS  
HI RES  
EPROM  
SPEECH  
RS 232  
PRINTERS**

Dealer Inquiries Invited.

Catalog—U.S. Free, \$1.00 Outside U.S.

**Sinclair Place**  
P.O. Box 2288A • Redmond, WA 98052

For more information, circle 12 on reader service card.

**R.I.S.T. Inc. ANNOUNCES  
SPEECH SYNTHESIZER**

**\$69.<sup>95</sup>**

**\*ACT NOW:**

Exclusive Phrase Finder Program "\$5. VALUE FREE"  
Speech Synthesis Instruction Manual "\$10. VALUE FREE"

Receive

**HOW YOU CAN MAKE YOUR COMPUTER TALK.**

The PARROT newly introduced by R.I.S.T. Inc. gives the power of speech to Timex/Sinclair Computers. This simple to use plug-in speech module is capable of generating all the sounds in the English language. The combination of these sounds, in the order of your choice, will generate an unlimited vocabulary of words, phrases, and sentences as well as an array of sound effects.

Piggy-back expandability allows other modules (eg. memory) to be operating with the Parrot simultaneously.

Paul Donnelly had this to say in the April issue of Syntax:

"Documentation is professional..."  
"Overall, R.I.S.T.'s Parrot is an excellent unit and performs up to and beyond my expectations."

Many different applications can be shared among this common software interface: **GAME APPLICATION** programs for fierce competition between you and your computer can now be guided and accentuated with speech.

**HOUSEHOLD APPLICATIONS:** Relieve the pressure of "one eye on the clock". Program your computer to give you a call when your on a tight schedule and your time in the shower is running out; call you when your roast is ready; tell you when your favorite TV show is about to come on. The possibilities are endless in solving every day problems.

**EDUCATIONAL PROGRAMS:** Generate a program for your child, bringing the overwhelming simplicity of listening and learning. **YOU WILL ALSO RECEIVE:**

An exclusive phrase finder program—FREE. This program enables you to select, string together and pronounce your desired phrases. It makes editing of speech easy.

A 40 page speech synthesis manual—FREE.

\* See how certain sounds can be used to give your computer an unlimited vocabulary.

Other products available include:

Talking Poker Game Cartridge - brings excitement to the normal poker match between you and your computer. (R.I.S.T. Speech Synthesizer Required) - \$14.95 + \$1.00 S/H

SPS - 2 Amp Power Supply - UL Listed, the 9v, 2 amp supply gives all the power needed for expanded system operation. \$24.95 + \$2.50 S/H

**ORDER NOW  
LIMITED TIME OFFER**

HEAR THE POWER...

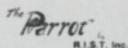

**SALE**

Send To: R.I.S.T. Inc.  
Dept. 2 (Formerly  
Voicetech)

P.O. Box 499, Ft.  
Hamilton Station  
Brooklyn, N.Y.  
11209 - (212) 259-4934

Please send me # \_\_\_\_\_  
Parrot(s) Speech Synthesizers for my   
ZX80  ZX81   
TS1000 at \$89.95 ea. plus  
\$4.00 sh/hd.

I will also receive an exclusive phrase finder program and a 40 page instruction manual, FREE.  
**15 DAY MONEY BACK GUARANTEE/C.O.D. ORDERS ADD \$1.75 PAY BY BANK CHECK OR MONEY ORDER**

*News*

is established. Within six weeks of starting in the Burlington system, there were over 130 names on the waiting list.

This type of project seems a logical step for libraries to take. They dispense information and certainly computers are part of the information world. It is only a matter of time until computers become a part of the lending program in every library.

**...and  
software  
does too**

PC Telemart, a national microcomputer software information and research service, has announced the opening of a software library, which it claims is the first institution of its kind.

Not a lending library, the National Software Library will serve as a major reference and research facility for the microcomputer industry. It will house a collection of thousands of microcomputer software programs and associated documentation, along with appropriate personal computer configurations.

Membership will be on a subscription basis, available to individuals as well as hardware and software firms and corporate end users.

PC Telemart publishes the *PC Clearinghouse Software Directory* and is launching an instore on-line database for software shoppers.

The National Software Library is located at 11781 Lee Jackson Highway, Fairfax, Virginia, on the first floor of the Dominion Federal Building at Fair Oaks Mall. It is about 20 minutes by car from downtown Washington, D.C.

**Of Things  
To Come**

The 1983 International Summer Consumer Electronics Show held in Chicago in early June gave us glimpses of the future. Over 1,200 exhibitors spread out in the huge McCormick Place, McCormick West and the McCormick Inn. They displayed, for the trade only, all their new ideas and products; the things you and I will be seeing in our stores in the fall. Everything from new electronic pens to the latest and cleverest electronic chess games were being hawked. Over 40 different companies showed personal computers, while over 100 displayed software and peripherals for those computers.

As well as exhibits, shows and products, there was a wide range of seminars provided by the different manufacturers on product and product sales.

Of special interest to us was the marvellous Timex booth. They did themselves proud. The new products, of which there were many, were well displayed and beautiful to use. The T/S1500 was there, the first 16K personal computer with a price tag under \$80. Beside it was the full T/S2000 line, including the 2048.

Timex proved to us again that it is determined to maintain the quality and low price features that have made it a leader in the personal computer field. Comparing the T/S1500 and T/S2000-series to the other low-priced computers at the show led us to conclude that Timex once more has left the competition far behind. We felt proud being Timex Computer owners.



For more information, circle 13 on reader service card.

TIMEX SINCLAIR USER

## Computers and Confusion



**T**WO NEW COMPUTERS FROM TIMEX! That's good news. The 2000 series is described on page 12. We looked at the 1500 in our previous issue. We're glad these new machines are with us. But having said that, let's look at the way Timex brought them to us. No sooner had we all bought our T/S1000s and were extolling its virtues when rumors of the 2000 series started making the rounds. Should we have waited? Did we purchase a Timex machine too soon? Some of us felt bewildered, out in the cold, "suckered".

Then, at the summer Computer and Electronics Show in Chicago, Timex unveiled the 2000 for all the world. It looked great then and still does today (though we have serious reservations about the design). What were we as consumers to do? Buy the 1000 or wait for the 2000? But wait. While we were still in a quandary about that problem, Timex leaked the news about the T/S1500, a beefed up 1000! If sales of the 1000 sagged before that leak, they definitely collapsed after. Everyone took a wait-and-watch attitude, and who can blame them!

Public relations is not a dirty act! Timex is a large company dealing with the public and better learn soon that the public will not stand for long being taken for granted. Timex inherited a large and loyal following from Sinclair. They introduced a great computer at a great price to us in North America. But how long does Timex expect to ride that crest? Eventually they must come to terms with the fact that we as consumers demand fair response.

In Britain, where the development of the incredible T/S1000 began, there is a close link between the public and the manufacturer of the ZX81. Information about

the computers developed and marketed by Sinclair is readily available. Here at home, Timex has greedily guarded every morsel of information as though you the user will run away with it. When will Timex understand that users keep them in business? T/S owners and users deserve the best available and will only get that when Timex loosens its stranglehold on the information surrounding its machines!

An interesting letter appears on page 38 regarding ZX owners. Here's a great chance for Timex to help a lot of owners. When Timex took over the sales in the United States, many ZX81 computers had already been sold here. Those machines need servicing, parts and support. Timex could do those users a great service by providing the needed support through their regular channels. C'mon Timex, the ball is definitely in your court on this one!

**T**HE WINNERS of our first contest are listed on page 18. They will receive a contract to have their programs marketed nationally.

We were lucky enough to attend a meeting of the Timex Sinclair User Group branch of the Boston Computer Society. It was fantastic! Over 100 enthusiasts spread out in the science auditorium of the University of Massachusetts. Users presented new ideas, product reviews and great personal announcements — like televisions for sale, where to get cheap parts, and so on. The library was an ongoing activity. User Group members could borrow books, cassettes or articles all related to T/S computers. The last hour was spent in small interest groups ranging from beginning in BASIC to machine code debugging. A great group! A great meeting! Thanks! ☺☺

Cover

# The New Arrivals

I. The T/S2000 series • II. The T/S1500



PHOTOGRAPHY • Bernie Prost ILLUSTRATION • Don Kletke

**T**IMEX Computer Corporation last year grabbed what some industry analysts think is the largest market share in home computing with a simple appeal: "the least expensive computer you can buy." The Timex Sinclair 1000 was essentially a Sinclair ZX81, unaltered since springing from the brow of Uncle Clive.

Appealing as the price was, the machine quickly revealed itself to have several flaws — the membrane keyboard, the RAM pack wobble, the cantankerous cassette storage circuitry — which did not bother the British "nation of tinkers," but enraged many of the impatient Americans.

Timex is correcting the 1000, with the redesigned Timex Sinclair 1500. But more importantly, they have learned their lesson and extensively redesigned the Sinclair Spectrum for the American market.

The Timex Sinclair 2000 is a more subtle "sell" than the 1000 was. It is not the least expensive computer. But it is very likely the best inexpensive computer . . . or the least expensive computer with an impressive array of features.

The machine is indeed impressive. It has a number of features that are easily accessible to the beginning user, and a number of other capabilities — largely added by Timex engineers — which are likely to be used by few home computerists, but whose availability to software developers will result in superb software for entertainment, education, and business applications.

### High Tech look

The Timex Sinclair 2000 comes in a sleek silver case, with a high-tech look. The keyboard is full-sized and spaced, although the solid plastic (not rubber 'chiclet') keys are not as large as on a normal typewriter — to allow space for the keyboard/function legends above and below the keys. The look is Olivetti rather than IBM.

There is a cartridge port beside the keyboard, with a door or lid over it. Dozens of tiny but powerful Timex Command Cartridges are

## "Bank-switching" gives access to up to 16 megabytes

available, containing software of all kinds.

There are ports for standard Atari-style joysticks on each side (room for two, not one).

There is an on/off switch, a television channel selector switch, cassette input and output ports, a television connection and a separate monitor output, and the unique Sinclair edge connector for peripherals.

Initially, the Timex Sinclair 2040 printer will attach to the edge con-

necter, and a wide variety of expanders and peripherals are sure to follow, from Timex and from third parties.

### Bank-switching capability

The 2000 comes with 48K RAM and 24K ROM. Timex points out that some competing machines claim a large amount of RAM but then use it up with programs and housekeeping functions which, in the T/S2000, remain in ROM or in the cartridges. There is even a unique "bank-switching" capability, which allows the machine to address up to 16 megabytes (!) on-line — yes, 16,000,000 bytes. For those who know that an 8-bit Z80 CPU can only address 64K at a time, have faith: the bank switching feature lives with that by switching "chunks" of memory in and out of

## Who Needs the Timex Sinclair 1500?

**S**OMEONE recently asked me the following question about the Timex Sinclair 1500: "Who needs a black-and-white machine anymore, with color computers down around \$100?"

It took weeks to figure out the answer. I believe it is as follows:

1. People who don't want to tie up the family color television set or drop \$300 more for a second set.
2. People who are, on the other hand, willing to spend \$80 for the computer and \$60 for the television (a b&w portable).
3. People who want a computer to run home "productivity software" — the new buzzword.

When Timex first started producing software for the T/S1000, they avoided game programs — "in black and white, with low resolution graphics, this machine can't compete with Ataris and the like" — and went in, instead, for business programs: inventory managers, mailing list maintenance, and so on.

Unfortunately, given the unreliable loading and saving, the flat keyboard and the wobbling RAM pack, the machine wasn't really appropriate for that software either.

But now much of the existing software becomes useful with the T/S1500. My free (and worth every penny) advice is:

1. To Timex: Explore the possibilities of portability. Specifically, link the 1500 with a tiny portable television (assuming Uncle Clive may never get done inventing his flat-screen) and some kind of internal battery power.
2. To software developers, Timex and others: Look hard at expanding the available "productivity software." With the Memotech printer interface making it possible to use a full-width plain paper printer, a word processing program seems a high priority . . .



## Whither the T/S1000?

At this writing, I suspect that Timex has not decided what to do about the 1000 — whether to discontinue it or keep it alive at ridiculously low prices. The likelihood is that they would like to discontinue it once they get the existing inventory out of the warehouse.

It seems likely that this machine — at least the insides, and very possibly the case too — can be “bundled” with peripheral devices and programs in firmware (“wired in” as in ROMs) for specific uses.

I can think of educational packages including the computer along with the programs . . . the T/S1000 as a control device packaged with the home or industrial machinery it controls . . . and other packaging notions similar to the current “calculator in a checkbook” gimmick now being used for credit-card sized calculators.

The T/S1000 has always had an allure for engineers because, in addition to its virtues as an inexpensive, easy-to-use beginner’s computer, it has some additional features:

1. It enables one to do very scientific things, not always easy to do on inexpensive computers (besides the one-key functions, for instance, it is programmable in Z80 machine code).
2. It is a very inexpensive complete Z80-based computer, making it ideal for experimental or classroom use.

The key word “inexpensive” means you need to get past the idea that you will be “wasting” most of its features if you dedicate it to a single task. It still may be the most cost-efficient way of accomplishing that task.

operation without having to read and write to disk or other off-line storage devices.

There is a full-featured sound and music synthesizer in there, another Timex enhancement. A simple sound command, BEEP, has two parameters, pitch and duration. The SOUND command, which uses the synthesizer, is much more powerful — and complex.

The 2000 comes with eight colors, easily applied independently to the border and to the working area of the screen (the latter called PAPER), and to the items printed on the screen (INK).

The loading and saving circuitry for cassette operation is vastly superior to that of the T/S1000.

### Novice-friendly

The beginning computer user will find the single-stroke keywords and functions of Sinclair BASIC easy to use. The T/S2000’s BASIC is a superset of the 1000’s; programs written for the 1000 can be used on the 2000, but cannot be loaded from 1000 tapes.

Software on cassettes or — especially — on cartridges are easy to use without learning programming at all.

Single key commands like BEEP, DRAW, CIRCLE, and the color selection keys allow easy access to powerful functions. There is even a reasonably easy way to design your own graphic symbols.

And a phalanx of pre-publication reviewers have spoken well of the novice-friendly user's manual, with extensive graphics and color illustrations.

### Spectacular programs possible

Advanced features available only in machine code will not be used much by beginners. But when implemented by software designers, they will result in spectacular programs — and some of the software this reporter has seen for the unadorned Spectrum will knock your hat in the creek!

There will be an alternate 64-character screen (for use with monitors but not usually with televisions), besides the standard 32-character display.

A "dual screen mode" will allow for animation by switching instantly between two separate display files.

## Reviewers have applauded the user's manual

A high resolution color mode will allow each 1x8 pixel line of a character position to carry its own colors (one INK color and one PAPER color per 8x8 pixel position is standard).

The complexity of the synthesizer chip and its SOUND command, together with the capability of outputting the sound to an amplifier and external speakers, provides for superb music and sound effects.

### Marketing a must

Like the T/S1000, this computer is a good beginner's machine, and also a machine with enough bells and whistles to keep experts happy for years. It has, of course, a much wider range of capabilities than the 1000, and in fact compares favorably with any other machine anywhere near its price range.

The prognosis for the 2000 depends very much on Timex's marketing and peripheral development commitments. In a chicken-

and-egg fashion, the good folks in Norway and Connecticut must invest heavily in marketing — especially consumer advertising — to make this computer a major force in the marketplace ... not wait to check its early foot before getting behind it.

And the planned peripherals — many are under development, starting with a much-rumored modem — will have to come quickly.

But at under \$200, the Timex Sinclair 2000 has The Right Stuff. I'd buy one.

— Chuck Durang

### STOP THE PRESS!

As this issue goes to press, we are informed that Timex has changed its marketing strategies. The company now plans to market only the 2072, the 48K version of the 2000-series, which for reasons unknown will be renumbered the 2068. The 2016 is now but a gleam in some designer's eye.

### STOP THE TIMEX MERRY-GO-ROUND (Editorial)

Confusion seems to be the order of the day at Timex. First it squeezed its own machine, the 1000, off the market by prematurely announcing the 2000-series, which had not yet been finalized on paper. Then news of the 1500 was leaked; it came almost as an afterthought — a great machine lost in the welter of misinformation. Rather than receiving an orderly presentation of information from Timex, potential buyers are faced with an unending stream of rumors, leaks, uncertainties and changes. Not a great way to inspire consumer confidence!

We understand Timex is trying very hard to provide a top machine for their customers. We do not understand why a company that is so strong in its marketing of other products can't devise a logical sales campaign that allows purchasers to make logical decisions.



# D.K. Electronics

## ZX KEYBOARD FOR USE WITH 80/81 SPECTRUM

Our new cased keyboard has 52 keys, 12 of these are used for the numeric pad. The numeric pad offers some useful features, you can cursor with one hand and it will be a boon for anyone who enters a lot of numeric data. The pad is a repeat of the 1-9 keys plus it has a full stop and a shift key. The numeric pad keys are coloured in red, the normal keyboard keys are grey, with the case being black which makes the whole thing very attractive. The case measures 15 x 9 x 2½. The computer (either 80/81 or spectrum) fits neatly inside. You will have to remove the computer from its original case, it is then screwed to the base of the case. The case had all the bosses already fitted and the screw holes are marked. Also fitted inside the case is a mother board (81 model only) which allows 16K, 32K and 64K to be fitted in the case. All the connections are at the rear of the case i.e. Power, Mic, Ear, T.V. and the expansion port. The case is large enough for other add ons also to be fitted inside. One of these could be the power supply, then you could very quickly fit a mains switch, or a switch on the 9V line. This means you have a very smart self-contained unit. This case does not stop you from using any other add-ons that you may have e.g. Printer etc. We are convinced that this is the best keyboard available at present. It offers more keys and features than any other keyboard in its price range.

**\$81.00**

### NOTE

The case can be purchased separately with the keyboard aperture uncut, so if you have one of our early uncased keyboards, or in fact any other suppliers' keyboards, these could be fitted. The keyboard is connected to your computer by a ribbon cable and this has connectors fitted which simply push into the Sinclair connectors. It is a simple two minute job and requires no electronic skills. This keyboard does not need any soldering. Please specify on order whether you require the ZX 81 or Spectrum case.

### SPECTRUM MODEL

This is supplied with spectrum legends, and a slightly different base for fitting the spectrum inside, again all the connectors are at the rear of the case and there is plenty of room for the power supply (and other add-ons). Should you want to change, we can supply both the Spectrum legends and details of updating your case which will enable modification from the ZX 81 to spectrum. PLEASE specify on your order whether you require the ZX 81 or spectrum case.



**KEYBOARD  
(SPECTRUM/81)**

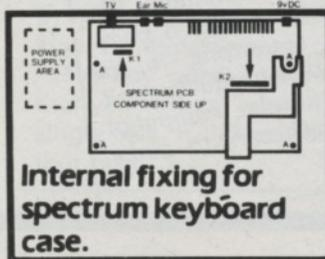
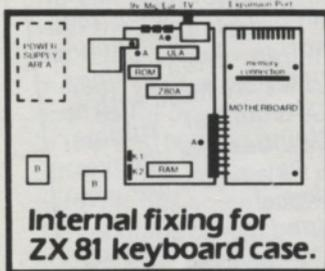

## SPECTRUM LIGHT PEN

The pen enables you to produce high resolution drawings on your own television set, saving a vast amount of time over using basic programming statements, such as Plot, Draw etc. You can erase, modify and save drawings and it comes complete with software program. The superb light pen is available from D.K. Electronics.

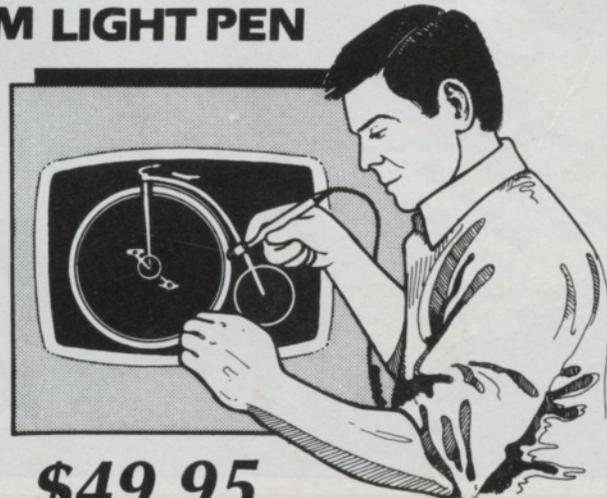

**\$49.95**

**SPECTRUM  
16K Memory Expansion**  
The 16K uses 4116 Static Ram and occupies using the Static Ram speed low power the computer. All which comes to y where. Position in

**64K Memory Expansion**  
All the above info advantage lies in 56K of usable memory the use of other a 8192-65536. The **Spectrum Memory Upgrade** your Spectrum it is simply slipped are supplied, and time. The fitting r same as Sinclair's



# Contest

## CONTESTS

**I**N OUR premier issue we asked readers to write a great 2K program and win a chance to have their programs sold nationally. We would like to thank all those who took the time to enter. It has taken us till our fourth issue to announce the winners due to the huge number of entries. All were good; our judges headed by Elaine Lum have decided that these ten are the best. They are presented here in no particular order. Each winner has received a contract to have their programs published both on cassette and in book format.

WINNER: Douglas S. Williamson,  
Gainesville, Florida

**TITLE: Diffusion**  
**DESCRIPTION:** You must defuse a bomb before it explodes. There are 100 possible wires to try for the three connections. You only have enough time for 18 tries; after each you are told whether the charge is too high or too low. One of the wires will immediately set the bomb off.

WINNER: Daniel C. McConnell, Manchester, Vermont

**TITLE: Munch**  
**DESCRIPTION:** Your computer randomly places 10 "seeds" on the screen. You send your "animal" across the screen to eat seeds (each is worth 25 calories). The T/S computes how many calories your animal used to eat the seeds. Unfortunately, one of the seeds is poisonous. You can exit the game at any point and see how many calories your animal has collected to that point.

WINNER: Bruce Harding, Holding, Maine

**TITLE: Carom-2**  
**DESCRIPTION:** This is a great billiard game for 2K. It is a three-cushion table and you can hit in two directions. Your cue can be shifted up or down. Bruce says of the contest: "Having been spoiled by 16K and 64K memory we had not before enjoyed the challenge of 2K programming. It was quite an ordeal and we used almost every byte-saving trick we have ever heard of. Thank you for this challenge."  
Thank you for a great game.

WINNER: Todd MacDonald, Sydney, Nova Scotia, Canada

**TITLE: Crazy Farmer**  
**DESCRIPTION:** Your automated farm machinery has gone crazy. Your chickens won't stop laying eggs. You must catch each egg in the first barn, then move to the next, which has a lower roof. It gets wild and woolly as the number and speed of the eggs increase.

# Contest

## WINNERS

WINNER: C. Lynn Fate, Manchester, Vermont

TITLE: **Where**

DESCRIPTION: You must guess the position of yours or the computer's symbols. The closer you get, the faster the game plays. Conversely, wrong answers slow the game down. This game is a good deal of fun to play. You have to have quick recognition of symbols and a fast reaction.

WINNER: Robert J. Mioura, Worcester, Maine

TITLE: **Highway**

DESCRIPTION: Drive your car (an inverse X) along a highway filled with medians, potholes and closed lanes. There are 12 different sections which include random left and right turns. The game moves well and can be replayed by pressing CONT.

WINNER: Andrea Boles, Memphis, Tennessee

TITLE: **Monster from Mars, Merlin**

DESCRIPTION: In this game, you must catch the monster, Merlin, inside the cage. The monster is tricky, not savage, but sly. If Merlin escapes the game starts over again automatically.

Andrea has packed a good game into the 2K of memory.

WINNER: Steven R. Rindone, Cerritos, California

TITLE: **Walls of Eryx**

DESCRIPTION: In Walls of Eryx from a short story by H.P. Lovecraft, a space explorer must find the way back to the spaceship. The game sounds simple, except the walls of an invisible maze separate the explorer from the ship. You must act as the guide through the transparent maze — but watch out for surprises.

WINNER: Christopher Raynak, North Ridgeville, Ohio

TITLE: **Strike Force**

DESCRIPTION: You are dragged out of hyperspace to face a fleet of aliens. They can only be destroyed by hitting them at a single point. To make the battle even more difficult, you must destroy them in correct order. You have until you are crushed, or use all your shots (20 of them), or destroy the alien fleet.

WINNER: Greg Adams, Norfolk, Nebraska

TITLE: **Battleship**

DESCRIPTION: The computer hides four ships in a 10 x 10 grid (the ocean). You must find and sink them using the least amount of ammunition. This is a one person, cut-down version of the classic battleship game. Greg suggests to do better in the game, you should use FAST mode.



# FULL SIZE KEYBOARD CONVERSION

FOR  
YOUR  
ZX-81/  
TS-1000



Only  
**\$69<sup>95</sup>**

Fully Warranted  
For 90 Days!

**SUN KD-81**

If you're tired of not knowing whether your data got entered or tired of poking data in with one or two fingers, then it's time to upgrade your ZX-81 to a full size, professional keyboard. The **SUN KD-81 KEYBOARD** offers all the ease and comfort of inputting your programs and text on a fast and efficient professional-sized keyboard!

## KD-81 FEATURES

- Full size keyboard with 41 keys
- Two color silk-screened key tops for easy reading
- Key tops have commands and graphics spelled out the same as ZX-81
- Extra shift key for real keyboard-style typing
- Full size space bar
- Allows touch typing
- Rear cutout allows any RAM or expansion module to be plugged in
- Keyboard comes with own cables
- Keyboard case holds both keyboard and computer with room to spare
- High impact plastic case with vaporized metal shielding
- Easy assembly — no soldering, no modifications
- Measures 10<sup>3</sup>/<sub>4</sub>" x 7<sup>1</sup>/<sub>4</sub>" x 2<sup>1</sup>/<sub>8</sub>"

DEALER INQUIRIES WELCOME

## GET A BETTER PICTURE WITH SAMWOO MONITORS

SAMWOO provides a much better picture for your Sinclair Computer than your TV monitor. Simple modification procedure includes easy-to-follow instructions.



**9" 18Mhz BANDWIDTH**  
Green ..... \$121.00  
Orange ..... 125.00



**12" 12Mhz BANDWIDTH**  
Green ..... \$130.00  
Orange ..... 134.00

Add \$7.50 Shipping and Handling for this item.

## Features:

- Composite Video Input/Output
- Switchable Input Impedance 75 or 10K ohm
- 750 Line Resolution at Center and 500 Lines at Corners
- Dimensions are 12.13" x 11.34" x 11.65" for the 12" model and 8.66" x 8.54" x 9.05" for the 9" model

## EASY TO INSTALL

- No Soldering
- No Modifications

Simple installation  
steps included  
with  
each  
kit.



## RAM MODULES

- Built-in output connector for piggyback
- Lip for mounting on ZX-81 & KD-81
- High-impact plastic case with vaporized metal shielding
- 6.6" wide, 3.2" high, 1.08" deep

**16K \$49.95 MX-16KP**  
**64K \$119.00 MX-64KP**



**SUNTRONICS CO., INC.**

12621 Crenshaw Blvd., Hawthorne, CA 90250

STORE HOURS: MON.-FRI. 9:00 am to 6:30 pm  
SATURDAY 10:00 am to 5:00 pm

For more information, circle 17 on reader service card.

CALIFORNIA  
**213-644-1149**

(for Tech Info and Calif. orders)

OUTSIDE CALIFORNIA TOLL FREE  
**1-800-421-5775**

(Order Desk Only)

Mail Order — Minimum Order \$10. Send Money Order or Check to P.O. BOX 1957 — HAWTHORNE, CA 90250. VISA or Mastercard (please include expiration date). Add \$4.00 postage and handling to order. CA residents add 6% sales tax.

numbers in the DATA statements, the subroutines allow you to program any shape that will fit in a 5 x 7 matrix.

Line 150 prints two blank lines so that the banner characters are separated. The RESTORE puts the "data pointer" back to the first DATA statement (line 1000). The "NEXT 1" loops the program back to "LET a\$=m\$(1 TO 1)" in line 30, to select the next character of your message. This continues to the end of the banner, when the STOP at the end of line 150 terminates the program.

## The Subroutines — 7-Bit Binary Code

THE SUBROUTINES do the actual forming and printing of the characters you've put in DATA statements. But how does that work, and how can you program your own characters? Well, it may take some head-scratching to follow this, but give it a try and you may be able to penetrate the mumbo-jumbo world of binary code. The real "key" is understanding figure 1, a typical character and its coding.

Figure 1 is a "matrix", 7-across by 5-high, and is an example of a single character to show how the system works. The boxes filled in black form the letter A, lying on its right side. Turn the figure 90-degrees counter-clockwise and you'll see it really is an upper-case A. Along the top, from left to right, are the numbers 64, 32, 16, 8, 4, 2 and 1. These are powers of 2, in descending order — binary code. At the left side of the figure you see, from top to bottom, that each line of the matrix is numbered from 1 to 5. When this character is output to the printer, it will be printed sideways, as shown, first line 1, then 2, 3, 4 and 5.

Let's examine the first line, marked 1. It has, looking from left to right, the first five squares blacked in, then the last two blank. Adding the numbers only above the black squares, you'd get  $64 + 32 + 16 + 8 + 4 = 124$ . That's the number on

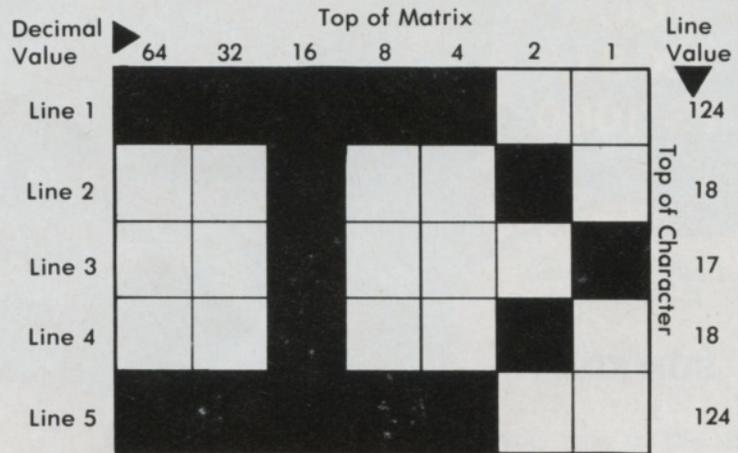

Figure 1 — Upper-Case A

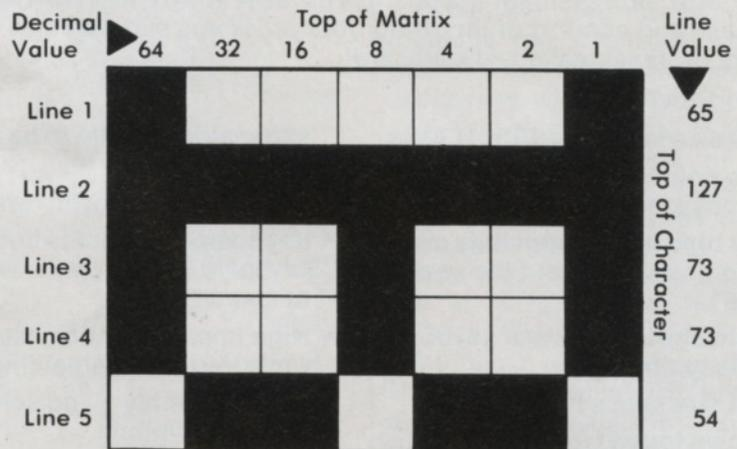

Figure 2 — Upper-Case B

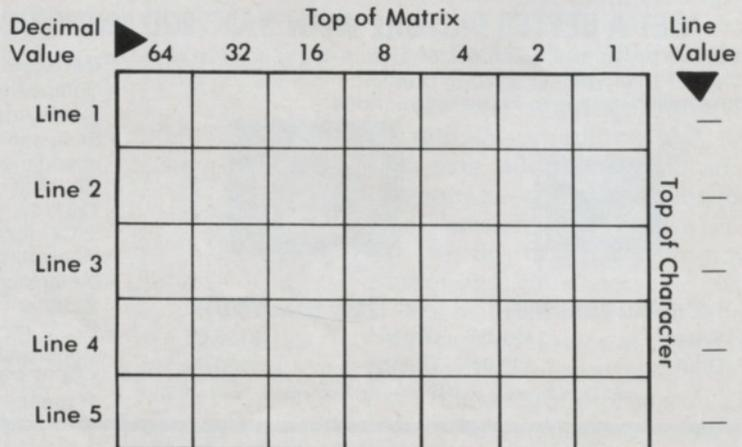

Figure 3 — Plot Your Own

the right side of Figure 1 on line 1. In conventional 7-bit binary code, this would be 1111100. But here we are using the total decimal values, from the "most significant bit" (MSB) of 64 to the "least significant bit" (LSB) of 4 in this case. Beginning to get the idea? Line 2 would be 0010010 in 7-bit binary code. Adding the MSB of 16 to the LSB of 2 gives 18. Similarly, line 3 of this character would be  $16 + 1 = 17$ . Lines 4 and 5 are the same as lines 1 and 2 respectively.

Figure 2 shows an upper-case B plotted in the 7 x 5 matrix, and the binary-derived decimal numbers. Add the decimal values of each black space on a line and you'll see that they total the number on the right side of that line. It takes very little imagination to see that you can plot any shape into the matrix and then derive the decimal numbers to define each line. But then what? How are these decimal numbers used?

## Using The Matrix Numbers

THE NUMBERS you get by "adding" the black squares in the 7 x 5 character block are used in the program DATA statements, as shown in program lines 1010 and 1020 for A and B, Figures 1 and 2. It's that simple! Therefore, plotting lower-case characters or any special characters merely involves filling in the appropriate squares in a 7 x 5 drawing (like figure 3), then totaling the decimal values of the black blocks on each line. You then use these totals in DATA statements that begin with the keyboard character you will use to define that character in your message. Caution: Don't use the quote on the keyboard to define any character — it will cause an error on message entry.

The explanation of the subroutines, lines 200-510, would require more space than available for this article. Basically, lines 300

through 330 examine each of the five character lines, as defined by the five numbers in each DATA statement, and build a string by "concatenation" (lines 500 and 510). The string consists of seven sets of four each of either keyboard characters or blanks. This string, consisting of a total of 28 characters, is printed twice (line 340), then the program goes on to the next of the five character lines. At the end of the character, line 150 generates two blank lines on the printer as a space before the next character.

If you wish "wider" letters, add more ":LPRINT p\$" in line 340. To add more space between characters, add more ":LPRINT" on line 150. To make characters that are not as "high", use less a\$ on line 500 and the same lesser number of blanks on line 510. Design your own lower-case characters and punctuation and add DATA lines. Have fun! ☺/☺

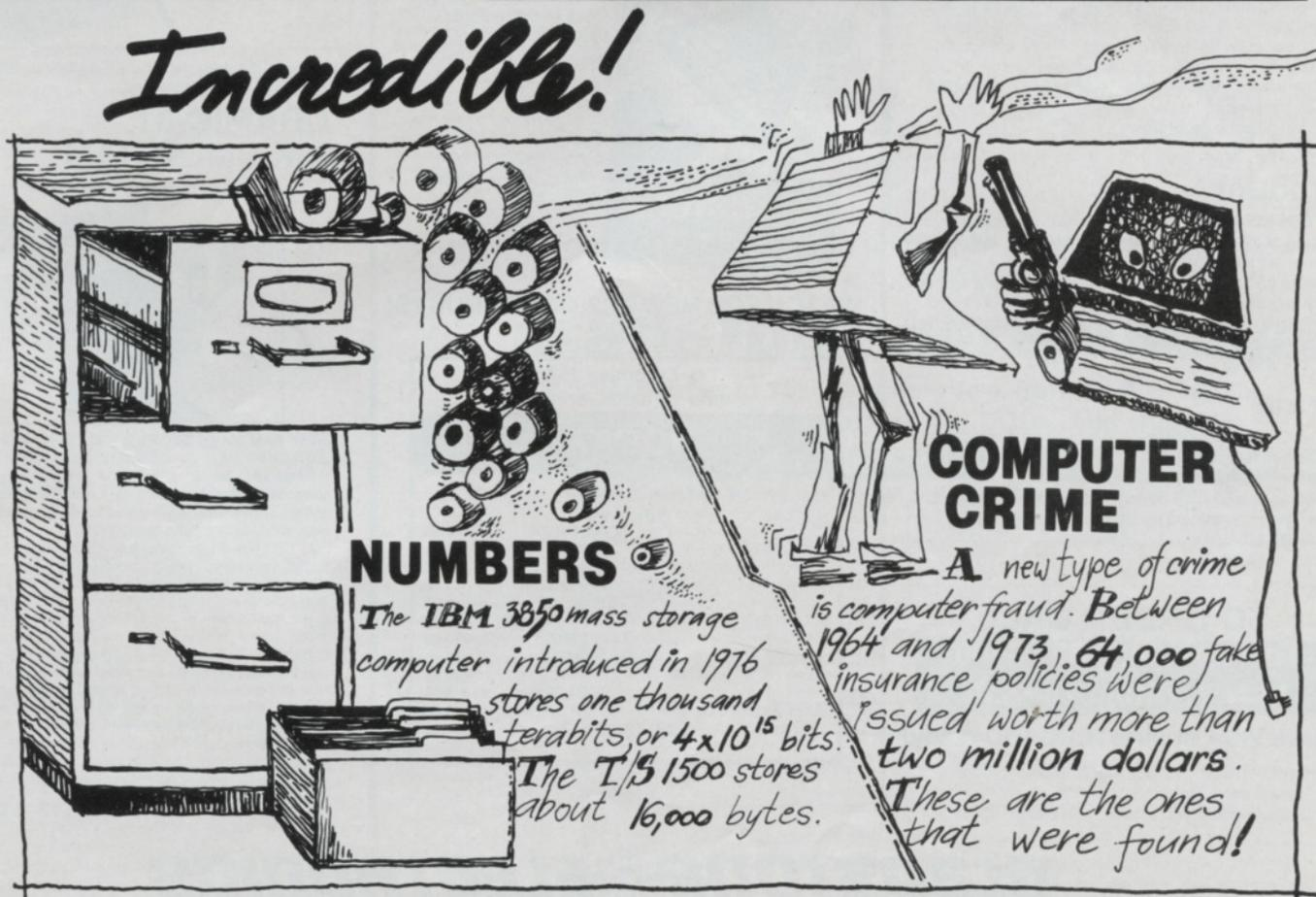

# Get Serious about TS1000/ TS1500/ZX81 Computing!

Best selling  
cassette software

## ZX FORTH

FORTH is an interactive, compiled language that expands the capabilities of the TS1000 and ZX81. It has the simplicity of BASIC but runs up to ten times faster! FORTH's most distinctive feature is its flexibility. Its unit is the WORD. The programmer can use existing WORDS to define new ones. ZX FORTH has over 250 commands and occupies only 6K of memory. Works on 16 bit numbers, and also includes some 32 bit arithmetic routines. Comes complete with a comprehensive 60-page user programmer manual.

Z43 \$29.95

## ZX Bug

Machine Code Monitor and Disassembler

ZXBUG is a powerful tool for machine language programming. It is 4K long and uses memory from 71EO to the top memory. ZXBug works in hexadecimal (base 16), not decimal, so all addresses are a maximum of 4 Hex bits long. Provides a total of 28 commands.

Z41 \$14.95

## ZX Assembler

This Machine Code program occupies 7K of memory and locates itself at the top of memory. The program is a full Editor Assembler and Monitor. Labels may be used instead of any string. The features include Line Insertion Delete, Insert Characters, Auto Repeat on all keys. The monitor has facilities to inspect memory, registers and run machine code programs.

Z40 \$14.95

## TOOLKIT

TOOLKIT adds these 9 new, powerful functions to your computer: Renumbering, Memory indicator, Print all string and numerical variables, Find any string up to 255 characters long, Replace any string by any other string, Transfer programs to Ramtop, Join two programs together, Remove all REM statements, Delete whole sections at once.

Z42 \$14.95

## Z-AID

Z-AID is a programmer's tool, adding 5 important functions to TS1000, ZX81 computer. VERIFY checks for corrupted program saves; MSAVE allows entry to the memory saved using MSAVE; TPTR allows instant access variables; CHAIN links two BASIC programs together.

Z98 \$14.95

## TO ORDER CALL

Toll free (800) 833-8400

In N.Y. (716) 874-5510

Have VISA or MASTERCARD ready!

IMPORTANT NOTE All software products shown are fully compatible with Timex Sinclair 1000, 1500, and Sinclair ZX81



Z61 \$19.95

An incredible breakthrough in TS1000 and ZX81 software development. Enables you to load and save programs up to 6 times faster than normal. You can easily convert your existing programs into new I.P.S. FASTLOAD programs. And unlike other systems, NO ADDITIONAL HARDWARE is required! FASTLOAD has won rave reviews from users, and has proven to be exceptionally reliable in test after test. Occupies only 1/2K of memory. Additional features include verification of proper loading, and catalog of program names and memory usage. Complete with comprehensive user manual.

## Write for Gladstone's FREE CATALOG

Circle reader service number or write



New from Gladstone Electronics! Our ZX81 TS1000 catalog will take you where no one has dared go before! You will view the widest selection of up-to-date software, books and hardware add-ons available to get the most from your personal computer. This exciting new 34 page color catalog lists arcade/fantasy and family games, business and educational programs, books for beginners as well as experienced users, hardware add-ons and other peripherals for use with ZX81 TS1000 Home Computer! Use the convenient coupon and send for your FREE catalog TODAY!

WATCH FOR NEW TS2000 PRODUCTS!

## The Complete ZX81 and TS1000 Library!

### BOOKS

|   |             |
|---|-------------|
| The Complete TIMEX SINCLAIR BASIC Learning Course complete with 2 program cassettes | B70 \$24.95 |
| Getting Acquainted with your ZX81 TS1000  | C70 \$8.95  |
| ZX81 TS1000 Pocket Book   | P70 \$10.95 |
| Making the most of your ZX81 TS1000   | P71 \$10.95 |
| Computers for kids ZX81 TS1000 Edition  | C71 \$4.94  |
| Exploring Guide to the ZX81 TS1000  | T70 \$12.95 |
| ZX81 TS1000 Companion   | C72 \$8.95  |
| 49 Exploding Games for the ZX81 TS1000  | P72 \$10.95 |
| Not Only 30 Programs for ZX81 TS1000 IK   | B72 \$9.95  |
| Machine Language Made Simple  | B73 \$14.95 |
| Mastering Machine Code on your ZX81 TS1000  | P73 \$12.95 |
| ZX81 TS1000 ROM Disassembly Parts A & B   | B74 \$19.95 |
| Understanding your ZX81 TS1000 ROM  | B76 \$14.95 |

Professional  
KEYBOARD with metal case

Special  
\$79.95

A full-sized TS1000 professional keyboard. Features 47 keys and a full-sized space bar. Connects with no soldering required, via a plug-in flexible connector. Expansion devices (i.e. RAM packs, etc) connect to the ZX81 edge-connector which extends from the rear of the cabinet.

• American made • Keycap legends will NOT wear out • Keys with life rated at 20 MILLION cycles.

Keyboard and metal case both for \$79.95 K71

## GLADSTONE 64K RAM

Special  
\$99.95



Expands the capacity of the T/S 1000 or ZX81 to its maximum. User transparent.

## CRAMIC-81 16K CMOS RAM

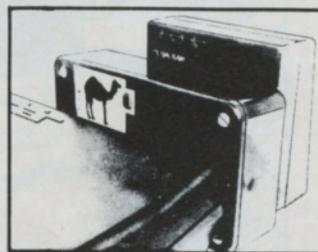

NEW RAM PACK STORES 16K EVEN WITH POWER SWITCHED OFF

CRAMIC-81 is a 16K RAM pack using CMOS technology for permanent data retention. Data can be stored almost indefinitely and loaded almost instantly with virtually zero chance of error.

CRAMIC-81 module uses chips made in a special CMOS technology which require only a tiny amount of power to retain data when not actually in operation. A state-of-the-art, long life (10 years) lithium battery supplies this power in the standby mode. In the active mode, power is taken from the ZX81. Used on its own it behaves like an ordinary Rampack EXCEPT that it can be powered down and removed. Program and data in it is permanently stored when this is done.

An ordinary Rampack can also be connected simultaneously. The two RAM units then occupy the same memory area but either can be selected. Two separate programs can actually run alternately.

CRAMIC-81 comes in an elegantly molded lie-flat case with a cabled connector.

C12 \$179.95

# GLADSTONE ELECTRONICS

1585 Kenmore Ave. Buffalo N.Y. 14217

# Have Fun with TS1000/ TS1500/ZX81 Computing!

Now choose  
from many  
great games!

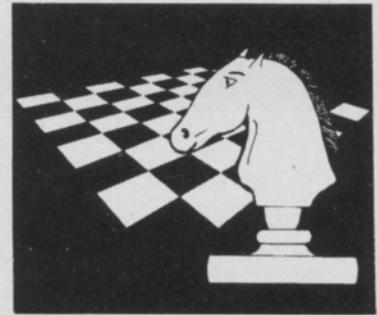

**KRAKIT**™ Bored with crosswords? Want a real mental challenge? Try solving **KRAKIT**, the ultimate adventure and treasure hunt for the personal microcomputer. **KRAKIT** consists of 12 clues that will lead you around the world in search of 12 cities, 12 countries and 12 numbers. And if you are clever enough to be the first to solve these clues, then you can win at least \$20,000 prize money. Each cassette also includes a full sized **KRAKIT** poster at no charge!  
Z48 \$14.95

## Computerized Diet Program

Gain control over your eating patterns. This is an individually tailored, systematic weight loss program. Uses a personal status assessment. Based on your assessment, the **TS1000/ZX81** becomes your monitor and feedback system, allowing you to discretely track yourself against your optimum model. Complete with a 22 page Guide Book, personal data storage tape, and vinyl storage case. Z47 \$29.95

**ZX Scramble** You are flying into the heart of alien territory. As you dodge in and out of the rapidly changing terrain you fire laser rockets and bombs at the enemy weapons installations. They respond with missiles and flying bombs. Destroy them before they destroy you!  
Z90 \$14.95

## Business Pac I: Cash Management

The most needed financial analysis routines for many business decisions, plus a detailed guide on how to use them. Five long programs are supplied on 2 cassettes. Invaluable aid for the business man. Break Even Analysis. Cash Flow Analysis. Payback Analysis. Internal Rate of Return. Depreciation Analysis. Z49 \$29.95

## Business Pac II: Project Scheduler & Proposal Sheet.

Time is the most valuable commodity for the businessman. **Project Scheduler** helps you keep track of work in progress and billings in progress. **Proposal Sheet** is a tool to help you quickly record work items and hours, billing rates, overheads, material and labor costs, to finalize your proposals. Z50 \$14.95

## Personal Financial Planning Pac

Contains 2 tapes with a detailed reference flash instruction manual to help you gain and maintain control of your personal finances. The programs include: Checkbook balancing; Personal Net Worth; Budget Plan (for home or business); Mortgage Plan.  
Z53 \$29.95

**Personal Stock  
Market Planning** Contains 4 programs recorded on 2 tapes, accompanied by a detailed manual. To help you plan, record and control your stock market activities. These programs have been adapted for the **ZX81** and **TS1000** from routines used in large scale computers by a leading software house. Programs include: Dow Jones Moving Average; Personal Stock/Bond Transaction Recorder; Portfolio Review; Point and Figure.  
Z54 \$29.95

In Canada Order Toll Free  
1-800-268-3640  
Prices may vary in Canada

Gladstone Electronics,  
1736 Avenue Road,  
Toronto, Ont. M5M 3Y7

## New Software



### Tiny Logo

Let the world of computers become a comfortable one for your child through the use of this powerful and fun teaching language. In the age of the computer, **Tiny Logo** is the key to helping your child to learn and understand real computer programming. (Tiny Logo is a sub-set of the popular MIT Logo)  
Z111 \$19.95

### Home Money Manager

This complete home budgeting system allows you to establish your own budget categories, keep track of monthly bills and income, and do a monthly and year end balance sheet. No bookkeeping knowledge is needed.  
Z104 \$14.95

**Gobbleman** Arcade action fun for the family. A superb realization of this exciting classic game, showing the true capability of the **TS1000** and **ZX81** computer. Written in machine code, this one is fast, fun and challenging.  
Z70 \$14.95

**Run the Country** A strategy game of political and financial management. What would you do if you ran a country? Here you can grapple with problems like inflation, unemployment, foreign currency exchange. It's both fun and educational. Can you do better than the politicians?  
Z77 \$11.95

**Galaxy Invaders** Another arcade classic, masterfully translated to the **TS1000** and **ZX81**. Protect your seven lives against fleets of hostile invaders. Fast, exciting and unpredictable.  
Z91 \$14.95

NEWSFLASH: Timex announces new TS1500 personal computer will run all ZX81 and TS1000 software!

We make Computing easy!

# GLADSTONE ELECTRONICS

Mail order to 1585 Kenmore Ave. Buffalo N.Y. 14217

Checks or money orders. No CODs. Add shipping

In N.Y. Call (716) 874-5510 Toll Free (800) 833-8400

| CHARGE TO:   |             | Code# | Qty | Price | Total | Code# | Qty | Price | Total |
|--|-------------|-------|-----|-------|-------|-------|-----|-------|-------|
| <input type="checkbox"/>   | Check       |       |     |       |       |       |     |       |       |
| <input type="checkbox"/>   | Money Order |       |     |       |       |       |     |       |       |
| <input type="checkbox"/>   | VISA        |       |     |       |       |       |     |       |       |
| <input type="checkbox"/>   | MASTERCARD  |       |     |       |       |       |     |       |       |
| Expiry date  |             |       |     |       |       |       |     |       |       |
| account number   |             |       |     |       |       |       |     |       |       |
| NAME   |             |       |     |       |       |       |     |       |       |
| ADDRESS  |             |       |     |       |       |       |     |       |       |
| CITY: _____ STATE: _____ ZIP: _____                              |             |       |     |       |       |       |     |       |       |
| To: Gladstone Electronics, 1585 Kenmore Ave., Buffalo N.Y. 14217 |             |       |     |       |       |       |     |       |       |

Shipping and handling  
SOFTWARE AND BOOKS:  
add \$1.50 for first item, 50  
cents for each additional  
item, to a maximum of \$6.00.  
HARDWARE: add \$3.00  
for first item, \$1.00 each  
additional item, to a  
maximum of \$6.00.  
Maximum shipping charge  
on combined software,  
books, and hardware orders  
is \$9.00.

Sub-Total \_\_\_\_\_  
New York Res. add sales tax \_\_\_\_\_  
SHIPPING \_\_\_\_\_  
TOTAL \_\_\_\_\_

Call or write for free TS1000 & ZX81 catalog

TSU 8

For more information, circle 16 on reader service card.

John Gilbert continues his series of articles by looking at retrieving data

## Searching at routine speed

**I**N THE LAST few months I hope you have learned that programming is not an exact science but an art. There are no best ways to program — there are only guidelines. If you can think of a better way of doing something, or improving established methods, do not be worried by the so-called experts. Experts are not always correct.

There are many methods of searching data, just as last month we indicated that there is more than one way of sorting data items. No technique is better than another but in the proper circumstances one technique can be used in favor of another. The Binary Search with which I deal is one of the fastest searching routines and one of the easiest to learn.

Obviously, speed is important in any searching routine. Someone cannot wait for an hour for data contained in a list of 30 items to be retrieved by the computer. If that

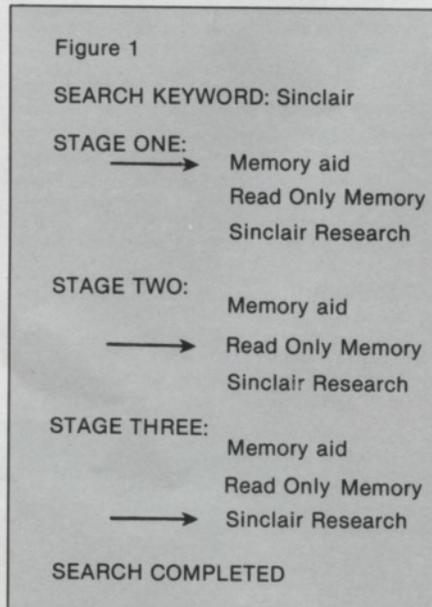

were the case it would be easier to search through a list on paper.

One method of searching a list would simulate a person doing it by hand very well. That is called the Serial Search — figures one and

two — which can take up to half an hour to search a list of 100 names and addresses. The routines will run without the database but if you want to include one of them within the main program you use lines 2000 to 2040.

The computer scans the data list, item by item, trying to match the key, a name or telephone number entered by the user, with the items in internal memory. When a match is made the item will be displayed in full on the screen.

The length of time of the process will depend on the speed of the high-level language, such as BASIC, or the speed of the central processor if the program is written in machine code. The number of items in the list to be searched will also be a factor in the amount of time taken by the computer.

If you are planning to use only a few data items you could use the Serial Search technique. The coding is simple. Use a variable as a counter to point to each data item in the listing in turn. Increase the pointer by one every time an item is compared to the user's entry and no match is made. When the match is made, print it to the screen.

The Binary Search is as easy to program as the Serial Search but the routine is much faster, as it does not have to search every data item on the list. The data must be sorted in alphabetical or numeric order and the computer will look at the element at the center of the list of data as the starting-point — figure three — cutting the list into two halves.

If the identification keyword or number, typed in by the user to trace an item in a file, and the element in the file do not match, the

Figure 2

```
2000 SLOW
2002 REM SET UP DATA FILE
2004 DIM B$(10,12)
2006 REM DATA FILE ENTRY
2010 FOR K=1 TO 10
2020 INPUT B$(K)
2030 NEXT K
2032 PRINT "FILE ENTRY COMPLETE"
2034 PAUSE 100
2036 CLS
2038 REM SEARCH KEYWORD
2040 INPUT A$
2048 REM A = NUMBER OF FILE ELEMENT BEING MATCHED
2050 LET A=1
2052 FOR X=1 TO 10
2060 PRINT AT 10,10; "SEARCHING"
2062 NEXT X
2070 IF B$(A)(1 TO LEN A$) = A$ THEN GOTO 2110
2080 IF A=10 THEN GOTO 2098
2090 LET A=A+1
2092 GOTO 2070
2098 FOR X=1 TO 10
2100 PRINT AT 10,10; A$; " NOT FOUND"
2102 NEXT X
2104 STOP
2110 CLS
2112 PRINT AT 12,0; "ITEM LOCATED "; B$(A)
```

# How to program

computer has to continue its search. The computer will find if the alphabetic character or number is higher or lower than the keyword typed in by the user. If it is lower the computer will take the last element examined and make that the end of the file, cutting away the other half.

If it is higher, the computer will take the last examined item as the beginning of the new, shorter file. The computer will then find how many elements are in the short file and divide it by two. The number found will be the element at the middle of the file and that is the element looked at next by the computer.

The process continues until a match is made. Then the computer will print out the full data item found in the file. The whole process is shown in figure three and a listing of the resulting program is shown in figure four. The listing can be used alone with a short data entry routine or with the database which has been discussed as an example throughout this series.

Line 2070 of figure four will check to see if the keyword entered at line 2040 is the same as the element pointed to by variable L in the data file. If it is less than the value of the file entry, the pointer, L, will move further up the list and if it is greater it will move down the list.

Figure 3

SEARCH KEYWORD: Sinclair

STAGE ONE:

→ Alphabet  
Bubble  
Memory  
Research  
Sinclair  
ZX-81

STAGE TWO:

→ Alphabet  
Bubble  
Memory  
Research  
Sinclair  
ZX-81

STAGE THREE:

→ Alphabet  
Bubble  
Memory  
Research  
Sinclair  
ZX-81

SEARCH COMPLETED

That part of the program is executed in lines 2060 to 2080. The number of the file element in L must be an integer, so INT is used in those lines. The 0.5 at the end of the lines mentioned must be added to the integer in L to round it up and not down, as the Timex Sinclair machines do automatically during mathematical operations.

In some cases it is necessary to display every item in a data file

which has an entry which corresponds to the keyword input by the user. That can be done by adding an extra condition, IF... THEN, statement before line 40 so that if a match occurs the program will continue to search the file in case there are more corresponding items. If a long file of data is to be processed and displayed it is a good idea to introduce paging into the display routine.

The computer should display the data in pages, and at the bottom of each page a message to the user should be displayed asking whether he wants to see more. If the user types in 'no' the program control can be returned to the main menu.

The display of data is an important facet of any program, and the guidelines in the second article of this series apply to data output as well as data entry. When a menu is used in a program and is not displayed for some time while other operations are taking place, it is important to let the user know what other options are available at that time. That can best be done by displaying a band across the bottom of the screen with the options and the 'return to main menu' option on it.

The main point I want to stress is that not all users are programmers. That may be less so now than in the past with the advent of home computing but there are still some users who have difficulty even getting around the keyboard.

While it is important to know about techniques for file processing, such as those discussed in this and the previous article, it is more important to know about the user interface — how the user will interact with the computer and how he will cope with your program. Once you can see the likely reaction of the user and fit the program around your intended user, everything else will seem simple.

Next month, in the final article in this series, I will show how to develop techniques for ridding yourself of those little creatures which users do not see but which can make a hash of a program — the bugs. 

Figure 4

```
2000 SLOW
2002 REM SET UP EXAMPLE DATA FILE
2004 DIM B$(10,12)
2006 REM DATA FILE ENTRY
2010 FOR K=1 TO 10
2020 INPUT B$(K)
2030 NEXT K
2031 PRINT "FILE ENTRY COMPLETE"
2032 PAUSE 100
2033 CLS
2034 REM A = LOWEST FILE NUMBER ELEMENT
2035 REM B = HIGHEST FILE NUMBER ELEMENT
2036 LET A=1
2037 LET B=10
2038 REM SEARCH KEYWORD
2040 INPUT A$
2048 REM BEGIN SEARCH IN THE MIDDLE OF FILE
2050 LET L=INT ((B-A)/2 + .5)
2052 GOTO 2060
2054 IF B$(L) (1 TO LEN A$) > A$ THEN
LET L = INT ((B-A)/2 + .5)
2056 IF B$(L) (1 TO LEN A$) < A$ THEN
LET L = INT ((B-A)/2 + .5) + A
2060 IF B$(L) (1 TO LEN A$) = A$ THEN
PRINT "ITEM LOCATED "; B$(L)
2062 IF B$(L) (1 TO LEN A$) = A$ THEN STOP
2070 IF B$(L) (1 TO LEN A$) > A$ THEN B=L
2080 IF B$(L) (1 TO LEN A$) < A$ THEN A=L
2090 GOTO 2054
```

Get the only monthly magazine devoted to Timex computers!

# timex sinclair user



Subscribe now to get your free bonus!

12 issues  
only \$29.95  
Save \$5.45!  
Plus receive  
free  
software



Now that you've got a TIMEX SINCLAIR computer make sure you get the new magazine that helps you to get the most out of it... TIMEX SINCLAIR USER! And take advantage of our special bonus of a free software cassette (\$15.00 retail value) with each subscription.

TIMEX SINCLAIR USER is published monthly. It keeps you totally up-to-date. It helps you make full use of the power of your computer.



**TIMEX SINCLAIR COMPUTERS:** the price and technology breakthrough that finally made computers affordable.  
**TIMEX SINCLAIR 1500 & 2000 SERIES:** the new members of the Timex computer family.  
**TIMEX SINCLAIR USER:** the magazine that helps you make the best use of these computers.

TIMEX SINCLAIR USER covers the full spectrum of user interests. Education. Business applications. Home management. Games and family entertainment. And TIMEX SINCLAIR USER does it in a easy-to-understand style that's authoritative yet friendly.

Each issue is packed with articles and information that help owners make use of the power of their computer. News about software releases. Reviews. Hardware developments. Reader question and answer column. Eight pages of program listings in every issue. New and unique user applications. How to program. Interviews. Special money saving offers to readers.

In fact, all the latest ideas and information to ensure that new owners and expert users never tire of their computer.

### FREE BONUS WITH YOUR SUBSCRIPTION



"Packrabbit"  
Retail value  
\$15.00

for T/S1000 & T/S1500  
(16K)

A good reason to order now! Receive a software program cassette of an exciting, new arcade game! "Packrabbit" is a regular \$15.00 retail value. Free with subscriptions for a limited time only.



For any age  
or experience

For all Timex Computers

Remember: Whatever your age and experience in computers, TIMEX SINCLAIR USER can help you use the power of your computer.

**SUBSCRIBE NOW** and take advantage of our special offer. Only \$29.95 for 12 monthly issues postage paid. This represents a \$5.45 saving over regular newsstand prices. And remember, you receive a **FREE BONUS** with every subscription, a "Packrabbit" software cassette (\$15.00 retail value).

To order call TOLL FREE

## 800-543-3000

Ask for Operator 243. In Canada call (513) 729-4300 and ask for Operator 243. These numbers are for orders only. Have your VISA or Mastercard ready.

Mail to TIMEX SINCLAIR USER, 49 La Salle Avenue, Buffalo, New York, 14214

Name \_\_\_\_\_

Address \_\_\_\_\_

City \_\_\_\_\_ State \_\_\_\_\_ Zip \_\_\_\_\_

Check  Money order Or charge to

Visa  Mastercard  Bill me later.

Number \_\_\_\_\_

Expiry \_\_\_\_\_

Signature \_\_\_\_\_



Yes, I want to subscribe to TIMEX SINCLAIR USER at the special rate of \$29.95 for 12 issues delivered to my door. In addition, I understand I will receive the FREE software cassette with my first issue.

#### GUARANTEE

You may cancel at any time you are not satisfied. Full value for unmailed issues will be promptly refunded.

AD Code  
TSU4

# PROGRAM PRINTOUT

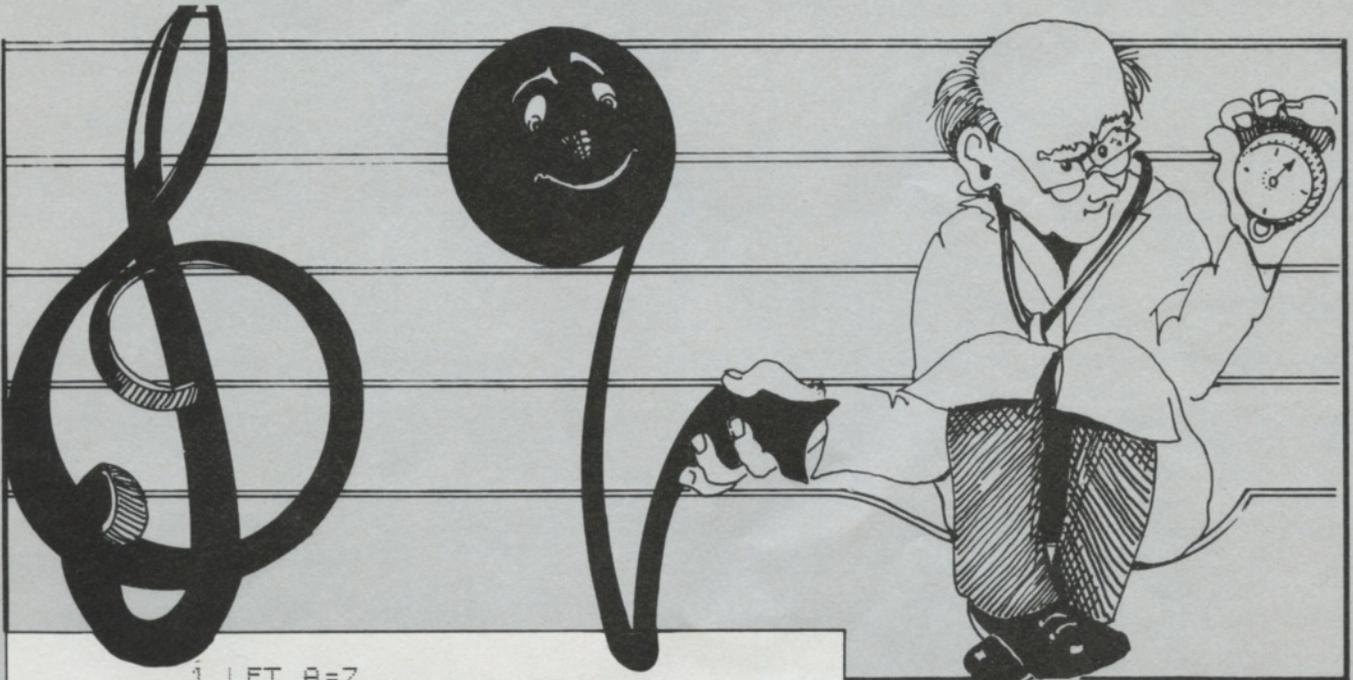

```

1 LET A=7
2 PRINT
3 PRINT
4 PRINT
10 FOR B=1 TO 5
20 FOR N=0 TO 10
30 PRINT "-";
40 NEXT N
45 PRINT
46 PRINT
50 NEXT B
60 PRINT AT 0,0;" -"
70 PRINT
80 PRINT " "
90 PRINT " "
100 PRINT " "
110 PRINT " "
120 PRINT " "
130 PRINT " "
140 PRINT " "
150 PRINT " "
160 PRINT " "
170 PRINT " "
180 PRINT " "
190 PRINT " "
200 LET B=INT (RAND*11)+1
210 PRINT AT B,A;"█"
215 IF B>=8 THEN LET B=B-7
220 LET B=(11-B)+34
230 PRINT AT 15,10;"YOUR GUESS?"

240 INPUT A$
250 IF CODE A$(<>)B THEN PRINT AT
15,10;"WRONG"
260 IF CODE A$=B THEN PRINT AT
15,10;"RIGHT"
270 PAUSE 4E4
275 CLS
280 RUN

```

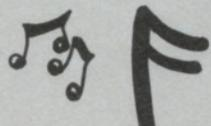

## NOTE TESTER

**I**F YOU do not know notes but want to learn, **Note Tester** for the 1K T/S1000,ZX81 is bound to help. The display features a treble staff and a blob at some random position on it. The blob represents a musical note which you have to guess, or know.

The computer will tell you whether you are correct and will then wait for you to press any key before **RUNNING** once again.

Listing buffs might like the way the random number is linked to the note through **CHR\$**.

**T**REASURE HUNT is a game of almost arcade quality. You are in a system of 21 underground caves filled with monsters and poisonous fungoids. The aim is to collect treasure, by running over the asterisks, and deposit it in Cave O. You cannot carry more than five bags of treasure at a time and even one will slow your progress.

The display is of the current cave — see the illustration. You are able to move around with the cursor keys and the exits are represented by the areas of graphic A at the top and bottom of the screen. It is not possible to return to the previous cavern.

To protect yourself against monsters and to clear a path through the fungoids you can loose an arrow, with F followed by the appropriate cursor key. Remember, though, that new arrows are obtainable only in the entrance cave in exchange for captured treasure.

In Cave 21 there is a hoard of treasure guarded by a growing serpent which will attempt to seal off exits. Shooting a hole in it is usually only a temporary measure, unless you also shoot at something else, in which case the serpent will attach itself to the other target.

The score is calculated by monsters killed  $\times 5$ ; + treasure captured  $\times 10$ ; - arrows bought  $\times 4$ . Reincarnation is granted if you score more than 50 between deaths.

A fine program, to be typed and taped, from Paul Sherwood (T/S1000,ZX81, 16K).

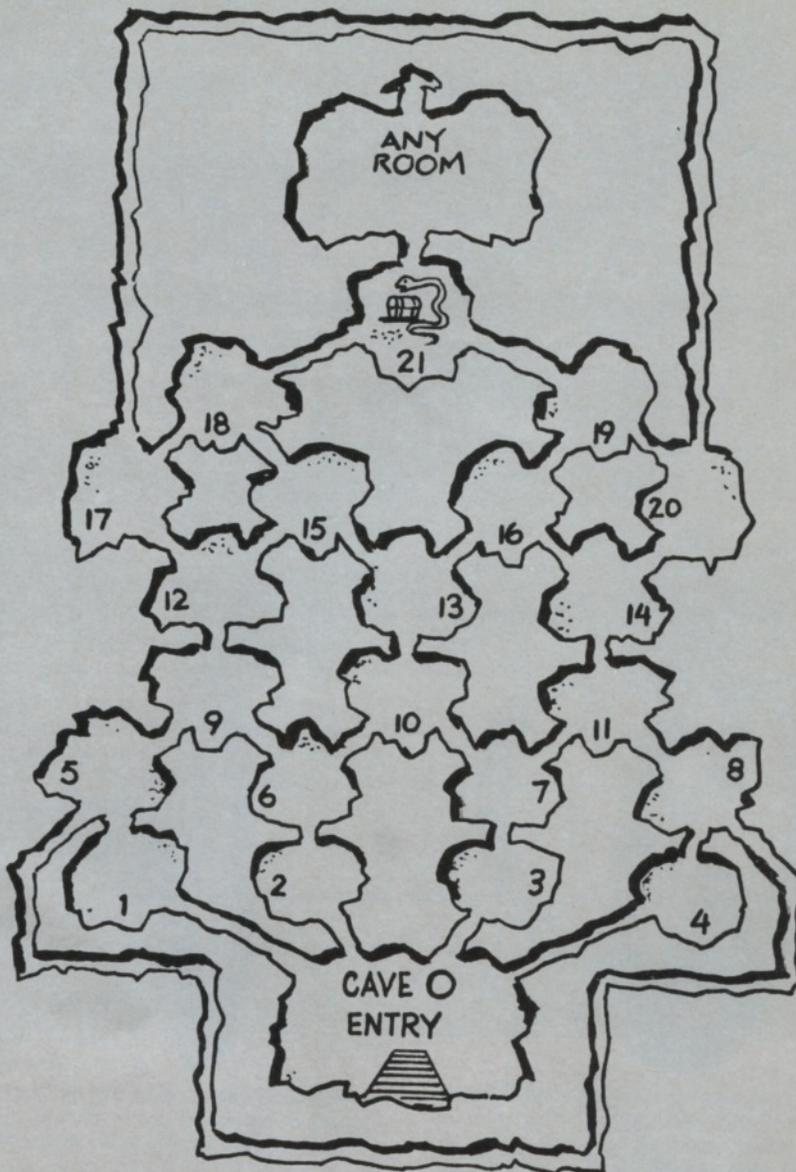

100  
A  
P=FILE

```

5 DIM D(3,2)
7 DIM T(20)
8 LET Z$="YOU ARE IN THE ENTRA
ANCE HALL"
10 LET LR=0
11 LET C$="████████████████████"
13 LET C$=C$+"████████████████████"
15 LET C$=C$+"████████████████████"
20 LET ARR=5
25 FOR I=1 TO 20
30 LET T(I)=1
35 NEXT I
37 LET PS=0
40 LET S=0
55 LET Q=PEEK 16395+256*PEEK 1
6397+1
60 LET TR=0
65 RAND
68 LET NOW=INT (RAND*5000)
70 LET B$="9BE9AF9D0G9CHAHIBIU"
72 LET B$=B$+"CJKEKEFLFGMGHN"
74 LET B$=B$+"IQJQJPKPTLMRMNS"
76 LET B$=B$+"LATOQUPTUNOS9RS"
80 LET R1=0
82 LET R2=0
84 LET R3=0
95 GOTO 1300
150 CLS
160 REM CAVE PLOT
162 RAND (PR*10+NOW)
165 FOR I=0 TO 20
170 LET IY=RND*16+2
175 LET IX=RND*27+2
180 PRINT AT IY,IX;"██";
185 IF RND>.5 THEN PRINT AT IY-
1,IX-1;CHR$(128+RND*2);
190 PRINT AT IY,IX+1;"██";
195 PRINT AT IY+1,IX;CHR$(128+
RND*2);

```

TH side key

```

200 IF RND>.6 THEN PRINT AT IY+
1,IX+1;CHR$(130);
205 PRINT AT I,0;"██";AT I,31;"██"
210 NEXT I
212 PRINT AT 0,1;C$;AT 20,1;C$;
214 PRINT AT 0,17;R1;AT 20,17;R
215 LET N=11
220 LET M=1
222 IF T(PR)=1 THEN PRINT AT IY
,IX+1;"*";
224 LET T(PR)=0
225 REM SERPENT PLOT
230 LET DEM=INT (RAND*4)
235 FOR I=1 TO DEM
240 LET D(I,1)=INT (RAND*19+1)
245 LET D(I,2)=INT (RAND*30+1)
250 PRINT AT D(I,1),D(I,2);"██";
255 NEXT I
265 REM HEAD AND
275 PRINT AT N,M;"X";
280 IF INKEY$(1)"F" THEN GOTO 300
285 IF ARR=0 THEN GOTO 300
290 LET ARR=ARR-1
295 GOSUB 1000
298 PRINT AT 21,0;"ARROWS:";ARR
300 LET N1=N
305 LET M1=M
310 LET M=M+(1 AND INKEY$="8") -
(1 AND INKEY$="5")
315 LET N=N+(1 AND INKEY$="6") -
(1 AND INKEY$="7")
320 LET Q1=PEEK (Q+33*N+M)
325 IF Q1>62 THEN GOTO 2000
330 IF Q1=23 AND TR<50 THEN LET
TR=TR+10
335 IF Q1=8 THEN GOTO 300

```

# Treasure Hunt

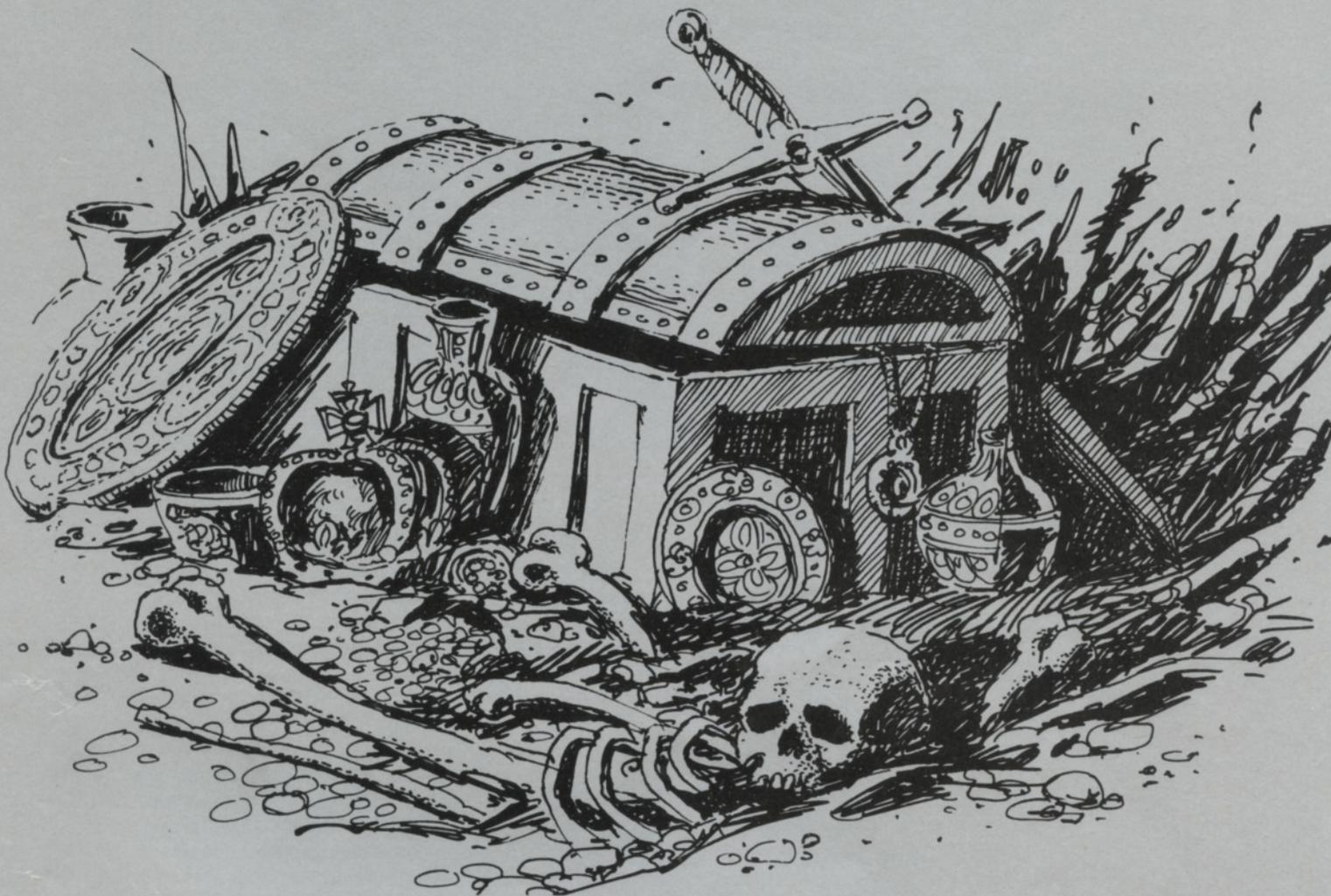

```

338 IF ABS (10-N)=10 THEN GOTO
2000
339 IF PR=21 THEN GOTO 355
340 IF DEM=0 AND AND<.03 THEN L
ET DEM=1
342 IF AND<.3+TR/200 THEN GOSUB
1200
345 PRINT AT N1,M1;" ";
350 GOTO 265
355 GOSUB 3000
360 GOTO 345
800 REM ROOM SWITCH
805 CLS
810 LET LR=PR
812 IF PR<>21 THEN GOTO 815
813 LET PR=INT (AND*19+1)
814 GOTO 825
815 IF N=0 THEN LET PR=R1
820 IF N=20 THEN LET PR=R2
822 IF PR=0 THEN GOTO 1505
825 PRINT AT 3,2;"YOU ARE IN TH
E TUNNEL"
830 PRINT AT 5,2;"BETWEEN ";LR;
" AND ";PR
835 PRINT AT 8,2;"YOU HAVE ";AR
R;" ARROWS";
840 PRINT AT 11,2;"YOUR SCORE I
S ";TR+S
915 IF PR=21 THEN GOTO 2050
920 LET R$=B$(PR*3-2)
925 LET R1=CODE (R$)-37
930 LET R$=B$(PR*3-1)
935 LET R2=CODE (R$)-37
940 LET R$=B$(PR*3)
945 LET R3=CODE (R$)-37
950 IF R1=LR THEN LET R1=R3
955 IF R2=LR THEN LET R2=R3
970 GOTO 150
1000 REM FIRE
1003 IF PR=21 THEN GOSUB 3000
1005 IF AND<.5 THEN GOSUB 1200
1010 LET F$=INKEY$
1015 IF F$="" OR F$="F" THEN GOT
O 1000
1020 LET Y1=N
1025 LET X1=M
1030 LET MY=0+(1 AND F$="5")-(1
AND F$="7")
1035 LET MX=0+(1 AND F$="3")-(1
AND F$="5")
1040 LET X1=X1+MX
1045 LET Y1=Y1+MY
1050 IF ABS (15-X1)=15 OR ABS (1
0-Y1)=10 THEN GOTO 1125
1053 IF PEEK (0+33*Y1+X1)<>0 THE
N GOTO 1070
1055 PRINT AT Y1,X1;" ";
1060 PRINT AT Y1,X1;" ";
1065 GOTO 1040
1070 LET DHIT=DEM
1075 FOR I=1 TO DHIT
1080 LET Y=D(I,1)
1085 LET X=D(I,2)
1090 IF X<>X1 OR Y<>Y1 THEN GOTO
1115
1095 PRINT AT Y1,X1;" ";
1098 LET S=S+5
1100 LET D(I,1)=D(DEM,1)
1105 LET D(I,2)=D(DEM,2)
1110 LET DEM=DEM-1
1115 NEXT I
1117 IF PR=21 THEN LET FX=X1
1118 IF PR=21 THEN LET FY=Y1
1120 PRINT AT Y1,X1;" ";
1125 RETURN
1200 REM DEMON RUN
1201 FOR I=1 TO DEM
1205 LET X=D(I,2)

```

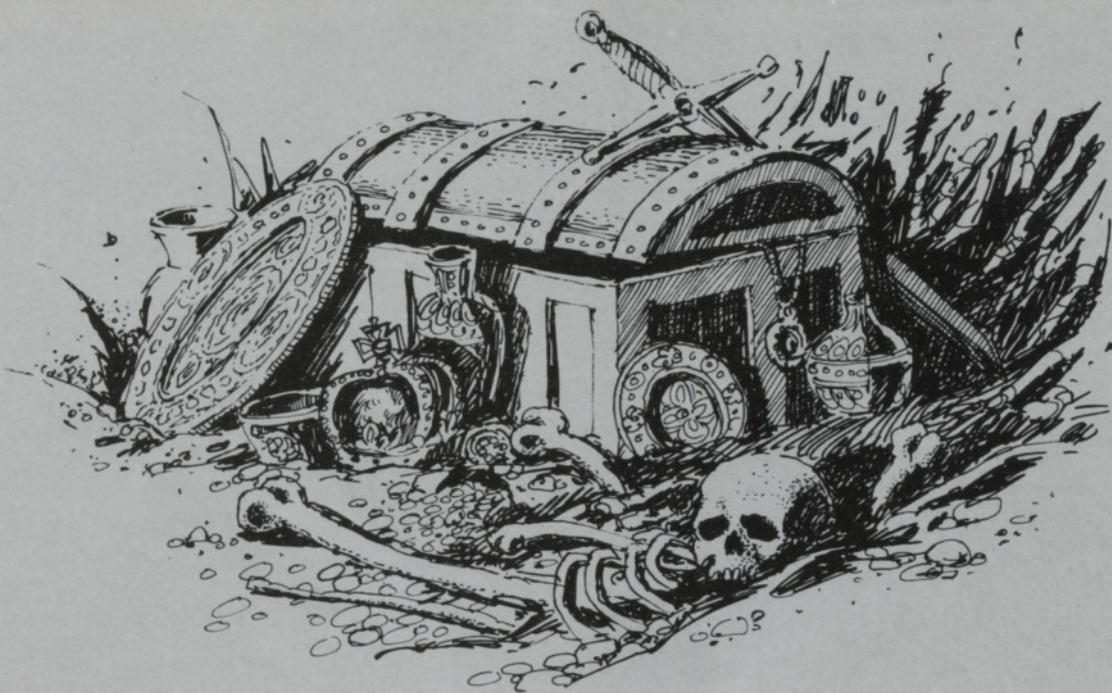

```

1210 LET Y=D(I,1)
1215 PRINT AT Y,X;" "
1220 LET Y=Y+SGN (M-Y)
1225 LET X=X+SGN (M-X)
1235 PRINT AT Y,X;" "
1238 IF X=M AND Y=N THEN GOTO 20
00

```

```

1240 LET D(I,1)=Y
1245 LET D(I,2)=X
1250 NEXT I
1255 RETURN
1295 REM DEATH
1300 PRINT " THIS IS TREASURE-
HUNT"
1305 PRINT " YOU ARE IN A NETWO
RK OF CAVES."
1310 PRINT "YOU ARE LOOKING FOR
GOLD."
1315 PRINT "IF YOU ARE CAREFUL Y
OU MAY REACH"
1320 PRINT "THE TREASURE ROOM, B
UT BEWARE:"
1325 PRINT "THERE ARE MONSTERS W
HICH WILL"
1330 PRINT "EAT YOU: EVEN TO TOU
CH THE ROCKS"
1335 PRINT "MEANS INSTANT DEATH."
1340 PRINT Z$
1342 PRINT "CHOOSE CAVE 1,2,3 OR
4?"
1345 INPUT PR
1350 IF PR<1 OR PR>4 THEN GOTO 1
345
1360 LET LR=0
1500 GOTO 915
1505 PRINT Z$
1510 PRINT "YOUR TREASURE IS SAF
E HERE."
1515 PRINT "YOUR SCORE IS ";S+TR
1516 PRINT TAB 0;"YOU HAVE ";ARR
;" ARROWS."
1520 PRINT TAB 0;"ARE YOU GOING
BACK IN?"
1525 INPUT F$
1530 IF F$="NO" THEN PRINT "YOU
SCORED ";S+TR
1535 IF F$="NO" THEN STOP
1540 LET S=S+TR
1545 LET TR=0
1550 PRINT "HOW MANY ARROWS DO Y
OU WANT?"
1560 PRINT "THEY ARE 4 POINTS EA
CH"
1570 INPUT F
1580 IF F+4>5 THEN GOTO 1650
1590 LET S=S-F+4
1600 LET ARR=ARR+F
1610 GOTO 1342
1650 CLS
1665 PRINT " YOU CANT AFFORD TH
EM"
1660 GOTO 1550
2000 REM DEATH OF A HERO

```

```

2005 CLS
2010 PRINT AT 5,1;"UNFORTUNATELY
YOU HAVE PERISHED"
2015 PRINT AT 8,1;"YOU SCORED:";
S+TR
2018 PRINT
2019 PRINT
2020 IF S+TR<50+PS THEN STOP
2025 LET S=S-15
2028 LET PS=S+TR
2029 PRINT "YOU PLAYED WELL:";"/"
2030 PRINT "I SHALL DEDUCT 15"
2031 PRINT
2032 PRINT "FOR DAMAGE TO THE BO
DY";

```

```

2033 PRINT
2034 PRINT
2035 PRINT "YOU MAY CONTINUE";
2036 FOR I=1 TO 50
2037 NEXT I
2038 CLS
2040 GOTO 1505
2045 REM TREASURE ROOM
2050 PRINT AT 0,0;
2052 CLS
2055 FOR I=-10 TO 10
2058 LET AI=ABS I
2060 PRINT TAB 0;C$( TO AI);
2065 PRINT TAB (30-AI);C$( TO AI
)
2070 NEXT I
2075 PRINT AT 0,10;C$( TO 10)
2080 PRINT AT 20,10;C$( TO 10)
2085 PRINT AT 10,0;" ";TAB 29;" "

```

```

2086 LET DEM=1
2087 LET QU=INT (RAND*4)
2090 FOR I=1 TO QU+1
2095 PRINT AT 12+I,12+(RAND*2);"*
*"
2100 NEXT I
2105 LET N=10
2106 LET MY=-1
2107 LET MX=0
2108 LET K=10
2109 LET J=7
2110 LET M=2
2111 LET FX=J
2112 LET FY=K
2115 GOTO 265
2999 REM TAPP
3000 IF PEEK (0+33*(K+MY)+J+MX) =
0 THEN GOTO 3015
3002 LET AD=MY
3005 IF AD=0 THEN LET MY=MX
3006 IF AD=0 THEN LET MX=0
3007 IF AD<>0 THEN LET MY=0
3008 IF AD<>0 THEN LET MX=0-AD
3015 LET J=J+MX
3020 LET K=K+MY
3025 PRINT AT K,J;" ";
3030 IF RAND>.5 THEN PRINT AT FY,
FX;" "
3032 IF RAND<.25 THEN GOSUB 1200
3035 RETURN

```

# 3D Xs AND Os

**P**.R. SCOTT has sent the kind of program Mr. Spock plays on long, winter evenings. **3D Tic Tac Toe** displays a cube and 27 possible positions for the Xs and Os. Unlike the 2D version, the game must be continued until all the positions are filled, the object being not to obtain the first completed row but as many as possible.

The player who starts has an advantage, as finally he occupies one space more than his opponent and so, to level matters, the first player is prevented from occupying the center square on his first attempt.

The program checks for that and other illegal moves, as well as setting-up the board, indicating whose turn is next, and giving the correct score throughout. Moves are entered by keying-in a letter, then a number, then ENTER.

"A" indicates the front face of the cube, "B" the center and "C" the rear. Entering "R" will restart the game (T/S1000,ZX81, 16K).

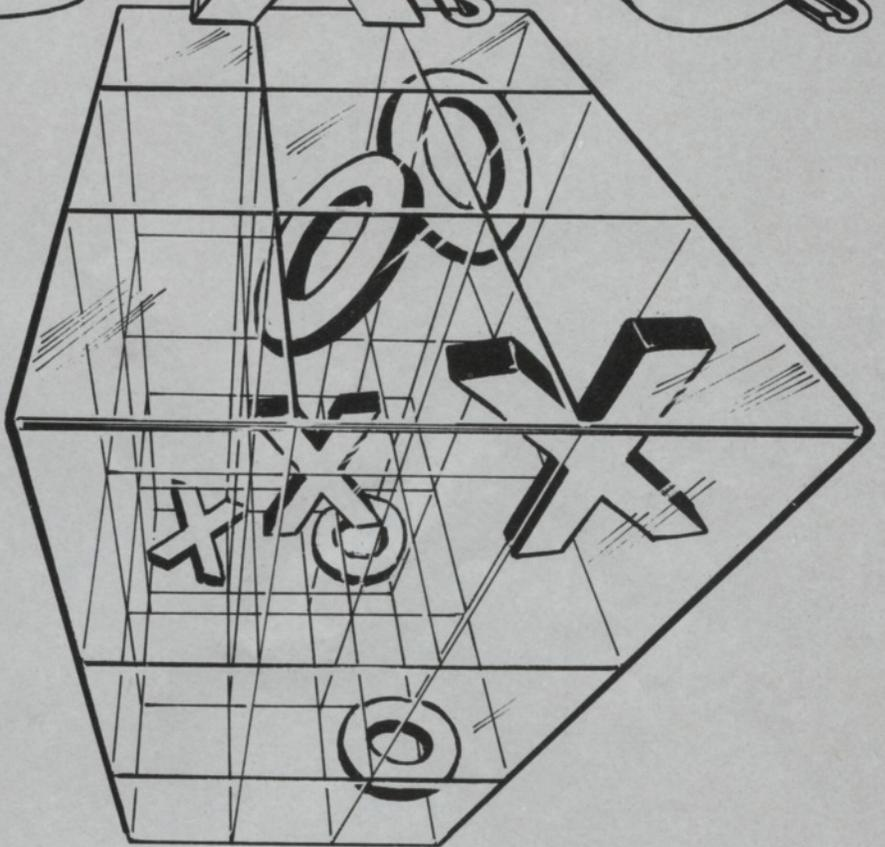

```

5 DIM A(27)
10 DIM G(18)
15 DIM R(18)
20 DIM X(27)
30 LET X$ = "0208140208140208140612180612180612181016"+
"22101622101622"
35 LET Y$ = "0606061212121818180404041010101616160202"+
"02080808141414"
40 FOR Z=1 TO 27
45 LET X(Z) = VAL X$(2*Z-1 TO 2*Z)
50 LET Y(Z) = VAL Y$(2*Z-1 TO 2*Z)
55 NEXT Z
60 LET C$="02040505050506081011111111213131313"
65 LET R$="010301020304030109010809100903060912"
70 FOR Z=1 TO 18
75 LET C(Z)=VAL C$(2*Z-1 TO 2*Z)
80 LET R(Z)=VAL R$(2*Z-1 TO 2*Z)
90 NEXT Z

```

```

100 FOR Z=1 TO 27
105 LET A(Z)=0
110 NEXT Z
115 LET S=1
120 LET N=1
170 CLS
175 GOSUB 1000
180 IF S=1 THEN PRINT AT 2,0;"X" TO GO"
185 IF S=-1 THEN PRINT AT 2,0;"O" TO GO"
190 PRINT AT 20,14;" "
200 INPUT Z$
205 IF N=28 THEN GOTO 100
210 IF Z$(1)="R" THEN GOTO 100
215 IF Z$(1)="A" THEN LET Z=0
220 IF Z$(1)="B" THEN LET Z=9
225 IF Z$(1)="C" THEN LET Z=18
235 LET Z=Z+ VAL Z$(2)
240 IF A(Z) <> 0 THEN GOTO 390

```



**M**ANY PEOPLE today are health and fitness conscious and have exercise programs to keep in shape. **Exercise and calories** by Robert D. Teague is a program that allows the person who wishes to remain fit and trim a way of keeping track of the calories burned up during exercise. Twenty common exercises are provided for in the program. All the user must do is enter the activities and time involved. The T/S1000 does the rest, summarizing the activities and giving calories used as well as a total. This can be done

daily, weekly, or monthly. The program will also determine weight loss assuming the user has stayed away from those "extra" calories.

For the beginning programmer, the program provides a look at arrays, FOR-NEXT loops, conditional statements, INKEY\$, TAB, and PRINT AT. Subroutine 2000 shows how to line up columns of numbers using STR\$ and the line 110 shows how a string (lines 510-700) can be given a numeric value by using VAL.

America is shaping up and the T/S1000, thin and trim itself, can help.

**EXERCISE AND CALORIES**

DO YOU EXERCISE? BELOW IS A LIST OF SOME COMMON EXERCISE ACTIVITIES.

|            |              |
|------------|--------------|
| BADMINTON  | RACQUETBALL  |
| BASEBALL   | RUNNING      |
| BASKETBALL | SITTING      |
| BICYCLING  | SKATING      |
| BOWLING    | SKIING       |
| DANCING    | SOCCER       |
| FOOTBALL   | TABLE TENNIS |
| GOLF       | TENNIS       |
| HANDBALL   | VOLLEYBALL   |
| JOGGING    | WALKING      |

HIT <ENTER> TO CONTINUE

| ACTIVITY   | CALORIES USED |
|------------|---------------|
| GOLF       | 1250          |
| RUNNING    | 450           |
| SITTING    | 800           |
| BICYCLING  | 300           |
| BOWLING    | 1200          |
| HANDBALL   | 900           |
| BASEBALL   | 1080          |
| DANCING    | 900           |
| BASKETBALL | 1000          |
| VOLLEYBALL | 525           |

PROGRAM LISTING

```

1 REM *****
2 REM *PROGRAM BY BOB TEAGUE*
3 REM * 3 OAK ST. *
4 REM * WINTHROP *
5 REM * MAINE 04364 *
6 REM *****
8 GOSUB 500
10 GOSUB 1000
15 DIM A$(20,12)
17 DIM H(20)
20 REM ***USER INPUT***
25 PRINT "HOW MANY ACTIVITIES?"

30 INPUT X
35 PRINT AT 0,22;X
40 PRINT
45 FOR N=1 TO X
50 PRINT "ACTIVITY?"
60 INPUT A$(N)
65 PRINT A$(N)
70 PRINT "HOURS?"
75 INPUT H(N)
80 PRINT H(N)
85 PRINT
90 NEXT N
91 REM ***MAIN PROGRAM***
92 CLS
93 PRINT "ACTIVITY", "CALORIES
USED"
94 PRINT "-----"
95 PRINT
96 LET T=24
100 FOR N=1 TO X
103 GOSUB 2000
105 PRINT A$(N);TAB T-LEN X$;X$
110 LET C=C+(VAL A$(N)*H(N))
120 NEXT N
125 PRINT
127 GOSUB 3000
    
```

```

130 PRINT TAB 10;"TOTAL";TAB T-
LEN Y$;Y$
135 PRINT
140 PRINT "WEIGHT LOSS = ";C/70
00;" KG/"; (C/7000)/2.2;" LBS"
150 PRINT
160 PRINT
170 PRINT "GO AGAIN? (Y/N)"
175 INPUT C$
177 CLS
180 IF C$="Y" THEN GOTO 8
190 IF C$="N" THEN STOP
200 IF C$<>"Y" AND C$<>"N" THEN
GOTO 170
500 REM ***ASSIGN VALUES***
505 LET C=0
510 LET BADMINTON=300
520 LET BASEBALL=360
530 LET BASKETBALL=500
540 LET BICYCLING=400
550 LET BOWLING=400
560 LET DANCING=300
570 LET FOOTBALL=550
580 LET GOLF=250
590 LET HANDBALL=600
600 LET JOGGING=560
610 LET RACQUETBALL=600
620 LET RUNNING=900
630 LET SITTING=100
640 LET SKATING=400
650 LET SKIING=600
660 LET SOCCER=550
670 LET TABLE TENNIS=230
680 LET TENNIS=440
690 LET VOLLEYBALL=350
700 LET WALKING=300
800 RETURN
1000 REM ***ACTIVITIES LIST***
1010 PRINT TAB 5;"EXERCISE AND C
ALORIES"
1020 PRINT
1030 PRINT
1040 PRINT "DO YOU EXERCISE? BE
LOW IS A"
1050 PRINT "LIST OF SOME COMMON
EXERCISE"
1060 PRINT "ACTIVITIES."
1070 PRINT
1080 PRINT "BADMINTON", "RACQUETB
ALL"
1090 PRINT "BASEBALL", "RUNNING"
1100 PRINT "BASKETBALL", "SITTING"
"
1110 PRINT "BICYCLING", "SKATING"
1120 PRINT "BOWLING", "SKIING"
1130 PRINT "DANCING", "SOCCER"
1140 PRINT "FOOTBALL", "TABLE TEN
NIS"
1150 PRINT "GOLF", "TENNIS"
1160 PRINT "HANDBALL", "VOLLEYBAL
L"
1170 PRINT "JOGGING", "WALKING"
1180 PRINT
1185 PRINT
1190 PRINT "HIT <ENTER> TO CONTI
NUE"
1200 IF INKEY$="" THEN GOTO 1200
1210 CLS
1220 RETURN
2000 REM ***LINE UP ROUTINE***
2005 LET Y=VAL A$(N)*H(N)
2010 LET X$=STR$ Y
2015 LET Y=0
2020 RETURN
3000 LET Z=C
3010 LET Y$=STR$ Z
3020 LET Z=0
3030 RETURN
    
```

**H**AMPSON'S PLANE for the 16K T/S1000,ZX81 is derived from an attempt to simulate in two dimensions as many features of Rubik's Cube as possible.

The rules of the game are fairly simple. The screen is covered by 20 lines of plus signs. The computer, running in FAST, selects one of the symbols at random and inverts it and its eight immediate neighbors. The process is repeated a number of times, depending on the skill level.

When the computer has finished, your job is to convert the screen to normal, using the same technique, i.e.,defining the center square of a group and ordering the machine to invert it and its neighbors. The move should be input as "Letter, number, ENTER."

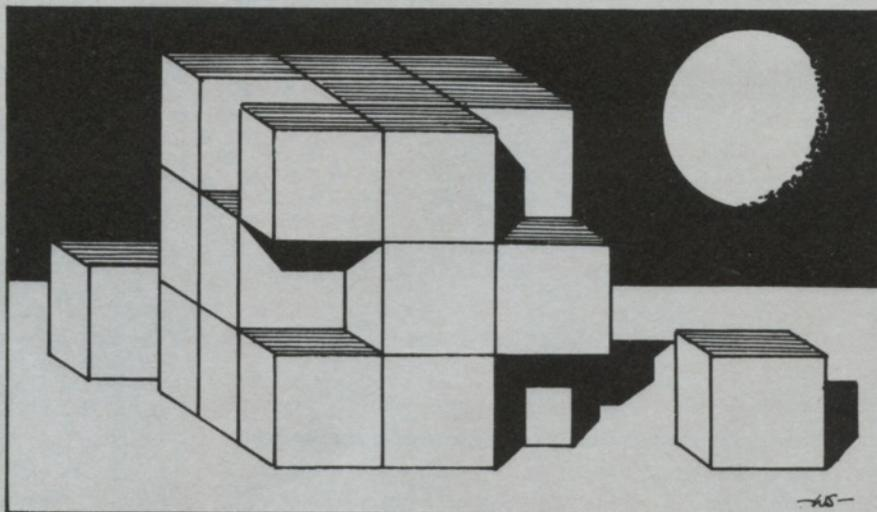

# HAMPSON'S PLANE

```

1  REM ██████████
2  REM ██████████
3  REM ██████████
4  REM ██████████
5  REM ██████████
6  REM ██████████
7  REM ██████████
8  REM ██████████
9  REM ██████████
10 PRINT TAB 7;"HAMPSON""S PLA
NE"
20 PRINT
30 PRINT "ENTER SKILL LEVEL"
40 INPUT S
50 CLS
60 PRINT " ABCDEFGHIJKLMNOPQR
STUUVWXYZ"
70 FOR Z=1 TO 20
80 IF Z<10 THEN PRINT " ";
90 PRINT Z;"+++++";
+++++";Z
100 NEXT Z
101 PRINT " ABCDEFGHIJKLMNOPQR
STUUVWXYZ"
103 FOR W=1 TO 1
105 NEXT W
110 LET D=0
120 LET P=0
125 LET U=0
130 LET X=0
140 LET Y=0
150 DIM K$(3)
160 DIM A(9)
170 LET A(1)=-34
180 LET A(2)=-33
190 LET A(3)=-32
200 LET A(4)=-1
210 LET A(5)=0
220 LET A(6)=1
230 LET A(7)=32
240 LET A(8)=33
250 LET A(9)=34
259 REM ██████████
260 LET D=PEEK 16396+256*PEEK 1
6397
265 RAND
269 REM ██████████
270 FOR W=1 TO S
280 LET X=INT (RND*24)+4
290 LET Y=INT (RND*18)+2
300 GOSUB 400
310 NEXT W
319 REM ██████████
320 INPUT K$
330 LET X=CODE (K$)-35
340 LET Y=VAL K$(2 TO )
349 REM CHECK MOVE
350 IF X<4 OR X>27 OR Y<2 OR Y>
19 THEN GOTO 320
360 GOSUB 400
370 GOTO 320
399 REM ██████████
400 FOR Z=1 TO 9
410 LET P=D+Y*33+X+A(Z)
415 LET U=PEEK (P)
420 LET U=U-128*(U=149)+128*(U=
21)
425 POKE P,U
430 NEXT Z
440 RETURN

```

```

ABCDEFGHIJKLMNPOQRSTUVWXYZ
1+++++1+++++1+++++1+++++1
2+++++2+++++2+++++2+++++2
3+++++3+++++3+++++3+++++3
4+++++4+++++4+++++4+++++4
5+++++5+++++5+++++5+++++5
6+++++6+++++6+++++6+++++6
7+++++7+++++7+++++7+++++7
8+++++8+++++8+++++8+++++8
9+++++9+++++9+++++9+++++9
10+++++10+++++10+++++10+++++10
11+++++11+++++11+++++11+++++11
12+++++12+++++12+++++12+++++12
13+++++13+++++13+++++13+++++13
14+++++14+++++14+++++14+++++14
15+++++15+++++15+++++15+++++15
16+++++16+++++16+++++16+++++16
17+++++17+++++17+++++17+++++17
18+++++18+++++18+++++18+++++18
19+++++19+++++19+++++19+++++19
20+++++20+++++20+++++20+++++20
ABCDEFGHIJKLMNPOQRSTUVWXYZ

```

# NOW. A TS1000/ZX81 PUSH-BUTTON KEYBOARD FOR UNDER \$20.00.

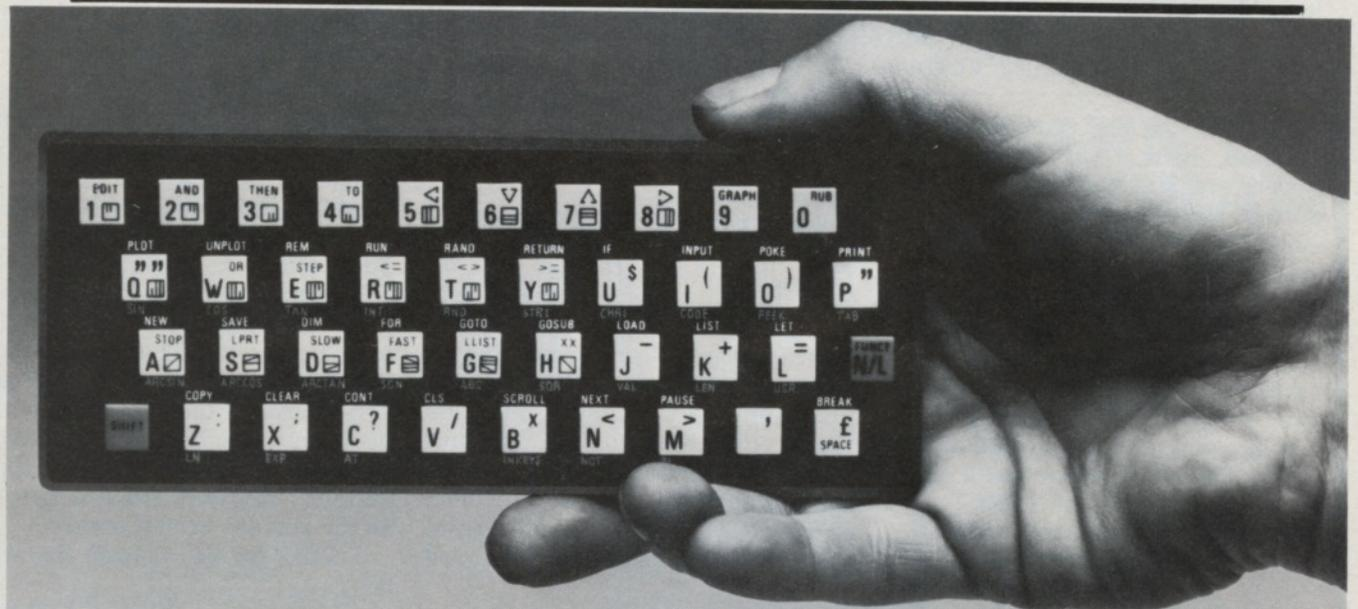

At last there's a really cheap but efficient way of ironing out the TS1000/ZX81's only real bug: its keyboard. The Filesixty Buttonset offers

- A full-travel calculator-type moving keyboard for only \$19.50.
- Installed in seconds. The peel off adhesive backing means you just register into position and press.
- No messy labels, dismantling or soldering.
- 3 groups of colour keys to pick out shift, numerals and newline.
- Precision moulded in ABS to match your TS1000/ZX81, with contrasting legends for maximum legibility.

Orders to Filesixty Ltd.,  
37 Fruehauf St., Buffalo, N.Y. 14226  
For more information, circle 18 on reader service card.

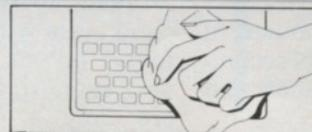

1. Make sure the original keyboard is clean and check that all the keys function.

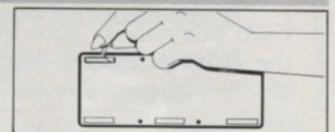

3. So all you do is remove the protective backing.

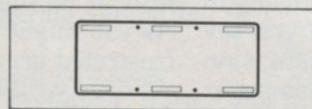

2. The Buttonset is held in place by self-adhesive pads.



4. And place it centrally on your TS1000/ZX81.

Cheques/money orders made payable to Filesixty Ltd.

Please send me \_\_\_\_\_ (qty.) Buttonset(s)  
at \$19.50 each (inclusive of postage & packaging).

Total \$ \_\_\_\_\_ BLOCK CAPITALS

Name \_\_\_\_\_

Address \_\_\_\_\_

State \_\_\_\_\_

Zip \_\_\_\_\_

**FILESIXTY**

USA2TSU

# Letters

## FAIR SHARE

I am thoroughly satisfied with my first issue of *Timex Sinclair User* and impressed with the programs in it. Keep it up! One thing I've been worried about is that with the new T/S2000 coming out, your magazine will start to be overrun with T/S2000 programs and articles. This would be totally worthless to T/S1000 owners.

**John J. O'Dell**  
Blacksbury, Virginia

Thanks for the kind words about our premier issue, John. We're glad you're enjoying the programs. You refer to *Timex Sinclair User* as our magazine; let me assure you we are trying as hard as we can to make it your magazine. To that end, there is no way we would abandon T/S1000 owners — quite the contrary! We have some fabulous projects, articles and programs all set to go. Keep reading and we're sure you'll see the T/S1000, ZX81 is given its fair share of the pages, and then some!

## ON THE 2040

I am puzzled by your statement in the first paragraph of the second column on page five of your second issue.

I assume you mean the 2040, a great machine which I am using to write this letter. How can you say the paper is untreated? There is no ribbon in the machine. This paper prints blue. This must be a thermal printer using treated paper, previous paper was gray. Please clarify in a future issue.

The new magazine is excellent. Very truly yours,

**Charles J. Levin**  
Towson, Maryland

You caught us, Charles! We made an error. I guess perfection is still around the corner for us. Seriously, thanks for showing us the mistake. The 2040 does take treated paper as pointed out in our In-Depth article in issue two.

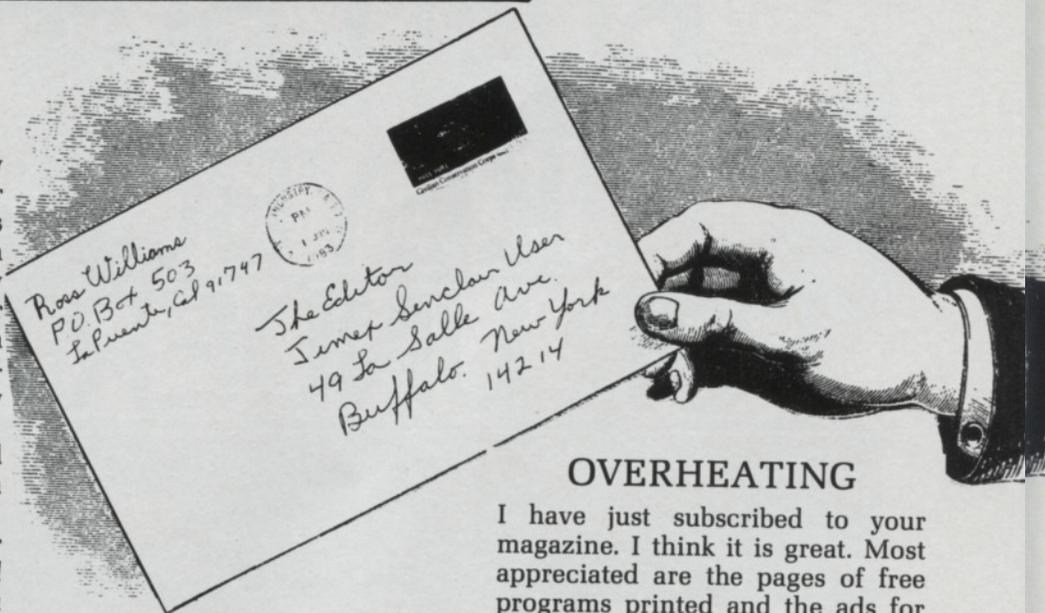

## ON USER SUPPORT

First, let me congratulate you on your fine magazine. I teach programming in Oakland, Maine, and *Timex Sinclair User* has become an important tool in furthering my programming techniques. My kids really enjoy the game section and spend hours entering and playing the games you publish. *Timex Sinclair User* is a welcome respite from the overpriced books that are available.

I read *Timexpectations* in your second issue with interest. I too have found myself a victim of lack of user support. Here in Maine, there are only a few outlets for the T/S1000, and after the sale there is little or no support from the stores. As you might imagine, I am a very frustrated user.

I have written a rather strong letter to Timex asking them to help us loyal users, and referred to your column. I hope it does some good. I hope that many of your readers will also write. We deserve better than we're getting.

**Robert D. Teague**  
Winthrop, Maine

Thanks for the kind words, Robert. As to Timex support, it seems they have heard you. You can now write or call Timex for help in finding suppliers and service centers. Write to: Timex, P.O. Box 1378, Little Rock, Arkansas 72203.

## OVERHEATING

I have just subscribed to your magazine. I think it is great. Most appreciated are the pages of free programs printed and the ads for related products. I had been searching the newsstands for a publication like yours.

I have a question for your *Hints & Tips* section. I have noticed that after I use my T/S1000 for an hour or more the bottom of the unit gets very warm to the touch. Does this have any effect on the "glitches" that occur from time to time? Should I take any steps to provide an air current in that area?

Thanks for any help in this matter.

**William J. Pideck**  
Mendham, New Jersey

Thanks for the kind words. Compliments are always welcome. About the overheating problem — yes, it can cause all sorts of difficulties. Read *Hints & Tips* in our second issue. Many ideas on how to overcome the overheating problem were given. Let us know how they work for you.

## PROGRAMS IMPROVED

I very much enjoyed your first issue, especially the programs. However, I believe the following four lines will improve the Rear Gunner program:

82 PRINT AT A, B - 1; "space"  
83 PRINT AT A, B + 1; "space"  
194 PAUSE 100  
195 CLS

Also, if you handle INKEYS in the

## THE EXPLORER'S GUIDE TO THE ZX81 OR T/S1000

If you have a ZX81 or T/S1000 then you need this book. 1K and 16K programs. Games and Applications. RAM and I/O circuits. Programming hints. ROM routines.

**\$8.95 from:**  
**TIMEDATA**  
3 Waldon Road,  
Califon, NJ 07830

For more information, circle 19 on reader service card.

following manner, you can eliminate two lines:

90 LET A = A - (INKEYS \$ = "7") + (INKEYS \$ = "6")  
100 LET B = B - (INKEYS \$ = "5") + (INKEYS \$ = "8")

It seems cleaner, don't you agree? Congratulations on this long awaited magazine.

P.S. More programs by the creator of London Bridge please!

**Howard F. Gold**  
Greenville, S.C.

Thank you — your compliments have been well-received by our hard-working staff! We do agree, your changes to Rear Gunner are good. Instead of more programs from London Bridge author, why not a program from you? Thanks again.

## TS1000/ZX81

FAST SAVE/LOAD PROGRAM  
+ LOADING AID PROGRAM  
ONLY \$15.00

Up to 20 times faster (4800 Baud)  
At least 10 times faster on any decoder that can load TS1000 normal speed programs

### FEATURES:

Full variable speed save  
Automatic load at any speed  
True verify  
Any part of memory save  
Any memory size up to 64K

### Details:

\$3 Refundable against purchase  
Cheques/Money Order payable to  
MUSAMY SOFTWARE  
11 Brettenham Ave.  
Walthamstow, E17 5DG England.

For more information, circle 22 on reader service card.

## TS 1000

### UTILITY

Quick Load ..... \$11.99  
Assembler ..... 11.99  
Disassembler ..... 11.99  
Compiler ..... 9.95  
Graph ..... 9.95

### GAMES

Packman ..... \$9.95  
Snakebite ..... 9.95  
Chess ..... 9.95  
Fungaloids ..... 9.95

### BUSINESS

Bookkeeping ..... \$12.99  
Financial Analyzer ..... 11.99  
Inventory Control ..... 11.99

MANY MORE EXCITING  
PROGRAMS!

CALL FOR FREE CATALOG  
DISCOUNT SOFTWARE

320 E. 59th St., NY, NY 10022  
Tel: (212) 486-0980

For more information, circle 20 on reader service card.

## HORSE TRADING

A short time ago, I received an advertisement for Timex Sinclair User. I would very much like to get a subscription to your magazine, as I own a T/S1000 with a 16K memory. The only problem is I spent all but my last dollar purchasing the computer, the 16K RAM pack and a TV set. Perhaps we could work around that minor inconvenience.

What I have in mind is this — sort of a trade. I will give you my program, "Checkbook Calculator," to do whatever you want with, and what I would like in return is a subscription to your magazine for one year. I am assuming that you are interested in obtaining practical software that has a definite use and also can help the Timex Sinclair user the way a program should be designed.

I hope to hear from you soon.

**Freddie T. Reitz**  
Madison, Wisconsin

Freddie, there is nothing we like better than a little honest "horse trading." I think we can do something here. We pay \$20 for



# LEARN TO PROGRAM

Text and File Organizers with  
**ZX DATA FINDER**

A high capacity information storage and retrieval tool for 16 K Timex and Sinclair Computers.

Advanced file input and editing routines are thoroughly analyzed.

Comprehensive search and display methods are fully explained.

## AN ADVANCED COURSE IN DATA HANDLING

Free specifications are available, or send \$9.95 for program listing and text to:

**THOMAS B. WOODS**  
P.O. Box 64, Jefferson, N.H. 03583

For more information, circle 23 on reader service card.

# COMPUTER CASSETTES



**BASF  
-DPS**

THE WORLD'S FINEST

Data media for all microcomputers. Used nationwide by software manufacturers, hobbyists, schools and businesses. Premium 5-screw shell with leader fits all standard recorders.

SATISFACTION GUARANTEED OR MONEY BACK.

| ITEM     | 1 DOZ.                         | 2 DOZ.                         |
|----------|--------------------------------|--------------------------------|
| C-05     | <input type="checkbox"/> 7.50  | <input type="checkbox"/> 13.50 |
| C-10     | <input type="checkbox"/> 8.00  | <input type="checkbox"/> 14.40 |
| C-20     | <input type="checkbox"/> 10.00 | <input type="checkbox"/> 18.00 |
| Hard Box | <input type="checkbox"/> 2.50  | <input type="checkbox"/> 4.00  |

Send for free brochure. Ask for quantity discounts. Calif. residents add sales tax. SHIPPING HANDLING (UPS) 1 doz. \$2. 2 doz. \$3.50. 3 doz. \$4.50. ea. additional doz. \$5.00. For parcel post instead of UPS, add \$1. Outside Continental USA, add \$2.

FOR IMMEDIATE SHIPMENT  
USE YOUR VISA OR MASTERCARD CALL 213/710-1430

**YORK 10™ Computerware**  
24573 Kittridge St., TS Canoga Park, CA 91307

For more information, circle 21 on reader service card.

## DYNACOMP PRESENTS -

Quality Software for the TIMEX/SINCLAIR DYNACOMP, the leading distributor of software for small computers is pleased to announce a new line of software for the TIMEX/SINCLAIR computer. We examined what the others were offering, and went two steps beyond!

|                       |         |
|-----------------------|---------|
| BLACKJACK .....       | \$12.95 |
| TIC-TAC-TOE .....     | \$ 9.95 |
| WORD SCRAMBLE .....   | \$ 9.95 |
| PIXEL DRAWER .....    | \$14.95 |
| GRAPHICS DRAWER ..... | \$14.95 |
| CHECKBOOK .....       | \$14.95 |
| DATA FILER .....      | \$19.95 |
| PHONEBOOK .....       | \$12.95 |

Order 3 or more and deduct 10%; 5 or more, 20%.

A documentation package which covers all of the above is available for \$4.95 (can be applied to the purchase of any program).

Available on cassette. Requires 16K RAM. Please include \$2.00 for shipping and handling. N.Y. residents add 7% sales tax. All orders processed within 48 hours. 30 day guarantee.

**DYNACOMP, Inc. Dept. S**  
1427 Monroe Avenue  
Rochester, NY 14618  
(716) 442-8960 (24 Hours)  
(716) 442-8731 (9 AM - 5 PM EST)

For more information, circle 55 on Reader Service Card.

Available  
Now From

**PRISM**  
MICROPRODUCTS

**Word processor**

# Challenging games,

Over a million people world-wide have bought a Timex Sinclair personal computer, and every month the figure grows.

And it's true of any serious computer that 'the software makes the system'.

So, what better software to buy than Prism software? As Exclusive Trade Distributors for the Sinclair range of computers, peripherals and software in the U.K., Prism in-depth knowledge and experience is unrivalled.

With a significant reputation to maintain, you can be sure Prism software has been thoroughly 'field-proven'.

Word processing, challenging games, educational programs . . . now they're all available to you in North America.

They give you even more scope with your TS1000, and allow you to use your computer immediately\*.

This easy-to-use software is even easier to order! Complete and mail the coupon opposite for the programs of your choice — today.

*\*16K programs require 16K RAM memory pack.*

## BUSINESS

**B1. Word Processor** — Use your TS1000 to familiarise yourself with word processing. If you have a printer, prepare a letter to your friends. (16K)

## GAMES

**G1. Party Tricks** — A range of programs with listings supplied, to give the novice an insight into the TS1000 BASIC. (1K)

**B3. Trawler** — A business-management game set in the North Sea. Can you match the catch of a top trawler captain? (16K)

## ADVENTURE

**A1. Samurai Warrior** — A game where, as a Samurai warrior, you battle with other Samurai and with bandits to protect villages. Can you become Shogun? (16K)

**A2. Tyrant of Athens** — Disasters, famines, attacks from land and sea. Can you resist them all and remain Lord of Athens? (16K)

**A3. Roman Empire** — Send legions to conquer Mediterranean countries — and if you succeed, crown yourself Caesar! (16K)

**A4. Peloponnesian** — A re-enactment of the famous battles between Athens and Sparta. Try to win allies and influence people before the final battle! (16K)

**A5. Warlord** — You'll need swift judgement to protect your village from marauding bandits and Samurai, your fleet from pirates, and your people from slavery. (16K)

**A6. Escape From Manhattan** — MAY DAY . . . MAY DAY . . . The President's plane has crashed, on an island of convicts! Get there! Get him! Then get out again! (16K)

**A7. Demon Adventure** — Standard-text adventure game with real-time battles and which relies on complexity rather than difficulty of play. (16K)

**A8. The Thing** — A graphic adventure game set in the Antarctic. Escape to the helicopter and save your life — if you can. (16K)

## ARCADE ACTION

**R1. J.D. Arcades** — Three popular m/code games with some novel twists. (16K)

**R2. Outrider** — Save your mother ship. She's being assailed by aliens! (16K)

**R3. Xaraks** — Get round the maze without

**All designed to let you get  
from your TS1000 & TS1500**

# Processing, programming aids, educational programs...

the guard catching you. And if you want to make things difficult for yourself, there are nine levels of play, all m/code. (16K)

**R4. Avenger** — A classic. Can you win the planet? Destroy oncoming missiles, bombs, and the city below to stake your claim. (16K)

**R5. Protector** — Defend your ship against oncoming missiles. Can you create the highest-ever score? (16K)

**R6. Bomber** — You must land, but not before all alien life forms are neutralized... but they want to neutralize you! (16K)

**R7. Alien Rain** — There's an Extra Terrestrial on one side of the screen, and you're on the other. It's raining — bombs! Please try and rescue the Extra-Terrestrial. (16K)

## CHALLENGE

**C1. Video Map** — Navigate your plane cross-country. Sounds easy? If you go off course... (16K)

**C2. Golf** — Play your game of golf in the comfort of your own home! But don't be deceived — you still have to deal with sand, rough, trees, etc. (16K)

**C3. Pilot** — That's you. Can you land your plane safely in the dark? (16K)

## COMPUTING

**P1. Hi-Res Package** — Greatly enhances the graphics facilities of your TS1000, increasing the resolution to 256 x 192. (16K)

**P2. Video Graph** — Despite the name this one doesn't plot graphs! Instead, this fascinating program enables you to create pictures which can be stored, and then merged — like an Identikit. (16K)

**P3. Video Sketch** — Use the full graphics facilities of the TS1000 — draw, type, use the large alphabet and reverse images. (16K)

## Now order your Prism programs direct

### Adventure

- A1. Samurai Warrior .. \$9.95
- A2. Tyrant of Athens .. \$9.95
- A3. Roman Empire .... \$9.95
- A4. Peloponnesian .... \$9.95
- A5. Warlord ..... \$9.95
- A6. Escape From Manhattan..... \$14.95
- A7. Demon Adventure . \$9.95
- A8. The Thing ..... \$9.95

### Challenge

- C1. Video Map ..... \$9.95
- C2. Golf ..... \$9.95
- C3. Pilot ..... \$9.95

### Computer

- P1. Hi-Res Package .. \$19.95
- P2. Video Graph ..... \$14.95
- P3. Video Sketch ..... \$14.95

### Arcade Action

- R1. F.D. Arcades ..... \$9.95
- R2. Outrider ..... \$9.95
- R3. Xaraks ..... \$9.95
- R4. Avenger ..... \$9.95
- R5. Protector ..... \$9.95
- R6. Bomber ..... \$9.95
- R7. Alien Rain ..... \$9.95

### Games

- G1. Party Tricks ..... \$9.95
- B3. Trawler..... \$9.95

### Business

- B1. Word Processor .. \$19.95

Please send me: \_\_\_\_\_ @ 9.95 = \_\_\_\_\_  
 \_\_\_\_\_ @ 14.95 = \_\_\_\_\_  
 \_\_\_\_\_ @ 19.95 = \_\_\_\_\_  
 Sub Total \_\_\_\_\_  
 Shipping + 1.50 \_\_\_\_\_  
 Total \_\_\_\_\_

International Publishing & Software  
 49 La Salle Avenue  
 Buffalo, NY 14214

Visa  Master Card  Money order

Name \_\_\_\_\_ Card No. Expiry \_\_\_\_\_

Street \_\_\_\_\_ Signature \_\_\_\_\_

City \_\_\_\_\_ State \_\_\_\_\_ Zip \_\_\_\_\_

Prism Microproducts are published and distributed in North America by International Publishing & Software Inc.

**PRISM**  
 MICROPRODUCTS

the most

00

# SETTING FORTH

**F**ORTH is a computer language that uses less memory and runs at higher speeds than most high-level languages. In many ways, it is similar to BASIC, and is used with many computers. The following is a summary of its properties.

- FORTH commands can be issued in an immediate execution mode or included as statements for later execution.

- FORTH statements are compiled and contain high-level structured constructs such as

```
IF ... ENDIF
IF ... ELSE ... ENDIF
DO ... LOOP (like BASIC FOR/NEXT)
DO ... +LOOP (like BASIC FOR/NEXT/STEP)
BEGIN ... AGAIN
BEGIN ... UNTIL
BEGIN ... WHILE ... REPEAT
```

- The execution speed of FORTH commands approaches that of assembler programs.

- FORTH is highly portable — it can be easily transferred from one hardware host to another.

- There are no barriers between the compiler, system, or applications code. FORTHS are frequently implemented as language systems as opposed to being included under operating systems.

- FORTH uses an efficient virtual memory system.

- FORTHS are frequently multitasking.

- FORTHS permit easy user definition of new data types and structures.

- New verbs can be added to the language either in terms of existing verbs or assembly language of the host processor.

- FORTHS are frequently in the public domain and as a result do not require software licensing for their reproduction. A team of systems level program-

mers in 1978 created a portable model of FORTH which they originally implemented on nine different microcomputers. This FORTH model became known as fig-FORTH (FORTH Interest Group). There is a fig-FORTH 1979 standard and upcoming 1983 standard.

## How FORTH works

The fundamental goal of a FORTH is to transform any computer into a standard FORTH stack computer. The computer code required for this transformation can be a combination of FORTH and machine language.

FORTHS can be viewed as composed of three stacks. These stacks are:

1. A *parameter stack* which is normally two bytes wide. This stack expands downward in memory.
2. A *return stack* which is normally two bytes wide. This stack expands downward in memory.
3. A *word dictionary* which behaves much like a stack with variable width elements but is a linear linked list. The word dictionary expands upward in memory.

The following programming examples in FORTH will make clear some of its powerful features. Spaces are the delimiter in FORTH text. OK is FORTH's prompt for input from a system console. **All responses from FORTH will be printed in bold.** A carriage return keyed by the programmer causes a transition from input to the bold output of FORTH in these examples.

*Example 1:*  
2 3 + .5 OK

This example adds 2 to 3 and prints the result on the console output device. The number 2 is identified as a number, converted to a two-byte binary number and placed on the top of the parameter stack. The same process occurs for the

number 3. At this point in the FORTH interpretation, the parameter stack is

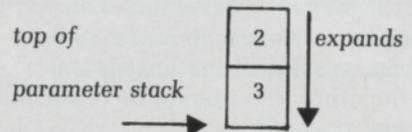

The + is identified as a verb and is executed immediately. The + verb adds the top two values of the parameter stack, discards both, then pushes the sum on top of the parameter stack. The words "Uses - Leaves" or "Before - After" are frequently used to describe the contents of the parameter stack prior to and after the execution of a word. In this case.

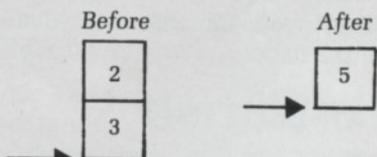

The . verb prints the signed number at the top of the parameter stack and has the Before - After parameter stack.

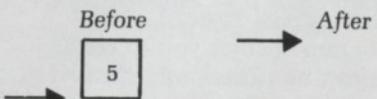

FORTH requires that expressions be written in reverse Polish as is done when using Hewlett-Packard calculators. The expression (A + B)\*(C - D) would be written A B + C D - \* for evaluation in FORTH.

A FORTH "WORD" is much like a line number in BASIC or a label in a language like PL/I. A FORTH word can be defined for later execution. The next example contains a definition of a user-defined FORTH word named CUBE which is designed to take the cube of the number

located at the top of the parameter stack. The : is similar to a line number in BASIC.

**Example 2:**

```
: CUBE DUP DUP * * ; OK
```

The : informs FORTH that the word following the : is to be compiled into the FORTH language. DUP is part of the core FORTH language and this verb causes a copy of the top number on the parameter stack to be pushed on the parameter stack. If X is a number, then the Before - After parameter stack values for DUP are

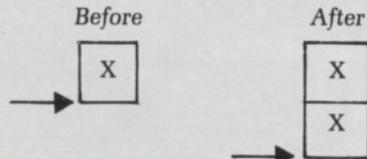

The FORTH word \* is part of the core language and has the Before - After parameter stack values

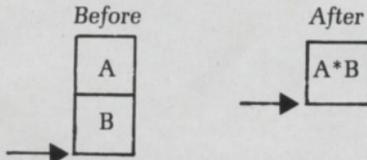

for numbers A and B where A\*B is the product of A times B. The ; ends the definition of CUBE. When CUBE is issued as a command in the form

```
3 CUBE .27 OK
```

3 is placed on the parameter stack then CUBE is invoked. A rough execution trace of 3 CUBE . is

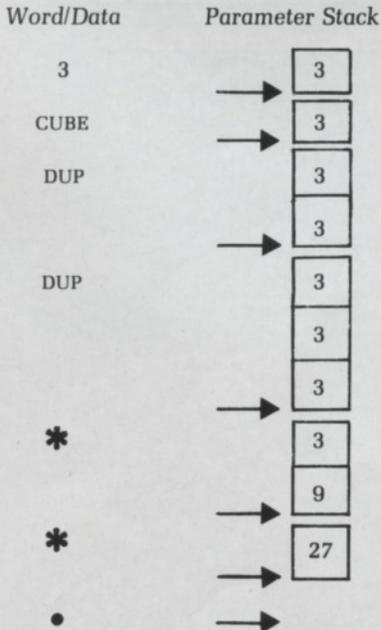

## FORTH is used in video games, word processors, cameras . . .

**Example 3:**

The control structure DO . . . LOOP is used within the user-defined word TEST.

```
: TEST 1 DO 1 . LOOP ; OK
```

Execution of the command sequence 10 TEST gives

```
10 TEST 1 2 3 4 5 6 7 8 9 OK
```

TEST contained three new words; DO, LOOP, and I. The FORTH core word I makes a copy of the value on the top of the return stack and places it on the parameter stack. The functions of DO and LOOP are best examined by looking at a rough trace of execution of 10 TEST.

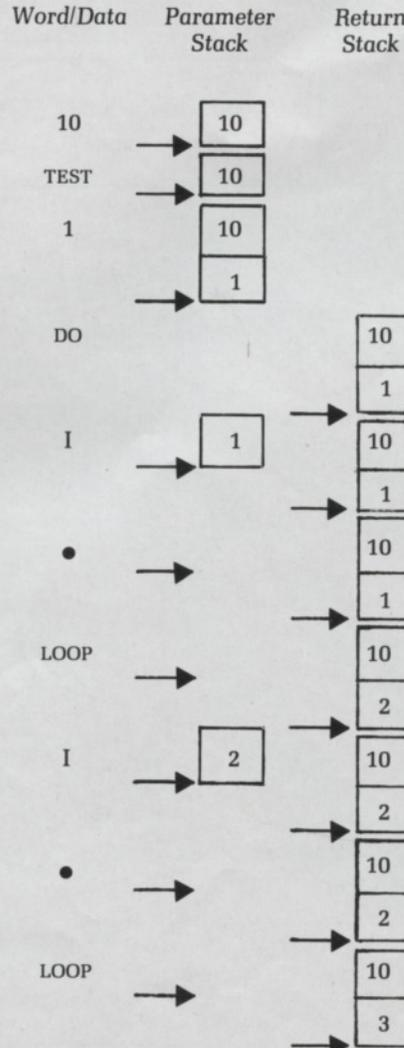

This process continues until

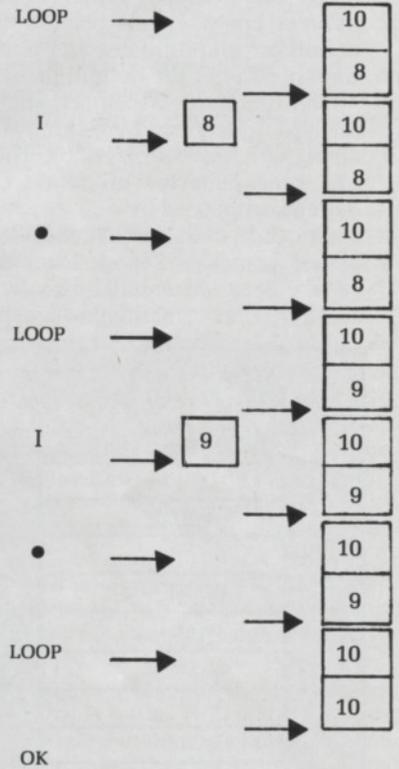

When in value of the INDEX - LIMIT >= 0, the INDEX and LIMIT are popped off the return stack and program control continues at the statement following LOOP which, although not covered yet, is the execution time code for ;.

**Example 4:**

The next example illustrates specification of both execution time and compile time behavior of a FORTH word. The attribute of specification of both execution time and compile time behavior sets FORTHS apart from other languages in terms of power (performing what is needed easily). Before specifying compile and execution time behavior of a word, the definitions

```
: RED ." RED" ; : WHITE ." WHITE" ; : BLUE ." BLUE" ; OK
```

When you type in red, the following will appear on the screen:  
RED REDOK

The FORTH words <BUILDS and DOES> are used respectively to specify compile time and execution time behavior of a new FORTH word. The : definition : :CASE <BUILDS ] DOES> SWAP 2 \* + @ EXECUTE ; OK

defines a new word :CASE. When :CASE is executed, <BUILDS causes the word following :CASE to be included in the FORTH language. The ] causes FORTH to enter the compile mode. DOES> terminates compile time portion of the : definition and initiates the execution time portion of the definition.

The functions of <BUILDS and DOES> are best understood by looking at an example of a new word, COLOR. The compile time behavior of COLOR can be defined with :CASE by  
:CASE COLOR RED WHITE BLUE [ OK  
where [ means "enter the interpret state". :CASE is executed directly by issuing the above command sequence. Its

## FORTH uses less memory and runs at higher speeds than most high-level languages

first action is to execute <BUILDS which creates a new FORTH word called COLOR. The ] places FORTH in the compile state. All subsequent words encountered are

compiled rather than executed until the [ places FORTH back in the interpret state.

FORTH object code can frequently be decompiled. :CASE, RED, WHITE, and BLUE were decompiled using a decompiler written in FORTH. This decompiler was unable to decompile DOES> because it was written largely in machine code and COLOR. COLOR was dumped in hexadecimal to the screen and manually decompiled. Decompilations of these words are shown below. The ;s is the execution time code of ; and : stands for the execution time code (DOCOL) of : . DODOES is the execution time code of DOES>.

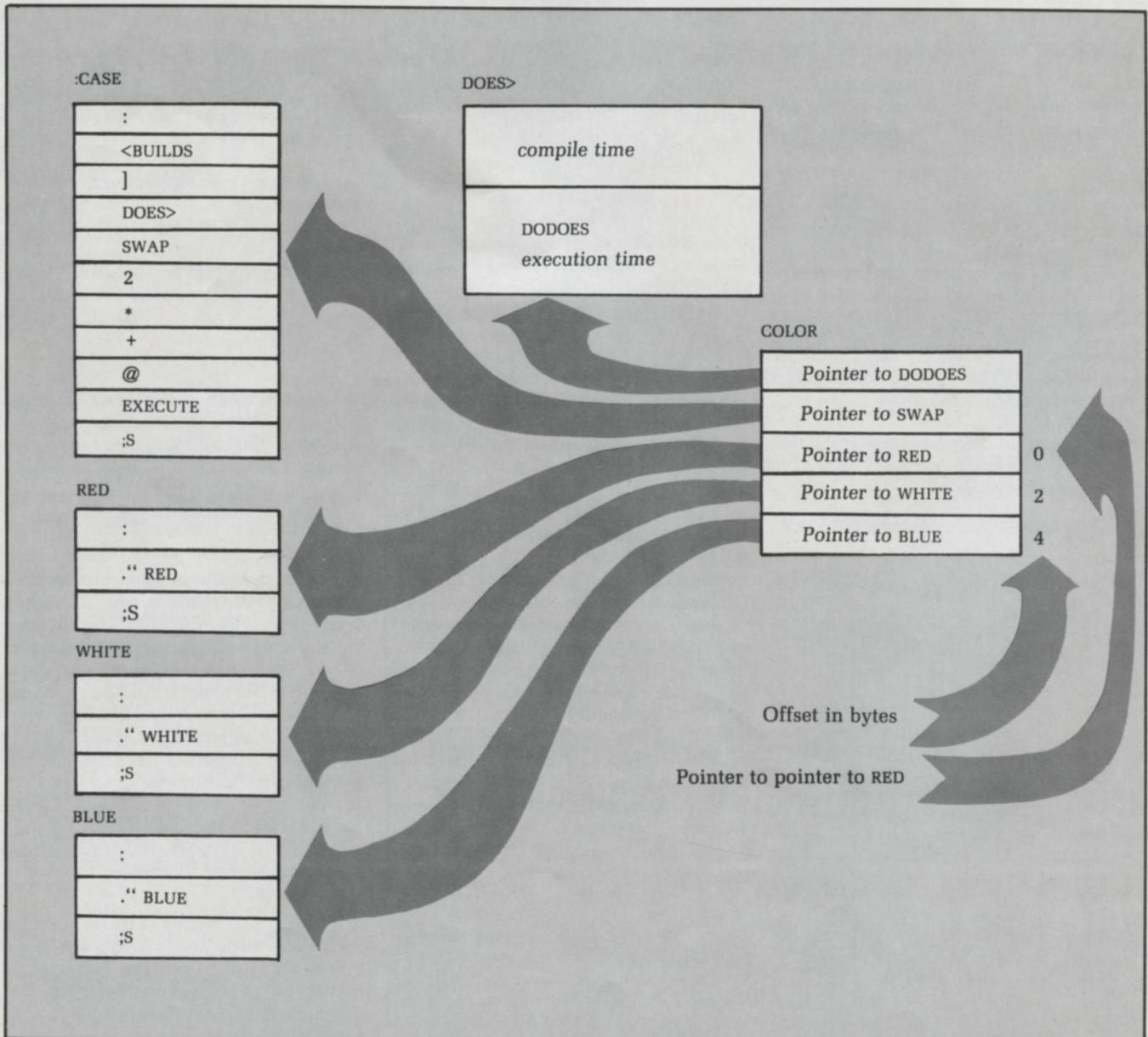

# In-depth

DODOES causes (1) a pointer to the pointer to RED to be placed at the top of the parameter stack; (2) SWAP to be executed. COLOR can be exercised by

```

0 COLOR REDOK
1 COLOR WHITEOK
2 COLOR BLUEOK

```

and the execution time behavior of :CASE can be understood by tracing execution of its DOES> portion for 1 COLOR. At the beginning of execution of SWAP

the parameter stack contains the material shown in figure 1.

Assembler programs can be written in FORTH without leaving FORTH. The Z80 Stack Pointer register, SP, points to the top of the Z80 FORTH parameter stack. A FORTH assembler routine which doubles the number at the top of the parameter stack is

```

CODE DOUBLE HL POP HL, HL ADD HL PUSH
NEXT OK

```

DOUBLE can be used like this:

```

2 DOUBLE .4 OK

```

and within a FORTH high-level statement. For example,

```

: IDOUBLE 1 DO I DOUBLE . LOOP ; OK

```

exercised by

```

10 IDOUBLE
2 4 6 8 10 12 14 16 18 OK

```

Even FORTH's assembler requires writing the Z80 mnemonics in a type of reverse Polish: HL POP for POP HL; HL, HL ADD for ADD HL,HL; and HL PUSH for PUSH HL.

Figure 1

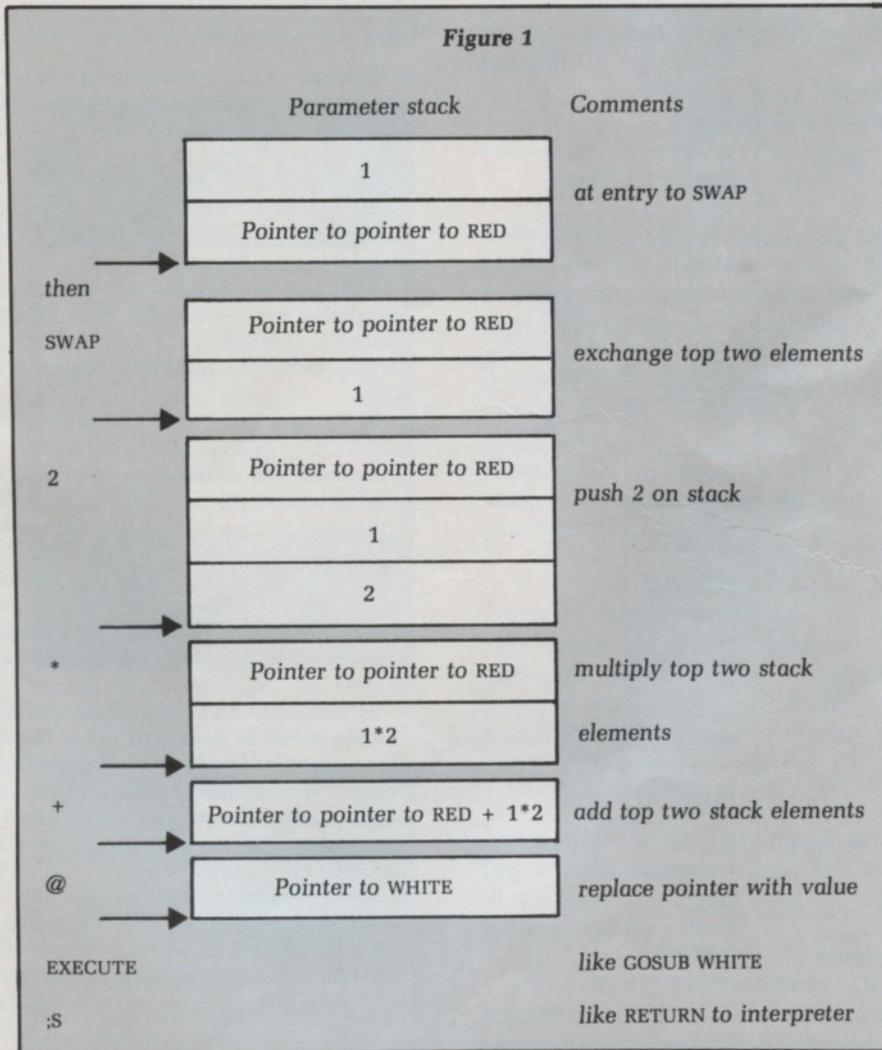

Most FORTHS include a line editor, a mini full screen editor, and complete full screen editor.

### Sinclair's FORTH

This introductory description of the FORTH software technology will give enough background that readers can understand how Sinclair's software engineers put the FORTH software technology to use to write ZX81 BASIC.

Sinclair's FORTH can be viewed as composed of three stacks. These stacks are

1. A parameter stack which is five bytes wide (also called the *calculator stack*). This stack expands upward in memory.
2. A return stack which is normally two bytes wide. This stack expands downward in memory and is the Z80 machine stack which is pointed to by stack pointer register SP.
3. A word dictionary stack which is one byte wide and expands upward in memory.

Values on a BASIC parameter stack are assigned a type attribute. ZX81 BASIC has the type attributes of number and string. Two data structures contained in the five-byte values on the parameter stack are shown in figure 2.

Figure 2

| Number |                            | String |                            |
|--------|----------------------------|--------|----------------------------|
| Offset |                            | Offset |                            |
| 0      | Sign and value of exponent | 0      | Unused                     |
|        |                            | 1-2    | Pointer to start of string |
| 1-4    | Sign and value of mantissa | 3-4    | Length of string           |

# In-depth

The type attribute is contained in bit 6 of the ZX81 system variable called FLAGS (Bit 6 = 1 for a number and 0 for a string).

Sinclair's one byte FORTH word dictionary operates by ZX81 BASIC doubling the byte value and using the resulting number as an offset into a table which contains a pointer to the executable word code.

As an example of some of the values in the table, their Sinclair definition, and comparable FORTH definition:

| Value | Sinclair definition | FORTH definition |
|-------|---------------------|------------------|
| 00    | Jump-true           |                  |
| 01    | exchange            | SWAP             |
| 02    | delete              | DROP             |
| 03    | subtract            | -                |
| 04    | multiply            | *                |
| 05    | division            | /                |
| •     | •                   | •                |
| •     | •                   | •                |
| •     | •                   | •                |
| •     | •                   | •                |
| 2D    | duplicate           | DUP              |
| •     | •                   | •                |
| •     | •                   | •                |
| •     | •                   | •                |
| 3C    | get-mem-O etc.      |                  |

An example of a `:`-type high-level language Sinclair FORTH program contained in the ZX81 BASIC is `N mod M`. `N mod M` is not available for use through normal T/S1000,ZX81 keyboard entries but is available for use through `USR` calls. `N mod M` computes both a quotient and remainder of `N` divided by `M`. For example 5 divided by 3 leaves a quotient of 1 and a remainder of 2. In terms of Before and After stack frames (several stack values considered as a unit)

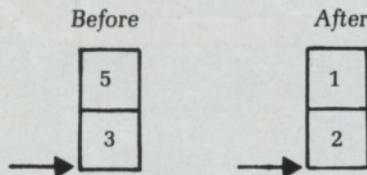

Sinclair's FORTH allows storing or retrieving numbers from or to the top of the parameter stack. `GETO` and `STOREO` respectively fetch the contents of memory 0 to the top of the parameter stack and stores the value at the top of the parameter stack to memory 0. The definition of `N mod M` written with FORTH-like mnemonics is

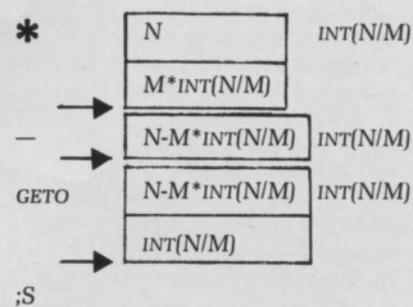
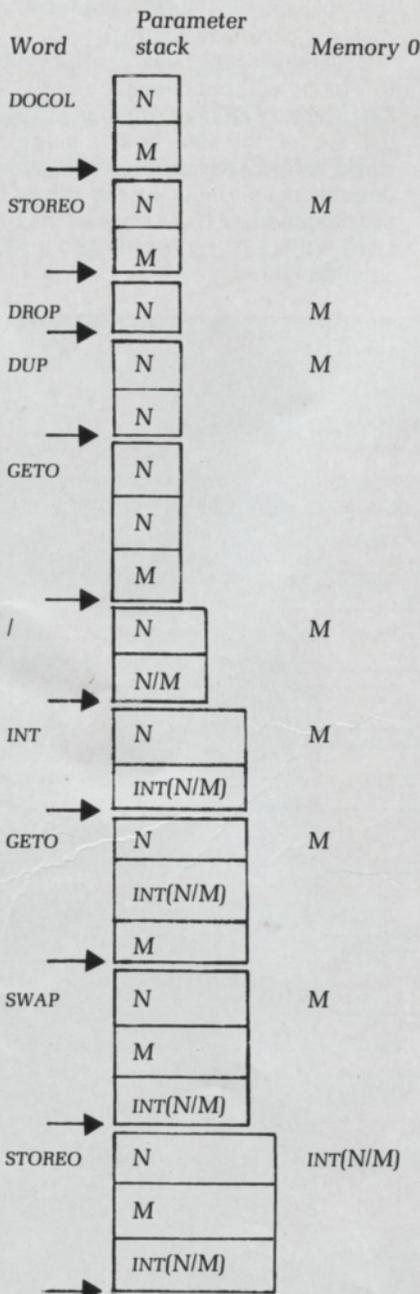

Sinclair's FORTH words of `INT`, `*`, `/` and `-` are available from the keyboard but `SWAP`, `DUP`, `DROP`, `STOREO`, and `GETO` are not. While `N mod M` was a high-level language word definition, many of Sinclair's FORTH words are `CODE`-type (machine language) definitions or even combinations of both.

Sinclair's FORTH decomposes numbers into numbers and logical types. A numeric 0 is a logical `FALSE` while a non-zero numeric is logical type `TRUE`.

Numbers can be compared in Sinclair's FORTH and forward or backward conditional jumps can be made depending on the logical value contained at the top of the parameter stack.

Sinclair's FORTH facilitates compiling constants into a compiled `:`-type definition, and pushing several predefined constants such as `Pi` onto the parameter stack.

In summary, the T/S1000's BASIC was implemented in large part using the advanced FORTH software technology. FORTH is currently regarded as an underground language. FORTH resides in video games, word processors, camera controllers, and so on. The FORTH software technology resides in likely the most widely distributed software package ever written. This is the T/S1000's ZX81 BASIC language system.

## For further reading

The FORTH programs contained in this article were written in Laboratory Microsystems ZX80 FORTH implemented on a CD110 and PC FORTH implemented for the IBM PC. The bulletined FORTH attributes were adapted from Peter Kogge's article *Architectural trail to threaded codes languages*, IEEE Computer, March 1982 and Ray Duncan's PC FORTH documentation. Ian Logan's Sinclair ZX81 ROM Disassembly, Part A 0000H-0F54H Melbourne House, 1981 and Ian Logan's and Frank O'Hara's Sinclair ZX81 ROM Disassembly, Part B 0F55H-1DFFH, Melbourne House, 1982, gives detailed comments on the ZX81 BASIC language Z80 machine language disassembly. I recommend *Starting FORTH* by Leo Brodie, published by Prentice-Hall, 1981, for learning introductory FORTH, *FORTH Encyclopedia* by Mitch Derick and Linda Baker, published by Mountain View Press, 1982, for learning FORTH internals, and *Implementing BASICs: How Basics Work* by William and Patricia Payne, published by Reston/Prentice-Hall, 1982, for learning about BASIC language system design.

## ScreenMate

ScreenMate's Lightpen and InterFace for the Atari® Joystick adds versatility to your ZX81 or TS1000.

- Play Action Games
- Direct Interaction with the TV Screen.
- Features a "Piggy-back" Add On Feedthrough
- Draw and Doodle
- Ideal for Educational Programs
- Independent of Keyboard



**\$39.95 includes**

- Lightpen with Joystick Interface
- User Guide • 90 Day Limited Warranty
- All Postage and Handling

**NEW! ScreenMate Program Cassette**  
**\$9.95 includes**

- Draw • Doodle • Math Quiz • Master Mind
- Tic-Tac-Toe • Word Scramble • Break Out
- States • Safe Cracker

### Interface Innovations

4372 Casa Brazilia, Suite 201, St. Louis, Mo. 63129  
Check Money Order MasterCard or Visa Accepted

For more information, circle 25 on reader service card.

## robotec, inc.

Professional Software  
Personal Prices

|                                       |         |
|---------------------------------------|---------|
| TEACHER'S GRADEBOOK                   | \$12.95 |
| WORD PROCESSING                       | \$12.95 |
| RECORD FILING (Addresses, etc.)       | \$16.95 |
| CHECK REGISTER & BUDGET               | \$12.95 |
| PROFITABILITY ANALYSIS                | \$12.95 |
| EQUATION GRAPHER                      | \$14.95 |
| DELUXE PLANET FINDER                  | \$14.95 |
| HEX CODE WRITER & EDITOR              | \$12.95 |
| ZX DATA FINDER 28 p. tutorial         | \$14.95 |
| FOOTBALL STATS                        | \$14.95 |
| USFL, or NFL, '81-'83 or NFL, '82-'84 |         |
| TIMEBLASTERS fast M/L                 | \$14.95 |
| PHASER WARS                           | \$ 9.95 |
| TORPEDO ATTACK                        | \$ 9.95 |

Add \$1.25 per order S & H  
Orders and Information  
419-666-2410 VISA & MC  
Robotec, Inc. P.O. Box 55T  
Rossford, OH 43460

For more information, circle 26 on reader service card.

**TIMEX-SINCLAIR**

**MEMOCALC** Spreadsheet Analysis

**MEMOTEK**

ZX81      TS1000      TS1500

MEMOCALC Spreadsheet (16-64K) ..... \$ 48.95  
Up to 99 cols. X 250 rows

MEMOTEK Word Processor (16-64K) ... \$ 48.95

TIMEX-Sinclair "1500" Computer ..... \$ 94.95

TIMEX-Sinclair "2040" Printer ..... \$ 89.95

Seikosha 80 Char. Printer Pkg. .... \$339.95  
(Incl. Parallel Interface & Cable)

Memopak 64K ..... \$138.95,  
32K ..... \$89.95, 16K ..... \$54.95

Memotech Keyboard ..... \$89.95

TIMEX-Sinclair 1983 Directory ..... \$ 5.00

**WE Pay Shipping on all USA Orders**

**To Order:** Send check, money order, or VISA/MC number and exp. date. MN res. add 6% sales tax. Foreign: Get shipping estimate from your post office and include with your payment.

**Write For Our Free Descriptive Catalog**

**E. Arthur Brown Company**  
Dept. TSU 4      1702 Oak Knoll Drive  
Alexandria, MN 56308      Ph. 612/762-8847

TSU4

continued from  
page 39



every program we accept for our Program Printout section. If you send in two programs that we print, we'll pay you \$40. The subscription rate to Timex Sinclair User is only \$29.95. We get two good programs. You get a subscription plus \$10.05 change. Everyone wins!

## MORE GAMES

How come so much emphasis on games? After all, we senior citizens like more adult programs also. But thanks!

**A.L. Francis**  
Yucaipa, California

## READABILITY

I enjoyed reading/using the programs in your first two issues. The articles are well written and I especially enjoy the programs.

Being in the over-50 group, my eyesight isn't what it used to be, so I would greatly appreciate it if the programs were in darker and clearer type. I'm sure the many senior readers would really appreciate this change.

**Harvey Weitz**

La Puente, California

Harvey, you are right. We will do everything we can in the future to make the programs more readable. Keep in touch and let us know how you think we're doing. Thanks!

## IMPROVEMENT

Just a note to tell you that I think the second issue is a big improvement over the first. Keep up the good work!

**David N. Hoshor**

Lancaster, Ohio

Improvement is the name of the game around here, David! What do you think of issues 3 and 4? ☺/☺

## Write to us

Timex Sinclair User welcomes reader's comments, compliments, queries and complaints. Letters should be addressed to: The Editor, Timex Sinclair User, 49 La Salle Avenue, Buffalo, N.Y. 14214. Please include your full name and address when writing.

## cottage technology

- ACZ GENERAL LEDGER**—Computerize your small business accounting. This system prepares a full set of financial statements and keeps a record of the ledger transactions. It can handle any combination of up to 400 entries and accounts per session, sorts 150 entries in 10 seconds, and works with or without a printer. **\$29.95**
- ACZ CHECK REGISTER**—Does more than just balance your checkbook. It summarizes expenses by account so it's easy to see just where your money is going. This program can be used alone, or as a companion to the ACZ General Ledger. **16K. \$10.95**
- ACZ EASY GRAPH** takes the tedium out of bar graph preparation. It automatically calculates the correct scale, offers continuous updates, and stores 4 different graphs in one program. **16K. \$9.95**

### IMPROVE YOUR PROGRAMMING

- Looking for ways to improve your BASIC programming techniques? We've listed 10 of our best routines with examples of how to use them in your programs. One routine makes it "impossible" to enter the wrong data. Another aligns columns of numbers by the decimal point. 8 more. **\$4.95 or FREE** with software purchase.

### COTTAGE TECHNOLOGY

Dept. U8, 5720 W. Little York  
Suite 178, Houston, TX 77091  
Add \$1.50 per item shipping and handling.

For more information, circle 27 on reader service card.



Get the only monthly magazine devoted to Timex Computers!

### ECC Publications Inc.

49 La Salle Avenue, Buffalo,  
New York 14214  
(716) 834-1972

### TIMEX/SINCLAIR COMPUTER USERS

We Have The Books You Need



- ART OF PROGRAMMING THE 1K ZX81.**  
How to use the features of the ZX81 in programs that fit into the 1K machine. 96pp. **\$5.75 postpaid.**
- ART OF PROGRAMMING THE 16K ZX81.**  
How to use your 16K RAM pack and ZX printer to the full. 144 pp. **\$6.95 postpaid.**
- ART OF PROGRAMMING THE ZX SPECTRUM.**  
Everything you need to know to put the ZX Spectrum to work for you. 144 pp. **\$8 postpaid.**

ELECTRONIC TECHNOLOGY TODAY, INC.  
P.O. BOX 83  
MASSAPEQUA PARK, NY 11762

Name: \_\_\_\_\_  
Address: \_\_\_\_\_  
City: \_\_\_\_\_ State: \_\_\_\_\_ Zip: \_\_\_\_\_  
 Number of books ordered \_\_\_\_\_ T/S 4

For more information, circle 29 on reader service card.

## Tiny invention makes perfect

### The inch-square Winky Board 2

The dream of every user of the T/S1000, ZX81 is to own a secret device that will virtually guarantee a good load every time, no matter what tape player is being used. Add to that an ability to let you save a program on one tape recorder

and to load it using a different one. Impossible, we hear you cry! Well, the impossible is with us in the form of Bill Russell's **Winky Board 2**. He named it for its winking LED lights.

This little piece of hardware (only about an inch

## 2-BIT SOFTWARE

P.O. Box 2036 Del Mar, CA 92014  
Dept. TSU1 (619) 481-3629

## 16KQUALITY IN 2K MEMORY

Games and Educational Programs  
for Timex/Sinclair Computers.

FOUR GAMES ON  
EVERY CASSETTE!

FREE  
CATALOG

DEALER INQUIRIES  
INVITED

For more information, circle 34 on reader service card.

## WHO WAS FIRST?

As early as 1835, the computer concept had been developed.

Charles Babbage, a Cambridge mathematician knew what was needed for a punch-card controlled calculating machine,

but lacked the technology. The man was before his **TIME!**

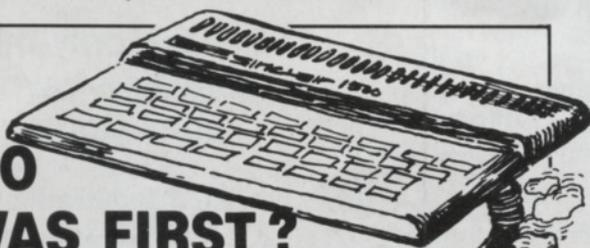

TIMEX and SINCLAIR FORGOT!

Here's

## LYON SWITCH

Power switch for Timex 1000 and Sinclair ZX-81



- Installs instantly - no computer modification
- Eliminates expensive plug and jack damage
- Does not interfere with other cables
- Styled to match your computer
- An economical **must** to protect your computing equipment

Mail to: Lyon Ware, 1520 S. Lyon, Santa Ana, CA 92705 (714) 835-9512

Rush my LYON SWITCH for \$11.95 plus \$2.00 handling & shipping

Check  Visa  Master Charge

Signature \_\_\_\_\_

Card No. \_\_\_\_\_ Exp. \_\_\_\_\_

Name \_\_\_\_\_

Street \_\_\_\_\_

City \_\_\_\_\_ State \_\_\_\_\_ Zip \_\_\_\_\_

Calif. residents add 6% sales tax.

Dealer inquiries invited

Lyon Ware is an affiliate of Development Associates

For more information, circle 31 on reader service card.

## saves & loads

is worth its weight in gold

square) was demonstrated to us at the last meeting of the T/S division of the Boston Computer Society. Nearly every person at that meeting bought one. We brought ours back to our office to give it a "real" test.

The Winky 2 is an open board cassette/computer interface designed specifically for the T/S1000 and T/S1500 computers. It actually eliminated every difficulty we had loading and saving even the most problematic programs. If that was all it did, we would consider it worth the money. But that is just the start of the wonders this little device will perform.

The copyright laws allow you to make one back-up copy of any cassette you buy. That's all well and good, but if the program is in machine code and you can't break it, how can you make your back-up copy? Bring on the Winky board. It will copy any program you can load, and you don't have to break into the program to do it. The Winky has the ability to make copies as it is loading. That is, the load and the copy are made at the same time. And the copy is usable even if the entire original is done in machine code.

Is it beginning to sound too good to be true? Well, as a little added bonus there is

an earphone plug that lets you listen in on the signal while you are saving or loading. This lets you monitor verbal information on the tape before the program without having to unplug the computer from the tape machine.

The two LED monitor lights that wink at you can be used to find the ideal volume setting for any program or tape recorder to further enhance your chance for a perfect load every time. To use this mode of the Winky board, set the volume on the tape player to low. Plug in the earphone to monitor any verbal instructions on the tape. When the program signal starts coming through, turn the volume up until the first LED is very bright and the second LED is barely lit. At that point you have found the ideal volume setting for that load. Rewind the tape and load the program into the computer.

When a program is being saved, some RAM packs may add high frequency electrical interference in the form of noise to the cassette. This will make loading the program later very difficult. The Winky board has a filter built into it to cut that "noise" out when you save a program.

Poorly aligned tape

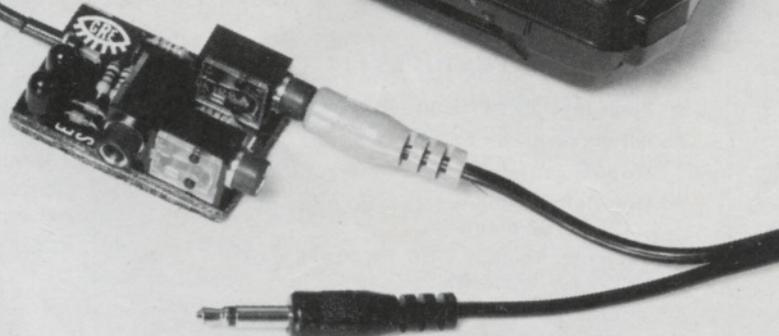

## About the Winky

### USES

1. To give almost guaranteed loads.
2. To give cleaner saves.
3. To allow you to duplicate unbreakable programs.
4. To save and load simultaneously.
5. To make two saves at the same time.
6. To hear the signal while loading or saving.

### FEATURES

1. No modifications to the computer or tape machine needed.
2. No power required.
3. Does not use a RAM pack connector. Simply plugs into the tape and computer jacks.
4. It is only one inch square.

### AVAILABLE FROM

G. Russell Electronics  
Road #1 Box 359 Center Hall, PA 16828

### COST

Assembled and tested ..... \$19.95  
Kit ..... \$14.95  
(earphone \$1 extra)

For more information, circle 50 on reader service card.

CHANGE YOUR  
TIMEX/SINCLAIR 1000 DISPLAY  
TO FULL COLOUR GRAPHICS

with

## KOLORWORKS

LOOK AT THE FEATURES !!!

- \* Plugs into ZX81/1000 (edge connector)
- \* All text will run on the color tv
- \* Module contains it's own memory
- \* User defined characters & graphics up to 256x192 pixels
- \* Latest technology with TMS9918 VDP (32 sprite levels)
- \* Module contains extension of basic commands including: PAPER/INK/BORDER/BIN/SPRITE/OUT/INP/ etc.

for \$149.95

Use your KOLORWORKS immediately with a game cassette for \$9.95

This delightful game is designed for hours of fun using some of the color graphic capabilities of KOLORWORKS. The cassette also contains a short program to familiarize you with some of the commands and graphics.

MAIL TO:

BRAINCHILD COMPUTER WORKS, INC.  
P.O. Box 506  
Pewaukee, WI 53072

|   | Price +  | Qty.  | Amount |
|---|----------|-------|--------|
| KOLORWORKS  | \$149.95 |       |        |
| CASSETTE  | 9.95     |       |        |
| Shipping and Handling   | 4.95     |       | \$4.95 |
| Wi. Res. add Sales Tax  |          |       |        |
| My <input type="checkbox"/> check <input type="checkbox"/> money order enclosed |          | TOTAL |        |

Name \_\_\_\_\_

Street \_\_\_\_\_

City \_\_\_\_\_

State \_\_\_\_\_

Zip \_\_\_\_\_

Please allow six to eight weeks for processing. Thank you.

For further information - Send \$2.00 (credited to order)

WATCH FOR:

"GAAMWORKS" -

Joystick Ports / Sound / Cartridge Slot

The Winky board requires no power, so you really can't hurt anything even if you do manage to hook it up incorrectly.

recorder heads cause many load failures. Again, the Winky board comes to the rescue. Using the LED monitor lights and the ear-phone, you can easily adjust the heads on your tape. When the lights are at their brightest and the volume at its loudest, the heads are correctly adjusted. It is not a difficult procedure, and we were able to do it quickly by following Bill Russell's clear instructions.

The documentation with the Winky board is

straightforward, complete and easy to follow. Each of the Winky board's uses is well described and diagrammed. The Winky board is passive (requires no power) so you really can't hurt anything even if you do manage to hook it up incorrectly. It attaches to the computer and tape recorder jacks, thus leaving the RAM pack connector free.

★★★★

4-star rating

## TELL ME WHO WON!

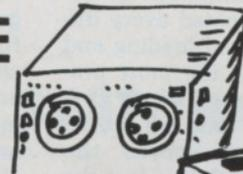

*A computer was used to make election predictions in the Presidential race of 1952. With only 7% of the votes in, UNIVAC I correctly foretold the Eisenhower landslide victory! In 1983, with fewer than 3% of the votes in, the B.B.C. used its computer to foretell the Margaret Thatcher victory. Soon we won't have to vote at all and just wait to be told by the computer who's going to be in charge.*

*It'll probably name itself!*

## You Could Be Your Computer's Worst Enemy

These suggestions will make your time with your computer more beneficial

**Y**OU COULD be your computer's worst enemy! No, your computer doesn't hate you, and we're not suggesting that you skulk about, waiting for the perfect time to pounce on and destroy your unsuspecting

machine. No, nothing so obvious or brutal, but often unnoticed habits or unthinking acts can damage your computer or corrupt a save or load. The points made in these charts obviously do not exhaust the matter. I'm sure you have some

special way of caring for or avoiding problems with your machine. Write and tell us! Address your letters to:  
**ENEMY EDITOR,**  
 Timex Sinclair User, 49 LaSalle Avenue, Buffalo, N.Y. 14214-1414.

### Computer Troubles

| POTENTIAL PROBLEM  | POSSIBLE EFFECT   | CURE  |
|--|---|---|
| Overheating in the computer                                      | Loss of program   | Keep out of direct sunlight<br>Read issue #3 on overheating problems and cures  |
| Liquids spilling onto computer                                   | Loss of computer  | Keep your coffee and Cokes away from the machine. Accidents will happen wherever they can. (Murphy's Law of Computers.) |
| Smoke and grease   | We have been told that smoke and grease build-up could damage the computer. We're not sure how! | Keep your room ventilated. Never compute near an open grill.  |
| Submerging your computer into a cauldron of boiling fat or water | CPU sends SOS to ROM thus disabling all INPUT commands  | Keep your computer securely fastened to a stain-resistant, non-static, life preserver                                   |
| RAM pack wobble  | Loss of program   | Secure the rampack to your machine using tape, velcro or rubber bands to insure it is "wobble free"                     |

# hints & tips

## Tape Troubles

| POTENTIAL PROBLEM                                 | POSSIBLE EFFECT  | CURE   |
|---|--|--|
| Storing tapes in a hot place                      | The constant heating and cooling of recording tape can weaken it. The tape will stretch and/or break                         | Store your recording tapes in a cool place                         |
| Touching the recording surface of a tape          | The oils from your fingers could cause enough damage to corrupt a future LOAD or SAVE  | Keep your hands off the business end of the tapes.                 |
| Dirt on the recording tape                        | Dirt will inevitably cause a bad "read" of the signal coming from the tape causing a loss of the program                     | Keep your tapes in their cases (you may take them out to use them) |
| Storing tapes near a large electrical appliance   | Large appliances can create an electrical or magnetic field which could interfere with the recorded signal on the tape.      | Store tapes away from large appliances                             |
| Dirt on the recording heads of your tape recorder | Dirt on the recording heads causes an incomplete SAVE or LOAD. You will think you have a good tape made . . . but you won't. | Clean tape heads on a regular basis                                |
| Old tapes can have worn spots                     | You won't see the worn spots, but they'll be there and ruin your LOAD or SAVE.   | Use new tapes every once in a while                                |

## Programming Troubles

| POTENTIAL PROBLEM                               | POSSIBLE EFFECT  | CURE   |
|---|--|--|
| Can't remember what's on a tape                 | If you're programming and are SAVEing as you go along, you may have a dozen tapes near you after a while. Which is what? You can get confused. | Label all your cassettes carefully and completely              |
| Can't reload a program you completed previously | We don't know why, but some programs after a while won't reload. You have lost a tape.   | Make back up copies (at least two) of all your important tapes |
| Can't find a cassette of an important program   | Have to redo the entire program and remember how you did it.   | Keep hard copies of key programs on file                       |

Three years ago, Cliff Danielson of the Boston Computer Society purchased a MicroAce — a copy of the ZX80 — and began building onto it. To date, when you include the workbench and everything around it, he's spent about \$2,500

## Converting Your Computer Into An Octopus



PHOTOGRAPHY: Patrice Flech

**T**O MANY of you, MicroAce may be a new term, and you may ask how it relates to Timex Sinclair technology. Let me give you a short history.

Sinclair's first computer, the ZX80, is similar in size and operation to the ZX81 and T/S1000, but limited in capability. Because it has no capability to handle decimal fractions and no SLOW mode, a smaller ROM was possible than that needed with the ZX81 and T/S1000 — 4K bytes in the ZX80 versus 8K bytes in the ZX81.

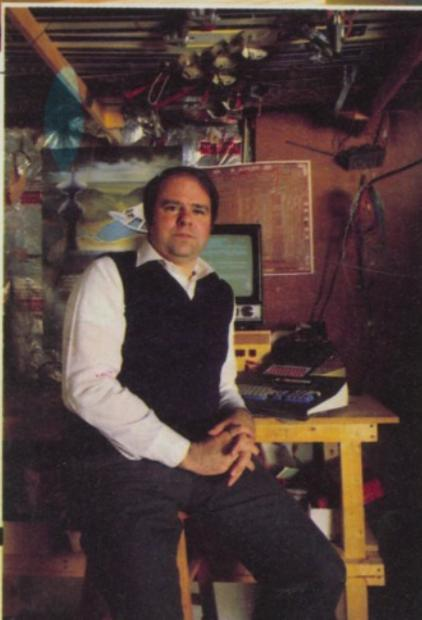

Cliff Danielson's system (above) and Cliff Danielson (left).

Shortly after the ZX80 was introduced, MicroAce began offering by mail a copy of the ZX80 at a much reduced price. I bought a MicroAce kit for \$100 when the ZX80 was selling for \$199.95. Functionally, the MicroAce is the same as the ZX80: just the board layout and packaging were changed, and two pins of the ROM socket were interchanged, necessitating a different ROM. In addition to being cheaper, the MicroAce offered 2K

CHANGE YOUR  
TIMEX/SINCLAIR 1000 DISPLAY  
TO FULL COLOUR GRAPHICS  
with

# KOLORWORKS

**LOOK AT THE FEATURES !!!**

- ◆ Plugs into ZX81/1000 (edge connector)
- ◆ Latest technology with TMS9918 VDP (32 sprite levels)
- ◆ Module contains it's own memory
- ◆ All text will run on the color tv
- ◆ User defined characters & graphics up to 256x192 pixels
- ◆ Module contains extension of basic commands including: PAPER/INK/BORDER/BIN/SPRITE/OUT/INP/etc.

**for \$149.95**

**KOLORWORKS COMES WITH A LIMITED WARRANTY ON PARTS AND WORKMANSHIP  
USE YOUR KOLORWORKS IMMEDIATELY WITH A GAME CASSETTE FOR \$9.95**

This delightful game is designed for hours of fun using some of the color graphic capabilities of KOLORWORKS. The cassette also contains a short program to familiarize you with some of the commands and graphics.

*"AVAILABLE AT LOCAL RETAILERS"*

Enjoy Game Fun With

## GAAMWORKS

THE SOON TO BE RELEASED GAME MODULE (proto-type stage) WILL OFFER SOUND, ROM CARTRIDGES AND JOY STICK PORTS FOR YOUR TS1000/ZX81.

- ◆ **THE SOUND** will be of arcade game quality which you can program for music, animals, transportation (auto, train, airplane, etc.) and machine sounds.
- ◆ **ROM CARTRIDGES** will have up to 8K of ROM using either 2716, 2732 or 2764 EPROMS. We will have pre-programed cartridges and blank cartridges which you can program. We will be offering a service to burn EPROMS from your cassettes.
- ◆ **JOY STICK PORTS** will allow for the use of two "Atari" compatible joy sticks.

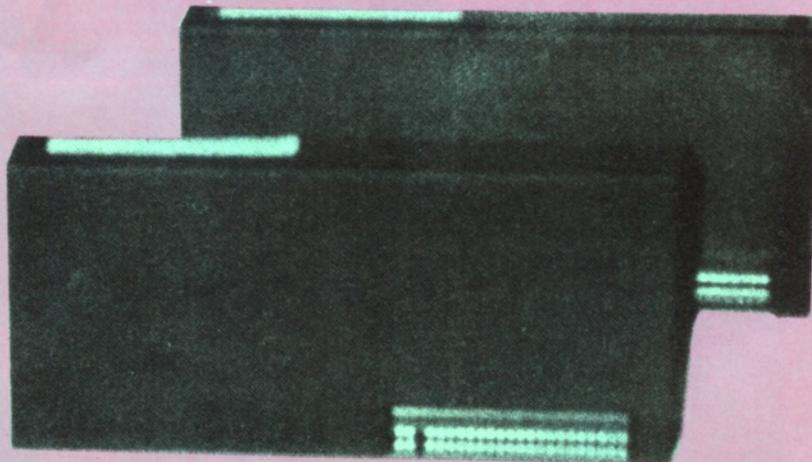

*FOR FURTHER INFORMATION, SEND \$2.00 (Credited to Order).*

MAIL TO: **BRAINCHILD COMPUTER WORKS, INC.**  
P.O. Box 506  
Pewaukee, WI 53072



|   | PRICE    | QTY. | AMOUNT |
|---|----------|------|--------|
| KOLORWORKS  | \$149.95 |      |        |
| CASSETTE  | 9.95     |      |        |
| Shipping & Handling   | 4.95     |      | 4.95   |
| Wi. residents add sales tax                                       | TAX      |      |        |
| <input type="checkbox"/> VISA <input type="checkbox"/> Mastercard | TOTAL    |      |        |

My  check  money order is enclosed

Name \_\_\_\_\_ Card No. \_\_\_\_\_

Street \_\_\_\_\_

City \_\_\_\_\_ State \_\_\_\_\_ Zip \_\_\_\_\_

Please allow six to eight weeks for processing. Thank you.  
For more information, circle 44 on reader service card.

onboard RAM, compared with 1K in the ZX80. Via mutual agreement, shortly after Sinclair began offering the ZX81, MicroAce ceased selling the computer.

Introduced in January 1981, the ZX81 corrected numerous shortcomings of the ZX80, provided floating point arithmetic, a SLOW mode (the capability of maintaining the television display without flicker) and a few other features. An 8K ROM (twice the size of the ZX80) was included. (Note that there were two versions of the ZX81, one with bag and a corrected version. Sinclair replaced all of the problem ROMs which were returned to them.)

Finally, in June 1981, Timex introduced the T/S1000. This computer was electrically and functionally the same as the ZX81, except for an extra 1K RAM memory — the T/S1000 contains 2K RAM. Soon, however, Timex modified the ZX81, replacing twelve computer-glue chips with one LSI (large scale integration) chip. Computer glue refers to all the decoding, buffering, timing and other support functions required by a microprocessor chip. Thus the newest Timex computer has only four integrated circuits where the ZX80 and ZX81 have 18.

### Why I Bought the MicroAce

In October 1979, after many months of dreaming about owning a computer and much talk about how to design one, I went out and purchased a number of integrated circuits. My first project was a flashing LED using a 555 timer chip and a few resistors and capacitors in a standard configuration. It worked! I still remember the satisfaction this gave me. (My wife wasn't impressed, it didn't do windows — a problem I still have.)

After the flashing LED came experimenting with various ICs to determine how each worked. Circuits in every increasing complexity were required. It doesn't take long to realize there isn't really anything mystical about hardware — it just takes time to learn how each component works.

On the recommendation of a

friend, I purchased a Z-80 microprocessor chip and began to assemble a computer. Pieces of the design were copied from various books and articles. Parts came from local electronics surplus stores and mail-order parts suppliers. I fabricated a wooden box for the computer. (Another hobby of mine is woodworking, one that has been much neglected since the computer's arrival.) Wiring the back plane and building power supplies took time, but weren't difficult. I made many mistakes, such as burning out components and inverting power and ground leads, and learned to solder and to fabricate PC boards. Then came time to make the computer work.

My first program was the opcode 76 hex, the halt instruction. This computer instruction was wired into the back plane so that when the computer was reset the opcode was executed, and then a LED connected to the halt pin of the computer chip would illuminate. Again a flashing LED marked a milestone only two months after the start of the project.



For almost a year, I built upon my computer — adding a hex keyboard, hex displays, memory, and parallel input/output. Machine language programs exercised all the parts of the system. The hex display (four characters for address and two for data) worked very nicely as a 24-hour clock. Soon I had over 2K of machine language program. Unfortunately, each time there was a power failure, which seemed frequent, the system crashed. Hand-loading over 2,000 bytes

takes a long time. A scheme to back up memory with a motorcycle battery solved the problem regarding power failures, but did nothing for human error.

In November 1980, I got the opportunity to participate in a group purchase of MicroAce, and made the plunge into Sinclair technology. Initially, the MicroAce was to serve as a smart front-end to the homebrew computer. It would display information on the television and provide cassette tape storage of machine code to eliminate the machine code loading drudgery.

Well, now the MicroAce is the heart of my system. The homebrew computer is just a smart interface unit. The homebrew provides interface to a printer, to the furnace (to collect usage data in winter), and many planned functions. The power in the BASIC ROM is far beyond anything in the homebrew.

### Keeping Up with Sinclair

The ZX81 was such an improvement over the ZX80 that I immediately wanted the greater capability, but couldn't bring myself to throw out the MicroAce. Luckily, Sinclair sold the 8K ROM for one-third the cost of the computer. Thus, I bought the new ROM. The 8K ROM simply replaced the 4K ROM in the ZX80. However, a wiring change was necessary in the MicroAce because of the interchanged pins. The MicroAce upgrade was not difficult. With the change in the ROM, the equivalent of the ZX81 was provided, except no SLOW mode. To save the capability to run 4K ROM programs, which took many hours to create, I soldered the 4K ROM to the top of the 8K ROM. A switch mounted on the back of the computer was used to select the ROM.

The FAST mode only restriction was solved with a circuit I obtained from a friend. The circuit consisted of six ICs and a number of diodes, resistors, capacitors and transistors. I had to play around a bit with values of resistors and capacitors to get the SLOW mode to work properly. The circuit fits nice-

# User groups

ly on a 3 x 4 inch board installed in the computer case. I had to raise the lid of the case slightly to make room for the board.

Now with the 8K ROM and SLOW mode, all the capabilities of the ZX81 were available. More memory was now in order. A 16K static RAM board, using pieces I acquired from an electronics junk store, filled the memory void. Eventually, I bought a Timex 16K RAM pack — at a fraction of the cost of the first 16K. The original memory board is now mapped into different address spaces, providing a total of 32K of RAM.

## Other Computer Projects

I found it necessary not only to keep up with Sinclair but also to adopt just about every enhancement described in Timex Sinclair User and other related magazines and newsletters. The first and best has been a full-sized keyboard. With a real keyboard, the computer becomes a real computer. You'll find that your speed and accuracy of entry of programs will increase and likewise your confidence in the machine.

For a keyboard, select any contact closure keyboard for which you have access to all printed circuits. You need this access to cut the previous connections. The keyboards are available for between \$10 and \$30. The keyboard with contact closures can usually be identified by the fact that only two contacts are visible on the bottom. If four terminals are below a key, be careful. It may be a Hall effect keyboard, not suitable for the ZX81 and T/S1000.

Wiring the keyboard is simple and straightforward. It just takes time. Instructions can be found in many books and articles. Remember to keep cabling between the computer and keyboard short.

The MicroAce, ZX80 and early versions of the ZX81 were simpler than the T/S1000. All computer glue, the circuitry surrounding the computer, employed standard TTL logic chips. Thus, modification of logic and selection of intermediate signals are possible. One example is the video signal. This video signal

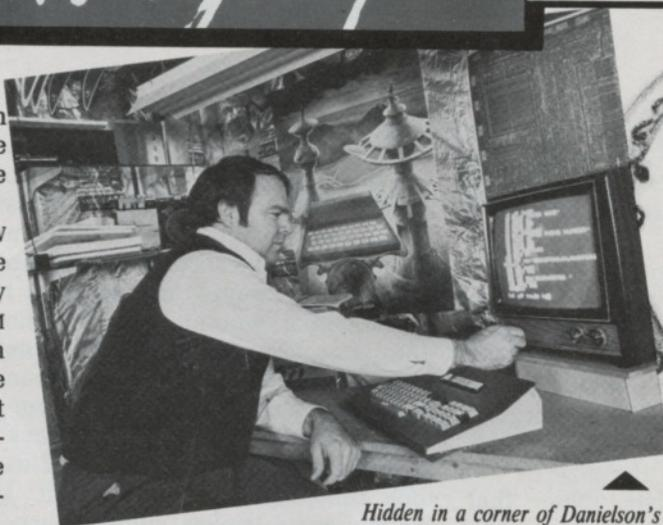

*Hidden in a corner of Danielson's unfinished basement is his computer system, at its heart a MicroAce, a copy of the ZX80. The computer is spread over the top of a 3-ft. by 6-ft. homemade workbench, surrounded by boxes of electronic parts and equipment. Beside it are a keyboard, tape recorder, portable television and cables leading to a printer and furnace.*



*Here's a keyboard purchased from an electronics junk store. The printed circuits previously on the bottom were cut with a razor blade, and the keyboard rewired. Tucked away in the corner is a small circuit board, which provides the capability to enter cursor controls, switch to the function mode, edit a BASIC statement, delete characters and perform other two-key functions via a single keystroke. This board greatly increases the speed of program entry and editing.*

*A hand-wired backplane, a cooling fan and power supplies are visible from the back of the homebrew system. The space at the bottom right once held a lead acid motorcycle battery to provide a back-up memory to prevent memory loss during power failures. With the MicroAce, it is easy to load the homebrew memory from a cassette tape, so the battery back-up wasn't needed.*

# User groups

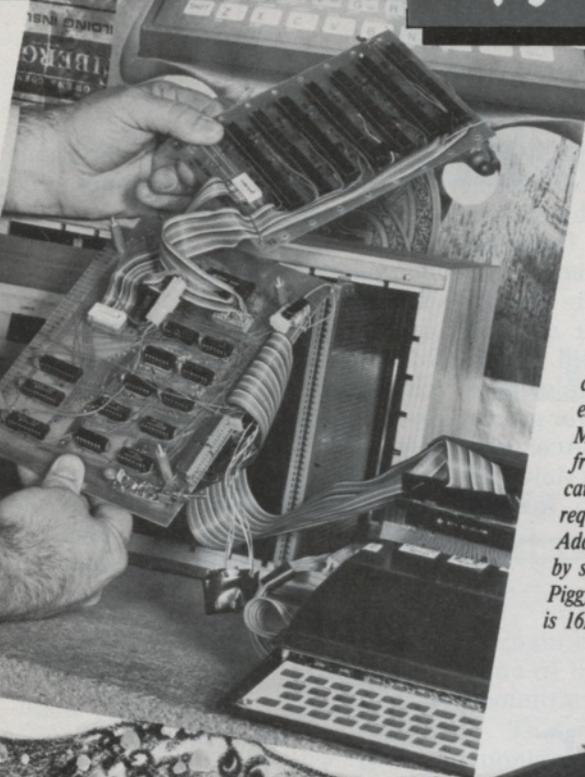

From a homemade T-connector on the rear of the MicroAce runs a 50-wire ribbon cable to the 6-in. by 8-in. board shown here, which interfaces the MicroAce and homebrew computers. All interfacing signals are buffered, and intercomputer handshaking is handled on the board. Both computers operate independently except when the program in the MicroAce requests information from the homebrew, which causes appropriate wait and bus request signals to be generated. Address translation is controlled by strapping options. Piggybacked on the interface card is 16K static RAM.

will produce both black on white characters, standard on the MicroAce, or black on white as in the T/S1000. By cutting a single foil connection on the printed circuit board and installing an external switch, one can switch the display format. (An inexpensive board requiring one or two ICs and a number of other components is needed to get the same capability on the ZX81 or T/S1000.) My preference is white on a black background, because it is easier to read and because there seems to be less interference.

Incidentally, I've had very few interference problems with my system. This seems remarkable especially in light of the many interconnects and long leads. My success is primarily because the MicroAce uses an UHF (channel 34) instead of a VHF (channel 2 or 3) modulator. (It is possible to change modulators on the T/S1000.) At one time, my system interfered with the kids' television programs, which were upstairs on channel 2. A number of changes to reduce conducted interference over the power line diminished the interference to a level that it is barely noticeable.

Another useful modification is a cassette tape load level indicator. The circuit involves a couple of LEDs (flashing LEDs again a milestone) plus one other diode. These are installed across the tape recorder input to the computer. The LEDs in the proper circuit illuminate at different signal levels, so that by observing their relative brightness you can check the tape amplitude. It doesn't work all the time but provides a great improvement over no level indication.

The replacement of the data bus separation resistors with bus transceivers was a less visible modification to the internal electronics. This eliminated data bus loading problems. Also, the value of several components were changes, but with no noticeable improvement.

## Interfacing Two Computers

The MicroAce is in command of the interface between itself and

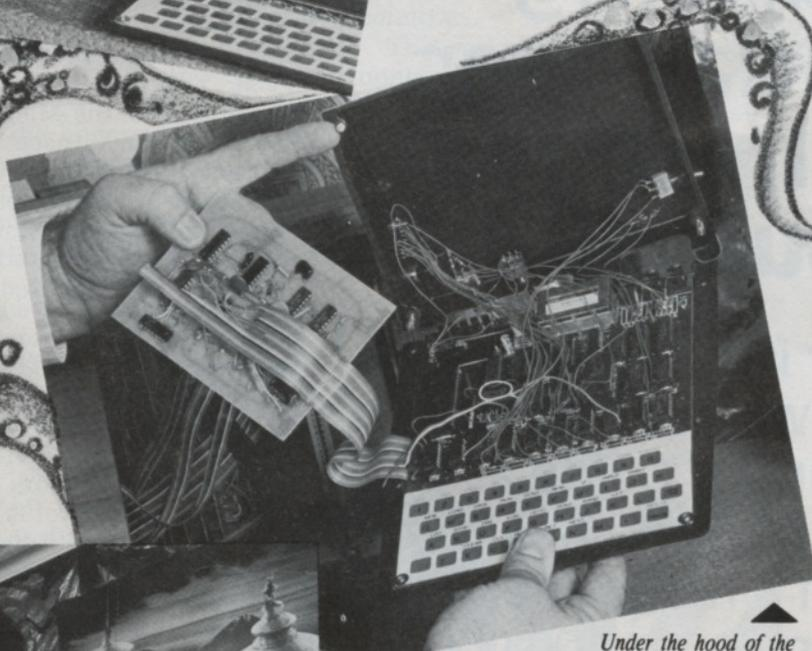

Under the hood of the MicroAce is this rat's nest — but it works! At left is a board which allows the MicroAce a SLOW mode capability; the SLOW mode, available in the ZX81 and TS1000, was not included with the MicroAce or ZX80. Other modifications, not all visible, include piggybacking the 4K and 8K ROMs, data line buffering, black-on-white or white-on-black character switch, and various component changes.

homebrew computers. It initiates all exchanges. When the homebrew wants to signal the MicroAce — for example, when it wants to indicate that it has successfully printed a character — it sets a flag in a designated memory location. The MicroAce program PEEKs into the location. The interface circuitry generates a wait to the MicroAce and a bus request to the homebrew, and translates the MicroAce address to the appropriate address in

homebrew address space. When the homebrew grants the MicroAce access to its bus, a single byte of information is transferred from the homebrew to the MicroAce.

Sounds simple. But the design and debug extended over approximately two years, and still not all the bugs are out. For example, if the homebrew is halted, it never grants the bus to the MicroAce; the MicroAce goes into a wait state and the dynamic memory forgets

everything. But, when all programs are properly loaded and operating, the interface works well.

The advantage of having two computers interfaced in this way is that they can share processing loads — printing, for example. The MicroAce passes (POKEs) the characters to the homebrew one byte at a time. The MicroAce then goes into a wait loop until the homebrew indicated the job is done. The homebrew has all the conversion tables and machine language code required to interface with the printer. The homebrew senses the request, prints the character, signals the MicroAce that it's done, and returns to its previous task — currently, maintaining a time of day display (clock). The homebrew also provides a clock to the MicroAce. An interface to the furnace to obtain usage data on cold nights is similarly managed by the homebrew. All these could have been done by the MicroAce, but by separating them, the code is not required in each MicroAce program.

#### Software — The Unmentioned Element

As described above, I made a lot of hardware changes to the computer. However, I have used the computer throughout the process, programming in both BASIC and machine language. Programs have primarily been related to using the hardware: disassembling the 4K (ZX80) and 8K (ZX81) ROMs, improving the program interface between the computers, driving the printer. But software, as you may know, can require infinite time and energy with little visible return. Hardware with the highly visible return has been my favorite activity. In future, whenever I must decide whether to write a checkbook program, for example, or put a new modification on the computer, the hardware will win.

☺/☺

*Cliff Danielson is editor of the Sinclair-Timex User Group Newsletter of the Boston Computer Society.*

## Announcing Timex Sinclair User Special Christmas Issue

The December issue of Timex Sinclair User will feature a Christmas Shoppers' Guide as a special "pull-out" section. This mini-magazine within a magazine will help our readers (over 100,000 strong) make their Christmas shopping decisions.

### Watch for it!

All listings are free of charge. For information on how your product may be included, contact Elisabeth Warlow, 49 La Salle Avenue, Buffalo, N.Y. 14214-1414, or phone (716) 834-1972.

# Clive Sinclair is Knighted

And now British users of his computers may buy records with music and computer programs on them

**M**ICROCOMPUTERS have come of age in Britain. In the Queen's official birthday honors list, Clive Sinclair received a knighthood, the establishment's seal of approval.

While the honors are nominally given by the Queen, she usually relies on the Prime Minister of the day to advise her. Margaret Thatcher is known to be a fan of Clive Sinclair's, although in a recent interview he said that he would not be voting for her in the recent election. She took an early Spectrum to show the Japanese what British enterprise could do when she visited the Far East last year. The award is probably in recognition of one of the few bright spots on the British industrial scene at the moment.

The depth of gratitude can be gauged by the fact that most people have to wait many many years before receiving a knighthood whereas Clive has been in business for a comparatively short time.

There is now a major problem for his many supporters. Do they address him as Sir Uncle Clive or Uncle Sir Clive? No doubt the difficulty will be quickly resolved.

The knighthood is only the latest in the signs of public acclaim for a man who has revolutionized the leisure industry in Britain. Frequent articles in newspapers and magazines and appearances on the radio and television all build up the image of Clive as the sort of person

Britain needs to regain its place as one of the world's great industrial countries.

That sort of build-up places great unnecessary pressure on a person

---

## Margaret Thatcher took a Spectrum to Japan

---

who, despite having done a great deal to make computers more accessible to the average consumer in many parts of the world, is still only trading on one or two good ideas.



**WINDOW**



This pressure is in great danger of increasing rapidly with the news that he has taken an option on the former De Lorean car factory in Belfast for the production of his electric town car. Northern Ireland has long been an unemployed blackspot and when John De Lorean first suggested making his gull-winged car in the province he was given a large amount of support by the British government to help ease the job problems.

At the time De Lorean was seen as a savior, and this impression grew as he quickly built up the jobs to more than 2,000. Clive is in danger of taking over that mantle no matter how many provisos he makes about the difficulty of saying how many jobs will be brought.

Returning to the world of computers, the last few weeks have seen moves which could open up new markets for them. Pop music has long used light shows to enhance the music at live shows but in the past people at home have been unable to enjoy them. Now a number of companies are experimenting with home computers to achieve a similar effect.

One of the first was Island Records. Pete Shelley, a former member of the leading British punk band The Buzzcocks has brought out an album called XL1 on which the last track on side two is a program for the Spectrum.

It can be recorded on cassette and then loaded, and when played

# U.K. Window

it displays the words and graphics synchronized to the music.

Not wishing to be left out, EMI has released a single by Chris Sievey, famed for his pioneering moves in the music industry. He was the first person to release a full length pop video film, and he has followed this up by bringing out a single called Camouflage on the B side of which are the three programs for the ZX81. The first displays the lyrics of the A side and the other two are games, one for the 1K version and the other for the 16K.

A third contender for the title of computer music innovator is a band called Mainframe, which is planning to release on a private label a record called Talk To Me. On the B side are four programs, one of each for the Spectrum and the ZX81 and the Apple II and the BBC MICRO.

Whether this is just a five-day wonder or the beginning of a new phenomenon in the



record industry depends on how easily the technological problems can be dealt with. In theory it should be possible to load a program direct from the record using the computer's ear socket. However so far the companies have been advising people to record the tracks on cassettes, being careful to use only one channel of stereo and making sure the record player does not have Dolby sound as both of these can distort the signal. The cassette is then entered in the normal way and the program is run.

The effects can be interesting, but whether it will act as a great incentive to buy remains to be seen. What is certain is that anyone playing the records must be sure not to get the wrong side or the wrong track. Programs may be good for providing graphics but they are definitely no benefit to the eardrums.

-Nigel Clark  
in London



Get the only monthly magazine devoted to Timex Computers!

Mail to TIMEX SINCLAIR USER, 49 La Salle Avenue, Buffalo, New York, 14214

Name \_\_\_\_\_  
 Address \_\_\_\_\_  
 City \_\_\_\_\_ State \_\_\_\_\_ Zip \_\_\_\_\_  
 Check                       Money order or charge to  
 Visa                       Mastercard                       Bill me later.  
 Number \_\_\_\_\_  
 Expiry \_\_\_\_\_  
 Signature \_\_\_\_\_



Yes, I want to subscribe to TIMEX SINCLAIR USER at the special rate of \$29.95 for 12 issues delivered to my door. In addition, I understand I will receive the FREE software cassette with my first issue.

**GUARANTEE**

You may cancel at any time you are not satisfied. Full value for unmailed issues will be promptly refunded.

## Beginner's BASIC book a beauty

**W**HEN I learned that Dr. David Lien was authoring a book on the T/S1000, ZX81, I immediately ordered it. Lien's Radio Shack TRS-80 Model I Level I User's Manual was my introduction to computing and BASIC programming back in 1978, and it gave me such a good foundation in BASIC that I've since written and sold many thousands of dollars worth of BASIC programs without ever attending a class in programming. Lien has well over a million book sales to his credit, including such popular titles as *The BASIC Handbook*, *Learning TRS-80 BASIC*, *Learning IBM BASIC* and the *EPSON MX-Printer Manuals*.

I just received the book yesterday and spent the whole day — and into the late hours — reading. I couldn't put it down! The beautifully-printed 331-page book is a pleasure to read and use.

This book assumes the reader has no previous knowledge of the BASIC computer language in any version, and goes through the most important commands and statements with numerous examples. The writing is light and breezy, with many cartoons and side-bar comments for emphasis. The actual programming commands and statements are printed in large dot-matrix type to simulate actual display characters and to stand out from the regular text. A whole series of special typeset characters (reverse-video cursors and Timex Sinclair special graphic characters) are used throughout the book to make it absolutely clear which keys are being used, and what the screen should show. Line-by-line explanations of the short programs entered by the user are coupled with the results on the screen, so the reader can correlate the programming with the results, and create his (or her) own variations.

There are four sections to the book. Section A, with 38 chapters,

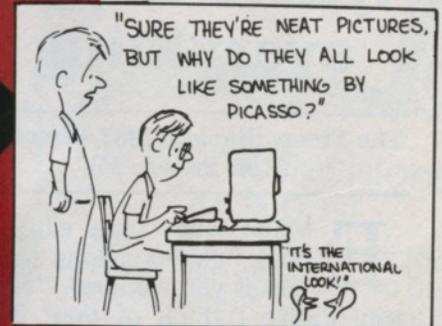
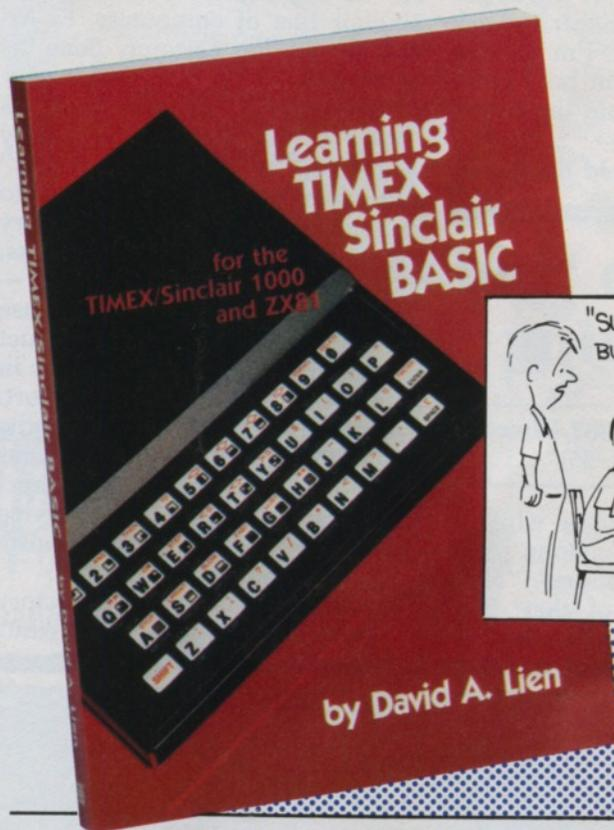

*Learning Timex Sinclair BASIC*, by Dr. David Lien  
(CompuSoft, \$14.95)

has eight parts: Getting Started, Speak To Me, Strings, Math Functions, Graphics & Display Formatting, Arrays, Miscellaneous and Program Control. Most chapters have exercises at the end to test your understanding and creativity, so this book could easily be used as a classroom text. Section B has the Answers to the Exercises. Section C has some examples of interesting and practical programs ready for the reader to type in and use. Section D is composed of three appendices: The Character Set, Error Report Codes and a four-page Index.

Unfortunately, the manuals that are furnished with the T/S1000, ZX81 computers are so detailed that they are intimidating, and it's hard to penetrate the details to get an overview. This book could be us-

ed in place of the Timex or Sinclair Users Manuals for those wishing to learn the most important features of Timex Sinclair BASIC. Most beginners will find more than enough here to keep them interested and excited, and for those with the thirst for more detail, there are always the very complete (but sometimes hard to follow) manuals that come with the computer.

As with any first edition, there are some goofs. I noted two that would cause a beginner some problems. The first was the answer to the first exercise; it shows the line number as 0 instead of 50. The second was much more serious. A very important full-page layout of screen coordinates is terribly wrong in several ways, and could only cause great confusion to a reader depending on it for explana-

# Books

tion of the text dealing with screen formatting and graphics. What are the errors? If you don't get the book, it doesn't matter. If you do get the book, write CompuSoft and ask for a correction sheet. I'm writing David Lien today about how great the book is — and about the errors in Figure 25-1.

— Fred Blechman

## Where to find everything

*The Timex Sinclair 1983 Directory*  
(E.A. Brown, \$5)

**E**VERY once in a while a book comes along that makes you wonder? "Now why didn't I think of that? The *Timex Sinclair 1983 Directory* is

such a book. The *Directory* is a refreshing change from the many "how-to" books that have sprung up in the wake of the Timex Sinclair line of computers. E. Arthur Brown has certainly done his homework.

The subtitle of this book is "Where to find practically everything for the T/S computer," and inside you will learn where to find printers, keyboards, memory expansion units, periodicals, books, programming aids, software — everything you can possibly use with a T/S computer. Each product is listed in its appropriate section in bold print followed by a short, detailed description that gives the price of the product and the names of its distributors. This little directory provides shop-at-home service that allows you to compare products without seeing them.

The *Timex Sinclair 1983 Directory* is published by the E. Arthur

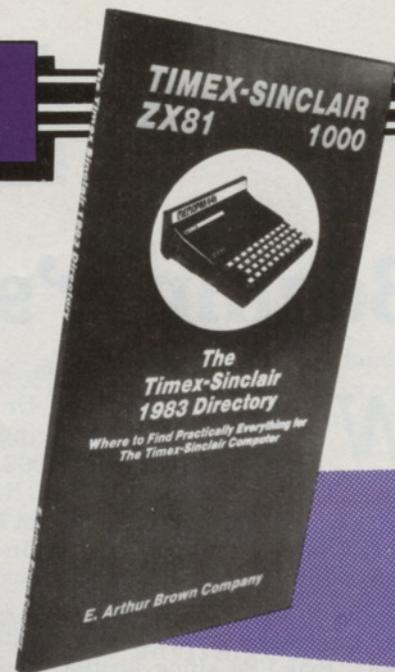

Brown Company, and is a must for every T/S owner. Whether or not you decide to expand your current system, this useful guide will keep you up to date on what products are available. Mr. Brown is now collecting material for the next edition, which gives us all something to look forward to with interest.

— M.K. Wilson



Next Month

## COLORBOARD

Convert your T/S1000 or 1500 or ZX81  
to

## COLOR

Complete project in the next issue of  
**TIMEX SINCLAIR USER**

# Bulletins

HEAR & LEARN!  
MICRO INSTRUCTIONAL INC.  
WILL SELL YOU AN AUDIO  
TAPE DESIGNED TO GET YOU  
RIGHT INTO YOUR COMPUTER.  
AS THEY SAY, "... YOU MAY  
WISH TO READ THE MANUAL  
AT SOME POINT ... BUT FOR  
NOW USE OUR TAPE TO  
GET STARTED IMMEDI-  
ATELY. " AN INTERESTING  
CONCEPT! TO FIND OUT  
MORE, WRITE TO:  
MICRO INSTRUCTIONAL  
3453 N.W. 55<sup>TH</sup> ST.  
FORT LAUDERDALE  
FL 33309 OR  
CIRCLE 47  
ON THE  
READERS SER-  
VICE CARD!

## UTILITY

Utility programs are sought out by serious programmers, and **Sirius Ware** publishes some excellent ones. All are written in machine code and are very user-friendly. Such programs as File Basic (has save/merge/erase BASIC and much more). BASIC OLAY (moves BASIC code into and out of RAM storage area) COPY (duplicates any cassette tape written for a T/S computer) and many others. For complete details circle 41 on the reader service card or write to Sirius Ware, 6 Turning Mill Road, Lexington, Massachusetts 02173.

## TSU Discount

Hey, T.S.U. readers, here's a bargain just for you! **Lipinski Software** will give you a 10 percent discount on any of its software if you simply mention this announcement on your order. They currently have seven titles available (INVENTORY, STOCK, TUTOR, LIST, CHECK, INDEX, and the new LEDGER). To get full details about these products, circle 42 on the reader service card, or write to D.F. Lipinski, 2737 Susquehanna Road, Roslyn, Pennsylvania 19001.

## Decisions! Decisions! Decisions!

If you have a tough decision to make, like which car to buy, offer to accept, job to take or school to choose, then MAA from **Stuart Software** is for you. MAA stands for Multi-Attribute Analysis. It is designed to help you make those tough decisions, the ones that have several alternatives, each with many characteristics. Now your T/S can help you think it out! For more information, circle 44 on the reader service card or write to Stuart Software, 25381-G Alicia Parkway, Suite 316, Laguna Hills, California 92653.

## Rehabilitation Software Required

Every year approximately 70,000 young adults suffer head injuries in road accidents. More than half experience short-term disruptions in memory and learning capability. Months of repetitious memory exercises are required to "reprogram" the association of letters with sounds, words with things, names with people and places.

Unfortunately, all the existing computer programs are written for computers that cost \$2,000 or more. There is no **Sinclair BASIC Cognitive Rehabilitation Programming**.

These programs are not easy to write. To be used by adults with adult perceptive capability whose ability to respond is impaired, they should be entertaining and engaging. Anyone interested in more information or wishing to suggest sources for such programming can circle 43 on the reader service card or write to the American Head Trauma Alliance, P.O. Box 711046, Los Angeles, California 90017. More than 100,000 customers are waiting for this software.

Got some info.  
to share?

A new product?

An idea? An event?

Let us know.

Write: Bulletin Board  
T.S.U., 49 LaSalle Ave.  
Buffalo, NY 14214

## OUR MISTAKE!

In Volume 1 #2, our program printout of "16 Pin Bowling" in line 45 & 120 we refer to CODE "W". CODE "W" is equivalent to GOTO 60. Thanks to Ssg Ralph Hammer of Illinois for pointing out the problem to us. We do apologize if this caused any of you any frustration!

# Bulletins

## NOW 64K

**Barlog Software** introduces a new under-\$100 64K RAM pack kit. It is about 10 percent more expensive assembled. If you are interested, write to Barlog Software at 401 N. Geyer Road, Kirkwood, Missouri, 63122, or circle 51 on the reader service card.

Another company offering a 64K RAM pack is **Sunflower Systems**, 718 East Avenue B, Hutchinson, Kansas 67501. For more information on their product, write to them or circle 48 on the reader service card.

## A Smart Printer Interface

**C.R.C. Software** has introduced a new printer interface for T/S computers (the 1,000, 1500 and ZX81) and serial or parallel printers. It is a single key operation and uses the LPRINT, LLIST, or the COPY commands. Now you can get upper and lower case letters. For more information, circle 46 on the reader service card or write to C.R.C. Software, 2901 Auburn Road, Auburn Heights, Massachusetts 48057.

## Games for Adults

**2-Bit Software** seems to have the knack for getting a lot out of a little. Witness their newest addition to their "Games for Adults" series. It contains four 2K games that simulate executive problems. You are challenged to "Get to the Top" of the corporate ladder, keep your own desk while others lose theirs playing "Musical desks", survive and maintain your job as your office "Automates" or work your way through a corporate maze to gain the "Corner Office". All four games are available on one cassette for \$14.95. No one at this office dared try them! For more information, circle 40 on the reader service card or write to 2-Bit Software, P.O. Box 2036, Del Mar, California 92014.

## Use this free info service

To obtain more information on any advertiser or product in *Timex Sinclair User*, circle the appropriate number on the reader service card opposite.

| Circle Reader Service No. | Advertiser                  | Page  |
|---------------------------|-----------------------------|-------|
| 33                        | Brainchild                  | 50    |
| 44                        | Brainchild                  | 54    |
| 10                        | Busyness                    | 9     |
| 27                        | Cottage Technology          | 47    |
| 20                        | Discount Software           | 39    |
| 14                        | D.K. Tronics                | 16-17 |
| -                         | E. A. Brown                 | 47    |
| 29                        | Electronic Technology Today | 47    |
| 18                        | Filesixty                   | 37    |
| 16                        | Gladstone Electronics       | 24-25 |
| 38                        | Gladstone Electronics       | C3    |
| 1                         | Intercomputer               | 1     |

| Circle Reader Service No. | Advertiser      | Page  |
|---------------------------|-----------------|-------|
| 39                        | Leading Edge    | C4    |
| 31                        | Lyon Software   | 48    |
| 37                        | Memotech        | C2    |
| 22                        | Musamy          | 39    |
| -                         | Prism           | 40-41 |
| 13                        | R.I.S.T.        | 10    |
| 26                        | Robotec         | 47    |
| 12                        | Sinclair Place  | 10    |
| 17                        | Suntronics      | 21    |
| 11                        | Synchrosette    | 10    |
| 23                        | Thomas B. Woods | 39    |
| 19                        | Timedata        | 39    |
| 34                        | 2-Bit Software  | 48    |
| 21                        | York 10         | 39    |

## Word Processing

How would you like a program that has INSERT, DELETE, CHANGE, SAVE, error checking, and is menu-driven? **Sync Master** has just released such a word processing package. It leaves 11K of RAM on a 16K RAM pack which translates into 370 lines at 30 characters per line. The line length is user set. VU-WRITE text editor is set up for a printer as well. For more information circle 45 on the reader service card or write to Sync-Master, P.O. Box 511, Oak Ridge, North Carolina 27310.

**YOUR TS1000/ZX81 NEVER HAD IT SO GOOD!**

**ZX81 & T/S 1000 CATALOG**  
SOFTWARE/HARDWARE/BOOKS



**GLADSTONE**

**GLADSTONE ELECTRONICS**

PHONE ORDERS  
1-800-833-8400  
N.Y. 1-716-874-5510



**Send for your FREE catalog Today!**

NEW from Gladstone Electronics! Our TS1000/ZX81 catalog will take you where no other has gone before! You will view the widest selection of up-to-date software, books and hardware add-ons available to get the most from your personal computer. This exciting new 34 page color catalog lists arcade, fantasy and family games, business and educational programs; books for beginners as well as experienced users; hardware add-ons and other peripherals for use with your TS1000/ZX81 Home Computer! Use the convenient coupon below and send for your FREE catalog TODAY!

**SPECIAL of the month**  
Gladstone  
64K RAM **\$99.95**  
Reg. \$149.95

For more information, circle 38 on reader service card. See our ads on pages 24 &

**FORM**

Mail orders to: Gladstone Electronics Inc.,  
1585 Kenmore Ave., Buffalo, N.Y. 14217

Please RUSH my FREE catalog to me Today!

Name \_\_\_\_\_

Address \_\_\_\_\_

City \_\_\_\_\_ State \_\_\_\_\_ Zip \_\_\_\_\_

**ORDER**

**GLADSTONE ELECTRONICS**

1585 Kenmore Ave., Buffalo, N.Y. 14217

Orders only call toll free 1-800-833-8400

For further information (716) 874-5510  
In Canada call toll free 1-800-268-3640  
or (416) 787-1448



## BUY A BANANA.™ SAVE A BUNCH.

Meet the Banana,™ the very tough, versatile, portable, and reliable dot-matrix printer from Gorilla.™

At \$249.95 retail it's an ideal and inexpensive companion for personal computers like Apple® (or Apple "look alikes" such as Franklin® or Albert®), TI®, Commodore®, TRS-80®, Kaypro®, Timex®, Osborne®, etc.

After that, it's merely comparable to other printers that can cost up to three times as much: 10" carriages (to handle standard 9½" paper), 80 columns, graphics capability, 10 characters per inch (expandable to 5 cpi) draft-quality print (for perfectly acceptable form letters, data processing,

business reports, etc.) tractor feed (for precise alignment and quick loading), parallel or serial interface (take your pick), self-inking ribbon cassette (for long life and easy installation), 10 portable pounds in weight, and compatibility with so many of the most popular personal computers on the market.

Plus its printhead features a unique single-hammer design that eliminates a lot of moving parts, to eliminate a lot of annoying repairs.

That's the Banana: silly name, serious service. It's everything the expensive dot-matrix printers are . . .

Except expensive.



Leading Edge Products, Inc., 225 Turnpike Street, Canton, Massachusetts 02021  
Toll-free: 1-800-343-6833; In Massachusetts (617) 828-8150. Telex 951-624.

For more information, circle 39 on reader service card.