

SONIC™ HEROES

**SUPER
MAP
SECTION**



primagames.com



This game has received the following rating from the ESRB



CREATED BY KAIZEN MEDIA GROUP

PRESIDENT / PRODUCER: HOWARD GROSSMAN
AUTHOR: GERALD GUESS
DESIGNER: TIM DAVIS
MAPS: MIKE REGISTER



ACKNOWLEDGEMENTS

SPECIAL THANKS TO PC, MIKE "THE DOCTOR"
VALLAS, WYCKOFF, NELSON "TUROK" TARUC,
AND DAN PELUSO

PRIMA GAMES
A DIVISION OF RANDOM HOUSE, INC.

3000 LAVA RIDGE COURT
ROSEVILLE, CA 95661
1-800-733-3000
WWW.PRIMAGAMES.COM



THE PRIMA GAMES LOGO IS A REGISTERED
TRADEMARK OF RANDOM HOUSE, INC.,
REGISTERED IN THE UNITED STATES AND
OTHER COUNTRIES. PRIMAGAMES.COM IS A
REGISTERED TRADEMARK OF RANDOM
HOUSE, INC., REGISTERED IN THE UNITED
STATES. PRIMA GAMES IS A DIVISION OF RANDOM
HOUSE, INC.

© 2003-2004 BY PRIMA GAMES. ALL RIGHTS
RESERVED. NO PART OF THIS BOOK MAY BE
REPRODUCED OR TRANSMITTED IN ANY FORM OR
BY ANY MEANS, ELECTRONIC OR MECHANICAL,
INCLUDING PHOTOCOPIING, RECORDING, OR BY
ANY INFORMATION STORAGE OR RETRIEVAL SYS-
TEM WITHOUT WRITTEN PERMISSION FROM PRIMA
GAMES. PRIMA GAMES IS A DIVISION OF RANDOM
HOUSE, INC.

PRODUCT MANAGER: JILL HINCKLEY

SEGA IS REGISTERED IN THE U.S. PATENT AND
TRADEMARK OFFICE. SEGA, THE SEGA LOGO, SONIC
HEROES AND SONIC THE HEDGEHOG ARE EITHER REG-
ISTERED TRADEMARKS OR TRADEMARKS OF SEGA
CORPORATION. © SEGA © SEGA ©
SONICTEAM/SEGA, 2003. ALL RIGHTS RESERVED.
™, © AND THE NINTENDO GAMECUBE LOGO ARE
TRADEMARKS OF NINTENDO. "PLAYSTATION" AND THE
"PS" FAMILY LOGO ARE REGISTERED TRADEMARKS OF
SONY COMPUTER ENTERTAINMENT, INC. MICROSOFT,
XBOX AND THE XBOX LOGOS ARE EITHER REGISTERED
TRADEMARKS OF MICROSOFT CORPORATION IN THE
U.S. AND/OR OTHER TERRITORIES AND ARE USED
UNDER LICENSE FROM MICROSOFT. ALL RIGHTS
RESERVED.

ALL PRODUCTS AND CHARACTERS MENTIONED IN THIS BOOK
ARE TRADEMARKS OF THEIR RESPECTIVE COMPANIES.

PLEASE BE ADVISED THAT THE ESRB RATING ICONS,
"EC", "K-A", "E", "T", "M", "AO" AND "RP" ARE
COPYRIGHTED WORKS AND CERTIFICATION MARKS
OWNED BY THE ENTERTAINMENT DIGITAL SOFTWARE
ASSOCIATION AND THE ENTERTAINMENT SOFTWARE
RATING BOARD AND MAY ONLY BE USED WITH THEIR
PERMISSION AND AUTHORITY. UNDER NO CIRCUM-
STANCES MAY THE RATING ICONS BE SELF-APPLIED OR
USED IN CONNECTION WITH ANY PRODUCT THAT HAS
NOT BEEN RATED BY THE ESRB. FOR INFORMATION
REGARDING WHETHER A PRODUCT HAS BEEN RATED
BY THE ESRB, PLEASE CALL THE ESRB AT 1-800-771-
3772 OR VISIT WWW.ESRB.ORG. FOR INFORMATION
REGARDING LICENSING ISSUES, PLEASE CALL THE ESA
AT (212) 223-8936. PLEASE NOTE THAT ESRB RAT-
INGS ONLY APPLY TO THE CONTENT OF THE GAME
ITSELF AND DOES NOT APPLY TO THE CONTENT OF
THIS BOOK.

IMPORTANT:
PRIMA GAMES HAS MADE EVERY EFFORT TO DETER-
MINE THAT THE INFORMATION CONTAINED IN THIS
BOOK IS ACCURATE. HOWEVER, THE PUBLISHER MAKES
NO WARRANTY, EITHER EXPRESSED OR IMPLIED, AS TO
THE ACCURACY, EFFECTIVENESS, OR COMPLETENESS OF
THE MATERIAL IN THIS BOOK; NOR DOES THE PUBLISHER
ASSUME LIABILITY FOR DAMAGES, EITHER INCIDENT-
AL OR CONSEQUENTIAL, THAT MAY RESULT FROM
USING THE INFORMATION IN THIS BOOK. THE PUBLISHER
CANNOT PROVIDE INFORMATION REGARDING GAME
PLAY, HINTS AND STRATEGIES, OR PROBLEMS WITH
HARDWARE OR SOFTWARE. QUESTIONS SHOULD BE
DIRECTED TO THE SUPPORT NUMBERS PROVIDED BY
THE GAME AND DEVICE MANUFACTURERS IN THEIR
DOCUMENTATION. SOME GAME TRICKS REQUIRE PRE-
CISE TIMING AND MAY REQUIRE REPEATED ATTEMPTS
BEFORE THE DESIRED RESULT IS ACHIEVED.

ISBN: 0-7615-4449-6

LIBRARY OF CONGRESS CATALOG CARD NUMBER:
2003114652

SONIC™ HEROES



TABLE OF CONTENTS

TRAINING	02-07
TEAM PROFILES	08-11
WALKTHROUGH	
• TEAM ROSE	12-35
• TEAM SONIC	36-69
• TEAM DARK	70-103
• TEAM CHAOTIX	104-131
SPECIAL STAGES/FINAL BOSS	132-133
STAGE MAPS	134-153
2P PLAY BATTLE MODES	154-155
ITEM & ENEMY APPENDIX	156-157
FLOWCHARTS & RANKINGS	158-159



TRAINING



SONIC HEROES



Sonic Heroes™ introduces the brand-new Team Action control system, whereby teams of characters are controlled together in Formation. Each team has three members individually representing Speed, Flight, and Power. The character leading the team at any given point determines the Formation type, allowing a unique set of manoeuvres to be performed.

CONTROLLER KEY

- In-Game Function
- Menu Function

GAME CONTROLS

GAMECUBE™

L BUTTON

- Rotate Camera Counterclockwise
- N/A

CONTROL STICK

- Control Characters
- Navigate the Menu

Z BUTTON

- Team Blast when Gauge is full
- N/A

C-Stick

- First-Person View
- N/A



R BUTTON

- Rotate Camera Clockwise
- N/A

Y BUTTON

- Switch Character
- Info

X BUTTON

- Switch Character
- N/A

A BUTTON

- Jump
- Confirm

B BUTTON

- Attack
- Cancel

PLAYSTATION®2

L1 BUTTON

- Rotate Camera Clockwise
- N/A

LEFT ANALOG

- Control Characters
- Navigate the Menu

RIGHT ANALOG

- First-Person View®
- N/A

SQUARE BUTTON

- Jump
- Confirm

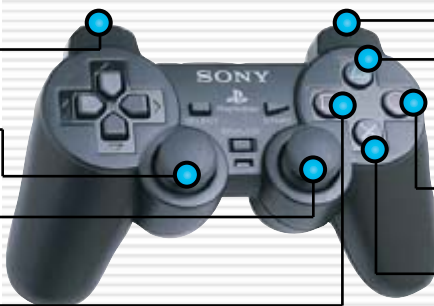

R1 BUTTON

- Rotate Camera Counterclockwise
- N/A

TRIANGLE BUTTON

- Switch Character
- Info

CIRCLE BUTTON

- Switch Character
- N/A

X BUTTON

- Jump
- Confirm

XBOX®

RIGHT TRIGGER (BACK)

- Rotate Camera Counterclockwise
- N/A

LEFT TRIGGER (BACK)

- Rotate Camera Clockwise
- N/A

LEFT THUMBSTICK

- Control Characters
- Navigate the Menu

RIGHT THUMBSTICK

- First-Person View®
- N/A



Z BUTTON

- Team Blast when Gauge is full
- N/A

Y BUTTON

- Switch Character
- Info

B BUTTON

- Attack
- Cancel

X BUTTON

- Switch Character
- Info

A BUTTON

- Jump
- Confirm



**GENERAL
GAME TIPS**

FORMATIONS

Formations play a key role in *Sonic Heroes*. The different Formations allow your team to access different places. To bring out the most in your game, learn how to use every Formation effectively and don't limit yourself to just one. The three Formations are Speed (blue), Flying (yellow), and Power (red). To switch between the Formations, press one of the Formation change buttons. You can change Formation while in mid-air but it will not take effect until your team lands on the ground. If you aren't sure which Formation you're in, the character icon on the bottom of the upper-right corner of the game screen is the current one selected.



A SPEED

The Speed Formation is used for fast-paced gameplay. Use the Speed Formation when you are performing a Speed run, defeating certain enemies, or using special objects. Speed is especially important when using Team Sonic. There are four different teams in *Sonic Heroes* and each team has a Speed character. While in Speed



Characters in Speed Formation run in a line.

Formation you will have control of the Speed character in the group and the others will follow behind. There are differences between the Speed-type characters, but they also share similar abilities. These abilities are Homing Attack, Rocket Accel, and Triangle Jump.

1 Homing Attack



Use this to spring out of jump range.

- Homing Attack is performed by pressing the jump button and then pressing the jump button again when near an enemy. To make sure you perform Homing Attack in the correct direction, use the stick to point your character in the right direction. You can use Homing Attack to bounce off of multiple enemies and you can use it to target springs. If you come into contact with an enemy's weapon you will get hit and lose your Rings.



Bounce from enemy to enemy to get to hard-to-reach places.

2 Spin

- While running you can press and hold the attack button to Spin. Use the Spin to increase your Speed, as well as attack enemies. You can Spin to achieve great times on many of the Stages.

3 Rocket Accel



Break wooden boxes using Rocket Accel.

- Rocket Accel is used to get a quick burst of speed. To perform Rocket Accel, press and hold the attack button until the other team members say that they are ready, then release it. Your character will roll forward in a ball very quickly. This rolling ball also works as an attack, and you can roll into and break wooden boxes with it. If you just press the attack button but don't hold it down, you will still roll but not as fast.

4 Solo Attack

- This is like Rocket Accel except that it is performed by the Speed character when they are alone. Sonic and Shadow will slide with their feet out, Amy will fly forward with a Hammer Attack, and Espio will throw a Shuriken star. These attacks are very useful if you are alone.

5 Triangle Jump

- In areas where the walls are close together, use Homing Attack to jump from wall to wall. Use Homing Attack and direct it to the wall; your character will stick to the wall. Press the jump button while pointing to the other wall and your char-



Jump from wall to wall using Triangle Jump.

B FLYING

The Flying Formation is used to ascend to greater heights within a Stage. When you are in this Formation your characters float a bit when you jump, but you also have the ability to ascend. The characters will line up vertically, allowing you to grab Rings that are lined up on top of each other. The two key techniques in the Flying Formation are Flying and Thunder Shoot.



Get the stacked-up Rings by using Flying Formation.

1 Flying

- Flying is used to get to higher places in the level or simply to bypass obstacles or enemies. To Fly, press the jump button. While in the air, press and hold the jump button to ascend slowly. When you release the button your character will descend. If



Ascending to get over obstacles.



you press the jump button again, your character will ascend quickly. While it seems like you can get to amazing heights, you can't. Once a certain height is reached you will not ascend anymore. When you ascend you will see a green Gauge appear underneath the character portrait on the game screen. The Gauge will only go down if you move forward while in Flying Formation. Once the Gauge is fully depleted, you will drop like a rock.



2 Solo Attack

• When the Flying Formation character is the only one remaining, you will perform a solo attack. Depending on who you are using, the solo attack will be different for each character. Rouge and Tails have the same solo attack, but Cream's and Charmy's are different. Check the character profiles section to see the Solo Attacks.

3 Thunder Shoot

• Thunder Shoot is a technique where your Flying character will throw another team member at an enemy. To use it, face an enemy or object and press the attack button. With Thunder Shoot, you can immobilize enemies, destroy wooden boxes, grab items, and hit target



switches. As Thunder Shoot increases in level the range and power increases. You can also destroy multiple enemies with it and it works great versus flying enemies. If neither of your team members is underneath the Flying character, then you can't use Thunder Shoot.



Kill multiple enemies when powered up.

C POWER

Power Formation is what you will want to be in to deal with ground enemies and powerful foes. Depending on your team the power attacks will be different. The Power Formation attacks become very strong at level three. You can also use this Formation to break stone rocks and metal boxes that the other Formations can't. Use this Formation to take out enemies fast. In Power Formation your characters will run side by side.

1 Fighting Pose

• Press the attack button once and the Speed and Flying characters will join the Power character in a Fighting Pose.

2 Fire Dunk

• Fire Dunk is an attack where you use your allies as fireballs while jumping in the air. You must be in the Fighting Pose, then jump up and press the attack button. As Knuckles or Omega, you can press the attack button multiple times to perform Fire Dunk.



Destroy rocks like this one using the Power Formation.

3 Combo Attacks

• When you are in this Formation you will do multiple attacks on the ground by pressing the attack button repeatedly. As the level increases the final attack becomes more powerful. If you would like to see what the character's Combo Attacks look like, check them out in the Team Profiles section.

4 Smashing Objects

• Power Formation is the Formation you will use to smash many objects like stone, metal, and wood. Many of the objects that you smash will contain items and Level-ups. Make sure to smash everything in order to find items in the game.

5 Triangle Dive

• The Dive is a technique where all three characters get together and float in the air, descending slowly. This is a good technique for getting down slowly but the main purpose that it serves in the game is to rise to great heights using fans.



Use Triangle Dive over fans.

When you get caught in one of the fans found throughout the game, press the jump button and all three characters will come together and your team will rise as long as they are above the breeze from the fan. If you do this above a really strong fan then you will rise to even greater heights.

A COLLECTING RINGS

Collecting Rings is the most important thing to do in this game because as long as you have at least one you will be able to take a hit. Rings can be found throughout the game on the path and inside item con-



Power Formation is great for grabbing coins arranged like this.

tainers. The Rings that you see on the path will be in a variety of Formations and to get them all you will need to be in the correct Formation. You can even win Rings in the Casino Park area of the game. For every 100 Rings that you collect, you will gain an extra life. If you get hit while you have Rings, some of the Rings will scatter and you will be able to get some of them back by collecting them again.

B LOSING A LIFE

It's inevitable that during the course of the game you may lose a life. The two most common ways that you will lose a life is by falling, or getting hit when your Ring count is zero. To avoid falling use the Flying Formation because even if you somehow jump off of a ledge there is still a chance that you can save yourself by Flying. You can also save yourself with Triangle Dive in the Power Formation but there must be something below to land on. If you don't want to lose a life by getting hit, make sure that you have at least one Ring at all times. If you do get hit during the game, make getting a Ring back your number-one priority and then take care of the enemies.



Collect scattered Rings after being hit.



C SPECIAL BONUSES

Points and Rings can be obtained by defeating enemies or through collection, but there are also other ways to get extra points and Rings. Throughout many of the Stages you will see three rainbow-colored hoops in different Formations. If you pass through the hoops you will gain bonus points.



Pass through the rainbow hoops for extra bonus points.

By killing enemies quickly you can get extra bonus points depending on the number of enemies killed. Using the Light Dash can also get you bonus points. For enemies killed, you will gain bonus points as follows:

Enemy (#)	Points
1 Enemy	0 points
2 Enemies	200 points
3 Enemies	400 points
4 Enemies	1,000 points
5 Enemies	2,000 points



There is also a way to get extra bonus Rings. Throughout many of the levels there is a long spring that will contain three star symbols.



Light all three stars...



... to get bonus Rings.

If you light all three you will receive five bonus Rings. The most obvious way is to jump on each one, but you can also use Thunder Shoot to light them. When you really become good at the game, you will be able to position your team so that all three characters will jump on the stars. This can be done in the Power Formation.

D LEVELING UP

Leveling up is important because the higher the level that your characters are the more damage you will do. To level up a character you will need to collect an item called a Power Core. The Power Cores come in three colors and the color of Power Core that you collect is the character that will level up. Next to the character's portrait on the game screen are three dots



which represent the character's level. At the end of the Level, if you haven't lost a life, you will receive a bonus for each character's level. The other way to level up is by crossing the Check Point. Whichever character crosses the Check Point will increase in level by one. When deciding who gets the Check Point level, make sure that it's a character who isn't maxed out or one that will be the most useful.

E BATTLE TIPS

Battling is very important because you not only get points for defeating enemies and a bonus at the end of the level, it also keeps you from getting hit. Pay attention to which enemies are vulnerable to what. As a general rule, use the Speed character to take out the gun-toting enemies, the Fly character to take out flying enemies, and the Power character to get rid of ground and power enemies. If you stick to those general rules, you should be fine. For specific enemy-killing tactics, refer to the Enemy section in the back of the guide.



F TEAM BLAST

The Team Blast is equivalent to a bomb in shooters. When you use the Team Blast, all of the enemies in the vicinity are destroyed and your team will also unleash a hidden ability. You can do the Team Blast by pressing the Team Blast button. To power up the Team Blast you must perform an action like collecting a Ring, killing an enemy, or attacking.



The Gauge for the Team Blast is above the character portraits. As you do actions, the Gauge will fill up. When the Gauge is full, you will be able to use the Team Blast. Don't worry about time because the Team Blast stops time temporarily. The best situation is when you are surrounded by powerful enemies.

G EMBLEMS & RANKINGS

Emblems are earned by completing stages in Story and Challenge Mode. There are a lot of Emblems and as you collect Emblems you will unlock 2P Play modes. Getting every Emblem isn't necessary to finish the game but if you want to master the game, this is something that you will need to do.

For each stage, you are ranked on your performance from A to D. Ranking is based on points, but you will not find enough enemies to kill to get enough points.



An extra 2P Play mode is unlocked.

Finish the Stage fast enough and you will receive a time bonus which gives you points and a level bonus. The other part of completing the game completely is to get all A Rankings.

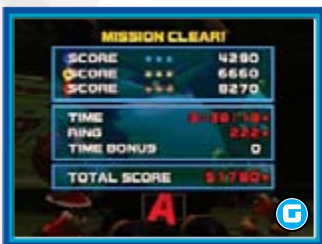

Complete each level in the required time to receive an A Ranking.



STAGE OBJECTS

A DASH PANEL

The Dash Panels accelerate your characters, making them fast enough to get through certain obstacles or outrun traps. The Dash Panels will sometimes be in a different Formation, which will let you know to switch so that you can collect the items.



B SPRINGS

Springs bounce your characters to different places. There are two types of springs in this game. The first bounces you higher and the second is used to get to places. Generally the springs will not lead you to a bad situation, so use them when you can.



C CANNONS

Cannons are used to reach new areas or destroy objects. The cannon direction is determined by your Formation when you enter the cannon. To enter the cannon, jump near it. Speed and Flying Formation shoot automatically, but when you enter while in the Power Formation, you can control where the cannon shoots. In Power Formation, each character will be shot out of the cannon individually. You shoot the cannon by pressing the jump button and cancel by pressing the attack button.



Use Power Formation to destroy blocks or enemies from the cannon.

You can shoot the cannon twice to destroy objects or enemies with your first two characters, and then cancel the last shot.

D DASH RINGS

Throughout each level are accelerator hoops which are placed in midair. When you pass through one of these, your characters will shoot forward quickly. These are generally used to get through a level faster.

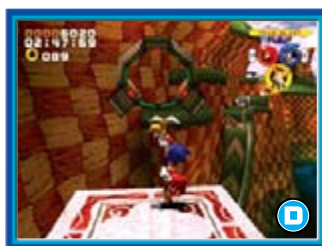

E BOBSLEDS & TROLLEYS

The Bobsled and the Trolley are vehicles that your team will occasionally use. These vehicles continue to move forward but you can move to the left and right, jump or brake. To jump, press the jump button; to brake, press the attack button. Later in the game there will be obstacles like laser beams and ghosts which you can run into. Every time the vehicle gets hit,



Jump over beams like this one.

a team member is lost (as is a crucial ability). Lucky for you, your teammates support you by telling you when to jump.

F RAILS & GRINDING

In Rail Canyon, you will see many rails. When you are on a rail, your character will ride it. This is called grinding. To speed up while grinding, hold the attack button on a downward slope, you will increase in speed greatly. It may be necessary to press the button a couple of times to reach higher speeds. Besides rails, you can also grind on vines and other similar objects.



If there are multiple tracks, you can jump from one to the other by pushing right or left and then pressing the jump button. Press the jump button to jump over obstacles in your way. And remember the better your balance on the rails, the faster you go!





G POLES

When you see a pole in the game this is your queue to switch to Speed Formation. Jump up near the pole and press the attack button to do a Tornado Attack. Your character will grab onto the pole and spin around. This is known as the Tornado Jump.



Use Tornado Jump to swing around the pole.

Your character will spin in a whirlwind to the top of the pole, then jump off. It is very important that you do not try to control your character on the release. Otherwise they will lose distance, which in some cases will result in death.

H FLOWERS

Certain stages will have flowers that can be activated by the Tornado Attack in the Speed Formation. Your character uses the flower like a hang glider. You can't control where you go, but you can control if you go up or down. There are many items that you can collect, so be aware of the heights so you can get them all.



Grab the items while on the propeller.

I SWINGING FROM VINES

Vines can be found in the jungle area; when you attach to

one your characters will swing. You can jump from the vine at any time, but to get maximum distance, press the jump button when the vine swing is at its apex.



The right time to press jump.

J PULLEY

The Pulley will pull you up to a higher location or down to a lower one. To grab the Pulley you only need to touch it. If you press the jump button while on the Ring you will let go of it.

WHAT TO LOOK FOR IN A LEVEL

A FORMATION SIGNALS

Formation signals are signs that tell you which Formation you should use for a particular section. You will also see them near cannons to show you which way the cannon will fire. The Formation signals are there for a reason so make sure that you follow them.



B FORMATION CHANGE GATE

The Formation change gate is a gate that when passed through will change the leader automatically to the same type as the

Formation signal indicates. Just like the Formation signal shows you the recommended Formation, the Formation change gate will change you to the correct one.



Characters change automatically...



... when passing through the Formation change gate.

C CHECK POINT

Check Points are found throughout each level. A Check Point creates a point that you can start from if you die and increases the level of the character that crosses the Check Point. Be aware of your character's levels and make sure that the character that crosses the Check Point needs it.



D SWITCHES

Switches are found throughout the game, and there are all types. There are the target switches which need to be hit by Thunder Shoot, touch switches, and pull switches. To use a pull switch, get close to it and press the attack button to grab on. After they grab on, pull



or push the switch using the controller. Switches are used to open doors, raise poles, and open new paths. Whenever you are at a point in the game where you can't go on, there is probably a switch somewhere. Look for switches high, low, and underneath objects.



E GOAL RING

The Goal Ring is what you need to touch to finish a Stage. On Extra Missions that require you to fulfill certain conditions, the Goal Ring will bring you back to the beginning of the Stage.





TEAM SONIC

This tenacious trio of Sonic, Tails, and Knuckles combines exhilarating high-speed action with medium difficulty.

SONIC

Age: 15 Formation(SPEED)



SPECIAL ABILITIES

① Blue Tornado

• While jumping, press the attack button.

The Blue Tornado is an attack that you can use to toss enemies into the air and to do Tornado Jump. Use Blue Tornado to remove shields from enemies.



Tornado Jump on the pole.



Remove an enemy shield.

② Light Dash

• While near a line of Rings, press the attack button.

The Light Dash is used to not only grab all of the coins in a line, but also as a shortcut in a level. The more Rings in a line that you get, the more bonus points you will receive.

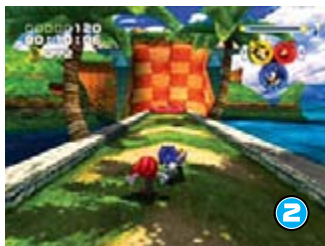

Use Light Dash to collect extra bonus points.

③ Dummy Ring Bomb

• Press the attack button when Tails is alone.

The Dummy Ring Bomb is an attack where Tails will shoot Rings on the ground. If an enemy comes into contact with them then they will suffer damage.

TAILS

Age: 8 Formation(FLYING)



COMBO ATTACKS

Attack 1



Attack 2



Level 1 Final Attack



Level 2 Final Attack



Level 3 Final Attack



FIREBALL JUMP



Jump and press the attack button.

KNUCKLES

Age: 16 Formation(POWER)



TEAM BLAST



TEAM PROFILE

Sonic may be a drifter, but Knuckles' home is firmly fixed in the mountains. Wild, tough, stubborn, and inflexible, Knuckles sees himself as Sonic's rival, perhaps because of his own dreams of a free lifestyle. He's also known as a treasure hunter, and possesses martial arts skills. Tails and Knuckles finally catch up with Sonic as he tours around the globe, and pass him a letter from his arch-nemesis, Dr. Eggman, threatening another outrageous revenge scheme. This time, the deranged scientist announces that he has finally completed his ultimate weapon, and in a matter of 3 days, he will be ready to bring the world to its knees! Unlike Tails, disturbed by the message and unsure what will happen, Knuckles relaxes confident there's nothing to worry about. Sonic, however, shows a brief flicker of a smile and takes off again into the distance. With that familiar grin of confidence, Sonic says he wouldn't miss this party for the world! And this is how the three reunite for their greatest adventure, to put an end to Dr. Eggman's wicked ploy.

TEAM DARK



A villainous team of Shadow, Rouge, and Omega.
Skill and concentration is required to endure heavy battle.

SPECIAL ABILITIES

① Black Tornado

- While jumping press the attack button.

The Black Tornado is an attack that you can use to toss enemies into the air and to do the Tornado Jump. Use Black Tornado to remove shields from the enemies.



Tornado Jump on the pole.



Remove an enemy shield.

② Dark Dash

- While near a line of Rings, press the attack button.

The Dark Dash is used to not only grab all of the Rings in a line but also as a shortcut in a level. The more coins in a line that you get; the more bonus points you will receive.



Use Dark Dash to collect extra bonus points.

③ Dummy Ring Bomb

- Press the attack button when Rouge is alone.

The Dummy Ring Bomb is an attack where Rouge will shoot Rings on the ground. If an enemy comes into contact with them then they will suffer damage.

COMBO ATTACKS

Attack 1



Attack 2



Level 1 Final Attack



Level 2 Final Attack



Level 3 Final Attack



FIREBALL JUMP



Jump and press the attack button.

TEAM PROFILE

Treasure hunter Rouge, who flies all over the world in search of precious jewels, one day hears that Dr. Eggman is accumulating a massive treasure collection. She immediately heads for Dr. Eggman's headquarters to liberate these riches, but discovers the base abandoned with all the valuables gone. However, she comes across a stasis capsule that to her surprise houses the figure of Shadow. Far from being deceased as everybody thought, he was indeed very much alive, but unconscious. In order to release Shadow from the capsule, Rouge switches on the facility's power, unintentionally reactivating the final E-Series robot, Omega. Shadow wakes to find his memory gone, unable to recall why or how he went into stasis. Omega, on the other hand, was rather upset about Dr. Eggman shutting him down. Mistaking Shadow for one of Eggman's robots, he immediately starts to attack him. Rouge steps in to break up the fighting, and reminding them both that their enemy is Eggman, the three shake hands and the team is formed. "Yeah baby!" announces Rouge. "That makes us a team! Let's go find Eggman!"

TEAM BLAST

Chaos Inferno

- Temporarily stops the time after the Omega's blast is fired.



SHADOW

Age: N/A Formation(SPEED)



ROUGE

Age: 17 Formation(FLYING)



OMEGA

Age: N/A Formation(POWER)





TEAM ROSE

A delightful trio of Amy, Cream, and Big.
Shorter missions are suitable for younger players.

AMY

Age: 12 Formation(SPEED)



SPECIAL ABILITIES

① Tornado Hammer

- While jumping press the attack button.

The Tornado Hammer is an attack that you can use to toss enemies into the air. Use Tornado Hammer to remove shields from enemies.



Tornado Jump on the pole.



Remove an enemy's shield.

② Propeller Hammer

- Press and hold the jump button.

You can control her while floating and extend the float by pressing the attack button while holding the jump button. After your second float you can do a Homing Attack. If you bounce off of an enemy, swing the Hammer and float again.



Use Tornado Hammer.

③ Chao Attack

- Press the attack button when Cream is alone.

Cream sends her tiny Chao "Cheese" to attack enemies on her behalf.

CREAM

Age: 6 Formation(FLYING)



COMBO ATTACKS

Attack 1



Attack 2



Level 1 Final Attack



Level 2 Final Attack



Level 3 Final Attack



BODY PRESS



Jump and press the attack button.

BIG

Age: 19 Formation(POWER)



TEAM BLAST

Flower Festival

- After the blast is executed every team member increases in level by one and becomes invulnerable for a short period of time.



TEAM PROFILE

Amy, crazily in love with Sonic as always, is concerned that she hasn't had any contact for over a month. Making little progress on his trail, she is about to give up hope when she catches sight of Sonic's picture in a newspaper. In her excitement, Amy runs straight to the publishers to ask where the picture was taken, and on her arrival, she meets a huge, familiar-looking cat called Big and a cute rabbit named Cream. A quick exchange of stories reveals that Big is looking for his best friend Froggy, and Cream is looking for her friend Chao's twin Chococha, both of whom had appeared in the picture with Sonic. From this, they decide to continue their search together. "You can't run forever Sonic! Mark my words we WILL be married!!"

TEAM CHAOTIX



This devious team of crack detectives is made up of Espio, Vector, and Charmy. Each Mission they undertake lands them in unexpected situations, which leads to some very unusual and sometimes dubious adventures.

SPECIAL ABILITIES

① Leaf Swirl

- While jumping press the attack button

The Leaf Swirl is an attack that you can use to toss enemies into the air and execute Tornado Jump. Use the Leaf Swirl to remove shields from enemies. When you use Leaf Swirl, Espio becomes invisible and cannot be hit by beams that may block the path in the later levels. Espio loses the ability to Rocket Accel but gains the ability to throw Shuriken stars. These can also be thrown when not invincible by pressing the attack button twice, but only one can be thrown.



Tornado Jump on the pole.



Remove an enemy shield.



Throwing a Shuriken star.

② Stinging Tail

- Press the attack button when Charmy is alone.

Charmy will dash at the enemy quickly and sting them with his tail.

COMBO ATTACKS



HAMMER DOWN



Jump and press the attack button.

TEAM PROFILE

This devious team of crack detectives is made up of Espio, Vector, and Charmy. Each Mission they undertake lands them in unexpected situations, which leads to some very unusual and sometimes dubious adventures. The Chaotix Detective Agency is always at your service if the price is right. Lately however, things have been quiet with very little work available. One lazy day, a mysterious package is delivered to Chaotix, and inside they find a transceiver which mysteriously promises a handsome payment if Chaotix will take on a case. Charmy is thrilled by the offer, but Espio remains sceptical due to the strange nature of the communication. Boss Vector, with dollar signs in his eyes, wastes no time in gathering his troop together to take hasty advantage of the opportunity. "You know our policy! We never turn down work that pays!"

TEAM BLAST

Chaotix Recital

- After the blast is executed, each enemy destroyed will give you a certain number of Rings.



ESPIO

Age: 16 Formation(SPEED)



CHARMY

Age: 6 Formation(FLYING)



VECTOR

Age: 20 Foramtion(POWER)



STAGE 01
SEASIDE HILL



See map on page 134

STAGE 01 MISSION	A RANKING REQUIREMENTS	EXTRA MISSION	A RANKING REQUIREMENTS
Get to the other side of the sea!	48,000 points or more	Collect 200 Rings!	02:30:00

START

① Jump up onto the ruins and at the top, switch to Power Formation and smash the rocks blocking your path.



② When you reach the Flying and Speed Formation signals, switch to the Speed Formation and cross over using Amy's Floating technique. Or use the Flying Formation to get over to the other side.



Float over using Amy.



Use Homing Attack.

③ Use Homing Attack to get across the two flying enemies, hit the attack button to use Tornado Hammer, and then hold down the jump button to pass through the Dash Ring and get the balloon that contains 10 Rings.



Use Tornado Hammer.



Float through the Dash Ring.



④ At the edge where the ruins rise, switch to Power Formation and get the **Special Key** inside of the cage.

⑤ Switch to the Flying Formation and jump up to the top of the ledge to the Speed Formation change gate. Below the balloons is a hard-to-see **Power Core** that will level up Cream.

⑥ Use the Bobsled to grab as many Rings as possible. If you want to be accurate and grab them all, use the attack button to brake and take it slow.



⑦ Switch to Power Formation and run straight up the Jump Plate. You will be launched through all three rainbow hoops giving you a 2,600-point bonus and an extra boost of speed.



Earn bonus points to increase your Rank.

CHECK POINT 1

① At the wide spring, you can either fly to the right side through the Dash Ring or use the spring to bounce up to the next ledge. Taking the right path will lead to a **Special Key** and 20 Rings.





The right path leads to extra Rings.

② When you reach the top of the cliff, be careful, the ruins will fall this time when you get close. Use Cream to fly up and get the **Shield** in the balloon.



cage with a **Special Key** in it. If you don't have a **Special Key**, you can run up the hill to the left of the cannon to reach it.

⑤ When you reach the cannon, jump in using one of your Formations. Depending on your formation, the cannon will shoot to a different spot. First start by jumping in the cannon while in Power Formation. Remember that while in Power Formation you can control where you shoot, and cancel by pressing the attack button.

A Power

You can shoot a number of blocks while in this Formation. Shoot the balloon out in the sea to get a **1up** and then cancel the rest of your shots.

B Flying & Speed Formations

Both of these shoot you to the top of the cliff. Use the Speed Formation to collect all of the Rings. Once you are at the top, use the Flying Formation to get over to the Jump Plate on the lone platform. Get enough height to grab the **10 Rings** in the balloon.



③ Jump to the right platform with four Rings on it and use Amy to float over to the far platform containing a **1up** and **5 Rings**. If you fall down to the beach below, don't worry about it because you can easily get to the other side of the beach.

④ Have Amy float over to the platform with the Dash Panel. Run on the center to pass through the three rainbow hoops, launching your team to the other side of the beach. You will see a



The cage below contains a **Special Key**.



Fly back over to the Jump Plate.



CHECK POINT 2

① Run straight down the center of the slope with Amy as the leader and when you run on the Dash Panel it will boost your characters through the rainbow hoops.

② After passing through the Speed Formation change gate, switch to Power Formation and run straight ahead. If you run straight you will be able to get most of the Rings and items.

③ Break the final blocks with Big and you will see the Goal Ring. If you want an extra **5 Rings** before finishing the Stage, break the block located on the wall behind the goal.





STAGE 02 OCEAN PALACE



See map on page 135

STAGE 02 MISSION	A RANKING REQUIREMENTS
Find the ruins floating on the sea!	40,000 points or more

EXTRA MISSION	A RANKING REQUIREMENTS
Collect 200 Rings!	05:30:00

START

① Break through the stone door with Big and run down the path. Watch out for the falling weights. If you want to get every point possible, you can destroy the weights for 20 points each.



② Switch to Cream, bounce off of the spring, and fly through the Dash Ring to get the balloon.



CHECK POINT 1

① Run down the path. When you reach the fan, use Triangle Dive when above the fan to fly up to the upper level of the path.



Use Triangle Dive to reach the upper level.

② After you pass through the stone doors, you will come up to a point in the path where you can either use the Speed Formation or the Flying Formation. Both paths will lead to the same spot.



A Speed

① Run down the path and avoid the falling stone weights.



② Underneath one of the stone weights in the grass area is a container containing 10 Rings.



B Flying

① Run along this path if you want to collect more Rings. This path is especially good if you are trying to achieve an A Rank on the extra Mission.



③ After breaking through the stone door, run on the Jump Plate in Flying Formation and at the end, jump off of the wide spring and fly towards the camera to land on the ledge containing a Special Key. Inside of one of the wooden boxes underneath the first Jump Plate are 20 Rings.



Check these wooden boxes for 20 Rings.



Hold down the jump button and move forward to stay above the fans.

④ When you reach the fans, use Triangle Dive to get the balloon above. Hold down the jump button and move forward. As you go over the second fan, your team will rise. When you reach the top of the ruins, don't be hasty to take the path down. Instead, break through the blocks on the top and grab the 1up on the other side.



⑤ Run down the path and on the right side of the steps behind the stone block is a Special Key. After that, break through the door at the top and run down the path to get to the Check Point.





CHECK POINT 2

① Use the cannon to determine your path. All three paths will lead to the Goal Ring.



A Speed (island A)

This Formation shoots you to the left island. After landing on the island break the metal box with Big to reveal the switch. Touch the switch and jump into the cannon. Depending on your Formation, you will once again be shot to one of three islands.



The switch is located under the metal boxes.

- ① **Speed**
This will shoot you to island E.
- ② **Flying**
This will shoot you to island F.
- ③ **Power**
This will shoot you to island B.

B Flying (island B)

This Formation shoots you to the middle island. Kill the two robots to unlock the cage containing the cannon. Jump into the cannon in one of three Formations.



- ① **Speed**
This will shoot you to island G.
- ② **Flying**
This will shoot you to island F.
- ③ **Power**
This will shoot you to island E.

C Power (island C)

This Formation shoots you to the right island. Jump up on the spring and then into the cannon.

- ① **Speed**
This will shoot you to island A.
- ② **Flying**
This will shoot you to island D.
- ③ **Power**
This will shoot you to island B.

Island D: This island has a bunch of Jump Plates. Get on the main Jump Plate pointed out to sea to get to island G.

Island E: Jump onto the spring to reach island H.

Island F: Use Triangle Dive in Power Formation and rise up to the Dash Ring. This will shoot you to island H.



Island G: Destroy the two robots and jump into the cannon.

- ① **Speed**
This will shoot you to island H.
- ② **Flying**
Shoots the team straight up to get the balloon.
- ③ **Power**
This will shoot you to island M.

Island H: Break the boxes on the island to get extra Rings and then jump into the cannon.

- ① **Speed**
This will shoot you to island K.
- ② **Flying**
This will shoot you to island J.
- ③ **Power**
This will shoot you to island I.

Island I: Jump on the spring and through the Dash Ring to reach island J.



Island J: Switch to Power Formation and use Triangle Dive over the fan and float through the Dash Rings which will shoot you to island L.

Island K: Get on the Jump Plate to reach the island with the Goal Ring.

Island L: Jump on the spring and then onto the Jump Plate to reach the island that has the goal Ring.

Island M: Grab the **Special Key** inside of the cage and then use the Dash Ring to reach the island with the Goal Ring.

If you kill all of the enemies and break open the wooden boxes you can get an additional **20 Rings** before touching the goal.

BOSS BATTLE:



EGG HAWK

RANKING REQUIREMENTS

00:30:00

Strategy:
Run down the path of Rings with Amy, avoiding fire from Dr. Eggman (①). The whole battle will have you running around in a giant circle. There are **Power Cores** in boxes and on the sides of the beaches, but you won't need them to defeat this guy (②). When you reach the beach areas, Dr. Eggman will land the plane and it will begin to spin and fire (③). Change to Power Formation and attack the right gunner to damage the plane's body. You can finish him off by jumping up and doing Body



Press with Big (④). Each hit will decrease his hit points by five. If you don't kill him the first time that you land, finish the job on the second beach, or, if you have a Team Blast, use that to finish him off.



When he lands on the beach, attack with Big.



Power Cores can be found throughout the beach area.



Attack using Belly Press.



See map on page 136

STAGE 03 MISSION	A RANKING REQUIREMENTS	EXTRA MISSION	A RANKING REQUIREMENTS
Stroll through the modern city!	50,000 points or more	Collect 200 Rings!	03:45:00

START

① Run on the energy path until you reach the first enemy. The path is always moving forward, so all of your characters will run fast. If you switch to Flying Formation on that platform and fly straight up from the middle, you can get **10 Rings** from the balloon.



② Fly across and through the dash ring hoop to get to the next platform quickly, or drop down and kill both flying enemies. After you defeat them, a cage containing **20 Rings** will be unlocked.



③ On the platform with the turtle, switch to Big and attack. You can also use Amy to flip him over using Tornado Hammer. When you defeat the turtle, the energy path will form, allowing you to move forward.



You can use Tornado Hammer to flip turtles on their backs.

④ When you reach the pull handle switch, walk up to it and press the attack button to grab onto it. Push it in to open the shutter adjacent to it. After killing the Flapper inside, the path will form and allow you to move on.



Press the attack button when close to grab onto the switch, then push it in.

CHECK POINT 1

① When you reach the area with five robots and a shutter on the right, push the switch in to open the shutter, then power up your **Blast Gauge UP**. Use it on the enemies, then run up the path.



② Switch to Power Formation and run up the Jump Plate, passing through the three hoops.



CHECK POINT 2

① Push the switch in on the left to open the left shutter and destroy the Flapper inside. Next, destroy the robot behind the right shutter to lower the path.



② Run up the middle Dash Panel and execute Homing Attack from enemy to enemy in order to pass through the hoops.





Push both switches to open the door.

③ Push the two switches on either side of the shutter to open it, and enter a long hallway.

④ Stay on the top portion by using Amy's Float ability. If you fall down, don't worry. You will end up in the same place, just not as quickly.



Float to stay on the top area.

⑤ Kill the turtle to unlock the switch and open the door. Turn around to get a **Special Key** inside of the cage.



The Special Key is located behind you.

⑥ Use Tornado Hammer to destroy the Egg Pawn's shield. Push in the switches on either side to open the door.



⑦ When you reach the pole, collect extra Rings by switching to Flying Formation. Fly over the barrier to reach the wooden boxes containing Rings hidden underneath. Go back to the pole and use Tornado Hammer to reach the next area.



Fly over this wall to reach the boxes (and more Rings).

⑧ Grab the **1up** in the balloon before continuing.



CHECK POINT 3

① Jump into the cannon.

A Speed

This shoots you over the lower middle ledge and onto the rail to grind.



B Flying

You land on a high ledge containing Rings and a **1up**. Grind along the rail while still in Flying Formation to pass through the rainbow hoops and collect bonus points. Land on the grinding rail that the Speed path leads to.



C Power

Land on the middle path and jump on the wide spring to land on the grinding rail.



② Follow the rails down to the bottom. You can jump on side rails that pass between the buildings and contain more Rings. At the end of the rails is the Goal Ring.



Get more Rings on side paths.



STAGE 04
POWER PLANT

See map available on page 137



STAGE 04 MISSION	A RANKING REQUIREMENTS
Escape from the energy plant!	45,000 points or more

EXTRA MISSION	A RANKING REQUIREMENTS
Collect 200 Rings!	03:30:00

START

① At the top of the lift, destroy the three Flappers to open up the path. Break open the wooden boxes to get a **Special Key**.



② When you reach the Formation Signals for Speed and Flying, choose which one you want to take. If you choose speed, just run down the path at full speed. If you chose Flying Formation, run down the path and then jump through the Dash Rings. The Flying Formation path gets you more Rings.



Get more Rings by taking the Flying path.



CHECK POINT 1

① You'll want to reach the very top section of this area, but if you want to explore everything, there are a couple of options open for you.

A Option 1

Run forward up the Jump Plate, then destroy all three flying robots to get the **1up**. Run up the wall, and when you reach the platform, fly up through the Dash Ring to reach two balloons situated up high.



The switch is located under the metal boxes.

B Option 2

From in front of the Check Point, fly straight up through the Dash Ring to get the balloons and land in each Dash Ring to continue the upward momentum. Use the last one to get to the top.



Grab all of the items on your way up.

② Run on the Dash Panels in Power Formation, but wait until the weight that drops on the path is in the upper position.



Wait until the weight is out of the way.

When you run up the next path, watch out for the fireballs.



Avoid the fireballs in this area.

③ Kill the turtle to make the path appear. If you have a Team Blast, use it now, because inside of the crates on the left side is another **Blast Gauge UP**.



④ Fly up through the Dash Ring or use the Pulley to get to the top. If you want to get all of the Rings, stop on the middle ledge and run the upward path.



⑤ Face the ramp leading up, then fly straight up and use Thunder Shoot to hit the target. You will receive 400 points and **5 Rings**.



⑥ After destroying the flying enemy, shoot the wooden boxes to open the path forward and reveal items such as **Power Cores**.



CHECK POINT 2

① There are two ways to go. Switch to Flying Formation and jump through the hoop which will ultimately lead to two **1ups**. If you fall, don't worry because you can follow the bottom path to get to the end of the corridor.

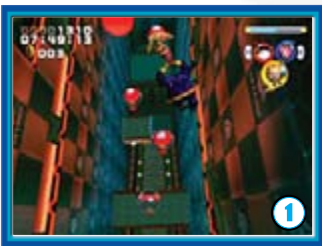

② Fly through the Dash Ring to land on the next ledge. Use the wide spring to bounce up and inside another Dash Ring. Bounce up through them, grabbing items. When you reach the next ledge with the locked spring, shoot the two target switches to unlock it.



Unlock the spring by shooting the target switches.

③ Use the spring to get on to the rail or use the Dash Ring to get to more items and a **1up**. Before reaching the end, drop down and you will see a cage with a **Special Key** in it that is hovering in the air. Shoot it to get the cage to drop to the ground and get the **Special Key** inside.



Avoid the fireballs while getting the **1up**.



④ Destroy the three Flappers to make the platforms come out of the wall and fly up to the ledge with the Goal Ring.



BOSS BATTLE:



TEAM SONIC

A RANKING REQUIREMENTS

00:30:00

Strategy:

The object of the battle is simple. Knock the other team off the ledge to win. Start by grabbing the **Blue Power Core** in the center, so Sonic can't use it. (①) Then when the other team is near Amy, use Tornado Hammer to fling them into the air (②). While they are grounded you can collect more **Power Cores** or steal their Rings (③). If Sonic's team doesn't have any Rings it will be easier to knock them off. Also, be sure to look around because there is nothing more annoying than getting hit from behind. This is a fairly easy battle and you should be able to get an A Ranking easily after a couple of tries.



Use Tornado Hammer to launch Sonic's team.



STAGE 05
CASINO PARK

See map on page 138



STAGE 05 MISSION	A RANKING REQUIREMENTS	EXTRA MISSION	A RANKING REQUIREMENTS
Play the giant pinball tables!	35,000 points or more	Collect 200 Rings!	04:00:00

START

① Grab the Pulley underneath the giant die to drop to the bottom level. When you reach the area with the die that is circling counterclockwise, float over it using Amy.



② After grabbing the **Special Key**, use the pull switch on the right to open the door. Jump above the glass with Big and use Body Press Attack to break it. Once the glass is broken you will drop onto the pinball table.



Use Body Press to smash through the glass.



③ You only need to fall down, but if you want to get to the goal a lot faster, try to fall into the center path. The center path leads right to where you need to go.



Fall into the center path to get to the goal faster.

CHECK POINT 1

① Behind the boxes is a **Special Key**. After you get it,



use the springs to reach the upper level. On the upper level, hit the Power Gong switch with Big. That will launch you onto the roulette table. After it circles, you can either go to the left or right. Both paths lead to the same spot.

② Use the Jump Plate to launch yourself onto the pinball table. This is where you can really cash in. By entering the slot reel you can win up to 200 Rings.



③ There are two sides to this giant table. If you want to leave, you are going to have to get to the right side of the table and get into the area where the giant arrow is pointing.



④ After exiting the table, pull out both switches on either side of the door and break the glass with Big.



⑤ Destroy the robots that are blocking the way, then fly up, using Cream to reach the Goal Ring. If you need a **Special Key**, enter the door behind you before going to the goal.

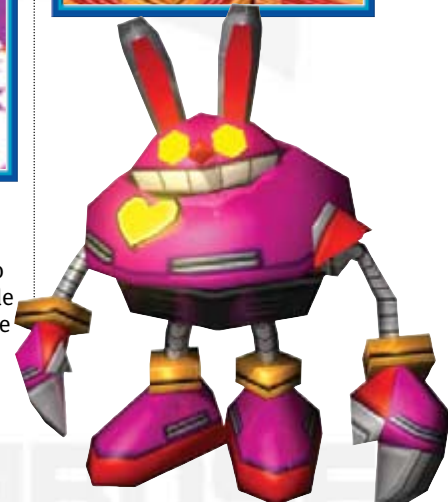



STAGE 06 BINGO HIGHWAY



See map on page 139

STAGE 06 MISSION	A RANKING REQUIREMENTS	EXTRA MISSION	A RANKING REQUIREMENTS
Try the bingo slides	35,000 points or more	Collect 200 Rings!	03:30:00

START

① You begin by going down the table. Go up the middle ramp to get to another pinball table with slots and increase your Ring count. It's kind of difficult, so most likely you will just go to the right or left.



Break through the three barriers to get up the ramp leading to the center.

② If you did go to the right or left, you will reach a Search Flapper. If the spotlight shines on you, more enemies will appear. Destroy the Klagen with Thunder Shoot to open the door.



Enemy reinforcements appear when the spotlight hits you.

③ Run down the corridor and switch to Power Formation. Use Triangle Dive above the fan to reach the top area.



④ You will see a new type of robot here. If this guy catches one of your characters, you won't be able to use them. Kill the robot using Homing Attack or Thunder Shoot. Grab the Special Key and then use Body Press to break through the glass.



Don't let this guy capture a team member.

⑤ At the moving dice, use Cream to fly to the Check Point. If you fall while over the dice, you will fall onto a pinball table. Roll down the table, but make sure you don't fall into the hole underneath the "Lost" sign.



CHECK POINT 1

① Hit the gong with Big and you will be launched onto the Bingo slide. Or use the springs to get onto the bingo slide, depending on if you fell or not. There are numbers on the bingo slide and for every line vertically, horizontally, or diagonally, you will receive **20 Rings**. Try to get a perfect card by touching all of the numbers and get an additional 40 Rings.



② Destroy all of the enemies using the Team Blast. Fly onto the die and then up to the ledge with the Flapper.



③ When the Flappers move to the side, use the Jump Plate to fly to the Check Point. If you fall, you will land on a pinball table. Reach the bottom of that table and you will lose a life. Make it to the top and there is a **1up** waiting for you.



CHECK POINT 2

① Use the spring to get up to the top of the giant slide. After falling down one level on the slide, use the flippers to get extra Rings and a **1up**.

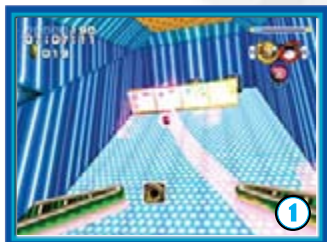

Use the flippers to get the 1up.

② Ride the current up and destroy all the enemies to unlock the switch. Touch the switch to open the door. Drop down through the glass to land on the second bingo slide.



③ The second bingo slide is the same as the first, except for one small difference. You will see signs that say "Lost." If you fall into one of these you will fall to your death. When you land on the next pinball area, let your team get to the bottom.



④ Break the metal boxes to reveal a switch. Touch the switch and the die ahead will stop spinning wildly. Don't fall or it will mean your death.



You cannot jump on the die while it is spinning.



Touch the switch to stop the die.

⑤ Jump off of the green bumpers and onto the die. Switch to Flying Formation if you aren't already in it. Turn around while on the die to get extra points and an item. At the top is the Goal Ring.

BOSS BATTLE:



ROBOT CARNIVAL

A RANKING REQUIREMENTS

01:30:00

Strategy:

This is more of an endurance battle than it is a Boss Battle. Dr. Eggman will send enemies at you in phases and you must survive them all in order to win.

① Phases 1 and 2

This phase only has Flappers. Use Amy's Homing Attack to kill them all by bouncing from one to the next. This is fairly simple and you get good practice at using Homing Attack.



Bounce off the enemies using Homing Attack.

② Phase 3

This consists of a combination of Casino Managers and Gun Flapper's attacks. Use Homing Attack to bounce off the Casino Managers and then off the Gun Flappers.



Bounce off the Casino Managers first!

③ Phase 4

This phase has nine Flappers that you can bounce off of using Homing Attack. If you want to be diverse, use Thunder Shoot.



Use Thunder Shoot to take these Flappers out.

④ Phase 5

Four Flappers, with lightning shooting down, will converge on the center. Destroy them all using Thunder Shoot.



Watch out as these Laser Flappers converge on you.



⑤ Phase 6

Casino Managers and Bomb Flappers are attacking again. By now you should have the Team Blast ready. Use the Team Blast to get rid of them all quickly.



⑥ Phase 7

A circle of Flappers attacks this time. Use Thunder Shoot or Homing Attack to get rid of them. Don't worry about getting hit because you are invulnerable from using the Team Blast on the previous phase.



⑦ Phase 8

Four Klagens and four Camerons will appear. Use Thunder Shoot to get rid of the robots, then switch to Power Formation and have Big take care of the Camerons. If you have a Team Blast ready, use it because this is the last phase.





STAGE 07 RAIL CANYON



See map on page 140

STAGE 07 MISSION	RANKING REQUIREMENTS
Go beyond the rails!	40,000 points or more

EXTRA MISSION	RANKING REQUIREMENTS
Collect 200 Rings!	Under 04:00:00

START

① Grind the rails and grab any Rings and items along them. This is a good time to practice grinding and switching tracks. To speed up press the attack button. To switch tracks, hold to the left or right and press the jump button. When you reach the end jump on the wide spring and up to the Check Point.



CHECK POINT 1

① Grind the blue glowing rails in Power Formation. When you reach the next platform, destroy the barrels on the left side and get the **Special Key** in the cage behind it. Bounce up using the wide spring, and grind into the track switch in the middle to change the path of the glowing rails.



This switch changes the path of the rails.

② Switch to Flying Formation and position yourself between the two Jump Plates. Fly up to the top of the tracks and bounce off of the spring to get a **Yellow Power Core**.



③ Grind on either rail, and after you pass through the Speed Formation change gates, drop down to the next set of rails. Jump over to the red rail (the right side) to increase your time.



Fall into the center path to get to the goal faster.

CHECK POINT 2

① Jump on the spring to get to the ledge above. Touch the switch to open the door and then jump onto the next set of rails. While grinding the rails you will see arrows that point you to the right path. Follow them to avoid hitting the stopped trains.



Avoid hitting the trains by following the arrows.

② At the bottom, jump off the track onto the platform and use Tornado Hammer to get up the pole.



CHECK POINT 3

① Grind the rails down to the bottom. Stay on the middle rail in Speed Formation. Jump through the rainbow hoops for a team trick.



② Follow the rails until you reach the next Check Point. After passing a small platform with metal boxes to either side, the rails head upward. Jump off in between them and use the Jump Plate to reach a **Blast Gauge UP**.

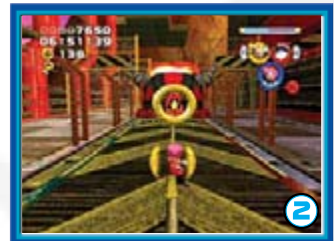

Drop down between the rails to get to a Blast Gauge UP.

CHECK POINT 4

① Fly up through the Dash Ring. Hit the track switch to make the red lit tracks appear. Follow the tracks and after a bunch of switches you will reach the Goal Ring.

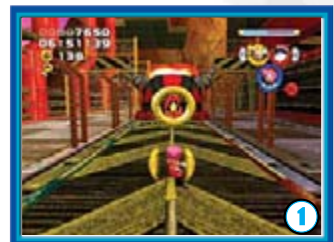



STAGE 08 BULLET STATION

See map available on page 142



STAGE 08 MISSION	A RANKING REQUIREMENTS
Find Eggman's base!	38,000 points or more

EXTRA MISSION	A RANKING REQUIREMENTS
Collect 200 Rings!	04:00:00

START

① At the end of the initial grind, destroy the enemies and walk along the rail. If you fall use the spring to get back up.



② Use Triangle Dive at the giant fan to get to the top area and grab the **Red Power Core** inside of the balloon. You can use Flying Formation along the left side, but you won't be able to grab the balloon.



③ Break the metal boxes on the ground to get 10 Rings.



Get this cleverly hidden item.

CHECK POINT 1

① Grab the **Special Key** and jump into the cannon. The cannon will fire your teammates down a corridor. Move to the left and right to grab the balloons. The rails you land on will eventually lead you to a tight corridor.



Move to the right and left while being shot out of the cannon.

CHECK POINT 2

① Switch to Power Formation and use Body Press to break through the duct. You will land on a train.



② Destroy or fly over the capsules. At the end, destroy the engine's core with Big.



③ Collect the Rings at the bottom of the rails and then jump into the cannon in Speed or Flying Formation to reach the Goal Ring. Power Formation will shoot you to a platform that contains a **Special Key**. This is perfect because you have an easy chance for the Emerald Challenge.



BOSS BATTLE:

EGG ALBATROSS

A RANKING REQUIREMENTS

02:00:00

Strategy:

There are three parts to this Boss. Destroy the bottom of the blimp, the blimp itself, and finally the Egg Hawk. To get an A Rank, you are going to have to work fast.



Bottom of the Blimp

Begin by running and grabbing Rings along the path until the Team Blast Gauge is full (①). When the Team Blast is powered up, use it when you are close to the Albatross. This will destroy most of the weapons (②). Jump into it with Amy and use Homing Attack to finish off the first part.



Power up your Team Blast by grabbing Rings.



The Blimp

Run up to it with Amy and when the propeller is close, jump up and continually use Homing Attack to take it down quickly. You may still be invulnerable from the Team Blast, so it shouldn't be a problem getting into position.

The Egg Hawk

This time the Egg Hawk will not land so you will need another way of defeating it. Just like the first part, run down the path and power up your Team Blast. When the Egg Hawk gets close, use the Team Blast and it will be destroyed (③).



Finish off the Egg Hawk with Team Blast.



STAGE 09 FROG FOREST



See map on page 144

STAGE 09 MISSION	RANKING REQUIREMENTS
Get through the forest!	40,000 points or more

EXTRA MISSION	RANKING REQUIREMENTS
Collect 200 Rings!	03:30:00

START

① After grinding down the vines, jump off of the plant to the right. Plants like these can be used as springs (so can mushrooms).



Plants on this stage can be used like springs.

② After running down the path, you will come across a green frog. Green frogs cause it to rain, thus making the plants in the area to grow.



Before the rain.



After the rain.

Jump on a newly sprouted plant to bounce up to the vine.

③ After grinding down the vine, get near the frog so that new plants will grow. If you run around the back of the tree and break the metal crates, you can get a **1up**.



④ In Flying Formation, fly up and jump on the mushrooms to reach the top of the tree. Grab the **Special Key** and then touch the Check Point.



CHECK POINT 1

① After using the Jump Plate to traverse the gap, you will run into a green frog. Jump to each ledge using the platforms that appear as a result of the rain. At the end, you can use the mushroom to bounce up to the high ledge with a switch that Big can hit.



② After passing through the Speed Formation change gate, switch to Power Formation to get everything. After running the path, you will land on a giant platform that forms as a result of the rain from the frog that you pass along the way.



CHECK POINT 2

① On the ledge with the two robots, destroy both robots to get the **Red Power Core** and then hit the Power Gong with Big.



② When you reach the flower, use Tornado Hammer to stir the wind to propel the flower. While on the flower, you can control up and down.



③ After jumping off the swinging ivy, turn around and jump down to get the **Special Key**. Once again you have an easy Special Stage opportunity. Run across the Dash Panel and touch the Goal Ring.



A Special Key is located on the ledge below.



STAGE 10
LOST JUNGLE

See map on page 146



STAGE 10 MISSION	A RANKING REQUIREMENTS	EXTRA MISSION	A RANKING REQUIREMENTS
Escape the jungle!	42,000 points	Collect 200 Rings!	04:00:00

START

① An Egg Hammer appears. Defeat this giant robot by getting into range so that he swings his hammer. Switch to Flying Formation and when the robot stops and is staggering, hit him with Thunder Shoot to knock him over.



Get the robot to swing his hammer.



Knock him over with Thunder Shoot.



Attack him when he's down.

Switch to Power Formation and hit him in the head. You can also hit him with an aerial attack while Amy and Cream are on Big's shoulders.

② The black frogs that you come across will cause it to rain black. The black rain makes the plants wither and die.



③ These Flappers will have spikes appear that will hit you if you try to use Homing Attack.



Don't attack when the spikes are out.

④ Make sure that you are at the apex while swinging from the ivy to land on the ledge above. When the weight up here drops down, jump on top of it to get to the higher ledge.



CHECK POINT 1

① Swing across the ivy and then destroy the robots with Thunder Shoot to unlock the case containing 20 Rings.



② The black frogs will cause it to rain black again and the plants will roll down the slope. Avoid these plants and let them kill the enemies at the same time.





③ Use the flower to fly over to the next area of the forest and run down the path toward the Check Point.

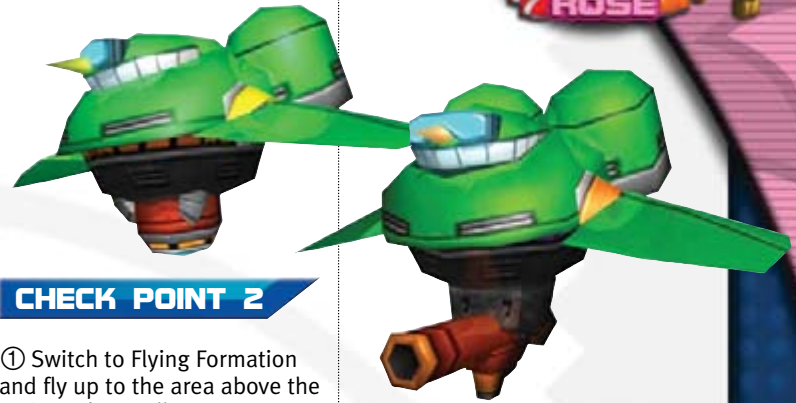

CHECK POINT 2

① Switch to Flying Formation and fly up to the area above the main path to collect more Rings. From where you jumped up you can jump down to the path on the left or run the path to reach the same spot.

② Use the Team Blast on the Egg Hammer and the two others and then use the plant spring to get to the top of the path.



Several Rings can be found above the path.



③ Run down the slope in Speed Formation to reach the Goal Ring.

BOSS BATTLE:



TEAM CHAOTIX

RANKING REQUIREMENTS

00:30:00

Strategy:

Just like the battle against Team Sonic, this one requires Amy as the point character. Grab a Ring and then use Tornado Hammer to knock Team Chaotix down (①). Once you have finished off at least one of the other Chaotix members, try to take down the other two as fast as possible. They will use their Team Blast to revive the fallen character (②-③) You could do the same but you may not get the opportunity. If you go for the balloons on the side, use Thunder Shoot to get them (④).



Team Blast will revive any fallen characters.

STAGE 11
HANG CASTLE



See map on page 148

STAGE 11 MISSION

Find the haunted castle!

RANKING REQUIREMENTS

45,000 points

EXTRA MISSION

Collect 200 Rings!

RANKING REQUIREMENTS

03:30:00

START

① Start by getting **10 Rings** from the wooden boxes on the right, then run down the path in Power Formation to grab all of the Rings.



② Take down the yellow flying robot and then get the **Special Key** inside of the cage. After that, break through the wooden boxes on the ground to drop down to the lower level of the castle.



③ Touch the switch at the bottom and the castle will be flipped upside down.



The castle is now inverted.

④ Fly on top of the platform with the Rings to activate the switch for the door and then jump down into the hole. The orb at the bottom will return the castle to normal.



The switch is on top of the platform.

CHECK POINT 1

① When you move forward three Egg Pawns with shields will appear. Use your Team Blast if you have it. If you don't, then use Tornado Hammer with Amy to remove their shields.

② Before going up the steps, break the walls to the left and right with Big. The breakable wall is distinguishable by a crack.



Cracks in the wall mean hidden items.

CHECK POINT 2

① Run down the path and at the end you will hit a Jump Plate in the center which will launch you into the air and against the wall. When you fall, you will land on the switch that inverts the castle.



② Jump up on the moving block to reach the next tower and while on the block, turn around and fly up to a balloon containing **10 Rings**.

③ After crossing the two floating platforms, watch out when grabbing the **10 Rings** because a ghost will appear on top of it.



④ When you reach the group of robots, use the Team Blast to destroy them quickly and then fly up to the Goal Ring.

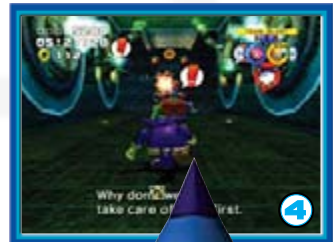



STAGE 12 MYSTIC MANSION



See map on page 150

STAGE 12 MISSION	A RANKING REQUIREMENTS	EXTRA MISSION	A RANKING REQUIREMENTS
Escape from the haunted castle!	45,000 points	Collect 200 Rings!	03:30:00

START

① Get the **Special Key** underneath the crate and then kill the enemy in order to open the door to the next room.



② Break the wooden boxes on the left side and touch the switch that's underneath to open the door and enter the circular room.



③ Kill the enemy behind the door to release the lock surrounding the orb switch.

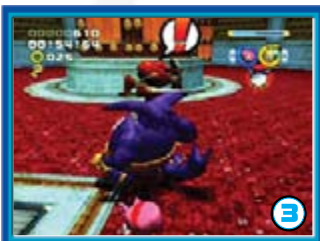

④ Kill the two robots and the center door will open. Once inside, grab all of the Rings and then fly up the rising platform to get to the Check Point.



CHECK POINT 1

① Smash the wooden boxes to get a **Shield**, then kill the robot to enter the next room.



② Use the Team Blast to clear out the enemies, then touch the orb switch just up the small set of stairs.



③ You should still be invincible, so take care of the two shield robots as well as the giant robot, to move on. If your invincibility has worn off, you can stay on the steps and finish the enemies from there.



You can stay at the bottom of the steps and kill the enemies.

Watch out for the Egg Hammer's swinging attack.

④ Use Amy to spin down the pole to reach the lower level of the mansion.



⑤ Ride the Bobsled down to the bottom. Watch out for the beams and ghosts along the track. When one of your team members says jump, be sure to jump so that you don't hit a beam.



Jump over beams and ghosts when your teammates say jump.

CHECK POINT 2

① On top of the left pillar, underneath the wooden box, is the switch that opens the door.





② You are now in a room with three orb switches. Touch the left one to place the platforms in the correct position.



The correct position for the platforms.

③ Use Flying Formation to get to the top and reach the Goal Ring. Watch out for the ghosts and the Egg Bishop along the way.



BOSS BATTLE:



ROBOT STORM

A RANKING REQUIREMENTS

02:00:00

Strategy:

This time Dr. Eggman will use stronger robots to attack you. Like last time, the object is to survive. After a couple of phases you will jump into a transporter to get to different areas of the battle.

① Phase 1

Flappers will appear in a pyramid formation. Have Amy use Homing Attack to bounce from one to the next and destroy them all.



② Phase 2

Switch to Power Formation and have Big take care of the lance-wielding Egg Pawns.



③ Phase 3

Stay to the back of the circular platform opposite the switch and use Thunder Shoot to kill the Flappers. This will power up your Team Blast and you can get rid of the enemies. You can also use Amy to get the job done. After this phase, touch the switch to get to the next set of enemies.



Stay to the back and get rid of the robots using Thunder Shoot.



Touch the orb to get to the next area.

④ Phase 4

You will be surrounded by Camerons. Instead of switching to Power Formation and risk getting hit, use the Team Blast to dispatch them all at once.

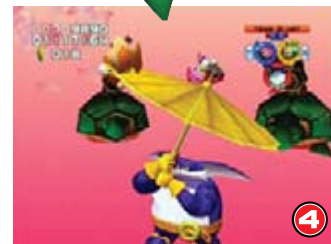

⑤ Phase 5

Cream should be leveled up to at least two by now. Use Thunder Shoot to kill all of the Egg Pawns as they drop down.



⑥ Phase 6

Finally take out the wall robot to finish off the stage.





STAGE 13 EGG FLEET



See map on page 151

STAGE 13 MISSION	A RANKING REQUIREMENTS	EXTRA MISSION	A RANKING REQUIREMENTS
Find Eggman's fleet	40,000 points	Collect 200 Rings!	05:00:00

START

① On the initial grind you have two paths open to you.

A Path 1

① Grind the center rail and then, before you reach the end, jump and float with Amy to get through the three hoops and land on the top platform.



② Float from there to the next platform and jump from there in Power Formation, using the Umbrella move to get up the rail and grind your way to the Check Point.



B Path 2

① If you didn't go through the hoops you will land on the bottom path and will have to take the long way. Slam down on the giant switch with Body Press to activate it.

② Fly up to the top of the structure above the rail to get **10 Rings**, and then break the metal crate in the center to drop onto the rail.



Fly up here to get extra Rings.

③ Switch to Power Formation and bounce off of the wide spring. Use Big's Umbrella move to get the balloon above the fan and on the ledge to the left.

④ Grind the rail in Power Formation and then use the Umbrella move to reach the spring. Bounce off the spring to land on the rail and then grind down to the Check Point.





CHECK POINT 1

① Get down to where the cannons are and have Big destroy them. When you see a circle appear near where you are, that means a shell from the cannon is targeting that spot.



Watch out for these circles when cannons are nearby.

Underneath the middle cannon is the switch that activates the fan on top.



The switch is located underneath this cannon.

② Use Big's Umbrella move to rise up to the next platform. Once up there, break the metal box and touch the switch to activate the fan that leads up to two more platforms.



③ When you reach the top, bounce off of the wide spring to reach the highest level of the ship.



④ Travel up the ship, avoiding the cannon fire, and use the spring underneath the cannon on the right side to get up to the ledge with a switch. The switch unlocks a 1up on the next ledge.



Destroy this cannon to get to a 1up.



⑤ Fly across from the 1up to get the Special Key in the cage and then drop down to where the E-2000 is and defeat it to unlock the switch and activate the fan.

CHECK POINT 2

① After passing through the rainbow hoops, run forward and jump onto one of the rails. After grinding the rails, you will land on the deck of another ship. Just above the middle cannon is the Invincibility item.



② Jump down to the cage with the Special Key from the platform with the propeller, then use the fan to get back to the walkway.

③ Use the propeller to fly across the fleet. When you see a ship with Rings, jump off of the propeller and land on the deck. At the end of the ship is a 1up.

Use the propeller on this ship to reach the rest of the fleet.



Land on the deck of this ship.



The Special Key is located on this small walkway.





Don't forget to grab the 1up.

④ Grab the items in the balloons by moving up and down. You will automatically land on the deck of the ship.



CHECK POINT 3

① At the end of the deck, destroy the cannon and bounce off of the spring underneath. Jump on the switch on top of the cannon and drop down to destroy the enemies, releasing the wide spring.

② When you reach the area with cannons, use Flying Formation to jump up from ledge to ledge.

③ Jump over to the right side and then fly over the gap toward the pole. If you fall you will lose time.



④ When you get to the top, cross the bridge and drop down on the opposite side. Break the metal boxes to reveal 25 Rings and a Blast Gauge UP.



STAGE 14
FINAL FORTRESS



See map on page 153

STAGE 14 MISSION	A RANKING REQUIREMENTS	EXTRA MISSION	A RANKING REQUIREMENTS
Hurry and find Eggman!	36,000 points	Collect 200 Rings!	04:30:00

START

① Use the Pulleys to go down, then jump to the platform and onto the path.



② After hitting the Jump Plate to cross the gap, quickly fly over to the next platform before it falls.



③ Break the object to the left side and bounce off of the spring underneath to reach the Check Point.



CHECK POINT 1

① Fly down to the platform and then fly across the walkways before they disappear. On the ledge with the robot and the wide spring, break the metal boxes on the floor to get 10 Rings.



The Special Key is located on this small walkway.

② After grabbing the **Special Key** in the cage, jump off of the path to the side ledges just after the Speed Formation signal. You'll get a total of **20 Rings**.



Jump off before continuing up the path to get

③ When you reach the Egg Hammer, use Big to destroy him. After the robot is defeated, jump on the spring which will bounce you onto the glowing rail.



④ When you reach the pole, jump over and use Speed to get to the top of it and then use the spring to reach the new rail located up high.



A 1up is located underneath this cannon.

⑥ At the end of the rail is a platform that will disappear. You can see a way to get to the top, but underneath (behind the gun) is a wide spring and a second path that is risky but a lot faster. If you make the top then you will have to deal with the E-2000 and drop down.





Save time by taking the underneath path.

⑦ Destroy the E-2000 to open the door and then avoid the laser to get to the Check Point.



Avoid the lasers on the way to the Check Point.

CHECK POINT 2

① Run directly at the center switch in Power Formation to activate all three switches for the fan. Use Big's Umbrella move to rise to the top and through the Dash Rings to land on the rails.



② Switch to Flying Formation after the rainbow hoops and then watch out for the spiked balls on the path.



③ At the end, fly up to the rail above the goal to get a 1up. After that drop down and touch the Goal Ring.



Fly up to this rail to get a 1up at the end.



BOSS BATTLE:

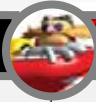

EGG EMPEROR

RANKING REQUIREMENTS

03:30:00

Strategy:

Start by running toward Eggman. His giant robot will swing the sword four times. You must dodge a vertical swipe, horizontal swipe, vertical, and then horizontal again. Dodge the horizontal ones by jumping over them (①). For this first part you must stay close because if you get too far then he will charge at you

(②). This is especially lethal if you are in mid-flight above a chasm. At the end of the path is a gong and a Jump Plate. Either way will take you to the center platform (③).

The center circle contains four cannons and Dr. Eggman. Destroy the four cannons first and then take out Eggman using Thunder Shoot (④-⑤). You should be able to come close to defeating him on the first go around. If you don't defeat him the first time, just circle again and finish the job the second time. Whenever you have a Team Blast, use it right away to take a big chunk away from his life.



Stay close otherwise he will charge at you.



Destroy the four cannons first.



Use Thunder Shoot to defeat him.



STAGE 01 SEASIDE HILL



See map on page 134

STAGE 01 MISSION
Head for the whale island!

RANKING REQUIREMENTS
60,000 points

EXTRA MISSION
Goal Ring in 05:00:00

RANKING REQUIREMENTS
50,000 points or more

START

① During the initial run, switch to Knuckles. When you reach the springs, you will burst through the hoops and get propelled to the Speed Formation signal. If you don't go through the hoops then you can get a total of **10 Rings** on the platforms to the side.



Knuckles

Knuckles must break the blocks to reveal jumping springs.



Break the blocks with Knuckles to reveal springs.

② When you reach the top use Tails to get up to the platform above and get **10 Rings**. After you drop down you will have a choice to use Sonic or Tails.

Sonic

If you are going for a fast time, take the lower path with Sonic.

Tails

The upper path with Tails leads to a total of 14 Rings and a **Power Core** for Knuckles.



Fly over to the Balloon to get the **Red Power Core**.

③ After the Power Formation change gate, you can use Knuckles to get the **Special Key** and gain access to the Special Stage, then bounce off of the wide spring to get up to the next ledge. At the top of the hill after you break through the stones is a Speed Formation change gate.



Flying Formation

Shoots you up to a platform on the left which leads to another platform with 3 Rings.



④ When you run down the hill, hit the attack button as you get close to the second set of Rings, then switch to Knuckles to get all three parts of the ramp. After the ramp you will land on a beach area. Use Blue Tornado to defeat the pawns and then use the cannon.



Speed Formation

A direct shot to the next beach area.



Hit the attack button when close to the Rings to perform **Light Dash**.

⑤ Depending on your Formation, the cannon will fire you toward a different direction.

Power Formation

Shoots the team toward the isolated platform in the sea and a **Power Core** for Sonic.



⑥ At the end of the beach area, platforms will rise up as you get close. Use Tails here to fly to the top of the platforms. At the top is a sled that the team will use to get to the next part. Switch to Sonic before using the Jump Plate so that you can get through the three hoops, then touch the Check Point.



Rings can be found on either side.

② Run in Power Formation to grab all of the Rings on the path. After you jump the gap you will reach the Check Point.



CHECK POINT 1

① Run up the ramp to get all of the Rings. At the end, destroy the three Egg Pawns and get to the top using either Tails or Knuckles.

Tails

Tails can fly up easily, making this the faster alternative.



CHECK POINT 2

① If speed is your only concern, use the spring to reach the top. If you are going for Rings, use Knuckles to break the block and then use the spring to get to the ledge with another block containing **20 Rings**.



② Reach the top of the cliff and switch to Tails. The ruins will sink after you defeat all of the enemies. Fly through the Dash Rings to stay on the top portion and save yourself time. Run along the top to the Check Point.



③ If you fall down to the beach, you will lose time and have to make it back up via the beach area.

A On the beach area, break the right stone block and get the **Speed UP**.



B Jump into the Cannon. Flying Speed and Power Formation will shoot you to the top area and Speed Formation will launch you into a series of springs that leads to the other side of the beach.



C Fly to the top of the platforms taking the speed path to get a **Blast Gauge UP**.



D Run up the path from the cannon, then drop on the small platforms to reach the **Special Key**.



Drop down to get a **Special Key** to the Special Stage.

E Jump into the cannon in Power Formation and land on the platform to which it points. After that, switch to Flying Formation and fly up to the next platform, grab the **Shield** from the balloon. Use the Jump Plate to reach the top of the hill.



Speed and Power Formation from the cannon will also lead to the top of the hill.

CHECK POINT 3

① Switch to Sonic and run down the path. Stay in the middle and you will pass through the set of rainbow hoops. After that, switch to Tails and kill, or simply fly up past, the enemies.



Earn extra points by passing through the Hoops.

② Switch to Sonic and accelerate down the path. Then, as Knuckles, continue running down the hall until you reach a small chamber.



③ Use the cannon to get to the top of the vertical tunnel using Sonic or Tails. If you use Knuckles, he will shoot straight ahead by default and destroy the block revealing a **1up**. Underneath the block to the left is a **Special Key**.



A **1up** is hidden behind the block.

CHECK POINT 4

① After the Check Point, take the sled ride and collect as many Rings as possible. When you get off, switch to Knuckles and use the Dash Panels to use the ramp. After switching to Sonic you will arrive at a path with a bunch of enemies. Kill them using the Team Blast or run by them on the right.



Use the **Team Blast** to take out this group of enemies.

② Accelerate up the ramp and you will fly over a gap. You will receive a **Blast Gauge UP**. Use it on the enemies for extra points.



③ Jump down the middle of the tree trunk to get a **1up** and then touch the Goal Ring to finish the stage.



Don't forget to grab the hidden **1up**.

STAGE 02
OCEAN PALACE



See map on page 135

STAGE 02 MISSION	A RANKING REQUIREMENTS
Escape from the ancient ruins!	50,000 points

START

① After running through the first loop, switch to Power Formation so you can get the items on both sides of the double loop, and pass through the rainbow hoops after the Jump Plate.



② Break through the door with Knuckles, then destroy the Egg Pawns on the other side. While running down this path, you can break or fly over the stone blocks on the path.



CHECK POINT 1

① Use Triangle Dive above the fan, then get the **Special Key** in the cage. Destroy the stone block just ahead, then bounce off the spring up to the next level.



② The path will branch off, and you will be able to use Speed Formation or Flying Formation.

A Speed Formation

① Run down the path, avoiding the blocks, and destroy the big block at the end. Use Triangle Dive to get back on the main path.



B Flying Formation

① Fly to the top path, then use the Dash Panels to speed up. Be sure to avoid the spiked balls so that you don't lose your Rings.



② Fly up at the end, and pass through the Dash Ring, grabbing the balloon.



Fly up through the Dash Ring to get the balloon.

EXTRA MISSION	A RANKING REQUIREMENTS
Goal Ring in 05:00:00	45,000 points

③ Use Triangle Jump while in Speed Formation to travel along the top of this narrow corridor. When you reach the other side, run off the Jump Plate with Sonic as the leader to pass through the three rainbow hoops. If you fall to the bottom, you can get back up using the fan or continue along the lower level.



④ Use Triangle Dive at this first fan, then hold down the jump button to continue floating all the way to the top of the ledge. This will save you a lot of time when going for the Speed Run.



Hold down the jump button to continue gliding.

⑤ Before running down the ramp past the Speed Formation change gate, run around the



blocks to the left and in the left corner is a **1up**.

⑥ After the stone doors and the Egg Pawns that ensue, run up the double ramp to the right to get the **Invincibility** item or the left to get a **Shield**.



CHECK POINT 2

① Use the cannon to determine your path. All three paths will lead to the Goal Ring.



A Power (Island A)

This Formation shoots you to the left island. After landing on the island, destroy all three of the Egg Pawns to unlock the cannon, then jump inside.

① **Power**
This will shoot you to island E.

② **Flying**
Shoots you straight up into the air so that you can grab a few Rings.

③ **Speed**
This will shoot you to island H.



B Speed (Island B)

This Formation shoots you to the middle island. Kill the three Egg Pawns to unlock the cage containing the cannon. Jump into the cannons in one of three Formations. If you use the Jump Plate, you will be taken to island **D**, which has nothing on it but a return trip.



- 1 Speed
This will shoot you to island **H**.
- 2 Flying
This will shoot you to island **F**.
- 3 Power
This will shoot you to island **E**.

C Flying (Island C)

Destroy the Egg Pawns and then grab the **Yellow Power Core**. After that, fly up to top of the pillar, grab the **Blast Gauge UP** and then ride the Jump Plate to reach island **A**.



Island D: This Island does nothing, and will just take you back to island **B**.

Island E: Kill the enemy with the Shield to unlock the switch, and then touch the switch to



Make sure to pass through the Dash Ring.

activate the fan. Use Triangle Dive to float upward, pass through the top Dash Ring to reach island **H**.

Island F: After killing the Egg Pawns, fly up through the Dash Ring to land on island **G**.

Island G: Get the **Special Key** inside of the cage, and then use the Jump Plate to reach island **I**.

Island H: Defeat all three Egg Pawns, then ride the Jump Plate to reach island **K**.

Island I: Jump into the cannon on this island.

- 1 Speed
This will shoot you to island **H**.
- 2 Flying
Shoot the team straight up to get the Dash Ring leading to the high up balloons and island **K**.
- 3 Power
This will shoot you to island **M**.

Island J: Defeat all of the Egg Pawns on this island to release the spring. Jump on the spring to reach island **L**.

Island K: Kill the two enemies here, then use the Jump Plate to get to the final island on the other side. Make sure to grab **20 Rings** in the metal box before you do so.



Island L: Bounce off the spring to get to the final island. Destroy the two Flappers for extra points.



Island M: You can't get to this island.

2 Destroy all of the enemies on the final island to unlock the springs. If you are in a hurry, fly up to the top and take the Jump Plate leading to the temple.



CHECK POINT 3

1 Destroy the five enemies after jumping up off of the wide springs, then break the stone

block in the corner on the left to get a **Shield**.

2 When the stone weight falls after running up the slope, fly on top of it, then fly up to the upper portion of the temple. Destroy all three enemies to unlock the **Yellow Power Core**, then continue upward. Taking the bottom path with the Power Formation gate will get you to the same spot.





③ Perform a series of Triangle Dives, cross the gap using the Jump Plate, then break through the door.



Follow the series of fans.

④ The narrow corridor will present you with two options.



Why don't we try going up there?



Use Triangle Jump to stay along the top, or drop down to the bottom level.

A Top Path

Grab the **Special Key** in the cage, and then continue on the path to reach the Check Point. The metal crates in the corner contain **20 Rings**.

B Bottom Path

Run along the bottom, then follow the series of fans to the top and the Check Point.

CHECK POINT 4

① Switch to Speed Formation before jumping on the spring. After you pass through the two Dash Rings, run toward the camera to outrun the giant wheels. When you reach the end, touch the Goal Ring.



Outrun the giant wheels by running with Sonic.

BOSS BATTLE:



EGG HAWK

A RANKING REQUIREMENTS

01:00:00

Strategy:

This is got to be one of the easiest Boss fights ever. Just run along the path, collecting Rings until you reach the first beach area (①). The Egg Hawk will land on the beach and begin to spin and fire wildly. Switch to Knuckles and attack continuously to defeat the Egg Hawk (②).

Because of Knuckles's small size, the Egg Hawk will not be able to hit him. If you fail to do this right away and the Egg Hawk becomes airborne again, just run until you reach the second beach and finish him off then. You should get an A Ranking after just a couple of tries (③).



Knuckles is so short that the Egg Hawk will not touch him.





STAGE 03 GRAND METROPOLIS



See map on page 136

STAGE 03 MISSION	A RANKING REQUIREMENTS	EXTRA MISSION	A RANKING REQUIREMENTS
Rescue the city from Eggman!	60,000 points	Goal Ring in 05:00:00	58,000 points

START

① When you reach the row of Flappers lined up, use Homing Attack to bounce from one to the other until you reach the other side. Destroy the Cameron on the next platform to get the path to appear.



② Pull the switch here to open the door and receive Rings and a **Blue Power Core**. To activate this switch, get near it, press the attack button and then use the control stick to push or pull the switch.



Switches like these can open doors on this stage. Follow the series of fans.

CHECK POINT 1

① Run down the ramp and bounce off the two Flappers to get up quickly. If you want to get to the Special Stage, there is a **Special Key** located below. At the top use your Team Blast on the robots for extra points because there is a **Blast Gauge UP** behind the door.



② Fly up through the Dash Ring and then switch to Power Formation to perform a team trick.



③ After jumping the large gap through the window, pull the switch to open the door. Destroy the enemy inside and the other door will open. Get the balloon in there for a **1up**.



④ After using Light Dash on the two rows of Rings, you now have two options. The first is to

use Light Dash at the Rings ahead, or you can use Homing Attack on the Flapper to the left, followed by Light Dash. This will get you a **1up**.



Destroy this Flapper with Homing Attack, and then use Light Dash.

⑤ In the narrow hallway, bounce off of the Flapper using Homing Attack and use Light Dash to get across. Bounce off of the next set of Flappers to get extra points.



⑥ Defeat a series of robots to release switches and unlock doors leading out of the building.



CHECK POINT 2

① Execute Blue Tornado when near the pole.



Poles like these can be used to get up or down.

② Bounce off of the enemies in the hall and do Light Dash, then perform Light Dash at the next set of Rings. At the top of the second set of Rings, turn around and hit the target switch with Thunder Shoot for extra points.



Look for hidden opportunities for extra points.



CHECK POINT 3

① Jump into the cannon.

A Speed

This is the fastest option, and shoots you ahead onto a rail.



B Flying

Flying Formation will put you on top of a building with four balloons. One of the balloons contains a **1up**.



C Power

Shoots you over to the wooden boxes. Shoot through the center box to receive a **1up**.



② Switch rails to grind between the buildings on the right or left side.

③ Destroy the Cameron and the Flappers to lower the path, and then fly over the path behind you to get a **Special Key**.

④ Run directly down the center of the Dash Panels in Speed Formation. Then when you reach the group of Rings at the top of the drawbridge, use Light Dash.

⑤ Switch to Power Formation to get all three boxes of Rings before the final Dash Panel and the Goal. There is a small area below the final Dash Panels which you can drop to, to for extra points.



More Rings can be found between the buildings.



Use Light Dash at the top of the drawbridge.



The Special Key is located at the end of this path.





STAGE 04 POWER PLANT



See map on page 137

STAGE 04 MISSION
Escape from the chaotic plant!

A RANKING REQUIREMENTS
45,000 points

EXTRA MISSION
Goal Ring in 09:00:00

A RANKING REQUIREMENTS
40,000 points

START

① Take out the two Flappers to get the energy path to appear. Do the same in the next room, as well.



② Check the sides of the energy path to get extra Rings. These can be very easy to miss.



CHECK POINT 1

① Above each of the side blocks are Rings that lead up to a balloon containing 5 Rings. Grab onto the Pull Ring to hoist yourself up to the next level.



② Wait until the block rises, and then travel underneath it to the Check Point.



CHECK POINT 2

① From here there are two ways to go. You can either run down the ramp to the right or switch to Flying Formation and grab onto the Pull Ring to hoist yourself up.

A Upward Path

① Fly across the balloons to the other side. Inside every balloon is the wing which will refill your Flying Gauge.



The wing will keep Tails afloat.

② Run on the energy path, and then make a left. Running underneath the rail leads to where the two paths come back together.



B Path to the Right

① Running down the path to the right will land you on a platform with a locked switch and a Flapper. You can go two directions from here. Traveling down the energy path will lead you to where the upper path went. You can bounce off of the enemies using Homing Attack to get up faster.



② Shoot the Flapper down to unlock the switch, and after pressing the switch, use the pole to go up. You will be flung onto a rail which drops down onto the main path.



② Kill all three Flappers to unlock the switch. Touch the switch, and then use the pole to reach the area with a Cameron.



③ Try to stay on the top portion of this area. Jump across the blocks that came out of the wall, then grab the pull switch to go up even higher.



④ Ride the rail, then switch to Sonic. When you see the flying enemy, use Homing Attack to jump off of him, and then land on the other rail.





⑤ Switch to Flying Formation, and then jump over to the newly protruded ledges on the left. On the top of the second one, use Thunder Shoot to hit the target.



⑥ Jump down, and then fly into the opening. Bounce up the wide spring, and then use the Jump Plate to get onto the spinning platform.



⑦ Halfway up, the platform will stop rising. Defeat the three Flappers to get it to move again. If your Thunder Shoot is powered up, it won't take long.



Defeat these three Egg Pawns to get the spinning platform moving again.

⑧ After traveling up the path past the Cameron, jump over the green boxes and get the Special Key out of the cage. Reach the top path using

the nearby Pull Rings or flying up from above the green boxes.



⑨ Watch out for the fireballs when going up the path. If you think you may run into them, then go partway up, and use the Team Blast.



Running into a fireball will cause you to lose Rings.

⑩ Continue upward and avoid fireballs while fighting enemies. When going up the path, take a look at the shadows to determine where the fireballs will be.



The shadows show you where the fireballs are.

CHECK POINT 3

① You only have one chance to stay on the top, so make it count. Use Homing Attack to bounce off of the first two robots, and then land on the new platform that will come out of the wall.



② Bounce off the next three robots, and use Thunder Shoot to destroy the three Flappers. Jump to the next ledge that comes out of the wall.



③ Destroy the Flapper, and then bounce up from the spring onto the rail. Grind down the rail with Tails as the leader; near the end jump up and use Thunder Shoot to kill the Flapper. Land on the platform there and get the

Special Key in the cage. This is a pretty tricky maneuver, so be careful and watch your step!

④ When you reach the rotating platform going up, watch out for the fireballs. Every third of the way up, it will stop and you will have to defeat Flappers.



This time you must dodge fireballs on the way up.



Kill the Flappers here using Thunder Shoot.



⑤ If you have a Team Blast, use it here to defeat the Cameron and the fireballs at the same time.



CHECK POINT 3

① After running across the Dash Panel, you will be in a giant room and lava will begin to rise. Make your way up by jumping through the Dash Rings.

② When you reach the speed signal, use Homing Attack to bounce off of the enemies. After the last enemy you can use Light Dash. If you missed the opportunity, then switch to Tails and fly up.

③ At the second group of enemies, fly up through the Dash Rings. A cage will be above you. Destroy the enemy at the top to get rid of it, and then grab onto the Pull Ring to get to the top.

④ Fly up to the spring, then destroy the two enemies in the next room. Bounce off of that spring to reach the top of the power plant and the Goal Ring.



BOSS BATTLE:



TEAM ROSE

A RANKING REQUIREMENTS

00:30:00

Strategy:

The object of the battle is simple: Knock the other team off of the ledge to win. Start by grabbing the **Blue Power Core** in the center (①) (so Amy can't use it), then when the other team members are near, have Sonic use **Blue Tornado** to fling them into the air (②). While they are grounded, you can collect

more **Power Cores** or steal their Rings (③). If Amy's team doesn't have any Rings, it will be easier to knock them off. Also be sure to look around, because there is nothing more annoying than to get hit from behind. This is a fairly easy battle, and you should be able to get an A Ranking after a couple of tries.



Use **Blue Tornado** to launch Amy's team into the air.



Use **Light Dash** here to reach the top faster.





See map on page 138

STAGE 05 MISSION	A RANKING REQUIREMENTS	EXTRA MISSION	A RANKING REQUIREMENTS
Dash through the giant theme park!	40,000 points	Goal Ring in 05:00:00	45,000

START

① Jump into the cannon to get on the pinball table. Press the jump button to use the flippers or use L and R to control the flippers individually. You can also use the control stick to move your characters on the table. The object is to reach the top of this table where the arrows are pointing.



The arrows point to where you need to go.

② Use Sonic's Homing Attack on the green balls. You'll bounce off of them to the platform on the other side with the switch. Activate the switch, and then use Light Dash up to the Rings. It will just take longer to reach the top if you fall to the bottom.



③ After pulling the switch out and opening the door, grab the **Special Key**, and then use the Fire Dunk with Knuckles to break the glass.



④ This pinball table has slots from which you can win Rings. The big slot can earn you up to 200 Rings. Get a **1up** by going up the ramp on the left middle part of the table. Exit this table by making it to the top.



Going up this ramp will lead to a **1up**.

CHECK POINT 1

① Break the metal crates to get the **Invincibility** item, and then use the springs to bounce up to the higher level of the casino.



② Hit the gong switch at the end of the hallway with Knuckles and you will be launched onto the roulette table. After you circle it, drop down to either the left or to the right.



③ Switch to Flying Formation and fly onto one of the dice above the pinball table. Once on it, fly down to your right so

that you will be closest to the exit which is indicated by an arrow.

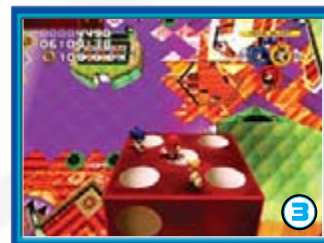

Standing on the dice, you can see the entire board.

④ Destroy the three Camerons, and then switch to Flying Formation. Switches that are high up like this can only be pulled while in Flying Formation. Once the door is open, defeat the robot inside, and then break through the glass.



Pull out the switches while in Flying Formation.

⑤ Kill all of the robots here or just switch to Tails and fly up to the ledge above. Killing all of the robots will open up a door hiding a **Special Key**.



This door opens up after the robots are defeated.



CHECK POINT 2

① Launch out of the cannon onto the giant pinball table. This pinball table has two levels to it. Get to the second level by using the ramp to the right. At the top of the lower level is the exit.



② Fall down at the bottom of this area to reach another side path containing a Casino Manager, Casino Clown, Klagen,

and an opportunity for more Rings. Follow the arrows and use the springs to get to the top.

③ There is a switch on the upper level of the pinball table. Hit this switch to gain access to the VIP room.

CHECK POINT 3

① Bounce up the green bumpers, then run past either the Casino Bunny or the Casino Clown and use the Jump Plate to get across the gap. Kill the monsters to get ranking points. If you hit the switch on the pinball table, you can go up into the VIP room.



The VIP room is only available if you touched the switch on the pinball table.

② Get close to the center of the door, and then with Tails, fly straight up and hit the attack button when you are near the pull switch. It takes getting used to, but with some practice you will be able to do it very quickly.

③ Reach the bottom of this board, and the chute will take you right to the Goal Ring.



Touching this switch will open up the VIP Room.

STAGE 06
BINGO HIGHWAY



See map on page 139

STAGE 06 MISSION	A RANKING REQUIREMENTS	EXTRA MISSION	A RANKING REQUIREMENTS
Blast down the high speed slides!	32,000 points	Goal Ring in 06:00:00	32,000 points

START

① You begin by going down the table. Try to go up the middle ramp to get to another pinball table with slots to increase your Ring count. It's kind of difficult, so most likely you will go to the right or left.



Break through the three barriers to get up the ramp leading to the center path.

② If you did go to the right or left, you will eventually reach a Search Flapper. If its spotlight goes over you, then more enemies will appear. Destroy this guy with Thunder Shoot to open the door.



Destroy this guy before he can see you.

③ Run down the corridor, and then switch to Power Formation and use Triangle Dive above the fan to reach the top area.



Eggman's robots!

④ You will see a new type of robot here. If the Klagen catches one of your characters, you won't be able to use them. Kill this guy using Homing Attack or Thunder Shoot. Grab the **Special Key**, and then use the Fire Dunk to break through the glass.



Don't let this guy capture a team member.

⑤ At the moving dice, use Tails to hit the Check Point. If you fall while over the dice, you will fall onto a pinball table. Roll down the table, but make sure that you don't fall into the hole underneath the "Lost" sign.



CHECK POINT 1

① Hit the target with Knuckles and you will be launched onto the bingo slide, or use the springs to get onto the bingo slide (depending on if you fell or not). There are numbers on the bingo slide, and for every line vertically, horizontally, or diagonally you make, you will receive **20 Rings**. Try to get a perfect card by touching all of the numbers, and get an additional **40 Rings**.



② Destroy all of the enemies using the Team Blast, then fly onto the die and up to the ledge with the Gold Klagen. If it captures you, then you will be taken away for good. The only way to get your team member back if this happens is to use the Team Blast.



③ Destroy the two Flappers, and use the dice get to the Check Point. If you fall, you will land on a pinball table. Fall to the bottom of that table, and you will lose a life. Make it to the top, and there is a **Special Key** waiting for you. You can also reach the **Special Key** by dropping off of the ledge to the side near the Check Point.



Drop down here to get the **Special Key**.

CHECK POINT 2

① Use the spring to get up to the top of the giant slide. After falling down one level on the slide, use the bumpers to bounce you up to get extra Rings.



② Ride the current up, and then destroy the three Casino Managers, and the Klagen to unlock the switch. If you grabbed the balloon, it will be much easier since that is an **Invincibility** item. Touch the switch to open the door. Drop down through the glass to land on the second bingo slide.



③ The second bingo slide is the same as the first except for one small difference. You will see signs that say "Lost." If you fall into one of these, you will fall to your death. When you land on the next pinball area, let your team get to the bottom.



④ At the end of the green blocks that disappear, drop down to land on the ledge below. Underneath the falling weight is a switch. Touch it, then fly on top of it. Fly up from there and pull the switch at the top. This opens a door above.



Use the spring to perform this trick.

② At the top, watch out for the flying enemy with lightning shooting down, and then ride the tunnel to the final but most difficult bingo slide.



③ Stay to the right side on this slide and control your characters carefully to avoid falling off of the board.

④ At the end of the bingo slide is one final pinball table. Hit yourself into the area with the Goal Ring and finish the stage.

⑤ If you bounce up to the top using the green bumpers, you will reach a Check Point. Inside of the room are a lot of Rings and a **Special Key**. From inside the room, hit the gong switch with Knuckles. (If you took the top path)



CHECK POINT 3

① Kill all of the enemies first to make collecting easier, and then break the glass to get the items in the boxes. The switch to make the dice stop spinning is in the upper-left square, and a spring is located in the upper-right square. A cool trick to save loads of time is to switch to Flying Formation, run into the spring, and then touch the green bumper, which will launch you straight up.



BOSS BATTLE:



ROBOT CARNIVAL

A RANKING REQUIREMENTS

Under 02:30:00

Strategy:

This is more of an endurance battle than it is a Boss Battle. Dr. Eggman will send enemies at you in phases and you must survive them all in order to win.

Phases 1 and 2

This just has Flappers. Use Sonic's Homing Attack to kill them all by bouncing off of one to the next. This is fairly simple and you get good practice at using Homing Attack.



Use Homing Attack to take care of the flying robots.

Phase 3

A combination of Casino Managers and Gun Flappers will attack. Use Knuckles to defeat the Casino Managers and then bounce off of the Gun Flappers using Sonic.



Phase 4

This phase has nine Flappers that you can bounce off of using Homing Attack or if you want to be diverse, use the Thunder Shoot.



Thunder Shoot or Homing Attack will do here.

Phase 5

Four Laser Flappers will converge on the center. Destroy them all using Thunder Shoot.



Don't stay in the center.

Phase 6

Casino Managers with shields and Bomb Flappers attack this time. By now you should have the Team Blast ready. Use the Team Blast to get rid of them all quickly. After you use it bounce off of the spring and get the balloon up high in the middle for another **Blast Gauge UP**.



You can fill up your Gauge right away.

Phase 7

A circle of Flappers attacks this time. Use Thunder Shoot or Homing Attack to get rid of them. This should be really easy because by now either Sonic or Tails should be at full level.



Phase 8

Four Klagens will appear, as well as four Camerons. Use Thunder Shoot to get rid of the Klagens, then switch to Power Formation to get rid of the Camerons.



Phase 9

Have Knuckles take care of the Camerons or you can use Homing Attack to bounce from Cameron to Cameron. If you have a Team Blast, save it for one of the later phases.



Phase 10

Flappers will surround you and converge in on you shooting lightning. Have Tails use Thunder Shoot to get rid of them all.



Phase 11

A combination of Solid Flappers, Casino Managers with Shields, and Camerons will attack. Get rid of one of the groups of enemies, and then the next. You can use the Team Blast here, but there is still one more phase to go.



Phase 12

A variety of Casino Managers with shields will attack this time. Use the Team Blast to finish them off. If you don't have a Team Blast, then just wait for the Egg Knight to land and kill it to finish the Stage.



Killing the gold Egg Knight destroys all of these Casino Managers.



STAGE 07 RAIL CANYON



See map on page 140

STAGE 07 MISSION	A RANKING REQUIREMENTS
Head for the terminal station!	35,000 points

EXTRA MISSION	A RANKING REQUIREMENTS
Goal Ring in 05:00:00	35,000 points

START

① Grind the rails and grab any Rings and items along them. This is a good time to practice grinding and switching tracks. To speed up, press the attack button and to switch tracks, hold to the left or right and press the jump button. When you reach the end, bounce up using one of the springs to get to the Check Point. Bounce off of the far left spring to get a 1up.



Don't miss this easy 1up.

CHECK POINT 1

① Grind the blue glowing rails in Power Formation, and when you reach the next platform, destroy the barrels on the left side and get the **Special Key** in the cage behind it. Pull yourself up using the Ring, and then grind into the track switch in the middle to change the path of the glowing rails.



② Switch to Flying Formation and position yourself between the two Jump Plates. Fly up to the top of the tracks, and bounce off of the spring to get a **Yellow Power Core**.



③ Grind on either rail, and after you pass through the Speed Formation change gate and drop down to the next set of rails, jump over to the red rail (the right side) to increase your time. Bounce off of the wide spring at the end to get over the wall.



CHECK POINT 2

① Break through the metal boxes to reach a wooden barrel containing a **Blast Gauge UP** then use the pole to get up to the ledge with the switch.



② Touch the switch to open the door, and then jump onto the next set of rails. While grinding the rails, you will see arrows that point you to the right path. Follow them to avoid hitting the stopped trains.



The arrows will point you to safety.

③ At the bottom, jump off of the track onto the platform before hitting the train, then use Blue Tornado to get up the pole.



④ You can fly over to the next platform with Tails, but it is faster to use Sonic's Light Dash to speed along the trail of Rings because you will be able to get to the top portion of this structure easily.



⑤ Activate all three switches to let down the force field, and then use Fly to fly through the Dash Ring and reach the Check Point.



CHECK POINT 3

① Grind the rails, and then switch to Speed Formation and pass through the three rainbow hoops. To reach the rails from the bottom Check Point, use the wide spring.



② Follow the rails until you reach the next Check Point. After passing a small platform with metal boxes to either side, the rails will go upward. Jump off in between them, and use the Jump Plate to reach a **Blast Gauge UP**.



Jump between here to reach the Blast Gauge UP.



CHECK POINT 4

① Fly up through the Dash Ring, then hit the track switch to make the red-lit tracks appear. Follow the tracks, and after a bunch of switches you will reach a door. When the door opens, jump off of the tracks to avoid hitting the train. You can do steps 2 or 3 of this section to move on.



② Inside of a small hallway on the right is a cage with a **Special Key**. After you have the **Special Key**, break the wooden box on the right, then pull yourself up using the hoop. Destroy the enemy inside to release the spring, and then use the pole to get to the Check Point.



③ Switch to Tails and touch the first switch. Knuckles will stand by the switch. Fly over and touch the second switch with Sonic, and then the third to unlock the case with a spring leading to the Check Point.



CHECK POINT 5

① Use Triangle Dive to get up to the rails above, and then jump up to the switch to change the tracks. If you don't, then you will keep grinding back and forth until you do.



Jump up to the switch to change the tracks.

② Follow the tracks and avoid the stopped trains by following the arrows left and right. When the track reaches an end, hold forward to stay on the top portion. Use the top portion of the track when going for the Extra Mission.



CHECK POINT 6

① Follow the rails to the left or to the right while Tails is the leader. When the track ends and you are sprung forward, fly down onto a platform to get a **Special Key**. Beware of the two enemies guarding it, though. After that, hit the target switch to raise the pole and continue on the path.

② There are many paths along the rails. If you stayed on the high path you will see them all. After numerous switches, you will end up at the terminal station.





STAGE 08 BULLET STATION



See map on page 142

STAGE 08 MISSION	A RANKING REQUIREMENTS
Destroy Eggman's base!	40,000 points

EXTRA MISSION	A RANKING REQUIREMENTS
Goal Ring in 06:00:00	40,000 points

START

① At the end of the initial grind, destroy the enemies. On the thin corridor, Triangle Jump across to the other side.



② Capsules like the three blocking your path can be destroyed by Knuckles. Destroy them to get Rings and other items hidden within.



③ Run along the right side of the Rails and get the **Special Key** located in between the two capsules. At the end, fly to the top of the building, and then use Fire Dunk to break through the grate.



Use Fire Dunk to break through this grate.

CHECK POINT 1

① Break the wooden boxes to get the **Red Power Core**, and then at the engine of the train, break through the **Blue Power Core** using Knuckles.



② Avoid the spiked ball in the path by moving to the right or left, or fly over it to land on the top middle rail. Jump off to the platform when you reach the bottom.



Avoid the spiked ball.

③ Jump into the cannon in Power Formation to shoot out to an area with a **Special Key**. After you return to the platform, jump into the cannon in Speed or Flying Formation to reach the top platform.



④ At the top platform, destroy the two robots to unlock the track switches, and then touch the right track switch. To the right of the switches is a Jump Plate which you can use to get onto the track.



CHECK POINT 2

① If you fall onto this ledge with the three capsules, destroy the last capsule, touch the switch, and then use the spring to get back up.



② Activate these three switches to open the door and then use the Fire Dunk with Knuckles to break through the grate. Try to grab all of the Rings as you fall down.



③ Jump into the cannon in the Flying Formation and you will be shot over to the other side. You will get a **Yellow Power Core** as well.



④ Go to the right until you reach a thin walkway. Walk along the walkway with Sonic, and when you get close to the Rings, press the attack button to perform Light Dash the rest of the way.



Use Light Dash to get across the thin walkway.

⑤ Fly over the fence, and then break the three capsules. Touch the three switches, and the door to the cannon will open up. If you want a few extra Rings, break through the metal boxes.





⑥ Jump into the giant cannon and it will launch you down a long corridor with many items. While you are moving like this, you can control your characters to the left and right. At the end, be careful because the middle rail is a bit higher. Move to the left and right to land on one of those rails.



Grab the balloons by moving to the left and right.



⑦ Grind the rails down to the area with the fans and then use Triangle Dive to get up to the Check Point.



CHECK POINT 3

① Take the Flying Formation path up to the left. On the second platform is a switch that opens the door at the top area. Inside of this room is a **Special Key**. If you are going for the extra Mission, then just use Sonic and Light Dash.



② Use the Pull Ring to get on the roof, and then use the Fire Dunk to break through the grate and land on the deck of a train in a tunnel.



③ Switch to Tails and fly over to the car on the left. On that car, use Blue Tornado at the pole, and you will end up on train number three.



Use Blue Tornado to get onto train number three.

④ Use Triangle Jump to get across the gap, and then destroy the engine core. You will land on a Bobsled.



⑤ Use the Bobsled to reach your destination. Watch out for lasers on the path. You can jump over these by pressing the jump button. Each time the sled is hit, a character will be thrown off. If Sonic is thrown off, speed decreases. If Tails is thrown off, you won't be able to jump. If Knuckles is thrown off, then you lose control.



Jump over the beams when your team members say to.

CHECK POINT 4

① To open the door, hit the three switches in this area. Destroy the robot in this area to unlock the switch.

the ledge above the robot, and switch three is in the cage adjacent to the door. Destroy the robot in this area to unlock the switch.



Switch 1



Switch 2



BOSS BATTLE:  **EGG ALBATROSS**

A RANKING REQUIREMENTS

02:00:00

Strategy:

There are three parts to this Boss. Destroy the bottom of the blimp, the blimp itself, and finally the Egg Hawk. To get an A Ranking you are going to have to work fast. The entire battle can be won using Sonic alone.

path, grind on one of the outside rails to avoid the train (4).

The Egg Hawk

The Egg Hawk is very fast and you will have a hard time catching it. The Egg Hawk will tilt down to the left or to the right. As Sonic, jump and use Homing Attack on the plane's head and continue until the Egg Hawk is finished (5).

Bottom of the Blimp

Begin by running toward Eggman. When you reach the base of the ship, go to his right side between the first gun and the blimp's body. Jump up using Homing Attacks. Aim Homing Attack to the right so it destroys the gun, and then continue to do Homing Attacks on that side of the wing (1). He will eventually go down and you will drop on the path or paths, depending on where you are.

The Blimp

The blimp is the easiest part. Jump into the side of the blimp with Sonic and use Homing Attack (2). Once you connect with it, continue to mash on the jump button for continuous Homing Attacks. If you have done this quickly, then you will drop to one of two paths. When you reach the rails at the end of the right path, grind the middle rail to avoid the train (3); if you are on the left



Right path



Left path



The bottom of the ship is low enough to do Homing Attacks.



Switch 3

2 Use the cannon to shoot yourself out and destroy Eggman's base. Before touching the Goal Ring, grab all of the

Rings around the area and destroy the capsules to get more Rings.



STAGE 09
FROG FOREST



See map on page 144

STAGE 09 MISSION	A RANKING REQUIREMENTS
Get through the forest!	35,000 points

EXTRA MISSION	A RANKING REQUIREMENTS
Goal Ring in 05:00:00	38,000 points

START

① At the end of the vines on the initial grind, jump through the rainbow hoops for extra points and to land on the ledge with the Jump Plates. If you didn't go through the hoops then you can use these plants as springs.



Plants like these can be used as springs.

② After running down the path, you will come across a frog. Frogs cause it to rain, thus making the plants in the area grow. Jump on a newly sprouted plant to bounce you up to the vine, or get to the top and fly through the Dash Rings to go in a different direction.



A Use the Vine

The vine will lead you down to the bottom of the forest. After you jump off and land on the ivy, swing across to the frog on the other side.

B Fly through the Hoops

Going this way will drop you down into hollowed-out tree. While in the air traveling toward the tree, hold forward to get a **Yellow Power Core**. Use the Jump Plate to reach the frog on the other side.



③ Go around to the rear of the tree that the frog is near and break the metal crates to obtain a **1up**.



④ After the frog causes it to rain, jump onto the newly sprouted mushroom to reach the top of the tree. You can get a balloon with **20 Rings** on the way up. Once you are at the top, break through the wooden boxes and get the **Special Key** in the center.



CHECK POINT 1

① Jump across to the frog, and then after it begins to rain, fly over to the plant spring to reach the top of another tree. Get a **Yellow Power Core** before that by jumping up to the left and then hitting the target above the cage with the core.



② Hit the Power Gong with Knuckles. After passing through the Speed Formation, change the gate switch to Power Formation to get everything. The path will lead you to a giant platform that forms as a result of the rain from the frog that you pass along the way.

CHECK POINT 2

① You can go one of two ways from the Check Point.

A Fly up to a platform and to the top of the tree that the Check Point is on. Hit the target switch with Tails and a Ring Path will form. Use Light Dash to get to a bunch of metal boxes. Destroy the boxes to get a **1up** and then fly through the Dash Ring to get to the tree on the other side.



A Top Path

1 Fly up to the plant, and then jump across platforms to the other side. If you go to the very top and hit the targets along the way, you can reach a second frog which will allow you to reach a high platform with a flower.



2 Jump over to the yellow platforms on the left, and then over to the area with the two Egg Pawns with shields. Destroy both robots to get the **Red Power Core**. Hit the gong switch to reach the tree on the other side.



Jump onto this vine to get multiple 1ups.

2 Use the flower, and you will reach a ledge with a frog on it. The newly sprouted plants will bounce you over to ivy, which leads to a Check Point.



CHECK POINT 3

1 Run down the path, and when you see the ramps fork into three, switch to Power Formation. After launching off of the ramp, bounce off of the plants to reach the top area. Destroy the robots up there, and you will release another frog.



2 Use the flower to get into the tree. To use the flower, get near it and use Blue Tornado. You can control up and down while riding the flower. If you are feeling brave, press the attack button to release the flower and land on the vine for two 1ups. It's no risk because you can get a 1up just before this.



You can use the flowers to glide with.

3 At the bottom of the ivy is a **Special Key**. Grab it, and then destroy all of the robots to release the frog. If you destroy the Egg Knight, then all of the other Egg Pawns will be destroyed.



Destroying the gold Egg Pawn will destroy all of the other Egg Pawns.

B Bottom Path

1 Fly across the platforms 'till you reach the area with a Cameron, a Solid Pawn with a shield, and a flower.



2 Use either flower, and you will reach a ledge. Swing across to the other side with three robots. Break through the wooden boxes, and you will get the **Invincibility** item. Fly up to the next ledge with Tails to reach the Check Point.

2 Grind down the vine, but don't go too quickly because the vine is growing as you are grinding down. At the bottom is the Goal Ring.



STAGE 10
LOST JUNGLE



See map on page 146

STAGE 10 MISSION	A RANKING REQUIREMENTS
Venture through deepest jungle!	32,000 points

START

① A new enemy appears. Defeat this Egg Hammer by getting into range so that he swings his hammer. Switch to Flying Formation, and when the robot stops and is staggering, hit him with Thunder Shoot to knock him over. If you get him stuck on the tree, you can have Knuckles destroy him.



② Grind down the vine to get to the other side. The black frogs that you come across will cause it to rain black. The black rain makes the plants wither and die. If you jump off before reaching the end, you can fly across the top portion without the black frog spotting you. This will save you time getting to the Check Point.



③ If you didn't jump off the vine, follow the path around and grab the **Special Key** along the way.

CHECK POINT 1

① After running through the loops, land on the vine and grind on it to avoid the Egg Hammer completely. After you jump off, you will see another black frog. When the plants are destroyed, watch out for the ones falling down the path. If they hit you, you will lose your Rings.



Land on this vine to avoid the Egg Hammer.



Watch out for falling Rings.

② On your way up the platforms, you will see a Needle Flapper. Use Homing Attack only when it's spikes are in.



EXTRA MISSION	A RANKING REQUIREMENTS
Goal Ring in 06:00:00	30,000 points

③ Swing from the vine up to the next ledge, and when you reach the top, use Sonic's Homing Attack on the spring to go up the rest of the way.



CHECK POINT 2

① Swing across the vines and destroy the Egg Hammer. Just after the robot is a frog. Let the Rings up the path. You will land on a vine that grows while you are on it, and then you will run into a black frog. The black frogs here are helpful because when the plants roll down the hill they destroy the enemies.



The plants that roll down the hill here destroy the enemy Egg Pawns.

② Use the flower to get to the path on the other side. A little ways down the path on the left will be a cage with a **Special Key**.



CHECK POINT 3

① Switch to Flying Formation and fly up to the area above the main path to reach a frog. Once it begins to rain, jump on the mushroom to some ivy, and then swing across the ivy to the vine, which you can grind to a loop. If you don't use the shortcut mentioned above, you will have to deal with two Egg Hammers to advance.



You must deal with these two if you don't take the top path.

② Run down the slope with Sonic and through the loop. If you had the frog summon rain earlier, you will begin to grind on a vine, and you will get a **1up**.



③ When you reach the frog, wait for the foliage to grow completely, then use Sonic to bounce off of plants and enemies until he reaches a **sup** in a cage. From here, you can drop the cage with Thunder Shoot, and then drop down to get the **sup**, or continue to fly over to the next platform.



② At the tree, go up to the middle level going to either the right or left. After you destroy the enemy, use the plant spring to get to an even higher level on the tree. Destroy those enemies to unlock the frog and fly to the very top.

② These frogs are lethal, and will try to drag you down into the swamp. When you reach the spring, use Sonic's Homing Attack to bounce to the ivy.



③ Swing across the ivy and outrun the giant alligator that is chasing you. At the end are a number of frogs and the Goal Ring.



Outrun the alligator by swinging from the ivy.



④ If you chose to stay on top, fly through the Dash Ring and you will land on a **Blast Gauge UP**. Ride the ivy and you'll arrive at the Check Point. Because you stayed on top, you have avoided most of the enemies.



③ Hit the gong switch to reach the other ledge, then follow the path to the Check Point. The switch here will create a path of Rings which can be followed using Sonic's Light Dash.

BOSS BATTLE: TEAM DARK

RANKING REQUIREMENTS 00:30:00

Strategy:
Start the battle by having Sonic use Blue Tornado on Team Dark (①). This will knock them down temporarily. Switch to Tails and use Thunder Shoot to collect the **Power Cores** in the balloons on the side of the arena, and then use Thunder Shoot to

keep the Team Dark members down (②). When a member of Team Dark is downed, switch to Knuckles and use Fire Dunk to knock them off of the edge (③). Once all three members of the other team are knocked over the edge, the battle is over.



Blue Tornado will lift Team Dark into the air.



Thunder Shoot can be used to get the items on the side.

CHECK POINT 4

① Ride the flower over to the next part of the jungle. You can get a **Special Key** by dropping off of the flower while inside the tunnel. Use the ivy to get out.

CHECK POINT 5

① Grind down the growing vine, and at the end use the Jump Plate to soar over to a bunch of platforms with black frogs.



Have Knuckles finish them off.

STAGE 11
HANG CASTLE



See map on page 148

STAGE 11 MISSION
Infiltrate the mysterious castle!

A RANKING REQUIREMENTS
45,000 points

START

① Destroy the middle enemy to open the door, then run and touch the orb in the back of the room. You will see a pumpkin ghost. Watch out for these guys throughout the Stage.



② Touching that switch inverted the castle. When you land, change to Tails and fly up to the walkway with the two Search Flappers, then use Light Dash at the row of Rings.



③ Break the wooden boxes in the back to uncover a switch, and then touch the orb to return the castle to normal.



④ Grab the **Special Key** in the cage, and then run down the path in Power Formation to grab the Rings.



CHECK POINT 1

① Break through the wooden boxes to the right to drop down the hole leading to another switch. You can get a **Blue Power Core** in the center of the wooden boxes here.



② After you touch the switch, grind the rail until you hit the spring. You don't need to jump off to the right because this is an inverted loop.



EXTRA MISSION
Goal Ring in 06:00:00

A RANKING REQUIREMENTS
45,000 points

③ After bouncing up using the spring, a couple of Egg Knights will attack and you will see a another type of robot. When it is an Egg Bishop, it can heal the other robots, and when it is an Egg Magician, it steals Rings.



Egg Bishop

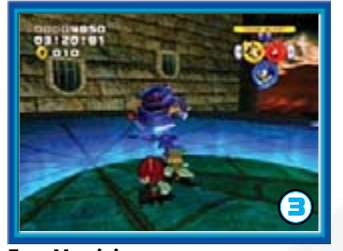

Egg Magician

④ The light spider marking shows you which way to go in this area. Fly up to the next tower, and then run the invisible path between the torches. Destroy the Search Flapper to unlock the switch and finally use Light Dash to get over to the next tower.



Run between the torches to walk on the invisible path.

⑤ Jump onto one of the floating platforms, and at the end drop down into the tower and touch the orb. This will return you back to the Check Point.



⑥ Break through the cracked walls on the side of this room to collect a **Special Key** and **10 Rings**. Hit the gong switch, and your team will be launched up to a balcony.





CHECK POINT 2

① Run along the slope leading downward. At the row of Rings at the bottom, follow them to run along a Dash Panel and land on another orb switch.



② Fly up onto the rising platform to reach the tower with two Flappers. Hit the target switches for more points, and then fly over to the next floating platform.



③ Use your Team Blast on this group of enemies to unlock the orb. In the speed run, it will save you a lot of time.



④ Turn around and touch the switch to make Rings appear in rows. Use Sonic's Light Dash to collect the Rings and earn extra points.

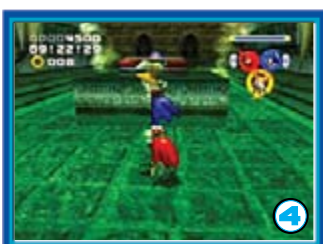

⑤ Walk between the torches and follow the path of flames. Be careful because the path is not straight. You can, however, use Tails to fly over the path in a straight line to save time.



Fly over the balloon and back on the path to save time.

⑥ Fly up above the center of the door with Tails and pull the switch out to open the door. The wall to the right is breakable, and doing so will earn you an additional 5 Rings.



⑦ Destroy the enemies, and then break open the center wall to get a Shield. Finally, fly up and destroy the Egg Magician to get the door open.



CHECK POINT 3

① Destroy all three Flappers to unlock the orb switch. After you touch the switch, you will fall to the bottom of the tower.



② Follow the winding path to the top of the tower, and when you get there, destroy the two Egg Pawns on the catwalk to release the orb. If you wait and fly straight up, a cage being lifted by a propeller will come into view. Shoot it down to get the **Special Key**.



③ Destroy the wooden boxes, and then have Tails pull the switch out. Use Light Dash to follow the path of Rings that appears afterward.



④ Get to the edge and use Thunder Shoot to hit the target switch to unlock the orb. After entering the orb, hit the other target switch to raise the pole.



⑤ Have Sonic use Blue Tornado on the pole and let the game do the rest. On the last pole, make sure you are not touching the control stick otherwise you will fall.



⑥ The door can be opened by defeating the Egg Pawn closest to it. Grind down the rail in the ensuing hallway to reach the final run of the stage.



⑦ Run down the path in Power Formation, and then in Speed Formation. Pass through the rainbow hoops for extra points and touch the balloons for extra Rings. At the end, run down the middle of the Dash Panel and you will touch the Goal Ring.



STAGE 12
MYSTIC MANSION



See map on page 150

STAGE 12 MISSION

Escape from the haunted castle!

A RANKING REQUIREMENTS

36,000 points

START

① Run forward and destroy the Egg Knight to kill the other Egg Pawns, and then hit the target switch. Defeat the Egg Pawn up the stairs, and the door will open up.



② In the large circular room, destroy the metal boxes on the floor and touch the switch. Touch the orb in the front of the room, and four pawns will drop. Destroy them and the door will open.



③ Run down the hall and you will see the **Special Key** in the cage. Don't be deceived because as soon as you step on the shadow, a weight will fall on you. Approach the cage on the side with Knuckles, and get the **Special Key**. When one of your other characters steps on the shadow, the **Special Key** will fall. After it falls, jump on top of it to get to the top.



Watch out when stepping on shadows.



CHECK POINT 1

① Kill all of the enemies to release the laser barrier, and then touch the orb. You can fly over the barrier and touch the orb if you are in a hurry. Once you touch the orb, defeat the giant robot and the two smaller ones.



② Use the pole to get to the bottom. Kill the Egg Magician quickly because he will steal your Rings. After that, jump on the Trolley.

EXTRA MISSION

Goal Ring in 07:00:00

A RANKING REQUIREMENTS

36,000 points



③ The Trolley controls are identical to the Bobsled. Jump over the beams when your teammates say "jump," and on the second part, jump up to get items from the balloon.



CHECK POINT 2

① Behind the crates on the right is a **Special Key**. To open the door, you only need to defeat the lone robot.



② In the room with the giant skeleton and three orbs, hit the right orb, and then fly up the plates to reach the top of the skeleton's head. Touch the orb at the top.



③ Grind along the left path to avoid falling off, and then grab the Pull Ring to go up to the next level of the mansion.



Start from the left to avoid falling off of the edge.

④ Break through two walls to get to a giant room with a fan. If you want to get the **20 Rings**, break the wall on the opposite side of the fan room, hit the switch to open the door at the top of the fan room, and then destroy the Egg Magician to unlock the Rings.





⑤ Triangle Dive up through the open door, grind up the railing to get Rings and jump into the pit. Bounce up to the hallway, then fly up with Tails and pull the switch out to open the door.



⑥ Touch the orb switch, and the statues will come to life. Destroy them and enter the door. Walk down the hallway, and you will end up in another room.



⑦ The Heavy Egg Hammer in this room is wearing a helmet which prevents him from taking damage. Get the robot to swing its hammer, and then knock it down. In the fall, the armor will fall off. Hit the Heavy Egg Hammer in the head with Knuckles to do damage.



You must knock this guy down to get rid of his helmet.

⑧ After touching the orb, drop down the hole between the stairs to move on.



CHECK POINT 3

① Jump on the Trolley. When the enemy Trolley drops onto your track, use the brakes to avoid hitting him.



Remember to use your brakes.

② After landing on the rail and grinding, fly up to the red track to get a **1up**. Stay on the red track to get to another trolley



CHECK POINT 4

① Fly to the top of the ledges, and at the top use Thunder Shoot to knock down the cage with a **Special Key** in it. Finish off the robot to open the door.



② Destroy the robots and touch the orb. Triangle Jump in the narrow corridor and land on the left rail to reach the hall on the other side. Watch the shadow, then after the block falls, jump on top and stay to the side to avoid getting hit by the ghost.



Avoid the ghost by staying to the side.

③ Grab onto the Pull Ring to get to the bottom of the well, and then touch all three switches. Use Light Dash on the Rings to reach the trial area.



④ There are three paths and a locked-up orb. You must conquer each of the paths to unlock the orb and reach the Goal Ring. Each path will require that you use each character.

A Speed

Use Homing Attack to bounce off of the ghosts and reach the main platform.



B Flying

Fly across the floating platforms to reach the main path again.



C Power

If you don't have Team Blast powered up, do so now and then Triangle Dive across the fans. Use the Team Blast to destroy the Egg Hammer and then touch the orb.



**Strategy:**

This time Dr. Eggman will use stronger robots to attack you. Like last time, the object is to survive. After a couple of phases, you will jump into a transporter to get to different areas of the battle.

Phase 1

Flappers will appear in a pyramid formation. Have Sonic use Homing Attack to bounce from one to the next to destroy them all.

**Phase 2**

Switch to Power Formation, and have Knuckles take care of the lance-wielding pawns. Be careful, though, because when Knuckles attacks, he moves forward. You wouldn't want to go over the edge.

**Phase 3**

Nine lance-wielding pawns will appear. Use Knuckles to take care of them. Take out the pawn leader and all of the others will be destroyed instantly. After this phase, touch the orb to move on to the next part of the battle.

BOSS BATTLE:**ROBOT STORM**

04:00:00

A RANKING REQUIREMENTS

Taking care of the Egg Knight will cause all of the other Egg Pawns to blow up.

Phase 4

You will be surrounded by Camerons. Instead of switching to Power Formation and risking getting hit, use the Team Blast to dispatch them all at once.

**Phase 5**

Destroy all of the pawns that drop down using Thunder Shoot or use Knuckles, but be careful because two of the robots are Solid Pawns. Use Sonic to get rid of these guys if Knuckles isn't that strong.

Phase 6

Use Thunder Shoot on the Egg Magicians that surround you to take them out. If you have a low-level Tails, then use Knuckles to get the job done. After they are defeated, jump into the cannon in Power Formation and shoot the balloons to get Rings and a **Shield**. Shoot the cannon using Speed or Flying Formation to get over to the next area.



Get items from the balloons on the outside of the arena.

Phase 7

There are a lot of enemies of different types in this phase, so just use the Team Blast here to get rid of them. If you don't have a Team Blast, then you will have to deal with Flappers, lance pawns, and gun pawns.

**Phase 8**

Three shield pawns with lances and an Egg Hammer will drop down. Have Sonic remove their shields and use Tails to stun the Egg Hammer with Thunder Shoot. By the time you destroy these robots you should have another Team Blast.

**Phase 9**

Use the Team Blast on the three Egg Hammers. If you don't have a Team Blast ready, keep your distance and stun them with Thunder Shoot. Use Knuckles to damage them. After they are taken care of, touch the orb to reach the next section.

Phase 10

You can use Thunder Shoot or Homing Attack to get rid of the rows of flying robots. If you touched the orb in Speed Formation, then you can have Sonic use Homing Attack on the top ship and work your way across, and then down.



Sonic can use Homing Attack to get rid of the flyers.

Phase 11

Take out the two gold capture robots by using Thunder Shoot, then take out the trains that are circling on the outside rail.

Phase 12

Use Knuckles or Tails to get rid of the lance-wielding robots as they drop down. After that, jump into the cannon in Power Formation to get a **Shield** and a **1up**. Jumping into the cannon in Speed or Flying Formation will get you to the final area.

Phase 13

Avoid the possibility of getting hit by using the Team Blast immediately after all of the enemies have landed. If you decide not to, be prepared to take a hit or waste a lot of time. Since that is the last phase, it makes no sense to save the Team Blast.



Use the Team Blast here because this is the final section.



STAGE 13 EGG FLEET



See map on page 151

STAGE 13 MISSION	RANKING REQUIREMENTS
Get to Eggman's flagship!	20,000 points

EXTRA MISSION	RANKING REQUIREMENTS
Goal Ring in 09:00:00	30,000 points

START

① After the initial run, you will land on some energy conduits. Grind down them, taking any path since they will all lead to the deck of the battleship.



② Destroy the two pawns at the end, and the door will open. Run down the path, destroy the robot, and then use the pole to go up.



③ Jump off of the wide spring and turn to the left inside the hallway with the cannon. Jump inside in Speed Formation to shoot to the other side, Power Formation to destroy the robots on the other side, or Flying Formation to end up on the top platform of the hallway leading to an Dash Ring.



Flying Formation will lead up to another platform.

④ If you entered the cannon in Flying Formation, then you will have landed on a pipe to grind on. If not, run around to the left and bounce off of the wide spring to go up to a ledge with another cannon.



⑤ Enter the cannon in Flying Formation to go up to the platform on the left, Power Formation to destroy the cannon and land on that platform, and Speed Formation to bypass the cannon platform and land on an energy conduit.



CHECK POINT 1

① Jump across the floating platforms, and when you reach the third one, have Sonic jump toward the line of Rings and use Light Dash when he is close. This saves time getting to the other side.



Use Light Dash when you get to this group of Rings.

② In the narrow corridor, use Light Dash to get to an energy conduit and ride it to the deck of the ship. At the end of the deck of the ship is an E2000. Jump on it's head to defeat him, and enter through the newly opened door.



③ Use Blue Tornado to pull out the propeller, and then ride it to the deck of another ship. Control the propeller up and down to avoid the cannon fire.



Avoid the cannon fire by moving up and down.

CHECK POINT 2

① Run along the deck of the ship and destroy the cannon at the end. Switch to Tails, fly up to the platform, and then fly to the other side of the ship where it goes up. You will be told to destroy the cannons with Thunder Shoot, but if it is not at least level two, then you will only stop the cannons from firing.



② When you reach the top, you can fly over to the other side either to the left or the right. Watch out for the laser the E2000 will shoot at you. The cannons may also pose a problem here as well, so just use the Team Blast.



③ Use Rocket Accel to run up the Dash Panel and destroy this battleship.





④ Grind down the conduit. Near the end, have Sonic jump through the rainbow hoops. If you don't make it through the hoops then Knuckles will have to Triangle Dive to the other side. Knuckles can also go to the left to land on a platform, which will earn you more Rings before continuing.



⑤ In this area with the giant fan, destroy the laser robot to release the switch, and then touch the switch to turn the fan on. To the right are three cannons. Destroy the center one to get a **Blast Gauge UP**.



The center cannon contains a **Blast Gauge UP**.

⑥ Fly up using Triangle Dive and when you reach the top, continue using the Triangle Dive in the center of the cannons. Land on this spot on the right side to touch a switch, and then fly over and grab the **1up**.



This switch unlocks the **1up**.

⑦ Fly across from the **1up** to get the **Special Key** in the cage and then over to the Check Point.



CHECK POINT 3

① Run across the Dash Panel. At the end of the ship, use Light Dash to get to the other side. From here you can use either path to get to the deck of the next ship.



② Run up the deck of the ship. At the end, grind the conduit to get to the next Check Point.



CHECK POINT 4

① Use the propeller here to fly again. After you go up and you are flying over the deck of the ship, let go and drop down onto it. At the very end is a **1up**. Use the propeller here and you will continue through the skies.



CHECK POINT 5

① Run straight up the middle of the ship. At the end, switch to Knuckles to destroy the cannon and bounce up off the spring underneath. Use the Triangle Dive on the giant fan to get up, and then destroy the robot and the cannons.



② Jump over to the right side, and then jump the gap with Sonic. Use Light Dash to get to the top quickly. If you fall, then you will need to defeat an enemy to get back up.



③ If you really want to get to the Special Stage, there is a **Special Key** at the very bottom. You can get it by waiting for the lasers to disappear.



Grab this **Special Key** if you want to get to the Special Stage.

④ Defeat the E2000 to open the door, and then run past the cannons and past another E2000 to end the level. Use the same technique you did to destroy the other battleship.





STAGE 14 FINAL FORTRESS



See map on page 153

STAGE 14 MISSION	RANKING REQUIREMENTS
Destroy the flagship's core!	62,000 points

EXTRA MISSION	RANKING REQUIREMENTS
Goal Ring in 09:00:00	40,000 points

START

① After grinding down the initial conduit and bouncing off the wide spring, you can use Light Dash to immediately get to the next conduit. If you don't make it, then you need to jump onto the path.



The spring is located underneath this cannon.

CHECK POINT 1

① From here you can see a Flying Formation signal. Jump as far as possible with Tails, and then press and hold the jump button to fly while holding forward. The **Fly Gauge UP** in the balloon will give you enough flying power to land on the collapsible ledge. If you didn't make it, disregard the second instruction.



A Stayed on the Conduit

Destroy the Egg Hammer at the top here to release the switch, and then use Light Dash to get to the platform with the balloon that contains a **1up**. After getting the 1up, jump forward and land on the platform with the Check Point.



② Switch to Sonic and use Triangle Jumps in the thin corridor to get a **Blast Gauge UP** and land on the main path again.



B Stayed on the Path

Fly across the platforms, and when you reach the area with the cannons, destroy the farthest cannon forward on the right side to reveal a spring. Jump on the spring to get up to the Check Point.



③ Destroy the block in your way with Knuckles, and then before riding the Dash Panel, destroy the cannon up on the left to get a **Shield**.



Only get this Shield if you missed the Shield above.

④ Destroy this Egg Hammer, and then touch the switch to raise the pole. Use the pole to get onto the conduit. When you reach the next pole, drop down and grab the **Special Key**.



⑤ After using the final pole to go up, you will land on a conduit. Before grinding the conduit, fly over to the left cannon and destroy it to get a **1up**.



A 1up is located underneath this conduit.

⑥ When you reach the end of this conduit, you can jump across to the pole, and then use Blue Tornado to reach the top. If you don't make it, then you will just have to take the long bottom path.



A Used the Pole

After the poles get you up to the next conduit, jump off and use Triangle Jump to get across to the top section with the giant door and a gold E2000.

① Fly up to the left or to the



B Fell Down

right with the robots, and then up to the next ledge with the shadow. Briefly pass under the shadow to get the block to drop down, and then use the block to rise up to the corridor with the laser robot.



② Destroy the robot, and then break the metal boxes on the floor to drop down to another path. Use the Jump Plates there to propel yourself up the path and bounce off the springs to go up.

③ Destroy the two robots to release the spring in the hole in the floor, and then bounce up from the spring to reach the top section with the door and an Ezooor.



CHECK POINT 2

① Jump onto the self destruction switch and you will be launched onto a set of three energy conduits. After the loop, avoid the laser fire. You will be alerted to it and you will see lightening on the conduits that the lasers will shoot at. Just stay in the middle to avoid the first set.



Watch for the lasers on the conduit.

② At the end of the conduit, you can once again jump with Sonic, then use the Blue Tornado to get up the pole. If you miss, then you will just have to take the long way.



Used the Pole

① When you jump off the pole, push the control stick slightly left to land on the conduit. From that conduit, use the Blue Tornado on the next pole to get to the top of this area.

② Use Triangle Jump to move from wall to wall, and at the end when you see the Rings, use Light Dash to land on another conduit up high and a 1up.



Fell Down

① Destroy the laser robot, and then hit the target switch to activate the fan. Fly up to the next ledge using Triangle Dive. By flying up to the right, you can give yourself a second chance at the 1up.



② Fly across the gap onto the collapsible platforms, and then fly up and grab the Pull Ring to go up.



③ Destroy the robot to release the switch, and then use Blue Tornado to get up the pole. At the top, run forward with Knuckles and destroy the block and the cannon behind it.



④ This platform has a laser robot and six cannons. You must activate three switches here to turn on the fan. The switches are underneath the two farthest cannons on either side and the first cannon on the right. Use the fan to glide up to the next platform.



Switch 1



Switch 2



Switch 3

③ Destroy the two Egg Hammers to release the switch, and then touch it to raise a pole on a ledge higher up. Hit the gong switch to land on a conduit going up to the pole.



④ Ride the conduit down to the platforms. When you see the Flying Formation signal, you can jump up and fly over to another conduit which will earn you a **Yellow Power Core**. Destroy the robots and then use Tails to fly up and pull the switch out that is located on the support behind where the laser robot was.





⑤ Use the fan to go up to the ledge on the left (while facing the switch) with the giant armored robot on it and destroy it to unlock the gong switch. Hit the gong switch to go up to the next ledge.



⑦ When the three robots drop down, use the Team Blast attack to get rid of them instantly and open the door.



⑥ Destroy two Egg Hammers this time, and a target switch will appear afterward. Resist the urge to use the Team Blast attack here because you will need it shortly. Hit the target switch and ride the pole up to the highest platform.

CHECK POINT 3

① Jump onto the detonator switch, and then grind the conduits. Avoid the laser fire by watching the conduits, and jump when you see the rainbow hoops to get extra points.



② Continually move to the left along the sets of three conduits to avoid the laser fire. When the conduit straightens out and you see the giant laser in the background, switch to Tails and fly straight up to avoid the laser. When you jump off the conduit, hold forward, and then jump on the final detonator to finish up the stage.



Fly straight up to avoid the giant laser.

BOSS BATTLE



EGG EMPEROR

A RANKING REQUIREMENTS

03:30:00

Strategy:

Start by running toward Eggman. His giant robot will swing the sword four times. You must dodge a vertical swipe, horizontal swipe, vertical, and then horizontal again. Dodge the horizontal ones by jumping over them (①). For this first part, you must stay close, because if you get too far, then he will charge at you (②). This

is especially lethal if you are in mid-flight above a chasm. At the end of the path is a gong and Dash Panel. Either way will take you to the center platform (③).

The center circle contains four cannons, four pawns with shields, and Eggman. Destroy the four cannons first (④), then the pawns, and then take out Eggman using Thunder Shoot. You won't be able to defeat him the first time, so save your Team Blast. On the second time that you reach here, take out the cannons, and then use the Team Blast to take out the pawns (⑤). This time you should have enough time to take down Eggman.



Stay close, otherwise he will charge at you.



Destroy the four cannons first.



Use the team blast to take out the pawns.



STAGE 01 SEASIDE HILL

See map on page 134



STAGE 01 MISSION	A RANKING REQUIREMENTS	EXTRA MISSION	A RANKING REQUIREMENTS
Get to the whale island!	70,000 points	Defeat 100 enemies!	07:00:00

START

① Hit the attack button with Omega just as you reach the enemy in front of the wide spring to keep up your momentum.



② After using the Jump Plate to traverse the gap, switch to Power Formation so that you can get all of the items in the loop.



③ Have Shadow bounce on the robots using Homing Attack and then get to the upper ledge using him or Rouge.



④ After you grab the **Special Key**, have Omega break the stone block and then run on the Jump Plate to get to the ledge on the other side.

Take the Speed path if you want to finish the stage quickly.



Break this rock to reveal the Jump Plate.

⑤ Kill the three enemies on the ledge, break the metal crate to get **10 Rings** and then fly over to the balloon to get a **Yellow Power Core**.



CHECK POINT 1

① Have Rouge kill all of the Flappers with Thunder Shoot and then run through the Speed Formation change gate at the top of the stones.



② When you run down the hill, hit the attack button as you get close to the second set of Rings and then switch to Omega to

get all three parts of the ramp. After the ramp you will land on a beach area. Have Shadow bounce on their heads using Homing Attack.



③ Jump into the cannon. Depending on your Formation the cannon will fire you in a different direction.



B Flying

This shoots you to the platform on the high right. From there you can use the Jump Plate to get to the second beach area.



C Speed

This Formation gives you a direct shot to the next beach area. This is the fastest option.



④ At the end of the beach area, platforms will rise up as you get close. Use Rouge here to fly to the top of the platforms. At the top is a sled that the team will use to get to the next part. Collect Rings and destroy any enemies in your way.



⑤ Run up the middle of the Dash Panel to pass through all three rainbow hoops and collect extra bonus points.





CHECK POINT 2

- ① Fly around to the ledge on the right and then break the stone block to reveal a spring and an **Invincibility** item.
- ② When you reach the cannon, jump inside.



With this item you can't be killed by getting hit but you can still fall.

A Speed

This shoots straight ahead onto the Jump Plate. Fall on the top balloon to get a **1up**.



Maneuver your character so that you can get a **1up**.

B Flying

Shoots you through the Dash Rings above and keeps you on the top portion of the stage.



Stay on the top part of the stage to increase your time bonus.

C Power

This shoots you onto the Dash Panel, but you can use the other two shots to get **Power Cores**.



Shoot the blocks to get the Power Cores.

- ③ You can get out of the beach area very easily if you ended up there.

A Grab the **Special Key** in the area just below the cannon.



B Fly over the water and land on the platform that rises. From there, fly over to the other side of the beach with the two robots with the shields.



C Destroy these three robots to get the blocks on the left to rise. Use Rouge to get to the top of the cliff using the blocks.



Rouge can easily scale this.

CHECK POINT 3

- ① Switch to Shadow and then run down the path. Stay in the middle and you will pass

through the set of rainbow hoops. After that switch to Rouge and then kill or simply fly up past the enemies. Be careful not to fall when flying from ledge to ledge.



Be careful so that you don't fall.

② After destroying the two stone blocks and killing the three robots behind it, switch to Shadow and accelerate down the path. As Omega, continue running down the hall breaking the blocks and destroying enemies until you reach a small chamber.



③ Use the cannon to get to the top of the vertical tunnel using Shadow or Rouge. If you use Omega, he will shoot straight ahead by default and destroy the block and the robot on top revealing a **Special Key**.



CHECK POINT 4

- ① After the Check Point, take the sled ride and collect as many Rings as possible. Watch out for the spiked ball in the middle of the path.



② When you get off, switch to Omega and use the Jump Plate and fly through the rainbow hoops. Continue using Omega and use the Jump Plate to get through the loops.



③ After bouncing on the wide spring, you will come up to a large group of enemies. Destroy them all using Omega.



④ After running up the giant loop, you will hit a wide spring and then get launched upward. When you come out of the tree stump, use the Team Blast to destroy all of the robots and then touch the Goal Ring.



Use the Team Blast to get a free 2000 points at the end.

STAGE 02
OCEAN PALACE



See map on page 135

STAGE 02 MISSION

Flee from the ancient ruins!

A RANKING REQUIREMENTS

90,000 points

START

① After running through the first loop, switch to Power Formation so that you can get the items on both sides of the double loop and pass through the rainbow hoops after the Jump Plate.



② The path will branch off, and you will be able to take the upper path or the lower path.

A Lower Path

Break the stone block with Omega and run down the path avoiding the blocks. Destroy the big block at the end and then Triangle Dive through the Dash Ring to get back on the main path.



B Upper Path

Bounce up to the top, and then use the Dash Panels to speed up. Kill every single robot up here to increase your score and rank.



More enemies await you if you go this way.

CHECK POINT 1

wide spring.

① Use Triangle Dive above the fan, and then in Flying Formation, bounce off the wide spring and fly up through the Dash Ring.

EXTRA MISSION

Defeat 100 Enemies!

A RANKING REQUIREMENTS

05:00:00

③ Use Triangle Jump while in Speed Formation to travel along the top of this narrow corridor, and pass through the rainbow hoops for a Team Trick and extra bonus points.



CHECK POINT 2

① Bounce off the wide spring in Power Formation and, while in the air, have Omega pass through the three hoops for another Team Trick.



② Before running down the ramp past the Speed Formation change gate, break through the blocks and fly up to get a 1up in the balloon.



③ After the stone doors and the robots that ensue, run up

the double ramp to the right to get the **Invincibility** item or the left to get a **Shield**.



CHECK POINT 3

① Use the cannon to determine your path. All three paths will lead to the Goal Ring.



A Flying (Island A)

This Formation shoots you to the left island. After landing on the island, destroy all three of the robots to unlock the spring, and then bounce off the spring and fly through the Dash Rings to reach island E.





B Power (Island C)

This Formation shoots you to the middle island. Kill the two robots to unlock the cage containing the cannon. Jump into the cannons in one of three Formations.



- 1 **Speed**
This will shoot you to island G.
- 2 **Flying**
This will shoot you to Island F.
- 3 **Power**
This will shoot you to island E.

C Speed (Island C)

After bouncing on the spring, use the Jump Plate to reach island H.

Island D: This island has no purpose.

Island E: Kill the three Egg Pawns on this island to release the spring and then bounce off that spring to reach the Dash Ring which leads to island H.



Island F: Stay in Fly Formation, bounce off the wide spring and then fly through the Dash Rings to reach island K.

Island G: Defeat both robots to release the cannon and then jump inside.

- 1 **Speed**
This will shoot you to island I.
- 2 **Flying**
This will shoot you to island I.
- 3 **Power**
This will shoot you to island H. Aim at the balloons to get an item for every shot.

Island H: Defeat the Egg Pawns and grab the **Special Key**. Use the Jump Plate to get to the last island.

Island I: You can fly up using Rouge to get the items in the balloons.



Island J: Bounce off a spring and onto the top of the stone ruin. From there, fly over to the Dash Ring to reach island L.

Island K: Defeat all of the robots on this island to release the spring. Jump on the spring to reach island L.

Island L: Kill all of the Egg Pawns here and then use the Jump Plate to get over to the final island.

Island M: Bounce off the spring and perform a Team Trick in Flying Formation to reach the final island.

Island N: This island has no purpose.

2 Final island: Destroy the enemies on the lower part of this island in a combo, then Triangle Dive up to the higher level and kill those enemies. This will earn you an additional 4,000 points.



A great opportunity for points.

CHECK POINT 4

1 Destroy the five enemies after jumping up off the wide springs and then break the stone block in the corner on the left to get a **Shield**.

2 After using Triangle Dive to reach the top of the ruins, search behind some stone blocks following the enemies to get a **Special Key**.



Grab a **Special Key** to get to the **Special Stage**.

3 After breaking through the stone door, fly up to the top of the ruins to get Rings and a **1up**. Drop down in Flying Formation at the end and land on the ledge with wide spring.

4 Use the wide spring to bounce up to the top area. If you fell to the bottom, then you will have to use Triangle Dive to get up.

CHECK POINT 5

1 Switch to Speed Formation before jumping on the spring. After you pass through the two Dash Rings, run toward the camera to outrun the giant wheels. When you reach the end, touch the Goal Ring.



Outrun the giant wheels by running with Shadow.

BOSS BATTLE



EGG HAWK

A RANKING REQUIREMENTS

01:00:00

Strategy: Run along the path collecting Rings until you reach the first beach area (1). The Egg Hawk will land on the beach and begin to spin and fire wildly. Switch to Omega and attack continuously to defeat it. Because of Omega's small size, the Egg Hawk will not be able to hit him (2). Be sure to kill the Egg Pawns that drop down here to avoid getting hit from behind (3). If you fail to do this right away and the Egg Hawk becomes airborne again, just run until

you reach the second beach and finish it off then. You should get an A Ranking after just a couple of tries.



Omega is so short that the Egg Hawk will not touch him.



Destroy the Egg Pawns that land on the beach.



See map on page 136

STAGE 03 MISSION

Crush Eggman's city!

RANKING REQUIREMENTS

65,000 points

EXTRA MISSION

Defeat 100 enemies!

RANKING REQUIREMENTS

08:00:00

START

① Bounce off the two Flappers using Homing Attack, and then pass through the hoops and perform a Team Trick. Destroy the Camerons to make the path appear.



② Destroy the three Flappers, and then push the switch in to open the door. Kill the Egg Knight, and the path will appear. To activate the switch, press the attack button to grab on and then use the control stick to push or pull it.



CHECK POINT 1

① Run down the ramp and bounce off the robot and then off the wide spring. If you want to get to the Special Stage, there is a **Special Key** located below. At the top, destroy all of the robots to release the switch. Touch the switch to open the door and get the **20 Rings** inside.



Bounce off of the Flappers using Homing Attack.

② Run up the ramp in Speed Formation, and when you reach the two Flappers, use Homing Attack to bounce off them and then perform a Team Trick.



CHECK POINT 2

① Destroy all of the enemies here to lower the path and release the switch. Touch the switch to open the left door. After killing the Egg Pawns inside, push the switch in to open the right door containing the **High Speed**.



② Use the Light Dash, kill the robots just after the wide spring, and then bounce off of the wide spring and use the Light Dash for more points.



Use the Light Dash to get more points.

③ Bounce off the left robot, and then use the Light Dash to get a **1up** that was locked up.



④ In the narrow hallway past the Cameron, jump through the hoop, and then use a series of Light Dashes. Defeat the Camerons at the bottom to release the switch to open the door.



⑤ After using the Jump Plate to get to the top of the blimp, use the Light Dash on the hoops to get to a **1up** in a balloon. Turn around to get a **Special Key**.





⑥ Use the pole to get to higher or lower places by performing Black Tornado, as shown in the picture below.



The Black Tornado can be performed using poles like this.

⑦ After passing through the Flying Formation change gate, jump up and fly through the Dash Ring. You will want to drop down because there are



Defeat as many enemies as possible for an A Ranking.

three robots to defeat.

⑧ At the first wide spring you can, bounce off of it, and then use the Light Dash. Since this Story is battle-intensive, choose



CHECK POINT 3

to take out the robots instead.

① Jump into the cannon.

A Speed

This is the fastest option and shoots you ahead onto a rail.



B Fly

Flying Formation will put you on top of a building with four balloons. One of the balloons contains a **1up**.



C Power

Shoots you over to center area. Destroy the four enemies to get the items.



② Switch rails to grind between the buildings on the right or left side or switch to Power Formation when you bounce off of the spring to perform a Team Trick.

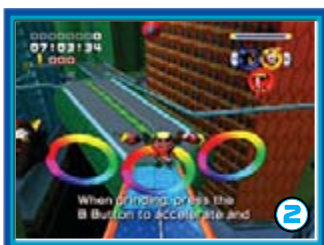

③ Bounce off enemies on the way down to gain extra bonus points. To get an A Rank you will need to use every trick that you know.



④ Defeat the two Flappers to release the switch and raise the pole. After going up the pole, bounce off the wide spring to exit the building.



CHECK POINT 4

① At the end of the long ramp, jump through the hoops to perform a Team Trick and save time. Going to the bottom will get you about the same amount of points.



② Fly through the Dash Ring, and then destroy the Cameron. Watch out for the weights that fall.



③ To get the final **Special Key** (if you don't have one), shoot down the cage with Thunder Shoot, and then drop down to the platform with the Camerons to get it. You can get back up using the wide spring.



④ Run in Power Formation along these three Jump Plates, and jump through the hoops for a Team Trick. Run straight up the center and then jump to perform another Team Trick.



⑤ Run in Power Formation to get all of the Rings before reaching the Goal.



Get the three Item Boxes in Power Formation.

STAGE 04
POWER PLANT

See map on page 137



STAGE 04 MISSION

Escape from the chaotic plant!

RANKING REQUIREMENTS

72,000 points

START

① Destroy the five Flappers or bounce off them using Shadow and use the Light Dash at the Rings. This will earn you a lot of Rings and a big bonus, as well.



Getting these Rings is a really big shortcut and a lot of Rings

② Run down the energy path in Speed Formation, then jump through the hoops for a Team Trick and a chance for a better time bonus at the end.



③ Omega can take care of these three Camerons. After they are destroyed, run up the path.



④ After the room with two Camerons, switch to Rouge and use Thunder Shoot to get rid of the five Flappers and gain another 2,000-point bonus.

Throughout this Stage, you are going to need combos to accumulate enough points for an A Ranking.



CHECK POINT 1

① You now have two paths to take from here. You can take the lower path, which is the fastest path to the end, or you can bounce on the wide spring to get a number of items. Bouncing up to the top will land you on the top of a building with five Camerons. There are four options open to you.



This is the normal path.



This is the extended path.

A If you ran down the path, destroy the four Flappers to release the spring, and then use it to arrive where you end up if you took the E path. You could

EXTRA MISSION

Defeat 100 enemies!

RANKING REQUIREMENTS

07:00:00

also bounce off the Flappers, and then use a Light Dash to reach the top path or run down the path and destroy the six Flappers with Thunder Shoot. We recommend a little of everything since you need all of the points that you can get.



B Turn around and fly over to the top of the overhang with three metal boxes. One of those boxes contains a 1up. On the last acceleration up, land on the building with a floating cage.



C Jump into the cannon in Power Formation and aim at the three balloons. Inside one of them is a Shield.



D Jump into the cannon and bounce through the Dash Rings. Grab the balloons. One of the balloons contains a 1up.



E Jump into the cannon in Speed Formation, and you will land on the top of a building. Grind the rail down to the bottom to continue forward.



② Defeat the three Flappers and the Gold Cameron to release the switch. Gold Camerons are protected, even from Omega's attacks. Flip the Cameron on its back with Black Tornado, then destroy it.



Flip the Gold Camerons over to destroy them easier.

③ Use the pole to go up, and you will flip over three



Camerons. Use Shadow to flip over the gold Cameron, and then finish them all off for a combo bonus.



④ Try to stay on the top portion of this area. Jump on the first ledge, destroy the three robots with Thunder Shoot, and then fly up to the next ledge.



⑤ Use the Light Dash to get to the Ring and jump off the Ring onto the rail. At the end of the rail, jump off and bounce off the Flapper using Homing Attack and then onto another ledge.



⑥ Switch to Flying Formation, and jump over to the newly protruded ledges on the left, and then to the right. On the top of the second one, use Thunder Shoot to hit the target.



⑦ Jump down, and then fly into the opening. Bounce up the wedge spring, and then use the Jump Plate to get onto the spinning platform.



⑧ While on the spinning platform, fly through the Dash Rings to get up quickly. About midway up, destroy the Flappers to keep the platform going. Continue to use the Dash Rings to go up to the top and save time.



⑨ Run down the energy path in Speed Formation and pass through the hoops for a Team Trick. Destroy the three Flappers, and then bounce off the spring and through the Dash Rings to get items and reach the top. You could have also ran forward up the path and gone up past the three gold Camerons.



Beware of fireballs.

⑩ Watch out for the fireballs going up this path. If you hit a fireball, then you will lose your Rings.

CHECK POINT 2

① Run up the path using the Dash Panels, and then use Rouge to defeat the Flappers. After that, switch to Omega and run up the path. Destroy the Camerons and fireballs by jumping up and pressing the attack button.



② Use the Team Blast to take care of the Flappers and the Camerons, and then stand on top of the red switch. When time resumes, you will rise up.



CHECK POINT 3

① Jump into the cannon to advance further from here.

A Jump in using Power Formation to get what's in the balloons in the distance. Use your final shot to pass through the hoops and perform a Team Trick. Travel to the end of the area from the bottom.



B Jump in the cannon in Flying Formation, and then fly to the Dash Ring to stay on top. Destroy the Flapper, and then bounce off the spring. Use flight to stay airborne while floating, collecting the **Fly Gauge UP**, and passing through Dash Rings to reach the end.



C You will be shot at the Flapper up high. After bouncing off of it, use the Light Dash to land on another platform. From there you can use Rouge to fly toward the end as explained in B.





② After running up the Jump Plate onto the floating platform, use Speed or Flying Formations to get to the top very quickly. Fly up through the Dash Rings or use the Light Dash on the path of Rings, and then through the Dash Rings.



The path of Rings leads to the top.

③ Use the Team Blast on the group of robots here, and then use the wide spring to go up. The metal boxes on the right side contain a **Special Key**.



CHECK POINT 4

① After running across the Dash Panel, you will be in a giant room and lava will begin to rise. Make your way up by flying from ledge to ledge.



② When you reach the speed signal, use Homing Attack to bounce off the enemies. After the last enemy, you can use the Light Dash. If you missed the opportunity, then switch to Rouge and fly up.



Fly up if you missed the Light Dash.

③ Fly up through the Dash Rings and when you reach the Pulley, use it to go higher.



④ Switch to Shadow, and when you see the cage above you, bounce off the Flappers to remove it. Switch to Rouge and continue to fly up through the Dash Rings and grab the Pulleys.



⑤ At the top, destroy the three Flappers and use the spring to get to the goal.



BOSS BATTLE:



TEAM CHAOTIX

A RANKING REQUIREMENTS

00:30:00

Strategy:
The object of the battle is to knock the other team off the ledge to win. Start by grabbing the **Blue Power Core** in the center (①) (so Espio can't use it) and when the other team is near, have

Shadow use Black Tornado to fling them into the air (②). While they are grounded, you can collect more **Power Cores** or steal their Rings (③). If Espio's team doesn't have any Rings, then it will be easier to knock them off. Also, be sure to look around because there is nothing more annoying than to get hit from behind. This is a fairly easy battle, and you should be able to get an A Ranking easily after a couple of tries.



Use Black Tornado to launch Espio's team into the air.





STAGE 05 CASINO PARK



See map on page 138

STAGE 05 MISSION	RANKING REQUIREMENTS	EXTRA MISSION	RANKING REQUIREMENTS
Blast through the giant theme park!	50,000 points	Defeat 100 Enemies!	10:00:00

START

① Run up the Dash Panel to get onto the pinball table. The moment you are on the pinball table, you will transform into a ball. When you are off the table, you will transform back. To use the flippers, press the jump button. Make it to the top of this table to continue forward through the level.



④ This pinball table has slots from which you can win Rings. The big slot can earn you up to 200 Rings. You can destroy three roulettes by going up the ramp on the left-middle part of the table. Exit this table by making it to the top. If you fall to the bottom, use the cannon to get back on the table.

② Fly or jump off of the glowing green blocks that form a staircase to another platform. From that platform, use Homing Attack to bounce off of the green bumper, then use the Light Dash to get to the top of the building. If you fall, just take the bottom path.



Going up this ramp will lead to three robots.

CHECK POINT 1

① Hit the Power Gong at the end of the hallway with Omega, and you will be launched onto the Roulette table. After you circle it, drop down to either the left or to the right.



② Have Shadow use Homing Attack off of the bumpers and onto the die. Once on it, fly down to your right, so that you will be closest to the exit, which is indicated by an arrow.



Standing on the dice, you can see the entire board.

③ Destroy the three Camerons, then switch to Flying Formation. Switches that are high up like this can only be pulled while in Flying Formation. Once the door is open, defeat the Klagen inside, then break through the glass.



Pull out the switches while in Flying Formation.

④ Kill the Casino trio and the three Klagen here or just switch to Rouge and fly up to the ledge above. Killing all of the robots will open up a door containing a **Special Key**.



CHECK POINT 2

① Use the Light Dash to follow the line of Rings, then hit the gong to get onto the pinball table.



② Fall down at the bottom of this area to reach another side path containing 3 Klagens. After



Touching this switch will open up the VIP room.

CHECK POINT 2

① Bounce up the green bumpers, and run past the Casino trio, using the Jump Plate to get across the gap. Kill the Casino trio to get ranking points. If you hit the switch on the pinball table, then you can go up into the VIP room.

the floating die, defeat the Casino trio, then use the spring at the top to get back onto the pinball table.

③ There is a switch on the lower level of the pinball table near the exit. Hit this switch to gain access to the VIP room. This is a tough switch to get to, so you may not get it.

③ Break through the glass to

sure to get them. When you fall to the bottom of the table, you will reach the Goal Ring.

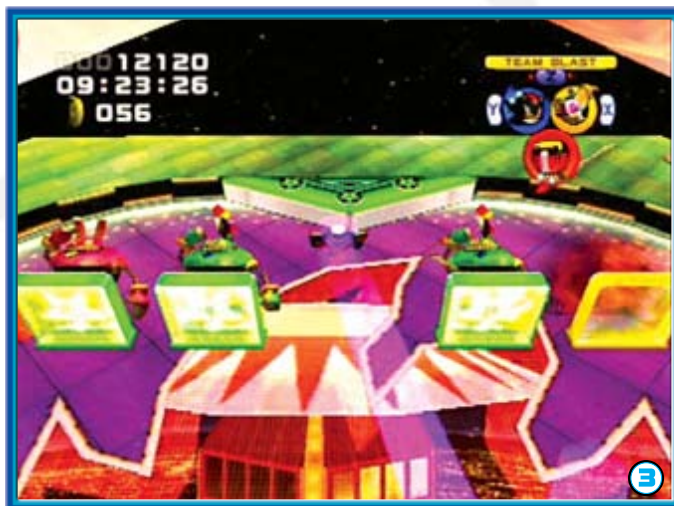



STAGE 06 BINGO HIGHWAY



See map on page 139

STAGE 06 MISSION	RANKING REQUIREMENTS	EXTRA MISSION	RANKING REQUIREMENTS
Try the high-speed slides!	42,000 points	Defeat 100 enemies!	12:00:00

START

① You begin immediately by going down the table. Try to go up the middle ramp to get to another pinball table with slots. Go to the right and you end up on the bottom left. This puts you in a good position at the top.



② Destroy the gold Flappers here, and then use Triangle Dive at the fan. If the spotlight sees you, then new enemies will be summoned. Summon new enemies to increase your kill count quickly in the Extra Mission.



Summon new enemies, and destroy them for extra points.

③ When you come up out of the pipe from Triangle Dive, hold down the jump button to continue floating and grab the Shield inside of the balloon.



④ Destroy the Solid Flappers to release the switch, and then touch it to make a row of Rings appear. Bounce off the bumper and use the Light Dash to follow the path of Rings to the Check Point.



⑤ If you fall down from the Solid Flappers, you will end up on a slide table. Don't fall into the hole where it says "Lost" or you will lose a life. Pull the switch with Rouge, and then fly up from the die and grab onto the Pulley to reach the Check Point.



CHECK POINT 1

① Hit the Power Gong with Omega, and you will be launched onto the bingo slide. Or, use the springs to get onto the bingo slide (depending on if you fell or not). There are numbers on the bingo slide, and for every line vertically, horizontally, or diagonally, you will receive **20 Rings**. Try to get a perfect card by touching all of the numbers and get an additional **40 Rings**.



② When you land on the pinball table, use the flippers to hit you to the top where the arrows are. When you land in the next hallway, jump on the dice to stay above the Gold Klagen and reach the next hallway.



Stay above the Gold Klagen by standing on the dice.

③ Destroy the Flapper, and then fly over the die to the Check Point. If you fall, you will land on a pinball table. Reach the bottom of that table, and you will lose a life. Make it to the top, and there is a **Special Key** waiting for you. You can also reach it by dropping off the ledge to the side near the Check Point.



Drop down here to get the Special Key.

CHECK POINT 2

① Use the spring to get up to the top of the giant slide. After falling down one level on the slide, use the flippers to get extra Rings, destroy Flappers, and get a **up**.



② Ride the current up, then destroy all of the enemies to unlock the switch. If you grab the balloon, it will be much easier since that is an **Invincibility** item. Touch the switch to open the door. Drop down through the glass to land on the second bingo slide.



③ The second bingo slide is the same as the first except for one small difference. You will see signs that say "Lost." If you fall into one of these, you will fall to your death. When you land on the next pinball area, let your team get to the bottom.



④ At the end of the green blocks that disappear, drop down to land on the ledge below. Underneath the falling block is a switch. Touch it, and then fly up to the top using the dice. Behind two of the light pillars are switches that will open the door ahead. Inside the door is a **Special Key** and a whole bunch of Rings. Use the green bumpers to get to the Check Point.



CHECK POINT 3

① Destroy all of the robots to release the spring. Some of the robots are underneath the glass, so you have to break through to get to them. Get into Flying Formation and bounce off of the spring. The green bumpers will bounce you straight up, and then you can fly the rest of the way up.



② At the top, watch out for the flying enemy shooting lightning down. Ride the tunnel to the final, but most difficult, bingo slide.

③ Stay to the right side on this slide and control your characters carefully to avoid falling off of the board. You can get to an additional bingo card by going into the center.



④ At the end of the bingo slide is one final pinball table. Hit yourself into the area with the Goal Ring and finish the Stage.



BOSS BATTLE:

ROBOT CARNIVAL

A RANKING REQUIREMENTS

03:00:00

Strategy:

This is more of an endurance battle than it is a Boss Battle. Dr. Eggman will send enemies at you in phases, and you must survive them all in order to win.

Phase 1

You will be surrounded by a circle of Flappers. Use Shadow's Homing Attack to bounce off of each and every one of them.



Shadow can use Homing Attack to get rid of the Flappers.

Phase 2

Twelve Casino Managers with lances will drop down. Switch to Omega and have him take care of them all.



Phase 3

A combination of Casino Managers and Flappers require you to use Omega to defeat the Casino Managers. Knock down the Flappers using Rouge. Finish them off with Omega when they are downed.



Phase 4

This phase has nine Flappers that you can bounce off of using Homing Attack, or if you want to be diverse, use Thunder Shoot.



Thunder Shoot or Homing Attack will do here.

Phase 5

Eight Flappers with lightning shooting down will converge on the center. Destroy them all using Thunder Shoot.



Don't stay in the center.

Phase 6

Casino Managers with shields and Bomb Flappers attack this time. By now you should have the Team Blast ready. Use the Team Blast to get rid of them all quickly. After you use it, bounce off of the spring and get the balloon up high in the middle for another Blast Gauge UP.



You can fill up your Gauge right away.

Phase 7

A circle of Solid Flappers attacks this time. Use Thunder Shoot or Homing Attack to knock them down, then have Omega finish them. You can also bounce off of the spring and use Fire Dunk from above.



Bounce off the spring to get more height.

Phase 8

Eight Klagens will appear, as well as four Camerons. Use Thunder Shoot to get rid of the robots.



Phase 9

Have Omega take care of the Camerons, or you can use Homing Attack to bounce from Cameron to Cameron. Flip the Gold Cameron over and destroy it last.



Phase 10

Flappers will surround and converge in on you, shooting lightning. Have Rouge use Thunder Shoot to get rid of them all.



Phase 11

A combination of Solid Flappers, Casino Managers with shields, and Camerons will attack. Get rid of one of the groups of enemies and then the next. Use the Team Blast here to get rid of them quickly.



Phase 12

All Egg Knights will appear. Use the Team blast to finish them off. If you don't have a Team Blast, then just have Omega go crazy attacking the robots as they fall.





STAGE 07 RAIL CANYON

See map on page 140



STAGE 07 MISSION	RANKING REQUIREMENTS
Find entrance to Eggman's base!	45,000 points

START

① Grind the rails and grab any Rings and items along them. This is a good time to practice grinding and switching tracks. To speed up, press the attack button. To switch tracks, hold to the left or right and press the jump button. This stretch of track is fairly long, so you will have plenty of time to practice. When you reach the end, bounce up using one of the springs to get to the Check Point. Bounce off the far left spring to get a **1up**.



Don't miss this easy 1up.

CHECK POINT 1

① Grind the blue glowing rails in Power Formation, and when you reach the next platform, destroy the barrels on the left side and get the **Special Key** in the cage to the right. Pull yourself up using the Pulley, and then grind into the track switch in the middle to change the path of the glowing rails.



② Switch to Flying Formation, and position yourself between the two Jump Plates. Fly up to the top of the tracks and bounce off of the spring to get a **Yellow Power Core**.



③ Grind on either rail, and after you pass through the Speed Formation change gate and drop down to the next set of rails, jump over to the red rail (the right side) to increase your time.



④ Jump off of the rails to the right, and use Black Tornado to get up to the roof on the right, and then jump off of the rail platform to reach the Check Point.



EXTRA MISSION	RANKING REQUIREMENTS
Defeat 100 Enemies!	10:30:00

CHECK POINT 2

① Don't be too hasty and jump on the rails right away. After opening the door, turn to the right, and then search the small hallway with a lone wooden box. Inside of that box is a **1up**.



Make sure not to miss this 1up.

② Jump onto the next set of rails. While grinding the rails, you will see arrows that point you to the right path. Follow them to avoid hitting the stopped trains.



The arrows will point to safety.

③ At the bottom, jump off of the track onto the platform, or you'll hit the switch and you will be traveling in circles. Use Black Tornado to get to the top of the pole.



④ Bounce off of the Flappers using Homing Attack, then activate the three switches to remove the laser barrier. You can get to the top by jumping off a barrel and flying to the mid portion of the structure, and then flying up from there. Up on top is a **1up**.



Reach the top of the structure by flying to the side.

CHECK POINT 3

① Grind the rails, and then switch to Speed Formation and pass through the three rainbow hoops. To reach the rails from the bottom Check Point, use the wide spring.



② Follow the rails until you reach the next Check Point. After passing a small platform with metal boxes to either side, the rails will go upward. Jump off in between them and use the Jump Plate to reach a **Blast Gauge UP**.



Jump between here to reach the Blast Gauge UP.

③ Grind the rails down to the bottom. If you are able to stay on the top, you'll skip Check Point 4.

CHECK POINT 4

① When the door opens and you see the train in your way, jump off to the right or the left. In a small hallway on the right is a **Special Key**.



② Destroy all of the Flappers to release the spring on the left, then fly over the left fence and use the spring to go up. Fly over the right fence, and then get a **Shield** in the hall to the right. Use the spring to get over the next fence, and then use the pole to reach the top.



CHECK POINT 5

① Destroy all the robots, and then hit the switch to turn on the fan. Ride the current using Triangle Dive to reach the next set of rails. You must change the tracks here by jumping up and hitting the switch.



Jump up and hit the switch, otherwise you will just grind back and forth.

② Follow the tracks and avoid the stopped trains by following the arrows left and right. When you reach a group of Flappers going up, use Shadow's Homing Attack to bounce up them like a ladder. Fail to do this and you will reach the Check Point.



CHECK POINT 6

① Follow the rails to the left or right while Rouge is the leader, and when the track ends and you are sprung forward, fly down onto a platform to get a **Special Key**. It is locked away, so you must defeat the enemies here first.

② There are many paths along the rails, and if you had stayed on the high path, you would have seen them all. After numerous switches, you will end up at Dr. Eggman's base.



STAGE 08
BULLET STATION



See map on page 142

STAGE 08 MISSION

Annihilate Eggman's base!

RANKING REQUIREMENTS

55,000 points

EXTRA MISSION

Defeat 100 enemies!

RANKING REQUIREMENTS

11:30:00

START

① At the end of the initial grind, walk across the thin walkway and then use the Light Dash to get across the rest of the way. Use the pole to get to the next ledge.



② You can get up using Flying Formation or Power Formation. If you use Power Formation and glide up the current using Triangle Dive, you can get a **Red Power Core**.



③ Grind the rails to the Check Point. In front of the Check Point, break the metal boxes on the floor to get extra Rings.



CHECK POINT 1

① Pull the switch to open the door. Get the **Special Key**, destroy the enemies, and then jump inside the cannonball chamber. The cannon will shoot you down a long corridor. While moving through the corridor you can move to the right and to the left to grab items in the balloons.



Move to the left and to the right to get what's in the balloons.

② After you reach the bottom of the rail, you will land on a platform with three robots and some strange capsules. Destroy the Capsules with Omega and the enemy behind it. Have Shadow Triangle Jump across the wall to the end. You will get a **1up** along the way.



CHECK POINT 2

① Jump on the ramp, then to the top of the building. Use Omega's Fire Dunk to break through the vent. This will drop you onto a transport inside of a tunnel.



② Destroy the capsules on the transport blocking your way and when you reach the engine, use Omega to destroy the core.



③ After you blow out of the transport tunnel, you will land on rails. If you grind down the center rail, watch out for the Rhino that will come toward you. Grind the rails and jump off at the bottom.



Watch out for the trains that come at you.

④ Use the cannon in Speed or Flying Formation to get to the top. Jump into the cannon in Power Formation to get shot over to a platform with a **Special Key** and 4 capsules.



⑤ At the top of the structure destroy the two Egg Pawns with shields and then hit the track switch in the back. Use the Dash Panel to the left to ride the glowing rails and the rails after to the Check Point.



The switch in back is the only one you need to hit.

CHECK POINT 3

① Use the pole at the end of the rails to get to the other side. When you reach the door, destroy the two capsules and pull the switches to open the door. Break through the vent at the end to drop down to another path. As you fall, try to get the balloons. The first one contains a **Shield**.

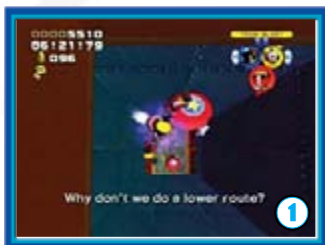

② Destroy the two robots at the top, past the five capsules, to release the switch. After touching the switch, use the Light Dash to get to the other side.



③ After destroying the gold capture robot, use the Light Dash to get across the thin platform. You will come up to a fence. Destroy the capsule on the other side of the fence and then fly over and pull the switch with Rouge to open the door.



④ Destroying all of the robots in the cannon room will lower the laser barriers. Now you can get the **1up** that you saw. After that, hop into the cannon chamber in Flying Formation.

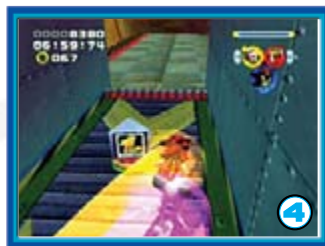

Get the 1up before jumping in the cannon.

⑤ This time when you are shot out of the cannon you must dodge spiked balls. Watch the position of the spiked balls and then move to the left or right to avoid them. When you land on the platform you will be

launched toward some rails. The middle rail is higher up so fly there to save yourself, if you need to.



Avoid the spiked balls by moving to the right or to the left.

⑥ Wait until the block near the Check Point rises and then quickly pull the switch out. That switch will open a door a little later. Make it easy and risk-free by using the Team Blast to stop time when the block is up.



Use Team Blast when the block is up to easily get to the switch.

CHECK POINT 4

① Use the hoops to Light Dash to the top or fly up with Rouge to the top of the building and then break through the vent. If you pulled the switch earlier, the door will be open and you can get a **Special Key**.



② Switch to Rouge and fly over to the car on the left. On that car, use Black Tornado at the pole and you will end up on train number three.



Black Tornado to get onto train number three.

③ Triangle Jump to get across the gap, and then destroy the engine core. It's actually safer to fly to the track in the center and onto the next part of the train. You will land on a Bobsled after being shot out of the tunnel.



④ Use the Bobsled to reach your destination. Watch out for lasers on the path as well as spiked balls. You can jump over the lasers by pressing the jump button and avoid the spikes by moving to the left or right. Each time the sled is hit a character will be thrown off. If Shadow is thrown off, speed decreases; if Rouge is thrown off, you won't be able to jump; if Omega is thrown off you will lose control.



Dodge the spiked balls.



CHECK POINT 5

① To open the door, hit the three switches in this area. switch one is located in front of



Switch 1



2



Switch 2



Switch 3

the door, switch two is on the ledge above the robot, and switch three is behind the unbreakable boxes.

② Use the cannon to shoot yourself out and destroy Eggman's base. Before touching the Goal Ring, grab all of the Rings around the area and destroy the capsules to get more Rings.

BOSS BATTLE:



EGG ALBATROSS

A RANKING REQUIREMENTS

02:00:00

Strategy:

There are three parts to this Boss. Destroy the bottom of the blimp, the blimp itself, and finally the Egg Hawk. To get an A Ranking you are going to have to work fast. The entire battle can be won using Shadow alone.

Bottom of the Blimp

Run toward Eggman. When you reach the base of the ship, go to his right side (between the first gun and the body) and jump up using Homing Attacks. Aim Homing Attack to the right so it destroys the gun and then continue to do Homing Attacks on that side of the wing (①). He will eventually go down and you will drop on the path or paths, depending on where you are.

The Blimp

The blimp is the easiest part. Jump into the side of the blimp with Shadow and use Homing Attack (②). Once you connect with it, mash on the jump button for continuous Homing Attacks to defeat it. Do this quickly to drop one of two paths. On the right path, bounce off of the flying robots and grab the **Power Cores** (③). On the left path, run the Dash Panels and grab the Rings along the way (④).

The Egg Hawk

The Egg Hawk is very fast and you will have a hard time catching it. The Egg Hawk will tilt to the left or the right. As Shadow, jump and use Homing Attack on the head and continue until the Egg Hawk is finished. Use a Team Blast if you have it powered up (⑤).



Right path



Left path



The bottom of the ship is low enough to do Homing Attacks.





STAGE 09 FROG FOREST



See map on page 144

STAGE 09 MISSION	RANKING REQUIREMENTS
Get through the forest!	45,000 points

EXTRA MISSION	RANKING REQUIREMENTS
Defeat 100 Enemies!	14:00:00

START

① At the end of the vines on the initial grind, kill the robots here, and use the circular plant as a spring.



Plants like these can be used as springs.

② After running down the path, you will come across a frog. Frogs cause it to rain, thus making the plants in the area grow. Jump on a newly sprouted plant to bounce you up to the vine. If you go to the top you can get a 1up.



③ At the end of grinding down the vine, go around to the rear of the tree to find a frog. Return to the front of the tree and bounce up using the mushroom.



④ At the top of the tree, break through the wooden boxes on the floor to get a **Special Key**.



CHECK POINT 1

① Fly across the platforms to reach the other side. After the turtle, fly across to another tree and then bounce up to the frog. The frog will make it rain, causing plants to grow ahead. Wait for the plants to grow completely before moving on.



② Fly over to the path on the other side using the newly grown platforms. After taking the gold turtle, run down the path and then switch to Power Formation to get everything. The path will lead you to a giant platform that forms as a result of the rain from the frog that you pass along the way.



③ Fly over to the next tree from the end of the ramp and use the wide spring to get on top. From there, fly over to the Check Point.

CHECK POINT 2

① Get to the platform with the gold turtle and defeat the robots there to release the plant spring. After they are defeated, jump across the yellow platforms to the plant spring and bounce up to the top of the tree.



② Jump over to the tree with metal boxes and break them. Behind the metal boxes is a 1up. Return to the tree that you were on and Light Dash across

the Rings. Fly over to the flower on the top of the tree.



③ Use the flower to get into the tree. To use the flower, get near it and use Black Tornado. You can control up and down while riding the flower. If you are feeling brave, press the attack button to release from the flower and land on the vine for two 1ups.



Drop onto the vine to get two 1ups.



④ At the end of grinding down the vine below the ivy is a **Special Key**. Grab it and then destroy all of the robots to release the frog. If you destroy the gold robot, then all of the other robots will be destroyed.



⑤ You can now take one of two paths to reach the next Check Point.

A Top Path

① Let the frog see you on this bottom area. Near the bottom propeller, bounce off a new plant up to another plant and onto the higher ledge with the flower.



② Use the flower and you will reach a ledge with a frog on it. The newly sprouted plants will bounce you over to ivy which leads to a ledge with robots on it. Destroy the robots and then use the Light Dash to get to the Check Point.



B Bottom Path

① Use either flower and you will reach a ledge. Swing across to the other side with three robots.



② Break through the wooden boxes and you will get the **Shield**. Fly up to the next ledge with Rouge to reach the Check Point.



CHECK POINT 3

① From the top Check Point, run on the Dash Panels in Power Formation. You will get a **Power Core** for each character and perform a Team Trick. Hit the Power Gong from the bottom Check Point to reach the same set of loops.



② At the end of the loop is a giant tree. Go to the back of the tree to get a **Special Key** and then use the plant springs to reach the top.



③ Destroy all of the enemies here to release the frog. After it rains, grind down the vine to the Goal Ring. Be careful not to go too fast because the vine is still growing.



The vine is still growing so don't go too fast.





STAGE 10 LOST JUNGLE



See map on page 146

STAGE 10 MISSION	RANKING REQUIREMENTS
Explore deepest part of the jungle!	40,000 points

EXTRA MISSION	RANKING REQUIREMENTS
Defeat 100 Enemies!	14:00:00

START

① Jump onto the vine and to the platforms with the Flappers. Destroy all of the Flappers and then travel along the platforms. An Egg Hammer will appear. Use Fire Dunk with Omega from on top of the platforms to destroy the Egg Hammers easily.



Staying on the platforms makes it easy to defeat the big robot.

② Grind down the vine and land on the plant rising out of the water. Go up to another with a Shield. When you get back on the main path, another Egg Hammer will block your way. You can run by him or fight. If you choose to fight, then use Thunder Shoot to stun him and Fire Dunk to do damage.

④ When you reach the blocks that will fall, fly on top of them and then up to the top of the ledge. Up on the ledges are a total of 40 Rings.



Watch out for falling plants.

② On your way up the platforms, you will see a Needle Flapper. Use Homing Attack to bounce off of it only when it's spikes are in. Thunder Shoot can knock it down and Omega can destroy it.



Flying is a whole lot easier.

CHECK POINT 2

① Swing across the vines and then destroy the three capture robots to release the green frog on the right. Let the frog see you and then follow the Rings up the path. You will land on a vine that grows while you are on it and then you will run into a black frog. The black frogs here are helpful because when the plants roll down the hill they destroy the enemies.

CHECK POINT 1

① Fly up and grab the Speed UP from the balloon and then run down the path and through the loops. After the jump, land on the vine and grind on it to avoid the two Egg Hammers completely. After you jump off, you will see another black frog. When the plants are destroyed, watch out for the ones falling down the path. If they hit you, you will lose your Rings.



③ When you get up the path a little farther, you will see a green frog. Use the newly grown platforms to fly up to the top of the tree.



The plants that roll down the hill here destroy enemy robots.

② Use the flower to get to the path on the other side. Down the path on the left will be a cage with a Special Key. You can avoid the black frog on the right by hugging the left side of the path.

③ You can go forward but you will run into a black frog which will cause it to rain. The rain from the black frog causes plants to die. Go past the black frog or bounce on the plant and fly over to the red Flapper to avoid it.



Land on this vine to avoid the two Egg Hammers.

④ You can use Homing Attack to travel up these Flappers to the next level, but it is just as easy to fly. Note: it is a lot safer to fly if your homing skills aren't up to par.





CHECK POINT 3

① Switch to Flying Formation and fly up to the area above the main path to reach four Flappers and a **Yellow Power Core**. Return to the path and then jump down to the left or follow it around. Inside of the tree defeat two Egg Hammers to release the plant spring.



② When you reach the frog, wait for the foliage to grow completely and then use Rouge to fly up to the newly grown platforms. At the row of Rings switch to Shadow and use the Light Dash to reach a **Special Key** and a **1up**. Grind the vine from here to reach the Check Point.



CHECK POINT 4

① Ride the flower over to the next part of the jungle. When you land, use the Team Blast to defeat the Egg Hammers and the Flapper behind the laser bars. The destroyed Flapper will cause the laser barrier to go down and grant you access to the tree. The flower will fly you up to step three in this section.



Use the Team Blast to destroy the Flapper behind the bars.

② At the tree, head up to the middle level going to the right or to the left. After you destroy the enemy, use the plant spring to get to an even higher level on the tree. Let the green frog see you and then bounce up to the next part of the tree and land on one of the vines.



Land on the vines for safety.

③ You will approach a locked spring; don't get too close because a Egg Hammers will fall. Destroy it to move on.



④ Hit the Power Gong to reach the other ledge and then follow the path to the Check Point. Don't worry about the black frog because there is also a green frog to return things to normal.



CHECK POINT 5

① The green frog will create a grindable vine but, like the others, don't go too quickly because it's still growing. When that vine ends, leap over the Flapper onto another vine going down to the swamp.



Watch out for this robot at the end of the vine.

② These frogs are lethal and will try to drag you down into the swamp. When you reach the spring, use Shadow's Homing Attack to bounce to the ivy.



③ Swing across the ivy and outrun the giant alligator that is chasing you. At the end are a number of black frogs and the Goal Ring.



Outrun the alligator by swinging from the ivy.

BOSS BATTLE:



TEAM SONIC

RANKING REQUIREMENTS

00:30:00

Strategy: Start the battle by having Shadow use Black Tornado on Team Sonic (①). This will knock them down temporarily. Switch to Rouge and use Thunder Shoot to collect the **Power Cores** in the balloons on the side of the arena. Use Thunder Shoot to keep the Team Dark members down (②). When a member of Team Sonic is downed, switch to Omega or Rouge to knock them off of the edge (③).

Once all three members of the other team are knocked over the edge, the battle is over.



Thunder Shoot can be used to get the items on the side.



Black Tornado will lift Team Dark into the air.



Have Rouge finish them off.



STAGE 11 HANG CASTLE



See map on page 148

STAGE 11 MISSION	RANKING REQUIREMENTS
Enter the spooky castle!	65,000 points

EXTRA MISSION	RANKING REQUIREMENTS
Defeat 100 enemies!	11:00:00

START

① Destroy the enemy near the door to open it, then run and touch the orb in the back of the room. You will see two pumpkin ghosts appear. Watch out for these guys throughout the stage.



④ Grab the **Special Key** in the cage and then run down the path in Power Formation to grab the Rings. This Check Point can be touched now or later.



③ After bouncing up using the spring, destroy the Solid Flappers and turn to the right to continue on. The light spider markings shows you which way to go.



⑥ Only destroy the two yellow robots in this room to kill all of the enemies and release the switch to raise the pole. Break through the cracked walls on the side of this room to collect a **Special Key** and **10 Rings**. Ride the pole to the top.



CHECK POINT 1

② Touching that switch inverted the castle. When you land, jump up the blocks and onto the path. Destroy the Egg Magician to release the switch, but watch out because you have to deal with three robots.



① Drop down the hole and land on a box of Rings. From there drop down to your left and touch the orb. You may want to defeat the enemies here to increase your point total.



④ Fly up to the next tower, destroy the two robots and the Egg Magician, and then run the invisible path between the torches. Destroy the spotlight robots to unlock the switch and use the Light Dash to get over to the next tower.



CHECK POINT 2

① Run along the slope leading downward. Follow the row of Rings at the bottom to run along a Jump Plate and land on another orb switch.



③ Touch the switch and a Ring Path will appear. Use the Light Dash to follow the Rings to the tower. Once inside the tower, destroy the two Egg Pawns to release the orb.



② After you touch the switch, grind the rail until you hit the spring. You don't need to jump off right because this is an inverted loop.



Run between the torches to walk on the invisible path.

⑤ Fly onto the rising platform in the distance and drop into the tower. Destroy the robots to unlock the orb and you'll be returned to the first Check Point.



② Bounce off the Flappers using Homing Attack or slowly fly over to the moving platform. Switch to Power Formation to collect the Rings and then use the Team Blast when the enemies surround you.





③ Touch the orb and then turn around and touch the switch to make Rings appear. Use Shadow's Light Dash to collect the Rings earning extra points and a **1up**.



④ Walk between the torches and follow the path of flames. Be careful because the path is not straight. You can use Rouge to fly over the path in a straight line to save time.

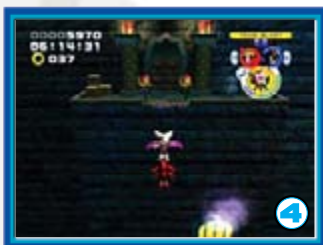

⑤ Break the cracked wall to the right, and inside, pull the switch to open the door.



⑥ Destroy the enemies and then break open the center wall underneath the falling weight to get a **Shield**. Finally, fly up and destroy the Solid Pawn to open the door.



Be careful not to get hit by the falling weight.

CHECK POINT 3

① Destroy all of the robots to unlock the orb switch. You only need to destroy the gold one and the rest will fall. After you touch the switch, you will fall to the bottom of the tower.



② Follow the winding path to the top of the tower. When you get there, destroy all of the robots on the way up to release the orb. At the top on the cat-walk is a **Special Key**.



All of the robots must be destroyed to release the orb.

③ Destroy the two robots to release the switch and touch the switch to make a line of Rings appear. These Rings lead to the entrance of the mansion. You only need to defeat the gold robot to open the door. For more points, let the Search Flappers spot you. When the new enemies appear, use the Team Blast to earn an additional 2,000 points.



Get spotted by the searchlight and then destroy all of the enemies.

④ Get to the edge and use Thunder Shoot to hit the target switch to unlock the orb. After entering the orb, destroy the robots here and then hit the other target switch to raise the pole.



⑤ Have Shadow use Black Tornado on the pole and let the game do the rest. On the last pole, make sure you are not touching the control stick or you will fall.



⑥ Open the door by defeating the gold robot closest to it. Grind down the rail in the ensuing hallway to reach the final run of the stage.



⑦ Run down the path in Power Formation and then in Speed Formation. Pass through the rainbow hoops for a Team Trick and then switch to Speed Formation. There are a total of three Team Trick opportunities. Making them could be the difference between an A Ranking and a B Ranking. At the end of the path you will fly into an orb.



⑧ As you fall straight down, avoid the ghosts and grab the balloons. Switch to Power Formation to touch all three switches and then touch the Goal Ring.



Watch out for the ghosts as you fall.





STAGE 12 MYSTIC MANSION

See map on page 150

STAGE 12 MISSION	RANKING REQUIREMENTS
Escape from the crazy castle!	58,000 points

EXTRA MISSION	RANKING REQUIREMENTS
Defeat 100 enemies!	11:00:00

START

① Run forward, destroy the Egg Hammers, and hit the target switch by going up to the top of the stairs and turning around. The switch opens the door.



② In the large circular room, destroy the metal boxes on the floor to get extra Rings and then touch the switch located behind the door to release the orb. Touch the orb in front of the room and five robots drop. Destroy the Egg Knight near the door and the door will open. You will also receive a 2,000 point bonus.



The switch to release the orb is located behind the door.

③ Run down the hall and you'll see the **Special Key** in the cage. Fly onto the platforms to the right and left, being careful of the robots.



CHECK POINT 1

① Kill all the enemies to release the orb. Use the Team Blast on the five enemies here to get 2,000 points and then charge up the Gauge again. After entering the orb you can use it again for even more points.

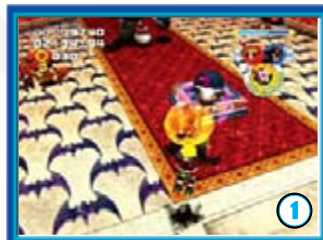

② Jump down in Power Formation and Triangle Dive down to the lower route. Grab the balloon on the way down to receive a **Red Power Core**.



③ The Trolley controls are identical to those of the Bobsled. Jump over the beams when your teammates say jump. On the second part, jump up to get items from the balloon, avoiding ghosts and spiked balls.



Jump over the laser beams in your way.

CHECK POINT 2

① Behind the crates on the right is a **Special Key**. To open the door you only need to defeat the lone robot.



② In the room with the giant skeleton and three orbs, hit the left orb and then fly up the plates to reach the top of the skeleton's head. Touch the orb on the left at the top.



③ Grind along the left path to avoid falling off, then grab the Pulley to go up to the next level of the mansion.



Start from the left to avoid falling off of the edge.

④ Destroy the three robots, then break through two walls to get to a giant room with a fan. Break the wall on the opposite side of the fan room, and hit the switch to open the door at the top of the fan room.

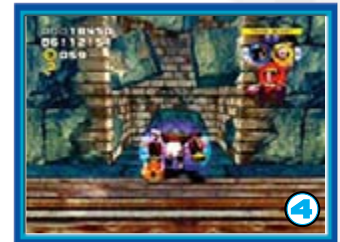

⑤ Triangle Dive up through the open door, grind up the railing to get Rings, jump into the pit and bounce up to the hallway. Destroy the Egg Magician to open the door.





⑥ Touch the orb switch and the statues will come to life. Destroy them and enter the door. Walk down the hallway and destroy the Egg Magician to open up the door to another room.



⑦ The Egg Hammers in this room is wearing a helmet which prevents him from taking damage. Get the robot to swing its hammer, then knock it down. On the knock-down, the armor will fall off. Hit the Egg Hammers in the head with Omega to do damage.



You must knock this guy down to get rid of his helmet.

⑧ There are unlit torches near the door. To light them, use Omega and the doors will open. Touch the orb and the statues and the picture will come to life. Use a Team Blast here to get 2,000 points.



Light the torches using Omega's attack.

CHECK POINT 3

① Fly up and pull the switch above the opening, then use the Light Dash to get to the Trolley. Ride the Trolley and you will be thrown off onto a rail.

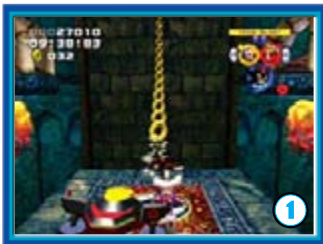

② After landing on the rail and grinding, fly up to the red track to get a 1up. Stay on the red track to get to another Trolley.



CHECK POINT 4

① Fly to the top of the ledges and at the top, use Thunder Shoot to knock down the cage with a Special Key in it. Light the torches here to open the door.



② Destroy the robots and touch the orb. Triangle Jump in the narrow corridor and land on the left rail to reach the hall on the other side. Use the Light Dash after jumping off the grind to get to the top quickly.



③ Destroy all of the enemies here and destroy the block covering the well. Drop down into the well and activate the three switches. The ghosts are annoying here they won't hurt you. Use the Light Dash to reach the trial area.



④ There are three paths and a locked-up orb. You must conquer each of the paths to unlock the orb and reach the Goal Ring. Each path will require that you use each character.

A Speed

Destroy the robot and the Egg Magician here to clear this trial. You can bounce on their heads.



B Fly

Use Thunder Shoot to destroy the Egg Magicians. When they fall, switch to Omega and use Fire Dunk.



C Power

Make sure that you have a Team Blast ready and use it to clear this trial easily. You don't want to get knocked over the edge by the hammer.



Don't give this guy a chance to swing his hammer.



BOSS BATTLE:

ROBOT STORM

A RANKING REQUIREMENTS

06:00:00

Strategy:

This time Dr. Eggman will use stronger robots to attack you. Like last time, the goal is to survive. After a couple of phases, you will jump into a transporter to get to different areas of the battle.

Phase 1

Flappers will appear in a pyramid formation. Have Shadow use Homing Attack to bounce from one to the next to destroy them all.



Phase 2

Four Falcos and an Egg Hammer will appear. Use Thunder Shoot to take out the Falcos and stun the Egg Hammer. Finish off the big robot with Fire Dunk.



Phase 3

Nine Egg Knights will appear. Use Omega to take care of them quickly and then use Thunder Shoot to take down the Egg Magicians on the outside. After this phase, touch the orb to move on to the next part of the battle.



Don't forget to destroy the Egg Magicians on the outside.

Phase 4

You will be surrounded by Gold Camerons. Instead of trying to get rid of them all through normal means and risk getting hit, use the Team Blast to dispatch them all at once.



This many Gold Camerons is a bit much.

Phase 5

Destroy all of the robots that drop down using Omega, but be careful because two of the robots have a shield and guns. Use Shadow to get rid of these guys if Omega isn't that strong.



Phase 6

Use Thunder Shoot to stun the Egg Hammer and the Egg Magicians. Use Omega to finish off the robot after the Egg Magicians are defeated. After they are all defeated jump into the cannon in Power Formation and shoot the balloons to get Rings and a **Shield**. Shoot the cannon using Speed or Flying Formation to get over to the next area.



Get items from the balloons on the outside of the arena.

Phase 7

There are a lot of enemies of different types on this phase so just use the Team Blast here to get rid of them. If you don't have a Team Blast, then you will have to deal with Flappers, lance-wielding Egg Pawns and Solid Pawns.

Phase 8

Four Egg Pawns with shields and an Egg Hammer will drop down. Have Shadow remove their shields and use Rouge to stun the Egg Hammer with Thunder Shoot. The Egg Magicians can heal the enemies here, so either take them out or defeat the enemies on the platform quickly. By the time you destroy these robots you should have another Team Blast.



Phase 9

Use the Team Blast on the three Egg Hammers and the Ring-stealing Egg Magicians. If you don't have a Team Blast ready, keep your distance, stun them with Thunder Shoot and use Knuckles to damage them. Take care of the Egg Magicians or you will find yourself out of Rings. After they are taken care of, touch the orb to reach the next



section.

Phase 10

You can use Thunder Shoot or Homing Attack to get rid of the rows of Flappers. If you touched the orb in Speed Formation, you can have Shadow use Homing Attack on the top ship and work your way across and then down.

Phase 11

Take out the two gold capture robots by using Thunder Shoot. Take out the trains that are circling on the outside rail.



Phase 12

Use Omega or Rouge to get rid of the lance-wielding Egg Pawns as they drop down. After they are defeated, jump into the cannon in Power Formation to get a **Shield** and a **1up**. Jumping into the cannon in Speed or Flying Formation will get you to the final area.

Phase 13

A bunch of enemies drop down. Avoid using the Team Blast because this is not the final phase. Destroy most of the enemies with Omega and stun the Egg Hammer with Thunder Shoot. Take care of the Falcos with Thunder Shoot as well.



Save your Team Blast for the final phase.

Phase 14

Don't mess around at all here. When the three robots fall, use the Team Blast immediately.

STAGE 13
EGG FLEET



See map on page 151

STAGE 13 MISSION

Land on Eggman's flagship!

RANKING REQUIREMENTS

30,000 points

EXTRA MISSION

Defeat 100 enemies!

RANKING REQUIREMENTS

13:30:00

START

① After the initial run, you land on some energy conduits. Grind down them, taking any path since they will all lead to the deck of the battleship. Destroy all of the robots on the deck and the door will open.



② Run down the path, destroy the robot, fly up, hit the target switch, and then ride the pole up to the next platform.



③ Jump off the wide spring and turn to the left inside the hallway. Use the Light Dash on the bottom line of Rings or fly up and Light Dash on the top line of Rings. The top path is much quicker and will help if you are going for a time bonus.



④ If you chose to take the bottom path, run to the left and bounce off the wide spring to go up to a ledge.

⑤ You can go to the left and use the fan to go up, or you can use the Light Dash on the line of Rings. Whichever path you choose will converge at the same spot.



⑥ Grab the **Special Key** in the cage and use the fans to go up. At the top, watch out for the three guns that will shoot at you. Use the Light Dash to get across the gap. If you fall, you can get up using Triangle Dive.



⑦ Grind the conduit after the line of Rings. When you launch off of it, use the Light Dash to stay on the upward path. If you don't make it, don't worry because you can still get to the Check Point by grinding the conduit down here.



CHECK POINT 1

① Run along the deck of the ship, and you will encounter two new robots from the E2000. Stun them with Thunder Shoot and destroy them with Omega or Shadow.



Watch out for the two E2000s.

② Use Black Tornado to pull out the propeller, then ride it to the deck of another ship. Control the propeller up and down to avoid the cannon fire and listen to your team.

① Destroy the cannon at the



Avoid the cannon fire by moving up and down.

CHECK POINT 2

end of the ship's deck. Use the spring underneath it to bounce up, then use the Light Dash to follow the paths of Rings to the top. If you don't use the Rings, you will have to Triangle Dive up to the top.



② When you reach the top, you can fly over to the other side either to the left or the right. Watch out for the E2000 that will shoot at you. The cannons may also pose a problem here, so use the Team Blast if you have one.



③ Use Rocket Accel to run up the Dash Panel and destroy this battleship.



Use Rocket Accel to destroy the battleship.

④ Grind down the conduit and, near the end, have Shadow jump through the rainbow hoops. If you don't make it through the hoops, Omega will have to Triangle Dive to the other side or have Rouge fly through the

Dash Ring on the right and then fly to the center platform. Activate the switch and Light Dash along the line of Rings.



Fly through the Dash Ring with Rouge.



⑤ In this area with the giant fan, destroy the E2000 to release the switch, then touch the switch to turn the fan on. To the right are three cannons. Destroy the center one to get a **Blast Gauge UP**.

from the spring underneath, still in Power Formation.

⑥ Fly up using Triangle Dive. When you reach the top, continue using Triangle Dive in the center of the cannons. When you reach the top area with three guns, destroy the guns on the right or left and then bounce up



⑦ Use Triangle Dive to glide from fan to fan. At the second fan, glide over to the switch on the right, which releases a **1up**. Fly across from the **1up** to get the **Special Key** in the cage, and then over to the Check Point.



CHECK POINT 3

① Run across the Dash Panel. At the end of the ship, use the Light Dash to get to the other side. From here you can use either path to get to the deck of the next ship.



② Run up the deck of the ship. At the end, grind the conduit to get to the next Check Point.



CHECK POINT 4

① Use the propeller here to fly again. After you go up and you are flying over the deck of the ship, let go and drop down onto it. At the very end is a **1up**. Use the propeller here and you will continue through the skies to the final Check Point.



Drop down to the deck of this ship for a **1up**.

CHECK POINT 5

① Run straight up the middle of the ship. At the end, switch to Omega to destroy the cannon and bounce up off the spring underneath. Use Rouge to shoot down the cage with a **Special Key** and get it when it drops down.



② Destroy the enemies down here to release the spring, then bounce from the spring into the Dash Ring. Use Rouge to fly up to the top level of this ship.

③ Jump over to the right side and then fly over the gap using Rouge. If you fall, you will need to defeat enemies to get back up.

④ Defeat the E2000 to open the door and release the Goal Ring.



The Goal Ring is locked in a giant cage.



STAGE 14 FINAL FORTRESS



See map on page 153

STAGE 11 MISSION	A RANKING REQUIREMENTS
Get to the Power Core where Eggman is!	100,000 points

EXTRA MISSION	A RANKING REQUIREMENTS
Defeat 100 enemies!	12:00:00

START

① While grinding down the initial conduit, gain speed with Shadow and switch to Rouge before the end. When you fly off, land on the right or left collapsible ledge. Fly to the high conduit and grind it.



B Bottom Conduit

① Destroy the two robots and the cannon. Drop down to a platform and fly up to the path.



CHECK POINT 1

① From here, you see a Speed Formation signal. When the platform rises to its highest point, use Homing Attack to destroy the robot and make the laser barrier fall, then use Homing Attack to attach to the wall. Triangle Jump to the end. If you fall on the ledges below, quickly get from one to the next because they will fall.



③ Destroy this E2000 to release the switch that raises the pole. Use the pole to get up onto the conduits. On the end pole either drop down to get the **Special Key** or use the pole to reach the next conduit.



Fly from here onto the top conduit.

A Top Conduit

① You'll end up on a ledge with two hammer robots. Drop off the ledge behind you to get a **Blast Gauge UP**. Use the Team Blast to destroy the two giants.



② Use the Dash Panel to get to the end of a set of collapsible platforms. Fly to the floating platforms.



Bounce off of this robot using Homing Attack...



...then Triangle Jump in the narrow corridor.

② Destroy the robots to get the **Red Power Core**, then run down the path. When you reach the two robots, jump up and destroy the barrier blocking your way. Use the Jump Plate to get up to the next section.

④ Use the fan to float up the next conduit. A **1up** is hidden underneath the cannon on the left.



② Touch the switch, then use the Light Dash to reach a ledge with a balloon containing a **1up**. The ledge collapses so quickly jump to get the 1up and land on the platform with the Check Point.

③ When you reach this area with cannons on either side, destroy the farthest cannon forward on the right and use the spring to bounce up to the Check Point.

⑤ When you reach the end of this conduit, jump at the end using Homing Attack to bounce off the wide spring, then bounce off the enemy and land on the platform he was on. From there, jump to the pole and use Black Tornado. If you don't make it, you will have to take the long bottom path.



A Used the Pole (Difficult)

After the poles get you to the next conduit, jump off and use Triangle Jump to get to the top section with the giant door and Heavy-Egg Hammer.



B Fell Down

① Fly up to the left or the right with the guns, then up to the next ledge with the cannon and the robot. After the cannon is destroyed, use the Pulley to go up.

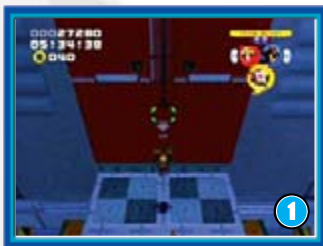

② Destroy the robot, fly up above the block, and pull the switch that removes the laser bars. Drop down the hole, using the Jump Plates to propel yourself up the path and bounce off of the springs behind the cannon to go up.



③ Destroy the E2000 to release the spring in the floor's hole, then bounce up from the spring to reach the top section. Defeat the two robots here to remove the first laser barrier and destroy the large shielded robot and his subordinates to open the door.



CHECK POINT 2

① Jump onto the self-destruction switch and you will be launched onto a set of three energy conduits. Watch out for the E2000 parked on the conduit. Avoid the laser fire after the loop. You will be alerted to it by the lightning on the conduits at which the lasers shoot.

② At the end of the conduit, jump and fly up through the Dash Ring above for a faster path.



Avoid robots on the conduits.

A Took the Top Course

① After passing through the Dash Ring, grab onto one of the Pulleys ahead. Once you are pulled to the top, quickly switch to Shadow when you land on the ledge.



② Use Triangle Jump to move from wall to wall. When you see the Rings at the end, use the Light Dash to land on another conduit and a 1up.



B Took the Bottom Course

① Destroy the Egg Hammers and the two other robots, then hit the target switch to raise the pole. By flying up to the right after the pole, you can give yourself a second chance at the upward path.

② Fly across the gap or Triangle Jump onto the collapsible platform, then fly up to the ledge with the E2000. Destroy it and touch the switch to activate the fan.



③ Use Triangle Dive to reach the top. Destroy the cannon at the end and ride the conduit down to the next section.



④ This platform has a giant shielded robot and six cannons. Destroy the robot, and hit the switch underneath the middle cannon on the left. Use the fan to glide up to the platform with the lone enemy.



③ Use the Dash Panel to get to either path. Destroy the cannon and the enemies so that you don't get hit. Activate three switches, one on each platform. Kill the enemies first before activating the switches. Once all three switches are activated, return to the platform with the fan and Triangle Dive up to the next platform with two robots.



Let the current take you above the platform.

④ Ride the conduit down to the platforms. When you see the platform, fly up to it and get a Shield. Destroy the two E2000s and the smaller robot, then hit the target switch to activate the fan.





⑤ Use the fan to go up to the ledge on the left (while facing the switch) with the giant armored robot on it. Destroy it and its subordinates to unlock the Power Gong. Hit the Power Gong to go up to the next ledge.

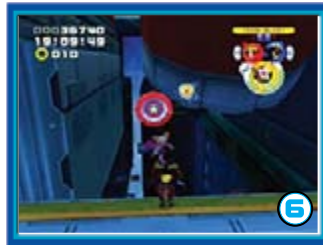

The target switch appears after the enemies are defeated.

⑦ When the three armored robots drop down, use the Team Attack to get rid of them instantly and open the door.



⑥ This ledge has the same enemies it had before. Destroy them and then hit the target switch to raise the pole. Use the pole to reach the highest platform.

CHECK POINT 3

① Jump onto the detonator switch and grind the conduits. Avoid the laser fire by watching the conduits and by jumping when you see the rainbow hoops for a Team Trick. Just before the hoops, enemies await you on the track.

② Continually move to the left along the sets of three conduits to avoid the laser fire. When the conduit straightens out and you

see the giant laser in the background, switch to Rouge and fly straight to avoid the laser. When you jump off the conduit, hold forward and jump on the final detonator to finish up the stage .



Don't press your luck with these.

BOSS BATTLE



EGG EMPEROR

RANKING REQUIREMENTS

03:30:00

Strategy:

Start by running toward Eggman. His Egg Hammers will swing the sword four times. You must dodge a vertical swipe, a horizontal swipe, a vertical, and then a horizontal swipe again. Dodge the horizontal ones by jumping over them.

For this first part, stay close – if you get too far, he will charge you. This is lethal if you are in mid-flight above a chasm.

Watch out when running down the path, because there are a lot of enemies that you encounter that weren't on the other character's Egg Emperor (①).

At the end of the path is a gong and Dash Panel. Either way will take you to the center platform (②).

The center circle contains four cannons, two E-2000s, and Eggman. Destroy the four cannons first, then take out Eggman using Thunder Shoot. Don't worry about destroying the E-2000s, just dodge the laser (③).

Once you get the Team Blast, use it because with it you can take him out on the first try with the time-stopping ability of Team Dark (④). If you don't, circle around and finish him off the second time.



Watch out for Falcos and other enemies.



Destroy the four cannons first.



Use the Team Blast with Team Dark to stop time.

STAGE 01
SEASIDE HILL



See map on page 134

STAGE 01 MISSION

Find 10 hermit crabs!

RANKING REQUIREMENTS

45,000 points

EXTRA MISSION

Find all 20 hermit crabs!

RANKING REQUIREMENTS

35,000 points

START

Hermit Crab #1

① When you see the three rows of Rings side by side, fly over the ledge to reach the first hermit crab. You will also get a **1up**.



Hermit Crab #2

② This one is located on the stone block after the first triple loop.



Hermit Crab #3

③ Break the stone block behind the Egg Pawn and get the crab underneath.



Hermit Crab #4

④ Break the wooden boxes, then use the jump Plate to get to the platform on the other side. Bounce on the wide spring, and up on the cliff is a hermit crab.

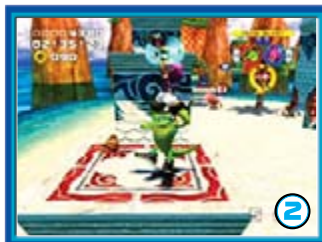

CHECK POINT 1

Hermit Crab #5

① Fly up on top of the left pillar, next to the stone blocking the path after the Egg Pawns.



Hermit Crab #7

③ Break the stone on top of the third right-side pillar and look underneath. You can fly from there to the platform on the right. Bounce off the wide spring to get up to the balloon and a **1up**.



Hermit Crab #9

⑤ Jump into the cannon in Power Formation. After you land, jump down to the wooden box and break it to get the hermit crab underneath.



Hermit Crab #6

② After landing on the beach, check the first pillar on the left.

Hermit Crab #8

④ Jump into the cannon in Flying Formation. Land on the platform with the hermit crab.

Hermit Crab #10

⑥ Stand on top of the incline and push the large stone block near the palm tree with Vector.



Hermit Crab #11

⑦ It is located on the path in front of the three Dash Panels after the beach area.



CHECK POINT 2

Hermit Crab #12

① Fly up to the ledge on the left and break the wooden box at the end.



Hermit Crab #13

② Jump into the cannon and destroy the three stone blocks. Underneath the right one is the hermit crab.



CHECK POINT 3

Hermit Crab #14

① Approach the flower with Charmy as the leader and press the attack button. Jump inside the flower and you will be warped to the matching flower. When you emerge, the crab will be there.



Hermit Crab #15

② Drop down below the Dash Rings. When you reach the stone block, push it with Vector to get the crab underneath.



Hermit Crab #16

③ Push the right stone block on the beach area before the cannon to get another hermit crab.



Hermit Crab #17

④ Follow the path of Rings on the second part of the beach to get another one.



Hermit Crab #18

⑤ On top of the fourth pillar and stone block is another crab.



Hermit Crab #19

⑥ Run up the path near the cannon and then fly up to the upper path. When you reach the large stone block, push it with Vector and get the crab underneath.



CHECK POINT 4

Hermit Crab #20

① Run down the path in Speed Formation and run across the Jump Plate to traverse the gap. Pass through the rainbow hoops for a Team Trick, then get the crab in the center of the path below the Flappers.



② If you failed to find all 20 Hermit Crabs for the Extra Mission, use this flower to return to the beginning of the Stage.





STAGE 02 OCEAN PALACE

See map on page 135



STAGE 01 MISSION	RANKING REQUIREMENTS	EXTRA MISSION	RANKING REQUIREMENTS
Rescue the Chao in the palace!	50,000 points	Rescue Chao and avoid detection!	43,000 points

OVERVIEW

Both the Extra Mission and the regular Mission objective in this Stage require you to rescue Chao. This guide covers the Extra Mission only. Remember, there is no difference between the two, except that in the normal mission, the enemies are able to see you.

START

① After smashing through the first stone door with Vector, use Leaf Swirl with Espio to become invisible. The Leaf Swirl is performed by jumping up and pressing the attack button. While invisible, Espio can throw Shurikens.



While invisible, enemies will not attack you.

② Destroy the first enemy, switch to Vector, smash the block, and turn invisible to finish off two more enemies. After that, smash the block and then fly up through the Dash Ring.



CHECK POINT 1

① Run down the path, avoiding the falling ruins, and turn invisible after the third one falls. Switch to Vector and have him blow a bubble to glide up using the current from the fan.



② After gliding up, land on the edge of the path and turn invisible again. Run past the Egg Pawn and jump onto the stone block. From there, you can hit it with your Shurikens.



Land on this block to hit the Flapper.

③ Grab the **Special Key** in the cage, then smash the block you were on to reveal a spring. Use the spring to bounce upward. After smashing through the door, turn invisible again.



EXTRA MISSION

Rescue Chao and avoid detection!

④ Run past the shielded Egg Pawns and kill the two unshielded ones. You can't smash the block here, but you can use the side railing to go around it. If this is your first time through this level, you can take these guys out easily and take the top path if you want.



This side railing is enough to get by the block.

⑤ Continue running down the path. When the final stone falls after the enemies, get behind it and have Vector glide up to the main path using the fan.



⑥ You can't do anything about that shielded robot while invisible, so just use a Team Blast to take it and the two Flappers out. If you don't have a Team Blast, destroy the Flappers and then get behind the shield Egg Pawn and smash through the stone door.



⑦ Turn invisible again and Triangle Jump to the other side of the hallway. Run directly down the middle of the Jump Plate and you will perform a Team Trick with the maximum number of points.



If you aren't invisible when Triangle Jumping, the enemies will see you.





CHECK POINT 2

① After gliding up the first fan, land on the stones that fall and switch to Espio. Turn invisible and finish off the Flapper from there.



② Have Vector glide up to the next level of the path. When you get up there, turn invisible with Espio and have him run around to the right. Just past the stone blocks is a 1up in the corner.



③ Run down the ramp past the Speed Formation change gate, destroying the weight that falls in front of you. Turn invisible again, run up the stairs, and break through the stone door to reveal a flower.



④ Open up the flower with Charmy, turn invisible, and jump inside. Run past the enemies here and at the end, stand on the railing and defeat one of the robots. In the next section, stand on the railing to take out the Flapper.



⑤ At the top of the series of fans, run to the left and break the weight that falls. Run forward to the ledge and drop down to get a 1up.



Drop down here and grab a 1up.

⑥ Turn invisible and position yourself near all of the enemies by the Chao. Use a Team Blast. Rescue the Chao and the Mission is over.



Use Team Blast at the end to finish up.



BOSS BATTLE:



EGG HAWK

A RANKING REQUIREMENTS

01:00:00



①



②

Perform the aerial attack above him.

Strategy:

This is one of the easiest Boss fights ever. Run along the path collecting Rings until you reach the first beach area. The Egg Hawk will land on the beach and begin to spin and fire wildly. Switch to Vector and fire at him while he is descending (①). When he lands, jump up above him and perform your aerial attack (②). If you fail to defeat him the first time and the Egg Hawk becomes airborne again, run until you reach the second beach and finish him off there. You should get an A Ranking after just a couple of tries (③).



③



STAGE 03

GRAND METROPOLIS



See map on page 136

STAGE 03 MISSION

Clear out the enemies in the city!

RANKING REQUIREMENTS

65,000 points

EXTRA MISSION

Clear out enemies in eight minutes!

RANKING REQUIREMENTS

60,000 points

OVERVIEW

The city has been overrun by Dr. Eggman's robots. It's your job to eradicate them. There are 85 in all, so don't miss one, or you may find yourself searching an entire level not knowing where you missed an enemy.

START

① Run down the energy path and, after bouncing off the wide spring, destroy the four Flappers.



② After the path appears, collect the Rings in Power Formation. Defeat the Egg Pawn between the wooden boxes.



③ Run up the ramp. On top of the wooden boxes, before the wide spring, are two robots.



④ Bounce off the wide spring in Speed Formation. When you are in the air above the Flappers, use Homing Attack to bounce off them, then land on the top of the blimp and take care of the other two Egg Pawns.



Bounce off these Flappers to reach the top of the blimp.

⑤ Switch to Power Formation and glide over to the balloon to grab the Red Power Core. When you land, defeat the Cameron.



⑥ Run down the newly formed path and defeat the two Flappers using Thunder Shoot. Past the Special Key, and defeat the next set of Flappers. Fly through the Dash Ring to reach the Check Point.



CHECK POINT 1

Enemy Count: 18/85

① Run off the Jump Plate to get the balloon up high. Destroy the robots at the bot-



tom. After bouncing up from the Dash Ring, use Team Blast to defeat the six Egg Pawns and the Cameron.

② Push the switch in to open up the door. Once inside, touch the switch to release the cage up ahead. Pull or push a switch near it, then press the attack button to grab on. After that, use the control stick to pull or push it.



③ Run up the ramp and then defeat the four Flappers before using the Jump Plate. After the robots are defeated, switch to Power Formation and run the Jump Plate to pass through the Rings and get a Team Trick bonus.



Run off the ramp in Power Formation for a Team Trick bonus.

CHECK POINT 2

Enemy Count: 31/85

① Defeat the Cameron to drop the path down, push the left switch in to open the left door, and defeat the three Egg Pawns inside. Push the right switch in to open the right door and defeat the Egg Pawn in there.



Don't forget about the Egg Pawns behind the doors.

② Defeat the three Egg Pawns in the area with the wooden boxes on top of the unbreakable boxes.



③ Run forward, defeat three more Egg Pawns and a Cameron, and jump into the cannon in Power Formation to shoot at three Flappers in the distance.



④ Fly across to the other platform by jumping into the cannon in Speed Formation. Defeat the two robots. Use Charmy to open up the flower and use it to warp.



⑤ Run down the hallway and kill the Egg Pawn, then finish off the other two robots. Use the Jump Plate to go up the path.



⑥ Use Homing Attack to bounce off the Flappers in this hallway. At the end drop, down and bounce on the spring to get to the other Egg Pawn in midair.



Use the spring to get the robot up high.

⑦ Turn around to get the **Special Key** and run down the hall. Defeat the Cameron, touch the switch, and the door opens.



⑧ Destroy the Flapper in the next hall and fly up through the Dash Ring. Run down the next

hall and defeat all of the robots in your way.



CHECK POINT 3

Enemy Count: 63/85

① Jump into the cannon in Power Formation and shoot down the three Flappers. Jump into the cannon in Flying Formation for a Team Trick.



Flying Formation will earn you extra points.

② Destroy the Flapper with Thunder Shoot, then drop down to defeat the two other robots. After that, use the leaf swirl with Espio



③ Destroy the Flapper with Thunder Shoot. Fly over the wall. When the two Egg Pawn drop down, destroy them too.



CHECK POINT 4

Enemy Count: 73/85

① You can use Espio to bounce on the Flappers to traverse the gap, or destroy them using Thunder Shoot. Thunder Shoot is safer. After you destroy them, fly through the Dash Ring and destroy the Cameron.



② Bounce over the wall and grind the rail down, finishing off enemies. You should be at 81 after bouncing off the spring at the end.



You should have 81 now.

③ Destroy the two Flappers and touch the switch to raise the pole. Use the pole and defeat the remaining two robots to finish the level.



STAGE 04
POWER PLANT



See map on page 137

STAGE 04 MISSION

Defeat the three Gold Camerons!

RANKING REQUIREMENTS

45,000 points

START

① Destroy the Cameron, grab the **Special Key**, and go up the path.



② Destroy the series of Flappers to go up. At the top a flower is locked away. A switch is on the right side wall. Fly up and touch it to release the flower and then get a **Yellow Power Core** from it.



③ Defeat the five Flappers to raise the platforms. After you are up, defeat two more to raise more platforms to the higher area.



Gold Cameron #1

④ Break the metal box on the right to reveal a switch. Touch the switch to release the Gold Cameron and use Leaf Swirl to flip it over.



Break this metal box to reveal the switch.

Because of the increased defense, Gold Camerons must be flipped over to make it easier to defeat them.



Gold Camerons must be flipped on their backs.

CHECK POINT 1

① Grab the **Shield** underneath the falling weight, jump on top of the weight, and fly up to grab the Pulley.



Gold Cameron #2

② Once you are on top with the Pulley, hit one of the targets to release the Gold Cameron from the cage. Defeat it and drop down to where the Check Point is.

EXTRA MISSION

Defeat the five Gold Camerons!

RANKING REQUIREMENTS

40,000 points



Hit the targets to release the Gold Cameron.

③ Run down the path from the Check Point. When you emerge from the bubble, destroy the Flapper with Thunder Shoot. Touch the newly released switch to raise the pole and ride the pole up to get a **Special Key**.



④ You can grind the rail down from the top to reach the main path. There are no Gold Camerons here, but you can explore the other parts of this section for Rings and Level-Ups.



⑤ Destroy the three Flappers, touch the switch, and ride the pole up. At the top, destroy the Cameron to open up the next area in the tall, thin corridor.



⑥ Jump across the platforms, using the Puller to go up. Jump onto the rail and grind it down. When you see the Flapper, jump up and use Homing Attack to destroy it and bounce to the next rail.

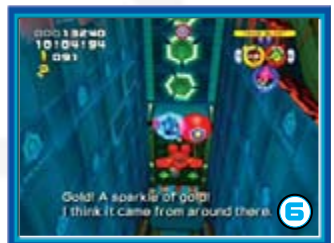

⑦ New platforms will appear. Fly to those and hit the target switch for extra points. Drop down to the bottom level from there and knock the flying cage down with Thunder Shoot. Inside is a switch that will release the Gold Cameron.





The switch is in this cage.

Gold Cameron #3

⑧ Backtrack a bit on the lower level of this hallway to find the Gold Cameron. Destroy it and you have two more to go for the Extra Mission.



This Cameron was released by touching the switch.

⑨ Use the flower to warp and then destroy the enemies here to go on. Ride the energy path to the next Check Point.



CHECK POINT 2

① You will see four flowers. None of them are warp flowers, but they do contain items. Run up the path past the falling weight and destroy the Cameron.



② Find your way to the top and then navigate the path of fireballs and enemies. Watch out for the fireballs — you'll lose Rings if you touch them.



③ After the fireball section, you'll reach another tall corridor. Shoot the Flappers down or bounce on them to make ledges come out of the wall. If your Charmy is a low level you will have to use Espio. Stay along the top portion to get out of this section quickly.



CHECK POINT 3

Gold Cameron #4

① After using the warp flower, you will emerge at the top of a large hole. Drop to the bottom and destroy the enemies to release the switch. Touch the switch and, in Flying Formation, use the Dash Ring to get to the top. At the top the Gold Cameron is released.



Drop down to reach the switch to release the Cameron.

Gold Cameron #5

② Run down the path across the Jump Plate and through the loop. You'll see a wall of fireballs, and behind it is a group of enemies and the final Gold Cameron. Destroy the fireballs with Vector, then deal with the enemies. Use Team Blast if you have one ready.



BOSS BATTLE:



TEAM DARK

A RANKING REQUIREMENTS

00:30:00

Strategy:

The object of the battle is simple: Knock the other team off the ledge to win. Start by grabbing the **Blue Power Core** in the center (so Shadow can't use it) (①), and when the other team is near, have Espio use Leaf Swirl to fling them into the air (②). While they are grounded, you can collect more **Power Cores** or steal their Rings (③). If Shadow's team doesn't have any Rings then it will be easier to knock them off. Also, look around so you don't get hit from behind. If Leaf Swirl doesn't work, switch to Charmy and shoot them off the edge. This is a fairly easy battle and you should be able to get an A Ranking easily on it after a couple of tries (or even on the first try).



Use the Leaf Swirl to launch Espio's team into the air.



STAGE 05 CASINO PARK

See map on page 138



STAGE 05 MISSION	A RANKING REQUIREMENTS	EXTRA MISSION	A RANKING REQUIREMENTS
Win 200 Rings!	32,000 points	Win 500 Rings!	14,000 points

OVERVIEW

The object of this stage is to collect Rings. You still need a certain amount of points, but you earn most of the points from the time bonus at the end. This level has slots which you can use to win up to 200 Rings. Use these to get your Ring total up, as well as using Team Attack.

START

① Run forward in Power Formation to collect Rings and then use the dice to get up to the ledge with the Casino Clown. Hit all three stars on the wide spring to get an extra **10 Rings**, then bounce up to the cannon.



② Use the cannon to get onto the pinball table. Use the flippers by pressing the jump button and control your characters a bit with the control stick.



③ You can win up to **200 Rings** on the slot, or 600 if you raise the bet by

having multiple characters in the slot. You can leave this pinball table by making it to the top.



Win Rings by using the slots.

CHECK POINT 1

① Break the metal box behind the Check Point and use the switch to open the door ahead. Inside are a total of **20 Rings**.



② Bounce up using the springs. At the top, grab the **Special Key** and then hit the gong behind the Cameron to land on the roulette wheel. After you enter the chute, fall to the left to get **5 Rings**, landing closer to the top of the pinball table, where the exit is.



③ Jump on one of the die to observe the giant pinball table. At the top-right side is the exit, and

on the left are slots from which you can win Rings. Fall to the bottom and you will have to use the cannon to get back up.



④ After leaving this pinball table, you'll come across two Camerons. Use Team Blast here to get more Rings, pull the switch on the left to open the door, and break the glass to drop down to the Check Point.



CHECK POINT 2

① Destroy all of Casino Trio robots on this level to open the door behind the Check Point. Inside the door is a **Special Key**. Use the Pulley to go up and hit the gong to get to the cannon leading to another pinball table.



② This pinball table gives you another chance to earn Rings. Use the ramp to get to the board's upper level. Use this to collect more Rings, or exit from the top part of the bottom portion.



③ At the laser barrier, turn Espio invisible and pass through. Go up the ramp into the VIP room to use the warp flower at the top.

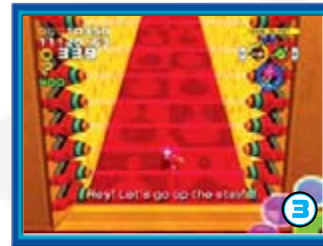

Espio can pass through lasers when invisible.

④ The warp flower will take you to a special VIP pinball table which has many slots for you to try and win Rings. If you fall to the bottom of the table, you will land on another pinball table. Fall to the bottom of it and you can use the flower to go back to the start.



The VIP table has many chances to win Rings.

STAGE 06 BINGO HIGHWAY



See map on page 139

STAGE 05 MISSION

Collect 10 casino chips!

A RANKING REQUIREMENTS

32,000 points

EXTRA MISSION

Collect all 20 casino chips!

A RANKING REQUIREMENTS

20,000 points

START

Casino Chip #1

① The first one is located right in front of you when you start.

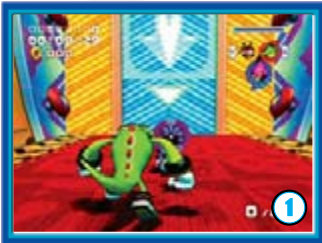

Casino Chip #2

② After riding the current of the fan, destroy 2 Klagen and a Casino Clown to release the casino chip.



CHECK POINT 1

Casino Chip #3

① When you see the spinning dice, fall onto the table. When you roll down the table, look for the chip in front of the "Lost" sign. There are barriers that will prevent you from falling, but they only take three hits so make sure to get the chip on your first try.



You will also see an arrow pointing down to the chip.

Casino Chip #4

② On the first bingo slide, fly off the ramp to get to number seven. The chip is right in front of it.



Casino Chip #5

③ This chip is at the start of the middle path leading to number nine.



If you missed chips four or five, you can use the flower after the bingo slide to warp you back to the start of the slide. This is an easy way to practice the slide and get a PERFECT.

Casino Chip #6

④ Bounce up from the highest green bumper in the center to get the chip.



Casino Chip #7

⑤ Jump across the dice and get the chip on the second die.



Casino Chip #8

⑥ Drop down from chip number seven to land on a pinball table. If you fall to the bottom you will lose a life. The chip is located near the top in a row on the left side.



CHECK POINT 2

Casino Chip #9

① After you drop off the first part of the slide, use the flippers to get the chip.



Use the flippers to get the chip.





Casino Chip #10

② After bouncing up from the slide, grab the chip from between the two dice.

Casino Chip #11

③ After rising from the fan, land on the green platforms that disappear after three hits. Bounce from platform to platform and at the end, get the chip.



Bounce across the green platforms to get the chip.



Casino Chip #12

④ After breaking the glass, drop down directly in the center. You may miss this one but there is a way to get back here later.



Break the glass, then float down using Vector to get it.

Casino Chip #13

⑤ Get this chip on the second bingo slide after the first "Lost" sign between numbers two and three.

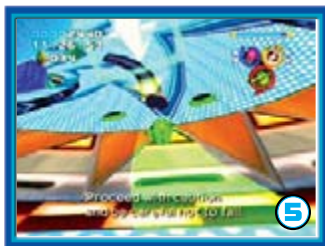

Casino Chip #14

⑥ Stay on the top of the slide on the thin path going toward number five. The chip is in the middle.



Casino Chip #15

⑦ After number six on the bingo slide, head straight for the arrow and you will get the chip.



Casino Chip #16

⑧ After the second bingo slide, you will land on a pinball table. Hit yourself to the top of the bingo table to get the chip, which is below the big slot in the middle.



Casino Chip #17

⑨ When you fall off the pinball table, you will land on a bunch of springs. Use the springs to bounce up to the chip. Drop down to a ledge below and you will be able to get a **Special Key** and use the flower to return to the slide before chip number nine. You get a lot of chances. (Probably because you wouldn't want to miss one chip and have to complete the entire Stage again.)



Casino Chip #18

⑩ Bounce up the green bumpers and in front of the flower in the center of the circle of Rings is the chip.



Casino Chip #19

⑪ On the sides of the room where you got chip # eighteen are two switches behind light pillars on either side. Activate the switches to open the door below. Drop down, turn invisible and then have Espio enter the vault and get the chip. Return to the flower.



Activate the switches up here to release the switch.

Casino Chip #20

⑫ Jump into the flower to land on a pinball table. The chip is on the upper-right half of the board just below the right flipper. If you fall off the edge, you will be returned to the beginning.





BOSS BATTLE:



ROBOT CARNIVAL

A RANKING REQUIREMENTS

03:00:00

Strategy:

This is more of an endurance battle than it is a Boss Battle. Dr. Eggman will send enemies at you in phases and you must survive them all in order to win.

1 Phases 1 and 2

The first two stages have a total of 10 Flappers (five for each stage). Bounce off the spring and grab the balloon above the center of the arena for a **Blast Gauge UP** and use it. On the second phase the bar will be going down. Use Homing Attack to take care of them. Since you just used a Team Blast, the robots you destroy afterward will give you Rings.



2 Phase 3

Four Flappers and three Falcos will attack. Use Team Blast to take them all out at once. Team Chaotix will need to use Team Blast a lot in order to get an A Ranking.



3 Phase 4

This phase has nine Flappers that you can bounce off using Homing Attack, or if you want to be diverse, use Thunder Shoot.



Thunder Shoot or Homing Attack will do here.

4 Phase 5

Four Solid Flappers with lightning shooting down will converge on the center. Destroy them all using Thunder Shoot. After they fall, switch to Power Formation and finish them off with Vector.



5 Phase 6

Casino Managers with shields and Bomb Flappers attack this time. By now you should have another Team Blast ready. Use the Team Blast to get rid of them quickly.



6 Phase 7

A circle of Flappers attacks this time. Use Thunder Shoot or Homing Attack to get rid of them. This should be easy because by now either Espio or Charmy should be at full level. Because of the special ability of the Team Chaotix Team Blast, you will earn Rings for defeating enemies while the Gauge goes down.



If you get another Team Blast before they are destroyed, use it again.

7 Phase 8

Four Klagen will appear as well as four Falcos. Use Thunder Shoot to get rid of them. After this phase, you should be close to having or have another Team Blast ready.



8 Phase 9

Use a Team Blast to take care of the circle of Cameron. There are so many that you will be close to another **Blast Gauge UP** again.



9 Phase 10

Flappers surround you and converge on you, shooting lightning down. Have Charmy use Thunder Shoot to get rid of them all.



10 Phase 11

A combination of Solid Flappers, Flappers, and Cameron will attack. Start shooting the Flappers down and when the Team Blast Gauge reaches the end, you should have another one ready to use.



11 Phase 12

A variety of Casino Managers with shields will attack. Use Team Blast to finish them off. If you don't have a Team Blast, wait for the Egg Knight to land and kill it to finish the stage.



STAGE 07
RAIL CANYON

See map on page 140



STAGE 08 MISSION	A RANKING REQUIREMENTS	EXTRA MISSION	A RANKING REQUIREMENTS
Infiltrate the terminal station!	32,000 points	Infiltrate within 6 Minutes!	34,000 points

START

① Grind the rails and grab any Rings and items along them. This is a good time to practice grinding and switching tracks. To speed up, press the attack button and to switch tracks, hold to the left or right and press the jump button.



② When you see the track switches, jump up and hit them to change the direction of the track. You will now be following glowing red tracks. Follow these until the track ends and you will fall down to another set of rails.



CHECK POINT 1

① Grind the blue glowing rails in Power Formation and when you reach the next platform and get the **Special Key** in the cage in the back, get on top of the unbreakable boxes and fly up on top. Break the barrel and hit the switch to change the track direction.



The track switch is underneath the barrel.

② Switch to Flying Formation and position yourself between the two Jump Plates. Fly up to the top of the tracks and bounce off the spring to get a **Yellow Power Core**.



③ Grind on either rail and after you pass through the Speed Formation change gate and drop down to the next set of rails, jump over to the red rail (the right side) to increase your time. Jump off to the right at the end and use the warp flower in the hallway.

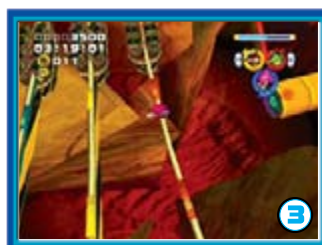

④ Exit it out of the new hallway and destroy the two Egg Pawns on the outside. The enemies being defeated will release the spring. Use the spring to get up to the Check Point. Go back to the start.



CHECK POINT 2

① After opening the door, turn right and enter the hallway with the warp flower. The flower will take you to the top of a platform with a bunch of Rings. Use the flower there to return to where you were.



This step is completely optional.

② Grind the rails here. While grinding, you will see arrows that point you to the right path. Follow them to avoid running into oncoming trains.





③ Jump onto the platform at the end. You will see a Flapper above a switch, between two barrels. Destroy the barrels to reveal two more switches and then press them all to remove the laser barrier. You can also turn invisible and pass through the bars.

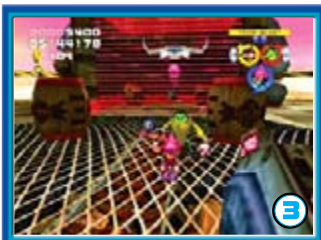

CHECK POINT 3

① Use the cannon to get to the other platform. Jump into it in Flying Formation to land on top of the structure. Speed and Power Formations will land you on the bottom.



② Follow the rails. After passing a small platform with metal crates to either side, the rails will go upward. Jump off in between them and use the Jump Plate to reach a **Blast Gauge UP**. Continue grinding the rails until you reach the Check Point. If you stay on top, you will avoid the forth Check Point.



Get a **Blast Gauge UP** by walking up the path between the rails.



CHECK POINT 4

① Jump up to the mini track platform, then onto another with an Egg Pawn. Defeat the foe and the track switch will be released. Hit the track switch and then grind the rails through a multitude of switches.



② When you reach the stopped train, jump off to the right or left and fly over the fences. If you want the items here, defeat the Flappers in this area.



CHECK POINT 5

① You can use either fence here, but if you are going for a time bonus, bounce off the wide spring in Speed Formation and use Homing Attack to bounce off the Flapper and over the second fence.

② Get back on the rails and when the circular track in the middle is on your right, jump over to it and then onto one of the platforms in the middle. Destroy the enemy near the switch that is locked up, then touch the switch.

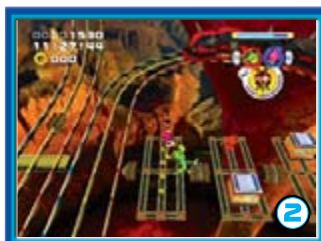

Avoid the train when getting to these platforms.

③ While facing the switch, jump to the outside track and grind up the rails around the loop. When you see a platform on the right with two pawns, jump on it and then destroy both of them plus the Rhino Liner on the other circular rails to release the switch here.



④ Hop back on the rails and follow it down to the terminal station and the Goal Ring.

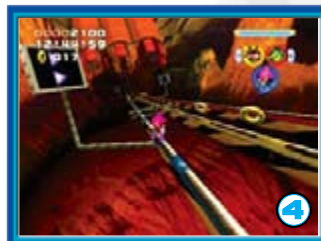

STAGE 08
BULLET STATION



See map on page 142

STAGE 08 MISSION

Destroy 30 capsules!

RANKING REQUIREMENTS

32,000 points

EXTRA MISSION

Destroy all 50 capsules!

RANKING REQUIREMENTS

26,000 points

START

① Grind down the path and destroy the four capsules on the platform at the bottom of the rails. Jump into the cannon in Power Formation, and after landing on the ledge in the distance, fly over the fence and destroy the two platforms there.



② Use the cannon in Speed or Flying Formation to reach the top and destroy the capsule. Hit the right switch to change the direction of the rails, then grind the rails by entering from the Dash Panel on the left.



CHECK POINT 1

Capusle Count: 7/50

① Destroy the Klagen and then the capsule behind it. Drop down, turn around, and destroy the capsule. The wooden box opposite the capsule has a switch underneath it that releases the spring.



② Run partway down the ramp and fly onto the platform with another capsule. Fly across to destroy two more and then touch both switches to raise the pole.



③ Destroy the two capsules in front of the door. Touch the three switches to open it. At the end of the hall, break through the duct using Vector.



④ Jump into the cannon in Flying Formation to get a **Yellow Power Core** and touch the Check Point.



CHECK POINT 2

Capusle Count: 14/50

① Walk carefully across the platform. When you reach the other side, hit the switch to open the door. Don't forget to destroy the capsule before moving on.



② Break the metal boxes inside the cannon room and the two capsules behind. Before you jump into the cannon, break the two capsules here as well.



③ Jump into the cannon and you will be shot down a very long corridor. While you are in a cannonball you can move left and right using the control stick to get the items in the balloons.



Move to the left and right to get the balloons.

At the end, be prepared to fall to the left or right rail as the middle one is elevated.

④ After flying off rails and into the fan section, don't miss the capsule on the ledge with two fans.



CHECK POINT 3

Capusle Count: 20/50

① Glide using the fan's current. At the third fan, glide up to the double platforms with two more capsules. After that, glide down to the fourth fan and touch the switch to open the door ahead.



② Destroy the capsule inside the opened door and then get the **Special Key**. Bounce up to the roof and then break through the duct to enter the transport tunnel.





③ Destroy the capsule and use Charmy to fly over to the car on the left. Destroy three more capsules.



⑦ On this wider portion, the first capsule will be in the middle and then on the right, left, and right. Watch out for the laser beams in the path here as well.



Jump over the laser beams.

④ Use Tornado Jump to get to the other car. Jump over the spiked balls and then use Triangle Jump to cross the narrow corridor. Triangle Jump past the platform when it is in the horizontal position. At the end, destroy the engine core with Vector.



Triangle jump past it when it's in this position.



CHECK POINT 4

① Capsule Count: 40/50

⑤ Ride the Bobsled and take care not to miss these capsules. Use the brakes to make it easier. The first two on the path will be on the right and then quickly left.



① Pass through the bars with Espio and then fly up to a platform to reach the switch that opens the door. Inside is a capsule and a **1up**. Bounce up to the roof and then drop down through the duct.



⑥ The next one is located behind three spiked balls. Take it slow and you won't miss this one. After this, the tracks will change.



② Triangle Jump or fly through the narrow corridor, then destroy the two capsules to uncover switches. Touch the switches and the pole will rise. Use the pole to reach the next train.

③ Fly over to the platform and destroy the capsule. Then fly back over and destroy the other



capsule on the train you were originally on.

④ Fly forward and destroy the last two capsules to finish the stage. If you missed any then the flower will warp you back to the start.



BOSS BATTLE

EGG ALBATROSS

A RANKING REQUIREMENTS

02:00:00

Strategy:

There are three parts to this Boss. Destroy the bottom of the blimp, the blimp itself, and finally the Egg Hawk. You'll have to work fast to earn an A Ranking. The entire battle can be won using Espio alone.

Bottom of the Blimp

Begin by running toward Eggman. When you reach a path that goes to the right and to the left, go right. (①) You will receive a **Blue Power Core** and an **Invisibility**. After you have the Invisibility, keep running into the side of Eggman's plane while doing Homing Attacks to take it down. (②) He will eventually go down and you will drop on the path or paths depending on where you are.

The Blimp

The blimp is the easiest part. Jump into the side of the blimp with Espio and use Homing Attack. (③) Once you connect with it, mash on the jump button for continuous Homing Attacks to defeat it. If you have done this quickly then you will drop to one of the two paths.

The Egg Hawk

The Egg Hawk is very fast and you will have a hard time catching it. The Egg Hawk will tilt lower to the left or to the right. As Espio, jump and use Homing Attack on the head and continue until the Egg Hawk is finished. You can also get close and then switch to Charmy and use Thunder Shoot. (④)



Bounce off the enemies and items.



Keep running into Eggman.



STAGE 09
FROG FOREST

See map on page 144



STAGE 01 MISSION

Avoid detection by the frogs!

A RANKING REQUIREMENTS

40,000 points

EXTRA MISSION

Avoid detection - You have 4 minutes

A RANKING REQUIREMENTS

42,000 points

START

① Run forward and bounce off the fruit to get to the ledge with the Cameron. Run up the Jump Plate behind the Cameron and through the loops.



② After you land, use the platforms on the right to avoid being seen by the frog. Jump on the fruit. When you reach the top of the plant, jump to the vine and grind it down to the end.



Use the platforms to the right.

③ At the end of the grind, you will jump off and grab onto an ivy swing. Press the jump button when the ivy is at its apex. On the third ivy swing, you will be propelled to the top of the tree.



CHECK POINT 1

① Fly through the Dash Ring, up to the next platform, and jump around on the platforms to the right to avoid the frog. Fly from the yellow platform to the spring and then bounce up to the top. You can get a **1up** where the frog is by having Espio turn invisible or using Vector to hit it from a distance.



You can get a **1up** here, but this is optional.

② Hit the gong and run down the path. After the first set of three loops, make Espio invisible and continue running the path. Being invisible will not alert your presence to the frogs up ahead.



③ Fly through the Dash Ring and bounce off the wide spring on the other side. You will gain considerable height over the frog, so take this opportunity to fly over to the Check Point.



CHECK POINT 2

① Jump over to the purple flower and have Charmy open it up. The flower will rise and you can reach the ledge above. From there, jump over to the right and break the metal boxes to get a **1up**.



② Return to the top ledge and fly through the Dash Ring to reach another. Jump past the platform with the **5 Rings** and you will land on one with a flower.



③ Use Leaf Swirl to pick the flower up from the ground and then jump and grab it. The flower will spin like a giant propeller and fly you to your next giant plant. While flying, if you drop down onto the vine, you can get two **1ups**. Grind the vine down to the bottom but remain invisible.



④ Jump to the path with three frogs and then up to the ledge with the gong and an Egg Knight. Destroy the Egg Knight with Vector to destroy the other Egg Pawns, or hit the power gong to get to the next section.



Destroying the Egg Knight destroys the rest of the robots.

CHECK POINT 3

① Swing across the ivy and past the Egg Pawns and frog, then jump to another platform and swing across that ivy. Run the path past two more frogs to get to the Goal Ring.



STAGE 10 LOST JUNGLE



See map on page 146

STAGE 05 MISSION

Rescue 10 Chao!

A RANKING REQUIREMENTS

40,000 points

EXTRA MISSION

Rescue 20 Chao!

A RANKING REQUIREMENTS

32,000 points

START

Chao #1

① Destroy the Egg Hammer to release the spring and the first Chao. After you grab it, bounce up to the next ledge using the spring.



Chao #2

② Run up around the path past the black frog. Just after the Flying Formation signal is the second Chao.



Chao #3

③ At the ivy swing, turn around and fly up to a Chao on a platform.



Turn around and jump up on this ledge.

Chao #4

④ Bounce off the fruit up to the ledge with three wooden boxes. Break the wooden boxes to get the Chao.



CHECK POINT 1

Chao #5

① After swinging on the ivy, defeat the Egg Hammer. To the right after the small tunnel on a platform is a Chao.



Chao #6

② To the left, the Chao is released from the container as a result of defeating the foe.



Chao #7

③ After running the loops and bouncing off the spring, check the small mushroom on the left for another Chao.



Chao #8

④ Check the platform on the right, just past the second black frog, in this area.



Chao #9

⑤ After landing from the flower ride, and before you reach the green frog, back up to the open part of the walls. From the right side, fly straight up to get this cleverly hidden Chao.



Fly up to get this one.

Chao #10

⑥ Let the green frog see you and when the vines and platforms grow, fly up to get the Chao.



Chao #11

⑦ Kill the Solid Flapper near the locked case to release the Chao inside.





CHECK POINT 2

Chao #12

① Fly above the path and destroy two Solid Flappers to release the caged Chao.



This one is above the main path.

Chao #13

② Take out the two Egg Hammers inside of the tree to release the Chao, then use the flower to warp to another place.



Chao #14

③ Grab the Pulley to go down, then jump to the platform. From that platform, fly over to a high platform to get the Chao. This one is easy to miss.



Chao #15

④ Fly down to the bottom of the path and destroy the Egg Hammer and release the Chao.



Chao #16

⑤ Don't go through the laser barrier. Continue on the path from Chao # 14 to the **Special Key**. Behind the **Special Key** and near a mushroom is the Chao.



Chao #17

⑥ Turn invisible and pass through the laser barrier. Use the flower to reach a ledge on top and then destroy the two Solid Flappers to release the green frog. After the frog sees you and it begins to rain, go to the right and bounce up from the fruit to get the Chao.



Chao #18

⑦ On the left side, after the frog sees you, jump up from the newly grown platform to get another Chao.



Chao #19

⑧ Bounce off the spring that the green frog was on, to the platform above. Swing from the ivy and destroy the Solid Flapper, then capture the robot on this path to release the Chao.



Chao #20

⑨ This one is hovering above the path. Look closely! If you fail to get them all, the flower will take you back to the start.



BOSS BATTLE:



TEAM ROSE

RANKING REQUIREMENTS

00:30:00

Strategy:

Start the battle by switching to Flying Formation and knocking Amy's team out of the air with Thunder Shoot (①). This will knock them down temporarily. Switch to

Vector and start using Power Attacks on them to knock them out of the ring (②). Once all three members are knocked over the edge, the battle is over (③).



Thunder Shoot will knock them out of the air.



Vector can knock them out as they recover.





STAGE 11 HANG CASTLE



See map on page 148

STAGE 05 MISSION	A RANKING REQUIREMENTS
Get the Keys in the castle!	35,000 points

EXTRA MISSION	A RANKING REQUIREMENTS
Get the Keys and avoid detection!	23,000 points

START

① After running down the first ramp and bouncing off the wide spring, you will see **Castle Key #1**. Grab it and then break the wooden boxes, then drop down the hole.



④ The glowing spider symbols will guide you here. Fly from them onto the next tower. **Castle Key #2** is underneath the platform. After you have it, fly on top to get a **Yellow Power Core** and then run between the torches along the invisible path.



⑦ When you jump off the platform onto the ledge, jump on the rail so that you go to the top. At the end of the path will be **Castle Key #4**. After that, grind the rail down to the Check Point.



CHECK POINT 1

① After touching the orb, look underneath the platform for **Castle Key #5**. Fly on top of that platform, then use the warp flower.



② Turn invisible with Espio and touch the orb switch. If this is your first time through the stage, don't worry about being detected by the enemies.



⑤ Before the end of the invisible path, have Espio turn invisible and touch the switch behind the two Egg Pawns. Get near the flower, switch to Charmy, and use the flower to warp. After the warp touch the orb to return to the area where the first Castle Key was.



Travel upward to get the Key.

③ Grind the rails after the castle is turned upside down and then, after you fly off, land on the platform. When the platform rises, fly to the top.



⑥ Turn invisible and run past the Egg Knight to get **Castle Key #3**. At the end of the room, jump onto the platform. It will rise upward.

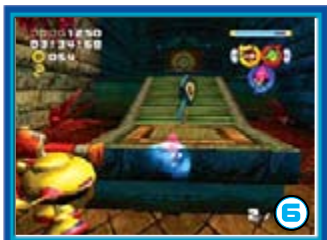



② Jump into the flower while invisible. When you emerge on the other end, sneak past the Egg Pawns and the Egg Knight to get **Castle Key #6**.



③ Jump onto the platform moving up while you are invisible. At the top are two Search Flappers. Walk past them invisible and then switch to Charmy to fly over to the moving platform to the other tower.



④ Touch the switch and turn invisible with Espio. Walk past the two Egg Pawns and the Egg Bishop, then touch the orb.

Once the orb places you, turn around and get **Castle Key #7**.

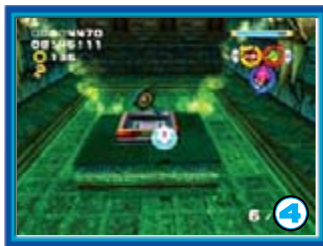

⑤ When you reach the invisible path, walk forward until you have to go right, then use Charmy to fly over to **Castle Key #8**.



⑥ Break the cracked wall to the right of the door and the wooden boxes to the left. Behind each of those are switches. Pull the switch out to open the door.



Cracked walls can be broken using Vector.



Break the wall in the back.

⑦ Turn invisible and run into the door. Get in the vicinity of the three robots on the bottom portion and use Team Blast. After they are destroyed, break the wall in the back and collect **Castle Key #9**.

⑧ Fly up to the ledge above the **Castle Key** and shoot down the Search Flapper with Charmy. Have Vector finish it off with his Far Attack.



CHECK POINT 2

① Turn invisible and run past the Egg Pawns. On the opposite side of the tower is the orb, sunken inside of a hole.



② You should still be invisible. Enter the tower and run by the robots on your way to the top. At the top, pull the switch and touch the orb.



③ When you land, grab **Castle Key #10**. The flower will warp you back to the start if you miss any.



STAGE 12 MYSTIC MANSION



See map on page 150

STAGE 05 MISSION

Blow out all 60 red torches!

RANKING REQUIREMENTS

25,000 points

EXTRA MISSION

Blow out all 46 blue torches!

RANKING REQUIREMENTS

20,000 points

OVERVIEW

This Mission requires you to blow out 60 red torches or 46 blue torches in the Extra Mission. This walkthrough will travel through each room, covering both the red and blue torches at the same time.

START

① Run forward and use Leaf Swirl to blow out the **four red torches** and **one blue torch**. After you have blown them out, destroy the Egg Pawn at the top of the stairs to open the door.



② Jump to the stone block and then fly up and hit the target switch using Thunder Shoot. That will release the orb. Touch the orb and defeat the three Egg Pawns to open the door.



③ In the next hallway and following room, there are a total of **six red torches** and **three blue torches**. The middle blue torch is underneath the falling weight so watch out. After the torches are out, grab the

Special Key in the cage and fly up to the Check Point from the top of the falling weight.



The blue torch is under a falling weight.

CHECK POINT 1

Red Torches: 10/60

Blue Torches: 4/46

① After opening the door, defeat all of the Egg Pawns and the Egg Magician to get rid of the laser barrier, then blow out the **four red torches**. Touch the orb and a Egg Hammer and two Egg Pawns with shields will block your path. Destroy them and the laser barrier to the next room will open.



② Blow out the **two red torches** and use the flower to warp to the next part of the mansion. To blow out the **blue torch**, you must use Homing Attack to bounce off the ghost and then, when you are near the flame, use Leaf Swirl.



Bounce off the ghost to get to the blue torch.

CHECK POINT 2

Red Torches: 16/60

Blue Torches: 5/46

① Get the **Special Key** underneath the wooden box on the right, then blow out the **two red torches**. Blow out the **two blue torches** before the door. For the first blue torch, jump onto the unbreakable box, then jump up to the flame in the center and use Leaf Swirl. For the second one, get on the skull symbol in front of the door and use Leaf Swirl.



② In the room with the giant statue, use the middle orb to extinguish **two blue torches** on the side plates. Return to the three orbs and hit the right switch.



③ Hit the right orb switch and jump up to the head while extinguishing the **two blue torches**. Use the flower if you are extinguishing red torches or hit the orb if you are extinguishing blue.



④ Hit the orb and grind over to the third plate to extinguish the **blue torch**. The lowest plate here has another **blue torch**. After you have blown them both out, use the flower on the top to warp.



⑤ After you warp, you will end up in a circular corridor. Although it may seem endless, it does contain a lot of torches. Start by traveling one direction and extinguishing the **12 red torches** and **four blue torches**. On the platform that one of the blue torches was on, a



target switch is visible. Shoot the target switch to open a door. Run down the hall and through the opened door to touch the orb.



Shoot the target switch to open the door.

CHECK POINT 3

Red Torches: 30/60

Blue Torches: 17/46

① In the hall before the pit, extinguish the **four red torches** and a **blue torch**. Triangle Jump across the pit and, to put out the **blue torch**, jump over it with Espio and use Leaf Swirl. You will land on the spot that the flame came out of.



② When you fall down to the area with the fan, break through the cracked wall and hit the switch to open the door. Use Bubbles with Vector to rise up through the newly opened door at the top of the room.



③ Blow out the **two red torches** in the hall and when you reach the door, fly up with Charmy and pull the switch out to open the door. Touch the orb in the next room and defeat all of the Egg Pawns to open the door.



④ Extinguish the **two red torches**, then touch the switch to open the door. Defeat the Heavy-Egg Hammer, then extinguish the **blue torch** between the stairs and the **two red torches** at the top of the stairs.



⑤ Enter the room with the flower and blow out the **two red torches** and the **four blue torches** above the statues' lances. After that, enter the warp flower.



⑥ Extinguish the **four red torches** in the center of the room, and break the cracked walls with Vector. Behind two of the walls are **two blue torches** to extinguish, a **Special Key**, and a new path to



⑦ In the new path you can extinguish **two red torches** and **two blue torches**. As long as you are invisible, the block above will not fall. Run to the blue flames while invisible and use the Leaf Swirl to put out the flames. When the block falls, jump onto it and ride it to the top.



CHECK POINT 4

Red Torches: 48/60

Blue Torches: 28/46

① This next room is shaped like a giant web. There are a total of **four red torches** and **five blue torches**. There are two red torches on the right and left and the blue torches are in the center. Navigate the grinding web using Flying Formation, and jump up when the path goes right or left. Don't forget to touch the switch on the right to exit this place.



② In the next room, with the laser beams, use Vector to destroy the Egg Magician near the orb and then have Espio turn invisible. Jump into the orb to warp to the next area.



③ Use Espio to jump over to each of the flames and blow out the **three blue torches**. After that, use the Pulley to go to the bottom of the well.



④ Inside the bottom of the well, blow out the **four red torches** and the **four blue torches**. When you blow a red torch out, the blue torch will go out as well. Watch out for the ghosts. When you are finished, use the flower to warp.



⑤ This is the final room. There are **four red torches** and **six blue torches**. The red flames are along the path, but the blue flames are on the outside platforms. You can reach these platforms by flying to them. Above the center of the room is a **1up**. The flower will warp you to the start of the stage if you missed any torches.



Fly to the platforms with blue torches.



BOSS BATTLE:

ROBOT STORM

A RANKING REQUIREMENTS

04:00:00

Strategy:

This time, Dr. Eggman will use stronger robots to attack you. Like last time, the object is to survive. After a couple of phases, you'll jump into a transporter to get to different areas of the battle.

1 Phase 1

Flappers will appear in a pyramid formation. Have Espio use Homing Attack to bounce from one to the next and destroy them all, or shoot them from the ground using Vector.

2 Phase 2

Switch to Power Formation and have Vector take care of the Egg Knights. Take them all out with one Hammer Down. After that, your Team Blast Gauge should be nearly full.

3 Phase 3

Twelve Egg Pawns will appear and fall down. Destroy the Egg Knight to defeat them all at once, or use Team Blast. If you use Team Blast, you will be close to another. Jump into the orb.



4 Phase 4

You will be surrounded by Camerons and Flappers. As soon as the Team Blast Gauge goes down, use another one to take out this group.

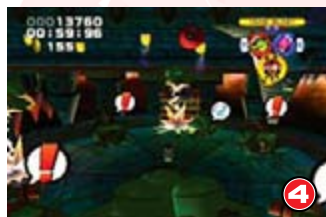

5 Phase 5

Destroy all of the Egg Knights and the Flappers. Don't use your Team Blast, but instead use it on the next set of enemies.



6 Phase 6

Use Team Blast to take out all of the enemies. After they're defeated, jump into the cannon in Power Formation and shoot the balloons to get Rings and a **Shield**. Shoot the cannon using Speed or Flying Formation to get to the next area.



Get items from the balloons on the outside of the arena.

7 Phase 7

There will be a lot of different enemies in this phase; use the Team Blast to get rid of them. If you don't have one, you'll have to beat Flappers, Egg Knights, gun pawns, and Falcos.



8 Phase 8

Shoot the Flappers and Falcos with Thunder Shoot, then use the Team Blast when the Gauge goes down.



9 Phase 9

Use the Team Blast on the three Egg Hammers. If you don't have one ready, keep your distance and stun them with Thunder Shoot, using Vector to damage them. Touch the orb to reach the next section.



10 Phase 10

You can use Thunder Shoot or Homing Attack to get rid of the rows of Flappers. If you touched the orb in Speed Formation, you can have Espio use Homing Attack on the top ship and work your way across and then down.



Espio's Homing Attack will get rid of the flyers quickly.

11 Phase 11

Jump onto the rail in Flying Formation and use Thunder Shoot to take down the enemies in the distance. Doing this quickly will help you get an A Ranking.

12 Phase 12

Egg Pawns will drop down. Destroy them as they fall using Thunder Shoot. Once they are almost done falling, use the Team Blast to finish the rest off. Jump into the newly opened cannon in Flying or Speed Formation.

13 Phase 13

Avoid the possibility of getting hit by using the Team Blast after all the enemies have landed.



Use the Team Blast here.

14 Phase 14

A group of Flappers and an Egg Magician will appear. Attack them, and when the two Egg Hammers drop down, use your Team Blast to finish them off.



Wait until the Egg Hammers drop down to use the Team Blast.



See map on page 151

STAGE 01 MISSION
Avoid enemy detection!

RANKING REQUIREMENTS
33,000 points

START

① Grind the initial conduit to the deck of the ship, then turn invisible. Run to the four Egg Pawns and hit the door switch. Run down the path to get to the Check Point.



CHECK POINT 1

① Fly up to the next path, switch to Vector, jump off the spring to the left, and then float up through the Dash Ring, past the Egg Pawn, and bounce on the wide spring into the hallway.



② Turn invisible to pass through the laser barrier, then touch the switch to turn the lasers off. Fly up to the ledge above the hallway, and fly through the Dash Ring to reach a conduit.



Espio can go through the barriers.

③ Grind the conduit across the ship. When you reach the end, bounce on the wide spring to reach the Check Point.



CHECK POINT 2

① Fly past the guns into the next hallway. Once inside, use Espio to turn invisible and pass through the laser bars. Touch the switch to remove the laser bars, then climb up the unbreakable crates and use the Jump Plate in Flying Formation.



② After being launched from the Jump Plate, fly up through the Dash Ring and land on the conduit. Ride the conduit to the next Check Point.



This is a big shortcut.

EXTRA MISSION
Avoid Detection—you have 6 minutes

RANKING REQUIREMENTS
55,000 points

CHECK POINT 3

① Run down the deck of the ship while invisible, killing the three Egg Pawns. If you have a Team Blast, use it to save time. Once killed, switch to Vector and destroy the cages covering the switches. Activate all three switches to open the door.



② After emerging from the right flower, switch to Power Formation and have Vector glide to the right to avoid the Egg Pawn. Jump on the cages up to the Jump Plate.



CHECK POINT 4

① Run up the deck of the ship while invisible and touch all of the switches not in cages. After that, switch to Vector and break the cages to touch the



Don't let a cannonball hit you.

switch. Hurry—if a cannon fires and hits you, the Mission is failed.

② Turn invisible with Espio and touch all of the switches to open the door. Use a flower at the end of the path to reach the final area.



③ From here, hit all the switches in the pit above the fan to release the target switch on the ground. This raises the pole, or you can fly between the lasers, which will likely earn you a faster time.



④ To get through the lasers, fly straight up and wait. Time the laser beams to get through them, then fly up and bounce off the spring to reach the top.



⑤ Turn invisible and use Team Blast to destroy the E-2000. After the door opens, run and touch the Goal Ring.

STAGE 14 FINAL FORTRESS



See map on page 153

STAGE 05 MISSION

Find the Keys to the client's cell!

RANKING REQUIREMENTS

65,000 points

EXTRA MISSION

Find 10 Cell Keys!

RANKING REQUIREMENTS

55,000 points

START

Cell Key #1

① Hit the gong switch at the start and grind the conduit. At the end, you will land on a platform with two Egg Pawns. Destroy them to release **Cell Key #1**.



⑤ Fly down to the left cannon for a **1up**, then get back onto the conduit. As soon as you bounce off the spring at the end, switch to Flying Formation and have Charmy fly up to where the cannons and guns are.



② Jump up from the Cell Key, and fly onto one of the platforms to the left or right. From there, jump down to the path. When you reach the end of the path fly over to the other ledge and Triangle Jump to the other side.



CHECK POINT 1

① Hit the gong to get to the narrow hallway, then Triangle Jump across to the other side. Once you're on the new path, run down past the laser beams and ride the Jump Plate.

③ Use the cannon in Power Formation to break the center crates on the other side. Breaking those crates reveals a switch that will raise the flagpole.

⑥ Run down the hall, destroy the E-2000, and break the metal boxes before dropping to the floor below. When you land, get a **Special Key** behind you, then turn invisible, pass through the laser bars, and run up the Jump Plate.



③ Fly across the platforms to the area with many cannons, get the **Special Key**, then fly up and grab the Pulley which will take you to the top and to the Check Point.

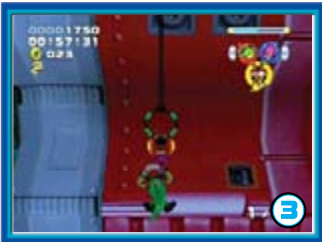

Cell Key #2

② Destroy the Heavy-Egg Hammer to release the **Special Key** and use the spring behind it to get onto the conduit above.

Cell Key #3

④ Jump up from the crates to the fan, then glide up to the highest point and onto the platform with the **Special Key** on it.



The unbreakable is breakable by using the cannon.



**Cell Key #4**

⑦ At the top of this section is a E-2000R. Destroy it and the door will open revealing the **Special Key** and Check Point.

**CHECK POINT 2**

① Step on the self-destruct switch, and ride the conduit. When you see lightning on the conduit, a laser is going to fire over that line. You can fly straight up over lasers, or jump to another conduit.



Prepare for laser fire.

Cell Key #5

② At the end is another E-2000R. Defeat this one and the **Cell Key** will be unlocked.



③ Fly over to the next ledge and Triangle Jump in the narrow passage. Be careful. There is a gun that will fire. When you know it will fire, stick to the wall a bit longer and go.



Be wary of the gun at the end of the corridor.

④ Destroy the Egg Pawn with a shield and touch the switch that opens up. When the pole drops, use Leaf Swirl to go up.



⑤ After you reach the bottom of the conduit, you will come to an area with six cannons and a Heavy-Egg Hammer. Defeat the foe to release the gong switch. You can also get a **Special Key** underneath the middle-left gun.

**Cell Key #6**

⑥ Hit the gong switch to land on a ledge, then use the Jump plate to land on another conduit. At the end of the grind, defeat the E-2000R and two Egg Pawns with shields to release the **Special Key**. When you get the **Special Key**, you will also touch the switch, making the pole lower.



⑦ Use the pole to reach the next section. Defeat the Egg Hammer here to release the gong switch. Use the gong to get to the third section, where you will have to take on a Heavy-Egg Hammer. Defeat it, then fly up and hit the target switch to raise the pole.

**Cell Key #7**

⑧ When you get to the top section, two Heavy-Egg Hammers will drop down. Use Team Blast to get rid of them. Get the **Special Key**, then touch the Check Point. After the Check Point, use the warp flower.

**Cell Key #8**

⑨ When you emerge from the warp, jump onto the platform and destroy everything around you. In the center is the **Special Key**.





Triangle Jump and land...

Cell Key #9

⑩ Hit the gong, run to the collapsible path on the right, and fly over to the narrow hallway. Triangle Jump quickly after landing to grab a **1up**. When you reach the spiked ball, land and then run before the platforms fall. Switch to Charmy and fly up to the Egg pawn. Destroy the foe to get the **Special key**.



...then use Charmy to get up to the ledge.

⑪ After warping from the flower, you will be in the top portion of a corridor. Ahead is a laser barrier and a Egg Knight. When the enemy is at a high point, bounce off it and then Triangle Jump to the other end over the barrier. Grind the conduit and then land on the center platform where the final **Special Key** is locked up.



Defeat three Heavy-Egg Hammers.

Cell Key #10

⑫ To get the last **Special Key** you will need to work for it. You must defeat a Heavy-Egg Hammer on the two ledges to the right and left, and the one on the U-shaped ledge to get the final **Special Key**.

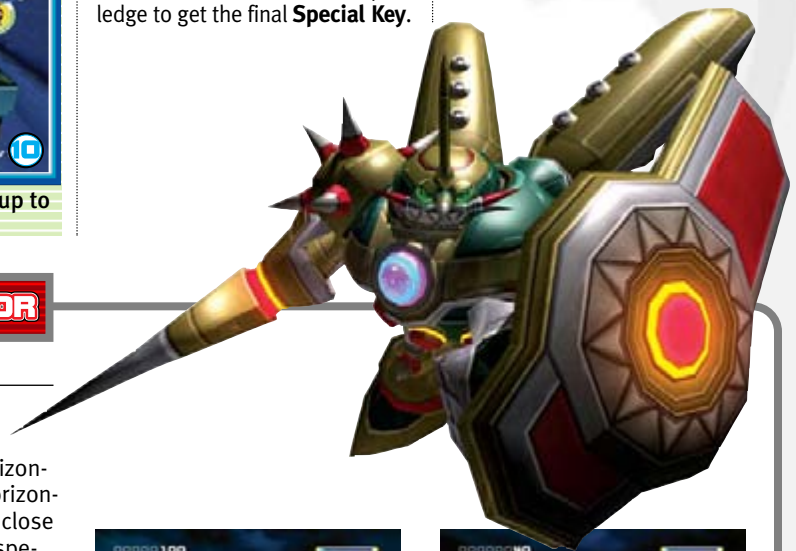

BOSS BATTLE:



EGG EMPEROR

RANKING REQUIREMENTS

03:030:00

Strategy:

Start by running toward Eggman. His giant robot will swing the sword four times. You must dodge a vertical swipe, horizontal swipe, vertical, and then horizontal again. Dodge the horizontal ones by jumping over them. (①) For this first part, stay close because if you get too far, he will charge you (②). This is especially lethal if you are in mid-flight above a chasm. At the end of the path is a gong and Jump Plate. Either way will take you to the center circle (③).

The center platform contains four cannons, four Klagens, and Eggman. Destroy the four cannons first, take out the Klagens, then Eggman using Thunder Shoot (④) (⑤). Use Team Blast whenever possible on him because Team Chaotix powers the Team Blast up quickly (⑥). If you don't, circle around and finish him off the second time.



1



2

Stay close, otherwise he will charge you.



3



4

Destroy the four cannons first.



5

Use Thunder Shoot to defeat him.



6

Use the Team Blast whenever possible.



SPECIAL STAGES



BONUS CHALLENGE VS. EMERALD CHALLENGE



The Special Stages in Sonic Heroes are completely optional Stages and are not necessary to finish the game but are necessary to getting the real ending. To get to a Special Stage you must obtain a Special Key during any one of the 14 Stages in the game and complete that Stage with the Special Key. If you get hit during a Stage, you will lose the Key. There are two types of Special Stages, the Bonus Challenge and the Emerald Challenge.

BONUS CHALLENGE



The Bonus Challenge is like a practice for the Emerald Challenge. Doing this will not earn you anything except extra lives. You can enter the Bonus Challenge by ending any of the odd-numbered stages with a Special Key (1).

EMERALD CHALLENGE

The object of the Emerald Challenge is to reach the Chaos Emerald before it reaches the end of the Special Stage. You can enter the Emerald Challenge by completing any of the even-numbered stages with a Special Key. If you are going for the emerald, then do it as Team Rose since their Stages are the easiest (1).



SPECIAL STAGE TIPS



Collect spheres to build Gauge.

During a Special Stage you cannot run or jump, but you do have a dash which you can use if your gauge is full. To build up your bar, collect spheres which are on the ground (1). These spheres give you points and increase your time. Once you have a full gauge, press the attack button to boost yourself forward (2). This is key to getting good times and catching the emerald. A couple things you must beware of are using your entire bar too early and spikes. Spikes will slow you down quickly and in most cases prevent you from finishing a Bonus Challenge or catching the emerald during the Emerald Challenge (3).



Watch out for spikes!





THE FINAL BOSS!

The last Boss in the game can only be accessed once you have beaten the game with all four characters and collected all seven Chaos Emeralds. When you have fulfilled these requirements, go to story and push right to see the LAST Boss.

BOSS BATTLE:



METAL MADNESS

RANKING REQUIREMENTS

Under 07:00:00

Strategy:

The last Boss, Metal Madness, will take all of your team's combined might to defeat. You will use team Rose, then Chaotix, Dark, and Sonic. The Check Points are when you defeat a portion of Metal Madness.

A Team Rose

Turn around and break a wooden box to get the **Blast Gauge UP**. Use it to take out a bit of Metal Madness's life and then hit the other wooden box to get another **Blast Gauge UP** (①). When the Team Blast Gauge goes down, use Team Blast again. Metal Madness should be low on life so use Thunder Shoot to finish this form off. Once defeated, you will take control of Team Chaotix (②).

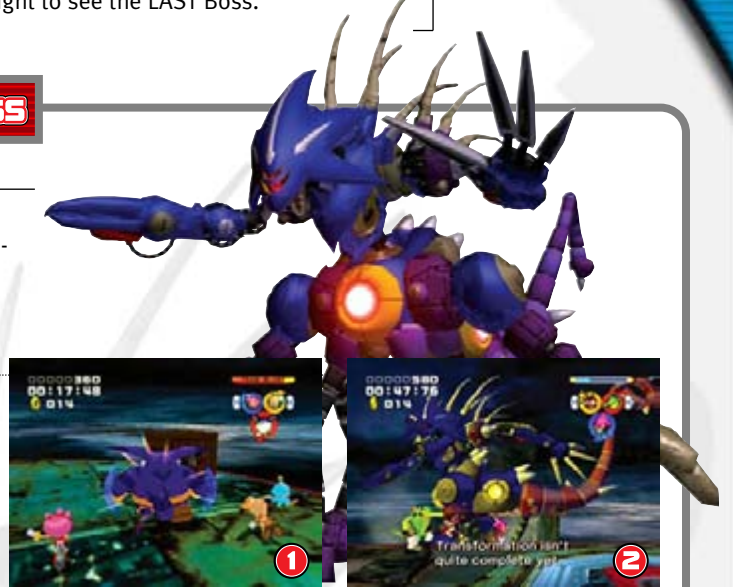

B Team Chaotix

Begin by jumping into the cannon in Speed and Flying formations to get **Power Cores**. Then in Power Formation, get two more **Power Cores** (①). The giant Metal Madness will fire at you. Avoid the shots and attack his weak spot. If you look at his weak spot, you'll notice that it is a certain color. The color represents a Formation. If the color is red then Power Formation is useless (②). Watch the colors and hit him with the correct attacks. When this form is defeated you get to use Team Dark.



Don't use Power Formation when the sphere is red.

C Team Dark

The first thing that you want to do is grab the **Power Cores**. Destroy the boxes on either side to get the **Red** and **Blue Cores** and fly up to get the **Yellow Cores** with Rouge (①). Attacking him is the same as it was with Chaotix. Look for which Formation is ineffective, and attack with the others. You will do the most damage if you stick with Omega and Rouge (②). After this form is defeated, it's time for the final battle.



Get the Power Cores first.

METAL OVERLORD

This is the final battle and Gold Sonic is ready to go with his super powers. The goal is to get the Team Blast Gauge up as fast as possible. To do this, counter the Overlords attacks. When he uses his Crystal Attack, use Sonic's speed to crash through them (①). When he turns around and uses the Spine Attack, use Tails to shoot them down. He will dive down and lift a ship from the egg fleet as the final attack (②). Destroy it using Knuckles. Once the Gauge is filled, use Team Blast. After five of them Metal Overlord is defeated (③).



Use Super Sonic Power.



STAGE 01

SEASIDE HILL

LEGEND

- Team Rose
- Team Sonic
- Team Dark
- Team Chaotix
- All Teams
- 1up
- Blue Power Core
- 5 Rings
- Barrier
- Team Start
- Team Blast Ring
- Yellow Power Core
- 10 Rings
- High Speed
- Team Finish
- Invincible
- Red Power Core
- 20 Rings
- Special Stage Key

STAGE MAPS - SEASIDE HILL

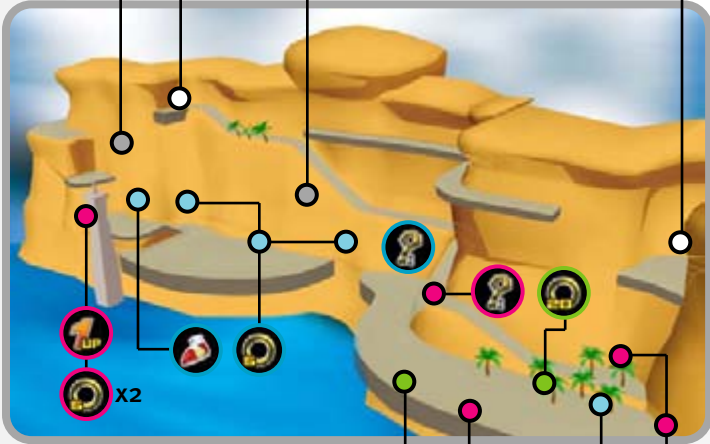
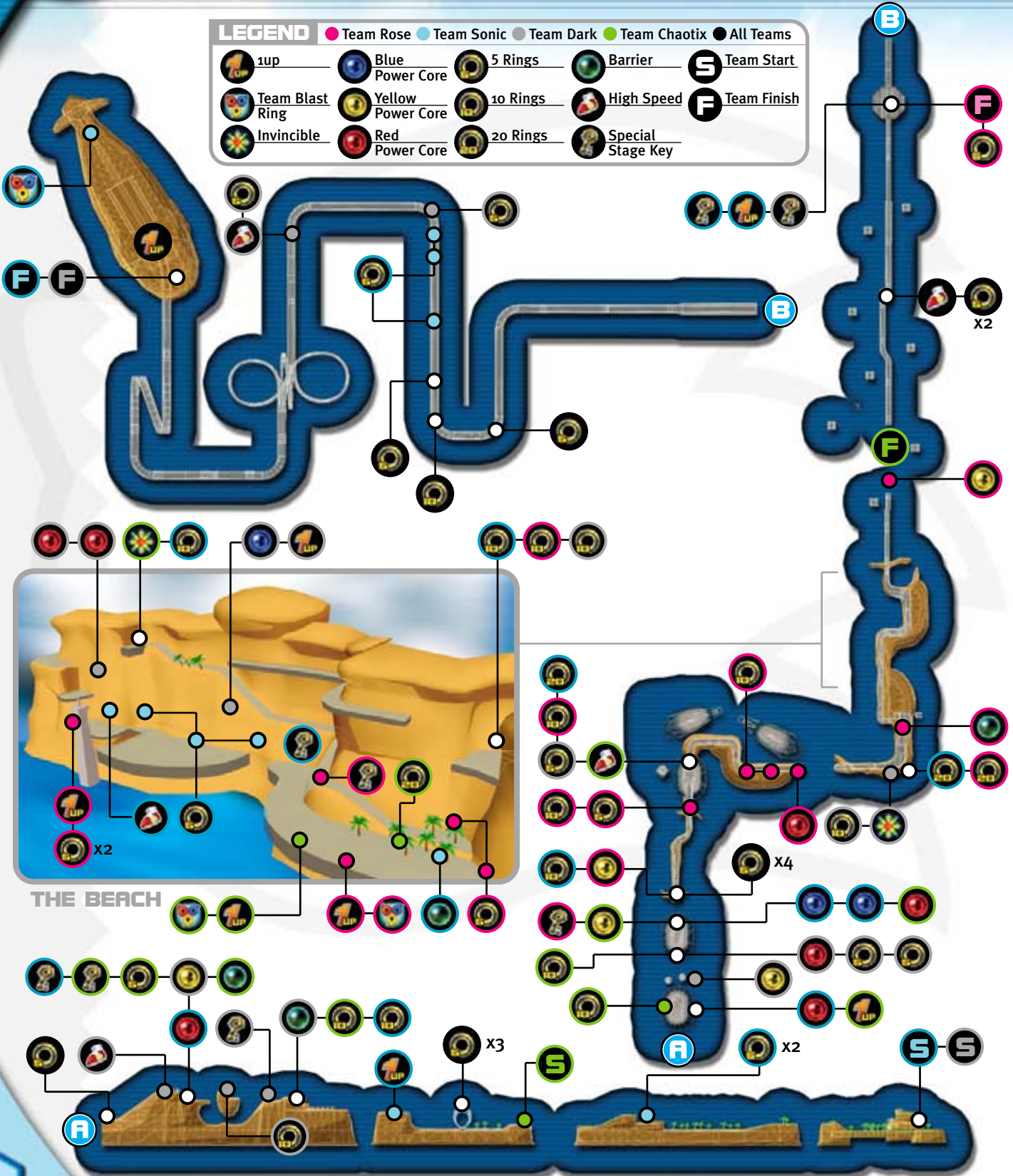

OCEAN PALACE

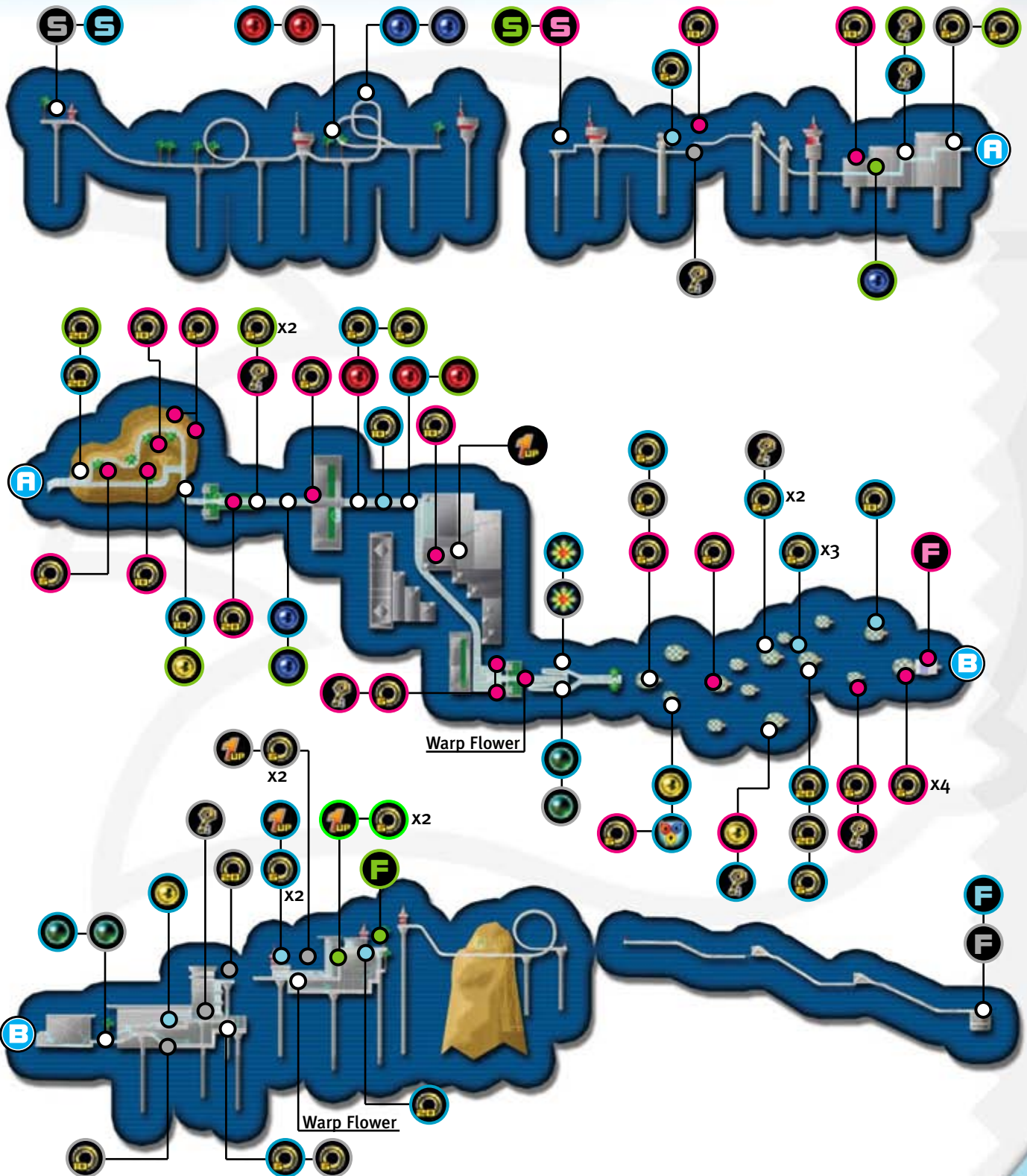



GRAND METROPOLIS

STAGE MAPS - GRAND METROPOLIS

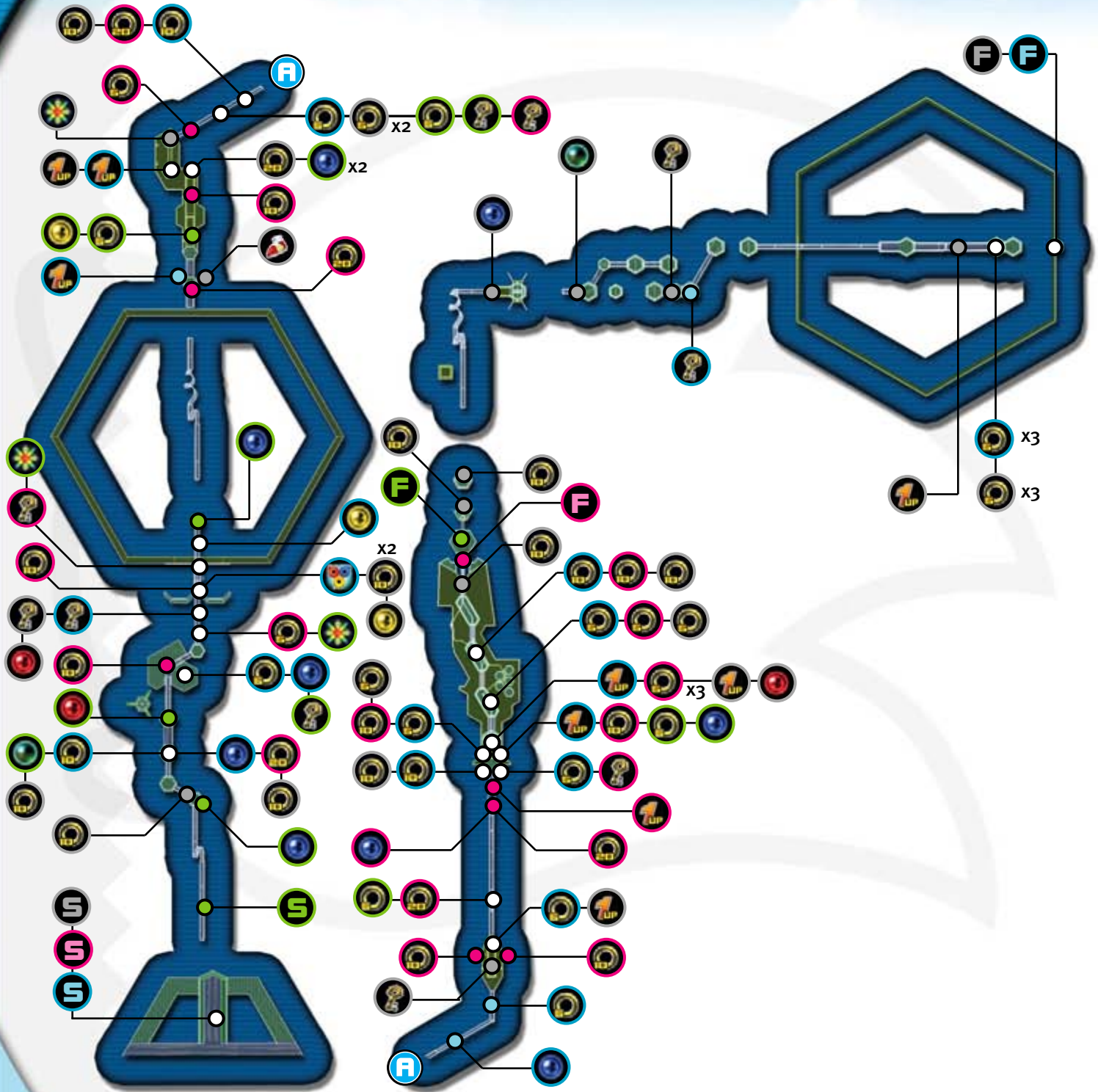

AGE MAP STAGE MAP

STAGE 04 POWER PLANT

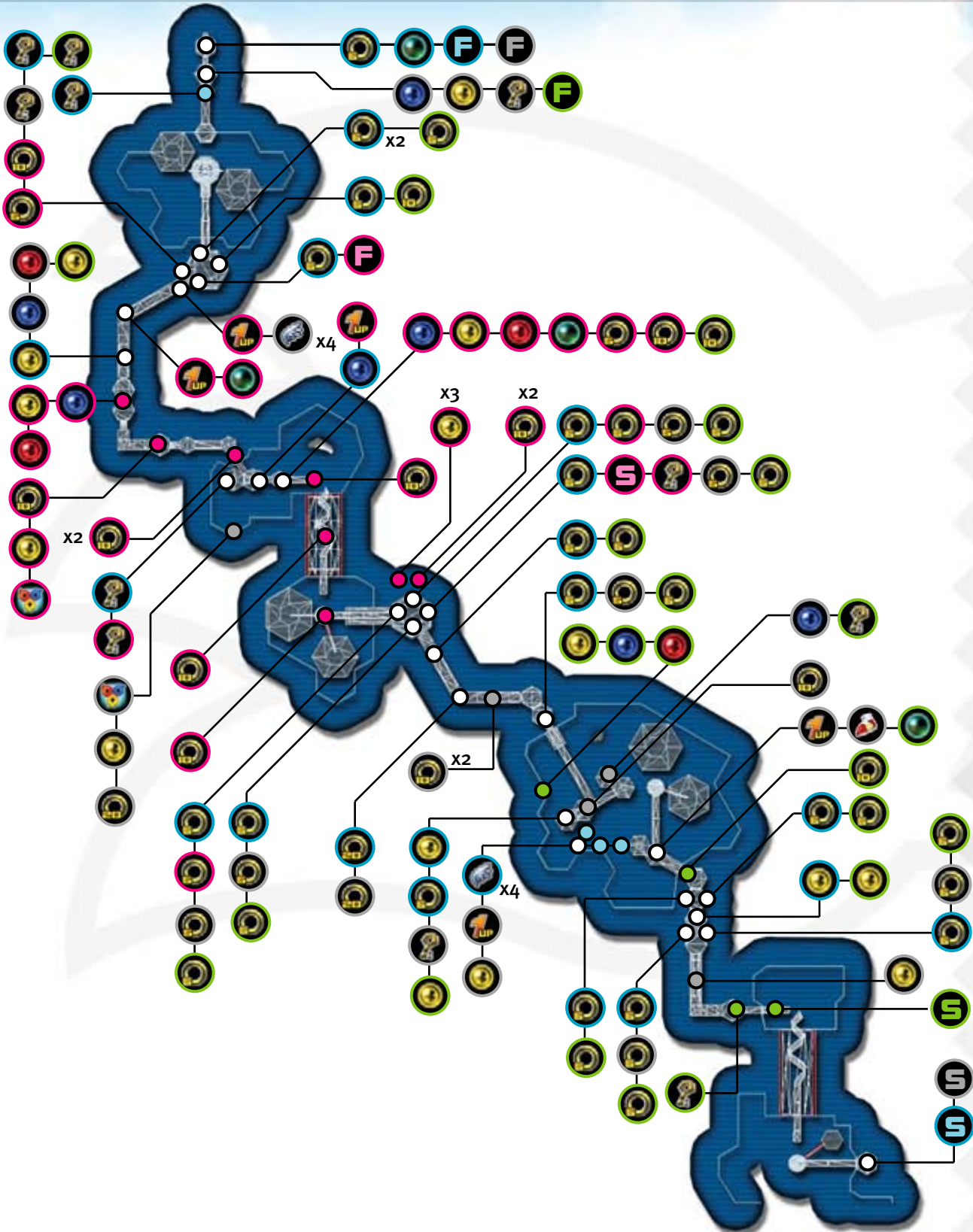

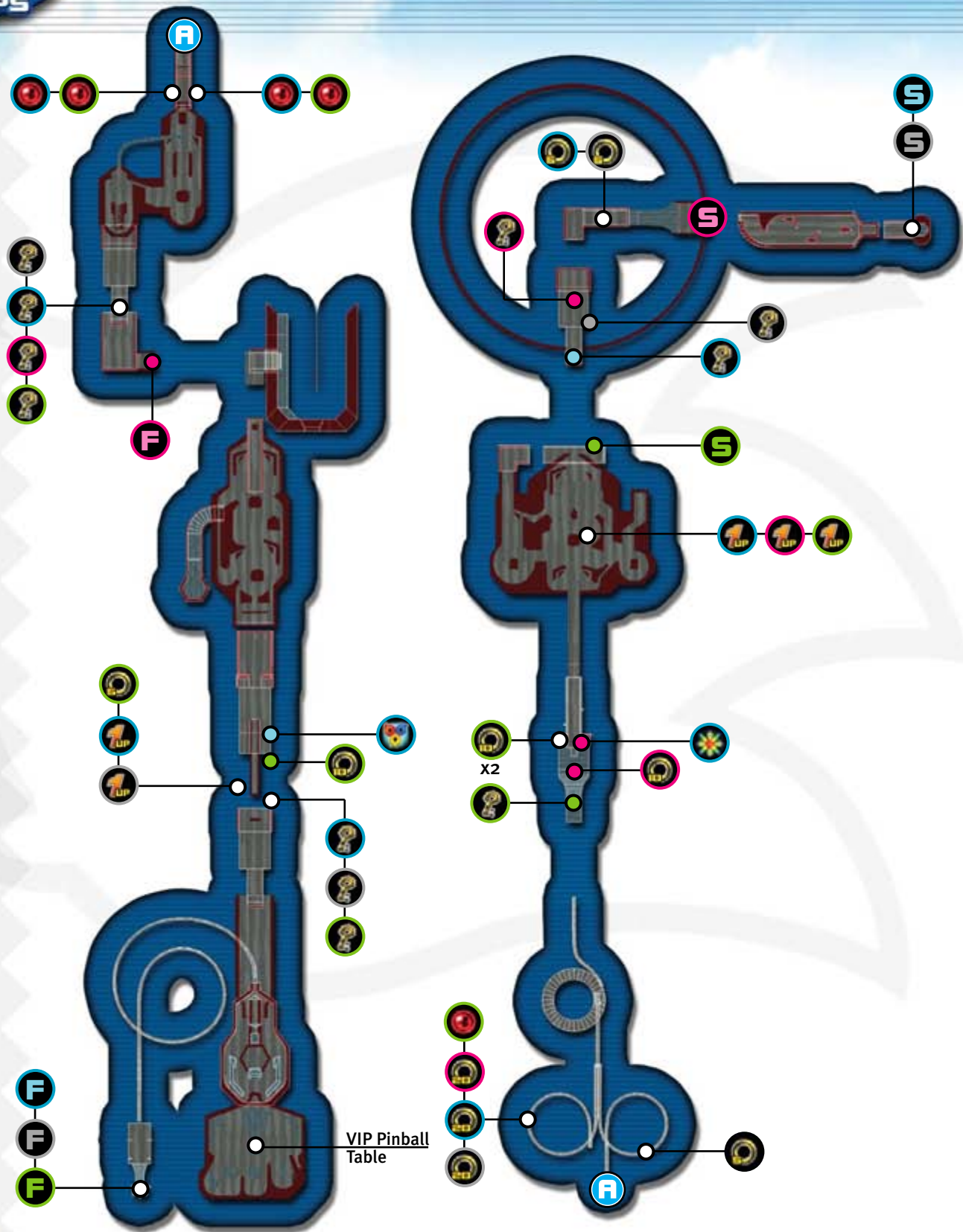

STAGE 06 BINGO HIGHWAY

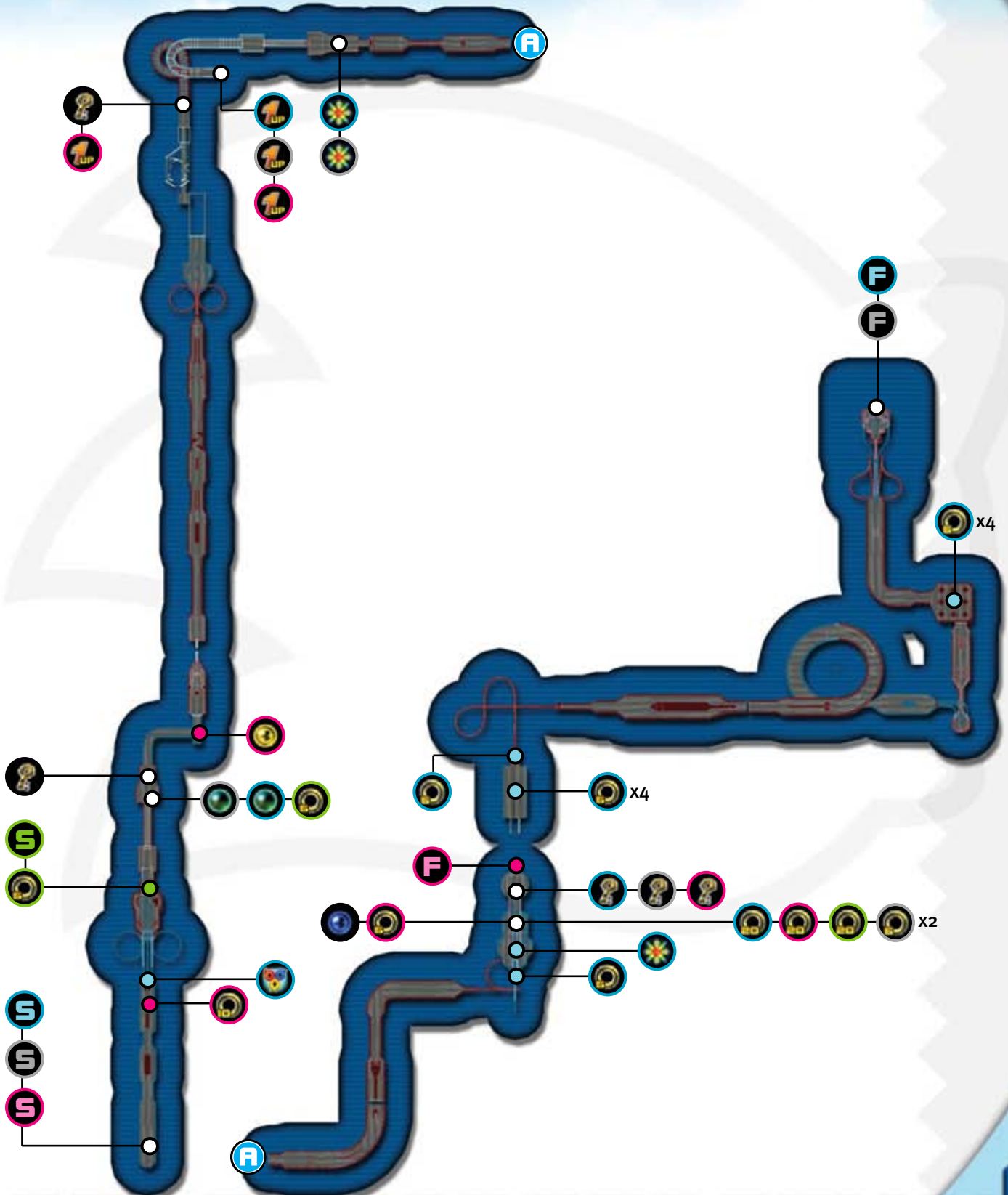



STAGE 07
RAIL CANYON

STAGE MAPS - RAIL CANYON

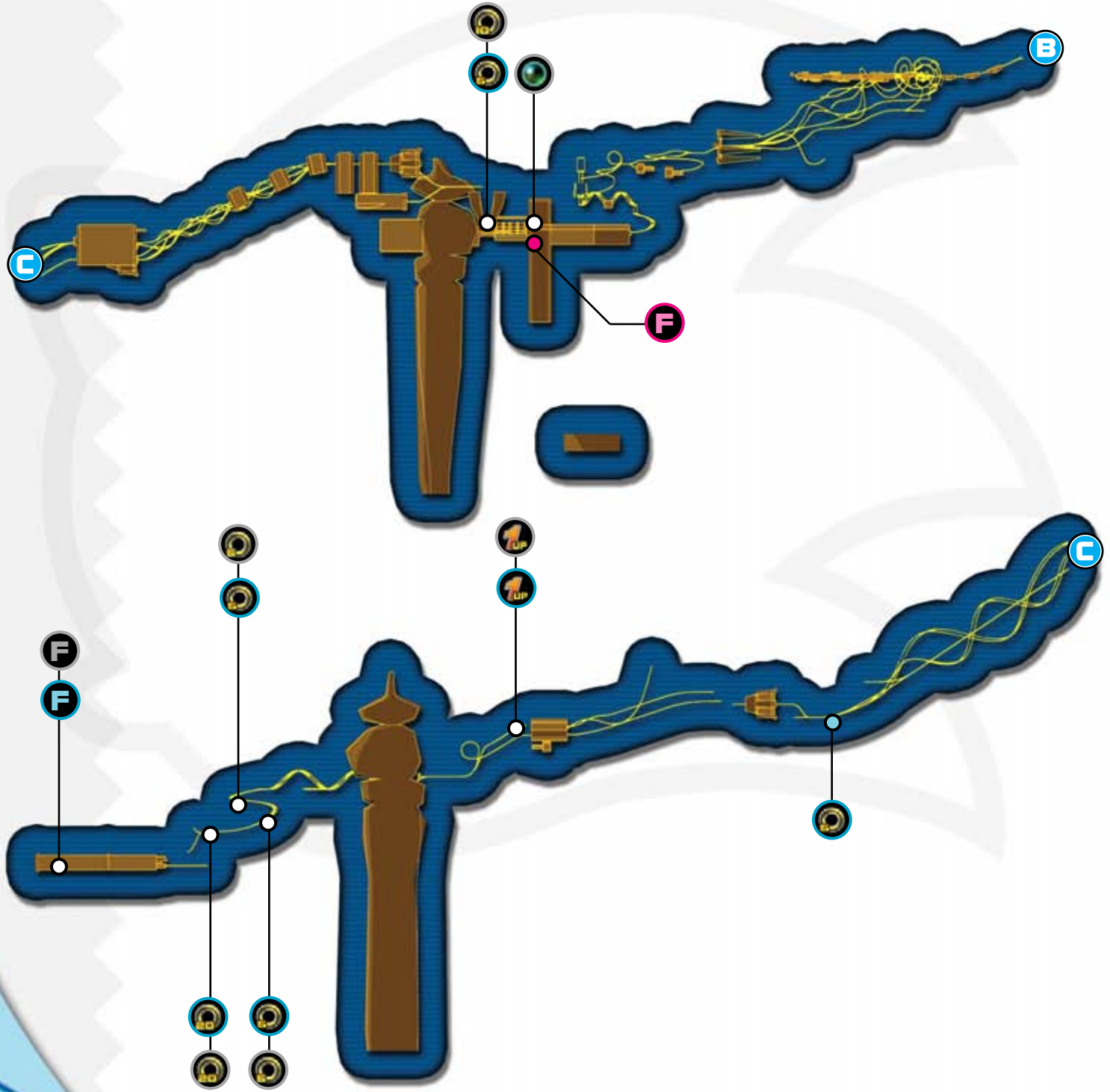

STAGE MAP STAGE MAP



STAGE 08 BULLET STATION

STAGE MAPS - BULLET STATION

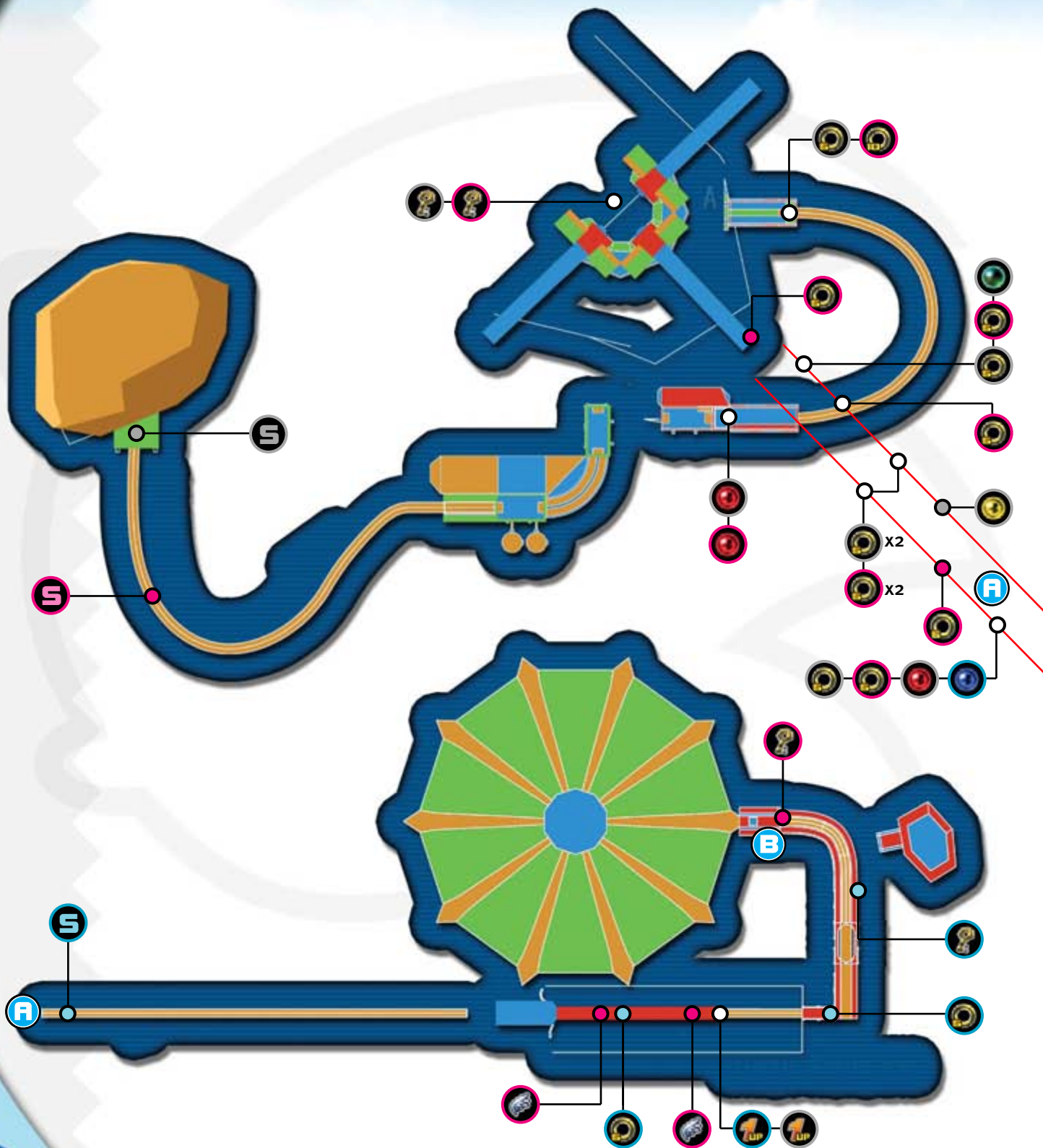

AGE MAP STAGE MAP

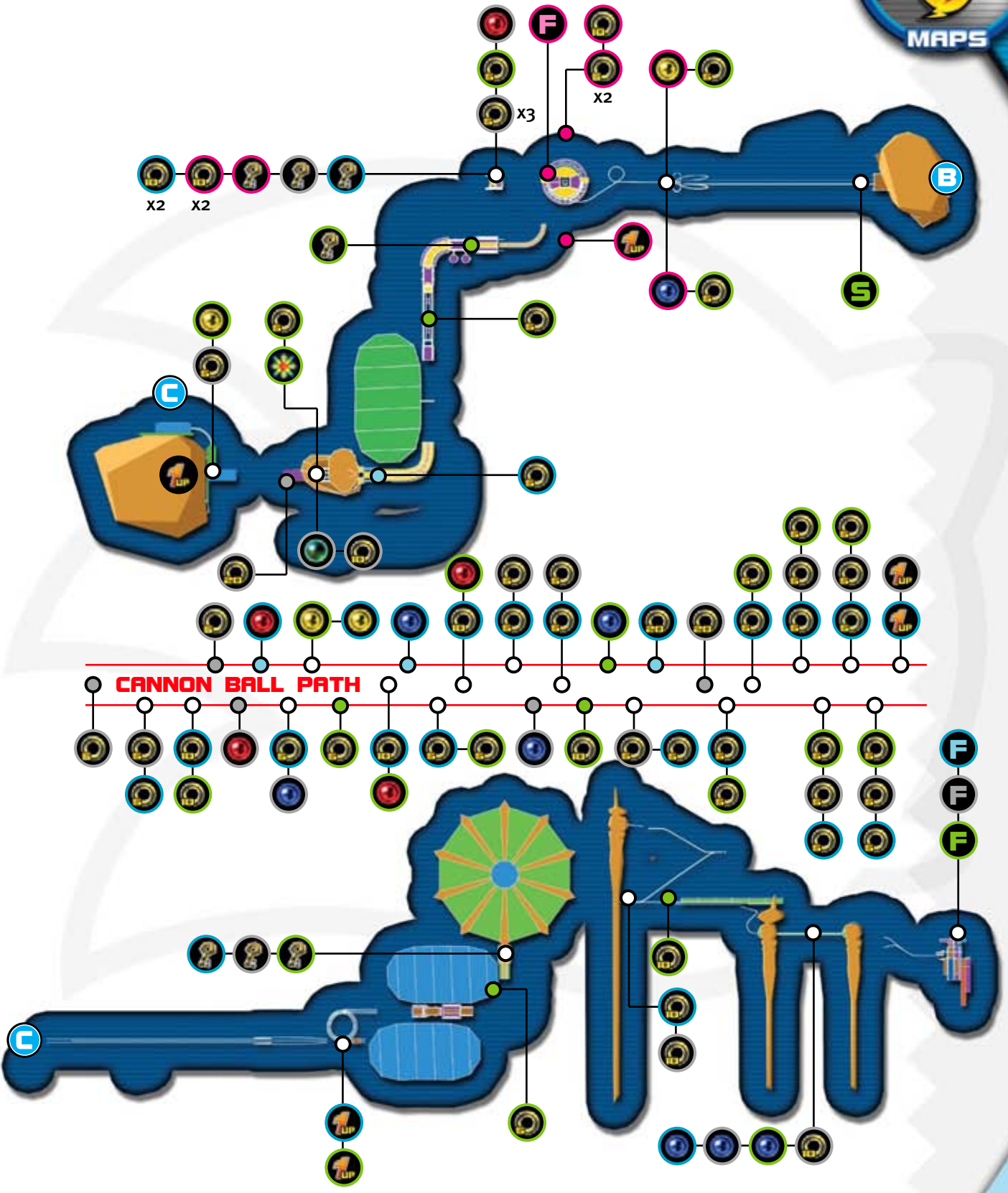

STAGE 09
FROG FOREST

STAGE MAPS - FROG FOREST

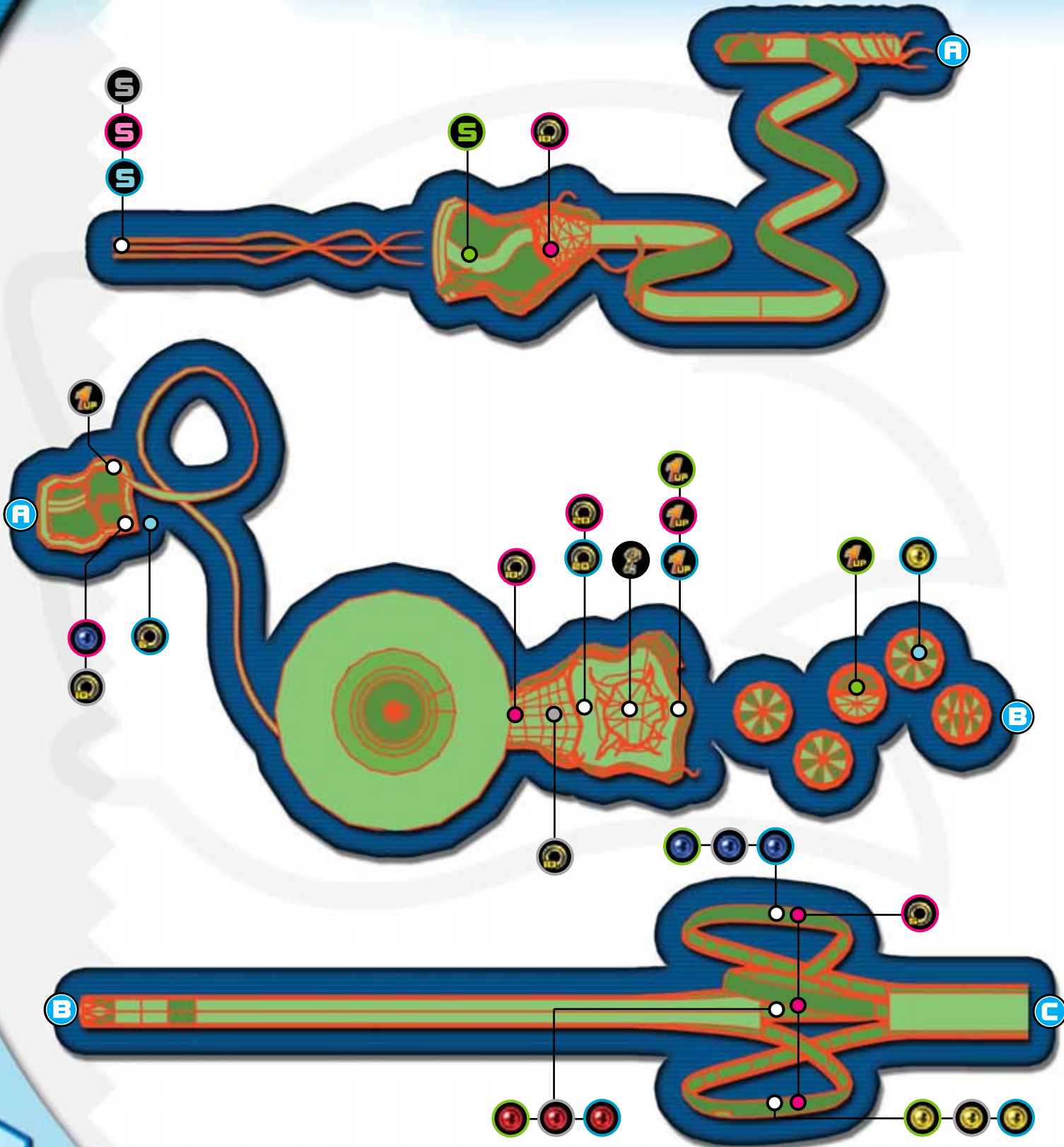

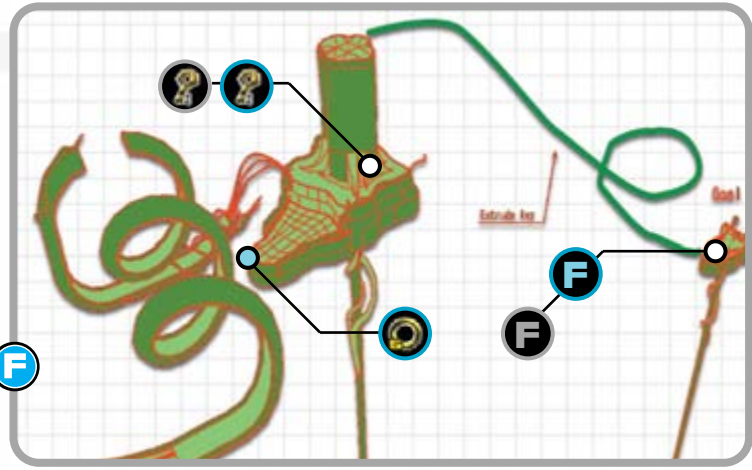
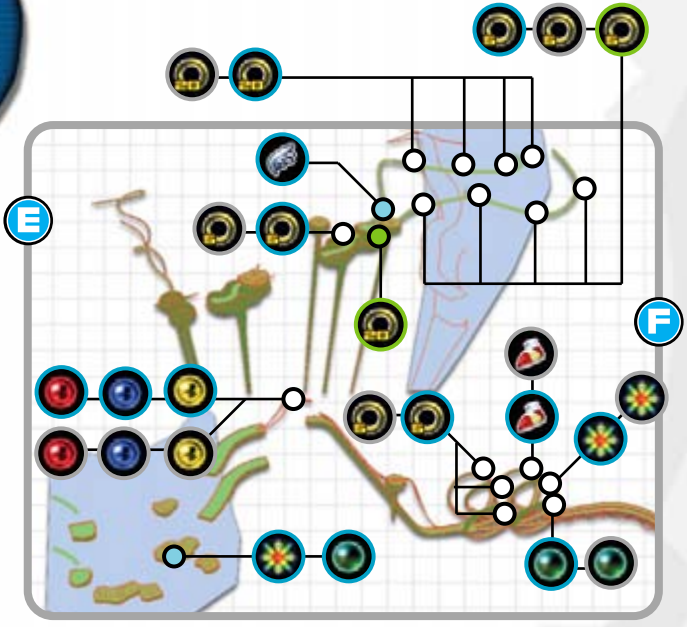
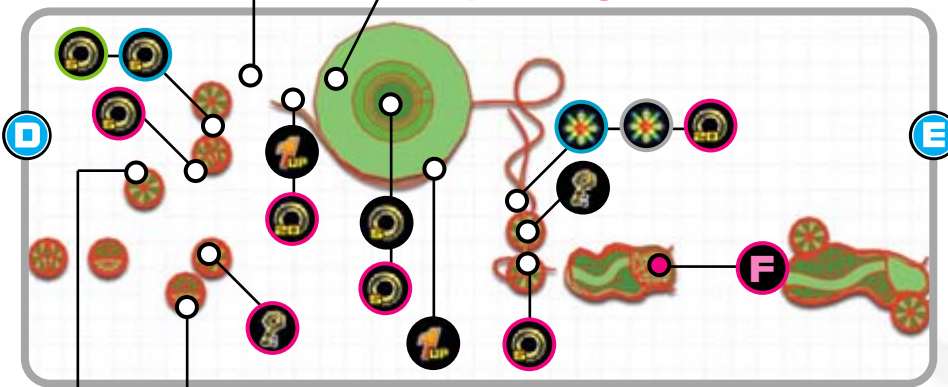
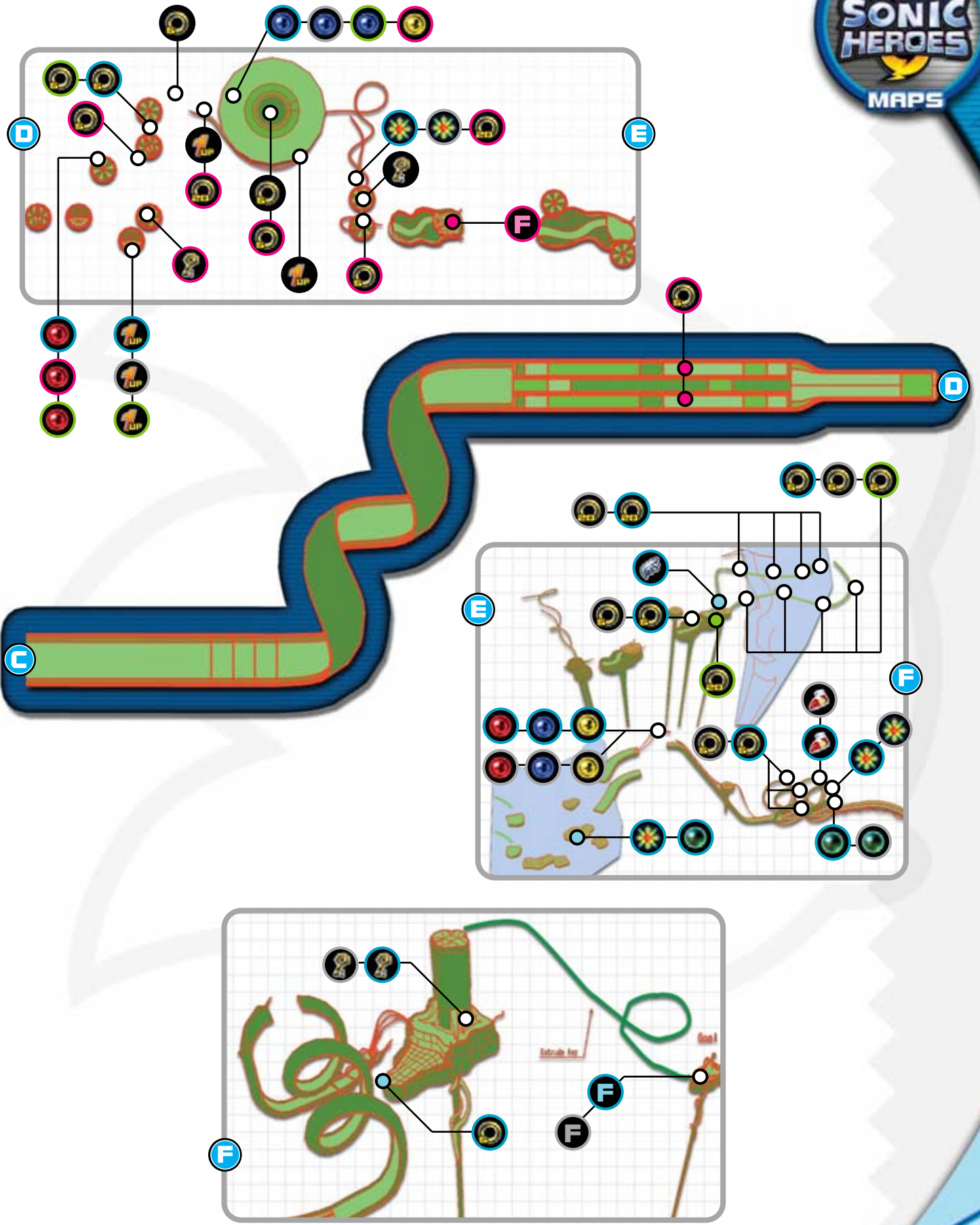



STAGE 10 LOST JUNGLE

STAGE MAPS · LOST JUNGLE

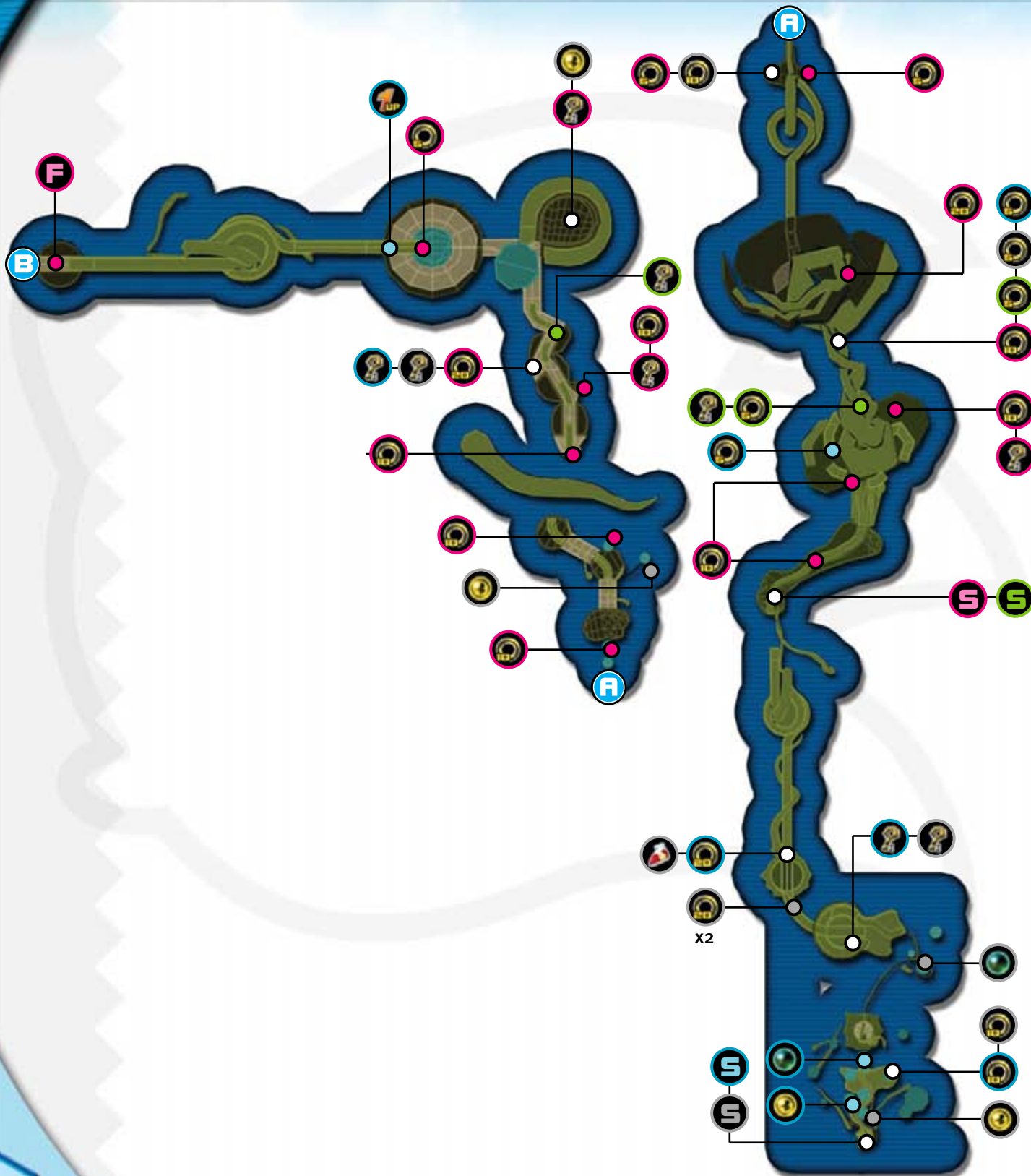

AGE MAP STAGE MAP



HANG CASTLE

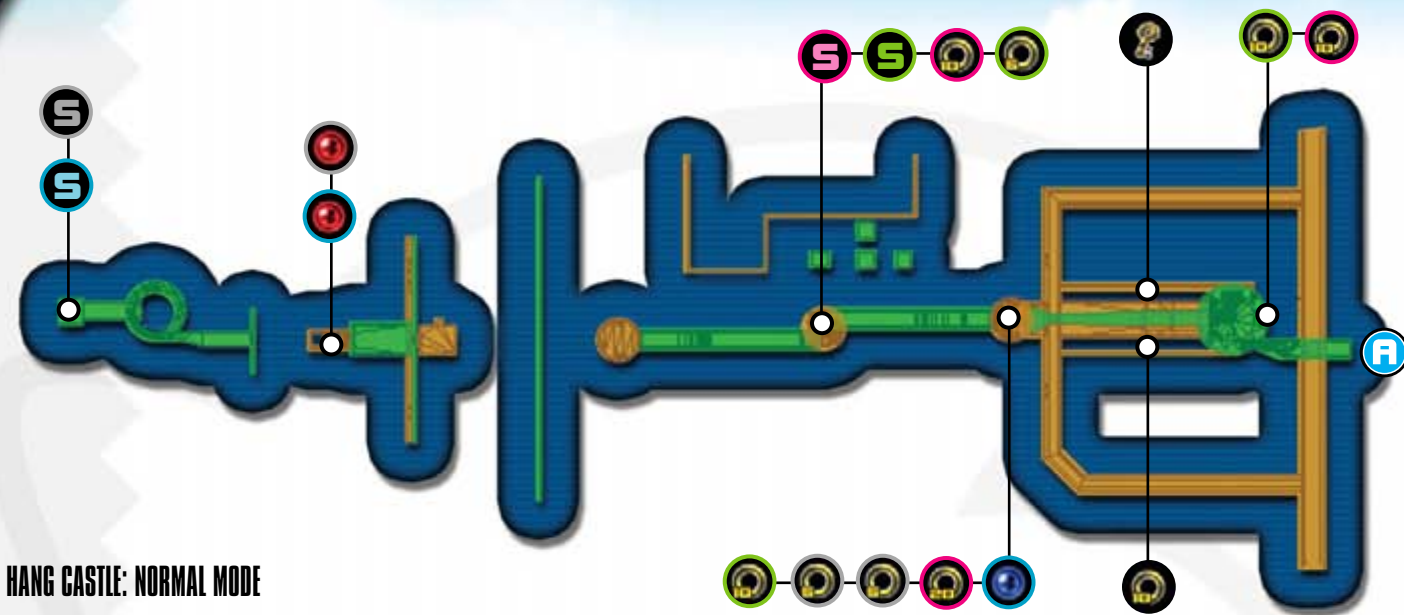

HANG CASTLE: NORMAL MODE

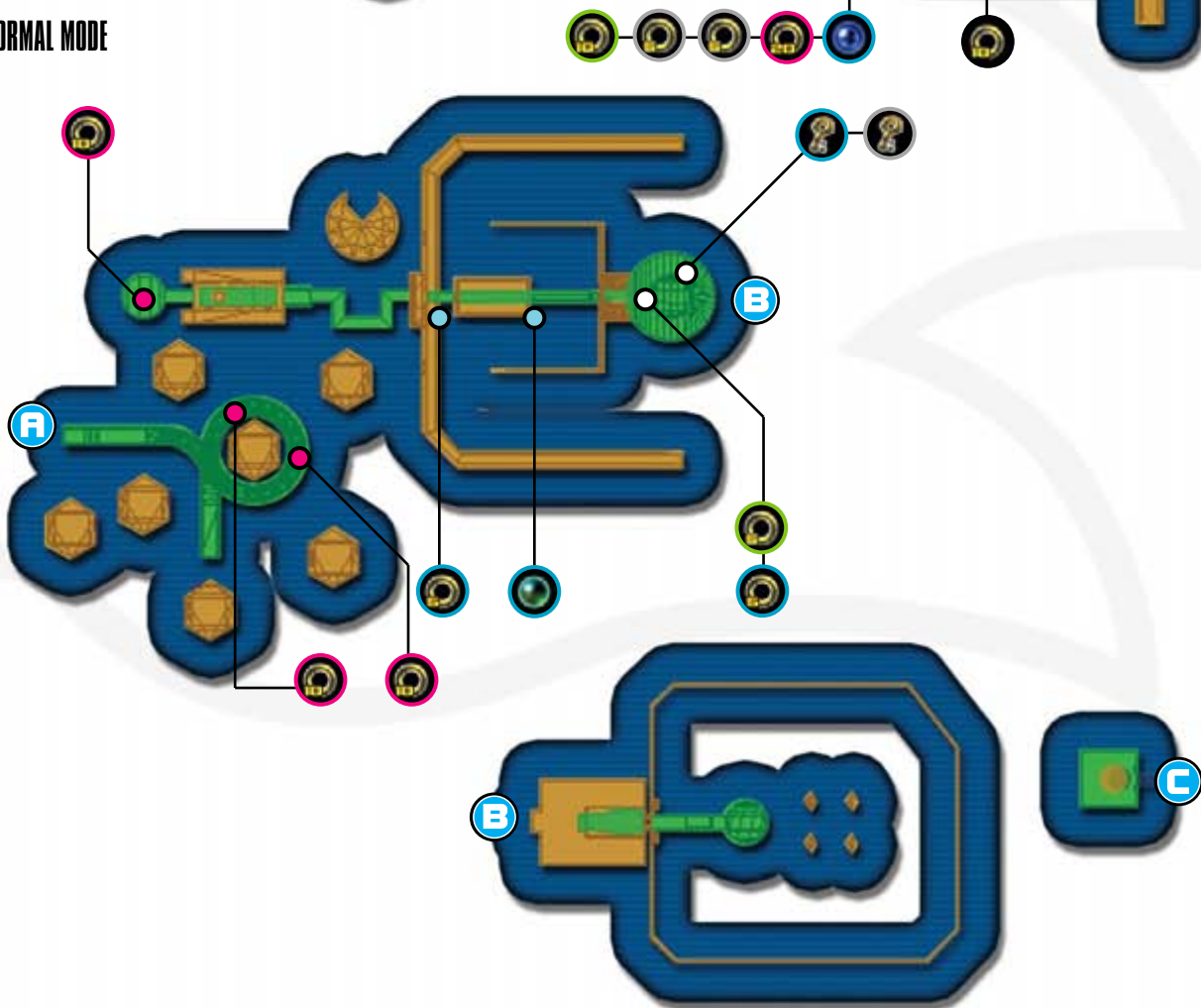

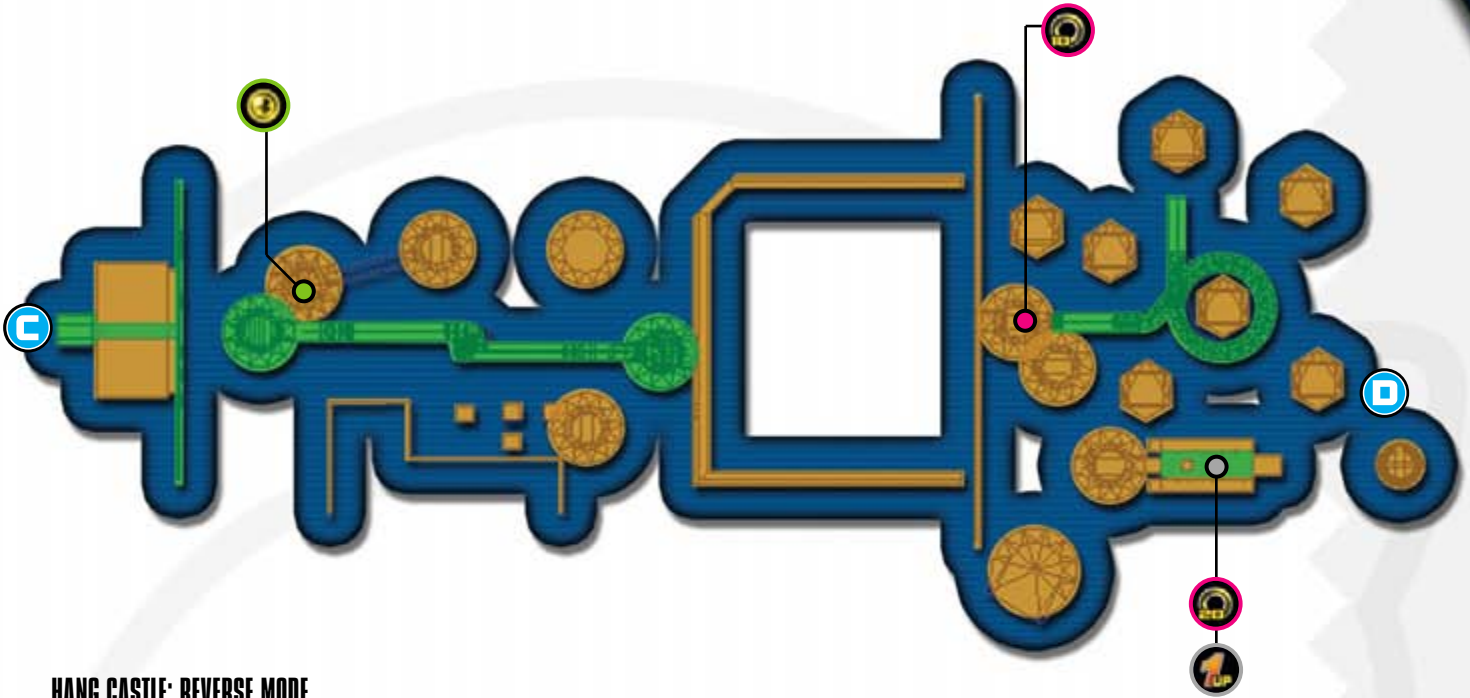

HANG CASTLE: REVERSE MODE

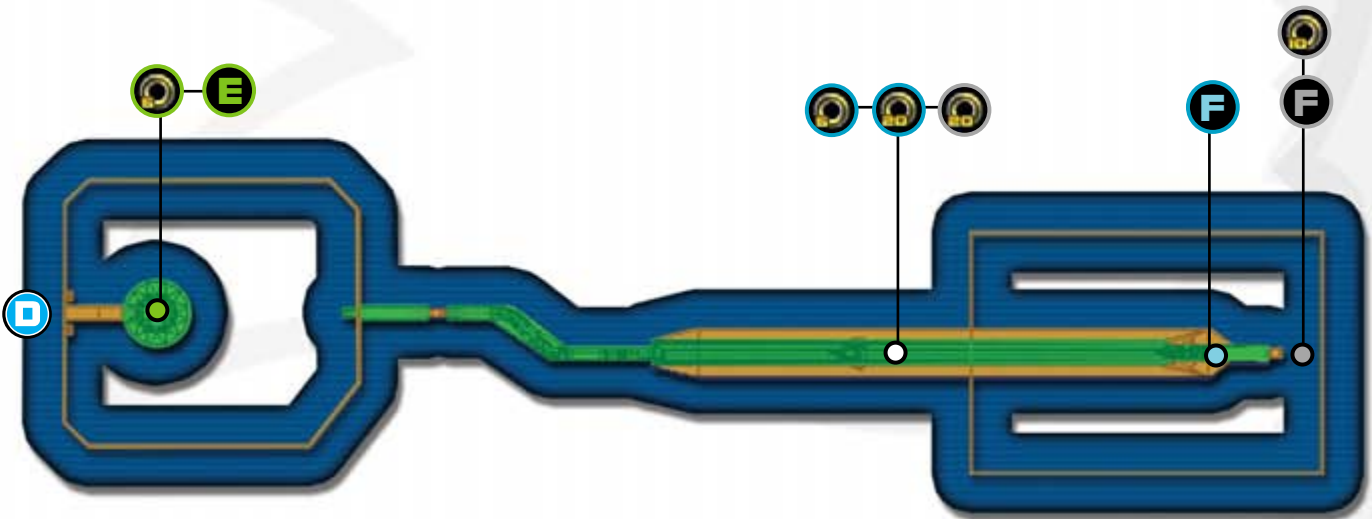



STAGE 12 MYSTIC MANSION



STAGE MAPS · MYSTIC MANSION

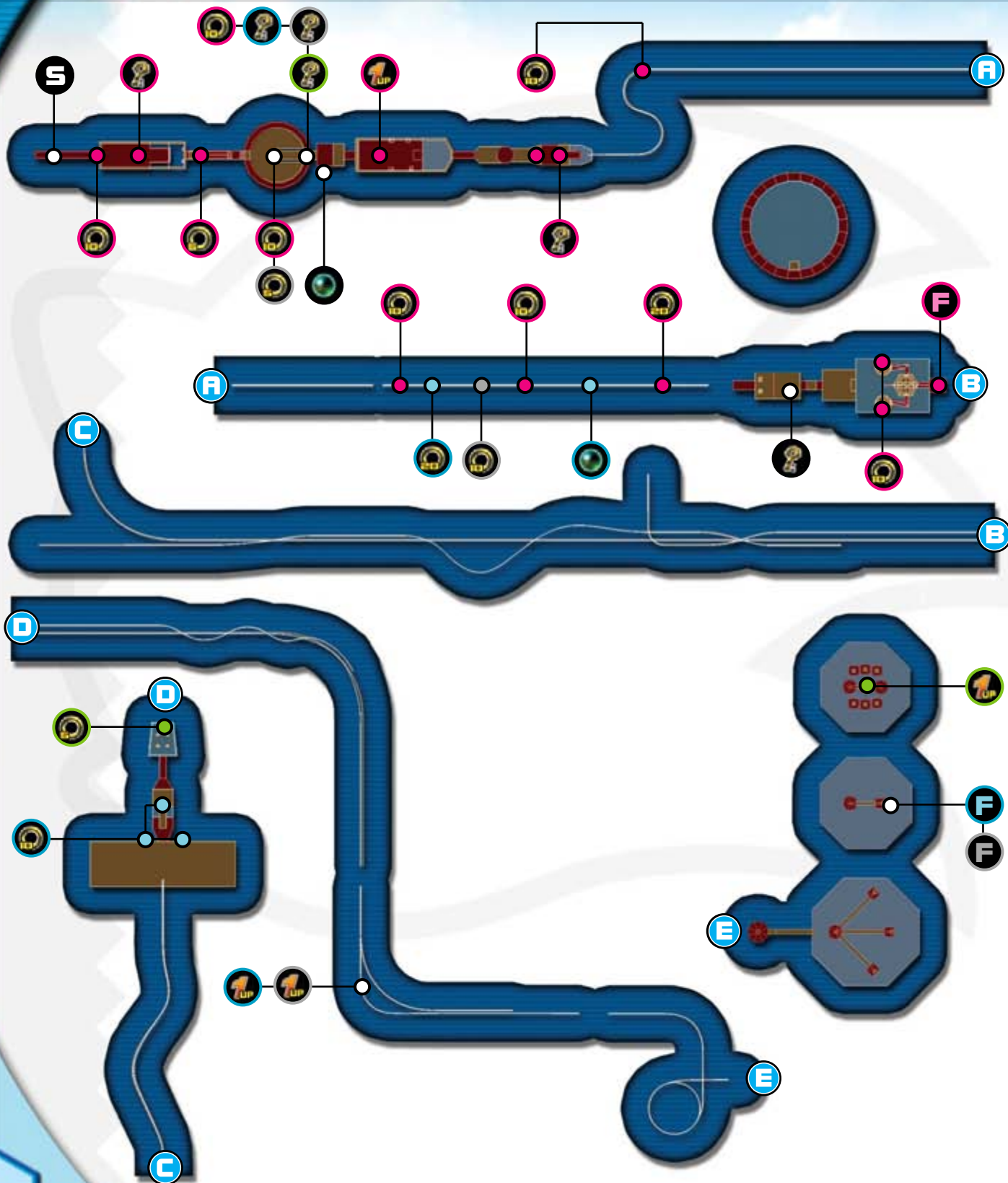

STAGE 13 EGG FLEET

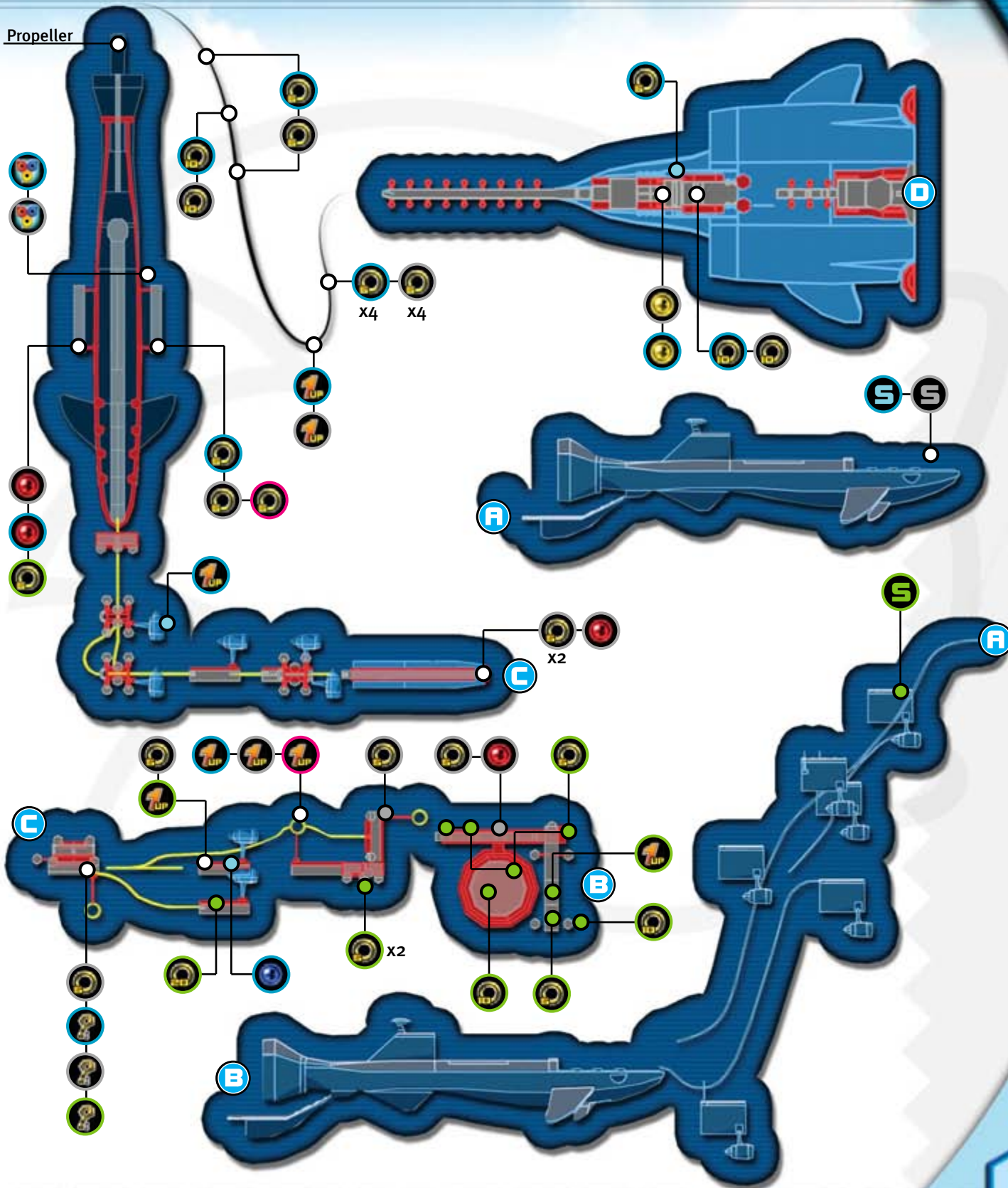

EGG FLEET · STAGE MAPS

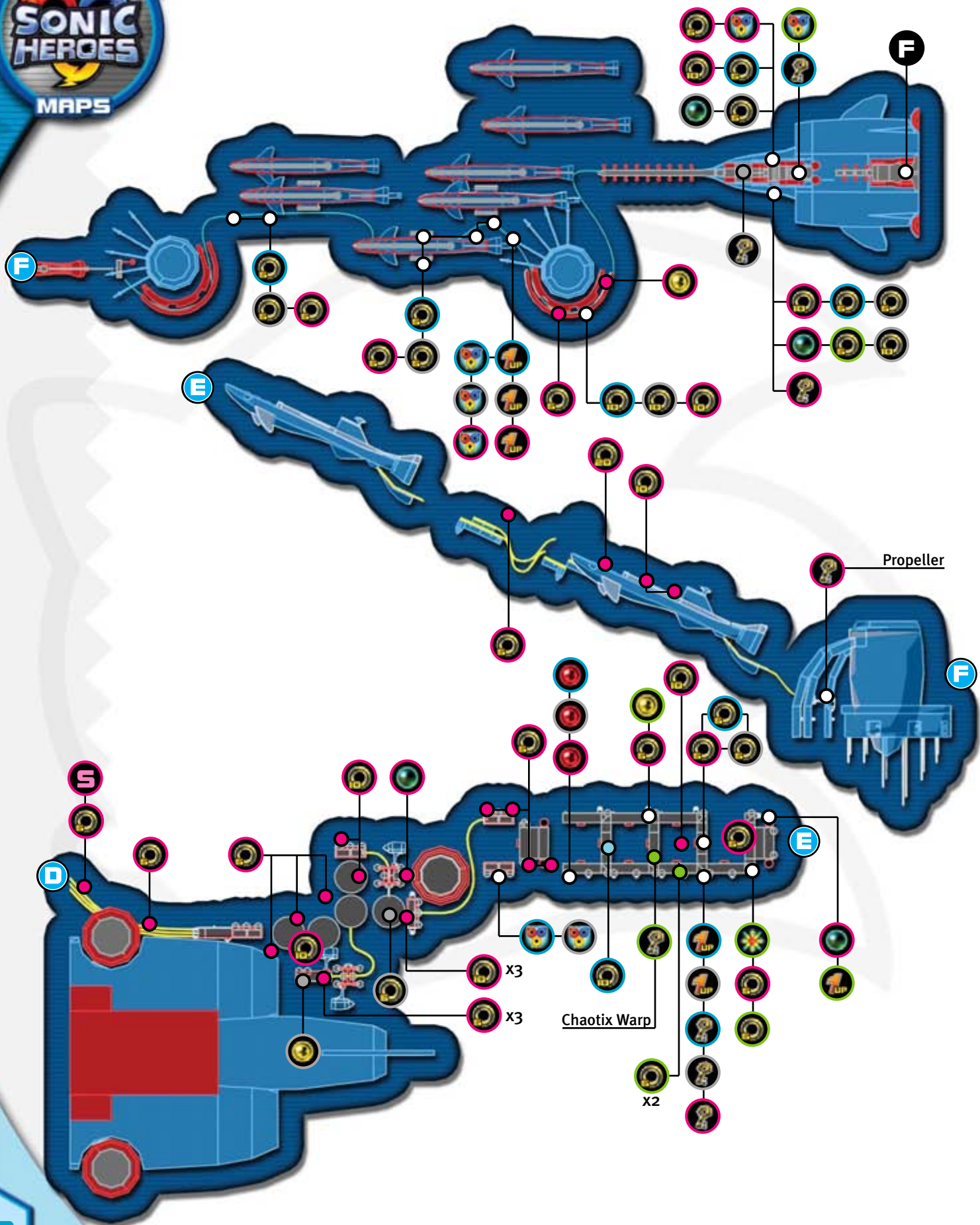

STAGE 14 FINAL FORTRESS

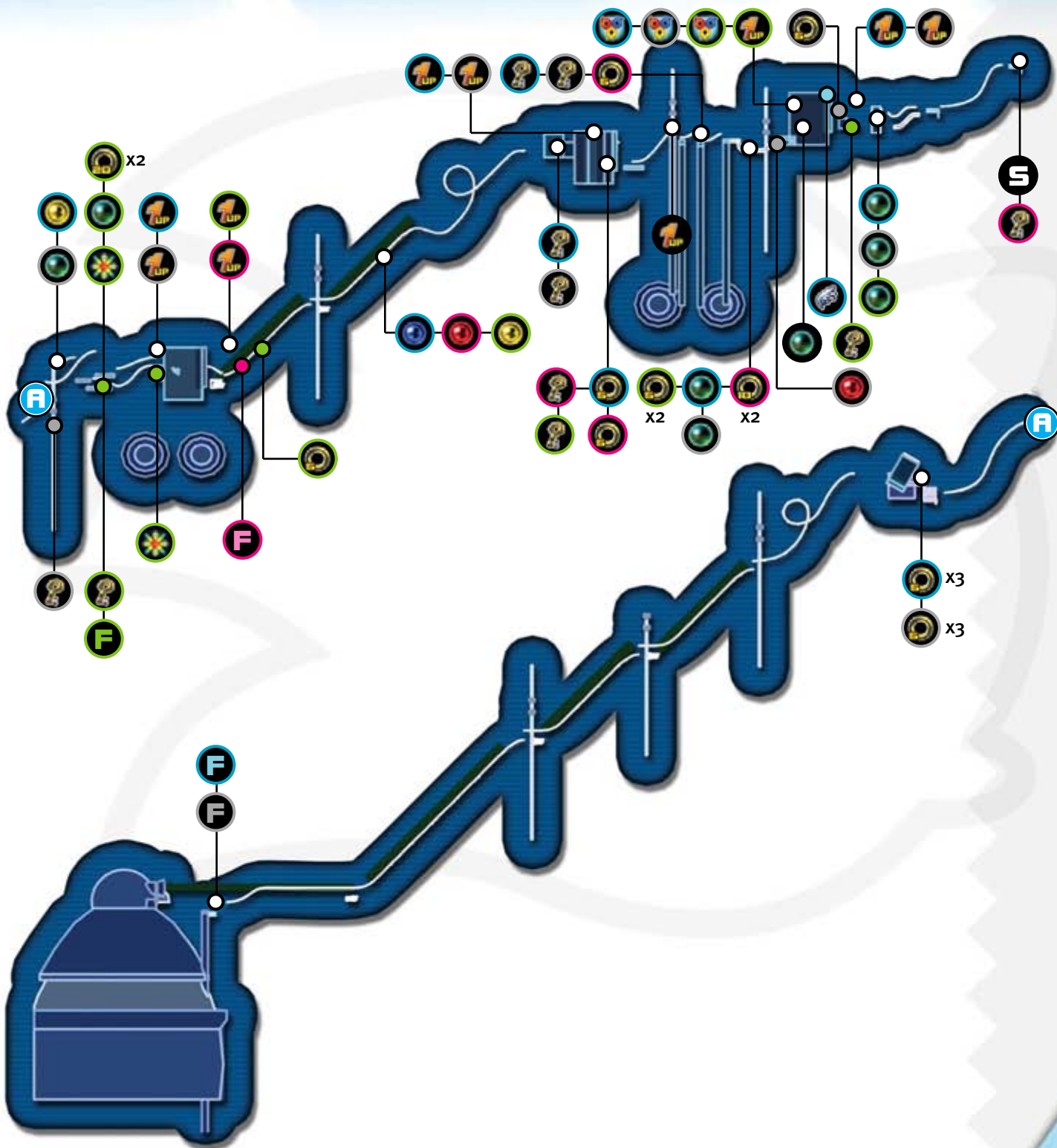

FINAL FORTRESS · STAGE MAPS



2P PLAY BATTLE MODE

ACTION RACE

Get to the Goal Ring first!

OVERVIEW



The object of Action Race is to reach the Goal Ring before your opponent does. But this is not just a race to the finish; you can attack your opponent's character and unleash a devastating Team Attack that will have various effects on your opponent regardless of their position on the course.

STRATEGY

① Save your Team Attack until your opponent has gone over a long jump. The Team Attack will stop time while it is being performed, and your opponent will lose momentum and fall off of the map. There are ways around this though.



② Both Team Rose and Team Dark have effective ways out of this. Team Rose can use their Team attack to stop all other team attacks for 5 seconds and become invulnerable from all hits. They can then use this time to get across jumps, or gain more distance on the other team. Team Dark's Team Attack will freeze time for 10 seconds. They can use this time to get across jumps safely. However, the other team can mash the buttons and rotate the control stick to make the time go down faster.



Mash the buttons to make the timer go down faster.

COURSES

Seaside Hill

① **Wide Springs at Beginning:** Use the wide springs at the beginning of the level to build meter and get Rings.



② **2nd Check Point:** This is the longest jump on the map; be cautious when your opponent has a full meter.



Grand Metropolis

① **Wide Springs:** The first wide spring can build your meter.



② **Last Check Point:** Be sure to get the last Check Point. Two jumps follow directly after it.



Bingo Highway

① **Finish Quickly:** There is not much room for battling in this Stage, so your goal should be to finish as quick as possible.



② **If You Fall, Build Meter for a Team Attack:** If you end up falling, you'll be brought back to the start of the course. Your only hope is to build meter quickly and use a Team Attack to knock your opponent off the course.



STRATEGY

① Go with the flyers! The Flying characters dominate this match. As soon as the round begins, switch to your Flying characters and start using Thunder Shot in the direction of your opponent. If you seem to end up on the receiving side of this, try to build your bar as fast as you can. Do not worry if you lose one or two characters. A Team Attack will bring all fallen characters back into play.



② If you find yourself left with either Tails or Rouge, you can start using the Thunder Shot without any of your teammates. Bad Rings will fall out in threes and act as land mines if your opponent picks them up.

BATTLE AREAS

City Top

A single power up will send a character to level 3!

Casino Ring

Destroy the crates for Level-Ups.

Turtle Shell

Activating all three stars on a wide spring will give your team a full blast.



BATTLE

Force your foes off the field!

OVERVIEW



In this mode, you and your foe are trying to knock each other off the edge of the map.



SPECIAL STAGE

Get the Chaos Emerald!

OVERVIEW



The object of the Special Stage is to reach the Chaos Emerald before your opponent does. You can go faster by going across Dash Panels or collecting either the single-colored or the star-colored balloons to gain boosts. Boosts are used with the B Button. You want to avoid the mines that are in stages 2 and 3.

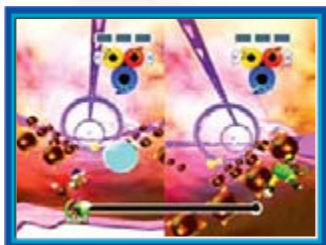

RING RACE

Get rings before time expires!

OVERVIEW



In this event, you want to collect the most Rings within a certain period of time. But be careful, because your opponent can hit you and you will lose all your Rings. A Team Blast will knock the Rings out of your opponent from anywhere on the screen, except for Team Dark. They will freeze time for 10 seconds, but this will not knock the Rings out. Saving your Team Attack for the last few seconds of the match is a great strategy to clinch a win.



COURSES

Egg Treat

The balloons carry 5 Rings each; they can be a big boost to your total Ring Count.



Pinball Match

If it's getting down to the final seconds, you can try purposely falling off the edge of the map, and then using your Team Attack to knock all of your opponent's Rings out.

Hot Elevator

Be careful, you can fall off the sides almost everywhere on this map.

BOBSLED RACE

Complete three laps first!

OVERVIEW



The key to this mode is to grab as many Rings as you can. Your main focus on the first lap is to grab as many Rings as you can, as this will make your Bobsled move a lot faster. Hitting crates will slow you down, and hitting mines will make you lose a character. The first character you lose is your Speed type, which will slow the sled down. The second is your Power type, and once he is lost you will have a hard time steering the sled. If you get hit a third time, it's game over.



COURSES

Seaside Course, City Course, Casino Course

All Bobsled races are the same. The more Rings you have the faster you go!



QUICK RACE

Get to the Goal Ring quickly!

OVERVIEW



Your goal here is to get the Goal Ring as fast as you can. You and your opponent start at opposite ends of an identical course, and the Goal Ring is in the middle. Speed is your only option here, as the match can end in a matter of seconds.



COURSES

Road Rock

You'll want to start out with your Power character and smash through the rocks. The Goal Ring is straight ahead from where you start, just watch out for the falling platform and the spinning spike balls.



Mad Express

Team Chaotix has the advantage: Espio can turn invisible and go through the laser gates! If you're not using Team Chaotix, you have to use your Flying character to get over the gates.

Terror Hall

For the large robot in the second room, use your Power character to easily drop this enemy.



EXPERT RACE

The ultimate race challenge!

OVERVIEW



In this mode, you will race your opponent on some very long, difficult courses. You must constantly watch both your own and your opponent's Team Attack meter. An untimely fall could mean the end of the race.

COURSES

**Rail Canyon
Frog Forest
Egg Fleet**

Hold on to those Team Attacks! As long as you have a Team Attack, you're in a good position.





APPENDIX



ENEMIES & ITEMS LIST



KLAGEN

Klagens can be taken out easily by using Thunder Shoot, Fire Dunk, or Homing Attack.



E-2000

Use Thunder Shoot to stun the E-2000 and then switch to Power or Speed Formation to finish it off. The E-2000 tends to block, so back off and when it lowers its guard, resume attacking.



FALCO

The Falcos are annoying little bird robots which can be taken out easiest by using Thunder Shoot.



EGG BISHOP

The Egg Bishop is an annoying robot that will heal itself and the other robots. Destroy him using any method except for a Tornado Attack. If you use your Tornado Attack on it, it will turn over and become the Egg Magician.



SOCIO PAWN

This Pawn is the most basic of enemies in the game. To defeat it, just use your Power Formation character. If you come across a pawn with a shield, then use the Tornado Attack with your Speed character to remove it.



EGG KNIGHT

The Egg Knight is just like the Egg Pawn except that it is gold colored. If you come across a group of Egg Pawns and the Egg Knight, just destroy the Knight and all of the other Egg Pawns will be destroyed.



RHYNO LINER

The Rhyno Liner is an armored train. To defeat it, use the Thunder Shoot at level.



EGG MAGICIAN

This is the alternate form of the Egg Bishop. Use the same methods as you did on the healing one. Be careful though, because if you wait too long then he will steal your Rings.



CASINO BUNNY

The Casino Bunnies (Egg Pawns) are identical to the regular Egg Pawns except that they only appear in the casino level.



BOMB FLAPPER

Flappers can be taken down easily with Thunder Shoot. If one shot of Thunder Shoot does not work, switch to Power Formation and finish it off when it's on the ground.



ENEMIES & ITEMS LIST



GOLD CAMERON

The Cameron is simple. Use Power Formation to destroy it or a Tornado Attack to flip it on its back. If you are fighting a Gold Cameron, you must flip it over first to be able to do damage to it.



EGG HAMMER

To get rid of the Egg Hammer, you can use Fire Dunk. If you use Thunder Shoot on it you will freeze him briefly. When he is done swinging the hammer, he will wobble a bit, so use Thunder Shoot or Fire Dunk to hit him and he will fall down. Once he is downed, attack continuously with Power Formation.



HEAVY-EGG HAMMER

This is just like the Egg Hammer except that it is wearing a helmet that protects him from attacks. To remove the helmet, you must get him to swing the hammer and then knock him down. After that, the only place that you will be able to hit him is in the head.

1 UP



This will increase your lives by one.

SHIELD

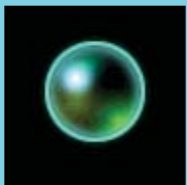

Grab this item and your team will be able to take one direct hit from an enemy.

FLY CHANGE

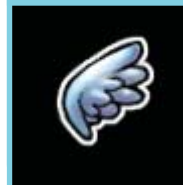

When you are flying through the air, grab this item and your flying Gauge will fill up allowing you to hover extra distance.

SPEED UP



Grabbing these shoes will increase your team's running speed for a limited amount of time.

INVINCIBLE



This item will make your team invincible for a short period of time, but beware because you can fall off a ledge and still die.

POWER CORE (YELLOW)



Power Cores come in three colors: blue, yellow, and red. Blue powers up the Speed character, yellow powers up the Flying character, and red powers up the Power character. You get a Power Core by passing through a Check Point, finding them in Item Boxes or defeating enemies.

RINGS



You can find Rings on the path or in item boxes. Rings in item boxes come in quantities of five, 10, and 20 Rings. For every 100 Rings that you collect, you will earn a 1up.

BLAST GAUGE UP



This item that looks like the Sonic Heroes logo will refill your Team Blast Gauge to full.

SPECIAL KEY



The Special Stage Key will allow you access to the Special Stage and Emerald Challenges. To get to a Special Stage however, you must finish with the Special Stage Key in hand.



STAGE FLOWCHARTS

FLOWCHARTS · UNLOCKING LEVELS/SECRETS

OVERVIEW

Sonic Heroes™ can be played in either 1P or 2P mode. 1P mode can be played with one of four teams: Team Sonic (medium difficulty), Team Dark (hard difficulty), Team Rose (easy difficulty), and Team Chaotix (objective-based missions). The two flowcharts at right depict the steps needed to progress through the game. The top chart shows the basic 1P Play Story Mode sequence. The bottom one shows how to unlock extra modes—including the game's biggest secrets!

2P MODES

To unlock additional levels in the 2P Play Mode (Level 1 is open by default), collect Emblems in the 1P Play Story Mode. You'll need 120 Emblems to unlock all seven levels (see the chart below for details):

EMBLEMS	2P MODE UNLOCKED
Collect 20	Unlock Level 2
Collect 40	Unlock Level 3
Collect 60	Unlock Level 4
Collect 80	Unlock Level 5
Collect 100	Unlock Level 6
Collect 120	Unlock Level 7

EXTRA STUFF

Here's how to unlock extra goodies hidden in the game:

Movies: Complete all the stages with each team to unlock a movie of that team in CG Theater.

View Credits: Complete all the stages with all the teams to view the Credits.

Hear Songs: Complete each stage with each team to unlock different songs in Audio Room.

FLOWCHART Basic Level Progression in 1P Play Story Mode

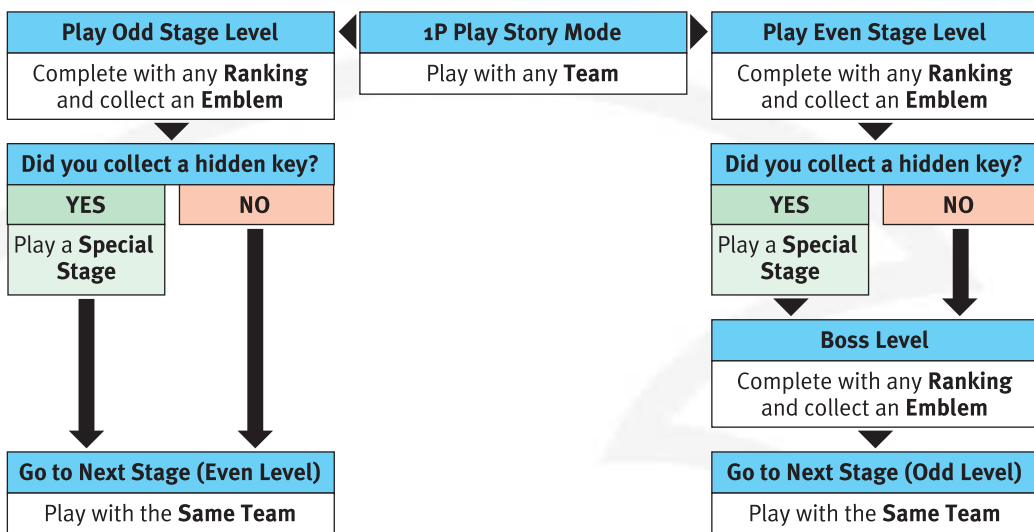

FLOWCHART Progression of Unlocking Secrets in Sonic Heroes

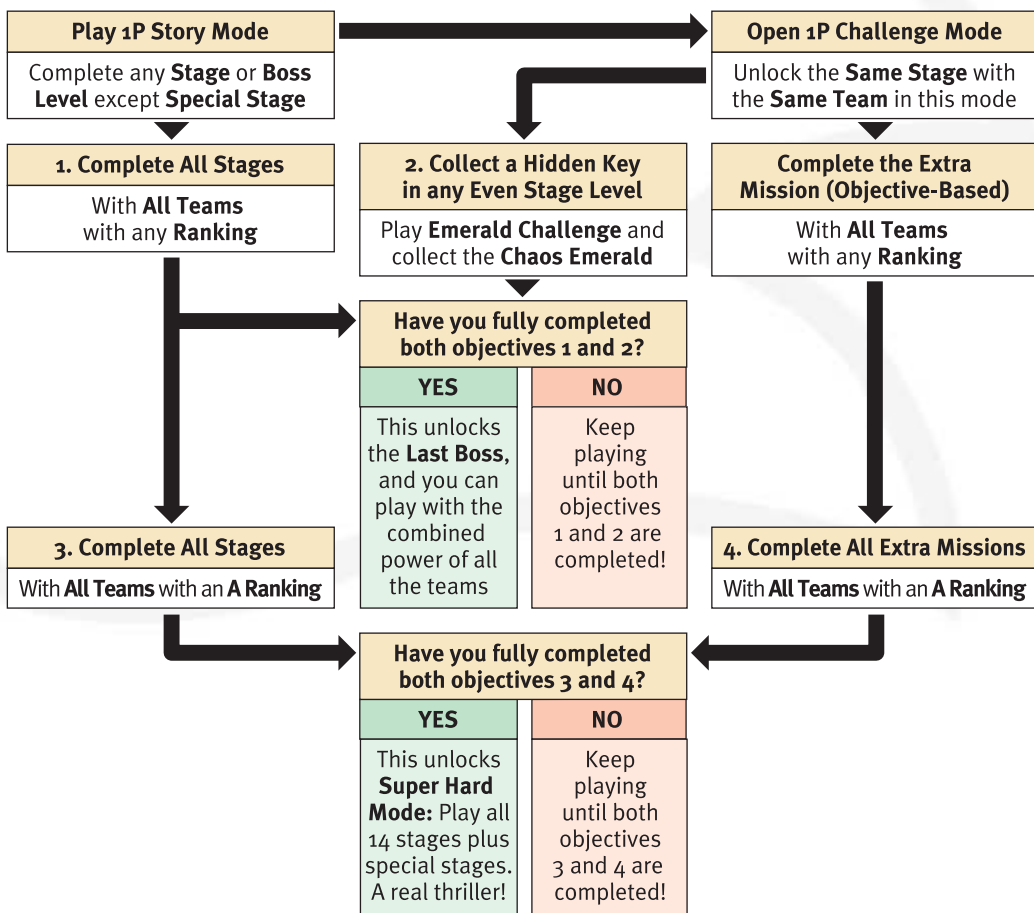

RANKINGS



STAGE	TEAM	A RANK	B RANK	C RANK	D RANK
① Seaside Hill	SONIC	60,000	55,000	50,000	45,000
	DARK	70,000	65,000	55,000	45,000
	ROSE	48,000	42,000	35,000	28,000
	CHAOTIX	45,000	40,000	35,000	28,000
② Ocean Palace	SONIC	50,000	45,000	40,000	32,000
	DARK	90,000	85,000	70,000	55,000
	ROSE	40,000	35,000	30,000	25,000
	CHAOTIX	50,000	45,000	37,000	32,000
③ Grand Metropolis	SONIC	60,000	55,000	45,000	35,000
	DARK	65,000	60,000	50,000	40,000
	ROSE	50,000	45,000	38,000	28,000
	CHAOTIX	65,000	60,000	50,000	40,000
④ Power Plant	SONIC	45,000	40,000	35,000	30,000
	DARK	72,000	62,000	52,000	42,000
	ROSE	45,000	40,000	35,000	30,000
	CHAOTIX	45,000	40,000	35,000	30,000
⑤ Casino Park	SONIC	40,000	36,000	32,000	28,000
	DARK	50,000	45,000	40,000	30,000
	ROSE	35,000	30,000	25,000	20,000
	CHAOTIX	32,000	30,000	26,000	22,000
⑥ Bingo Highway	SONIC	32,000	28,000	24,000	20,000
	DARK	42,000	35,000	28,000	20,000
	ROSE	35,000	30,000	25,000	15,000
	CHAOTIX	32,000	28,000	24,000	20,000
⑦ Rail Canyon	SONIC	35,000	30,000	25,000	20,000
	DARK	45,000	40,000	35,000	30,000
	ROSE	38,000	36,000	32,000	28,000
	CHAOTIX	32,000	28,000	24,000	20,000
⑧ Bullet Station	SONIC	40,000	35,000	30,000	20,000
	DARK	55,000	45,000	35,000	25,000
	ROSE	38,000	36,000	32,000	28,000
	CHAOTIX	32,000	28,000	24,000	20,000
⑨ Frog Forest	SONIC	35,000	32,000	28,000	25,000
	DARK	45,000	40,000	35,000	30,000
	ROSE	40,000	38,000	34,000	30,000
	CHAOTIX	40,000	38,000	34,000	30,000
⑩ Lost Jungle	SONIC	32,000	28,000	24,000	20,000
	DARK	40,000	35,000	30,000	25,000
	ROSE	42,000	38,000	32,000	28,000
	CHAOTIX	40,000	36,000	32,000	28,000
⑪ Hang Castle	SONIC	45,000	40,000	35,000	30,000
	DARK	65,000	60,000	55,000	45,000
	ROSE	45,000	40,000	35,000	30,000
	CHAOTIX	35,000	30,000	25,000	20,000
⑫ Mystic Mansion	SONIC	36,000	32,000	28,000	20,000
	DARK	58,000	50,000	40,000	25,000
	ROSE	45,000	40,000	35,000	25,000
	CHAOTIX	25,000	20,000	15,000	10,000
⑬ Egg Fleet	SONIC	20,000	18,000	15,000	10,000
	DARK	30,000	28,000	23,000	18,000
	ROSE	40,000	35,000	30,000	23,000
	CHAOTIX	33,000	30,000	25,000	15,000
⑭ Final Fortress	SONIC	62,000	57,000	47,000	35,000
	DARK	100,000	90,000	80,000	60,000
	ROSE	36,000	33,000	25,000	20,000
	CHAOTIX	65,000	60,000	50,000	40,000

BOSS STAGE	TEAM	A RANK	B RANK	C RANK	D RANK
① Egg Hawk	ALL TEAMS	1:00	2:00	3:00	4:00
② Team Battle 1	ALL TEAMS	0:30	1:00	1:30	2:30
③ Robot Carnival	SONIC	2:30	3:30	4:30	5:30
	DARK	3:00	4:00	5:00	6:00
	ROSE	1:30	2:30	3:30	4:30
	CHAOTIX	3:00	4:00	5:00	6:00
④ Egg Albatross	ALL TEAMS	2:00	3:00	4:00	5:00

EXTRA STAGE	TEAM	TARGET	GOAL	A RANK	B RANK	C RANK	D RANK
① Seaside Hill	SONIC	TIME	5:00	50,000	45,000	40,000	32,000
	DARK	ENEMY	100	7:00	7:30	9:00	11:00
	ROSE	RINGS	200	2:30	3:00	4:00	6:00
	CHAOTIX	TARGET	20	35,000	30,000	25,000	18,000
② Ocean Palace	SONIC	TIME	5:00	45,000	40,000	35,000	30,000
	DARK	ENEMY	100	5:00	5:30	7:00	9:00
	ROSE	RINGS	200	5:30	6:00	7:00	9:00
	CHAOTIX	TARGET	—	43,000	40,000	30,000	25,000
③ Grand Metropolis	SONIC	TIME	5:00	58,000	52,000	42,000	32,000
	DARK	ENEMY	100	8:00	8:30	9:30	11:00
	ROSE	RINGS	200	3:45	4:30	5:00	7:00
	CHAOTIX	TIME	8:00	60,000	55,000	40,000	35,000
④ Power Plant	SONIC	TIME	9:00	40,000	35,000	30,000	25,000
	DARK	ENEMY	100	7:00	8:00	9:00	10:00
	ROSE	RINGS	200	3:30	4:00	4:30	5:00
	CHAOTIX	TARGET	5	40,000	35,000	30,000	25,000
⑤ Casino Park	SONIC	TIME	5:00	45,000	40,000	35,000	30,000
	DARK	ENEMY	100	10:00	10:30	11:00	12:00
	ROSE	RINGS	200	4:00	6:00	8:00	10:00
	CHAOTIX	RINGS	500	14,000	12,000	10,000	8,000
⑥ Bingo Highway	SONIC	TIME	6:00	32,000	30,000	28,000	26,000
	DARK	ENEMY	100	12:00	12:30	13:00	14:00
	ROSE	RINGS	200	3:30	4:00	4:30	5:00
	CHAOTIX	TARGET	20	20,000	18,000	15,000	12,000
⑦ Rail Canyon	SONIC	TIME	5:00	35,000	30,000	25,000	20,000
	DARK	ENEMY	100	10:30	11:00	11:30	12:30
	ROSE	RINGS	200	4:00	4:30	5:00	5:30
	CHAOTIX	TIME	6:00	34,000	32,000	30,000	25,000
⑧ Bullet Station	SONIC	TIME	6:00	40,000	38,000	35,000	30,000
	DARK	ENEMY	100	11:30	12:00	12:30	13:30
	ROSE	RINGS	200	4:00	4:30	5:00	5:30
	CHAOTIX	TARGET	ALL	26,000	24,000	20,000	15,000
⑨ Frog Forest	SONIC	TIME	5:00	38,000	35,000	30,000	28,000
	DARK	ENEMY	100	14:00	14:30	15:00	16:00
	ROSE	RINGS	200	3:30	4:00	4:30	5:00
	CHAOTIX	TIME	4:00	42,000	40,000	36,000	32,000
⑩ Lost Jungle	SONIC	TIME	6:00	30,000	28,000	26,000	24,000
	DARK	ENEMY	100	14:00	14:30	15:00	16:00
	ROSE	RINGS	200	4:00	4:30	5:00	5:30
	CHAOTIX	TARGET	20	32,000	28,000	24,000	18,000
⑪ Hang Castle	SONIC	TIME	6:00	45,000	43,000	40,000	38,000
	DARK	ENEMY	100	11:00	11:30	12:00	13:00
	ROSE	RINGS	200	3:30	4:00	4:30	5:00
	CHAOTIX	TARGET	—	23,000	20,000	18,000	15,000
⑫ Mystic Mansion	SONIC	TIME	7:00	36,000	32,000	28,000	24,000
	DARK	ENEMY	100	11:00	11:30	12:00	13:00
	ROSE	RINGS	200	3:30	4:00	4:30	5:00
	CHAOTIX	TARGET	44	20,000	18,000	15,000	10,000
⑬ Egg Fleet	SONIC	TIME	9:00	30,000	25,000	18,000	10,000
	DARK	ENEMY	100	13:30	14:30	15:30	16:30
	ROSE	RINGS	200	5:00	5:30	7:00	9:00
	CHAOTIX	TIME	6:00	30,000	27,000	22,000	15,000
⑭ Final Fortress	SONIC	TIME	9:00	40,000	37,000	27,000	20,000
	DARK	ENEMY	100	12:00	13:00	14:00	15:00
	ROSE	RINGS	200	4:30	5:00	6:00	8:00
	CHAOTIX	TARGET	10	55,000	50,000	40,000	30,000

BOSS STAGE	TEAM	A RANK	B RANK	C RANK	D RANK
⑤ Team Battle 2	ALL TEAMS	0:30	1:00	1:30	2:30
⑥ Robot Storm	SONIC	4:00	5:00	6:00	7:00
	DARK	6:00	7:00	8:00	9:00
	ROSE	2:00	3:00	4:00	5:00
	CHAOTIX	4:00	5:00	6:00	7:00
⑦ Egg Empire	ALL TEAMS	3:30	4:30	5:30	6:30
⑧ Metal 1/2	ALL TEAMS	7:00	8:00	9:00	10:00