

# PRIMA'S OFFICIAL STRATEGY GUIDE



Mario De Govia  
Tri Pham  
Jeff Barton  
Michael Littlefield  
Brandon Smith  
Damien Waples



[primagames.com](http://primagames.com)



Dreamcast



# SONIC™ ADVENTURE 2

## PRIMA'S OFFICIAL STRATEGY GUIDE

Mario De Govia, Tri Pham, Jeff Barton, Michael Littlefield, Brandon Smith, Donato Tica, Damien Waples

**Prima Games**  
A Division of Prima Communications, Inc.

3000 Lava Ridge Court  
Roseville, CA 95661  
(800) 733-3000  
www.primagames.com



The Prima Games logo is a registered trademark of Prima Communications, Inc., registered in the United States and other countries. Primagames.com is a registered trademark of Prima Communications, Inc. in the United States.

© 2001-2004 by Prima Games. All rights reserved. No part of this book may be reproduced or transmitted in any form or by any means, electronic or mechanical, including photocopying, recording, or by any information storage or retrieval system without written permission from Prima Publishing.

Project Editor: Jill Hinckley  
Editorial Assistant: Michelle Pritchard  
Product Manager: Sara E. Wilson

Design Team: Melissa Francis, Marc Riegel, James Knight

Sega is registered in the U.S. Patent and Trademark Office. Sega, Dreamcast, the Dreamcast logo, Sonic The Hedgehog and Sonic Adventure are either registered trademarks or trademarks of Sega Corporation. ©SEGA CORPORATION, 2000, 2001 SEGA/SONIC TEAM. All Rights Reserved. Sega of America Dreamcast, Inc., P.O. Box 7639, San Francisco, CA 94120-7639. www.sega.com

All products and characters mentioned in this book are trademarks of their respective companies.

Important: Prima Games has made every effort to determine that the information contained in this book is accurate. However, the publisher makes no warranty, either expressed or implied, as to the accuracy, effectiveness, or completeness of the material in this book; nor does the publisher assume liability for damages, either incidental or consequential, that may result from using the information in this book. The publisher cannot provide information regarding game play, hints and strategies, or problems with hardware or software. Questions should be directed to the support numbers provided by the game and device manufacturers in their documentation. Some game tricks require precise timing and may require repeated attempts before the desired result is achieved.

ISBN: 7615-3614-0

Library of Congress Catalog Card Number: 001089934

### WHAT'S INSIDE

<b>The Beginning</b> . . . . .	2	<b>Hero Stage 15: Crazy Gadget</b> . . . . .	83
<b>Moves and Permanent Power-Ups</b> . . . . .	4	<b>Hero Stage 16: Final Rush</b> . . . . .	90
<b>Game Basics</b> . . . . .	8	<b>Dark Stage 1: Iron Gate</b> . . . . .	97
<b>Items</b> . . . . .	10	<b>Dark Stage 2: Dry Lagoon</b> . . . . .	102
<b>Interactive Objects</b> . . . . .	12	<b>Dark Stage 3: Sand Ocean</b> . . . . .	105
<b>Enemies</b> . . . . .	16	<b>Dark Stage 4: Radical Highway</b> . . . . .	109
<b>Using This Book</b> . . . . .	18	<b>Dark Stage 5: Egg Quarters</b> . . . . .	113
<b>Hero Stage 1: City Escape</b> . . . . .	22	<b>Dark Stage 6: Lost Colony</b> . . . . .	117
<b>Hero Stage 2: Wild Canyon</b> . . . . .	27	<b>Dark Stage 7: Weapons Bed</b> . . . . .	121
<b>Hero Stage 3: Prison Lane</b> . . . . .	31	<b>Dark Stage 8: Security Hall</b> . . . . .	125
<b>Hero Stage 4: Metal Harbor</b> . . . . .	35	<b>Dark Stage 9: White Jungle</b> . . . . .	130
<b>Hero Stage 5: Green Forest</b> . . . . .	40	<b>Dark Stage 10: Route 280</b> . . . . .	135
<b>Hero Stage 6: Pumpkin Hill</b> . . . . .	46	<b>Dark Stage 11: Sky Rail</b> . . . . .	137
<b>Hero Stage 7: Mission Street</b> . . . . .	50	<b>Dark Stage 12: Mad Space</b> . . . . .	143
<b>Hero Stage 8: Aquatic Mine</b> . . . . .	55	<b>Dark Stage 13: Cosmic Wall</b> . . . . .	149
<b>Hero Stage 9: Route 101</b> . . . . .	59	<b>Dark Stage 14: Final Chase</b> . . . . .	154
<b>Hero Stage 10: Hidden Base</b> . . . . .	61	<b>Cannon's Core</b> . . . . .	160
<b>Hero Stage 11: Pyramid Cave</b> . . . . .	65	<b>Kart Race</b> . . . . .	167
<b>Hero Stage 12: Death Chamber</b> . . . . .	69	<b>The Chao Primer</b> . . . . .	168
<b>Hero Stage 13: Eternal Engine</b> . . . . .	74	<b>Two-Player Mode</b> . . . . .	174
<b>Hero Stage 14: Meteor Herd</b> . . . . .	79	<b>Secrets</b> . . . . .	175

The authors would like to thank their families, the Prima team, and Steve Peck at Sega for his expert advice. Prima thanks Takashi Iizuka, Jane Thompson, Robert Leffler, Keith Palmer, and the rest of the Sonic Team for their assistance.



## THE BEGINNING

Our story starts 50 years ago. The world-renowned scientist, Professor Gerald, had just completed a revolutionary space colony called "ARK." Professor Gerald was a supergenius, having mastered many areas of study, including architecture, science, and astrology. However, he was most noted for his achievements in the field of biology. While aboard ARK, he was secretly working on a dangerous experiment, where he attempted to unlock the mysteries of life. He wanted to discover the secret of immortality by creating the ultimate life form. This secret project was called "Shadow."

Professor Gerald enjoyed the solitude of ARK as it allowed him the peace to work and care for his granddaughter Maria, who needed constant attention due to her illness. She was very weak and frail, but Maria meant the world to the professor. His research was conducted in part to help her weakening condition. After years of research, Professor Gerald succeeded in creating the first prototype of the ultimate life form, Shadow. But the experiments turned out to be a very dangerous and costly endeavor. Somehow, the military discovered what the professor had been working on and tried to take possession of the prototype. Before the professor was captured, he attempted to get Maria and Shadow out safely. Both were to board a space capsule and escape to earth. But something went terribly wrong...Maria managed to get Shadow into the capsule, but before she could board, she was killed. Shadow's last memories were with Maria....

The professor was taken to Prison Island, where he was forced to continue his experiments under military control. He was content knowing that both Maria and Shadow had safely escaped, although such was not the case. The military managed to retrieve the capsule containing Shadow and bring it back to Prison Island for the professor to continue his research. Discovering that Maria had been killed, the professor went into a rage. He vowed to avenge his granddaughter's death with a fury that this world had never known.

His rage drove the professor completely insane. While it was thought that he was continuing his research with Shadow, he was secretly plotting his revenge on the world. Unbeknownst to the military, ARK contained within its core superstructure, a very powerful laser called the Eclipse Cannon. The professor had quietly reprogrammed it to harness the power of the Chaos Emeralds and unleash a powerful laser blast at earth. He then biologically implanted his own will for revenge into Shadow to ensure that nothing would be able to stop him from avenging the death of his granddaughter. Soon afterward, the military incarcerated Professor Gerald for fear of what he might do in retaliation. Knowing only of the dangers of project Shadow, the military sealed the island and abandoned the professor's research.

After Professor Gerald's death, his grandson, Dr. Robotnik, discovered a laboratory notebook containing information on his grandfather's research: the experiments with Shadow and his plans to destroy the earth. Armed with this lethal knowledge, Robotnik, also known as Eggman, soon became obsessed with finding Shadow to help him carry out his own evil plan of world domination. And so the adventure continues....

## CHARACTERS

### Sonic the Hedgehog

Sonic is always on the move. When faced by his formidable enemy, Eggman, Sonic wins every time. He thinks that saving the world is no big feat, and he always helps the underdog. Sonic hates boredom and is consistently looking for his next adventure.

Sonic lives by his own rules, never thinking twice about what others perceive of him, and driven by his own desires. He was born to run, and he loves to cover as much ground as fast as he can. His demeanor is always cool and calm. When he finds himself in a pinch, he acts as though nothing can stop him. Cool all the way. When faced with a serious situation, he bears down and becomes intensely focused on the challenge.



### Miles "Tails" Prower

Tails is a young fox with a knack for building things. He's as talented as Eggman but has yet to discover the true potential of what he can accomplish. Sonic has taken Tails under his wing and treats him like a younger brother. Tails wants to prove to Sonic that he's someone Sonic can count on.

Besides his ability to fly using his tails, he has become an experienced pilot of his newly designed plane, the "Tornado." Tails's natural talent for building things helps Sonic more than ever this time around.



## THE BEGINNING

### Knuckles the Echidna

Knuckles was born on Angel Island and brought into this world to defend the Master Emerald. This is his destiny. If Sonic exemplifies the wind, then Knuckles is the mountain, stern and unmovable.

Wild and tough, his determination is unshakable. Knuckles thinks of Sonic as a rival, but is often envious of the adventurous lifestyle he lives and the fame that follows. He is a well-known treasure hunter versed in the martial arts.



### Omochao

These are the cute mechanical toy Chao that help you navigate Sonic's second adventure. They have been programmed to give you a tutorial of many new features in the game. Use their advice wisely, and you'll find that they will be your best Chao friend!



primagames.com



### Dr. Robotnik, a.k.a. Eggman

His nickname says it all. He's a scientist with a body shaped like an egg. With an IQ of 300, he's a certifiable genius, but his childish demeanor makes him believe that taking over the world is easy. Although he seems to think he has a master plan, he's never quite sure how he's going to pull it off.

Sonic and his friends make fun of Dr. Robotnik by calling him Eggman. In turn, Eggman views Sonic as his archenemy who always seems to spoil his plans of world conquest. Somewhere deep in his heart, though, he may have a certain fondness for Sonic.

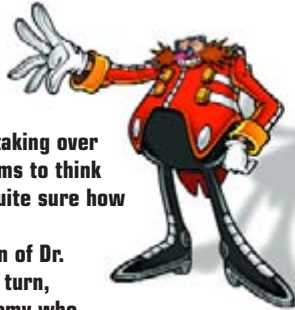

### Amy Rose

Amy has a one-track mind. She's infatuated with Sonic and his lifestyle of adventure and fun. A girl with little patience, she's very stubborn once her mind is set. Even though Sonic desperately tries to avoid her, she is relentless in her pursuit.

She is often the initiator, always pushing others to act on her every whim. Amy is hard to discourage and very strong-willed. Amy believes she must save Sonic, who has been captured by the army and sent to Prison Island. Her senses are sharp and she has a pure heart. Sonic feels Amy is sometimes more trouble than she's worth, but deep down he may actually have some feelings for her.



### Shadow the Hedgehog

Shadow is the spitting image of Sonic, except for his black body. Created by the world's most intelligent scientist, Professor Gerald, Shadow is ageless and immortal. He has the special ability to harness the power of the Chaos Emerald, which enables him to warp time and space.

Sharp-witted and willing to do whatever it takes to get what he wants, he always seems to be on the edge. The little girl he grew up with, and who he was very fond of, was violently killed in front of his eyes, gasping her final wish for him to save the world. Traumatized by the grief of her death, Shadow is determined to keep the promise he made to her.



### Professor Gerald Robotnik

Also known as Alchemist Gerald, he is Dr. Eggman's grandfather. Of all the genius scientists, Professor Gerald is the most intelligent. He has mastered many areas of study, from genetics to astrophysics to robotics, and is a modern day scientific Da Vinci. He looks very similar to Eggman, but is far more serious about his work. He invented the first space colony, ARK, and created various machines that can harness the power of the Chaos Emerald.

At the peak of his career fifty years ago, he was working on a secret project in the colony when there was a terrible accident, causing ARK to shut down. He took full responsibility and was incarcerated by the government. As a result, he went insane and died a broken man.



### Rouge the Bat

Rouge is a world-famous treasure hunter who loves jewels. The president hired Rouge to uncover information about the mysterious project "Shadow." This fearless female bat is full of sex appeal and knows how to get what she wants.

Although she looks innocent and carefree, she's always scheming. Once she makes a decision, her motives are always mercenary in nature.



### Maria Robotnik

Frail in appearance but strong in spirit, Maria is the granddaughter of Professor Gerald and one of Eggman's cousins. She was the jewel of the professor's eye.

Maria was born and raised on ARK along with Shadow, whom she considered a brother of sorts. She was physically very weak and couldn't leave the hospital. Looking down on Earth from ARK, she developed an interest in it and longed to go there. To cure her illness, the Professor began his research on the ultimate life-form. Ultimately, though, this research led to the terrible accident that ended her life. The results of his experiments and data were not enough to save her.



# MOVES AND PERMANENT POWER-UPS

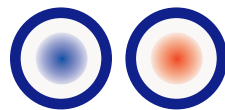

## ALL CHARACTERS

Although each character has his or her own special moves, all characters have a few moves in common. These common moves are described here.

### Walk and Run

The most basic moves are walk and run. Press the analog thumb pad in any direction to move your character that way. The farther you push, the faster they run. For controlled, precise movement, use walk.



### Jump

Get used to jumping because you'll be doing it a lot. Press **A** to initiate the jump. Holding down the button increases jump height.



### Whistle

How do you call an animal? Why, whistle, of course! When you're near a pipe, press **B** or **X** to whistle. Before long, a cuddly little animal should be at your feet.



### Mystic Melody

Each Stage has at least one Ancient Ruin. To bring these dormant ruins to life, each character must first find and then play his or her specific Mystic Melody. When you have done so, stand on or near an Ancient Ruin and press **B** or **X**. Upon doing so, new areas become available, revealing something very special—normally a lost Chao, but sometimes another power-up.



## SONIC AND SHADOW

Dust off your twitch reflexes, because speed is what Sonic and Shadow are all about. Undoubtedly the two fastest characters in the game, these hedgehogs will put your nerves to the test in the blink of an eye. Be ready to use any of these attacks at a moment's notice.

### Jumping

Sonic and Shadow can both use their simple jump as an attack. Position them over an enemy after pressing **A** and watch them smash the baddies. It's slow but precise.



### Homing Attack

Press **A** to perform a regular jump. Then, in mid-air, tap **A** again to zero in on and strike a nearby enemy. This quick attack is a great way to dispose of dangerous enemies while covering good distance. Link multiple Homing Attacks to cross areas where jumping alone doesn't reach.



### Somersault

Tap **B** or **X** while standing or running to perform the Somersault. More than just a fancy move, the Somersault is a powerful weapon. Use it to break through Wooden Containers or mow down enemies. This is one of the more versatile moves in your arsenal.



Need to get through a tight spot? The Somersault will squeeze you through.

### NOTE

You can break only Wooden Containers until you find the Flame Ring. With the Flame Ring, Metal Boxes can be broken.



### Spin Dash

Hold **B** or **X** while standing or running to charge up your spin. Release the button and watch Sonic or Shadow take off in a burst of colorful speed. In this state, you can defeat enemies as well. The drawback to all this speed is imprecise control. Watch yourself around cliffs or high edges. You wouldn't want to fall off, would you?



## MOVES AND PERMANENT POWER-UPS

### Light Dash

When near a string of rings, tap **B** or **X** to perform the Light Dash. Sonic and Shadow will be sent soaring through the rings at lightning speeds. This move maximizes the number of rings you pick up. To perform this attack, Sonic must first find his Light Shoes, and Shadow his Air Shoes.

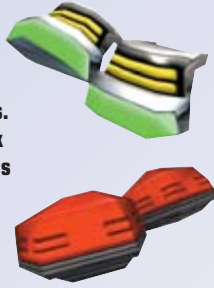

### Light Speed Attack

Once you find their Ancient Light, Sonic and Shadow are able to home in on and destroy multiple enemies within range. Hold down **B** or **X** until you stop spinning, then release.



### Bounce Attack (Sonic Only)

For some high-flying, destructive action, find Sonic's Bounce Bracelet. To use the Bounce Attack, press **B** or **X** in midjump. Continue bouncing to increase height. You can destroy enemies and reach higher ledges.



### Magic Gloves (Sonic Only)

Find Sonic's Magic Gloves and you can throw an enemy at his buddy. How? Approach an enemy and call up the Action Window by pressing **Y** until you see Magic Gloves. Hit **B** or **X** to suck your enemy right into your grubby little hands. Not only have you eliminated one enemy, but you can now throw your newly-eliminated foe at another one.



primagames.com

## TAILS AND DR. EGGMAN

Tails and Dr. Eggman are the slowest of the characters, but who needs speed when you have the firepower that these two have? Destroying enemies from a distance is only the beginning. Their specialty is to target multiple enemies and destroy them without further thought.

### Shoot

Press **B** or **X** to fire a shot at an enemy or containers. Use the analog thumb pad to aim.



The Volkan Cannon—the basic projectile weapon for both characters—can only destroy Wooden Containers until you find Tails' Bazooka or Dr. Eggman's Large Cannon. Once you find those, even Steel Containers will shatter under your firepower. If you think that's impressive, wait until you find their Laser Blasters.

### Lock-on Missile

Hold **B** or **X** to lock on to your enemy with the targeting laser. Use the analog thumb pad to aim. Once locked on, release the button to fire a homing Lock-on Missile. The Missile seeks and effortlessly destroys your enemy. You can lock on to multiple targets before releasing the button for bonus points. Once you get the Laser Blaster power-up, your rate of fire increases. Now your Lock-on Missiles will fire faster.



### Hovering

Find Tails' Booster and Dr. Eggman's Jet Engine to upgrade your walkers. Press **A** to perform a regular jump. While in mid-air, press and hold **A** again to hover. You'll stay in the air longer, but you'll slowly sink as you hover. Use this to cover distances that a normal jump won't reach.



## Propeller Punch or Punch

These attacks are fun and effective. The main drawback is that you have to be right next to an enemy to use it. When you're up close, press **B** and a battering ram will pop out. For Tails it's a propeller and for Dr. Eggman it's a boxing glove.



## Protection Armor (Dr. Eggman Only)

The Protection Armor increases Dr. Eggman's health.



# KNUCKLES AND ROUGE

Knuckles and Rouge are the most agile of the bunch, and with their ability to glide and climb walls, perhaps the most versatile. They're both after the same thing in their stages: Emerald pieces or Keys. Their skills are honed accordingly.



## Punch or Kick Attack

Knuckles' Punch and Rouge's Kick Attack are performed by pressing **B** or **X**. Use this powerful attack to dispose of enemies and obstacles. Press twice to double the fun with a one-two Punch or Kick.

When **B** or **X** is pressed a third time in a row, Knuckles and Rouge add a Jump Punch or Kick to their one-two move. This is perfect for indiscriminately clearing an area of enemies or obstacles.



Grab Knuckles's Hammer Gloves and Rouge's Iron Boots for added "punch" (or kick). Steel Containers don't stand a chance.



## Sliding Attack

The Sliding Attacks are the same as the Punch or Kick attacks except that they are performed while running. The single and one-two Punch or Kick combos cover some good distance while running. The third button press is a little different, however. Pressing **B** or **X** a third time while running shoots you directly forward instead of up.



## Gliding

In midjump, hold **A** to begin Gliding. Use the analog thumb pad to control your direction. Aim your fists at an enemy or obstacle to attack them. Be careful not to touch the enemy or obstacle with any other part of your body or you'll take damage. Release **A** to drop down. Press **A** again before hitting the ground if you wish to continue Gliding.



## Dig

To find some of the more well hidden items, you must Dig. Find Knuckles's Shovel Claw and Rouge's Pick Nails before attempting to Dig. To Dig for possibly valuable treasure, press **Y**, select Dig, then press **B** or **X**. You can also Dig by pressing **B** or **X** in midjump. When climbing walls, try **B** or **X**. Most walls are soft enough to Dig into.

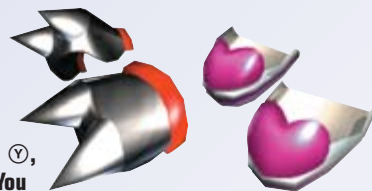

## Climb Wall

Both Knuckles and Rouge have the ability to Climb most walls. They will automatically grab onto nearby walls during Jumps or Glides. Note that while climbing, you can Dig into most walls.



## Air Necklace (Knuckles Only)

The Air Necklace literally gives Knuckles air to breathe. Once you find it, Knuckles can stay underwater indefinitely. No need for any special button presses; the Air Necklace works automatically.



## Spiral Upper or Screw Kick

Rotate the analog thumb pad in a circle and then press the **B** or **X** button. Rouge or Knuckles will perform an uppercut, enabling them to get containers above them in midair.

## MOVES AND PERMANENT POWER-UPS



primagames.com



### Sunglasses and Treasure Scope

Hidden in their respective Stages are Knuckles's Sunglasses and Rouge's Treasure Scope. When found and accessed through the Action Window, these power-ups give their owners special sight. With these on, you can see items and treasure that weren't visible before. In Hard Mode, more Hint Boxes are also available. To take off the Sunglasses or Scope, simply Jump.



### Swimming

Both of the treasure hunters need to take a dip every now and then. Jump in the water and press and hold **B** to dive. As soon as you let go of **B**, you'll begin to rise. To rise quickly, press and hold **A**.



## PERMANENT POWER-UP EFFECTS AND LOCATIONS

Character	Power-Up	Stage	Special Requirements	Action
Sonic	Magic Gloves	1: City Escape	Bounce Attack, Flame Ring	Captures enemies in hand-held bubble
Sonic	Light Shoes	4: Metal Harbor	—	Enables Light Dash ability
Sonic	Ancient Light	5: Green Forest	—	Attacks multiple enemies
Sonic	Bounce Bracelet	11: Pyramid Cave	—	Allows greater height in attacks
Sonic	Flame Ring	15: Crazy Gadget	—	Breaks Steel Containers
Sonic	Mystic Melody	16: Final Rush	—	Plays Mystic Melody to activate Ancient Ruin
Shadow	Flame Ring	4: Radical Highway	Air Shoes	Breaks Steel Containers
Shadow	Air Shoes	9: White Jungle	—	Enables Light Dash ability
Shadow	Ancient Light	11: Sky Rail	—	Attacks multiple enemies
Shadow	Mystic Melody	14: Final Chase	—	Plays Mystic Melody to activate Ancient Ruin
Knuckles	Mystic Melody	2: Wild Canyon	Shovel Claw	Plays Mystic Melody to activate Ancient Ruin
Knuckles	Shovel Claw	6: Pumpkin Hill	—	Enables Digging
Knuckles	Air Necklace	8: Aquatic Mine	—	Allows Knuckles to breathe underwater
Knuckles	Hammer Gloves	12: Death Chamber	—	Breaks Steel Containers
Knuckles	Sunglasses	14: Meteor Herd	Hammer Gloves	Enables special vision
Rouge	Mystic Melody	2: Dry Lagoon	Pick Nails	Plays Mystic Melody to activate Ancient Ruin
Rouge	Pick Nails	5: Egg Quarters	—	Enables Digging
Rouge	Treasure Scope	8: Security Hall	Mystic Melody, Iron Boots	Enables special vision
Rouge	Iron Boots	12: Mad Space	—	Breaks Steel Containers
Tails	Laser Blaster	3: Prison Lane	Bazooka	Increased rate of fire
Tails	Booster	7: Mission Street	—	Travel longer distances in the air
Tails	Mystic Melody	10: Hidden Base	Bazooka	Plays Mystic Melody to activate Ancient Ruin
Tails	Bazooka	13: Eternal Engine	—	Breaks Steel Containers
Dr. Eggman	Jet Engine	6: Lost Colony	—	Enables Hovering
Dr. Eggman	Large Cannon	7: Weapons Bed	—	Breaks Steel Containers
Dr. Eggman	Laser Blaster	1: Iron Gate	Bazooka	Increased rate of fire
Dr. Eggman	Mystic Melody	3: Sand Ocean	Jet Engine	Plays Mystic Melody to activate Ancient Ruin
Dr. Eggman	Protection Armor	13: Cosmic Wall	—	Increases Health



# GAME BASICS

Every game has a learning curve. *Sonic Adventure 2* is a big game, so the curve can be a little steep. Don't worry, though; we're here to help. This chapter goes over some of the important information that will help you understand the game better. Read this section to get an idea of what's going on around you as you play.

## GAME CONVENTIONS

### Omochao

These little wind-up Chao are full of good advice. Bump into them and they'll activate. If you see one around, it may mean that you're about to encounter something new. Similarly, if you encounter something new and baffling, look for an Omochao to explain it to you.



### Rings

Rings can be found in just about every Stage of *Sonic Adventure 2*. They act as a buffer against attacks from enemies. When you are hit by a foe, you'll bounce back and lose your rings, but you won't lose a life. If you are hit when you don't have any rings, you will lose a life and be sent back to the last Point Marker you hit.



So, when you get thumped and your rings scatter, make sure you pick up at least one. Also note that you can only recover a maximum of 20 rings when they've been scattered, so even if you had 150 rings, you may recover only 20 of them if you get bonked.



Finally, for every 100 rings you collect you'll receive an extra life. Make an effort to grab them as you go through the levels.

### Cameras

The camera views are ever changing to give you a view of the area and your character. You have some limited control by using the **R** and **L** triggers to swing it around. Use the triggers to get around any obstruction.



### Saves and Restarting

Point Markers save your progress up to that point in the Stage. If you lose a life—and still have lives left—you'll reappear at the last Point Marker you hit with no rings. If you have no lives left and are hit, you'll exit the Stage.



### The Action Window

When your character has skills and power-ups, you can perform many different actions. When you want to scroll through the actions you can perform, press **Y** to make the Action Window appear in the upper-right corner. When it shows the action you want, press **B** or **X** to do it.

### Emblems

The Sonic Emblems are tokens you collect for finishing various tasks. You can earn 180 Emblems. The bulk of them are awarded for completing the different missions for each of the Stages. You can also earn them for Chao Races.



### NOTE

Earning all 180 Emblems is a difficult task, but the reward is worth it. You'll be able to access a new area.



### Mission Ranks

When you start playing the different missions in the Stage Select area (see farther along in this section), you'll be able to earn ranks for each mission. Various criteria—time, number of points gained, etc.—determine the grade of performance, from A (highest) to E (lowest).





primagames.com

# MODES

We'll cover two modes here—the two that likely will consume most of your time.

## Story

When you first start the game you have a choice of playing the Hero side of the story or the Dark side. You can choose either to start. Once you complete both sides, who knows what may happen?



## Stage Select

When you've finished a Stage in Story Mode you can replay it in Stage Select, where you earn ranks and Emblems by playing the missions. Each Stage has five missions. Defeating one will open the next one. You can replay them as many times as it takes.

Notice that there's an entrance to the Chao Gardens as well as a mysterious island on the Stage Select map. Interesting, isn't it?



## Stage Ranks

Here's a table of the requirements necessary to earn the different ranks in the missions. It shows the minimum scores you need to get an A, B, C, or D rank. Any score below D level will get you an E ranking.

**NOTE**

Tails and Rouge's driving Stages are listed at the bottom, since the ranks are all based on time for each mission.



### HERO RANK REQUIREMENTS

Stage No. and Name	Character	Mission 1 Ranks				Mission 2 Ranks (Rings)				Mission 3 Ranks (Chao)				Mission 4 Ranks (Time)					Mission 5 Ranks			
		A	B	C	D	A	B	C	D	A	B	C	D	Limit	A	B	C	D				
1 City Escape	Sonic	18000	14000	11000	9000	1:20	1:40	2:00	2:30	2:30	2:50	3:10	4:00	18000	16000	14000	12000	3:00	19000	15000	12000	10000
2 Wild Canyon	Knuckles	16000	14000	10000	8000	1:30	2:00	3:00	4:30	0:40	1:00	2:00	2:30	16000	14000	10000	8000	2:00	17000	15000	10000	8000
3 Prison Lane	Tails	26000	23000	17000	13000	2:30	3:00	3:30	4:00	2:00	2:30	3:00	4:00	26000	23000	17000	13000	3:00	26000	23000	17000	13000
4 Metal Harbor	Sonic	20000	18000	16000	14000	1:10	1:20	1:30	1:50	0:50	1:00	1:10	1:20	18000	16000	14000	12000	2:00	18000	16000	14000	12000
5 Green Forest	Sonic	15000	13000	12000	9000	2:30	3:00	3:30	4:00	1:30	2:00	2:30	3:00	12000	10000	9000	7000	4:00	12000	10000	9000	8000
6 Pumpkin Hill	Knuckles	12000	10000	8000	6000	3:00	3:30	4:00	5:00	1:00	1:30	2:00	3:00	13000	11000	9000	7000	3:00	16000	14000	12000	10000
7 Mission Street	Tails	25000	22000	17000	13000	3:30	4:00	4:30	5:00	3:20	3:40	4:00	5:00	22000	20000	18000	15000	3:30	30000	26000	22000	18000
8 Aquatic Mine	Knuckles	14000	11000	10000	9000	1:50	2:30	3:00	4:00	1:00	1:30	2:30	4:00	14000	12000	10000	8000	3:30	15000	13000	10000	9000
10 Hidden Base	Tails	14000	12000	11000	10000	3:15	3:30	4:00	4:30	2:50	3:15	4:00	4:30	12000	11000	10000	8000	3:30	13000	11000	9000	8000
11 Pyramid Cave	Sonic	15000	13000	11000	10000	1:30	1:45	2:00	3:00	3:45	4:00	4:15	4:30	13000	11000	9000	8000	4:00	14000	13000	11000	9000
12 Death Chamber	Knuckles	12000	10000	8000	6000	2:30	3:00	3:30	4:30	2:00	2:30	3:00	4:00	12000	10000	8000	6000	5:00	12000	11000	10000	8000
13 Eternal Engine	Tails	35000	30000	25000	20000	3:30	4:00	5:00	6:00	2:45	3:00	3:30	4:00	30000	28000	25000	20000	5:00	35000	30000	25000	20000
14 Meteor Herd	Knuckles	13000	12000	11000	8000	2:00	3:00	4:00	5:00	1:30	2:30	3:30	5:00	14000	13000	11000	9000	4:30	13000	11000	10000	7000
15 Crazy Gadget	Sonic	17000	15000	12000	10000	3:00	3:30	4:00	4:30	5:00	5:30	6:00	7:00	16000	15000	14000	12000	5:00	15000	13000	11000	9000
16 Final Rush	Sonic	13000	11000	10000	9000	1:30	1:45	2:30	3:00	4:30	4:45	5:00	5:30	13000	12000	10000	8000	5:00	13000	12000	10000	9000

**DARK RANK REQUIREMENTS**

Stage No. and Name	Character	Mission 1 Ranks				Mission 2 Ranks (Rings)				Mission 3 Ranks (Chao)				Mission 4 Ranks (Time)					Mission 5 Ranks				
		A	B	C	D	A	B	C	D	A	B	C	D	A	B	C	D	Limit	A	B	C	D	
1	Iron Gate	Eggman	20000	18000	16000	14000	1:35	1:45	2:00	2:30	2:00	2:15	2:30	3:00	20000	18000	16000	14000	4:00	19000	17000	15000	12000
2	Dry Lagoon	Rouge	15000	12000	10000	8000	2:00	2:30	3:30	4:30	0:40	0:50	1:30	2:30	14000	12000	10000	8000	3:30	17000	15000	12000	10000
3	Sand Ocean	Eggman	25000	23000	20000	18000	3:30	4:00	4:30	5:00	3:00	3:30	4:00	4:30	25000	23000	20000	18000	4:00	23000	20000	18000	13000
4	Radical Highway	Shadow	14000	11000	8000	6000	1:20	1:40	2:00	2:30	2:30	2:45	3:00	3:30	14000	12000	10000	8000	3:00	16000	14000	12000	10000
5	Egg Quarters	Rouge	12000	10000	8000	6000	2:00	2:30	3:00	4:00	1:00	1:30	2:00	3:00	13000	12000	10000	8000	3:00	13000	12000	10000	8000
6	Lost Colony	Eggman	34000	30000	26000	22000	2:00	2:30	3:00	4:00	2:30	2:45	3:00	3:30	34000	30000	26000	22000	3:30	44000	40000	35000	30000
7	Weapons Bed	Eggman	30000	28000	25000	20000	2:00	2:15	2:45	3:30	2:15	2:30	3:00	3:30	30000	28000	25000	20000	2:45	30000	28000	24000	15000
8	Security Hall	Rouge	12000	10000	8000	6000	4:00	4:30	5:00	5:30	0:30	1:00	2:00	3:00	13000	12000	10000	8000	3:30	16000	15000	13000	10000
9	White Jungle	Shadow	14000	12000	10000	8000	1:30	2:00	2:30	3:00	3:20	3:40	4:00	5:00	14000	13000	12000	10000	3:00	13000	12000	10000	8000
11	Sky Rail	Shadow	14000	13000	11000	9000	1:15	1:45	2:15	2:30	1:10	1:30	1:45	2:00	14000	12000	10000	8000	2:00	10000	9000	8000	7000
12	Mad Space	Rouge	14000	12000	10000	8000	2:30	3:00	4:30	5:00	1:30	2:00	4:00	5:00	14000	12000	10000	8000	4:30	12000	10000	8000	6000
13	Cosmic Wall	Eggman	53000	45000	30000	15000	1:30	1:45	2:00	3:00	1:30	1:45	2:00	2:30	45000	40000	35000	30000	8:00	50000	45000	40000	30000
14	Final Chase	Shadow	12000	11000	10000	8000	1:30	1:45	2:00	2:30	5:15	5:30	6:00	6:30	11000	10000	9000	8000	5:30	10000	9000	8000	7000

**DRIVING STAGE RANK REQUIREMENTS**

Stage No. and Name	Character	Mission 1 Ranks				Mission 2 Ranks (Rings)				Mission 3 Ranks (Chao)				Mission 4 Ranks (Time)					Mission 5 Ranks				
		A	B	C	D	A	B	C	D	A	B	C	D	A	B	C	D	Limit	A	B	C	D	
1	Route 101	Tails	2:45	2:55	3:15	3:30	1:30	2:00	2:30	3:00	3:00	3:10	3:20	3:30	3:00	3:10	3:20	3:30	—	2:50	3:00	3:10	3:20
2	Route 280	Rouge	3:20	3:30	3:40	3:50	2:00	2:30	3:00	3:30	3:30	3:40	3:50	4:00	3:45	3:50	3:55	4:00	—	3:20	3:30	3:40	3:50

**CANNON'S CORE RANK REQUIREMENTS**

Stage No. and Name	Character	Mission 1 Ranks				Mission 2 Ranks (Rings)				Mission 3 Ranks (Chao)				Mission 4 Ranks (Time)					Mission 5 Ranks			
		A	B	C	D	A	B	C	D	A	B	C	D	A	B	C	D	Limit	A	B	C	D
Cannon's Core	All	29000	27000	25000	20000	3:30	4:00	4:30	5:30	7:30	8:00	8:30	9:00	29000	27000	25000	20000	7:00	29000	27000	25000	20000

**ITEMS**

Many things in *Sonic Adventure 2* can help you through the Stages. Some are interactive—that is, you have to actually use them (see the Interactive Objects section)—while others activate automatically when encountered. This section deals with the non-interactive Items that benefit you within the levels.

**Balloons**

Balloons contain hidden Items. Break them to receive your prize. You may need a boost to grab them, so look around for a Spring or a Swing Bar to help you reach it.



**Bombs**

Found in Item Boxes, the Bomb immediately destroys all surrounding enemies. It's a good item to run into when the area is crawling with robots.



**Chaos Drives**

The shards found in vials are Chaos Drives. They come in several colors and can be used in the raising of your Chao. See the section on Chao later in this guide for more information.



**Extra Lives**

A staple of video gaming since the early days, this pick-up has remained relatively unchanged to this very day. It is the Holy Grail of pick-ups; finding one gives you that much-needed extra chance to make a crucial jump or destroy a difficult opponent. Viva la Extra Life!



**Health**

As Tails and Dr. Eggman take damage, their health meters fall. When the meter hits zero the character is destroyed. Finding Health will fully restore their health meters.



**Item Boxes**

Destroying Item Boxes gives you the Item inside. They are all over the Stages, some obvious, some hidden. You can get several different Items from the Item Boxes: everything from rings to Shields.





primagames.com



### Power-up Platforms

Move within the green aura for a character power-up. These are worth every effort to find. The power-ups in the circle are permanent.

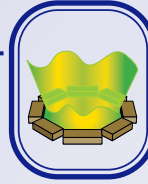

### Rings

All characters benefit from collecting rings. Doing so adds to their Stage score, but more importantly, awards an Extra Life for every 100 rings collected. Collecting rings also slowly refills Tails's and Dr. Eggman's health meters. Furthermore, collecting a ring from an Item Box adds a multiple number of rings to your total (the number added is shown below the ring).



### Shields

All Shields bestow a limited amount of protection upon the wearer. Be aware that Shield effects are not compounded. For example, if you pick up the Magnetic Shield and then immediately pick up the Invincibility Shield, the magnetic effect is replaced by the invincibility effect.



#### Invincibility

As you may have guessed, this Shield grants your character invincibility for a short time. Being hit throughout the duration of this power-up will not deprive you of rings, nor will it remove any health from your health meter. Plus, if you so much as touch an enemy, it will be destroyed.



#### Magnetic

A sphere of magnetic energy engulfs your character when possessing this Shield. The sphere attracts nearby rings, so you can collect them without actually moving through them. It also acts as a shield, allowing your character to take an enemy hit without any loss of rings. The sphere disappears if you are hit or if you pick up a different Shield.



#### Protective

The most basic Shield, this one grants your character one opportunity to absorb an enemy hit without losing rings or health. It will remain in effect until a hit is taken.



### Small Animals

These little creatures can be found throughout the Stages. Pick them up and bring them to the Chao Garden to give to your Chao. Collecting all the small animals in a Stage will earn you an Extra Life.



### Speed Shoes

These grant the wearer extra speed. Speed Shoes can help you outrace pesky enemies, or just get across the goal faster.



# INTERACTIVE OBJECTS

Throughout the game, you'll find several types of interactive objects to help you in your mission. Some objects are specific to certain characters and can be found only in certain Stages. Other, more general, objects appear on multiple Stages and can be used by a number of different characters. Keep an eye out for all of the interactive objects; sometimes they are crucial to passing a Stage.

## GENERAL OBJECTS

### Ancient Ruin

Ancient Ruins hold many ancient secrets. When you find one, something is probably hidden nearby. You must play your Mystic Melody to activate the Ancient Ruin.



### Dash Panels

Dash Panels give you a little boost when you need it most. Just touch the panels and you'll high-tail it along the path with more speed in your step.



### Goal Rings

What better way to end a Stage than to find a giant gold ring? Just touch the Goal Ring to end the Stage.



### Hourglasses

Found in Sonic's Pyramid Cave Stage and Death Chamber, Hourglasses can be used to open doors. Flip an Hourglass by jumping on it or hitting it. After it flips over, a door will open. Hurry through the doorway; as the sand falls through the Hourglass, the door slowly closes.



### Jump Plates

Jump Plates let you leap over large gaps. Just touch it and away you go.



### Missiles

Missiles are great for breaking objects that block your path. Find the Missile and step on the green button behind it. This launches the Missile and clears the way for you.



### Pipes

As you play through the game keep an eye out for Pipes. Stand in front of the bent white Pipes and whistle by pressing **Ⓢ**. A cuddly little animal pops out for you to collect. If you collect all the hidden animals on a mission you get an extra life.



#### NOTE

You can only whistle into the Pipe after the option to do so appears at the top right-hand corner of your screen. You won't be able to whistle into the Pipe again after you've collected the hidden animal.



### Point Markers

Point Markers can be your best friends. Just walk through the marker to activate it. If you happen to bite the dust somewhere in the Stage—and have Extra Lives—you'll restart at the last Point Marker you activated rather than at the beginning of the Stage.



### Pulleys

Use the Pulley to access high areas. Stand beneath the red handle and jump straight up. Look on the ground for a small, circular shadow to make sure you're underneath the handle. Stand on the shadow and jump. You'll be pulled up (hence the name "Pulley," get it?).



### Rockets

Plan on a long journey after you find a Rocket. Touch the Rocket and your character will grab the handle and blast off. You automatically let go when you reach the intended destination. Enjoy the ride, but don't expect any peanuts on this flight.



### Springs

Springs work just like a trampoline. Touch them to bounce high in the air. Springs may help you access some hard-to-reach areas or other interactive objects. You'll find both individual pads and rows of pads.



## INTERACTIVE OBJECTS



primagames.com

### Switches

These Switches look like little balloons. Bump into the Switch to activate it and it'll turn bright white. Now look around to see what it activated, such as opening a locked door or making a Rocket available.



### NOTE

It may not be obvious what the Switch actually activates. Sometimes the Switch is out of sight of the thing it affects.



### Time Switches

Walk over or shoot these switches and time stops for a short period of time.



### Weights

These Weights can hurt a lot. Don't be caught under them when they come crashing down. Sometimes you can stop Weights by activating a switch. Other times you can climb atop them and ride to higher areas.



## SPECIFIC OBJECTS FOR SONIC OR SHADOW

### Bungee Vine

Press and hold down the **A** button and you'll bungee farther and flip off for a better rating.



### Gate Key Doors

Some doors require a special key to open. To open the Gate Key Door, you need a...Gate Key. This Key is always handily located near a Gate Key Door. Find the Key and place it on the pedestal near the door to open it.



### Gravity Control Switches

Have you ever wanted to walk on the ceiling? The Gravity Control Switches change the gravity of the Stage. Stand on the triangle and press **B** to activate it.



### CAUTION

Do not attempt to change Rails while crouching or while you're on a sharp curve. You could end up flinging your hedgehog off into space.



### High-Speed Warp Tubes

These tubes take you to faraway places. Jump Dash to break the glass covering the entrance, then jump in. Away you go!



### Rails

Rails are everywhere for Sonic and Shadow. Just jump on the Rail to start sliding. Crouch using **B** to go faster. To go up vertical Rails, use your Homing Attack. To move to a Rail that's next to the one you're on, push in the direction you want to go and tap **A**. Sonic and Shadow will hop over without slowing down.



### Ramps

Use the Ramp to catch some major air. Race forward as fast as you can and press **A** when you near the end of the Ramp. If you hit the Ramp with the right amount of speed and press **A** at the right time, you'll flip and spin through the air, earning a better rating.



### Rubber Vines

Rubber Vines help you reach distant areas. Run up and touch the handle to slingshot yourself to your destination. Who knew vines were so elastic?



### Swing Bars

Jump up and grab the Swing Bar to start swinging around and around. Watch for the red streak as you spin. Press **A** when the streak is present and you'll go flying off. If you don't press **A** at the right time, you'll let go of the Swing Bar and fall straight down.

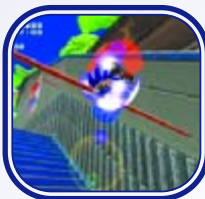

### Swing Vines

You hedgehog, but where Jane? After you grab the vine, just relax. You'll swing around and be dropped off at the place you want to go.



# SPECIFIC OBJECTS FOR KNUCKLES OR ROUGE

## Hint Boxes

Having problems finding the missing pieces of the Master Emerald or some missing Keys? Check out the Hint Boxes to learn some helpful clues. Stand in front of the Boxes and press **B** to get the information you need. These are crucial to finding the treasure quickly.



### TIP

The Hint Boxes give three clues for each piece of Emerald. In other words, after you get three clues, the Boxes shut down until you find the Emerald piece they lead you to. After you've found that piece, they reactivate and give three more clues leading to the next piece.



## Meteorech

Those Meteorech are huge! Get behind them and push them by using **B**. Push the Meteorech into boxes or doors to destroy either.

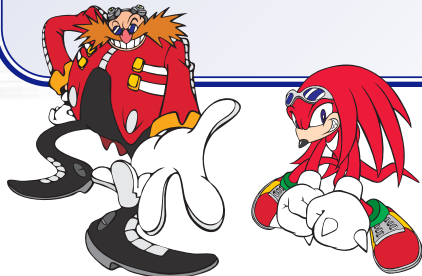

## Safes

Safes can contain hidden treasures. First find a switch to unlock the Safes. Then climb to the flashing symbol on the middle of the Safe you want to open. Press **B** and you're in.



## Stone Heads

Those Stone Heads look heavy, but don't worry, they're not too heavy for you. Grab them by pressing **X** and then push or pull them along the tracks so you can dig under them. You might find Shards of the Master Emerald.



## Turtles

Turtles might be slow, but they can get you where you need to go. Press **B** to ride them or grab on to them. It's a shell of a way to travel!



## Warp Walls

Some Walls have hidden items behind them. Jump on the Wall and climb over to the oval shape. Dig by pressing **B**, and you can go through the wall.



# SPECIFIC OBJECTS FOR TAILS OR DR. EGGMAN

## Dynamite Packs

Is the path ahead too high for you to reach? Not a problem. Shoot the Dynamite packs attached to walls to bring the path down to your level.



## Elevators

Elevators take you where you want to go. Hop on and enjoy the ride. Don't get too comfortable, though; there may be enemies to shoot along the way.



## Locks

Don't have Keys to those huge doors? No problem. Just shoot the four red door Locks to blow them wide open. Who needs a Key anyway?



## Mini-Lifts

Tails and Dr. Eggman can't jump very high. Luckily, there are Mini-lifts around to give you a boost. Just jump on them and away you go. You don't even have to listen to elevator music.



## Tanks

Don't be afraid of the Tanks. They might make a big explosion after you fire at them, but they won't hurt you. After they've blown up, you can jump on the remaining scrap metal to reach higher places.





primagames.com

# ITEMS TO DESTROY

Destroying certain items can uncover hidden objects or reveal hidden pathways. Most of these items can be destroyed by any of the characters from the very beginning of the game. Sometimes, Stage-ending objects are hidden underneath these items; destroy them if you can't proceed any farther on a Stage to see what you might find.

## Boxes and Containers

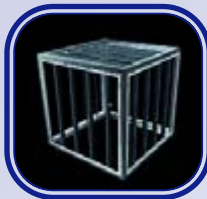

### Cages

Cages usually contain imprisoned animals that need to be freed. One way to do so is to locate a nearby Missile and fire it at the Cage. This destroys the Cage while leaving the animal unharmed. The Cages can also be broken with a Bomb thrown by a Kiki.



### Chao Containers

Three of these exist in every Stage. The first you find and destroy will contain the Chao Key. The other two will contain animals.



### Steel Containers

Harder to destroy than their wooden counterparts, Steel Containers require a specific power-up to do so. (For a list of all power-ups, including those required to destroy Steel Containers, see the power-up information in the Moves section).



### Unbreakable Containers

These dark gray Containers are indestructible but can be used as stepping stones to help you move to otherwise unreachable areas.



### Wooden Containers

The standard Wooden Container. All characters have enough strength to break these from the beginning of the game.



### Miscellaneous Containers

You'll find other types of boxes throughout your adventure. Destroy them all to uncover any objects they may contain.

## Destructible Items

There are many destructible items scattered throughout the game. These items are easily destroyed and may contain hidden objects. Hit, kick, or shoot these items to find out what they hide.



- Barrels
- Canisters
- Chests
- Cylinders
- Overturned mine carts



- Pots
- Strange-looking cubes
- Strange-looking walls
- Tanks
- Towers



# ITEMS TO PICK UP

Certain small items can be lifted to reveal hidden animals and/or used as weapons. Press **Ⓟ** to lift the item and reveal any hidden animals underneath. When you have the Item in your hands, you can use it as a weapon. Jump by pressing **Ⓜ** and then throw by pressing **Ⓟ**. The Item will destroy almost any enemy it hits.



- Cubes
- Golden Masks
- Hard Hats



- Mushrooms
- Pyramids
- Skulls





# ENEMIES

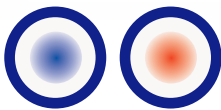

## BEETLE SERIES

These 'bots seem to be everywhere. Many of the Beetle series robots can help you along your journey by getting you to otherwise unreachable areas. Just Homing Attack from one to the next.

Not all of the robots are so friendly, though. Several of the Beetles have guns aimed in your direction. Take them out quickly before they can damage you and rob you of your rings. Some even drop Bombs on your head. Watch the skies and stay clear of any Bombs that land at your feet.

In addition, the Spark Beetles have electric shields. After a few seconds, the shield disappears, giving you a window of opportunity to attack. Beware though, the shield will return shortly.

### NOTE

All Beetle Series robots can be used as stepping stones by Sonic and Shadow. As long as there's a line of them, you can use the Homing Attack to get from one to the next.



Mono Beetle, 100 pts.

Gun Beetle, 100 pts.



Bomb Beetle, 100 pts.

Gun Wing, 500 pts.



Bomb Wing, 500 pts.

Spark Beetle, 100 pts.



Spring Beetle, 100 pts.

### Gold Beetle

What's the deal with these Gold robots? They appear out of thin air and disappear just as quickly. The good news is that they don't shoot at you and you can destroy them just by hitting them. You better take them out just to be on the safe side...and to earn 1,000 points toward your rank.

Gold Beetle, 1000 pts



## HUNTER SERIES

Hunters are common enemies throughout the game. They have only one gun and are fairly easy to destroy. Just be sure to get to them before they get to you and be aware of the protective shields that they carry to guard against your attacks. While playing Tails or Dr. Eggman, use your Lock-on Missile and hold **Ⓟ** until the 'bot moves the shield to take a shot at you, then attack before they can bring their guns to bear.

### TIP

Sonic, Shadow, Knuckles, and Rouge can attack them when the shield is up. Use the Somersault if you're Sonic or Shadow, and get behind them to attack if you're either of the treasure hunters.



Gun Hunter, 100 pts.



Laser Hunter, 100 pts.



Shield Hunter, 200 pts.

## RHINO SERIES

The Rhinos are tank-like vehicles. For the most part they move slowly. After they see you, though, expect a burst of speed.

The Rhino Spike, with it's protective spikes on top, demands that you hit it low. If you don't, you'll lose your rings for sure.



Rhino Jet, 100 pts.

Rhino Cannon, 100 pts.



Rhino Spike, 100 pts.

Rhino Metal, 100 pts.



## FIGHTER SERIES

Keep an eye on the horizon for low-flying Blue Eagle jets that like to drop Missiles on your head. Avoid running into the small blast radius of the Bombs, and you should be just fine. Jump Attack when a Blue Eagle is overhead and you can mark another downed bogey on your belt.

### CAUTION

It can be hazardous to attack the Blue Eagles. They are worth a good deal of points, but if you use a Homing Attack, you could end up dunking in the water and losing a life.



Blue Eagle, 500 pts.

# HORNET SERIES

There are also flying robots with Homing Missiles, the Hornet series. If you don't destroy them quickly, they launch a barrage of flying Bombs. Hit the center of the robot to destroy it and any Missiles that it might have launched. Once it has fired, it's helpless, so use that time to attack it.

If you're playing Tails or Dr. Eggman, make sure you Lock-on to the central body of the Hornet. If you just hit one of the Bombs, the others will still be able to get you.



Hornet-3, 100 pts.



Hornet-6, 200 pts.



Hornet-9, 300 pts.



Laser Hornet, 100 pts.



Phoenix, 100 pts.

# ARTIFICIAL CHAOS SERIES

These watery 'bots are GUN's attempt to make their own Chaos monsters (like the one in *Sonic Adventure*). Some of the toughest enemies you'll face, you can't hurt the guard types when they're crouched down. Wait until they pop their heads up, then aim for their noggin to take them out.

The most dangerous attacks are when the Chaos robots reach out to hit you with tendril-like arms. They'll home in on you first and then take a whack.

The floating type are fairly easy to destroy. When you see their big, hulking forms approaching, go on the offense. They'll pop after a hit to the head. Beware, though, some of them use the tendril attack as well.



Artificial Chaos P-1, 200 pts.



Guard Type, 200 pts.



Float Type, 200 pts.

## Artificial Chaos P-100

During the adventure, you'll also find the Artificial Chaos P-100. It looks like a floating type, but releases a ton of little Cells that can hurt you. You can Jump Attack on the Cells to destroy them, but your best bet is to go straight for the original robot's head, floating above. When the head is destroyed, the Cells explode.



Cell, 10 pts.

Artificial Chaos P-100, 200 pts.



# ENEMIES

## TIP

It's easiest to go for the head with a Homing Attack when playing as Sonic or Shadow. Tails and Dr. Eggman can target the head easily. Knuckles and Rouge, however, should try to Glide into the creatures.



primagames.com

# HAWK SERIES

Another common enemy, the Hawks are flying robots with guns. The Sky Hawks in particular like to drop out of the sky and crush you with their spikes. Plus, when they're not trying to poke you, they're shooting at you. Destroy them before they cause any serious damage.

Laser Hawk robots swoop down and strafe you. Dodge out of their path and you'll survive.



Gun Hawk, 200 pts.



Laser Hawk, 200 pts.



Gun Hawk, 200 pts.



Sky Hawk, 500 pts.

# GHOST SERIES

Be careful when you enter haunted areas. These places are crawling with Ghosts. Some Ghosts try to scare you, some try to grab you, and some try to hurt you. Overall it's just good sense to avoid any Ghosts you see.

## NOTE

Ghosts may try to grab you when there's a robot nearby that wants to shoot you. If the phantom grabs hold, you'll be a sitting duck. Go after the robot first.

Boo (normal), 0 pts.



Boo (attack), 100 pts.



Boom Boo, 300 pts.

# EGGMAN'S ROBOT SERIES

The Dr. Eggman robots, some of which look awfully familiar, all have animals in them instead of Chaos Drives like the GUN robots.

## E-1000

Have you seen these robots someplace before? When the E-1000 robot starts shooting, be sure to get out of the way. They have double cannons that can do major damage. Destroy them quickly.

E-1000, 200 pts.



## Unidus

Be careful when you're close to Unidus. Smaller spike balls circle a larger spike ball and will hurt you (surprise) if you touch them. You can't hurt the circling spike balls, so attack the central one as it moves around on the ground. Hit its center, and the Unidus is history.

Unidus, 100 pts.

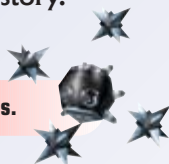

## Gola

Gola are similar to Unidus but have flames instead of spikes. Hit the center of the 'bot to destroy it.

Gola, 100 pts.



## Kiki

Bad monkey! The Kiki are monkey-like robots that fling Bombs at you. The Bombs detonate as soon as they hit you or after a short amount of time. So, you can pick them up. As soon as you do, the timer stops and you can transport them safely. This will be important to Knuckles and Rouge.

Kiki, 100 pts.



# BOSSSES

There are many bosses scattered throughout the game. Consult the walkthrough to find the best way to defeat each boss.



## USING THIS BOOK

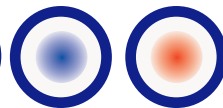

To use this book effectively, you must first understand a few things about the game. When you start playing a brand-new game, begin with the Story section. Choose Story from the 1P Play menu, then select Story Mode.

You'll be given two choices: Hero or Dark. While you'll eventually have to play both, you are initially given a choice of where to start.

### STORY SELECT



Where do you want to begin? With the Hero side or the Dark side of the story?

After you choose, you'll begin playing. You'll control various characters as they clear the Stages, and the story will unfold in the cutscenes between Stages.

After you've finished a Stage in Story Mode, it becomes available in Stage Select Mode. Go to Stage Select, and you'll see character icons on a map. Highlight an icon and press **A** to select it. Five slots appear under the name of the Stage. Each slot represents a mission. You cannot play a mission until you have completed the one before it.

### Select a stage.



On this Stage, Missions 1 and 2 have been completed, so Mission 3 is available.

When you play a mission in Stage Select, you'll be ranked based on points. Points are earned through collecting rings, defeating enemies, completing the objective quickly, pulling off tricks, and various other factors.



## NOTE

Some missions only award ranks based on one criteria, such as time.



## USING THIS BOOK

# HOW TO USE THE WALKTHROUGH

## MAPS AND NUMBERS

The walkthrough sections guide you through the Stages that each character must complete. To do this, we've employed a system using detailed maps, screenshots, and strategy sections.

When you're playing in Story Mode, you only need to pay attention to Mission 1 in each Stage. The other missions are available only in Stage Select Mode.

The numbers next to the screenshots and captions in the strategy area correspond to the numbers printed on the map. So, if you see the number 5 next to a screenshot, look for the number 5 on the map to see what the screenshot is referring to.

## CHARACTER DIFFERENCES

The six playable characters relate to one another in an interesting way. Each has a counterpart on the other side of the story. So, Sonic and Shadow are very much alike, as are Knuckles and Rouge, and Tails and Dr. Eggman. Each pair has a distinct style of play and a distinct type of game that they play in the Stages. Here's a rundown of what to expect and the strategies involved in playing each pair.

### Sonic and Shadow

The two hedgehogs are speedsters. They love running fast and get to show their stuff on a series of race courses. The trick with them is speed and timing. You'll be faced with narrow paths and enemies to dodge or attack with only a split second to react.



Sonic and Shadow will challenge you with high-speed races through complex courses. It takes a steady hand and quick reflexes.

Our Sonic and Shadow sections are split up between the five missions. The section on Mission 1 for each of their Stages will detail trouble spots, shortcuts, where to find permanent upgrades, and other points of interest. The other mission sections give advice for the specific goals you must achieve. Some are very straightforward, while others take some explaining.



primagames.com



If a clue refers to birds or treasure chests, it's a sure bet that it means any of the chests like these that are littered about the Stage.

### Knuckles and Rouge

While they have radically different personalities, Knuckles and Rouge are both premier treasure hunters. Both are equipped with radar that tells them when the objects they seek are nearby. Plus, Hint Boxes in their Stages provide clues about treasure location.

See that blinking red icon at the bottom of the screen? The treasure is very close. It blinks green when you're nearby, yellow as you get closer, then red when you close in.



Each time you replay a Knuckles or Rouge Stage, the treasure is hidden in a different place. There are many hiding spots in each Stage. Because it would take too much space to list them all, the Mission 1 sections describe areas that the Hint Boxes refer to often; this should give you an edge on the treasure hunt. Amongst other things, we'll point out unique and interesting things about each of the Stages, where to find permanent upgrades, and how to navigate some of the tricky areas.

## Tails and Dr. Eggman

These two are the brains of their groups. Both are accomplished inventors, have outfitted themselves with heavily-armed vehicles, and have adventures that involve a great deal of shooting. With their targeted blasts and powerful cannons, Tails and Dr. Eggman bring destruction to those foolish enough to stand before them.

### NOTE

Dr. Eggman is the nickname given to Dr. Robotnik. So don't get confused if you see both names; they refer to the same character.



The walkers are set for any challenge thrown at them. You'll learn to love them.



The walkthrough sections for the Tails and Eggman Stages point out the main tricks and traps you can fall into. They will also show the locations of permanent upgrades and other places of interest. The other mission sections give advice on how to achieve the goals and pass the missions.

## A NOTE ABOUT HARD MODE

Each Stage has a fifth mission that asks you to Clear Hard Mode. Often the placement of items, enemies, platforms, and other architecture is very different from the other missions. Our strategies give you the lowdown on several of the more drastic and dangerous changes that have been made, but be on your toes throughout the mission; surprises lurk around every corner.





primagames.com

# MAP KEY

Refer to this key to find out where items are on the maps

 <b>EXTRA LIFE</b>	 <b>HEALTH</b>	
 <b>SMALL ANIMAL</b>	 <b>HINT BOX</b>	 <b>RING</b>
 <b>BALLOON</b>	 <b>HOURGLASS</b>	 <b>ROCKET</b>
 <b>BOMB</b>	 <b>INVINCIBILITY</b>	 <b>ANCIENT RUIN</b>
 <b>CHAO</b>	 <b>MAGNET</b>	 <b>SHIELD</b>
 <b>CHAO BOX</b>	 <b>MISSILE</b>	 <b>SHOES</b>
 <b>GOAL RING</b>	 <b>OMOCHAO</b>	 <b>SWITCH</b>
 <b>GRAVITY CONTROL SWITCH</b>	 <b>POWER UP</b>	 <b>TIME SWITCH</b>

**START**

# CITY ESCAPE

Looks like Sonic can't be held for long. The brash, blue hedgehog has made his escape from the military and landed in the city's steep hills, perfect for a little street surfing. You'll tour the strange areas of this metropolis, fighting robots and collecting Items along the way.

## Missions

1. Escape from the military pursuit!
2. Collect 100 rings!
3. Find the lost Chao!
4. Reach the goal within 3 minutes 0 seconds!
5. Clear Hard Mode!

**POWER-UP:**



**MAGIC HANDS**

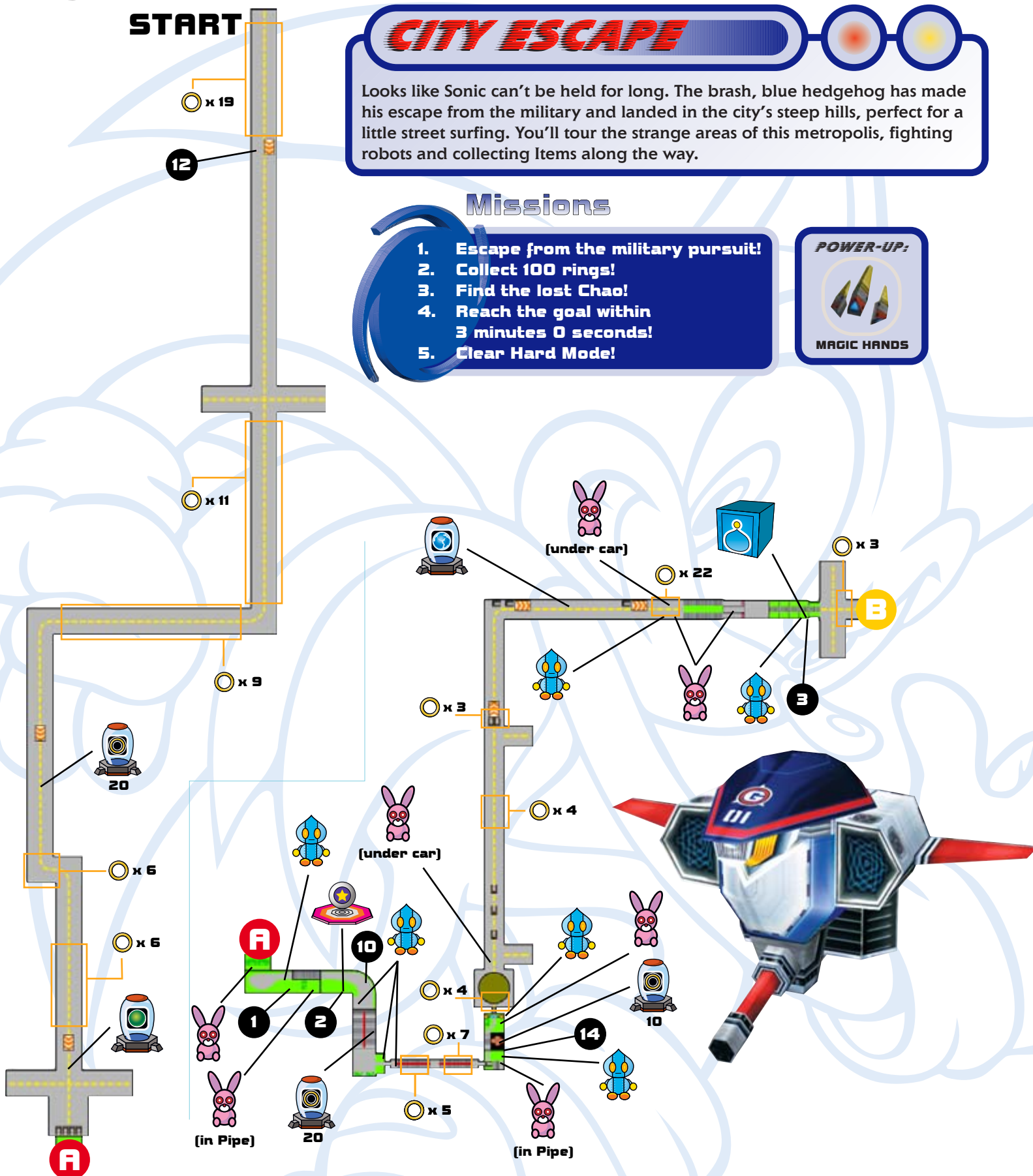

# HERO STAGE 1: SONIC



primagames.com

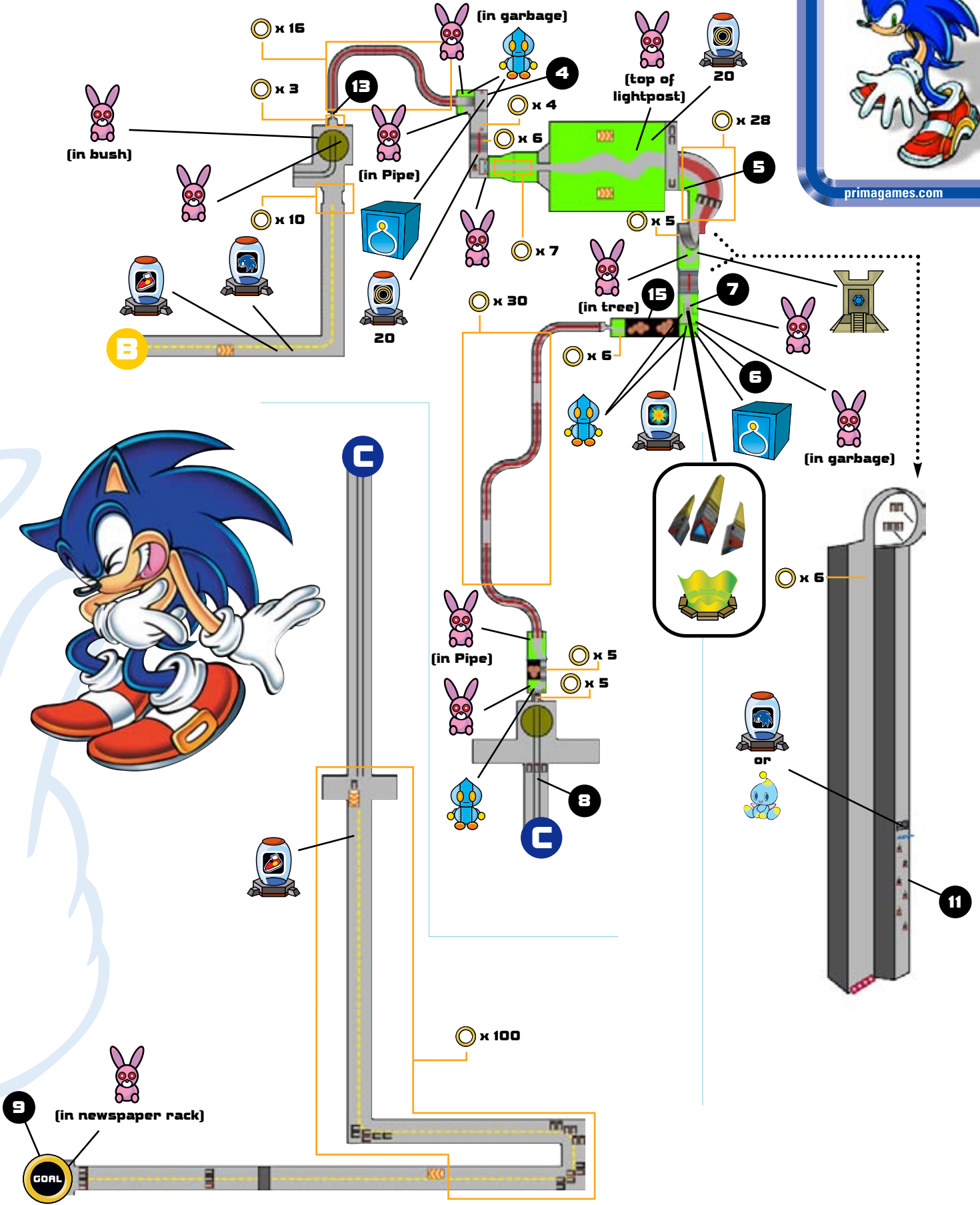



# MISSION 1: ESCAPE FROM THE MILITARY PURSUIT



**1** You meet your first Omochao here, and he gives a quick introduction. Find the Pipe in the boxes and the Raccoon behind the hedge, then head out.

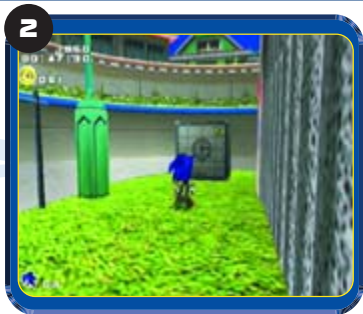

**2** When you have the Light Shoes (found in Hero Stage 4: Metal Harbor) and the Flame Ring (which you can pick up in Hero Stage 15: Crazy Gadget), Sonic can bust this Steel Container, flip the switch, and Light Dash along the path of rings.



**3** After more street action, you find the first Chao Container on the ledges next to the set of brick stairs. As the Omochao tell you, there are three Chao Containers in every level. Bust it open to get the Chao Key.

**TIP** As you're running down the street, you find two Ramps lined up. Bust tricks off both of them to be launched through a group of floating rings.



**4** The second Chao Container is at the top of the Ramp right after the long Rail. Stand Sonic at the bottom and use his Spin Attack to launch up the Ramp.



**5** If you hit either Ramp in the park, you can flip up to the short bridge. There's a line of rings you can pick up with a quick Light Dash.



**6** Use the Swing Bars to flip up to the third Chao Container.

**TIP** Reach the Swing Bars by jumping from the stairs or by using the Springs and pushing forward on the analog thumb pad. Also, check the trashcan at the top of the stairs. You should be able to whistle for an animal.



**7** When you have the Bounce Bracelet (found in Hero Stage 11: Pyramid Cave) and Flame Ring you can Bounce. Attack the metal floor here. Inside you'll find the Magic Hands power-up, a useful gadget.



**8** It seems that Sonic has made someone mad enough to send a big rig after him. Keep the analog thumb pad pulled down. If you don't, Sonic will slow down and become roadkill.



**9** After your harrowing truck chase, you shoot over a gate and find the Goal Ring. Congratulations! You've just finished the first mission of the first Stage.

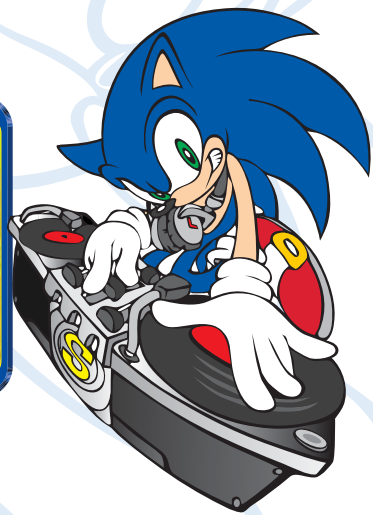

# MISSION 2: COLLECT 100 RINGS

This mission is almost impossible to fail. Rings are strewn around the Stage with wild abandon. Check the map and take care not to smack into any robots.



**10** Pick up speed and run along this wall to pick up 20 rings in an Item Box. You shouldn't have any trouble finding 80 more.

**TIP** Toward the end of the Stage, you'll be mostly preoccupied with the big rig that's chasing you, so we suggest collecting your 100 rings prior to reaching that point.

## HERO STAGE 1: SONIC

### MISSION 3: FIND THE LOST CHAO

You must find Sonic's Mystic Melody before you take a shot at Mission 3. Find the Ancient Ruin near the bottom of the building Sonic runs down.



**11** Stand by the Ruin and play the Mystic Melody to make a Spring appear. Use it to reach the first Pulley. Jump to the next Pulley and you'll be facing a Beetle robot.



**12** Use the Homing Attack, but hold down **A** to get a high bounce off the robot. It's hard and, unfortunately, you must do it three times. The third robot is a Spark Beetle and has a force field, so wait until it's lowered before jumping at it.



**13** Grab the Swing Bar and flip into the air, directing Sonic into the alcove. The unhappy Chao will be glad to see you. Mission accomplished.



primagames.com



### MISSION 4: REACH THE GOAL WITHIN 3 MINUTES 0 SECONDS

Despite this being the first Stage of the game, the fourth mission is pretty hard. You must be very, very good at negotiating this Stage to finish it in under three minutes. So, learn the path well enough that you can hit all the Ramps and land on all the Rails on the first try. The key to shaving time off is in the Ramps and Rails. Nail them and you'll be in good shape.



**14** In the first section, you can miss only one Ramp. If you miss more, restart.



**15** Jump into the Spring above the doorway. It will shoot you onto the Rail and get you going quickly.



**16** If you reach the truck chase section with 35 seconds left on the clock, you *might* make it. Run like crazy.

#### TIP

While on the Rail, crouch on the straightaways and don't touch anything on the curves. You're more likely to slow yourself down rather than help your speed if you monkey with the controls too much.

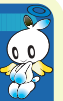

#### NOTE

You must direct Sonic into the Goal Ring to finish. He doesn't fly into it on his own after the truck chase. There's nothing more frustrating than losing at the last second because you miss the Goal Ring.



### MISSION 5: CLEAR HARD MODE

Hard Mode will show up as the fifth mission of every Stage. The architecture will be mainly the same although there will be minor changes to make things more difficult. There also may be more enemies dropping in on you at inopportune moments. The City Escape Hard Mode has both design changes and more enemies. A lot more enemies. We'll show you some of the more surprising changes and ambushes. Stay on your toes.



**17** The stairs are blocked off, so you must use the Elevator to cross the gap. There's only one this time and an enemy, so your aim must be dead on.



**18** You can't reach the upper level because a Swing Bar has been removed. So, jump and use your Homing Attack on the Beetle robot, then use Light Dash to zip along the row of rings to the other side of the gap.

#### NOTE

You need Sonic's Flame Ring (found in Hero Stage 15: Crazy Gadget) and his Light Shoes (on Hero Stage 4: Metal Harbor) to get through this level.



# SONIC VS BIG FOOT

The military is bent on getting Sonic back. They've sent out a state-of-the-art battle robot to try to take down our little blue friend. Sonic's not worried, though. He's got the shoes, he's got the skills. This military marvel is going down.

## BOSS ATTACKS

Big Foot has two attacks. Because it's the first boss, it's attacks aren't too challenging to avoid. Follow our advice and you should be fine. First order of business: Collect a few rings. Without rings, you'll lose a life in one hit.

### TIP

The area where you battle Big Foot is a smallish circle with Wooden Containers in it. These Containers are very handy because Sonic can stand on them to attack Big Foot with his Homing Attack. Try not to break them.



After a few passes with the machine guns, Big Foot will land and the Missile bays will open. Predictably, Missiles shoot out at you. Again, run around the edge of the circle until the barrage stops.



Try to time it so that you're close to Big Foot when the bay doors close. As soon as they do, leap high in the air and Homing Attack on Big Foot's cockpit.



Big Foot begins by flying up and strafing the ground with machine-gun fire. It's easily seen and he's not moving very fast. Run in a wide circle to avoid it.



After the fourth hit, Big Foot collapses. You've won! But just wait until you see who shows up....

Not being too imaginative, Big Foot repeats the pattern of machine-gun fire and Missile barrage, only firing more Missiles with each repetition.

Watch the "Enemy" health meter in the upper-right corner. It charts how much energy your foe has. Big Foot requires four hits to defeat.



# HERO STAGE 2: KNUCKLES

## WILD CANYON



primagames.com



### 1st Floor

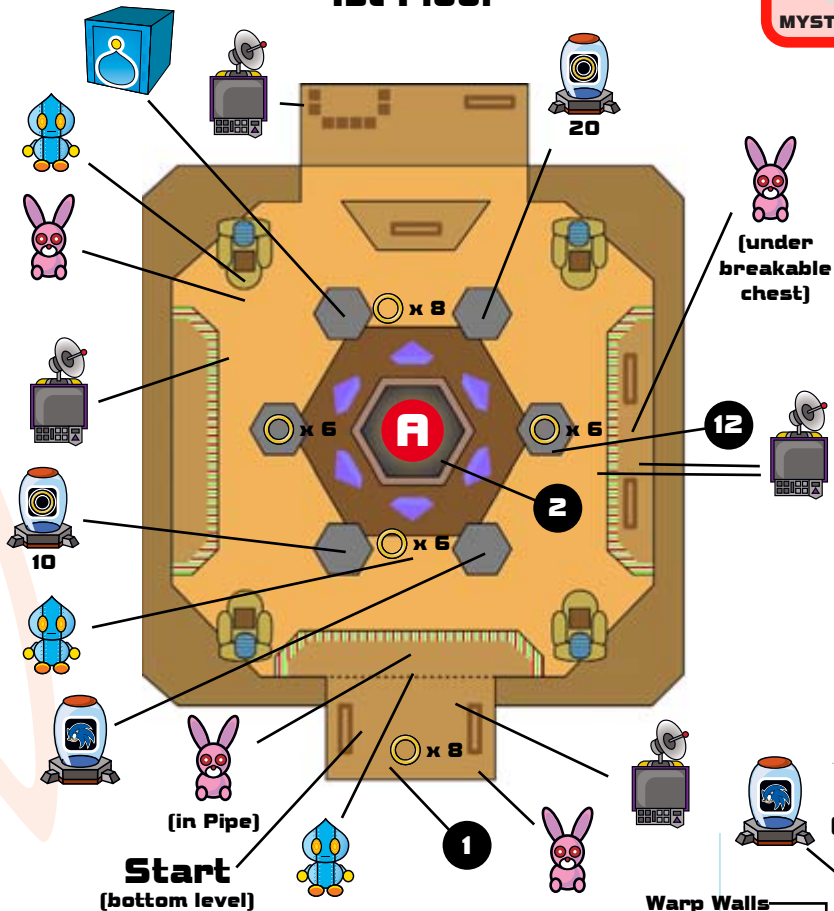

### 2nd Floor

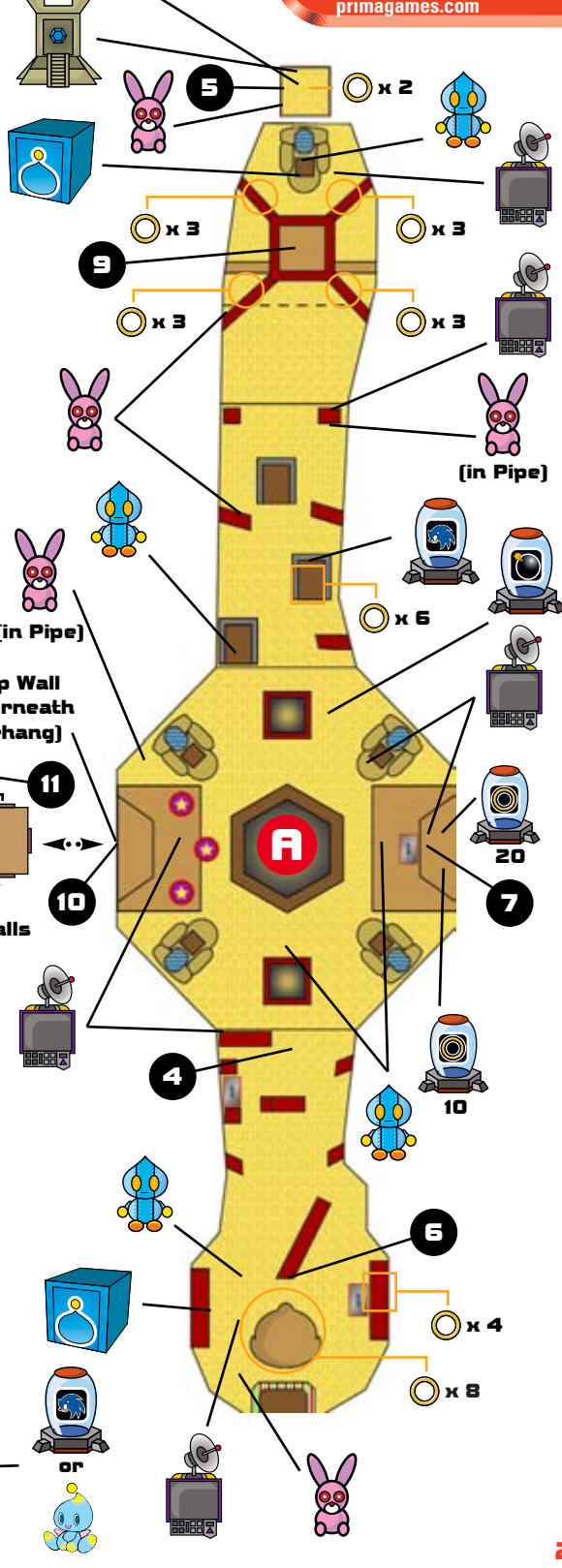
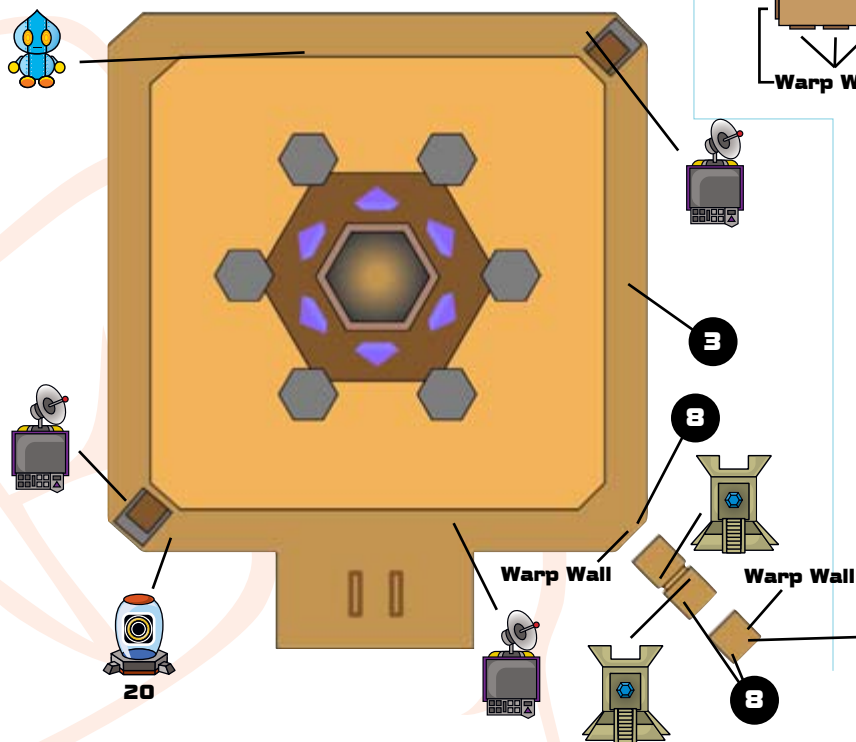

# WILD CANYON

Your first Knuckles Stage is a straightforward treasure hunt. You must pick up pieces of the Master Emerald in the dry sands of Wild Canyon. The work of an Emerald-guarding echidna is never finished.

## Missions

1. Find 3 pieces of the Master Emerald!
2. Collect 100 rings!
3. Find the lost Chao!
4. Collect the Emerald pieces in 2 minutes 0 seconds!
5. Clear Hard Mode!

## MISSION 1: FIND 3 PIECES OF THE MASTER EMERALD

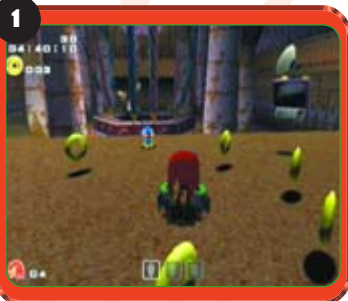

The first Hint Box is immediately to Knuckles's right. Grab a few rings, then check it out. The nearest Omochao is there, too. See what it has to say.

### TIP

Remember that the Hint Boxes are critical for finding the Emerald pieces. You are given three hints for each piece, so find three Hint Boxes and check them out right away. The Omochao give you advice about special features of the Stages.

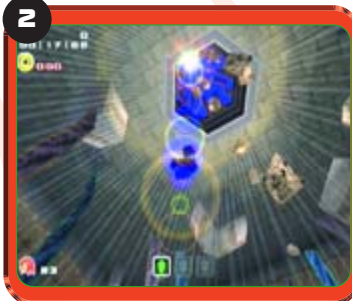

That big blowing column of wind will catch Knuckles and fling him to the upper area. Ride the air stream up high and Glide from the top.

### NOTE

As explained in the How to Use This Book section, these first sections of the Knuckles and Rouge Stages give you an overview of the most prominent features and dangers of the area. Because it would be impossible to list all the places Emerald pieces could be hidden, we'll give you a broad overview of each Stage.



In the underground area, this upper ledge is the "Wild Canyon Track." It's referred to in several Hint Boxes.



On the upper level are two valleys. Down one valley you'll find the "Lonely Statue," which will appear in clues, as will the "armored car pool" and the "square buildings," both of which are found in the same valley.

### TIP

The platform above the armored car pool is referred to as the "suspended ceiling" in some clues.



### NOTE

The Mystic Melody is essential to finding the lost Chao in each Stage. Find the Ancient Ruin in any Stage, and you'll most likely be close to finding the lost Chao.



When you have the Shovel Claw—found in Hero Stage 6: Pumpkin Hill—you can Dig through the painting above the Lonely Statue's head. It leads you to this room with the Mystic Melody.



Go down the valley facing the Lonely Statue to find the giant Sphinx Head, which is mentioned in the Hint Boxes.



If a clue refers to birds or treasure chests, it's a sure bet that it means any of the chests (like the ones in this screenshot) that are littered about the Stage.

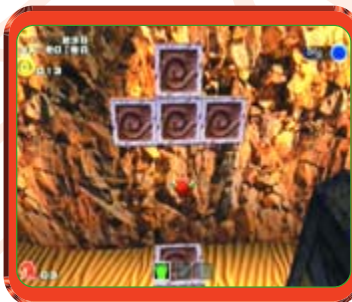

These tiles are called "swirl tiles" in the Hint Boxes. They are sometimes arranged in patterns: arrows, X shapes, etc.



These Stone Heads on tracks can be moved back and forth. Stand near one, press **B** to catch hold, then use the analog thumb pad to drag it along the tracks.

## HERO STAGE 2: KNUCKLES



primagames.com

### MISSION 2: COLLECT 100 RINGS

Because it's early in the game, it won't be too tough to hunt down 100 rings. In fact, you can find over 80 of them on the lower level alone. Clear out that lower level first, because there are no enemies to make you dump your rings.



When faced with a line of rings, jump and wait until Knuckles is on his way down before Gliding. If you Glide right away, you'll be too high and miss many of the rings.

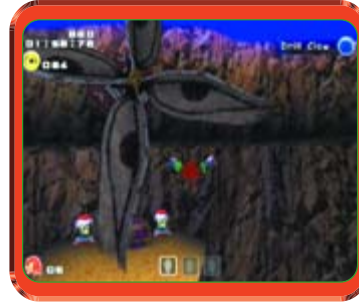

When you have cleared the lower chamber, ride the wind and Glide to the high cliff with two ring-filled Item Boxes on it. Grab those to hit 100 rings.

### MISSION 3: FIND THE LOST CHAO

You'll need the Shovel Claw (found in Hero Stage 6: Pumpkin Hill), the Hammer Gloves (found in Hero Stage 12: Death Chamber), and Knuckles' Mystic Melody (which you pick up in this stage after you get the Shovel Claw). When you're properly outfitted, go to the upper level of the underground area and find the four Steel Containers.



Smash these Steel Containers, then Dig through the wall painting you find behind them, which takes you into another room.



Play the Mystic Melody here to open the big door, then play it again at the other Ancient Ruin to create a warp. Jump into the warp.



You'll be taken to the room with the lost Chao in it. Pick it up to end the mission.

### MISSION 4: COLLECT THE EMERALD PIECES IN 2 MINUTES 0 SECONDS

The key to quickly finding Emerald pieces is to make use of the Hint Boxes. Once you have the layout of Wild Canyon in your head—and it's not a very big Stage—you'll have little trouble deciphering the clues and finding the pieces. Make sure to visit three Hint Boxes for every piece.

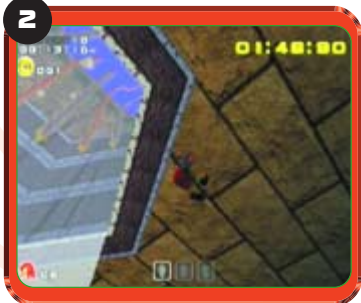

For a quick ride to the top of the lower area, catch the edge of the column of wind, then maneuver out of it before you are blown outside. It can shave some seconds off your travel time.

#### TIP

Refer to the Mission 1 section for this Stage to see some of the areas where the Hints may direct you.



## MISSION 5: CLEAR HARD MODE

You will need Knuckles's Sunglasses (found in Hero Stage 14: Meteor Herd) to get through the Hard Mode of this and every other subsequent Stage. You'll be able to grab the three pieces of the Master Emerald in this mission once you have the Sunglasses. Fortunately, the Emerald pieces are in the same locations every single time. Here's how to get them.



The first piece is under the suspended ceiling in the valley of the Lonely Statue. Stand on this stone building, jump as high as you can, then Glide to the piece and snap it out of the air.

**TIP**  
Many Hint Boxes are invisible unless you're wearing the Sunglasses. Flip them on to check the Hint Boxes.



Down below, climb the pillar that has a 20-ring Item Box on it. Use the Sunglasses to see a Spring, which sits at an odd angle on the edge of the pillar. Drop onto it to be shot directly to the third piece. You're home free.



The next piece is in a secret room. Head outside and find this painting on the wall under one of the overhangs. Dig through the center to find a room with more paintings.

**NOTE**  
Simply step off the pillar and onto the Spring without pressing the jump button. The Spring is useable only while Knuckles wears the Sunglasses, and jumping automatically takes them off.



Dig through the middle picture on the wall to Knuckles's right to enter this room. Pick up the second Emerald piece, then leave.

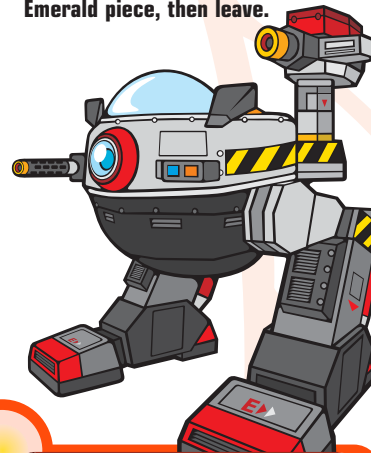

## TAILS VS DR. EGGMAN

On his way to save Sonic, Tails sees Amy in trouble. Looks like she's gotten mixed up in things again, and Dr. Robotnik is about to attack her. Tails can't let that happen!

### BOSS ATTACKS

Dr. Eggman has three attacks, but he doesn't use them in a pattern. He'll use his Lock-on Attack to fire a homing blast, a Volkan Cannon that fires single shots and, if you get in close to him, he'll hit you with a Punch Attack—a boxing glove that pops out of the front of his walker.



You'll become very familiar with the targeting laser and homing attack. Tails has exactly the same weapon. Run from the blast until it drops away.

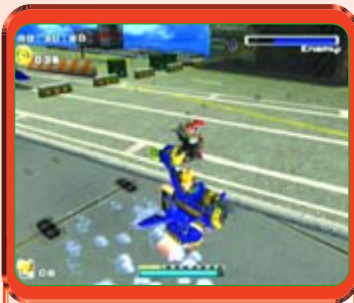

The cannon fire is hard to see, but if you take care not to stand directly in front of Dr. Eggman, he can't hit you with it. Same with the ram attack. He can use it only if he's right up next to you, so keep some distance.



Eggman folds under the onslaught from Tails. Take a moment to celebrate.

Tails has exactly the same attacks as Robotnik. So, use your targeting laser and cannon. A good trick is to fire the homing blast to make Eggman run. Then adjust and fire your cannon into his path.

Also, Dr. Eggman likes to rush in close to you. Face him and keep pressing **Ⓞ**. You'll fire at him and, if he gets too close, you should be able to ram him first.

The key to success is rapid firing. Get the homing blast chasing him and then fire away as he runs. If he stops, your blast will catch up. If he runs, you can tag him with your cannon. If he comes in close, you'll bash him with the ram.

## HERO STAGE 3: TAILS



primagames.com

# PRISON LANE

Tails is on a quest to find his friend Sonic in the middle of this prison. Will he make it?

## MISSION 1: FIND THE CORE OF THE PRISON

### TIP

Health is just off the main path. Creep to the edge and drop onto its platform.

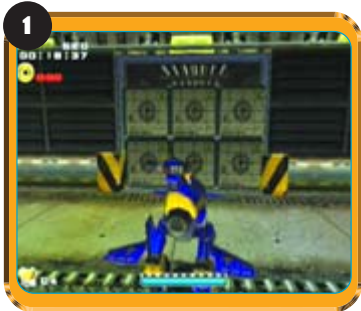

The first Chao Box is actually in the first room. However, you can't blast the Metal Boxes blocking it until you have the Bazoooka power-up found in Hero Stage 13: Eternal Engine.

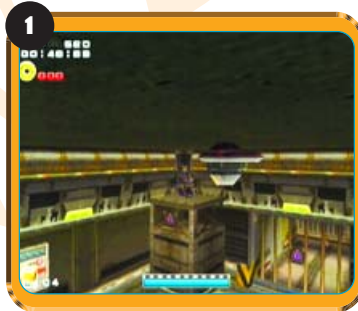

In the first room, ride the Mini-lift in the back corner. From there, shoot the Beetle robot to open another gate. In the short hall you find a Pipe.



From the Mini-lift, turn and jump onto the roof of the hall you just wandered through. Don't fall off the sides. Hit the Spring at the other end to reach the Extra Life. Don't forget to grab the animal farther along on the roof.

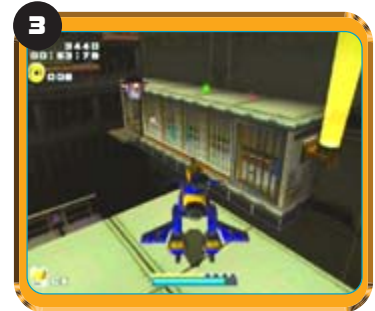

Use the Mini-lift to reach the roof and hop over the gate. The camera will face the hall across the way. Blast the robots to open the gates, then boost over and into the hall to grab the loot. The second Chao Container is here, too.

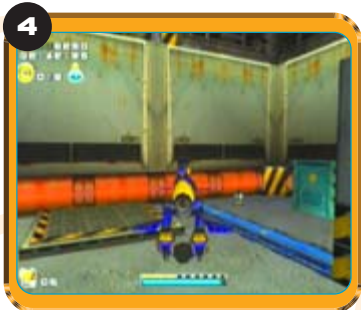

Hop off the Mini-lift over the gate to get at the third Chao Container. Blast the robot to drop the gate and get out.

### TIP

Blast the Gas Tanks to find hidden animals.



While riding the big Mini-lift, keep spinning the Laser around to target all the enemies around you. Target as many as you can before firing for maximum points. Also, keep moving to avoid enemy fire.

### TIP

For the moment, ignore the Ancient Ruin. They won't help you until you have Tails' Mystic Melody.



Make a blind jump from the Mini-lift and boost over to the roof of the lower covered hall. Step on the green button to fire the Rocket and free the caged animal. Make your way back and pick it up.

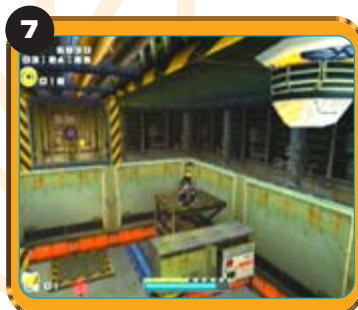

You must ride this second Mini-lift to get a shot at the last robot in this room. Once it's scrap, the gate will open.



A group of robots waits for you in this room. When they're gone, step inside and check the upper corners of the room; you should find a lurking robot. Jump up and shoot him.



If you have the Bazoooka you can bust the Steel Containers blocking the hall. Bust up the two robots in the hall and snag the Laser Blaster.



**PRISON LANE**

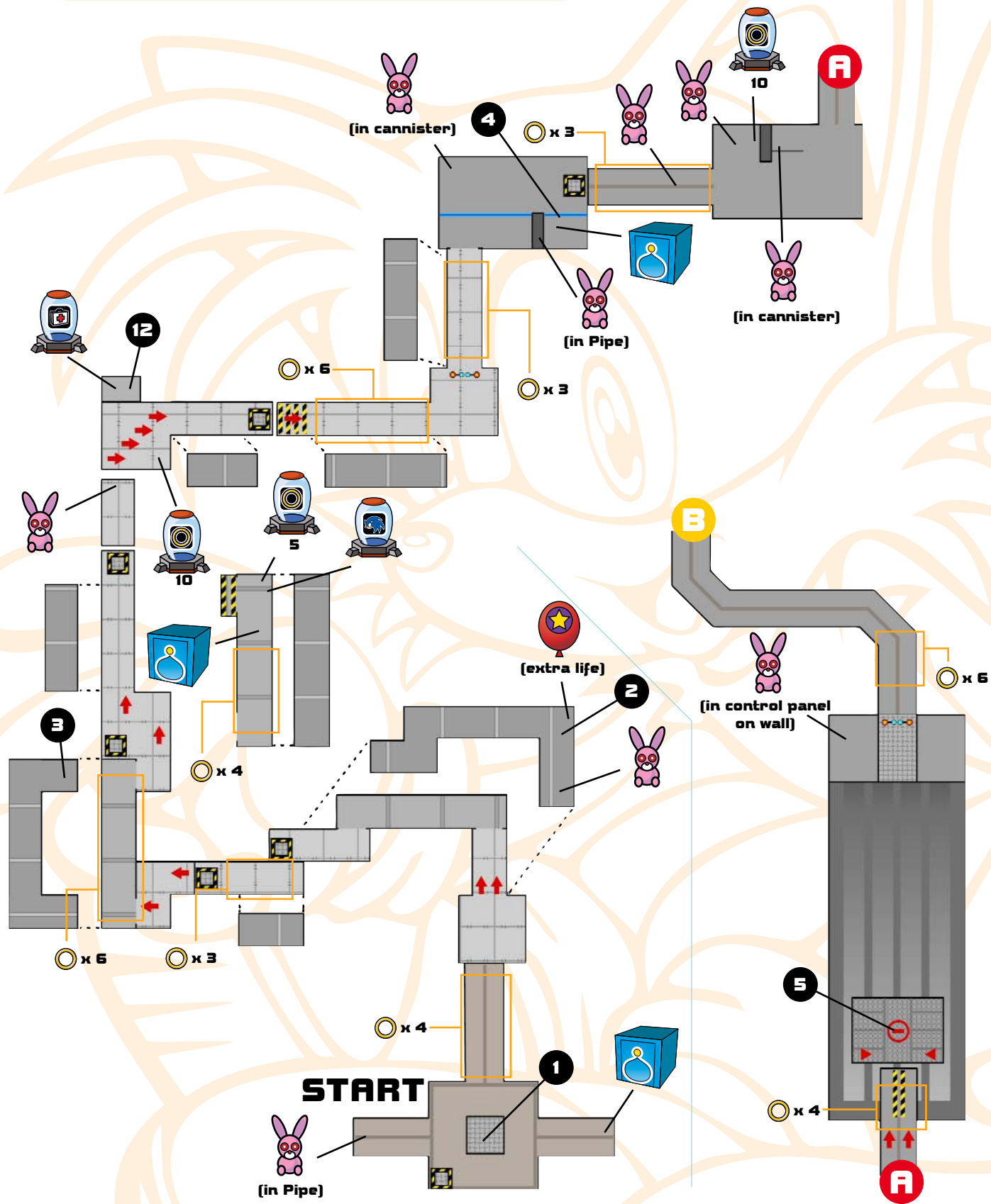

# HERO STAGE 3: TAILS



primagames.com

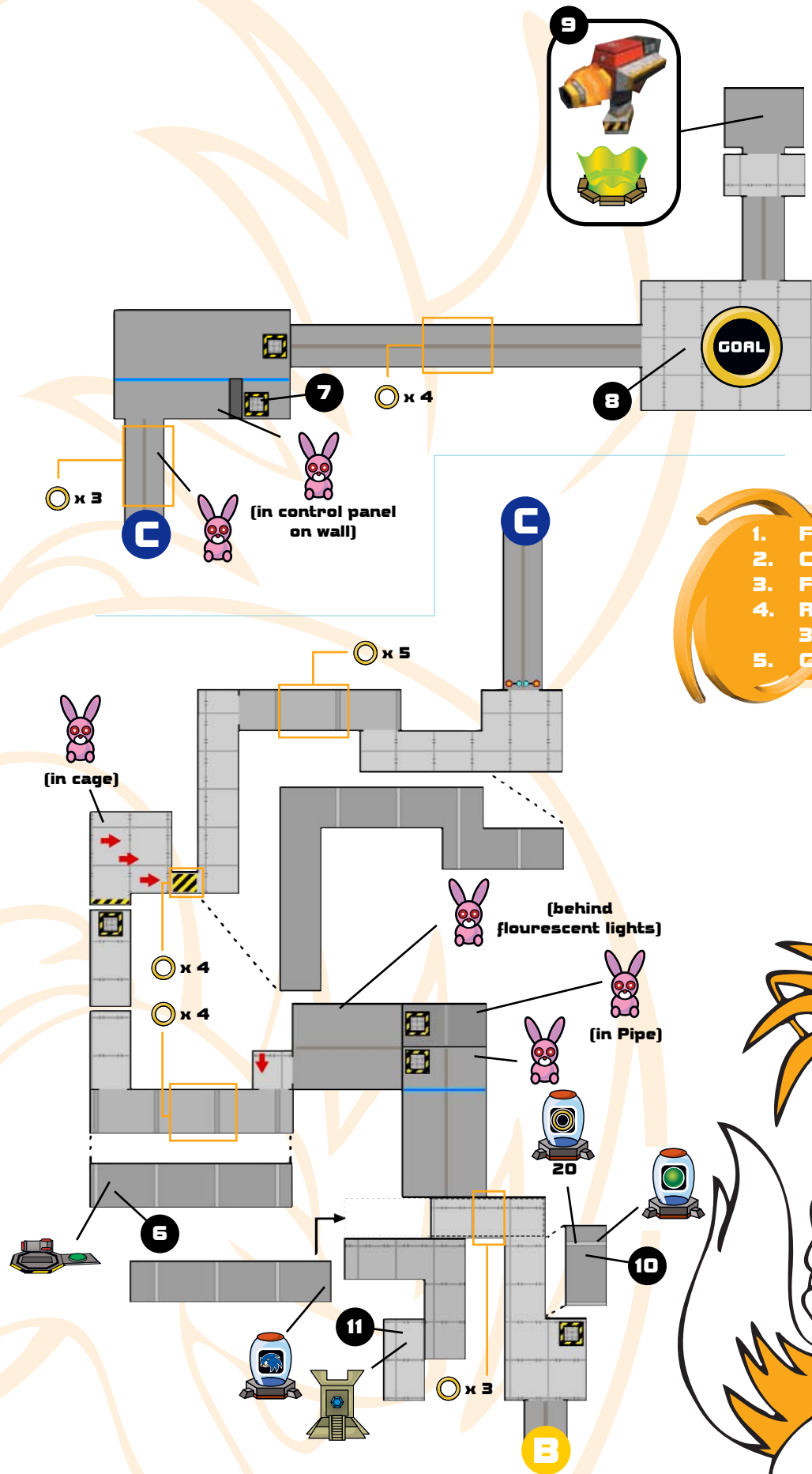

## Missions

1. Find the core of the prison!
2. Collect 100 Rings!
3. Find the lost Chao!
4. Reach the goal within 3 minutes 0 seconds!
5. Clear Hard mode!

POWER-UP:



LASER BLASTER



## MISSION 2: COLLECT 100 RINGS

The key to gathering 100 rings in this Stage is to avoid being hit. It seems obvious, but Tails is slow and does not change direction well, so enemies can bang into him rather easily. Play through the Stage enough to know when the robots are going to show up so you can blast them quickly.



The Item Box with 20 rings in it will help out, but you must scrap the robots quickly to hang onto the hoops.

## MISSION 3: FIND THE LOST CHAO

You'll need Tails' Mystic Melody (which you can find in Hero Stage 10: Hidden Base) to grab the lost Chao. Make your way to the Mystic Ruins and play the tune, then use the Spring to reach the hall with the Chao.



Bounce up to the hall and shoot the robots to unlock the gates. The little blue Chao is waiting to be taken away.

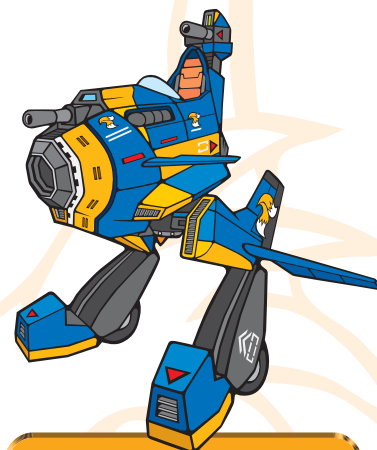

## MISSION 4: REACH THE GOAL WITHIN 3 MINUTES 0 SECONDS

You can complete this mission using much less finesse than the others. Because speed is your goal, don't spend time collecting the loot. Also, you can simply blow by some of the enemies. Bull through the robots. If you take a hit, just pick up a few rings as you run by.



To shave time, leap off of Mini-lifts before they've reached the top. It may be a small thing, but every second counts.

## MISSION 5: CLEAR HARD MODE

Hard Mode is, believe it or not, harder than you're used to. More robots and more guns are pitted against our hero, Tails. They drop from the sky and clog the hallways, but by the time you reach the fifth mission, you should be able to handle the pressure.



Where there was a Health item you'll find a switch that stops the smashing Weight trap in the hall.

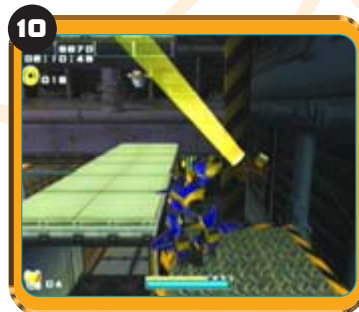

You must blast this robot to get the gate to drop a little farther along.



primagames.com

# METAL HARBOR

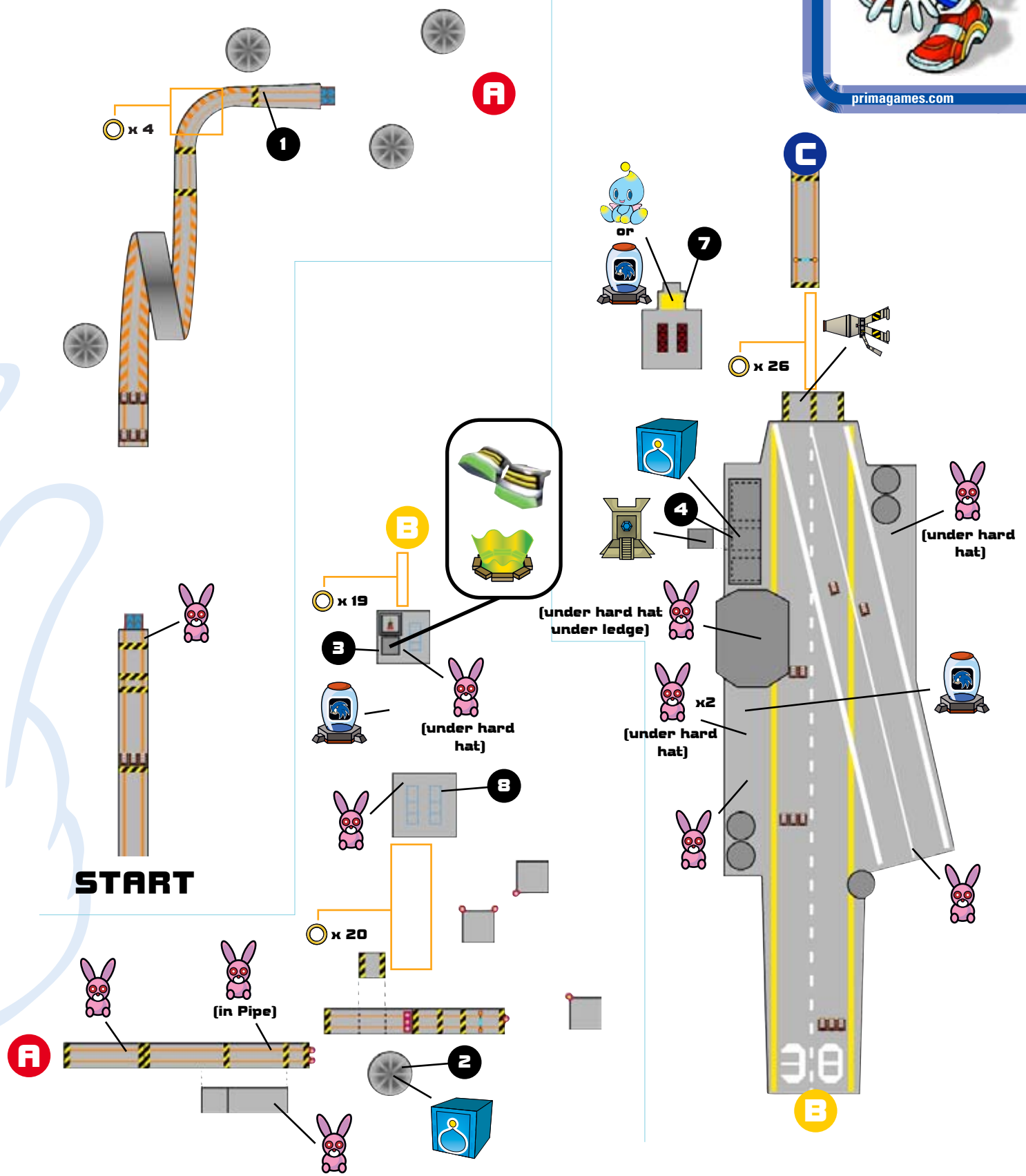

# METAL HARBOR

So you've been plopped into a little jail cell. You've got to get out of here so you can get on with business. Luckily for you, Amy Rose is here to bail you out. After refusing Amy's proposals, you find out that Dr. Eggman is behind all of this. No time for chit chat; let's get moving.

## Missions

1. Escape from the military base!
2. Collect 100 rings!
3. Find the lost Chao!
4. Reach the Goal in 5 minutes 0 seconds!
5. Clear Hard Mode!

POWER-UP:



LIGHT SHOES

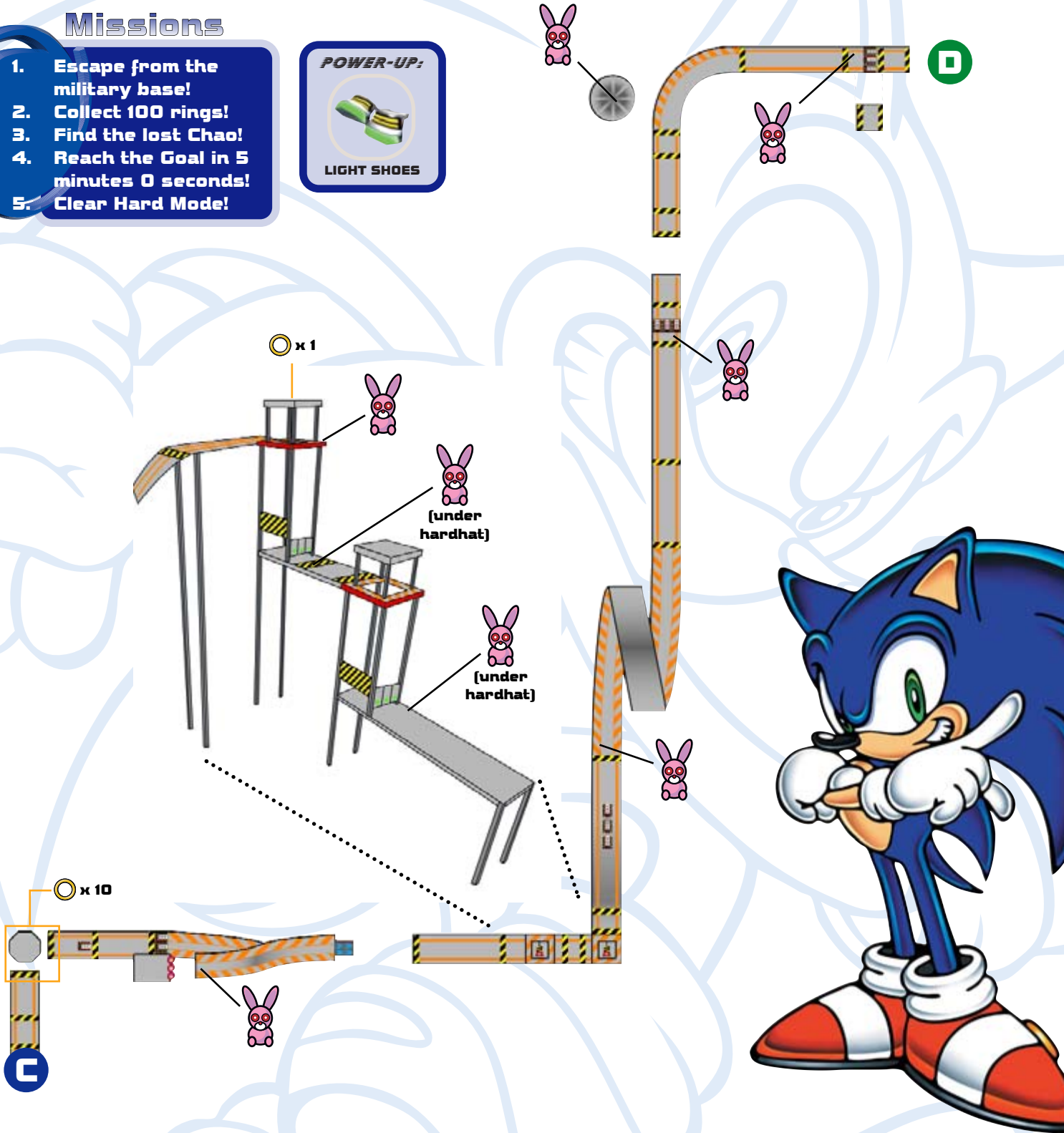

# HERO STAGE 4: SONIC



primagames.com

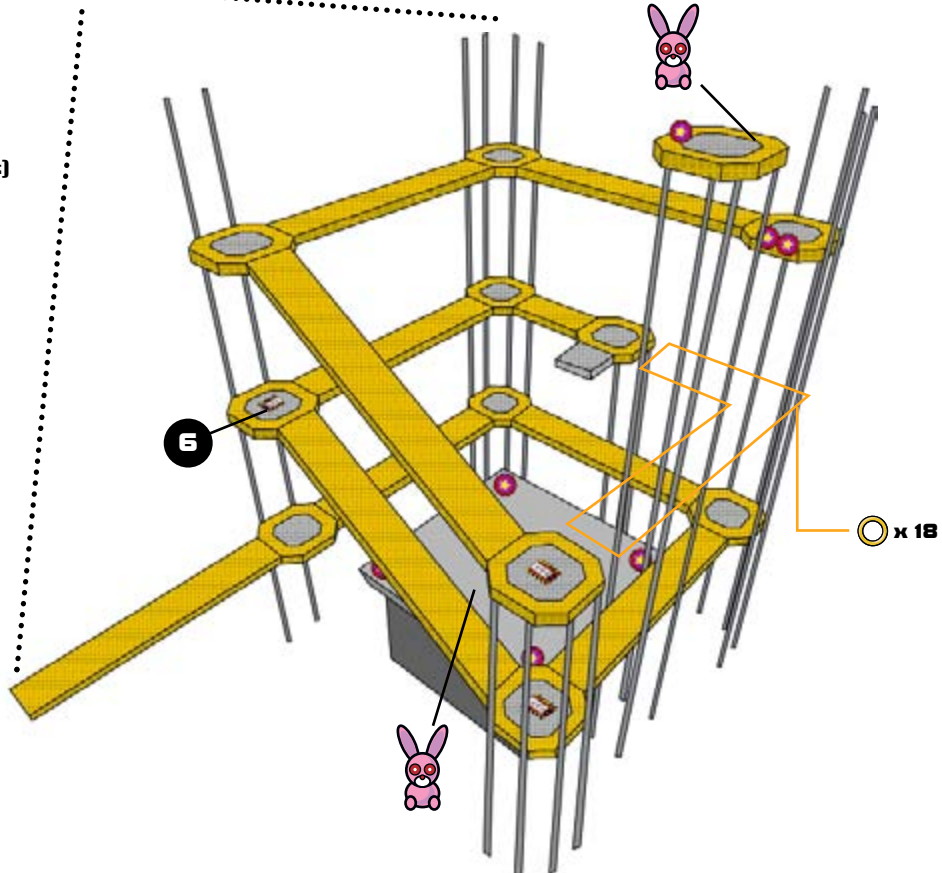
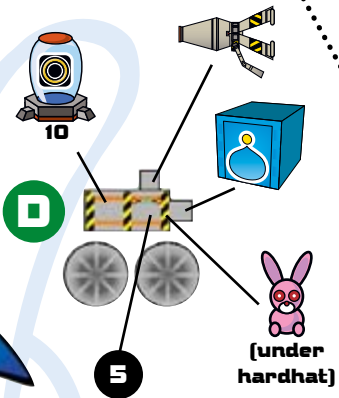
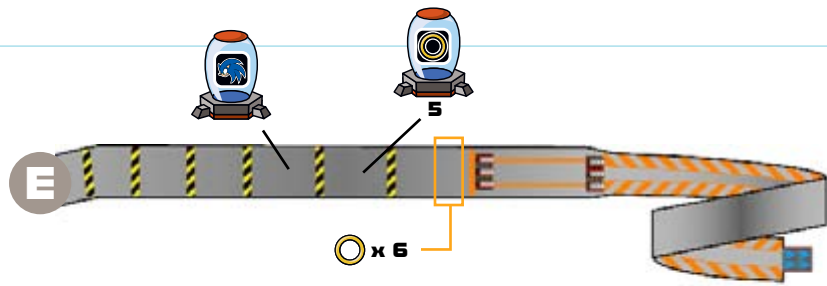
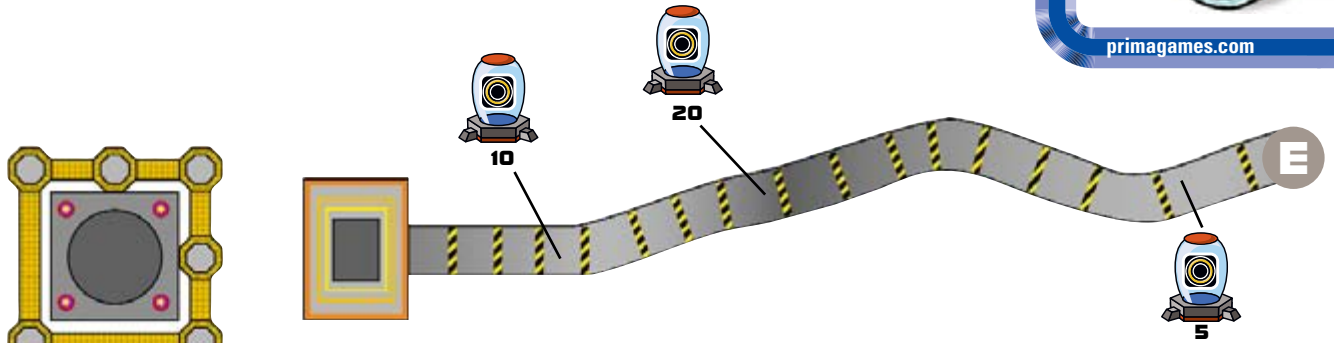

## MISSION 1: ESCAPE FROM THE MILITARY BASE



**1** If you already have the Light Shoes, Light Dashing automatically puts you on the Rail. Don't overshoot the Rail, or you'll be in for a swim.



**2** From this high vantage point, you can see the first Chao Container up to your right. Use the Homing Attack to reach it.



**3** If you don't already have the Light Shoes, hitch a ride on the Pulley here. At the top, your Light Shoes are just a hop and skip away. With these kicks, you can Light Dash to your heart's content.



**4** You'll find your second Chao Container in one of these storage alcoves.



## MISSION 2: COLLECT 100 RINGS

Snagging 100 rings on this Stage is a cinch if you make use of the Light Shoes.

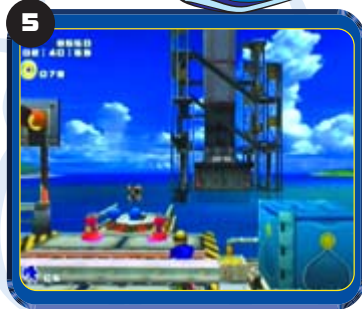

**5** Not so fast, fur ball. Before you go screaming through this point marker, look to your right for the last Chao Container.



**6** Run, Sonic, run! After you get off the Rocket, you have 15 seconds to grab onto the big rocket. Use the dash panels around the corners for a little boost.



**7** Combine strings of rings with Sonic's Light Dash, and this mission is in the bag. Line up the Light Dash so you don't shoot off the edge.



**8** At this point, you should have reached 100 rings. Do it faster to get the A rank.

## MISSION 3: FIND THE LOST CHAO

How do these Chao manage to get lost on each Stage? Have you found Sonic's Mystic Melody yet? It's in Hero Stage 16: Final Rush. The Bounce Bracelet (found in Hero Stage 11: Pyramid Cave) is also needed to reach the poor Chao.



**4** Make your way to the aircraft carrier and look above where you found the second Chao Container. Bounce your way up there and play your Mystic Melody.



**7** Platforms will slowly pop out, one by one, allowing you to hop over to the Chao on this lonely structure. Another lost Chao is saved!



## HERO STAGE 4: SONIC



primagames.com

### MISSION 4: REACH THE GOAL IN 5 MINUTES 0 SECONDS

Feel the need for some speed? Try your hand at this mission. You're only given five minutes to reach the Goal. Easy as pie....



There isn't much to this. Five minutes is plenty of time to complete this Stage. Try not to hurry, simple mistakes will hurt you more than a little caution will.

### MISSION 5: CLEAR HARD MODE

Uh oh. Hard Mode, eh? They think they can stop you by changing a few things in the course? Ha!



These Beetle robots are set up differently. If you expect to go flying through them like before, you have another thing coming. Use caution.



## SONIC VS SHADOW

Sonic runs into his Dark Story doppelganger in the forest. Some harsh words are exchanged, and then the two decide it's time to fight. It's a hedgehog throw down.

### BOSS ATTACKS

Shadow has only one attack in this first encounter. He can do the Homing Attack that you know so well. Plus, the little creep picks up rings. So, make sure that you grab some right off. Shadow isn't very aggressive in this battle. If you leave him alone, he doesn't do much. However, if you attack and miss—or he blocks you—he will retaliate immediately.

If you're in the middle of a jump when Shadow comes at you, you'll be fine. However, being hit will bounce you around. Try to stay in the middle of the grassy platform, or you risk being knocked off into the water.

You must wait until Shadow has his back to you in order to get a hit on him. The quickest way is to move around. Shadow will run about and then stop, back turned, for a second. That's when you strike.



When the gold glow surrounds Shadow, he's going to come at you. Hit **A** and you'll be protected from his attack.



Stay in the middle. Even when moving around, you should keep away from the Rails. Keep a sharp eye on Shadow and nail him when his back is turned.



Knock out Shadow and then get the heck off that island. Things are going from bad to worse.



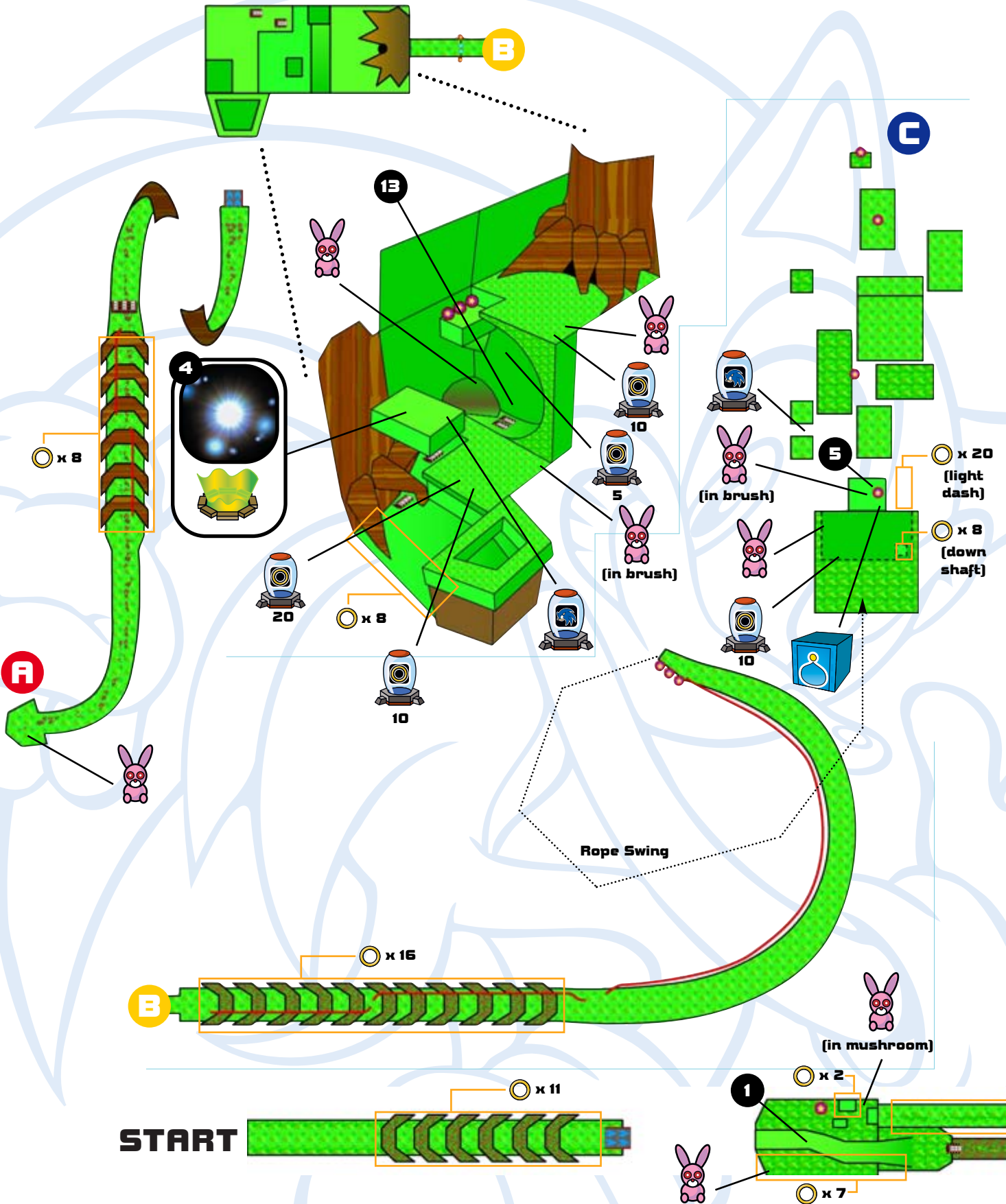



primagames.com

# GREEN FOREST

What a sore loser. After defeating Shadow, you realize that the island is going to explode. Time to blow this taco stand.

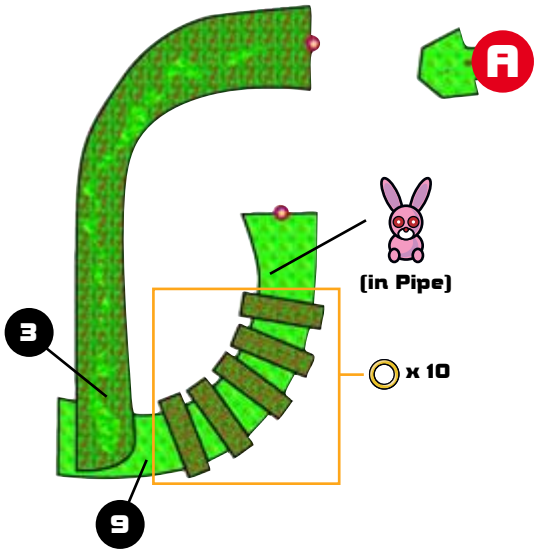
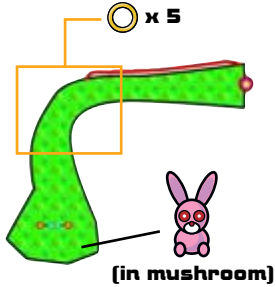

## Missions

1. Escape from the island in 8 minutes!
2. Collect 100 rings!
3. Find the lost Chao!
4. Reach the Goal within 4 minutes 0 seconds!
5. Clear Hard Mode!

POWER-UP:



ANCIENT LIGHT

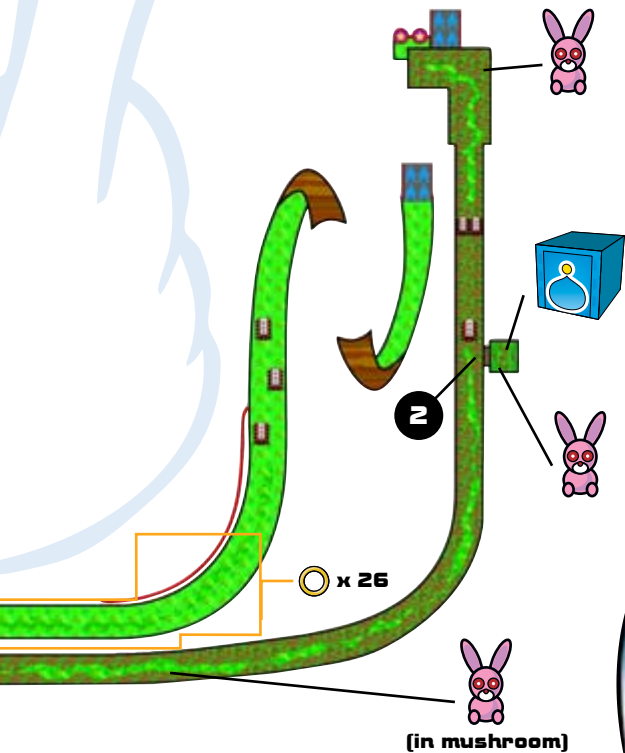

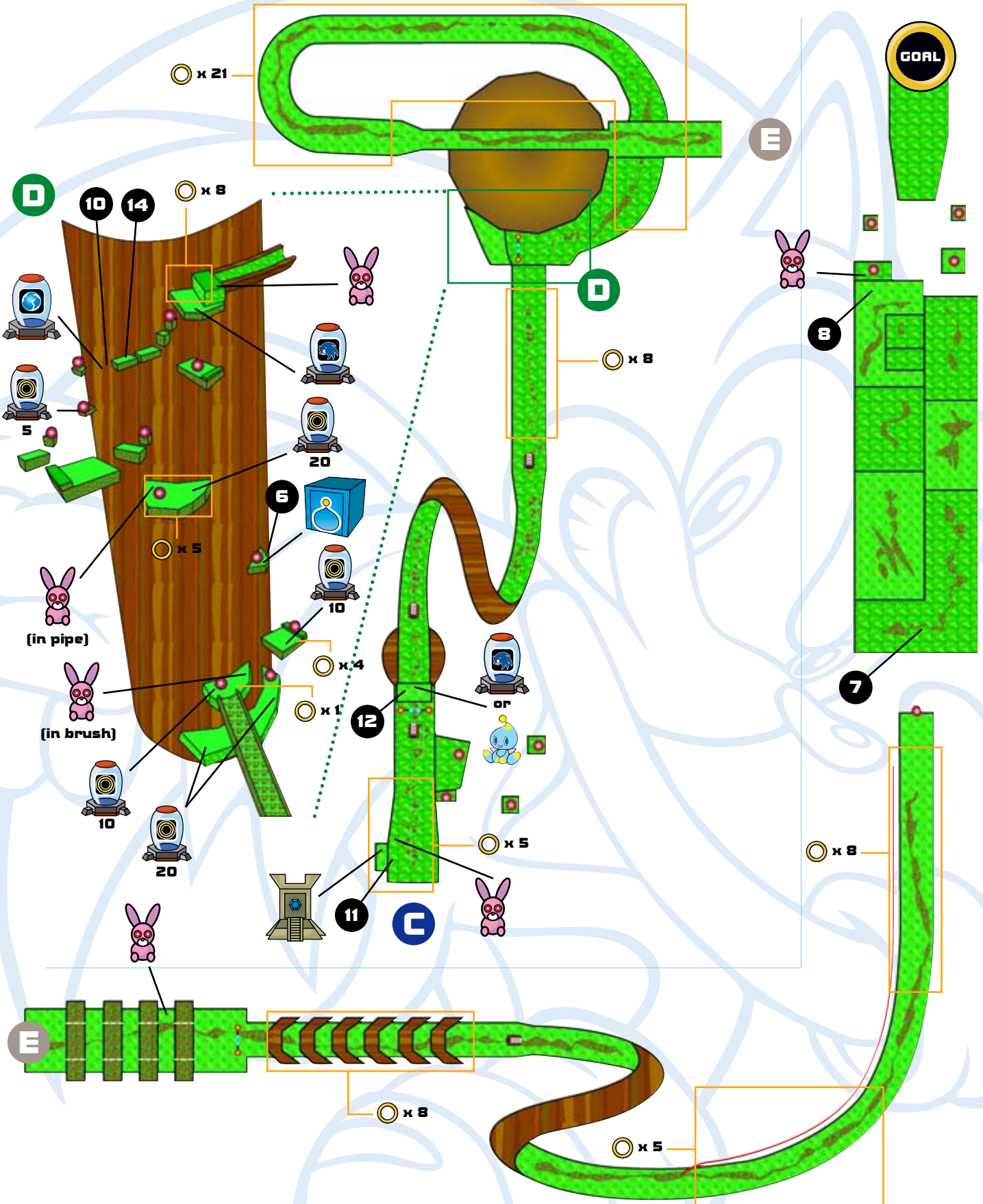



primagames.com

**MISSION 1: ESCAPE FROM THE ISLAND IN 8 MINUTES**



**1** Watch for Hawk robots here. Use Light Dash to sweep up the rings and destroy the robots. Looking for animals? Check under those brightly colored mushrooms on the left.



**2** Go easy on the Dash Panels in this tunnel. The pool of water located before a Dash Panel (but after the hidden animal) is where you access the first Chao Container. Somersault to your right to reach the cave.



**TIP**



If you're looking for animals, don't be in such a hurry to reach the end. You get shot around a lot on this Stage; when you land, back up and check the surrounding area, because you may find a friend or two. Remember that they like to hide under brightly-colored mushrooms.



**3** Link together a bunch of Homing Attacks to make short work of these robots and their floating companions.

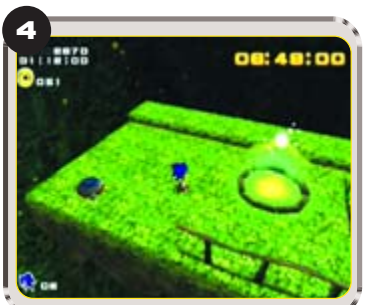

**4** Sonic's Ancient Light is found in this area. After landing from the loop, approach the near edge. Make a long and high jump toward the Beetle robot and home in on it. Link that with a couple more for an Extra Life and land on the platform beyond. Ta-da!

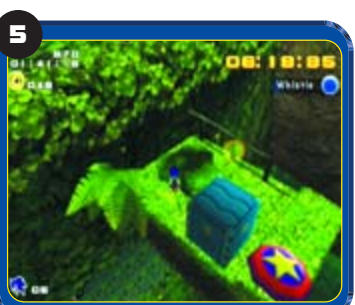

**5** The second Chao Container is just below this floating block of dirt. Use the Homing Attack to get that first Beetle robot out of the way, then step off the right edge of the block to reach the Chao Container.



**6** The last Chao Container is much easier to reach than the first. Control your jumps between these Springs and land on the blue Chao Container.



**7** Possibly the toughest part of the Stage is right before the Goal Ring. Hold down your jump button as long as you can while combining it with the Homing Attack to clear the rising chunks of earth.



**8** When you reach the last dropping platform, relax a bit until you can see a floating chunk of ground ahead. It should have a Spring on its side. This is your target.



## MISSION 2: COLLECT 100 RINGS

Again with the 100 rings! How fast can you collect them?



Remember these Hawk robots that drop down on you? If you're not ready for them, they'll knock the rings right from your grasp. While you're here, take the Spring to the upper level for more rings.



Avoid the robots on the upper level here by dropping down below, which also gives you access to 10 rings.



To aid in your search for rings, grab this Magnetic Shield Item Box. With this handy-dandy item, you'll be hard-pressed to miss any nearby rings. You're practically finished.

## MISSION 3: FIND THE LOST CHAO

If you were lost in this forest, wouldn't you be scared? So what are you waiting for? Imagine how the poor lost Chao feels. Do you have the Mystic Melody yet? What about the Bounce Attack? Find them in Hero Stages 16 and 11, respectively.



Screech to a halt at the top of this platform. The Ancient Ruin is to the left, beyond the ledge.



When you play your Mystic Melody, platforms appear beside you. Use the Bounce Attack to reach the high ones and the Homing Attack to reach the Chao on the far end. Speed is the key to achieving A rank.





primagames.com

## MISSION 4: REACH THE GOAL WITHIN 4 MINUTES 0 SECONDS

If you keep your nose to the grindstone, four minutes is plenty of time to complete this Stage. The Goal Ring isn't far away, just don't make any mistakes.



On straightaways like this, charge up your Spin Attack to barrel through safe areas at lightning speed.

### TIP

It's tempting to destroy enemies, but doing so takes up valuable time. By now, you should know when they'll drop down and where they'll be. Do your good deed for the day and pass them by, staying focused on the Goal Ring.



## MISSION 5: CLEAR HARD MODE

You must have ticked off someone by getting this far. The Stage has been altered to make your Goal Ring harder to reach. Not a problem: Momma didn't raise *this* hedgehog to quit in the face of adversity.



1 The robots here are more aggressive, and the log in your way prevents you from simply cruising by them. Beyond, the robot in the tunnel is now indestructible. Don't waste your time with it; cruise on through.



13 Uh-oh. The dash panels here have been removed. Charge up a Spin Attack, or you won't make it to the Dash Panels above.



14 We're missing a floating platform here. Thankfully, the Beetle robot is still there. Use the Homing Attack.





# HERO STAGE 6: KNUCKLES



primagames.com

**POWER-UP:**  
  
**SHOVEL CLAW**

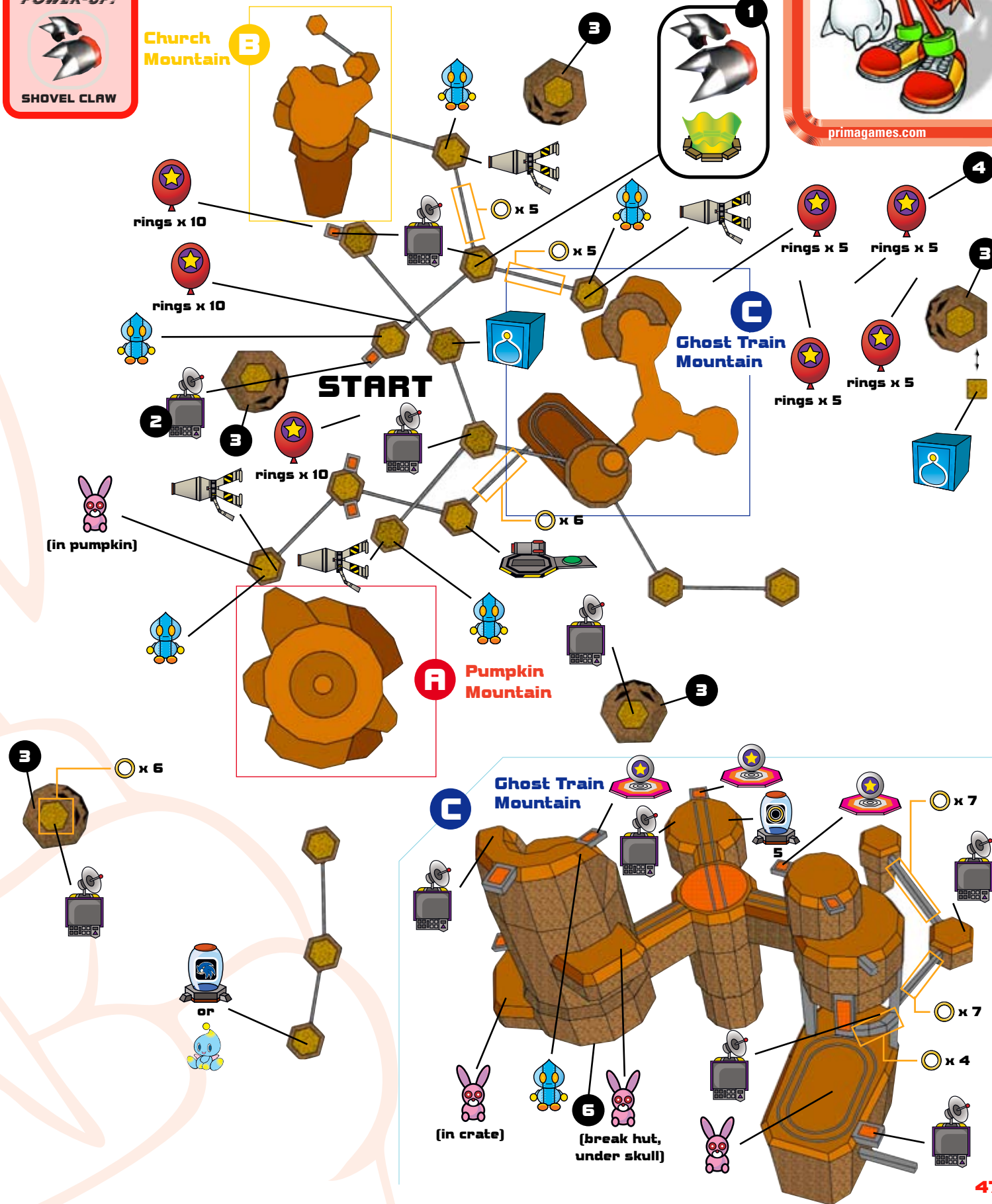



# PUMPKIN HILL

The search for the Master Emerald Shards continues. Knuckles must find three of them here in creepy Pumpkin Hill. The sunset is pretty, but there's no time to enjoy the view; you've got a job to do.

## MISSION 1: FIND 3 PIECES OF THE MASTER EMERALD



**1** The first thing to do here is grab the Shovel Claw. Use them to Dig into the ground or walls to find those Emerald Shards or goodies.

**TIP** For faster retrieval of the Emerald Shards, know the names and locations of the three mountains as well as the different characteristics of each.

**TIP** The Hint Boxes disappear after you use them. If you can find an Emerald without using the maximum of three Hint Boxes, do so. Save the others in case you're near them again later.



**2** The first Hint Box is right behind you. Use it immediately and save the others throughout the Stage for when you're closer to them.

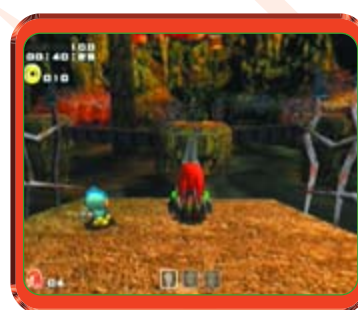

From the starting point and facing the island that contained the Shovel Claw, the Church Mountain is to your left. The Ghost Train Mountain is to the right. To get to the Pumpkin Mountain, take the Rockets from either Ghost Train or Church Mountain.

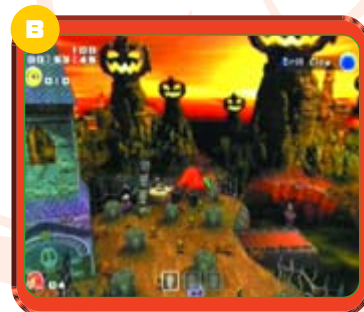

**B** Church Mountain is relatively small with some tombstones and grass at the top. Ledges around the sides sometimes hold Emerald Shards.



**C** The Ghost Train Mountain has a bunch of train tracks and a couple of trains that run on them. You can control the circular platform here with the different Switches along the edges. Changing the path of the tracks allows the train to retrieve any possible Emerald Shards from the corresponding tunnel.

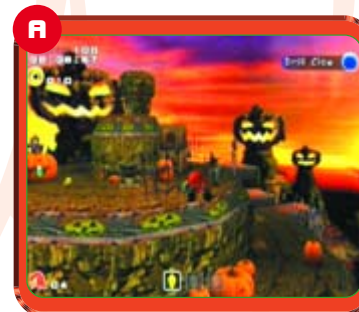

**A** Pumpkin Mountain has different areas with pumpkins growing on it. Along its side, as well as on top, are patches where you can find Emerald Shards.

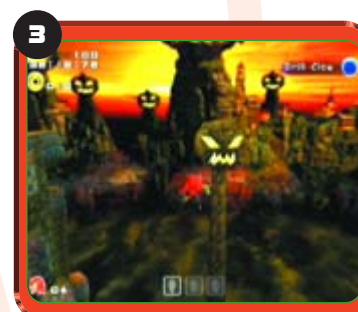

**E** Along the edge of the map are tall pillars with jack-o-lantern heads on top. These also house Emerald Shards and goodies.

## MISSION 2: COLLECT 100 RINGS

Good observation skills go a long way in this Stage. Rings are dispersed throughout the Stage; you just have to find them.

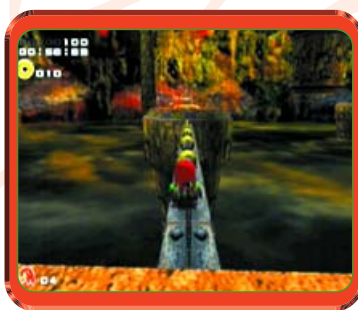
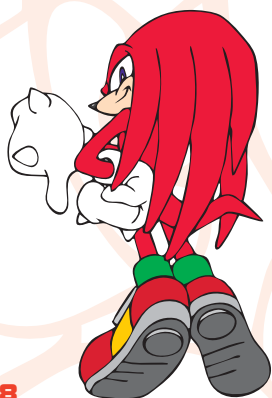

Look for rings on narrow beams. There are some in, and leading to, each mountain.

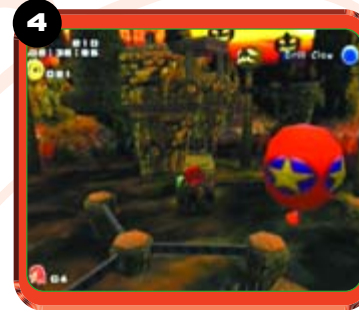

**4** Did you miss these Balloons floating up top?



As usual, be careful in areas with enemies. In this Stage, your enemies can include Ghosts as well as trains. They'll knock the rings right out of you.

## HERO STAGE 6: KNUCKLES



primagames.com

### MISSION 3: FIND THE LOST CHAO

This is a very creepy area for a little Chao. With all the grinning faces around, it's no surprise that the Chao is well hidden. You should have the Mystic Melody by now.

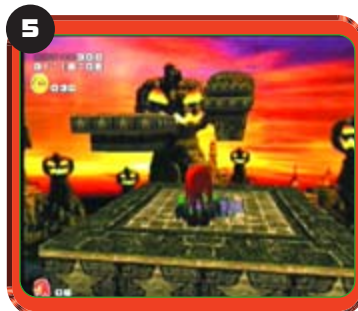

The Ancient Ruin is located at the very top of Pumpkin Mountain. Use the Mystic Melody to awaken the platforms you can use to reach the lost Chao. Finding all the lost Chao should be this easy!

### MISSION 4: COLLECT THE 3 EMERALD SHARDS IN 3 MINUTES 0 SECONDS

The random locations of the pieces of the Master Emerald make it a tricky task to complete this mission. With only three minutes to work with, you should be familiar with this Stage and where the Hint Boxes are. Good luck!



Don't forget to use the two Hint Boxes near the start position. Use these first to get a good bead on the first Emerald Shard. You don't want to waste a Hint Box at the top and discover that you can't find one later.

Use the Rockets. They take you from mountain to mountain much more quickly than climbing the walls.

#### TIP

If you remember where the Hint Boxes are, you'll notice some of them are missing. Put on your Sunglasses to find them again.



### MISSION 5: CLEAR HARD MODE

So you need a little more of a challenge? Hard Mode was made for you. Make sure you have the Sunglasses from Hero Stage 14: Meteor Herd, before you attempt this.

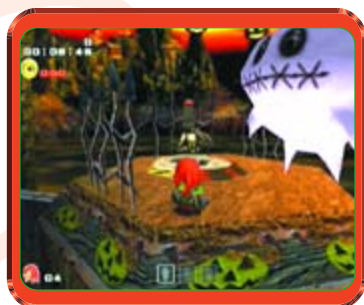

These Ghosts don't go away unless you destroy their smaller form. Each time you punch them, they get smaller. But if you leave the smallest Ghost running around, it regains its larger form.



The first Shard floats beneath this mountain but above the rotating spikes. Get a grip on the wall just above the bottom of the mountain and Glide on over to it.



The second Emerald Shard is near the bottom of the pumpkin mountain. Find the two heads shooting fire at the wall. Wait for the flames to stop, and Dig where the flame hits the wall. You dig?



Climb to the top of the church on the church mountain. "The top" here means the very tippy-top, the pointy end of the church. While standing up there, put on your Sunglasses and enjoy the view. Before you know it, you're sprung straight up into the air by a Spring. At the peak of your ascent, Glide on over to that shimmering Emerald Shard up ahead.

#### TIP

To use the Sunglasses, you must actually be standing. If you're in Climb Mode, the Sunglasses are inaccessible. Standing on top of the church takes careful attention. As you near the peak, make sure you are centered as pictured here. Adjust accordingly as you climb to the peak or you will fall off the edge. Small movements of the control stick push you up and into a standing position.



# MISSION STREET

Dr. Eggman has gone and blown up half the moon. Will the mad doctor ever stop? It's up to you, to find a way out of here and find Eggman!

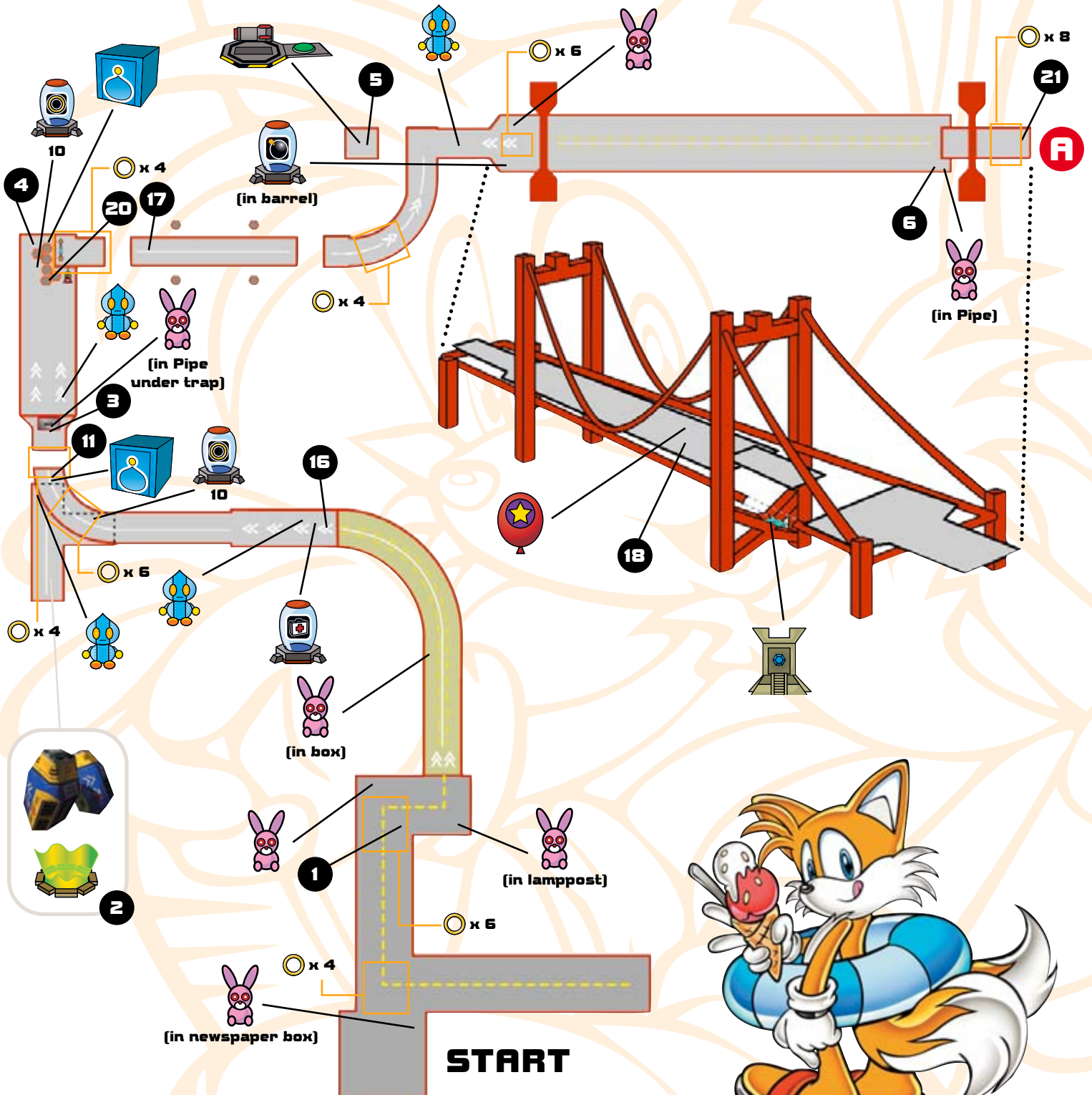

# HERO STAGE 7: TAILS



primagames.com

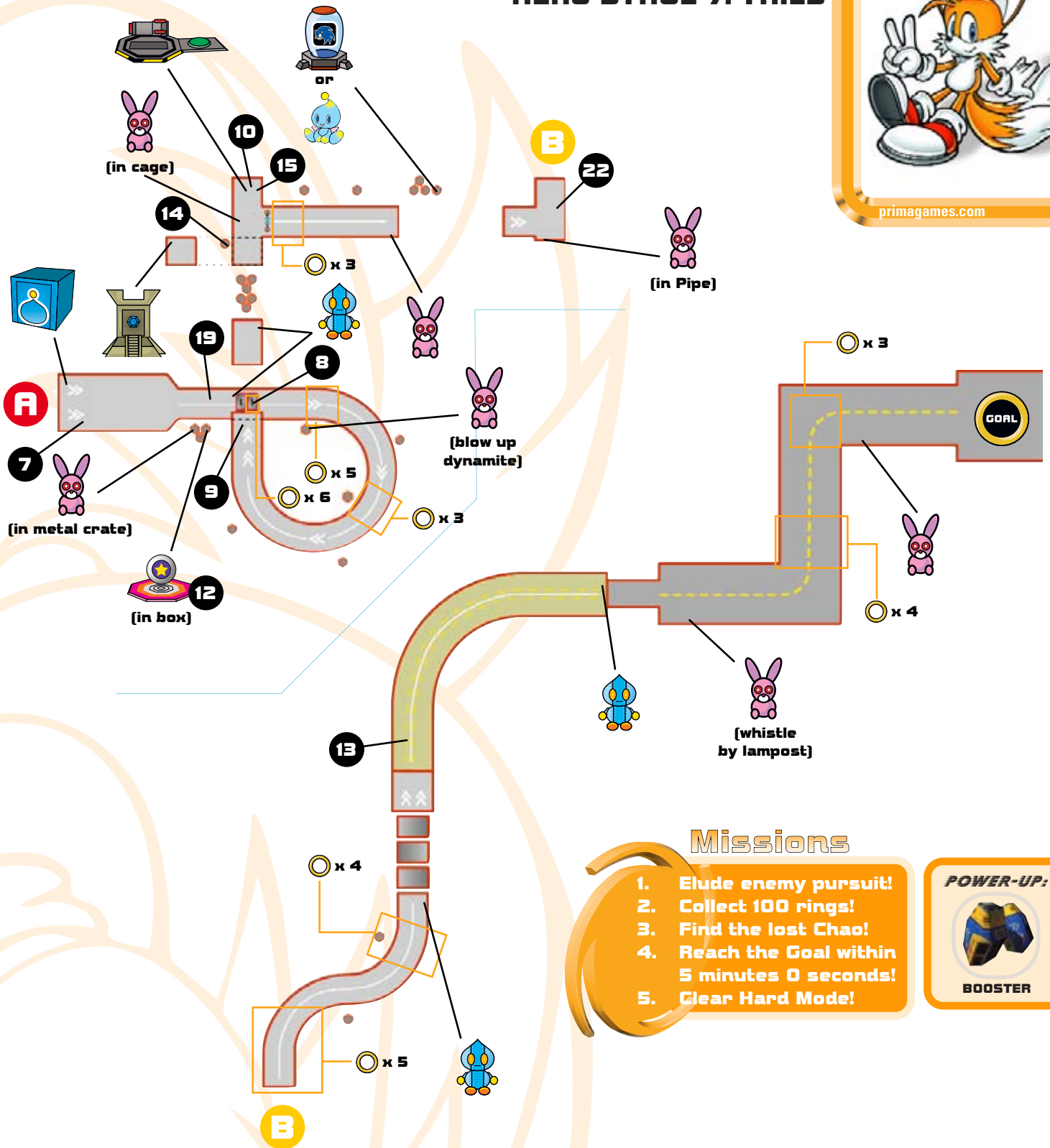

## Missions

1. Elude enemy pursuit!
2. Collect 100 rings!
3. Find the lost Chao!
4. Reach the Goal within 5 minutes 0 seconds!
5. Clear Hard Mode!

POWER-UP:



BOOSTER

## MISSION 1: ELUDE ENEMY PURSUIT

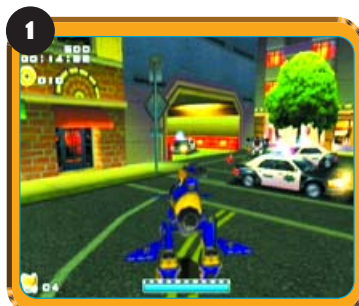

**1** Go down the street and through the tunnel, watching out for dropping bombs and robots. Don't forget to grab the rings in case you get hit.



**2** After you fall with the freeway, walk to the end and take a left here. Find Tails's Booster so that you can continue through the Stage.

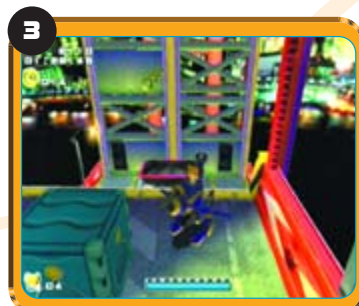

**3** For your first Chao Container, ride this Weight to the top. Instead of continuing forward, jump and Boost toward the screen so that Tails is coming directly at you. This is a leap of faith. As you drop down, you'll land on the freeway above where you were. Ta-da!

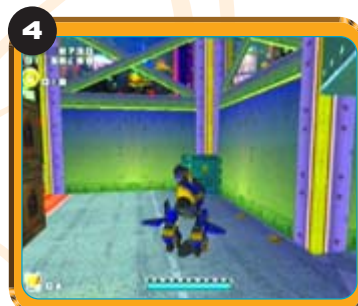

**4** The second Chao Container is very close. To the left of the Pulley here are some boxes. Snoop around in that corner and see what you find.



**5** Those Cages need some good firepower to break. Look to this platform for a Rocket with a button behind it. Launch it and continue your quest.

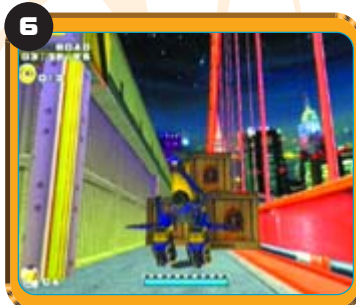

**6** To reach the top platform here, use the boxes on the right. Or, if you've already destroyed them (shame on you), use the fallen pillar to the left.

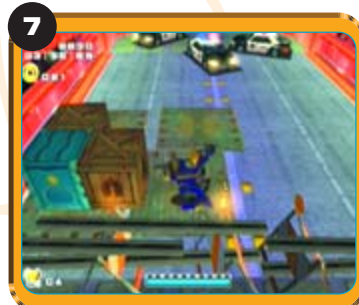

**7** After you clear this gap with the help of your Booster, break open the final Chao Container, inconspicuously nestled between some crates, on your left.

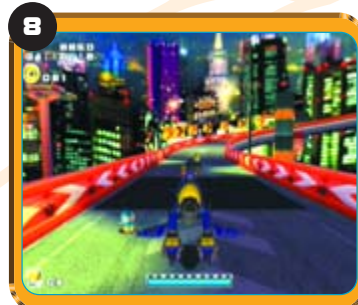

**8** Speak to the Omochao before you step into the shadow. It's a trap. Back away from it, and it should fall. But wait, you're not clear yet. If you simply jump over it, another one will come crashing down. Instead, hop on the fallen trap, step to the edge, and wait for the next trap to fall before continuing or hit the Switch to the right to stop them from falling.



**9** Use your Booster to clear this gap. If you fall with the dark traps here, you'll land on the level below.

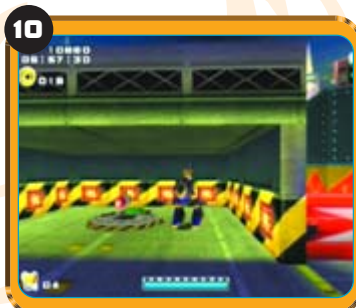

**10** If you haven't gotten Tails's Bazooka—found in Hero Stage 13: Eternal Engine—you can't save this animal from the Cage. If you have, smash those Steel Containers up ahead to find a Rocket capable of freeing the small animal.

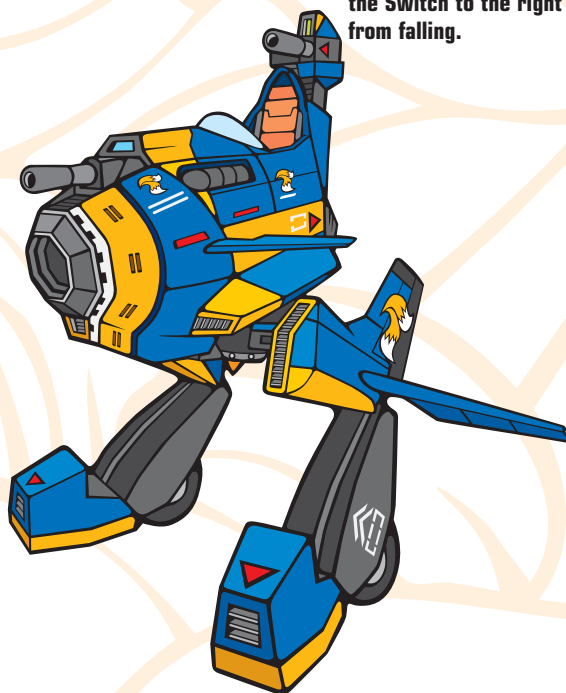

## HERO STAGE 7: TAILS



primagames.com

### TIP

This stage is full of harmful baddies. The more quickly you grab 100 rings, the better. Snag every ring that you pass to avoid facing unnecessary enemies. This includes ring Item Boxes and out-of-the-way caches.



## MISSION 2: COLLECT 100 RINGS

With so many enemies and surprises on this Stage, caution must be carefully observed to achieve the 100 rings goal. There's nothing worse than coming close only to be hit by an unexpected bomb. You have been warned.

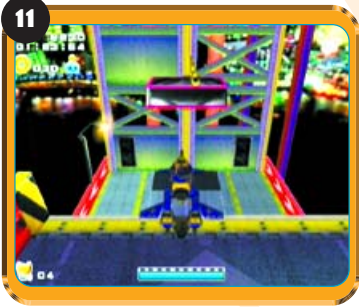

Whether or not the first Chao Container interests you, make your way to it. There are a bunch of rings you can safely collect on the way there.

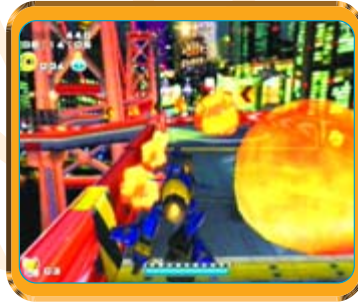

When you see Jets circling above as they do here, beware. Walk on the edge of the walkway to avoid their bombs. One hit will knock your rings out. Because you can recover only 20 rings at best if hit, it'll set you back quite a bit.



A Switch is hidden in a box directly to the right of the traps. Throw this Switch to disable them. Besides allowing you to walk through unharmed, throwing the Switch makes it possible for you to collect a few extra rings when you make it around to the top.



As long as you watch yourself and avoid being hit by enemy fire, you can collect 100 rings by the time you reach this point.

## MISSION 3: FIND THE LOST CHAO

How did a Chao manage to get this far into the city? No wonder it's lost. With all the danger around, finding him could prove tricky. Again, to find the lost Chao, you need Tails's Mystic Melody—found in Hero Stage 10: Hidden Base.

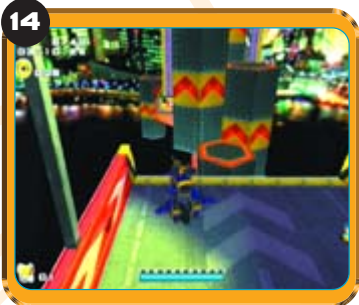

The process of rescuing this Chao is long, and it starts right here. It's easy to miss the bouncing column on the far left, because it almost blends in with the bunch of columns.



Wait at this ledge to get your bearings in relation to the bouncing column. Keep your eyes open and step onto it. It takes you down to where you can jump to an Ancient Ruin. Play the Mystic Melody to open a Warp Hole. This Warp Hole is the doorway to your Chao, so hop on the Ruin and warp on through.

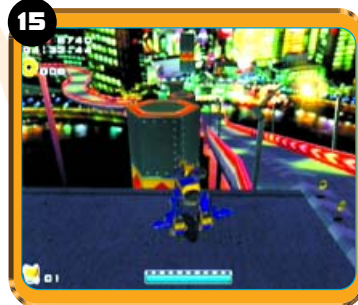

The Warp Hole drops you here, above the highway. Instead of dropping back to the road, note the bouncing columns in front of you and ahead. Hop from one to another until you reach the end. Destroy the robots on your path, and another lost Chao is saved.



## MISSION 4: REACH THE GOAL IN 3 MINUTES 30 SECONDS

Hurry, the place is gonna blow! Three minutes and thirty seconds is a challenge, even for a crafty fox like you. Ingenuity plays a big part here. It's essential that you find and take all shortcuts to shave time off the clock.

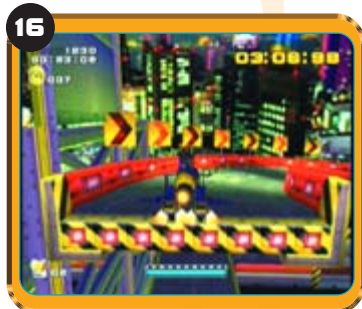

16 Make your way to this point as fast as possible, avoiding the delay caused by trying to kill *every* enemy. Line your sights straight down the middle and take out the center robot that drops from above. Do not pause to shoot the other two. Instead, run straight across the crumbling walkway to just before the halfway point. From here, jump and use your Booster to reach the other side. Land to the left or right of center to avoid the Jets' missiles.

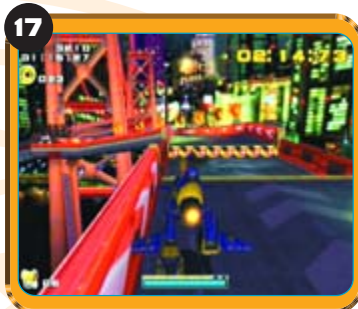

17 These crumbling walkways are short enough that you can simply run across them without using the Booster. However, stay to the right or left of center as you do so. Crumbling walkways usually indicate Missile-firing Jets.

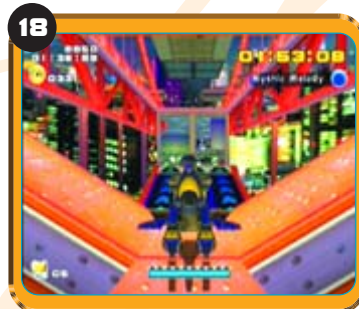

18 At the break in this bridge here, jump off the right side and float down and ahead to reach the Jump Plate below. This shoots you straight ahead and up, cutting your time. Make sure to shoot while airborne; the fencing can make you drop to your demise.

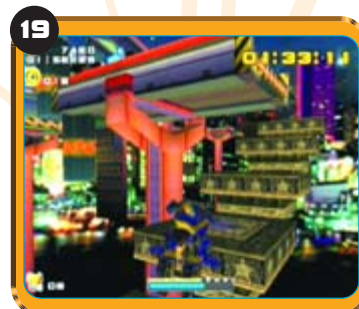

19 After you've been shot to just before the traps, you can continue ahead, making use of your momentum. The traps won't get you if you keep running. Alternatively, if you activated the Ancient Ruin below, floating platforms appear to the left of the stop sign, just before the traps.

## MISSION 5: CLEAR HARD MODE

More robots, fewer landing areas. These catwalks are falling apart faster than before. Be wary of new robots in new places. Platforms and moving columns have also been removed. Let's see what you've got.

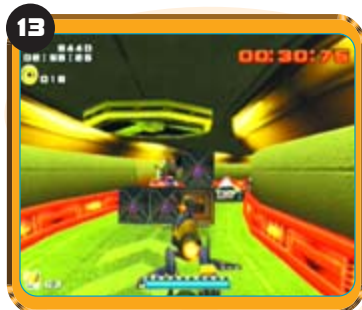

18 From here on out, it's a mad dash to the Goal Ring. Do not stop for anything; time is running short. Shoot anything in your way, but don't bother with any side projects.



19 Right away you notice many more robots on a mission to ruin your day. In the tunnel, more obstacles such as unbreakable Cages and Containers line your path. Keep calm and take it one step at a time.

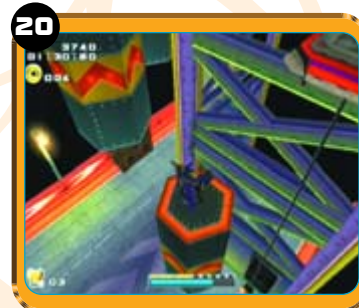

20 These bouncing columns are fewer and farther between. Hop to them with caution.

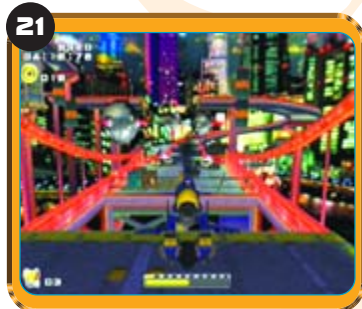

21 These spinning spikes float up and down. Wait for it to get low enough for you to clear with your Booster.



22 A whole section of this walkway is missing, leaving a teetering section up ahead. It's a little too far to simply jump to. Timing is everything here. Stand on this fallen column and wait for the left side (the nearest side) to begin dropping. As it does, jump with all your might and Boost over to the lower end.



23 From this point on, your chances of falling are gone. Step on the gas and get to the Goal Ring as fast as you can.

# HERO STAGE 8: KNUCKLES



primagames.com

## AQUATIC MINE

In his never-ending quest for the Master Emerald Shards, Knuckles finds himself in a mine that is a bit leaky. You must get wet to find all the Shards, so hold your breath.

### POWER-UP:



AIR NECKLACE

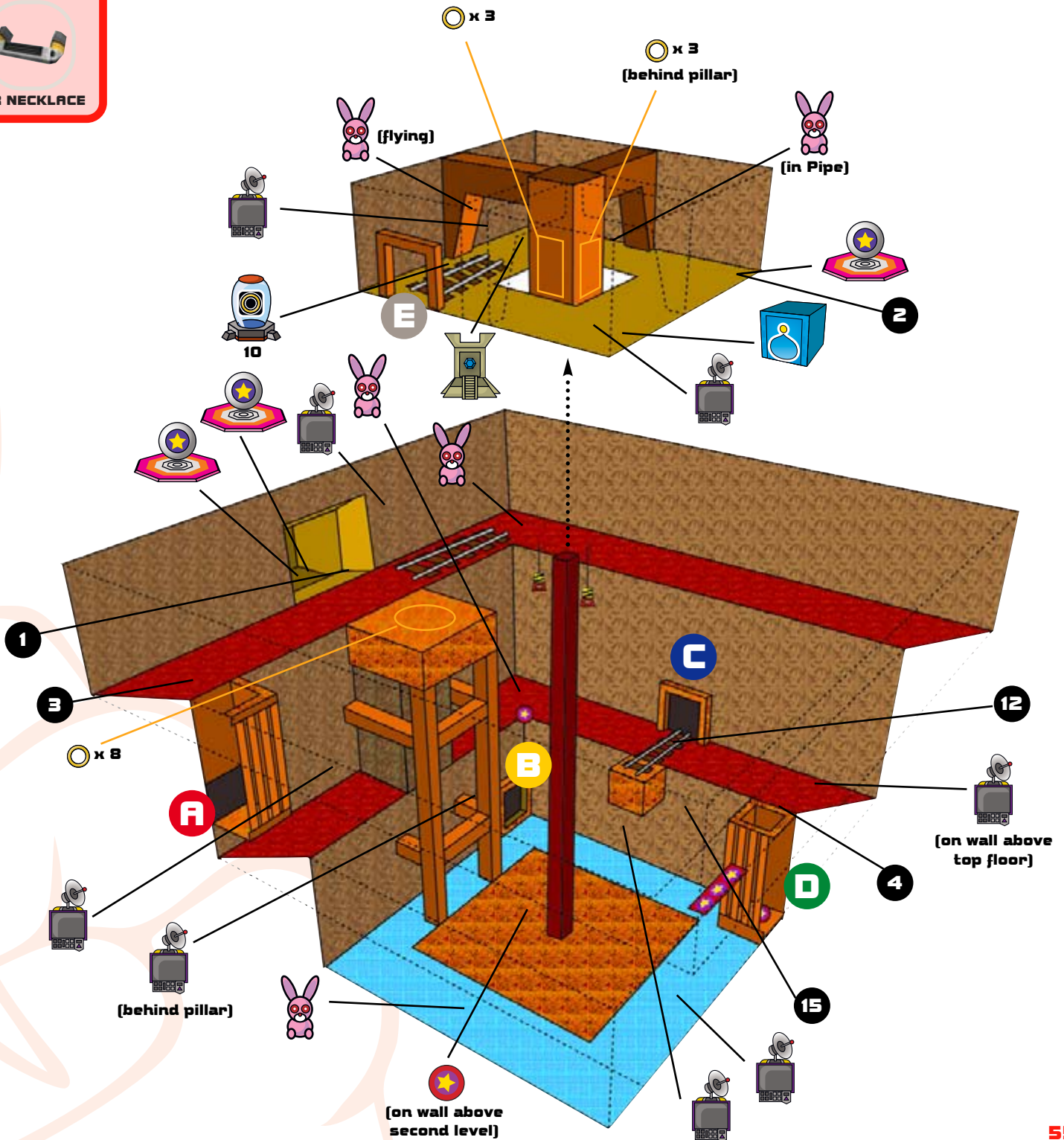



## Missions

1. Find 3 pieces of the Master Emerald!
2. Collect 100 rings!
3. Find the lost Chao!
4. Collect the Emerald pieces in 3 minutes 30 seconds
5. Clear Hard Mode!

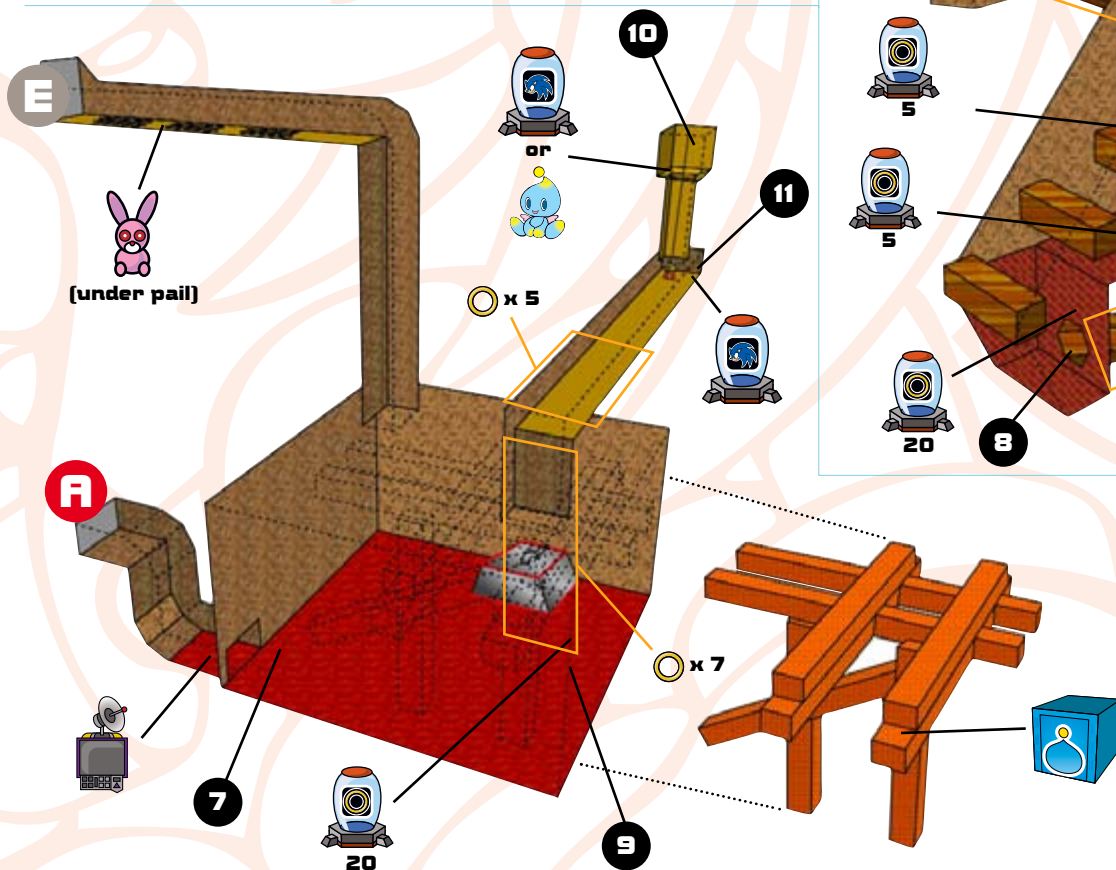
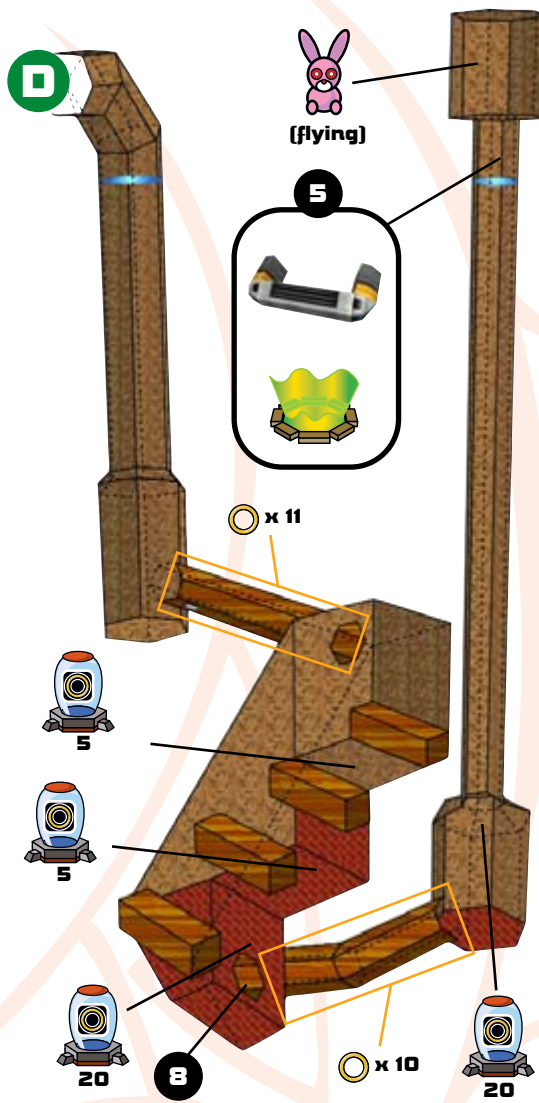
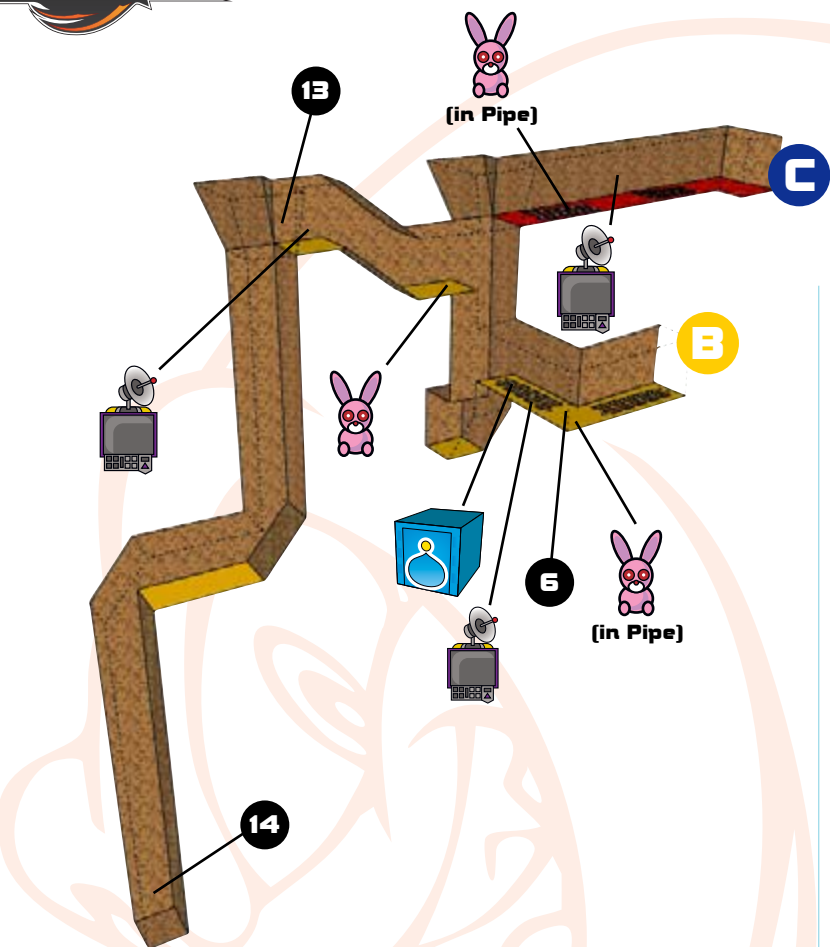

## HERO STAGE 8: KNUCKLES



primagames.com

### MISSION 1: FIND 3 PIECES OF THE MASTER EMERALD



The first Hint Box is to Knuckles's left as soon as you start.

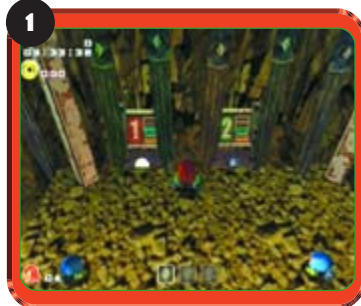

The two Omochao teach you about the water level Switches. The signs next to each Switch show what water level each one gives you. Level 1 is the highest water level.



Three shafts are accessible when the water level is low. You can get into this one when the water is at Level 2 or 3. The room below is full of Ghosts.

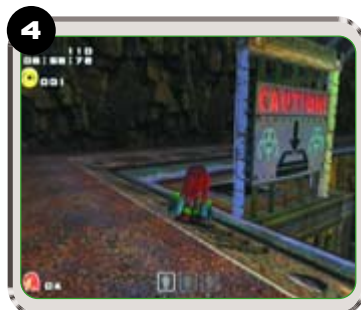

You can explore this mine shaft only when the water is at Level 3. Drop into the watery part and press **B** to swim down. Hold **B** as you go through the tunnels. It's a long stretch.



These are referred to as wooden windows. They can be differentiated from other windows by the Skulls within some of them. Dig into the dirt to check for Master Emerald pieces or loot.



Skulls in the walls, such as this line of three Skulls in the Ghost cavern, are also used by the Hint Boxes to describe locations.

#### TIP

To swim, jump in the water and press **B** to submerge. Until you get the Air Necklace, you're vulnerable to drowning. Numbers, starting with 5 and counting down, will flash on the screen when Knuckles is running out of air.

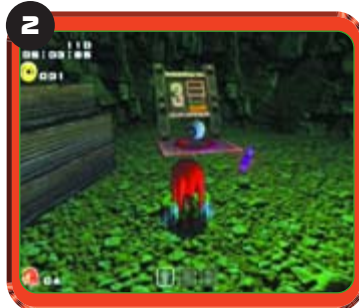

You can reach the top room only when the water is at Level 1. Climb the central pillar and jump to the Pulley to get up there. You find this Switch, which drops the water to its lowest level.



Go up this shaft. It brings you up to the Air Necklace. Now drowning won't be a worry. Climb the walls and pick up the Baby Dragon for your Chao.



This series of tunnels holds the Chao Container shown here. Also, several floating platforms block off areas or open them up depending on the water level. Become familiar with these tunnels, as they often hold a piece of the Master Emerald.

### MISSION 2: COLLECT 100 RINGS

This mine isn't very full of treasure. It's easiest to clear the mission if you already have the Air Necklace. See Mission 1 of this Stage to learn how to get this permanent upgrade.



Return to the tunnel where you found the Air Necklace. You'll find several loose rings and a couple of 20-ring Item Boxes. Not a bad haul.



Use the appropriate Switch to set the water at Level 1, then go to the uppermost level. Grab the rings up there and play Knuckles's Mystic Melody near the Ancient Ruin, then follow the revealed path. Swim down into the room with the falling Weight and find the ring Item Box there. It should put you over the top.

## MISSION 3: FIND THE LOST CHAO

You must grab the Air Necklace—found on this Stage in Mission 1—before hunting down the lost Chao. Play the Mystic Melody near the Ancient Ruin in the uppermost area, then go down the revealed path.



Swim into the room with the Weight and Ghosts. Notice the line of rings floating in front of the heavy trap. Follow it up.



Swim down the tunnel and grab the Pulley you find there (avoid the Iron Ball). The poor little fella is waiting for you.

## MISSION 4: COLLECT THE EMERALD PIECES IN 3 MINUTES 30 SECONDS

The key to doing this quickly is to find the hints quickly. Study the map and go to the Hint Boxes immediately. They'll give you a target area. Also, make sure you're familiar with the Switches and how they raise and lower water. You don't want to spend precious time mucking about with the water levels.

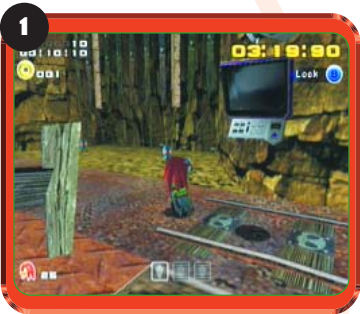

This is the Hint Box closest to Knuckles when he starts the mission. It's just to his left. Look at it immediately.

## MISSION 5: CLEAR HARD MODE

As with all the Hard Modes, you need the Sunglasses—found in Stage 14: Meteor Herd. You'll also need the Air Necklace, which you'll get in this Stage in Mission 1. All the Master Emerald pieces are in the same place every time in this Mission, so here's how to get them.

### NOTE

Remember that Hint Boxes are found by using the Sunglasses, too. Without them, many are invisible to you.

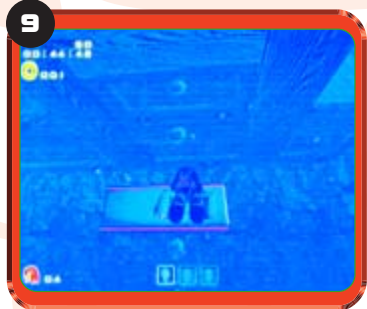

The first Emerald piece is back where you found the lost Chao. Play the Mystic Melody at the Ancient Ruin—with the water at Level 1—and go through the door it opens. Find this line of rings near the falling Weight and follow them up.

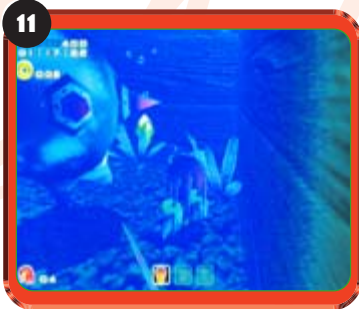

The Emerald piece is at the end of the tunnel, behind an Iron Ball. Swim past the ball and snap it up.



The second piece is in the network of cart track tunnels. Keep the water at Level 1 and dive in. Enter this gate and swim down the tunnel.



When you arrive at the shaft, dive down to the closest opening and head down it. You'll find these three Skulls arranged in a triangle pattern at the end of the new tunnel.

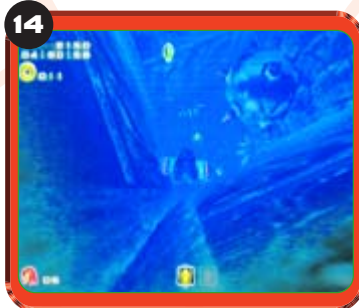

Now just follow the shaft down as far as you can, avoiding the Iron Balls, of course. Voilà! The second piece of the Master Emerald.

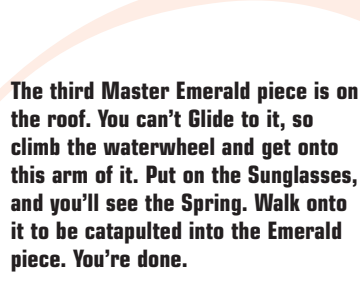

The third Master Emerald piece is on the roof. You can't Glide to it, so climb the waterwheel and get onto this arm of it. Put on the Sunglasses, and you'll see the Spring. Walk onto it to be catapulted into the Emerald piece. You're done.

## HERO STAGE 9: TAILS



primagames.com

### Missions

1. Chase the President's limousine!
2. Collect 100 rings!
3. Don't hit other cars!
4. Don't hit the walls!
5. Clear Hard Mode!

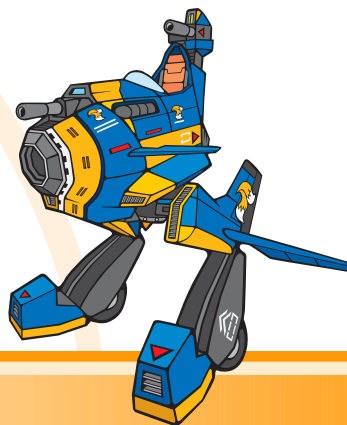

## ROUTE 101

Something shady is happening between the President and Eggman. If we catch up to the President's limousine, maybe we can trace the call back to Eggman.

## MISSION 1: CHASE THE PRESIDENT'S LIMOUSINE

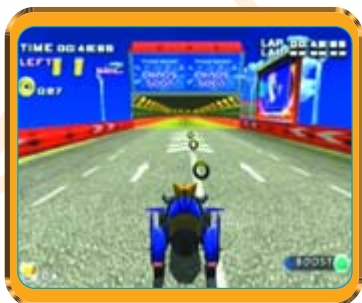

To catch the President's limousine, hold down **A** to keep the pedal to the metal. Rings are important here too. For every 20 rings you collect, you are equipped with a Boost. Press **Y** during the straightaways for a little extra zip.

### TIP

Make use of the boost before you reach another 20 rings. You can't hold more than one boost at a time. If you don't use it before you get another 20 rings, you will waste a boost and precious time.

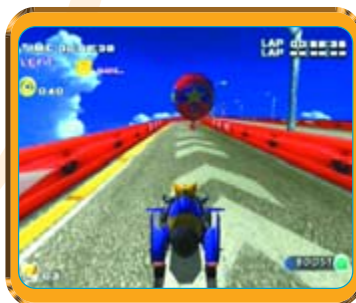

These Balloons each hold a cache of rings. Bust right through them to collect. Don't pass up these opportunities; Balloons require much less skill than a row of rings.



Watch yourself on these turns. You lose valuable seconds if you bang into the walls. Know where the sharp corners are and be prepared. As you enter the corner, release the gas for a split second and crank the wheel left or right. This gives your vehicle the ability to slide around corners.

### CAUTION

Sliding around corners is effective only with practice. At first, you may feel out of control, but being able to turn tight corners without slowing down pays off in the end.



At the top of this ramp is another Balloon. Geronimo!

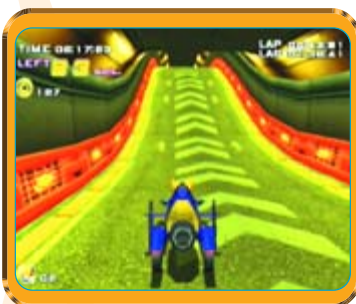

This narrow tunnel can be a tight squeeze when other cars are present. Drive around them and avoid hitting them or the walls. Slowing down is not an option.

### NOTE

As soon as you defeat either this Stage or Rouge's Route 280 level in Story Mode, you'll unlock the Kart Race Mode.



## MISSION 2: COLLECT 100 RINGS

With no chance of losing rings after you collect them, 100 is an easy goal in this stage. Don't forget to snag the Balloons as well as the rows of rings. Just keep decent time to complete Mission 2.

## MISSION 3: DON'T HIT OTHER CARS

To complete this mission, catch up to the President's limousine without touching any other cars. An expert driver like you should have no problems with this. Regardless, here are a few trouble points to watch for.



Sharp corners are where other cars like to get in your way. If you like to slide around the corners, use extra caution when other cars are present. Kiss even one car and the mission is failed.

**CAUTION**

Make sure no other cars are around you when using the boost. You could accidentally boost yourself right into another car's rear end.





This narrow tunnel is usually jammed with a few cars. Either slow down or go around them.

## MISSION 4: DON'T HIT THE WALLS

Drive fast. Don't hit the walls.

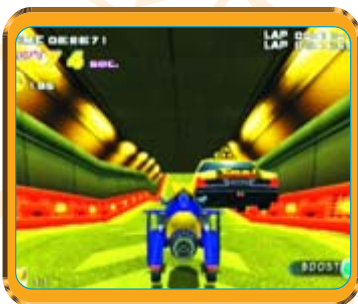

Turns are your worst enemy in this mission. Slow down around the turns. Unlike the other missions, you won't be able to recover from a harmless scrape into the guardrail.



This narrow tunnel is also dangerous, especially with the other cars in it. If you're bold and skilled enough, zoom on by between the cars and walls. If not, slow down.

## MISSION 5: CLEAR HARD MODE

For this Mission, the course stays the same, but each time you pass through a Point Marker, you get less time added to your total. It's tough, but not impossible.



To catch the President's limousine in Hard Mode, you need all the boosts you can get. Collect as many rings as you can, including all the ring Balloons. Don't forget to use the boost before your next 20 rings so you don't waste it.



As you turn onto this final straightaway, you need about 25 seconds on the clock and an available boost. With less time and/or no boost, you won't reach the limousine in time.

**CAUTION**

The time limit here is pretty tight. You can afford to hit the walls, but not if doing so spins you out. Keep on the gas, but know when to slow down.





primagames.com

# HIDDEN BASE

Tails has heroically volunteered to find the entrance to Eggman's Hidden Base. It's somewhere in the maze of stones and ruins outside the pyramid. But where?

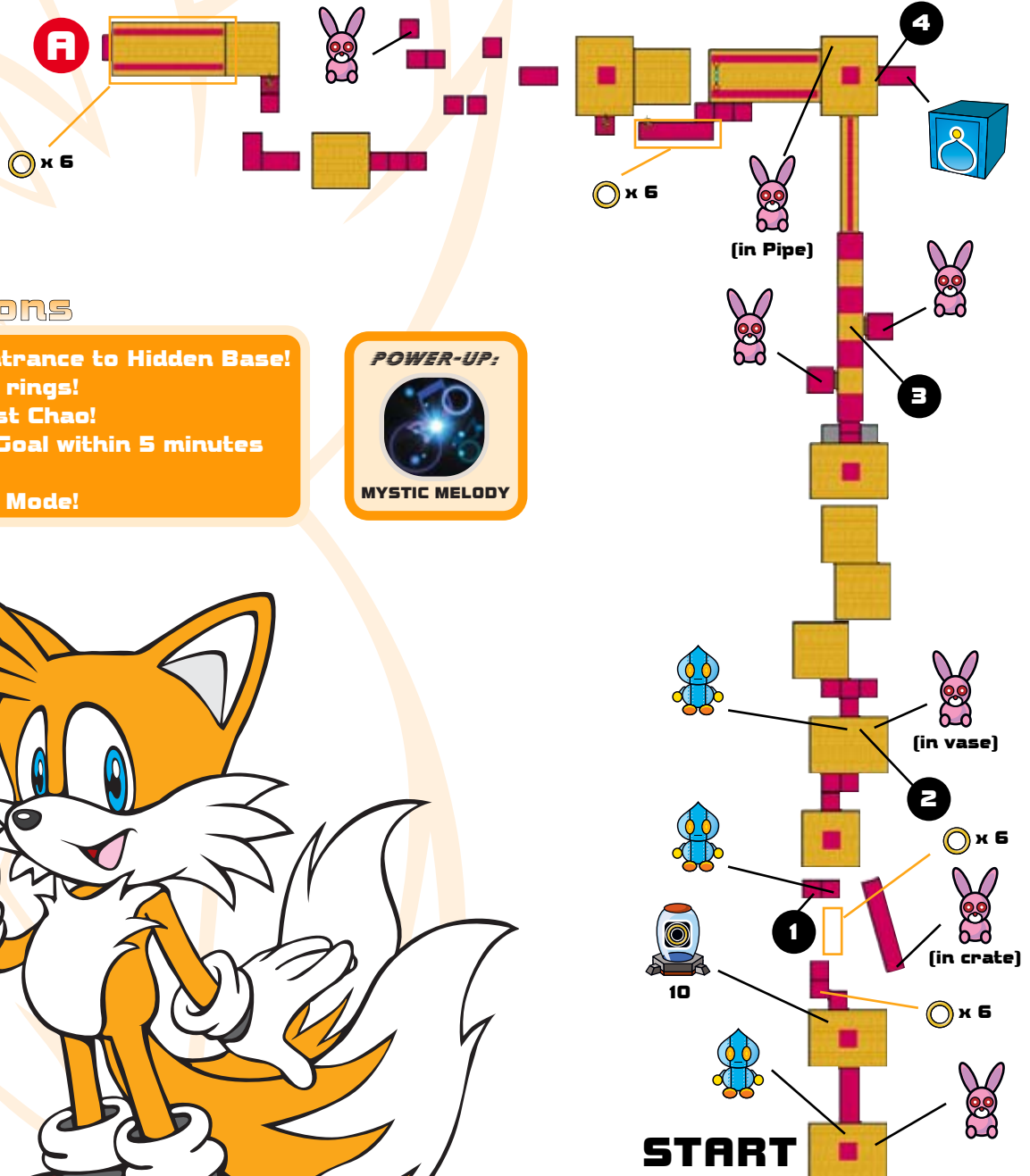

## Missions

1. Find the entrance to Hidden Base!
2. Collect 100 rings!
3. Find the lost Chao!
4. Reach the Goal within 5 minutes 0 seconds!
5. Clear Hard Mode!



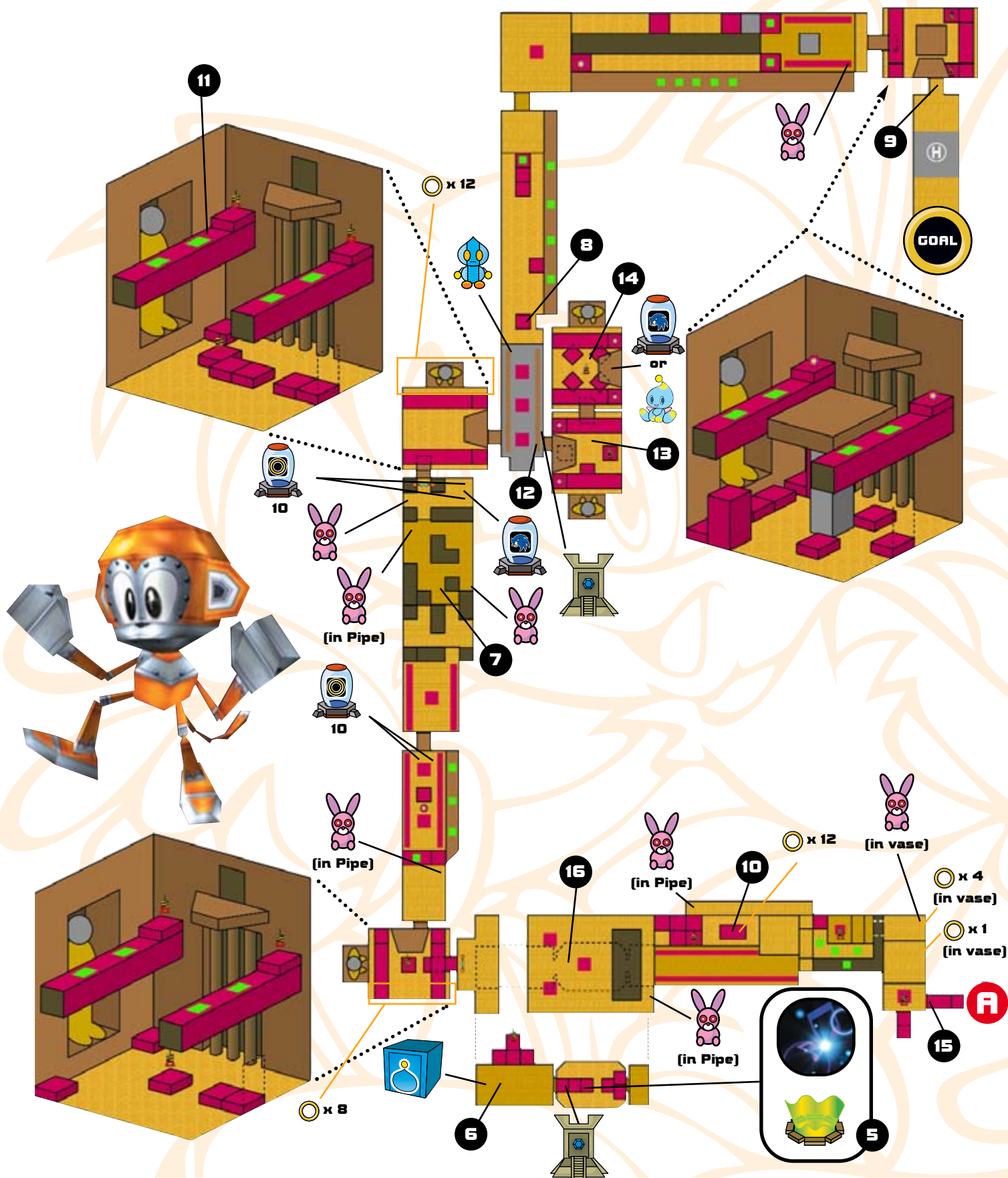



primagames.com

## MISSION 1: FIND THE ENTRANCE TO HIDDEN BASE

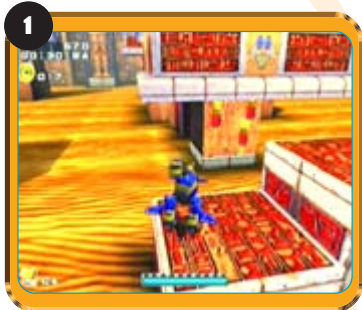

1 Targeting and shooting the Dynamite packs lowers platforms so Tails can leap up to them.

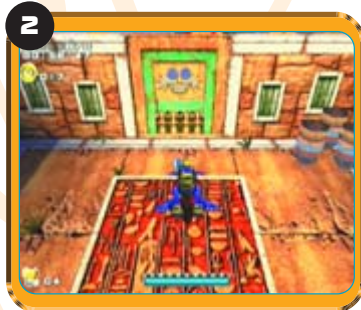

2 Walls and blocks of stone with the Eggman mark on them can be broken with a few shots from the Volkan Cannon.



3 This hallway has two hidden rooms behind breakable walls. Pound them to rubble and collect the animals inside.

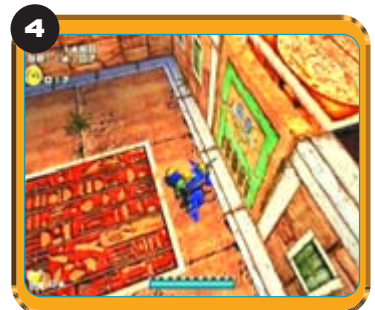

4 Break the wall and the block of stone here to get at the first Chao Container.

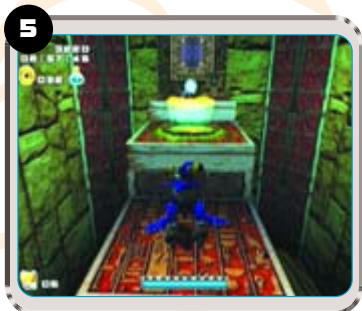

5 When you have the ability to smash Steel Containers, blast this set of four to pick up Tails's Mystic Melody. Play the tune at the Ancient Ruin, then you can move on.

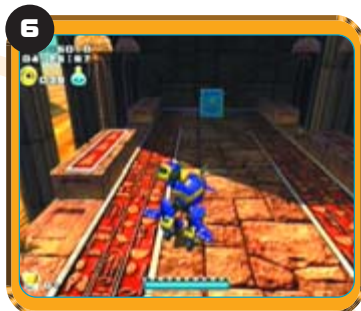

6 You can take the high road and just drop down to the second Chao Container. Or you can take the low road—the path you took to find the Mystic Melody.

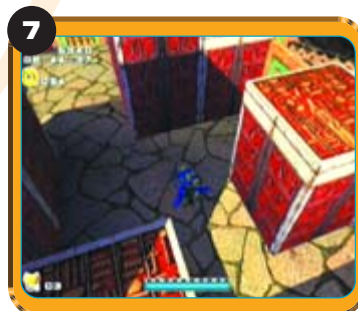

7 The maze is not very difficult. Continue shooting the breakable walls and blocks to clear a path. Make sure you find the ring Item Boxes near the end.

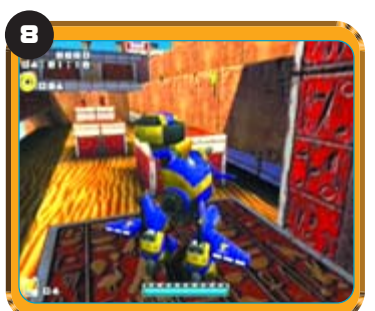

8 Target the bomb-throwing Kiki from the first block here. Take them out before you jump from block to block.

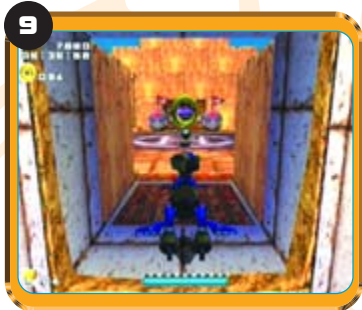

9 After another round of Pulleys, blast through a door to find the waiting Goal Ring.

## MISSION 2: COLLECT 100 RINGS

The pickings are a bit slim in the Hidden Base Stage, and the robots are fierce. It's hard just to find 100 rings, and harder still to hang on to them. Once again, it helps to know what the enemy will do. If you're familiar with the Stage and know when robots will pop up, then you'll have an easier time keeping the rings you collect. Here are a few hidden caches of rings.

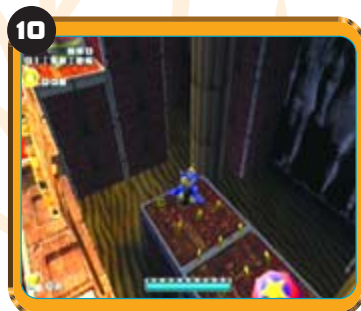

10 On the path leading to the four Steel Containers, take Tails to the right and drop down onto the platform with several rings arranged neatly in rows.

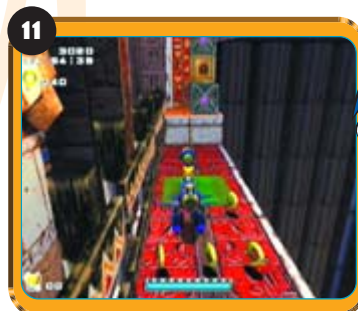

11 Ride the Pulleys to the top, but pass by the door and drop down to the other side of the room. There's a stash of rings guarded by a bomb-throwing Kiki. Blast the chimp before he can tag you.





## MISSION 3: FIND THE LOST CHAO

You'll need Tails's Mystic Melody to find the lost Chao. Luckily, the Mystic Melody is in the Hidden Base Stage, but you need the Bazooka to blast the Steel Containers to get the Mystic Melody. It's a vicious circle. When you have the Mystic Melody...

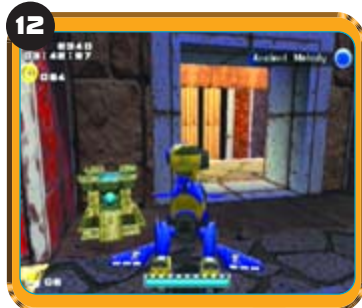

**12** Play the Melody next to the Ancient Ruin to open the door. Leap off the ledge and Hover, firing as you go to blast the robot waiting for you.

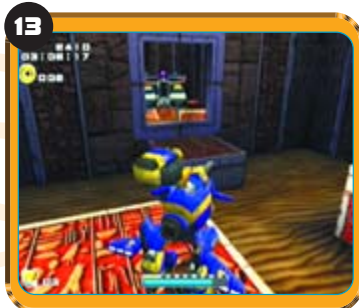

**13** Float to the bottom and land on a block. Hover over to the door and trash the foe there. You can Hover from the door to the Pulley in one jump, but jump high.

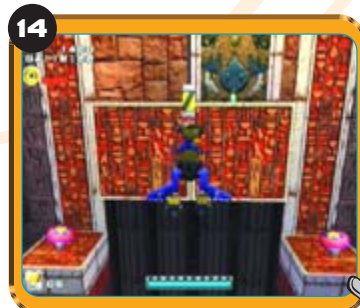

**14** Fire as the Pulley draws you higher. You can jump straight to the ledge with the Chao, but to play it safe, Hover over to a Spring and pop up to the little guy.

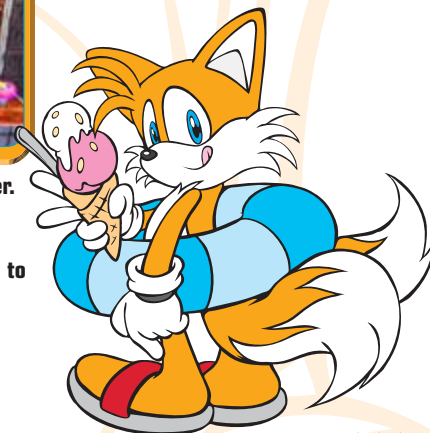

## MISSION 4: REACH THE GOAL WITHIN 5 MINUTES 0 SECONDS

The more permanent upgrade gear you have, the easier this time trial will be. Specifically, grab the Laser Blaster before you make the rush through this Stage. The pumped-up weapon will take out enemies faster and, most importantly, blast Dynamite packs more quickly. Plus, if an enemy is not directly in front of you, run on by. Don't take time to fight robots if you can avoid them. Finally, take long Hover leaps when you can, and shoot breakable walls as you run toward them. For example:



**3** Continue shooting as you run down the hall. You'll break the wall at the end before you get there, so Tails won't have to slow down.

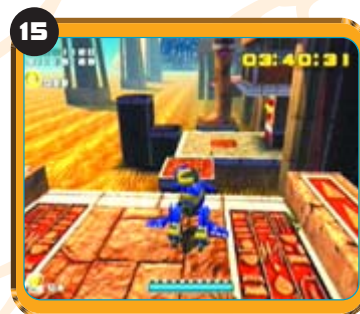

**15** Leap from this pillar and Hover to the Pulley to the right. You must shoot while Hovering—a useful skill—because a couple of robots show up.

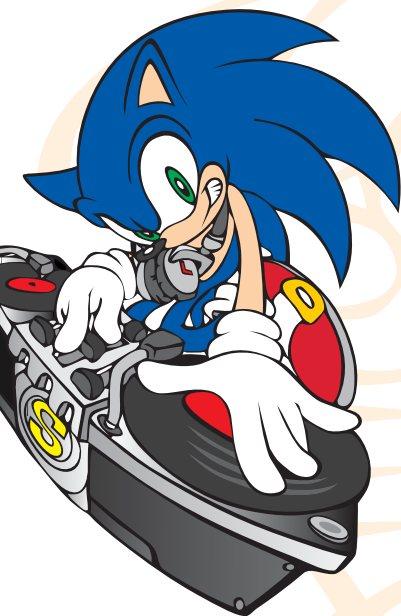

## MISSION 5: CLEAR HARD MODE

Hidden Base has several changes for Hard Mode. A subtle change is that all the Rails have been removed. Your jumps must be precise or you'll fall into the muck. The number of enemies is mostly unchanged. The challenges lay mostly in the design changes of certain areas.



**16** This spinning Iron Ball wasn't there before. You can hop from pillar to pillar to Tails's right and work your way around the trap.

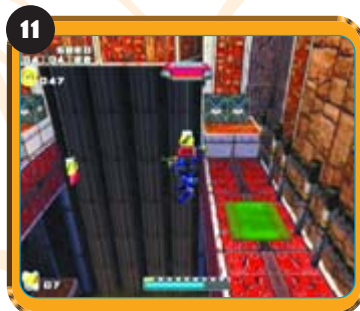

**11** This room has several Pulleys moved around. Nothing too fancy—just aim for the next Pulley before you jump.

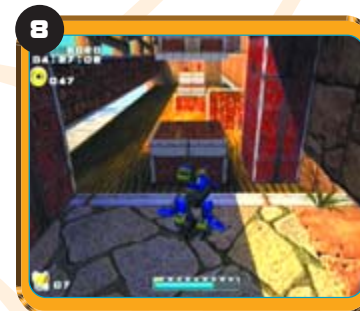

**8** Time the spinning blocks, then Hover jump to them one at a time. Make good use of the Hover, land, and then jump to the next one quickly.

# HERO STAGE 11: SONIC



primagames.com

## PYRAMID CAVE

Tails has done his part; now it's up to Sonic to venture deep into Eggman's base. Race along the caverns and tunnels to find the nefarious Robotnik's inner sanctum.

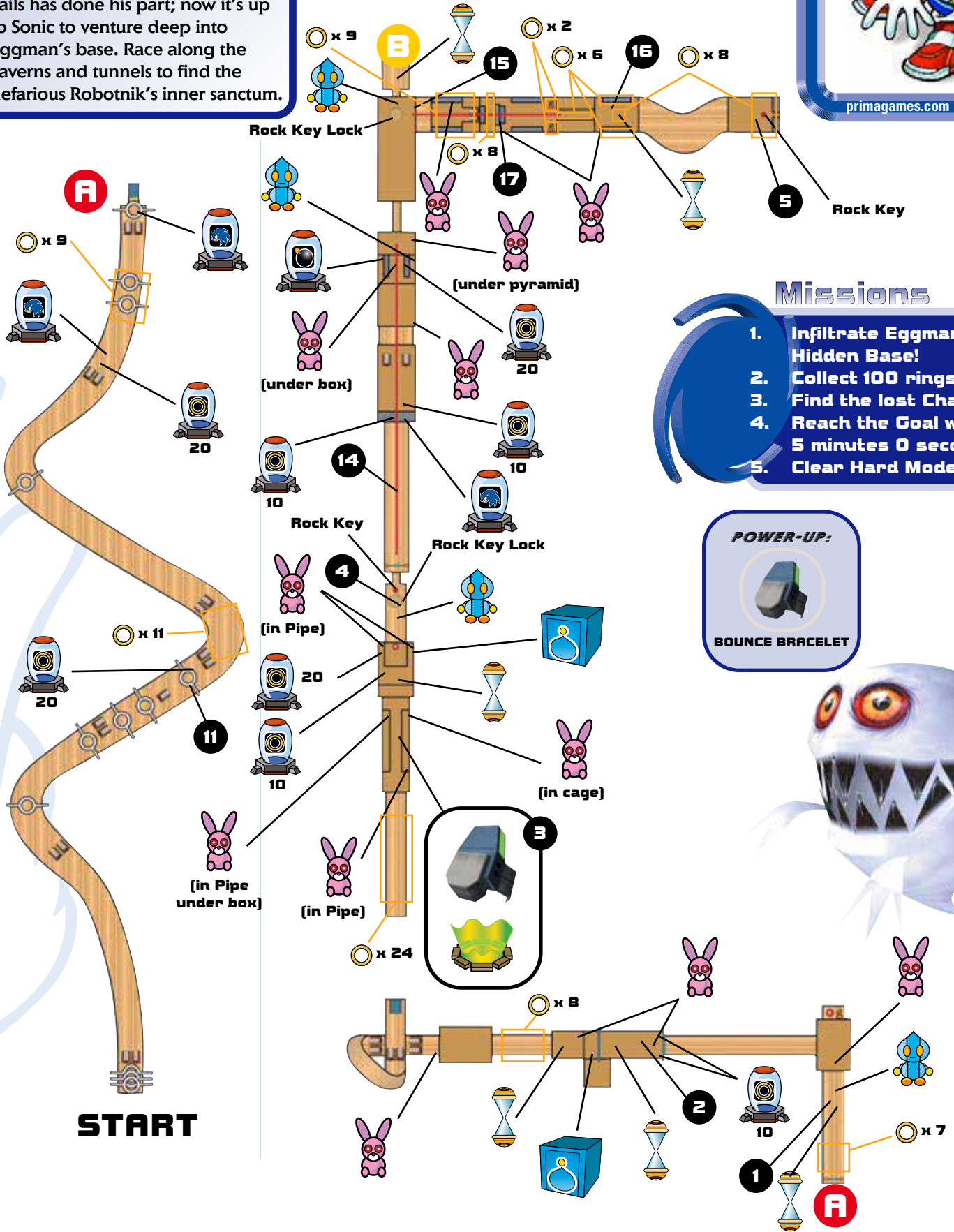
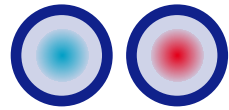

### Missions

1. Infiltrate Eggman's Hidden Base!
2. Collect 100 rings!
3. Find the lost Chao!
4. Reach the Goal within 5 minutes 0 seconds!
5. Clear Hard Mode!

**POWER-UP:**

**BOUNCE BRACELET**



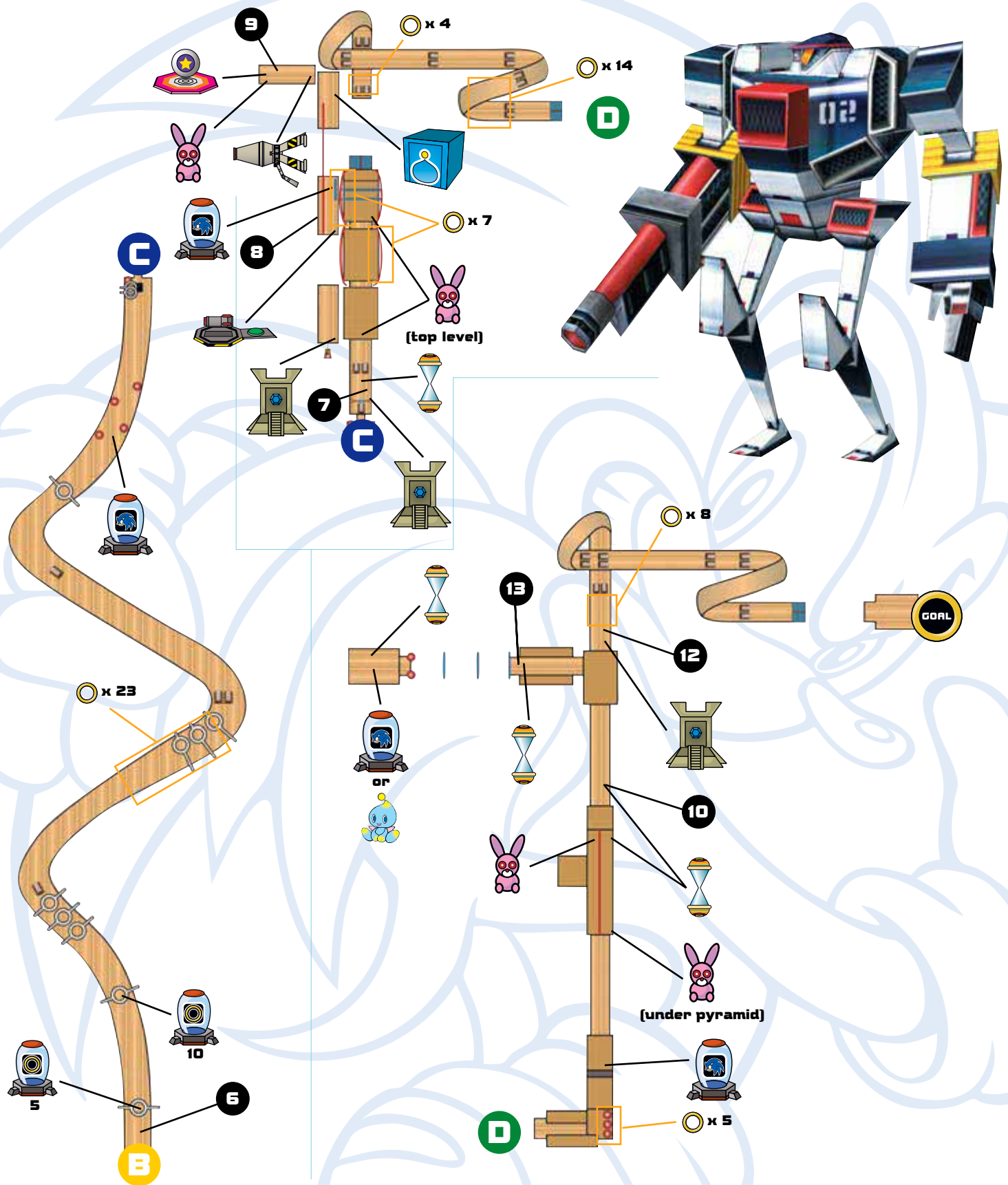



primagames.com

**MISSION 1:  
INFILTRATE EGGMAN'S HIDDEN BASE**

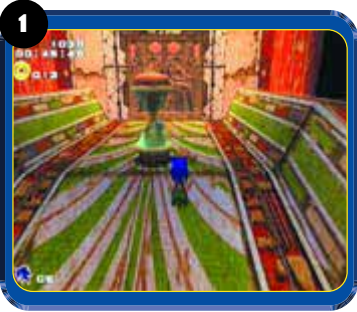

**1** You encounter the first Hourglass here. Jump on it to flip it over. The door just ahead stays open while the sand runs down in the glass. Get through it before time expires.

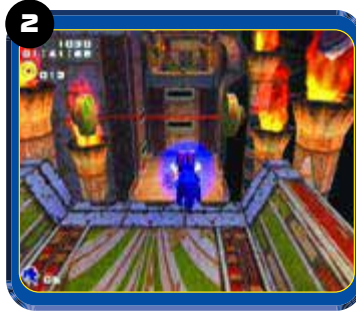

**2** Two Swing Bars are here. If you drop down, smash the Chao Container and flip the Hourglass. Out of the wall come steps for you to jump up. They retract as the sand spills down, so hop up them quickly.

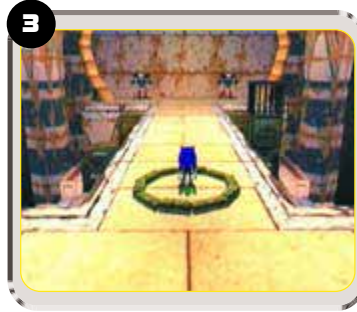

**3** The Bounce Bracelet waits for you here. Grab it, then deal with the two robots ahead. To the right is a Cage containing a Skeleton Dog. Smash the Wooden Container and then the Steel Container, and you'll be able to grab the special animal.

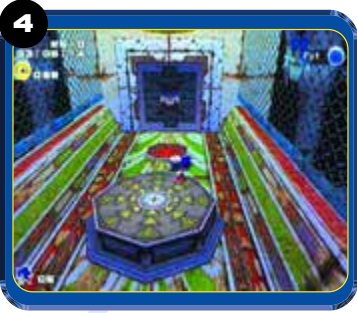

**4** Pick up the Gate Key in front of the door and place it on the raised dais. It will fit itself in and open the door.



**5** Grab the green Gate Key. Carry it back to the main path and fit it into the dais in front of the locked door.

**TIP**

Use the Gate Key as a weapon, throwing it at robots that get in your way as you return to the door, or simply put it down and deal with the robots.



**6** Hit the Hourglass and then run like crazy down the hall. Try to stay in the center, juking the Ghosts that want to slow you down. At the end of the hall is a pit and a door. If you were fast enough, avoid the pit and get under the closing door. If the door is closed, drop into the pit and try again.

**NOTE**  
The second Chao Container is just ahead.



**7** When you have Sonic's Mystic Melody—found in Hero Stage 16: Final Rush—play it near this Ancient Ruin. A line of rings will appear. Give it a second to fully appear, then Light Dash up it to a Pulley. Jump to the platform you find there.



**8** Play the Melody again and Light Dash up the newly formed rings. You can now fall onto a Rail or drop to another platform. The platform has a Missile and an Extra Life. The Rail leads to the third Chao Container.

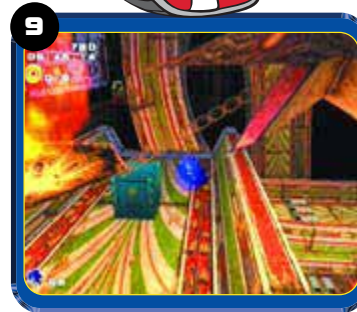

**9** Here's the third Chao Container. Bounce up to the Pulley, and at the back of the platform is a Switch that activates a Rocket. Ride the Rocket back to the regular path.

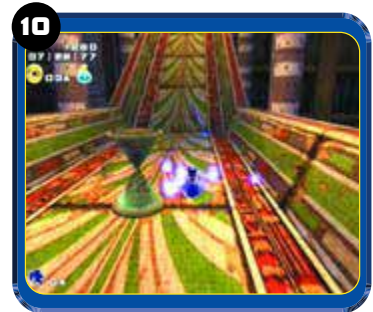

**10** Hit this Hourglass, then press **Ⓑ** to Spin. Release **Ⓑ** and you'll shoot up the incline and through the closing door. Just running won't get you there in time.

## MISSION 2: COLLECT 100 RINGS

For being a later Stage, Pyramid Cave is replete with rings and ring Item Boxes. You can collect 100 of them before you're even halfway through the Stage. Study the map to find the various groups of rings.

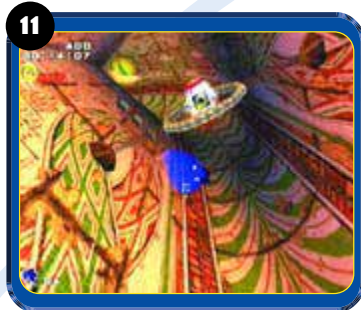

The first tunnel contains ring Item Boxes. Grab them for a good start on your century.



Instead of using the Swing Bars, drop down and grab the two ring Item Boxes.

## MISSION 4: REACH THE GOAL WITHIN 4 MINUTES 0 SECONDS

You can do a few things to ensure success in under four minutes. First, practice grabbing all the Swing Bars; they're a much quicker way to travel. Rails can also speed things up. Don't worry too much about loot; bunches of rings won't mean anything if you don't finish in under four minutes.



Ride this Rail to cut time. You need to move quickly.



For this Gate Key, it may behoove you *not* to ride the Rail. Instead, smash the robots on the way to the Gate Key so you don't have to deal with them while you're carrying it back.



## MISSION 3: FIND THE LOST CHAO

Go to the second set of Ancient Ruin on the regular path. Play the Mystic Melody, and a Spring appears. Use it to reach a higher path, and use the Swing Bars to reach the lost Chao.



Make the Spring appear with a quick bit of music.



Hit the Hourglass and then use the Swing Bars to cross the void. You need to cross quickly in order to get through the door. The blue guy is just on the other side.

## MISSION 5: CLEAR HARD MODE

Hard Mode in Pyramid Cave, like so many Hard Modes before, adds bad guys and a few twists to make your life a little tougher. Your path is now littered with Ghosts. You can attack them, but you can avoid them rather easily, too. The E-Series Robots are much faster-shooting than before, and the doors close more quickly after you hit an Hourglass. The hardest changes, however, come when you need to grab the green Gate Key.



Once you obtain the Gate Key, your problems begin. This Hourglass is impossible to reach while holding the Gate Key. Toss the Gate Key onto the blocks that the Hourglass is on. Jump up, grab the Gate Key, then hit the Hourglass and run out the door.



These ledges are too high to jump onto with the Gate Key in hand. Step a little bit back from the ledge, jump, and toss the Gate Key up. Jump after it and pick it up. Repeat.



primagames.com

# DEATH CHAMBER

Time to take a break from searching for all those Emerald pieces. This time, look for the crucial Gate Keys. Dr. Eggman's plans are progressing faster than expected. If you can collect the three Gate Keys, you might just stand a chance against him.

## Missions

1. Find the 3 Gate Keys!
2. Collect 100 rings!
3. Find the lost Chao!
4. Find the 3 Keys within 5 minutes 0 seconds!
5. Clear Hard Mode!

### POWER-UP!



HAMMER GLOVES

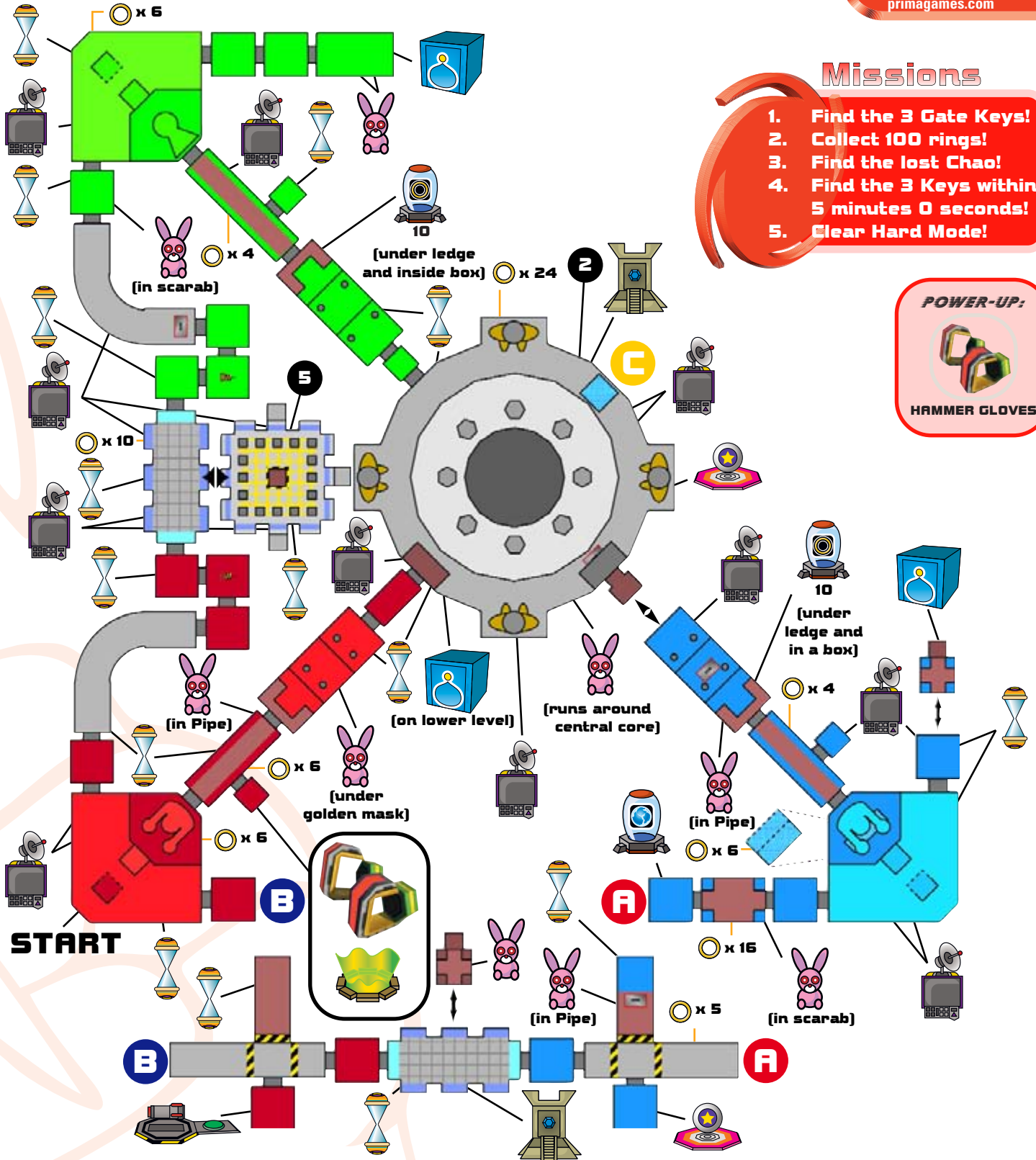

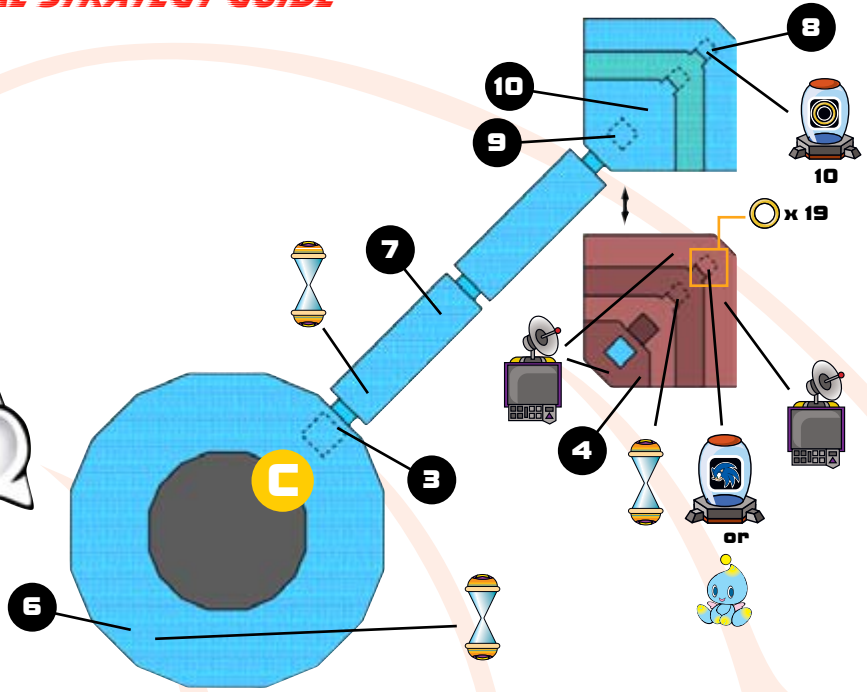

## MISSION 1: FIND THE 3 GATE KEYS

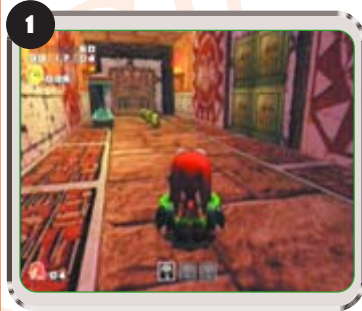

**1** The first order of business is to find the Hammer Gloves. Luckily for you, it's nearby. Pop the Hourglass to run through and find the Wooden Containers on your right. Bingo.



Familiarize yourself with the layout of the Stage. The place is divided into four main areas: blue, red, green, and the Pyramid Core. Each area connects with the Pyramid Core or each other. Also, color maps with a "You are here" blinking light are located throughout the stage.



These Hourglasses control nearby doors. The Hourglass isn't always placed directly in front of the door, so be prepared to look around after you've bopped one. Hourglasses also can control hidden platforms, traps, or any other interactive object.

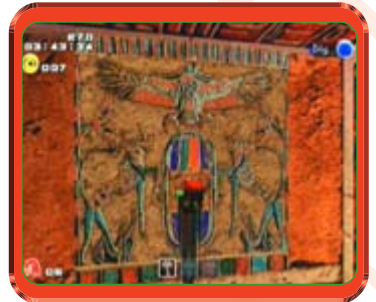

These large murals on the wall are often doorways to other areas. Position yourself over the blank square in the painted capsule. Dig to get through to the other side.



Gate Keys usually are not in the main rooms of each area. Check the side passages, where you'll often find Gate Keys hidden in walls or underground.



**2** A whole world exists under the Pyramid Core. Open the trapdoor to it by playing the Mystic Melody near this ruin.

## MISSION 2: COLLECT 100 RINGS

Rings are everywhere in this Death Chamber. Finding enough to complete this mission should be a breeze.

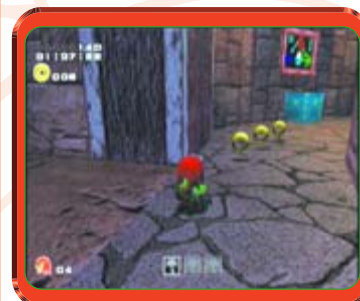

The Pyramid Core is a good place to find rings. They circle the edge of the lower level.

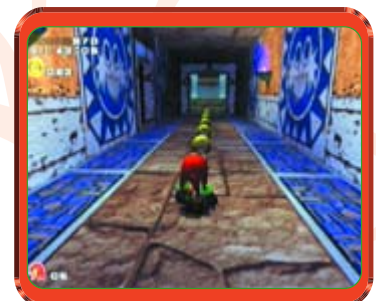

Although the main areas hold many rings, don't forget the many strings of rings on the paths from one area to another.

## HERO STAGE 12: KNUCKLES



primagames.com

### MISSION 3: FIND THE LOST CHAO

One of the Chao has become lost again. With all the nooks and crannies in this Stage, there's no way it's going to get out by itself. Can you help it?



**3** In the Pyramid Core area, find the Ancient Ruin and the trapdoor it opens. Flip the Switch at the bottom to open a door on the opposite wall. Time is limited, so hurry.

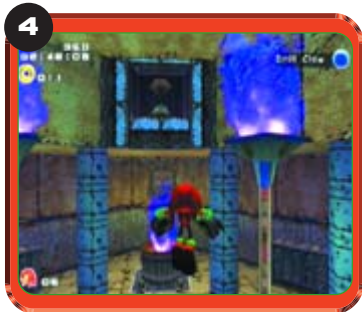

**4** After swimming through a few tunnels, you come up for air in this room. An Hourglass in the upper walls opens a door directly above it.

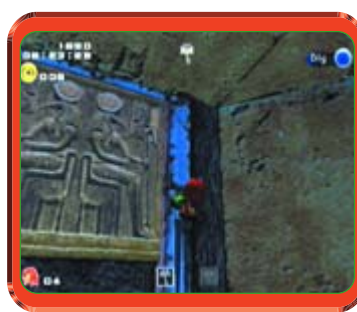

Timing is everything here. The door stays open for only a short time. After hitting the Hourglass, Glide out to the opposite wall. Grab the wall at the level of the door and Glide again over to the opening. If you simply climb rather than Glide over to the door, it'll be too late.

### MISSION 4: FIND THE 3 KEYS WITHIN 5 MINUTES 0 SECONDS

If you don't find the Gate Keys quickly, Dr. Eggman will progress with his plans. You can't let that happen.

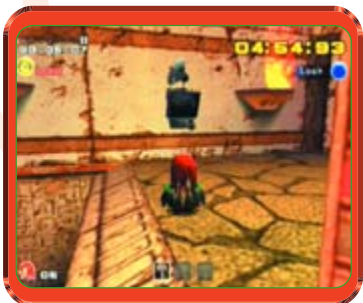

Activate the nearest Hint Box and get going. Until you have all three hints, do not pass up an opportunity to activate any Hint Box you pass.



Study the maps so that you can reach the desired area quickly. Have you been using the colored maps within the stage? If you lose your bearings, check these to see where you are. The blinking white light marks the spot.

### MISSION 5: CLEAR HARD MODE

More enemies have been let loose in these sandy areas. The three Gate Keys are hidden better this time. You'll need all your sleuthing talents to find them all.

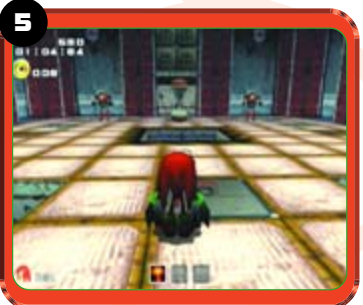

**5** The first Gate Key is in this room. Destroy the robots here before trying to find the Gate Key. You don't need their pesky lasers as you're looking for the Gate Key.

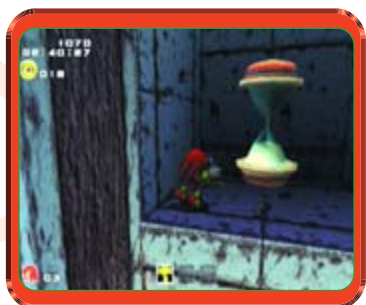

The Hourglass on the ground pulls out ledges on the walls to allow you to break the Steel Containers. When the Steel Containers are broken, you find another Hourglass that controls the trapdoor in the room's center. Dig when it's open to grab the first Gate Key.



**6** Start holding your breath. The second Gate Key is underwater. Activate the Ancient Ruin to open the trapdoor and dive down. The Hourglass still opens the door on the other side, but it closes much more quickly now.

**TIP** Collect plenty of rings before you dive underwater. The robots' rapid laser fire is dangerous and you'll need all the help you can get.





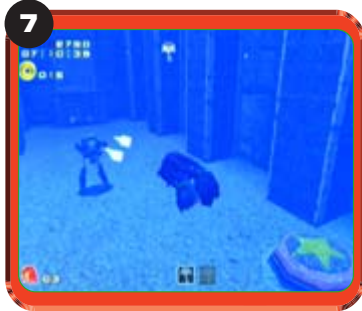

**7** You can't destroy the robot in the next room, so do what you can to avoid its fire. Change your swimming direction to dodge the lasers. Pop the Hourglass and swim on through to the next room.

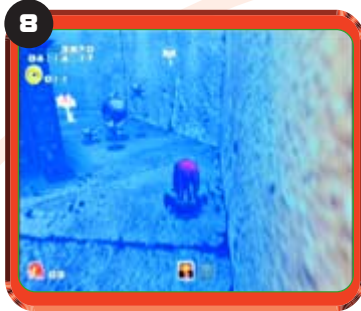

**8** Don't worry about the Ghosts. All they do is slow you down; they won't hurt you. The Gate Key is near the spinning spikes on the far end of the last room.



**9** Before leaving, how about surfacing for a little air? The inverted room up here contains the Hourglass you need to find the last Gate Key. It's the same Hourglass that you used to free the lost Chao in Mission 3.



**10** If you can't reach the inverted room, flip this switch on the ceiling.



After popping the Hourglass, jump back into the water and dive directly down. At the bottom is a little alcove with a Gate Key in it. Hurry, it's closing fast!



## KNUCKLES VS KING BOOM BOO

Knuckles has dealt with creepy places before, but now he's up against the big daddy of all things haunted. This spooky character is King Boom Boo, and he's looking to get Knuckles in his clutches. Try to disappoint the big baddie.

### BOSS ATTACKS

King Boom Boo has three attacks he uses to bring you to his side of thinking—the dead side, that is. He comes at you with a chomp from those vicious teeth, he can throw blue balls of fire, and he breathes a wall of flame at you.

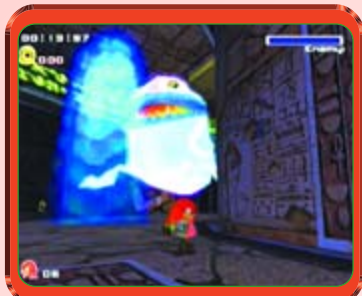

Those choppers can make a dent in Knuckles. You'd think a Ghost wouldn't have sharp teeth. You'd be wrong.



When the big guy starts blowing fire at you, it's time to attack.

The strategy is simple; run in a circle. Make sure that you run around the platform at the very edge—don't worry, you won't fall off. If you go around too fast, King Boom Boo will turn and charge you from the other direction. So, stay on the outside edge and run. This keeps you safe from all attacks.

When the Ghost King leans down and starts breathing fire, keep running. You'll end up finding his crony, a small Ghost holding an Hourglass. Hit him and the windows will open to let in sunlight. King Boom Boo will freak and hide in the ground.

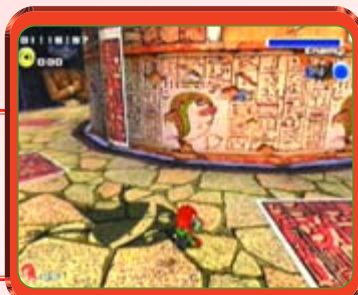

See his shadow in the floor? Catch up to it and use the Drill Claw move to Dig him out. Then chase him down and either Punch him or Glide into him.

#### TIP

The shadow of King Boom Boo runs around for a bit before it stops and starts vibrating. That's the time to Dig at it.



After the first hit, the Ghost King's shadow will climb the wall. Climb after him and use Dig to pry him out. Give him four hits and you're done. You've defeated the King of the Ghosts. Good job.

## BOSS: EGG GOLEM



### SONIC VS EGG GOLEM

Now you've done it. Dr. Eggman is upset more now than ever before. Now he wants your lives as well as the Chaos Emerald. Of course, he won't fight you himself. Instead, he calls up the humongous Egg Golem to do his dirty work for him. The Golem is big, very big. Not to worry though; the bigger they come....

### BOSS ATTACKS

While the Egg Golem may be big, you're much quicker. If you can anticipate his next move, you can defeat him without even being touched. Watch for signs of his three different attacks.



The Egg Golem's most common attack is a single fist slam. During this attack, he slams down one fist, followed by the other. Start running when you see this coming. Be careful not to run into the second fist as it comes down.



Possibly the most dangerous of the Egg Golem's attacks is his double-fisted attack. With thunderous force, the Golem slams down both fists at the same time, followed by a head-butt. The danger in this attack is that it leaves you little room to run. Wait for the fists to drop, then move toward either one. Stay close to the fists so when the head comes down, you won't be butted.

#### TIP

If you fall into the sand, simply tap the jump button repeatedly until you reach some rings and Pulleys.



The Egg Golem's final attack is a double sweep of the hands. In this attack, he puts his hands along the walkway and sweeps them around twice. It's possible to clear the hands with a jump, but that's risky. Instead, jump down to the sand below.

Once you've evaded the Golem's attack, run around to his backside. To defeat the Golem, use the Homing Attack on the top of his head. Jump up the larger platforms on his back until you reach the topmost three platforms. Notice the flashing yellow Emblems on those platforms.

Repeat this a few times until you see the Golem's health meter go empty.



Sonic's Homing Attack homes in on the yellow Emblems. Use them to quickly reach the top.

#### TIP

The quickest way to defeat the Golem is to keep moving. While you're running around the catwalk, throw in a Homing Attack to gain distance quickly. Keep this up, and you may never be directly in front of the Golem during his attacks.



**ETERNAL ENGINE**

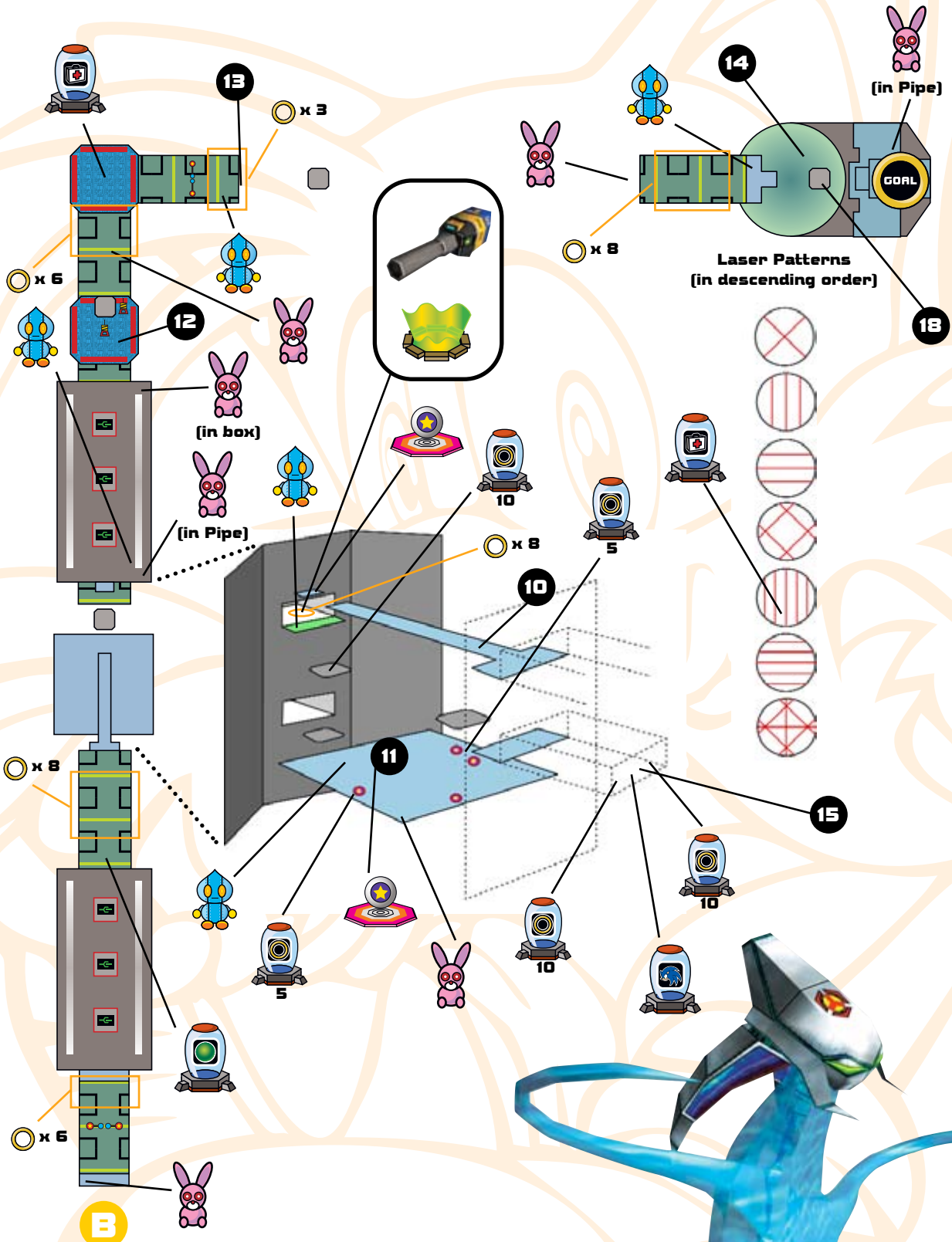

# HERO STAGE 13: TAILS



primagames.com

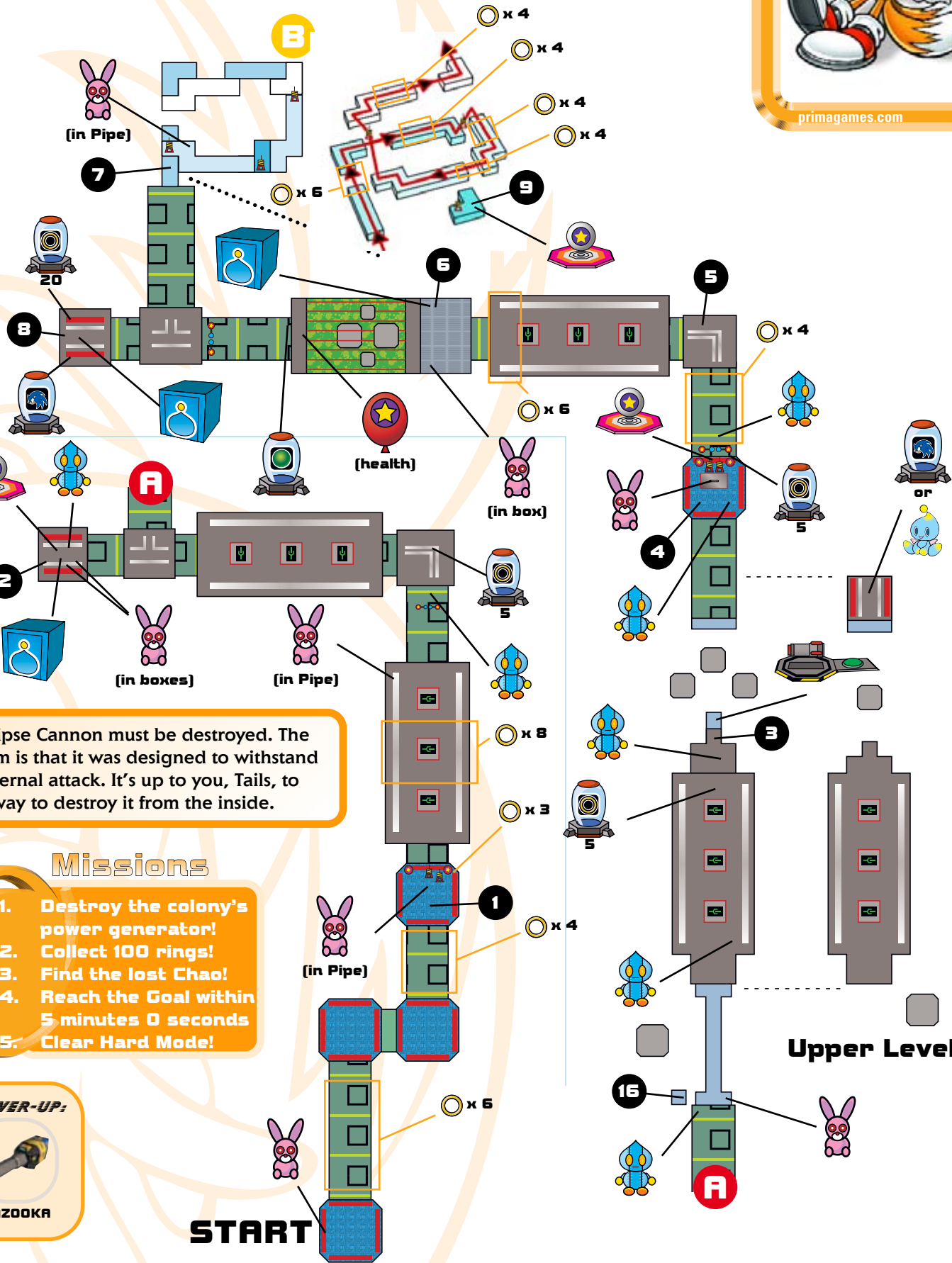

The Eclipse Cannon must be destroyed. The problem is that it was designed to withstand any external attack. It's up to you, Tails, to find a way to destroy it from the inside.

## Missions

1. Destroy the colony's power generator!
2. Collect 100 rings!
3. Find the lost Chao!
4. Reach the Goal within 5 minutes 0 seconds
5. Clear Hard Mode!

**POWER-UP:**

**BAZOOKA**

**START**

**Upper Level**

## MISSION 1: DESTROY THE COLONY'S POWER GENERATOR

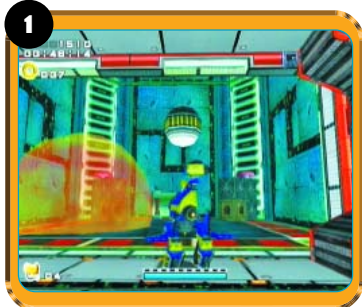

**1** Up to this point, some simple targeting and shooting does the trick. In this room, however. Bombs drop from above. If you make it quick, you can reach the Spring on the right before any Bombs are dropped. At the top of the Pulley, before you jump to the next one, scan the area and shoot the Bomb-dropping robot here.

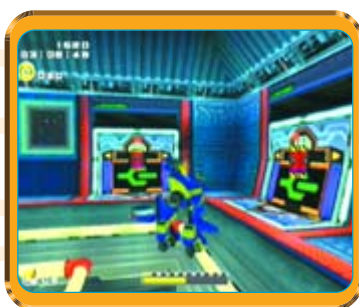

**2** Be careful not to hit the Dynamite packs on any of the walls. Doing so opens up a hole into space that can suck you out.

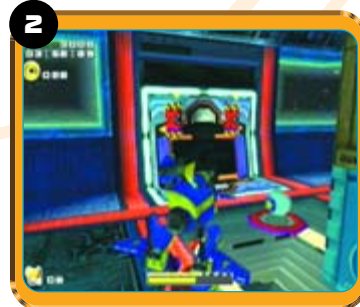

**3** The Switch to open the next door is in this room. Do not shoot the boxes here until you've flicked the Switch on the far side. A stray shot can blow up the door there and make it difficult for you to reach the Switch. Looking for a Chao Container? That's in here, too.



**3** Drop straight down off this edge. Walk over the button to fire the Rocket into the Cages before using the Elevators to get across.

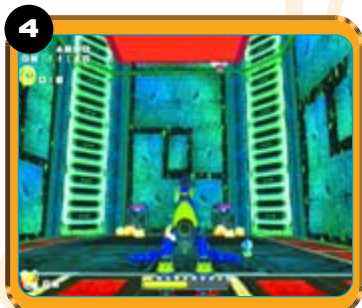

**4** In this room, stay near the door and blow up the Tank between the two boxes. Underneath it is a Switch that disables the trap. After the Switch is exposed, hug the right wall and walk around the rectangular shadow on the floor. After the Switch is flicked, use the left Spring to reach the top of the trap, where a Pulley awaits.

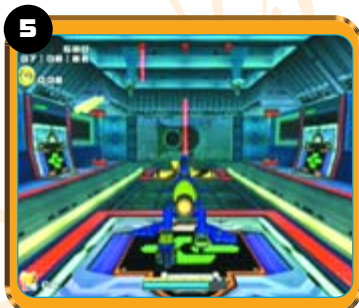

**5** There are two Artificial Chaos here. To defeat the robots, target and pummel them with gunfire as you walk toward them. Constant fire prevents them from shooting out their tendrils and knocking your rings from you. Eventually, they'll expose themselves and your gunfire will hit their vulnerable spot.

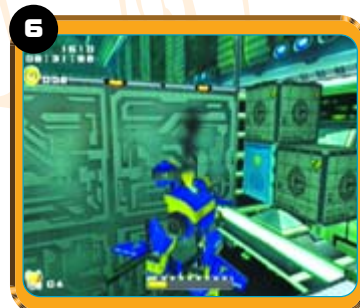

**6** For the second Chao Container, destroy these Steel Containers. You'll need the Bazooka to do so.



**6** Make sure you land between the lasers on these platforms. You can let the platforms drop below the lasers and still be safe if you keep your cool.



**7** In this area, be careful what you shoot and where you're standing when you do. Plenty of Dynamite packs are here for you to accidentally shoot. When the Dynamite goes kaboom, so does your walkway.

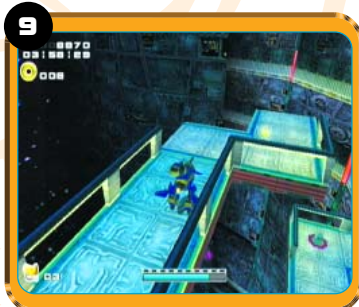

**9** What's this? Can you see the Switch below? Drop down only if you want the Chao Container from **8**. After the Switch is flicked, use the Pulley to launch yourself back to the door ahead.



**10** You need some extra firepower if you expect to get any farther. There are two ways to reach the Bazooka. The first is tricky because you must flick the Switch at the end of this walkway. Dispatching the enemies while preserving the walkway is the tough part. If you succeed, flick the Switch and drop below to enter the room.



**11** If the walkway is destroyed, the Bazooka can still be yours. Drop all the way to the bottom platform where you'll find another Switch. This Switch also opens up the door at top. To get back up there, use the Spring and floating platforms.

## HERO STAGE 13: TAILS



primagames.com

### MISSION 2: COLLECT 100 RINGS

While there are plenty of rings for you to collect on this Stage, holding on to them is the real challenge. Tough enemies and the danger of being sucked out into cold space help prevent you from reaching the Goal Ring. The key is to not miss any rings while strategically engaging enemies.



**12** Be very careful what you shoot in this room. The Pulley is right above a Dynamite-rigged floor. If you blow out the floor, the Pulley becomes much tougher to reach. However, all isn't lost if you accidentally blast it. Get a running start and jump when you're a short distance from the edge of the hole. Turn on your Boost to resist being sucked into space and grab the Pulley.

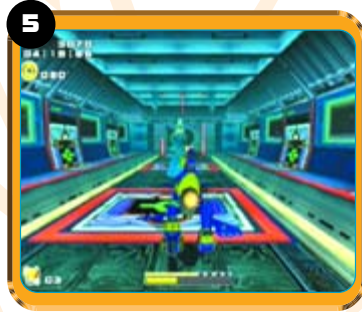

**5** The two Artificial Chaos robots here are the first real threats you face. Maintain your distance as you open the doors to avoid their long-reaching tendrils. Target them and approach while rapidly firing your weapon. Your gunfire will destroy them as they pop their heads from their protective cover.

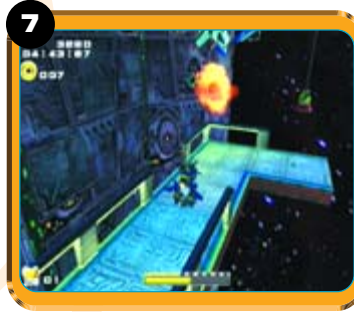

**7** It'd be a shame if you lost all your rings after getting this far. These Dynamite-laden catwalks leave you open to enemy attack from all sides. Scan the surrounding area with your Lock-on and remove the enemy's element of surprise. This can detonate many of the walkways, but a few well-placed jumps is a small price to pay for keeping your rings.

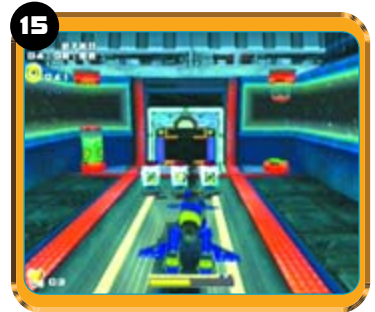

**15** If you've been diligent in your ring-collecting adventures, you should be close to, if not already, done. If you missed some, grab what you need here.



**13** Relax and enjoy the ride. You can't fall here, so spend your time targeting and eliminating the enemies. To stop the Somersaults, tap the Boost to keep yourself right-side up. You can aim better this way.

### MISSION 3: FIND THE LOST CHAO

When was the last time you saw a Chao in space? Exactly. Get the Chao outta here before the lack of atmospheric pressure boils its blood and it splatters all over your pretty fur. To do so, you need Tails's Mystic Melody and the Booster.



**14** The best way to reach the bottom floating platform is by using controlled free falls. Free-fall (do not use Boost) until you see lasers blocking your way. Use Boost just before reaching a laser in your way and move away from it before going back into free fall. This gets you down quickly while avoiding the floating enemies.

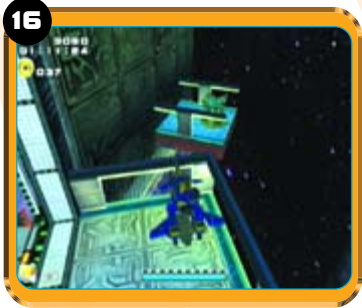

**16** Hop over to this out-of-the-way ledge and play the Mystic Melody to bring up the familiar floating platforms. Make your way to the top.



**17** The timing on the last jump to this platform is tricky. Time it so that you jump just as the platform ahead is about to reach its farthest point on the left. Aim for the break in the middle. If you miss and fall, don't panic. Use the Boost to bring you back to the lower platforms and try again.

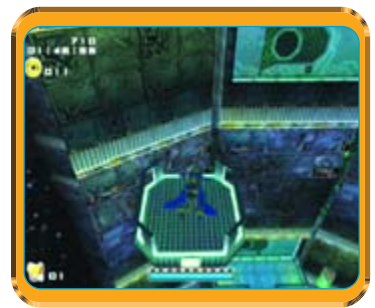

It looks a little far from here, but you can make it with a Boost. Jump when the platform is all the way left and cruise on through; the door opens as you approach.



How many floating platforms can a ship have? To reach the far side, use this one as a stepping-stone. From here, you see those lasers up ahead but nowhere to shut them off. Use your Boost to go over them and land on the other side.



## MISSION 4: REACH THE GOAL WITHIN 5 MINUTES 0 SECONDS

Time is of the essence. Keep moving and don't make any mistakes.

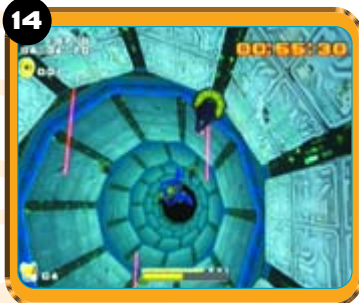
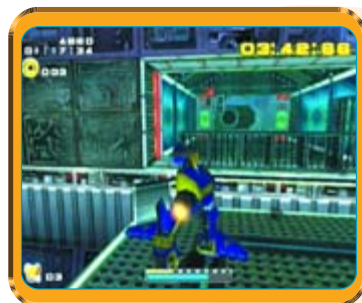

There are no Point Markers in this mission. If you fall off an edge or get smacked by an enemy, you start over. The key here is to keep moving. Do not stop to dispatch any enemies unnecessarily.

By this point, you'll realize how important free falling is. With only a few seconds left on the clock, free falling is the fastest way to reach the bottom. Once there, shoot the generator as fast as your calloused thumbs can move.

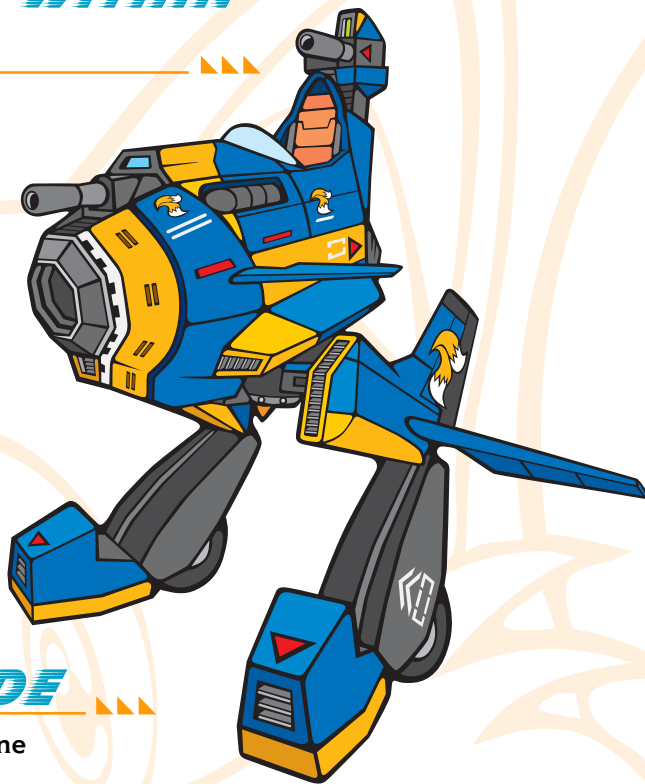

## MISSION 5: CLEAR HARD MODE

As if you didn't have enough to worry about on this Stage, they've gone and made it less fox-friendly. Keep an eye out for new dangers.

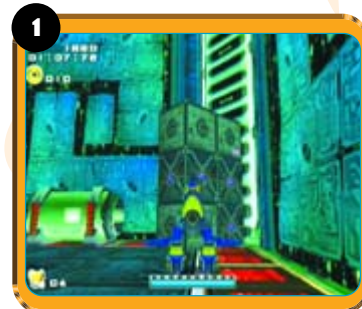

To reach the Spring in this room, you must destroy those Steel Containers on top of the pile. You should have the Bazooka by now (found in this Stage's first mission). So hop to it.

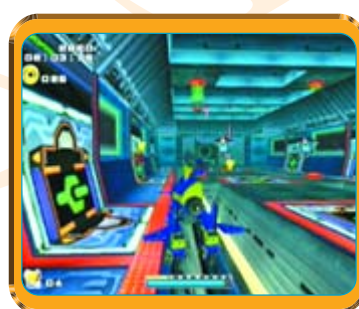

In some rooms it's better to run through and avoid the enemies rather than try to destroy them. Rooms like these have Dynamite packs on the walls and floors. It's safer to just run through than to come in with guns a-blazing.

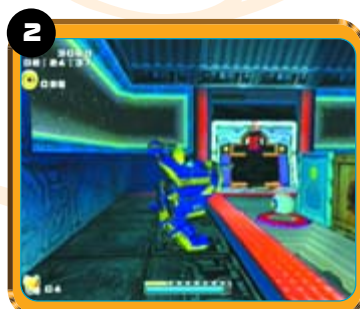

They moved the Switch in this room. Look under the far left box. Be careful not to shoot the door behind it.

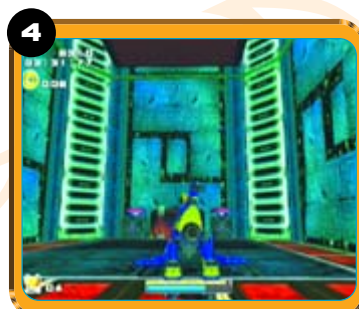

Before jumping to the trap, destroy the floating robot waiting for you at the top.

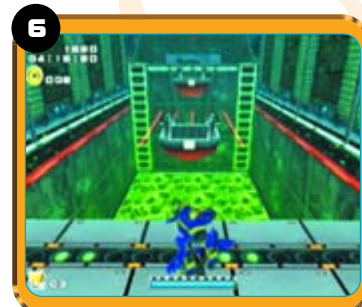

There are fewer platforms here, and they're smaller. You can't dodge these lasers, so timing is everything. Hop onto the first platform as it rises above the lasers. Then, wait for the next one to start its rise before hopping over to it.



The Dynamite packs are placed in different places here. Be careful in which direction you shoot if you're standing on a section that can be destroyed.



As you drop to this final platform, scan the area and keep hitting the fire button. They've added robots near the generator that'll shoot at you.





# METEOR HERD

The treasure hunting hero has made it to ARK. Now he needs to find more of the Master Emerald. This area is unlike any other you've visited with the red echidna. Step carefully.

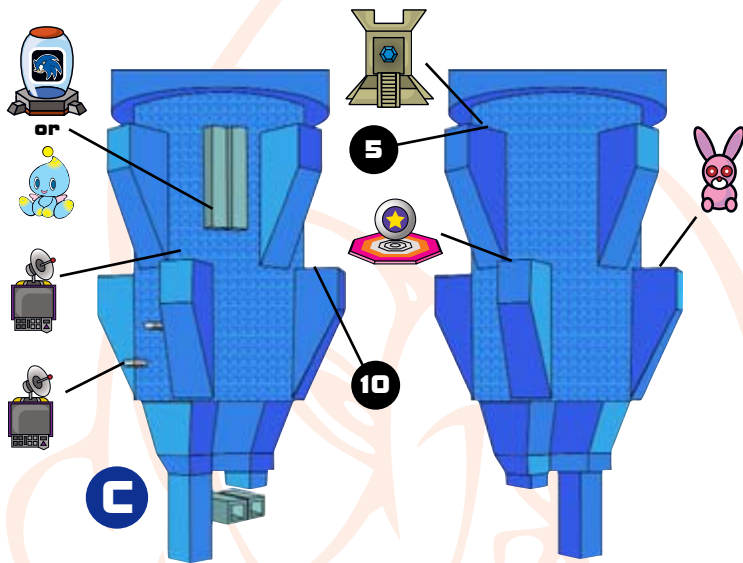

## Missions

1. Find 3 pieces of the Master Emerald!
2. Collect 100 rings!
3. Find the lost Chao!
4. Collect the Emerald Shards in 4 minutes 30 seconds!
5. Clear Hard Mode!

### POWER-UP:



SUNGLASSES

## MISSION 1: FIND 3 PIECES OF THE MASTER EMERALD



Meteors rain down constantly. Stay on the move to avoid being tagged. It never lets up, so don't get too comfortable.

### TIP

Because you're in space, the gravity is much lower here. Knuckles can jump much higher, and he descends more slowly as he Glides. Take advantage of this when you work your way up the howl far up you can send the little red guy.



These Meteoroch can be sent flying by a quick Punch. If you run and Punch, they'll fly farther. Meteoroch reappear when you turn your back on them. Punch them into doors or boxes to bust them open.

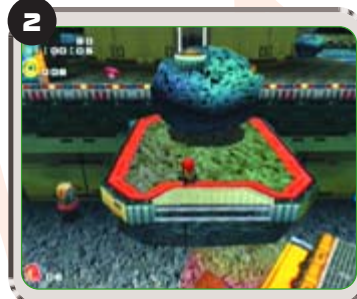

Find this Meteoroch on a platform. Line up behind it, take a running start, and Punch the rock into the door facing it. It'll pop to reveal a Steel Container. You need Hammer Gloves—found in Hero Stage 12: Death Chamber—to break the box.



Kick the Switch that the Steel Container reveals. Then climb the tower a ways and drop down into the open area. On the lowest platform, you find the Sunglasses.

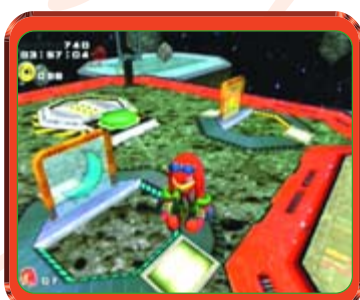

These are the stars and moons that the Hint Box talks about. Unfortunately, there are many, so use the other clues to narrow your search.

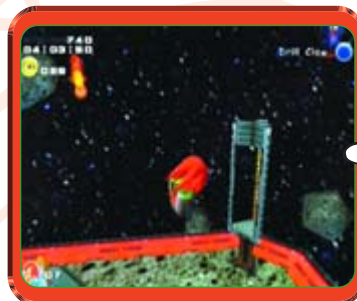

These structures are the rotating beacons. Again, there are many, but the clues mention them often.



## HERO STAGE 14: KNUCKLES



### MISSION 2: COLLECT 100 RINGS

The biggest obstacle to getting 100 rings is the constant threat of being hit by a Meteorch. One blow wipes out any progress you have made toward the 100 mark. The best advice is to keep on the move. Stay still too long and you'll be targeted. Of course, you could also run smack into a falling rock, so a safe passage depends on luck as well.

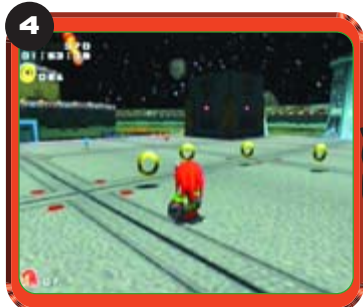

Clean out the rings in the base area before you launch higher. You can make a good start on the ground, and falling won't be an issue.



### MISSION 4: COLLECT THE EMERALD SHARDS IN 4 MINUTES 30 SECONDS

When you're familiar with the Stage, the Hints will make more sense. Use the Rockets to get you up high quickly; jumping from platform to platform wastes too much time.



This area is referred to often in several missions, but we'll mention it here. This can come up in the clues as "many meteorites" or similar phrases.

#### TIP

It may take some effort to maneuver the Meteorch in front of the door. Don't despair; keep giving it taps with your Punch until it's lined up.



Find your way to this platform with a steel beam sticking out of it and an Extra Life on the end of the beam. Walk out onto the beam to the very edge and use the Sunglasses to reveal the Spring.



### MISSION 3: FIND THE LOST CHAO

The Ancient Ruin is far up in the air, in the highest reaches of the level. Use the Rockets to get up there quickly and then play your Mystic Melody—found in Hero Stage 2: Wild Canyon.



This Warp Hole will appear. Jump in to be transported into a container, where you find another Ancient Ruin. Play the Melody again and use the second Warp Hole that appears.



And here's that Chao you've been looking for. Make it happy by picking it up to end the mission.

### MISSION 5: CLEAR HARD MODE

Once again, you need the Sunglasses to finish the Hard Mode. Luckily, they're found on this level—see Mission 1 in this section. Once you've got the super specs equipped, you can tackle Mission 5. As always, the three Emerald Shards are in the same places every time.

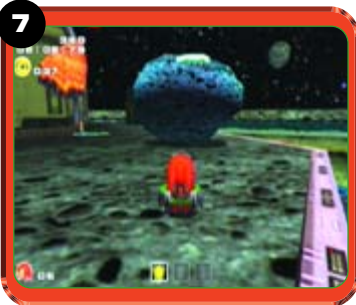

Find this Meteorch that you can Punch and then stand behind it. Tap it with a Punch to push it in front of the door closest to it.



When it's more or less in front of the door, Punch the Meteorch into the door to bust it open. Ta-da, there's the first Emerald Shard.



Step onto the Spring and maneuver Knuckles onto the floating Spring that you are launched toward. Do *not* press **A** while trying to hit the floating Spring. Doing so would remove the Sunglasses, and you wouldn't be able to hit it.



When you've hit the floating Spring and reached the peak of the jump it gives you, start your Glide and fly into the Emerald Shard floating there. It's a tough job and may require a few tries.

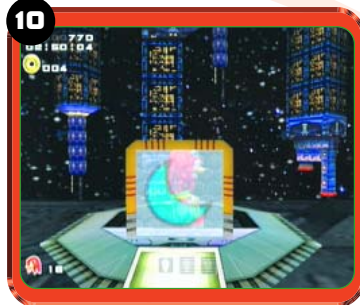

The third Emerald Shard is way up high. Take the Rockets to get to this blue moon station, on the second-highest tier of platforms.



Jump high and then Glide straight away from the blue moon. The last Emerald Shard waits out in the sky.

## KNUCKLES VS ROUGE

It's you against Rouge. She thinks you should give her the Emerald Shards you've found. Let's see her try to take them.

### BOSS ATTACKS

Rouge's attacks should be familiar to you; they're the same as yours. Remember that although she can attack while standing, she can also perform her Sliding attacks while running. In addition, she has a long-range wave attack that can reach you from afar.



Keep moving to avoid her attacks. In the meantime, throw in your own Sliding Punch attacks as you move. Though you can't hurt her while she's moving, you can be hurt if you're not attacking.

Throw continuous attacks at her. Eventually, she'll stop moving and you'll actually hurt her and prevent her from hurting you.

Periodically, the floor opens up and the hot air lifts you off the ground. When this happens, take the fight to the beams.

#### CAUTION

If Rouge decides to climb the supports, resist the urge not to follow her. From the supports, she can come right down on your vulnerable echidna head.



The beams are actually an easier place to engage Rouge. The narrow width limits your movements, but it also limits hers. Attack her as she stops to catch her breath.

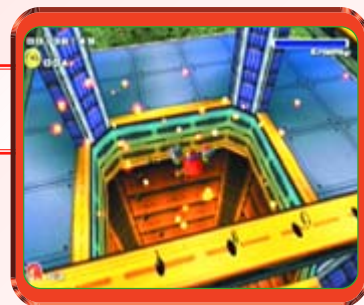

Rouge's Wave Attack can mean the end of you. You can tell it's coming when she screams, "Here I come!" Convenient. When she does, get ready for flight. Jump and start Gliding. It doesn't matter what direction, just get the heck out of there. Her wave attack has less chance of hitting you when you're in the air.

When the ground is open and Rouge is somewhere on the beams, it can be hard to find her. Climb high and Glide in a circular motion so you have a view of the arena. Find her and charge.





primagames.com

**CRAZY GADGET**

Looks like Knuckles and Rouge are starting to understand each other. For right now though, let's worry about the job at hand: Find Dr. Eggman!

**MISSION 1:  
HURRY AND FIND THE EGGMAN**

**Missions**

1. Hurry and find Eggman!
2. Collect 100 rings!
3. Find the lost Chao!
4. Reach the Goal within 5 minutes 0 seconds!
5. Clear Hard Mode!

**POWER-UP:**



**FLAME RING**

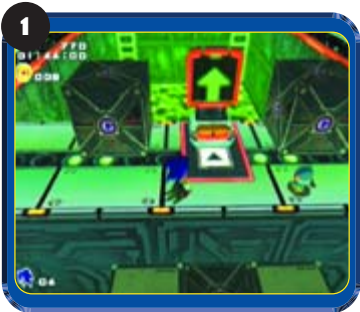

Things get really weird around here. Switches throughout this Stage change the gravitational field. If you don't keep your bearings, it's easy to get lost.



The Artificial Chaos robot here won't waste time reaching out to hurt you. Stand at the beginning of the row of rings and Light Dash toward it. If you do not run as you Light Dash, you'll become up close and personal with Artificial Chaos—too close for its already outstretched tendrils to reach you. Wait for the lasers to shoot out of the way, then jump and use the Homing Attack to get past the Artificial Chaos.



After a few changes of the gravitational field, you wind up here. Which to choose? The Gravity Control Switch in the middle spells doom. The Switch on the right is where you want to go. The left Switch is safe, but it eventually takes you to where the Switch on the right does.

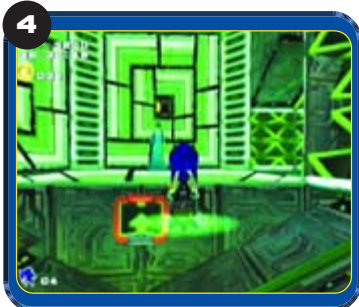

When you come off the Rail here, be ready to face another Artificial Chaos. The best way to deal with it is to jump up and sideways to avoid both the tendrils and laser beams.

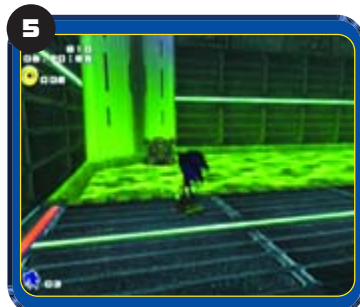

There is an Ancient Ruin in the corner here. Make sure you have a few rings on you in case you miss the jump. The platforms lead you to the ceiling where you can change the gravity and travel an alternate route.



The P-100 Chaos here breaks into many little Cells. Use the Bounce Attack to bounce your way toward the floating "head" and smack it. If you bounce high enough, you can add a Homing Attack to speed things up.



The Beetle robots here are nothing new. What is tricky is the string of rings after the last robot. After bopping the last 'bot, ready the Light Dash and hit it just as Sonic falls by the rings. A Chao Container awaits you on the other side.



When you flick the Switch here, it seems natural to walk forward. For now, back up and use a Spring in the corner. Notice anything special? That's called the Flame Ring. You can bust through Steel Containers now!

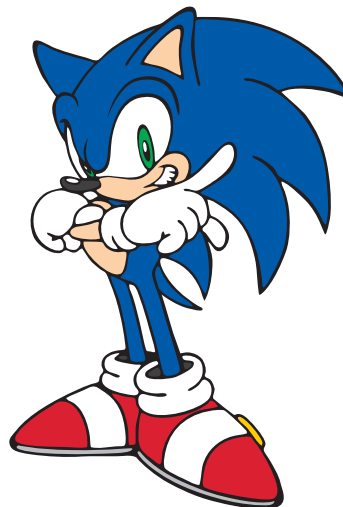

If you continue past the Flame Ring, you'll notice two Rails at the edge. Ride one of them across the pool of nasty green liquid below. The second Chao Container is here, covering a string of rings you must use to get back.



# HERO STAGE 15: SONIC



primagames.com

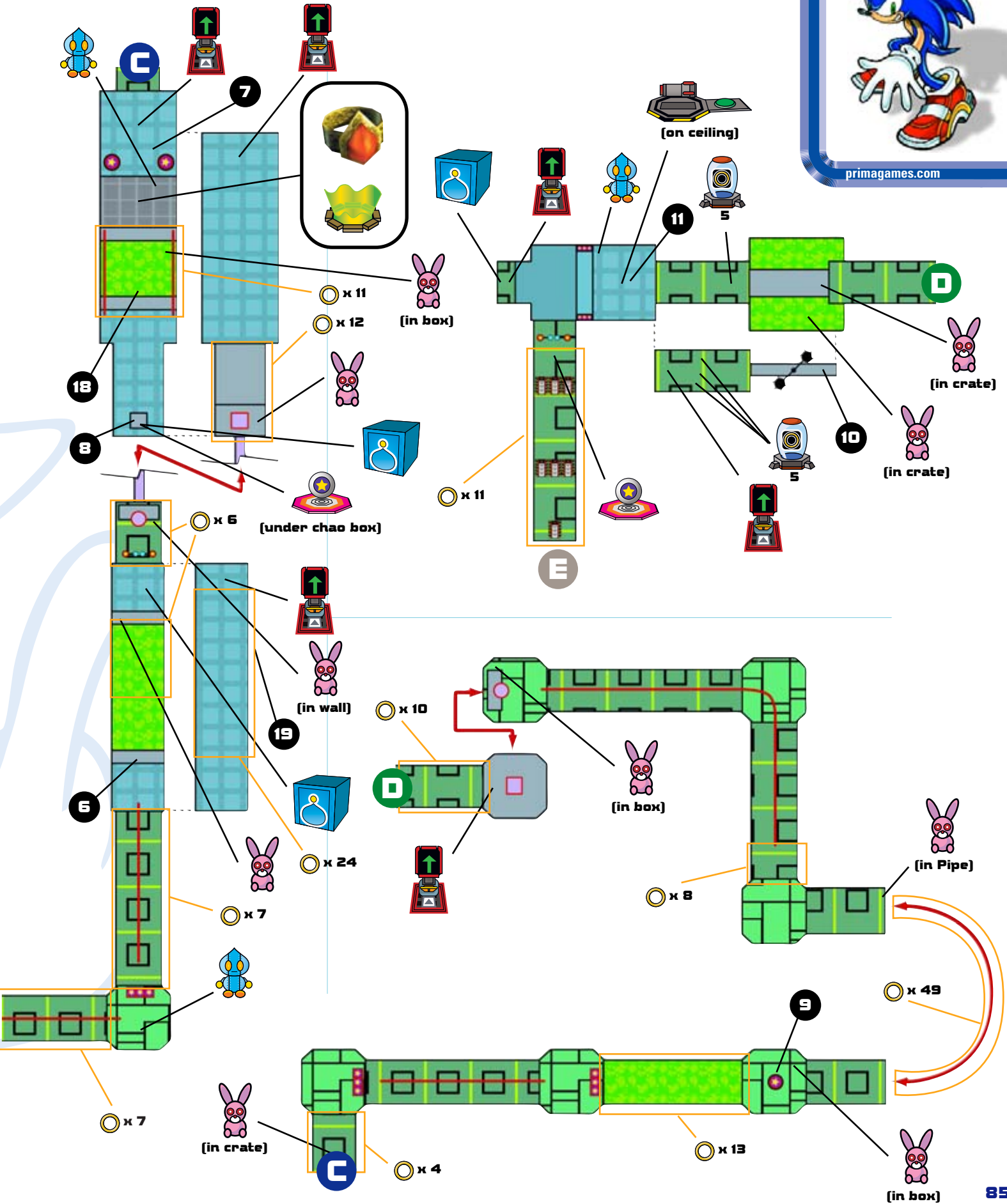

Level 12: A 3D block puzzle with a goal and various power-ups. The puzzle consists of several colored blocks: a red block at the top, a purple block in the middle, a green block on the left, a cyan block on the right, and a yellow block at the bottom. A goal ring is located on the right side. Power-ups include a rabbit in a cage (labeled '(in cage)'), a rocket, a blue robot, and a green robot. A '21' icon is positioned above the red block, and a '15' icon is above the cyan block. A '12' icon is located at the bottom left of the puzzle.

Level 13: A 3D block puzzle with a goal and various power-ups. The puzzle consists of several colored blocks: a red block at the top, a purple block in the middle, a green block on the left, a cyan block on the right, and a yellow block at the bottom. A goal ring is located on the right side. Power-ups include a rocket, a blue robot, and a green robot. A '19' icon is located at the bottom left of the puzzle, and a '20' icon is on the right side. A '13' icon is located at the bottom right of the puzzle.

Level 14: A 3D block puzzle with a goal and various power-ups. The puzzle consists of several colored blocks: a red block at the top, a purple block in the middle, a green block on the left, a cyan block on the right, and a yellow block at the bottom. A goal ring is located on the right side. Power-ups include a rocket, a blue robot, and a green robot. A '14' icon is located on the right side of the puzzle, and a '13' icon is at the bottom right.



## HERO STAGE 15: SONIC



primagames.com



Looks like there's no way out of here doesn't it? Break open the Steel Container in the center of the room.



The beam here is narrow and treacherous. Walk toward the spinning spikes, timing it so that you get close to its center without being swiped off. Then jump and land on the other side. After destroying that Beetle robot, you can continue.

### NOTE

If you fall off the beam, you can still finish the Stage. It just means you won't be able to grab the Chao Container.

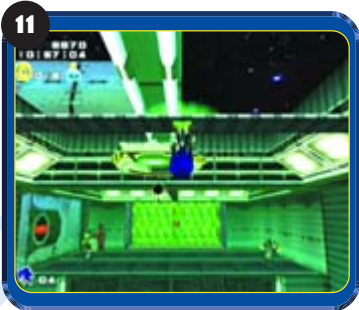

After crossing the beam, you can choose to reverse the gravity or not. If you don't reverse the gravity, you can continue on. If you do reverse the gravity, you can reach the Chao Container on the other side. First launch the Rocket to remove the force field.



Here we go. If you haven't become dizzy yet from all the walking on the ceiling, now's the time to pull out the barf bag. Now we have colored floating rectangular boxes to go back and forth to. The general rule here is to flick any Switch you find and let gravity take you to the next box.



Don't be in such a hurry when you reach this edge. Falling off isn't the only danger. Use a Homing Attack to destroy the scoundrel and land safely on the blue box.



To reach the Goal Ring, this Switch must be flicked.

## MISSION 2: COLLECT 100 RINGS

The hardest part about collecting the 100 rings is holding on to them. The Beetle robots and their long-reaching tendrils are the biggest thorns in your side. Keep your cool.

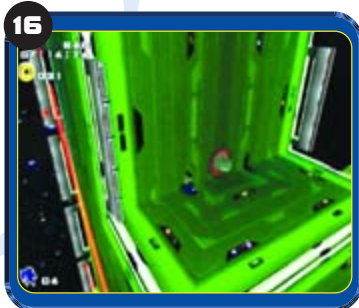

Collect all the rings and ring Item Boxes you encounter. Watch out for the robot that drops down here. You don't need a setback this early in the stage.



Before flicking this Switch, drop down beyond it to find a ring Item Box among the boxes. Then use the Springs and Rails to return to the Switch.

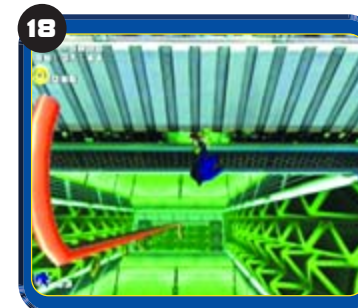

This Rail with the strings on it should be the last of the 100 rings if you've been diligent in your collection of them. If not, continue on and avoid being hit.



There's a button and a Rocket here only if you turned on that Switch earlier in 13. Launch the Rocket and grab the Goal Ring.

If you're confident in your jumping ability and need a good cache of rings, jump over to the Ancient Ruin and make your way to the top; there's a big load of rings up there on the ceiling at 19.



### MISSION 3: FIND THE LOST CHAO

Not again! These Chao seem to have a talent for losing themselves in dangerous, out-of-the-way places.



After flicking the Switch to enable the Rocket to the Goal Ring, you're plopped on a red, T-shaped box. Flick the one Switch you didn't last time to land on this purple box.



Use the Mystic Melody and follow the string of rings to the other side of the red T. There it is.

### MISSION 4: REACH THE GOAL WITHIN 5 MINUTES 0 SECONDS

Five minutes is tricky to achieve with all the changes in the gravitational field. If you keep your bearings true and your focus clear, you'll have time to spare.



Five minutes is a tough time to beat. To do so, you'll have to pass up many enemies.



Light Dashing is key. The Light Dash moves you along much more quickly than simply running.

### MISSION 5: CLEAR HARD MODE

These Hard Modes are becoming more and more difficult. This Stage poses a particularly unique challenge with its gravitational fields. The dangerous Beetle robots are more numerous, and some of the Gravity Control Switches behave differently.



Here's where the first real change in the stage takes place. You must now hop up on these boxes to get any farther.



As the Spark Beetle charges, hop onto the Rail. Float slowly toward the 'bot until it drops its shields. Use the Homing Attack to destroy it, then wait for Sonic to reach his peak height before aiming for the next 'bot. Repeat with the last one and make it to the ledge above.

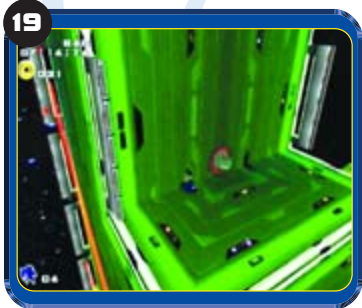

The final wrench in the gears for you in Hard Mode is the Switch to the final Rocket. It's been moved to this point. The problem is that it's covered by a crate. Fiddle with the tow Switches here to uncover the Switch. Timing is everything.

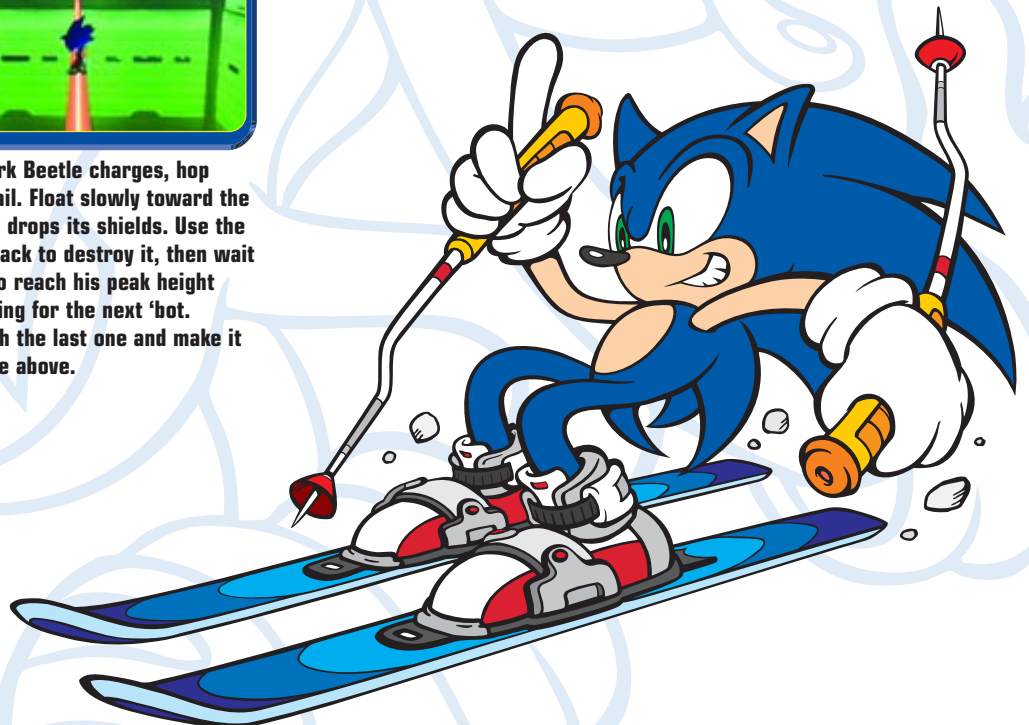

## BOSS: DR. EGGMAN



primagames.com

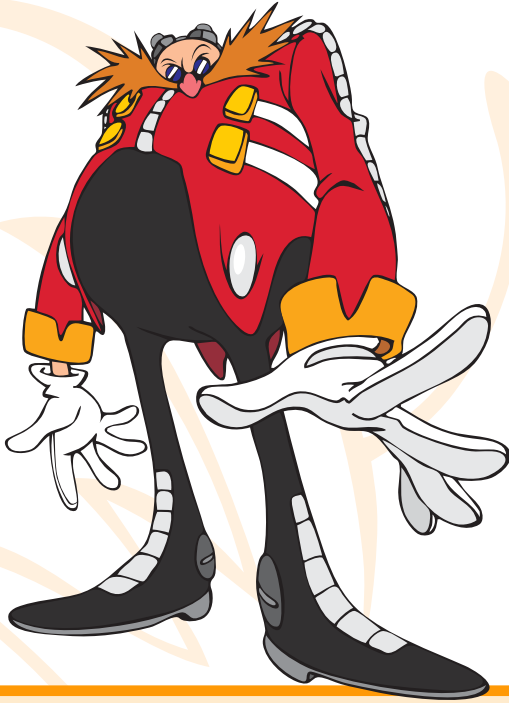

## TAILS VS DR. EGGMAN

It's up to you, Tails. Sonic's been blasted off into space, and only you stand between Dr. Eggman and the Emerald. Sonic doesn't ask much of you, so you cannot—must not—fail.

### BOSS ATTACKS

Dr. Eggman is faster than you, so keep on your toes. He can attack you in three ways: Cannon fire, Homing missile, and the Power Laser. Keep your distance if you can, and don't ease off the fire button.

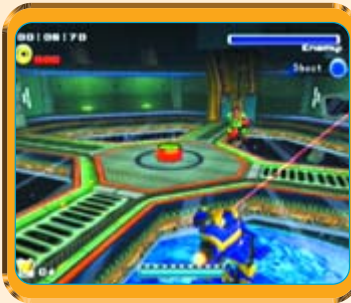

Although it may seem that your Homing Attack is the best way to dispatch of Dr. Eggman, while more powerful, it's too slow to hit reliably. You stand a better chance of hitting him with your regular cannon's rapid fire. However, it doesn't hurt to target him and hope that a Homing Missile will land.

The explosives in the middle of the room can hurt both you and Dr. Eggman. Keep to the outer perimeter and shoot the explosives if he nears them.

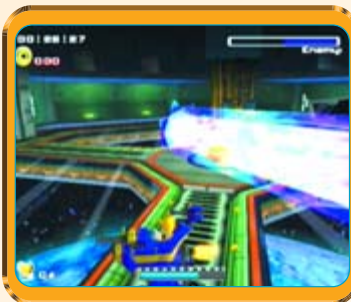

Once you've taken a good bite into Dr. Eggman's health meter, he pulls out his big Power Laser. This can mean the end if you're not careful.

When Dr. Eggman fires his Power Laser, it's time to run. Head toward him, but away from his line of fire. By moving toward him, you have a shorter distance to move your slow vehicle out of the way. The laser lasts for quite some time. Use this time to circle around Dr. Eggman and give him a taste of your cannons.

### TIP

When fleeing the laser, jump and use your Booster. Boosting gives you more responsive control over your movement. It's great for avoiding the laser.

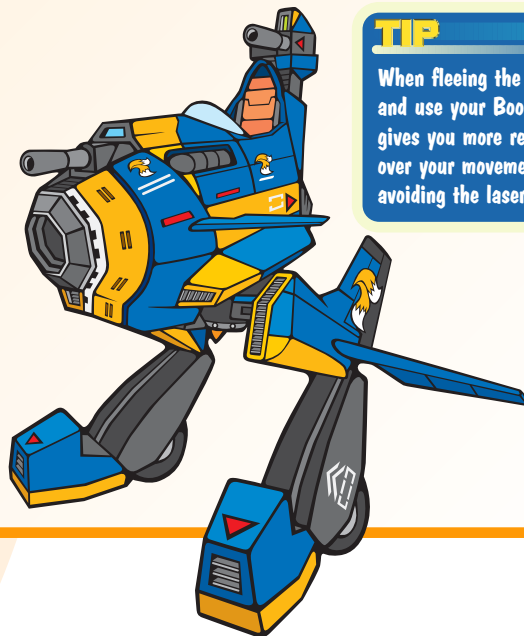

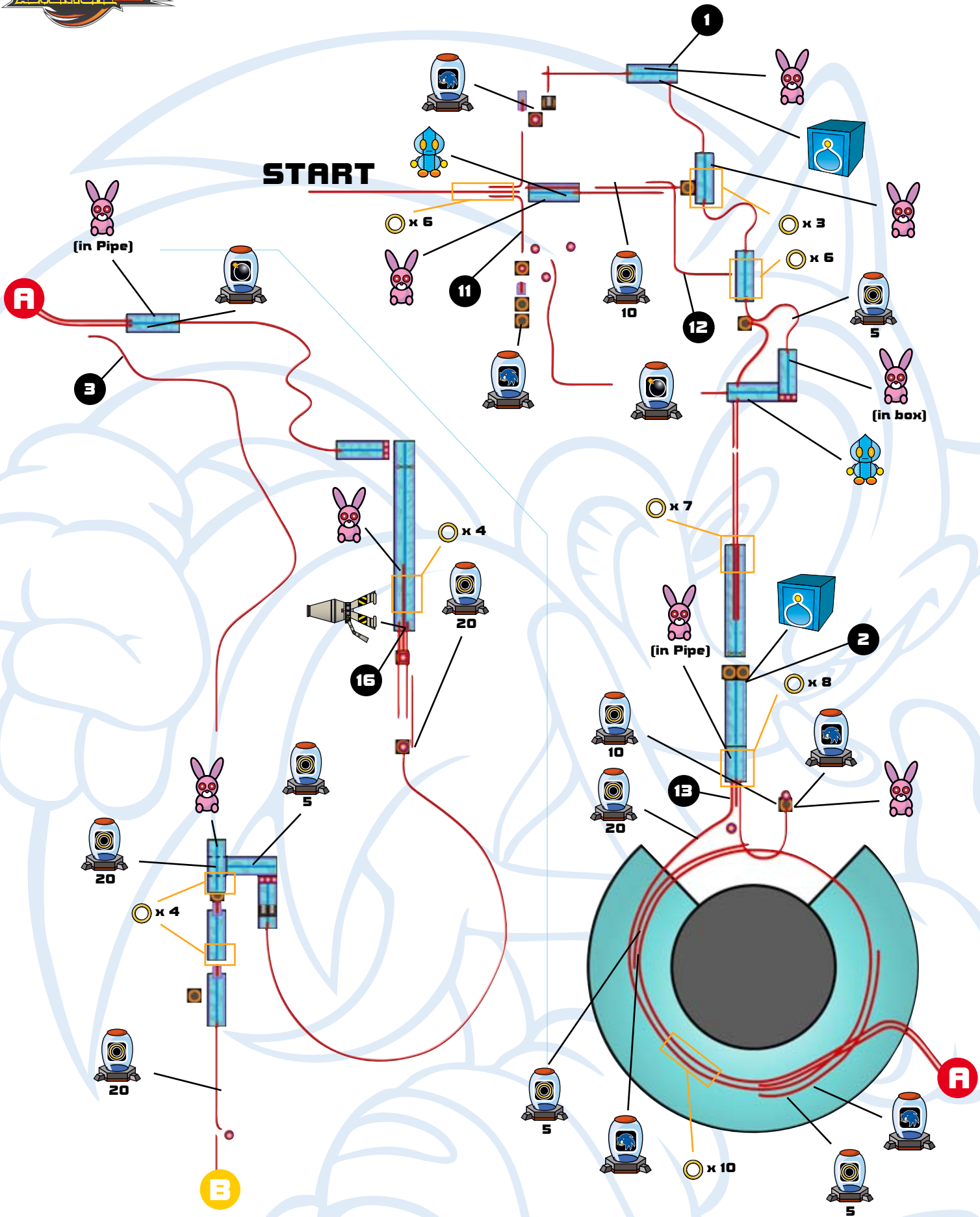

# HERO STAGE 16: SONIC



primagames.com

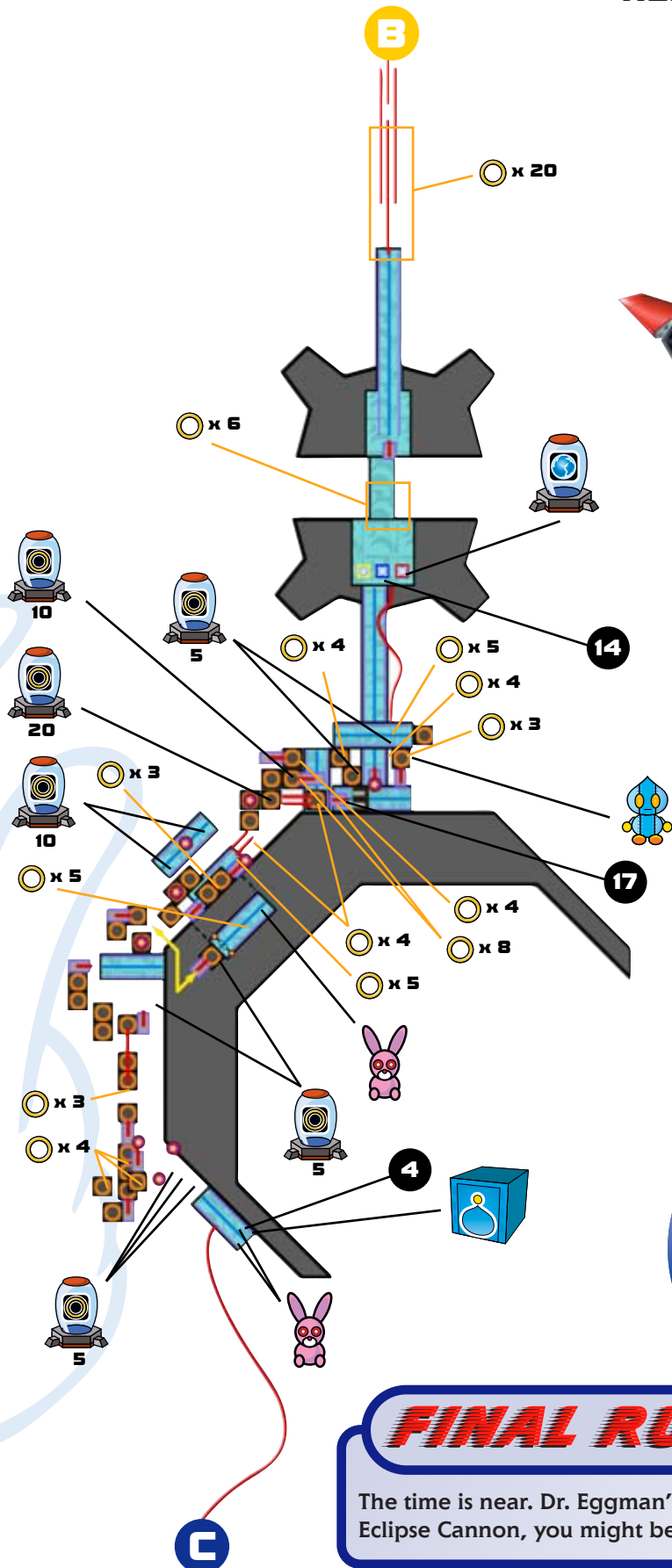

## Missions

1. Hurry and find the point of the Cannon!
2. Collect 100 rings!
3. Find the lost Chao!
4. Reach the Goal within 5 minutes 0 seconds!
5. Clear Hard Mode!

POWER-UP:



MYSTIC MELODY

## FINAL RUSH

The time is near. Dr. Eggman's plans are coming together. If you can find the Eclipse Cannon, you might be able to stop him.

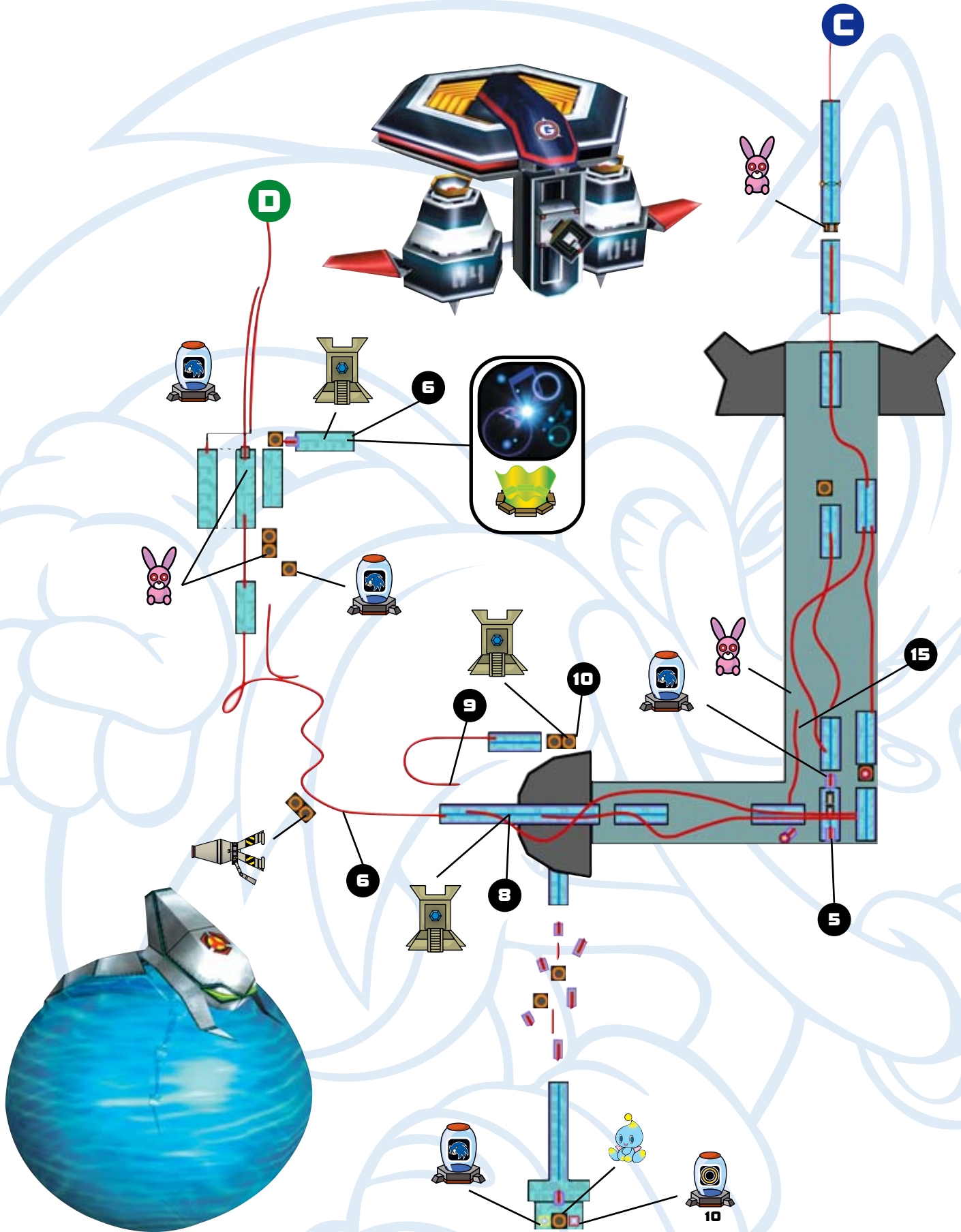

# HERO STAGE 16: SONIC



primagames.com

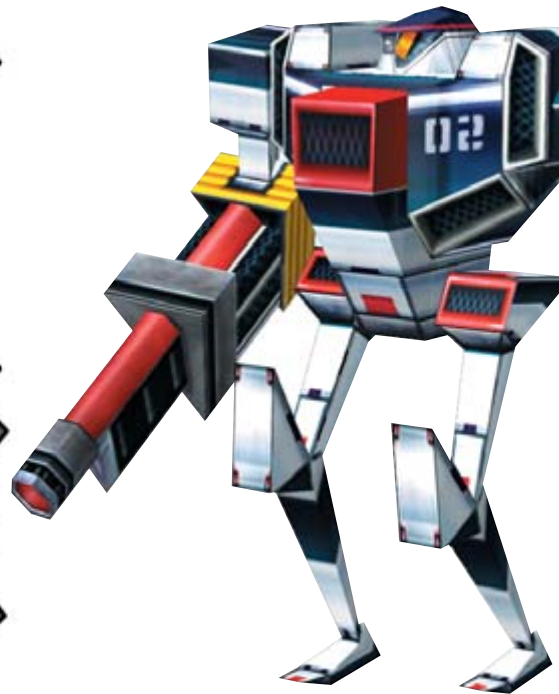
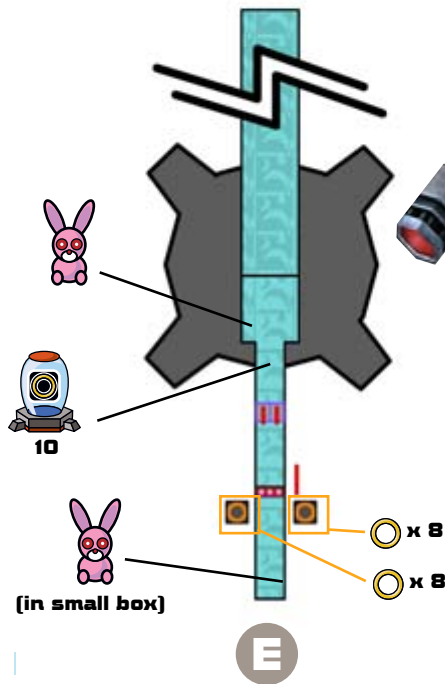
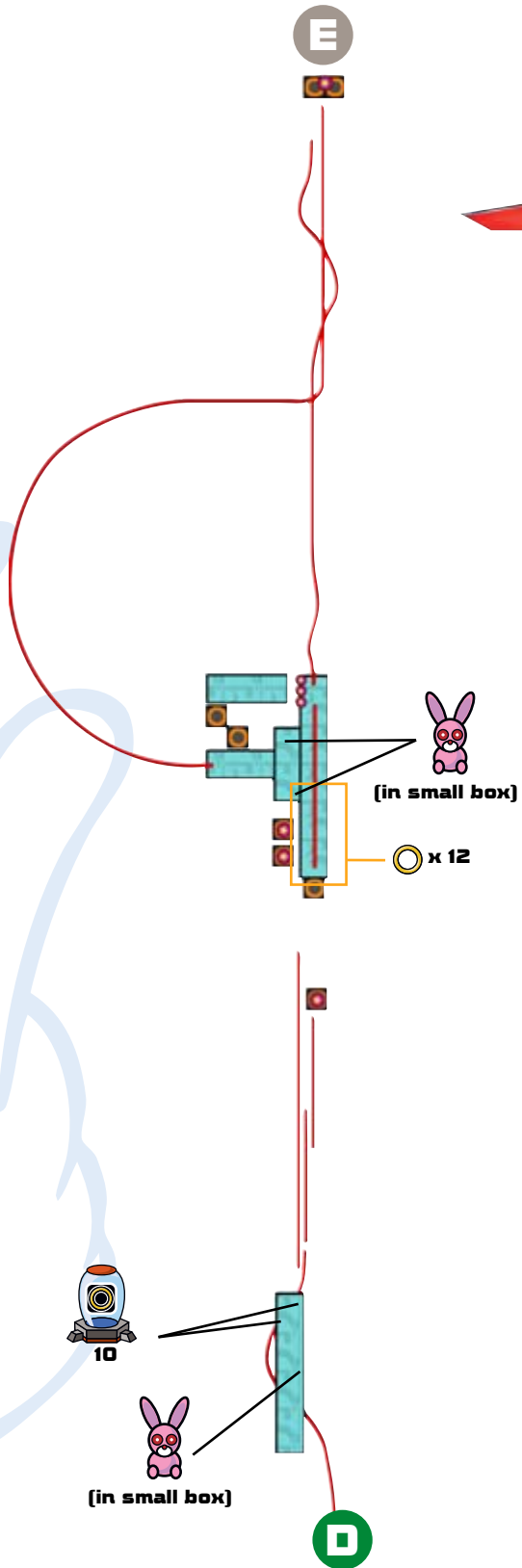

## MISSION 1: HURRY AND FIND THE POINT OF THE CANNON

### TIP

There are lots of parallel Rails on this Stage. Transfer from one Rail to the next by pressing the analog thumb pad in that direction and hitting **A**.



**1** Heads up, soldier. If you want the first Chao Container, skip over to the left Rail at the end of your ride. When you reach the vertical Rail, jump and use the Homing Attack to push yourself up. You can clear the next ledge with a single jump. Follow the Rails until you find the Chao Container.



**2** The second Chao Container is tucked away between the two Unbreakable Containers, just below the walkway.

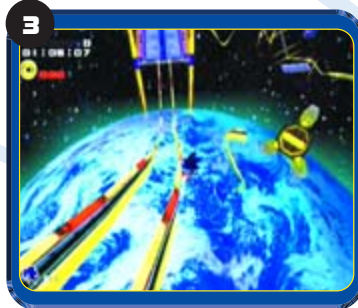

**3** For a shortcut, transfer to that Rail on the right. If you miss, stay calm. It's a pretty steep Rail, and if you guide yourself as you fall, you stand a good chance of landing on it farther down.



**4** If you blink, you'll miss the third Chao Container here. The Springs bounce you around very quickly. As soon as you land on that Rail, jump away from the Springs and land on the platform.



**5** Hold down **B** or **X** on this vertical Rail. If you don't, the Spring at the top will be out of reach.



**6** Hop off the Rail here to catch a ride on the Rocket. It plops you over an Extra Life Item Box. Follow the platforms, which lead you to the Mystic Melody.



All the choices on this Stage make it seem complex. Which Rail to take? Which direction to go? They all lead to the same place in the end. Just keep pressing forward to reach the Goal Ring. Check the map for details on what's available on each route.

## MISSION 2: COLLECT 100 RINGS

This Stage is full of rings. The trick is to know where they'll appear next. The furious pace of the Stage makes them easy to miss. Know how to switch back and forth between Rails.

### TIP

Study the map to know when rings are coming up. If they're on the next Rail over, prepare to position yourself accordingly. Ring Item Boxes are also important. Use the Homing Attack to pop them.

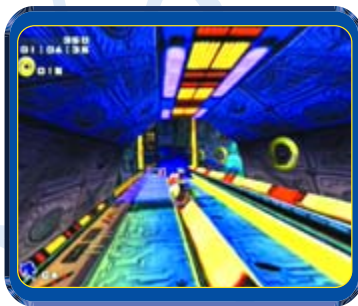

The Rails often contain strings of rings. Although it's easier to stay on one Rail until the end, you can collect more rings if you hop from one to the next and back.



Plenty of Ring Item Boxes float about. Hop up and grab them. This can be dangerous, so make sure you know how to land after the Item Box is popped before attempting this move.

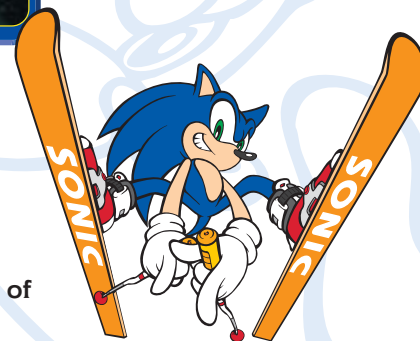



primagames.com

## MISSION 3: FIND THE LOST CHAO

How the Chao got lost in this out-of-the-way room you'll never know. For now, getting to it is the problem. The Mystic Melody, precise control, and nerves of steel are the only requirements.



When you reach this platform, activate the Point Marker before awakening the Ruin. If you fall off the edge on the way to the Chao, you can start again right here. Then activate the Ancient Ruin to bring forth the two platforms floating to the right.



That's right; you must tackle this curved, uphill Rail next. The combination of the Rail's curvature, its uphill attitude, and the rotating camera angles make this a tricky feat. The Homing Attack is the tool to use here.



Start by performing a jump, and use the Homing Attack to propel yourself onto the Rail. As soon as you stick to the Rail, hold down **B** or **X** to crouch. Crouching allows you to get more distance on the Rail. This is important because the farther you grind, the better the camera angle becomes for your next jump.



Because the Rail is uphill, you eventually slow to a stop. Just before you do, jump again and perform another Homing Attack toward the Rail to propel yourself farther. Repeat this as often as necessary until you reach the next platform.

### TIP

The camera angles make it difficult to judge in which direction to aim the Homing Attack. To be safe, jump as you normally would to set up the Homing Attack. But, instead of attacking at the height of the jump, wait until you fall closer to the Rail. Doing this reduces the chance that you'll fall off.



After you activate the next Ancient Ruin, the string of rings takes you to this platform. Up ahead are some floating Rails and platforms that lead to the next tunnel. Beware the Chaos robot in the tunnel, and find the Chao just beyond it. Whew!

### TIP

In general, grind on all Rails. Grinding increases your speed and improves your time. However, remember from the earlier missions that on some Rails it is safer *not* to grind. This is why good map knowledge is essential for this mission.



## MISSION 4: REACH THE GOAL WITHIN 5 MINUTES 0 SECONDS

To finish this mission, you need detailed knowledge of the Stage. Many shortcuts can help you on your way, though they may prove a bit trickier. Do you take the safe route and risk not making the time? Or are you daring enough to take the shortcuts...and risk not making it alive?

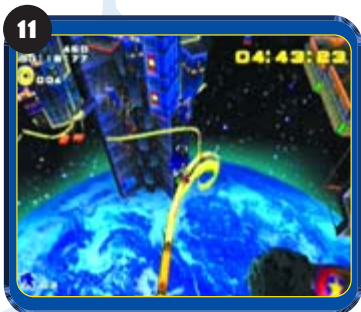

On the map, this Rail seems to provide a shortcut. In reality, it saves you a few seconds, but only if you nail it perfectly.



A better route is to hop over to the Rail that leads right. If you don't grind on the Rail leading up to it, you drop down on it.



From the top of the Ramp, jump to the Rail on the far right down below. The other two Rails eventually lead you there, but why waste time?



Off to the right is a lonely Rail. Hop off the Rail you're on now and catch that lonely Rail. If you miss, don't fret; guide yourself as you fall, and you can still catch it. This is a major shortcut.





**14** The middle Tube is what you want. The Tube on the right takes you to a lower spot, which will eat up precious seconds on the clock.



**15** Jump over to the Rail to the right. When it ends, use the Homing Attack to hit the Rail on the platform.



**17** To build enough speed for this vertical Rail, use the Spin Dash.



Flip the Switch under the Artificial Chaos on the right. The Switch controls the Weight so that you don't get crushed.

## MISSION 5: CLEAR HARD MODE

In Hard Mode, you find more enemies and fewer Rails. The precise nature of the Rails makes the aggressive enemies even more dangerous. Where you could previously slide down a rail undisturbed, now you must constantly be aware.

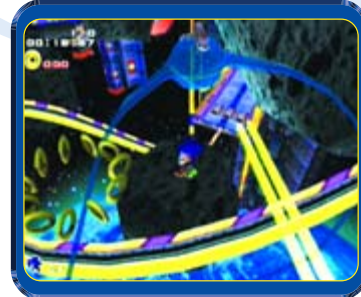

The Floating Chaos that wouldn't give you the time of day before now want to reach out and touch you. If you grind so that you pick up enough speed, you can escape some of them. For others, like this one, you must resort to different measures. Jump up and give it a taste of your Homing Attack.

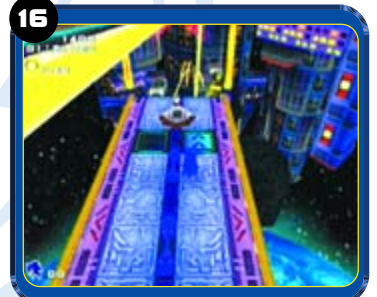

**16** Grab the Rocket here to avoid a few new enemies and obstacles.



## SONIC VS SHADOW

Shadow looks disappointed that you survived the space ride. Too bad for him. Now you're going to show him who the real hedgehog is. This ought to teach him to underestimate Sonic!

### BOSS ATTACKS

Shadow's bark is a lot worse than his bite. With all that talk, you'd think he'd pose a real threat to you. Instead, he has the standard arsenal of attacks that you have. The exception is his Chaos Control Attack, which is the only thing to worry about on this infinite highway.



When you start, continue to run alongside Shadow, collecting rings. You'll probably be hit at some point during this fight, and the rings will protect you for a few hits.



Early in the fight, your simple Homing Attack is enough to damage Shadow. Use it until you notice that your attacks just bounce off him.



Before long, your Homing Attacks won't affect him. Now's the time to hang back a little bit. Let Shadow run far enough ahead until he attacks with the Chaos Control. To perform this, he must stop.

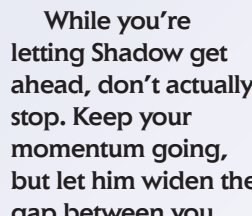

While you're letting Shadow get ahead, don't actually stop. Keep your momentum going, but let him widen the gap between you.



When Shadow is far enough ahead, he'll stop to do his attack. Now is the time for you to act. Watch for him to stop and begin to say, "Time to put this to rest!" Anticipate this and begin a jump toward him. After he finishes saying it, a yellow flash of lighting comes your way.

### CAUTION

When attacking Shadow, you're likely to get hit by the Chaos Control. Suck it up, collect a few rings, and continue the fight.

If you see Shadow spinning in the air, it means that he's about to attack you. Counter it with an attack of your own.

To escape the Chaos Control and smack Shadow at the same time, use the Homing Attack toward Shadow. If you don't hit him with the first shot, you're sure to be within range now. Repeat until Shadow is defeated.

## DARK STAGE 1: DR. EGGMAN



primagames.com

### IRON GATE

It seems that Dr. Eggman is up to his old tricks, and he's not being very quiet about it. He's looking for his grandfather's top-secret work, and you're going to help him find it.

### MISSION 1: GET TO THE CORE OF THE MILITARY BASE

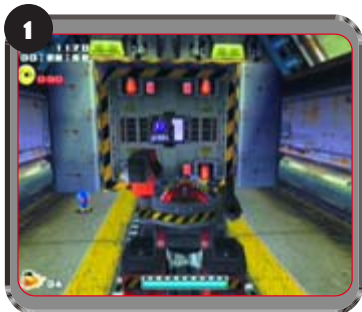

If you're quick enough, you can duck under this door before it shuts. If it locks down, though, just target the four locks and blast them to knock it out of your way.

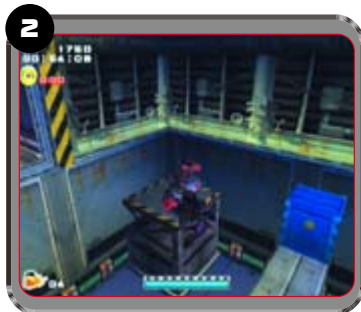

Pound away at the boxes and Tank in the corner to reveal the second Mini-lift. Ride it so that you can break the first Chao Container.



These two Tanks hide a stack of Steel Containers. When you have the Large Cannon—found on Dark Stage 7: Weapons Bed—you can blast the boxes and get to the Laser Blaster.



Ride on this Mini-lift and hop over to the platform to reach the second Chao Container.



When the security doors slam shut in your face, you'll need to launch a Missile to break through them. Ride the Mini-lift and target the console next to the Missile. Shoot it and the Missile launches, clearing your path.



Don't jump into the Goal Ring right away. Drop off to the side and find the third Chao Container, then you're finished.

#### TIP

You can target the console from below. Stay at the ledge near the security door and use your targeting laser from there.



#### POWER-UP:



LASER BLASTER

#### Missions

1. Get to the core of the military base!
2. Collect 100 rings!
3. Find the lost Chao!
4. Reach the Goal within 4 minutes 0 seconds!
5. Clear Hard Mode!

### MISSION 2: COLLECT 100 RINGS

Because this is the first of the Dark Stages, collecting 100 rings won't pose too much of a problem. In fact, if you take it slowly, you should be able to do it in one try. The main tactic is to avoid being hit by robots. Not very insightful, but it's true. Maintain a steady stream of bullets and Blaster shots, and you can tag most of your foes before they can fire off a shot. So, take care and you can meet the Goal before making it halfway through the level.

This room has a bonanza of rings. Blast away at the capsules and walk away happy.



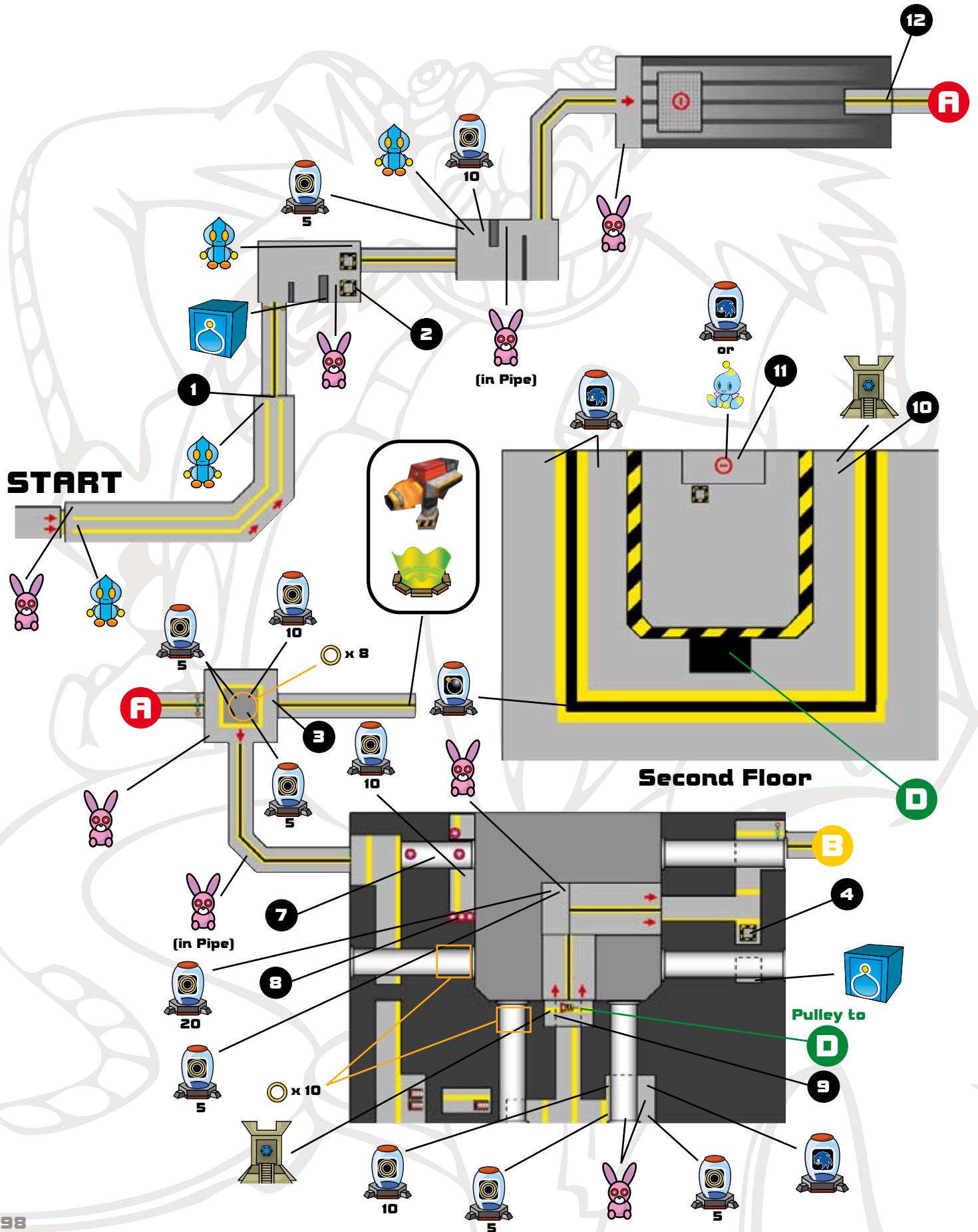

# DARK STAGE 1: DR. EGGMAN



primagames.com

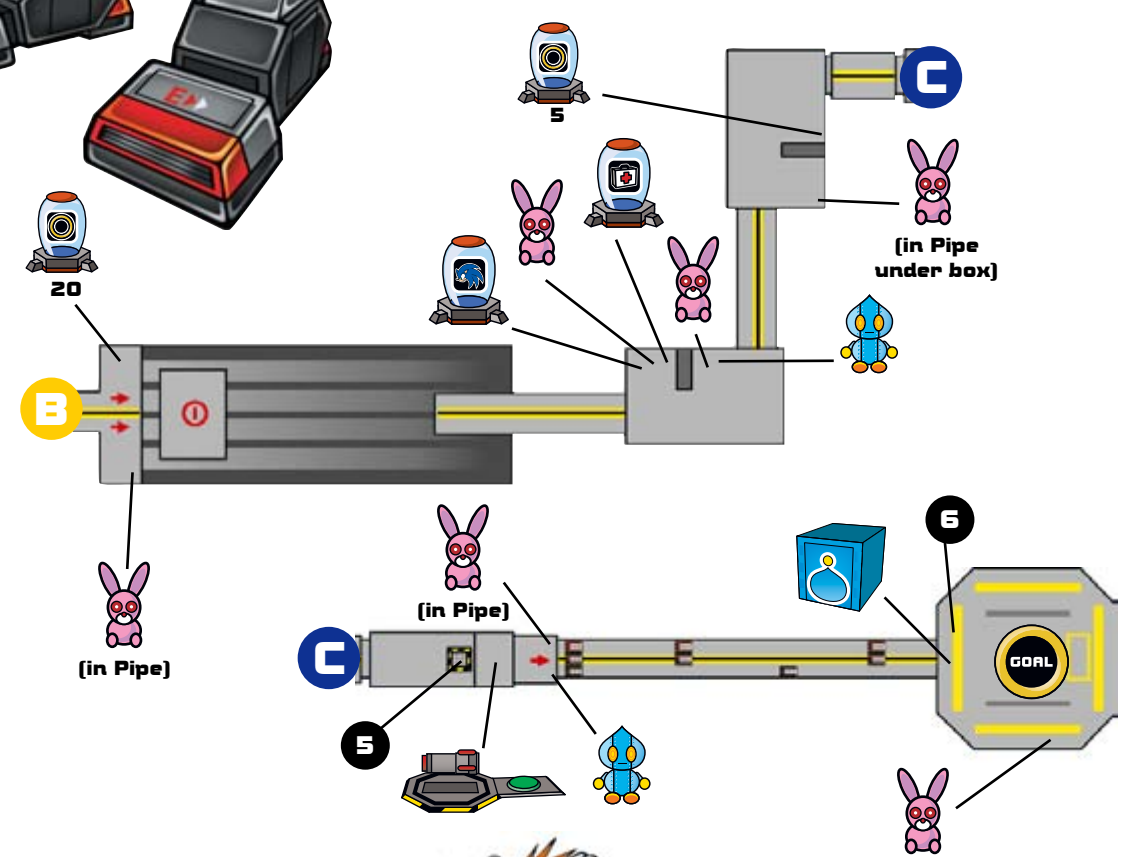

## MISSION 3: FIND THE LOST CHAO

You'll need three specific permanent upgrades for Robotnik before you can find the Lost Chao. Don't attempt it until you've found his Jet Engines in Dark Stage 6: Lost Colony, Dr. Eggman's Mystic Melody in Dark Stage 3: Sand Ocean, and his Large Cannon in Dark Stage 7: Weapons Bed. When you're properly equipped, you can make the trek to the Chao successfully.



7 Traverse to the Spring that is precariously perched on a pipe and pop up to the platform to the left. Blast the box and bounce. At the peak of the bounce, start Hovering and move to the higher platform.

**CAUTION**

Make sure you don't scrape into the wall as you Hover. The contact will kill your altitude and send you spiraling southward swiftly.



9 At the Ruin on the platform, use the Mystic Melody to make a new series of platforms appear. Hover jump up them, turn around, and Hover to the platform with a pull cord above it.



10 Check to the left to find the Extra Lives and then go to the right and find the Ruin. Play the Mystic Melody and leap up the platforms that appear. Careful: More robots wait at the top.



8 Use the Long Spring to launch up and Hover to the pipe. Be very careful to land directly on top of the pipe. Any error will cause you to slip off. Then jump and Hover around the corner.

**TIP**

The line of rings is tempting, but if you want to play it safe, make a tight turn around the corner to the platform past the next pipe.

**TIP**

Hang on to the handle when it reaches the top and swing your targeting laser around. You should be able to target and shoot several of the nasties waiting for you up here.

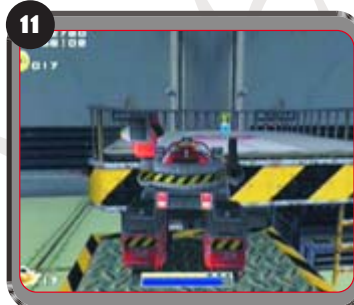

11 Ride the short Mini-lift and pick up the unhappy Chao. You've done it.

## MISSION 4: REACH THE GOAL WITHIN 4 MINUTES 0 SECONDS

A few tricks to this mission will help you beat the clock. First, notice that the doors that slam shut at various points pause before closing all the way. If you can reach them quickly, Dr. Eggman can squeeze his rotund figure through the gap. That will save you from having to blast the locks. Also, remember that the point is to beat the clock, not clear the Stage. You do want to collect points, but don't go out of your way to shoot enemies. If they're not in your way, ignore them.



12 Fire at the door from the descending platform. As soon as it's broken down, jump off the platform and Hover to the door.



## MISSION 5: CLEAR HARD MODE

Iron Gate's Hard Mode isn't very difficult. The major differences are a few more robots—that jump out at you—and more locking doors. By now you should be familiar enough with the Stage that it won't phase you.

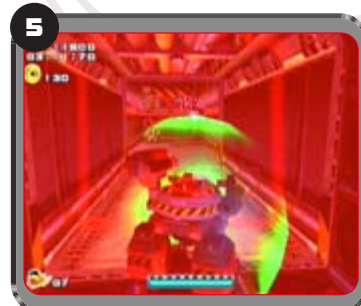

5 The Missile is heavily guarded this time around. Shouldn't be a problem with your skills, right?



## BOSS: B-3X HOTSHOT



primagames.com

# SHADOW VS HOTSHOT

Robotnik found a strange surprise in the military complex: a Dark hedgehog that goes by the name of Shadow. It seems that the military isn't too keen on leaving Shadow in one piece. See if you can help him out.

## BOSS ATTACKS

Hotshot is similar to Big Foot, the battle Mech that Sonic fights. This guy has one more attack than Big Foot does, but otherwise the strategy should be familiar (assuming you played the Hero Story first, that is). First off, collect a few rings to keep Shadow safe.



Hotshot begins by flying up and strafing the ground with machine-gun fire. It's easily seen and he's not moving very fast. Run in a wide circle to avoid it.

The area where you battle Hotshot is a square platform with Wooden Containers in it. Use the Containers to jump higher and defeat Hotshot faster.

### TIP

Leap high by pressing **A** and holding it for a moment before pressing it again to do the Homing Attack.



After a pass with the machine guns, Hotshot lands, the Missile bays open, and Missiles shoot out at you. Again, run around until the barrage stops. The Missiles aren't very good at homing in on you.



Try to time it so that you're close to Hotshot when the bay doors close. As soon as they do, leap high in the air and Homing Attack on Big Foot's cockpit.

Watch the "Enemy" health meter in the upper-right corner. It charts how much energy your foe has. Hotshot requires four hits to defeat.

After you hit him once, Hotshot reveals his new weapon. A round, red targeting reticle appears and latches onto Shadow. Run to avoid it. You must keep up your speed or else it will catch up, so loop around the platform rather than making stops to change direction. If you can't shake it, tap **A** twice to jump away from it.

Hotshot repeats these attacks as you run around and avoid them. After you hit him a third time, the bad robot uses his energy blast three times before landing. Keep on your toes. Every time he lands, he'll fire a barrage of Missiles. When that ends, pound on his cockpit. You'll soon be victorious.



This red target is a bad thing. Get away from it. Hotshot charges up an energy blast and fires it at the target—and whatever's inside it.

## Missions

1. Find 3 pieces of the Master Emerald!
2. Collect 100 rings!
3. Find the lost Chao!
4. Collect the 3 Emerald pieces in 3 minutes 30 seconds!
5. Clear Hard Mode

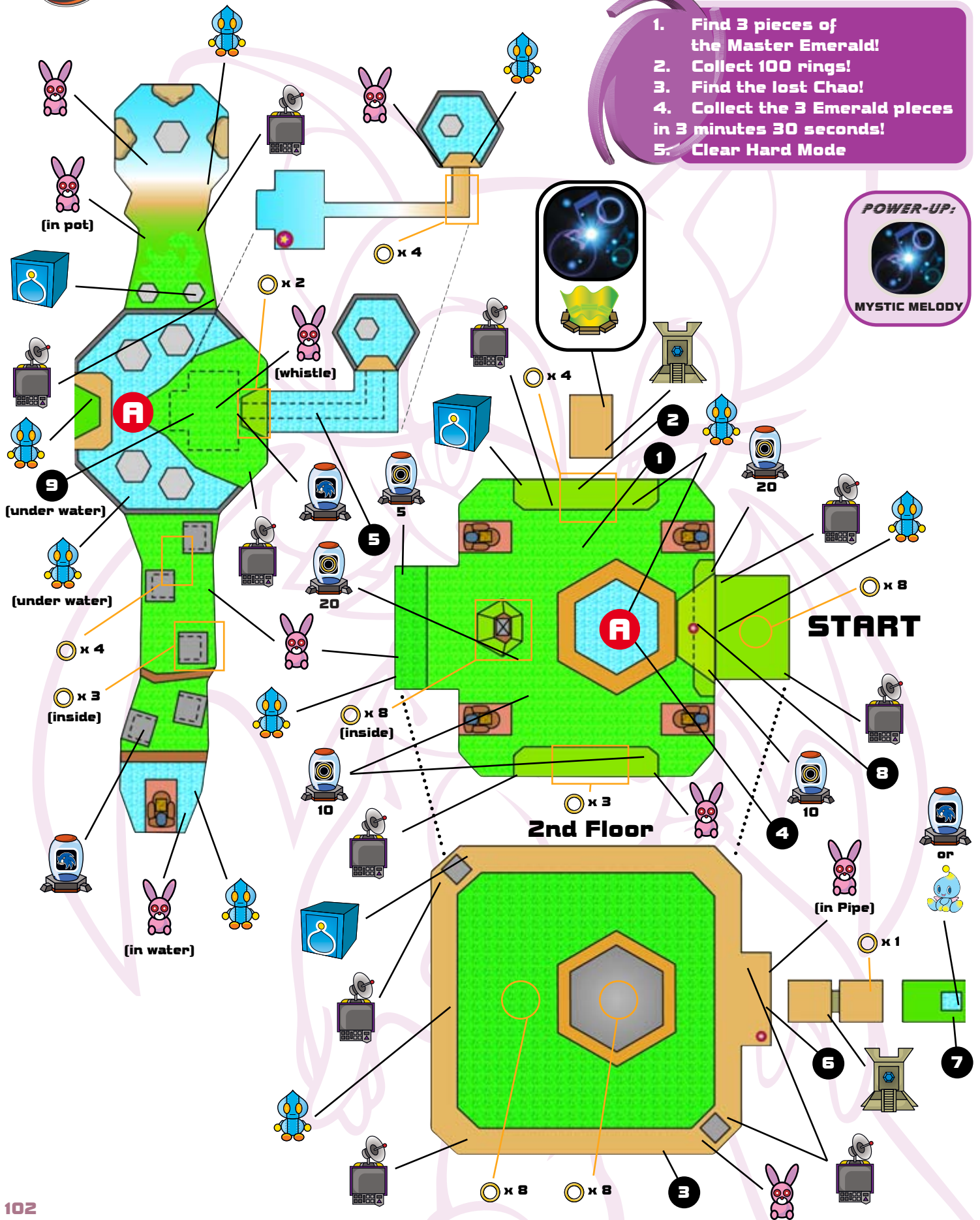



primagames.com

## DRY LAGOON

The good guys are busy scrounging around for the Master Emerald pieces. You should do the same. If you can find the pieces before they do, you'll be in good shape.

### MISSION 1: FIND 3 PIECES OF THE MASTER EMERALD

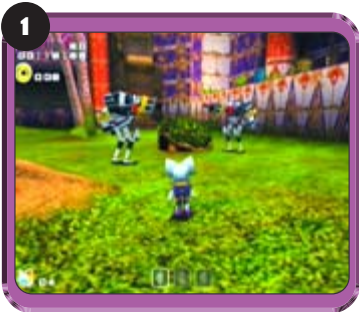

Divided into three areas, this Stage is relatively small. After you destroy the two robots here, the Turtle jumps into the pool and waits. The Turtle is your ride between the two main areas.



If you've acquired the Pick Nails from Dark Stage 5: Egg Quarters, you can now get the Mystic Melody. If not, come back later. The mural here is made for Digging, so Dig on through.

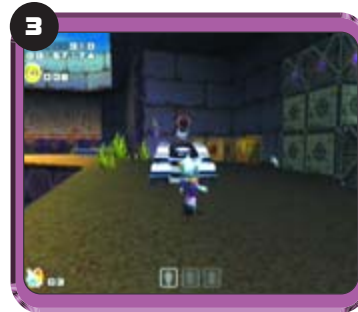

Above the small pool is a ledge that runs along the side of the walls. Goodies, enemies, and sometimes Emerald pieces are up here.



Hitching a ride with the Turtle takes you to a larger area. In this area, the oasis and the upper level is bigger.



There is another Turtle in this area. This one is swimming around. Grab it and let it take you through the opposing current of a water tunnel.

#### NOTE

If you don't see the swimming Turtle, give it some time. The Turtle runs a regular route between this area and the next.



### MISSION 2: COLLECT 100 RINGS

There are plenty of rings on this stage for you to find. The faster you can collect the 100 rings, the higher your rank.



The area where you start has so many rings that you don't even need to take a Turtle ride. Don't overlook the ring Item Boxes or strings of rings floating in high places.

### MISSION 3: FIND THE LOST CHAO

The lost Chao must have been attracted to the oasis. The hot desert would make any Chao look for water. Look for the lost Chao and help it find refreshment. To do so, you'll need the Iron Boots from Dark Stage 12: Mad Space and the Pick Nails from Dark Stage 5: Egg Quarters.



Make your way to the ledge above the start point and find the Steel Containers along the wall. To access the mural behind it, break the boxes and jump on through.



Climb to the top of this room and you'll notice a sparkly Warp Hole. Glide over to it to find the Lost Chao.



## MISSION 4: COLLECT THE EMERALD PIECES IN 3 MINUTES 30 SECONDS

Time is running short, so scramble to find the three pieces of the Master Emerald in this Stage before time runs.



By now you should be familiar with the Stage. Knowing the Hint Box locations and how quickly you can reach them are the keys to beating the time.



Don't forget that there are two other areas to this stage. The Turtle here will take you to the big oasis where you can hitch a ride with another Turtle to a different area.



## MISSION 5: CLEAR HARD MODE

They've thrown in more enemies and hidden the Shards of Master Emerald better. Don't let this discourage you, for you are Rouge the bat! Before you begin, you need the Treasure Scope found in Dark Stage 8: Security Hall.



To find the first Shard, climb up on the ledge with the Unbreakable Containers. Nestled between them is a Wooden Container, breakable by Digging. Surprise! The Spring pops you high enough to grab that first Shard floating high above.



The second Shard is really close. Directly above the oasis is a little air pocket that shoots air upward. Sitting in the middle of this air pocket is the second Shard. By climbing to higher ground and Gliding toward it, you can almost grab it. However, the air currents are strong. Glide slightly below it and let the current take you to it.



The third Shard is underwater. Take a ride on the Turtle to the large oasis. Dive down to the bottom and take a look in the center where the water is gushing out.



The currents are too strong for you to reach the piece. Jump back to shore and put on your Treasure Scope. Now, drop down and look just above the Emerald Shard for a Spring. Swim over to it to put this stage to rest.



# DARK STAGE 3: DR. EGGMAN



primagames.com

## SAND OCEAN

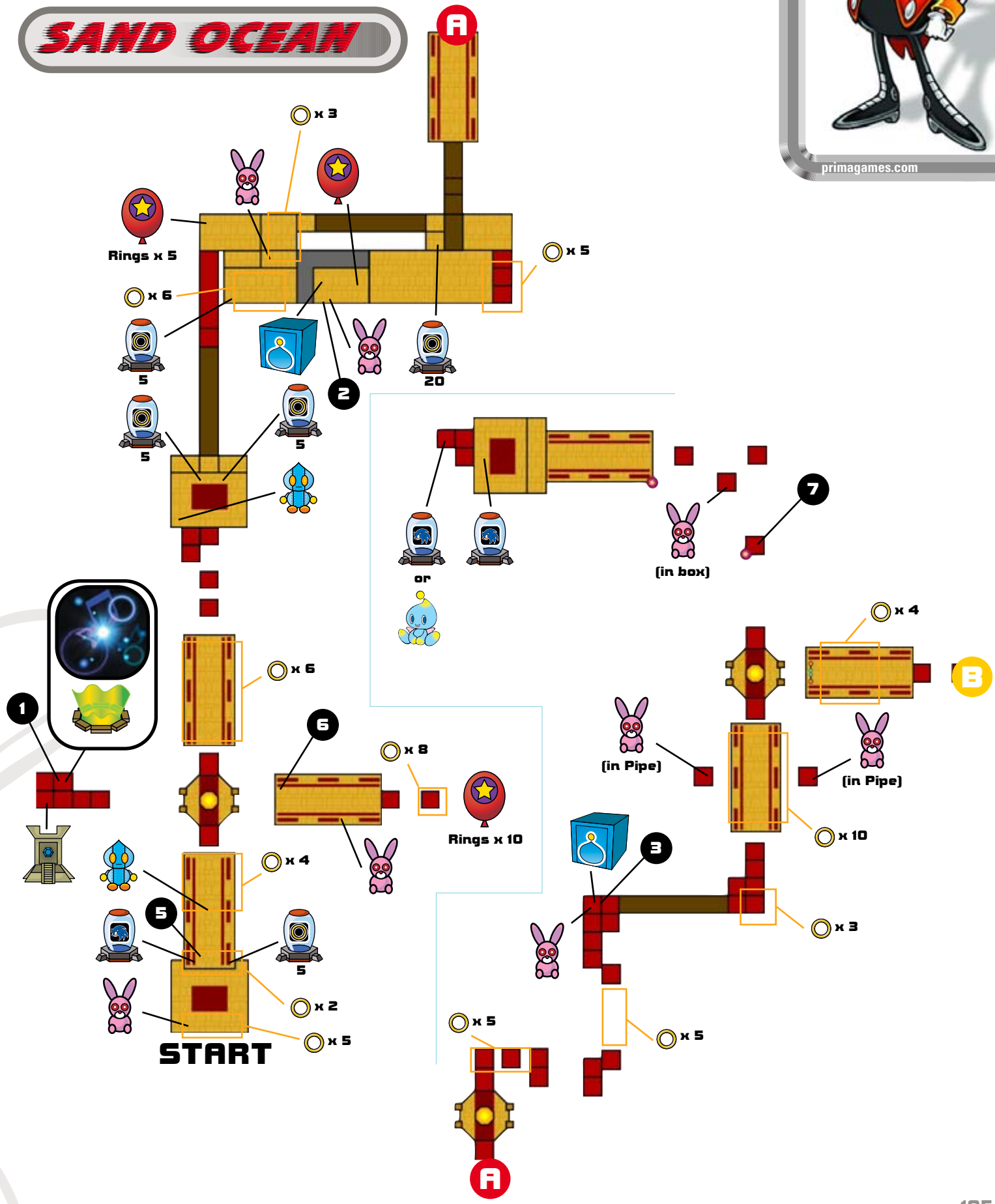

# SAND OCEAN

Those pesky critters are becoming annoying. If they can't find you, they can't bug you, right? The Hidden Base here will be impossible for them to find. Let's take care of business here first before going inside.

## Missions

1. Return to Hidden Base!
2. Collect 100 rings!
3. Find the lost Chao!
4. Reach the Goal within 4 minutes 0 seconds!
5. Clear Hard Mode

**POWER-UP:**

**MYSTIC MELODY**

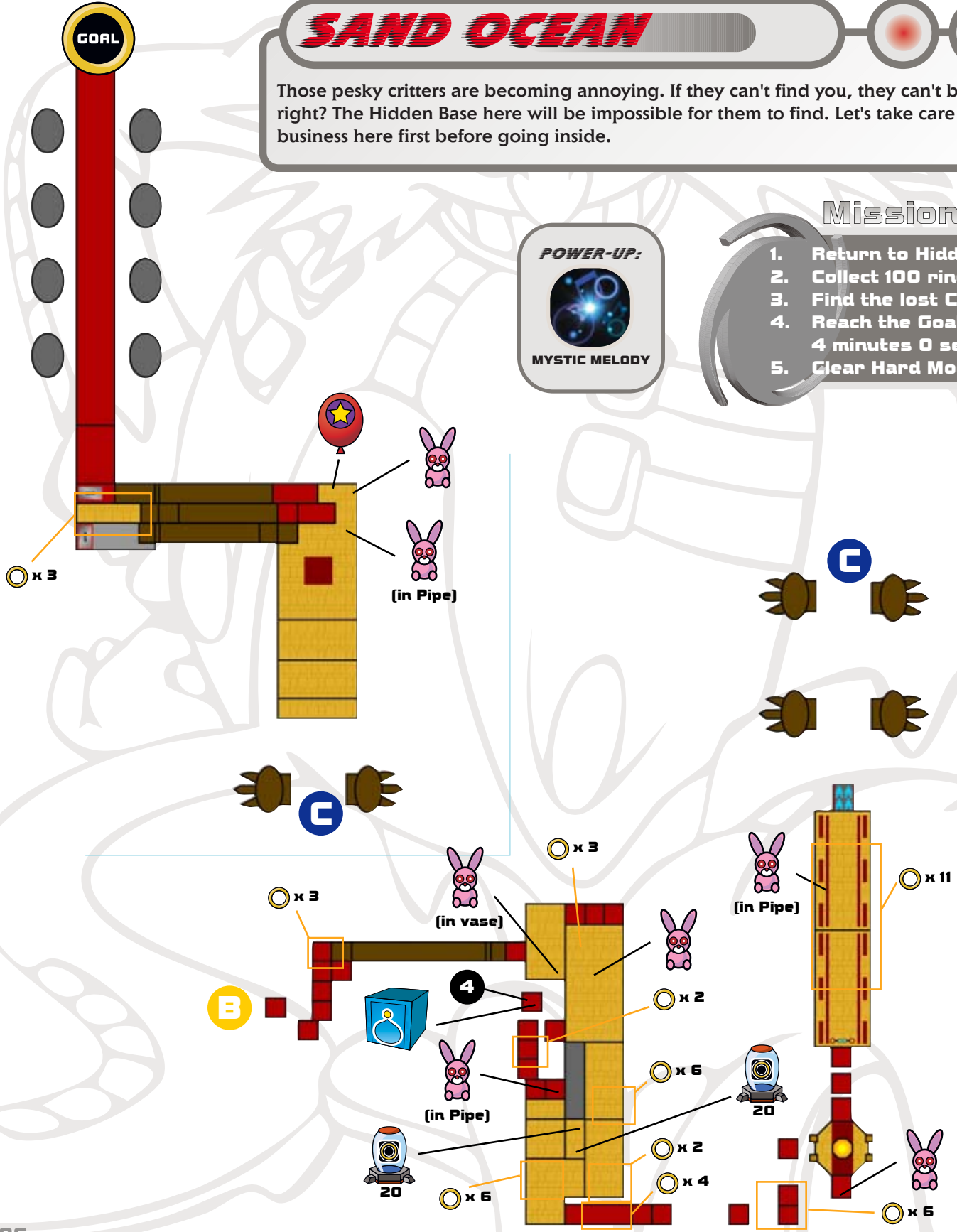

## DARK STAGE 3: DR. EGGMAN



primagames.com

### MISSION 1: RETURN TO HIDDEN BASE!



1 Once you acquire the Jet Engine from Dark Stage 6: Lost Colony, you can use it to reach the Mystic Melody way over here. Awaken the Ancient Ruin also located here and use it as a shortcut. If you're looking to find all three Chao Containers, however, this isn't a good idea; the Warp Hole puts you all the way near the third one.

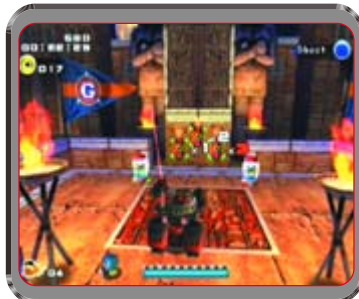

2 Shoot the Dynamite packs at the bottom of pillars to create walkways. Don't be directly underneath one as it falls.



3 The first Chao Container is right here. Use the Springs and Hover, if you have it, to clear the spinning spikes. If you can't Hover yet, use careful timing.

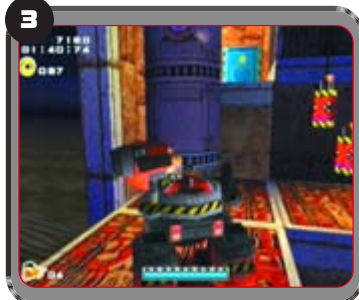

4 Not too far off from the first Chao Container is the second one, in plain sight.

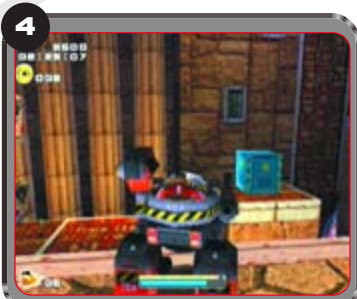

5 The third Chao Container is sitting on top of this pillar. You can reach it without the Jet Engine, but be careful. From here on, the Goal isn't far.

### MISSION 2: COLLECT 100 RINGS

With plenty of rings to snag, 100 should be no problem. Just watch out for enemies trying to knock them from you.



6 Right off the bat, don't miss the Extra Life and the ring Item Box here.



7 If you have the Large Cannon from Dark Stage 7: Weapons Bed, you can access this area. Beyond it is a bunch of rings.



8 Be cautious of the Beetle robots. They shoot at you as they approach. Master the use of your Homing Missile, and 100 rings will be yours in no time.

In the desert near Dr. Eggman's Hidden base is a lonely, lost Chao. Hurry up to find him before he becomes sunburned. But before you can rescue the Chao, you must have the Jet Engine from Dark Stage 6: Lost Colony.

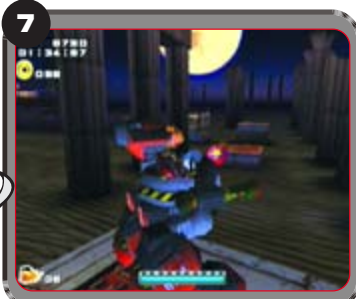

9 Beyond this rotating platform is a small landing square a long distance away. It looks far, but with the Jet Engine, you can easily make it. Once there, time the next landing and jump just as it comes close to its point nearest the next square.



10 From here, another jump and Hover will take you to the final landing where the lost Chao is. There is an Item Box that you don't want to miss right behind the Chao.

## MISSION 4: REACH THE GOAL WITHIN 4 MINUTES 0 SECONDS

Hurry and get Dr. Eggman to the Goal. The sooner he gets there, the better. Four minutes is a tough time to beat if without the Jet Engine, so go get it if you don't have it.



Remember the Ancient Ruin over here? The Warp Hole that you call from it is a great shortcut that'll put you near the third Chao Container.

### TIP

To save valuable time, continue pressing the fire button. Aim ahead if you see pillars with Dynamite packs at their bases so they'll be ready for you when you get there. In areas where robots float about, fire all around you to prevent them from ambushing you.



Think ahead when you encounter any moving platforms, including the rotating ones. With the Jet Engine, you do not have to move according to their schedule. You can often Hover right over them without waiting.

## MISSION 5: CLEAR HARD MODE

Hard Mode puts more enemies in your path and changes the layout of the Stage. Even so, it shouldn't be a problem for someone of your skills.



The first thing you'll notice is that the Elevators are fewer and farther between. Don't become complacent and expect them to be where you remember them. Some even move more quickly, so that by the time you reach them, they aren't there.



Beware the enemies. They're more numerous now, preventing you from easily running through the course. Keep your finger on the trigger throughout the stage.

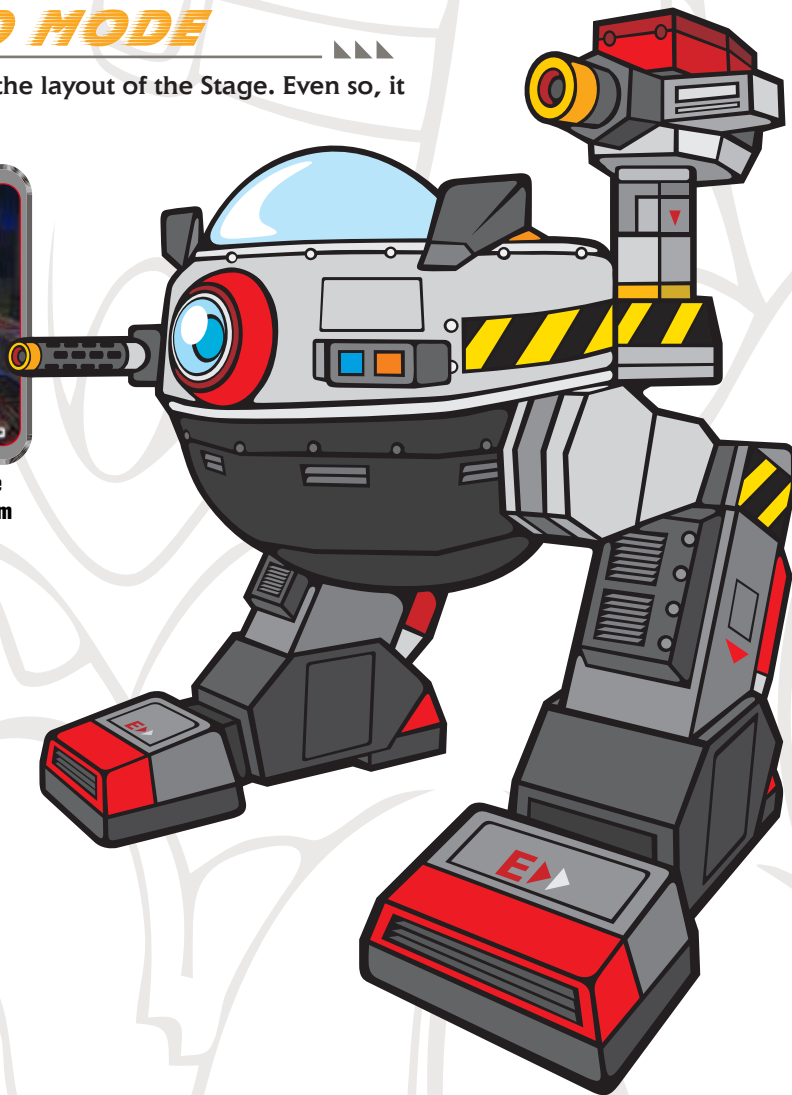



primagames.com

# RADICAL HIGHWAY

Shadow seems to be in high demand, so much so that the military doesn't think twice about destroying a city bridge to get at him. Race across the pavement to escape the military forces.

## TIP

When you first enter this level, don't forget to turn and find the small animal at the end of the bridge.



## MISSION 1: BREAK THROUGH THE BESIEGING MILITARY

## POWER-UP:



FLAME RING

## Missions

1. Break through the besieging military!
2. Collect 100 rings!
3. Find the lost Chao!
4. Reach the Goal within 3 minutes 0 seconds!
5. Clear Hard Mode!

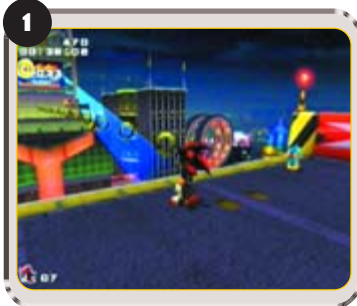

When you have the Air Shoes—found on Dark Stage 9: White Jungle—use the Pulley near the first Chao Container, turn around, and Somersault under the spinning drum. Then Light Dash along the Rings. You'll find Shadow's Flame Ring.

## NOTE

The Flame Ring allows Shadow to bust open Steel Containers by using his Somersault move. You'll need it to find the Switch near the spot where you pick it up.

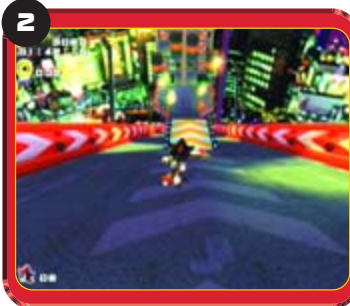

If you miss the Ramp, bust open the Wooden Container to reveal a Spring. Jump on it to be flung onto a Swing Bar. It's less risky than jumping up the Elevators.

## TIP

When racing against the clock (in Mission 4) you'll want to hit that Ramp to grab the Swing Bar. It takes far less time than messing around with the Springs.



Push forward on the analog thumb pad to make sure you don't fall into the void after grabbing the Rocket. Don't just hold it forward, though. If you want the 20 rings hanging in midair, push it slightly and let Shadow fall through the Item Box.

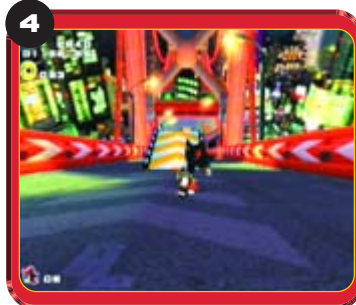

The Ramps here will help you. The first one, if you hit it fast enough, flings you onto the Spring set into a girder. The second flips you to the Swing Bar. If you miss both Ramps, smash the Wooden Containers to find a Spring that will get you to the Swing Bar.

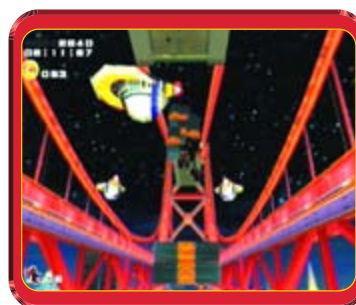

If you miss everything and hurl yourself into the empty space in front of the Ramps, don't despair; the updrafts keep you afloat, and you can push yourself forward. It takes a long time and there are enemies in your way, so try to take the upper route.

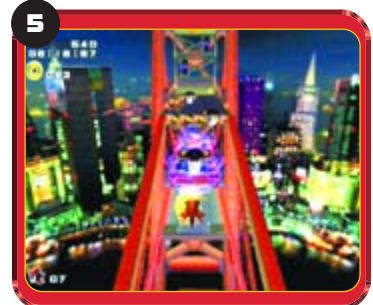

When you reach the top of these Elevators, Spark Beetles wait for you. This model has an electric field. Wait until the field drops *and* the platform you're on is near its peak, then use your Homing Attack to smash across them.



Slide down the suspension cable to Shadow's right. Crouch as you go down and then jump right at the end. You'll pick up an Extra Life as you shoot over to the next bridge section.



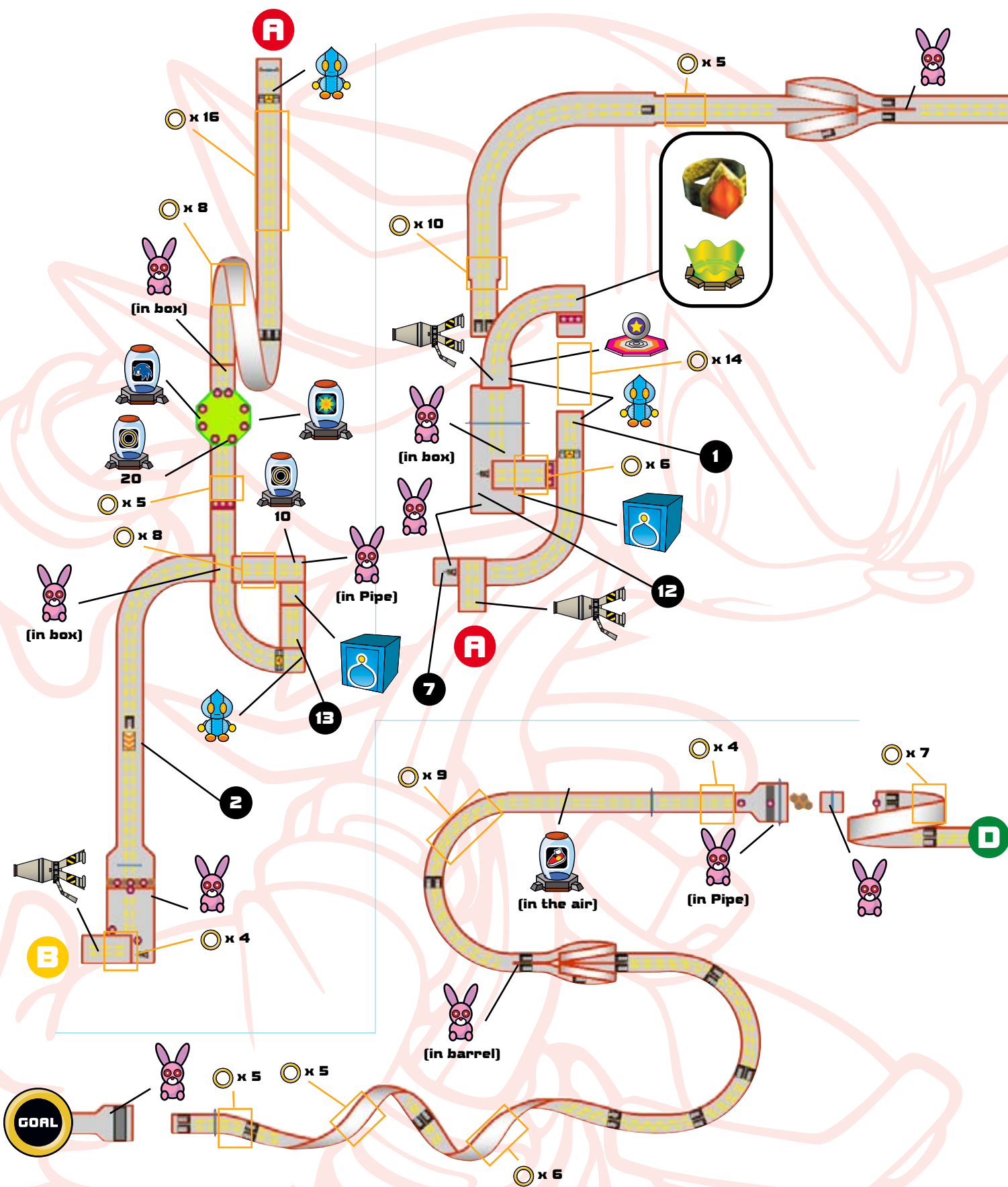

# DARK STAGE 4: SHADOW



primagames.com

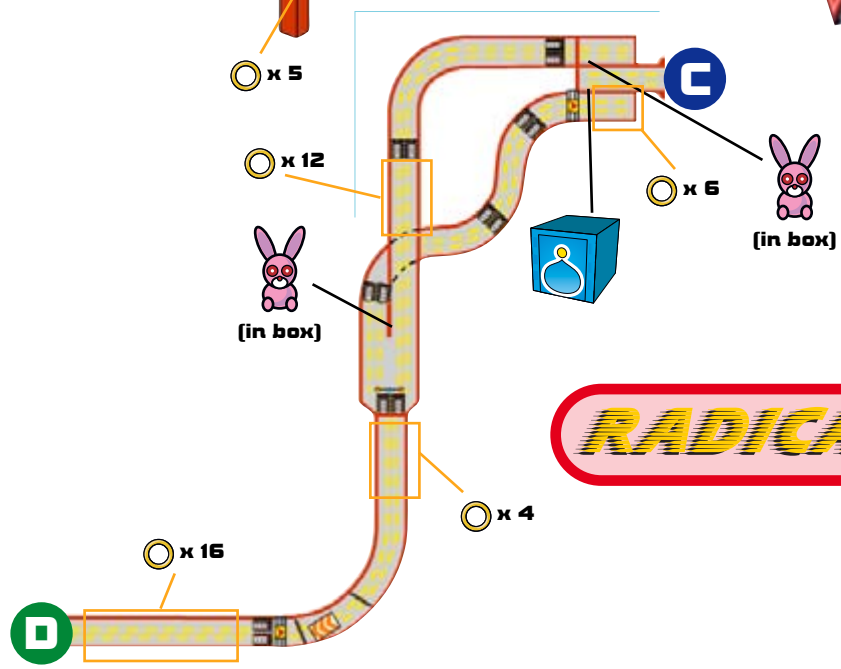
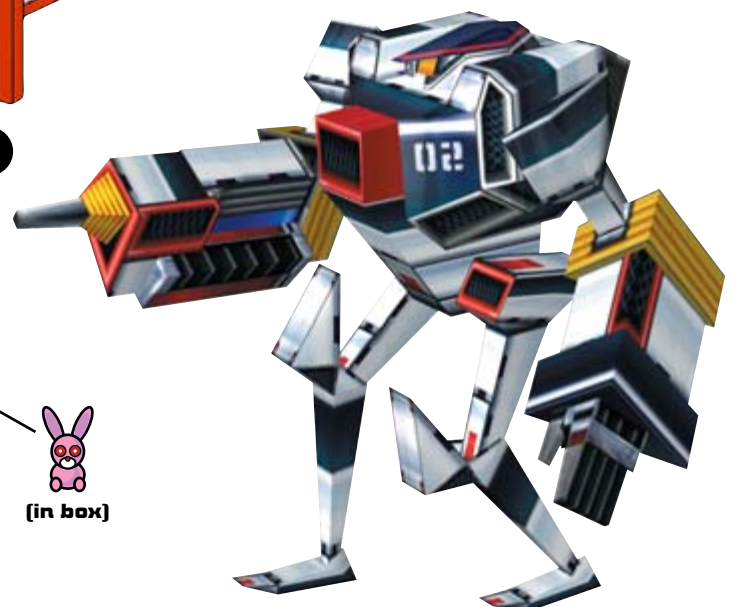
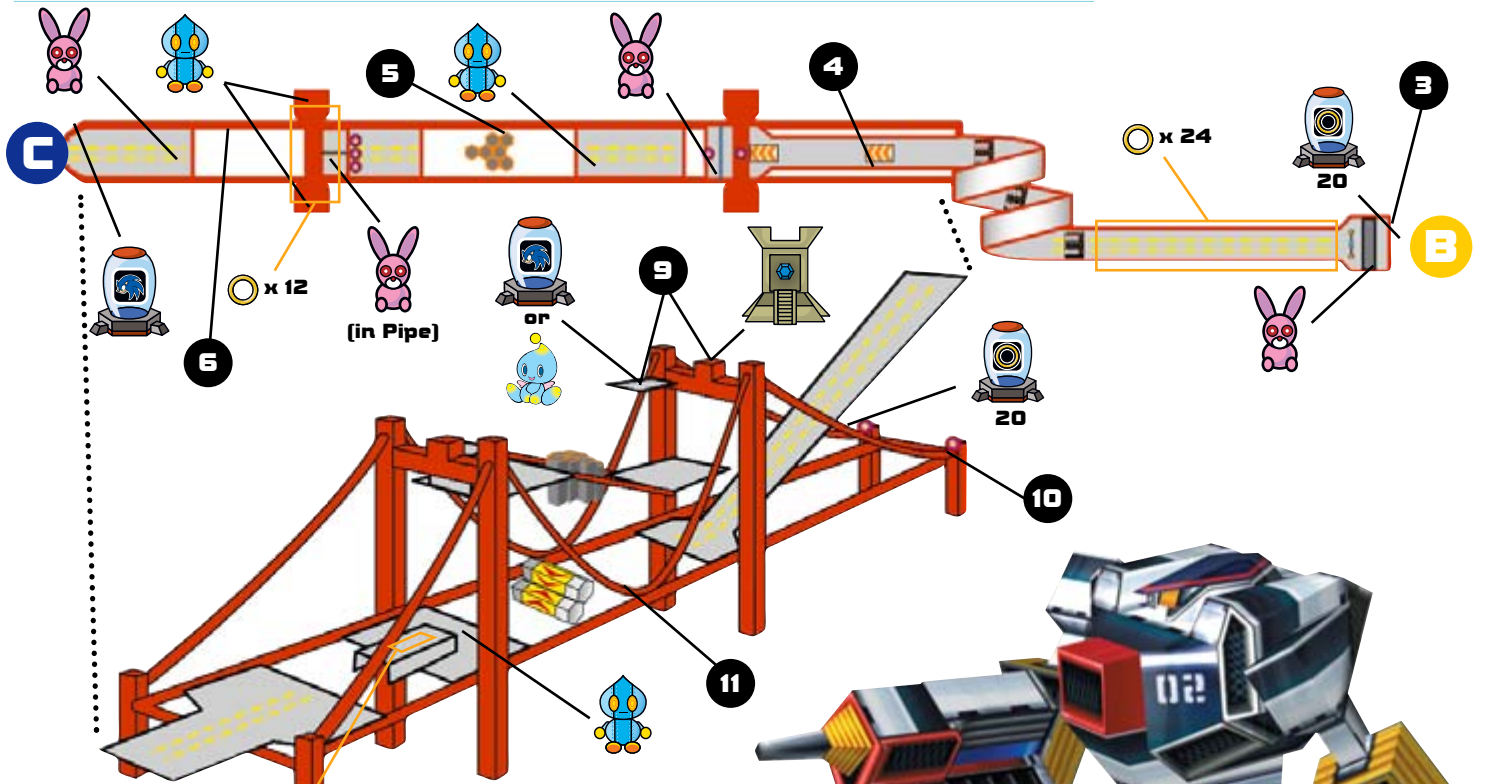
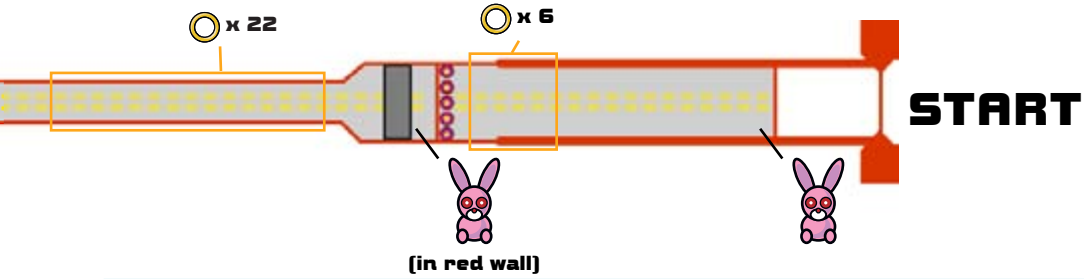

## RADICAL HIGHWAY



## MISSION 2: COLLECT 100 RINGS

It isn't too difficult to find 100 rings in this Stage. The problem is that robots drop out of the sky, usually when Shadow is running fast and can't stop or turn quickly. Learn where the robots drop on you.

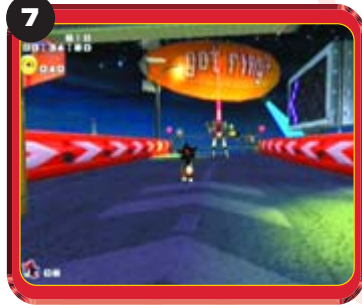

Here's the first surprise. Be ready for it, or you'll lose all the rings you've collected.



## MISSION 3: FIND THE LOST CHAO

You need Shadow's Mystic Melody—found in Dark Stage 14: Final Chase—to find the Chao in this Stage. You'll also need a steady hand to catch a grind on a bridge's suspension cable.

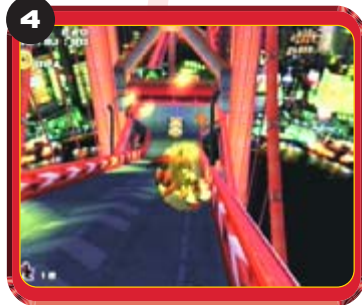

Stop here, next to the Ramp, and jump over the side. Yes, really. Aim at the large suspension cable and land on it.



You'll slide down the cable and hit a Spring. It will shoot you back up to the top of the bridge. Push forward on the analog thumb pad to land on the support strut. Then find the Ancient Ruin here.

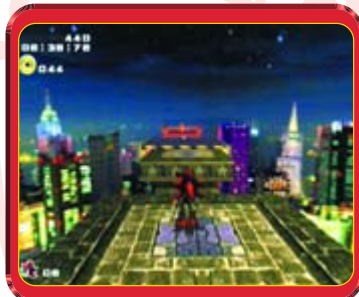

Play your Mystic Melody and platforms will appear. Hop up them to find your lost Chao.

## MISSION 4: REACH THE GOAL WITHIN 3 MINUTES 0 SECONDS

Running Radical Highway in three minutes is a tough operation. However, there is a major shortcut if you can manage to hit it. Remember that you're racing against time for this mission, not against robots. So, don't bother smashing the enemies that aren't directly in your way. Also, use Light Dash along lines of rings to shave a second or two.



You've already gotten the Chao, so you know about the Spring on the suspension cable. Use it to fling Shadow up to the support beam.

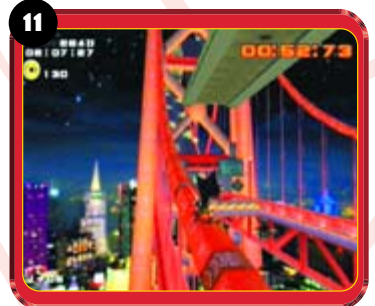

Then jump onto the next cable and use **B** to crouch and speed along to the next support beam. Doing this cuts several seconds off your time...if you land on the cables.

## MISSION 5: CLEAR HARD MODE

There are changes to the number, type, and placement of enemies, as well as to the design of the bridge itself. After four missions where you face the same patterns, it can be a shock to find so many surprises. Take it slowly and watch out for these things, some of the most drastic and dangerous changes:

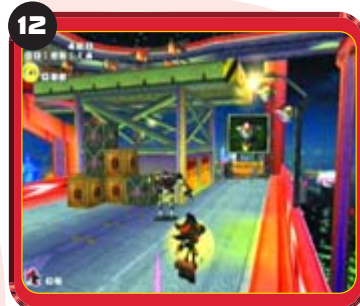

Instead of a Pulley, you'll find a bunch of robots that you can use as a ladder. Use your Homing Attack to smash your way up the line of robots.



Here you'll only see one Spark Beetle. When the shield drops, use your Homing Attack. Other robots will appear as you keep tapping **A** to use the Homing Attack.

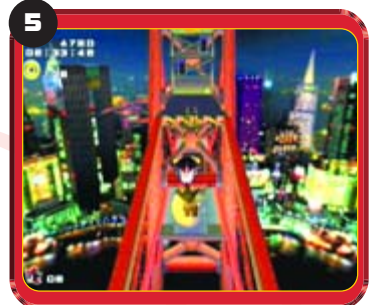

Here you'll find another Spark Beetle. However, behind it are only two rows of rings. To get across, you must use the Homing Attack on the robot and then use Light Dash to run along the rings to safety. Good luck.





# EGG QUARTER

Rouge the Bat is poking around to see what Dr. Eggman is up to. She'll need to find three Gate Keys in order to access the secure areas she seeks. It's up to you to help her get them.

## MISSION 1: FIND THE 3 GATE KEYS

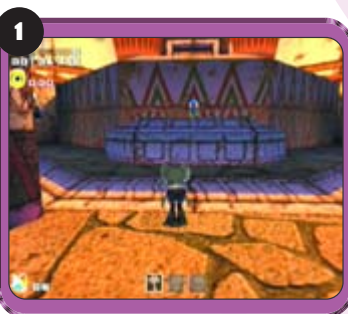

**1** The first Hint Boxes are to the left and right. The first Omochao is directly in front of you. Talk to it to learn some interesting info.



The Beetle robot patrols the Egg Quarters constantly in a clockwise direction. You'll know it is near when green light pulses through the room. Hide in a shadow or out of the robot's line of sight, or you'll be shot.

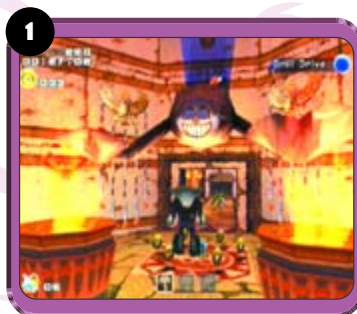

**1** This is the Egg Scorpion Chamber, the room you start in. Hints that refer to scorpions or the color red are referring to this room and the spaces around it.

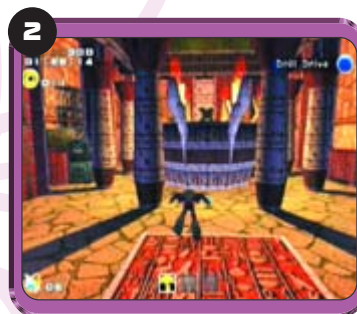

**2** This is the Egg Snake Altar room. Note the eight snake heads in the middle structure. The Ancient Ruin can be found on the Altar.

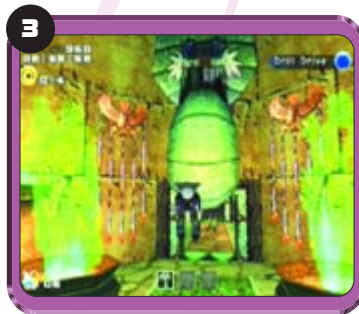

**3** Here is the Egg Snake Chamber. Hints that refer to a single snake or the color green are referring to this room.

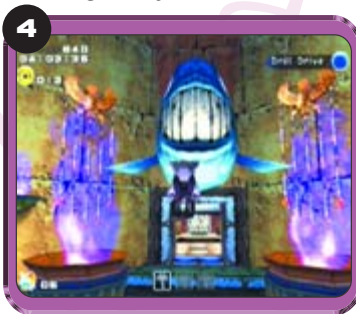

**4** This room is the Egg Fish Chamber. Any hint that speaks of fish or the color blue is referring to this area. There is also a Missile that you should launch to open the next room.

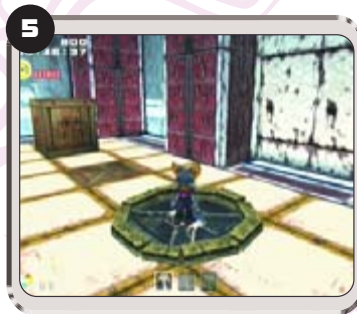

**5** After firing the missile in the Egg Fish Chamber, you can go into the next room and grab the Pick Nails. When Rouge has these, she can Dig in the ground for treasure.



Pay attention to the flames in the rooms. Different colors of fire appear in different areas. Hints often refer to the flames.

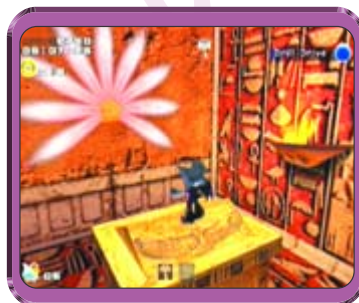

These wall decorations are made with feathers, not flower petals. Knowing this will help you with certain clues.

### Missions

1. Find the 3 Gate Keys!
2. Collect 100 rings!
3. Find the lost Chao!
4. Find the 3 Keys within 3 minutes 0 seconds!
5. Clear Hard Mode!

POWER-UP:



PICK NAILS

## DARK STAGE 5: ROUGE

### MISSION 2: COLLECT 100 RINGS

Not only can you collect 100 rings easily on this Stage, but you can do it really fast if you have the Iron Boots—found in Stage 12: Mad Space. Check the map for the Magnetic Shield near the Egg Fish Chamber. You need the Iron Boots to get it. Then you can just walk around the perimeter of the map and the rings will glide to you. No fuss. Watch out for the Beetle robots that patrol the area and other nasties that would stop you.

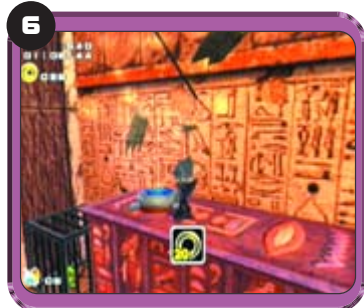

Picking up this container of 20 rings in the Egg Snake Altar room will be a big help. Don't mess with the rings floating above the pillars; there are 100 just lying around that are easier to get.

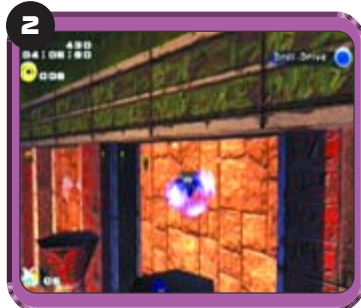

If you have the Magnetic Shield, climb a pillar in the Egg Snake Altar room and Glide around to pick up the rings floating above the Altar.

### MISSION 4: FIND THE 3 KEYS WITHIN 3 MINUTES 0 SECONDS

The Egg Quarter Stage isn't very big, so you shouldn't have too much trouble. Have the map ready and make use of all the Hint Boxes. Travel clockwise, staying ahead of the Beetle robots, and look at the Hint Boxes as you go, starting with the one to Rouge's left when the Mission starts. Staying ahead of the Beetle and using the Hint Boxes will see you through.

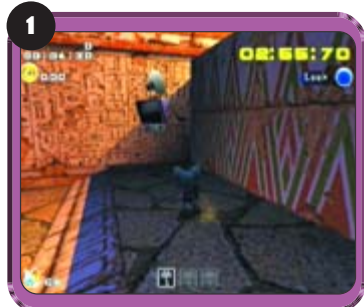

This is the first Hint Screen you should visit. Its clue will be vague, but when you get the third hint, you should be able to figure out where the Gate Key is hidden.



Run past enemies like these robots. There's no time to fight them.



### MISSION 3: FIND THE LOST CHAO

To get the lost Chao, you must have Rouge's Pick Nails found in this stage, Iron Boots found in Stage 12: Mad Space, and Mystic Melody found in Stage 2: Dry Lagoon. When you've got the gear, head for the Egg Snake Altar and play the Mystic Melody next to the Ancient Ruin in the center of the room. Take the Warp Hole that appears.

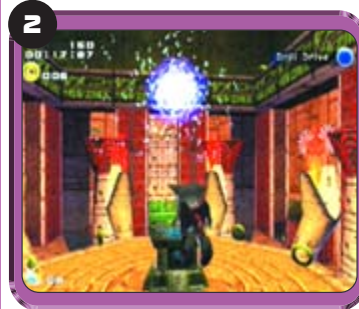

Play the tune by the Ruin and jump into the Warp Hole you generate.

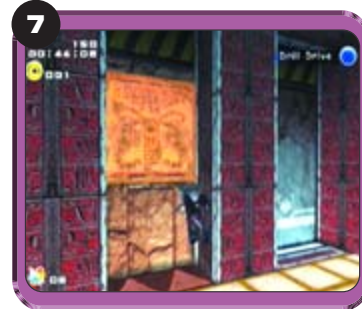

Watch out for the baddies in this chamber. Find this scorpion plate on the wall to the left of where the Warp Hole dropped you off.

#### TIP

Digging into the boxes in the floor can reveal rings and useful items. If you're not pressed for time, explore them.

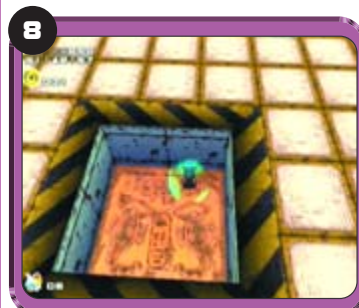

In the next room, Dig into the Steel Container with the Switch under it (check the map for precise location). When you hit it, go to the center of the room and Dig into the scorpion plate on the floor.



You'll end up back where you were, but the Weight trap will have locked in the up position. You can drop into the hole in the center of the room and pick up the little lost Chao.



primagames.com

## MISSION 5: CLEAR HARD MODE

To defeat this mission, you'll need Rouge's Treasure Scope—found in Stage 5: Security Hall. The enemies have become tougher and there are more traps set for your character, but the Gate Keys are always in the same three places.



**10** You need a bomb to get the first Gate Key. Find Kiki and wait for it to toss a round grenade at you. When the grenade bounces to a rest, pick it up before it goes off. Then run away.

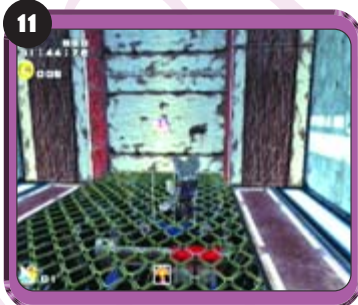

**11** Head back to the cage with the Gate Key inside and put the bomb down on it or next to it. Step back, and when the bomb blows the Gate Key is yours.

**CAUTION**  If a Ghost grabs hold of the bat-lady, Rouge will drop the bomb and get blasted. Avoid the haunting phantoms.



**12** The second Gate Key is here in the Egg Snake Altar room, and you'll need another bomb to get it. Collect one and place it on the top Cage in front of the scorpion picture on the wall. When it blows, Dig into the picture where the Cage used to cover it. Voilà.



**13** Yet another bomb is needed for Gate Key number three. Put on your Sunglasses and then get one from a convenient Kiki. Then head into the Egg Snake Chamber and step onto the Spring that reveals itself.

**TIP**  You must put on the Treasure Scope before you get the bomb so you can use the Spring. There's Kiki way up high in the hall just off the Egg Snake Chamber; get a bomb from it.



When you're up in the alcove, put the bomb down and it will smash the Cages around the third Gate Key. Pick it up and you're done.



# DARK STAGE 6: DR. EGGMAN



primagames.com

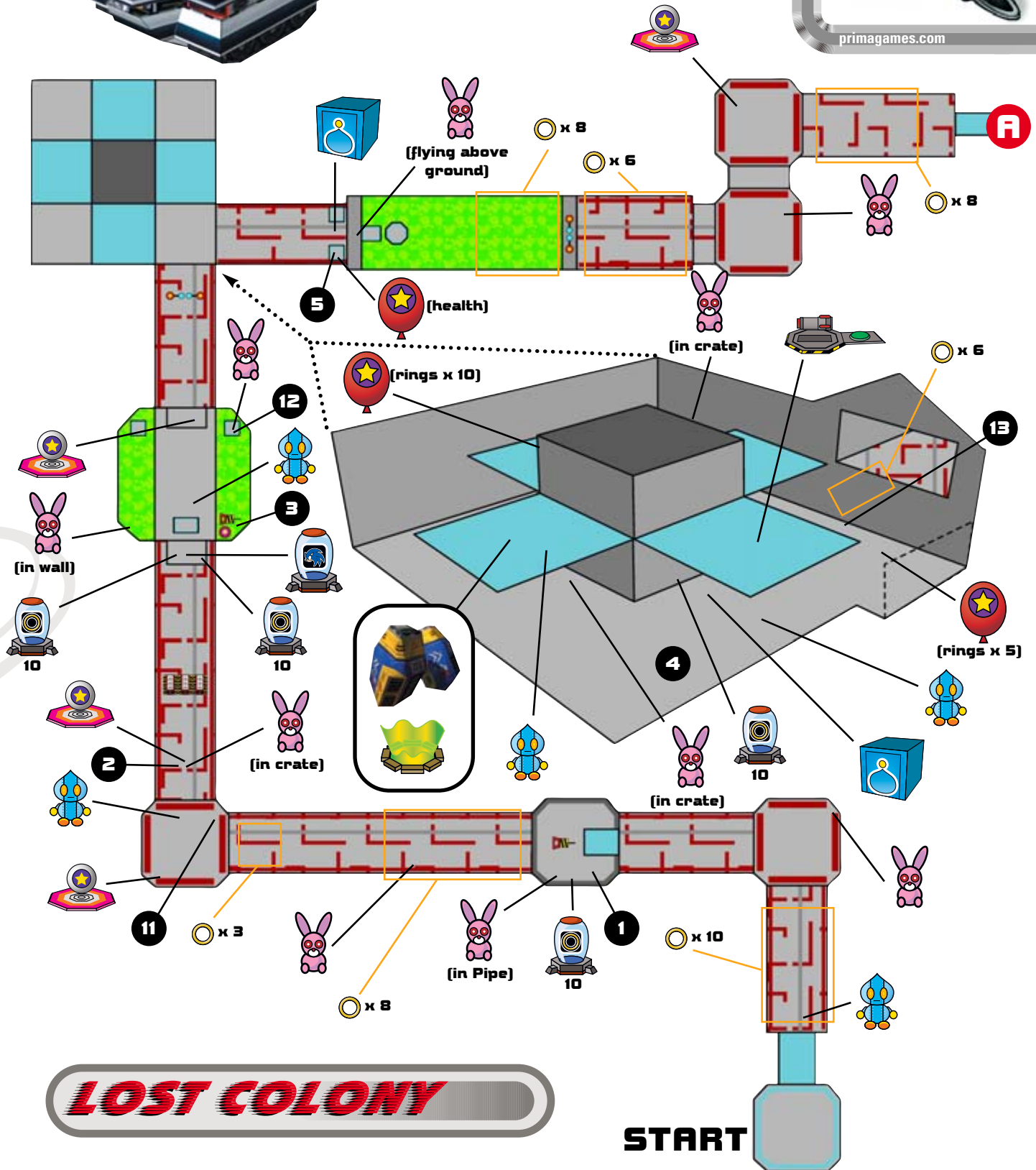

**LOST COLONY**

**START**

# LOST COLONY

This is your first visit to the space colony, ARK. Shadow mentioned something about the central control room somewhere in here. If you can find it, it could be very useful to you.

## Missions

1. Find the way to the colony's core!
2. Collect 100 rings!
3. Find the lost Chao!
4. Reach the goal within 3 minutes 30 seconds!
5. Clear Hard Mode!

**POWER-UP:**



**JET ENGINE**

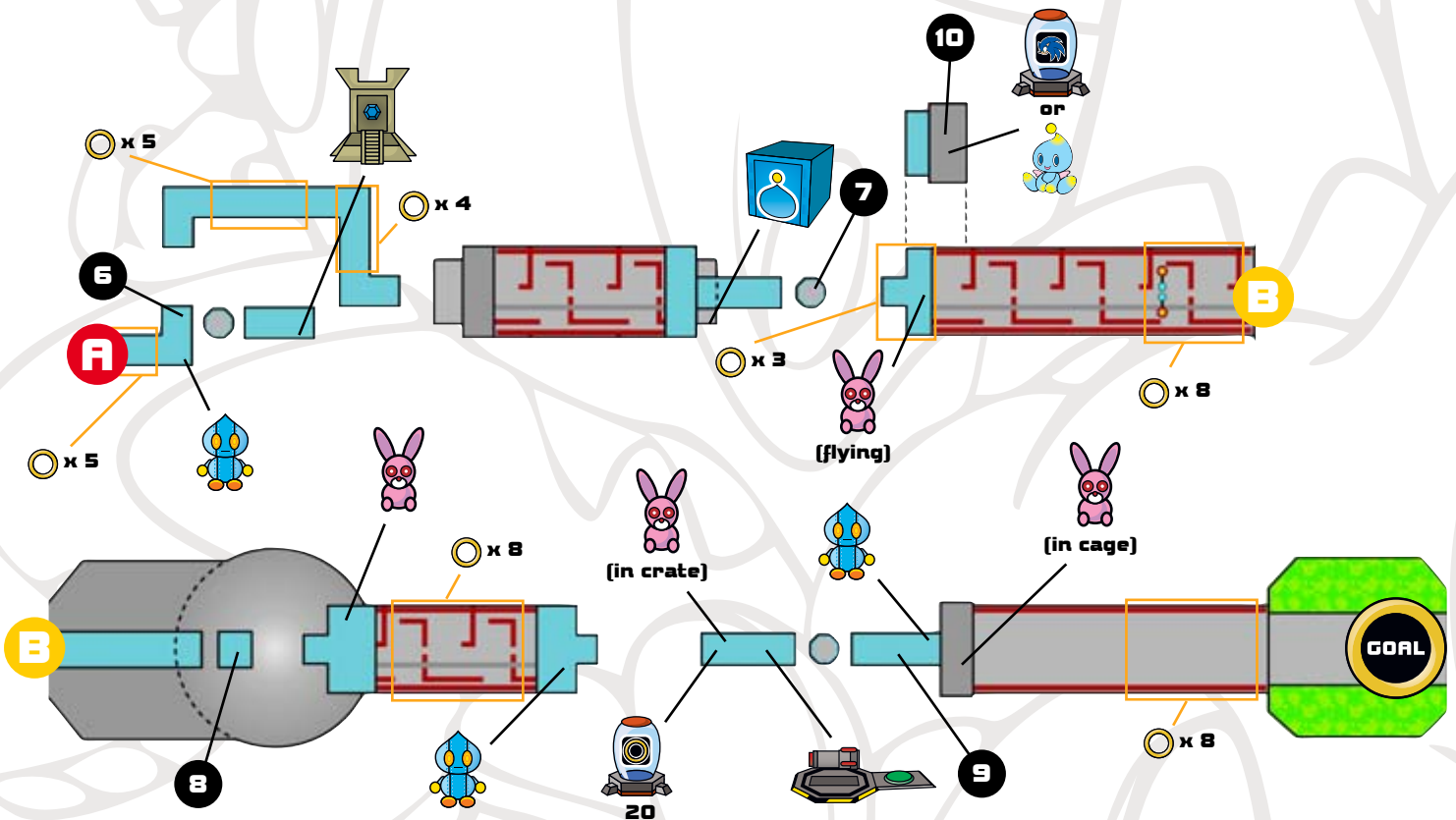

## DARK STAGE 6: DR. EGGMAN



primagames.com

### MISSION 1: FIND THE WAY TO THE COLONY'S CORE



The poor lighting in this place makes it hard to see enemies ahead. But who's afraid of the dark when you have cannons to clear the path? Shooting into the dark lights up the path with explosions and rids you of pesky enemies.



Grab the Pulley and let it lower you. Don't worry about the lasers at the bottom. Unless you want the small animal behind you, you can just move forward and ignore the lasers.

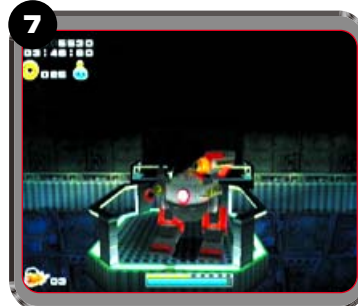

From this platform, jump backward and toward the screen. Don't worry; if you keep on the Hover, you'll land on a ledge where the last Chao Container is.



If you've got the Large Cannon—found in Dark Stage 7: Weapons Bed—you might have destroyed the Steel Containers at 3 to discover a Switch. The Switch opens a room that is accessed by the springpad at 4. Find three Item Boxes with goodies in there.



This room seems to be a dead end. The only thing that seems to be here is a Chao Container; there's no way out. Luckily, you're one resourceful doctor. Use these boxes to climb up here for the Jet Engine. With this, you can now Hover over longer distances than a simple jump allows.



While locked on to this rising platform, you are free to fire all around you without fear of falling. It's a good thing, too, because enemies are all around.



What to do about the Cages in your way? Back up along the ledge until you see that Rocket. Step on the button to bust through them.

### MISSION 2: COLLECT 100 RINGS

Snatch up all the rings you can find. Standard procedure, really. Just don't let the enemies touch you, and this mission will be over before you know it.



Right next to the second Chao Container are two platforms. Destroy the buggers hanging around here and hop on the platform on the right for a little prize at the top.



Make sure you dispose of all the robots in this room before venturing too far off. Though the rings protect you from immediate harm, you can be knocked off if the robots get their mitts on you.



Remember this room? Explore this area, both top and bottom. Don't forget the two strings of rings between the Rocket and the exit door. There are also enemies up high here, so use caution.



As a general rule, firing at everything in your path is a good idea. The exception to this tactic applies to rooms containing these explosives. Once touch from their blasts will send your rings flying.



## MISSION 3: FIND THE LOST CHAO

How did a little Chao get lost in ARK already? We just discovered it! Well, regardless, it's your job to find it. You'll need the Mystic Melody from Dark Stage 3: Sand Ocean.



Make your way to this room and destroy all the enemies to ensure a safe ride. From this point, you can see a floating platform just below. Jump to it, and it takes you to an Ancient Ruin. Play the Mystic Melody to bring out the floating platforms that lead you to an upper level.



Looks like a long jump to that door ahead. It's dark, too. You can't see it from here, but there's a Beetle robot directly in your path. Use the Hover to start your trip to the other side while firing your weapon straight ahead.

### TIP

Even if you hit the robot by accident, keep Hovering. You still may be able to make it across.



Push your way through a few more pesky robots to find your lost Chao.

## MISSION 4: REACH THE GOAL WITHIN 3 MINUTES 30 SECONDS

The pressure is on, Dr. Eggman. You've got to finish this on a tight schedule, so you better get cracking.



Keep pressing the fire button. Destroy everything in sight so that the doors are ready to open when you reach them.

## MISSION 5: CLEAR HARD MODE

If they think they can stop you by simply changing things around and adding a few more enemies, they have another thing coming. Dr. Eggman will not be stopped!



The Pulley here stops midway down, just above a second set of lasers. Grab the Balloon floating between the first and second set.



They've moved the Switch in this room. Destroy the Steel Containers where the old Switch used to be and hop to the top of the pile. The Switch is in the opposite corner, but you can't just jump to it. Follow the string of rings to reach it.



The left platform won't take you up this time. Use the right one. But first, you must uncover the Switch under these boxes to open the door at top.



You can't reach the upper level from the boxes you used before. Use the Cages here to hop on the crates near the exit door.



The catwalks have pieces missing. Be careful where you shoot on this last catwalk. It's rigged with Dynamite packs, so make sure you're not on it when it blows.



Skip the Pulley here and just free-fall to the bottom. Stay close to the wall so the lasers don't get you.



In areas that require Hovering over distances, shoot while you're in the air. Try not to pause to shoot enemies. You should be able to clear most dangerous enemies while continuing forward.

# DARK STAGE 7: DR. EGGMAN



primagames.com

## WEAPONS BED

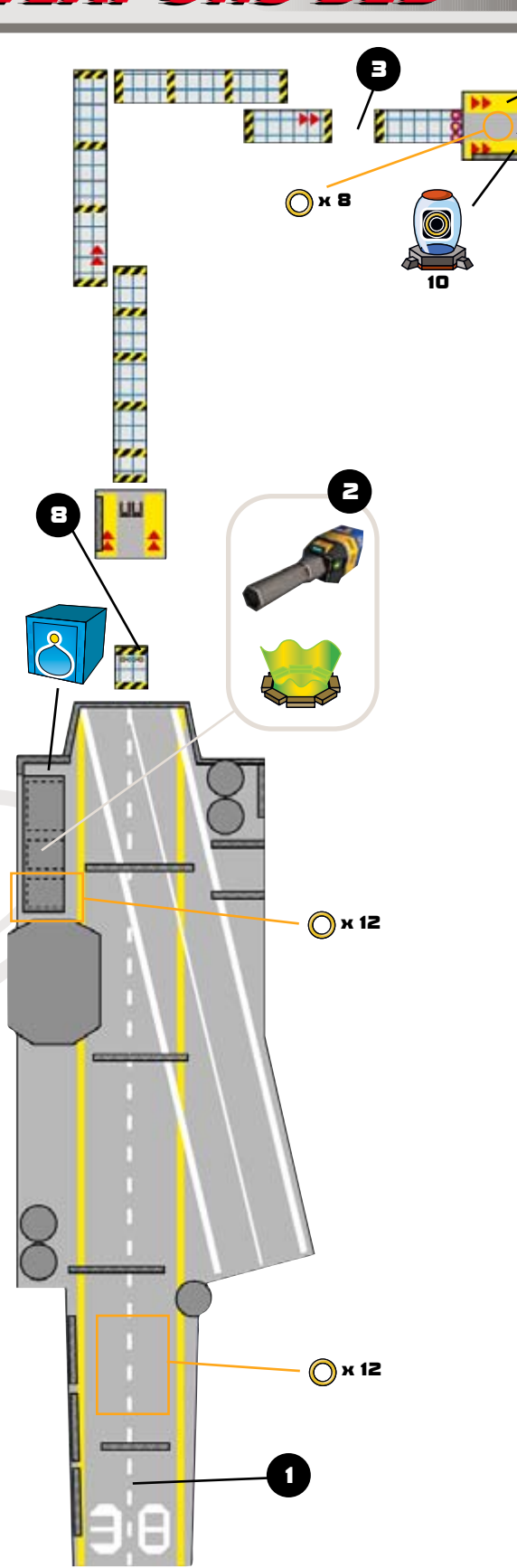

**START**

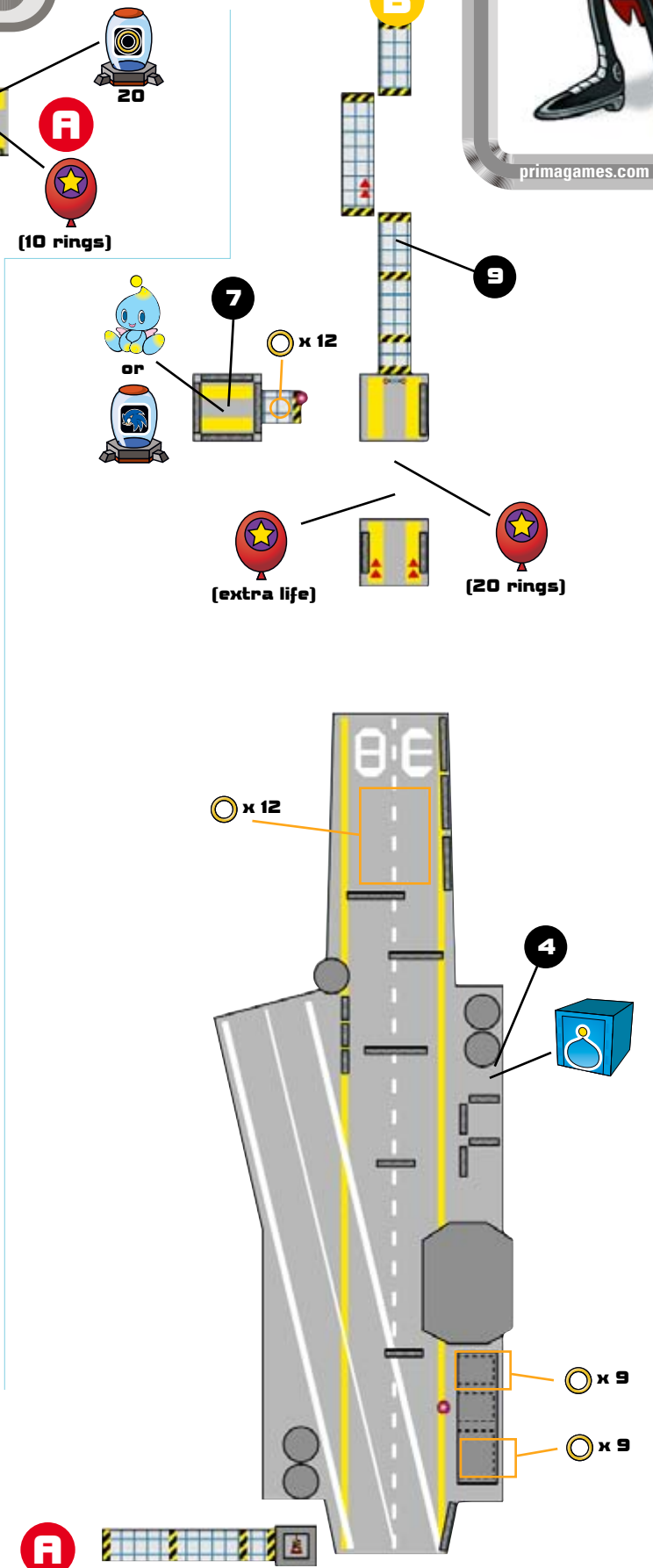

**A**

# WEAPONS BED

As part of the diabolical scheme to rule the world, Dr. Eggman is going to cause a distraction so Rouge can grab the Chaos Emeralds from Prison Island.

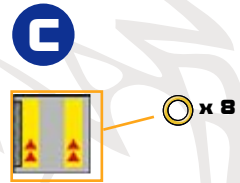
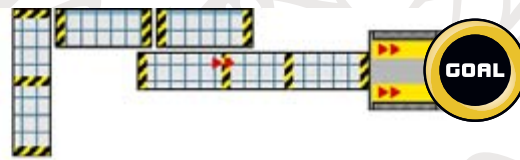

**C**

## Missions

1. Rush into the military base!
2. Collect 100 rings!
3. Find the lost Chao!
4. Reach the Goal within 2 minutes 45 seconds!
5. Clear Hard Mode!

**POWER-UP:**

**LARGE CANNON**



**6**



**5**

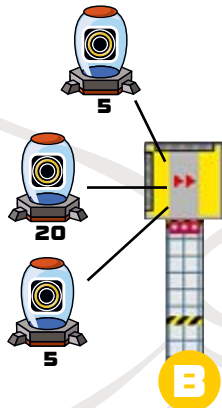

**x 12**

## DARK STAGE 7: DR. EGGMAN



primagames.com

### MISSION 1: RUSH INTO THE MILITARY BASE

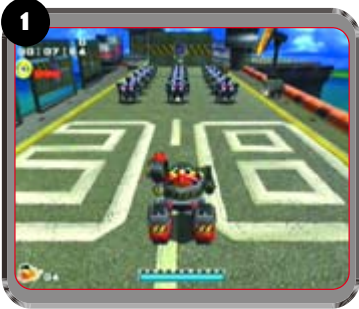

1 Several rows of robots are just chillin' on the ships. Have some fun targeting as many as you can at once.



2 Blast the doors off these storage areas and pick up the Large Cannon. Now you can demolish Steel Containers. Just to the right of the storage areas is the first Chao Container.



3 This metal jerk drops down in front of you when you near the edge. If you're not careful, you'll smack into him as you try to jump the gap. This is just the first of many ambushes the robots spring on you. Take it slow at first; get to know where they'll show up.



4 The second Chao Container is tucked back behind a Tank. You can avoid the spinning spiky balls entirely by ambling along the sides.



5 The Pulley here is part of a trap. If you grab hold, you'll be lifted into the middle of four robots that want to shoot you. Tap your fire button as you spin the analog thumb pad. Tapping ensures that you fire quickly and smash your foes efficiently.

#### TIP

Leap and Hover from the Pulley to the Tank with the Phoenix on it to pick up that rare animal. Drop back down and tag the third Chao Container between the Tanks where you picked up the Phoenix.



#### CAUTION

This whole Stage is full of rapidly firing, Hawk robots that love to ambush unsuspecting Eggmen. Run through this Stage a few times to familiarize yourself with the patterns you must confront.



### MISSION 2: COLLECT 100 RINGS

As usual, collecting 100 rings would be easy if it weren't for those robot morons who keep bothering you. The Weapons Bed Stage is murderous when it comes to hanging onto rings. The robots pop up out of nowhere and fire streams of shots at you. Knowing when they'll show up will help tremendously. Also, tap your fire button instead of holding on and waiting for multiple target locks. This makes it easier to blast enemy shots out of the sky.

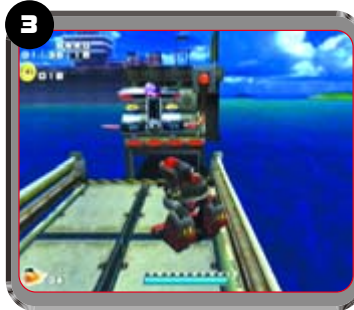

This area can be a problem. Before you smash the Metal Boxes, step to the side and try to target the robot across the way. When it's scrap, make the jump.

### MISSION 3: FIND THE LOST CHAO

Grabbing the little lost Chao is a straightforward matter. You need Robotnik's Mystic Melody—found in Stage 3: Sand Ocean. Go to the third aircraft carrier deck and find the Ruin.



6 Play the Mystic Melody by the Ancient Ruin and jump through the Warp Hole that appears. It'll take you to the Chao area.



7 Grab the lonely little blue guy and you're done.

## MISSION 4: REACH THE GOAL WITHIN 2 MINUTES 45 SECONDS

In a few spots you must fight the robots that come after you, but for the most part you can run on by them in a chaotic dash for the finish. Plus, you can take a few shortcuts that will cut some seconds off your time. The most fun, though, is using long Hover jumps to cover ground without having to stop for anything.



The jump off the first ship's deck can become a long, straight Hover to the paths in the ocean. Just hold **A** and fly as long as you can. Try to Hover for distance whenever you jump from a high point.



This is a favorite shortcut. Don't bother blasting the Steel Containers, just jump over the left rail and Hover to the next path. You avoid taking time to blast the boxes, and you don't have to deal with the foe that comes down to shoot at you.

## MISSION 5: CLEAR HARD MODE

The addition of more enemies and more Metal Boxes are the two hallmarks of this Stage's Hard Mode. There are other differences, but what you need most to succeed in this mission is a quick trigger finger. Keep moving to dodge your opponent's fire. There are more obstacles, too. Pay attention; places that you could normally jump may have been built up to slow you down.

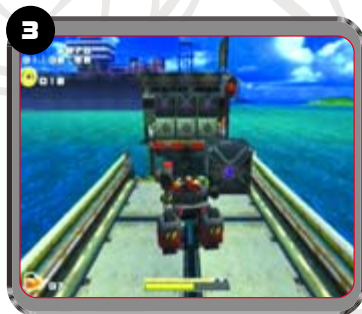

There are a few indestructible boxes added on here. Blast the Steel Containers under them, jump onto the box on your side, and then Hover jump from there across the gap.



Grab the closest Pulley to the left, jump, and Hover to the right to get onto a Pulley there—after you blast the flying robots, of course. Then Hover over to the other Pulley. You avoid the spinning spike balls entirely this way.

## DR. EGGMAN VS TAILS

Amy has stumbled into things again—although what she's doing on an aircraft carrier looking for Sonic is anybody's guess—and Dr. Eggman is ready to make her see the error of her ways. That meddling fox boy Tails, however, busts in on them and challenges the doctor.

### BOSS ATTACKS

Tails has three attacks, but he doesn't use them in any pattern. He will lock on to you with his targeting laser and then fire a Homing Missile. He also uses the Volkan Cannon, which fires single shots. Finally, if you get in close to him, he'll hit you with a Propeller Punch that pops out of the front of his vehicle, the Cyclone.



If you've played the Hero Story, you're familiar with the targeting laser and Homing Missile. Run from the blast until it drops away.



The Volkan Cannon fire is hard to see, but if you keep circling Tails, he can't hit you with it. Same with the ram attack; he can only use it if he's right next to you, so keep some distance.



Tails is no match for the evil might of Dr. Eggman. Gloat over your fallen enemy.

You have exactly the same attacks as Tails. So, use your Homing Missiles and Volkan Cannon. A good trick is to fire the Homing Missile to make Tails run. Then adjust and fire the Volkan Cannon into his path.

Also, Tails likes to rush in close to you. Face him and keep pressing **@**. You'll fire at him and, if he gets too close, you should be able to ram him first.

The key is rapid firing. Get the Homing Missile chasing him and then fire away as he runs. If he stops, your Missile will catch up. If he runs, you can tag him with the Volkan Cannon. If he comes in close, bash him with the ram.





## DARK STAGE 8: SECURITY HALL



primagames.com

# SECURITY HALL

Of all the places to look for Chaos Emeralds! The Security Hall is bound to have some formidable obstacles in your search for Emeralds. Find the Emeralds quickly and avoid the dangers.

### Missions

1. Steal the 3 Chaos Emeralds in 5 minutes!
2. Collect 100 rings!
3. Find the lost Chao!
4. Collect the Chaos Emeralds in 3 minutes 30 seconds!
5. Clear Hard Mode!

#### POWER-UP:



TREASURE SCOPE

#### NOTE

There are three levels of Safes, each color-coded by height. The ground floor is red, the middle level is yellow, and the very top level is blue.



## MISSION 1: STEAL THE 3 CHAOS EMERALDS IN 5 MINUTES



This Stage is divided into four areas: A, B, C, and the upper level. Everything looks the same around here, so use the letter markings on the floor to identify what area you're in.

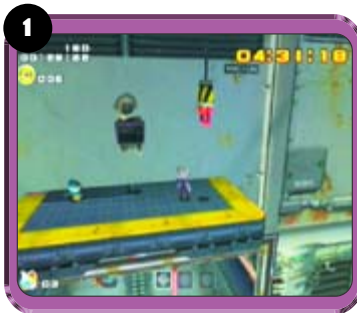

To go to the upper level, grab on to the Pulley on the high ledge in B.



Have you found the Treasure Scope yet? Play the Mystic Melody near the Ancient Ruin and watch as platforms appear before your very eyes. You need the Iron Boots found in Dark Stage 12: Mad Space to break through those Steel Containers.



Safes like this one are no match for a shifty bat like you. Position yourself over the blinking "G" and Dig. The Safes without the "G," however, need to be unlocked first. Use the Switches on the upper level.



Three Switches on the upper level activate the Safes so that you can open them. Each Switch is coded according to the levels of the Safes. The safest way to bypass the lasers for red and yellow is to go along this edge. When you reach the wall, climb it and position yourself over the desired Switch. For the yellow Switch, just climb down and hit it. The lasers won't reach you there.



Air currents prevent you from climbing down to the red Switch. Climb as close as you can before the current takes you, and wait for the laser to pass. When it does, jump off the wall and use the Drill Attack to force yourself down to the Switch.



There is no need to flip the blue Switch because the blue safes start out unlocked. If you still want to play with it, stay on the ground and walk with it, stay on the ground and walk perpendicular to the slanted lasers and duck under them to the side.



The time limit imposed here forces you to be quick with your retrievals. To get to the upper walkways from the bottom level, you can climb the inside walls or find the Rockets and Pulleys scattered about.



## MISSION 2: COLLECT 100 RINGS

The rings in the Security Hall are hard to come by. Keep an eye out and don't pass up any of them. Stay away from enemies.



Grab all the strings of rings you can find. These will be the easiest of your finds.



Don't overlook the different ledges along the walls. They're more dangerous, but they also hold your precious rings.



The Mystic Melody awakens the Ancient Ruin on this ledge. What for? Look behind you. There are now 40 rings floating above the air current! Jump out there and collect as many as you need.

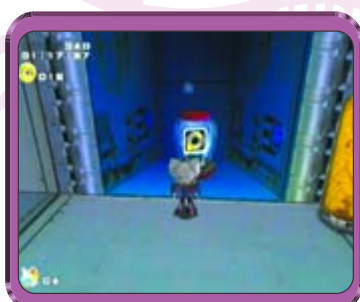

Strapped for rings? Start looking for them in the Safes. The rings like to be protected by lasers.

## MISSION 3: FIND THE LOST CHAO

The Security Hall seems like a pretty safe place, doesn't it? It isn't if you don't belong there. Get the Chao out of there before it cuts itself on the lasers.



Now that you have the Treasure Scope, finding the lost Chao is a matter of putting it on. Put it on here and take the newly found Spring to your friend.

## MISSION 4: COLLECT THE CHAOS EMERALDS IN 3 MINUTES 30 SECONDS

You thought five minutes wasn't enough time? You've only three and a half to work with now. A little luck and a lot of experience is all you need.

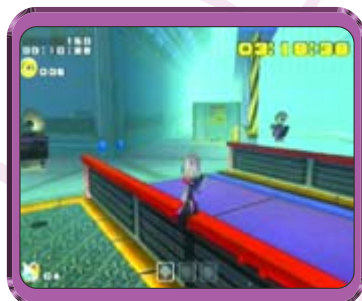

Know where all the Hint Boxes are, or you'll waste a lot of time running around looking for them. The three near the start position should get you going.



The quickest way to the upper level is to use this Spring. It takes you to the Pulley, making it unnecessary to climb any walls.

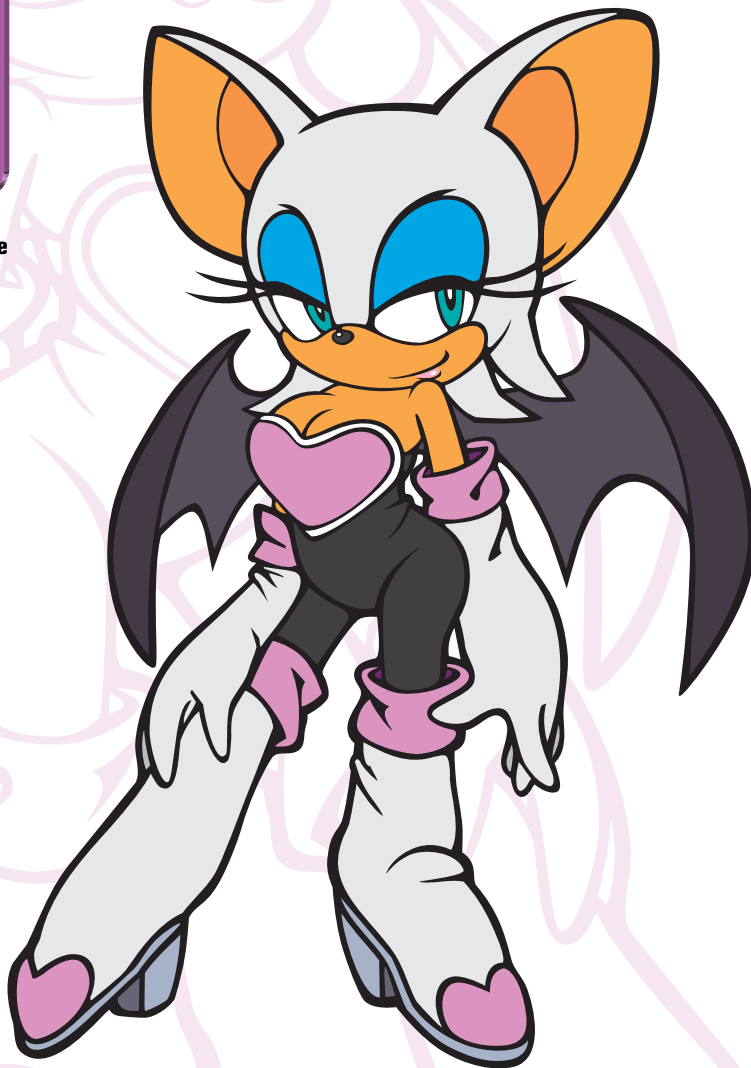

## BOSS: R-1/A FLYING DOG



primagames.com

### MISSION 5: CLEAR HARD MODE

The robots are more aggressive, there are more lasers, and the Emeralds are better hidden. Not to worry; the Treasure Scope you found in this Stage will help you find the Emeralds.

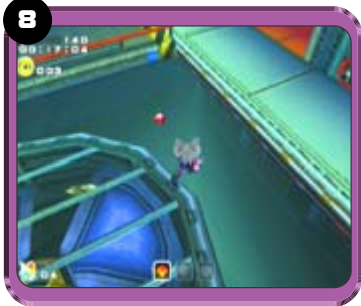

The first Emerald is in the corner of this windy floor. Simply jumping to it won't do. Perform a Drill Attack and grab it.



The second Emerald isn't hard to find; reaching it is the problem. Not only is it protected by a robot, but look at all those lasers!



Don't let the lasers intimidate you. If you Glide through, you can junk the robot and land safely between the lasers. Another little jump puts you directly underneath it.



Have you been practicing your Screw Kick? Spin the analog thumb pad a full 360 degrees and press **B** or **X**. Use it to reach the Chaos Emerald.



While you're up there, activate the red Switch. The last Emerald is in the red safe behind the trap.



To shut off the trap, put on your Treasure Scope on the beam high above. See anything bouncy? Flick the Switch on the ceiling and go back down to collect the Emerald.

## ROUGE VS FLYING DOG

The military has no end to their variety or supply of attack robots, and they've sent out yet another to get Rouge. The little bat-lady isn't going to be taken down by this bucket of bolts, though.

### BOSS ATTACKS

The Flying Dog has three attacks, all of which you've encountered before with Hotshot. So, you're up against machine-gun fire, a targeted energy blast, and Missiles. Unlike Sonic and Shadow, however, Rouge is able to climb the gates on either side of the platform.



You can avoid all the machine-gun fire if you just hang out on the gates. This will not protect you from the other two attacks, however.

When the Stage starts, grab a ring or two and leap onto a gate. Let the Flying Dog circle around shooting its guns. When it stops and fires Missiles, hop off and run for the other gate. Climb up and then Glide off it toward the Flying Dog. When you're over the cockpit, hit **B** to Drill Drive down on it for a hit.



When you're over the cockpit, use the Drill Drive to smash into the Flying Dog. You must hit it five times to get it off your back.

After being hit four times, the Flying Dog abandons the Missiles and uses only the machine gun and the energy blast. You can evade the machine gun as usual by climbing the gate. When you see the red targeting reticle, jump from the gate and Glide over the Flying Dog, Drill Driving into the cockpit.

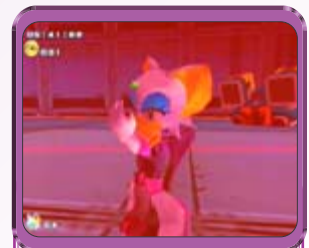

Smash the Flying Dog for the fifth and final time.

**START**

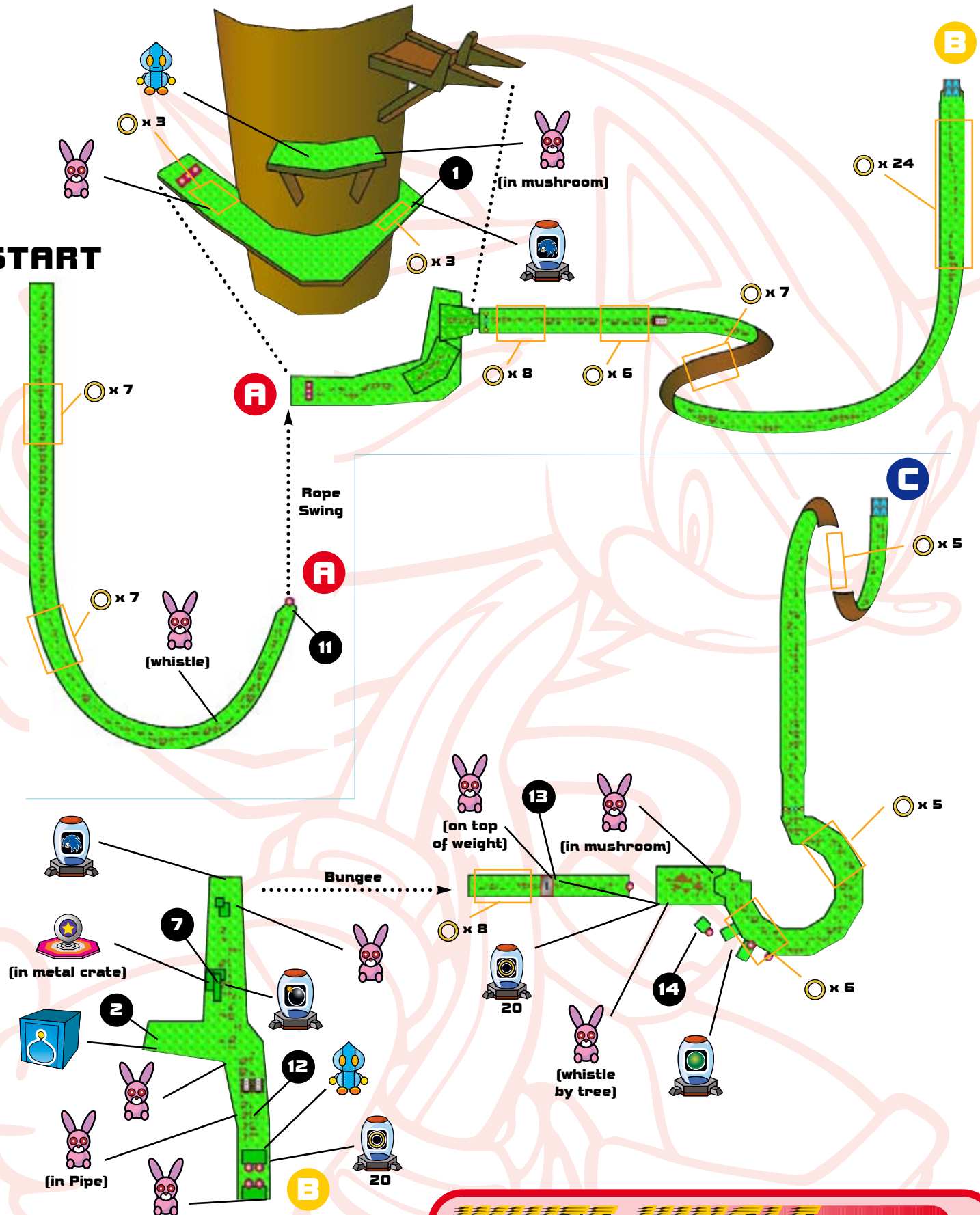

**WHITE JUNGLE**



# WHITE JUNGLE

The distress call from Rouge is a little upsetting. She needs help, Shadow, and you're her only chance. As you have visions of Maria, you realize that you can't let her down.



## Missions

1. Cut through the White Jungle in 10 minutes!
2. Collect 100 rings!
3. Find the lost Chao!
4. Reach the Goal within 3 minutes 0 seconds!
5. Clear Hard Mode!

### POWER-UP:



AIR SHOES

### TIP

To animal collectors: Check under the bright blue mushrooms. They're the small animal's favorite snack.



## MISSION 1: CUT THROUGH THE WHITE JUNGLE IN 10 MINUTES



You can grab the vine here or Somersault under the fence. Beyond the fence are a few robots. Smash the Steel Container ahead of the wooden fence. Grab the farther one, as it skips you ahead a bit to a higher level.



If you're looking for Chao Containers, the first one is beyond these wooden fences to the left. Smash the Steel Container ahead to reveal a Switch that leads to an Extra Life; that is, if you already have the Air Shoes.



Grab the Swing Vine here instead of the loop. It pops you up to a high ledge where there is an Invincibility Shield.



Before you can continue, you need the Air Shoes. Hmm, where could they be? Bust through the Wooden Container here and find out.

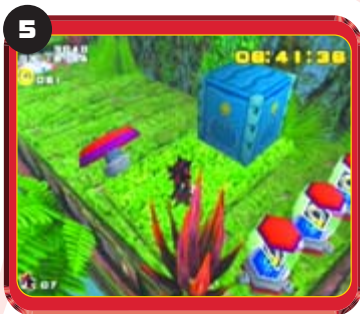

Grab the second Chao Container here and don't forget the ring Item Boxes behind it.



Don't grab this Swing Vine yet if you want the last Chao Container. It sits to the left over here. If you grab the Swing Vine prematurely, it'll send you straight to the Goal.

## MISSION 2: COLLECT 100 RINGS

There are plenty of rings on this Stage. Keep your eyes open for danger, and you'll be there in no time.



Skip the first Swing Vine and use the second one. There are only a few more rings this way, but it cuts down on your time.

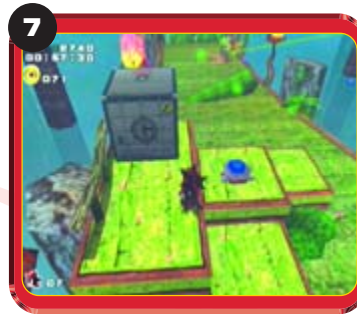

Break open the Steel Container here to call up the rings for some easy money.

### TIP

A hit from an enemy knocks all your rings from you. You can only recover 20, so take your time and avoid them.



## DARK STAGE 9: SHADOW



primagames.com

### MISSION 3: FIND THE LOST CHAO

Chao become lost easily in overgrown jungles like this. There's one in here somewhere.

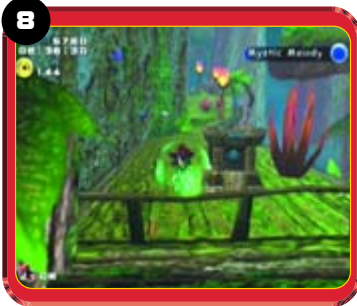

The Ancient Ruin is tucked away along this ledge. Use the Bounce Pad at **5** to reach it. Play your Mystic Melody to awaken the platforms that lead to it.

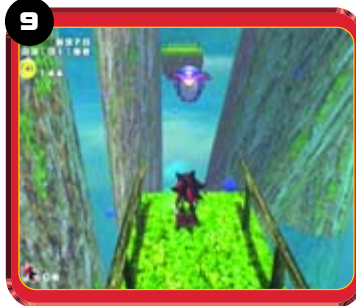

Even if you use your Homing Attack on that Beetle robot, the ledge beyond seems a little too far to reach. It's time for a leap of faith. Jump and attack the robot, and another will appear. And another. And another. The Chao awaits.

#### TIP

You're in a hurry. There is no time to unnecessarily destroy enemies. Be the bigger hedgehog and let them live so that you can make the time.



### MISSION 4: REACH THE GOAL WITHIN 3 MINUTES 0 SECONDS

Who do these people think they're dealing with? Three minutes is plenty of time for a speedy dark hedgehog like you. Show 'em who's boss.



Remember the second Swing Vine? It skips a level and is much quicker.



To avoid the Spark Beetle past the fence here, hop on the rising chunk of dirt. Waiting for the electric shield to shut off wastes valuable time.

### MISSION 5: CLEAR HARD MODE

Now they've gone too far; they've changed the jungle around with no regard for the environment just to make it harder on you. And all these extra enemies can't be good for the air either.

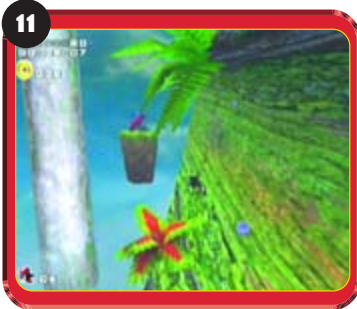

The Spring at the end of this tube is floating in the air now. Get ready to jump and use a Homing Attack, or you'll go right off the edge.

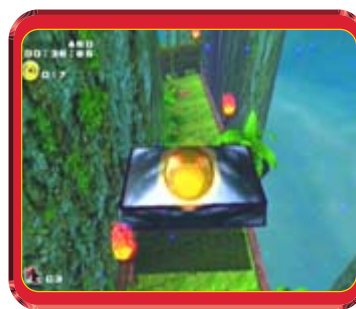

Watch out for these large metal traps. You can usually just cruise right over them.

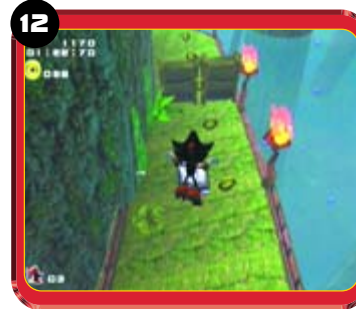

As you drop from above, use the Light Dash on this string of rings to avoid the enemies below.



The Bomb has moved from the open spot here. Break open the Steel Container, flip the Switch, and Light Dash over to the floating platform to find it.



To get through the trap and fence here, step up to the trap and back off. As the trap drops, hop over it and use the Homing Attack on the robot behind it.



The ledges over here are the only way to go. Hop over the robot if you don't want to risk falling off.



Where's the string of rings here? Crack open the box and drop on down. They're making you take the long way now.

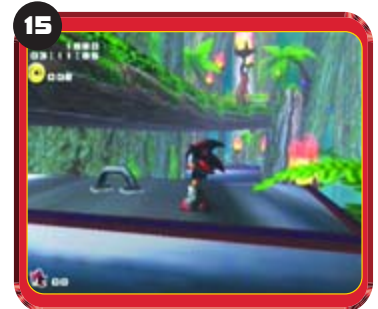

Looks like a dead end over here. The Ancient Ruin just takes you back to these traps. It must be a hint. Hop on one of them to get to the upper level, and the Goal Ring is within sight. **133**

## SHADOW VS SONIC

While wandering peacefully through the forest, Shadow is accosted by the miserable hedgehog, Sonic. The rude blue guy heaps verbal abuse on Shadow. Not being one to back down from a fight, Shadow decides to take on his nemesis.

### BOSS ATTACKS

Sonic has only one attack—the Homing Attack that you know so well. Plus, the little creep picks up rings. Grab four rings at the beginning to keep yourself safe. Sonic doesn't attack very aggressively in this encounter. If you leave him alone, he doesn't do much. However, if you attack and miss—or he blocks you—he will retaliate immediately.



When the blue glow surrounds Sonic as he jumps, he's going to come at you. Hit **A** and you'll be protected from his attack.



Stay in the middle. Even when moving around, you should stay away from the Rails. Pounce on Sonic when his back is turned.

If you're in the middle of a jump when Sonic comes at you, you'll be fine. However, being hit will bounce you around. Try to stay in the middle of the grassy platform, or you risk being knocked off into the water.

You must wait until Sonic has his back to you in order to hit him. Move around until you find the correct angle. Sonic will run around as well and then stop, back turned, for a second. That's when you strike.

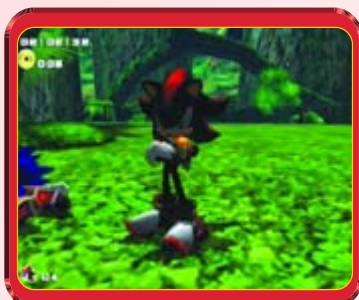

Once you knock Sonic out cold, you can concentrate on other things—like the island blowing up around you.

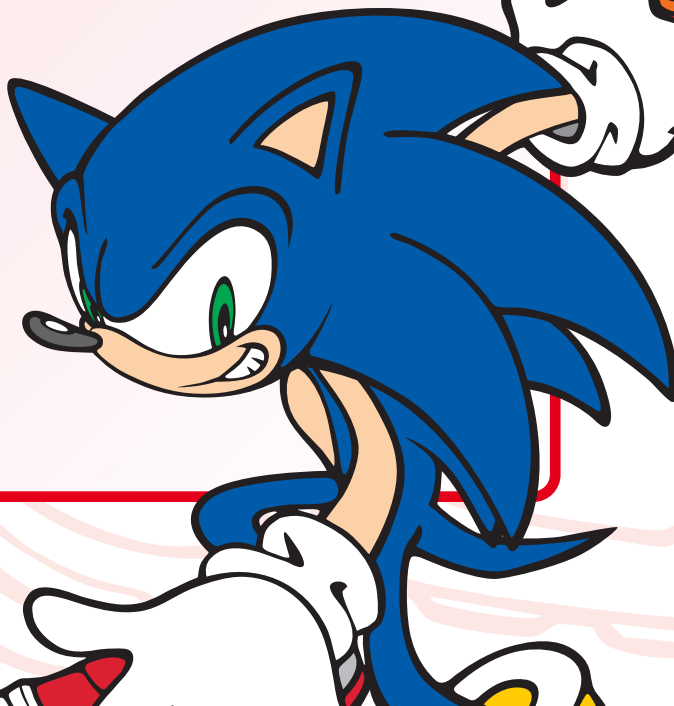

## DARK STAGE 10: ROUGE



primagames.com

### ROUTE 280

Tails has the seventh Chaos Emerald, and the forces of Dark want it. Rouge hops in her roadster and makes tracks after the Tornado, Tails's cool plane.

### MISSION 1: CHASE THE TORNADO

#### TIP

When you get a Boost it will show up in the lower-right corner of the screen. Press to send Rouge speeding along. Try to save Boosts for straightaways, though, or you may end up speeding right into a guard rail.



Right off the bat (heh, heh) you should collect the double row of rings in the center of the road. As a rule, go after rings; you get a Boost for every 20 rings you collect.



This is the first gap you see. This may sound obvious, but we should mention that you don't want to fall into it.



Sections of guard rail are missing, usually on sharp corners. Again, try not to fall off the exposed ledges.



The Balloons in the turnoffs all contain rings. Grab 'em as you need 'em.

#### TIP

Save a Boost for the final straightaway. The extra speed can make up for time you may have lost crashing or scraping along walls.



#### NOTE

As soon as you defeat either this Stage or Tails's Route 101 Stage in Story Mode, you'll unlock the Kart Race option.



### Missions

1. Chase the Tornado!
2. Collect 100 rings!
3. Don't hit other cars!
4. Don't hit the walls!
5. Clear Hard Mode!

### MISSION 2: COLLECT 100 RINGS

The one thing you don't have to worry about on this Stage is losing your rings. Smacking into the walls or other cars doesn't result in an explosion of rings. However, you still must be an accurate enough driver to speed through the lines of gold hoops. Familiarize yourself with the layout of the map and where the rings are. Don't panic if you miss a few here and there; keep plugging away.



The double lines of rings are the meat of this mission. Try to center on them and grab the whole lot.

#### CAUTION

Remember that you don't have to complete the level, just grab 100 Rings. You can ease up a bit on the speed and concentrate on rings. Don't forget, though, that you still must make it to checkpoints to extend your time.





### MISSION 3: DON'T HIT OTHER CARS

Not as hard as it sounds. Really. The other cars weave across the road but aren't out to hit you. The worst areas for crashing are when you reach a sharp curve at the same time as another car. Rouge slides a bit on turns and can easily slam into another vehicle. Let off the gas if you're approaching the turn next to a car. Allow it to go first.



These narrow tunnels can also cause problems. Once again, let the other cars go ahead until you can pass them in a wider space.

### MISSION 4: DON'T HIT THE WALLS

This mission will most likely take several tries. Don't despair; by the time you're able to clear it, you'll be a Kart master. You must rely on slides and time your turns very well. Release **A** and then quickly hold it down again as you turn the analog thumb pad. That should help you corner faster. One other thing: There's a timer that starts at five minutes and counts down. Every time you hit a wall, you are put back at the beginning, but the clock doesn't reset—double jeopardy.



This is a nasty corner. Slow down before you approach it, and then hit the gas when you clear the first edge.

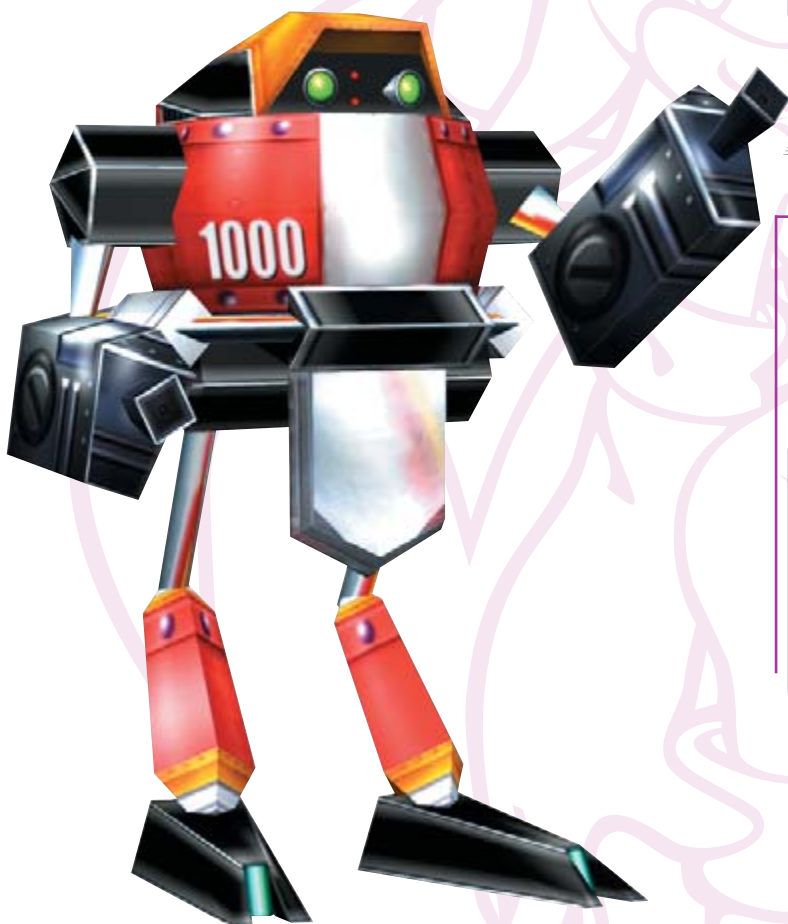

### MISSION 5: CLEAR HARD MODE

The Hard Mode for this Stage is made difficult by taking time away from you. You don't get as much time from the checkpoints, and it takes more time to catch the Tornado at the end. The main cure for these ills is to put the pedal down and keep it there. And don't mess up.



The long stretch at the end is just an endless expanse. Keep hold of a Boost to use on this last straightaway.

## DARK STAGE 11: SHADOW



primagames.com

### SKY RAIL

Rouge kept up with Tails for a time, but now she's passing the torch to Shadow. He needs to speed across this stage to find where the plane ends up.

### Missions

1. Chase the Tornado!
2. Collect 100 rings!
3. Find the lost Chao!
4. Reach the Goal within 2 minutes 0 seconds!
5. Clear Hard Mode!

#### POWER-UP:



ANCIENT LIGHT

#### TIP

The Propeller Pads can be frustrating. Jump and make sure you're directly over them before using the Homing Attack to bounce them up. If you're too far off to a side, you'll end up ricocheting off it and into the void.



## MISSION 1: CHASE THE TORNADO



Don't feel too rushed; you have time to explore. You have two choices: Jump over to the Rocket and skip some stuff, or you can get that Chao Container farther along.

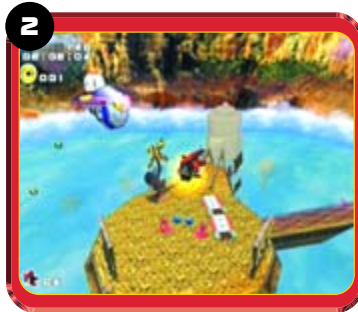

If you skip the Rocket and ride the short Rail, you'll end up next to a Propeller Pad. When it reaches its peak, you'll notice a Spark Beetle. Continue riding the Propeller Pad until you see the field go down, then Homing Attack the robot.

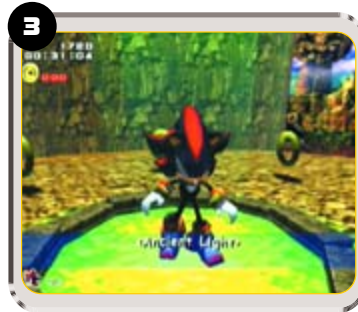

Continue using the Homing Attack to smash along a line of Beetle robots. You'll end up here, right in front of the Ancient Light permanent upgrade. Grab it.

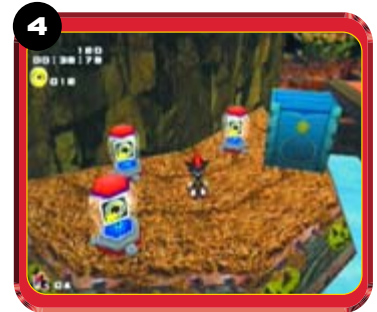

The second Chao Container and 30 rings are on this ledge, down below the area with two Hawk robots and a Propeller Pad. After you've picked it all up, leap to the Propeller Pad and bounce out of there.

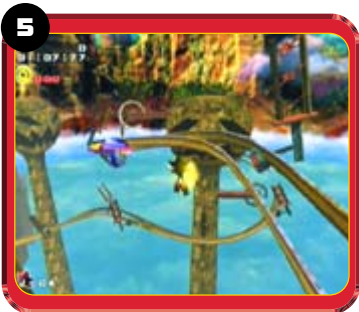

A Beetle robot just hangs out next to this long Rail. Jump and Homing Attack to it, then press **A** again to land on a pumpkin rock.



Use the Spring on the first pumpkin rock and you'll launch to another; press on the analog thumb pad to get a little extra distance. You can pick up a bunch of rings and an Extra Life, but then you must return on the Rail.

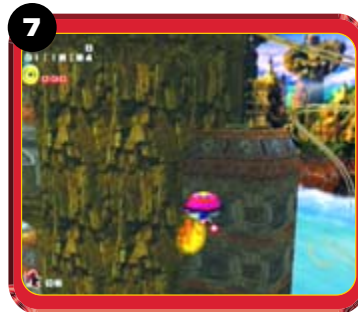

Grind down the right Rail that winds around the pumpkin rocks, then jump at the end. Use a Homing Attack and you'll hit the Spring hanging here. There's a lot of loot on the precarious ledges beyond.



If you don't want to go the Spring route, use the Propeller Pads to the left. Notice the Chao Container to the right.



Don't worry about this gap in the Rails. If you don't touch the analog thumb pad, Shadow will land right on the next Rail.

#### TIP

The camera is not your friend when you jump back to the Rail. It will switch views in midjump, making it very difficult to land on the skinny Rail. You may need to use up that Extra Life you just found.



**SKY RAIL**

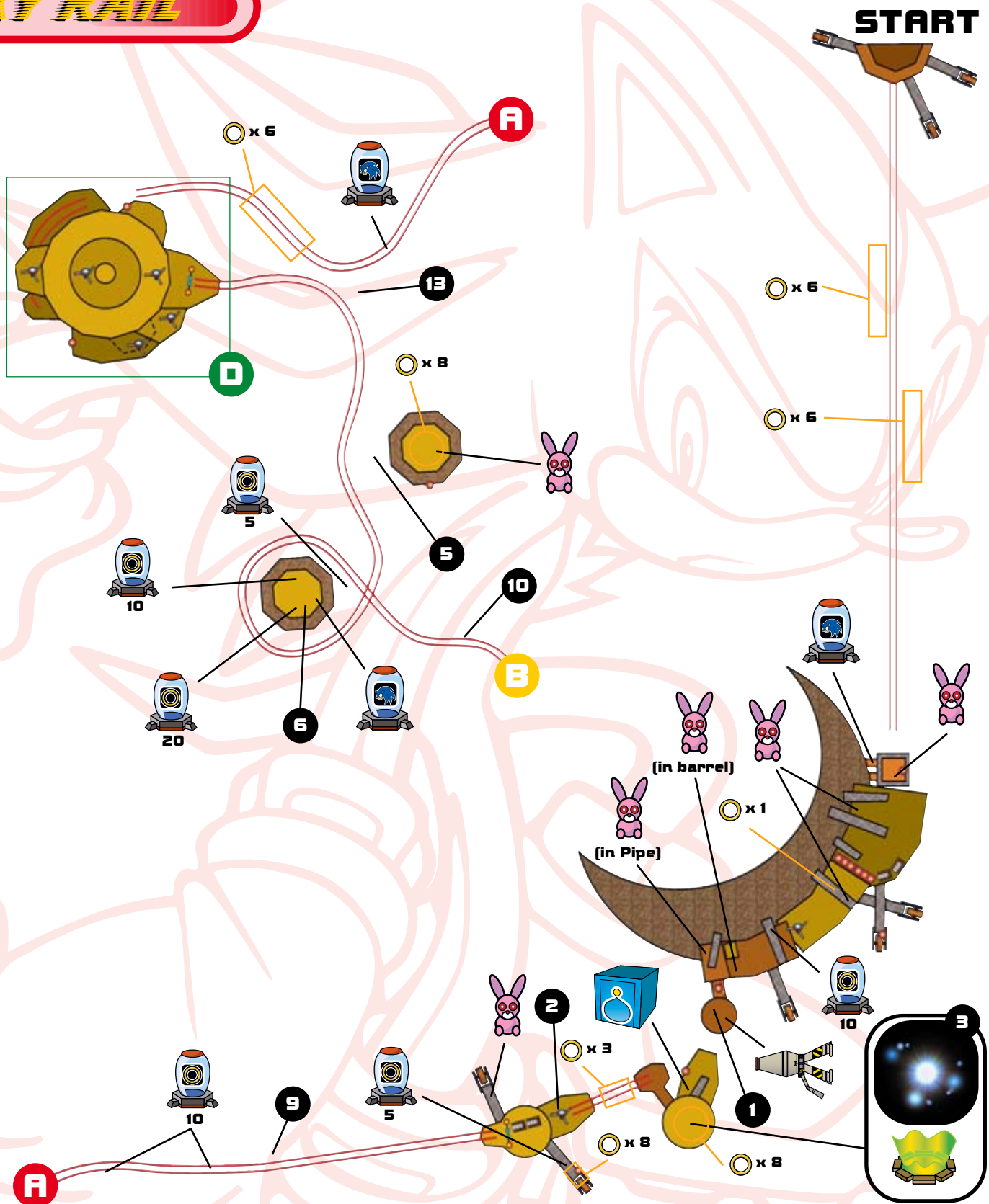

# DARK STAGE 11: SHADOW



primagames.com

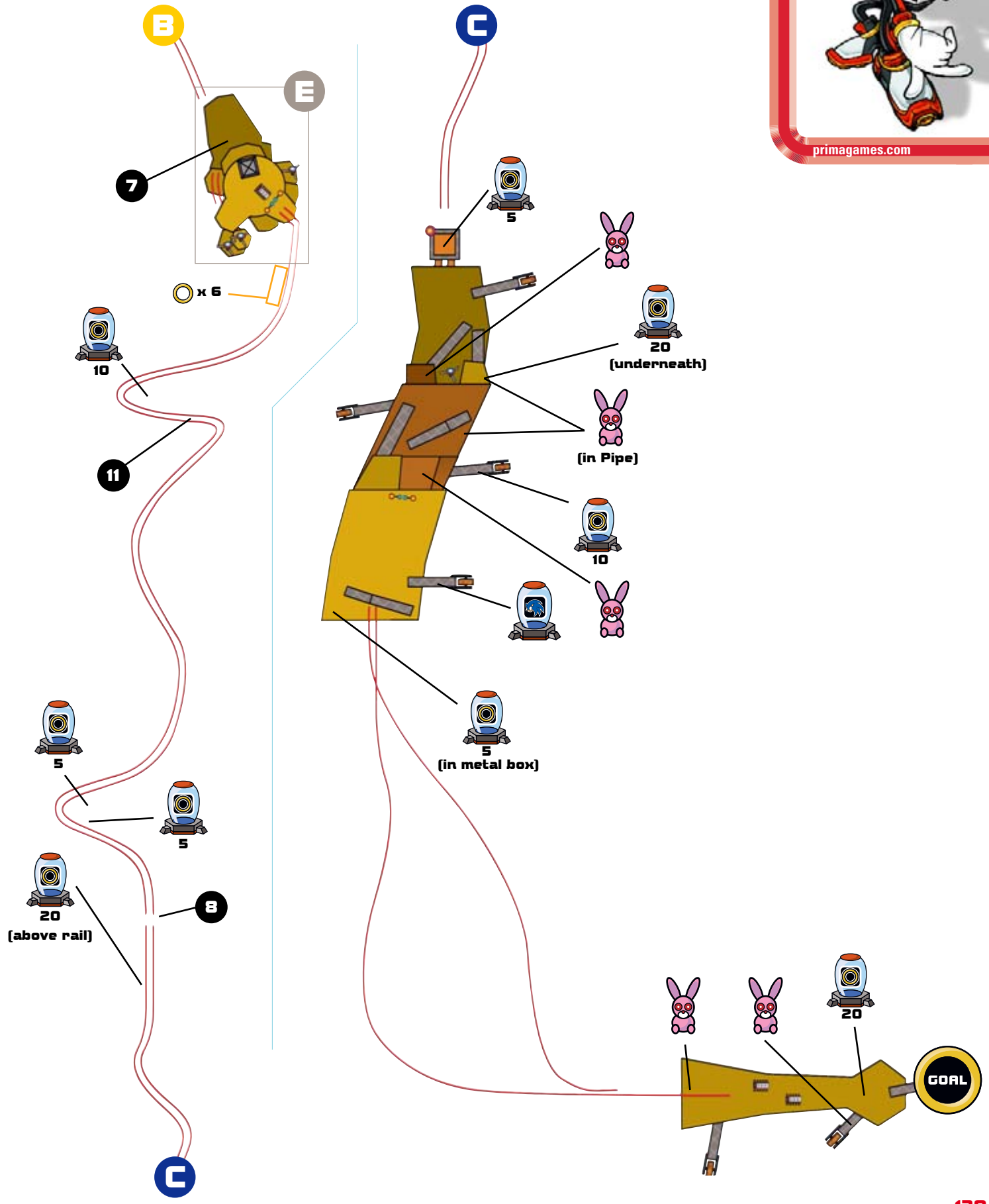

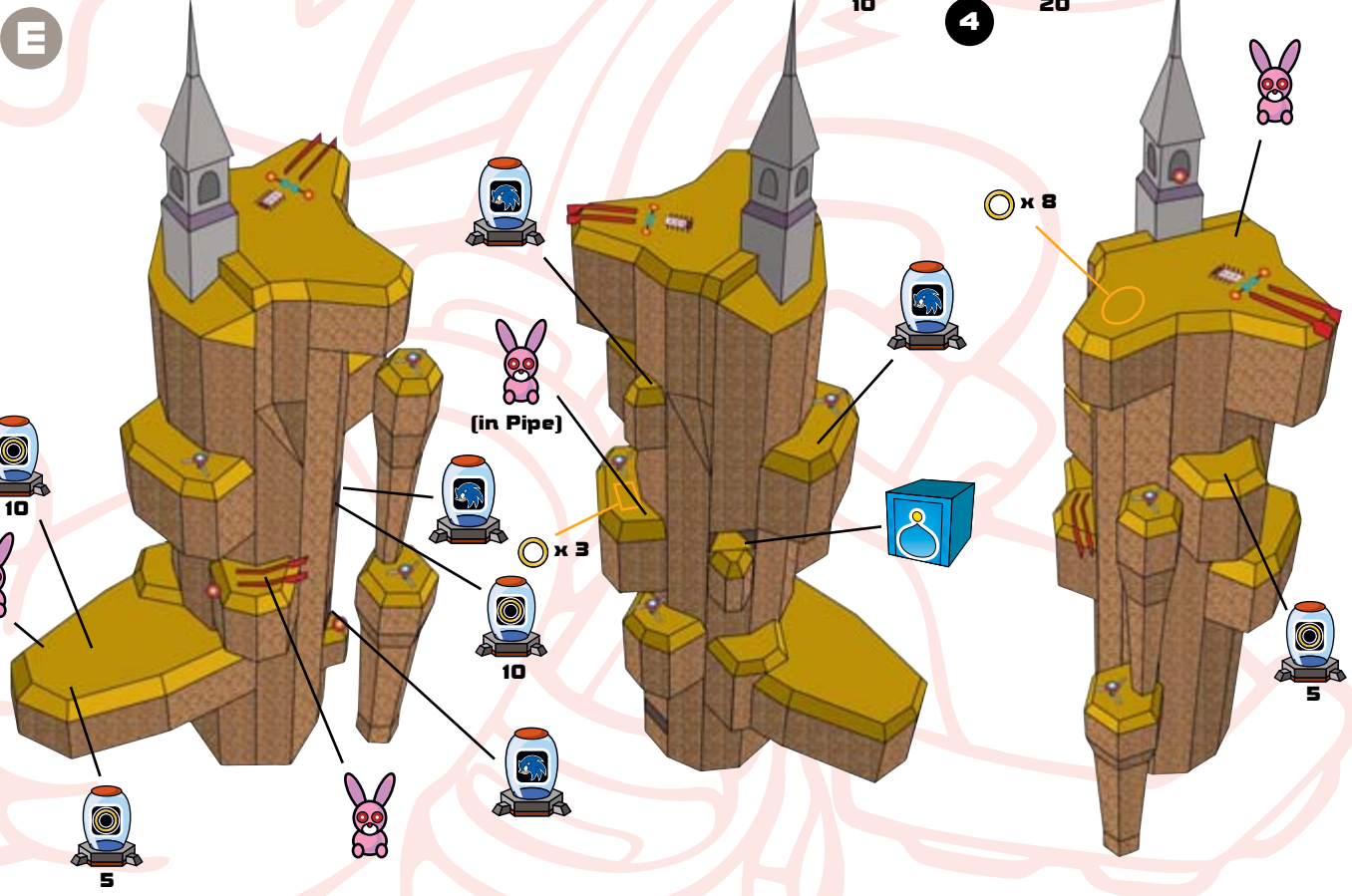
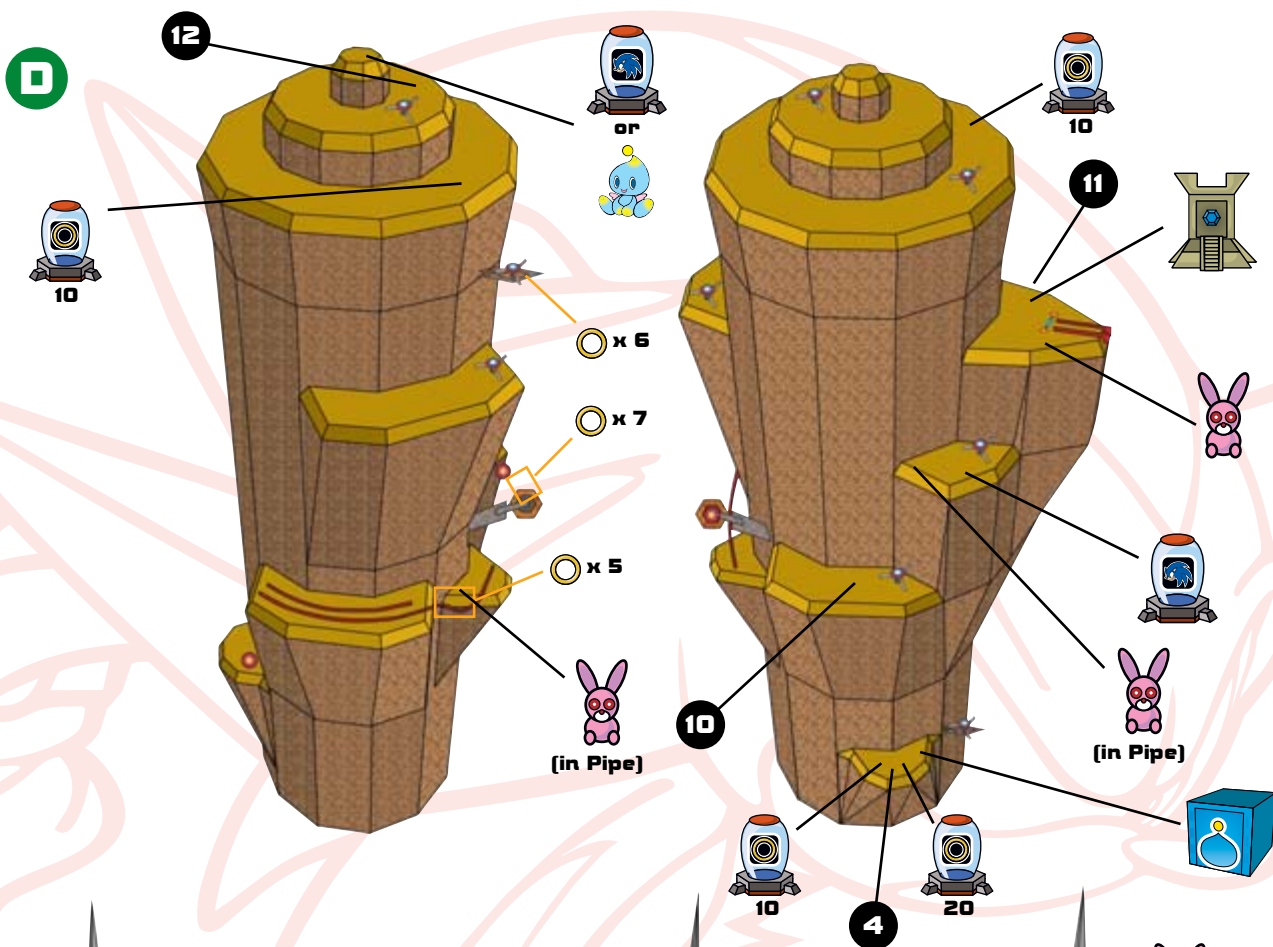

## DARK STAGE 11: SHADOW



primagames.com

### MISSION 2: COLLECT 100 RINGS

This level has a lot of rings in it, but they're in hard-to-reach places. Mostly, you'll find them in Item Boxes throughout the level. Here's a fast way to grab the 100 you need.

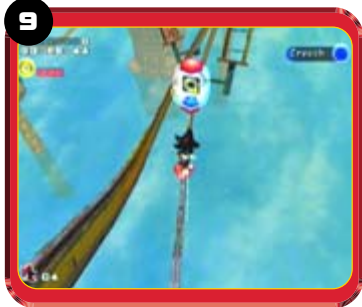

On the first long Rail, take the right Rail first, grab the ring Item Box, switch to the left Rail, and grab the other Item Box and the loose rings on the Rail.



These Hawk robots will fire multiple blasts at you, so be ready. Bust the first one, then jump off the ledge and drop to the Chao Container. Ring Item Boxes are there as well.



After the long Propeller Pad ride back, take the Rail and jump onto the Beetle robot, and then over to the pumpkin rock. Use the Spring there and you'll be able to get over the 100 mark at the other pumpkin rock.

### MISSION 3: FIND THE LOST CHAO

Compared to the hoops you must jump through for the Chao in other Stages, getting the Sky Rail Chao is rather straightforward. The worst part is the high concentration of Unidus and other killer robots that surround the Chao. Be ready to take a few hits.



Play Shadow's Mystic Melody at the Ancient Ruin to reveal a line of rings. Light Dash along the trail, then ride the Propeller Pads up.



It's chaotic up on the mesa. You may get lucky and bounce up to the second tier off a robot, but more likely you'll have to run around to the other side to the Propeller Pad. Ride it up and grab the Chao.

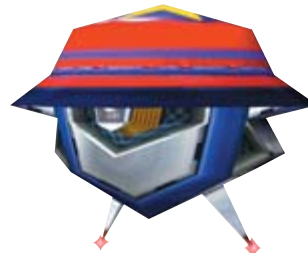

### MISSION 4: REACH THE GOAL WITHIN 2 MINUTES 0 SECONDS

It's entirely possible to bomb through Sky Rail within the time limit, but you can't make any mistakes. Whenever you're on a Rail, press **Ⓢ** to crouch and pick up speed. Ignore enemies that aren't directly in your path. Other than that, just be perfect.

This is the best shortcut; as you're sliding down the first long set of Rails, right before you reach this turn, jump over to the other set of Rails. It takes a steady hand, but if you nail it, you'll save a lot of time.

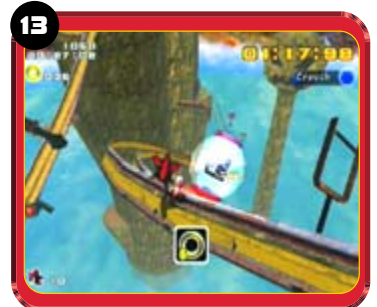

### MISSION 5: CLEAR HARD MODE

This Hard Mode lives up to its name. The additional enemies in unexpected places are nasty because the ledges are so small. Shadow may end up getting pitched off the sides a few times before you succeed.

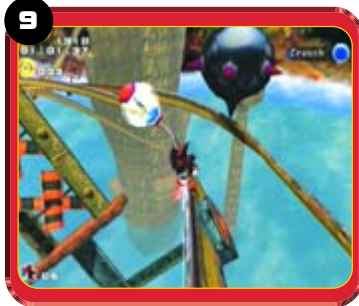

The worst surprise is finding a spiked ball on the Rail. Switch from Rail to Rail to avoid them. The first set of long Rails has a ball on the right Rail and then on the left farther along.

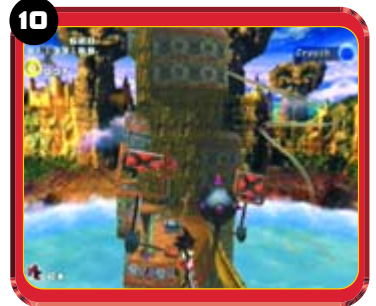

The Rails that run around the pumpkin hills have a ball on the left Rail and then the Right rail. Switch after you pass the first one.



**TIP**  
It's not too hard to drop back onto the Rails. Don't panic; just make small movements on the analog thumb pad and line up Shadow over a Rail.

After the long Propeller Pad ride back, take the Rail and jump onto the Beetle robot, and then over to the pumpkin rock. Use the Spring there and you'll be able to get over the 100 mark at the other pumpkin rock.

## DR. EGGMAN VS EGG GOLEM

Sonic has managed to defeat your Egg Golem. After his head-pounding, the Egg Golem's restraints have been broken and now he's after you! Man, why does this stuff always happen to the bad guys?

### BOSS ATTACKS

The Egg Golem's three different attacks are meant to throw you off. In your heavy walker, your movements are slower than Sonic's, so you must use different tactics to defeat him.



The Egg Golem's most common attack is a single fist slam. During this attack, he slams down one fist, followed by the other. Time your movement so that you are moving toward the first fist after it comes down. The point is to get out of the way of the second fist.

When some of the walkway sections are gone, drop down below to safety. Don't forget to use Hover so you don't fall in the sand. Unlike Sonic, Dr. Eggman can't escape the sand.



Go to one of the Pulleys and let it pull you up. At the top, stay on the Pulley and unleash your cannons at the Golem. It's much safer here than on the catwalk.

From the Pulley, watch for the Golem's next attack. If he pulls a single fist slam, you are safe from the first fist. Continue firing at him until the second fist begins to drop. Time to move, Doc. Jump off the Pulley away from the fist and down toward the sand. Move around to different Pulleys and repeat. Don't forget to collect some goodies down below.



During your attack from the Pulley, the Golem may try a double fist slam. Don't worry; the fists won't hit you. What will hit you is his stony head. After the fists land, jump off the Pulley and move on to the next Pulley.

If you stay off the catwalk, the Egg Golem rarely uses his third attack, a double sweep with his hands. In this attack, he puts his hands along the walkway and sweeps them around twice. You can't clear the hands while in your clunky piece of machinery, so just jump off and find a Pulley.



After breaking through some of the Golem's exterior, some Dynamite is revealed in his chest. Target this with your Homing Missiles and let them fly. This Golem soon learns not to mess with his maker.

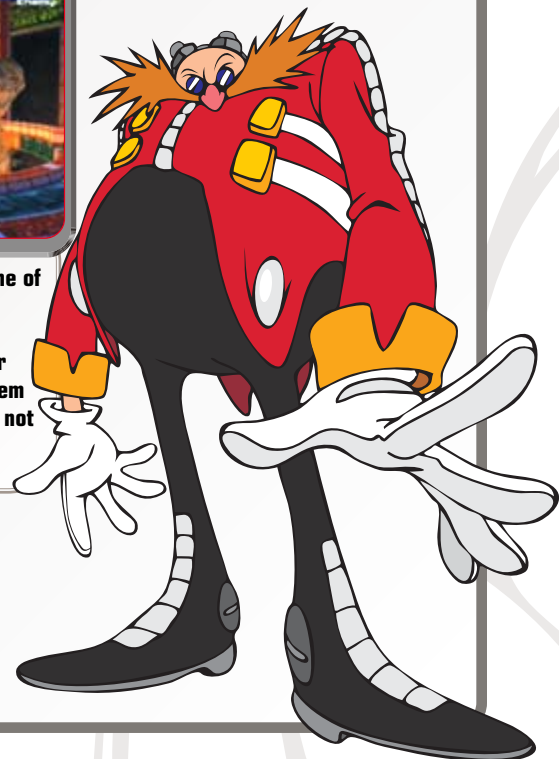

## DARK STAGE 12: ROUGE



primagames.com

### MISSION 1: FIND 3 PIECES OF THE MASTER EMERALD



The first Hint Box and Omochao (as well as a robot) are right in front of you. The hints are either written backward or they are the opposite of the truth. For example, a clue that says "The lowest place" means the highest place, so don't waste time searching low.

#### TIP

Don't overthink the reverse clues. For example, a clue that says "It's not under a moon on a yellow platform near an inverted tower" means that "It is under a moon on a yellow platform near an inverted tower." That's all the reversing you need to do; don't try to reverse every part of the clue.



### MAD SPACE

Rouge snoops around in ARK's computers to find info on Shadow. She's surprised by what she finds, but is lured away by the possibility of finding more Master Emerald pieces.



Rockets are on all three arms of the first platform. Before you acquire the Iron Boots, though, you can reach only one of them.



Become familiar with the three planetoids. This is the "Capsule Planet." You can escape its gravity by walking to a side and jumping.



This planetoid with a dip at the top is the "Holy Planet." Take the Rocket on top of the building to reach the platforms above.

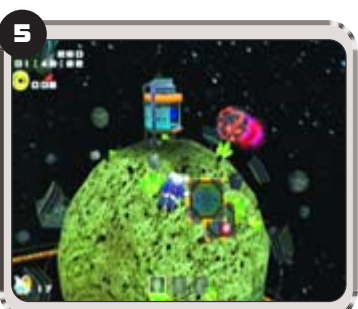

The round planetoid is called the "Spherical Planet." You find the Iron Boots here. They rest in the building.

#### TIP

You can reach any planetoid by falling to it. If you get up to the platforms above the planetoids, step off and use the analog thumb pad to guide Rouge's descent.



Just as in Knuckles's Meteor Herd Stage, star and moon signs are scattered throughout the level. Hints often refer to them.

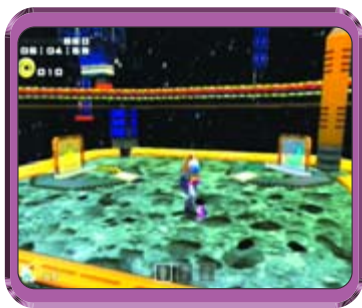

### Missions

1. Find 3 pieces of the Master Emerald!
2. Collect 100 rings!
3. Find the lost Chao!
4. Collect the Emerald pieces in 4 minutes 30 seconds!  
Clear Hard Mode!

#### POWER-UP:



IRON BOOTS

### MISSION 2: COLLECT 100 RINGS

There are enough ring Item Boxes to see you through this Mission. Search through the map for them. We like to clear out the area below the starting platform and then move on to the planetoids. The Capsule Planet has many Item Boxes.



If you go to the platform just below where you start and use the Treasure Scope—found in Stage 8: Security Hall—you can find this 20-ring Item Box.





# MAD SPACE

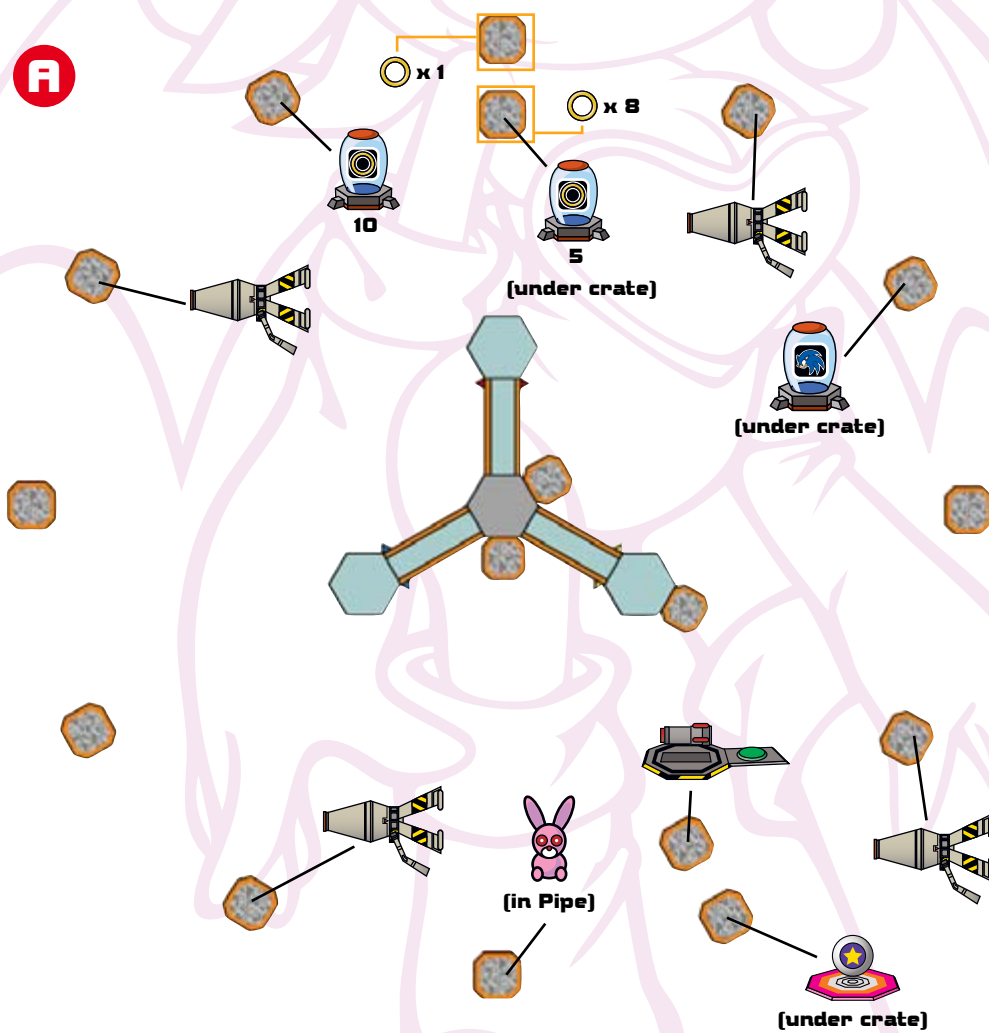
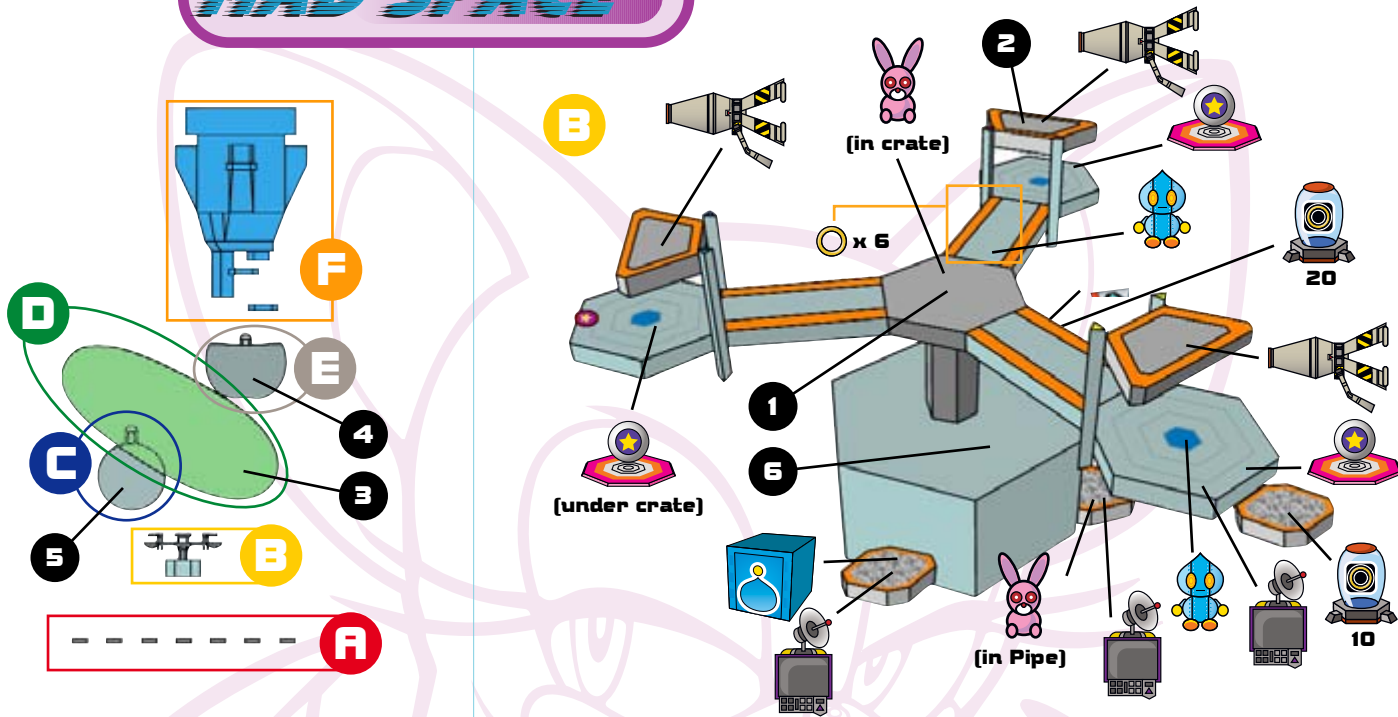

# DARK STAGE 12: ROUGE



primagames.com

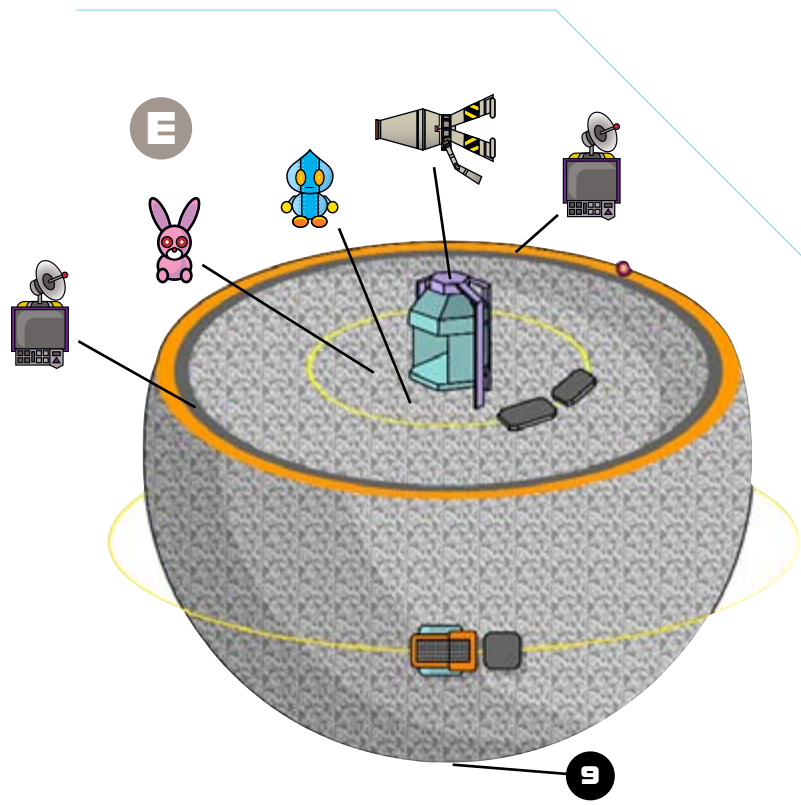
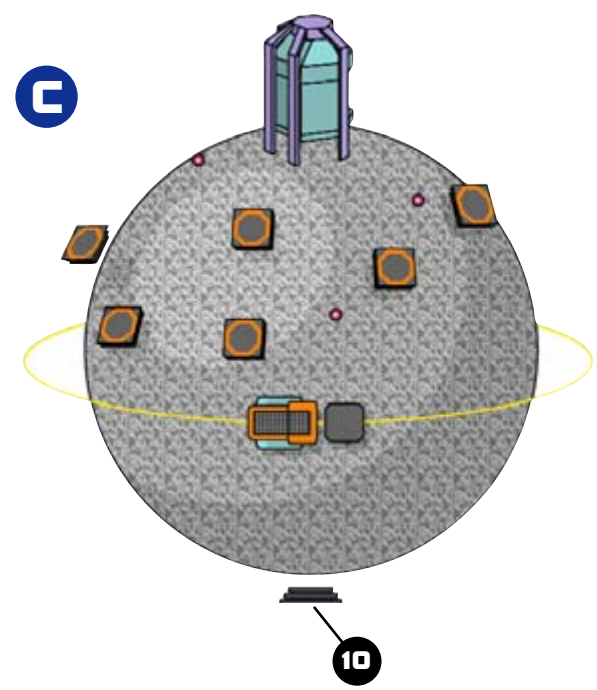
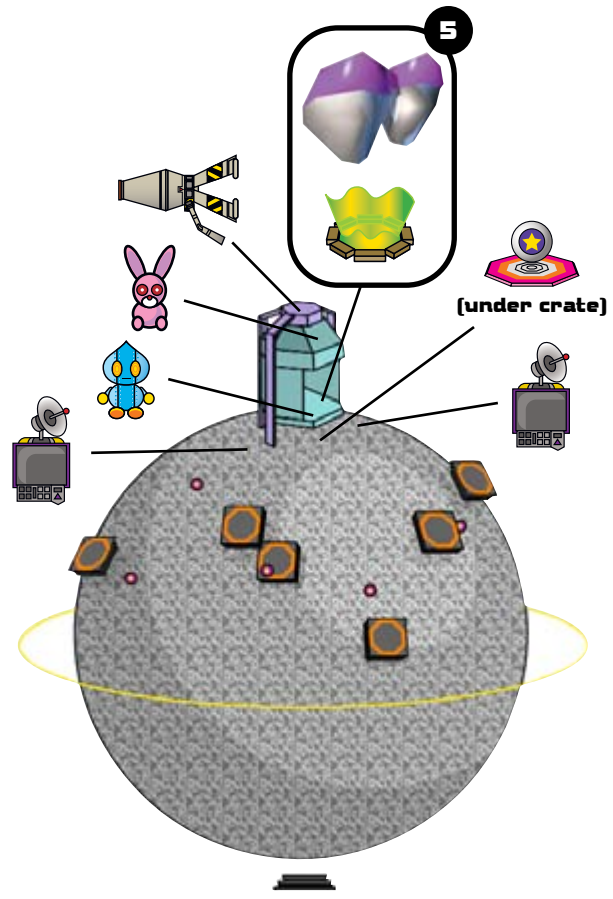

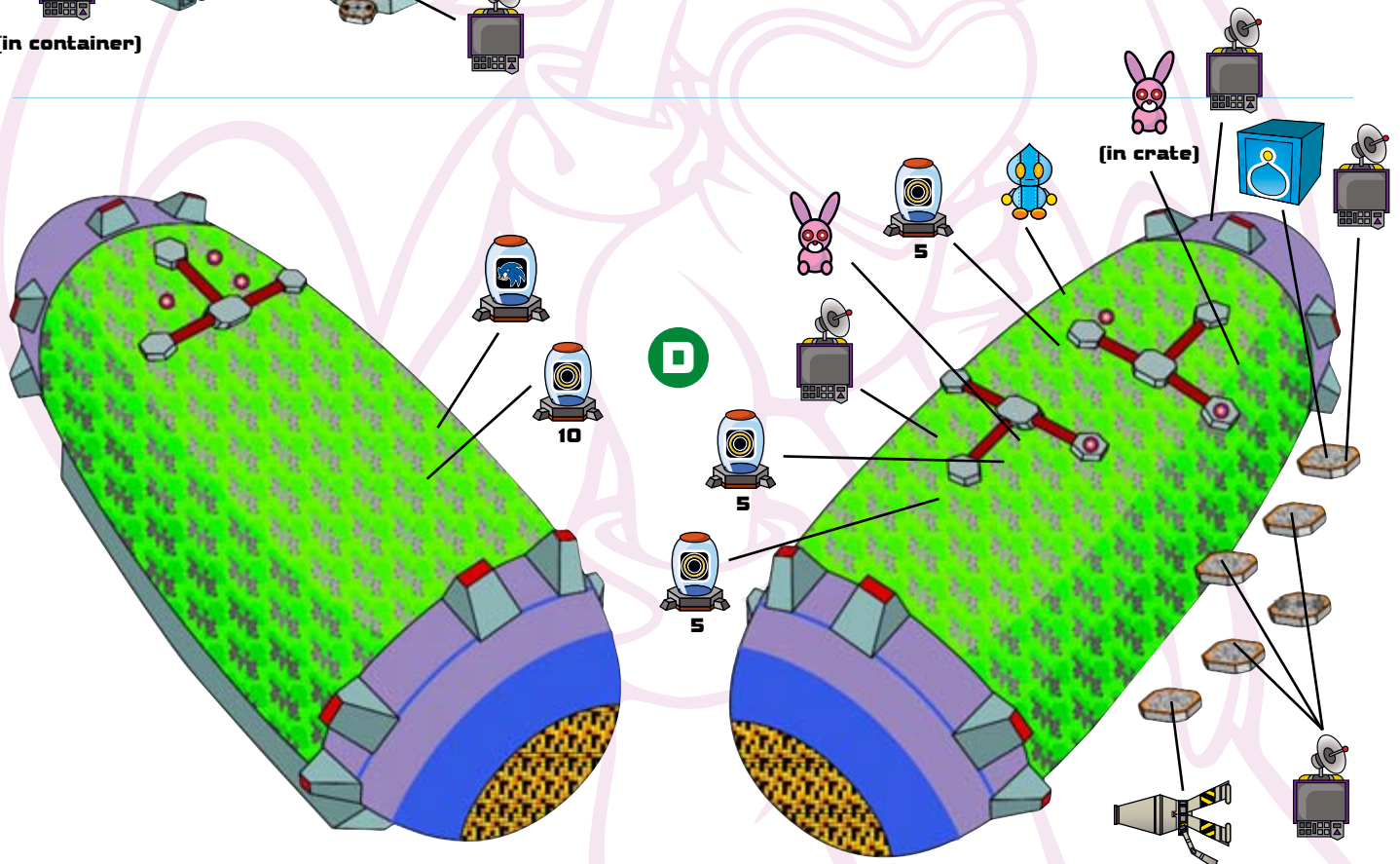
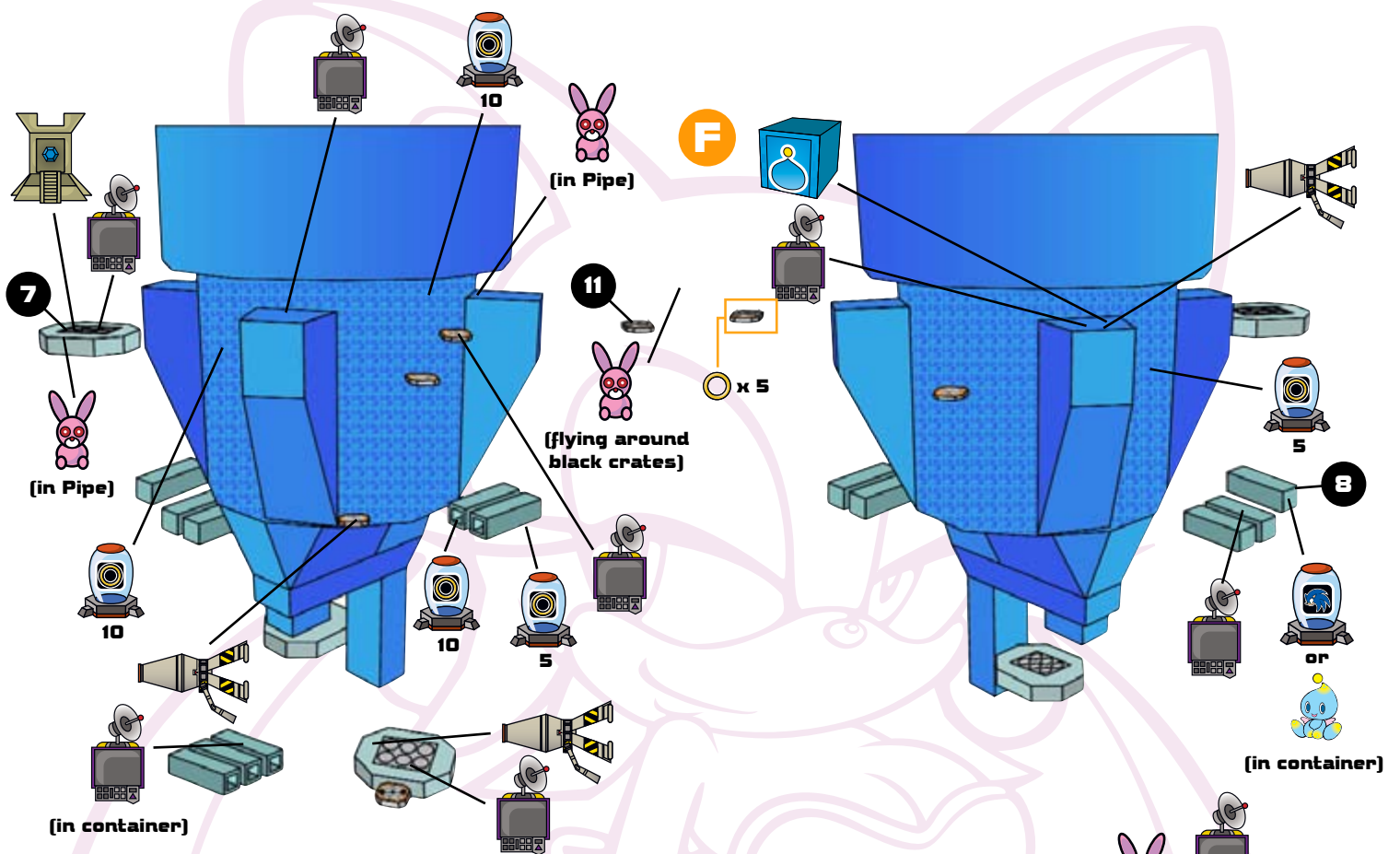

## DARK STAGE 12: ROUGE



primagames.com

### MISSION 3: FIND THE LOST CHAO

You must climb high to find the missing blue guy. Use the Rockets to travel quickly to the Ancient Ruin. After that, it's just a matter of using Rouge's Mystic Melody—found in Stage 2: Dry Lagoon.



Defeat the Artificial Chaos 'bot and play the tune to open up a Warp Hole. Climb in.



Excellent work. Now it's time for the harder missions.

### MISSION 4: COLLECT THE EMERALD PIECES IN 4 MINUTES 30 SECONDS

As usual, knowing your way around the map is especially important in the time trial. Understanding the Hints is also key. Press **START** to pause the game and study the Hints you've collected. Mad Space is a large Stage and it's cumbersome to move through. Learn where each Rocket brings you so that you won't be trapped in a planetoid's gravity well for precious seconds.



If you need to reach the platforms quickly, hit this Switch next to the Spring and take the Rocket right above it to the Holy Planet. Then ride the Rocket there to the platforms.

### MISSION 5: CLEAR HARD MODE

The Treasure Scope—found in Stage 8: Security Hall—is mandatory for this mission. When you have it, you can tackle Hard Mode. As with the other Rouge and Knuckles Stages, the Emerald pieces in the fifth mission are always in the same places.



The first Shard floats below the Holy Planet. Climb down the side of the planetoid until Rouge stops. Then Glide to the Emerald floating underneath. That's one.



Make your way to the Spherical Planet and walk down to the bottom. There's a platform down there that you must jump onto. It's tough because the directions are wonky. Use a Spring to bounce up, then Glide to the prize.



Jump to this platform high up and notice the Emerald Shard floating above the star symbol. Stand on the corner behind the star symbol and do the Quick Swing Kick—turn the analog thumb pad in a complete circle and press **B** to do it. That's it.

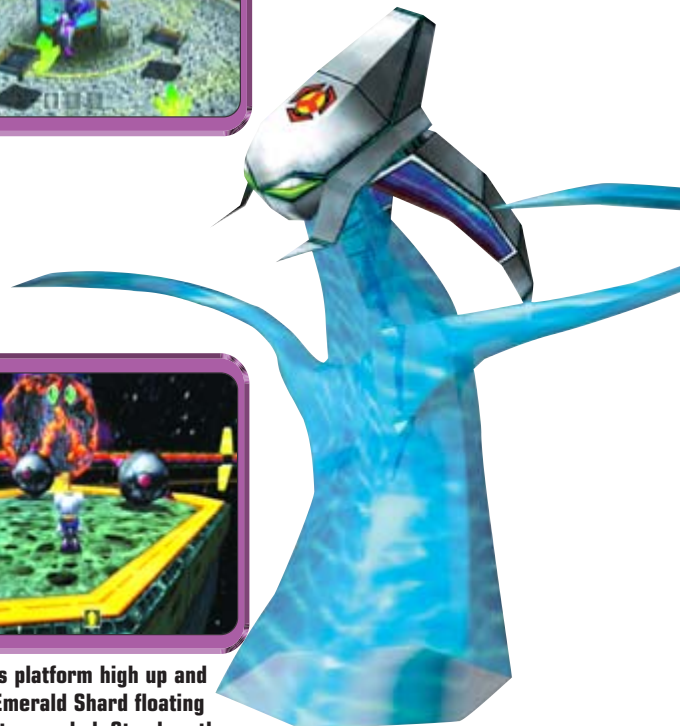



## ROUGE VS KNUCKLES

It's you against Knuckles. Your archenemy has found some of the Emeralds Shards you've been looking for. It's too bad he doesn't want to give them up. If he wants to do it the hard way, so be it.

### BOSS ATTACKS

Knuckles' attacks should be familiar; they're the same as Rouge's. Remember that although he attacks while standing, he also performs his Sliding Attack while running. In addition, his Hammer Fist Attack reaches you from afar.



Keep moving to avoid his attacks, throwing in your own Sliding Punch Attacks as you move. Even though you can't hurt him while he's moving, he can hurt you if you're not attacking.

The beams are actually an easier place to engage Knuckles. The narrow width limits your movements, but it also limits his. Attack him as he stops to catch his breath.

Throw continuous attacks at him. Eventually, he'll stop and you'll hurt him. This way, you also prevent him from hurting you. Don't forget to use your Drill Attack. Glide above Knuckles and push **Ⓢ** or **ⓧ** to come crashing down on him.



Knuckles's Hammer Fist can mean the end of you. You know it's coming when he screams, "Now witness my power." Convenient. When he does this, get ready to fly. Jump and start Gliding in any direction to get the heck out of there. His Hammer Fist Attack has less chance of hitting you when you're in the air.

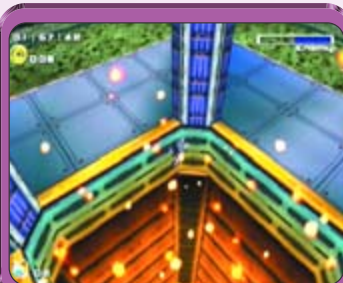

Periodically, the floor opens up and hot air puts you in the air. When this happens, take the fight to the beams.

When the ground is open and Knuckles is somewhere on the beams, it's hard to find him. Climb high and Glide in a circular motion to view the arena. Find him and charge.

### CAUTION

If Knuckles climbs the supports, resist the urge to follow him. From the supports, he comes right down on your pretty little head.





primagames.com

# COSMIC WALL

The time is at hand, Dr. Eggman. You've got a lesson to teach those Hero critters about the greatest genius of all time. If they think they can fool you with a fake Emerald, let them beware.

## MISSION 1: GET AND CONFRONT THE TRESPASSERS



The gravity here is really weak. Reach really high places by using your Jet Engine. Turn it on at the peak of your jump for maximum height.

### TIP

Learn to fire while boosting up to the next level. The height you can reach in this low gravity allows you to dispatch enemies as you rise to their level.



The first Chao Container is easy to miss if you aren't careful. A pyramid is on a platform to the right of the main walkway. Destroy the pyramid to reveal the Chao Container and an Ancient Ruin. The Ancient Ruin leads to the lost Chao in Mission 3.

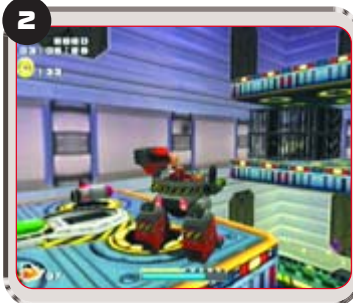

Time for a little upgrade. Use a rocket to bust out the Protection Shield. It's tricky to boost from the Rocket platform to the Protection Shield, so hop onto the platform above the Shield. From there, drop off the side and move toward the Shield to get it.

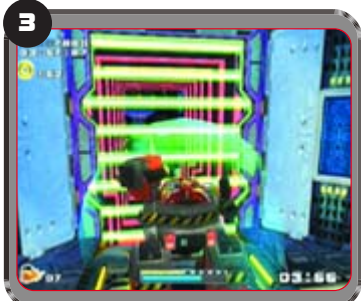

Walk up to the green lasers to activate the cart. It locks down your Eggwalker and takes you for a ride. During your ride, quickly destroy everything you can.



After you're released from the cart, find the second Chao Container just before the next Point Marker.

## Missions

1. Get and confront the trespassers!
2. Collect 100 rings!
3. Find the lost Chao!
4. Reach the Goal within 8 minutes 0 seconds!
5. Clear Hard Mode!

### POWER-UP:



PROTECTION SHIELD

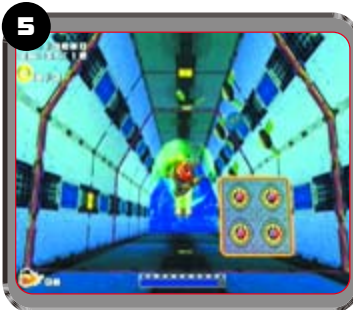

The safest way to drop down this shaft is to free-fall because you can dodge the Chaos 'bots tendrils. Free-fall just as you see each wave's tendrils extend. They won't have time to touch you.

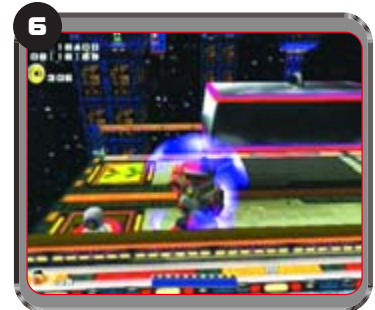

This Switch pauses the trap at the top. Jump on it to gain the height needed for the next platform.



The final Chao Container is at the bottom of this Chaos-infested shaft right before the second cart ride to the Goal Ring.



# COSMIC WALL

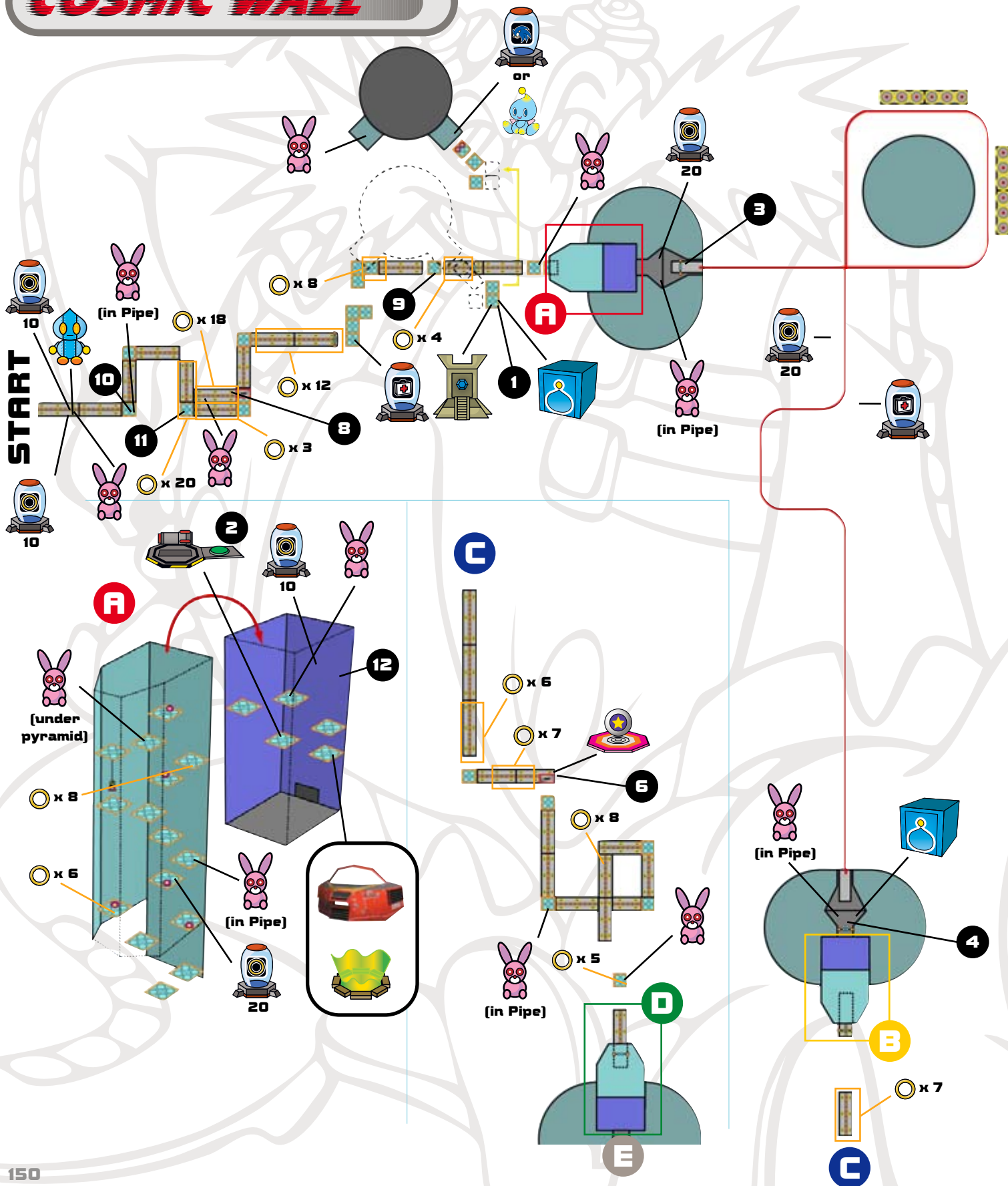

# DARK STAGE 13: DR. EGGMAN



primagames.com

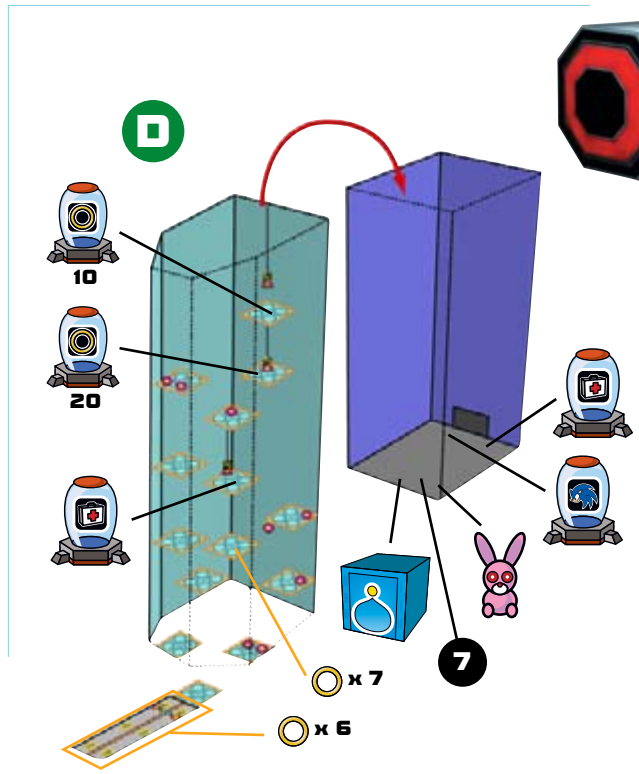
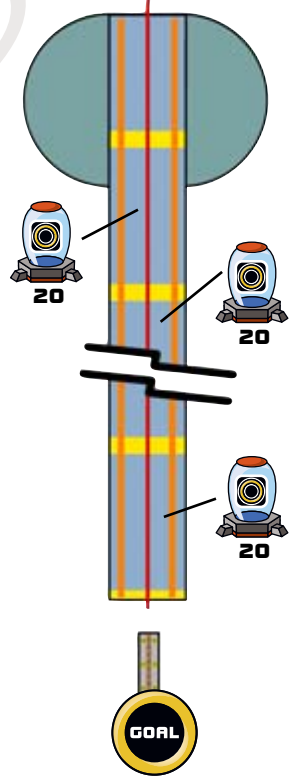
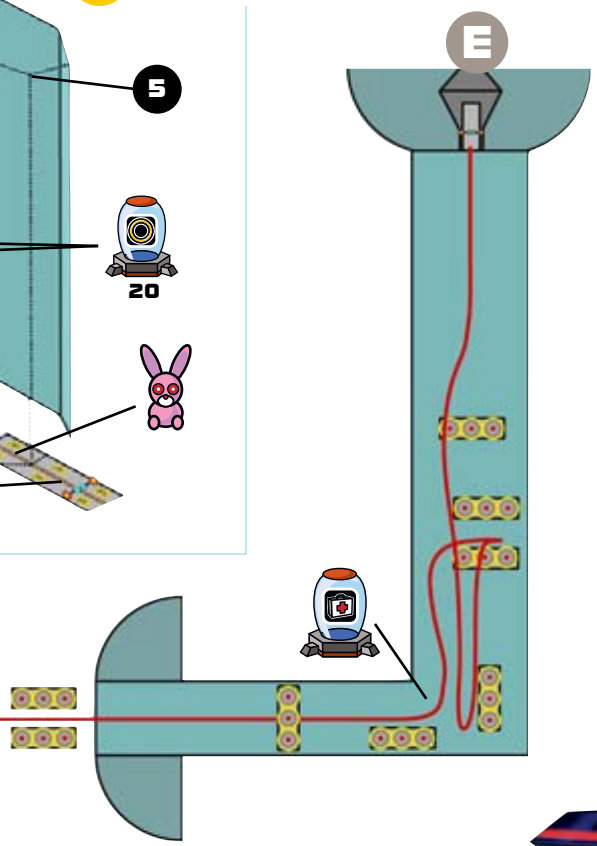
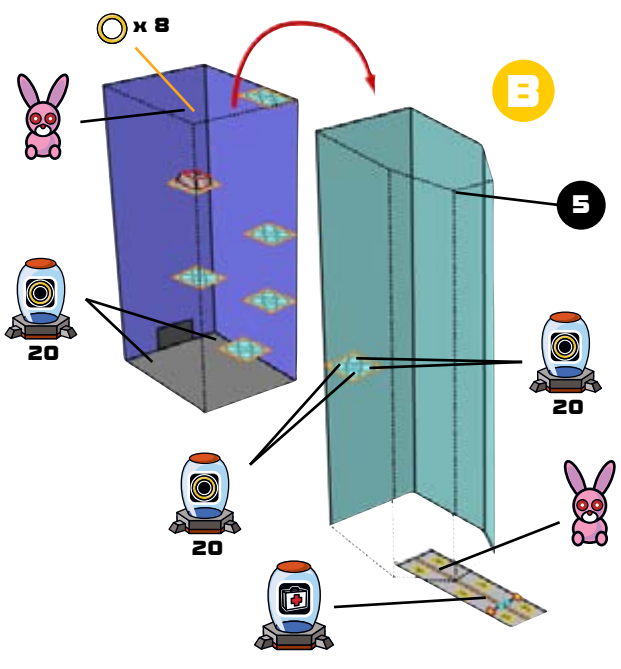



## MISSION 2: COLLECT 100 RINGS

Rings are everywhere in the Cosmic Wall. Collecting 100 rings early on this stage is a breeze.



To the left of this trap is a ton of rings. It's like picking strawberries.



Continue shooting as you move to destroy enemies as well as any ring Item Boxes. Rings are what we're here for, right?



If you've been diligent in destroying the enemies and picking up the rings, you should have 100 rings by this point. If not, keep at it to complete the second mission.

## MISSION 3: FIND THE LOST CHAO

Chao seem to have a knack for getting themselves lost in the oddest places. Do your deed and find it.

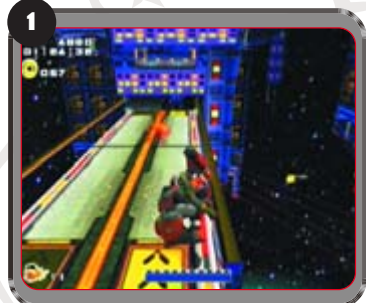

A lonely pyramid-topped platform is to your left. It's tough to get a good aim at it from the main walkway, so hop over to it and destroy it as you get closer.

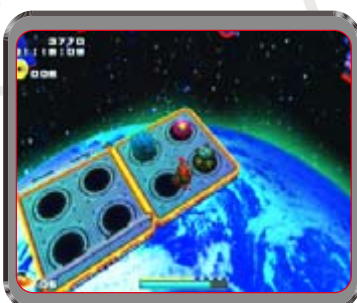

Awaken the Ancient Ruin to bring out the Spring that shoots you up to the next platform.

The next platforms have meteors occupying them. Jump straight up and destroy the meteors before you land on the platforms. You've saved the lost Chao before you know it.



## MISSION 4: REACH THE GOAL WITHIN 8 MINUTES 0 SECONDS

Eight minutes is all you have to go through this long, treacherous stage. The trick here is to know where to cut corners.



Don't underestimate your Jet Engine. You can boost farther and higher than the walkways suggest. Easily skip over intermediate platforms like this. Don't waste valuable time when you can land on the platform above it.



Because the walkway turns back on itself, skip this whole section. Get a good boost going and jump to 11 straight from 10.



Don't forget to free-fall down these shafts. Leave the enemies alone to save valuable time.

## MISSION 5: CLEAR HARD MODE

The number of enemies has increased and the course has been changed again. Stay on your toes.



What's this? These enemies have changed positions since you last saw them. No worries; you can adapt.

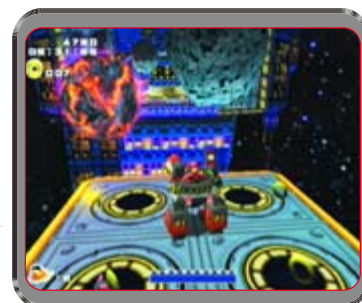

The course has been changed as well. What's a doctor to do? Take your time going through the mission. Be ready for any unexpected changes in the catwalks.



## BOSS: TAILS



primagames.com

# DR. EGGMAN VS TAILS

How cute. This little fox boy thinks he can go up against the all-powerful Dr. Eggman. You've already shot Sonic into space. If that didn't scare off Tails, it's time to teach him a little lesson.

## BOSS ATTACKS

Keep on your toes; Tails can be sneaky. He attacks you three ways: cannon fire, Homing Missile, and the Power Laser. Maintain your distance, and don't let off the fire button.



Your Homing Missile is not the best way to dispatch Tails. While more powerful, it's too slow to hit reliably. Your regular cannon's rapid fire has a better chance of hitting Tails. However, it doesn't hurt to target him and hope that a Homing Missile will land.

The Dynamite packs in the middle of the room can hurt both you and Tails. Stay to the outer perimeter and shoot the explosives if Tails nears them.



After you've taken a good bite out of Tails's health meter, he pulls out his Power Laser. This can be the end of you if you're not careful.

When Tails fires his Power Laser, it's time to book. Head toward him and away from his line of fire. By moving toward him, you have a shorter distance to move your slow vehicle out of the way. If Tails cuts you off with the laser, change directions, pronto. The Power Laser lasts for quite some time. Use this time to circle around Tails and give him a taste of your cannons.



### TIP

When fleeing the Power Laser, jump and use your Jet Engine. Boosting provides more responsive control over your movement. It's great for avoiding the laser.



**FINAL CHASE**

**START**

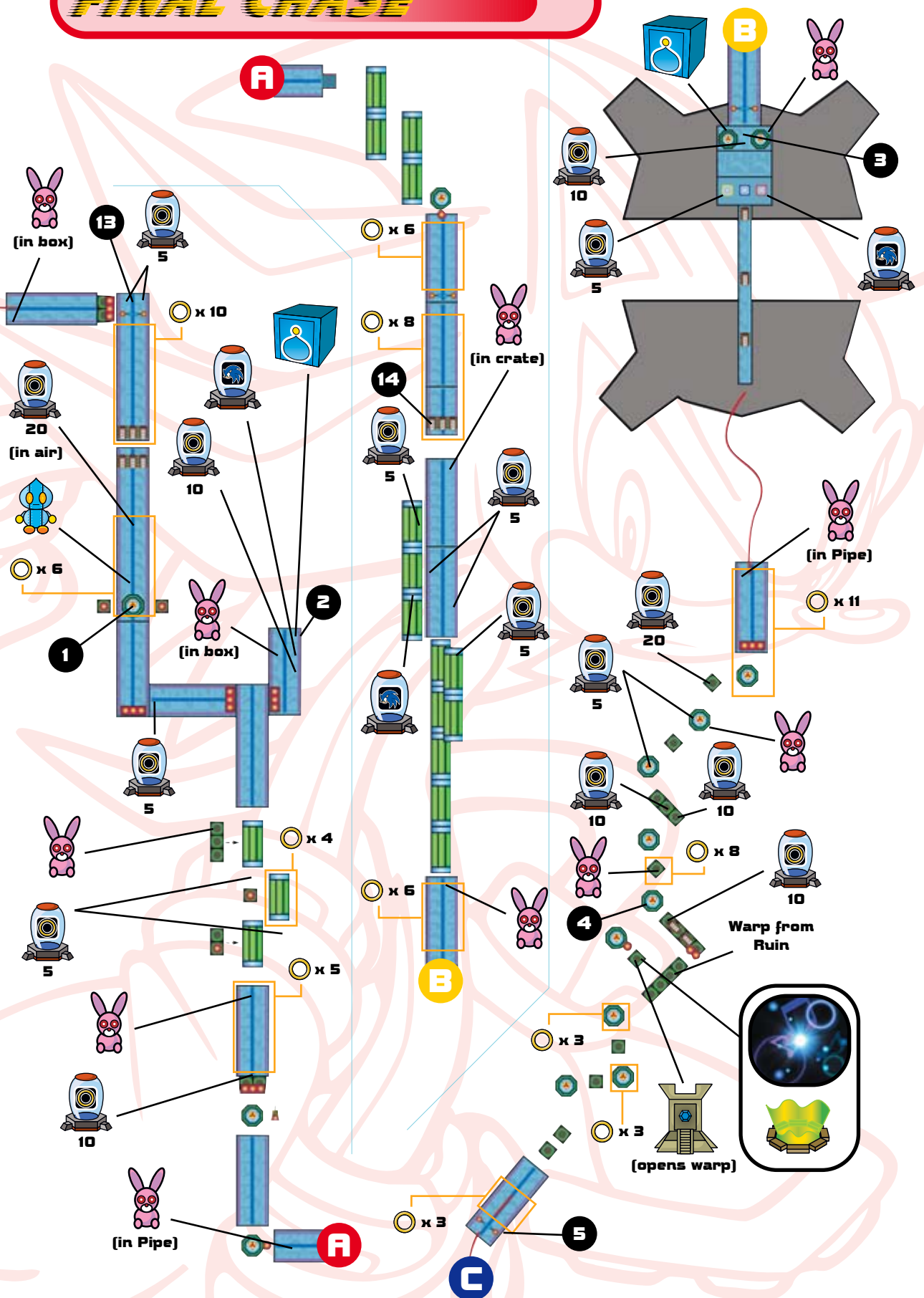

# DARK STAGE 14: SHADOW



primagames.com

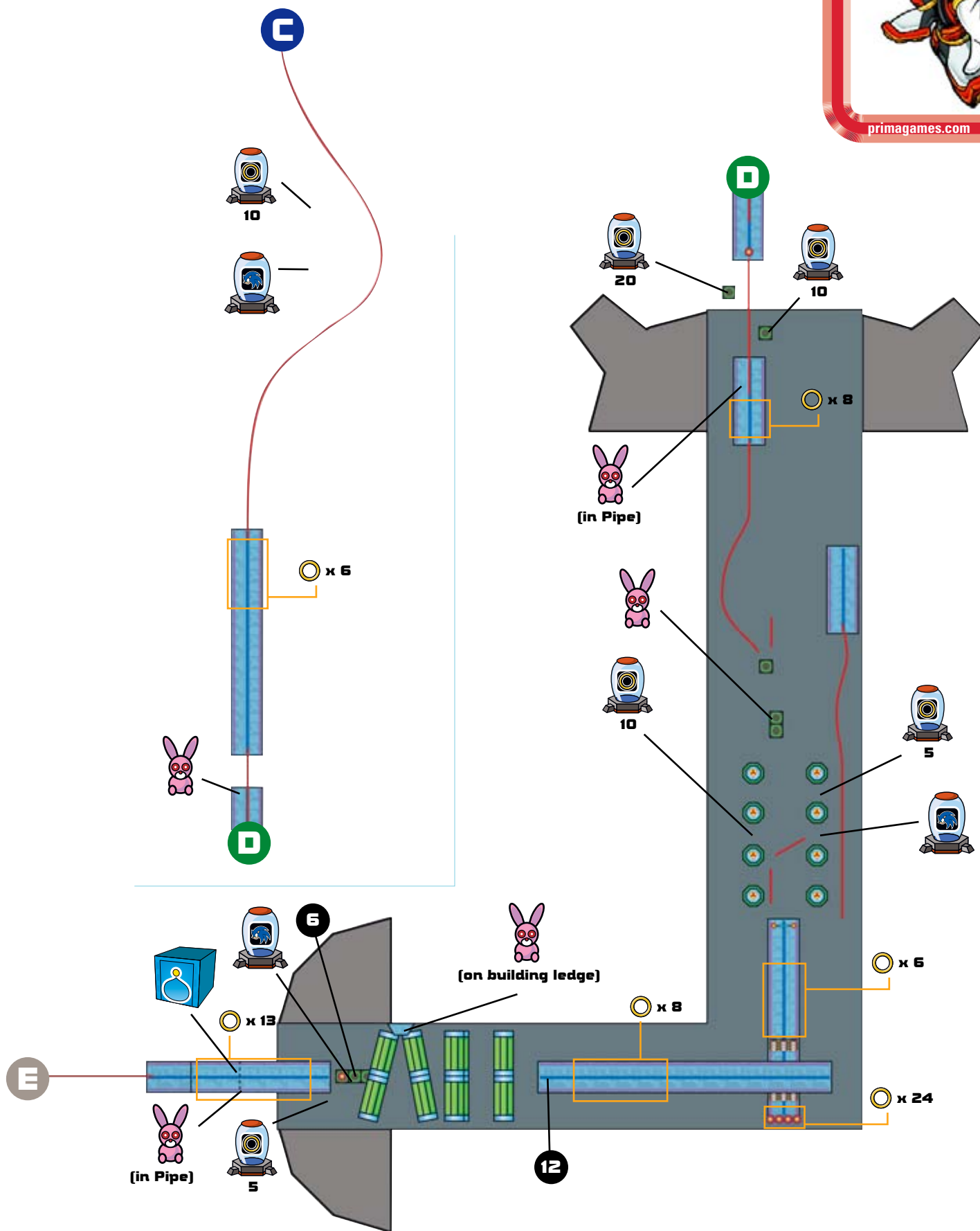

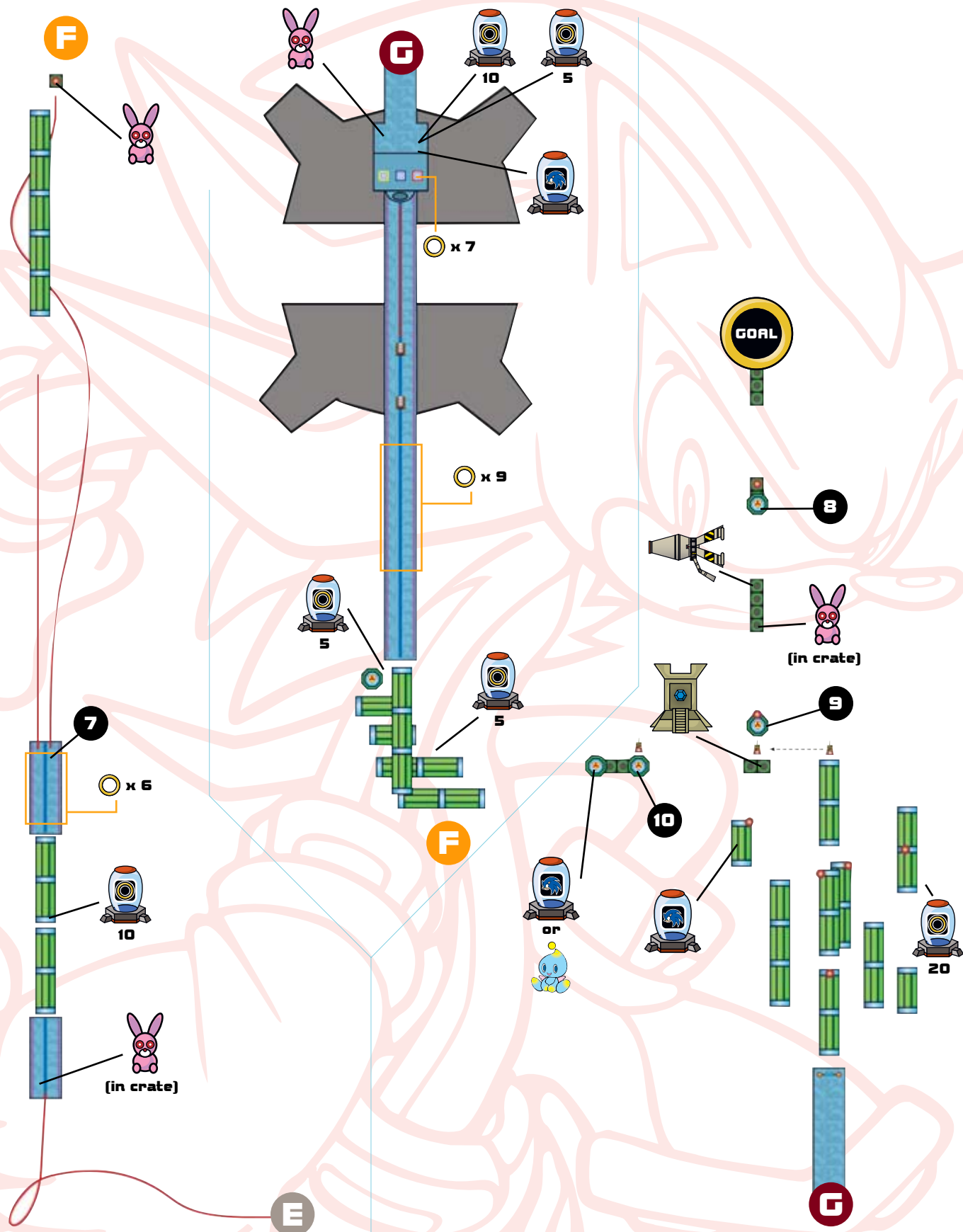



primagames.com

# FINAL CHASE

Dr. Eggman has all he needs for his plans to come through. But what's this? Looks like someone is moving toward the Eclipse Cannon. Go check it out.

## Missions

1. **Hurry to the Eclipse Cannon!**
2. **Collect 100 rings!**
3. **Find the lost Chao!**
4. **Reach the Goal within 5 minutes 30 seconds!**
5. **Clear Hard Mode!**

**POWER-UP:**



**MYSTIC MELODY**

## MISSION 1: HURRY TO THE ECLIPSE CANNON

### NOTE

The first things you notice on this stage are the green spinning drums. They have their own gravitational field that spins you around the shaft. Learn to use and navigate these.



When you come to the first spinning drum, walk up to it and let it take you. To move up as you spin around it, push the analog thumb pad up. To move down, push it down. At the top, ease up on the analog thumb pad or you'll fall off.



Although the general rule is to follow the green arrows on the ground, you must go against the grain at this point to find the first Chao Container. A couple Item Boxes are here too.



To move from one spinning drum to the next, wait until it spins you around to the top. Jump to the next drum and let its gravity take control.



These electric fields aren't as tough as they seem. Just wait until you come around to the top of the drum, then hold the jump button for maximum height.



The second Chao Container is in the right corner of this room, just past the Point Marker.

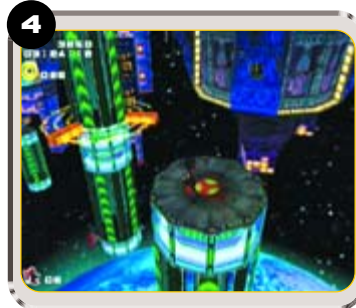

You must clear this electric fence to reach the Mystic Melody at the top.

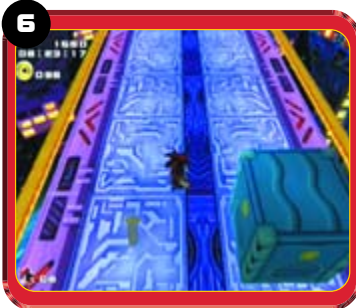

Does it look like there's nothing below? If you make the jump, you find platforms. The platform just before the next Rail also holds the last Chao Container.



The vertical drums are a good distance apart. For greater jumping distance, wait until you reach the maximum height of the jump, then use the Homing Attack. This adds extra distance while keeping you from losing altitude.

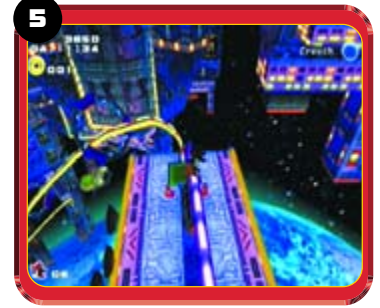

The Spring puts you on the Rail at top here. You'll miss the Point Marker just below it if you stay on the Rail. Not confident you're going to survive? Drop down to activate the Point Marker so you can start back here if you fall off the edge.

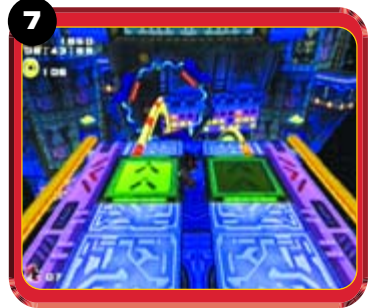

Which way to go? They both lead to the same place. Take the left route; it's faster if you keep jumping.

Until now, you've only gone up the vertical spinning drums. These have arrows pointing down, so that's where you go.

## MISSION 2: COLLECT 100 RINGS

It's amazing how many rings are on this stage. Collecting 100 should be no problem. Enemies are sparse, so holding on to rings shouldn't be a problem either.



Drop down near the first Chao Container to collect the rings.



Although jumping from one vertical spinning drum to the next saves time, jumping to the floating platforms rewards you with rings.

## MISSION 4: REACH THE GOAL WITHIN 5 MINUTES 30 SECONDS

To clear the stage within the time limit, precision is key. Your technique around the spinning drums will decide whether you make the time.

### TIP

This stage involves many jumps. To shave precious seconds off the clock, use the Homing Attack to speed things up.



There's no need to spin around these drums. As you land on them, immediately jump again to keep on top of them. You'll never make the time if you spin around each drum.

### CAUTION

The Artificial Chaos with the long-reaching tendrils are your worst enemies. Stay away from them, or your rings will be yours no more.



## MISSION 3: FIND THE LOST CHAO

Another lost Chao in space. When will they ever learn? It's a good thing you get the Mystic Melody on this stage.



Not so fast, tiger. The Spring seems a natural way to go here, but what's that Pulley for? Time it just right and push up onto the platform without hitting the Spring.

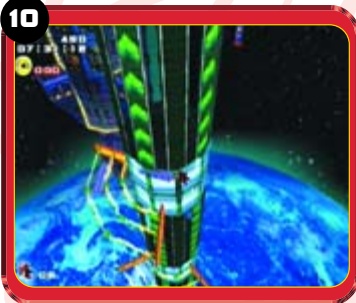

You can't jump over these fences. Stand just below them and wait until you're spun in front of them; this is the time to start moving. This way, you'll be moving past it on the other side.

### TIP

If you accidentally hit the springpad, you can easily make it back with a long jump.



## MISSION 5: CLEAR HARD MODE

The Artificial Chaos have been let loose. These tricky jokers will give you nightmares by the time you're through with this Stage.

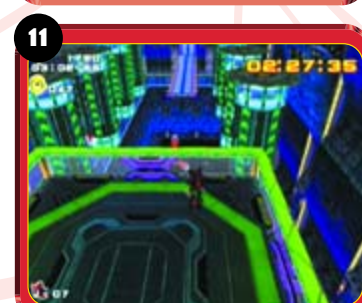

From this platform you can jump to the flat tops of these spinning drums. From the tops, you can skip along them much more quickly.



Take a flying leap here instead of going down the walkway. The leap takes you to a higher spinning drum. From there, you can jump all the way down to the next walkway without dealing with time-consuming obstacles.



The Artificial Chaos here can reach you much earlier. Don't wait around on the walkway until it does. After using the Homing Attack to grab the ring Item Box, use another one to quickly shoot yourself past it.



Take a flying leap here instead of following the walkway. The spinning drums up here are easier to navigate than what you'll find below.

The spinning drums here are all staked out by new and faster enemies. Artificial Chaos reach out with their tendrils at a faster rate, and spinning spikes wait for you at the top. Cool nerves and a little luck will take you through.

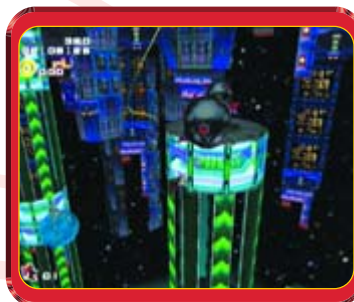



**BOSS: SONIC**



primagames.com

## SHADOW VS SONIC

How did that blue hedgehog survive that trip into space? No matter. The final showdown has come.

### BOSS ATTACKS

Sonic is wily, but you're shifter. He has the standard arsenal of attacks that you also have. The exception is his Sonic Wind Attack: the only thing you have to worry about on this infinite highway.



When you start, run alongside Sonic, collecting rings. You'll probably be hit at some point during this fight, and the rings will protect you for a few hits.



Early in the fight, your simple Homing Attack is enough to damage Sonic. Use it until you notice that your attacks just bounce off him.

If you see Sonic spinning in the air, it means that he's about to attack you. Counter with an attack of your own.



Before long, your Homing Attacks won't affect Sonic. Now's the time to hang back a little bit. Let Sonic run ahead of you until he attacks with the Sonic Wind. To perform this, he must stop.

While you're letting Sonic run ahead of you, charge up your Spin Dash by holding down **B** or **X**. If you notice the highway breaking apart, stop your spin, go to the upper level, and start the Spin Dash again. If you don't, you'll end up spinning off the edge.



When Sonic is far enough ahead, he'll stop to do his attack. Now is the time for you to act. Watch for him to stop and begin to say, "I'm not done with you yet!" Anticipate this and let go of **B** or **X** to Dash toward him. After he finishes speaking, a blue flash of lightning is sent your way.

When your Spin Dash takes you near him, give Sonic a taste of your Homing Attack. Because of the speed at which you approach him, the Homing Attack should be executed with a double tap of **A**. Be careful not to overshoot him. Repeat until Sonic is defeated.

### CAUTION

When attacking Sonic, you're likely to get hit by the Sonic Wind. Suck it up, collect a few rings, and continue the fight.





# CANNON'S CORE

What's this? ARK is plummeting to earth and the two sides are banding together to stop it. During this unusual Stage you will control each of the six playable characters to help save the planet. There are no missions for this level in the Stage Select area. Each section is for a different character.

By now you've played hours and hours of *Sonic Adventure 2* and should be an expert at playing each of the six characters. Especially since Cannon's Core can only be opened after conquering the Hero and Dark Stages! There are some new tricks to these levels, but with the skills you possess, you should be able to get through it handily.

## CANNON'S CORE: TAILS

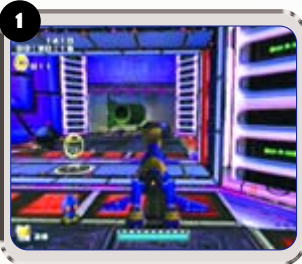

**1** Cannon's Core has a lot of these Time Stop Switches. Hit them and all motion—except yours—comes to a halt. Robots freeze, lasers stop, and platforms stay still. Hit this one to drop the laser gate.

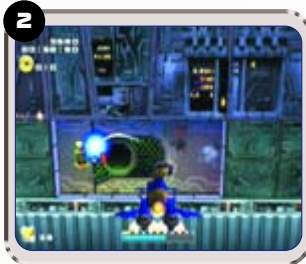

**2** Jump and hover so that you slowly descend this bottomless pit. There are three Hornet robots that you can target and blast. Get close to the door on the other wall and target the Dynamite packs. Blasting them opens the door.

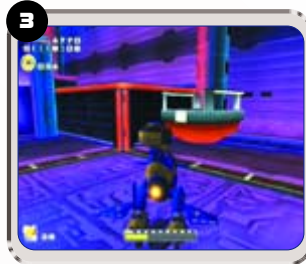

**3** Hit the Time Stop Switch in this room and jump onto the platform to your left or right. From there, jump to the next level, where a falling Weight is pounding away (it's identical on either side).



**3** Target the Time Stop Switch and shoot when the Weight comes down. Jump on the Weight and hop up to the platform. Open the door by blasting it with your cannon. When the Time Stop Switch releases, though, you'll be surrounded by robots. Stay ready.

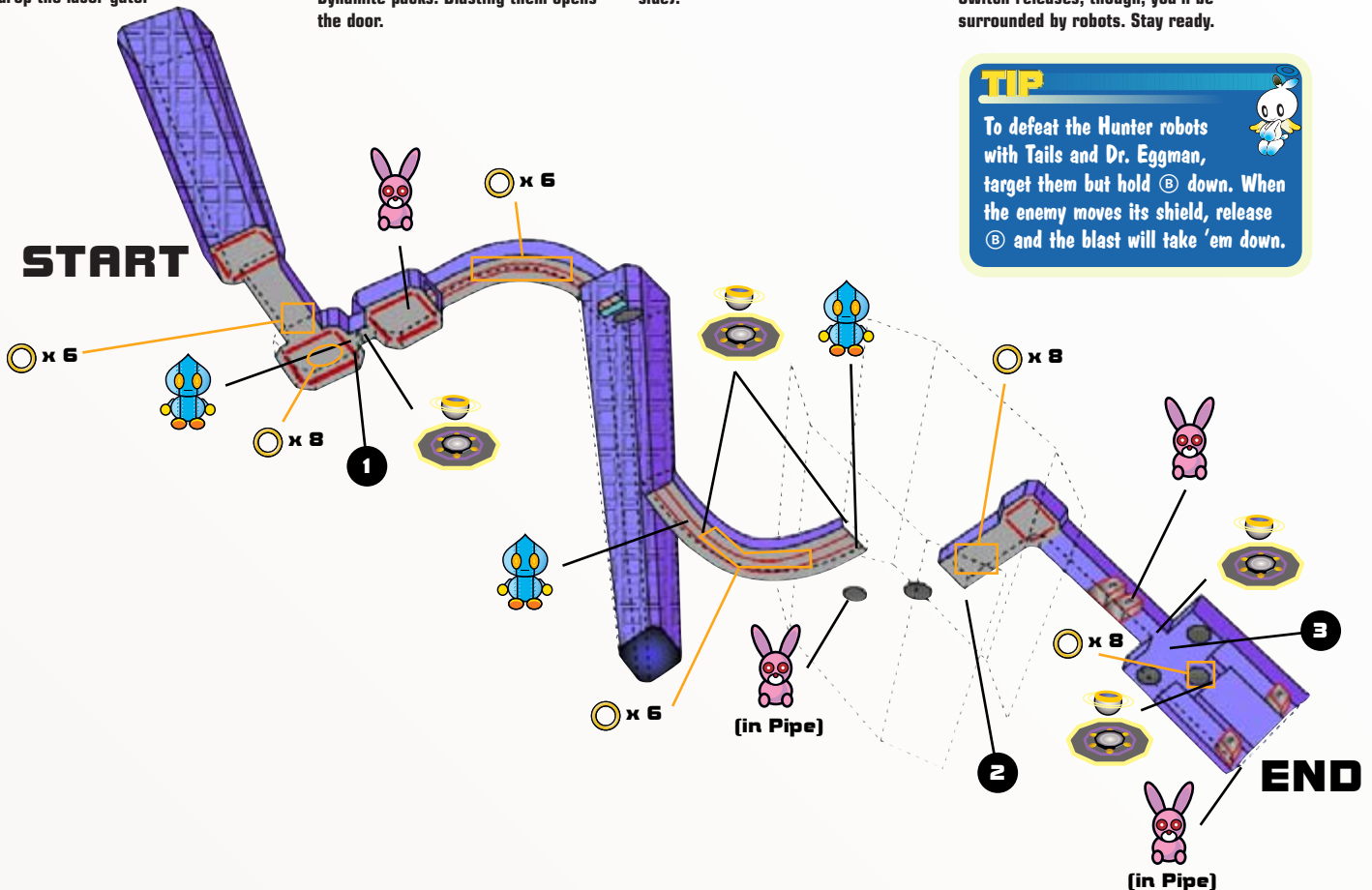



primagames.com

**CANNON'S CORE: DR. EGGMAN**

**START**



This room is a pain to negotiate. Target the Time Stop Switch and fire when the two blocks that rise out of the floor are just barely emerging. Hover from one to the next, then hover to the lower area.

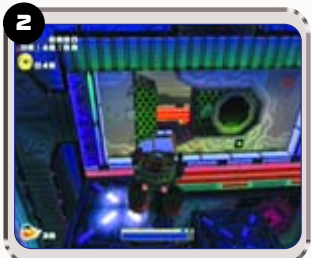

Jump onto the first block you can that has an X on it. When it reaches the door, Hover off and through the door.

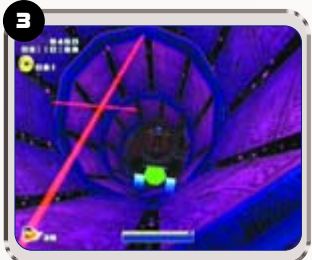

When the platform disappears under you, don't panic. Hover, then plummet to make it down the shaft. Line up so that you're not going to hit the lasers that you can see, then fall until more lasers are visible and Hover again. Keep it up all the way down the shaft.

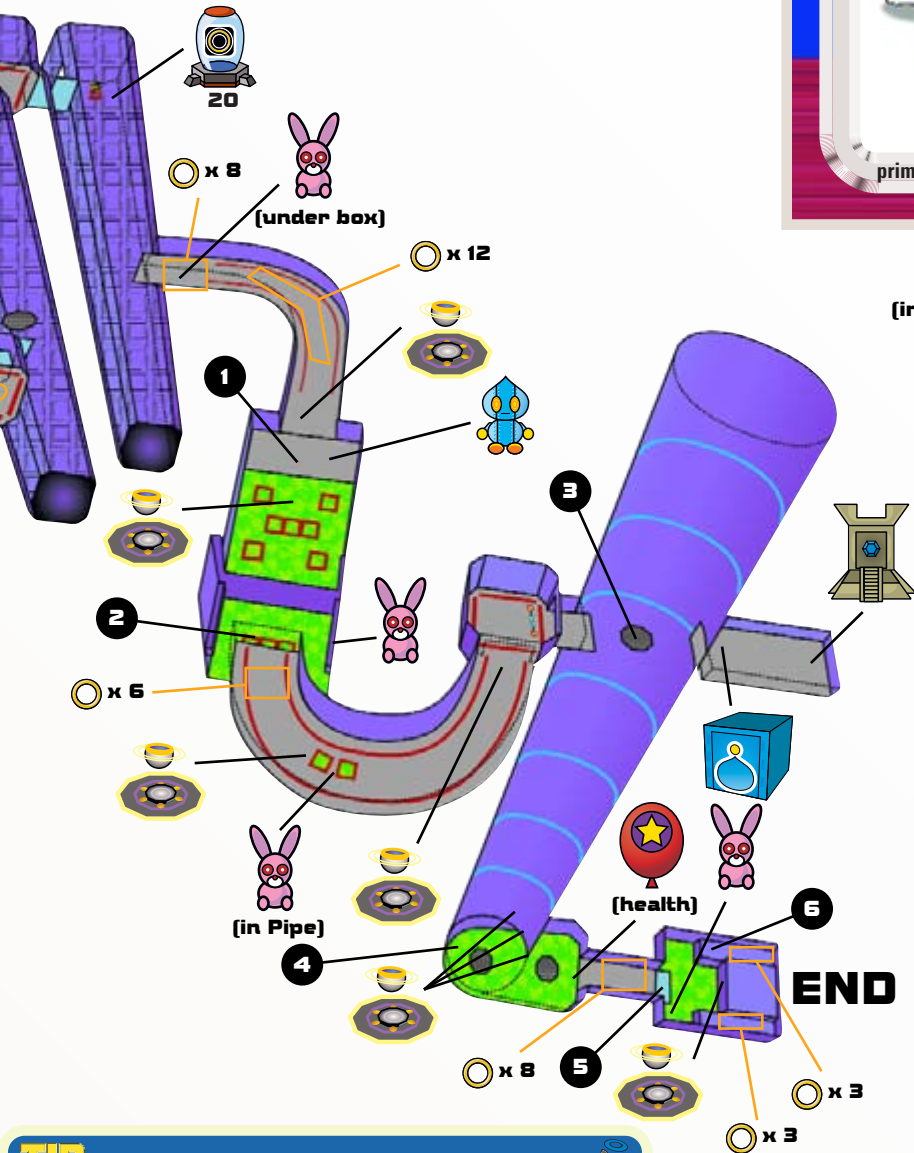

**Laser Patterns**  
(in descending order)

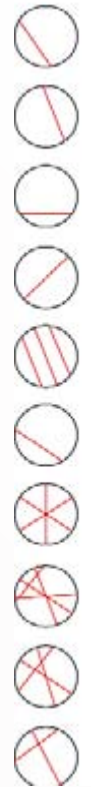

**TIP**

The blocks all show you which direction they are traveling. They have light up arrows pointing left or right, or Xs if they are traveling up and down.

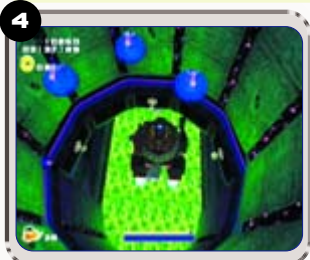

When you see the three enemies near the bottom, Hover and blast them. Then, hit the Time Stop Switch and head for the door.



In this room, hit the Time Stop Switch when the blocks to the left look like this, stepped up to the lower platform.



Freeze time again, when the two blocks in front of the platform are stepped, like this. Use them to jump up to the higher platform, then blast the door open.

**END**

## CANNON'S CORE: ROUGE

Rouge needs to find a Switch that will raise the water. Rather than search for treasure, hit a series of Switches to get to the big red button.

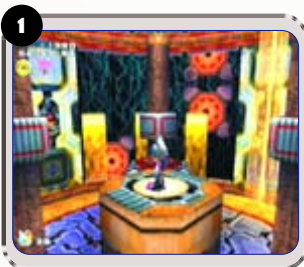

**1** Climb the pillars. Find the one without a block at the top, stand on it, Glide to the next tallest one, climb to the top, then Glide to the next tallest. At the top of the fourth pillar is a Time Stop Switch.

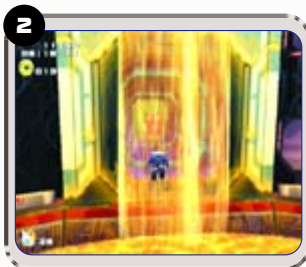

**2** Kick the Switch, then fall and Glide into the door behind the waterfall. Tackle the Hunter robot.

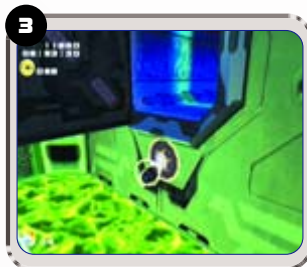

**3** Cling to this wall, right next to the Time Stop Switch. As soon as a block has passed through the tunnel, hit the Switch so you can climb into the tunnel and run down.

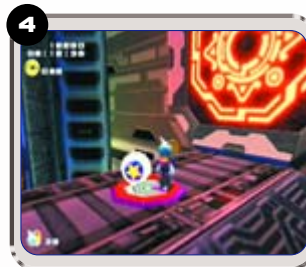

**4** Bust the Steel Containers to get the Invincibility, and climb up here to hit the Switch. Now make your way back.

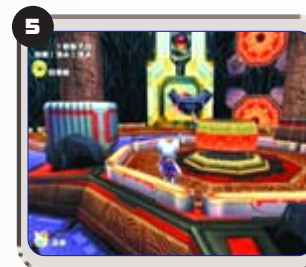

**5** Jump on the big red button and Rouge is finished.

**NOTE**  
You have to use the Time Stop Switch, then the Spring to get back out to the main room.

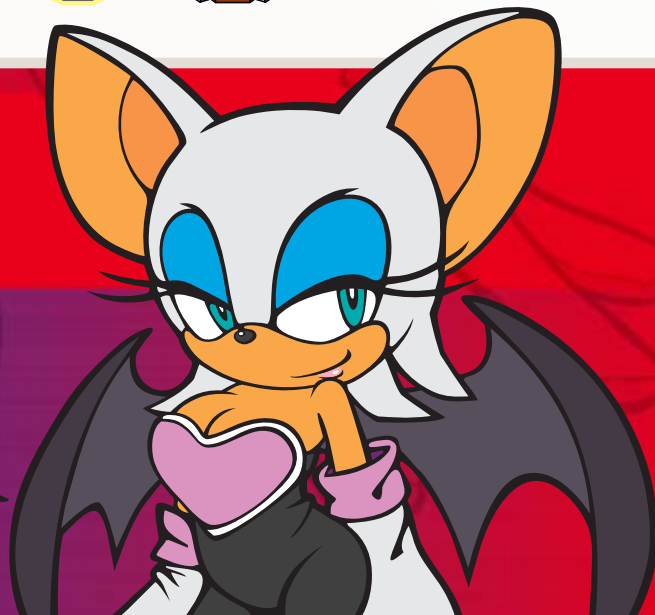
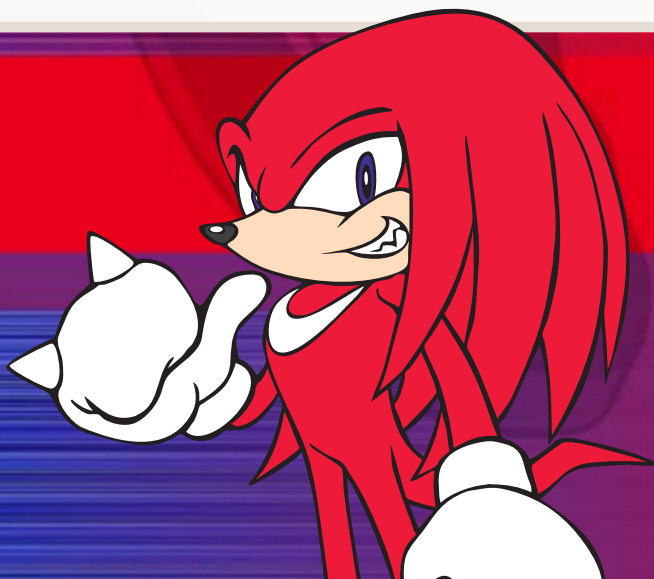
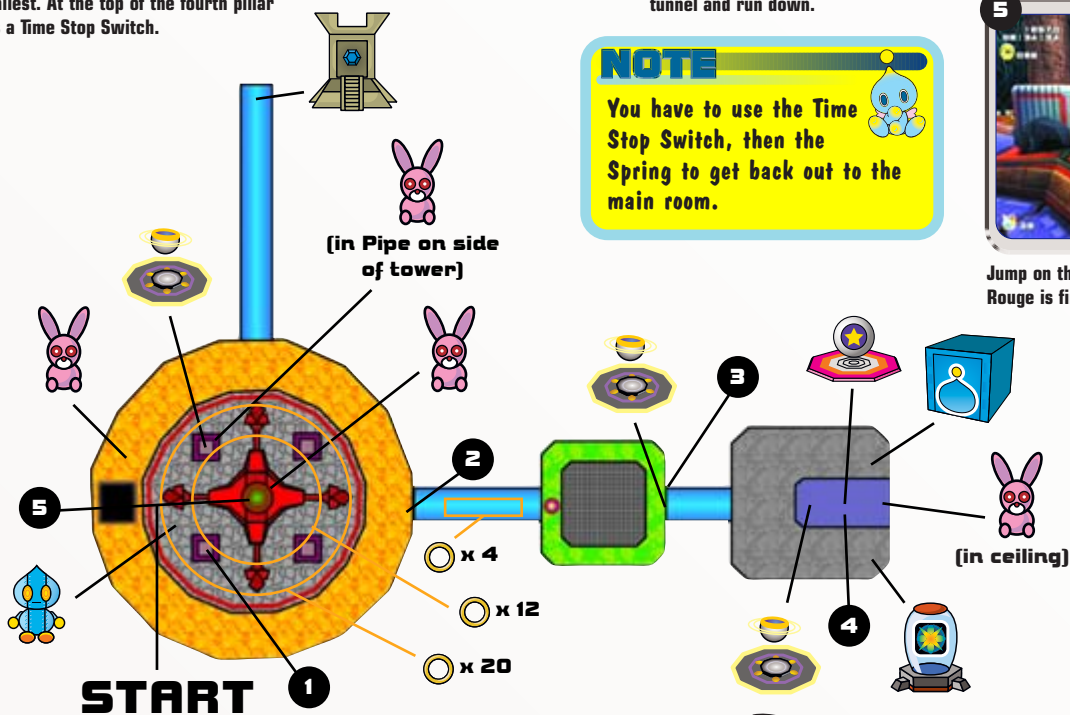







primagames.com

## SHADOW VS BIOLIZARD

This can be the toughest fight of the game. Shadow must defeat the prototype of the ultimate life-form. This huge lizard is not in the mood to play games, possibly because he can't move well. Hang tough; we'll give you the info you need.

### BOSS ATTACKS

The Biolizard has a few attacks up its...sleeve. His vicious bite will do damage and send you flying. He starts chomping away and shuffling around. You must stay ahead of his mouth on the circular track. Don't run *too* fast, though, or he'll switch direction and whack at you with his tail.



Run away from the gaping mouth and pick up some rings. When you see the wood divider, jump over the water that cuts through the circular path.

After a time, the Biolizard will tire and start huffing and puffing. Now's your chance to attack. The pipe along its neck has lights running up it. Jump onto the pipe and grind up it. Jump just before the big red light, then use a Homing Attack to bash into the light.



This is your target. You must hit it several times to win.

That's one hit. Now things change a bit. The Biolizard recovers and starts chasing you again. Stay away. When it stops moving, it spits balls of energy that roll toward you. Some go low, others high. Jump over the low ones and Somersault under the high ones.



These energy balls can be a pain. If you are hit and lose rings, you'll have a moment to gather them again.

### TIP

It is crucial to gather rings after being hit. You can last through the whole barrage of energy attacks even if you are hit by every one, as long as you grab rings after each hit.



When the energy attacks stop, the Biolizard presents its neck pipe for you to grind up again. Take another whack at his life-support system.

This pattern—chasing, energy attack, then Grinding—repeats once more. Then there's an addition made. The Biolizard chases and uses its energy attack, but after you're done dodging the energy balls, it rears back and generates floating pink eggs. The eggs charge and attack you, so strike first and fast.



You can use the eggs to reach your target with your Homing Attack.

Use the Homing Attack to bounce to the top of the Biolizard. You can direct Shadow a bit with the analog thumb pad. Bounce off an egg near the top, hold the jump button (A) until you're directly over the target, then tap (A) again to attack it.

You must deal with the cloud of eggs twice. Then, after you make a hit the second time, the Biolizard roars, spits out more eggs, and levitates you and them.

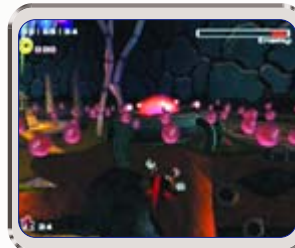

You can't use your attacks while floating, but you can use the analog thumb pad to direct Shadow. All you have to do is get to the target. Push toward the red light on the Biolizard's back.

First, the eggs swirl to the right, so direct Shadow that way. Find a gap free of eggs and push Shadow down it, closer to the life-support light. All you have to do is push him into it. However, eggs will be bombing you continuously. Keep moving forward and try not to run into any.



When you hit the life support for the final time, the Biolizard slumps in defeat.



## SONIC AND SHADOW VS THE FINAL HAZARD

It's not over yet! The Biolizard has taken control of space colony ARK and is going to crash it into Earth. Only two Hedgehogs—working together—can stop it. Using the power of the Chaos Emeralds, they transform into their super forms and go out to do battle. Now you can control both Hedgehogs—one at a time—to defeat the final menace.

### BOSS ATTACKS

Before describing the attacks you'll face, you must know how to control the characters. Sonic and Shadow have changed form and now have new abilities. You can't use any of the moves and powers they've had throughout the game. But they can fly through space. Use the analog thumb pad to direct them; press **A** to make them blast forward and up, press **B** to make them blast forward and down.

You must aim for the red, swelling blisters on the lizard's hide.

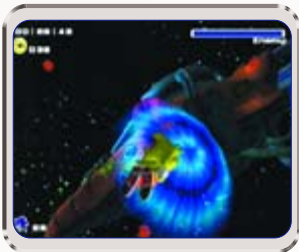

Blast forward and dodge the eggs that swarm after you. It may take some maneuvering, but you can hit the first few easily.

Each time you successfully hit a blister, the Biolizard throws up more defenses. At first it's just eggs, then a beam that repels you if it touches you. After that comes a combination of the two, and more beams. It can get pretty hairy trying to get at those blisters.

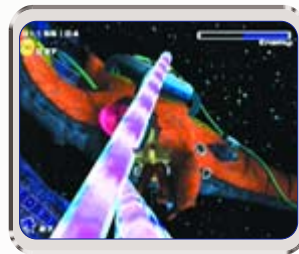

This lizard won't go quietly. Use the analog thumb pad to perform evasive maneuvers and slip under the defenses.

The super forms that the hedgehogs use are powered by rings. The ring counter in the upper-left corner will count down as the rings are used. You must either hit a red blister on the lizard or switch to the other character before the ring counter hits zero.

You can switch between Sonic and Shadow as you fight the Final Hazard. Simply fly under or over the lizard, and you'll swap out characters. Do this when you're running out of rings. It can keep you going indefinitely.



When you're in trouble, simply fly under or over the lizard. Hold **A** or **B** and run under the big jerk.

#### TIP

A good tactic is to swap characters whenever you have been thrown back twice. By being cautious and switching whenever you're low on rings, you ensure that you don't lose a life.



It takes some fast-and-furious maneuvering to hit those blisters at the end. Using the analog thumb pad is a good start, but also alternate pressing **A** and **B** to sweep up and down as you move in. Continue switching characters to avoid losing a life as you make runs at the lizard.

# START YOUR ENGINES

As soon as you successfully complete one of the two car driving Stages—Tails’s Route 101 or Rouge’s Route 280—the Kart Race option opens up for 1P. Beat both the driving Stages, and you can play it 1P or 2P vs. Mode.

The Kart Race is a fun addition to the game that lets you pit your driving skills against the computer and your friends. There are three courses to choose from (and more may be coming from Sega as a download later): Beginner, Standard, and Expert.

The controls are quite simple. Press and hold **A** to accelerate, and **B** or **X** will engage the brakes.

Rather than brake, however, you should control your turns with a slide. As you come to a turn, move into it and release **A** for a second. Then jam it back down and continue turning. Your character will do a short power slide around the corner—very handy for sharp turns.



primagames.com

## THE DRIVERS

Each of the six playable characters has his or her own Kart. Here’s a quick rundown on what you can expect from each.

### Sonic

The hedgehog is a fast driver. His speed is only matched by Shadow, his acceleration is good, and his grip is fine. His braking is low, but hey, who wants to slow down?



### Tails

The fox is quick off the line with very high acceleration. Sustained speed is not his forte, but the decent grip helps maintain control.



### Knuckles

The red guardian isn't the fastest, but his excellent grip helps you negotiate the tight turns.



### Shadow

Shadow’s stats are almost equal to Sonic’s. He’s a great driver for beginning players.



### Dr. Eggman

Robotnik’s stats are very well rounded. For an evil scientist, he’s a very good Kart driver.



### Rouge

This bad bat-girl has a nice set of wheels. Her acceleration is top-notch and her grip is good. Her speed is average.



## THE TRACKS

Here are a few pointers on the tracks. Nothing beats playing the tracks to know how to handle their layouts, but we’ll show you the parts to watch for.

Try to pick up rings as you race the tracks. Every 20 rings you pick up gives you a boost. Press **Y** to boost. Make sure you wait until you reach a straightaway; nothing’s worse than boosting straight into a wall.

### TIP

Boosts don’t stack up. You can only hold one at a time. So if you have a boost at 20 rings, use it before you hit 40 rings.



## BEGINNER

This track is very straightforward. The one thing to watch for is this turnoff just before the start line. It has a Dash Panel that gives you a boost as you pass over it.





## NORMAL

This is the first right-angle turn you face in the Kart Races. Use the slide to get around. Start to turn early. As you turn, release **A** for a second and then jam it down again. It takes some practice.



This is a sharp right turn followed by an immediate sharp left. Once again, start the turn early and use a slide. Use a second slide to get around the left turn.



This hump of road leads to a wide left turn. If you have enough speed, you'll launch into the air. You can still control your Kart, so angle it into the turn to make a little headway as you fly.



## EXPERT

Watch out: There really isn't any guard rail at this sharp turn. Turn early to avoid a dip in the bay.



This rise in the road acts as a ramp. Once again, build up speed and launch into the air. Angle into the turn and you'll shave some time.



This ramp over the gap in the road will send any Kart flying. Some Karts, however, are heavier than others. Tails can clear the gap, but Eggman will fall well short. You can steer in the air, so angle toward the side if you're afraid of falling.



## WHAT ARE CHAO?

For those of you new to the world of *Sonic*, let us introduce you to the cute creatures known as Chao. Strange beings who live in the Chao Gardens, their origin is shrouded in mystery, although some answers can be found in the original *Sonic Adventure*.

Chao can be raised as if they are living creatures. They need food, attention, and exercise. You can shape how they act and mold their personalities.



Cute little fellas, aren't they? You can raise two dozen of them at once, though that would be quite a handful.



There are three basic types of Chao—Neutral, Hero, and Dark—from which you can raise other types.

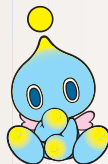

### Chao

Basic Chao Type

All Chao are this type when born.

They can grow into Hero, Dark Chao, or stay Neutral.

### Hero Chao

Chao on the Hero side

These are good Chao children who are warm, kind, and polite.

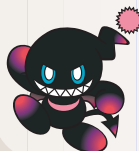

### Dark Chao

Chao on the Dark side

These bad Chao children are violent and like to play pranks. They like dark and mysterious places.



primagames.com

**NOTE**

Depending on how they are raised, there are up to 108 types of Chao!



**BASIC INTERACTION**

To start raising your Chao, you must find the Chao Gardens. Do this by smashing open a Chao Container and picking up the Chao Key during an Action Stage. Then, when you have finished the Stage, you'll be transported to the Garden.

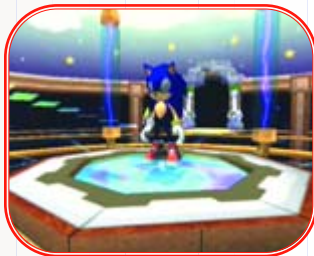

Boom—here you are in the transporter room of the Chao world.

**NOTE**

Characters must pick up a Chao Key in one of their Stages before they can access the Chao Garden through the Stage Select area.



In the Garden you'll find two eggs. To hatch them, pick up and cradle them by holding **Ⓢ** and moving the analog thumb pad.

After doing this, put the egg down and your Chao should hatch, happy and healthy.



A little cuddling is all it takes to make a Chao hatch.

**NOTE**

You can also hatch a Chao by throwing it into a wall, but that's not a nice way to start your relationship.



**OTHER GARDENS**

The first Garden you reach is a nice place with green grass and a waterfall to cool down in. When you have successfully raised a Hero Chao, the Hero Garden opens. If you raise a Dark Chao, the Dark Garden opens.

The regular Chao Garden



The Hero Garden



The Dark Garden

A quick way to raise a Dark or Hero Chao is to bring a character into the Garden—either a Hero character for Hero Chao or a Dark character for a Dark Chao. Have the character hatch a Chao and then pet it continually. Feed it every now and then, but mostly just pet it. It takes a bit of time (an hour or so), but the Chao will start to change color and eventually change.



Here's the basic Hero Chao.



And here's a basic Dark Chao.

It's easier to raise Dark Chao in the Dark Garden and easier to raise Hero Chao in the Hero Garden. You can raise Dark Chao in the Hero Garden, and vice versa, but it takes longer. You can raise eight Chao at a time in each Garden, for a total of twenty-four, which would be quite a handful.

## CHAO ABILITIES

Eventually, you will be able to enter your Chao in races. To prepare them, you must raise their abilities in several categories. There are a few ways to do this.

### SWIM, FLY, RUN, POWER

These four movement abilities can be raised in two ways: with small animals and with Chaos Drives. When you play a Stage, you'll find small animals scattered about. Touch them to pick them up. Also, when you defeat a robot, it will drop a small, colored piece of crystal in a vial. This is a Chaos Drive. Pick them up as well.

Here you can see the small animals and the Chaos Drives in the Garden. When you enter the Garden after completing a Stage, the items you picked up will be dropped off.



Pick up a small animal or Chaos Drive and give it to your Chao. You decide which Chao get which animals and Drives, but before you do, study the charts in this section to learn what each item will do for your Chao.

Plan carefully when giving these items to your Chao. Decide what you want your Chao to be good at, and give them the items that will either enhance those specific skills or shore up weak points.

You can raise them as pets for fun and curiosity, and you can raise and train them to compete against other Chao in races that test their specific skills.

### INTELLIGENCE, STAMINA, LUCK

These three attributes are increased by playing the VMU Chao game, *Chao Adventure 2*.

- **Intelligence** increases if the Smart Fruit is eaten.
- **Stamina** increases if the seed won at the end of *Chao Adventure 2* is planted and the fruit is eaten.
- **Luck** increases if you choose the correct treasure chest and decreases if you choose an empty chest.

The seeds you find in *Chao Adventure 2* can be planted in the Chao Gardens. The fruit that grows should be fed to your Chao to increase Stamina. The plants eventually die, so monitor them to get the most benefit from their fruits.

### NOTE

These three attributes are essential to a well-rounded high-level Chao, so playing the VMU game is very important.



## ANIMAL LOCATIONS BY STAGE

These tables reveal which animals can be found in the various Stages. The tables are organized by Stages.

### SONIC

1: City Escape	Raccoon	Rabbit	Skunk	Sheep	Unicorn
4: Metal Harbor	Seal	Penguin	Peacock	Raccoon	Phoenix
5: Green Forest	Rabbit	Cheetah	Parrot	Raccoon	Half Fish
11: Pyramid Cave	Condor	Peacock	Bat	Sheep	Skeleton Dog
15: Crazy Gadget	Bear	Tiger	Seal	Skunk	Phoenix
16: Final Rush	Peacock	Condor	Penguin	Sheep	Dragon
Cannon Sonic	Cheetah	Rabbit	Parrot	Skunk	Dragon

### KNUCKLES

2: Wild Canyon	Peacock	Condor	Cheetah	Sheep	Dragon
6: Pumpkin Hill	Cheetah	Boar	Bat	Skeleton Dog	Half Fish
8: Aquatic Mine	Penguin	Seal	Condor	Skunk	Dragon
12: Death Chamber	Tiger	Gorilla	Rabbit	Skunk	Skeleton Dog
14: Meteor Herd	Penguin	Seal	Rabbit	Sheep	Phoenix
Cannon Knuckles	Seal	Sea Otter	Cheetah	Raccoon	Unicorn

### TAILS

3: Prison Lane	Tiger	Gorilla	Sea Otter	Sheep	Unicorn
7: Mission Street	Boar	Rabbit	Gorilla	Sheep	Phoenix
10: Hidden Base	Penguin	Sea Otter	Tiger	Skunk	Half Fish
13: Eternal Engine	Condor	Parrot	Boar	Raccoon	Dragon
Cannon Tails	Seal	Sea Otter	Bear	Raccoon	Phoenix

### SHADOW

4: Radical Highway	Cheetah	Boar	Seal	Raccoon	Unicorn
9: White Jungle	Peacock	Parrot	Bear	Skunk	Dragon
11: Sky Rail	Bear	Tiger	Condor	Sheep	Phoenix
14: Final Chase	Sea Otter	Penguin	Tiger	Skunk	Phoenix

### ROUGE

2: Dry Lagoon	Sea Otter	Penguin	Peacock	Sheep	Unicorn
5: Egg Quarters	Gorilla	Bear	Parrot	Skunk	Half Fish
8: Security Hall	Parrot	Condor	Tiger	Raccoon	Phoenix
12: Mad Space	Parrot	Peacock	Gorilla	Raccoon	Phoenix
Cannon Rouge	Boar	Cheetah	Condor	Skunk	Dragon

### EGGMAN

1: Iron Gate	Gorilla	Tiger	Rabbit	Skunk	Dragon
3: Sand Ocean	Parrot	Peacock	Bat	Raccoon	Skeleton Dog
6: Lost Colony	Rabbit	Boar	Bat	Raccoon	Skeleton Dog
7: Weapons Bed	Seal	Sea Otter	Cheetah	Sheep	Phoenix
13: Cosmic Wall	Rabbit	Cheetah	Sea Otter	Sheep	Unicorn
Cannon Eggman	Bear	Gorilla	Seal	Skunk	Unicorn

# THE CHAO PRIMER



primagames.com

## NOTE

An animal's color indicates what attribute it focuses on.



- Swim
  - Fly
  - Run
  - Power

## SMALL ANIMALS AND CHAOS DRIVES

Here is a ton of information about the animals and Drives you can bring to your Chao, and how the little blue guys will be affected by them. As you will see, some animals will boost some attributes while subtracting from others. Have a plan for passing out animals.

### CHAOS DRIVES

Color	Swim	Fly	Run	Power
Yellow	8	0	0	0
Purple	0	8	0	0
Green	0	0	8	0
Red	0	0	0	8

### SMALL ANIMALS

Animal	Swim	Fly	Run	Power
Penguin	18	6	4	-12
Seal	20	-8	0	4
Sea Otter	22	-2	4	-8
Peacock	6	24	-8	-6
Parrot	0	24	-10	2
Condor	-10	30	-12	8
Rabbit	0	4	20	-8
Cheetah	-4	-4	20	4
Boar	-2	-6	16	8
Bear	4	-8	2	18
Tiger	-4	-8	10	18
Gorilla	-2	-4	2	20

### SPECIAL ANIMALS

Animal	Swim	Fly	Run	Power
Skunk	4	6	6	4
Sheep	4	6	10	10
Raccoon	10	6	2	4

## NOTE

Special animals don't reduce any attributes.



### GHOST ANIMALS

Animal	Swim	Fly	Run	Power
Half Fish	16	0	4	12
Skeleton Dog	4	4	16	8
Bat	4	20	4	4

### IMAGINARY ANIMALS

Animal	Swim	Fly	Run	Power
Dragon	10	2	4	16
Unicorn	8	6	18	0
Phoenix	6	16	2	8

## ANIMAL TRAITS AND ACTIONS

You can tell which animals you've given your Chao by the actions the Chao learn and the physical traits they acquire. Here's a quick list of what to expect from your Chao when they receive certain animals.

### CHAOS BEHAVIOR LEARNED FROM SMALL ANIMALS

Animal	Action	Animal	Action
Bear	Roar	Phoenix	Tail-wagging
Boar	Dashes	Rabbit	Hops around
Cheetah	Face washing	Raccoon	????
Condor	????	Sea Otter	Swims on back
Dragon	Breathe fire	Seal	Rolls around
Gorilla	Drumming (beats chest)	Sheep	Somersault
Parrot	Sings	Skunk	Gas
Peacock	Struts/haughty	Tiger	Sharpens nails
Penguin	Slides on belly	Unicorn	Bucking

## LIFE IN THE GARDEN

Things are usually peaceful in the Chao Gardens. Time passes only when one of the characters is actually in a Garden, so you don't have to worry about your Chao while you're out playing.

When you spend time with the little guys, you can pet them and pick them up to show them you care. Cycle through the Action menu by using  $\odot$ , and use  $\textcircled{B}$  to execute the action.



A quick hug and nuzzle can put a Chao into a good mood. If it squirms, though, put it back down.

Chao have moods that are indicated by symbols that appear above their heads. You can also tell how they're doing by their facial expressions and their actions.



This Chao is happy. The heart above it means it's healthy and having a good time.

Note the scowl and stance of this Chao. It's in the middle of a tantrum. You'd better take care of it.



Chao love nuts. Luckily, there are nut trees in the regular Garden. The nuts grow as time passes and fall randomly, or you can grab hold and shake the tree to knock them off. Pick up a nut and give it to a Chao to boost the Chao's mood.



Grab a tree by standing next to it and pressing **Ⓢ**. Shake it by holding the analog thumb pad in any direction.

Continue giving attention to your Chao and bring them into the VMU for the adventure. Provide them with animals and Chaos Drives to boost their skills, and eventually they will metamorphose into the different types of Chao.

### NOTE

Different trees sprout different fruit in the Hero and Dark Gardens. Treat them the same as the nut trees.



## CHAO KINDERGARTEN

In the Chao world lobby you'll see a door to the Chao Kindergarten. Enter the school either to find out more detailed information about the Chao you are raising or to teach them new skills.



### PRINCIPAL'S OFFICE

The principal of the Chao Kindergarten, Professor Chao, can give you tips on raising and caring for your Chao. He is a wealth of knowledge on everything from seeds to racing. Drop by for a visit as soon as you can.



### BULLETIN BOARD

The Bulletin Board allows you to access the online BBS. You can swap stories and tips with other people who are raising Chao around the world.



## CLASSROOM

The Classroom is where your Chao learn different skills. Pick up a Chao from a Garden and carry them to the Kindergarten to learn.



## HEALTH CENTER

You can bring your Chao here and have the nurse examine it. You'll learn what the Chao's strengths or weaknesses are. That information can guide your choices of which animals or Chaos Drives to give your Chao.



### TIP

Try to raise Chao with specialized abilities. Have a running Chao, a swimming Chao, and so on. Doing this will give you competitive Chao to tackle whatever is thrown at you.



## CHAO RACES

Chao aren't just cute little pets; they're also fierce competitors in various races. Many courses are available for them to compete on, but you must first tackle the Beginner race.

All the races are tests of the various Chao abilities, and each race focuses on one particular ability. For example, the Crab Pool course is a swimming competition. Plus, each race has different levels. The higher the level, the better the opponents.

Here is the menu for the Beginner race. Each course challenges a different ability.



This plucky little guy has won all the Beginner races. Note the medal on his chest.





primagames.com

**CHAO RACE FLOW CHART**

Here's a quick overview of how the races are structured. It's a simple system.

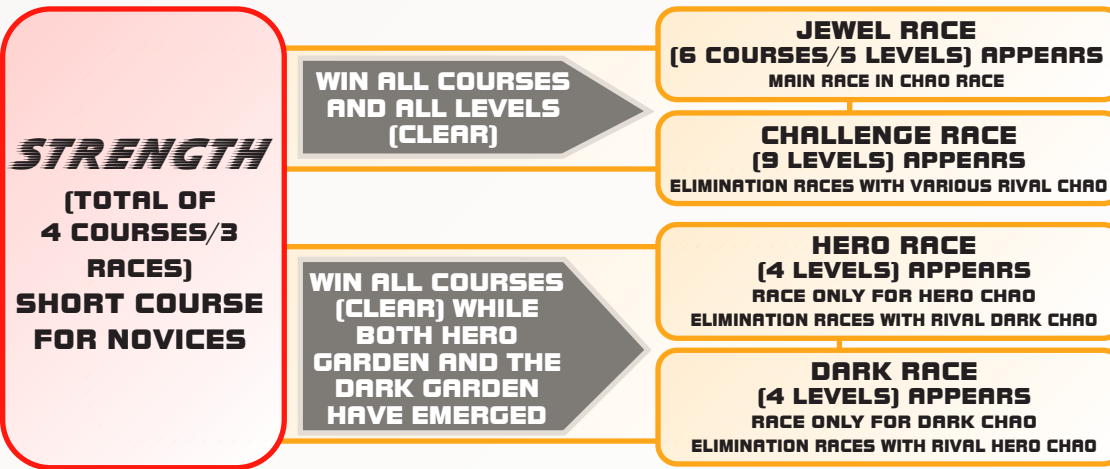

**ALL CHALLENGER RACE**

MULTI-ENTRY RACE FOR A MAXIMUM OF 8 CHAO. YOU CAN ONLY CHOOSE THOSE COURSES THAT HAVE ALREADY APPEARED

**ENCOURAGE CHAO**

YOU CAN ENCOURAGE CHAO DURING THE CHAO RACE. IF YOU PRESS THE **R** or **L** TRIGGER ON THE CONTROLLER DURING THE RACE, CHAO WILL SPEED UP. CHEER ON YOUR CHAO WITH EFFECTIVE TIMING, AND ENCOURAGE IT WHEN IT GETS THE GEOGRAPHICAL AREA THAT IS ITS SPECIALTY. WHEN CHAO ARE ENCOURAGED, STAMINA IS USED. IF STAMINA TOTALLY DISAPPEARS, CHAO WILL LOSE.

**RACE TIPS AND INFO**

As mentioned before, you win various items for completing races. Most important, though, is that you can win 10 of the 180 Emblems through the Chao races. So if you're looking to complete your Emblem collection, you better get into the racing mood.

You can encourage your Chao by using **L** or **R**. Be careful, though; each time you encourage the Chao, it strains and uses up stamina. It's important to keep an eye on your Chao's Stamina bar while racing. It will lower slowly as the race continues, and when the Stamina bar is empty, your Chao will slow down. Don't use it all up by constantly encouraging.



Note the exclamation point over the Chao's head. That shows up every time you press **L** or **R**.

Stamina is very important for the races. Make sure you raise it as often as possible. You want enough to last for the longer races and still have some left over for a burst of speed at the end.

**TIP**

You can gain seeds from the Chao Adventure 2 VMU game. Plant the seeds, and special plants will grow and sprout fruit. Feed those fruit to your Chao to raise their stamina.



**AND SO...**

Your Chao can provide hours of fun and amusement. Raise them well and they'll love you for it. Remember that there are many different types you can raise, so don't just stick to one formula. Keep at it and you'll be a champion trainer, raising cute, winning, and strong Chao.



You'll soon see your little buddies in the winner's circle. Good luck!

**TWO-PLAYER MODE**



**HEAD TO HEAD**

Want to share the thrill of Sonic Adventure 2 with your friends? Now you can. Three areas let you compete against your friends, pitting character against character in direct combat and tests of skill.

## ACTION STAGES

Sonic Adventure 2 lets you play aspects of the game against your friends. The counterparts of the Hero and Dark Characters are paired (for example, Sonic with Shadow) to compete against each other in three Stages. This creates nine Action Stages, all of which are taken from the main game.

You can compete with Sonic vs. Shadow in a foot race, Tails vs. Dr. Eggman in a shooting match, or Knuckles vs. Rouge in treasure hunting. Each pair has three stages in which to compete.

### ACTION STAGES

SONIC VS. SHADOW	KNUCKLES VS. ROUGE	TAILS VS. DR. EGGMAN
Green Forest	Wild Canyon	Mission Street
Radical Highway	Pumpkin Hill	Sand Ocean
Sky Rail	Meteor Herd	Weapons Bed

## SONIC VS. SHADOW

Knowing the levels is the best strategy for beating your opponent in the races. Luckily, the levels are almost the same as in the main game, so you don't have to learn new courses. Be aware of where enemies appear and run past them. Smashing robots requires time you don't have.

The split view can take some time to become accustomed to. It cuts off some of your side view. Give it a few tries to get used to it.



### SONIC AND SHADOW SPECIALS

SONIC ABILITY	SHADOW ABILITY	RINGS NEEDED
Speed Up	Speed Up	20
Sonic Wind	Chaos Spear	40
Time Stop	Chaos Control	60

These abilities cycle: you receive a Speed Up at 20 rings and again at 80 rings. You get Chaos Spear at 40 and 100 rings, and so on. As soon as you get an ability, press **Ⓢ** to use it.

Speed Up makes your character run faster. Sonic Wind and Chaos Spear blast your opponent, stunning them and making them lose their rings. Time Stop and Chaos Control literally stop time for your opponents, freezing them for nine seconds. Take advantage of these gifts.



The Time Stop and Chaos Control put a crimp in your foe's stride.

To rule at the races, study them in the Two-Player Mode. There are important differences and several places where you can outpace your opponent. Know the road to kick butt.

If you can reach this Pulley in Radical Highway (Sonic is on it in this screen) before your opponent, force him or her to hop up the Boxes or wait for the Pulley, either of which will slow them down.



## KNUCKLES VS ROUGE

Once again, the competition areas are taken from the main game. Know them well to have an edge. The tricky bit in the treasure hunting games is that you're both going after the same Emerald Shards. Whoever gets two out of the three Shards wins the match. Remember that when you use Hint Boxes, your opponent is also able to see the hint.

The hint is available to both players. There's no way to hide it, but maybe you know more than your opponent does about the level and can figure it out more quickly. It's a risk.



Both Knuckles and Rouge have abilities and attacks that can hamper your opponent's progress. You "charge up" these special abilities by collecting rings.

### KNUCKLES AND ROUGE SPECIALS

KNUCKLES ABILITY	ROUGE ABILITY	RINGS NEEDED
Hammer Punch	Hip Drop	20
Thunder Arrow	Black Wave	40
Power Flash	Charm Ray	60

These abilities cycle: you receive a Hammer Punch or Hip Drop at 20 rings and again at 80 rings. You get Thunder Arrow or Black Wave at 40 and 100 rings, and so on. As soon as you get an ability, press **Ⓢ** to use it.

The Hammer Punch and Hip Drop are like a long-range punch. They'll knock your opponent down for a moment. Thunder Arrow and Black Wave blast your opponents, making them lose their rings and confusing them for a bit. Power Flash and Charm Ray stop time for your opponent, freezing him or her for nine seconds.

Notice the little stars over Rouge's head? Those are the after-effects of a Thunder Arrow. As long as those stars are there, Rouge's directional control will be wonky.



There's no substitute for knowing a level inside and out. Keep a sharp eye on the radar to zero in on the Emerald Shards. Don't Dig for rings; digging consumes time. Stick with the rings you can find lying around.

## TWO-PLAYER MODE

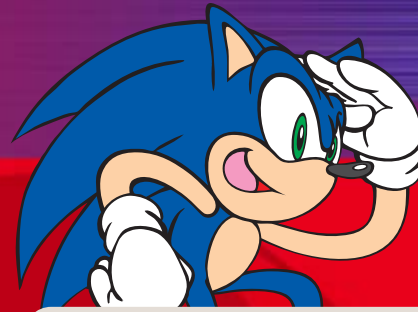

primagames.com

## TAILS VS. DR. EGGMAN

The arenas for the slugfests between the two robot riders are small and intimate. These two characters blast it out in confined spaces. The areas are taken from the main game, but they are packed with new items and object. Play them each a few times to get the feel of where things are.



The camera angles change depending on how far away the two characters are. You can see most of the playing area in this screenshot.

Both Tails and Dr. Eggman have abilities and attacks that hamper your opponent's progress. You "charge up" these special abilities by collecting rings.

More details on handling the Karts appears in "Kart Race" earlier in the guide. To improve your racing, learn each of the maps. If you play them enough, you can anticipate curves and avoid tricky turns. Master the layout to win.

## TAILS AND DR. EGGMAN SPECIALS

TAILS ABILITY	DR. EGGMAN ABILITY	RINGS NEEDED
Laser Missile	Laser Missile	20
Rocket Launcher	Rocket Launcher	40
Power Laser	Power Laser	60

These abilities cycle: You receive a Laser Missile at 20 rings and again at 80 rings. You get Rocket Launcher at 40 and 100 rings, and so on. As soon as you get an ability, press **B** to use it.

The Laser Missile is like a barrage of the targeted blasts the two walkers use. The Rocket Launcher is a bank of rockets that shoot out the back of the vehicle and fall on your opponent. The Power Laser is a huge laser blast that knocks the wind out of your foe. All these attacks will make the targets drop whatever rings they have.



When the Power Laser is firing, you can't aim it. There's a second after you hit **B** that you can align yourself with your opponent. After the beam starts, though, you're stuck.

The rings are limited in the shooting battles. It's difficult to scramble after them as your opponent takes you to pieces. However, the rings also heal damage you take. So, balance between fighting and grabbing the golden hoops.

### TIP

Every one of Tails's and Eggman's special attacks can be avoided. A timely Spring jump or some fancy footwork confounds the attacks. So, line up and get close before you fire.



## KART RACE

You can play a versus game with the Karts. Select the Kart Race option, choose your characters, and race away.



Here you can decide whose Kart you will control.

## CHAO RACE

You have your Chao and your friend has Chao he or she has raised. Perhaps you might want to pit them against each other? This is the place to do it. Set up with Chao from a VMU or the Chao Garden and watch the little critters go.



They are all so darn cute. How can you choose which one to root for?

More details on the raising and racing of Chao appear in "Chao" earlier in this guide. Become familiar with the raising techniques to bring up a champion Chao racer.

## SECRETS

### THE HIDDEN LAND

Sonic Adventure 2 has a few surprises for you. They aren't easy to earn, but it's worth it. There are 180 Emblems you can earn in the game. Kart Racing, Chao Racing, the Boss mode, and the Stage Select mode all have Emblems you can earn. Hardest of all, though, is earning the Emblem for getting all A ranks. There are five Missions for each Stage in the Stage Select mode. If you can earn an A rank on each and every one, you earn special Emblems. It's a heck of a task to complete, but it's worth it.

Once you've earned all the Emblems, you'll unlock the extra Stage.

Notice that green island on the Stage Select map? It hides a secret that takes a lot of work to uncover.



### THE HIDDEN LOOKS

If you complete every Mission in every Stage for a specific character, you may find something rather interesting when you open the Two-Player Mode.