

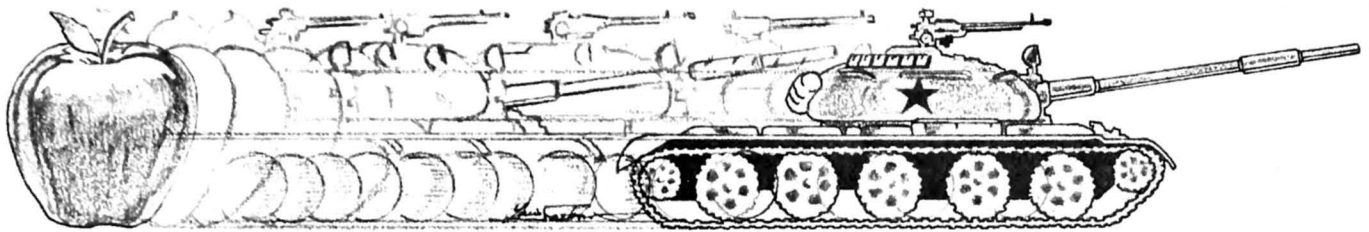

The Apple and Cable TV



Exec On-Line
Bill Budge—A Portrait
The Pascal Path: Part 1
Bestsellers



HOW TO TURN AN APPLE INTO A TANK.

With **Computer Conflict™** and a little imagination, we'll transform your staid and respectable Apple computer into the fearsome war machine of the Soviet Red Army. Computer Conflict actually consists of two fast-paced, action-packed war-games played on full-color mapboards of Hi-Res graphics: **Rebel Force** and **Red Attack!**

REBEL FORCE puts you in the role of a Soviet commander whose regiment must face a computer-directed guerrilla uprising which has overrun a vital town. Armed with your tank, heavy-weapons, and infantry units, your mission is to regain the town through the annihilation of the Rebel Force.

Your advance will be brutally opposed by minefields, ambushes, militia, and anti-tank guns — all skillfully deployed by your computer. Survival and success of your units will depend on your ability to take advantage of the variable terrains — open, forest, and rough — each of which has different movement costs and shelter values.

In this finely-balanced solitaire wargame, every move is played under real-time conditions: Procrastinate and lose. At

the same time, caution cannot be cast aside; severe unit losses will only result in a Pyrrhic victory at best.

With its five levels of difficulty (plus one where you make up your own), the computer can and will stress your tactical skills to their fullest.

RED ATTACK! simulates an invasion by a mixed Soviet tank and infantry force against a defending battalion. As the defender, your task is to deploy your infantry units effectively to protect three crucial towns — towns that must not fall!

As the Russian aggressor, your objective is to crush the resistance by taking two of these three towns with your tanks and infantry. With control of these strongpoints, the enemy's capitulation is assured.

Red Attack! is a two-player computer simulation of modern warfare that adds a nice touch: At the start of each game, the computer displays a random setup of terrains and units, providing every game with a new, challenging twist.

Computer Conflict, for \$39.95, comes with the game program mini-disc and a rule book.

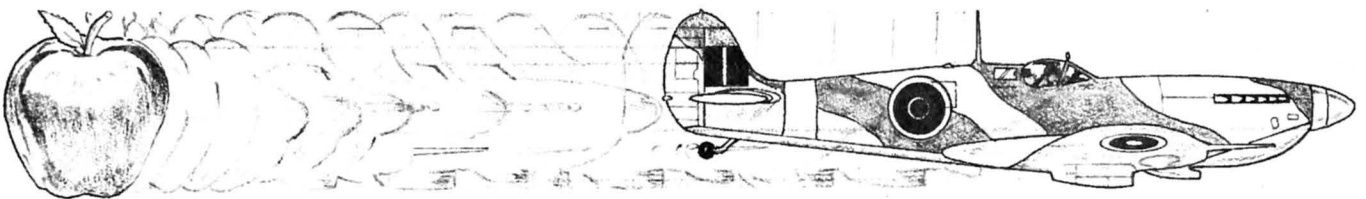

OR A SPITFIRE.

After you're done playing Computer Conflict, you may be in a mood for something other than ground-attack wargames. In that case, **Computer Air Combat™** is just what you need.

With Computer Air Combat, your screen lights up with an open sky generated by Hi-Res graphics offering global and tactical plots. Squint your eyes a bit, let loose your mind, and you'd swear your keyboard has melted into the throttle, rudder, altimeter, and other cockpit instrumentation of a World War II combat plane. In fact, any of 36 famous fighters or bombers, from a Spitfire and B-17 Flying Fortress to the Focke-Wulf 190 and A6M5 Zero. Each plane is rated — in strict historical accuracy and detail — for firepower, speed, maneuverability, damage-tolerance, and climbing and diving ability.

Practically every factor involved in flying these magnificent airplanes has been taken into account, even down (or up?) to the blinding sun. Climb, dive, twist, and turn. Anything a real plane can do, you can do. However, the computer prevents all "illegal" moves — such as making an outside loop (which in real life, would disastrously stall a plane).

PLAY THE COMPUTER. Aside from being the game's perfect administrator and referee, the computer will serve as a fierce opponent in the solitaire scenarios provided: Dogfight, Bomber Formation, radar-controlled Nightfighter, and V-1 Intercept. There's even an Introductory Familiarization Flight (with Air Race option) to help you get off the ground.

With the number and type of planes and pilot ability variable, you can make the computer as challenging as you want to give you the ultimate flying experience.

PLAY A HUMAN. Two can play this game as well, in dogfights and bomber attacks. Given a handicap of more or better planes or an ace pilot (or all of the above), even a novice at Computer Air Combat stands a chance to defeat a battle-hardened veteran.

For \$59.95, Computer Air Combat gives you the game disc, a rule book, two mapboard charts (for plotting strategies between moves), and three player-aid charts.

Credit card holders, if you own an Apple® II 48K (Apple soft ROM) and a mini-floppy disc drive, call **800-227-1617 ext. 335 (toll free)** and charge your order to your VISA or MASTERCHARGE. In California, call 800-772-3545, ext. 335.

To order by mail, send your check to:
Strategic Simulations Inc, Dept. S, 465 Fairchild Drive,
No. 108, Mountain View, CA 94043. All our games carry a 14-day money back guarantee to assure your satisfaction.

While you're at it, you can also get our other games:

- Computer Bismarck** for your Apple: \$59.95
- Computer Bismarck, TRS-80® 48K Disc:** \$59.95
- Computer Bismarck, TRS-80 32K Cassette:** \$49.95
- Computer Ambush** (a tactical simulation of man-to-man combat in WWII) for your apple: \$59.95
- Computer Napoleonic**, the Battle of Waterloo for your Apple: \$59.95
- Computer Quarterback** (a real-time strategy football game): \$39.95



Chairman John Haller
 President Margot Comstock Tommervik
 Vice-President Al Tommervik
 Vice-President William Depew
 Treasurer William V. R. Smith
 Secretary John Mitchell
 Editor Margot Comstock Tommervik
 Technical Editor William Depew
 Contributing Editors Roger Wagner James A. Merritt
 Art Director Kurt A. Wahlner
 Production Manager Al Tommervik
 Business Manager William V. R. Smith
 Operations Manager John Mitchell
 Editorial Assistants Robert Koehler Patrick J. Ratchford
 Advertising Sales Al Tommervik 213-980-5074 Margot Tommervik Bill Smith
 Cover photo of the Cible News Network control room and news studio by Rob Bornes.

Composition by Photographics, Hollywood, California. Printing by California Offset Printers, Glendale, California.

Apple is a trademark of Apple Computer Inc., Cupertino, California.

UCSD Pascal is a trademark of the University of California at San Diego.

Subscriptions to *Softalk* are complimentary to all owners of Apple computers in the USA. Back issues, \$2; November and December issues are sold out; multiple or non-Apple-owners subscriptions for one year: one, \$10; two through five, \$8 each; more than five, \$6 each.

Softalk, Volume 1, Number 6, Copyright © 1981 by Softalk Publishing Inc. All rights reserved. ISSN: 0274-9629. *Softalk* is published monthly by Softalk Publishing Inc., 10432 Burbank Boulevard, North Hollywood, CA 91601. Tel. (213) 980-5074. Controlled circulation postage paid at Los Angeles, CA. Postmaster: Send address changes to *Softalk*, 10432 Burbank Boulevard, North Hollywood, CA 91601.

ADVERTISERS INDEX

Advanced Business Technology 3
 Beagle Bros. Software 44
 Book 1981 20
 Broderbund Software 42
 California Pacific Cover 3
 Computer Station 27
 Continental Software 2
 Dakin5 23
 Eastern House Software 40
 Edu-Ware Services 10
 FSI 9
 High Technology 5
 Howard Software Services 11
 Image Computer Products 15, 26
 Information Unlimited Software 7
 Lanari Investment 6
 Micro-Ware 35
 Microlab Software 33
 Microsoft 13
 MicroStand 18
 Moneydisk 25
 MUSE Software 21
 On-Line Systems 32, 38, 43, Cover 4
 Progressive Software 19
 Rainbow Computing 16
 Sirius Software 29, 31
 Softape 37
 Sophisticated Microsystems 41
 Southwestern Data Systems 39
 Spectrum Software 28
 Stellation Two 36
 Strategic Simulations Cover 2
 Synergistic Software 8, 12
 Technical Analysis Group 17

Exec On-Line Systems

In six months, this husband and wife company has come from nowhere to the top of the bestseller list for entertainment programs—and stays there.

AL TOMMERVIK 4

The Pascal Path

Introducing a beginner-level tutorial in Apple Pascal written by Apple Computer Inc.'s senior technical adviser for Apple Pascal.

JAMES A. MERRITT 14

The Apple and Cable TV: Growing Up Together

The Apple has eased the production and business end of cable television since its inception. Now, new technology sends the Apple's graphics directly to the video waves.

MARGOT COMSTOCK TOMMERVIK AND ROBERT KOEHLER 22

Computer Living: The Apple as Homemaker

The Future Today: A look at the Apple-run home to be, and how a new program can have your Apple running your food planning today.

RICHARD L. COLEMAN, Ph.D. 30

The Miraculous Modem

First in a three-part series on the uses and advantages of having a modem.

JEFFREY MAZUR 34

Portrait of a Programmer

Closeup—in photograph and interview—of popular programmer Bill Budge.

ROBERT KOEHLER AND KURT WAHLNER 40

DEPARTMENTS

More Contest Winners 2
 Contest 3
 Open Discussion 8
 Tradetalk 12
 Marketalk: News 16
 Assembly Lines: Rager Wagner 26
 Marketalk: Reviews 37
 Softalk Presents the Bestsellers 43

PREVIEWS

Remarkable about March ... Women—in an industry too young to be prejudiced ... programming women designing women, engineers ... en, managing women ... but all Apple com ... Exec Apple, Jean ... the Women of Apple ... omp ... tive review, the five ... boards ... Assembly Lines ... The Pascal Path, Part 2 ... and

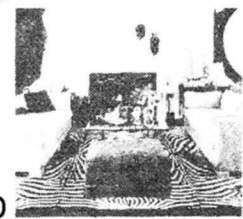
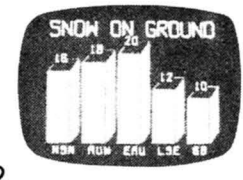
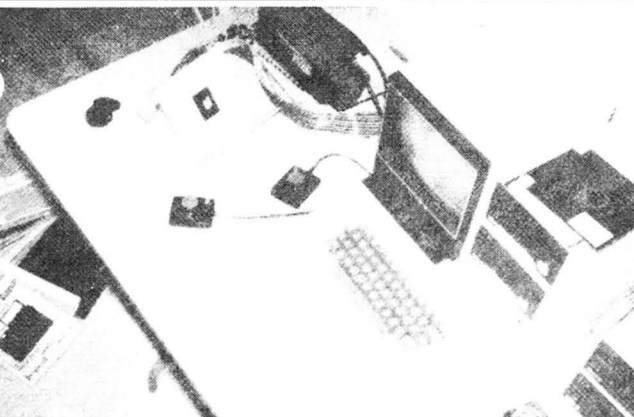

Some Contest Winners... Some Predictions...

According to *Softalk* readers, Robert DeNiro, Mary Tyler Moore, and *Ordinary People* are ticketed for Oscars. Those were some of the results of the December Oracle contest, which will actually run for a full year before an overall winner is declared.

The first preliminary winner, the one who came closest to predicting the combined winning margins of the Rose Bowl and Super Bowl games, will be announced in the March issue.

All three Oscar predictions were the result of landslide votes. DeNiro received four times the votes of runnerup Peter Sellers. Closely following Sellers were Robert Duvall and Donald Sutherland.

Mary Tyler Moore received three times the votes of Sissy Spacek, who received fairly strong support. Shirley MacLaine was a distant third with no other actress receiving as many as fifteen votes.

Ordinary People doubled the vote totals of *Raging Bull* in the best movie race. The two movies were clearly consensus choices of Apple owners—receiving more than 80 percent of the ballots.

Most Oracles figured the average winning speed in this year's Indianapolis 500 would be in the range of 160-170 miles per hour. Because most entries broke the

speed down to a fractional time, i.e., 165.05 mph, there were very few duplications. Amazingly, however, five individual entries predicted 162.7 mph as the winning average speed.

The tightest cluster of predictions of the price of Apple stock on July 30, 1981, range in the \$30 to \$50 range. One pessimist thought the stock would have dropped to eighty cents by that time, while the most optimistic seer saw a price of \$215.25. Closest thing to a consensus was \$35, predicted by four people.

Apple owners have just about conceded the World Series next fall to the New York Yankees. They received three times the votes of the Kansas City Royals to become the American League standard bearer, and four times the votes of the Royals to win the Series.

The Philadelphia Phillies, Houston Astros, and Los Angeles Dodgers all received strong support as the National League winner.

Closest of the preliminary contests, with the widest spread of support for the most candidates, was which company would have the most programs in *Softalk's* Top Thirty during the 1981 year.

Automated Simulations led Personal Software by only three votes in this category. Apple Computer Inc. and On-Line

Systems tied for third, only ten votes further back.

Old Business Closed Out. Jordan Mechner of Chappaqua, New York, and Ronald Bohatch of Waukegan, Illinois, were the other winners of the September Conpeople contest. Mechner was the east coast region winner and Bohatch was the winner chosen from all other correct entries. Prize was a copy of Stoneware's *Bloody Murder*.

Correct answers were that Henry Gondorff was the con man played by Paul Newman in *The Sting* and Christine Vole was the character played by Marlene Dietrich in *Witness for the Prosecution*.

Prisoner Solved. Theron Fuller, Alexandria, Virginia, was the first entrant to submit a correct solution to the *Prisoner* program from Edu-Ware. Only five other correct entries have been submitted. Look for his review of the program—without giving away the solution—in March's *Softalk*. □

Who Is Lord British? Second Clue

The mystery of the true identity of Lord British, author of California Pacific's *Akalabeth*, remains unsolved. *Softalk* is offering a fifty-dollar reward to the first person who correctly identifies him.

This month's clue: **Lord British attends the largest university in the state of friendship.**

Guesses as to his identity should be sent to *Softalk*.



REVOLUTIONARY PROGRAMS FROM CONTINENTAL SOFTWARE

for your Apple Computer

✓ THOROUGHLY TESTED ✓ WELL DOCUMENTED
✓ WRITTEN BY PROFESSIONALS ✓ USER ORIENTED

AVAILABLE NOW!

L.A. LAND MONOPOLY \$29.95

The object of *L.A. Land Monopoly* is to become the richest player in the game in terms of total assets—cash, property, and buildings—and to drive all your opponents into bankruptcy. Hi-Res Graphics!

HYPERSPACE WARS \$29.95 48-K TREK

The Terraunion is being attacked by a deadly Klepton invasion force. As commander of the United Starship Excalibur, it is your mission to destroy this invasion force. Hi-Res Graphics!

3-D SPACE BATTLE

A high resolution three dimensional space game where the player searches for an alien ship using the on-board scanners.

THE MAILROOM \$29.95

★ Up to 650 names per disk. ★ Ability to sort on any of 12 items and/or special sorts on a portion of total entries. ★ Prints labels 1, 2, or 3 across. ★ Sorts names in 1-6 seconds.

THE HOME MONEY MINDER \$34.95

★ Transactions for month by each type of expense: check, credit card & cash. ★ Transactions for month by check, credit card and cash sorted by budget category. ★ Bank reconciliation. ★ Budget for year. ★ Comparison of total expenses for month and year to date sorted by budget category.

Complete Program \$175

We challenge the competition with the first revolutionary general ledger program for the Apple that your accountant will like as much as you will.

GENERAL LEDGER

Manual Only \$15

★ Complete step-by-step instructions ★ Automatic double-entry ★ Complete audit trails ★ Menu Driven ★ Easiest to use by far ★ Hi-Res charting of all accounts ★ Maintains Complete Year's history of all transactions ★ Excellent error-checking

See All CONTINENTAL SOFTWARE at your Local Dealer or Order from
CONTINENTAL SOFTWARE

30448 Via Victoria Rancho Palos Verdes, CA 90274 Phone (213) 371-5612

California residents add 6% sales tax. Apple is a registered trademark of the Apple Corporation





Computer Solutions, a retail store in San Antonio, Texas, conducted a Wizard and Princess contest. Basis of the contest was measurement of elapsed time between the time the program was purchased and the time the user returned with verifiable proof that he had solved the adventure. The winner (left) was Ronald Baeger. Making the presentation is Dave Speer. Baeger received a thirty-five dollar gift certificate.

CONTEST: THE UNKNOWN A

This month's contest should please the mathematicians among us—but you don't have to be a number nut to solve it. Anyone can do it.

The equation results in a number, *A*, which has reason to be familiar to all of us, although not necessarily so familiar that you won't have to do some sharp—or crafty—thinking and a bit of searching to find out why.

Identifying the significance of the number represented by *A* is part of the answer required to win the contest.

Of course, to identify its significance, you must discover the value *A* represents. This you accomplish by filling in the values for the letters in the formula from the clues given, then working out the formula. The number represented by *A* is the other essential answer to the contest.

Here is the formula, followed by the clues. Have fun.

$$A = \frac{4Kmc^d(x + y)}{w}$$

K = ____ . *K* is a prime number; a bust hand in cribbage; 00010011.

m = ____ . *m* is the square root of the number of years Marilyn Monroe lived; the Constitutional amendment guaranteeing speedy public trial by impartial jury; FILE NOT FOUND.

c = ____ . *c* is the number of witches of Endor; number of heavenly bodies involved in the most propitious aspect in astrology; CHR\$(51).

x = ____ . *x* is lowest integer whose cube is a different integer's square; num-

ber of "horsemen" in Notre Dame's 1920-1923 backfield.

y = ____ . *y* is true, according to Apple; eyes of a cyclops; difference between hex locations to initialize Integer Basic and Applesoft ROM.

w = ____ . *w* is the number of floors in On-Line Systems's new office building; number of the pin controlling paddle 0 button on Apple game I/O connector.

Substitute numbers (all are positive whole numbers) for letters according to clues. Solve the formula. Determine the significance of the number represented by *A*. Fill in the coupon and mail it in.

There are several clues for each letter; if you get the answer from one clue for a letter, you need not solve the other clues for the same letter (except to check yourself). Do *not* combine the answers to the clues for one letter to reach the value of that letter; the purpose of multiple clues is to give you several shots at a single answer for that letter. All clues for one letter will render the same number.

Prize is \$100 worth of products from February's *Softalk* advertisers at your local retail store. Ties will be settled by Apple's random generator. A sweepstakes will be held, also using the random generator, among all entries that submit the correct solution to the formula, regardless of whether they correctly identify the significance of *A*. Winner of the sweepstakes will win \$25 worth of product from our advertisers.

Deadline is March 15, 1981. ■

Mail your entry to The Unknown A, 10432 Burbank Boulevard, North Hollywood, CA 91601.

A = ____ . The significance of *A* is: _____.

The prize I'd like if I win the contest is _____.

If I win the sweeps, I'd like _____.

Name: _____

Address: _____

City/State/Zip: _____

Local Retailer: _____

Your Autograph: _____

(Contest is open to all Apple owners and their immediate families except those in any way associated with *Softalk* or employed by Apple Computer. Use of computers in deriving answers to this contest is strictly encouraged. Multiple entries are acceptable, but only one per coupon. Photocopies of the coupon are okay, as are handwritten copies on old parimutuel tickets, used grocery lists, or the backs of heretofore unknown signed Old Masters, whatever, as long as they're legible and reproduce the entire coupon.)

IMPROVE Your Data Entry!

With ABT APPLE* Peripherals

BarWand™



Compatible with U.P.C., Paperbyte**, LabelCode and others. It sells Point-of-Sale inventory systems, but is also useful in libraries, factories and for security.

KeyPad™



Used for entering numeric data, it is essential to business applications. It features an accountants keyboard layout and permits a relaxed arm position.

SoftKey™



A great programmer's aid, this features single key string entry and also customized key functions.

Available from your local APPLE* Dealer



ADVANCED BUSINESS TECHNOLOGY, INC.

12333 Saratoga Sunnyvale Rd., Saratoga, CA 408/446-2013

*Trademark of APPLE COMPUTER, INC.
**Trademark of McGRAW-HILL



Left: Roberta and Ken Williams. Right: John Heuer, On-Line's northern California distributor. Family resemblance is not coincidental—he is Roberta's father.

Exec On-Line Systems

Adventures in Program

BY ALLAN TOMMERVIK

In the world of the programming cognoscenti, the name of Ken Williams is much honored—with good reason.

Williams is one of the first programmers, independent of those at Apple Computer Inc., to step down from higher-level languages to those used on the Apple. It hasn't been much of a comedown for him, since he does most of his programming in assembly language; but he's still one of the few programmers who have made the switch from the big mainframes and minis to the microcomputers.

Actually, He's the Man Behind the Woman. The success of On-Line Systems and Williams's programming prowess have been synonymous. Almost totally overlooked has been the second half of the On-Line Systems team, Roberta Williams.

Yet the fact is that there would probably be no On-Line Systems—and if there were, it would have a totally different product line—had it not been for Roberta.

The genesis and evolution of the company defies even the word serendipity to describe adequately what occurred.

Ken was busy with five other programmers attempting to develop a Fortran compiler for the Apple II. Understand that this was a part-time project, but the six of them were getting in plenty of time trying to perfect the product.

While this was occurring, Roberta discovered and mastered Microsoft's *Adventure* and fell in love with the genre. She bought Softape's *Journey* and every Scott Adams adventure that was released. She loved them all, and then there were none left.

Creative Genius on Distaff Side. So while Ken and his cronies were futilely wrestling with the Fortran compiler, Roberta sat down and wrote the scenario of a mystery—the one Apple owners now recognize as *Hi-Res Adventure #1: Mystery House*.

Having finished the scenario, she presented it to Ken in hopes that he'd do the programming to convert the scenario to

an Apple program. But Ken had no time for such frivolities as programming mysteries for the Apple—he was still determined to best the Fortran problem.

Finally, after much persistence on Roberta's part, he agreed to have a look at the scenario. Together they decided that if the scenario was to be put to computer code, it would need something to distinguish it from other adventures then on the market. They determined that hi-res graphics could serve that purpose.

But Ken was still somewhat leery of the commercial potential of the scenario and of wasting his time on mere entertainment. At Roberta's insistence, he called Programma's Dave Gordon for an insight into the commercial possibilities for a hi-res adventure.

Programma's Gordon Turned the Tables. Gordon assured Ken that he could sell five hundred programs per month if the final product matched the description he was given. Ken, who's no dummy with figures, a pencil, and some paper, immediately decided that if Gordon was correct, the program could serve as a springboard for a new company.

On-Line Systems was formed with *Mystery House* as its first product and it's been going great guns since. In the ten months it has been in business, On-Line has placed three programs on *Softalk's* Top Thirty and has developed other product that sells regularly.

But it was Roberta's enchantment with *Adventure* that started it all. "When I finished *Adventure*, it was as if a new world was open to me. I couldn't believe it. I played all the other adventures and they were fun, but they didn't match the original."

With no sign of mock humility, Roberta pronounces the same judgment on her first three mysteries—fun but no match for *Adventure*.

What she contemplates now is a monster mystery. Orig-



Brian Wilkinson photos

Programming

nally, it was planned to be a multiple diskette adventure with multiple possible endings. Now she reports that the project has metamorphosed into "the hardest adventure I can make, so it won't have multiple endings. I'll probably do that next in a shorter adventure."

Founded in Literature. Roberta takes her foundation from literature. *Mystery House* was based on Agatha Christie's *Ten Little Indians (And Then There Were None)* and the board game *Clue*; *Wizard and the Princess* was based on traditional fairy tales; and *Mission: Asteroid* was based on *Lucifer's Hammer* by Larry Nevin and Jerry Pournelle.

But the monster adventure "will come directly out of my own imagination." Theme of the program will be time travel. If the original plot holds up, Earth will be threatened by the planet Neburon sometime in the distant future. You'll stumble across a time machine that will permit you to go back in time to gather the information and objects needed to ward off the threat. Perhaps as many as thirty mini-adventures will be contained in the search. Projected delivery date to retail stores is sometime in autumn.

Roberta's more complicated scenarios have pushed Ken's programming abilities. He illustrated *Mystery House* with the *VersaWriter* from Peripherals Plus. Now he's written an interpreter that does much of the graphics work for him after he defines the basic outlines of a given room.

Paddle Graphics and *Tablet Graphics*, On-line's two graphic utilities, were devised for use in programming the mysteries in twenty-one hi-res colors.

And his interpreter required considerable expansion to include the real-time feature of *Mission: Asteroid*.

Raison d'être for Ken's original programming efforts were the Williams's desire to move from the city to the country and the necessity to find a means of supporting themselves once they made the move.

High Technology

We make our competition obsolete with Information Master.™

Information Master™ is the sophisticate of software packages, but it also speaks your language. Its uncomplicated English-speaking design makes it easy to learn. No programming knowledge is necessary. Put it in your Apple II*, and you're ready to go.

High Technology's Information Master organizes and prints everything from mailing lists to stock market data. Specify what records to store, type in the information, and Information Master organizes, calculates, stores and reports. Design your own reports and labels. Information Master is revolutionary in its adaptability and comes with a simple step-by-step instruction manual. Its screen layouts are designed to show you maximum information for easy operation. Information Master is so smart it stops mistakes that our competition lets you make.

If your computer dealer doesn't have Information Master, see one who does.

High Technology's perfect complement to Information Master, Data Master,™ allows you to change your mind months later

without redoing all the work you've already done. Ask about it!

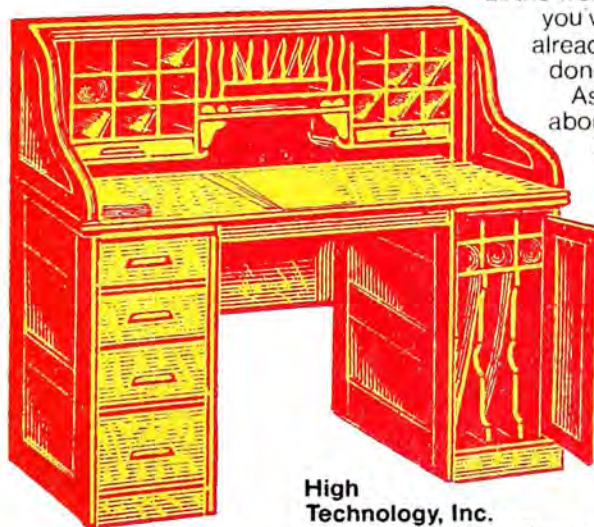

High Technology, Inc.
Software Products Division
P.O. Box S-14665
8001 N. Classen Blvd
Oklahoma City, Okla. 73113
405 840-9900

*Apple II is a trade name of Apple Computer, Inc.

Ken Wrote VisiCalc Equal for Mainframes. Ken was working for Financial Decision Systems, a Los Angeles firm that supplies financial accounting assistance to nearly half the companies on the Fortune 500 list. He headed their data processing department and developed a mainframe financial tool that anticipated *VisiCalc* in its interactive and calculative facets.

Just as *VisiCalc* has proven the most powerful tool for the personal computer market, so Ken's program has proven itself in the larger computer market. More than two hundred international corporations are tied by modem to Financial Decision's computers to take advantage of the flexibility the program offers in defining data bases, routing data to computation matrices, and calculating federal and international taxes.

But both felt the pull of the country. Ken had been raised in Pomona, California, which is not exactly a megalopolis. And Roberta's childhood home was in Claremont, California, located on two acres of land that gave her plenty of room to roam.

Both desired a less urban environment in which to raise their two boys, D.J., age seven, and Chris, now nearing two.

Programs Led to Country Dream Home. The early success of *Mystery House* enabled them to achieve this goal, moving to Coarsegold, California, within hiking distance of Yosemite National Park. The environment is definitely different. As Ken explains it, "In Coarsegold, if they promise you something on Tuesday, they still think they're on time when they get it to you Friday."

From the beginning, their success has posed a new set of problems: How long will a given program continue to sell? What will be their next program to maintain the company's momentum? How do they diversify the company?

These are particularly real problems in Coarsegold, where the programming talent may be a bit sparser than in more settled areas of the country. "I've got immediate openings for two 6502 programmers who are willing to live in Coarsegold," reports Ken.

Coarsegold is not the end of the earth by any means, but when you consider that Oakhurst (Oakhurst?) is the largest community nearby, you get the idea that the cultural delights of the area are not varied and unlimited.

Diversifying To Avoid Type-Casting. Ken has feared that On-Line Systems would eventually become known as only an adventure programming house. He's aggressively moved to diversify the product line, first with games such as *Hi-Res Football* and *Cribbage*, and now with his *SuperScript* text processor, announced this month in Marketalk News.

Hi-Res Football was a collaborative effort between Ken and Jay Sullivan, a former programming colleague at Informatics. Sullivan, a football buff, provided the game expertise while Williams added some graphic innovations.

It may have escaped your notice, but in *Hi-Res Football*, movement of one image through the field of another image does not cause the stationary image to be erased. A player can dash down the sidelines and all the sideline markers are hidden from view only for that time during which the player would normally obscure view of the markers from the viewers' perspective. This is the first program that hasn't erased those auxiliary images.

Cribbage by Warren Schwader and *SuperScript* by David Kidwell represent the first attempt by On-Line Systems to publish programs totally generated by outside authors.

The company is also moving to change its graphics image, as indicated by the new corporate logo exhibited in its advertisements in this issue.

Future Promises More Adventures—Plus. In the meantime, Ken yearns for six to eight months of relative solitude when he could sit down and do some serious programming.

He's still eyeing that Fortran compiler, although he now concedes that the Apple II was probably too small for a good program and has elevated his sights to the Apple III. He also is contemplating converting his Financial Decisions financial program into an Apple III program.

Other than the projected monster adventure, the next of that genre likely to be seen may be *Cranston Manor*. The program was originally written for the Sorcerer microcomputer and Ken and Roberta are anxiously awaiting the author's Apple version.

"We've stayed completely away from the program and its conversion because we want to play it," says Roberta. "The big drawback to developing your own adventures is that you never get a chance to play them."

Williamses Participate in Fans' Solving. Ken may be trying to put some distance between the company and its adventure image in his new endeavors, but both he and Roberta remain responsive to the cries for help from purchasers of their programs.

A new fad among microcomputer owners is to buy *Wizard* and the *Princess* and invite their friends over for an evening of solving.

The problem usually is that such parties get partially into the program and are stumped. Then On-Line's phone starts ringing. Ken grins as he relates that they've had calls as late as three o'clock in the morning.

"I usually try to give them hints that will get them over the hurdle they're facing. I don't want to solve the program for them—they'll feel cheated if I do all the work after they've paid over \$30 for the program."

Roberta adds, "We enjoy and encourage the calls as long as they're kept to reasonable hours. We'd much rather help someone over the telephone than try to do it by letter."

Expansion and the Urbanization of Coarsegold. The Williams family was all there was to On-Line Systems until recently. Now they've opened an office and hired their first two employees.

As it happens, they haven't been entirely able to escape urbanization; their office is on the top floor of Coarsegold's tallest office building—a two-story structure.

They can't go higher in Coarsegold, but the Williams have their sights set on bigger, better things for Apple owners. ■

NEW STOCK MARKET & COMMODITY CHARTS FOR YOUR PERSONAL COMPUTER

Make your own stock charts:

- Plus-Minus Balance Volume
- High-Low-Close
- Advance-Decline

Any one of these programs (available in Poscol or Basic) on disc—\$30.00

A combination of all 3—\$75.00
Daily and weekly stock data available on disc

A program for getting ticker tapes (no time delay) on your Apple—\$75.00

For a demonstration disc send \$10.00

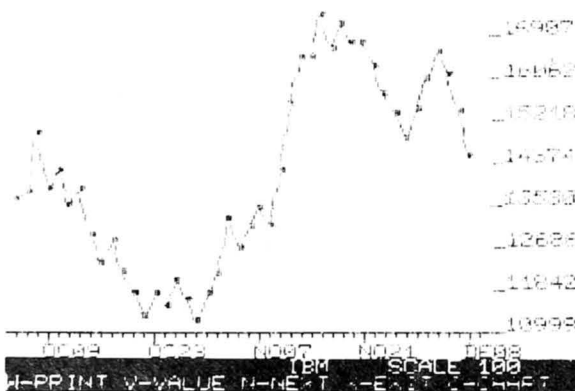

For further information, or for any of the above, send a check and your name and address to:

Lanari Investment Advisory Services, Inc.

Computer Software Division
P.O. Box 1020
East Brunswick, N.J. 08816

For the latest issue of our stock market newsletter send \$2.00

Consulting services available



EasyWriter is a powerful word processor designed for the people who want the best.

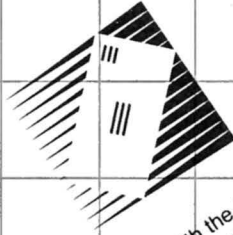

Now, with the **EasyMailer** system, your Apple can be used to greatly reduce time, paperwork, and money spent on form letters, mailing labels, and other documents.

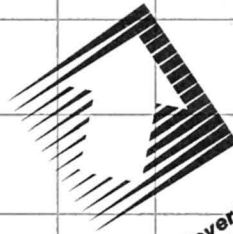

EasyMover is the first Electronic Mail System which combines the versatility of a word processor with the ability to move or transmit text files to another computer.

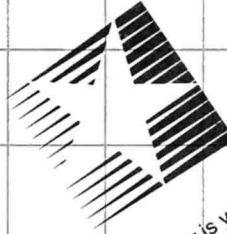

TellStar is your computer window to the celestial objects as they appear at your home, or any location on the Earth you desire.

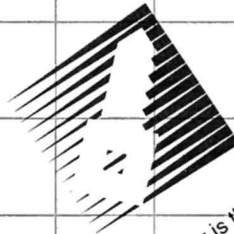

Datadex is the key to interactive data management for your Apple computer and the heart of an automated office's operation.
(Available first quarter 1981.)



IUS is word processing, data management, data communications, and educational software for the Apple computer. Write or call your local dealer to find out more about the automated office made easy!

IUS (Information Unlimited Software, Inc.)
281 Arlington Avenue, Berkeley, CA 94707
415-525-9452

Apple is a (tm) of Apple Computers, Inc.
EasyWriter copyright 1980, Cap'n Software
Datadex copyright 1980, Sonoma Softworks
TellStar copyright 1980, Scharf Software Services

O P E N D I S C U S S I O N

Reviews: Positive or Negative?

As I read the answer to Michael S. Lorenz's letter in the December 1980 issue, "A Call for the Negative" . . . I would like to comment . . . when software is reviewed the good features are expected but I would also like to know about some of the limitations . . . also I would hope the trend of software developers will be to furnish sample data on diskette so the software can be tested more easily. Thank you for asking.
Carroll O. Johnson, Orangeville, CA

Take issue with your not calling attention to or covering substandard software products. We neophytes who are not smart enough to know good from bad when not highlighted can assume you haven't had time to cover the product rather than that it is a bad product. On buying a bad product, we waste money and further a myth that the software is good. It would be good to look to a knowledgeable source. When you call a spade a spade you help all to upgrade programs. Robert A. Rowe, Rancho Palos Verdes, CA

I enjoy the opportunity to know about new software as it becomes available. However, feel you need to compare the

relative merits of similar packages given their price. For example, the \$75 DOS Tool Kit with better features than the \$95 Dakin 3.3 Programming Aids.
Dick Dramstad, Missoula, MT

Please review more software, both good and bad. Would also like a rating system for complexity, replayability, etc.
Geoff Booth, Houston, TX

Your reviews need to be tougher; for example, the December review of *Tax Planner*. Unless Apple will provide low cost updates for changes in laws, the \$120 will be worth \$0 very soon.
Bill Cozad, Kansas City, MO

What if it saves you a thousand dollars in taxes this year in the meantime?

I enjoyed articles on music boards and programs. As for reviews, magazines like *Popular Photography* and *Stereo Review* have little credibility because they never print negative reviews of advertised products. Some negative reviews are essential to establish the credibility of positive reviews.
David Hough, Cupertino, CA

Does it take my hating your spaghetti

to convince you I like the way you fix fried chicken?

Particularly like reviews—but am suspicious that all seem positive—suggests that reviews used to sell ads.

Dr. Randall Engle, Department of Psychology, University of South Carolina, Columbia, SC

It is a lot easier to write a negative review than a positive review. Negative adjectives are more colorful, more descriptive, and more numerous than positive adjectives—perhaps because the world in general seems to have a greater market these days for negatives. What this country needs is not another voice crying negatives. As a psychology professor, you should recognize that the vicarious superiority people feel when reading a cutting negative review reveals their insecurities. The frailest part of the human is still his mind, not his body; and his mind is not strengthened by an overdose of negativism.

That was a philosophical statement. There remain two practical aspects: (1) makers of bad programs seldom offer them for review; and (2) we are not the final arbiters of program quality for the Apple. I have seen programs I abhor en-

SYNERGISTIC SOFTWARE presents ODYSSEY: THE COMPLEAT APVENTURE

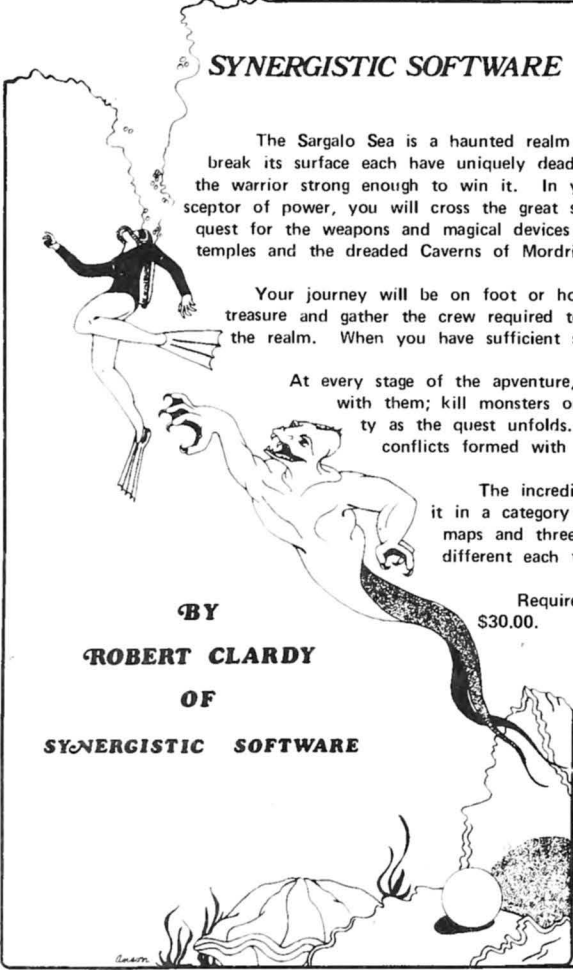

The Sargalo Sea is a haunted realm of sea serpents, dragons and fabulous beasts. The mysterious islands which break its surface each have uniquely deadly perils. Yet, it is a land which can provide great wealth and power to the warrior strong enough to win it. In your crusade to defeat the dreaded Caliph of Lapour and win the golden scepter of power, you will cross the great sea, explore the jungles, swamps, and mountains of the islands. As you quest for the weapons and magical devices you will need to enter his fortress, you will search ancient tombs and temples and the dreaded Caverns of Mordril.

Your journey will be on foot or horseback across the high resolution map of an island until you win enough treasure and gather the crew required to buy and man a ship. You can then continue your odyssey throughout the realm. When you have sufficient strength, your attack of the fortress on Lapour can begin.

At every stage of the apventure, you will decide the action to be taken - attack the merchants or trade with them; kill monsters or try to recruit them. Such decisions establish the character of your party as the quest unfolds. Your revealed capacity for good or evil will determine the alliances or conflicts formed with the beings you encounter.

The incredibly detailed graphics and animation effects of Robert Clardy's Odyssey put it in a category by itself in the annuals of mythic adventure games. Five separate detailed maps and three programs interlink to bring you an unendingly varied apventure uniquely different each time you play.

BY

ROBERT CLARDY

OF

SYNERGISTIC SOFTWARE

Requires 48K Apple][computer with disk. Only available in Integer Basic for \$30.00.

AVAILABLE NOW AT YOUR LOCAL DEALER
OR SEND CHECK OR INQUIRY TO:
SYNERGISTIC SOFTWARE
5221 - 120th Ave. S.E.
Bellevue, WA 98006
(WASHINGTON STATE RESIDENTS ADD 5.3%
SALES TAX.)

joyed or profitably used by others. I would consider it a far greater disservice to turn one person off a program they might want by a negative review. Every reputable retailer of my knowledge is willing to demonstrate a program prior to sale. That's where the final buying decision should be made—not through the mail and not through reading these columns.

As to the possibility that we would sell our review space in exchange for advertising revenues: No amount of money can buy one column inch of our editorial pages. Our reviews are positive because that's how we perceive the programs. We might not always be right; but we always review in good faith.

We invite further comment. ART

I enjoy the industry news, new hardware, and new software announcements a lot with software reviews the most! The local computer stores can't stock it all! Please continue to review the best software first!

Dwaine Hurta, Dallas, TX

Review the good ones, but list all that you review under headings such as OK, Needs Improvement, and Forget It. Now, we don't know if software is poor or just on your waiting list.

Margaret G. Irwin, California School for the Deaf, Fremont, CA

This strikes us as an excellent compromise. We plan to begin implementing a form of this idea in March. Thanks, Ms. Irwin.

I'd like to see more in-depth software reviews and software application articles—more comparison tests like the music system shootout. How about word processing software and home finance? Thanks for a needed magazine. James Krog, Ojai, CA

Look for a home finance roundup in April or May. The November/December 1980 issue of *Peelings II* has an excellent comparative review of word processing software. If you can't find *Peelings II* at your local retailer, write to *Peelings II*, 945 Brook Circle, Las Cruces, NM 88001. Back issues are \$3.00.

I am pleased to see that [Softalk] is free to all Apple owners but I would be willing to pay to receive this publication. It is both timely and interesting. I appreciate all the reviews you have on software. By the way, in one of your recent issues you asked if readers would like to see reviews on software that doesn't deserve a good review—I feel that if you don't review it then the less said about that puff 'n' stuff! I also think your assembly language tutoring section by Roger Wagner is excellent.

Mary S. Kessler and Milton G. Kessler, Oakland, CA

Like To Input

How about some subscriber contributed programs?

Alan S. Rubenstein, Montclair, CA

It would be nice if there were little game programs in each issue.

Scott Shackleton, Newport Beach, CA

As they develop, Softalk's tutorials, *Assembly Lines*, *Pascal Path*, and an *AppleSoft one to come*, will include small programs as examples of the language being taught.

Contest Buffs

We have been most pleased to be receiving your publication and wish it every success. We know that its continued availability depends on the advertisers. Just a couple of days ago, we did buy *Mystery House* and the [IFR] *Flight Simulator*, which were advertised in the last issue.

We are enclosing our registration coupon, so that we can continue to receive the magazine.

We are also enclosing our solutions (!) to the turkey puzzle. Neither of us believes that he has found it. But, you must know the number of combinations and permutations. Although we did have the computer help us a lot, there was not time for us to look at all of the possibilities. I figured it to take over 1,000 hours,

figuring on four words/phrases per second on the screen. Oh, well, we're sending them along, because they are possibilities, and perhaps you will decide to make an award to the first letter you get from a Spanish professor and a nurse who both use the Apple in their work! Robert Phillips and John M. Dool, Oxford, OH

Bobbing Once Too Often

For what it is worth, I found twenty-four apples on page 24 of the October issue of *Softalk*. . . . Line 24—you can't see the word "Apple" but you can see the little apple; the same goes for the picture on top of the keyboard [in the top photograph of Joe Villareal].

Mark McDaniel, Maidson Heights, MI

That was tricky. The cover Joe's friends made for his keyboard, shown in the bottom picture on that page, proves slightly unstable at times, so often Joe removes it and uses the keyboard without it. This is the case in the top photograph. There is no cover on the keyboard, and, therefore, no apple.

Queuing Up for Assembly Lines

Softalk has to be the absolute best of the group of magazines devoted to the computing fruit!! After my exposure to the magazine, I would purchase a lifetime subscription if need be. First on the list of

NEW!

7 data-shielding improvements. Greater durability. Longer data life.



APPLE-LOVERS. Specify "apple", for Verbatim's new Flexible disks with reinforcing hub rings. No slippage, minimized wear in the hub area, reduced errors.

Verbatim . . . a name that makes a promise . . . and keeps it! Ask for new literature on the Verbatim Datalife series.

FULL LINE . . . ALWAYS IN STOCK

OVERNIGHT DELIVERY*

* If order phoned in before 1 pm, same day shipment.



6901 Canby Avenue, Reseda, CA 91335
Los Angeles Phone (213) 705-4202

2680 Bayshore Frontage Road, Suite 1030
Mountain View, CA 94043 (415) 962-9275

LARGEST MASTER DISTRIBUTOR FOR VERBATIM REMOVABLE MAGNETIC STORAGE MEDIA

OPEN DISCUSSION

pluses is Roger Wagner's Assembly Lines. For the first time, someone explains assembler programming without presupposing the reader has already designed and constructed a one megabyte mainframe. No meetings to attend and no secret handshakes to remember. Keep Roger healthy and happy till he completes the series.

All the departments are excellent! The contests are intriguing and challenging. In short, your magazine has something no other publication can lay claim to—concern for the reader rather than a dazzling array of buzz words, nonfunctioning program listings, and self-serving compliments to everyone on the publisher's staff. You guys (gals) are doing it right—don't change—and thanks for a refreshing, informative, and pleasant publication.

C. J. Armstrong, Dallas, TX

Technical articles start at the right level. Better than what I subscribe to.
Kim R. Shuette, Los Angeles, CA

Your contests are great; not easy, but very challenging. I worked several hours each day for a week before I came up with my first answer. Even a random word generator did not help.

Assembly Lines by Roger Wagner is

just what I need. I hope it continues and when it is finished I hope it is replaced by a tutorial in Basic programming. I'm a real rank amateur and need all the help I can get.

I read somewhere that Apple Computer Inc. stock would soon be issued but not available in Michigan. Could you comment on this please?

Thanks for a good "dedicated" magazine.

Jerry McGinn, Mount Clemens, MI

Apple stock was issued December 12 and is available on the Over-the-Counter market; it remains one of the leaders in volume traded.

[Softalk is] very interesting. Especially Roger Wagner's article on assembly language. However, he mentions a book, *The Apple Monitor Peeled* by W. M. Dougherty, as the "best reference." He does not give the publisher or how to obtain the book. . . . Could you tell me how to obtain the book?

Thomas K. Boehme, Goleta, CA

First try should be your dealer; that's where we found one. If your dealer doesn't carry it, you might write to the author at 14349 San Jose Street, Mission Hills, CA 91345.

Roger Wagner's Assembly Lines is really great. He writes with a very interesting style and his information has repaired a lot of confusion. I had a short circuit between my earphones before A.L.! Now I can communicate with my monitor. Yea!

Larry Engel, Garden Grove, CA

Have been programming ALC 360/00 but couldn't get a handle on assembler till I started reading your Assembly Lines articles. Am able to correlate a few items and similarities due to your articles. Thank you.

Jack W. Linderman, Wheaton, MD

Roger Wagner's column on assembly language has really helped me. I would still be banging my head on the keyboard if it weren't for him.

Joe Powell, Jacksonville, FL

Good Temptation

I'm seventy-one years old and get about forty magazines per month—I didn't need another one—but yours was too tempting. Picked up the last two issues at a computer store; last issue was great—ordered three of the programs listed in it. Like the simple explanation of machine language.

Ernest P. Hufnagel, Pompton Plains, NJ

+ - x ÷ The apple does this superbly!
How about your kids?

COMPU-MATH

In this age of computers, a basic understanding of numbers is a matter of survival. The COMPU-MATH series is designed to provide these skills, for both the primary and older

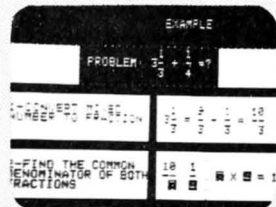
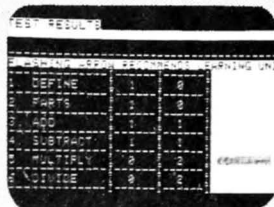

FRACTIONS and DECIMALS each begin with a Pre-Test and diagnostic report which then routes the learner to the appropriate instructional unit. \$39.95 each.

learner. As an infinitely patient tutor, the computer will identify instructional goals, move the learner towards them and provide feedback on his/her level of mastery. (Requires APPLESOFT, 48K, disk).

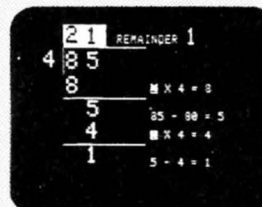

ARITHMETIC SKILLS uses high-resolution graphics, an absolute minimum of text, and aids for those new to the computer, as it teaches counting and basic arithmetic. \$49.95.

Available at fine computer stores everywhere.

Calif. residents add 6% tax.

Add \$1.00 for shipping.

EDU-WARE T.M.
UNIQUE SOFTWARE FOR THE UNIQUE MIND

EDU-WARE SERVICES, INC.
22222 Sherman Way, Suite 102
Canoga Park, CA 91303
(213) 346-6783

THIS YEAR . . . DO TAXES THE EASY WAY!

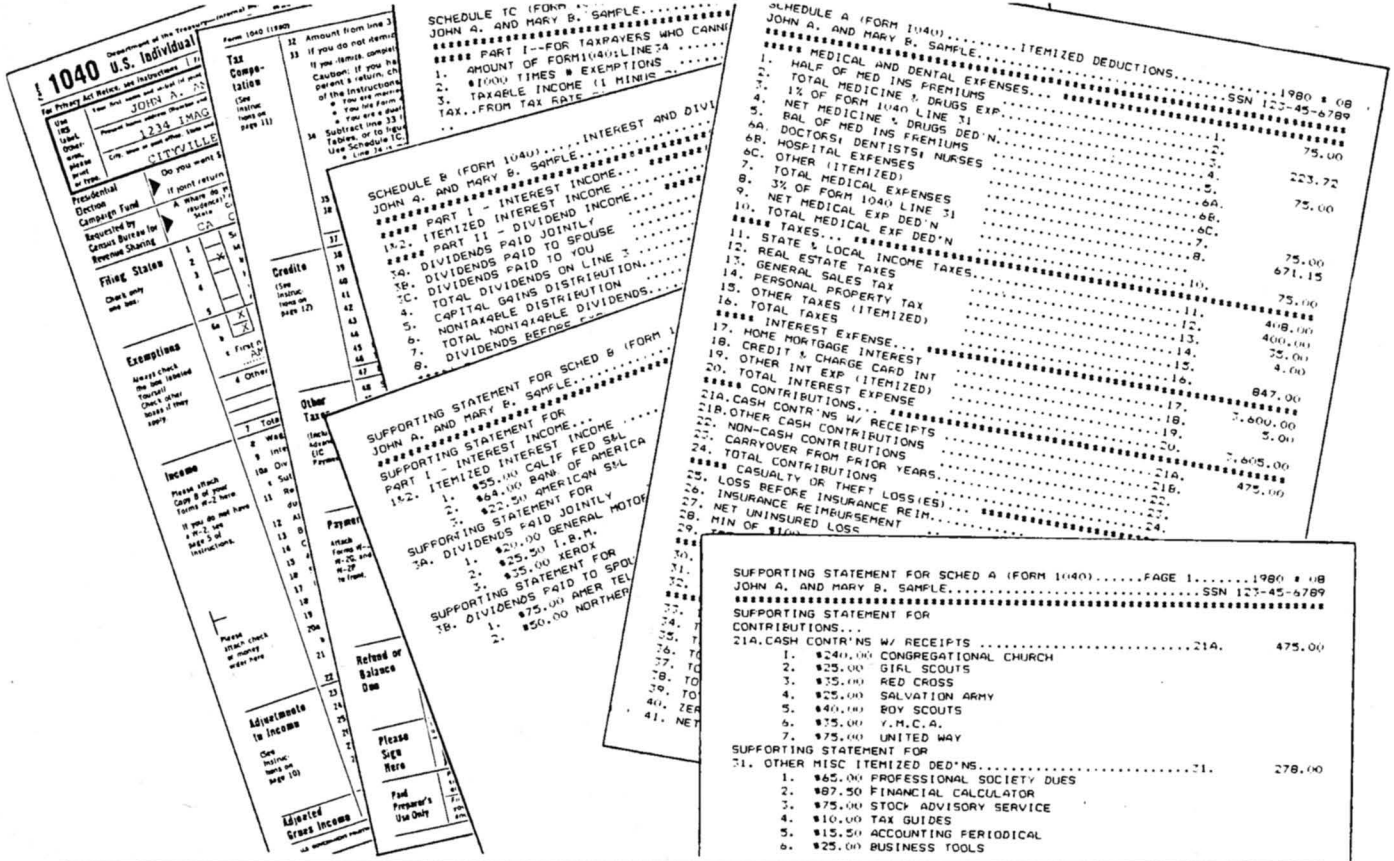

. . . for the **SERIOUS** Apple II User

1981 TAX PREPARER by HowardSoft™

(COMPUTER-AIDED TAX FILING & RECORD-KEEPING)

EASY - TO - USE
TIME - SAVING
CONVENIENT
COMPLETE
SOPHISTICATED

Self-instructing with built-in sample return • Prompted by questions & memos • On-screen preparation uses facsimile of IRS forms • Easily created itemized lists with sums computed & entered on proper lines • Full-feature editing of all data • Error-tolerant disk filing for retrieval & updating.

All math & linking of forms performed automatically • Changes in one form automatically reflected in all others • Reenter preparation at any point • Once data entered & editing complete, computer produces complete printout of forms, schedules, itemized lists • File forms directly with the IRS.

Year-long record-keeping makes year-end tax filing easy • Interactive & on-line, no prior organizing necessary • Use with or without line printer • No special printer or paper • Creates own facsimile of IRS forms • Paginated with IRS-type header • Can print on preprinted Form 1040s.

All schedules (A,B,C,D,E,F,G,R&P,SE,TC) and many forms (1040,2210,2106,3468,4562,4726,4797,5695) • Low-cost annual updates to stay current with new tax laws • Designed for future expansion to include additional forms • Full documentation & instructions in handsome notebook.

Alternative tax strategies easily compared • Special handling of gain/loss, depreciation, rental income • All files coded for use by multiple taxpayers • Used by tax professionals for numerous clients • Extra features when used with 2 disk drives • All tax rate schedules are built in.

AVAILABLE NOW for Apple Computers with 48K, Applesoft ROM, & 1 or 2 disk drives . . . \$99

INQUIRE AT YOUR DEALER

Should you prefer to order direct, please enclose check or M.O. for full amount. California residents add 6% sales tax.

Also ask about our Real Estate Analyzer and Creative Financing packages.

HOWARD SOFTWARE SERVICES

7722 Hosford Avenue
Los Angeles, CA 90045
(213) 645-4069



□ Only six months old, **Robwin Computing Corporation** has emerged as a significant force in the national distribution of Apple software. Under the direction of **Bob Leff** and **Dave Wagman**, Robwin has recently added the Broderbund Software line to a catalog that includes the products of Adventure International, EduWare, USA, Synergistic, Strategic Simulations, Avalon Hill, On-Line, Automated Simulations, and Sirius. According to retailers nationwide, Robwin's rise to prominence derives from a simple fact: they do their work well. Orders are filled speedily and accurately, and problems are handled pleasantly, fairly, and swiftly. Negotiations are reportedly ensuing with Muse, SubLogic, and Personal Software for distribution deals in the near future. A more immediate move on Robwin's part has been to new quarters at 4079 Glencoe Avenue, Marina Del Rey, CA 90291.

□ **SSM Microcomputer Products** has ap-

pointed **Brent C. Olson** its director of marketing and sales. A veteran in the mainframe and microcomputer industries, Olson's background in engineering and marketing makes him highly elig-



ible in a field that prizes the nonspecialist with many skills. Silicon Gulch has been Olson's territory for several years; he worked for Signetics, Hewlett-Packard, and Fairchild, gaining the experi-

ence SSM expects will aid them in their accelerated marketing program.

□ On November 20, 1980, **Sirius** became an official California corporation and was thus dubbed **Sirius Software Incorporated**. The firm's braintrust is presently composed of **Jerry Jewell**, president; **Terry A. Bradley**, secretary/treasurer; **Patricia Bradley**, vice-president; **Philip Knopp**, general manager; and **Nasir Gebelli**, head of software development. Sirius, ever prolific, has announced two new arcade-style games: *Phantoms 5*, available since mid-January, and *Space Eggs*, a unique thriller hatching ghastly monsters, ready for mid-February release.

□ **Dwight Kelly** of Rome, Georgia, is a person who started this new year right. He bought his first Apple—with two disk drives, Language System, and Z-80 card—on December 31, 1980. We suspect he ushered in 1981 not with toots but with "beeps." □

New From SYNERGISTIC SOFTWARE HIGHER GRAPHICS II

A High Resolution Graphics Utility Package for the Apple II

Higher Graphics II is an unexcelled collection of high resolution graphic utility programs and documentation which enables even the casual programmer to add stunningly detailed and colorful graphical effects to his program quickly and easily. The versatile capabilities of Apple II's high resolution graphics can now be utilized by anyone without having to master the cumbersome procedures once required.

GAMES - Chess, tank, spacewar, gameboards, animation effects, etc.

BUSINESS - Graph, bar charts, etc.

EDUCATION - Math symbols, scientific notation, maps, etc.

DESIGN - Electrical components, architectural symbols, etc.

COMPUTER ART - Figures, scenes, abstract graphic designs, etc.

ANY PROGRAM - High-resolution logos, etc.

Higher Graphics II allows the user to produce shapes and shape tables, edit shape tables, and quickly and easily create beautiful high resolution screens. Shapes, text, lines, points, and areas of color can be placed anywhere on the screen at any color, angle, and scale. No other graphics utility does so much.

The package includes extensive shape tables and detailed instructive text on high resolution graphics.

A UTILITY WHICH MEETS A WORLD OF NEEDS

Requires 48K, Disk, Integer or Applesoft, \$35.00.

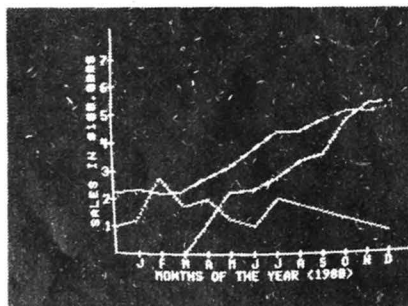

Business

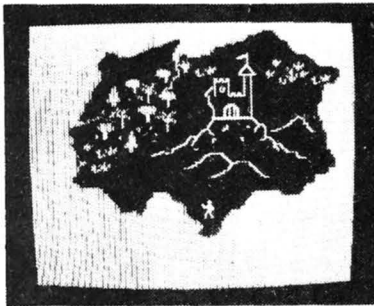

Games

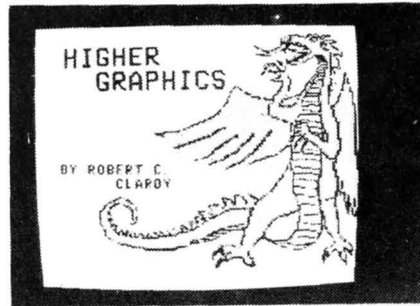

Program Logos

Available at your local dealer or send check or inquiry to:
SYNERGISTIC SOFTWARE, 5221 - 120th S.E., Bellevue, WA 98006, (206) 641-1917
(WA residents add 5.3% sales tax.)

WHY THE MICROSOFT RAMCARD™ MAKES OUR SOFTCARD™ AN EVEN BETTER IDEA.

Memory — you never seem to have quite enough of it.

But if you're one of the thousands of Apple owners using the SoftCard, there's an economical new way to expand your memory dramatically.

16K ON A PLUG-IN CARD.

Microsoft's new RAMCard simply plugs into your Apple II®, and adds 16k bytes of dependable, buffered read/write storage.

Together with the SoftCard, the RAMCard gives you a 56k CP/M® system that's big enough to take on all kinds of chores that would never fit before (until now, the only way to get this much memory was to have an Apple Language Card installed).

GREAT SOFTWARE: YOURS, OURS, OR THEIRS.

With the RAMCard and SoftCard, you can tackle large-scale business and scientific computing with our COBOL and FORTRAN languages. Or greatly increase the capability of CP/M

applications like the Peachtree Software accounting systems. VisiCalc™ and other Apple software packages can take advantage of RAMCard too.

And RAMCard gives you the extra capacity to develop advanced programs of your own, using the SoftCard and CP/M. *Even with the RAMCard in place, you can still access your ROM BASIC and monitor routines.*

JOIN THE SOFTCARD FAMILY.

The RAMCard is just the latest addition to the SoftCard family — a comprehensive system of hardware and software that can make your Apple more versatile and powerful than you ever imagined.

Your Microsoft dealer has all the exciting details. Visit him soon, and discover a great idea that keeps getting better.

Microsoft Consumer Products, 400 108th Ave. N.E., Suite 200, Bellevue, WA 98004. (206) 454-1315.

16 k

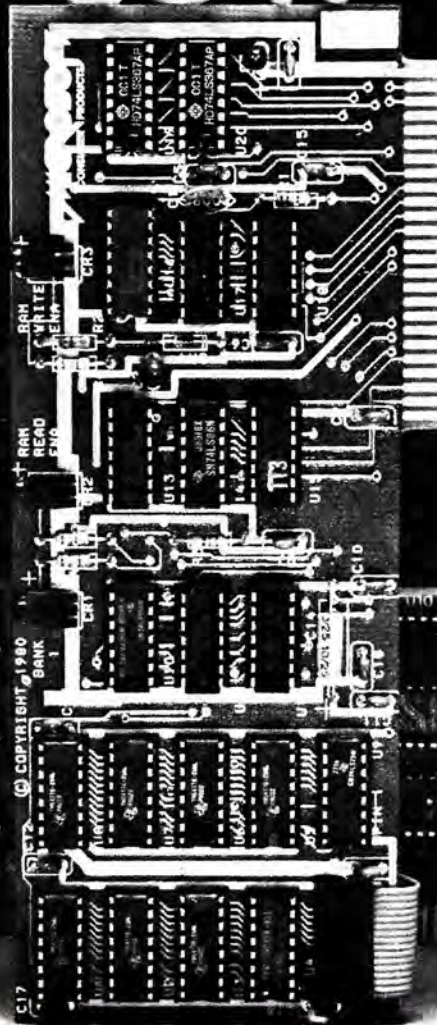
SoftCard and RAMCard are trademarks of Microsoft. Apple II is a registered trademark of Apple Computer, Inc. 2.80 is a registered trademark of ZiLOG, Inc. CP/M is a registered trademark of Digital Research Corp. VisiCalc is a trademark of Personal Software, Inc.

MICROSOFT

THE PASCAL PATH

By James A. Merritt

FIRST STEPS

Welcome to the Path! When she remarked "Curiouser and curiouser," Alice might have been referring to the microcomputer world—or even to its members. That you have read this column even this far implies your own curiosity about Apple Pascal.

Maybe you've been programming in Basic or assembly language for quite a while, and all the talk about the exotic "new kid on the block" has finally piqued your interest. Or perhaps, never having programmed before, you are shopping around for your first language and have heard enough intriguing gossip about Pascal to give it a try. Or you may already have been using Pascal on your Apple, and that experience has inspired you to learn even more about the system than you can discover from the user manuals.

Whatever your reason, thanks for taking an interest in my favorite microcomputer programming language. My goal for this series is simple: I want to satisfy your Pascal curiosity as completely as possible. Although the column begins as a monologue, I hope it will soon evolve into a dialogue that is responsive to your own personal needs.

Having programmed in several different languages, on so-called mainframe, mini, and micro computers, I have chosen to do almost all my microcomputer work with Pascal. This is because Pascal, of all the programming languages now available for microcomputers, best supports the organized, methodical, deliberate style of programming that allows me to get my work done in the least time and with the least difficulty. In the coming months, I will share this methodology with you, and will show how it meshes remarkably well with the features and underlying philosophy of Pascal.

Besides taking for granted your interest in Pascal, I have made the following assumptions about you for my own convenience as a writer:

1. You have access to an Apple computer equipped with disk drives and the Apple Language System.
2. You have the latest version (1.1) of Apple's Pascal software. What you learn here will apply in a general way to the earlier Pascal release (1.0), but specific information and examples have been verified for the latest version only.
3. You know how to take a floppy diskette, insert it into a disk drive, and hit the Apple's reset key (or turn on the power switch), to bring the system up. I don't want to spend our time talking about details which have little to do with Pascal. If you aren't familiar with this ritual, refer to the *Apple Pascal Language Reference Manual*. Read either "One-Drive Startup" or "Two-Drive Startup," depending upon whether yours is a single-drive or a multiple-drive system.

Since I don't expect you to know much about computers at this point, the first few installments we will explore some of the fundamental concepts of computing and Pascal. If you have previous knowledge of the language and are eager to get on to advanced topics, please be patient. We'll work up to some challenging projects soon enough.

Starting Concepts. Let's get going by defining *programming as the art of telling a computer what to do*. In programming, you must design, prepare, and deliver to the computer the lists of instructions—*programs*—that you want it to obey.

Your computer is very much like a child. It starts out know-

ing practically nothing, and so you must describe, in painstaking, step-by-step detail, every task you want it to perform. Like a child, your computer learns quickly—in fact, much faster than most children can! It needs to be told how to do something only once. Unless you explicitly command otherwise or its memory is impaired by some accident, your computer will remember your instructions forever. Unlike a child, a computer can obey the same set of instructions over and over again without tiring or making a mistake.

But the computer shares the child's naivete. It has no way of distinguishing between proper instructions and silly ones. The computer does *exactly* what it is told, no more and no less. It is up to you to anticipate *all* the consequences of the instructions you give to a computer and to improve or eliminate any instructions that will cause undesirable results.

It is not yet possible to program computers using plain English; programs must still be written using programming languages, such as Pascal. You may be surprised to learn that no microcomputer actually *knows* Pascal. At the heart of your computer is a chip, which we call the *CPU* (for Central Processor Unit). This is the component that does all the computing, yet it can understand and manipulate only numbers. Special programs, called *compilers* and *interpreters*, enable a computer to accept and obey programs that have been written in specific programming languages.

A *compiler* is a translator. You give it your original program, called the *source*, and it generates another, called the *object*. The object program is written in the language of numbers that your computer's CPU can obey immediately (its machine language). The object produces exactly the results you expect of your source program, but is *not* the source; it is only a translated copy.

An *interpreter* is a simulator. It is a program that performs as if it were a CPU that actually understood instructions written in a programming language. For every instruction in your program, an interpreter, like a compiler, must first determine what you mean to accomplish. However,

As senior technical adviser for Apple Pascal in Apple's Personal Computer Systems Division, Jim Merritt's job is to help professional programmers, software houses, and Apple's major customers use the Apple Pascal system to their best advantage in producing commercial software packages.

Before joining Apple, Merritt was Pascal project manager for North Star, floor manager of a pioneer Computerland store in Hayward, California, and a professional radio disk jockey. He keeps a hand in the latter as a weekend DJ for KLOK, San Jose, California. Merritt is the author of the *Moonshadow Text Formatter* for computer systems that support UCSD Pascal, including the Apple.

Merritt has been programming in Pascal for five years—three professionally—and has been using the UCSD Pascal system from which Apple Pascal is derived for two. Through his work, he has access to the most timely and accurate technical information about Apple Pascal, which he will incorporate in these columns.

The Pascal Path, however, is in no way an official Apple presentation, but represents only Merritt's personal view of programming. Merritt and *Softalk* hope you will enjoy sharing this walk along a new path, gathering the treasures of knowledge.

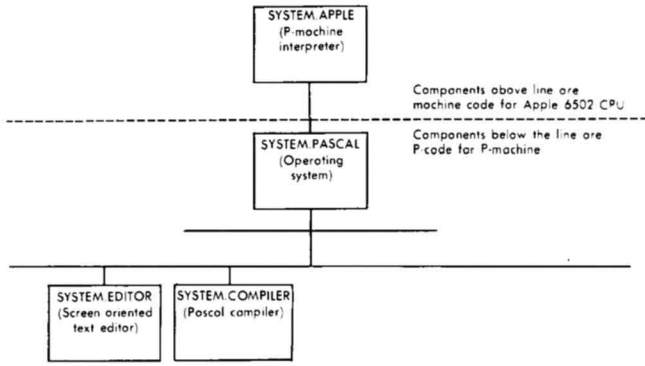

Diagram 1. Apple Pascal System: Partial Hierarchy.

whereas the compiler uses this knowledge to generate the object program, the interpreter actually performs the indicated action, causing the expected result.

Because an interpreter must go to the trouble of deciphering each instruction prior to obeying it and must even decipher a recurrent instruction over and over again, a source program executed indirectly by an interpreter produces results more slowly (under typical circumstances) than the compiled, object version of that source, which is executed, at high speed, directly by the CPU.

Putting It Together. The term *Apple Pascal* refers not only to a specific programming language, but also to the organized system of programs provided by Apple that permits you to develop, modify, and run (execute) your own programs. Diagram 1 shows the beginnings of a Pascal system hierarchy, which will be expanded in subsequent installments of the Pascal Path. For the immediate future, however, we will be interested in only three of the components in that hierarchy:

1. Operating system: The system provides a friendly environment in which Pascal programs may be executed.

2. Screen editor: With the editor, you may create and modify your own Pascal programs. You enter and manipulate the text of your program on the video screen. Possible manipulations include the on-screen erasure or replacement of text, movement of blocks of text from one point in the program to another, and so on.

3. Compiler: The compiler uses your Pascal source program to generate an object program suitable for execution. You may be interested to learn that the object code produced by the Apple Pascal compiler is machine language—but not for the Apple's own 6502 CPU chip! Instead, the compiler produces *P-code* for the so-called *P-machine*. Because the Apple's CPU does not understand P-code, a special P-machine interpreter sits at the heart of the Apple Pascal system. The P-

machine interpreter is written in 6502 machine language and, as interpreters do, makes the Apple appear to have a P-machine as its CPU. The operating system, editor, and compiler are written in Pascal and are executed as P-code by the P-machine interpreter. So you see, a careful blend of both compilation and interpretation is necessary for program execution in Apple Pascal. We'll discuss the reasons why the system was designed this way in a future column.

Diagram 2 illustrates the general process involved in developing software programs for the compiler-oriented Apple Pascal system:

1. Specify the task to be performed by computer, and devise a method for the computer to accomplish that task.

2. Using as your guide the method you have designed, write the source program in Pascal. You can use the screen editor to enter your source programs directly into the computer. When you finish, you will have one or more text files, depending upon the size of the source.

3. Compile the source into an object program, using the compiler. The compiler may detect syntax errors in your source program—instances where you have violated the rules of the Pascal language. If so, you will have to debug (fix) the source with the editor, then repeat compilation.

4. Execute the object program under the auspices of the operating system, and determine if it actually does the job you intended. If not, there are logical errors in your program, and you will have to rewrite (perhaps redesign) the source, then recompile until the object program does as you wish.

For now, it's enough for you to know what these steps are. Of course, you must learn to use the editor, compiler, and operating system, not to mention some smattering of Pascal, in order to carry them out! Tackling the three system components is a big task. Before we do, we'll talk a little about programming itself, a little about some specific Pascal rules, and examine a tiny sample program, all in the next installment. We'll be ready to enter, compile, and execute the program right after that. ■

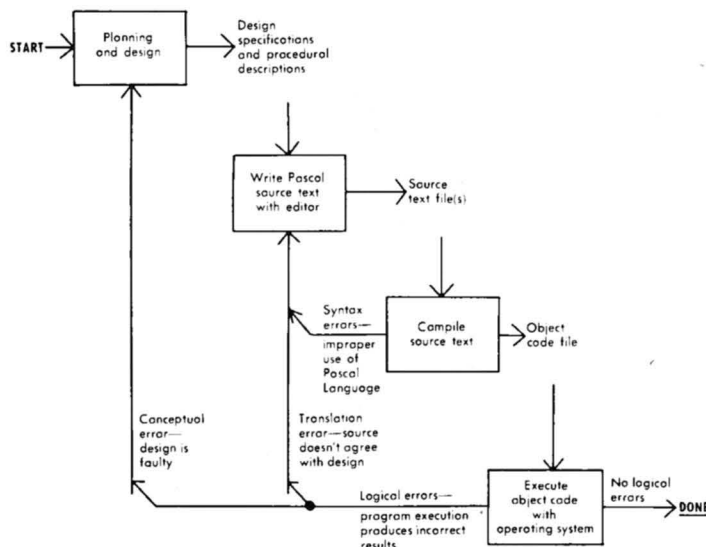



Diagram 2. Apple Pascal Software Development Cycle

Apple Monitor Extender



APPLE II 16K, CASSETTE

This utility program works in complete harmony with the Apple monitor to extend your computer's capability and help you use the full power of machine language programming. Screen display shows memory in HEX, ASCII or BINARY. Move data anywhere in memory without regard to direction or overlapping and read or write any sector on disk. Insertions may be in HEX or ASCII so you can easily format high speed text displays without conversions.

Study, modify or disassemble any program, complete with labels. Several programs may be combined, and the entire disassembled text file stored on disk/tape for later assembly. The slow listing feature steps through listings with ease.

© Copyright 1980 Glenn R. Sogge, All Rights Reserved.

IMAGE COMPUTER PRODUCTS™

615 Academy Drive
Northbrook, IL 60062
312/564-5060

MARKET TALK

News

□ **Computer Station** (Granite City, IL) has produced complementing software for *VisiCalc*, the bestselling program for the Apple. *Visilist* is designed to provide a hard-copy list of formulas and grid locations of *VisiCalc* storage files. Copy-protected; usable with parallel or serial card. Applesoft in ROM or language system. \$24.95.

□ *The Analyzer* from **Dakin5** (Denver, CO) is a software aid for evaluating a small company's financial health. Breadth of its evaluation capability encompasses budget comparisons, resource effectiveness, profit and loss comparisons, and estimates of control costs and cash flow. Program also generates analytical reports on source and application of funds, financial ratio studies, and budgeting, among others. *Analyzer* can process accounting information from the Apple/Dakin5 Controller program. Apple II Plus or Apple III. \$625.

□ Software for the frivolous and serious comes from **On-Line Systems** (Coarsegold, CA). *Hi-Res Cribbage* brings the classic game to the Apple. Manual guides the rookie against a tough digital opponent that's a strong match for the veteran as well. Cards dealt with sleight-of-hand; watch scores being pegged. Cribbage board done in hi-res. \$24.95. *Superscript* joins the ranks of the growing legion of word processor programs, but offers some special attributes, including upper and lower case modes on an unmodified Apple, 65K text buffer, ability to edit files larger than the memory space, edit capability on text and binary files, multiple character sets for foreign languages, and a help command that, pressed once, produces the program's

command menu from which the user can get access to a short explanation of the command desired. Program also has page numbering and selective page printing (suitable with any printer) and step-by-step tutorial. \$89.95.



Dr. Albert Whetstone, founder and chairman of Summagraphics, demonstrates the Supergrid digitizer. When X-ray films are digitized, computers can analyze them and even recommend treatment programs.

□ For users with a graphic turn of mind who need a tablet/digitizer larger than 11 inches square, **Summagraphics** (Fairfield, CT) has filled the bill. It offers digitizers from 11 inches square to 42 by 60 inches, and ranging in price from \$700 to \$10,000. An RS232 interface is required for the Apple II, priced from \$700 to \$1,295 according to the digitizer chosen. *Supergrid*, newest in the line, boasts high accuracy and resolution in small format; dual tablet, stylus or cursor, easy interfacing. There's a multitude of accessories for each digitizer.

□ **Micro-Ware** (Pompton Plains, NJ) offers the Tymac DD13-16 *Double DOS Plus* board, which gives user selectable DOS in hardware, switchable between 3.2 and 3.3. \$39. *Apple Card*, a special guide of interest to every Apple owner. Two-sided, laminated, and 8½ by 11 inches, it catalogs all DOS and Applesoft commands, decimal tokens with keywords, monitor commands and subroutines, calls, peeks, pokes, ASCII characters, graphics and game controls, the programmer's aid memory test, and codes for ONERR GOTO, lo-res and hi-res colors. Plus more. \$3.98

□ *Vanloves 1981 Apple Software Directory "Master Catalog,"* published by **Vital Information** (Kansas City, MO), contains more than six hundred pages devoted to products for use with your Apple. According to the publisher, it is "the most comprehensive source on anything for the Apple," and exclusively for the Apple. Volume contains twenty-eight subject sections in software alone—categories from gambling, word processing, and data bases to medical aids, stock market, and programs for the blind. Included is all CPM software that runs with the Microsoft Z-80 card and all 6809 software that runs with *The Mill* 6809 card from *Stellation Two*. Each listing, by package title, lists publisher, description, hardware requirements, and price. Descriptions for more than five hundred entertainment software packages are subcategorized as graphics, general fun, or strategy. A special separate section details programming aids and utilities. Despite the directory's name, another hundred-page section covers hardware and peripherals, from cards and printers to hard-disk mediums. Finally, there is a vendor list, giving the address and phone number of each entry, and a list of all Apple clubs. Even magazines have a section, to which *Softalk* was invited to contribute the introduction. Book is available at most Apple dealers. \$11.95.

□ In the wake of the ever-increasing demand for Applesoft software comes **Microsoft's** (Bellevue, WA) Applesoft version of *Typing Tutor*. Operation is same as the original Integer Basic version. The demand from Apple II Plus owners for this highly praised drilling and teaching program has been characterized by Microsoft president Vern Raburn as a "deluge." Apple II or Plus, 32K. \$19.95.

□ **Howard Software Services** (Los Angeles, CA) has en-

MR. RAINBOW
SAYS...

BLAST-OFF

WITH OUR SPECIAL
CATALOG FEATURE...

**A STELLAR
TREK**

OUR HI-RES COLOR VERSION OF
THE CLASSIC STARTREK GAME
WITH 22 PAGES OF DOCUMENTATION
NEEDS 48K APPLESOFT ROM
DISK..... \$24.95

WRITE OR CALL TODAY
FOR YOUR FREE
CATALOG (OVER 100
PAGES - INCLUDES
PRODUCTS FROM
EVERY MAJOR
MANUFACTURER.)

FOR INNER STELLAR DELIVERY
(BARRING KLINGONS) ADD \$2.00 US/
\$10.00 FOREIGN FOR SHIPPING AND
6% TAX IN CALIFORNIA

apple computer inc.

OPEN TUES. - SUN.
VISA / MASTERCARD WELCOME

RAINBOW COMPUTING INC.

GARDEN PLAZA SHOPPING CENTER
9719 RESEDA BOULEVARD DEPT. 15T
NORTHBRIDGE, CALIFORNIA 91324
PHONE: (213) 349-5560

“Technical Analysis Group”

“The Commodity Analysis Group”



1033 Pleasant Street
Suite, C
New Orleans
Louisiana 70115 U.S.A.
(504) 895-1474

- Complete bookkeeping – equity, P&S open /closed positions, statements.
- Automatic access daily and history data – open, high, low, close, volume, OI
- Graphs—charts—bar and point and figure
- Trendlines – oscillators - histograms
- OB Volume – detrending
- Spreads – percent retracement
- Sibbet demand index
- HAL overbought/oversold
- HAL momentum index
- Stochastic K% D
- All types moving averages
- GANN
- Welles Wilder - parabolic directional movement – RSI – swing index – CSI
- New programs added constantly and supplied to group members

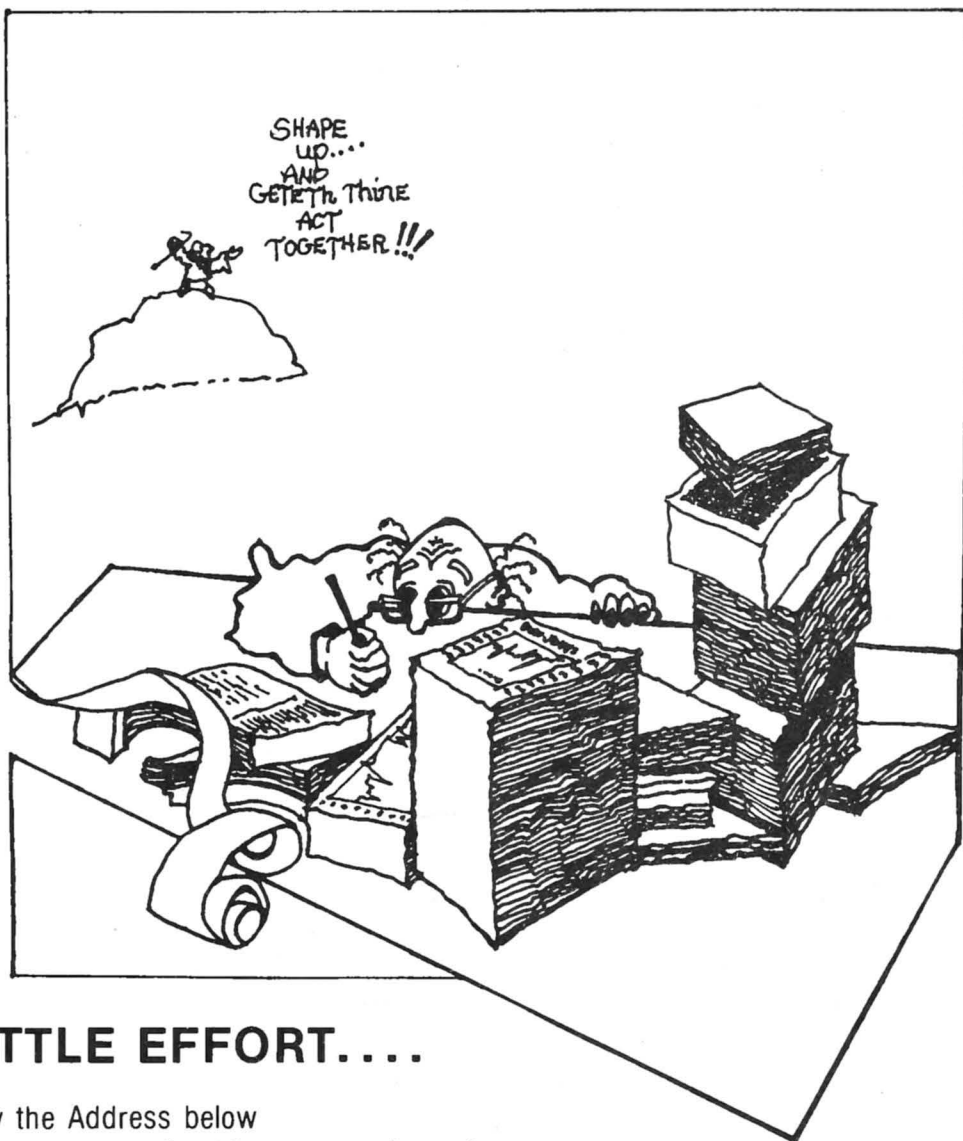

SURE IT TAKES A LITTLE EFFORT....

YOU WILL HAVE TO:

1. Copy the Address below
2. Print your name & address on a piece of paper
3. Enclose with \$10.00 (to cover our costs)
4. Go to your local Apple* computer dealer and see a demonstration of our computer programs

WITH YOUR “ACT TOGETHER” YOU MAY.....

1. Have a little more time for the family
2. Have extra time for yourself
3. Get organized with a focus on your technical work, the computer will help you do your technical analysis in an accurate and timely manner
4. Join our group of traders who are using their own “Home Computer” to help them trade effectively

The Group has prepared a demonstration computer disk. You may take this disk with you to a local computer store. With this disk is a coordinated hour long tape cassette which describes the programs and functions as you see them displayed on the screen. The disk and tape recording are accompanied by a full description of the Group, the computer equipment needed, sample printouts of data and charts, a detailed description of the programs to date, and membership costs.

Send \$10.00 to cover our costs. We will rush the information to you.

TECHNICAL ANALYSIS GROUP, 1033 Pleasant St., Suite C, New Orleans, LA 70115.

*APPLE is a registered trademark of APPLE COMPUTER, INC.

YES! I AM INTERESTED – \$10.00 IS ENCLOSED TO COVER COSTS.

NAME: _____

ADDRESS: _____

CITY: _____ STATE: _____

ZIP CODE: _____ TEL. NO. (____) _____

PLEASE RUSH ME THE DEMONSTRATION DISK, CASSETTE TAPE, AND FULL DESCRIPTION OF YOUR GROUP.

hanced their software, packaging, and documentation. The 1981 edition of the *Tax Preparer* includes many additions to the 1980 version, such as printouts in formats suitable for filing with the IRS, including that for the new form 2210, and continuous-stream printing for tax preparers. The program allows for easy editing, filing, arithmetic computation, itemization. Like Howard's revised *Real Estate Analyzer*, the *Tax Preparer* retails at \$99.

□ Two new products for education Applers come from **Charles Mann and Associates** (Yucca Valley, CA): these education catalogs for grading and scheduling (\$25 each), of particular interest to teachers and administrators, are a compilation of all education software the company has produced to date. The *Counselor's Program* is used with the firm's *Grading System Program* to create master student records, semesterly grade summaries, and file folder labels that condense pertinent student data. \$89.95.

□ Not so accidentally, **Serendipity Systems** (Ithaca, NY) is also contributing to the surging education market with its *Instructor Gradebook* package. It's designed to keep records and reports on students' grades and statistically measure teaching methods. Reports can be made for individuals or classes, as well as for blind grade listings by student I.D. number. Several statistical modes are available to judge curriculum and teaching effectiveness. \$169.

□ *Prescriptive Math Drill* from **Hartley Software** (Kentwood, MI) runs multiplication, division, addition, and subtraction exercises for student. Varying levels of difficulty; storage capability for one hundred students; displays results in percentage of last three drills for comparison purposes. Teacher can set percentage needed to advance student to higher level. \$79.95.

□ **Corvus System** (San Jose, CA) has expanded its microcomputer multiplexer, *Constellation*, to embrace as many as sixty-four micros in an interactive system with potential storage capacity of eighty million bytes. Each computer has access to disk storage. System allows open or secured access to any part of data base. Spooling technique permits peripherals to be integrated into system. Burst data transfer rate of sixty kilo-

bytes; eight bytes of lockable keys; maximum link lengths of fifty feet. \$750 for host multiplexer linking eight computers and \$250 per complete interface.

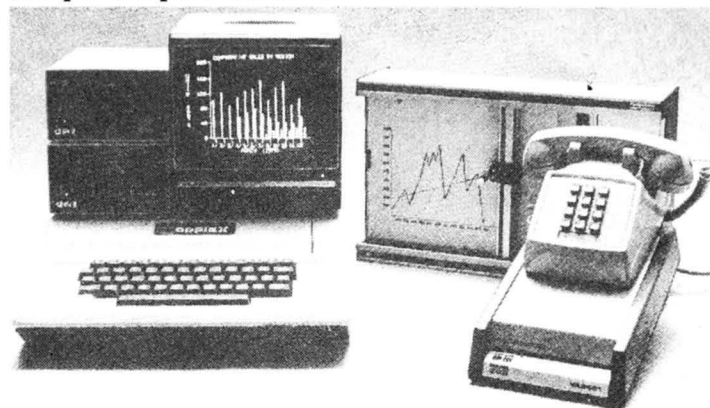

The Apple gets down to business with Business and Professional Software's AppleGraph package.

□ A new general-purpose data plotting graphics package is being produced by **Business and Professional Software** (Cambridge, MA). For statistical research and business analysis, *AppleGraph* produces hi-res pie charts, bar graphs, area plots, lines, or points. Commands—always in English—may be placed in advance for uninterrupted presentations. Includes sample data disk and user manual; special dealer support package features hard-copy output and color literature. \$200.

□ **Adam Osborne's Practical Basic Programs** has metamorphosed from book to disk with the help of **High Technology** (Oklahoma City, OK). The package contains forty programs categorized under business, statistics, mathematics, and miscellaneous, all preluded with assist material. 32K, \$40.00, including book.

□ **Andent** (Waukegan, IL) announces a novel piece of software: *Hypnosis* is intended as a means of trance and relaxation inducement to aid in behavior modification. It's designed with medical, social science, and psychology students and professionals in mind. \$20.

□ **PKay Corporation** (Costa Mesa, CA) has designed one of the configurations of its new copystand *Keyboard Companion* especially for the Apple II. Keyboarding copy is made easier with this 16-inch stand that snugly fits between the keyboard and the monitor with PKay's patented tilt adjuster. \$19.95. A nonmagnetic line guide (\$19.95) is optional.

□ Now landlords can have software specifically designed for them, titled, appropriately enough, *The Landlord*. **MIN Microcomputer Software** (Norcross, GA) has published this system, suitable for apartment complexes as large as four-hundred units. Program maintains financial transactions, reports on apartments, residents, rent records, vacancy notices, and lease expirations. 48K, two disk drives, Silentype or Centronics 779 printer (recommended). \$795.

□ The package for *Microgammon 2.0*, new from **Softape** (North Hollywood, CA), looks a lot like the package for *Microgammon 1.0*, but there the resemblance ends. The new version is done in clear hi-res, with pieces that float from point to point. Single level of play is said to adjust to the skill of the player. Doubling cube is active. The space bar moves a cursor from point to point that the player occupies. When it rests on the point you wish to move from, you merely press the number corresponding to the die you wish to use. Correction is possible anytime before the full move is entered by a carriage return. Dice roll with a rolling sound and disappear individually as they're used. Doubles are shown as four dice. This program is competitive with Personal Software's *Gammon Gambler*, and it boots on every configuration of Apple, including either DOS 3.2 or DOS 3.3. 32K, disk. \$19.95. Softape has also introduced *Crosswords*, the first real set of crossword puzzles for the Apple. Disk contains twenty-five puzzles on authentic and varying crossword diagrams, ranging from easy to hard. Program also allows you to configure your own diagram and create,

MICROSTAND™



Organize your Apple II¹ or TRS-80² Model I hardware for convenience, protection, and that professional appearance. MicroStand will accommodate your Disc Drive, Stringy Floppy,³ Cassette Player, or combination of either. Professionally constructed, color and texture coordinated, it is a piece of quality hardware which will enhance your home or office microcomputing system. Apple users will enjoy the easy slide out access for internal adjustments.

Add \$5.00 for handling and shipping

\$32.95



MicroStand
P.O. Box 96
Tolovana Park, OR. 97145
1 (503) 738-5629



1. TM of Apple Computers Inc

2. TM of Tandy Corp

3. TM of Exatron

Apple II

Winners



Here Are The Winners

THE TWO BIG WINNERS

**THE NEW SPECIAL LIPSON LIGHT PEN
FOR THE EIGHTY CHARACTER
VIDEX VIDIOTERM CARD**

- Comes With Extensive Documentation
- The Only Pen Sanctioned By Videx
- Comes Complete With Software

FREE WITH THE PURCHASE OF A VIDIOTERM CARD

(Graphics Rom Included) \$336.00

And

VU #3

VU #3 Is a VISICALC UTILITY Program That Allows The User To:

- Take data from any program (that is first put into a text file) and load it into VisiCalc
- Form VisiCalc files
- Load data from VisiCalc into text files that can easily be loaded into any basic language program

ONLY \$69.95 (\$4.95 for postage and handling)

**YOU TOO CAN BE A WINNER WHEN YOU BUY
THESE PRODUCTS!**

Videoterm and Videx are Registered Trademarks of Videx Inc.
Apple II is a Registered Trademark of Apple Computer Co.
VisiCalc is a Registered Trademark of Personal Software Inc.
Mail CHECKS AND MONEY ORDERS TO:

PROGRESSIVE SOFTWARE

BOX 273

PLY. MTG., PA 19462

Phone No. 215-279-4438

PA Residents Pay 6 Percent Tax

save, even print out your own crossword puzzles. Applesoft, 48K, disk. \$29.95.

□ The modem, that revolutionizing peripheral that is allowing Apples—and other computers—to talk to each other, becomes cheaper with **Micromate Electronics's** (East Meadow, NY) *Micronet*. It is an asynchronous, half/full duplex modem that connects through the Apple's game paddle I/O port. Such a capability eliminates the need of a card, which means that much less hardware and a lower price. With it is a direct coupler, registered with the FCC, from which a twenty-five foot telephone cord connects the user with the telephone system. *Micronet* operates in originate-answer and auto-answer modes; the software for modem operation can function in deferred or immediate operation modes with the user's software. A built-in FIFO memory permits stacking of telephone number digits, making consecutive output of digit entries possible. Accuracy of dial pulses and modulation tones is maintained by crystal control. Notable is *Micronet's* front panel of diodes that indicate network and modem conditions, facilitating any needed debugging operation. *Softalk* is test-using the product and will give you a further report on its performance in a later issue. \$269.

□ **Sirius Software** (Sacramento, CA) announces an updated version of its popular E-Z Draw graphics utility called *E-Z Draw 3.3*. The package retains the best of the original version and adds several new features beyond the name-apparent compatibility with DOS 3.3. (3.2 is provided on the flip side of the disk for unconverted drives.) One significant omission from the new package is the use of game paddles for drawing. What originally appeared to be an advantage turned out not to be the best alternative. Instead, the I, J, K, and M keys move the cursor a distance specified by inputting a number one through nine. One moves the cursor one dot on the hi-res screen; nine jumps about a quarter inch, permitting quick movement around the screen. The consistency of distance in the jumps also allows for simple setting up of graphs or charts.

The other major change from the original package is in the text mode. Several new Sirius text fonts are available and access is improved. In addition, the fonts from Ron and Darrel Aldrich's *Higher Text* (**Synergistic Software**, Bellevue, WA) are included; all text is placed on the screen with ease using that program's character generator, which Sirius calls "simply the best written." New fonts include Old English (Gothic), Broadway (Manhattan), Countdown (Computer), and script. Another font is actually a selection of thirty-one border designs. A concise chart shows what text colors to use on what background color for various effects. By Nasir Gebelli and Jerry W. Jewell. Apple II/II Plus, Pascal or Applesoft in ROM, 48K, disk. \$49.95.

□ Perhaps you remember diagramming sentences as a seemingly meaningless exercise consuming hours you'd rather have spent playing basketball or going to the movies. Yet, when you come to a long, convoluted sentence, you probably have those hours of drill in sentence diagramming to thank for your ability to clear away the chaff and find the root meaning. If you still can't make your way through such a sentence, you need *Sentence Diagramming* from **Avant-Garde Creations** (Eugene, OR). Intended for use in schools, but equally applicable for the adult wanting to brush up grammar, program requires identification of parts of speech and open-ended noting of usages before diagramming. Diagramming is done on set form for each of twenty sentences per level on three possible levels. Question mark prompts for each spot in diagram to be filled. Provision is made for keeping student records and progress summaries, with automatic level advancement according to user specifications. Applesoft, 48K, DOS 3.2. \$19.95.

□ **Siro-tech** (Ogdensburg, NY) introduces *Galactic Attack*, a real-time space war simulation. Fine-lined, smooth-motion animated hi-res of space battles, planet invasion. Requires building up skills—strategy and tactics to overcome enemy in long-run, dexterity for immediate ship manipulation and firing. 48K, DOS 3.3 or Language System, disk. \$29.95. ■

ATTENTION!
Apple Computer Owners.
 Before buying your next piece of Apple Software, Consult



**This is the one book that should be on
 all Apple Computer Owners' shelves.**

**THE
 BOOK**

OF
 APPLE COMPUTER SOFTWARE

1981

\$19.95

\$19.95

THE BOOK contains a complete critical analysis of the majority of Apple Software on the market today.

Each review is done by an expert; teachers for education programs, businessmen and accountants for business programs, programmers for utilities, etc.

Order Today from your local dealer or from:

THE BOOK 1981

14013 Old Harbor Lane, Suite 312

Marina Del Rey, CA. 90291

[213] 371-4012

TWO NEW ONES FOR THE APPLE II® OR II plus®

ABM

Invader and Asteroids move over... ABM has arrived! Command your launch sites to fire 1 and 5 kiloton anti-ballistic missiles (ABMs). Save the East Coast from increasingly fierce Enemy nuclear attack. Position your target crosshairs to blast the green streamers before they fire—ball your cities—or worse—split into multiple warhead MIRVs turning the entire coast into a thundering specter of destruction. Hi-res color graphics, sound, high score to date memory, paddle or joystick control. On disk, requires Applesoft ROM. (\$24.95)

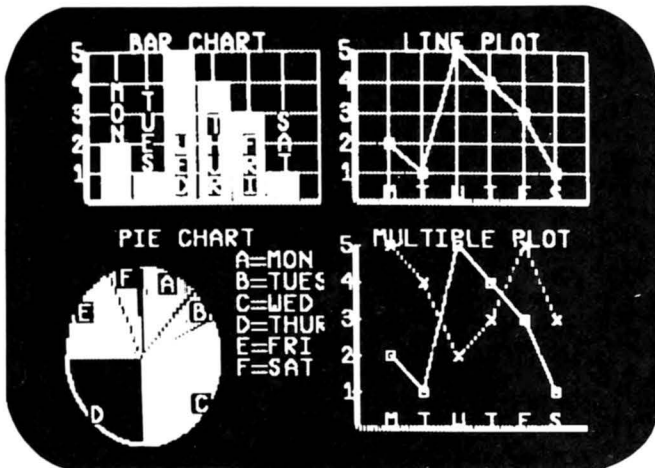
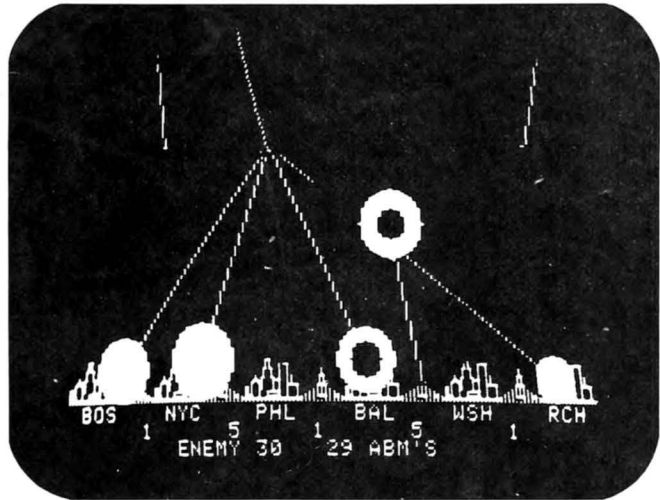

DATA PLOT

Easy editing features allow you to create and modify a wide variety of full color graphic representations of numerical information. Bar charts, including additive bars, as well as single and multiple line charts may be plotted individually or cumulatively. Pie charts are easily sliced. All figures may be output to a graphics printer or saved as hi-res "pictures" for dramatic full color recall as visual aids during presentations. Basic statistics are displayed automatically. On disk, requires 48 k and Applesoft ROM. (\$59.95)

available now at your local computer store

MUSE SOFTWARE™

Apple II is a trademark of Apple Computer Corp

330 N. CHARLES STREET
BALTIMORE, MD 21201
(301) 659-7212

Dealer Inquiries Welcome

The Apple and Cable TV:

BY MARGOT COMSTOCK TOMMERVIK AND ROBERT KOEHLER

An Office Apple Looks to TV Stardom

Way back in the dawn of the Apple Age, all of two and a half or three years ago, but early enough that his Apple is number 412, Rob Barnes took an inventory program he developed on *Bob Bishop's Index Card File*—one of very few data bases then available—to his employer as a more efficient way of keeping track of needed parts and tools.

His employer, an independent UHF television station in Atlanta, Georgia, bought the program—and Barnes's personal Apple—on the spot.

News and Sports Via Satellite. The company, Turner Broadcasting Inc., and its founder, Ted Turner, still own the station, WTWS, but that station, better known as the Superstation, now reaches a satellite audience of more than ten million homes on cable in forty-nine states. Among other programs, it brings to these viewers all the baseball games of the Atlanta Braves, the basketball games of the Atlanta Hawks, and the soccer games of the Atlanta Chiefs—because the company owns those teams as well.

Besides this expansion, Turner Broadcasting began a new network on June 1, 1980: the Cable News Network, a wholly

owned subsidiary. Cable News, with a format that's "like watching Walter Cronkite all day long," is already bringing twenty-four-hour-a-day news to more than four million homes in forty-eight states via satellite.

In the process, Turner has expanded its electronic personnel to three Apples and two Onyxes.

Before the Apple, it often took employees more than an hour to find individual parts; sometimes they gave up and sent someone out for a new one—it was faster and cheaper. With the Apple in charge, every item is accessible in seconds.

Antique Apple Still Going Strong. Apple number 412—still running perfectly after only one repair since its purchase: constant use required the on/off button to be replaced—now works in the WTWS engineering department, still keeping inventory. In fact, this inventory is still kept on the *Bishop Index Card File*, despite more up-to-the minute data bases used for every other purpose. "Two years worth of inventory input is just too much to ask the staff to transfer to a new system; and the Bishop file still works well for its purpose," Barnes explains.

Apple 412's time is in demand. Members of the promotion

The Peripheral That Makes It Possible

In 1974 Video Associates Labs was founded in Austin, Texas; the company specialized in making other people's equipment work better in specific applications. Until recently, products were strictly for video use. Then, one of VAL's engineers bought an Apple II for his home, and the entire staff became fascinated by the graphics and the possibilities. As often happens, they began noticing input from other sources that led them to believe they weren't the only people curious about the possibility of using the Apple II in video production work.

Now the company has designed two devices to marry the technology of computers and video. One, the RAVE System, places a video cassette recorder under computer control for educational purposes.

Double Board Does the Job. The first units of VAL's other video/computer product are scheduled for mid February delivery. The product is the VB-1 Board—actually two boards—that plugs into any Apple peripheral slot and transforms the Apple's output to a signal that can go through a switcher, be re-



Terry Kelly of Wisconsin's Weather Central programs on Apple's Graphics

corded, or achieve any other effect possible with a legally usable NTSC signal.

Until now, television stations that have used Apple graphics in television broadcasts have done so by generating the Apple output to a standard monitor, then shooting the video picture off the monitor for broadcast. This process loses quality in translation. But the Apple alone could not generate a direct signal acceptable to the government, thus the intervention of the monitor.

The VB-1 changes all that. The two boards—one of which plugs into an Apple slot, the other resting on the power source—have as many chips as the Apple itself. They bypass the Apple's memory entirely, but make use of the Apple's intelligence and graphics capabilities.

Invention Required the Video Mind. How is it that a computer breakthrough should come from people who are relatively unversed in computers? According to VAL director of operations Mike Dyer, the question contains its own answer:



Growing Up Together

department descend on it daily to index video tapes of film clips to be used for promotion. A movie may be shown two or three times in the course of a month, then dropped for five years. Apple's Index—this one kept on a *DB Master* from Stoneware—will instantaneously locate the thirty-second spot to promote that showing.

Apple Computer's *File Cabinet*, revised by Barnes, took over most tasks from Softape's pioneering *Index Card File*, and now is itself being replaced in several areas by the new *DB Master* from Stoneware. Barnes has had the *DB Master* only a few months—he's one of those chosen as a guinea pig for that program—and he thinks it's great—"a *VisiCalc* of data bases." Unfortunately, it's like *VisiCalc* in one too many ways: *DB Master* is also heavily protected and consequently inaccessible and can't be backed up. But, says Barnes, "Stoneware plans to offer a free backup after six months, which will include any updates that have been made to the system."

File Cabinet Shares Spotlight. The old reliable *File Cabinet* will not be totally replaced. "*File Cabinet*, with its provision for user revision, is still the best for some uses," Barnes remarks. "The *Index Card File* was great for its time, but it's outdated now. Probably because of its versatility, *File Cabinet* just goes on and on."

The first task *DB Master* assumed was upkeep of the inter-company phonebook—a considerable job with a 475-person staff. The phonebook Apple is never turned off, as Turner is a round-the-clock operation. Once a week, the phonebook is modified to reflect changes, and when there are enough changes, the Apple prints a new phonebook.

DB Master is also used for a nightly library run. In the wee small hours of the morning, there is one thirty-minute stretch when the library staff moves in, entering identification and descriptions of extremely significant bits of videotape from the day's news and recording them and their videotape locations

in the Apple. Qualifying for this elevated status are events such as Begin's handshake with Sedat, the Mount Saint Helens eruption, and the recent Italian earthquake. Once a month, the Apple produces a report showing what events are thus captured and where to find the relevant tapes. In the meantime, a producer needing reference to such an event can ask the Apple for immediate access by any key word.

The same Apple does a weekly run for the sports department of Cable News Network. The network videotapes all popular or major sports events for later showing or for accurate reporting. Previously, sports department people had to keep tabs on events by frequent hunting through TV guides and newspapers. Now, all sports schedules are fed into the Apple at the beginning of a season; then, once a week the Apple prints out the next week's schedule for recording games, including contenders, viewing time, and channel.

A Writer, Too. This particular Apple sits on Rob Barnes's desk. He uses the Apple and Apple Computer Inc.'s *Apple Writer* for word processing and claims their system to give the best quality output in existence—"it looks like a published book." A great deal of searching and trial through expensive systems and boards led Barnes to an inexpensive interface from CompuSystems in Columbia, South Carolina, which proved to be what its name suggests: the *Missing Link*. This board interfaces the Apple to an IBM Electronic—not Selectric—50, 60, or 70 typewriter, providing Apple-generated output in a perfectly justified, proportional letter spaced, high quality typeface.

The third Apple, this one using *File Cabinet*, serves as a major troubleshooter. With offices in London, Rome, Peking, New York, Chicago, Dallas, San Francisco, Los Angeles, and Washington, DC, as well as Atlanta, for immediate on-the-spot

GOTO 24: CNN



Terry Kelly photos

et. Output is displayed on the right.

"It's because we're not computer people that we could create the VB-1. The crucial problems involved in enabling the Apple to produce legal television signals required video expertise far more than computer knowledge. Being video specialists first and computer buffs only lately, we came at the problems from the direction necessary to find solutions, and we made it work."

Although this government standard signal achievement may seem somewhat technical to nontelevision industry pros, what it means for all who are interested in the progress and propagation of the Apple is that our computer is, with the VB-1, the best and most economic means of achieving computer graphics and text on television.

It also enhances the versatility of the Apple's uses on television. One major breakthrough enabled by the VB-1 is that the Apple output can be keyed over any standard NTSC signal, such as video black, camera output, or switcher output.

GOTO 24: VIDEO BOARD



The Dakin5 12-in-1 Utility Kit gives your programming more punch!

Dakin5 Corporation, a Colorado software house, is making available to the public 12 utility programs on one 16 sector diskette, utilizing the new Apple DOS 3.3, which provides 23% more storage.

All of the Dakin5 Programming Aids 3.3 programs are also compatible with the Corvus Disk Drive system.

Features

- Remove REM statements, unreferenced (dead) code, and compress code to increase program speed and save memory and disk space.
- Copy any file or program from one diskette to another. Only the name is needed.
- Print or display a line cross reference and variable name cross reference.
- Print or display all or selected records from a text file.
- Display any sector of a given file or program, and then update any data within that sector, or specify the sector you wish to update, such as directory sectors and sectors occupied by DOS.
- Create, print and modify your own text and Exec files.
- Perform 20-digit arithmetic.

- Copy a diskette without DOS; initialize without DOS; verify source diskette; verify copied data is the same as the original.
- Use a powerful data entry routine that handles both string and numeric data.

Plus Many More Utility Programs for Sophisticated Programmers

Many of these utility programs have been developed and tested for in-house use while producing The Controller™ business package for Apple Computer Inc.

Each programming aids package includes a program diskette and very complete documentation, all attractively packaged in a padded, blue print vinyl 3-hole notebook with silver lettering. An identifying tab separates each program for convenient reference.

See your Apple dealer or contact Dakin5 Corporation, P.O. Box 21187, Denver, Colo. 80221. Telephone: 800-525-0463. VISA or MC welcome.

Apple is a registered trademark of Apple Computer Inc. The Controller is a registered trademark of Dakin5 Corporation.

DAKINS CORPORATION
 "committed to solving the right problems"

Rob Barnes photo



Rob Barnes

CNN

news coverage, keeping track of names, numbers, and circuits would be nearly impossible without the computer. When a news story breaks anywhere in the world, the Apple can instantly locate the nearest camera and report on the immediate activities of nearby reporters who might cover the event.

Recently relocated in the Cable News engineering department, the third Apple is also kept busy keeping this department's inventory—but, since it's starting fresh, the data base is *DB Master*.

Larger System Takes Over City Room. The word-processing Apple is particularly useful for Turner's latest manual, which is constantly being revised because the system it documents has never been implemented before. That system is the Onyx redundant, sixty-terminal system that has totally replaced typewriters and teletypes at Turner Broadcasting.

Newspapers have done it, and even a radio station, but Turner is the first television station to boast a completely computerized city room. Rob Barnes designed the plan and hired Barys, a programming company in San Jose, California, to program the system. Barys chose the Onyx because of its ability for redundancy (having a backup computer accepting everything the in-use computer does) and its capacity for multiple terminals. The language used is Unix Language C.

No longer do ten different department heads clamber over who'll get the teletype printout of a hot wireservice item. Now, sixty key employees get the wireservices individually at their desks merely by tuning them in. With a twenty megabyte hard disk at each terminal, each person can record what he wishes. The system also serves the assignment desk by keeping contact with the worldwide newsbureaus of Cable News via electronic mail. At any moment, the desk can ask a terminal who's covering what and what's happening.

Planning the Apple's Turner TV Debut. Despite the pioneering nature of the new system, Apple is not taking a backseat to the Onyx in the least. Instead, Turner is preparing the Apple to make its on-the-air debut.

Barnes knows broadcasting execution as well as he knows computers. No well-known video-computer conversion board for the Apple produces a legal video signal, according to Barnes. Some are used at small stations, but they are not sending the Apple's output directly to the television waves; rather, they are shooting off the monitor with a television camera.

After extensive searching, Barnes is evaluating a \$2,200 double board from Video Associates Labs in Austin, Texas, which promises to produce at last a "genuinely legal video signal that would make even graphics such as [*DOS Tool Kit's*] *Rabbit* okay for broadcasting." In addition, the system, which has as many chips itself as the Apple, permits the videocaster to run the computer signals against its own legal black background or against a background from a camera.

Barnes's first plan for the Apple on television is as a time-teller. In league with the Video Associates Labs boards and a Mountain Computer Superclock, the Apple would broadcast a multi-time-zone digital clock before every commercial break. Leading into the clock would be animated Apple graphics that Barnes looks forward to designing.

When Ted Turner's TV station bought Rob Barnes's "Model A" Apple with its doctored version of *Bob Bishop's Index Card File* for keeping their inventory, no one had any idea that the new "employee" had its sights set on becoming a star. ■

Terry Kelly photo



Terry Kelly

Video Board

Apple Graphics Blend with Camera Background. This means that you could be watching Apple-generated closing credits scrolling over the wrapup of a football game; or you might see Apple graphics providing a cartoon character who points out the geographical areas on a real weather satellite photo as the television weather person explains the day's highs and lows.

Where updated weather maps were desired, the Apple could generate the maps themselves. In fact, Weather Central, a division of CoLoRgraphics in Madison, Wisconsin, has developed software that enables the Apple to obtain the latest United States Weather Bureau information via modem or teletype, interpret and integrate the data, and automatically produce updated maps, charts, plots, and analyses, which, with the addition of the VB-1, can be broadcast directly.

Boards Lead to Apple-TV Software Revolution. Before the Apple, computer-generated graphics for television were only available to the favored (with riches) few. The McIDAS system is typical of the pre-Apple versions of this utility: Designed by Dick Daly and J. T. Young of the NASA Space Science Center in Madison, Wisconsin, and for which the same men generated operating weather software, McIDAS units have formed the bases for experimental graphics systems at Chico State, WTVT in Tampa, and at the National Weather Service's Severe Storms Center in Kansas City.

The McIDAS system, and all other forerunners of the Apple system, cost from \$250,000 to \$1,000,000.

The Apple system, including an Apple II Plus, \$2,200 VB-1 board, two disk drives, Apple Graphics Input Tablet, and all software—written by the same two men who designed the McIDAS system—costs about \$14,000. If you're willing to create your own software, like Rob Barnes and Turner Broadcasting, the hardware will run about \$5,000.

Meteorologist Takes the Reins. No one is more enthusiastic about this system than Terry Kelly, president of Weather Central and chief meteorologist for the Wisconsin TV Network, both in Madison, Wisconsin. Although one of the minds behind CoLoRgraphics, Kelly is not a programmer or computer expert. He is first a meteorologist, and his expertise in this area adds greatly to other stations' confidence in the CoLoRgraphics package. The fifty-odd stations presently showing interest in the package find further encouragement in the fact that Weather Central and its associated television station use the system themselves.

Kelly is so proud of the system that it's hard to believe he didn't program it himself. "Displaying weather graphics through the Apple is a revolution in television weather reports," Kelly says. "The Apple automatically ingests and stores data received by direct connection to service A teletype lines on an hourly basis. The latest information is available for comparison and analysis instantly.

"Also, based on the data, the Apple plots scales and maps of the data in hi-res. Intermingled with the graphics can be text in various sizes and fonts."

Kelly's also excited about their being the first to implement direct connection of the Apple to the station video switcher, a major video engineering advance. Full frames of hi-res Apple color graphics can be transmitted to another Apple in a remote location using three hundred to fifteen hundred baud—up to a full page every one and a quarter minutes. ■

The TV Apple on the Local Level

In the Finger Lakes region of upstate New York, the Apple and television have a very different relationship.

It occurred to the management of WKRT cable television that the news their sister radio station, WNOX-FM, was broadcasting every day could perform a new role that would have been an impossibility before microcomputers. The WNOX reports would have a greater public impact if they reached the larger television audience in the form of a video newspaper. In-depth national news, not just to be seen and heard, but to be read, would be the order of the day.

TV News You Can Read. What was required was a processor that would print the news on the air. By November 1979, the station's management, headed by general manager Don Kelly, had chosen the Apple.

The readership for this experiment lives in the Cortland-Ithaca area, where Licable 2, WKRT channel two's nickname, is the major cable service. Even in a situation where, according to Kelly, "there are more television stations than people know what to do with," the newspaper service was a genuinely original idea whose time—as the revenues from the project's first month airing indicated—had come.

The presentation on-the-air was simple enough: news text in black and white with commercials in color interspersed. The foundation of the process was Ithaca-based Serendipity System's video message display system, supported in the studio by two Apples, three disc drives, and two editors called O.R.A.C.L.E. (Optical Reception of Announcement by Coded Line Entry).

This combination produced a show that was a big hit. And the success reached out beyond the Finger Lakes. Television station representatives from other parts of New York State, Pennsylvania, and from Canada and Australia came to the WKRT studios to see this news breakthrough.

Yet there was a fly in the ointment.

Black Matrix TV Sets Brought Bad News. "We began receiving more and more reports of poor to bad reception from viewers with black matrix televisions," Kelly recalls. "A persistent ghost on the right side of the screen prevented them from being able to read the video newspaper. This is a common problem with VHF cable broadcasts, and especially problematic with the kind of format we're dealing with that requires an absolutely clear signal. If everybody watched the program on a Sony, we'd have no problem."

Not everyone does, and the revenue drop reflected the problem as surely as the first month's receipt of sixteen hundred dollars had reflected the initial success: one thousand dollars by the second month, seventy-five dollars by the third. Such a loss did not instigate an impetuous executive order, however. Kelly's faith in the project was such that he insisted on allowing it five more months of life. At that point, it was clear that the newspaper could go to the electronic press no longer—until, that is, the signal problem was solved.

"The program was postponed, not cancelled. We're talking about solvable bugs, not the fatal kind. I'm very confident that Licable 2 will have the newspaper back on air by summer."

Vital Statistics Fill In for News. A time/temperature/weather broadcast has been the replacement since Sep-

tember 1980, with the Serendipity program still in use. The video slides are in hi-res and lo-res; the time is generated by the Mountain clock. And during the hours spent on debugging, Don Kelly has decided on a major revision for the newspaper's thrust.

He is convinced that the viewer/readership wants an emphasis on local over national news. Though it is less practical from the journalistic perspective—local reporting ultimately costs five times as much as the mere culling of national headlines from wire services—it is very practical when considering the viewer.

Apple Carries On in Second Edition. "People want the latest police blotter information, the instant local news and weather analysis, the school lunch list for the next day," Kelly explains. "We're in the business of providing information over the fastest medium our technology has developed: television. It seems to follow that the best kind of information is the kind people can use, and this is what we're going to try for with the newspaper's second edition."

And the Apple, like the printing press, carries on regardless of the nature of the news it transmits. ■

Apple
Owners:

DEPRECIATION PROGRAM

- ★ 5 DEPRECIATION RATES
- ★ UP TO 99 YR TERM
- ★ RECORDS UP TO 600 ITEMS ON DISK
- ★ UP TO \$1 MILLION FOR EACH ITEM
- ★ REPORTS EACH MONTH, QUARTER, OR ANNUALLY
- ★ BONUS DEPR., INVESTMENT CREDIT
- ★ PRO-RATES DEPRECIATION
- ★ UPDATE RECORDS EACH YEAR
- ★ EQUIPMENT INVENTORY
- ★ FISCAL YEAR BASED
- ★ CONVERT METHODS ANY TIME
- ★ AN ACCOUNTANTS DREAM

APPLESOFT 32K MIN. \$225.00
HANDBOOK..... \$5.00

VISA & M/C USERS — CALL
509-943-9004

MONEYDISK
P.O. BOX 1531
RICHLAND, WA 99352



APPLE IS A REGISTERED TRADEMARK
OF APPLE COMPUTER INC.
WA Residents, add 5% sales tax



DEALER INQUIRIES INVITED

Assembly Lines

BY ROGER WAGNER

Everyone's Guide to Assembly Language,

Part 5

Commands Covered So Far:

| | | | |
|-----|-----|-----|-----|
| JSR | LDA | LDX | LDY |
| RTS | STA | STX | STY |
| INC | — | INX | INY |
| DEC | — | DEX | DEY |

BNE

Last month, we started into the various techniques of creating and using counters and loops in machine language. To accomplish the loop, we used the value in one of the registers as a counter and the branch instruction that tests for the presence of a nonzero number in the register to actually do the looping. Recall that this evaluation of zero/nonzero is done via the zero bit, or *flag*, of the status register of the 6502.

The complement of the BNE (*Branch Not Equal*) instruction is something called BEQ, which obscurely enough stands for *Branch Equal*. It operates in just the opposite fashion from BNE; that is, it branches only when the register or memory location reaches a value of zero.

For example, consider this Basic listing:

```
10 HOME
20 X=255
30 PRINT X
40 X=X-1
```

```
50 IF X=0 THEN 70
60 GOTO 30
70 END
```

In this case, the loop continues as long as *X* is not equal to zero. If it is, the branch instruction is carried out and the program ends. In assembly language, this program would be the equivalent:

```
1 *****
2 *****
3 *LOOP PROG. 2
4 *****
5 *
6 OBJ $300
7 ORG $300
8 HOME EQU $FC58
9 *
10 START JSR HOME
11 LDX #5FF
12 LOOP STX $700
13 DEX
14 BEQ END
15 JMP LOOP
16 END RTS
```

Notice that this program requires the addition of a new instruction to our repertoire, the JMP command. This is analogous to a GOTO in Basic, and in this program will cause program execution to jump to the routine starting at LOOP each time. Only when the *X* register reaches zero does the BEQ take effect and cause the program to skip to the RTS at end. Here is the way this would appear when put into memory, and then listed with the "L" command from the monitor:

```
*300L
0300- 20 58 FC JSR $FC58
0303- A2 FF LDX #5FF
0305- 8E 00 07 STX $0700
0308- CA DEX
0309- F0 03 BEQ $030E
030B- 4C 05 03 JMP $0305
030E- 60 RTS
```

The assembler automatically translates the position of LOOP and END into the appropriate addresses to be used by the BEQ and JMP when it assembles the code.

Remember that to the left are the addresses and the values for each opcode and its accompanying operand. The more intelligible translation to the right is Apple's interpretation of this data.

Notice that the JMPs and JSRs are immediately followed by the address (reversed) that they are to jump to, such as in the first JSR at \$300.

However, branch instructions are handled a little differently. At \$309, the \$F0 is the opcode for BEQ. The \$03 follows the address of the next instruction (\$30B). Adding \$03 to \$30B gives us \$30E, the address of the desired RTS.

Branching in the reverse direction—up through the listing—is also possible and is shown by operands greater than \$80. There is not much need of going into great detail on this though since your assembler will determine the proper values for you when assembling code, and Apple's disassembler will give the destination address when reading other code.

This is also a good time to stress the importance of working through each of these examples on your own, step by step, to make sure you understand exactly what happens at each step, and how it relates to the rest of the program. If you're not sure, go back over it until that proverbial light comes on!

As the *X* register is incremented in this program, we'll stuff

Apple Disk Fixer

DOS 3.2
DOS 3.3 &
LANGUAGE
SYSTEM DISK

APPLE II
32K, DISK

13 OR 16 SECTOR

If you care enough to back up critical programs and files, Disk Fixer™ will give additional peace of mind. This powerful utility for experienced Apple users is a tool kit for manipulating, repairing, and protecting all data on disk.

Use the high-speed full screen editor to examine and easily change any portion of a disk, correct space usage within files, and save money by locking out bad tracks on disks. Directories are alphabetized, if you choose.

The display and search capabilities show where specific HEX or ASCII data is located and you can modify any data including binary files.

DOS 3.2, DOS 3.3 & LANGUAGE SYSTEM DISK

Written by Jeffrey P. Garbers

©1980 The Image Producers, Inc., All Rights Reserved

IMAGE COMPUTER PRODUCTS™

615 Academy Drive
Northbrook, IL 60062
312/564-5060

the value into \$700 so we can see something on the screen as the counter advances.

Now you may remark that from last month's experience, although this program is pleasantly simple in its logic, it was not much fun to watch on the screen because it was done so quickly.

To solve this, this month we will start to make more extensive use of the routines already present in the Monitor to do certain tasks, and thus make our programming requirements a little simpler. Referring the 1979 edition (newest) of the *Apple II Reference Manual*, page 61, it happens that the first routine listed is something called COUT. This is the routine that actually sends a character we want output to whatever device(s) may currently be in use. Most of the time, this just goes directly to the next routine listed, COUT1 (clever with the names, aren't they?), which specifically handles the screen output. What this means for us is that anytime we want to output a character, we don't have to write our own routines to worry about all the in-depth details about the screen (cursor position, screen size, whether it's time to scroll), we just load the accumulator with the ASCII value for the character we want to print, and then do a JSR \$FDED!

Now comes some programming technique. We would like to have the counter value in the accumulator so we can print it via COUT, but unfortunately our increment/decrement commands only work for the X and Y registers and given memory locations. To solve this, we'll have to expand our listing a little. This time, we'll use a memory location as the counter, and then load the accumulator on each pass through to print out a visible sign of the counter's activity. Good locations to use for experimenting are \$06 to \$09. These are not used by either Integer, Applesoft, DOS, or the monitor. This is important for avoiding conflicts with the Apple's normal activities while running your own programs.

And now our revised listing:

```

1 *****
2 *LOOP PROG. 2A
3 *****
4 *
5 OBJ $300
6 ORG $300
7 CTR EQU $06
8 HOME EQU $FC58
9 COUT EQU $FDED
10 *
11 START JSR HOME
12 LDA #$FF
13 STA CTR
14 LOOP LDA CTR
15 JSR COUT
16 DEC CTR
17 BEQ END
18 JMP LOOP
19 END RTS
    
```

Apple's "L" command will give this after you've assembled it in memory:

```

*300L

0300- 20 58 FC JSR $FC58
0303- A9 FF LDA $FF
0305- 85 06 STA $06
0307- A5 06 LDA $06
0309- 20 ED FD JSR $FDED
030C- C6 06 DEC $06
030E- FO 03 BEQ $0313
0310- 4C 07 03 JMP $0307
0313- 60 RTS
    
```

A call to this routing via our usual 300G from the Monitor, or a CALL 768 from Basic should clear the screen, then print all the available characters on your Apple, in all three display modes (normal, flashing, and inverse). The beep you hear is the Control-G (bell) being "printed" to the screen via COUT. The invisible control characters account for the blank region between the two main segments of output characters. You will also see some characters that are not normally generated by the Apple, such as underscore, reverse slash, and the left square bracket (__,/,|).

The alphabet is backward because we started at the high-

Computer Station 12 Crossroads Plaza Granite City, IL. 62040 (618) 452-1860

COMPUTER STATION proudly offers a high-speed binary video digitizer for the Apple II called the **DITHERIZER II**. The peripheral board uses a video camera with external sync to load the hi-res page of the Apple with any image the camera can capture. The **DITHERIZER II** is a frame grabber, DMA type digitizer requiring only 1/60th of a second to capture a binary image. Software supplied with the board enables building dithered images and capturing image intensity contours. Intensity and contrast are user controllable via the game paddles. Matrix size for dithering changable with one keystroke. Requires video camera, with external sync; recommended model, Sanyo VC1610X.

DITHERIZER II, \$300; B/W SANYO VIDEO CAMERA, \$410; PACKAGE OF DITHERIZER II AND CAMERA, \$650.



GRAPHICS DUMPS: COMPUTER STATION offers the highest degree of human engineering on the market for hard copy graphics from the hi-res pages of the Apple. The following machine language dump routines are available for BASIC:

| | |
|----------------------------|----------------|
| IDS440G/445G* | \$44.95 |
| IDS460G* | 44.95 |
| ANADEX 9501 | 44.95 |
| NEC SPINWRITER 5510 | 44.95 |
| NEC SPINWRITER 5520 | 44.95 |

* Also available for use with Pascal, \$44.95.

APPLEWRITER GRAPHICS: Hard copy of character sets found in DOS Tool Kit for use with Applewriter or print statements in your own programs. Requires DOS 3.3, DOS Tool Kit, one of graphic printers below:

| | |
|---------------------|----------------|
| Silentype | \$34.95 |
| IDS440G/445G | 34.95 |

VISILIST: Get hard copy of the FORMULAS used in VISICALC models. Prints grid location, contents (formulas or labels), and global parameters. Handy utility for all VISICALC users. **\$24.95**

PROGRAMMER'S GUIDE TO THE APPLE II: Thick reference card (40 page booklet). **\$4.95**

Send or call for free catalog.



Apple II is a registered trademark of Apple Computer, Inc. VISICALC is a registered trademark of Personal Software, Inc. DITHERIZER II is a registered trademark of Computer Stations, Inc.

APPLE II TRS-80

QUALITY DISK SOFTWARE

HOME FINANCE PAK I: Entire Series \$49.95 (A) (T)

- CHECK REGISTER AND BUDGET This comprehensive CHECKING ACCOUNT MANAGEMENT SYSTEM not only keeps complete records, it also gives you the analysis and control tools you need to actively manage your account. The system provides routines for BUDGETING INCOME AND EXPENSE, AUTOMATIC CHECK SEARCH, and BANK STATEMENT RECONCILING. CRT or printer reports are produced for ACTUAL EXPENSE vs BUDGET, CHECK SEARCH DISPLAY, RECONCILIATION REPORT and CHECK REGISTER DISPLAY by month. Check entry is prompted by user defined menus of standard purposes and recipient codes, speeding data entry and reducing disk storage and retrieval time. Six fields of data are stored for each check: amount, check no., date, purpose, recipient and TAX DEDUCTIBLE REMINDER. CHECK SEARCH routines allow searching on any of these data fields. Routines are also provided for CHECK SORT by date and check no., DATA EDITING and Report Formats. Up to 100 checks/mo. storage \$39.95
- SAVINGS Account management system for up to 20 separate Savings accounts. Organizes, files and displays deposits, withdrawals and interest earned for each account. Complete records shown via CRT or printer. \$14.95
- CREDIT CARD Get control of your credit cards with this program. Organizes, stores and displays purchases, payments and service charges for up to 20 separate cards. Use for credit cards or bank loans. CRT or printer reports. \$14.95

UNIVERSAL COMPUTING MACHINE: \$49.95 (A) (T)

A user programmable computing system structured around a 50 row x 50 column table. User defines row and column names and equations forming a unique computing machine. Table elements can be multiplied, divided, subtracted or added to any other element. User can define repeated functions common to a row or column greatly simplifying table setup. Hundreds of unique computing machines can be defined, used, stored and recalled, with or without old data, for later use. Excellent for sales forecasts, engineering design analysis, budgets, inventory lists, income statements, production planning, project cost estimates in short for any planning, analysis or reporting problem that can be solved with a table. Unique cursor commands allow you to move to any element, change its value and immediately see the effect on other table values. Entire table can be printed by machine pages (user defined 35 columns) on a 40 column printer.

COLOR CALENDAR: \$29.95 (A)

HI-RES color graphics display of your personal calendar. Automatic multiple entry of repetitive events. Review at a glance important dates, appointments, anniversaries, birthdays, action dates, etc. over a 1 year period. Graphic calendar marks dates. Printer and screen display a summary report by month of your full text describing each day's action item or event. Ideal for anyone with a busy calendar.

BUSINESS SOFTWARE: Entire Series \$159.95 (A) (T)

- MICROACCOUNTANT The ideal accounting system for the small business. Based on classic T accounts and double-entry bookkeeping, this efficient program records and produces reports on account balances, general ledger journals, revenue and expenses. Screen or 40 column printer reports. Handles up to 1000 journal entries per month up to 300 accounts. Includes a short primer in Financial Accounting. \$49.95
- UNIVERSAL BUSINESS MACHINE This program is designed to SIMPLIFY and SAVE TIME for the serious businessman who must periodically Analyze, Plan and Estimate. The program was created using our Universal Computing Machine and it is programmed to provide the following planning and forecasting tools:
CASH FLOW ANALYSIS PROFIT AND LOSS STATEMENT SOURCE AND USE OF FUNDS
PERFORMANCE PROFIT & LOSS SALES FORECASTER JOB COST ESTIMATOR

Price, including a copy of the Universal Computing Machine \$89.95

- BUSINESS CHECK REGISTER AND BUDGET Our Check Register and Budget programs expanded to include up to 50 budgetable items and up to 400 checks per month. Includes bank statement reconciling and automatic check search (48K). \$49.95

ELECTRONICS SERIES: Entire Series \$259.95 (A) (T)

- LOGIC SIMULATOR SAVE TIME AND MONEY Simulate your digital logic circuits before you build them. CMOS TTL, or whatever, if it's digital logic, this program can handle it. The program is an interactive, menu driven, full fledged logic simulator capable of simulating the bit time by bit time response of a logic network to user specified input patterns. It will handle up to 1000 gates, including NANDS, NORs, INVERTERS, FLIP FLOPS, SHIFT REGISTERS, COUNTERS and user defined MACROS. Up to 40 user defined, random, or binary input patterns. Simulation results displayed on CRT or printer. Accepts network descriptions from keyboard or from LOGIC DESIGNER for simulation. \$159.95
- LOGIC DESIGNER Interactive HI-RES Graphics program for designing digital logic systems. A menu driven series of keyboard commands allows you to draw directly on the screen up to 15 different gate types, including 10 gate shape patterns supplied with the program and 5 reserved for user specification. Standard patterns supplied are: NAND, NOR, INVERTER, EX OR, T FLOP, JK FLOP, D FLOP, RS FLOP, 4 Bit COUNTER and 8 BIT SHIFT REGISTER. User interconnects gates just as you would normally draw using line graphics commands. Network descriptions for LOGIC SIMULATOR generated simultaneously with the CRT diagram being drawn. \$159.95
- MANUAL AND DEMO DISK Instruction manual and demo disk illustrating capabilities of both programs \$29.95

MATHEMATICS SERIES: Entire Series \$49.95 (A)

- STATISTICAL ANALYSIS I This menu driven program performs SIMPLE LINEAR REGRESSION analysis, determines the mean, standard deviation and plots the frequency distribution of user supplied data sets. Printer, Disk, I/O and edit routines included (32K min). \$19.95
- NUMERICAL ANALYSIS HI-RES 2 Dimensional plot of any function. Automatic scaling. At your option, the program will plot the function, plot the INTEGRAL, plot the DERIVATIVE, determine the ROOTS, find the MAXIMA and MINIMA and list the INTEGRAL VALUE. \$19.95
- MATRIX A general purpose, menu driven program for determining the INVERSE and DETERMINANT of any matrix, as well as the SOLUTION to any set of SIMULTANEOUS LINEAR EQUATIONS. Disk I/O for data save. Specify 55 eqn. set (48K) or 35 eqn. (32K). \$19.95
- 3-D SURFACE PLOTTER Explore the ELEGANCE and BEAUTY of MATHEMATICS by creating HI-RES PLOTS of 3 dimensional surfaces from any 3 variable equation. Disk save and recall routines, for plots. Menu driven to vary surface parameters. Hidden line or transparent plotting. \$19.95

ACTION ADVENTURE GAMES: Entire Series \$29.95 (A)

- RED BARON Can you outfly the RED BARON? This fast action game simulates a machine gun DOG FIGHT between your WORLD WAR I BIPLANE and the baron's. You can LOOP, DIVE, BANK or CLIMB in any one of 8 directions, and so can the BARON. In HI-RES graphics. \$14.95
- BATTLE OF MIDWAY You are in command of the U.S.S. HORNETS' DIVE BOMBER squadron. Your targets are the Aircraft carriers, Akagi, Soryu and Kaga. You must fly your way through ZEROS and AA FIRE to make your OIVE BOMB run. In HI-RES graphics. \$14.95
- SUB ATTACK It's April, 1943. The enemy convoy is headed for the CORAL SEA. Your sub, the MORAY, has just sighted the CARRIERS and BATTLESHIPS. Easy pickings. But watch out for the DESTROYERS, they're fast and deadly. In HI-RES graphics. \$14.95

- FREE CATALOG All programs are supplied on disk and run on Apple II or Disk & Applesoft ROM Card & TRS-80 Level II and require 32K RAM unless otherwise noted. Detailed instructions included. Orders ship post within 5 days. Card orders include card number. Add \$1.50 postage and handling with each order. California residents add 6% sales tax. Foreign orders add \$5.00 postage and handling.

Make checks payable to:

SPECTRUM SOFTWARE
P.O. Box 2084 142 Carlow, Sunnyvale, CA 94087
For phone orders - 408-738-4387
DEALER INQUIRIES INVITED

est value and worked our way down. From last month though, you'll remember that when a byte is incremented by 1 from \$FF, the result "wraps around" back to \$00. This will produce an action testable by a BEQ. Using this wrap-around effect of the increment command, we can rewrite the program to be a little more conventional like so:

```

1 *****
2 *LOOP PROG. 3
3 *****
4 OBJ $300
5 ORG $300
6 CTR EQU $06
7 HOME EQU $FC58
8 COUT EQU $FDED
9 *
10 START JSR HOME
11 LDA #$00
12 STA CTR
13 LOOP LDA CTR
14 JSR COUT
15 INC CTR
16 BEQ END
17 JMP LOOP
18 END RTS

```

With the Apple showing:

```

*300L
0300- 20 58 FC JSR $FC58
0303- A9 00 LDA #$00
0305- 85 06 STA $06
0307- A5 06 LDA $06
0309- 20 ED FD JSR $FDED
030C- E6 06 INC $06
030E- F0 03 BEQ $0313
0310- 4C 07 03 JMP $0307
0313- 60 RTS

```

A call to this routine should now print out the characters in a more familiar manner. At last our programs are starting to do something interesting! It gets better!

Let's try reading a game paddle, and use what we get back to print something to the screen! Granted, I'm not any more sure than you are what good this might be, but it's guaranteed to be a new program in your library!

On page 64 of the reference manual, it indicates that a paddle can be read by loading the X register with the value for the paddle you wish to read, followed by a JSR \$FB1E. When the routine returns, the value of the paddle will be in the Y register. All we have to do then is grab this, stuff it in the accumulator, and then do our JSR COUT.

```

1 *****
2 *PADDLE PROG. 1
3 *****
4 OBJ $300
5 ORG $300
6 TEMP EQU $06
7 PREAD EQU $FB1E
8 HOME EQU $FC58
9 COUT EQU $FDED
10 *
11 START JSR HOME
12 LDX #$00
13 LOOP JSR PREAD
14 STY TEMP
15 LDA TEMP
16 JSR COUT
17 JMP LOOP
18 * (INF. LOOP)

```

You should get this in memory:

```

*300L
0300- 20 58 FC JSR $FC58
0303- A2 00 LDX #$00
0305- 20 1E FB JSR $FB1E
0308- 84 06 STY $06
030A- A5 06 LDA $06
030C- 20 ED FD JSR $FDED
030F- 4C 05 03 JMP $0305

```

This routine when called will quickly fill up the screen and then change the stream of characters output as you turn paddle zero. Since we have no test for an end, reset is the only way to stop this infinite loop.

Depending on your propensity toward being hypnotized,

you may lose touch with the world for indefinite periods of time. At the inverse and flashing end, it's also remarkably good at stimulating migraine headaches in record time. By carefully controlling the paddle, you can also observe some interesting bits of ASCII trivia. For example, after the inverse and flashing range, you should be able to stop the flow by moving into the control character range. With sufficient dexterity, you should be able to lock onto the persistent beep of the bell (Control-G).

Shortly after this point, the screen will zip into motion when you hit the line feed character (Control-J) and, of course, also at Control-M (carriage return). What fun, eh! When normal character output returns as you pass the halfway point, you can delight in various patterns of screen filling. Why, you may even wish to try writing your name by deft control of the paddle—child's play!

Returning to reality here, it is worth mentioning that some problems in accuracy can arise from repeatedly reading the paddle so quickly. The analog circuits don't have time to return to zero, and various problems creep in.

Also, we have been a bit negligent in looking out for conflicting use of the registers by the various routines we are calling. There is often no assurance that the register you're using for your own routine won't be clobbered by the monitor routine you use. In the case of the paddle and output routines, you'll note they did mention how the X and Y registers and the accumulator were affected by each of the routines.

For the record, here is a reasonable facsimile of our program in Applesoft:

```
10 HOME
20 T = PDL(0)
30 PRINT CHR$(T);
40 GOTO 20
```

It is also worth mentioning that our machine language version takes eighteen bytes, while the Applesoft one takes thirty-eight, not counting space used by the variable, T.

Execution speed may seem to be similar, but this is because of the printing of the characters to the screen. In most cases, machine execution would be orders of magnitude faster.

Before I end, I'd like to toss just a few more commands your way. In our program, we have to go through a rather inelegant way of transferring the value from the Y register to the accumulator, using a temporary storage byte. Fortunately, there is an easier way. There are four commands for transferring contents of the X and Y registers to and from the accumulator. They are as follows:

- TXA: Transfers contents of X register to accumulator.
- TYA: Transfers contents of Y register to accumulator.
- TAZ: Transfers contents of accumulator to X register.
- TAY: Transfers contents of accumulator to Y register.

Each of these actions conditions the zero flag upon execution, so it is possible to test what has been transferred. There is no command to transfer directly between the X and Y registers themselves.

This gives us an even shorter program:

```
1 *****          9 *
2 * PADDLE PROG. 1A 10 START JSR HOME
3 *****          11 LDX #$00
4 OBJ $300          12 LOOP JSR PREAD
5 ORG $300          13 TYA
6 PREAD EQU $FB1E  14 JSR COUT
7 HOME EQU $FC58   15 JMP LOOP
8 COUT EQU $FDED   16 * (INF. LOOP)
```

Now it's only fifteen bytes long!

*300L

```
0300- 20 58 FC JSR $FC58
0303- A2 00 LDX #$00
0305- 20 1E FB JSR $FB1E
0308- 98 TYA
0309- 20 ED FD JSR $FDED
030C- 4C 05 03 JMP $0305
```

With twenty commands at your disposal, you now know just over a third of the total vocabulary of the language. In a few more issues, you'll be dangerous! See you next month! ☐

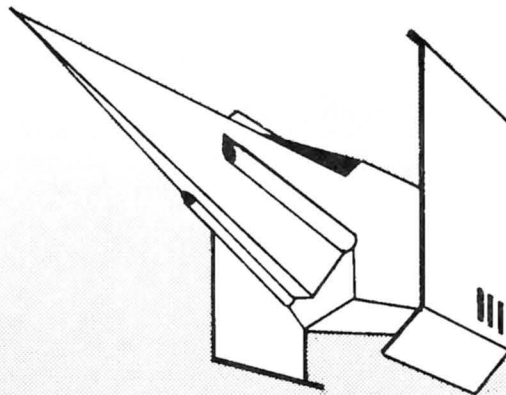

SIRIUS SOFTWARE PRESENTS

Action Software For The Apple

Both Barrels

This package features two games: HIGH NOON and DUCK HUNT. Fun for the very young and the young at heart...you'll love the bad guy that falls off the roof and the dogs fighting over the ducks.

Star Cruiser

STAR CRUISER is a fast action arcade game that can be played by ages 3 and up. SOFTALK magazine rated this one number three...need we say more?

Cyber Strike

CYBER STRIKE This is brand new game for the APPLE II...a hi-res action adventure in space with a full 48k of Assembly Language programming with animation and 3-D effects you haven't seen before. MIND BOGLING! Everyone said a game like this wasn't possible on the APPLE II, but we did it. Also includes a real time clock (software implemented) and several levels of play. WARNING...THIS GAME REQUIRES PRACTICE TO PLAY SUCCESSFULLY! Uses either 13 or 16 sector APPLE II, II+, or III.

*APPLE II is a registered trademark of Apple Computer, Inc. HIGHER TEXT is a copyrighted product of Synergistic Software. BOTH BARRELS, DUCK HUNT, HIGH NOON, STAR CRUISER, and CYBER STRIKE are all copyrighted products of SIRIUS SOFTWARE. All rights reserved.



Sirius Software

1537 Howe Ave., Suite 106, Sacramento, CA 95825

Upstairs, Downstairs: A Tale of Housekeeping Computers

BY RICHARD L. COLEMAN

The future is tumbling down upon us. In his book, *Future Shock*, sociologist Alvin Toffler warns of an adverse effect on people of too much technological change in too short a time. Although we may not share Dr. Toffler's pessimism, it's true that technological change is progressing at an unbelievable rate, especially in the electronics industry.

Advances in microcomputer technology, with consequent decreases in cost, are making it possible for many more people to have microcomputers in their homes. Only recently have we begun to uncover the immense potential in home use of the microcomputer.

But What Does It Do? Most of the public still suffers from computer ignorance. For example, recently, when an enthusiastic computer owner was demonstrating his Apple II to acquaintances, one observer asked, quite seriously, "But what good is it? It just seems like a sophisticated toy to me." The demonstrator's response took the form of two questions: "What good was the telephone when Alexander Graham Bell first spoke those immortal words, 'Mr. Watson, come here, I need you!?' What good is a newborn baby?"

We are, in fact, witness to the birth of an electronics baby that, in the course of time, will alter and improve our lifestyles even more radically than did the invention of the telephone. The potential of microcomputers, those electronic marvels spawned from integrated circuits, is unbelievable. Since the beginning of time, most inventions have been aimed at one primary goal—to make life easier and more enjoyable.

There was a time when only the very wealthy could enjoy lives of ease; they were attended by hosts of servants, ready to do their every bidding. The microcomputer offers the potential of an unlimited number of personal servants to do our every bidding. Consider, for a minute, the following fantasy flight through a computerized home of the not too distant future.

A Computer Fantasy. After a hard day at work, Steve Appleby, our computer-age executive, heads for home in his car, which is, of course, equipped with a multitude of microprocessor controlled devices to keep it working in optimum condition. As he pulls into his driveway, a sensor on the garage detects his approach and transmits a query signal to the car, which automatically responds with the appropriate answer code. Recognizing this as a friendly code, the garage sensor raises the door and turns on the lights.

As Appleby enters the house, he is met by his wife who arrived home from her job minutes before. She has just finished consulting the kitchen terminal of their home computer for dinner suggestions. Meal planning has become a snap with their menu planner programs; the computer now plans all the meals, making sure they are nutritious and well balanced. Within minutes, the couple has assembled the raw materials; they place the food in the microwave ovens and inform the computer that the dinner is ready for cooking. While the Applebys relax in the den with an aperitif, the computer prepares dinner to perfection.

As they enter the den, the lights automatically come on and, at the same time, the kitchen lights go off.

"TV, on; Channel 80," intones Appleby. Doors on a hutch swing open to reveal a wide-screen television, which bursts into life with information from the New York Stock Exchange. With a smile, Appleby notes that Apple Computer stock is up $\frac{3}{8}$ of a point. At another spoken command, the television shuts off, the cabinet doors close, and soft stereo music begins.

Meanwhile, up in the children's rooms, twins Christopher and Jamie are locked in battle as they try to save the galaxy from the space invaders, realistically simulated on their computer terminals.

Older sister, Melissa, is locked in a battle of her own. She has her computer terminal tied in through her modem to her best friend's computer. Together the girls are trying to work out their latest problem in advanced computer programming, a class required for all sixth graders.

After a few minutes, a soft tone sounds throughout the house and a quiet voice (computer generated, of course) announces, "Dinner will be ready in five minutes."

As members of the family head for the dining room, the home environmental controls shut down the heating system to other parts of the house and recycle the warm air from the va-

What's for Dinner

One of the most nagging of household chores a family faces on a daily basis is deciding what to eat. It has been estimated that average homemakers spend between one and two hours per week each planning meals for their families and preparing shopping lists of the items needed to prepare those meals. With husband and wife both working in most families, this becomes a more burdensome task than in past years.

If you stop and think about it, you—like most people—will probably conclude that your family has fifteen to twenty favorite menus that you serve on a regular basis. You prepare these menus over and over, the same way each time, using the same basic ingredients. Yet you spend time each week deciding which of the menus to prepare and determining which items are needed from the grocery store to prepare the meals; even so, invariably you overlook something. All this adds up to a boring, repetitious, but necessary chore. Wouldn't it be nice to have a personal servant to perform this job?

Such a servant exists in a software program; it's called, simply, *Menu Planner*. *Menu Planner* is one of a series of labor-saving, home-management programs for the Apple computer being produced under my guidance by the College of Home Economics of Louisiana Tech University in Ruston, Louisiana. This servant only works in an environment it shares with an Apple II, a disk drive, and a printer.

Menu Planner uses your own favorite breakfast, lunch, and dinner menus along with a list of ingredients required to prepare each meal. The program, therefore, is personalized to you. There are no prepackaged menus, only those you like, and menus can easily be added, deleted, or amended as you choose.

When run, *Menu Planner* assembles menus for the number of days you choose, displays the menus for your approval, then

cant rooms into those that are occupied. Just about the same time, a soft whirring sound is heard from the attic. The sensors on the roof have detected nightfall and have shuttered the solar panels to prevent heat loss during the cool night. Window sensors are closing the drapes.

After dinner, the family retires to the den to play a game. As the children are setting it up, Steve contacts his office computer, using his portable remote terminal, to make a last minute check on a new contract. Later in the evening, just before the family retires, the home computer will begin to cycle warm air back into the bedrooms.

In the middle of the night, after the family is asleep, the computer washes the clothes and supper dishes, taking advantage of the lower power rates during nonpeak hours. It also senses that the ground outside is rather dry so it turns on the sprinkler system to water the lawn.

Early in the morning it will turn up the heat, perk the coffee, videotape the early morning news, and gently awaken everyone to music. Another day begins, more comfortable and infinitely more convenient because of the tireless, efficient computer.

And Now the Facts. "Sounds great," you are probably saying with a wistful sigh, "but that is a long way off in the future." Wrong! This story is not set in the future; it is now. Every device, every piece of software, every control unit described in this fantasy is available to the public now, although you do have to hunt around and do some of the assembly yourself.

We are still a few years away from having all these conveniences built into houses as standard features; but what was impossible only a few years ago is merely difficult today. In a few more years, it will be not only easy but common.

The future of microcomputers for home use is exciting. As the saying goes, you ain't seen nothin' yet. ■

er? Ask Apple

prints the menus along with a grocery list. The program is designed to be used as a turnkey system, so the user needs to know almost nothing about the computer. Let us follow a homemaker through the use of the program as an illustration.

Our homemaker is seated at the Apple. The Menu Planner disk has been inserted into the disk drive and the TV monitor and printer have been turned on. When the computer is turned on the program is automatically loaded and run. The Screen displays:

```
*****
*   MENU PLANNER   *
* BY DR. RICK COLEMAN *
*****
```

WELCOME TO MENU PLANNER, A LABOR SAVING PROGRAM DESIGNED FOR HOME MANAGEMENT.

WHICH DO YOU WANT?

1. INSTRUCTIONS
2. PREPARE MENUS AND SHOPPING LIST
3. ADD MENUS OR SHOPPING LIST ITEMS
4. DELETE MENUS OR SHOPPING LIST ITEMS
5. PRINT ALL MENUS OR SHOPPING LISTS
6. INITIALIZE FILES

TYPE THE NUMBER OF YOUR CHOICE

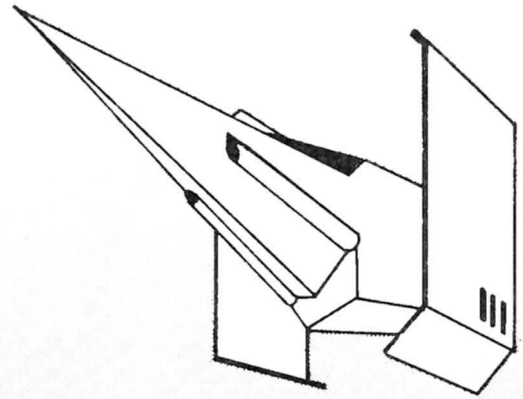

SIRIUS SOFTWARE PRESENTS Action Software For The Apple

E-Z Draw

E-Z DRAW is the software that started it all...the poor man's graphic tablet. But now it has been updated to 3.3 DOS and completely rewritten for the professional user. E-Z DRAW now includes the powerful HIGHER TEXT character generator written by Ron and Darrel Aldrich. With our new routines the fonts or any part of the picture can be flipped upside down, slanted left or right, rotated 90 or 180 degrees, mirrored or any combination of the above. Also the fonts or parts of the screen can be expanded in width or height, or compressed in height or width. You can mix portions of pictures together, or save only a portion of the screen on disk. Now fully keyboard controlled for better accuracy. Professional documentation and 20 different and imaginative type styles included. Also included are commands to print the hi-res screen on the Trendcom or Silentype printers. Updates are available for the customer who already purchased E-Z DRAW 2.0. The update is only \$10.00 for those who return their original disk directly to us...please don't bug your dealer for the update.

*APPLE II is a registered trademark of Apple Computer, Inc. HIGHER TEXT is a copyrighted product of Synergistic Software. Trendcom is a registered trademark of Trendcom. Silentype is a registered trademark of Apple Computer, Inc. E-Z DRAW is a copyrighted product of SIRIUS SOFTWARE. All rights reserved.



Sirius Software

1537 Howe Ave, Suite 104, Sacramento, CA 95825



ON AN OLD FAVORITE!

announcing...

HI-RES CRIBBAGE

FOR THE APPLE II OR II PLUS COMPUTERS

ON-LINE SYSTEMS is now offering a Cribbage game to challenge even the best Cribbage player as you play against the computer. The cribbage board is done with beautiful Hi-Res Graphics and you can watch (and hear) the scores being pegged. The cards are dealt randomly; they actually look as if they are being turned over one by one by an invisible hand. If you're not careful, and don't play your cards right, the computer will skunk you. For the beginning Cribbage player, HI-RES CRIBBAGE comes with complete instruction and strategy aspects of the game. For the experienced Cribbage player, HI-RES CRIBBAGE offers a totally challenging game.

Hi-Res Cribbage is available now at your local computer store and requires a disk drive. To order directly send \$24.95 to:

On-Line Systems
36575 Mudge Ranch Road
Coarsegold, CA 93614
209-683-6858

VISA, MASTER CHARGE, COD, CHECK ACCEPTED

The interchange between Apple and our homemaker then continues:

Homemaker: 2

Apple: FOR HOW MANY DAYS DO YOU WANT MENUS PLANNED? (14 DAYS MAXIMUM. TYPE THE NUMBER AND PRESS 'RETURN'.)

Homemaker: 7 (RETURN)

Apple: DO YOU WANT MENUS PLANNED FOR THREE MEALS EACH DAY? (TYPE 'Y' OR 'N')

Homemaker: N

Because both husband and wife work all day and the kids are in school, there is no need to prepare lunch, so the homemaker skips to the subroutine to specify the number of meals needed.

Apple: HOW MANY BREAKFAST MENUS DO YOU WANT? (TYPE THE NUMBER AND PRESS 'RETURN')

Homemaker: 7 (RETURN)

Apple: HOW MANY LUNCH MENUS DO YOU WANT? (TYPE THE NUMBER AND PRESS 'RETURN')

Homemaker: 2 (RETURN)

On the weekend, the entire family is usually home for lunch.

Apple: HOW MANY DINNER MENUS DO YOU WANT? (TYPE THE NUMBER AND PRESS 'RETURN')

Homemaker: 7 (RETURN)

Apple: WILL YOU WANT TO APPROVE MENUS BEFORE I PRINT THEM (TYPE 'Y' OR 'N')?

This program gives our homemaker the option of approving the menus. If one is rejected then Apple runs back to the list to get a substitute and asks if the substitute will be acceptable. In this case, our homemaker is not choosy and decides to take Apple's recommendations.

Homemaker: N

Apple: WHAT SLOT NUMBER IS YOUR PRINTER CONTROL CARD IN? (TYPE NUMBER FROM 1 TO 7).

Apple will then dutifully hum away and prepare the list of menus, assemble the grocery list and a list of miscellaneous items, print everything, and beep when it is finished. All this in less time than it takes to get your coat and car keys.

Meal planning cannot be easier than it is with the *Menu Planner*—until you train your Apple to cook the meals as well.

Dr. Coleman is director of the microcomputer laboratory in the college of home economics at Louisiana Tech University, Ruston, Louisiana. The lab, probably the first of its kind, has two Apple II systems for which Coleman is developing home economics applications. Menu Planner is the first of these. The lab serves as a learning facility for a course on microcomputers in home management.

Further information about *Menu Planner* and other home management programs may be obtained by writing to Coleman, Director of the Microcomputer Laboratory, College of Home Economics, Louisiana Tech University, Ruston, Louisiana 71272.

IT'S HERE



GET THE BEST

The Data Factory was nationally rated as the best selling data base on the market and now we have made it even better. It will help you solve your problems. Thousands of people have chosen The Data Factory since we introduced it nationally last June. MAJOR CORPORATIONS use The Data Factory to handle jobs that they do not want to put on their large computers, or that would be too time consuming or costly to program. SMALL BUSINESSES use The Data Factory to control their accounts receivable and accounts payable. Mailing lists and sales records are easily maintained with the Data Factory. CHURCHES, CLUBS, HOSPITALS and SCHOOLS can keep their financial, inventory, and individuals records up to date. At HOME, your hobbies and collection lists, bank statement reconciliations, taxes, and appointment or subscription renewal calendars keep your life organized! At work or at home, The Data Factory solves problems.

WE ADDED YOUR IDEAS

We now have the next version of the Data Factory ready on 3.3 DOS. This new version, 4.0, has over 40 new and expanded features that were not in the 3.0 version. We have increased your efficiency by expanding the Data Factory's usefulness and the ease of operation. When users called us with suggestions we listened. When users wrote to us asking for new features we considered them all. We have been responsive to your needs and have given you a better and more valuable investment. The upgraded DOS gave us more space to add the new features. We used it all and still had more to give you. A SECOND PROGRAM DISK was needed to include everything!

If you have our EXTENDED WARRANTY, now selling for an annual rate of \$30, send us ONE original program disk and we will replace it with the TWO disk system at no additional cost. Any renewals needed due to "blown" or damaged disks will be replaced as well during that period. If you have not yet purchased it, be sure to do so at once, as users with this Extended Warranty have priority on receiving the 4.0 version. Without an Extended Warranty, any upgrades or renewals are always \$10 per disk. Extended Warranties may be purchased anytime from your local dealer or from Micro Lab.

We found that while adding more power and features to the Data Factory, it became larger than some people needed as a beginning system. We decided that there should be a way to introduce a user to the Data Factory on a more limited basis.

THE MINI FACTORY IS HERE

The Mini Factory is the EASIEST WAY TO LEARN the Data Factory System. The Mini Factory has the major routines of the original program and is on one program disk in 3.3 DOS. You can still add or delete fields after your information has been entered, do the same 20 level search, and find records that are from one date to another date. You may also choose to search for items by entering only a few characters

within the record, replace information in your records with a constant, and much of what was available in the 3.0 edition. The Mini Factory will NOT have a periodically updated version. The data that you store on the Mini Factory WILL be compatible with the big Data Factory if you decide to upgrade to the larger system. Many people may find that the Mini Factory is all that they need, but it is reassuring to know that if your needs expand, the Data Factory is there to grow with you. The Mini Factory is at your Micro Lab Dealer now.

THE SYSTEM GROWS

Micro Lab will be introducing its first "Data Factory Compatible" BUSINESS SYSTEM shortly. You will be able to use all the Data Factory features on this powerful but easy to use system. Check with your Micro Lab dealer for more information.

REQUIREMENTS AND COSTS

To operate the Data Factory or the Mini Factory you must have Applesoft in ROM and a 48K machine. You need only one disk drive but two are recommended. A printer is helpful but optional. Your Micro Lab Dealer has our products at the following prices, although some dealers supply other services along with the sale of our products so prices may vary.

| | |
|-----------------------|----------|
| The Data Factory | \$150.00 |
| The Mini Factory | 75.00 |
| The Mini-Data upgrade | 90.00 |





BY JEFFREY MAZUR

You'll soon be able to make travel and hotel reservations, perform banking transactions—already available from one New York bank—buy products, and eventually do all your grocery shopping, even vote, via your computer. Your means to opening up these vast worlds to your computer is the modem.

Modems have already provided many new capabilities to microcomputer owners who want to talk to each other, show each other their latest programming coups, tap in on the Dow-Jones reports, or watch the latest New York Stock Exchange quotes. Many modem systems provide bulletin boards—sources of information you can tap into anytime and learn the latest from that system owner; some are single purpose, some general.

The modem hooks you up with the phone system and, once there, you'll find that the world is, indeed, your Apple.

How the Modem Works. Computer equipment uses binary data to store and transfer information. To send binary data from one device to another, we need some transmission medium, such as wires or radio waves. For equipment within the same building, ordinary wire cable generally does the job; but, for long distance communication, it is usually not possible to string up such a hard wire connection.

Glossary

ABBS. Apple bulletin board system. A CBBS that is run on an Apple II computer. See **CBBS**.

Asynchronous. A method of serial data transmission whereby the decoding clock signal is transmitted indirectly in the format of the actual data. The data is also said to be self-clocking.

Acoustic coupler. A device for connecting a modem to the telephone network by placing the telephone handset into a holder containing a microphone and speaker.

Answer mode. The state of the host modem while awaiting or having established connection with a calling modem.

Auto-answer. The ability of a modem to answer the phone when it rings and then attempt to establish connection with a calling modem.

Baud rate. Loosely, bits per second of

The logical alternative is to use the telephone network, because it already exists and it can link almost any two points. Unfortunately, normal telephone circuits cannot pass straight digital signals, which are basically DC voltage levels. Therefore, these must be converted into signals compatible with the phone system—for example, audible tones. This process is known as modulation.

A simple and reliable technique for modulation is frequency shift keying. FSK translates binary ones and zeros into two different frequencies that are easily transmitted over the phone circuits. If you wish to have simultaneous two-way communication, *full duplex*, you'll need two distinct frequency bands that can be isolated from each other.

The Bell System 103 specifications were devised to set a standard for this type of communication; this is by far the most widely used standard in North America. There are some limitations to this standard, however, the most crucial being speed. For an acceptable degree of reliability, the baud rate must be limited to three hundred, or about thirty characters per second.

Selecting a Modem. Connecting your Apple II to the phone usually requires two pieces of hardware: a serial communications card and a modem. Each of these costs between one hundred and two hundred dollars and is available from

transmitted data. With the normal eight data bits (seven-bit ASCII plus parity), one start bit, and one stop bit for each byte, the number of characters or bytes sent per second equals the baud rate divided by ten.

Bell System 103. A standard for telecommunications specifying modem frequencies and modulation techniques.

CBBS. Community bulletin board system. A computer system that allows other people to call in and read bulletins, post messages, download programs.

Data set. Another name for modem.

Direct Connect. A type of modem that connects directly to the phone network by plugging in the modular phone jack.

Download. Transferring a program or file from a computer system into your own computer.

Forum 80. A CBBS run on a Radio

Apple as well as from several independent suppliers. One system, the Hayes Microcomputer Products *Micromodem II*, has a built-in communications card, and costs about the same as each other modem and card combined. The Hayes *Micromodem II* was the peripheral used as the basis for this article.

On a single peripheral board, the Micromodem II combines a serial interface and modem with PROM firmware for easy use; a separate Microcoupler makes the direct connection to the phone lines. The Micromodem provides all common modes of operation (full/half duplex, 110/300 baud, answer/originate) and, because it is an integrated direct connect modem, it also allows auto answer/originate. This means that the Micromodem can automatically dial the phone or answer it, in case you desire remote access to your Apple. All these functions are easily accessed from Basic through the on-board PROM.

The Micromodem recognizes control character commands from the keyboard and several other commands from a remote terminal. More sophisticated programming of the modem is possible through a number of software switches or registers, all of which are documented in the owner's manual.

An advantage of a modem is the ability to download programs from other computer systems. However, some avail-

Shack TRS-80 computer. See **CBBS**.

FSK. Frequency shift keying. A modulation technique using two different frequencies to represent binary data.

Full duplex. Simultaneous two-way communication: normal telephone conversation is full duplex.

Half duplex. Communication one way at a time: CB radio is half duplex; parties must take turns talking and listening.

Modem. MODulator-DEModulator. A device for converting binary data into audio signals capable of being sent over telephone lines.

Null character. The ASCII character (00) sent by a computer that is ignored by a receiving device. Null characters are typically used with hard-copy (printing) terminals to give the printhead time to return to the left margin after printing

MODEM Part 1

able computer systems will download only to the Micromodem at present.

Using a Modem. Perhaps the best way to describe the operation of a modem is to show a sample session of how one would "log on" to a remote computer system from the Micromodem II. After turning on the computer, you simply type:

[User's responses in italic]

IN#n assuming in Basic; *n ctrl-K* from monitor; *n* is the slot in which you have your Micromodem.

ctrl-A

MICROMODEM: ? *ctrl-F*

MICROMODEM: BEGIN TERM *ctrl-A*

(Now running terminal program)

MICROMODEM: ? *ctrl-Q*

MICROMODEM: DIALING:

346-1849 <cr>

(Calling Woodland Hills ABBS)

MICROMODEM: AWAIT CARR.

MICROMODEM: CONN.

(ABBS has answered!)

TYPE <C/R> *<cr>*

(Greeting message received from ABBS)

TYPE <C/R> *<cr>*

.....
WELCOME TO THE WOODLAND
HILLS
.....

The first command, *IN#n*, informs the Apple II that the modem is there, but otherwise there is no change until one of the modem's commands is issued.

each line.

Originate mode. The state of a calling modem when it is attempting, or has established, connection with a computer system.

RS-232. An interface standard for serial data communication that specifies voltage levels and connector pin assignments.

Serial communication. A method of transferring data one bit at a time, as opposed to bitwise (parallel).

Synchronous. A method of serial data transmission where the encoding clock signal is transmitted separately and then used by the decoder to recover the data.

Sysop. SYStem OPERator. The person in charge of a computer system.

Upload. Transferring a program or file from your computer into another computer system.

As you can see, all commands to the Micromodem begin with Control-A. Thus, whenever Control-A is typed on the keyboard, the Micromodem displays the line "MICROMODEM: ?" indicating that it is ready for another command character.

At this point, you type a Control-F. This tells the modem to put the Apple in the terminal mode running full duplex. Basically, this just shuts off the Apple's operating system and Basic interpreter, allowing the keyboard and video display to communicate solely through the modem. This is necessary because you want to talk to the remote computer and not to the Apple, which would mostly respond with syntax errors.

Although the Apple has not taken the role of a dumb terminal, it is possible to switch back to the Apple's operating system at any point. Control-A Control-X does this, returning you to find the Apple just where you left it before entering the terminal mode.

The next command, Control-A Control-Q, tells the Micromodem that you wish to dial the remote computer. The modem will then simulate the phone being picked up, and, after a short delay (to get a dial tone), it starts to dial the number you type in. Hitting <cr> after the last digit informs the modem that you have finished dialing; hopefully, the line is ringing.

At this point the modem is listening to the line, waiting for the other computer to answer and send its carrier tone. When the modem detects this carrier, it conveys this fact on the screen and starts sending its own carrier to the other modem. Then you are ready to begin communicating with the other computer.

In this example, the remote computer (an ABBS) has sent us a message requesting that we send a <cr>. This is a typical greeting that allows the remote computer to ascertain that a terminal has called and that it is set at the proper baud rate. If the line had been busy or was not answered within thirty seconds, the modem would have hung up and displayed: MICROMODEM: HUNG UP.

All the Micromodem commands can be imbedded into a Basic program to run on the Apple. This allows you to write, for example, an auto-dialer program containing the names and numbers of many computer systems, enabling you to dial them with one or two keystrokes. Placing the modem in the auto-answer mode is even simpler. Just type:

IN#n

PR#n

where *n* is the modem slot.

The modem is now ready to answer the phone when it rings and attempt to establish communication with another modem. With the appropriate software, you could set up your own bulletin board system—a menu of messages others can read when dialing your modem—or simply leave the computer in this state allowing another terminal to call and take over control of the Apple.

Experience with an Allen. This idea intrigued me, so I decided to try working my Apple from a friend's TRS-80.

Since I wanted to put the Apple through its paces—from entering the machine language monitor to booting a disk and finally running programs—I knew I would have to add the following line to the disk's hello program:

0 PRINT "dIN#n": PRINT "dPR#n"

Where *d* is Control-D and *n* is the slot number of the modem. This is necessary because booting a disk will disconnect any peripheral cards and this line effectively hooks in the modem again.

The next step was to select a disk with programs on it that were suitable for use with the modem. Anything that used the Apple's graphics was of no worth since the remote terminal was a TRS-80 and would not be capable of displaying these. A disk of text games seemed a reasonable choice. After modifying its hello program, I hit reset, called the Monitor language, and initialized the modem:

* 3k

* 3p

*

Where *k* is Control-K and *p* is Control-P. Now I was ready to use my friend's remote terminal to call my Apple.

NEW FOR APPLE II® COMPUTERS

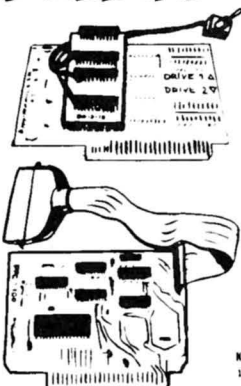

DEALER INQUIRES INVITED !!

FROM TYMAC
CONTROLS CORP.
Franklin, N.J. 07416

DOUBLE DOS PLUS - DD13-16 A piggyback board that plugs into the disk controller card so that you can switch select between 13 and 16 sector disks. Works great with the language system eliminating the need in many cases, to boot the Basics disk. Eliminates the need to convert all of your disks to 3.5 format..... ONLY \$39.00

PARALLEL PRINTER CARD - PPC-100 A universal Centronics® type parallel printer board complete with cable and connector for the Apple computer. This unique board will allow you to turn on and off the high bit in software so that text and graphics can be mixed on many printers.....\$139.00

SOFTWARE - UNCOPY - GRAPH*FIT DISTRIBUTED BY: Micro-Mare Distributing Inc.
ULTIMATE TRANSFER - ROAD RALLYE 439A Route 23
SUPER SEA WAR - Popperton Pl., N.J. 07444
THE APPLE CARD-PLASTIC REFERENCE CARD \$3.98 201-839-3478

NOTES: APPLE is a registered trademark of APPLE COMPUTER INC., CUPERTINO, CALIFORNIA. CENTRONICS is a registered trademark of Centronics Data Computer Corp Hudson, NH.

We proceeded to the computer room where he warmed up his TRS-80. As we called back to my house, the modem worked perfectly, answering the phone and putting our remote TRS-80 into full control (well, *almost* full control) of my Apple. I did some tricks with the Apple's monitor, to the awe of my TRS-80-owner friend, and then booted the disk.

Everything was working well. The disk booted and began running its hello program—a catalog menu program. During the working of the program, the Apple prompted for a single keystroke to select which program on the disk to run.

At this point, the Apple seemed to die. No matter what we typed on the terminal, nothing happened. It became apparent that the menu program, written in Integer Basic, used a peek function to read the Apple keyboard directly (similar to the GET statement in Applesoft). Because a peek directs the Apple to look in its own memory to see if a certain instruction has been typed, the Apple was waiting for someone to type on its keyboard. A call home to my wife on a different line soon brought life back into the computer and we continued on.

After this experience and looking at many of my programs, I realized that the great majority of my programs contained peeks, pokes, calls, and tabs that would work only with the Apple. Most however, could be modified slightly to make them more suitable for remote use via the modem.

The addition of a modem has opened up new uses for the Apple. One quickly finds oneself using a list of modem-accessible computer systems like the one accompanying this article, as well as larger time-sharing systems such as Micronet and The Source. And this is just the beginning. In the second part of this three-part article, we'll look at Computer Bulletin Board Systems.

This is a partial list of free bulletin boards and services you can contact by modem. Asterisked entries are usually available round the clock.

| City | Type | Phone No. |
|-------------------|----------------|----------------|
| Boundbrook NJ | Elect Mail | (201) 457-0893 |
| Monmouth NJ | Forum 80* | (201) 528-6623 |
| Union NJ | Forum 80 | (201) 688-7117 |
| Vernon NJ | Forum 80 | (201) 764-4974 |
| Pompton Plains NJ | ABBS | (201) 835-7228 |
| Princeton NJ | Forum 80 | (201) 874-6833 |
| Wyckoff NJ | ABBS | (201) 891-7441 |
| Piscataway NJ | ABBS | (201) 968-1074 |
| Washington DC | CBBS* | (202) 281-2125 |
| Washington DC | Prog Store* | (202) 337-4694 |
| Stamford CT | ABBS* | (203) 348-6353 |
| Birmingham AL | ABBS | (205) 945-1489 |
| Seattle WA | ABBS | (206) 244-5438 |
| Elma WA | ABBS* | (208) 482-5134 |
| Seattle WA | ABBS | (206) 524-0203 |
| Seattle WA | ABBS | (206) 546-6239 |
| Seattle WA | Info 80 | (206) 723-3282 |
| Fresno CA | Limited Access | (209) 638-6392 |
| Staten Island NY | ABBS | (212) 448-6576 |
| Los Angeles CA | ABBS | (213) 276-4276 |
| Torrance CA | ABBS | (213) 316-5206 |
| Torrance CA | Prog Sales | (213) 329-3715 |
| Canoga Park CA | ABBS* | (213) 340-0135 |
| Woodland Hills CA | ABBS* | (213) 346-1849 |
| Los Angeles CA | ABBS | (213) 349-5728 |
| Los Angeles CA | ABBS | (213) 360-6332 |
| Lawndale CA | ABBS | (213) 370-3160 |
| Santa Monica CA | ABBS | (213) 394-1505 |
| Brentwood CA | ABBS | (213) 395-1592 |
| Santa Monica CA | ABBS | (213) 396-3905 |
| Pac. Palisades CA | ABBS | (213) 459-6400 |
| Los Angeles CA | ABBS | (213) 873-2206 |
| Hawthorne CA | ABBS | (213) 875-8803 |
| Pasadena CA | CBBS | (213) 795-3788 |
| Pasadena CA | ABBS* | (213) 799-1632 |
| So. Pasadena CA | ABBS | (213) 799-6514 |
| Los Angeles CA | ABBS | (213) 826-0325 |
| Santa Monica CA | ABBS | (213) 828-3400 |
| Los Angeles CA | Novation* | (213) 881-6880 |
| Los Angeles CA | ABBS | (213) 921-2111 |
| Dallas TX | Forum 80 | (214) 288-4859 |
| Dallas TX | ABBS | (214) 634-2668 |
| Dallas TX | CBBS | (214) 641-8759 |
| Akron OH | Forum 80 | (216) 486-4178 |
| Akron OH | CBBS* | (216) 745-7855 |
| Ft. Lauderdale FL | ABBS | (305) 566-0805 |
| W. Palm Beach FL | ABBS | (305) 689-3234 |
| Ft. Lauderdale FL | Forum 80 | (305) 772-4444 |
| Miami FL | ABBS* | (305) 821-7401 |
| Hollywood FL | ABBS | (305) 989-9847 |
| Chicago IL | ABBS | (312) 236-7522 |
| Arlington Hts IL | ABBS | (312) 255-6489 |
| Chicago IL | Forum 80 | (312) 269-8083 |
| Chicago IL | Forum 80 | (312) 296-7486 |

| | | |
|-------------------|-------------|----------------|
| Chicago IL | ABBS | (312) 337-6631 |
| Chicago IL | ABBS | (312) 359-9450 |
| Naperville IL | ABBS | (312) 420-7995 |
| Chicago IL | CBBS | (312) 528-7141 |
| Chicago IL | CBBS* | (312) 545-8086 |
| Chicago IL | ABBS* | (312) 726-8263 |
| Downers Grove IL | ABBS | (312) 764-7768 |
| Chicago IL | CBBS* | (312) 767-2022 |
| Chicago IL | CBBS* | (312) 782-8180 |
| Southfield MI | ABBS | (313) 357-1422 |
| Detroit MI | Forum 80* | (313) 465-9531 |
| Ypsilanti MI | PET BBS | (313) 484-0732 |
| Detroit MI | ABBS | (313) 569-2063 |
| St. Louis MO | Forum 80 | (314) 838-7784 |
| Wichita KS | Forum 80 | (316) 746-2078 |
| Iowa City IA | ABBS | (319) 353-6528 |
| Dubuque IA | ABBS | (319) 557-9618 |
| Atlanta GA | CBBS* | (404) 394-4220 |
| Augusta GA | ABBS | (404) 733-3461 |
| Augusta GA | ABBS | (404) 790-8614 |
| Augusta GA | ABBS | (404) 793-1045 |
| Atlanta GA | Northstar* | (404) 939-1520 |
| Atlanta GA | ABBS | (404) 939-8429 |
| Atlanta GA | ABBS | (404) 953-0723 |
| San Jose CA | ABBS | (408) 957-9799 |
| Milwaukee WI | Forum 80 | (414) 241-5406 |
| San Francisco CA | Forum 80* | (415) 348-2139 |
| Palo Alto CA | ABBS | (415) 493-7691 |
| San Francisco CA | ABBS | (415) 661-0705 |
| Fremont CA | ABBS | (415) 792-8406 |
| Los Altos CA | ABBS | (415) 948-1474 |
| Toledo OH | ABBS | (419) 351-3845 |
| Louisville KY | ABBS | (502) 245-8288 |
| Portland OR | CBBS | (503) 646-5510 |
| San Antonio TX | ABBS | (512) 657-0779 |
| Long Island NY | CBBS | (516) 939-9043 |
| Phoenix AZ | ABBS | (601) 866-0258 |
| Phoenix AZ | ABBS | (602) 955-1486 |
| Phoenix AZ | ABBS | (602) 957-4428 |
| Phoenix AZ | CBBS | (602) 957-9282 |
| Vancouver BC | CBBS* | (604) 687-2640 |
| Marlton NJ | ABBS | (609) 983-5970 |
| Minneapolis MN | ABBS* | (612) 929-8966 |
| Columbus OH | CBBS | (614) 272-2759 |
| Nashville TN | CBBS* | (615) 254-9193 |
| Boston MA | ABBS | (617) 354-4682 |
| Wellesley MA | Forum 80 | (617) 431-1669 |
| Dunstable MA | Forum 80 | (617) 649-7097 |
| Westford MA | Forum 80 | (617) 692-3973 |
| Cambridge MA | CBBS* | (617) 864-3819 |
| Maynard MA | CBBS | (617) 897-0346 |
| Boston MA | CBBS* | (617) 963-8310 |
| Las Vegas NV | Forum 80 | (702) 873-9451 |
| Washington DC | AMRAD | (703) 281-2125 |
| Alexandria VA | CBBS* | (703) 620-4990 |
| Falis Church VA | CBBS | (703) 734-1387 |
| Fairfax VA | Genealogy* | (703) 978-7561 |
| Vacaville CA | ABBS | (707) 448-9055 |
| Freeport TX | ABBS | (713) 233-7943 |
| College Sta TX | ABBS | (713) 693-8080 |
| Houston TX | ABBS | (713) 977-7019 |
| San Diego CA | ABBS* | (714) 287-9379 |
| San Diego CA | ABBS* | (714) 449-5689 |
| Lemon Grove CA | ABBS | (714) 463-0461 |
| Laguna Niguel CA | ABBS | (714) 495-6458 |
| Fullerton CA | Comm 80 | (714) 526-3687 |
| Garden Grove CA | Forum 80 | (714) 537-7913 |
| San Diego CA | ABBS | (714) 582-9557 |
| Santa Fe Spgs CA | ABBS* | (714) 739-0711 |
| Irvine CA | ABBS* | (714) 751-1422 |
| Anaheim CA | ABBS | (714) 772-8868 |
| Orange CA | ABBS* | (714) 952-2110 |
| Huntington Bch CA | ABBS | (714) 962-7979 |
| Huntington Bch CA | ABBS | (714) 963-7222 |
| Logan UT | ABBS | (801) 753-6800 |
| Columbia SC | Forum 80* | (803) 279-5392 |
| Columbia SC | Northstar | (803) 771-0922 |
| Columbia SC | ABBS | (803) 772-1592 |
| Ventura CA | Forum 80 | (805) 484-9904 |
| Tampa FL | Forum 80 | (813) 223-7688 |
| Kansas City MO | Forum 80 | (816) 861-7040 |
| Kansas City MO | Commodities | (816) 931-3135 |
| Kansas City MO | Forum 80* | (816) 931-9316 |
| Wichita Falls TX | Forum 80 | (817) 855-3916 |
| Ft. Worth TX | Forum 80 | (817) 923-0009 |
| Memphis TN | Forum 80* | (901) 276-8196 |
| Memphis TN | Hobbyist 80 | (901) 362-2222 |
| Memphis TN | ABBS | (901) 761-4743 |
| Destin FL | ABBS | (904) 243-1257 |
| Leavenworth KS | Forum 80 | (913) 851-3744 |
| Olathe KS | Engineer 80 | (913) 764-1520 |
| Olathe KS | Avionics | (913) 782-5115 |
| El Paso TX | CBBS | (915) 584-5393 |
| Tulsa OK | Forum 80 | (918) 224-5347 |

SUPERCHARGE

6809

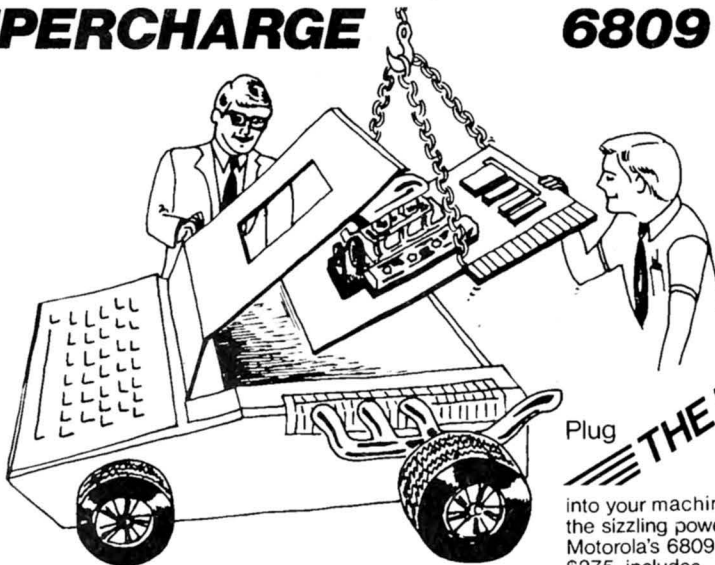

Plug **THE MILL**
into your machine and tap the sizzling power of Motorola's 6809. \$275, includes Complete Documentation



STELLATION TWO, Box 2342, Santa Barbara, CA 93120 - phone (805) 966-1140



Apple Galaxian. By Tony Suzuki. The people who brought you Godzilla, Rodan, Gamera, and Mothra on the movie screen have created a whole new set of monsters for the Apple. Taking a page from American filmmakers, Tony Suzuki of Star-Craft in Japan has written an invaders game with rabid fruits as the adversary, a la *Day of the Triffids* or *Attack of the Killer Tomatoes*.

December of 1980 proved to be a big month for the antivogitarian folk. First, the movie *Popeye* revealed that the title character has always hated spinach, much to the relief of all of us who never wanted to pack cans of the green stuff around to ward off bullies.

Now, the fruit haters can get their revenge by combatting bananas, oranges, and apples.

Nasir's *Star Cruiser* was the logical extension of the original *Super Invaders*. *Apple Galaxian* holds the same relationship with *Star Cruiser*.

In *Galaxian*, eighteen downright nasty fruits move across the top of the screen in *Invaders* fashion. They also peel off, singly or in bunches, to attack, perfectly willing to sacrifice themselves in the best kamikaze tradition to effect your cannon's death.

Not only are these critters naturally mean, they seem to take it personally if you succeed in gunning down some of their ilk. The better you do, and the higher you score, the more vicious and unpredictable they become.

Nothing yet created for the Apple matches the vindictiveness of a lone orange when your score is above seven thousand and you've killed the other members of its raiding party. Consummate skill is required to do battle with this devil.

One of the more satisfying elements of the program, which is beautifully done in colorful hi-res, is that each time you decimate a raiding party, a win flag is hoisted in the lower right corner of the screen. You will be destroyed eventually, but your accomplishments are duly noted.

The author is a twenty-one-year-old college student who is apparently without honor in his own land. As Gary Carlston of publisher Broderbund tells it, Suzuki was directed toward a career in medicine before he became hooked on programming. He's now switched his major to philosophy and spends his spare time programming for *Star-Craft*.

Programming, being a fairly recent occupational development, does not rank high as a vocation among tradition-oriented Japanese. Suzuki is looked upon as somewhat of a disappointment even within his own family.

However, Suzuki's programming accomplishment in *Apple Galaxian* merits the highest praise and greatest esteem. Steve Shendelman, general manager of the Data Domain retail outlet in Schaumburg, Illinois, called the program the finest example of Apple hi-res graphics yet and the buy of the past Christmas season.

Technical assets notwithstanding, anyone who hates fruit enough to make them the villains certainly stands in high honor in our household.

Apple Galaxian by Tony Suzuki. Star-Craft, Japan. Published in the United States by Broderbund Software, Eugene, OR. Applesoft ROM, 48K, disk. \$24.95.

ABM. By Silas Warner. A fast-moving new twist on the invader games, *ABM* is contemporary, set on earth rather than space. The player directs numerous antiballistic missiles in an attempt to save six U.S. cities from missile attack. The missiles begin their slow streak through the sky individually, but the better your defense, the more missiles come at once and the faster they fall.

Just when you think you've mastered it, you're treated to some missiles that work like fireworks, bursting into six prongs, each aimed directly at one of the cities. If you can hit these at the start of the forking, you can stop them; otherwise, it's time to choose between cities.

Although the game is no different in philosophy than space shootouts, the fact that the cities being destroyed are ones we all know and love may make the game unpalatable to those who cannot divorce the computer game from reality without the game's cooperation. When the game does cooperate—by calling the enemy aliens, monsters, or even your own hang-ups—the same people thoroughly enjoy the game.

Paddles control whether you fire inside or outside antiballistic missiles and placement of your shot. You must shoot at the beginning of the oncoming streak: if you're short, your ABM will explode too soon; if you're long, you'll merely cut off the tail of the enemy missile, and the warhead will continue on its course.

ABM, based on a popular arcade game, was written by Silas Warner, creator of *Robot War*, in his spare time. It shows the excellence of a game into which much time and effort were put.

ABM, by Silas Warner. MUSE Software, Baltimore, MD. \$24.95.

Phantoms Five. By Nasir. It seems as though a few weeks ago, but actually it's a few months ago, few computer owners had ever heard of Nasir. Since then, his prolific stream of beauti-

| | | | | | | | | | |
|---|---|---|---|---|---|---|---|---|---|
| | C | | | | | | | | |
| C | R | O | S | S | W | O | R | D | S |
| | O | | | | | | | | |
| | S | | | | | | | | |
| | S | | | | | | | | |
| | W | | | | | | | | |
| | O | | | | | | | | |
| | R | | | | | | | | |
| | D | | | | | | | | |
| | S | | | | | | | | |

EXERCISE YOUR MIND NOT YOUR REFLEXES

Crosswords is great for relaxing and educating and is fun to work.

- ★ 24 hires puzzles
- ★ Create your own puzzles
- ★ Fun and educational
- ★ Dos 3.2 or 3.3 systems
- ★ Print puzzles to paper

\$29.95

Available at finer software stores everywhere or from

SOFTAPE
 10432 Burbank Blvd.
 N. Hollywood, CA 91601
 213-985-5763



SUPERSCRIPT

SuperScript is the most powerful and easiest to use Word Processor available for your Apple II or II Plus computer. Besides leaping tall buildings in a single bound it:

- Gives true upper/lower case text on your screen with no additional hardware whatsoever.
- Works with documents larger than the amount of memory in your Apple - transparently to you!
- Edit not only letters but also any text or binary file, or even basic programs!
- Automatically generates up to 4 separate indices for your document!
- Save typing time through a unique ability to designate specified keys as commonly used words, phrases or even commands!
- Globally search for or replace character strings.
- SuperScript has a built-in instruction capability such that if you forget how to use a command and the manual is not close by - you may simply ask SuperScript!
- Supports multiple disk drives!
- Will support alternate character sets.
- Produces form letters using address files easily!
- Supports the shift key modification if made to your Apple.
- Lets you work with your text on a screen at a time basis - reducing typos and allowing you to see your document as you edit it.
- Works with any printer!
- Supports the language card or any 16K expansion Ram card to keep more of your document readily available in memory.

SuperScript is 100% machine language and requires only a 48K Apple II or II Plus with a disk drive. It may be purchased through your local computer store or direct from us by sending \$89.95 plus \$2.50 to cover shipping to:

MARKETALK

Reviews

fully drawn, fast-moving arcade-type games has made his name nearly as well-known as that of Bill Budge. *Phantoms Five* is his latest release on the market, but not his latest effort: that, called *Space Eggs*, is promised for mid-February release.

In *Phantoms Five*, you have five bombers to pilot over an enemy military camp, one at a time. The object is twofold: to achieve Level 5, accomplished by flying over the entire enemy facility five times without being shot down; and to build a high score. The latter becomes the sole effort once the former is achieved—if you get that far.

You can see your own plane moving as the earth scrolls below—in full-color hi-res. Bombing is a matter of timing your shots to have the bombs land on appropriate lettered targets, using the game paddle or joystick buttons. The paddle dial steers your plane. For an alternate point of view, toggling the space bar lets you look through your bombsight.

Mindless bombing won't do, because there are some you must avoid: hitting any of several prisoner-of-war camps halves your score, the hospital takes you back to zero.

The installations on land are not idle. The enemy in this case is identified: you are fighting the Atarians. They are as eager to down your plane as you are to take out their key facilities. You cannot see their artillery, only the effects. And when your plane is downed, you can see it fall to earth and explode. Incidentally, you earn the appropriate points if you happen to crash on a target. Every little bit helps . . .

There's another twist: the Atarians are apt to send up fighters to get you, about once a round. When they do, you are warned of the air attack and your downward view is replaced by a forward view. Beautifully drawn and animated planes attack two at a time, coming at you faster the longer you hold them off. Your paddle button becomes your trigger, the dial your aimer. Once you have dispatched the fleet of planes, or they have dispatched you, in which case you'll see your windshield shatter, you are switched back to the downward view for another go-round. (MCT)

Phantoms Five by Nasir. Sirius Software, Sacramento, CA. Apple II, DOS 3.2 or 3.3. \$29.95.

Ultracheckers is an interesting twist on an old game that makes it a worthwhile addition to your library of Apple strategy games.

Checkers programs normally rank slightly below crashed disks on my esteem scale because of the essential futility of the effort. If the program is well constructed, you can't beat the higher difficulty levels; if the program is poorly constructed, why bother?

But *Ultracheckers* throws in the interesting deviation of playing by international rules. These vary from American rules in that the board is ten squares each way, instead of eight; all pieces must jump backward, not just kings; and kings can move more than one space at a time along diagonals, which leads to a king jumping a piece three or four squares away.

These rules change the strategy of the game so much as to make it almost totally different than conventional checkers.

The program is well done with excellent hi-res graphics and easy input of moves. Whether a player who masters the intricacies of the game has a chance against the computer at the most advanced levels is still a question—the easiest levels have so far proved a sufficient test for this reviewer. ART

Ultracheckers by Most, from Malibu Microcomputing, Malibu, CA. 32K, disk. \$29.95. ☐

Powerful & Efficient Apple Software SDS Guarantees It.

You depend on good software to save you time and to have your computer help you do a job more efficiently. Our software is designed to do just that. We are one of the oldest companies supplying software for the Apple II*, and one of the very few that offers an unconditional guarantee of satisfaction or your money back! Here are a few that you'll want to add to your library:

Super Terminal Software

ASCII EXPRESS II, by Bill Blue: The most complete communications package available for the Apple II. Designed for the most efficient transfer of data to or from practically any online computer. Fully supports upper/lower case, including characters normally unavailable: underscore, rubout, break, and most others. Keyboard macros allow you to define dual keystrokes as entire strings for fast sign-ons, sign-offs, and system commands. A 20K data buffer allows for large files, and a convenient line editor means easy editing before and after transfer. Buffer can be output to printer, disk, or viewed at any time. Supports Micromodem II** and most other communication devices.

Price: \$64.95 on Disk.

And for the Z80 Apple . . .

Z-TERM, by Bill Blue: A flexible communications package for the Apple II equipped with Z80 Softcard* and the CP/M** environment. Allows file transfers to or from all types of dial-in systems. Fully supports Micromodem II and most other communication devices, as well as 80 column display boards and external terminals! Utilizes standard CP/M sequential text files, with up to a 40K internal buffer (using additional RAM or Language Card.) Supports multiple modes of data transfer and includes keyboard macros, autodial (with Micromodem II), and upper/lower case.

Price \$74.95 on 16 sector diskette.

Also available . . .

APPLE-DOC, by Roger Wagner: A set of several utilities to speed up software development and customization. **VarDoc** makes a list of all the variables in a program and every line on which they occur. Also allows you to create a list of descriptors of what each one does. **LineDoc** makes a similar list for each line/subroutine called by a GOTO, GOSUB, etc. **ConDoc** is similar but documents all numeric constants — great for scientific & business uses! **Replace** is a powerful replacement editor which makes changing any occurrence of a variable or group of statements a breeze!

Price \$34.95, Disk.

THE CORRESPONDENT, by Roger Wagner: An extremely versatile program! Designed primarily for writing letters and other documents in a very visual way. The Apple screen acts as a "window" onto a 40-80 column page. 4-directional scrolling lets you see any part of the page just as it will be printed. Editor functions include full upper/lower case & control chars., block move/copy, split screen option, even math functions! Additional utilities & uses include printing form letters, a free-form database, putting bi-directional scrolling in your own programs, single-disk copy program, DOS remove for greater storage on diskettes, and more!

Price: \$44.95 on Disk.

*Apple II is a registered trademark of Apple Computer Co.

**Micromodem II is a registered trademark of Hayes Microcomputer Products, Inc.

*Z80 Softcard is a registered trademark of Microsoft Consumer Products, Inc.

**CP/M is a registered trademark of Digital Research, Inc.

All programs require 48K and Applesoft in ROM or language card. Specify DOS 3.2 or 3.3. California residents add 6% to all prices.

See these and other S.D.S. products at your local dealer, or for more information, write or call:

SDS

southwestern data systems

P.O. Box 582-S • Santee, CA 92072 • (714) 562-3670



BY ROBERT KOEHLER WITH PHOTOGRAPHS BY KURT A. WAHLNER

The notion of microcomputer software selling solely on the name of its programmer would have been treated as absurd two years ago. Now, it is a growing phenomenon that isn't likely to subside. Programs, particularly games, are increasingly often packaged with the identifying stamp of the author on them, and, if the author's name is not prominently displayed on the packaging, users know the difference nevertheless.

Today, no name is more instantly recognizable in the microcomputer world than that of Bill Budge. As the author of such popular packages as *Trilogy* and *Space Album*, Budge has created a particular graphic style that sets him apart: a fluid sense of movement, usually in the outer reaches of space, with engrossing vector-structured images. That Budge's unique style is part of the reason for his

and his publisher's (California Pacific) success is undoubted; that style is a germane aspect of a program is a matter of fact for Budge.

"A creative programmer," he asserts, "should, by definition, generate a style in the work he or she does."

Disney Influence Bore Fruit. The seeds of what users find so visually exciting in Budge's games lie in animation tinged by the fantastic. "The reason I first bought my Apple was to do Disney-style animation. I like to play with unusual ideas that require unique imagery, which is why animation is my first love. The idea of fantasy with animation was especially spurred by my admiration for Ray Harryhausen."

Animator Harryhausen's lifelike monsters and fairy-tale creatures for the movies (*The Seventh Voyage of Sinbad*) have been objects of reverence for animation fans for years. Budge counts himself among that legion. "The emotionalism and individuality of his creatures, plus the meticulous eye to detail," he explains, "is something I would like to integrate into my own work."

All this suggests that Budge has a yearning for the earthly after his forays into the galaxies. "None of the games I've done is very subtle," he says. "How deep or intellectually challenging can shooting down spaceships be? Besides this, the space trend is bound to become outdated. It'll be amusing to see how old-fashioned space graphics of today look in ten years. Since it's the current thing to do, there is a glut of it. And how simple they are to make! After all, the programmer/artist is dealing with little more than stars on a black background and some shapes."

Programmer/Artist Looks to New Techniques. The programmer/artist is what Budge quintessentially is. He ex-

presses a healthy, critical discontent with his past achievements and a persistent zeal about projects in the throes of speculation and germination.

"The early games were inspired by the vector games I saw in the arcades," Budge recalls. "I was very impressed with their fine lines that gave the illusion of infinite resolution. I wanted to duplicate that on the Apple, but, frankly, I don't feel I achieved that. The games were composed of transparent line drawings and didn't really exploit what the Apple, being a kind of pixel machine, does well: drawing lines with dots."

Emerging from this dissatisfaction is a new technique "to draw bit maps on the screen very fast. It's making my old line-drawing technique obsolete. I'm spending about one-tenth of the time I once devoted to a graphics program—with twenty-five lines, code, and some tables, it's the ultimate in speed. Now I want to do all of the old games over again!"

Endings Are Mysteries Programming Unlocks. New keys like the dot technique that open programming padlocks are a relief to someone like Budge searching for the small breakthroughs that will make his ideas realizable on screen. But, then, there is the hurdle of every new program itself.

"I like to write programs for the Apple in which I don't know the ending. I especially like the tension and suspense that comes from not knowing if I can pull it off. For instance, I'm not sure how the game I'm presently working on will look in its final form. When I started, I wasn't sure if I could do it at all."

"Not knowing how a game will end is something I unconsciously strive for. In *Death Star* from *Space Album*, I added that last, toughest target as an afterthought when the entire game had already been completed. Yet it is that

APPLE II MACRO

Works with 3.2 DOS
Disk or Cassette based Systems
Also DOS 3.3

Assembler/Text Editor

(Nearly all serious Machine Language Programmers use this
ASSM, TED — do you own a copy?)

- Assembler and Text Editor (resident in just over 9 K (8 K without disk patches). Works on 16K, 32K, or 48K APPLES.
- Works with 3.2 APPLE II or PLUS — Disk or Cassette.
- Supports Macros and Conditional Assembly.
- String Search and Replace and/or Conditionally Replace.
- Move, Copy, Delete, Duplicate, Auto Line #ing.
- User allocates size and location of text buffer and symbol table.
- Up to 31 characters label — User specifies length.
- 25 Commands, 22 pseudo ops, 5 conditional operators.

We also have versions for PET, SYM, and KIM!

\$49.95 includes Cassette and Manual

Add \$3.00 Foreign Air Mail

Eastern House Software

3239 Linda Dr.

Winston-Salem, N. C. 27106

Phone (919) 748-8446 or 924-2889

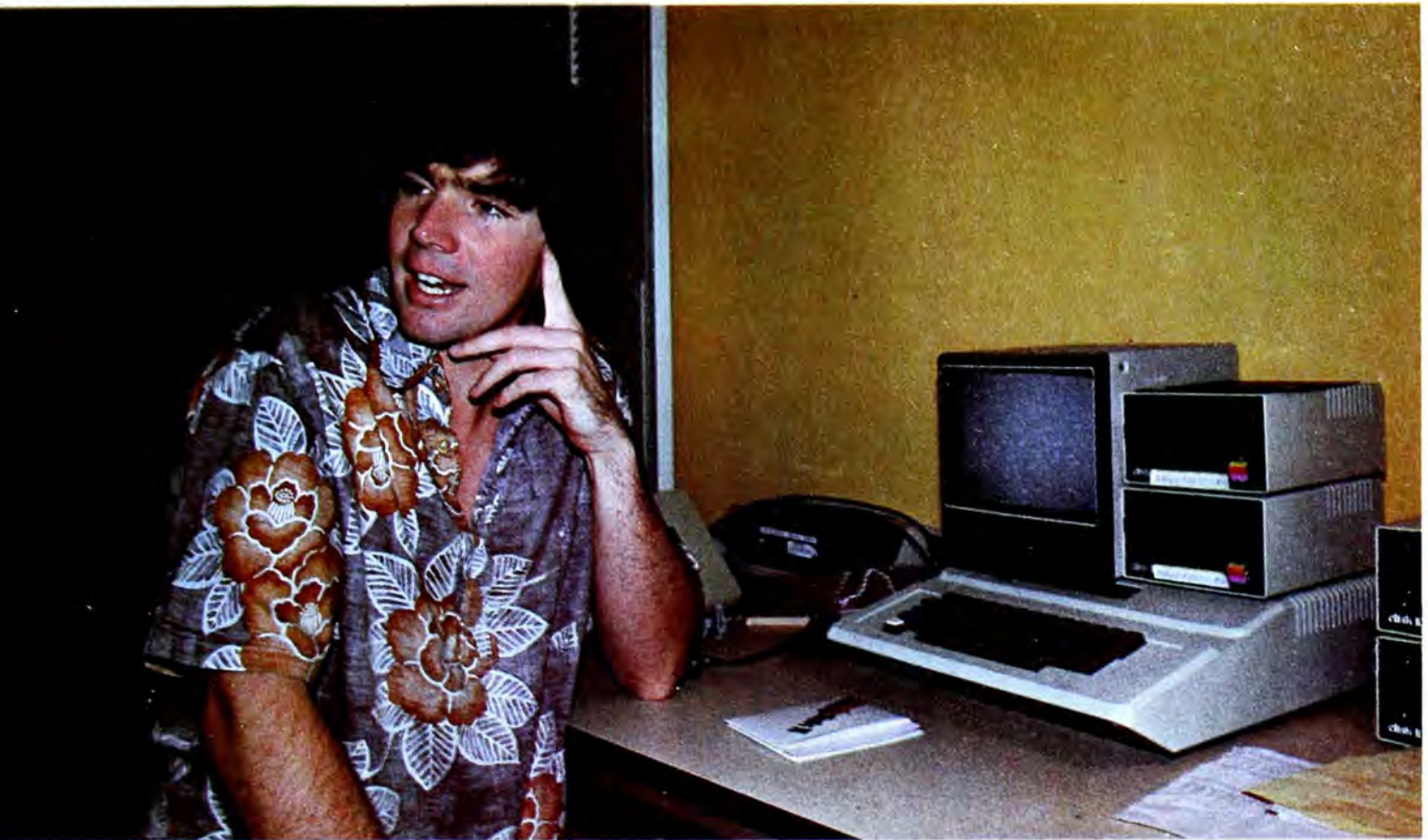

A Portrait of Bill Budge

feature that makes the game so effective for many people."

This risky process, he speculated, is very much like writing. "I write and program the same way: from the top down. And then, there is the refining, constantly going over passages. In a program, it's code. In a story, it's a paragraph. The agony of the creative process is knowing that this part or that part is not quite right, and staying up until three in the morning polishing it, or, as we programmers say, iterating. If you're a perfectionist, iterating is a full-time job.

"A good writer doesn't know how a story will end. He's concentrating on good characters. Many authors claim that they simply let their characters loose and see where they go. Sometimes, a story writes itself. The same thing can happen with a program."

Robot War's New Concept Budes Imagination. When the user can write the story, as in the case of MUSE's *Robot War*, Budge finds the possibilities enthralling. "The idea behind *Robot War* is

wonderful, because it allows for an unprecedented degree of user participation. I would like to put together a package that lets people do much of the creative work themselves. It would have a language that one would use to define all the objects on screen, how they interact and move. In essence, creating characters. The user literally defines the game, like kids do when they invent a play."

This sense of play is important to him: "My better programs always originate from my love for playing with the machine." The Apple, he realized some time ago, permits a margin of programming freedom to let a playful spirit wander loose. "On a computer like the Apple, whatever you want to draw is up to you. It's all free, which is a great attraction of graphics. There are no worries about expensive hardware in this medium. If you have the software, you're only as limited as your imagination." In Budge's case, it is hard to conceive of such limits.

Life Away from the Keyboard. But he does have a limit to the amount of time

New Program Tracks Your Investments!

... gives your Apple II* all the capabilities of a Wall Street Brokerage!

- Records Purchases and Sales
 - Maintains Short Sales, Puts and Calls
 - Records Gains and Losses - Both Short & Long Term
 - Prepares Schedule D ... and More!
- Accompanying manual provides complete instructions with examples. (Requires 1 disk drive.)

INVESTOR™ Diskette and Manual Only **\$75⁰⁰**
Send check or money order to:
Sophisticated Microsystems, Inc.
550 Frontage Road, Northfield, IL 60093
(312) 441-5802

(*Apple II is a registered trademark of Apple Computer, Inc.)



Softalk photos

he spends in front of a keyboard. "I sometimes wonder if I'm going to spend the rest of my life looking at a video tube. . . ." So he indulges in his whims—for pinball, for a bicycle ride from his newly purchased home in Oakland, for some tanning during the summer months when the San Francisco Bay fog dissolves, or for astronomy: "I'd like to build a small observatory on my patio and hook it up to the Apple. And if I could take my Apple outside all the time, I would do that."

The Apple and Budge have more than a one-on-one relationship, however. A couple of days every week, he can be found in Cupertino working on software development for Apple Computer Inc.,

which he has found quite to his liking. "Apple has put together a great group: Charlie Kellner, who has a spectacular new keyboard for the Mountain synthesizer board, Andy Hertzfeld, Pete Rowe—and Bob Bishop, who I talk with just about every day. The man's a genius, chock full of good ideas, like his micropainter that has a palette of twenty-one colors." This collective work, trading ideas with peers, offers Budge a kind of ideal counterbalance to the solitary labors back home.

Framing a Program. The laborious moments at home are part of the necessary yoke to bear, be they spent completing a code or putting the finishing

touch in the graphics. He does these things with sheer discipline by eliminating all outside distractions. "The world is full of them," he says, noting that, with the last-minute work, "it's like framing a painting: after the fun, the finishing touches have to be done."

There is a different kind of discipline involved in the constant generation of new ideas, which Budge seems unusually adept at. The animator in him ensures that the programming will always be at the service of the ideas, which allows him to invent an alternative to invading Martians and spaceships: "How about attacking piranha? It would demand the same agility and skill from the player as any space game, but would add the images of ferocious fish chomping down on their prey. Nothing matches the visual entertainment of living organisms in action—the Harryhausen touch. This is what I like, but whether thousands of users will like it too is the troubling unknown. The pressure that derives from this is ever-present, and the more I can mentally eliminate it from my work, the happier I'll be."

Like many in the microcomputer industry, Bill Budge is in his twenties, and appreciative of his parents' support of his goals. "They are very excited about my success." But, he modestly adds, "Since the Apple is doing so phenomenally well, anyone who makes games for it is going to see some of that success come their way."

Fun Breeds Fun—with Integrity. With that success comes the ability to observe, with some considerable experience, the pitfalls of his profession. "It can be a weird way to make a living, largely because of the volatile market and the competition, which is getting stronger all the time. The beginning programmer must remember not to get tangled in the web of just making money. If you do, then you compromise the quality of the program and, worse, yourself."

He smiles, as if recalling something he told himself when he first recognized that he was, indeed, a programmer. "Do what is fun for you, and, more often than not, you'll create something that will be great fun for others." ■

NEW! FROM **Brøderbund Software**

STRATEGY GAMES!



THE SAGA CONTINUES . . .
IV TAWALA'S LAST REDOUBT

The cruel Emperor Tawala has been forced from his throne on the world of Galactica and has fled for his life to the planet of Farside, where he and a small bank of adherents prepare to make their last stand. Extreme solar conditions have isolated Farside from the rest of the galaxy, and so it remains to Benth, leader of the local insurrectionists, to press the final assault on Tawala and his minions.

TAWALA'S LAST REDOUBT puts you in the position of rebel leader. You must intercept and decipher Tawala's secret messages to his supporters, form alliances with local chiefs, detect Tawala's spies in your midst, separate hard intelligence from enemy disinformation, avoid Tawala's military forays against you and, finally, lead the assault against the Prince's stronghold.

Minimum Configuration:
TRS-80 Cassette, 16K, Level II, \$19.95
TRS-80 Disk, 32K, \$24.95
APPLE Disk, 48K with APPLESOFT, \$29.95

FAST ACTION GAMES!



APPLE GALAXIAN

Apple Galaxian — In brilliantly colored array, the Galaxians swoop down from all sides in dazzlingly swift attacks to do battle upon the lone defender. This faithful rendition of that most popular of all bar games may drive you around the bend, but think of all the quarters you'll be saving! Apple II Integer or Plus, 48K disk, \$24.95.

How to order: Ask your dealer or send check or money order for the exact retail price to:

♦ ♦ ♦

Brøderbund Software
Box 3266, Eugene, Oregon 97403
Call (503) 343-9024 to order. NO CHARGE FOR SHIPPING AND HANDLING!
Visa and Mastercard accepted.

We've got more! Send for our free catalog!

Softalk Presents The Bestsellers

Softalk's Bestseller List takes on a new appearance this month with the addition of two supplementary lists of programs. The new lists chart the leading programs bought for business purposes and for serious home and hobby uses.

However, the biggest bestseller news this month was the toppling of *VisiCalc* as the leading program. *Apple Galaxian*, an arcade game in the *Invaders* genre, captured the imagination of the Apple owners throughout the nation and walked away with overall top honors.

Because no industry statistics are systematically kept, it is not possible to verify *Galaxian's* December sales as a one-month record for the industry. However, it seems likely that *Galaxian's* nationwide retail sales in December exceed those of any other program in a single month in the short history of the Apple microcomputer.

Such a claim must naturally ignore sales made via mail by software publishers. Such sales are not independently verifiable and cannot be taken into account.

Ben Herrman of Computerland of Ithaca noted that the Christmas season brought a dramatic change in the configuration of software sales. "We were much heavier in the sale of games and entertainment programs in December, reflecting the gift-giving choices of Apple owners."

That was the case in general, with entertainment product doing relatively stronger business throughout the country than more serious product. Nevertheless, the overall strength and value of *VisiCalc* continued to show as it repulsed several other entertainment challengers to achieve a commanding hold on second place.

Business 10

1. *VisiCalc*, Software Arts Inc./Dan Bricklin and Robert Frankston, Personal Software
2. *Apple Plot*, Apple Computer Inc.
3. *Data Factory*, Bill Passauer, Micro Lab
4. *CCA Data Management System*, Creative Computer Applications, Personal Software
5. *Easy Writer*, John Draper, Information Unlimited
6. *Apple Writer*, Apple Computer Inc.
7. *BPI General Ledger*, John Moss and Ken Debower, BPI
8. *Apple PIE*, Tom Crossley, Programma
9. *DB Master*, Barney Stone, Stoneware
10. *SuperText II*, Ed Zaron, MUSE

Home/Hobby 10

1. *DOS 3.3*, Apple Computer Inc.
2. *DOS Tool Kit*, Apple Computer Inc.
3. *Typing Tutor*, Image Producers, Microsoft
4. *Bill Budge's 3-D Graphics Package*, Bill Budge, California Pacific
5. *Enhanced Paper Tiger Graphics*, David K. Hudson, Granite Station
6. *Super Disk Copy*, Sensible Software
7. *Apple World*, Paul Lutus, United Software of America
8. *LISA Assembler*, Randy Hyde, Programma
9. *3-D Graphics Animation Package*, Bruce Artwick, Sub-Logic
10. *Dow Jones News & Quotes Reporter*, Apple Computer Inc.



HI-RES FOOTBALL

This is the football game you always knew the Apple was capable of, but no one could deliver—until now.

Skill and strategy are combined as you call the plays and control the players in this exciting real-time action game. You can run, pass, kick, sack the quarterback, or fake-out the defense—all in fully animated Hi-Res Graphics. Play against a human opponent or against the computer.

Hi-Res Football runs on any 48k Apple II or II Plus, DOS 3.2 or 3.3. Available now for \$39.95 on disk from your local computer store or you may order directly from:

Q-N-LINE systems

36575 MUDGE RANCH ROAD
COARSEGOLD, CA 93614
209-683-6858

ORDERS MAY BE CHECK, VISA, MASTER CHARGE OR C O D

Because of the December emphasis on entertainment programs for gift giving, it almost seems quixotic to begin charting more serious programs with December results. However, there is no season to business and serious software sales. Apples purchased for more serious uses require software support, regardless of the time of year.

Softalk divided the serious software into two categories, reflecting the diverse uses to which the software is put. In some cases the placement of a program in one category or the other was arbitrary. For instance, the majority of *Typing Tutors* from Microsoft are sold to business users. However, the program itself was placed in the home/hobby category on the theory that it is not a business tool per se.

As would be expected, *VisiCalc* dominated the Business 10 list. Most noteworthy achievement of any program in the Business 10 list was that of *DB Master* by Barney Stone of Stoneware. In its first full month of national release, the program achieved ninth place on the Business 10.

Also noteworthy in the Business 10 was the reassertion of *Easy Writer* as bestselling word processor. Last month's results had shown *Apple Writer* as pulling ahead.

Apple-franchised retail stores representing approximately 8 percent of all sales of Apple and Apple-related products volunteered to participate in the poll.

Respondents were contacted early in January to ascertain their sales leaders for the month of December.

The only criterion for inclusion on the list was number of sales made—such other criteria as quality of product, profitability to the computer retailer, and personal preference of the individual respondents were not considered.

Respondents in January represented every geographical area of the continental United States as well as Hawaii.

Results of the responses were tabulated using a formula that resulted in the index number to the left of the program name in the Top Thirty listing. The index number is an arbitrary measure of relative strength of the programs listed. Index numbers are correlative only for the month in which they are printed; readers cannot assume that an index rating of 50 in one month represents equivalent sales to an index number of 50 in another month.

Probability of statistical error is plus-or-minus 6.4 percent, which translates roughly into the theoretical possibility of a change of five points, plus or minus, in any index number.

In the Home/Hobby 10, Apple's *DOS 3.3* was the leader, although its sales are lagging as many Apple II owners have already converted to the 3.3 operating system. *DOS Tool Kit* was second, narrowly edging *Typing Tutor*.

Most notable about the Home/Hobby 10 was the inclusion of Granite Station's *Enhanced Paper Tiger Graphics Software*. Many retailers report a sale of the program with each IDS printer sold.

It should be noted that inclusion of a program in these supplementary lists is not grounds for exclusion from the Top Thirty. The Top Thirty list remains the measure of a program's overall marketplace acceptance vis a vis all other Apple products.

December appears to have been a record-setting month for Apple-related software. For that reason, it is necessary to caution that the disappearance of a particular program from the Top Thirty is not necessarily an indication that its sales dropped off, but merely an indication that its sales were lower relative to other programs in the marketplace. ■

The Top Thirty

1. — 97.22 *Apple Galaxian*, Tony Suzuki, Broderbund Software
2. 1. 69.44 *VisiCalc*, Software Arts Inc./Dan Bricklin and Robert Frankston, Personal Software
3. 5. 53.42 *Flight Simulator*, Bruce Artwick, SubLogic
4. 4. 45.58 *Hi-Res Adventure #2: The Wizard and the Princess*, Roberta and Ken Williams, On-Line Systems
5. 7. 41.66 *Super Invaders*, M. Hata, Creative Computing
6. 8. 39.17 *Dogfight*, Bill Basham, Micro Lab
7. 14. 37.03 *Hi-Res Football*, Jay Sullivan and Ken Williams, On-Line Systems
8. 17. 34.90 *Sargon*, Dan and Kathe Spracklen, Hayden
3. 34.90 *Star Cruiser*, Nasir, Sirius Software
10. 6. 33.12 *Cyber Strike*, Nasir, Sirius Software
11. 2. 32.05 *DOS 3.3*, Apple Computer Inc.
12. 12. 31.69 *Asteroids in Space*, Bruce Wallace, Quality Software
13. 9. 30.98 *Apple Plot*, Apple Computer Inc.
14. 20. 27.78 *Bill Budge's Space Album*, Bill Budge, California Pacific
15. 11. 26.35 *Hellfire Warrior*, Automated Simulations
16. 10. 25.99 *Data Factory*, Bill Passauer, Micro Lab
17. 13. 25.28 *DOS Tool Kit*, Apple Computer Inc.
18. — 24.57 *Typing Tutor*, Image Producers, Microsoft
19. 16. 23.50 *Odyssey*, Bob Clardy, Synergistic Software
20. — 23.15 *ABM*, Silas Warner, MUSE
21. 22. 19.59 *Adventure*, Software Associates/Gordon Letwin, Microsoft
22. 27. 19.23 *Computer Quarterback*, Dan Bunten, Strategic Simulations
23. 15. 18.87 *CCA Data Management System*, Creative Computer Applications, Personal Software
24. — 18.16 *Hi-Res Adventure #1: Mystery House*, Roberta and Ken Williams, On-Line Systems
25. 18. 17.09 *Temple of Apshai*, Automated Simulations
26. 30. 16.38 *Bill Budge's 3-D Graphics Package*, Bill Budge, California Pacific
25. 16.38 *Planetoids*, Marc Goodman, Adventure International (previously called *Asteroids*)
28. 27. 15.67 *Easy Writer*, John Draper, Information International
- 15.67 *Planet Miners*, National Microcomputer Associates, Avalon Hill
30. 21. 15.31 *Apple Writer*, Apple Computer Inc.

APPLE COMMAND CHART OFFER!

APPLE USERS! Here's a special 4-item offer from Beagle Bros.!

★ **FIRST, OUR APPLE COMMAND CHART!** A heavy-duty 11x17 listing of EVERY Applesoft, Integer and DOS Command AND its function. Indispensable to any Apple user. Experiment with commands you never knew existed!

★ **PLUS our 36-pg APPLE TIP BOOK** of tricks, listings and articles on Customizing your Apple. Printing "unprintable" characters. Fixing garbaged program lines. Converting languages. Entering machine code... B Bros. Catalog too!

★ **TWO GAMES TOO!** In Applesoft and Integer Basic!

Game #1: TEXTTRAIN! You keyboard control a text-format freight train on your Apple video layout! Real-time switching & coupling simulations! Race the on-screen clerk & avoid a game-ending derail! One or more players test their skills! Strategically assembling a user-defined series of computer freight cars! A fascinating demonstration of the versatility of your Apple! (\$16, Winter Catalog)

Game #2: SUB SEARCH! Your assignment: Find a gang of invisible enemy subs on your Apple color graphics scope before your oxygen & fuel run out. Use your deep-sea scanner switch & video tracer to watch for blips & clues to each sub's location! (\$12, Winter Catalog)

TextTrain & Sub Search are 2 more machine language-enhanced winners from Beagle Bros. Designed & programmed exclusively for the best Micro there is!

Special Offer! Both 16K games, the Command Chart & Tip Book for only \$16.00

(Use this coupon or separate sheet)

Rush TextTrain, Sub Search, the Apple Tip Book & Command Chart!

DISK \$16.00 (BOTH Applesoft AND Integer)

CASSETTE \$16.00 (SPECIFY Applesoft OR Integer)

All Shipped First Class
within 24 hours!

PLEASE ADD \$1.00 for First Class Shipping and Handling.

NAMES = _____ Amt. Enclosed = \$ _____
(Cal residents, add 6% tax)

ADDRS = _____
CITYS = _____ ZIP = _____

VISA/MASTERCARD, include ACCOUNT NO., EXP. DATE & SIGNATURE.



Mail to: 4315 Sierra Vista / San Diego, CA 92103

Beyond Adventure Lies

AKALABETH WORLD OF DOOM

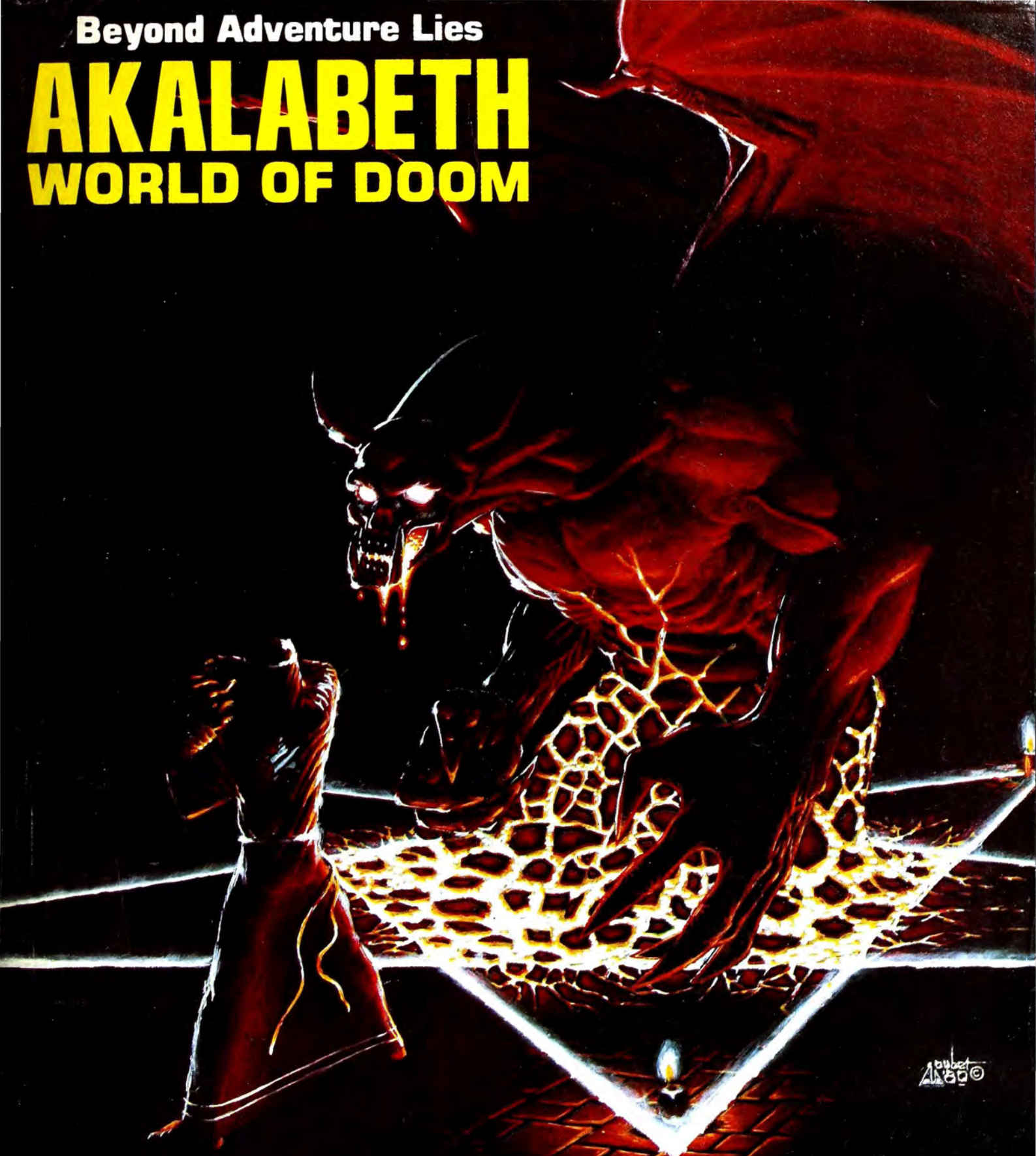

Akalabeth
© 1985

Available thru your local Computer Store.

A TOP OF THE ORCHARD SOFTWARE PRODUCT
from California Pacific Computer Company

PRESENTS

HI-RES ADVENTURE

MISSION: ASTEROID HI-RES ADVENTURE # 0

MISSION: ASTEROID is an introduction to the HI-RES ADVENTURE family of games. This adventure is slightly easier and a little shorter than our other HI-RES ADVENTURE games. MISSION: ASTEROID is designed to acquaint beginning Adventure players to the wonderful world of Hi-Res Adventure.

In this adventure you find that an Asteroid is about to hit the Earth and destroy it. It is your mission, as an Astronaut, to rocket to the Asteroid and blow it up before it reaches Earth.

OVER A HUNDRED HI-RES PICTURES. (Looks great on b/w and color televisions).

FULL 21-COLOR!! HI-RES GRAPHICS. (Each room a work of art).

YOUR GAME MAY BE SAVED FOR LATER CONTINUANCE.

RUNS ON BOTH 48K APPLE-II AND APPLE-II PLUS.

THIS EXCITING GRAPHIC GAME WILL CHALLENGE YOUR IMAGINATION AND TEST YOUR CREATIVITY EVERY STEP OF THE WAY!

\$19.95 Disk

MYSTERY HOUSE HI-RES ADVENTURE # 1

Through the use of over a hundred Hi-Res pictures you play and see your adventure. You communicate with HI-RES ADVENTURE in plain English (it understands over 300 words.) All rooms of this spooky old house appear in full Hi-Res Graphics complete with objects you can get, carry, throw, drop or ?

In this particular HI-RES ADVENTURE game, you are transported to the front yard of a large, old victorian house. When you enter the house, you are pulled into the mystery, murder and intrigue and can not leave until you solve the puzzles. Your friends are being murdered one by one. You must find out why, and who the killer is. Be careful, because the killer may find you! As you explore the house there are puzzles to be solved and hazards to overcome. The secret passage way may lead you to the answer.

\$24.95 Disk



THE WIZARD AND THE PRINCESS HI-RES ADVENTURE # 2

Only ON-LINE SYSTEMS could deliver a HI-RES ADVENTURE game on such an epic scale. In this adventure you find you must do battle against an evil wizard in order to save the life of the princess. To find the wizard and his castle you must first cross deserts, oceans, mountains, travel to an island and encounter many strange beasts. You will be forced to learn magic, navigate at sea and dig for treasure. This game should provide months of adventure.

HUNDREDS OF HI-RES PICTURES. (Looks great on b/w and color televisions).

FULL 21-COLOR!! HI-RES GRAPHICS. (Each room a work of art).

YOUR GAME MAY BE SAVED FOR LATER CONTINUANCE.

RUNS ON BOTH 48K APPLE II AND APPLE II PLUS.

BY FAR THE MOST AMBITIOUS GRAPHIC GAME EVER WRITTEN FOR THE APPLE!!

\$32.95 Disk



All of these Hi-Res Adventures are available now at your local computer store. They will run on any 48K Apple II or II Plus with a disk drive. To order direct send the purchase price plus one dollar for shipping to:

ON-LINE SYSTEMS - 36575 Mudge Ranch Rd. - Coarsegold, CA 93614 - 209-683-6858

Visa, Master Charge, C.O.D. or Checks Accepted.