

Little Brothers should be seen but not heard.



**NOW ONLY
£159.95
inc.VAT.**

A maxim which eloquently describes the Brother HR-5.

Less than a foot across, it's nonetheless loaded with features.

The little printer that's low on decibels.

There's one thing the HR-5 won't give you. Earache.

For the annoying 'clickety clack' many printers produce is mercifully absent from the HR-5.

Quietly efficient, it delivers high definition dot matrix text over 80 columns at 30 characters per second (maximum).

Text or graphics with ease.

The HR-5 also has something of an artistic bent. Being capable of producing uni-directional graphics and chart images together with bi-directional text. What's more it will hone down characters into a condensed face, or extend them for added emphasis.

At home with home computers.

Incorporating either a Centronics parallel or

RS-232C interface, the HR-5 is compatible with BBC, Spectrum, Oric, Dragon, Atari and most other home computers and popular software.

Perfectly portable, the battery or mains operated HR-5 weighs less than 4 lbs, and has a starting price of only £159.95 (inc. VAT).

Which is really something to shout about.



REGULAR, CONDENSED, OR EXTENDED FACES.



CUT SHEET A4 OR ROLLER PAPER.



BATTERY OR MAINS OPERATED.

PLEASE SEND ME MORE DETAILS OF THE REMARKABLE BROTHER HR-5 PRINTER.

NAME _____

ADDRESS _____

TEL. NO. _____ SPJ 8/84

AVAILABLE FROM: BOOTS, RYMANS, WILDINGS, SELFRIDGES AND ALL GOOD COMPUTER EQUIPMENT STOCKISTS.



SINCLAIR PROJECTS

4 REVIEWS

John Lambert assesses the latest peripherals in depth.

7 LETTERS

Your views on the changes in *Sinclair Projects*.

7 UPDATE

We return to previous issues.

8 ADVICE COLUMN

Trevor Marchant is receiving an increasing number of queries and we print replies to a selection.

10 LOCOTROL

Brian Lee continues his project to control your model railway system.

20 MONEY CONTROL

Bill Johnson helps you to make those awkward investment comparisons.

26 FIRST AID

Donald Maynard shows how to repair your micro when it stops working.

31 TRANSISTOR BIASING

John Conway has written an interesting program which allows you to calculate the correct values for components to achieve a given output.

33 DIGITAL ELECTRONICS

Joe Pritchard considers clock circuits and how to use them as counters.

43 MOTOROLA 68008

John Mellor describes the interfacing possibilities of the chip which is the basis of the QL.

47 EDGE CONNECTOR

Our regular page showing the edge connections for the Spectrum and ZX-81 returns.

48 ARTICLE OUTLINE

For readers who wish to let others know useful projects they have built, we offer advice on the format to follow.

WHILE we await the first large-scale batches of the QL we are watching closely what is happening so that we can keep you informed of developments.

John Mellor continues his investigation of the possibilities of the Motorola 68008 chip, which is the main processor of the new Sinclair machine.

We are working on some projects for the QL which we expect to be able to publish in the near future. We are, of course, bearing in mind the fact that as the development work on the QL continues some changes may have to be made.

At the recent Computer Fair at Earls Court, London the public was allowed to get near to the great machine. Let us hope that it is not long before the many customers who have been waiting with more than their fair share of patience will be able to receive their machines.

It is likely to be a forlorn hope.

In this issue we have four projects to help you get the most from your Sinclairs. The main one gives advice on what to do when your ZX-81 or Spectrum stops working. The article is based on the ZX-81 but Donald Maynard gives hints which can be applied to all home computers for that awful moment when the system goes down.

Our other main hardware feature is the second part of the control system for a model railway. Brian Lee builds on the last issue and enables budding controllers of British Rail to operate a complex system using either the ZX-81 or Spectrum.

Bill Johnson has called on his experience as an insurance salesman to write two programs to help in making personal financial decisions. Both help in the understanding of investments, allowing you to compare the effects of various compound interests and also assess the benefits of different forms of instalment saving.

In the second article in the new regular series of advice columns, Trevor Marchant answers queries on the power supply, joysticks and making a portable system.

We also have our regular review pages where we test the latest add-ons available in the hardware market, letters, and the edge connector page.

Regular readers will have noticed that we have increased the price. That is the result of the increased costs of publishing a high-quality specialist magazine. It is the first increase since we began *Sinclair Projects* 18 months ago and was unfortunately unavoidable.

The increased price will allow us to continue to produce an interesting magazine which will appeal to all who wish to make more serious use of Sinclair machines.

Managing editor Nigel Clark Consultant editor David Buckley Managing production editor Harold Mayes MBE News writer John Lambert Design Elaine Bishop Advertisement manager Holly Fleming Advertisement Executive Robert Marcus Editorial assistant Colette McDermott Production assistant Dezi Epaminondou Assistant managing director Barry Hazel Managing director Terry Cartwright Chairman Richard Hease.

Sinclair Projects is published bi-monthly by ECC Publications Ltd. It is in no way connected with Sinclair Research Ltd.

Telephone, all departments: 01-359 3525. If you would like to contribute to any of the *Sinclair User* group of publications please send programs, articles or ideas for hardware projects to Sinclair User and Projects, ECC Publications, 2 Newington Green Road, London N1 4AQ. We pay £50 per 1,000 words for each article used.

© Copyright 1984 Sinclair Projects. ISSN 0264/0449. Printed and typeset by Cradley Print PLC, Warley, W. Midlands. Distributed by Spotlight Magazine Distribution Ltd, 1 Benwell Road, Holloway, London N7. 01-607 6411.

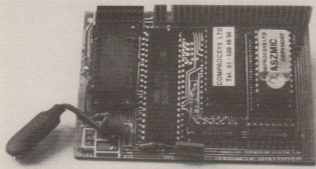

Expanding the ROM on ZX-81

NEW ADD-ONS for the ZX-81 are few and far between but the SP ROM by Comprocsys Ltd could well cause a few to be taken from the cupboard and dusted. It is to all intents an extra ROM, mapped into 2000 hex — 8192 decimal — with an optional external card on which to fit it. While the card is not really necessary, many of the I/O routines in the ROM use specific addresses and could not be used easily without it.

To use the ROM it must first be initialised by a RAND USR 8195 which calls the Master Virus, a Basic extension. The extra commands are then called by following the line number with a full stop in a Basic listing. Those commands cover two main areas — HI RES graphics with windows and psuedo sprites — and I/O with routines for Centronics and RS232 printers, with input from RS232 devices, EPROM programming and enhanced cassette operation. Asynchronous scheduling of Basic lines using On Frame is also possible.

To use the HI RES graphics the external card has two diodes connected to the edge connector; details are shown in the instructions of how to alter your existing RAM pack if you do not have the card. Without that modification the graphics will be

there but you cannot see them. RAM-TOP is lowered by the usual POKE 16389 to 26112 — poking 102 — followed by NEW. That allows for a Spectrum-sized (256×192) bit-mapped display which can be used instead of the normal LO RES which is still available.

Because of the normal ZX-81 method of blanking the display in FAST mode, a new .FAST — .CLEAR in HI RES — is used. That BRISK mode will blank the display for a set — 0 to 255 — number of frames, allowing you to trade speed of operation against clarity. Pause is also upgraded to the Spectrum style to .PAUSE with no parameter giving an infinite pause until a key is pressed; it also gives a constant display.

Once called, the new graphics offer a wealth of possibilities. The .PLOT will either plot a point or, with the addition of a X, Y TO X1, Y1 parameter, draw a line, which can be either solid or in an 8-bit pattern using .UNPLOT (num). .NOT will invert, white on black; the screen and .CLS clears the graphics screen. Followed by a number it will clear a pre-defined window. The windows are set up with .DIM .REM is used to Remove bytes from the window to a pre-set area of memory, which can be the screen, or to move bytes in the reverse direction.

.PRINT, as expected, prints to the HI RES screen but offers not only normal characters but both upper- and lower-case, double-height, over-written, transparent, inverse and, (384), user-definable. The cursor can also be moved to anywhere on the screen and used to force a scroll.

EPROM operations use the .LOAD and .SAVE commands. The external card has an empty 28-pin socket for a 2764 and PP3-type connector for the additional 25V supply. .LOAD loads the program above any existing program, to give a simple form of merge and .LOAD " " will give a catalogue.

All the I/O operations use a memory-mapped 8255; the lines from its three ports are taken to the EPROM socket. The necessary lines for Centronics operation are then taken to another 16-pin socket which can also be used for RS232.

That socket is configured using .IF, for interface. It allows for serial/parallel operation, with control over direction, baud rate — 75-19,200 — echo and stop bit. The non-standard Sinclair characters can be converted optionally to ASCII with CHR\$128-159 mapped to ASCII control codes 0-31.

Information is input using the .INPUT command. It can be either to a DIMmed string variable or a memory address. Output can be .LIST, equivalent to LLIST, but to the external device .LPRINT, output of variables or four versions of .COPY. The first three output the HI or LO RES screens to the external or Sinclair printer while the last .COPY 3 sends a listing. That can be used to form a simple NET system.

Users who already have the Aszmic ROM, a replacement for the existing Basic with monitor/assembler, can fit it on the card and switch between all three under software control. At £19.95 for the ROM and £17.95 for the external card, ZX-81 owners can give machines a new lease of life and both can be recommended. The Aszmic ROM is still available at £29.95. For more information contact Comprocsys Ltd, 29 Campden Road, South Croydon, Surrey CR2 7ER.

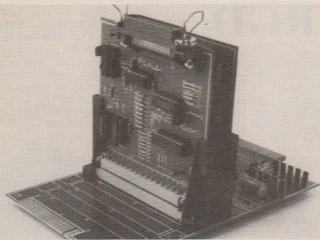

Instructive links

VELLEMAN U.K. is the importer of a number of interface kits for the ZX-81 and Spectrum. Heart of the system is a motherboard — K2615 for the ZX-81 and K2616 for the Spectrum — to which all the other boards connect. In that way if you change your computer you do not have to buy a new set of interfaces.

At present those interfaces include K2609, an 8-bit output board, K2610 A/D converter, K2611 8-bit input board, K2614 Centronics interface and K2618 D/A converter.

The motherboard connects to the computer user port via a ZX-81-size 23-way edge connector, the connections of which are continued through to the back of the board for other add-ons. Its power is taken from the computer, via a regulator, with provision for an external 9V supply if required. All the signal lines are buffered through 74LS244s.

What sets this kit, and the interface boards, apart

from many of the kits on the market is the quality of the instructions. They include large circuit diagrams and a full explanation of the construction and how it works, in four languages. On the Spectrum version a long explanation of which address lines are used by the various Sinclair add-ons is given, so that you can ensure the interface cards will not clash.

The output board, K2609, connects to the motherboard via a 31-way gold-plated connector. The address decoding is set by eight jumper leads, on A₂ to A₇, which are spaced so that they can be replaced by a DIL switch package if required.

The address lines are EORed with the output of the jumpers and the address, if valid, used with the WR line to latch the data through a flip-flop. The data lines are connected to the base of a transistor and output taken, through a resistor, from the collector. That output, max. 25V/

50mA, can be tested using the LED supplied.

Circuit diagrams are provided in the instructions to show how to connect a relay or, through an opto-isolator, a mains lamp.

The Centronics interface, K2614, connects to the motherboard and the address is decoded in the same way as the output board. The data is sent straight to the Centronics socket with the additional signals required — strobe, busy — provided by a 74LS123 and 74LS365 respectively. Jumpers are used to configure it for non-standard printers.

These kits — motherboard £25.69, output board £19.01, and Centronics £30.83 — are well thought out and provide a good introduction to computer interfacing.

For details of the rest of the range and prices contact Velleman U.K. Ltd, PO Box 30, St Leonards-on-Sea, East Sussex TN37 7NL. Tel: 0424-753246.

Expensive I/O port

THE Domestic Controller from Indescomp for the Spectrum provides users who do not wish to build their own I/O port with a complete package for input and output. It has four independent input and four output lines each isolated electrically from the computer and, provided mains current is not used, is an easy-to-use system.

The controller is I/O-mapped to port 61441 and uses the upper nibble for input and the lower one for output. Changes in Issue 3 Spectrums mean that the input value may vary by seven but a Basic program in the instructions shows how to overcome that.

The instructions also show, in simple terms, how to write to and read from the controller, giving the binary representation of the nibble, the decimal value, and which input or output will be on or off. Connections to it are via screw terminals and it has an extender card for more add-ons.

The address is decoded by two CMOS chips and then passes through two 4-bit D-type registers acting as latches. Output is through one of four micro-miniature relays, each with a maximum rating of 1 amp.

The home hobbyist may find the price of £49.95 a little high but for the newcomer to computer control it provides a convenient, ready-built package. It is available from the Spectrum chain of shops.

More reviews page 6

Ingenious RGD

MIRACLE Systems is one of the few if not the only maker of an RGB interface for the Spectrum. The reason is undoubtedly the difficulty involved in getting the correct signals out of a Spectrum.

Normally either the necessary signals would be generated internally or the screen memory could be accessed directly. Neither of those methods is possible with the Spectrum.

The M13 interface uses an ingenious system whereby it has 8K of on-board static RAM and, when information is written to the

screen, it is also written to the memory. It is then relatively straightforward to convert the memory to the necessary RGB signals. Those signals are made available for either linear or TTL level monitors through two standard 5-pin DIN sockets.

By using that method the interface will work on all three issues of the Spectrum without the need to open it and solder jumper leads into the PCB. The resulting display is rock steady, with none of the usual Spectrum dot crawl.

There is a MIC socket on

the interface, also with its signals taken from the edge connector, which is not connected electrically to the EAR socket. In that way you no longer have contin-

ually to swap leads when LOADING and SAVEing.

The M13 interface costs £74.95. Re-designed to reduce the chip count, the new version is expected to retail for around £50. Miracle Systems Ltd, 6 Armistage Way, Kings Hedges, Cambridge CB4 2UE.



$\hat{H}\psi = E\psi$ EIGEN SOFTWARE PHOTON wraith/disassembler for 48K ZX Spectrum Z80 MACHINE CODE PROGRAMMING WITHOUT TEARING YOUR HAIR OUT

Like all computers, Spectrum has a rather irksome feature: it faithfully follows the instructions that we *actually* give it, paying no regard whatsoever to the instructions we thought we had given it. In a word: bugs. What's more, erroneous machine code programs tend to crash, forcing us to pull the plug and start again.

If you're beginning to learn Z80 assembly language (machine code) or are an accomplished Z80 programmer you'll appreciate the time and effort that goes into removing even the smallest bugs. At EIGEN SOFTWARE we aim to change all this and make you a better programmer too. Simply by providing you with that most precious commodity: time. Less time debugging means more time creating sensational programs.

Our PHOTON contains a *sensible* disassembler (the only Spectrum disassembler that inserts labels!) and an escape facility in order to regain control after a crash without losing your precious machine code (even if your program includes an interrupt routine!). More importantly, though, PHOTON contains a wraith which steps through machine code routines one instruction at a time, giving continuous display of the contents of *all* registers and flags before and after the current instruction, mnemonics of current and previous instructions, stack details, interrupt system status and more. So bugs are very easy to spot since you can identify the precise point at which Spectrums' Z80A does something you didn't want it to do. Wraith allows you to initialize all registers and flags in dec, hex or bin. A users' screen/attribute file can be implemented for graphics programs.

Furthermore, a whole host of excellent routines are sitting in the ROM just waiting for you to use them. PHOTON will show you how these work (one instruction at a time!) so that you can save time and RAM when writing your programs.

PHOTON's disassembler handles fp-calc and error restarts correctly, gives dec or hex, upper or lower case mnemonics, informative labels and is ZX printer/microdrive compatible.

PHOTON also includes BASIC line deletion and character contents of data blocks. For the absolute beginner PHOTON is an invaluable learning aid since the wraith clearly shows the effect of ALL Z80 instructions. Using PHOTON is amazingly simple: the menu drive takes care of all parameters.

PHOTON is a full colour, menu driven, machine code program and is accompanied by comprehensive instructions.

ORDER TODAY AND KEEP YOUR HAIR!

Send cheque/P.O. for £10.85 (inc. p&g*) to: EIGEN SOFTWARE,

45 Bancroft Road, Widnes, Cheshire WA8 0LR.

*Please add £1 if outside UK.

If you don't want to spoil your magazine
write your order on a piece of paper
Please send me by return post
at £10.85 each (inc. p&g*). PHOTON!

Name _____
Address _____
*Please add £1 if
outside UK.

$\hat{H}\psi = E\psi$ EIGEN SOFTWARE
create reality

Greater divide

IN THE April/May issue of *Sinclair Projects*, Stephen Rush's article on mathematical accuracy can be extended to division by a number of more than eight digits, like this:

```
100 Let p$="" : Let k$="1"
```

```
110 Gosub subtract
```

```
120 For n=1 to Len t$: if t$(n)=""
```

```
then next n: Goto 300
```

```
125 if t$(1)="" or dpl then goto 200
```

```
130 let m$=t$: let n$=s$
```

```
140 let f$=p$: let s$=k$
```

```
150 gosub Add
```

```
160 let p$=t$
```

```
170 let f$=m$: let S$=n$
```

```
175 Print mk 2, at 17,0: p$'
```

```
f$
```

```
180 Goto 110
```

```
200 if Len p$=p+1 then goto 335
```

```
210 let n$=s$
```

```
215 let s$="10"
```

```
220 Gosub MULTIPLY
```

```
225 let m$=t$
```

```
230 let f$=k$: let s$="0.1"
```

```
240 Gosub MULTIPLY
```

```
245 let k$=t$: let f$=m$:
```

```
let s$=n$
```

```
250 goto 110
```

```
300 let f$=p$: let s$=k$
```

```
310 Gosub Add
```

```
320 Goto 7400
```

```
335 let t$=p$
```

By way of explanation,

In line 100, p\$ acts as a

count for the number of times S\$ — the divisor — can be subtracted from f\$ — the dividend. k\$ is the increment of the count, i.e., value 1 if the result of f\$-s\$ is positive, and henceforth 0.1, 0.01, 0.001 and so on.

Lines 120 and 125 check the result of f\$-s\$: if it is zero, the program jumps to 300 for the final increment. In line 125 the OR dp 1 is to ensure that the correct result is obtained when dividing by decimal numbers.

Line 130 saves dividend and divisor.

Line 140 to 160 increment p\$.

Line 170 restores divisor and dividend.

Line 175 prints-out current state of the calculation.

Line 200 checks the required number of decimal places has been reached. Line 210 saves the divisor.

Lines 215-225 take any remainder less than the divisor, brings down a zero for further division and saves this in m\$.

Lines 230-240 reduce the increment of the count by 0.1. This is done by multiplying by 0.1 rather than dividing by 10 as the latter leads to place errors.

Lines 300-310 add final

increment to p\$ prior to printing the answer when division is exact.

Line 335 places p\$ into t\$ when division is not exact prior to printing.

The routine works as well as exponentiation for speed and performs division by a 400-place decimal number in about an hour.

Ronald Liddle
Brandon, Durham.

Changes not welcomed

I WRITE to express, at the very least, displeasure at the way *Sinclair Projects* has been changed, starting with the April/May and now, I see, the June/July issues.

The first year your magazine was excellent with six projects and one or two software — if we were unlucky. Now we have four projects. I have found only two and an update on the joystick article in the last issue. That is one-third of the normal number of projects.

You must be trying to help readers with the advice column and that is a useful change but articles like the ones about the QL, which are best left for *Sinclair User*, drive me round the bend.

If you are running out of ideas, here are a few — a

speech synthesis project based on the SP0256; a Spectrum keyboard; radio-control system for the prowl; light pen-power via the Spectrum power plug, based on an extremely fast photodiode amplified, and signals from it passed to the Spectrum EAR socket.

You no longer publish names of technical assessors. Could it be that you design your projects exclusively?

In common, I am sure, with many other Sinclair users, I want *Sinclair Projects* to return to the old format — six projects, one software if you must.

David Ely,
East Horsley, Surrey.

● *The changes are the result of a change in the direction of the magazine. We felt that previously it had been too limited and that readers would appreciate a wider look at the Sinclair hardware scene. The result is that we now publish more news and reviews as well as general information, such as this month's articles on the Motorola 68008 chip.*

That means that there is less space for projects but we consider them an important part of the magazine and will attempt to give two hardware and two software projects in each issue.

UPDATE

JUNE/JULY, Update, line 16, should read $C = A + B + (A + B)$ Column 2, line 19, should read AB.Q2,A13,A13. Column 3, line 14, should read A13 to pin 6.

Motorola 68008, page 11, column 1, second paragraph, UDS and LDS are low. Page 12, line 6, should read BR pin.

Digitiser, page 19, line 22 should read ADC1 and ADC2 conversion

cycles. ADC1 enables . . .

Locotrol, page 26, components list, all resistors are $\frac{1}{4}W$. Page 33, diagram 13, the longer lead is the anode.

Joystick, page 40, figure three, line A8, the first switch should read SH not G/S.

Digital Electronics page 42, third column, line 13 should read $B=0$, $Q=1$ and $\bar{Q}=0$, Q and \bar{Q} are. Page 44, third column, line 16 should read "of a gated SR flip-flop occurs when

both S and R are low and as that affair can no longer happen . . ."

Page 46, line 15, should read "Alternative symbols for the rising edge are

\uparrow and \int Second column line 16 should read "but no \bar{Q} output. That is no loss, as the \bar{Q} output . . ." Page 47, first column, line 17 should read "from \bar{Q} , which will be low." Line 19, "and \bar{Q} and hence D." Third column, line 15 should be "previous state of \bar{Q} and \bar{Q} ."

Trapping errors on the important power source

Our advice correspondent, Trevor Marchant, offers help on connectors, joysticks and other problem areas.

HOW MUCH we take the humble power supply for granted. Inside the little black box by your computer is the source of its power. You plug it in and either it works or it does not. What if it does not? There are three types of power supply used by Sinclair — UK 700, on the ZX-81; UK 1200, on the ZX-81 with printer; and UK 1400 on the Spectrum.

At one time if you bought a ZX printer you also had a 1200 power supply but things have changed; now you get paper instead. That may seem a little strange when you think a ZX-81 requires the 1200 power supply to be able to use the printer — plenty of paper but nothing on which to use it. I hope that gives you some idea of just how important that little box is.

For those with some knowledge of the things a relatively simple example is using a mains transformer with thermal cut-out, four diodes and two smoothing capacitors — see figure one.

The 220-250V mains is fed via the blue/brown leads to the transformer, the live lead via a thermal cut-out. The device is sensitive to temperature

Figure 1.

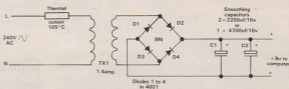

and will open circuit at about 105 degrees Centigrade. Most cut-outs are non-resettable and, if open, require replacing; always use the same type or the closest possible i.e., ± 5 percent of the value; the same applies to fuses.

The transformer converts 240V AC to a lower AC voltage, although it can be higher but not in this case. The transformer also isolates you from the mains, so if you hold the 9V DC plug in your hands it will not harm you. To continue, the AC voltage is rectified by the diodes D1 to D4 and smoothed by C1 and C2 to give an output of approximately 9V DC.

While that output is well-smoothed it does not need to be well-regulated as the Spectrum will accept anything from 7V to 14V, but consider the 5V regulator inside your computer — the more voltage you feed to it the more it has to drop, hence the higher the input the hotter it will get.

Some PSUs will give out up to 16V DC without a computer connected

but that should fall to approximately 12V when connected. If you wish to build your own PSU the output should be about 10V at 1.4amps for the Spectrum and 1.2amps for the ZX-81 — that allows for use of the ZX printer. For those with Microdrives and interfaces I would suggest going up to 2amps if you are building your own.

I have a 0-30V/0-3amp PSU built by myself and it is a most helpful device, costing around £20. The problem with power supplies is that sometimes they do not work, so for what do you check first?

If you have a friend with a computer, try his power supply, assuming it is the same type, of course. If it works on your computer, your PSU is at fault. First check the fuse of your PSU plug — maximum of 3amps; if in doubt, change it. Try your computer again; if it does not work try wriggling the input plug to your computer. If it produces rubbish on the screen or goes off again, unplug your

Figure 2.

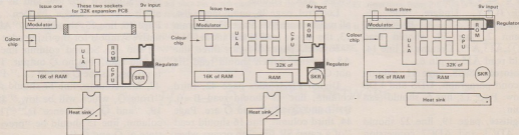

computer and, using cutters, cut off the 9V DC plug. Take it to any electrical shop and buy a replacement of the same type. The new one will have to be soldered on — striped lead to tip, ZX-81; striped lead to inner/outer, Spectrum.

If you have any other fault on your PSU you should not connect it as it may damage your computer; fix it if you know how or seek technical advice, perhaps at your computer club or from Sinclair. Under no circumstances should you attempt this if it is under guarantee, as it will invalidate it. Send your complete computer with a note to Sinclair. Remember mains can kill, so do not mess with it.

Many people have their computers in other cases — for example, the Fuller FDS, which I have. For one reason or another some people do not like the original Sinclair keyboard. I want to do word processing/typing, so a standard keyboard has its advantages, especially if you are learning to



type or doing a good deal of programming.

The wiring inside the keyboards is fairly easy but, even so, I managed to make mistakes. So if you consider changing, be careful. Changing keyboards also invalidates the guarantee, so think carefully before you do so, as Sinclair could refuse to fix it.

For people who like to look inside their Spectrums, there are three types — figure two. Issue one may have a modification fitted on top of the board, a little PCB with wire legs. It will also have an oblong PCB fitted on top — the expansion 32K RAM pack. Issue two has the same style heatsink as issue one, but no RAM pack; all the 32K expansion RAM is on the main PCB, which has been tidied as well as being re-laid. Issue three has a heatsink at the top, unlike issue one and two. Otherwise it is

much the same as issue two, except the regulator has moved along with the heatsink.

If you buy a Spectrum today it is possible to have any of the three types, since the repair units are not numbered differently. Do not worry — the difference between them in computing terms is insignificant.

Any reader with a problem can write to *Sinclair Projects* and I will try to answer. Programming is not one of my strong suits, so please bear that in mind, but I will be pleased to

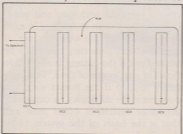

deal with any computer or add-on faults.

K J Durkin writes of difficulty with the joystick in the October/November issue. I have two suggestions. First, try a friend's joystick to see if that is the problem; try to use a non-Atari type. Second, check the polarity of your components, diodes, transistors and ICs. Then check your PCB tracks for shorts and opens; the soldering is the final check. If that is satisfactory all I can suggest is that you obtain some breadboard — Tandy — and try to re-build the circuit on it. When you have a work-

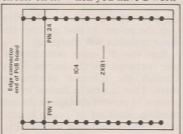

ing circuit transfer it carefully to a PCB.

R A Latham writes that he has a ZX-81 kit and wishes to fit a ZX RAM — 4816. The information I have on 4816 is that it is a 16-pin, 16K

× 1-bit device. It is, however, of no importance if yours is not Hitachi, since no allowance is made for 16-pin chips on the ZX-81. Therefore you must use one of the following: 1K — 2114 NEC, 2 off, 18-pin device, requires no links; 4118 Mostek, 1 off 24-pin device, with link L1 made; 2114 Motorola, 2 off, 18-pin device, requires no links; 2K — TMM 2016P-Toshiba, 24-pin device, with link L2 made; D4016-1 NEC, 24-pin device, with link L2 made; TMS 4016-Texas, 24-pin device, with link L2 made.

Note that L1 = 1K except 18-pin devices and L2 = 2K with no exceptions.

Do not leave in any link next to RAM IC4 unless it is required. You will notice 28 holes in IC4. You will need to use the pins from 3 round to



26; there is a line to show you on the PCB.

Sean Ogden writes that he has lost the use of his ZX-81 power supply. He can either buy one or build his own. If he wishes to buy one I would advise contacting either Adaptors and Eliminators, 14 Thames Street, Louth, Lincs or Hinchley, Southgate



House, Deves, Wilts. Both companies produce ZX-81/Spectrum PSUs.

Mathew Burgin writes that he would like to control light bulbs to robots with his 48K Spectrum, as on a BBC micro. There are controller boards to do almost anything with the Spectrum. Try contacting Harley Systems Ltd, Box 7, The Pepperboxes, Great Missenden, Bucks.

Making sure the turns are correct

Following last month's article, Brian Lee has extended the capabilities of his model railway controller, which works with both the ZX-81 and Spectrum.

BEFORE developing the Locotrol system further, a small modification is required to the speed controller described in part one. Figure one shows the relevant part of the circuit diagram. An extra diode, D8, has been inserted and the connections altered as shown.

With the original arrangement, capacitor C1 has far too small a value to smooth the track voltage at the high current taken by the train motor and the resulting ripple on the supply can cause difficulties with the electronics. D8 isolates the track supply from C1, so the supply to the track is now unsmoothed DC.

That also improves the slow-running performance when using manual control. D8 will also protect C1 should the polarity of the power supply be connected the wrong way. Any

pin. Finally, fit the new link A, as in figure 2b.

Electrically-operated points usually have a solenoid with two coil windings, one to switch the points in each direction. Since the windings are of very low resistance they can easily be burned out if the current is allowed to flow for any length of time. That may easily happen if the points stick. To overcome the difficulty, a capacitive discharge system is often used and that is the basis of the system to be described.

The circuit diagram of a controller for one set of points is shown in figure three. With the relay contacts in the position shown, the upper capacitor will charge up to supply voltage via the 390R resistor. When the relay contacts change over, that capacitor will discharge through the up-

Table 1.

Data Bit	D ₇	D ₆	D ₅	D ₄	D ₃	D ₂	D ₁	D ₀
Value for Logic 1	128	64	32	16	8	4	2	1
Function	Pt ₁	Pt ₂	Pt ₃	Direction		Speed		

further modules to be powered from the same supply must now have an isolating diode and their own smoothing arrangements.

Figure two shows the changes required on the circuit board — 2a is the original circuit and 2b shows the changes to be made. First remove the link A, then remove the diode D1 carefully. That diode may then be refitted as D8 as the lead length is the same. A new diode is fitted as shown for D1. Make a new track break B and solder a new Veropin at the end of that track. The flying lead marked 15V IN should be transferred to that

per solenoid coil, AC, thus throwing over the points. In that position the lower capacitor will charge up.

Note that the upper capacitor will not re-charge, as the current flows through the solenoid winding to earth. That current is limited by the resistor to prevent damage to the coil winding. Each set of points is controlled by the data from terminal Pt₁, Pt₂ or Pt₃ on the speed controller, as explained in the previous article. That data switches the relay via the transistor as shown.

The design was chosen for simplicity and cheapness and because only

Figure 1.

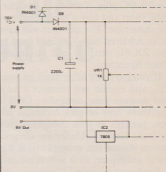

COMPONENTS LIST

Speed control unit modification

D8 IN4001

One additional IN4001 diode and one 2,200µF capacitor on output of power supply — see figure 12.

Points control board

Transistors

TR1, TR2, TR3 BC107B (3 off)

Diodes

D₁ to D₆ IN4001 (6 off)

D₇, D₈, D₉ IN4148 (3 off)

Resistors

R1 to R6 390R 3W (6 off)

R7, R8, R9 10K 1W (3 off)

Capacitors

C1 to C6 2,200µF 25V (6 off)

Relays

Ultra min. relay

12V DPDT Maplin YX95D (3 off)

Switches (optional)

S1, S2, S3 SPST Ultra min. toggle
Maplin FH97F (3 off)

Veroboard

1 piece 36 tracks x 43 holes

Strip connector block

12-way or 15-way if fitting manual switches

Sundries

Veropins, connecting wire

TRACK SENSORS

Components to make one sensor

Semi-conductors

TR1 IR sensor TIL 78

TR2 BC107B

D₁ IR LED TIL 38

Resistors

R1 See text

R2, R3 10K 1W

Strip connector block

5-way one off

Track sensor buffer board

IC1, IC2 74LS132 (2 off)

Capacitors

C1, C2 0.1µF disc ceramic (2 off)

Veroboard

1 piece 20 tracks x 32 holes

Strip connector block

10-way 1 off

LOCOTROL 2

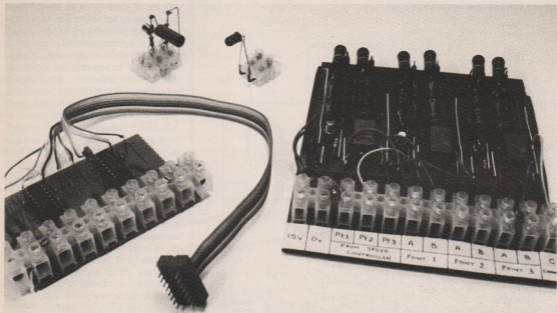

Figure 2a.

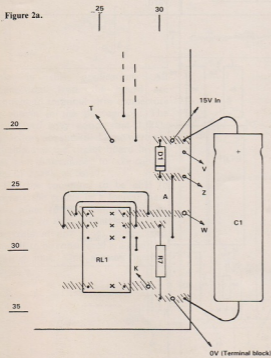
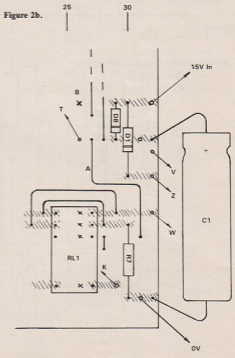
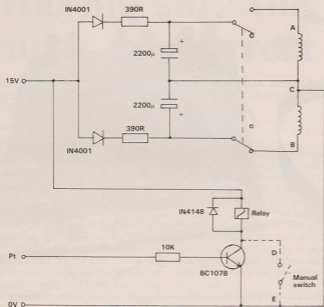

Figure 2b.



LOCOTROL 2

Figure 3. Circuit to operate one set of points.



one bit of data is required to switch the points either way. One disadvantage is that once the points have been operated, several seconds must elapse before the other capacitor is charged sufficiently to operate the points in the opposite direction. That should present no great difficulty provided a suitable time delay is incorporated, where necessary, in the software.

Before starting to build the controller a few points are worth bearing in mind. Most points motors are supposed to work from a 12V supply but those devices are notoriously temperamental and some require a far higher voltage. If it is possible, I suggest you test your sets of points by making the circuit of figure three on a breadboard to see if your power supply is adequate.

In the next instalment details will be given of a more sophisticated, high-power controller which also has a much faster recovery time, more suitable for repeated points-switching operations, such as in a model goods yard.

Figure 4.

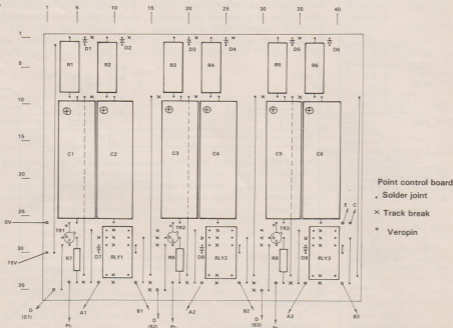

For the simple system, however, figure four shows the component layout for a board to control three sets of points. The Veroboard has 36 strips by 43 holes and the construction is straightforward. Fit the three link wires which run beneath the capacitors before those components are fitted. The 390R resistors should be mounted clear of the board, as a fair amount of heat is generated in the components. Manual switches were not fitted on the prototype, as it was a simple matter to flick over the points by hand.

The wiring for one switch is shown, however, in figure three and the switch connections are shown on the board layout. If that arrangement is to be used, remember to leave all such switches in the open position when using computer control. Note that the signal-box-type switches supplied with Hornby points motors are passing-contact switches and are unsuit-

Figure 5.

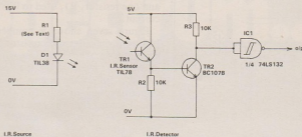
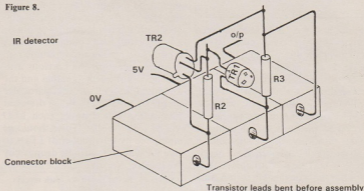

Figure 8.



pins viewed from below



Figure 6, IR LED mounting

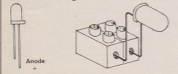

able in this application. All connections from the board are brought to terminal strip connectors as shown in the photograph. The sharp-eyed may notice that 1,000 μ capacitors are shown. Those were unreliable and the circuit board layout has been dimensioned to take capacitors of 2,200 μ as listed.

For the computer to be able to operate the points in a logical manner, some form of input must be provided to indicate the position of the train at any time, so the next module to be considered is a position-sensing unit. One sensing method

Figure 7.

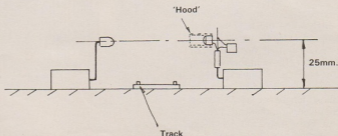
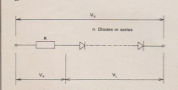

LOCOTROL 2

Figure 9. Line of sensor angled to prevent gaps between rolling stock giving false signals.

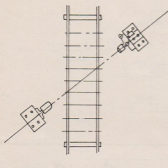

commonly used is to have reed switches on the track actuated by small magnets fitted under the rolling stock.

The method is inexpensive but has several disadvantages. For instance, the items of rolling stock with the magnets attached must always be positioned at the ends of the train. A bigger disadvantage is the contact bounce experienced with the devices. Circuitry may be used to compensate for it but it is not reliable for all train speeds.

The devices used in this project consist of an infra-red LED providing a light beam across the track, the interruption of which is detected by a photo-transistor. Figure five shows the circuit diagram for one complete sensor. R1 limits the current to the IR LED. The LED specified is a high-power type and can safely pass 100mA or so. In the detector, transistor TR2 amplifies the output from the photo-transistor TR1 and the output is buffered by the Schmitt NAND gate.

In this configuration, the output will be high when the light beam is uninterrupted. Up to eight of the devices may be used on one input port. The IR LED is mounted on a connector block as in figure six. Each lead should be extended by soldering on a short length of single-strand connecting wire and the leads bent as shown to bring the LED to about 25mm. above the baseboard, as

shown in figure nine. I used a piece of red-sleeved wire on the anode of the LED for identification when wiring. The LEDs may be connected in series and one resistor, R1, used to limit the current.

Figure seven shows a number of LEDs (n), in series with resistor R, n being the number of devices you are to use. First measure V_s , the voltage available from your supply. Separate smoothing has to be provided for modules other than the speed controller and V_s must be measured with that in circuit.

Figure 12 shows the wiring of a complete control system and V_s should be measured at a point after the IN4001 diode as shown, preferably with the train running to obtain a realistic full-load voltage. The other modules do not need to be connected.

As mentioned in the previous article, the 15V figure is nominal and the smoothed output of my particular supply is around 22V. When driven at 100mA the volt drop of each LED will be 1.4V, so that figure should be multiplied by the number of LEDs to give V_1 . The voltage to be dropped by the resistor, V_r , may then be calculated,

$V_r = V_s - V_1$. Since the components are in series, the same current will flow through R as that taken by the LEDs i.e., 100mA. So, using Ohm's Law, $R = V_r / 100mA$.

Now for the power rating. The power dissipated by the resistor is equal to $V_r \times I$, so a suitably-rated component should be chosen. When testing the system I used six sensors, so my calculation for R1 was:

$$V_s = 22V \text{ — Measured at the supply}$$

$$V_1 = 6 \times 1.4V = 8.4V$$

$$V_r = V_s - V_1$$

$$= 22 - 8.4 = 13.6V$$

$$R1 = V_r / 100mA$$

$$= 13.6 / 100mA = 136R$$

The nearest higher preferred value is 150R:

$$P = V \times I$$

$$= 13.6 \times 100mA = 1.36W$$

The nearest higher rating is 3W, so the resistor to use is a 150R 3W.

By selecting a higher preferred value, the error is on the safe side, as the current will be less than 100mA. In this case the current proved to be 90mA when measured, which gives ample light intensity.

continued on page 18

Figure 10. Buffer board for track sensors.

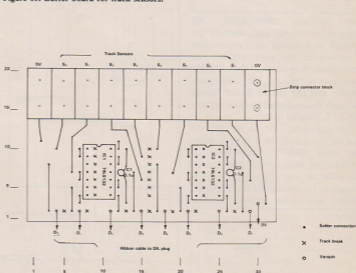

**Sneak into a
mainframe with
your Spectrum...**

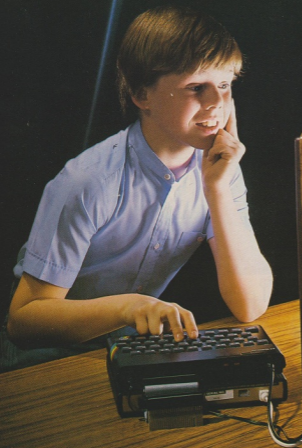

...and access an of news, view

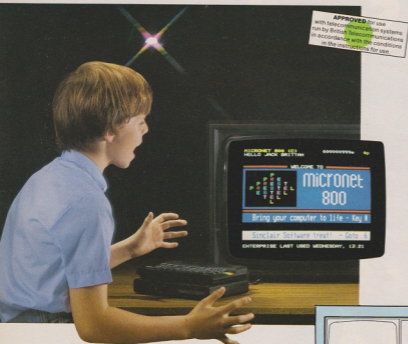

Games



Travel

Simply by connecting your Spectrum to the telephone line, via the award-winning Prism VTX 5000 communications modem, you can get to all the information, games and communication facilities held on viewdata mainframes.

So, you can link into a variety of services, including Prestel and Micronet 800. Access hundreds of software programs - many completely free. Talk to fellow users. Keep up-to-date with all the latest national, international and micro news. Play on-screen games. Check sports results. Book travel and entertainment.

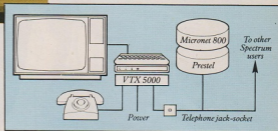

Learn a language.

The choice is simply vast. Plus, your Prism VTX 5000 allows you to communicate directly with other Spectrum owners.

And now, our special offer means that you can do all this for just £11* a month. So complete the coupon and send it to us today, and we will let you have full details of our unbeatable offer.

* All prices quoted refer to domestic use only. For business use the prelat annual standing charge is £66. Therefore business users will be billed £44.50 per quarter.

exciting world s, facts & fun!



Swapping



Educational software

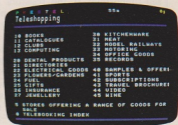

Shopping

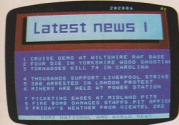

News



Competitions



Telesoftware



Sport

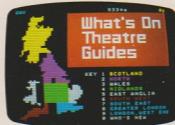

Booking

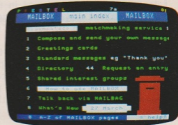

Mailbox

Prism Microproducts Ltd.
Prism House, 18-29 Mora Street
City Road, London EC1V 8BT.
Tel: 01-253 2277



Prestel and the Prestel symbol are trademarks of British Telecommunications.

FOR JUST £11* A MONTH YOU WILL GET:

- A Prism VTX 5000 worth £99.95.
- One year's subscription to Prestel worth £20.00.
- One year's subscription to Mircronet worth £32.00.
- Free user-to-user software - normally retailing at £19.00.
- Quarterly hardware and software offers.
- Discounted software through Mircronet (up to 20% off retail prices).

Please send me full information on your special offer to Spectrum users.

Name:

Address:

LOCOTROL 2

continued from page 14

Each IR detector is wired as shown in figure eight, the assembly being self-supporting. If the resistors R2 and R3 are first fitted to the connector block with their leads left straight, the two transistors may then be attached as shown. That is made easier if each lead first has a small loop made on its end, using long-nosed pliers, the loops being nipped to hold the component in place while the soldering is performed. Note that the base of TR1 is not connected.

After soldering, bend the leads as in figures eight and nine. Daylight affects the operation of the device, so some form of hood is required. I used a $\frac{1}{2}$ in. length of plastic sleeving which was a neat fit on the photo-transistor. Figure 10 shows a suitable board layout for two 74LS132 Schmitt NAND ICs. That will provide a buffer for eight sensor devices.

The 5V supply for the sensors and buffer board is from the 5V extension connector on the speed controller. The 0V line and the eight outputs, D₀ to D₇, are connected by ribbon cable to a 16-pin DIL plug using the standard pin configuration used in this magazine. That may then be plugged into an output port such as one of the ports on the sound board.

Using the modules described so far, a simple railway layout could be operated completely under computer control. Signals or signal lights do not need to be controlled directly as they may be wired easily to follow the operation of the points.

Figure 11 shows a basic track layout. Each siding has two track sensors, one to indicate that the train is clear of the siding, the second to detect that the train is at the end of the siding. For this layout it is assumed that no train will be longer than the siding.

A more complex system would include a third sensor on the other side of the points and the computer program would test to see if the train was too long. Two sensors are sited on the main line, one adjacent to the station. Figure 12 shows the inter-wiring to hook-up the system. On the subject of power supplies, transformers are

expensive items, so if you do not have a suitable supply I would suggest using a 12V car battery charger. They may be obtained relatively cheaply and supply a similar voltage to that of train controllers and will deliver in excess of 4A, which should be adequate for the biggest railway layout.

Their output, like that of conventional railway power supplies, is unsmoothed DC, so such a unit could be used without modification.

The cases of the units are, however, bulky and a much more compact unit could be made. If, however, you have doubts about working on mains

Figure 11. Track layout.

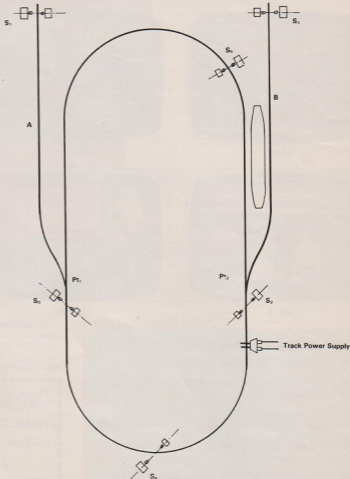

Play with figures on your ZX-81

Calculating and comparing interest rates is made easier with these two programs by Bill Johnson.

AS A life assurance salesman for 11 years, I have been involved closely with clients' personal financial planning. Naturally, I have made things easier for myself by developing a number of utilities for my 16K ZX-81. This Compound Interest program is one of five such financial utilities for which the ZX-81 is ideal.

In any compound interest calculation there are four elements — 1, present value; 2, future value; 3, period; and 4, interest rate. Given any three of the four elements the program will calculate the fourth. Here are some examples:

What capital sum would need to be invested today to provide £5,000 in four years and four months for, say, retirement, given an interest rate of 7.25 percent per annum?

By selecting option 1 of the program and inputting the data given, the objective would be achieved by investing £3,691.89 now.

Future value

Option 2 provides for the calculation of future value which is often used in compound interest calculations but with the difference that the period can be in years and odd months.

Try an illustration. I have £2,000; the current rate of interest is 9.25 percent per annum; how long will it take for my capital to grow to £5,000? The answer will be shown, 10yrs, 4mths.

Option 4 enables you to check the rates of growth of your capital investments. For instance, you could check what your life assurance salesman was offering. He may have said that his company could probably turn

your capital of, say, £1,500 into £3,000 in 10 years, assuming a rate of growth on the fund of 7.5 percent per annum. Using option 4 you could check the true rate of growth of your money and see how much is taken in charges. Using the program shows that the return on the investment would be 7.13 percent per annum.

Program

0- 250 MENU and Option selection 'mechanics'
 1200-1295 Calculation of Present Value
 1400-1540 Calculation of Future Value
 1600-1740 Calculation of Period of Time
 1800-1940 Calculation of Interest Rate
 8000-8060 Display sub-routine
 8620-8650 Display sub-routine
 8660-8740 Display sub-routine

Points to note are that you SAVE your newly-entered program with SAVE "PFP 1" or similar; there may be others; loading time is just over two minutes; after entering or loading your program enter RUN or GOTO 1; when entering the period — years and months — be sure to press Newline after entering years and again after entering months. A screen prompt reminds you to enter 'Ø' if years=0 or months=0; after each calculation the screen prompt indicates (P=COPY; M=MAIN MENU; R=NEW CALC). The first two options are self-explanatory — the third, 'R', will give you another opportunity of carrying-out the same type of calculation as that just completed.

Try calculating the value of your house in 10 years, assuming an inflation rate of four percent. Also, assuming the same inflation rate, what would be the purchasing power of £1 in 10 years, in today's terms? Both of those questions can be solved using option 2 of the program. The clue to the solution of the second problem is

to enter the interest rate as $-4+100/104$.

The second program tells me what I would need to save each month over the next 10 years, assuming a growth rate of nine percent per annum, to give me £3,000. How much would £100 saved annually give me after seven years six months if it grew at 7.25 percent per annum? What difference would it make if I put in an extra £100, once only, at the beginning? What growth rate would I have enjoyed on my savings of £500 per annum for those to have grown to £7,650 in 10 years eight months? All those and many similar questions can be answered using this program.

Present value

The main menu offers the choice of saving monthly or annually. Touching '1' or '2' instantly produces a sub-menu offering five options. Again a touch on any key '1' to '5' produces a user-friendly call to action.

On selecting option 2 on the sub-menu for calculating future values of savings, you can also ascertain the effect of putting in an initial cash lump sum at the time the first monthly or annual payment is made. Alternatively, it can be used to take account of the present value of your savings and what the total value would be at a certain time in the future if you continued to save a given amount and growth continued at a certain assumed rate.

The program occupies just over 10K of RAM. Save your newly-entered program with SAVE "PFP 2" or similar. It takes approximately four-and-a-half minutes to re-load. The breakdown of the program is:

0- 120 Main menu and Option selection mechanics
 1000-1270 Installment Savings: Monthly — sub-menu options
 1200-1270 Calculation of monthly payments
 1400-1570 Calculation of future values (monthly payments)
 1600-1780 Calculation of period (monthly savings)
 1800-1997 Calculation of interest rates (monthly savings)
 2000-2020 Installment Savings: Annual sub-menu options
 2200-2280 Calculation of annual payments
 2400-2580 Calculation of future values (annual payments)

- 2600-2780 Calculation of period (annual savings)
- 2800-2999 Calculation of interest rates (annual savings)
- 8000-8020 Display sub-routine — monthly savings
- 8030-8050 Display sub-routine — annual savings
- 8060-8190 Sub-routines for sub-menu
- 8600-8650 Sub-routines for user-friendly prompts
- 8660-8720 Sub-routine for inputs and screen display
- 8810-8850 Sub-routine for future value calculations
- 9000-9060 Screen management sub-routine

The formulae used in the calculations look complicated but are really straightforward. The only option which may take a little time is that of the interest calculation; it can sometimes take up to 30 seconds to provide the answer. If the screen stays blank for much longer or you want to regain control of the program key, 'BREAK' followed by 'SLOW' and then 'GOTO 1'. In such a case try doubling the payment and future value figures and re-enter using the same period.

The program will not cope with negative rates of interest on option 4 of the sub-menu. If, inadvertently, you enter data where the future value is less than the total amount saved for the period, the screen will show "What kind of investment is this?" You can then return to the main or sub-menu as required for another calculation.

The interest calculation is an approximation formula which makes up to three attempts, using loops, at finding an interest rate which will satisfy a given set of criteria — see program lines 1920-1990 and 2920-2993. At the end of the process the figure appearing on the screen should be reasonably accurate.

Where very small or very large interest rates are involved, the results may be less accurate than with those between five and 25 percent. Initially, until you have the measure of the interest rate calculation, try feeding the interest rate calculated back into option 2 of the sub-menu and see how the future value compares to that with which you started.

The program comes into its own when calculations are made involving

years and months, as the examples show.

After each calculation the screen prompt indicates (P=COPY; M=MAIN MENU; R=NEW

CALC). The first two options are self-explanatory; the third, 'R', will return you to the sub-menu, monthly or annual, to whichever one you were on in the last calculation.

Program 1.

```

5 REM personal financial plan
6 DIM I(1,1)
7 DIM V(1,1)
8 DIM I(1,1)
9 DIM V(1,1)
10 CLS
20 PRINT TAB 3;"PERSONAL FINA
NCIAL PLANNING"
30 PRINT TAB 3;"-----"
40 PRINT AT 3,7;"COMPOUND INTE
REST"
50 PRINT AT 4,7;"-----"
60 PRINT AT 6,8;"CALCULATION O
F:"
70 PRINT AT 8,3;"1.PRESENT VAL
UE"
80 PRINT AT 10,3;"2.FUTURE VAL
UE"
90 PRINT AT 12,3;"3.PERIOD"
100 PRINT AT 14,3;"4.INTEREST R
ATE"
190 PRINT AT 20,6;"SELECT OPTIO
N:1-4)"
200 IF INKEY#<>"*" THEN GOTO 200
210 IF INKEY#="*" THEN GOTO 210
220 LET OF=INKEY#
230 IF OF<"1" OR OF>"7" THEN GO
TO 200
240 LET S=VAL OF
250 GOTO 1000+200*S
1200 REM calculation of present
value
1201 CLS
1202 PRINT AT 0,8;"COMPOUND INTE
REST"
1205 PRINT AT 1,8;"-----"
1210 PRINT AT 3,2;"CALCULATION
OF PRESENT VALUE"
1215 PRINT AT 4,2;"-----"
1220 GOSUB 8620
1230 GOSUB 8660
1275 LET N=Y*12+X
1280 LET I(1,1)=(EXP(LN((100+I
)/100)/12)-1)*100
1285 LET P=(INT((V/((1+(1,1)/
100)**N))*100+.5))/100
1290 PRINT AT 19,0;"PRESENT VALU
E =";P
1295 GOTO 8000
1400 REM calculation of future v
alue
1401 CLS
1402 PRINT AT 0,8;"COMPOUND INTE
REST"
1405 PRINT AT 1,8;"-----"
1420 PRINT AT 3,2;"CALCULATION O
F FUTURE VALUE"
1430 PRINT AT 4,2;"-----"
1440 PRINT AT 6,2;"ENTER PRESENT
VALUE,NUMBER OF"
1450 GOSUB 8630
1460 INPUT P
1470 PRINT AT 13,0;"PRESENT VALU
E =";P
1480 GOSUB 8680
1515 LET N=Y*12+X
1520 LET I(1,1)=(EXP(LN((100+I
)/100)/12)-1)*100
1525 LET V=(INT((P*((1+(1,1)/
100)**N))*100+.5))/100
1530 PRINT AT 19,0;"FUTURE VALUE
= £";V
1540 GOTO 8000
1600 REM calculation of period
1601 CLS
1602 PRINT AT 0,8;"COMPOUND INTE
REST"
1605 PRINT AT 1,8;"-----"
1620 PRINT AT 3,6;"CALCULATION O
F PERIOD"
1630 PRINT AT 4,6;"-----"
1640 PRINT AT 6,0;"ENTER PRESENT
VALUE,FUTURE VALUE"
1650 PRINT AT 7,4;"AND ANNUAL IN
TEREST RATE"
1660 INPUT P
1670 PRINT AT 9,1;"PRESENT VALUE
= £";P
1680 INPUT V
1690 PRINT AT 11,1;"FUTURE VALUE
= £";V
1700 INPUT I
1710 PRINT AT 13,1;"INTEREST RAT
E:1;TAB 22;"P,CENT P.A"
1715 LET I(1,1)=(EXP(LN((100+I
)/100)/12)-1)*100
1720 LET N=(LN(V/P))/(LN(1+
I(1,1)/100))+.5
1725 LET Y=(N/12)
1730 LET X=N-Y*12
1735 PRINT AT 15,1;"PERIOD
= ";Y;"YEARS-";X;"MONTHS"
1740 GOTO 8000
1800 REM calculation of interest
rate
1801 CLS
1802 PRINT AT 0,8;"COMPOUND INTE
REST"
1805 PRINT AT 1,8;"-----"
1820 PRINT AT 3,2;"CALCULATION O
F INTEREST RATE"
1830 PRINT AT 4,2;"-----"
1840 PRINT AT 6,0;"ENTER PRESENT
VALUE,FUTURE VALUE"
1845 PRINT AT 7,1;"AND NUMBER OF
YEARS AND MONTHS"
1850 GOSUB 8640
1860 INPUT P
1870 PRINT AT 13,0;"PRESENT VALU
E: £";P
1880 INPUT V
1890 PRINT AT 15,0;"FUTURE VALUE
= £";V
1895 INPUT Y
1897 PRINT AT 17,0;"PERIOD
1 ";Y;"TAB 18;"YRS="
1900 INPUT X
1910 PRINT AT 17,23;X;"TAB 26;"MN
THS."
1915 LET N=Y*12+X
1920 LET I(1,1)=(EXP(LN(V/P)**
1/N)-1)*100

```

continued on page 24

- University of Leicester, Department of Psychology
- The Finance & Estates Officer, University College of Swansea
- University of East Anglia, School of Biological Sciences
- Westfield College, University of London
- Westfield College, Department of Zoology, University of London
- School of Physics, University of Newcastle upon Tyne
- Oxford University Compulsory Service
- The University of Warwick
- University of Aberdeen, Department of Geography
- The University of Sussex
- University of Bristol
- Heriot-Watt University Dept. of Civil Engineering
- The New University of Ulster
- The University of Strathclyde
- The University of Southampton
- University of Liverpool
- The University of Aston in Birmingham
- University of Keele
- University of Surrey
- University College of London
- The University of Dundee, Microcomputer Centre

- Barnsley College of Technology
- The College of St. Paul & St. Mary
- Thanet Technical College
- Ballymena Technical College
- Cannock Chase Technical College
- Deanshall & Morecambe College of Further Education
- Uxbridge Technical College
- New College Durham
- Bath College of Higher Education
- North Trafford College
- Dept. of Educational Resources
- Southampton College of Higher Education
- Bournemouth and Poole College of Further Education
- Harrow College of Higher Education
- Southall College of Technology
- Shircliffe College
- Southwark College
- Dewsbury & Batley Technical & Art College
- Tresham College
- Ware College
- Thurrock Technical College
- Kicklade College, Dept. Science & Technology
- Rebriidge Technical College
- South Thames College
- York College of Arts & Tech.
- Somerset College of Arts & Technology
- Borough of Trafford, North Trafford College
- North Trafford College
- Thurrock Technical College
- Thurrock Technical College, Computer Department
- Fairham Community College
- Mid College of Higher & Further Education
- East Ham College of Technology
- Sesle-Hayne College
- Homerton College
- Uxbridge Technical College
- North Oxfordshire Technical College & School of Art
- Ealing College of Higher Education
- Welsh National School of Medicine
- Lord Mayor Trillor College
- South East London College
- Farnborough (Sixth Form) College
- Wigston College of Further Education 'Annex'
- Strode's College
- Dundee College of Education
- Isle of Wight College of Arts and Technology
- Kendal College of Further Education
- Wigan College of Technology
- Chippenham Technical College
- South Devon College of Arts & Technology
- South Shields Marine & Technical College

- North Trafford College
- Thurrock Technical College
- Thurrock Technical College, Computer Department
- Fairham Community College
- Mid College of Higher & Further Education
- East Ham College of Technology
- Sesle-Hayne College
- Homerton College
- Uxbridge Technical College
- North Oxfordshire Technical College & School of Art
- Ealing College of Higher Education
- Welsh National School of Medicine
- Lord Mayor Trillor College
- South East London College
- Farnborough (Sixth Form) College
- Wigston College of Further Education 'Annex'
- Strode's College
- Dundee College of Education
- Isle of Wight College of Arts and Technology
- Kendal College of Further Education
- Wigan College of Technology
- Chippenham Technical College
- South Devon College of Arts & Technology
- South Shields Marine & Technical College

SCHOOLS

- Camborne School of Mines
- Longton High School
- Berry Hill High School
- Epson District School of Mines Management Department
- School of Physics
- Queen Philippa's School
- Carter Lodge School
- Ashfield School
- All Hallows School
- Mead Vale Primary School
- Vincent Thompson High School
- St. Aubyn's School
- Imberhorne School
- Newham School for the Deaf
- Dorcan School
- Beaumont School
- Bilmericy School
- Eraser School Computer Department
- Clandon School
- The Lavinia Norfolk Unit
- St. John's C of E Primary School
- St. Peter's High School
- Rock Ferry High School
- Stoke on Trent Language Centre
- Connah's Quay High School
- Buckhurst Hill County High School

- Heath Comprehensive School
- The High School Ballynashinch
- Bishop Hedley High School
- Clywd Lea School
- Monks Dyke High School
- King Edward's School, Bath
- The Godolphin & Lushington School
- Francis Bristley School
- Shaw House Comprehensive
- New Parks School
- St. Paul's Way School
- Larkman Middle School
- Rushcroft High School
- Training and Educ. Management High Green School
- Ogmore Comprehensive School
- Brakenhale School
- Oxford International Business School
- Hampstead School

GOVERNMENT DEPARTMENTS

- Hertfordshire County Council
- Advisory Unit for Computers
- Leicestershire County Council
- The Director of Finance & Administration, Cambridgeshire County Council
- The National Institute for Medical Research
- Department of the Environment Building Research Establishment
- Kent County Council Education Department
- Ministry of Defence
- Basildon Council Accounts Department
- Department of Trade
- Devon County Council Committee, Department of Electrical Eng. College of Further Education
- Strathclyde Regional Council
- County Borough of Sunderland
- Kent County Council
- Nottinghamshire County Council
- Basildon District Council
- City of Newcastle upon Tyne Education Committee
- Hampshire County Council
- Buckinghamshire County Council, Education Services
- Cambridgeshire Education Committee
- Metropolitan Borough of Gateshead
- Cleveland Education Committee, Gateshead Teachers Centre
- Metropolitan Borough of Rochdale, Education and Training Centre
- Leicestershire Education Committee
- Department of Industry & Trade
- Leicester Info. Tech. Centre
- Solihull Education Department
- Manpower Services Commission, Training Services Division
- Skill Centres Training Agency
- Powys County Council
- Information Technology Centre
- East Berkshire Health Authority
- Devon County Council Ed. Comm.
- Mid Surrey Health Authority
- Epson District Hospital
- Scottish Council for Educational Technology
- Clywd County Council
- Norfolk Education Committee
- Agricultural & Food Research Council
- Mid Glamorgan County Council Education Department
- Kent County Supplies Centre
- London Borough of Barnet
- West Midlands Regional Health Authority
- Scottish Community Education Council
- The Scottish Adult Basic Education Unit
- Birmingham Social Services
- Microelectronics Education Programs
- Greater London Council
- Doncaster Metropolitan Borough Council
- United Kingdom Atomic Energy Authority

- COMPANIES
- Cambridge Applied Micro
- Sirton Computer Systems
- Assurance Sun Life Court
- Radala & Associates
- Computer Services
- Laser Systems Ltd
- National Physical Laboratory
- Central Trade Exchange Ltd
- Software Invasion
- Argonaut Systems
- Integrex Ltd
- British Telecommunications
- B.T. Research Labs Accounts
- Windsor Wine Supplies
- Janerflow Ltd
- Robinson Design Software
- H.C.C.S. Association Ltd
- Molspin Ltd
- Pisons Pharmaceuticals, Pharmaceutical Division
- Information Technology Marketing
- Steele Microsystems Ltd
- The Television Centre
- Education & Microchips Unit
- British Telecom Enterprises
- Display Distribution Ltd
- Northern Gas
- Spencer Source Trading
- IBC Publications
- M.S. Simmitt Computers Ltd
- Rosville Timothy Ltd
- M.E. Electronics
- Microstore
- Eastern Region Info. Centre
- The Video Palace
- Laser Creations Ltd
- Lasermission
- Gustoni Video Productions
- BBC TV South
- Kellogg Company of Great Britain Ltd
- The British Library
- Walter Computer Systems
- Standard Telecommunications Laboratories
- Granada Computer Services Ltd
- Applied Systems Knowledge Ltd
- Cipher Systems and Communications Ltd
- Cogwell, Cormick Associates
- Ashfield Project Centre
- Andrew Shyte & Son Ltd
- Acornsoft
- Robot Technology Ltd
- British Shipbuilders (Training, Ed. & Safety) Ltd
- Boston Computers Handeleges
- Fisher Controls Ltd
- Implex Corporation
- Robot Technology Ltd
- United Kingdom Atomic Energy Authority
- British Aerospace Public Ltd
- Salam Group Ltd
- Plessey Avionics & Comm.
- Elite Software Co. Ltd
- Computer Advisory Unit, Chelmer-Institute
- Intec (Inverclyde) Ltd
- Universal Sonar Ltd
- Digital Equipment Scotland Ltd
- Edward Davies Chemical Labs.
- Pyramid Services Ltd
- Philips Research Laboratories
- Kingway-Princeton College
- Microtronix S.A.R.L.
- Thomas Law Associates
- Transvideo Productions Ltd
- Dash Electrical & Electronic Services
- Aakun Engineering
- The Electricity Council
- Triptych Publishing Ltd
- ZX Data
- Octocoon Data
- North Wales Newspapers Ltd
- Janssen Pharmaceutical Ltd
- National Coal Board
- Five Ways Software Ltd
- Edeta Ltd
- John Elmer Office Equipment
- Micronet
- Central Electricity Generating Board
- Guesmay Computers Ltd
- Currah Computer Components Ltd

GRAFPAD

for Sinclair Spectrum ... Drawing into the future!

Now you too can have the benefit of drawing your own applications by the simple use of our NEW ZX Spectrum version of Grafpad!



Size
25mm height
51mm width
260 depth
weight 1.2k (gross)



- ★ Dealer inquiries welcomed
- ★ Special discounts to educational authorities & government departments
- ★ Export inquiries invited

BRITISH MICRO

A HEGOTRON GROUP COMPANY

Unit Q2, Penfold Works,
Imperial Way, Watford, HERTS WD2 4YY
TEL: (0923) 48222. TELEX: 946024



THE GRAFPAD comes complete with Cassette Programme, Special Keyboard, Overlay, Plug, Light Pen and, of course, a comprehensive manual full of tips and instructions ... all of the usual high quality expected from

BRITISH MICRO!

STARTING UP is simple. Connect the Grafpad, switch on your Spectrum and connect the cassette player, type "LOAD" and press ENTER, then start the cassette player, place the keyboard overlay, and by the time you are ready, the "MENU" will flash on to your screen! Usage? Well there is ...

AS MANY USES AS YOU CAN IMAGINE by first following our easy manual, then, in no time, you will be able to utilise as you think best!

A UNIQUE PRODUCT that will improve your skills and give you endless hours of excitement!

HOW TO ORDER

BY TELEPHONE: (0923) 48222
If you are an American Express, Barclaycard, Diners Club or Access Card Holder simply telephone us giving your Card No., Name, Address and item(s) required and your order will be despatched within 48 hours!

BY POST:

Simply fill in the coupon enclosing your cheque/P.O. made payable to: BRITISH MICRO or use the special section for Credit Card Holders and post to the address below.

OVERSEAS ORDERS:
Please add £10 per item ordered.

Post to: BRITISH MICRO, UNIT Q2, PENFOLD WORKS, IMPERIAL WAY, WATFORD, HERTS. WD2 4YY.

Please send me GRAFPAD for: SINCLAIR SPECTRUM

BBC MODEL B COMMODORE 64

If you require details of the above versions, please tick.

Qty.	Item	Ex. VAT	Inc. VAT	Total
	Grafpad Complete	£125.00	£143.75	
Postage, Packing & Insurance				£5.00
I enclose my cheque for / P.O. £.....				TOTAL £

I prefer to pay with my American Express, Barclaycard, Diners Club, Access Card.

(Please delete whichever is not applicable)

Card No.

Signature

Name

Address

Address above must be the same as Card Holder

MONEY PLAN

continued from page 21

```

1925 LET I=(INT ((100*((1+(I(1,1)
)/100)**12)-100)*100+.5)/100)
1930 PRINT AT 19,0;"INTEREST RAT
E = ";I;TAB 20;"PER CENT P.A"
1940 GOTO 8000
8000 PRINT AT 21,0;"(P=COPY;M=MA
IN MENU);R=NEW CALC. I."
9010 INPUT Z#
9020 IF Z#="P" THEN COPY
9030 IF Z#="M" THEN GOTO 10
9040 IF Z#="R" THEN CLS
9050 IF Z#="R" THEN GOTO 1000+20
0*5

```

Program 2.

```

5 REM personal financial plan
ning (2) BY BILL JOHNSON
10 CLS
12 DIM I(6)
15 DIM W(5)
17 DIM V(5)
20 PRINT TAB 3;"PERSONAL FINAN
CIAL PLANNING"
30 PRINT TAB 3;"-----
-----"
40 PRINT AT 5,3;"1.INSTALLMENT
SAVINGS-MONTHLY"
50 PRINT AT 7,3;"2.INSTALLMENT
SAVINGS-ANNUAL"
60 PRINT AT 18,6;"SELECT OPTIO
N: 1 OR 2"
70 IF INKEY#>">" THEN GOTO 70
80 IF INKEY#=">" THEN GOTO 80
90 LET O#="INKEY#"
100 IF O#<"1" OR O#>"2" THEN GO
TO 70
110 LET S=VAL O#
120 GOTO 1000+S
1000 REM installment savings\mon
thly
1005 CLS
1010 GOSUB 8000
1020 GOTO 8060
1200 REM calculation of monthly
payments
1205 CLS
1210 GOSUB 8000
1215 GOSUB 8600
1220 GOSUB 8660
1225 INPUT I
1228 PRINT AT 17,0;"INTEREST RAT
E = ";I;"P.CENT P.A"
1230 LET N=Y*M12+X
1240 LET I(1)=(EXP (LN ((100+I)/
100)/12)-1)*100
1250 LET P=(INT (((V/(1+I(1)/100
)^(I(1)/100))/((1+I(1)/100)**N
1-1)))*100+.5)/100)
1260 PRINT AT 19,0;"PAYMENT";TAB
15;" ";I;"P;PER MNTH"
1270 GOTO 9000
1400 REM calculation of future v
alue(monthly payments)
1405 CLS
1410 GOSUB 8000
1420 PRINT AT 4,0;"IF AN INITIAL
DEPOSIT IS BEING MADE OR THE P
LAN HAS GOT A VALUE AT THIS TIME,
ENTER AMOUNT;IF NOTENTER 0"
1430 INPUT Z
1440 CLS
1445 GOSUB 8000
1450 PRINT AT 3,3;"CALCULATION O
F FUTURE VALUE"
1460 PRINT AT 4,3;"-----
-----"

```

```

8060 GOTO 8000
8620 PRINT AT 6,2;"ENTER FUTURE
VALUE,NUMBER OF"
8630 PRINT AT 7,1;"YEARS AND MON
THS,AND INT.RATE"
8640 PRINT AT 9,0;"(PRESS NEWLIN
E AFTER each ENTRY)",,"note:ENTE
R 0 IF YRS=0 OR MNTHS=0"
8650 RETURN
8660 INPUT V
8670 PRINT AT 13,0;"FUTURE VALUE
: I";V
8680 INPUT Y

```

```

8690 PRINT AT 15,0;"PERIOD
";Y;TAB 18;"YRS--"
8700 INPUT X
8710 PRINT AT 15,23;X;TAB 26;"MN
THS."
8720 INPUT I
8730 PRINT AT 17,0;"INTEREST RAT
E = ";I;TAB 22;"P.CENT P.A"
8740 RETURN
9990 REM PERSONAL FINANCIAL PLAN
NING (1)
9991 REM
9992 REM (C)BILL JOHNSON 28JUL83

```

```

1470 PRINT AT 6,0;"ENTER MONTHLY
PAYMENT,NUMBER OF"
1480 GOSUB 8630
1490 INPUT P
1500 PRINT AT 13,0;"INIT.DEP./VA
LUE: I";Z
1505 PRINT AT 14,0;"PAYMENT
: I";P;"PER MNTH"
1510 GOSUB 8680
1520 INPUT I
1530 PRINT AT 16,0;"INTEREST RAT
E = ";I;"P.CENT P.A"
1540 GOSUB 8810
1550 LET V=(INT ((P*(1+I(1)/100
)*(((1+I(1)/100)**N)-1)/(I(1)/10
0)))*100+.5)/100)
1560 PRINT AT 18,0;"FUTURE VALUE
INCLUDING INITIAL DEPOSIT/CURR
ENT VALUE=I";V+V(2)
1570 GOTO 9000
1600 REM calculation of period(m
onthly savings)
1605 CLS
1610 GOSUB 8000
1620 PRINT AT 3,5;"CALCULATION O
F PERIOD"
1630 PRINT AT 4,5;"-----
-----"
1640 PRINT AT 6,1;"ENTER MONTHLY
PAYMENT,INT.RATE"
1650 PRINT AT 7,8;"AND FUTURE VA
LUE"
1660 PRINT AT 9,0;"(PRESS NEWLIN
E AFTER EACH ENTRY)"
1670 INPUT P
1680 PRINT AT 13,0;"PAYMENT
: I";P;"PER MONTH"
1690 INPUT I
1700 PRINT AT 15,0;"INTEREST RAT
E = ";I;TAB 22;"P.CENT P.A"
1710 INPUT V
1720 PRINT AT 17,0;"FUTURE VALUE
: I";V
1730 LET I(1)=(EXP (LN ((100+I)/
100)/12)-1)*100
1740 LET N=INT ((LN (((1+I(1)/100
)/(1+I(1)/100))*(V/P)+1)/LN (1+I(
1)/100))+.5)
1750 LET Y=INT (N/12)
1760 LET X=N-Y*12
1770 PRINT AT 19,0;"PERIOD
: ";Y;TAB 18;"YEARS-";X;"MNTHS"
1780 GOTO 9000
1800 REM calculation of interest
rates(monthly savings)
1805 CLS
1810 GOSUB 8000
1815 PRINT AT 3,0;"CALCULATION O
F MONTHLY INT.RATES"
1817 PRINT AT 4,0;"-----
-----"

```

```

1820 PRINT AT 6,2;"ENTER FUTURE
VALUE,NUMBER OF"
1830 PRINT AT 7,1;"YEARS AND MON
THS,AND PAYMENT"
1840 GOSUB 8640
1850 GOSUB 8660
1905 INPUT P
1910 PRINT AT 17,0;"MONTHLY PAYM
ENT: I";P
1912 IF V<=N*P THEN PRINT AT 19,
0;"WHAT KIND OF INVESTMENT IS TH
IS?"
1913 IF V<=N*P THEN GOTO 9000
1915 FAST
1920 FOR I=1 TO 50 STEP (2)
1930 LET I(2)=(EXP (LN ((100+I)/
100)/12)-1)*100
1935 LET N=Y*I2+X
1940 LET M=(INT (P*(1+I(2)/100)*
(((1+I(2)/100)**N)-1)/(I(2)/100
)+.5)
1945 IF V-M=-40000 AND V-M<=350
00 THEN GOTO 1955
1950 NEXT I
1955 FOR I=(1-.5) TO (1+25) STEP
(.5)
1965 LET I(3)=(EXP (LN ((100+I)/
100)/12)-1)*100
1975 LET W(1)=(INT ((P*(1+I(3)/
100)*(((1+I(3)/100)**N)-1)/(I(3)
/100)))*100+.5)/100)
1980 IF V-W(1)>=1 AND V-W(1)<=1
THEN GOTO 1995
1981 IF V-W(1)>=20000 AND V-W(1)
<=25 THEN GOTO 1983
1982 NEXT I
1985 FOR I=(1-.5) TO (1+.5) STEP
(.01)
1985 LET I(4)=(EXP (LN ((100+I)/
100)/12)-1)*100
1987 LET W(2)=(INT ((P*(1+I(4)/
100)*(((1+I(4)/100)**N)-1)/(I(4)
/100)))*100+.5)/100)
1989 IF V-W(2)>=7 AND V-W(2)<=1
THEN GOTO 1995
1990 NEXT I
1995 SLOW
1995 PRINT AT 19,0;"INTEREST RAT
E = ";I;"INT (1*100+.5)/100;TAB 2
2"
1997 GOTO 9000
2000 REM installment savings\ann
ual
2005 CLS
2010 GOSUB 8030
2020 GOSUB 8060
2200 REM calculation of annual p
ayments
2205 CLS
2210 GOSUB 8030
2215 GOSUB 8600

```



```

2220 GOSUB B660
2225 INPUT I
2228 PRINT AT 17,0;"INTEREST RATE"
E : "I";"P.CENT P.A"
2230 LET I(1)=(EXP(LN((100+I)/100)/12)-1)*100
2240 IF X=0 THEN LET V(1)=V
2250 LET V(1)=V/((1+I(1)/100)**X)
2260 LET P=(INT((V(1)/(1+I(1)/100)*100)/((1+I(1)/100)**Y)-1))*100+.5/100)
2270 PRINT AT 19,0;"PAYMENT";TAB 15;"I";P;"PER ANN."
2280 GOTO 9000
2400 REM calculation of future value(annual payments)
2405 CLS
2410 GOSUB B030
2420 PRINT AT 4,0;"IF AN INITIAL DEPOSIT IS BEING MADE OR THE PLAN HAS GOT A VALUE AT THIS TIME, ENTER AMOUNT;IF NODENTER 0"
2430 INPUT Z
2440 CLS
2445 GOSUB B030
2450 PRINT AT 3,3;"CALCULATION OF FUTURE VALUE"
2460 PRINT AT 4,3;"-----"
2470 PRINT AT 6,1;"ENTER ANNUAL PAYMENT,NUMBER OF"
2480 GOSUB B630
2490 INPUT P
2500 PRINT AT 13,0;"INIT.DEP./VA LUE: I;Z"
2505 PRINT AT 14,0;"PAYMENT I ; I;P;"PER ANN."
2510 GOSUB B680
2520 INPUT I
2530 PRINT AT 16,0;"INTEREST RATE I";"P.CENT P.A"
2535 GOSUB B810
2540 IF X=0 THEN LET V(1)=V
2550 LET V(1)=(INT(((P*(1+I/100)^(1+I/100)**Y)-1)/(I/100))*100+.5)/100)
2560 IF X>0 OR X<12 THEN LET V=(INT(V(1)*((1+I(1)/100)**X)+100+.5)/100)
2570 PRINT AT 18,0;"FUTURE VALUE INCLUDING INITIAL DEPOSIT/CURRENT VALUE=<I>;V+V(2)"
2580 GOTO 9000
2600 REM calculation of period(annual savings)
2605 CLS
2610 GOSUB B030
2620 PRINT AT 3,5;"CALCULATION OF F PERIOD"
2630 PRINT AT 4,5;"-----"
2640 PRINT AT 6,1;"ENTER ANNUAL PAYMENT,INT.RATE"
2650 PRINT AT 7,8;"AND FUTURE VALUE"
2660 PRINT AT 9,0;"(PRESS NEWLINE E AFTER EACH ENTRY)"
2670 INPUT P
2680 PRINT AT 13,0;"PAYMENT I ; I;P;"PER ANN"
2690 INPUT I
2700 PRINT AT 15,0;"INTEREST RATE I ; I;TAB 22;"P.CENT P.A"
2710 INPUT V
2720 PRINT AT 17,0;"FUTURE VALUE I ; I;V

```

```

2730 LET I(1)=(EXP(LN((100+I)/100)/12)-1)*100
2740 LET Y=INT(LN(((1/100)/(1+I/100))*(V/P)+1)/LN((1+I/100)))
2750 LET V(3)=INT((P*(1+I/100)**((1+I/100)**Y)-1)/(I/100)+.5)
2760 LET X=INT(LN((V/V(3))/LN((1+I(1)/100)))+.5)
2765 IF X>11 THEN LET Y=Y+1
2767 IF X>11 THEN GOTO 2750
2770 PRINT AT 19,0;"PERIOD I ; Y;TAB 18;"YEARS--I;X;"MNTHS"
2780 GOTO 9000
2800 REM calculation of interest rates(annual savings)
2805 CLS
2810 GOSUB B030
2815 PRINT AT 3,0;"CALCULATION OF F ANNUAL INT. RATES"
2817 PRINT AT 4,0;"-----"
2820 PRINT AT 6,2;"ENTER FUTURE VALUE,NUMBER OF"
2830 PRINT AT 7,1;"YEARS AND MONTHS,AND PAYMENT"
2840 GOSUB B640
2850 GOSUB B660
2905 INPUT P
2910 PRINT AT 17,0;"ANNUAL PAYMENT I ; I;P"
2912 IF V<=Y*P THEN PRINT AT 19,0;"WHAT KIND OF INVESTMENT IS THIS?"
2913 IF V<=Y*P THEN GOTO 9000
2915 FAST
2920 FOR I=1 TO 50 STEP (2)
2930 LET W=INT((V/(1+I/100))*((1+I/100)/((1+I/100)**Y)-1)+.5)
2935 IF P-W>=200 AND P-W<=150 THEN GOTO 2940
2939 NEXT I
2940 FOR I=ABS(I-2.5) TO (I+2.5) STEP (.5)
2945 LET I(5)=(EXP(LN((100+I)/100)/12)-1)*100
2948 IF X=0 THEN LET W=W
2953 LET W(4)=INT((V/(1+I(5)/100)**X)+.5)
2958 LET V(4)=INT((P*(1+I/100)**((1+I/100)**Y)-1)/(I/100)+.5)
2965 IF N(4)-V(4)>=-3 AND W(4)-V(4)<=1 THEN GOTO 2995
2967 IF W(4)-V(4)>=-20000 AND W(4)-V(4)<=-25 THEN GOTO 2975
2970 NEXT I
2975 FOR I=(-.5) TO (I+.5) STEP (.01)
2977 LET I(6)=(EXP(LN((100+I)/100)/12)-1)*100
2980 IF X=0 THEN LET W=V
2985 LET W(5)=INT((V/(1+I(6)/100)**X)+.5)
2988 LET V(5)=INT((P*(1+I/100)**((1+I/100)**Y)-1)/(I/100)+.5)
2992 IF W(5)-V(5)>=-3 AND W(5)-V(5)<=-.5 THEN GOTO 2995
2993 NEXT I
2995 SLOW
2997 PRINT AT 19,0;"INTEREST RATE I ; I;INT (I*100+.5)/100;TAB 22;"P.CENT P.A"
2999 GOTO 9000
3000 PRINT AT 0,3;"INSTALLMENT SAVINGS-MONTHLY"

```

```

3010 PRINT AT 1,3;"-----"
3020 RETURN
3030 PRINT AT 0,3;"INSTALLMENT SAVINGS-ANNUAL"
3040 PRINT AT 1,3;"-----"
3050 RETURN
3060 PRINT AT 6,8;"CALCULATION OF F;"
3070 PRINT AT 8,3;"1.PAYMENT"
3080 PRINT AT 10,3;"2.FUTURE VALUE"
3090 PRINT AT 12,3;"3.PERIOD"
3100 PRINT AT 14,3;"4.INTEREST RATE"
3105 PRINT AT 16,3;"-----"
3110 PRINT AT 18,3;"5.MAIN MENU"
3120 PRINT AT 20,6;"SELECT OPTION N(1-5)"
3130 IF INKEY#<>="" THEN GOTO B130
3140 IF INKEY#="" THEN GOTO B140
3150 LET P#="INKEY#"
3160 IF P#="5" THEN GOTO 10
3170 IF P#<"1" OR P#>"4" THEN GOTO B130
3180 LET T=VAL P#
3190 GOTO 1000#*5+200#*T
3600 PRINT AT 3,4;"CALCULATION OF F PAYMENTS"
3610 PRINT AT 4,4;"-----"
3620 PRINT AT 6,2;"ENTER FUTURE VALUE,NUMBER OF"
3630 PRINT AT 7,1;"YEARS AND MONTHS,AND INT.RATE"
3640 PRINT AT 9,0;"(PRESS NEWLINE E AFTER EACH ENTRY)",,,"note:ENTER 0 IF YRS=OR MNTHS=0"
3650 RETURN
3660 INPUT V
3670 PRINT AT 13,0;"FUTURE VALUE I ; I;V"
3680 INPUT Y
3690 PRINT AT 15,0;"PERIOD I ; I;Y;"RS-"
3700 INPUT X
3710 PRINT AT 15,23;I;"MONTHS"
3715 LET N=Y*12+X
3720 RETURN
3810 LET N=Y*12+X
3820 LET I(1)=(EXP(LN((100+I)/100)/12)-1)*100
3840 LET V(2)=(INT((I*(1+I(1)/100)**N)+100+.5)/100)
3850 RETURN
9000 PRINT AT 21,0;"(P=COPY;M=MAIN MENU;R=NEW CALC.)"
9010 INPUT Z#
9020 IF Z#="P" THEN COPY
9030 IF Z#="M" THEN GOTO 10
9040 IF Z#="R" THEN CLS
9050 IF Z#="R" THEN GOTO 1000#5
9060 GOTO 9000
9990 REM PERSONAL FINANCIAL PLAN NING (2)
9991 REM
9992 REM (C)BILL JOHNSON 28SEP83

```

MENDING COMPUTERS

First aid kit for your ZX-81

When your computer goes wrong it is often not easy to spot the problem. Donald Maynard gives some advice on how to look for breakdowns and how to cure them when they occur

COMPUTING IS FUN but when the marvellous machine goes wrong, doom, gloom and despondency settle over those members of the family who are computer buffs. In view of the cost of repairs, it is sensible to do everything possible to try first to find the fault. A word of warning, though; if the computer is still under guarantee return it to the place from where it was bought. That

even big ones — to have moved tuning dials.

The best method is to use a different button and turn it from fully anticlockwise to fully clockwise looking for the signal. Have the brightness turned well up and if you have the sound away from minimum, a sudden reduction in noise level as you are tuning indicates that a signal is close. Beware, though — it may be just

Table 1. Test circuit values.

Voltage V	Resistor ohms	Formula for resistor value
5	220	$R = (V - 0.6) \times 50$ Use preferred value above the one calculated.
6	270	
7	330	
8	360	
9	430	
10	470	
11	560	
12	620	

All resistors are $\frac{1}{2}$, $\frac{1}{4}$, or $\frac{1}{8}$ watt.

is because any attempt to open cases or reach the insides of computers under guarantee invalidates that guarantee automatically.

This article is based on the ZX-81 but the same principles apply to most home computers. It is important first to determine that it is the computer at fault and not something else. If, having connected everything as stated in the manual, the television screen does not light even with the brightness turned full up, then suspect the television set — it should be possible to see the white lines known as the raster on the screen even with the computer disconnected.

There are two other possibilities why the computer may be working and yet nothing is on the screen. The television set has to be tuned to the modulator in the computer and it is not unknown for little fingers — or

stray pick-up from a normal BBC or ITV transmission.

One final word on the television set; eliminate the lead between the computer and the television set either by borrowing from someone else or by making another with parts bought from a local electronics shop. Note that the normal TV aerial lead will not suffice because the end which goes into the computer has a phono-plug on it.

Another troublesome area can be the cassette recorder. If the computer runs programs entered from the keyboard but not those loaded from the cassette player, suspect the tape recorder. Very often the socket on the recorder or on the computer is a source of error. Plug and unplug the lead a number of times in rapid succession to remove any small build-up of oxidation. Make sure the cassette



player works completely, including the use of an earphone, before trying to use it with the computer.

Any noise, crackle or hum will make the recorder useless for computer work. Also try replacing the lead between the cassette player and the computer to make sure it is not causing the problem.

Before we leave the cassette player, one word about setting the volume control. Each supplier of software seems to produce software cassettes with different output levels. The volume control, therefore, may need setting at a different point for each type. The optimum level occurs when there are even black-and-white stripes on the screen during loading. If you cannot make them exactly even, make the black stripes slightly wider than the white ones.

If the computer works with the RAM pack removed but not when it is plugged-in, suspect either the connector or the RAM integrated circuits. Clean the connector on the computer using a cotton bud dipped in methylated spirit and rubbed on both sides of the connector. Allow it

Table 2. Fault-finding summary.

1. Ensure the television set is working and tuned to the computer.
2. Ensure the cassette recorder is working and the volume control set to the correct level.
3. Test or replace all the leads.
4. Remove the RAM pack and test the computer on its own.
5. Change the power supply fuse.
6. Test the power supply.
7. Test the keyboard.
8. Open the case of the computer and make a visual examination.
9. Test the 5V regulator 7805.
10. Replace the Sinclair logic IC1.
11. Replace the Z-80A processor, IC3.
12. Replace each RAM IC2 — 2114 or 4118 — IC4.
13. Replace the ROM, IC2 — 2364.
14. Replace the modulator — UM1233; do it first if you have a faint reversed picture.

Figure 1. Test circuit.

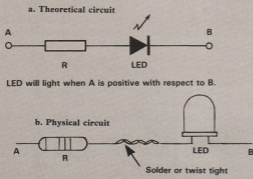

to evaporate before reconnecting the RAM pack. Examine the RAM pack socket for any sign of distortion or misaligned connections.

The integrated circuits in the RAM pack can be replaced by items bought from a local electronics shop or by mail order. Follow the procedure detailed later for the computer integrated circuits.

Power supply

Having eliminated the television set, the tape recorder and the RAM pack, if they are satisfactory you are left with the computer and its power supply if things are still not as they should be. Have patience, banish the rest of the family to another room, and take your time.

Taking the easy one first, if everything is dead the most likely cause is a faulty power supply. Do not overlook the obvious. Start by changing the fuse, making sure it is a 3amp fuse with which you replace it. Using a 13amp fuse is as bad as using a bent nail and big fuses can damage your computer's health.

If that does not bring the computer springing back to life, measure the power supply voltage. If you do not own a meter it is a reasonably easy matter to construct a test circuit. Figure one shows a simple circuit to achieve it. Ideally, the components should be soldered together but if that is beyond your ability make sure that the wires are twisted tightly together. Do not bend the wires near the bodies of the components.

$R1$ can be estimated from the expression $R1 = (V - 0.7) \times 50$. The value you choose for $R1$ should be the nearest preferred value above the value calculated. A quarter-watt size may be used but half-watt resistors are more robust.

Any LED should be satisfactory but, in general, red ones give the best light output. LEDs vary in size and shape. If you can determine when you buy the LED which lead is the anode and which is cathode, connect the anode to the resistor; then, when test-

Figure 2. Testing the power supply.

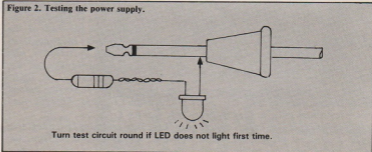

ing, put the resistor towards the positive voltage and the other LED lead to earth. If you cannot determine which is anode and which is cathode you will need to try the circuit both ways when using it to test a voltage.

Having constructed the test circuit we need to use it. Connect one end of the circuit A to the tip of the power supply plug and the other end B to the other plug connection — see figure two. An illuminated LED indicates a satisfactory supply. If the LED does not illuminate, do not panic. Try

turning round the test circuit so that B is on the tip and A on the other connection.

If the LED does not light that time that is the time to panic. There is a fault in the supply. On the other hand, curing power supply faults is often cheaper than curing computer faults. If you are not used to soldering, either seek help — after you have checked that the fuse you put in was a good one — or take the supply to a professional repairer.

Faulty capacitor

Assuming you are doing it yourself, with the power supply disconnected, open it and check that nothing has become loose. Horizontal black-and-white lines on the TV screen are an indication of a faulty capacitor in the power supply.

Some power supplies have a thermal fuse inside. If everything else looks satisfactory, suspect the thermal fuse. It will be the device in series with one of the supply leads, not connected across them, and it will be the only one of its type in the supply. If necessary, take it to an electronics shop for checking.

Many intermittent problems can be caused by the keyboard. Fortunately there are a number of very good keyboard kits available and although at first sight they may seem expensive, the increased speed and reliability they provide make them worth the expense.

If everything checked so far seems to be satisfactory it is time to start on the computer. The first step is to open the case. For the ZX-81 that means getting at the four screws under the stick-on pads on the bottom of the

MENDING COMPUTERS

Figure 3.

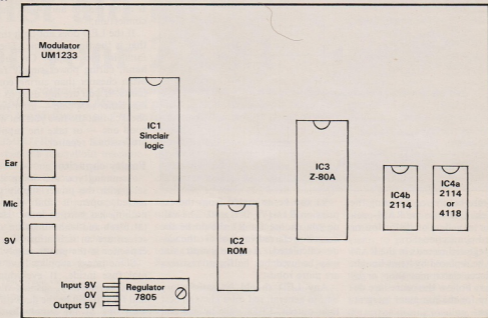

computer. If you cut a cross in the centre of the pads with a sharp knife you can insert a small cross-point screwdriver to unscrew the fixing screws.

Keyboard tails

Also unscrew the screw near the expansion port. Separate the two halves of the computer carefully, making sure that you do not damage the keyboard flexible tails. Do not over-stress those tails, as they can be damaged easily. If you pull them out of the sockets on the printed circuit board accidentally, replace them carefully, although the computer will still produce the initial screen with the K cursor even when disconnected.

Search carefully for any loose pieces of wire or solder which may be causing the problem. If the visual inspection fails to find anything, expenditure probably cannot be avoided.

Figure three shows the layout and component types in the ZX-81. Start with the 5V regulator. That is the three-pin device attached to the flat aluminium heat sink near the power

socket. Make a 5V test circuit using a 220 ohm resistor and a LED. With an assistant holding the top of the computer so that you can see inside, plug in the power supply, then connect the test circuit between the case of the modulator, the big silver-coloured box with the aerial socket on it, and the pin nearest the outside of the board on the regulator — see figure four. Do not forget to reverse the test circuit if the LED does not light when first you try it.

The ZX-81 contains five integrated circuits. It also has a modulator, the regulator and a few other smaller components. Luckily the chances of having a fault in one of the other components is very small. The easiest method of fault-finding is by substitution. It will be necessary to buy the integrated circuits.

Apart from the Sinclair computer logic device and the ROM, the integrated circuits can be bought from a local electronics shop or by mail order. Your computer will have a Z-80A processor and either two type 2114 RAMs or one 4118 RAM — either will do. To buy the ROM or the

Sinclair computer logic IC you will have either to buy them from a specialist computer repairer or a possible alternative is to use devices from another ZX-81 until you find the faulty device.

It is possible to antagonise friends doing that if you are not very careful. If you do not want to buy all the integrated circuits at once, my experience is that the most likely candidate is the Sinclair computer logic IC. It is a semi-custom device sometimes called a ULA or uncommitted logic array.

Take extreme care

When substituting integrated circuits, extreme care must be taken. Take the case where they are in sockets. Use a proper IC extractor. It is possible to ease out the IC gently using a screwdriver at each end but you run a grave risk either of breaking the IC in two or of scratching the circuit board underneath and causing a short circuit or open circuit, which is almost impossible to find and clear.

Even with the proper extractor, take extreme care on 40-pin devices to

Amplified calculations— & music

John Conway uses the Spectrum to assist in deciding on relevant components

FOR ALL electronics-thinking readers, Transistor Biasing could be very useful. It calculates transistor amplifying circuits. When you want to make an amplifier you cannot use any value of resistor or any value of transistor gain; everything must be calculated so that the input signal is amplified as required.

The program occupies all the memory in a 16K Spectrum but you can enter it in three parts — base biasing, collector feedback biasing, and voltage divider biasing with its equivalent circuit.

Those are the three types of biasing used normally for an amplifier circuit. Note the user-defined A represents Ω , the Greek letter omega, meaning ohms — measure of resistance.

If you are entering each part separately, put in line 700 to 900 Omega — and line 650 if you like *Für Elise*. The computer will ask whether you want to find the gain of the transistor; if you enter no it will put a menu on the screen for the three biasing methods chosen.

Then the computer will ask you to Input supply — i.e., Vcc: power supply; Input Rc — i.e., collector resistor; Input gain — i.e., the amplification of the transistor; Input Re — i.e., emitter resistor.

The answer will be then printed—
Ic = . . .
Ve = . . .
R1 = . . .
R2 = . . .
and so on.

After a slight pause the circuit, with its values, is drawn, as shown in figures one to three, with the value Rb, the base resistor, flashing; *Für Elise* is played as background music.

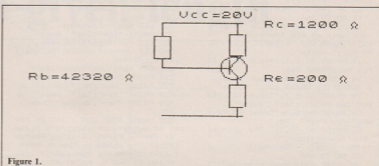

Figure 1.

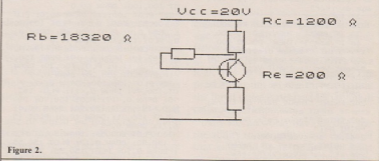

Figure 2.

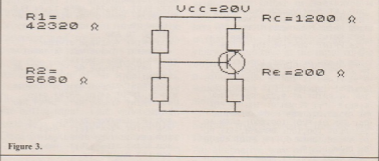
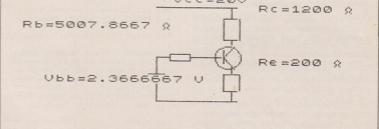

Figure 3.



Equivalent circuit for figure 3.

Generating an accurate pulse of a given length

In the latest part of his series Joe Pritchard considers clock circuits, including the popular 555 integrated circuits and how to use them as counters of various kinds

WE EXAMINED flip-flop circuits in the previous part and soon became aware of the need for circuits to generate electronic pulses to clock the flip-flop circuits. We noted that switches could not do the job because of the phenomenon of contact bounce and we saw how flip-flops could help us circumvent the problem. For truly automatic systems, however, a means of generating pulses electronically is required, so that the pulses used can be as long or as short as required, and so that it is possible to generate strings of pulses — a pulse train — automatically.

This time we look at how we can do that, and also look at some of the many applications for flip-flops in digital electronics. To generate pulses of a given pulse width, we must have a method of generating a time delay to give accurately-timed pulses. To see how we can do that, it is necessary to look briefly at some analogue electronics. A typical circuit for generating a time delay is shown in figure one and uses a capacitor. The device can be treated for our purposes as an

Figure 1.

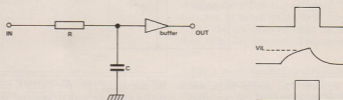

electrical 'jug', with the current being the water. The capacitor stores electrical charge and as it does so the voltage across it increases. As soon as it is the same as the voltage applied to the capacitor, the charging process stops — the jug is full.

The process takes time and it is that time of which we make use in pulse generating circuits. The time for the capacitor to charge to a given voltage is dependent on the value of the capacitor and the amount of charge flowing into it. That latter parameter depends on the current flowing to the capacitor and so in figure one depends on the value of the resistor.

In this circuit, the capacitor will, on application of an input signal, eventually charge to a voltage above the threshold voltage for a logic 1 at the buffer input. That will result in logic 1 at the output of the buffer. Once the input voltage is removed the

capacitor will discharge and the voltage across it will fall, eventually going below that needed to give a logic low at the buffer input. That gives us a logic low at the buffer output. The practical result of the circuit is that the input pulse is delayed by the input resistor and capacitor.

Any RC network, like this one, has the ability to introduce time delays of that kind and lie at the heart of most electronic timing circuits. The simple arrangement shown in figure one is not often used for practical time delays for various reasons. One of them is that during both charge and discharge the voltage at the input of the buffer will, for a certain period, be of a magnitude outside the regions which define TTL 0 and 1 input states.

That can be circumvented by Schmitt trigger circuits but we will soon examine more reliable circuits. An alternative way of using an RC network is shown in figure two, where the RC network shortens the length of the input pulse. The theory behind the operation of the RC network is beyond the scope of this article but it is a useful network to know. The width of the output pulse will either be that of the input pulse or that length in seconds given by multiplying the value in ohms of the resistor by the value of the capacitor in farads. The latter value, by a mathematical trick or two, is always a time

Figure 2.

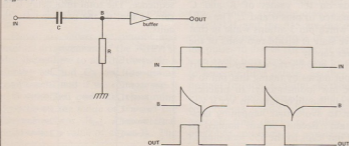
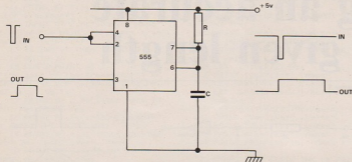

Figure 3.



in seconds. The output pulse width will be the shorter of the two times.

If we look back to an earlier part of the series, it was noted that the passage of a signal through a logic gate took a certain time, called the propagation delay of the gate. That fact, however, is used very rarely to set up a practical time delay circuit as the exact value of the delay varies from gate to gate and it is extremely short.

From figure two it can be seen that we can acquire pulses of a given pulse length via a suitable RC network. That is done rarely in practice, except in very few cases where the exact length of the pulse is not very important. It is much better to use black box units, such as the 74121, which uses an RC network to give pulse widths of accurately-defined lengths.

Integrated circuits, or circuits comprising transistors and other devices which are used to generate pulses or time delays, are called monostables. The name is derived from the fact that they have only one stable state — that is the circuit is in before and after an output pulse is generated. The state of the circuit after an output has been received — while the pulse or time delay is being generated — is short-lived, the length of that state being dependent on the design of the circuit and, for a 74121, the RC network employed.

Another monostable device is the highly-popular 555 integrated circuit. Both the 74121 and the 555 use RC networks for timing and they can both be used directly with TTL devices. I shall concentrate mainly on

the use of the 555. The 74121 is most useful when we wish to generate very short time delays, as the 555 cannot manage very short output pulses or time delays. Figure three shows a 555 configuration to give an output pulse of a given pulse width. I will not deal with the internal construction of the device except where it is necessary to

Figure 4.

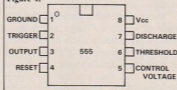

permit the effective use of the device.

Figure four shows the pin-out of the device. The names given to some of the pins of the device may worry you but they need not. Let us look at the role of each pin on the chip. The ground pin is connected to the 0 volts line. Pin 2 is the input of the device; a negative-going pulse there will initiate the generation at pin 3 of an output pulse. The length of that pulse depends on the values of R and C connected to pins 6 and 7. The voltage which pin 3 attains while in that active state is within two volts of the power supply.

Pin 4 enables the user to cut short output pulses by taking that pin to a logic low momentarily. In practice, that pin should be taken to Vcc if you want to avoid that happening accidentally. Because a low applied to that pin leads to the 555 returning to its resting state, the pin is called the

re-set pin. In the pulse generator circuit we have just seen, pin 2 is connected to pin 4. That means that whenever pin 2 is taken low to initiate another pulse at the output, pin 4 is taken low to ensure that the device first assumes its resting state. Thus the duration of the output pulse is always the same.

Pin 5 is interesting; if we apply a voltage to it, we can vary the duration of the output pulse generated without altering the values of the resistor or capacitor involved in the timing network of the circuit. From a practical point of view, pins 6 and 7 are best looked at as the timing pins of the device; we connect a resistor and capacitor to give the desired pulse width at the output. Pin 8 is the connection to Vcc. The 555 is a very versatile device, running satisfactorily from any supply between five and 15 volts.

The width of the output pulse obtained from a given combination of resistor (R) and capacitor (C) is given by the equation:

$$T = 1.1 R \cdot C$$

where R is the resistor value in ohms, C is the capacitor value in farads and T is the pulse width in seconds.

Two important points are that the 555 is not designed to give very short pulse widths and the lowest pulse width obtainable is around 10 microseconds. There is no theoretical upper limit to the pulse width which can be obtained but that is usually limited by the quality of the capacitor used.

An upper limit is usually in the region of a few hundredths of a second. Longer delays can be generated in other ways, such as cascading 555 chips, where the output of one device is used to trigger the next in the sequence. The total time delay is the sum of that of the two separate circuits.

Figure 5.

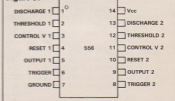
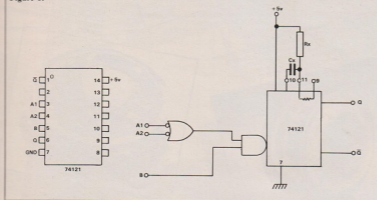

Figure 6.



You might like to consider how to obtain a continuous train of pulses using two 555 devices, connecting the output of the second to the input of the first. A much neater way to obtain longer delays is to use a circuit which counts a given number of pulses and then triggers an output.

We look at counter circuits later. Several chips are available which work on this principle and they give time delays which can be measured in months or even years. Pulse widths of high accuracy can be attained only if we use good-quality resistors and capacitors in the timing part of the circuit. The pulse widths given by a 555 circuit are remarkably unaffected by the supply voltage being fed to the device.

A package is available which provides two 555 timers in one chip. It is a 556 and its pin-out is shown in figure five. The 74121 device is a TTL monostable which can generate pulses much shorter than those obtainable from a 555. It is not particularly good at generating long pulses and so the 555 and the 74121 form a good team, the 121 dealing with the short pulses and the 555 being used for longer ones.

Figure six shows the pin-out and internal arrangement of the 74121. It also shows how to use the device in a circuit. Rx and Cx are the timing components and if we connect pin 9 to 5 volts and omit Rx, the timing depends on the value of Cx and the internal resistor, R_{int}. That internal resistor has a value of about 2k. The

pulse duration at the output is given by the equation:

$$T = 0.694 * Cx * Rx$$

Again, Cx is in farads and Rx in ohms. If we use the internal resistor, then put 2000 in the equation instead of Rx. There are three input pins to the chip, called A1, A2 and B. Should B be at a logic high, an output pulse is generated when A1 OR A2 OR both go to a logic low. If, however, we

the need for using such discrete devices in this area of digital electronics.

A natural extension of the monostable was hinted at earlier — a means of generating a continuous train of pulses. A device to do the task is called an astable, an oscillator or a clock. The latter name is derived from the computing field, where crystal-controlled oscillators generate steady pulse trains at great speed. The function of those pulses is to synchronise the activities of large circuits; they help the machine keep proper time.

For a more detailed description of a crystal oscillator, the reader is directed to a text book on general electronics or radio. The crystal is used in very accurate applications to replace the RC networks we have examined so far. A crystal-controlled clock circuit generating more than three million pulses each second is at the heart of the Spectrum, where it keeps the electronics functioning smoothly.

In the remainder of this article I

Figure 7.

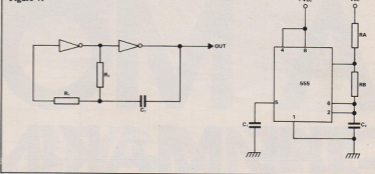

take B low, the device does not care about the states of A1 and A2.

The 74123 integrated circuit has two of those versatile devices in it. The 74121 and the 555 are the most commonly-used methods of generating pulses in digital circuits. It can be seen easily how they can also be used to generate time delays, another important feature of digital electronics. Five years ago transistors and other components would still be used to generate time delays or pulses; the black box approach has now removed

will be looking at clock or astable circuits which use RC networks but the reader should be aware also of crystal-controlled clocks. The frequency of the astable is controlled by the RC network or crystal and there are many circuit configurations which can be used to put together a clock circuit.

Some use transistors, others use gates and, of course, there are chips whose sole role is to be an astable circuit. Figure seven shows two such

continued on page 38



Line Tracer II £17.99
Draw a line and the infra-red sensor picks it up and sends this 3 wheeled, twin motor robot along the course you plot.

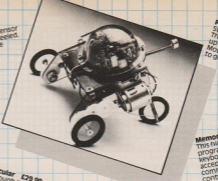

Piper Mouse £18.99
Subsonic sound sensor activated. The condenser microphone picks up the sound to send the Piper Mouse scurrying where you want it to go.



Monkey £9.99
A command from you into the condenser microphone activates the gripper arms and sets the Monkey clamping along its rope.



Circular £29.99
Through its own hand-held remote control you issue instructions to the two independently driven wheels - sending the circular wherever you want it to go.

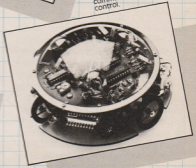

Memocon Crawler £34.99
This highly intelligent Movit is programmed through its own keyboard. Its impressive memory accepts a broad range of commands and gives you complete control.

MASTER A MOVIT -THE MAKING IS O

Are you ready to take on the challenge?
When you open up a MOVIT box, you move into the exciting new world of robots.

Everything from the printed circuit board to the motors are included, just waiting for you to make a start. And the detailed instructions take you through each stage of this new adventure.

To create this new generation of robot models all you need is a screwdriver and a knife.

What's more, MOVITS cost a lot less than you might think. In fact, the price is the only thing about them that's down-to-earth!

MOVITS all have their own characters and appeal. They're fun to put together, fun to run. Take your first step into the world of serious robotics. Send off for your MOVITS today.



ONLY THE BEGINNING

PRISM

MOVITS - THE CHALLENGE CONTINUES

Please send me my MOVIT(S) straight away.
I enclose my cheque for £ _____ payable to Prism Consumer Products
(add £2.95 p&p for one MOVIT and £1.00 extra for each subsequent MOVIT)

Name _____ Address _____

LINE TRACER II @ £17.99 PIPER MOUSE @ £19.99

MEMOCON CRAWLER @ £34.99 MONKEY @ £9.99

CIRCULAR @ £29.99

SP/18/84

Prism Consumer Products Limited
Prism House, 18-29 Mora St.,
London EC1V 8BT
Telephone: 01-253 2277

Enter number of MOVITS required in boxes above.
Allow 28 days for delivery. All prices include VAT.
Batteries not included. Dealer enquiries welcome.
Send your cheque to: **Movit Offer Prism Consumer Products**, Prism
House, 18-29 Mora Street, London EC1V 8BT.

Figure 8.

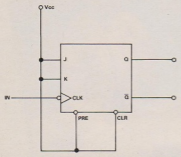

continued from page 35

configurations, one using the 7404 inverter and the other using the 555 chip. Of those, the 555 is the easiest to use.

If high-frequency pulse trains are needed, i.e., those with frequencies of greater than 100,000 pulses per second — 100kHz — the inverter-based circuit, or one of its close relations, can be used.

For any great accuracy from that type of circuit, crystal control will have to be used but back to the 555. The frequency of the waveform generated is given by the equation:

$$f = \frac{1.4}{C_1 (R_A + 2 \cdot R_B)}$$

Notes on the practical design of 555 oscillators will be given in the practical notes at the end of this article. It should be noted that pin 5 of the chip can again be used to vary the frequency of the waveform generated. A CMOS 555-type device is available, the 7555, which has the great advantage over the standard 555 of not requiring much power when it is doing nothing. Having said that, the power consumption of the standard 555 is not very high.

Once we can generate pulses in that

way it soon becomes useful to have ways of counting them. The subject of pulse counting and digital counter circuits will now be explored.

Let us begin by examining the flip-flop circuit is shown in figure eight. It is a T-type flip-flop, synthesised from a master slave flip-flop, and it has some rather interesting capabilities. The frequency of the pulse train applied to the input is halved by the circuit, producing one output pulse for every two input pulses. The truth table for such a configuration is shown in figure nine.

It can be seen that the circuit has two output states, 0 and 1, and the circuit is thus said to have the characteristics of a counter with a modulus

Figure 9.

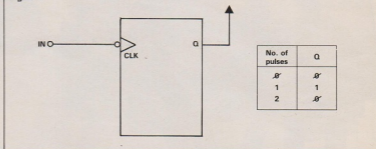

of two. If we add another flip-flop, we have the arrangement shown in figure 10. The counter has a modulus of 4; note how the outputs give a binary representation of the number of pulses applied to the input. Thus effectively we are counting the input pulses.

The second flip-flop toggles when the output of the first flip-flop goes from high to low and so the logic states at various points in the circuit at various times are as shown in figure 11.

It is very easy to extend the cascading of flip-flops to give us, in theory, a counter of any modulus. There are, however, practical difficulties to be overcome with cascading many flip-flops together and we very rarely need to cascade more than 32 or so flip-flops together. Usually, instead of using separate flip-flops, we use chips which are designed specially to be counters. Examination of counters wired from flip-flops shows that a modulus 4 counter has two outputs, a modulus 8 counter has three outputs and a modulus 16 counter four outputs.

We can thus put together a general rule which relates the modulus of a counter and the number of outputs it

will possess. The number of outputs for a counter with a modulus m is given by:

$$m = 2^n$$

As there is one output to each flip-flop, the n is also the number of flip-flops required for the counter.

If we remember the previous article which gave details about master-slave flip-flops, we can see that there are various control signals we can apply to the flip-flops which make up the counters to control how they behave. Look at figure 12. It is a modification of the circuit shown in figure 10, the simple modulus 4 counter. After four pulses, the outputs are both at logic low again.

In this new circuit we can put both outputs to logic low at any point during the counting cycle using the CLR input to each flip-flop. By connecting all the inputs together, a process known as commoning, and taking them low, the outputs of the

Figure 10.

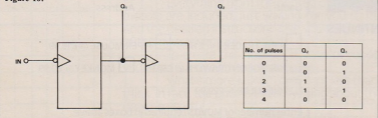

flip-flops are all set to zero. For as long as that line is held low, no counting will occur but as soon as it goes back to a logic high the counting process will start again from 0.

More alterations can be made to the circuit which give even greater control over it; if we take both J and K inputs to a logic low, that particular flip-flop will retain its current output state for as long as the two inputs are held low. If we connect all the J and K lines in the counter we can have a "hold" function on the counter.

Figure 13 shows how that might be accomplished. It is not necessary to take all the J and K lines to a logic low — only those of the first flip-flop

Figure 12.

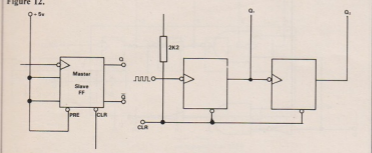

on the chain. Taking the input marked STOP to a logic low will inhibit counting until that line goes high again.

The simple two-stage counters we have examined so far have been configured so that the counting starts at 0 and each pulse at the input increments the binary value shown at the output of the counter. Counters of that type are called UP counters. By altering the wiring to flip-flops, it is possible to produce DOWN counters — circuits which start at the binary value obtained with all the outputs at a logic high and count down towards zero with each pulse.

A modulus 4 down counter will start with a value of decimal 3 represented on its outputs and will count down to zero with each pulse. A circuit for it is shown in figure 14. Note how clear will set all the outputs to zero and so to return to the starting state for down counting an extra

Figure 11.

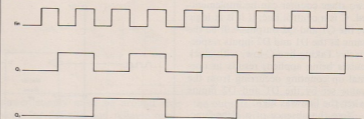

clock pulse would need to be provided.

It is possible to produce counters which can either be up or down counters depending on the state of a control signal applied to the circuit. They are fairly complex circuits and

usually in a given application we will need only one of the two types, up or down, and very rarely both.

Before we look at some real counter chips, a final type of counter to examine is the pre-settable counter. It is a circuit in which we can set up the flip-flops with whatever output states we want and then we can allow the counter to count from there. Those types of counter can also be up or down counters. A fundamental circuit block in the pre-settable counter is a type of latch, shown in figure 15 along with its truth table.

Outputs A and B from the circuit are connected to the pre-set and clear inputs of flip-flops in the counter. One of the latches is needed for each flip-flop in the counter.

Figure 13.

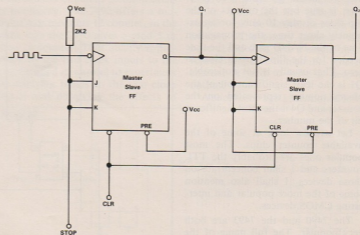

Figure 16 shows how a pre-settable two-stage counter can be implemented. C is a control line; if it is at logic 1, the Q1 and Q2 outputs will be the same as the D1 and D2 inputs respectively. Taking line C low, with clock pulses being applied, results in normal up counting occurring from the value set by the D1 and D2 inputs when the line was high.

Note the absence of a clear function; it is not really needed, as we set both D1 and D2 to logic low and then C high and then low again, placing the data on to the flip-flop outputs.

We have seen how we can have counters made up of chains of flip-flops. They can have any modulus but, so far, the modulus has always been a power of two. So how do we get counter circuits with moduli which are not powers of two? We need to use some combinatorial logic gates to provide control. Figure 17 shows how we can implement a counter with a modulus of 10.

As we work in the decimal system, it is obvious that such counters are popular. When the binary for 10 — 1010 — is displayed at the outputs, the counter is set back to zero by means of the NAND gate, which takes the CLR inputs of the flip-flops low. It would appear from this description that the binary code for 10 is displayed on the outputs, where in fact we should go from 9 to zero. That is true but the outputs of the flip-flops display 10 only for an extremely short time, the propagation time of the NAND gate and the time needed for the flip-flops to clear to zero. That usually is not noticeable. Q1 is the least significant bit of the binary number represented on the counter and Q4 is the most significant bit of the number.

Let us now look at some of the available counter chips. The most popular ones are probably the TTL counters and I shall concentrate on those devices. I shall also mention some of the more popular and interesting CMOS devices.

The 7490 and the 7493 are both very popular. The full name of the 7490 is a BCD up counter. BCD stands for binary coded decimal and

Figure 14.

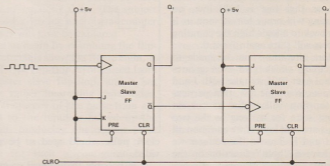

Figure 15.

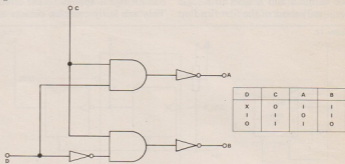
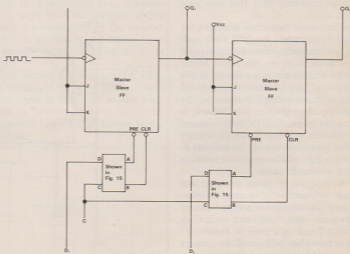

Figure 16.



all that means is that the counter has a modulus of 10. On the tenth pulse, the counter will re-set to zero.

The 7493 is a counter with a modulus of 16. The pin-outs of the two devices are effectively the same, although the 7493 does not possess the control lines of the 7490, as can be seen in figure 18. On the 7490, R3 and R4, if taken high, stop counting occurring, and on both chips R1 and R2 will clear the counter. Note how the flip-flops have two clock inputs, one serving flip-flop one and the other serving the other three.

Figure 19 shows the basic configuration for the 7490 as a BCD counter, as well as how to utilise the 7490 as a

Figure 17.

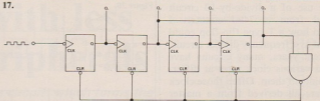

power supply must be around five volts for definite and reliable operation. When testing the circuits, always provide the input pulses from a pulse generator circuit, like the ones we have looked at this time, or from a switch debouncing circuit like that we examined in the last issue. Using a non-debounced switch will give multi-

the outputs. The 74176 is a BCD up counter with pre-set and clear functions. The pin-out is shown in figure 20. It can therefore be considered as a 7490 with pre-set and clear. The 74177 similarly can be seen as a 7493 with pre-set and clear functions and its pin-out is the same as for the 74176.

Figure 21 shows how the counter is controlled by the CLR and LOAD lines. The 74196 and 74197 are versions of those two counters which can operate at higher clock frequencies. Remember if you choose to use LS series counters in any circuits they will be slower than their standard TTL counterparts.

With regard to CMOS counters, two deserve brief mention. The first is the 4020, a 14-stage counter with re-set. The 4024 is a similar seven-stage counter.

An interesting variation on the counters is the 4017. It is a modulus 10 counter, with 10 outputs. Instead of displaying the result of counting in binary, one of the output lines is active. Thus for five pulses the 5 output will be active and the rest inactive. The binary numbers have been decoded to give a single output representing a certain count. Thus the counter is said to have a decoded output.

A short time ago I mentioned brief-

Figure 18.

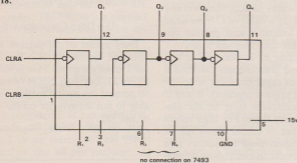

divide-by-10 circuit. Before looking at more counters, I would like to pause for a few practical hints for counter circuits.

Decoupling the power supply lines with capacitors is important, as the rapid operation of the counters can lead to problems with rogue pulses appearing on the power supply lines. Second, when you apply power to a counter circuit, you will not always power-up with the outputs in the zero state.

It is vitally important that one of the first things your circuit does on power-up is to re-set all the counters to the initial state you require. That can be done by a manual re-set switch, or a device like a 555 configured to provide a re-set pulse shortly after turn-on. Those devices also tend to be more power-supply-conscious than the combinatorial devices.

You can do work with NAND gates using 4.5 volts but for counters the

ple input pulses which will provide unreliable results.

There are some other interesting TTL counter circuits I mention briefly in passing. The 7492 offers a modulus 6 or modulus 12 counter, in the same way the 7490 gives a mod 5 or mod 10 counter. That quality is provided by the two clock inputs to the counters and it is useful to experiment by applying pulses to the two clock inputs and observing the effects of

Figure 19.

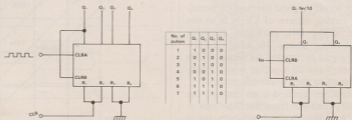

ly the use of a divide-by-10 circuit formed from a 7490 counter. I showed how a T-type flip-flop could be used as a frequency divider circuit. In recent years, many circuits have needed various clock rates at different points in them. Often those clock rates are all derived from a master clock oscillator by dividing the frequency using flip-flops or counters. In the example shown in figure 19, we divided the input frequency by 10 using the 7490.

If we connected the output of it to the input of a similar circuit, the frequency obtained from the output of the second circuit would again be divided by 10, giving a total frequen-

Figure 21.

CLR	LOAD	CLK A B	action
0	X	X	Clear to zero
1	0	X	Transfer data from D to Flip Flops
1	1		Count Upwards

cy division by 100. That cascading of counters and flip-flops makes it possible to generate a wide range of frequencies from a single clock oscillator, such as a crystal oscillator or a 555 astable. Those who are interested might like to make a 555 astable circuit and use it to drive two 7490 counters to obtain frequency outputs of f , $f/10$ and $f/100$. When doing any work with computers, frequency divider circuits are often employed to obtain a clock signal for the add-on circuit from the computer clock signal.

Monitoring of flip-flop and counter circuit outputs is best done using the inverter-LED combination. The main problem you may encounter is the sheer number of LEDs you may want. A good method of avoiding having dozens of LEDs is to use one of the DIL packages available containing about 10 small LEDs. They can be treated as single LEDs but they are all together in one package and so they make life easier.

Another method is to convert the binary read-out from the flip-flops or counters into decimal numbers, using a special decoder chip and a seven-

Figure 20.

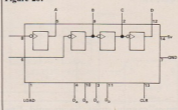

segment display. I will now give a brief introduction to design using the 555 device. It is very versatile, enabling the user to generate pulses and square waves of a wide range of frequencies. To look at the problems of design of monostable circuits, first the pulse width desired must be greater than $10\mu\text{s}$ and preferably less than 100s . The value of R is then worked out by picking a value of C from what you have available and putting the numbers into the equation below.

If the value of R obtained is less than 1k and greater than 1Mohms a new value of capacitor must be selected and the process repeated. R and C in the calculations refer to the diagram in figure three. For high values of capacitors — values above $1\mu\text{F}$ or so — tantalum bead capacitors give superior results to electrolytic capacitors, due to having more accurate values and being better at holding electrical charge.

The duty cycle, which is the ratio of mark to mark and space, must always be greater than 0.5 due to a design peculiarity of the 555. So the procedure is to select a value of C for the

frequency of interest. To do so, use the graph in figure 22. The lines of resistance value represent the resistance given by $R_a + 2R_b$.

We read this value of resistance from the point at which the capacitance value selected from the frequency required intersects the resistance line. The equations which describe 555 operation can then be re-arranged to calculate values for R_a and R_b . These are given without going through the arithmetic involved in rearranging the equations. Once R_b is obtained in that fashion, R_a follows naturally from the fact R is equal to $R_a + 2R_b$:

$$R_b = R * (1 - D)$$

Where $R = (R_a + 2R_b)$ —value from graph

$D =$ Duty Cycle wanted

Duty cycles of 50 percent can be obtained by the use of a flip-flop in the T configuration. That is shown in figure 23. For duty cycles of less than 50 percent the easiest method is probably to put an inverter on the output of the 555.

Figure 23.

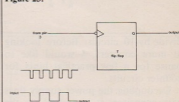
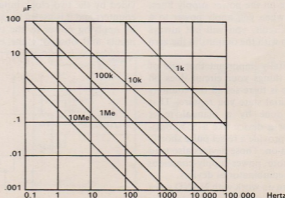

Figure 22.



Interfacing with less expensive peripherals

In his second article on the Motorola circuit, which forms the basis for the QL, John Mellor considers its capabilities when linked to the 6800 family of peripherals, although there are other chips which can provide greater facilities

CONTINUING the series on the 68008, we look at how the processor and hence the QL can be interfaced with the 6800 family of peripherals. A growing number of very powerful chips are being developed specifically for use with the 68000. The 68230 and the 68901 are two examples. The 68230 is a parallel interface/timer which has 24-bit bidirectional I/O and a 24-bit counter/timer. It can perform direct memory access and is, therefore, able to transfer data into memory directly without involving the CPU.

The other chip is called a multi-function peripheral. It has eight I/O lines, each of which can be programmed as an interrupt line. Also contained in the 48-pin package of

the 68901 are four timers, a USART and 24 control and status registers.

So why use a chip which is old technology and which is not able to make full use of the 68008 facilities or power? One reason is that the 6821 is easy to program and use but a more important reason is that the 68000 family of peripherals are 50 to 100 times more expensive. Realising that it takes time to design, market and obtain high yields from complex peripheral chips, the 68000 designers have provided facilities for it to be able to interface with 6800 peripherals.

Two signals on the 68008 processor provide the 6800 interface. They are the enable output signal and the valid peripheral address input signal. They are used to synchronise the transfer

Figure 3.

Word Read Cycle Timing

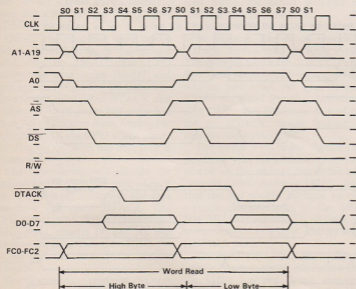

10.1 PIN ASSIGNMENTS 68008

A3	1	48	A2
A4	2	47	A1
A5	3	46	A0
A6	4	45	FC0
A7	5	44	FC1
A8	6	43	FC2
A9	7	42	IPCL0
A10	8	41	IPCL1
A11	9	40	BERR
A12	10	39	VPA
A13	11	38	E
A14	12	37	RESET
VCC	13	36	HALT
A15	14	35	GND
GND	15	34	CLK
A16	16	33	BR
A17	17	32	BG
A18	18	31	DTACK
A19	19	30	R/W
D7	20	29	DS
D6	21	28	AS
D5	22	27	DO
D4	23	26	D1
D3	24	25	D2

Figure 1. Comparison of pin layouts for 68008 and 68000, showing absence of VMA on 68008.

PIN ASSIGNMENT 68000

D4	1	64	D5
D3	2	63	D6
D2	3	62	D7
D1	4	61	D8
D0	5	60	D9
AS	6	59	D10
UDS	7	58	D11
LDS	8	57	D12
R/W	9	56	D13
DTACK	10	55	D14
BG	11	54	D15
BGACK	12	53	GNC
BR	13	52	A23
V _{cc}	14	51	A22
CLK	15	50	A21
GND	16	49	V _{cc}
HALT	17	48	A20
RESET	18	47	A19
VMA	19	46	A18
E	20	45	A17
VPA	21	44	A16
BERR	22	43	A15
IPCL2	23	42	A14
IPCL1	24	41	A13
IPLO	25	40	A12
FC2	26	39	A11
FC1	27	38	A10
FC0	28	37	A9
A1	29	36	A8
A2	30	35	A7
A3	31	34	A6
A4	32	33	A5

Figure 2.

MOTOROLA 68008

of data between the 68008 and 6800 peripherals, because normally the 68008 works in an asynchronous fashion.

We must investigate how the 68008 transfers data. With asynchronous data transfer the CPU does not control the rate of transfer but relies on handshaking with the device, so that the device can transfer the data at its maximum speed. Each device accessed is told when the address is valid by the address strobe \overline{AS} . As soon as valid data has been placed on the data bus by the accessed device it will signal to the CPU by taking the data transfer acknowledge — \overline{DTACK} — line low.

When the processor recognises \overline{DTACK} during a read cycle, data is latched into the CPU and the bus cycle is terminated. In a similar way during a write cycle that input indicates to the CPU that the data transfer is completed. After asserting \overline{AS} the CPU will wait until \overline{DTACK} is recognised so that the speed of data transfer is controlled by the slave device — memory or peripheral.

It is possible that a software fault results in a read or write to an invalid address or that a hardware fault re-

Figure 4.

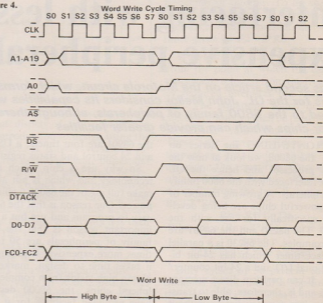

sults in \overline{DTACK} not being asserted. In that case the CPU would wait for ever. To avoid that situation external logic can be added to the 68008 system which will assert \overline{BERR} , or \overline{BERR} and \overline{HALT} to abort or re-run the bus

cycle should no \overline{DTACK} occur after a given time or if the access was invalid.

A simple watchdog timer using a monostable circuit can be arranged to terminate access by asserting \overline{DTACK} and \overline{BERR} simultaneously should

Figure 5.

Byte Read and write cycle timing diagram

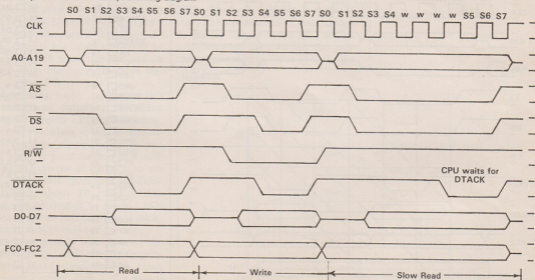

DTACK not occur if, for example, an unpopulated address space is accessed. A great advantage of having those signals is when error-detection circuitry is used, for example a parity checker. Should a parity error occur during a read, taking BERR and HALT low at the same time will cause that cycle — the memory read — to be terminated and re-run.

The fastest bus cycle time possible with the 68008 is four clock periods — 500, 400 and 320nS with the 8, 10 and 12.5MHz devices respectively.

Now we can look at the timing diagrams and the hardware required to interface synchronous devices to the 68008. Figures three and four show how a 16-bit processor copes with an 8-bit bus. As can be seen from figure three the processor performs two successive read operations to read a 16-bit word. A single command or op code cycles the CPU through S0 to S7 to read the high byte and then S0 to S7 again to read the low byte.

The high byte is always stored at an even address — see figure six in the previous issue and, therefore, A0 is low. A1 to A19 will remain the same for both bytes. Figure five shows the byte read and write cycles side by side. All the signals shown originate from the CPU, except D0-D7 and DTACK.

During the read the slave device asserts DTACK after it has placed valid data on D0-D7. The CPU latches the data from D0-D7 and then negates the AS and DS lines. The slave device will release DTACK and disconnect itself from the data bus when AS or DS goes high. During the write cycle it is the CPU which places the data on the data bus and then it asserts DS.

The slave device will decode the address and latch-in the data when it sees DS. Having latched-in the data the slave will assert DTACK. The CPU then knows that a transfer has taken place, negates DS and AS and removes the data from D0-D7. As DS or AS rise, the slave device negates DTACK.

Spend some time studying the next timing diagram — figure six — as it

Figure 6.

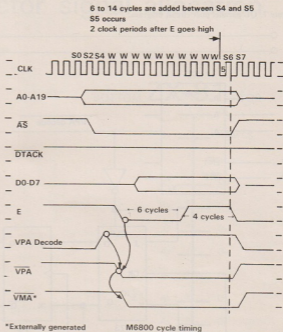

shows how a synchronous transfer is made to take place. The diagrams are the industry-standard way of showing how and when communication takes place in a computer system, so it is well worth the effort involved in learning how to read them.

When the 6821 is addressed, this is what happens. The 68008 processor starts a normal read or write cycle. The external hardware — ICs 1, 2 and 3 in figure seven — recognise the 6821 address and when AS goes low it asserts the Valid Peripheral Address DECODE. The processor is waiting for its DTACK signal; instead it receives the VPA signal.

The 68008 VPA input signals the processor that the address it has just placed on the address bus is the address of a 6800 device — 6821 — and that the bus should conform to the transfer characteristics of the 6800 bus. The 6821 normally is selected by a combination of a valid address with the VMA signal.

The 68000 has a VMA pin — figure one — but because of pin limitations the 68008 has not. Valid memory address is, therefore, generated by the

circuitry of figure seven and that is used to enable the chip select of the 6821.

The VPA DECODE is gated with the Enable (E) signal, which is a slow clock signal with a cycle equal to 10 clock cycles — six low, four high — of the 68008. When VPA DECODE is high and E goes low, the VPA signal is sent to the processor and one clock cycle later the flip-flop IC3 generates the VMA signal. The 6821 will then be selected.

During a read cycle, the processor latches-in the peripheral data during state six. The read will be terminated in state seven. During a write cycle the data bus is put into the high-impedance state until S6. The peripheral logic must remove VPA from the processor within one clock after the address strobe is negated.

DTACK should not go low while VPA is low. If an active low VMA is required, the Q output of IC3 can be used. Full construction details will be given in the next issue. We will also give details of where to buy the edge connectors and the prototyping boards on which to build QL projects.

MOTOROLA 68008

Figure 7. QL parallel port circuit diagram.

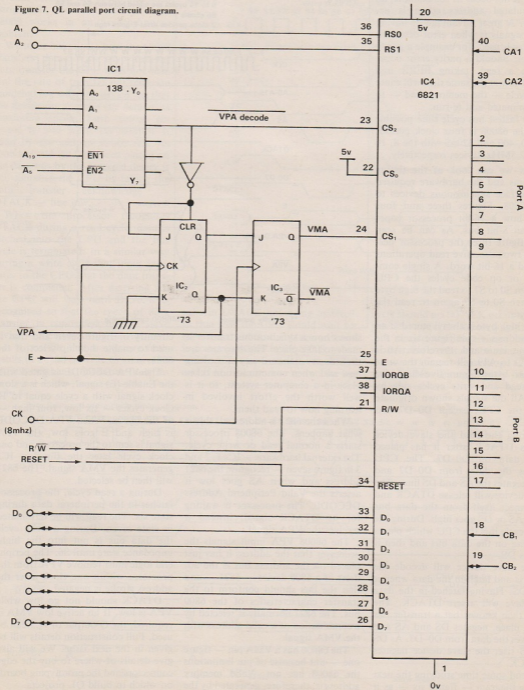

EDGE CONNECTOR

Edge Connector signal allocation

BOTTOM SPECTRUM TOP

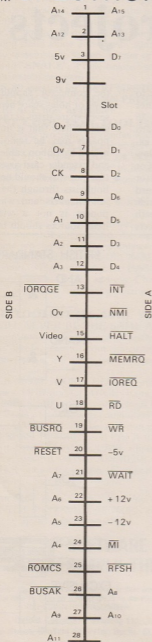

BOTTOM ZX-81 TOP

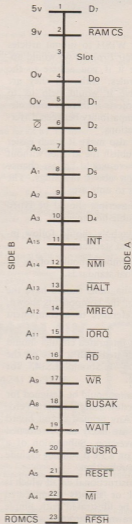

The good author's guide to explaining projects

IF YOU WISH to submit articles to *Sinclair Projects* we would appreciate it if you adhere to the following rules. Although they are not exclusive it would help us to evaluate projects if there is some element of compatibility between different presentations.

It would also make it much easier for us to publish the articles without errors as there would be less chance of confusion about meanings. The main points to note are:

- All manuscripts should be typed with double-line spacing.
- Logic symbols should follow international standards.
- Circuit symbols should follow international standards.
- Circuit diagrams should have the values of the components shown, not a reference to a component table.
- Parts of integrated circuits should be designated with a note on the diagrams—IC5 - 74LS14, for example.
- All circuits should be designed for construction using standard Veroboard. Any printed circuit board designs are likely to be returned for conversion. Submission of a project on a PCB will not exclude future publication.
- Any constructional detail which is unusual or slightly complicated should be illustrated with simple hand-drawn diagrams, showing how it can be implemented.

For those who are familiar with British Standards logic symbols, they are shown here, along with the international symbols.

- Where projects are designed to plug into the rear of the computer they should be built on the 36 strips \times 50 holes size of Veroboard with the board vertical and an extender card at the rear to allow other projects to be stacked. For Spectrum projects the connector should be central on the board with four strips spare at each side and one row of holes spare beneath the connector. For ZX-81 projects

the connector should have two rows of holes spare beneath it with seven spare strips at the right-hand side. Where that is impracticable, boards may be remote and connected by ribbon cable to a socket and extender card assembly.

- Components should be available to hobbyists through the normal retail channels and where a component is not a widely-stocked item, sources should be given.

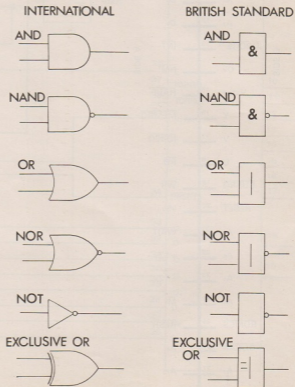

ZX PROGRAMMERS.™

look no further than

Whether you write MACHINE CODE or BASIC we have the very latest "state of the art" programming tools for you, try them and see why our product is widely regarded by professionals as the very best available.

FULL SCREEN EDITOR/ASSEMBLER (16/48K) voted THE MOST POWERFUL MACHINE CODE PROGRAMMING TOOL YET SEEN by HOME COMPUTER WEEKLY

- Editing facilities comparable to the most sophisticated word processor with MOVE, COPY and/or DELETE lines or blocks of code.
 - LOCATE, CHANGE or DELETE specified strings or characters, full Z80 instruction set supported, comprehensive syntax check, powerful expression evaluator, 8 derivatives including stand alone and quash, symbol table display, assembly to screen, printer or save to tape and "SNAKE", a fully notated source code demonstration program.
- (PLUS 80 version for the KEMPSTON CENTRONICS 80 COLUMN PRINTER INTERFACE now available).

MACHINE CODE TEST TOOL (16/48K)

tutor and de-bug program, co-resides with the FULL SCREEN EDITOR/ASSEMBLER in 48K to give a COMPLETE MACHINE CODE DEVELOPMENT ENVIRONMENT that is second to none. The programmer can switch between programs within moments.

- Allows easy entry and testing of machine coded instructions.
- Pages and displays memory registers so you actually see what's happening, displays Main and Alternate register sets. Breakpoints can be Set, Viewed and Nullified. HEX.DECIMAL conversion, STOP and return to BASIC, MOVE a memory block, GOTO address, Character Generator and full supporting documentation and tutorial.

MASTER TOOLKIT (16/48K). YOUR BASIC WILL NEVER BE THE SAME AGAIN!

This program adds a whole range of really powerful commands and facilities for your Spectrum.

- Real time clock and alarm with off on set and print commands.
- BLOCK MOVE, COPY, DELETE and MERGE two lines, FIND and CHANGE character string, RENUMBER, 10 programmable keys (up to 255 chars. each), TRACE with continuous execution display, VARIABLE display and dump, COMPRESS, REMKILL, and PACK to minimise program bytes, CHANGE CASE upper to lower and vice versa, RAMTOP ADDRESS and PRINTER output for vectors, Comprehensive manual and instructions supplied.

Available from selected branches of W H SMITH, BOOTS and MENZIES and other good software stockists.

SOFTWARE ... SIMPLY THE BEST

If you experience any difficulty obtaining your copy of these programs send a cheque or postal order for £9.95 per program (if 19.95 for the PLUS 80 version of FULL SCREEN EDITOR/ASSEMBLER)

Oxford Computer Publishing Ltd.

4 High Street, Chalfont St. Peter, Bucks. SL9 90B 

VELLEMAN

INTERFACE SYSTEM FOR SINCLAIR ZX 81 AND ZX SPECTRUM



Turn your computer into a practical and useful instrument ...

... Velleman introduce their interface system consisting of a specific motherboard for each type of computer, and interface cards that can be plugged onto the motherboards.

The systems for the ZX81 and Spectrum are now available, each motherboard provides space for four interface cards and is supplied with a 23 pole edge connector making it possible to connect the ZX printer or to stack more motherboards.

K2615 Motherboard for ZX 81. Kit form £25.69

K2616 Motherboard for ZX Spectrum. Kit form £25.69

Interface cards now available:

K2609—DC output board with 8 open collector outputs (25 V/50 mA)	£19.01
K2610—A/D converter, 8 bit precision	£28.26
K2611—8 optocoupler inputs	£20.55
K2614—Centronics parallel printer interface	£30.83
K2618—D/A converter, 8 bit precision	£24.66

OTHER NEW KITS IN THE VELLEMAN RANGE

K2601—Stroboscope	£10.79
K2602—4 channel running light with modulator	£20.55
K2604—Kojak Siren	£ 6.94
K2606—LED Audio power meter	£12.48

(all prices inclusive of VAT)

SEND FOR NEW FULL COLOUR SHEET DETAILING COMPLETE RANGE available free from:

VELLEMAN UK. Ltd

P.O. Box 30, St. Leonards-on-Sea,
East Sussex TN37 7NL, England.
Telephone: (0424) 753246



Velleman kits are also available from the following:

- AVON: L.F. Hanney 77 Lower Road, Bath.
BERKS: Lovinger Bros. 76 King's Road, Reading.
BLACKPOOL: Eteson Electronics, 15B Lower Green, Poulton-Le-Fylde.
DEVON: S & R Brewster, Union Street, Plymouth.
ESSEX: R. Jones Electronics, 267 Rectory Road, Grays.
GLASGOW: Marshalls Electronics, 86 West Regent Street.
HERTS: Hemmings Electronics 15 Brand Street, Hitchin.
IRELAND: Baxol Tele Exports, Co. Wicklow.
LIVERPOOL: Progressive Radio, 93 Dale Street.
LONDON: Bradley Marshall, 325 Edgware Road.
MANCHESTER: Spectron Electronics, 7 Oldfield Road, Salford.
NORTHANTS: M.W. Associates, 10 Crown Street, Kettering.
SURREY: D.R. & J.G. Taylor, 24 Beckenshaw Gardens, Woodmansterne.
WILTS: Camlab Electronics, 27 Faringdon Road, Swindon.

Retail enquiries welcome.

FLOPPY DISC SYSTEM FOR SPECTRUM

Our new model — BETA DISK is even better than ever.

Some of the main features:

- * Disc Operating System in EPROM
- * Uses *ONLY* 128 bytes of Spectrum Memory
- * Locates below BASIC programs
- * Uses Spectrum Keywords
- * Supports up to *FOUR* disc drives
- * Compatible with 40, 80, single or double sided drives
- * Up to 400K storage for 80 tracks, double sided drive
- * Random access is provided
- * BASIC programs can be merged
- * Duplicated Spectrum connector is provided
- * Password protected

£85.00 ex VAT
£2.00 p.&p.



Technology Research Limited

Unit 18 Central Trading Estate, Staines, Middlesex.
Tel: Staines (0784) 63547

MAIL ORDER PROTECTION SCHEME

Advertisements in this magazine are required to conform to the British Code of Advertising Practice. In respect of mail order advertisements where money is sought in advance of the despatch of goods the Code requires the advertiser to despatch goods within 28 days, unless a longer period is stated. Where goods are returned to an advertiser, undamaged, within 7 days, the purchaser's money must be refunded, plus the cost of returning the goods. The reader should retain evidence of despatch.

If you order goods from mail order advertisements in this magazine and pay in advance of delivery you will be considered for compensation under the Scheme if the advertiser becomes insolvent or ceases to trade provided that:

(a) you have not received the goods, or a refund in respect of returning same, AND:

(b) you write to the Advertisement Manager of this magazine, stating the facts, not earlier than 28 days from the date of the order and NOT LATER THAN THREE MONTHS from the date on which the advertisement appeared.

THE SCHEME ONLY COVERS ADVANCE PAYMENT SENT IN DIRECT RESPONSE TO AN ADVERTISEMENT IN THIS MAGAZINE. IT DOES NOT COVER:-

- (a) Classified advertising;
- (b) payment made in response to catalogues, brochures, etc. received as a result of responding to such advertisements;
- (c) advertisers offering services as opposed to goods,
- (d) claims where payment is made with Access or Barclaycard and where the cost of the goods is over £30. In this case claims should be made to the Credit Card Company concerned.

Full details of the Scheme are available by sending a stamped and addressed envelope to Mail Order Protection Scheme, Periodical Publishers Association, Imperial House, Kingsway, London WC2B 6UN.

SINCLAIR PROJECTS

Sinclair Projects broadens its horizons

Subscription Form

Mail to: ECC Publications Limited: 196-200 Balls Pond Road, N1 4AQ. Yes — I'd like to subscribe to Sinclair Projects (6 issues — price £6.60 including P&P). I enclose a cheque for £

Please charge my credit card:

Card name Number

Name

Address

Signature Date

NB This offer applies to UK subscribers only. Overseas rates available on request.

More hardware news

In-depth analysis of peripherals

Top interviews

Plus the regular projects and advice to help you get the most from your Sinclair Spectrum or ZX-81

THE COMPLETE SINCLAIR
HARDWARE COMPANION

DO NOT MISS IT

Second Edition
Just Published

THE GOOD
COMPUTING
BOOK FOR
BEGINNERS

PLUS a current technical glossary

If you want to know
about computing . . .

THE FACTS DON'T HAVE TO BE BORING!

An entertaining, but **thorough** reference source with the most readable, comprehensive glossary you'll find anywhere. The Good Computing Book for Beginners is an essential A-Z of all the facts you need to know about computing — and none you don't!

Whether you're brand new to computing, or an old hand keen to stay ahead, you'll score by keeping this classic, top-selling book within reach to use again and again.

The author, Dennis Jarrett, is a successful journalist who was also founder editor of Which Computer? magazine — so his first edition quickly became a standard work. Now this new, substantially enlarged and revised edition covers the latest trends, terms and technology with the relevant facts — and **ONLY** the relevant facts — in **plain English**.

Here's another fact you'll find fascinating: **it will only cost you £2.95!**

Use the coupon below to get your copy right away — or buy it soon from your bookshop. It's the no-nonsense book you'll turn to again and again.

Please send me _____ copy(ies) of The Good Computing Book for Beginners by Dennis Jarrett at £2.95 each plus 50p post and packing. I enclose a cheque for _____ / Please debit my credit card
account Visa/Access/Diners/Amex number _____
Signature _____ Name _____ Address _____
Send to: _____ (please print clearly)
ECC PUBLICATIONS LIMITED
196-200 Balls Pond Road
Islington
London N1 4AQ

3" Disk Drive

for your Spectrum...



...for £199

The Thurnall disk drive is a fully developed professional model, available now. It converts your SPECTRUM into a professional computer with no loss of memory.

- * 150K formatted capacity per disk expanded to 300K with a second drive.
- * Typically less than one second to LOAD/SAVE or ERASE a file.
- * Simple—just plug into your SPECTRUM and you're away.
- * Built in interface includes full DISK BASIC operating system—no computer memory used.
- * High speed random access to files means faster programme development.
- * Latest format 3" disks—fully protected against shocks and dust.
- * Can be used with 16K or 48K SPECTRUM.

The Thurnall drive comes complete with DISK BASIC manual, programmer's reference card, disk with free introductory programmes, power supply (including plug), and all necessary connecting leads.

Telephone sales by Access or Barclaycard only on 061-775-7922

thurnall

Complete and send to :- Thurnall Electronics Ltd Freepost (no stamp required) Cadishead, Manchester, M30 6DX

Please send me :-

Item	Qty	Price*	Total
Disk Drive		£199.00	
Additional 2nd Drive		£189.00	
3" Disks		£4.60	
		Total	

*Price includes VAT, postage and packing.
Delivery within 28 days of receipt of order.

All drives ordered by 30th September 1984 will receive a second free disk worth £4.60.

I enclose a cheque/postal order for £ _____

OR Please debit my
Access/Barclaycard No. _____

Signature _____

Name _____

Address _____

(please print)