

SINCLAIR PROJECTS

THE MAGAZINE FOR THE SERIOUS SINCLAIR USER

**BUMPER CARS—ADD SENSORS
TO YOUR PROWLER**

**BATTERY BACK-UP SYSTEM
AMPLIFY YOUR SOUND
BETTER BEEPING
SPECTRUM CASE
JOYSTICK**



**SIX PROJECTS FOR
SPECTRUM AND ZX-81**

Upgrade your 16K ZX SPECTRUM Now!

The CHEETAH 32K RAMPACK simply plugs into the user port at the rear of your computer and increases the memory instantly to 48K.

- ★ Fully compatible with all accessories via rear edge connector
- ★ No need to open computer and invalidate guarantee
- ★ Why send your computer away and wait weeks for upgrade
- ★ Fully cased tested and guaranteed.

Why wait any longer?

Only £39.95 including VAT and P&P.



Now make your Spectrum and ZX-81 Talk

The Cheetah "SWEET TALKER" just plugs into the back of the computer using the existing power supply. Based on an allophone system you can easily program any word sentence or phrase. Fully cased, tested guaranteed and compatible with all accessories via rear edge connector. Complete with demonstration cassette and full instructions. No more lonely nights! Simply incredible at £29.75 (Please quote when ordering whether Spectrum or ZX81 owner)

16K RAM Pack for ZX-81
64K RAM Pack for ZX-81

£19.75
£44.75

Prices include VAT, postage & packing. Delivery normally 14 days. Export orders at no extra cost. Dealer enquiries welcome.

Send cheque/PO now to:
CHEETAH MARKETING LTD
Dept SPJ
24 Ray Street
London EC1 R3 DJ
Tel: 01-278 6954

32K RAM Pack and "SWEET TALKER" also available from larger Branches of

 John Menzies

 Boots

 WH SMITH

SINCLAIR PROJECTS

9 NEWS

Stephen Adams reviews some of the latest additions.

11 LETTERS

More of your comments about serious uses for Sinclair computers.

12 READERS' TIPS

Where you share some of your ideas with other readers.

14 SHOPPING GUIDE

Your easy-to-find list of suppliers.

14 UPDATE

More information on previous articles.

15 SOUND GENERATOR

Graham Bradley overcomes the problems of our earlier generator and adds some improvements.

19 DIGITAL LOGIC

Joe Pritchard explains some electronics terms and the ways in which they work.

25 SOUND AMPLIFIER

Roger Frost increases the sound levels from the Spectrum.

26 PROWLER

David Buckley adds sensors to the computer-controlled mobile we built in a previous issue.

32 SPECTRUM CASE

John Kenny shows how to build a useful case for your Spectrum.

36 JOYSTICK

Brian Lee writes about how to make a games controller for the Spectrum and ZX-81.

40 BATTERY SUPPORT

Power surges are overcome by David Buckley.

44 AUTHORS' GUIDE

If you wish to write for *Sinclair Projects*, this indicates the way to present your ideas.

45 SOUND EFFECTS

Robert Stafford has produced an elegant method of improving the quality of Spectrum sound.

47 EDGE CONNECTOR

Our regular page showing the connections to the Spectrum and ZX-81.

FROM THE EDITOR

PUTTING SOUND into programs on the Spectrum is featured in three of our articles this month. The range of noises which can be produced is widened by a sophisticated software solution provided by Robert Stafford. Our consultant editor was impressed by the method adopted to achieve the improvement in Spectrum performance.

To overcome the problem of the sound level, Roger Frost found a better method than merely removing the cassette and ear lead from the player and pressing play or record. He describes his system as reckless but effective and considers it a worthwhile improvement to the working of his Spectrum.

We return to the Sound Generator project we described originally in our issue of June/July. Many people found difficulty making it work so we gave it to Graham Bradley. He made some adjustments and it now works on both the Spectrum and ZX-81. The results can also be used in place of the Latch Card built in our first issue as a interface for the Prowler robot of our August/September issue. If you prefer hardware solutions to your sound problems this is the article for you.

We also return to the Prowler, with an enhancement for the earlier basic model. David Buckley has added four sensors made from balsa which allow the mobile to detect obstacles and to take avoiding action. The additions make it similar to other computer-controlled mobiles used in education.

The rest of the projects this month are an improved joystick, a battery-support system and a special case for your Spectrum.

The joystick was built by Brian Lee, who used many old pieces of electrical equipment to make a peripheral which can be used both for the ZX-81 and Spectrum. The total cost is reasonable and has a short stick travel with a positive self-centring effect.

To avoid the annoyance of losing long programs once they have been typed-in because of a power surge, David Buckley has produced a battery-support system. It will allow the Spectrum or ZX-81 to continue working for between 20 minutes and one hour if the worst happens and the power is cut off.

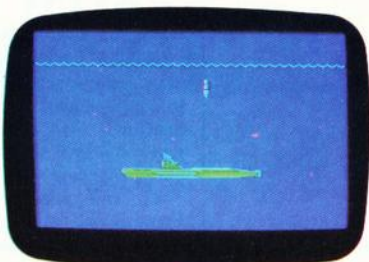
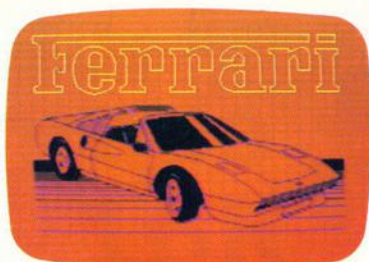
Finally, John Kenny explains how the transporting of the Spectrum complete with its power pack, cassette player and printer and the usual number of wires and connections can be made easier. The result is a neat case which tides all those trailing wires.

Editor Nigel Clark **Consultant editor** David Buckley **Production editor** Harold Mayes MBE **News writer** Stephen Adams **Design** Elaine Bishop **Cover** Stuart Briers **Advertisement manager** John Ross **Advertisement Executive** Annette Burrows **Editorial assistant** Dezi Epaminondu **Managing director** Terry Cartwright **Chairman** Richard Hease.

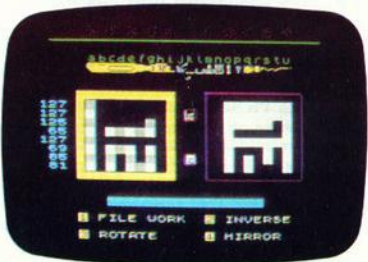
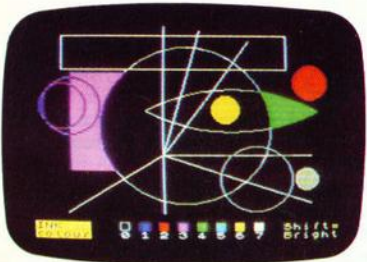
Sinclair Projects is published bi-monthly by ECC Publications Ltd. It is in no way connected with Sinclair Research Ltd.

Telephone, all departments: 01-359 3525. If you would like to contribute to any of the *Sinclair User* group of publications please send programs, articles or ideas for hardware projects to Sinclair User and Projects, ECC Publications, 196-200 Balls Pond Road, London N1 4AQ. We pay £50 per 1,000 words for each article used.

© Copyright 1983 Sinclair Projects. ISSN 0264/0449. Printed and typeset by Cradley Print PLC, Warley, W. Midlands. Distributed by Spotlight Magazine Distribution Ltd, 1 Benwell Road, Holloway, London N7. 01-607 6411.



THE MOST IMAGINATIVE GRAPHICS PROGRAMMING SOFTWARE FOR YOUR SPECTRUM.



There's now one piece of software that's a *must* for every 48K SPECTRUM owner.

It's called "PAINTBOX".

If you wish to exploit the full graphics capability of your machine, you can do so . . . simply and easily with "PAINTBOX".

"PAINTBOX" is produced by Print 'n' Plotter Products — the company that has pioneered (and led) the field of graphics aids for ZX Computers.

With our name and reputation you are assured of quality and immense graphics capability!

Take a look at the actual screen prints opposite. They are the sort of thing you could produce on your SPECTRUM.

With a little practice — and "PAINTBOX" — you could be planning, producing, and utilizing these sort of graphics in your programs — producing software that will come alive with originality!

Just look at some of the facilities available from "PAINTBOX":

UDG EDITOR:

Giving you the facility to define (and re-define) up to 84 graphics characters which can be held in memory, stored in your BASIC programs for instant recall from its own built-in machine code!

UDG DRAWING BOARD:

A fully integrated UDG Planner for up to 4 Banks of user-defined characters. Planning facilities include MIRROR IMAGE, ROTATE, INVERSE, and FILE.

SKETCHPAD:

An experimentation "window" that allows you to try-out your UDG ideas during development of the 84 graphic character set.

PRECISION PLOTTER:

An amazingly versatile high-resolution drawing board which includes PAPER choice, INK choice, PLOT, DRAW, DRAW RADIALLY, CIRCLE, ARC, OVER, FILL, instant change of INK colours (including BRIGHT), ERASE, and STORE in permanent memory during development!

All cursor movements can be controlled by Joystick or Keyboard operations, with choices which include FAST or SLOW movement and "Crosswire" or single Pixel cursor!

SCREEN PLANNER!

Combining the best of both worlds! PRECISION PLOTTER and UDG Characters! For complete screen planning of graphics. A multi-purpose graphics facility to enable you to produce screen graphics that are the equal of those seen in best-selling software!

All graphic results can be sent to the Printer, saved as SCREEN\$ or SAVED as CODE with its built-in machine code routines for instant recall from BASIC.

"PAINTBOX" is such a comprehensive graphics toolkit that it is impossible to describe it all in one advertisement!

The program comes complete with a cassette demonstration of what you could produce with "PAINTBOX" including a 28 page booklet describing in easy-to-understand language how to use it for best results and many tips for storing and using your graphics in BASIC programs.

Of course, "PAINTBOX" is ideally suited for use with Print 'n' Plotter's other great graphics aids.

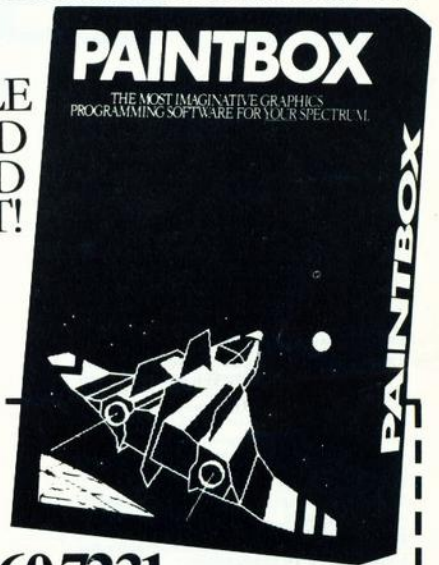
The dedicated programmer will want to use it in conjunction with our ZX SPECTRUM JOTTER PAD — THE ORIGINAL (AND BEST) GRAPHICS PLANNING PAD!

So why not place your order today?

Write now. Phone your Credit Card. Ask at your local computer shop.

At only £7.50 (plus p&p) it's a marvellous investment for all ZX SPECTRUM owners . . . of all ages!

SO SIMPLE
A CHILD
COULD
USE IT!



01-660 7231

24 HOUR CREDIT CARD ORDERING

Post to: Dept SP Print 'n' Plotter Products Ltd., 19 Borough High Street, London SE1 9SE. Please send me:

- "PAINTBOX" SOFTWARE @ £7.50 (+75p p+p total £8.25)
- SPECTRUM JOTTER PADS @ £7.50 (£1.50 p+p total £9)
- SPECTRUM KEYBOARD OVERLAYS @ £2.60 (35p p+p total £2.95)
- 5 ROLLS ZX PRINTER PAPER @ £11.55 (95p p+p total £12.50)
- SELF-ASSEMBLY CONSOLE (SPECTRUM) @ £4.50 (75p p+p total £5.25)

I enclose remittance in full

Please bill my Access/Barclaycard/Visa/Mastercard No: _____

Overseas orders please add 25% for additional surface mail rate.

NAME _____

ADDRESS _____

*Print 'n' Plotter
Products*

DEALERS:

Phone 01-403 6644 for enquiries

AGF

MICRODRIVE

O.K. FOR ALL IS

PROGRAMMABLE JOYSTICK INTERFACE for Spectrum or ZX81



NOW
AVAILABLE
from
SELECTED
RETAILERS

PROGRAMMABLE INTERFACE

The AGF Programmable Joystick Interface is a unique design offering the use of any Atari-compatible joystick with absolutely all software, whether it is cassette or ROM cartridge, with the Sinclair Spectrum or ZX81.

The hardware programmable interface requires no additional software and accurately replicates the keys of the computer in a manner which is responsive to absolutely ALL key reading methods, both BASIC and Machine Code.

The interface does not interfere with key operation and can therefore be used simultaneously with the keyboard.

There is no need to remove the interface once fitted as the rear extension connector will accommodate further expansion, i.e. printers or RAM packs etc. This important feature avoids excessive wear to the expansion port.

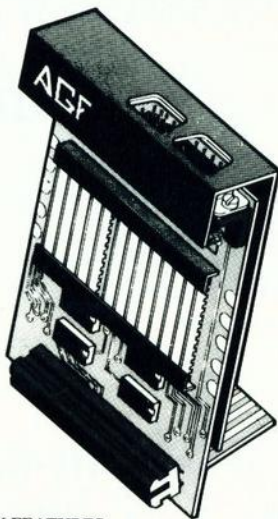
The key replication principle pioneered by AGF means that your own programs can use eight directional joystick movement by utilising simple key reading BASIC.

Two joystick sockets are provided which share the same keys, for use with the majority of two player games. Several interfaces may be used on the same computer for multiple joystick applications.

The interface is programmed by a two digit code, which is looked up on a programming chart supplied, for each direction and firing button. The two numbers are then selected on a pair of leads which are clipped onto appropriately numbered strips on the interface.

Once configured this can be marked on a Quick Reference Programming Card for storing with the game. As the programming is *not* power dependent the interface retains the last configuration made and can be immediately used when next switched on.

PLEASE ALLOW 28 DAYS FOR DELIVERY



KEY FEATURES

- * Programmable design gives TOTAL software support.
- * Accepts Atari, Competition Pro, Wico, Starfighter, Quick Shot, Le Stick etc.
- * Rear extension connector for all other add-ons.
- * Free demo program and instructions.

PACKAGE CONTENTS SUPPLIED

- Programmable Interface Module as illustrated, complete with clip-on programming leads.
- Self adhesive programming chart detailing how to define which key is simulated by UP, DOWN, LEFT, RIGHT, and FIRE. This can be fixed on to the case of your computer or if preferred the protective backing can be left on. The chart is made of a very durable reverse printed plastic and is extremely easy to read.
- One pack of ten Quick Reference Programming Cards for at-a-glance setting to your games requirements. The card allows you to mark the configuration in an easy to read fashion with space to record the software title and company name.
- Video Graffiti demonstration program which is written totally in BASIC to illustrate how all eight directions and fire can be read. This is also a useful high resolution drawing program.
- 12 months guarantee and full written instructions.

JOYSTICKS

CONTROLLERS

FOR USE WITH OUR INTERFACE Module or VIC 20, Commodore 64, Atari VCS, Atari 400, Atari 800

If you require extra Joysticks for our original interface module mark order 'OLD' Joysticks

ONLY £7.54 inc VAT + P&P

ALL ORDERS CONFIRMED

FROM: MR/MRS/MISS			
ADDRESS			
SEND C.W.O. (NO STAMP NEEDED) TO: A.G.F. HARDWARE, DEPT. SU			
FREEPOST, BOGNOR REGIS, WEST SUSSEX, PO22 9BR			
QTY	ITEM	ITEM PRICE	TOTAL
	PROGRAMMABLE INTERFACE	33.95	
	JOYSTICK(S)	7.54	
	PACK(S) QUICK REFERENCE CARDS	1.00	
ONE	VIDEO GRAFFITI	FREE	
ZX81 <input type="checkbox"/> ZX SPECTRUM <input type="checkbox"/>		Please tick	
DEALER ENQUIRIES WELCOME		EXPORT PRICES ON APPLICATION	
		FINAL TOTAL	



JOYSTICK INTERFACE II for Spectrum or ZX81

NEW PRICE

ONLY
~~19.95~~
+£10.00P
15.95

JOYSTICK INTERFACE

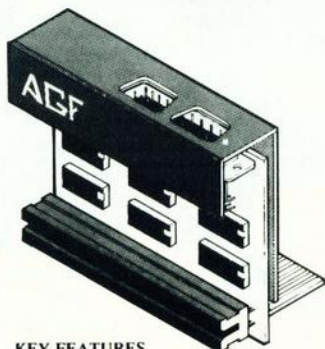
The Interface Module II has been specially designed to plug on to the rear connector of your ZX Spectrum or ZX81 and allow you to connect any standard Atari type digital Joysticks. All of the computer's connections are duplicated on an extension connector so that you can still use any other devices intended for use with your computer.

The Interface Module II resides in the same memory space as the keyboard, which remains fully functional at all times, therefore it will not interfere with anything else connected.

When a suitable joystick is plugged into 'Player 1' socket its action will mimic pressing the cursor keys, up "↑", left "←" and so on. The firing button will simulate key φ. This unique feature guarantees the best software support.

Take a look at the selection of compatible games we have listed. More are being added all the time as a result of our contact with the various software companies.

A second Joystick may be connected in the 'Player 2' position which simulates in a parallel fashion keys T-Y-U-I-P. This will allow you to play a whole new generation of two player games.



KEY FEATURES

- * Proven cursor key simulation for maximum software support
- * Accepts Atari, Competition Pro, Wico, Starfighter, Le Stick, etc Joysticks
- * Second Joystick facility
- * Rear extension connector for all other add-ons

AGF COMPATIBLE SOFTWARE - AVAILABLE NATIONWIDE

The following titles are available from us:

Galactic Jailbreak/ Snake	: Apocalypse Software	£4.95
3D Tanx	: DK Tronics	£4.95
Splat!	: Incentive Software Ltd	£5.50
Phenix	: Megadodo Software	£5.50
Escape	: New Generation Software	£4.95
3D Tunnel	: " "	£5.95
Knot in 3D	: " "	£5.95
Cyber Rats	: Silversoft	£5.95

COMPATIBILITY CASSETTES £4.95

These cassettes have short programs to load before the chosen game which will convert it to use the cursor keys and therefore become compatible with the Interface Module II.

Cassette 1 converts	Cassette 2 converts
Arcadia	Centipede
Schizoids	Planetoids
Hungry Horace	Jet-Pac
Horace Goes Skiing	+ Psst
Spectres	+ 3D Combat Zone
Penetrator	+ Invaders

+ Will require 48K Memory.

FROM: MR/MRS/MISS			
ADDRESS			
SEND C.W.O. (NO STAMP NEEDED) TO: A.G.F. HARDWARE, DEPT. SU			
FREEPOST, BOGNOR REGIS, WEST SUSSEX, PO22 9BR			
QTY	ITEM	ITEM PRICE	TOTAL
	INTERFACE MODULE II	16.95	
	JOYSTICK(S)	7.54	
	SOFTWARE:		
	SOFTWARE:		
ZX81 <input type="checkbox"/>	ZX SPECTRUM <input type="checkbox"/>	Please tick	
FINAL TOTAL			
DEALER ENQUIRIES WELCOME EXPORT PRICES ON APPLICATION			
WHERE TO BUY AGF PRODUCTS OVER THE COUNTER			
Ashby Computer Centre 186 Ashby High Street, Scunthorpe, S. Humberside DN16 2JR Brainwave Microcomputers 24 Crown Street, Ipswich, Suffolk IP1 3LD Buffer Micro Ltd 310 Streatham High Road, London SW16 Chelsea Micros Ltd 14 Jerdan Place, London SW6 1BH Computers of Wigmore Street 87 Wigmore Street, London W1H 9FA Everybodys Hobbies 1 Great Colman Street, Ipswich, Suffolk IP4 2AA	4Mat Computing 67 Friargate, Preston, Lancashire PR1 2AT Gamer 24 Gloucester Road, Brighton BN1 4AQ GB Microland 7 Queens Parade, London Road, Waterlooville, Hants Melgray Hi-Tech Ltd 49 Broad Street, Hereford HR4 9AR Micro Fare 296 Gloucester Road, Horfield, Bristol Raven Video 74 Green Lane, Tettenhall, Wolverhampton Screen Scene 144 St George's Road, Cheltenham Gloucestershire GL50 3EL	Screens 6 Main Avenue, Moor Park, Northwood Middlesex. Syntax Computers 76 Cornwall Street, Plymouth PL1 1NS Teleco Video 53 Maple Road, Penge, London SE20 Telford Electronics & Computing 26a Bradford Street, Shipnal, Shropshire TF11 8AU The Computer Shop Unit 25, Handyside Arcade, Percy Street, Newcastle-upon-Tyne NE1 4PZ The Computer Centre (Humberside) Ltd 26 Anlaby Road, Hull HU1 2PA	

Look what your Computer can do with a **GE** TIME CONTROLLER

AMAZING FEATURES AT A VERY LOW COST
Battery backed up Real Time Clock with month, day, date, hours, minutes and seconds.

Program to control the Clock in on board PROM MEMORY — saves your computers memory.

Only ONE LINE in your BASIC PROGRAM is needed to read or write the date and time. Eight programmable OUTPUT channels (TTL compatible)

Eight programmable INPUT channels (TTL compatible)

EXTENSION for Rampack, Printer etc. included

POSSIBLE APPLICATIONS INCLUDE:

Home Control, Electronic Diary with Alarm, Programmable Timer, Sophisticated Burglar Alarm, Auto Stopwatch, Sound Effects, Time & Date Displays, Light Chaser, Disco Control Console, Auto Telephone Dialer, On/Off Switch Control, Temperature Control, Power Monitoring, Automatic Testing, Robot Control, Electronic Games, Reaction Timer, Effects for Games, Train Controller, Audio Output, Counter, Process Control, Scientific Applications, Lab. Experiments, Time Recorder etc.

Notes on a few of the above applications are included in the manual.

ADD ON MODULES which plug into the Time Controller's INPUT and OUTPUT connectors will be available shortly, and will cover most of the above applications.

AMAZING VALUE

ZX81 TIME CONTROLLER only £34.50,
SPECTRUM TIME CONTROLLER only £38.50. If you can buy a similar product at a lower price, we will match it.

FOR THE ZX81 AND SPECTRUM

BUILT IN PROGRAMME IN PROM MEMORY

EXTENSION FOR RAM PACK ETC.

EIGHT INPUTS

EIGHT OUTPUTS

CLOCK DATE AND TIME

BATTERY BACK UP

OTHER PRODUCTS

PRODUCTS FOR THE APPLE 11/11E COMPUTER*

LOOK AT THESE PRICES

64K 80 COL CARD 11E	Unbeatable value	£129.00
TIME KIT	Clock Calendar with Electronic Diary Software	£59.00
PASCAL ROUTINES.....	For the Time Kit	£16.50
PARALAX CLOCK DISPLAYS	For the Time Kit	£16.50
8 CHANNEL A/D CARD.....	An inexpensive data acquisition system	£88.00
8 CHANNEL INPUT OUTPUT CARD		£59.00

*Also available from PETE & PAM COMPUTERS AND SBD SOFTWARE



Glanmire Electronics

UNITED KINGDOM
Westley House,
Trinity Avenue
Bush Hill Park
Enfield EN1 1PH
Telephone: 01-366 3245 (24 hrs)

IRELAND
Meenane,
Watergrasshill, Co. Cork. Ireland
Telephone: 010-353-21-889209 (24 hrs)
Telex: 75444 CTT

Apple is a Trademark of Apple Computer Inc.

ORDER FORM

PLEASE SEND ME THE FOLLOWING

Info	Qty		Price	Info	Qty		Price
<input type="checkbox"/>	<input type="checkbox"/>	Time Controller ZX81	£34.50	<input type="checkbox"/>	<input type="checkbox"/>	64K, 80 Col. Card	£129.00
<input type="checkbox"/>	<input type="checkbox"/>	Time Controller Spectrum	£38.50	<input type="checkbox"/>	<input type="checkbox"/>	A/D Card	£88.00
<input type="checkbox"/>	<input type="checkbox"/>	Time Kit	£59.00	<input type="checkbox"/>	<input type="checkbox"/>	Pascal for Time Kit	£16.50
<input type="checkbox"/>	<input type="checkbox"/>	8 Channel input output card	£59.00	<input type="checkbox"/>	<input type="checkbox"/>	Paralax Clock Display	£16.50

Add £1.50 p & p, any size order. Do NOT add VAT. Send SAE for information.

I enclose cheque / P.O. / Credit Card for

BLOCK CAPITALS PLEASE

Total of £ _____ sterling and understand I may return this product within seven days if I am not satisfied.

NAME _____

ADDRESS _____

COUNTRY _____



Access / Barclay / Visa No.

TEL _____

DEALER ENQUIRIES WELCOME — GENEROUS QUANTITY DISCOUNTS AVAILABLE



Dual interface which is simple to use

MOREX has produced a Centronics and a proper RS232 interface for the Spectrum. Both are contained in a small black box which plugs into the back of the Spectrum. Only 850 bytes of machine code are required to operate the interface and it is located below the USR-definable graphics section of the 16K or 48K RAM — both versions are supplied on the same tape.

Both interfaces will operate via the LLIST and LPRINT commands once a call to the machine code has been made via the USR command. The RS232 will also allow INKEY\$ from an RS232 device. The code sent can either be all codes from 0 to 255 or they can be sent as TEXT which would normally appear on the screen.

Various speeds can be set on the RS232 to a maximum of 600 baud on a 16K machine — it can be set higher but the manual warns it can be unreliable

— or 4,800 baud on the 48K. The baud rate cannot be split, to work Prestel for instance, at 1,200 one way and 75 the other.

The RS232 has the same handshaking as most professional devices — CTS, RTS and TX, RX data — on a 7-pin DIN socket. No plug is supplied.

The only difficulty was finding some device with which to try it. It will not work with non-standard devices as it requires a negative voltage to register as the LOW condition. With a BBC Micro Model B it worked very well; as the BBC allows the RS232 to act as the keyboard, the whole machine could be controlled from the Spectrum, which should be very useful for schools.

The RS232 is also a both-way device, so PRINT statements and programs can be fed into the Spectrum as well. It is simple to use and very well-documented in the manual supplied, including a list of system

variables for machine code users.

The Centronics interface has a 26-way IDC connector — the same type as the BBC — so there should be no difficulty in obtaining a printer cable. The Morex interface costs £45.95 from Morex Peripherals Ltd. An RS232 lead to a 25 D-plug costs £13.45. It will also work with a version of Tasword 2, the Spectrum word processor.

Interesting amplifier

KELWOOD COMPUTER Cases has produced a powerful amplifier for the Spectrum to amplify games and keyboard beeps. It is contained in a plastic box only $4\frac{1}{2} \times 2\frac{1}{2} \times 1\frac{1}{2}$ in. and contains a one-chip amplifier based on the LM380 chip.

It has a power ON/OFF switch, volume control and loudspeaker built-in and it runs off a single 9V PP3-type battery, included in the price. It should improve most graphics games which have sound and make them more interesting.

A version of the amplifier can also be obtained built into the company's power base module — a metal sloping stand with power ON/OFF and tape LOAD-SAVE switch. It is called the Sound Power Base. It requires no battery as it is driven from the Spectrum power supply.

The Supersound Spectrum costs £7 and the Sound Power Base £19.95 or £17.70 from Kelwood Computer Cases, Downs Row, Moorgate, Rotherham S60 2HD. Tel: 0709-63242.

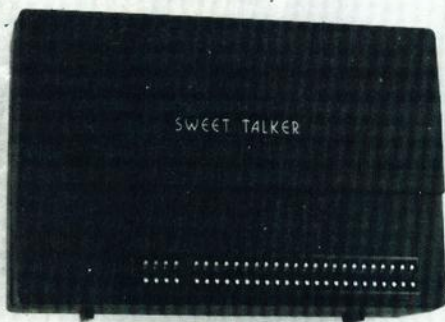
Spectrum pack

A HARD green plastic briefcase which can be used for a Spectrum costs only £3.99 at W H Smith. It is intended for children going to school and is approximately $15 \times 11 \times 3\frac{1}{2}$ in. Although it contains no foam or other fixings to hold down a Spectrum, they can be put in by a user easily. It will hold a tape recorder, Spectrum, power supply, printer, plus a manual and a copy of Sinclair

Projects. The only thing to watch with the cases is the hinges on the front clasps as they are thin and will snap after prolonged use.

They should be strengthened with carpet tape or flexible plastic sheet should be stuck over them.

The cases are available in four colours and are strong as well as cheap. They also make the computer easier to pack and store.



Natural sounds by Cheetah

CHEETAH MARKETING has produced a speech output device called the Sweet Talker. It is complete in a black plastic box the same size as the 32K RAM pack for the Spectrum. The unit contains a very powerful amplifier and the tape with

it not only auto-runs to introduce itself but also shows some very good programming practice.

The instructions are very simple and the unit should not clash with any joysticks or other items, as it uses I/O port address 7. That may

clash with some Sinclair peripherals — the Micro-drive, for instance — as Sinclair tends to use only one bit of an address going low to operate equipment and using port 7 takes all the bits from B7 to B3 low. Cheetah may modify the address.

Programming is done by using phonetic sounds which allow you to produce the sounds necessary to make up a full word. Silences can be included to stop the words or to provide pauses between words — of up to 200ms. The Sweet Talker seems to be about eight to 10 times as slow as others available, which makes it sound more natural. There are ZX-81 and Spectrum versions.

Sweet Talker is available from Cheetah Marketing, 359 The Strand, London WC2. Tel: 01-240 7939. John Menzies and Boots also stock it. The cost is £34.95.

Simple link with world

AMBIT has produced a modem to go with its ZX-81 RS232 interface. The 300 baud modem is acoustic-coupled to the telephone line by pushing the standard telephone handset into two foam blocks containing a microphone and loudspeaker on top of the modem.

That makes the unit usable on a normal telephone and it does not have to be wired-in and does not require British Telecom to provide a special plug. The modem is easy to construct but a few points need to be emphasised which are not in the notes.

One is that the kit does not include a power supply

for +12V/+5V/-12V required to run the modem. You will have to design and build one on Veroboard, as the company does not market a suitable one. The circuit relies on through-the-board connections made by soldering the component wires on both sides of the board, so check them carefully.

No mention was made of how to connect the piezoelectric devices used as loudspeaker and microphone. The microphone has three connections and was found to work correctly only when the outer two were used.

It is recommended that

you also buy the hardware kit, as it makes a portable box as well as containing all the electronics.

Tried with several databases, including the Ambit Rewtel, it worked well.

The ZX-81 interface costs £32.40, the modem £22.94, and the hardware kit for the modem £13.80, plus a flat charge of 60 pence for postage. The interface to the modem is TX data, RX data and Carrier — RS232 standard. You will also need a motherboard of some size with the interface.

Ambit International, 200 North Service Road, Brentwood, Essex CM14 4SG. Tel: 0277-23090.

Aid to better loading

THE ELINCA ZX Tape-loader is a box which contains all the elements to clean doubtful tapes and to ensure perfect SAVEing and LOADing of programs. The black box contains a small meter with which to set the level of the input from the tape recorder, a three-position switch for selecting SAVE and LOAD, and two tape filters.

It also has a red LED to indicate what mode it is in. The LOAD amplifier keeps the signal constant and filters-out noise caused by the tape recorder, as well as sharpening the signal. The SAVE filter is a passive — non-powered — one which eliminates noise from the Spectrum or ZX-81.

The unit has two jack sockets in one side and two leads from the other to plug into the EAR and MIC sockets of the computer. It is not necessary to keep unplugging the leads with the unit on SAVEing and LOADing, as the switch deals with that.

The unit is powered by a PP3 battery which has to be fitted inside the unit by the user — it is not supplied. It works very well and having a meter on it makes it easy to set up. It will not cure all tape problems but generous hints are given in the instructions as to what can be causing non-loading.

The unit is guaranteed for one year and may be returned within seven days for a refund if you are not satisfied with it. The Elinca ZX Tapeloader is sold by Elinca Products Ltd, Lyon Works, Chapel Street, Sheffield, priced at £14.99.

Attempting to get complete simplicity

I FEEL I must write to draw attention to a trend which I see occurring in the projects you publish — that they are not complete projects within themselves.

In the RTTY interface project a terminal unit also had to be built for which no circuit was given. Two references were quoted but many people would not have access to them, so although I wanted to build the project I could not do so. If a circuit had been given, the project would have been complete.

The EPROM programmer was incomplete in that the article gave no details of interfacing the EPROM back into the ZX-81 after blowing. A person who knew how to do it would probably also have the knowledge to build an EPROM programmer anyway.

Your requirement that projects be designed for building on Veroboard is commendable but if the point I have mentioned is not acted on I feel the projects will be of interest to fewer people.

Your magazine is otherwise very good and I enjoy every issue.

**Robert Dawkes,
Christchurch,
New Zealand.**

• *While it is our intention to keep most of the projects simple, in that they can be used on their own, there will be a few special-interest projects which will need extra equipment, as in the*

RTTY project. The extra equipment needed in that project is really beyond the scope of a project for the magazine.

Graphics

THANKS to Tony Noel for the article on a graphics support system. Just two comments. Line 303 was not given as a black space and line 704 should have been eight inverse spaces.

I also found it useful to put fast and slow at lines 1507 and 1575, with after "Copy" in line 1303 an instruction to wait 10.

Thanking you for a great magazine.

**Anton Matthews,
Twickenham,
Middlesex.**

Generator

I WAS very pleased to see a new magazine for ZX users. I started to build the Graphics Generator and I spent several hours studying the text, diagrams and photographs. The text was so clear even I could understand it but the photographs were totally incomprehensible; on both photographs, the connections seemed to be neither here nor there, the pins of the ICs appeared to go down between the rows, and the photographs were inadequately illuminated, so it was very difficult to see the connections in some places.

I tried to build the circuit despite that and it would not work. When the second

issue appeared, with the Veroboard plan view, I tried again to build the circuit and again it did not work. The diagram was labelled PCB layout and in fact is the top view of the Veroboard. The connections shown are not the same as in the photographs in the first issue; all the tracks are not shown, which makes it very difficult to see the alignment with the IC pins.

Even where the tracks are shown the connections are not on them — they are often in the middle of the two. Could you give a neat diagram of the top of the Veroboard showing the tracks and with the connections on the tracks, and the tracks running through the middle of the IC pins?

**Clive Morton (aged 14)
Sheffield.**

• *The sockets used in the Graphics Generator were a little unusual in that the sockets and pins were offset, making it difficult to follow the photographs. Issue 3, page 16 should help you to get the board working.*

Sound

I BOUGHT the June/July copy of *Sinclair Projects* for the Spectrum Sound Generator. I bought most of the components and got under way. I followed the Veroboard diagram very carefully. It was not until mounting the components that I noticed a mistake in the diagram. The breaks be-

tween IC3 and IC5 are in the wrong place.

The mistake cost me an expensive piece of Veroboard. As it was the first project that I decided to build I was very disappointed. Also can you tell me the value of the resistor between pins 1 and 4 of IC1 — AY-3-8910.

**N Brayne,
Banbury,
Oxon.**

• *We apologise for the error. All cuts on the figure six keyboard hole 24 should be moved left one place. Do not discard an expensive piece of Veroboard because of the mistake. Breaks in the track can be bridged with short lengths of wire.*

The value of the resistor between pins 1 and 4 or pins 4, 3, 38 and ground in 1KSL as indicated on the circuit diagram, figure one on page 25. See the update in this issue for a change to the sound board decoding. With that change you will not need IC5 and you need only IC3 if you build the separate clock, so the incorrect track breaks should cause no great difficulty.

Prowler

AFTER READING the fifth issue of *Sinclair Projects*, I was very interested in the Prowler robot, but I have a 48K Spectrum.

Could you please tell me all the necessary changes; also what rating are the motors? Would it work on a 16K Spectrum?

**S Munns,
Northampton.**

• *The cable from the Prowler plugs into a standard 8-bit output port and so will run on any computer. No changes will be necessary in the construction of the Prowler. The*

LETTERS

only change necessary will be in the software. For a 48K Spectrum you will need to use an I/O-mapped port and use OUT instead of POKE. The motors are 1½ to 3V and draw about 300mA from the battery on Prowler.

Drummer

AFTER BEING bought a ZX-81 for my birthday I soon became bored with monotonous, aggressive games. Turning to *Sinclair Projects* for inspiration, I was soon impressed by the professional attitude to projects, marred only by poor circuit diagrams and so I am turning to you to ask how, if it is possible, could I run a drum machine off my ZX-81?

The internal triggering of the unit requires a rising edge voltage pulse of about 7 to 15 volts in amplitude.

Would it be possible to trigger the unit by diode buffering one, or more, of the output channels? Is transistor switching required or complex digital-to-analogue conversion needed. Opto-isolators being too slow for rapid triggering, the drum machine triggering is less than one-tenth of a second.

**A D Judd,
Nuneaton.**

● We hope in the future to have an article on interfacing a computer to a synthesiser which could give you some ideas. In the meantime, try opto-isolators. Most of them work to well

over 100KHz and so will be more than fast enough.

Clock

I READ with interest the article on the Real-time Clock for the Spectrum and am interested in adapting it to the 48K machine. As I am a hardware man, I would appreciate information on the correct program location to use for a 48K Spectrum. Perhaps you could give some pointers.

**D Fowler,
Bognor Regis,
West Sussex.**

● To use the machine code routine with the 48K Spectrum, the following alterations must be made to routine 2:

LINE 10 SHOULD READ: "CLEAR 65267"

LINE 20 SHOULD READ: "FOR a=65268 to 65307"

LINE 60 SHOULD READ: "POKE 65268, etc: POKE 65269, etc"

LINE 80 SHOULD READ: "POKE 65270, etc: POKE 65271, etc"

LINE 100 SHOULD READ: "POKE 65272, etc"

LINE 160 SHOULD READ: "SAVE a\$ CODE 65268,99"

The following bytes should be changed in the data statements: Bytes 4 and 7 should be 254 Bytes 9 and 11 should be 120 Byte 10 should be 237

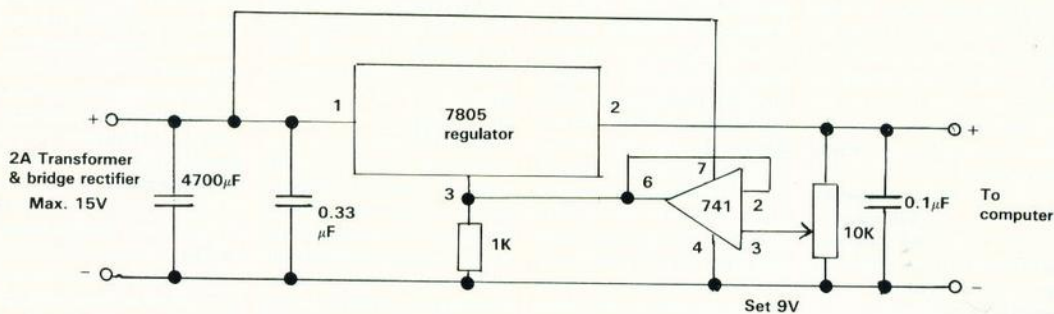
You should then be able to use the project with your 48K Spectrum.

Over-heating crashes can now be prevented

D J EASTON of Taunton has followed the discussion on over-heating of the ZX-81 with interest as he has also suffered system crashes. He has

now found an effective remedy, having constructed a completely-regulated 9V supply and it has prevented over-heating of the computer. While

claiming no originality for the circuit, he can vouch for its efficiency.



Using a 7805 regulator, there is sufficient power to drive a 16K ZX-81 with a printer. The regulator requires a heatsink.

Doubling graphics capabilities

FOR THOSE who have mastered the Graphics Board project there is a very simple way of doubling the graphics ability, discovered by Tony Noel and Mark Paraskeva while at Southampton University.

At present the original Sinclair 1K RAM inside the computer is used to store the codes but it is engaged only from 15872 to 16384, i.e., only 512 bytes are used. As to whether the top ½K or the bottom ½K is used depends on address line A9 being either high

or low, which is controlled by the Z-80. By switching A9 it is possible to have complete control over which half of RAM is engaged, thus giving access to two independent character sets. The construction details are:

For single 4118 1K RAM IC remove RAM IC carefully from its socket; bend pin 2 — address line A9 — of the IC in a similar manner to the remaining pins and replace; connect pin 2 of the RAM IC to the centre terminal of a new toggle switch, S2;

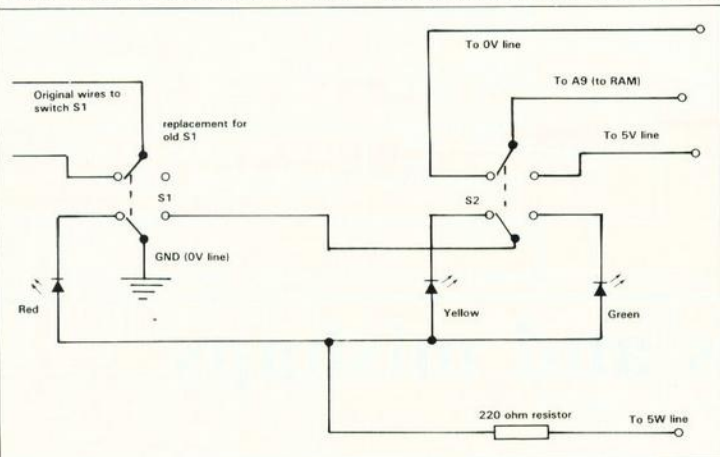
connect one of the other two terminals on the switch to 0V, the other to +5V. For two 2114 ½K RAM ICs remove each IC and bend pin 15 of each IC carefully — address line A9; connect together those two pins by using fine insulated wire as accomplished previously; join one of the pins to the centre terminal of a new toggle switch, S2; proceed as for single 1K RAM. Check for the cursor before re-assembling. If the modification has worked, two slightly-different random patterns will be seen when switching S2 — with S1 open. Switching S2 with S1 closed will have no effect. To write to either section of the 1K RAM, write to 15872–16383 as normal, regardless of the position of S2. To write to the other half, switch S2 and re-write to the same address, i.e., the ZX-81 has been fooled into writing to the opposite half of the RAM because we have intervened.

The switch S2 may be used as an inverse video switch by first poking into memory the character codes as normal, then changing the POKE line to:

POKE (whatever),255—(previous) then switch S2 before running.

On Noel's ZX-81 he found it useful to include three LEDs which serve to tell the mode. They are red, normal; yellow, graphics 1; green, graphics 2.

It is necessary to exchange the two miniature toggle switches for two double-throw toggle switches.

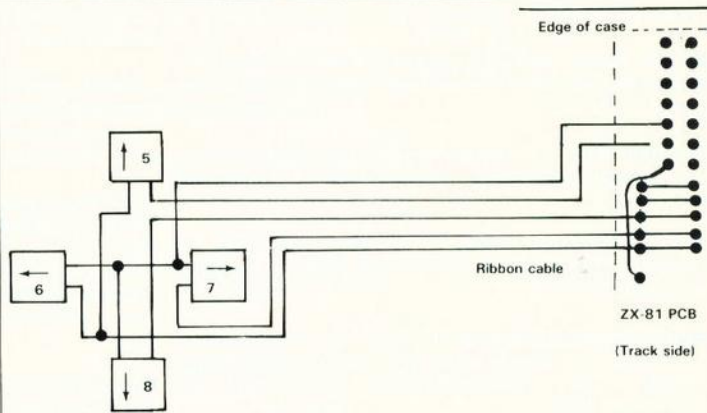


Four-button keypad

ONE OF OUR young readers, 14-year-old Christopher Cook from Anglesey, has discovered this cheap and simple way of producing a four-button keypad which gives similar functions to that of a joystick.

It requires no interface but has one disadvantage — the case of the ZX-81 must be opened to make the five connections.

Readers can take advantage by following the diagrams of the connections to the ZX-81 and the keypad wiring.



SHOPPING LIST

Project buyers' guide

HERE IS a list of suppliers for difficult-to-obtain items which have been used in projects.

PCB mounting 3.5mm. jack sockets as used in the Central Heating Controller project.

MS Components Ltd

Edge connectors 23-way for ZX-81 and 28-way for Spectrum.

Innovonics

Extender cards for fitting to rear of edge connector to allow stacking add-ons.

23-way for ZX-81 — ZXTONGUE
28-way for Spectrum — SPECTONGUE
Innovonics

Weather Station anemometer
Ribbon cable
DIL headers

Innovonics

AY-3-8910 Sound Chip
Cricklewood Electronics
Watford Electronics

Bimboxes, microswitches and push switch for Joystick project.

Shudehill Supply Co Ltd

Ten-core cable for the Joystick project. Cricklewood Electronics has 12-core at 80 pence plus VAT and p&p per metre (minimum).

Cricklewood Electronics

MS Components Ltd, Zephyr House, Waring Street, West Norwood, London SE27. Tel: 01-670 4466.

Ambit International, 200 North Service Road, Brentwood, Essex. Tel: 0277-230909.

Watford Electronics, 33-34 Cardiff Road, Watford, Herts. Tel: 0923-40588.

Innovonics, 147 Upland Road, East Dulwich, London SE22.

Cricklewood Electronics Ltd, 40 Cricklewood Broadway, London NW2 3ET. Tel: 01-452 0161.

Shudehill Supply Co Ltd, 53 Shudehill, Manchester M4 4AW.

UPDATE

Errors and mishaps

August/September. **Graphics toolkit**, last paragraph, "press 6" should be "press L."

Burglar alarm, page 31, column 3, line 1. "until you execute OUT 65503,0" should read "until you turn off the supply to the bell".

Real-time clock. C3 should be 16 μ F 16V. Last sentence, "... memory address ... should read ... port address ...

Issue 1. **Christmas lights**. C1 is 100 μ F 16V. Page 12, column 1, last paragraph should read "twist ... together until tight, you."

Battery-backed RAM, page 20, figure six, the connection to position 50,1 should be to 50,2; page 18, figure four, column 1 "OE ... data output lock" should read "... data output latch".

Weather station page 29, figure eight. The circle with a cross in it and marked 6V 50ma should also have been labelled "bulb".

Joystick, page 33, figure three. R6 is either the upper or lower circle but not both; page 30, figure four, 74LS365. The buffer connected to pins 11 and 12 should be connected to the enable line like the others.

Waveforms page 34, column 3, paragraph 2, last line should be "above" not "following". Figure one should be figure two; page 35, figure two should be figure three and figure three should be figure one. Page 36 should be labelled "figure one continued". Drawing of D-type flip-flop — the lower Q should be Q; similarly for the JK flip-flop.

Burglar alarm, page 40, figure two should be figure three. The RD by connector 10 should be WR.

Problems on earlier sound board now overcome

The clock signal on Series One Spectrums may be too weak to drive the original project. Graham Bradley has made modifications which allow it to be used with the ZX-81 and Spectrum.

SOME READERS have had difficulty making the Spectrum Sound Generator project of the June/July issue work. The reason is that the clock signal on Series One Spectrums is very weak and may not be sufficient to drive the sound generator chip. So we have modified the address decoding to use fewer gates and used the spare ones to build a clock oscillator. The modified decoding circuit uses only four gates.

If you are just starting the sound generator board we recommend that

Test program produces note of desired pitch and duration

```

3 INPUT "pitch (0-15)" :a
4 INPUT "duration" :b
5 OUT 111,1: OUT 127,a
10 OUT 111,0: OUT 127,1a
20 OUT 111,7: OUT 127,5a
30 OUT 111,3: OUT 127,1a
40 OUT 111,12: OUT 127,1a
50 OUT 111,13: OUT 127,b
60 GO TO 3

```

you build it so that the board stands vertically; by adding a ZXtongue or Spectongue you can use it with other add-ons. If you use the shorter ZX-81 connector you can use the board with both the ZX-81 and the Spectrum, because the modified decoding scheme only uses A7 and A4, which are in the same connector position on both machines.

The modified sound board gives access to the two bi-directional 8-bit ports of the AY-3-8910 which can be used with the projects Prowler or

```

Chimes
3 FOR i=1 TO 15
4 LET a=i: LET b=10*i
5 OUT 111,1: OUT 127,a
10 OUT 111,0: OUT 127,1a
20 OUT 111,7: OUT 127,5a
30 OUT 111,3: OUT 127,1a
40 OUT 111,12: OUT 127,1a
50 OUT 111,13: OUT 127,b
60 PAUSE 50
70 NEXT i
80 GO TO 3

```

Weather Station. The connections to the two ports are the same as the modified Latch Card socket in the Prowler project of the August/September issue.

If you wish to drive much ad-

ditional circuitry from the sockets, to avoid overloading the computer 5V regulator a separate 5V regulator should be mounted on the sound board and used to supply the 5V for the two port sockets. Alternatively

Figure 1.

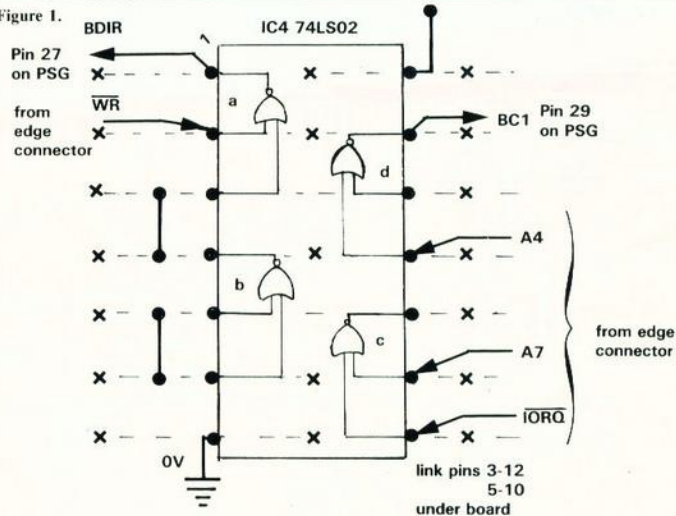
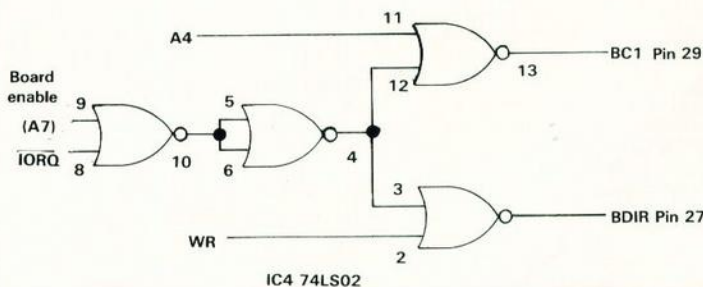
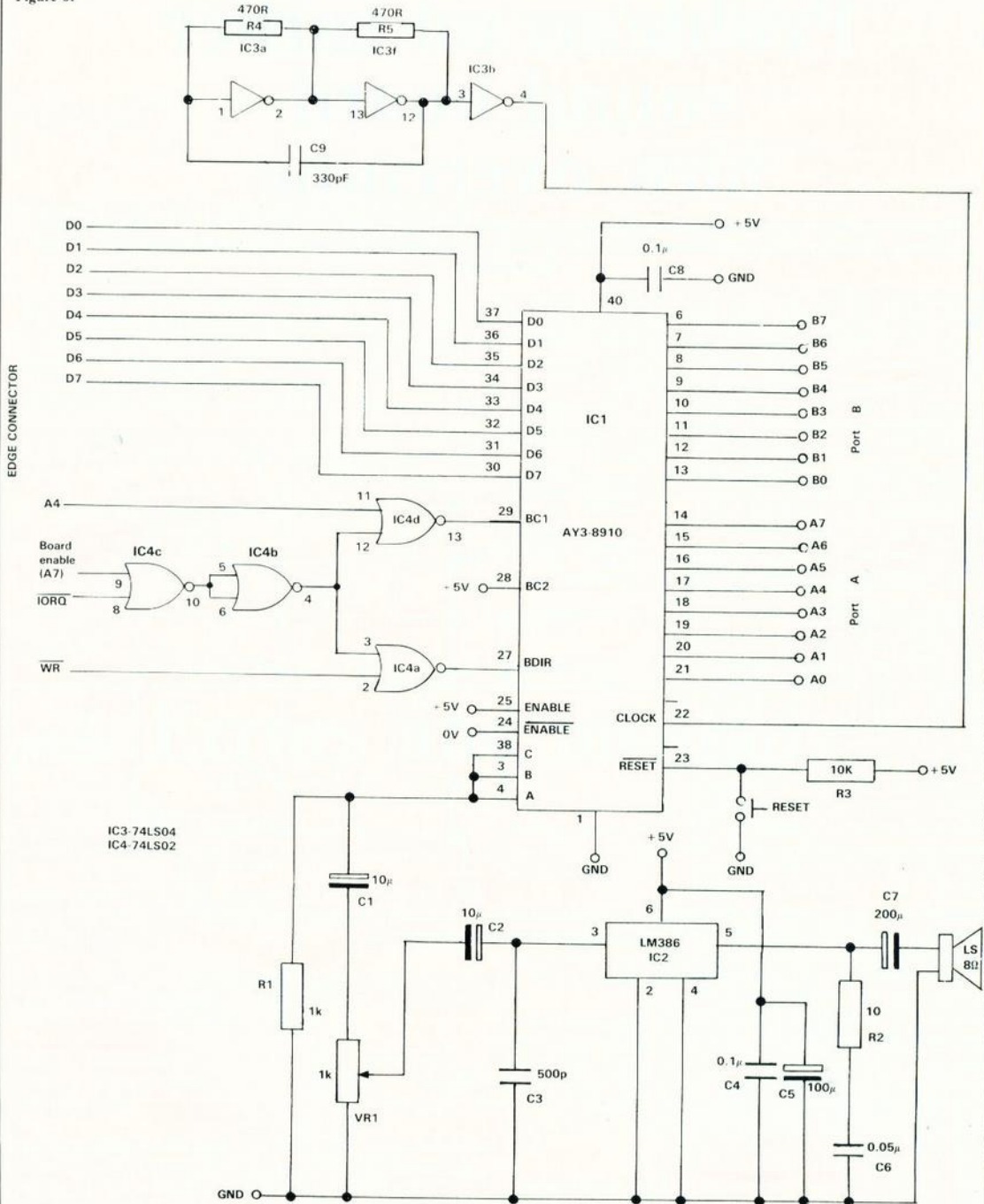


Figure 2. New recording circuit using IC4.

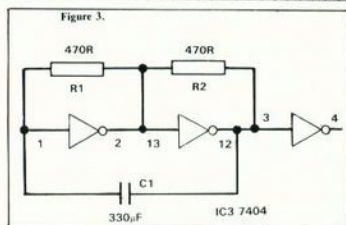


SOUND GENERATOR

Figure 6.



SOUND GENERATOR



the regulator could be built alongside the external circuitry and powered from the 9V lines from the port sockets.

With the re-arranged decoding, address 111 enables the address latch input by causing BDIR and BC1 to go high. OUT 111, *n* selects register *n*. That will then be followed by the command OUT 127, a which will load register *n* with the value *a*. Address line A7 can be replaced with A6 or A5 to change the address location for use with other add-ons, or it could be decoded further as described in the article Address Decoding — April to July issues. The new decoding circuit is shown in figure two. It is built around the existing IC4 which is a quad NOR gate.

Table 1. Output addresses.

Decimal Binary	A ₇	A ₆	A ₅	A ₄	A ₃	A ₂	A ₁	A ₀	BDIR	BC1
111	0	1	1	0	1	1	1	1	1	1
127	0	1	1	1	1	1	1	1	1	0

Figure one shows where the connections are made to the chip on the Veroboard. The oscillator circuit is built around three inverter gates on the existing 7404 IC. Changing the value of C1 will affect the frequency of oscillation and thus can be used to tune the pitch of the PSG output.

To change the existing circuitry on your board, take all the ICs out of their sockets, then take off all the wires going to the sockets for IC3 and IC4, except those wires going to pins

Program 3.

Test program to produce gunshot.

```

10 OUT 111, 6: OUT 127,31
20 OUT 111, 7: OUT 127,7
30 OUT 111, 8: OUT 127,16
40 OUT 111, 9: OUT 127,16
50 OUT 111, 10: OUT 127,16
60 OUT 111, 12: OUT 127,20
70 OUT 111, 13: OUT 127,0
    
```

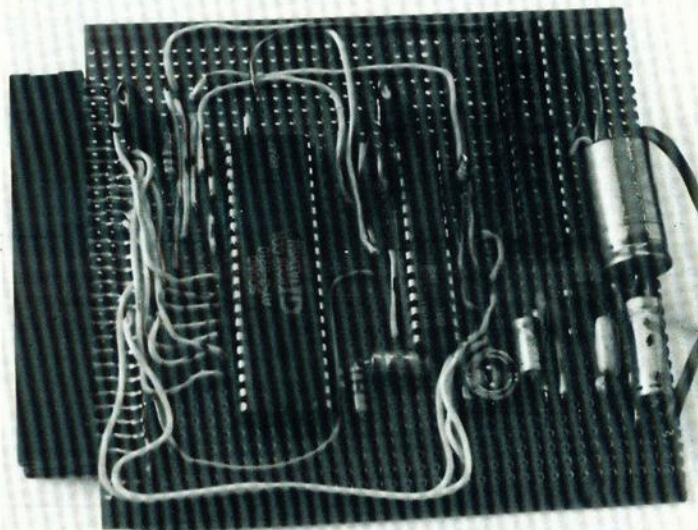
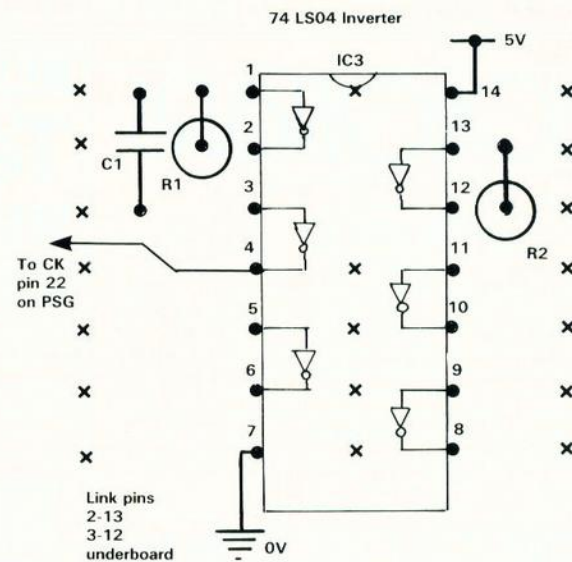


Figure 4. Verob layout of IC3 oscillator circuit.



7 and 14 of the sockets. They are the supply lines and will be needed for the new circuitry. Then re-wire the sockets according to figures one and four.

Then if you wish you can fit the sockets for the AY-38910 ports by

first removing the socket for IC5, the 74LS08 which is not needed, and then fitting and wiring the sockets according to figure five.

Leave at least one track between them so you will be able to insert

SOUND GENERATOR

header plugs in each socket without them fouling each other. Use pieces of insulated wire to make links under the Veroboard directly to the pins of the AY-3-8910 IC and to the 5V, 9V and 0V lines.

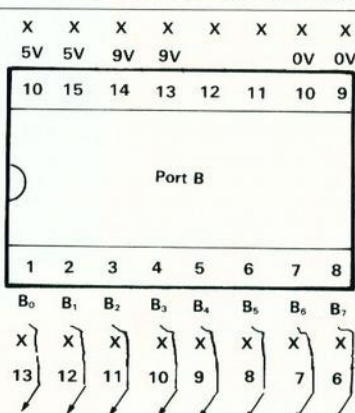
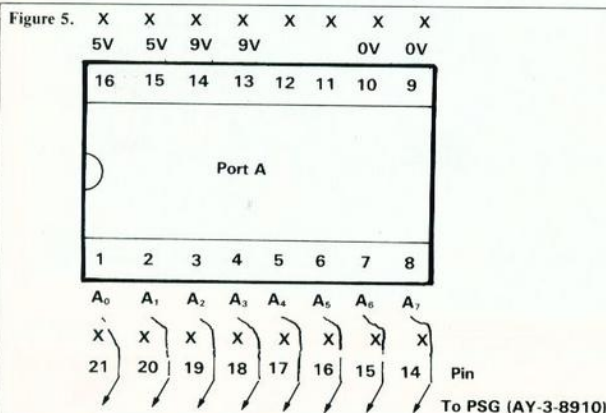
If you had difficulty inserting the two ICs IC3 and IC4 because of their close proximity it is possible to file a little from the end of an IC without

damaging it to ease insertion. Figure five shows the pin configuration for 16-pin header plugs used with all *Sinclair Projects* I/O ports. That will ensure that a peripheral designed to work with the Latch Card — e.g., Prowler stage one — can be plugged directly into the sound generator or any future I/O circuit.

If you do not have the June/July

issue of *Sinclair Projects* and wish to build the sound generator, a full circuit diagram and Veroboard layout incorporating all the enhancements indicated will appear in the next issue.

It will be fully-compatible with the ZX-81 and is built to the now standard *Sinclair Projects* style allowing it to be used with other add-on cards through the PCB tongue.



CYBORGWARS

NOT ANOTHER TOY

BUT A COMPLEX SIMULATION OF FOUR MILITARY-INDUSTRIAL ECONOMIES LOCKED IN A DEADLY STRUGGLE FOR SURVIVAL. ONE TO FOUR PLAYERS COMPETE WITH EACH OTHER AND/OR THE COMPUTER. BALANCE OF POWER DEPENDS UPON SKILL IN DEVELOPING RESOURCES, USE OF ESPIONAGE, EXPLOITATION OF ALLIANCES, AND UTILIZATION OF MILITARY POTENTIAL. REQUIRES ZX81 OR TS1000 WITH 16K RAM. ALSO AVAILABLE FOR THE TRS-80 MODS I & III.

ORDER FORM FOR CYBORGWARS

Send \$15 (U.S.) Int'l M.O. to: STRATAGEM CYBERNETICS, INC.,
286 Corbin Place, 2E, Brooklyn, New York 11235.

NAME _____
ADDRESS _____
STATE _____ CITY _____ ZIP _____



HEARING IS BELIEVING Tele Sound SPECTRUM BEEP BOOSTER

TELESOUND is ready built and tested so that you can get the full sound of your Spectrum through any unmodified television set, black and white or colour. The unit is easy to fit in minutes without any previous experience as full fitting instructions are provided.

TELESOUND has been designed using the very latest ultra miniature components so it's size is an incredible 2 x 1.3 x 1mm. and fits neatly inside the Spectrum. Three easy push-on connections are made to the Spectrum. The connections are clearly shown in a diagram that comes with full fitting instructions.

TELESOUND FEATURES

- SOUND AND VISION TOGETHER FOR ADDED REALISM
- BEEP VOLUME CONTROLLABLE FROM A WHISPER TO A ROAR
- KEYBOARD CLICK CLEARLY HEARD TO ASSIST PROGRAM ENTRY
- PROGRAMS CAN BE HEARD WHEN BEING LOADED • NO SOLDERING OR CASE CUTTING REQUIRED
- ADDITIONAL AMPLIFIER NOT NECESSARY • SEPARATE POWER SUPPLY NOT REQUIRED
- USES NO MEMORY SO WORKS WITH ALL PROGRAMS • COMPATIBLE WITH ALL OTHER ADD-ONS INCLUDING MICRODRIVE

TELESOUND comes complete with easy to follow fitting instructions and costs £9.95 inclusive of post, packing etc. Please state your computer when ordering.

COMPUSOUND



C T A



DEPT: SP12/1 32 - 33 LANGLEY CLOSE, REDDITCH, WORCESTERSHIRE.
B98 0ET. TELEPHONE: (0527) 21429 (21439 Answerphone)

Getting switched-on to the capabilities of electronics

Most projects involve the use of electronic components. Joe Pritchard explains some of the ways in which they work and terms which are commonly used.

OF WHAT use is a knowledge of digital electronics to the computer enthusiast? Well, using electronics circuits made up of components called logic devices, we can connect, or interface, the computer to other electronics circuits which enable us to monitor the outside world and to control it. It will also enable us to add more facilities to the computer. I hope to give the enthusiast sufficient knowledge to utilise digital electronics.

In the world of digital electronics, there are two states in which an output or input to a device can be found. They are on or off, also known as 1 or 0, or high or low. That two-state logic of true and false is all your computer knows and all of its programs depend ultimately on thousands of those decisions.

Logic devices do not have to be silicon chips. We can make logic circuits of switches, electromagnetic relays or valves. As demonstrations of two simple logic functions, look at the two switch circuits in figures one and two.

Figure one and its accompanying table show the behaviour of a logic function called an AND function. The small table, which shows the output of the logic system for combinations of inputs, is called a truth

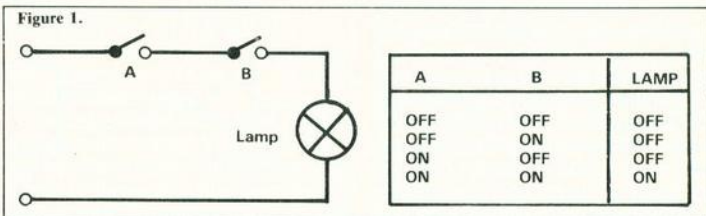
table. As we can see from it, the output is active only when input A and input B are both true, hence the name AND gate. Figure two shows an OR function, in which a true output is obtained if either A OR B is true.

Those are simple examples of logic circuits which we can define as an electrical or electronic circuit which performs a logical function — AND and OR in these cases — on one or more inputs to the logic circuit. Computers, however, are not very good at pressing buttons, as they would need to in those systems, and so we must

use electronic logic chips, known officially as integrated circuits, to perform the logic functions. Semiconductors logic devices fall into distinct families. Although we shall deal mainly with one family group, called TTL, I will also describe briefly the other major family. The families are formed of circuits exhibiting different fabrication techniques. What that means is that different families of devices are made by the manufacturer in various ways. Although the methods of integrated circuit manufacture do not really concern us, the way in which a circuit behaves electrically will to some extent depend on how it was made. So let us look at the two major groups you will encounter.

The TTL family is probably the most commonly used. These devices can be recognised by their part numbers. TTL devices all have the numbers 74 at the start of the part number and at least two more numbers and possibly a letter or two in the rest of the part number.

The following are all TTL devices

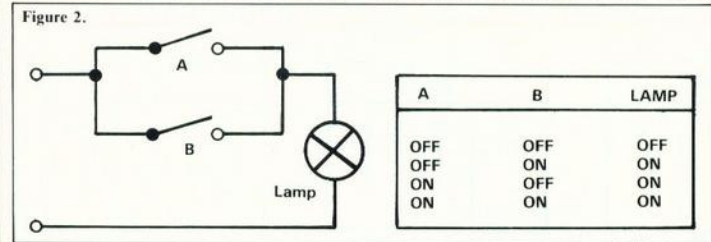


use electronic logic chips, known officially as integrated circuits, to perform the logic functions.

Semiconductor logic devices fall into distinct families. Although we shall deal mainly with one family group, called TTL, I will also describe briefly the other major family. The families are formed of circuits exhibiting different fabrication techniques.

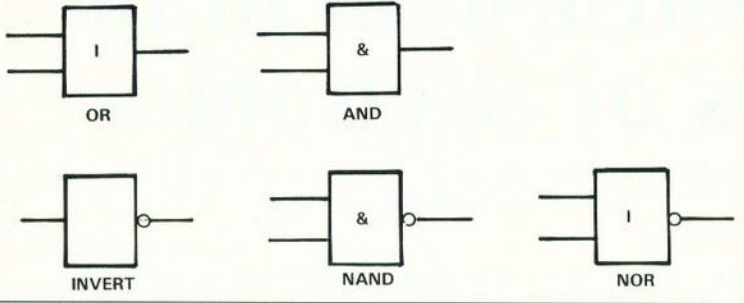
of one kind or another — SN7400, 7402, 74LS04. In the family of TTL devices there are many branches, of which two are of importance to us. They are the standard TTL devices designated by 74xx and the so-called low-power Schottky devices, designated 74LSxx. The 7400 and the 74LS00 perform exactly the same functions but the 74 series devices use more power than the LS devices.

The LS series devices are used where power consumption is important and they are also used to connect logic devices to computers. The reason they are used at the computer interface will be described later in the series. Sometimes you may meet ICs marked with a 54 instead of a 74; they are military-specification versions of the 74 range and will work with a



DIGITAL LOGIC

Figure 3.



wider range of temperature and voltage.

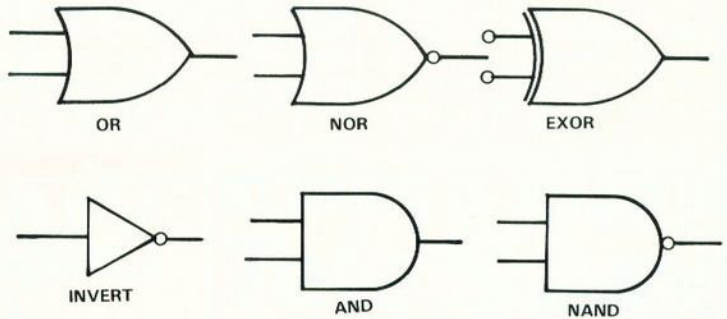
CMOS devices comprise the second big family in which we are interested. They are slightly slower in operation than the TTL devices but consume much less power. By slower, I should first say that we are dealing in nano-seconds — one thousand-millionth of a second. A TTL output can respond to a change at the input in as little as 10ns for a 74 series device, or 40ns or so for a 74LS series device.

The corresponding time for a CMOS device is 60ns. The figures become significant only when we are trying to change the input state of a device millions of times each second. Incidentally, the time taken for an output to respond to a change in the input state of the device is called the propagation delay of the device. CMOS devices can be recognised by their part numbers which begin with 40, 45 or 74C. The latter are pin-for-pin compatible with the equivalent 74 series TTL devices.

TTL, LSTTL and CMOS devices are all used in different situations when any of their special abilities is required. I shall be concentrating mainly on the first two sets, the TTL and the LSTTL devices, but will mention CMOS when needed.

Logic devices of any fabrication family can be broken down further on a functional basis. One of those groups, the combinatorial group of devices, gives outputs which are dependent purely on the input condi-

Figure 4.



tions at that moment. The second group is called the sequential devices and the output depends on the inputs the device has received previously, as well as those at that moment.

We have already met two combinatorial devices, the AND and OR functions of figures one and two. There are four other combinatorial functions called INVERT, NAND, NOR and EXOR.

The EXOR or EOR function, or,

to give it its full title, the Exclusive OR function, is a function which gives, for a two-input gate, an output only when one of the inputs is high. If both of the inputs are high, a low output is obtained. Thus a two-input EXOR gate gives an output when the inputs are different.

The truth tables for those functions are shown in table one. Note that whereas all the other functions have at least two inputs, the INVERT function has only one input.

Later I will show how to combine those functions to produce more complex and more useful logic functions.

First, though, let us look at the symbols used to represent those logic functions and some TTL devices

which perform those functions in circuits.

Figure three shows the British Standard symbols for various logic functions and figure four the international versions of those symbols. The international versions are much less confusing.

The TTL chip which performs the AND function is the 7408 device, a chip containing four separate two-input AND gates. A gate is an elec-

Table 1.

Invert	
IN	OUT
0	1
1	0

NAND		
IN	IN	OUT
0	0	1
0	1	1
1	0	1
1	1	0

NOR		
IN	IN	OUT
0	0	1
0	1	0
1	0	0
1	1	0

EXOR		
IN	IN	OUT
0	0	0
0	1	1
1	0	1
1	1	0

Table 2

A	B	C	D
0	0	1	0
0	1	1	0
1	0	1	0
1	1	0	1

Table 3. Fan-out ability.

Source (driving) device	Load (driven) device	
	74	74LS
74	10	40
74LS	5	40

Table 4.

Pin 1	Pin 2	LED
1	1	OFF
1	0	ON
0	1	ON
0	0	ON

tronic circuit which performs a logic function on the signals supplied to it as inputs. The 7408 chip is known technically as a quad two-input AND gate, the quad referring to the presence of four gates in the package, and the two-input part of the description is self-explanatory.

The INVERTER function is performed by the 7404 hex inverter package, which has six inverter gates. The NAND function is performed by the very common 7400, a quad two-input NAND chip, and the NOR function is provided by the quad two-input 7402. The OR function is the 7432 quad two-input OR package.

Although all the devices listed so far have had either one or two input lines, there are gates with as many as 13 inputs, such as the 74131 13 input NAND gate, which are available as standard components.

If we wish to have a logic function which is not available as a standard package, what do we do? The answer is simple — we combine the simple gates we have already met to create new functions which are more complex. We can even synthesise the gates

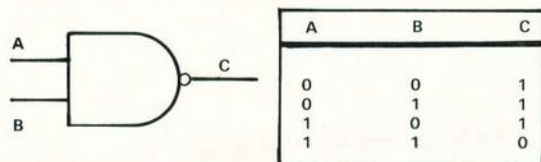
from simple functions such as NAND functions and NOR functions.

That synthesis of logic functions from simpler units is of fundamental importance to the design of logic systems and so we will look at what we can do. More examples will be given

in later articles and in the practical work at the end of this article.

We will now look at combining logic functions. Take the NAND function truth table.

Figure 5. NAND function.



in later articles and in the practical work at the end of this article.

We will now look at combining logic functions. Take the NAND function truth table.

We can see that when both inputs are high, the output is low. Imagine that we then connect the two inputs as shown in figure six. Whatever input, high or low, is applied to "IN" will be present at both A and B and it can be seen that A and B cannot possibly

be at different values. We can then simplify the truth table to remove the impossible combinations and that gives the table in figure six.

That truth table is exactly the same as that for the invert or, as it is also known, the NOT function shown in

table one. Thus we have synthesised one logic function from another.

Look at the truth table for a NOR function. Can you see that by the same kind of reasoning we can synthesise a NOT function from a NOR function? It is also possible to connect the output of one gate to the input of another function, thus offering the possibility of combining different gates. What will happen is in figure seven.

Let us make a truth table for this logic circuit — table two.

At point C, we have the output from the NAND gate, which acts as the input to the NOT function. The output at point D is the output of the total logic system. Ignoring column C of the table and taking columns A, B and D we see the truth table of an AND function, thus demonstrating the formation of a logic function from a combination of other functions. As we can make a NOT function from a NAND function, we can make an AND function from two NAND gates — figure eight.

Similarly, we can combine AND and NOT to form a NAND gate —

Figure 6.

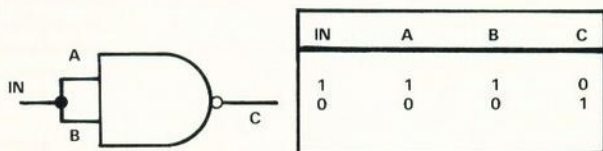
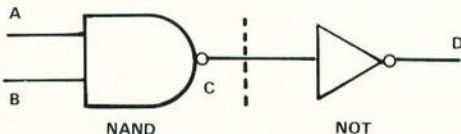


Figure 7.



DIGITAL LOGIC

Figure 8.

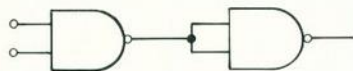


Figure 9.



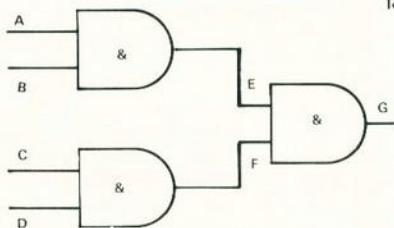
figure nine. That is, in fact, the origin of the name NAND — NOT AND. You can make a NOR function from an OR function and a NOT function. It is possible to make AND, OR, NOR and NOT functions from the NAND gate and similarly from the NOR gate. That explains the popularity of NAND and NOR gates in the eyes of manufacturers and designers of logic circuits using TTL devices.

It is usually much easier for the amateur constructor to use specific AND gates rather than go to all that trouble. As well as synthesising new logic functions we can expand existing ones, i.e., we could use three of the two-input gates in a 7408 package to produce a four-input AND gate, as shown in figure 10. The only time an output from gate 3 can occur is when the inputs to it are both high. Input E can be high only when A and B are high and input F to gate 3 can be high only when inputs C and D are high. Thus we have an output only when all the inputs are high.

There are many useful combinations of those simple gates which are used in logic design and I shall investigate some of the more important ones. A branch of mathematics has grown up to describe the effects of combining those various logic func-

tions and it is called Boolean algebra. It was invented long before computers and logic circuits but has been extremely useful in these fields. I shall begin a cautious examination of the subject in my next article but let us now look at some practical exercises

Figure 10.



you can do to demonstrate the functions.

The best way to learn about digital electronics is by practical experience. These ideas will reinforce the foregoing text, whether you perform the exercises or not. For combinatorial devices, all you need is two 7400 quad NAND gates; you can make all the other functions mentioned from them. For an easier life, you might care to buy two of the other devices mentioned. All the devices we will be using in this series will be easily available from any of the many electronics firms which advertise in the popular computing magazines.

You will also need a few other components as well. The best way to build experimental circuits is to use one of the very useful solderless breadboards available from several sources. Components and connecting wires are plugged-in and can be removed when the circuit has been tested, thus providing a saving in components.

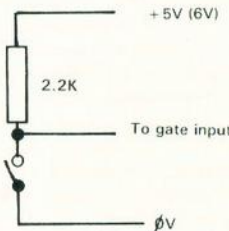
Any other components needed will be mentioned in each article. All will

be inexpensive and will be useful in future digital electronics projects you may wish to be build.

Power for the circuits using TTL devices can be obtained from a 6V battery; however 4.5V is the absolute minimum specified voltage for correct working and 5.5V is the maximum specified voltage; they will work on as low as 3.5V and the absolute maximum voltage is 7V.

If an input to a TTL device is left unconnected to anything, it assumes a logical high, or 1 value. That unconnected state is also known as leaving

Figure 11. When switch is open, we have a logic 1 on the gate input. When closed, we have a logic 0.



the input floating. We supply 1 or 0 logic inputs to the inputs of the gates by the below circuit — figure 11.

In future articles, we will determine how to get other non-TTL circuits to provide inputs to TTL circuits. To make sure that the TTL devices respond to inputs, certain conditions have to be met by the input signals. Generally, we need a voltage on an input of more than 2.5V for a high input and one of less than 1V for a low input.

Figure 12a

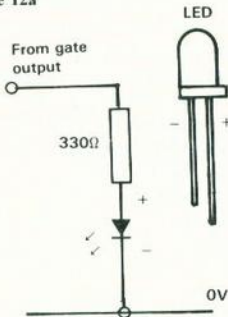


Figure 12b.

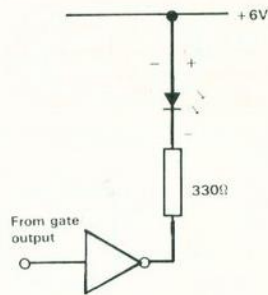
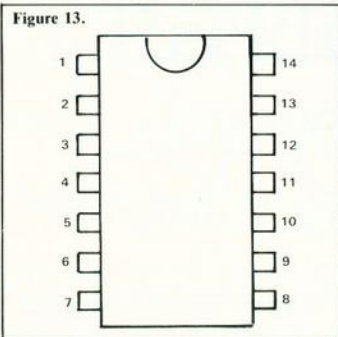


Figure 13.



Making sure that the signals which reach the TTL inputs are suitable is called input signal conditioning and will be dealt with in a later article.

With regard to monitoring the output of the logic devices, we use light emitting diode circuits. It should be noted that the circuit shown in figure 12b is the best, despite the need for an extra NOT gate.

In figure 12a, the TTL gate is said to provide, or source, the current needed to turn on the LED when it is giving a high output. TTL devices can source only a maximum of 400 microamps, which is not really sufficient. In figure 12b, the TTL device is not providing the current but is providing a way for the current to go to ground, or 0V. There the TTL device is said to be sinking the current. It can sink 16 milliamps and that is sufficient to drive a LED.

A TTL device sinks current only when its output is low. Thus in figure 12b the LED will be lit when the output of the TTL gate is giving a low output. To get a LED connected in that way to light when the output being monitored is high, we must connect a NOT gate between the LED and the gate being monitored. That is why we have the extra gate in figure 12b.

We can connect the output of one TTL device to the input of another device. There is a limit to the number of inputs each TTL output can supply or drive. That depends on the the TTL device driving the inputs and the driven device.

Table three shows the number of devices which can be driven. The abil-

ity to drive other devices is known as the FAN OUT capability of the TTL device. So, armed with those technical points, we will start some experiments using NAND gates.

The 7400 device is known as a dual-in-line package, or DIL. Figure 13 shows the appearance of one of those devices. Most of the TTL devices have 14 or 16 pins, although some exist with more pins.

In most 14-pin devices, pin 14 is connected to the +5V and pin 7 is connected to 0V, and in most 16-pin devices pin 16 is connected to +5V and pin 8 to 0V. To see how the gates are arranged in the package, see figure 14. For a 7408 device the pin-out is the same but with AND gates replacing the NAND gates. Similar situations exist for the NOR and OR packages. There is a difference in the packaging for the 7404 inverter package — figure 15.

So let us set up a demonstration circuit for the NAND gate, as in figure 16.

Figure 14.

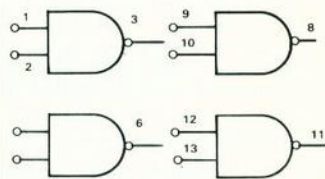


Figure 15.

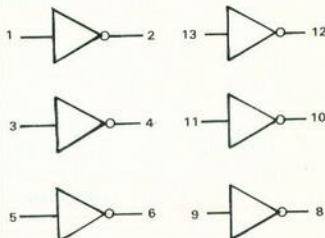


Figure 16.

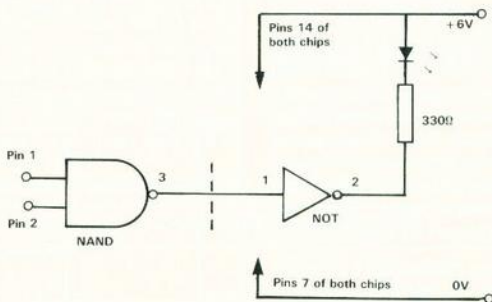
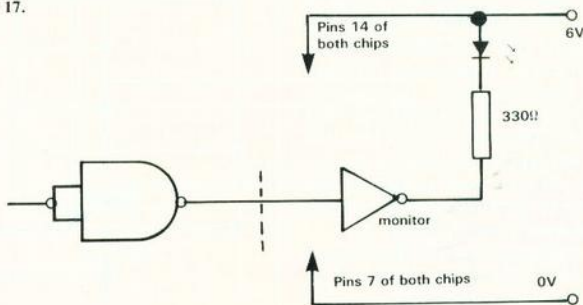


Figure 17.



DIGITAL LOGIC

Remember that any input to a TTL gate left floating will appear to the device to be a logic high. We can then set up a truth table for the circuit and we can set up the various inputs and monitor the output LED. Note the NOT gate which is used to drive the LED in accordance with figure 12b. The truth table is shown in table four.

If we then wire pin 1 and 2 together, we can demonstrate the inverter function. Again, note the inverter which drives the LED. We give the inverter/LED circuit a special name — a monitor circuit, because it monitors the state of a point in the circuit at that time.

Let us then combine gates in the chip to form new logic functions. Note that all the gates in a particular device will behave identically unless otherwise stated. Although the gate with pins 1, 2 and 3 is used, the one with pins 4, 5 and 6 could also be used.

Figure 18 shows an AND function made up of two NAND functions. Make a truth table and check it against that in table one.

Figure 19 shows how we can synthesise an OR function from NAND gates. Again, try the circuit and make a truth table for it. How could we get a NOR function from those gates? You should be able to see how easy it is to form complex logic functions from these simple gates. Take, for example, the circuit in figure 20.

The function performed by the circuit in figure 20 is fairly complex; there are four outputs and one of them is active for a given A and B combination as inputs. Thus for any input state, only one output is high. Try making a truth table for that circuit. The numbers on the diagram refer to the pins on the 7408 and 7404 chips. Use the inverter LED monitor circuit of figure 12b. Remember to connect pin 14 of each package to the plus side of the battery and connect pin 7 of each package to 0V.

Try repeating some of the experiments using LS devices; you will find there is no difference in the way the circuits behave.

Figure 18.

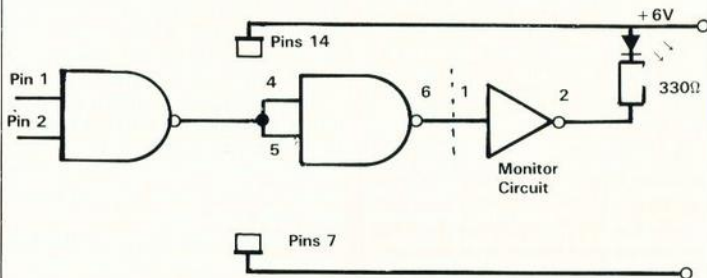


Figure 19.

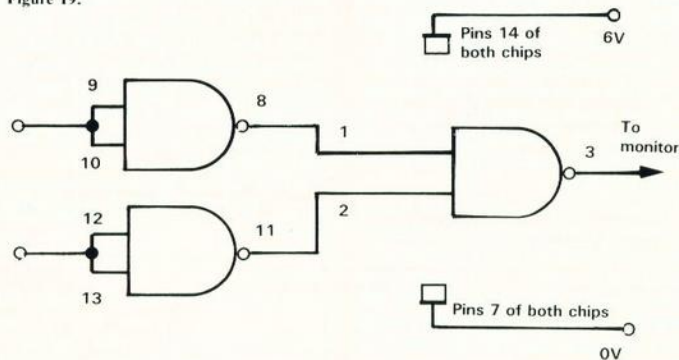
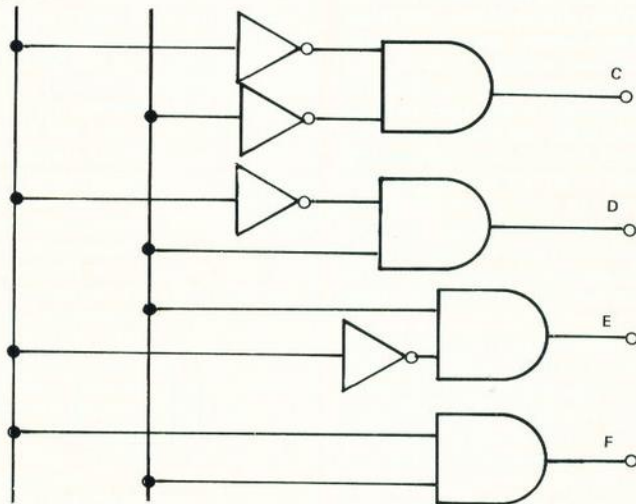


Figure 20.



Recklessness rewarded by amplified sound

Roger Frost has found a better way to increase the Spectrum BEEP than merely removing the cassette and EAR lead from the player and pressing play or record

SOME CASSETTE players can amplify the Spectrum sound simply by removing the cassette and EAR lead from the player and then pressing play or record. My cassette player did not improve on the sound very well, so I set to work, armed with a screwdriver, apparently about to ruin a perfectly good player to modify it. Recklessness was rewarded but the solution will invalidate any guarantee on the player.

The signal from the tape head inside the player passes along two wires to the circuit board. That is where the amplifier circuit begins. The MIC lead carries two wires from the Spectrum which carry the signal which needs amplifying. The first step in amplifying was therefore to connect the two wires from the MIC lead to the amplifier circuit of the cassette player. A switch was used to make the connection, so that the normal operation of the cassette player was not interfered with in any way.

I traced the two wires from the tape heads to the circuit board and identified the points at which they connected. The two wires were unsoldered from the circuit board and re-soldered on to the end terminals of a double-pole, double-throw switch. Two new wires were then taken from the points on the circuit board to the central terminals on the switch.

So far that arrangement would switch the operation of the tape head on or off. Next I needed to find where the MIC input went, so that it could be connected to the remaining terminals on the switch. I used a small circuit meter — though a battery and bulb set-up would do — to test the back of the MIC socket with the tip of the MIC jack plug and to test again with the shank of the jack plug. Having found those two points on the back of the socket, two new wires were soldered on to them and run to the switch terminals.

A hacksaw blade was then used to

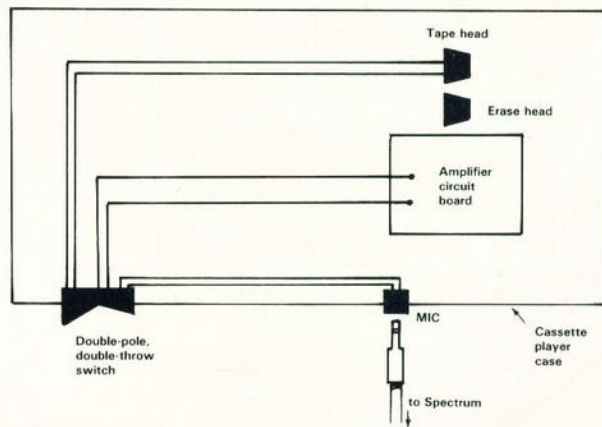
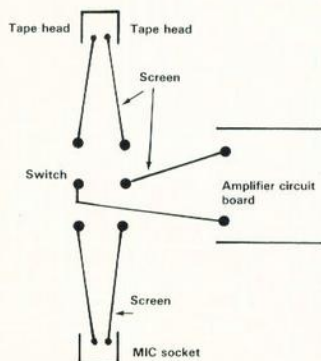
cut some plastic cleanly from the cassette case and install the switch neatly into it.

Locating a good position for the switch was, perhaps, the most difficult part of all, care being needed about routing of wires and possible obstructions when screwing together the two halves of the case. The exact type of double-pole, double-throw switch will depend largely on the amount of room inside your player.

The transformed cassette player amplifies brilliantly, both in quality and volume. To operate the player as an amplifier the switch is pressed, the EAR lead removed from the cassette socket and the player set in play mode. Re-set the switch when using the cassette player normally.

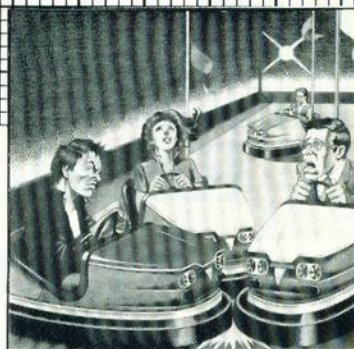
The total cost was less than £8 — and the amplifier has worked for six months without a hitch. My Spectrum is now a very portable and a very independent little machine.

Schematised diagrams of the cassette player and circuit



PROWLER

Sensors on mobile enable it to avoid dead-end situations



In our August/September issue we built the Prowler, which proved popular. David Buckley has improved it by adding four fenders which allow it to take action when it meets something on its travels while under control from the ZX-81 or Spectrum.

THIS IS the second stage to Project Prowler, the basic chassis of which was described in the August/September issue. With the additions detailed in this instalment, Prowler will be able to sense the presence of obstacles and so take the necessary avoiding action. That sensing is done through four fenders, each connected to two sensitive switches. The state of the eight switches can then be read with a PEEK or IN.

In this enhanced version of Prowler a simple address and data bus has been formed, the baseboard is at address one and other add-on boards for speech sound or other sensors, such as a simple camera, will be at higher addresses.

The modification means that Prowler now needs two eight-bit ports to control it, one of which must be output and the other software-switchable between input and output.

The two bi-directional ports on the AY-3-8910 sound generator IC are ideal for this. Pins 11, 12, 13 and 14 on SK1 are used for the address input and pin 15 is used for a R/W read-write line to control the direction of data on the bus. Pin 9 is spare as yet; it may be used later.

Figure one gives the circuit with the address decoding done by IC5 and IC4. IC2 and IC3 plug in the old SK2 and SK3 on the Prowler board. IC2 has a master re-set input and R4 with C3 provide a low to this on switch-on, so there is no need quickly to POKE

or OUT a 0 to switch off the horn.

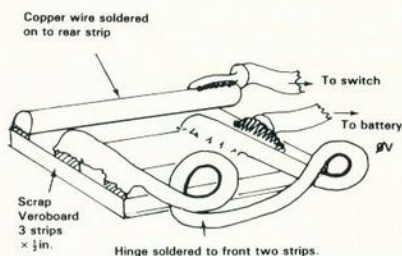
The sensors are connected to the board by two four-pin, board-mounted plugs at the two rear corners. Opportunity has also been taken to fit two more four-pin plugs at the star-board rear to make the connections to the motors and battery.

Figure two shows the additions and corrections to the original Prowler board; no modification of existing circuitry is needed. Some of the new connections go over the board and some go under it. Make sure when fitting the S₁ to S₄ connections from near IC3 to the two rear plugs that you can still plug back the board on to the hinges.

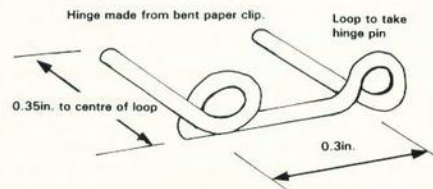
There is a short link by D3 which is soldered on top of the board to two

Figure 3. Hinge parts.

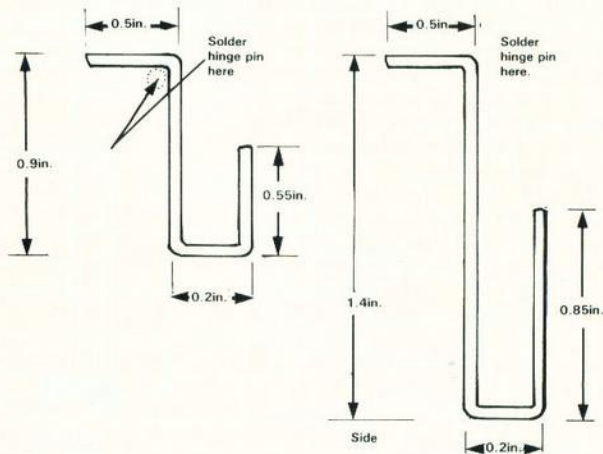
a Assembly



b Hinge



c Front/rear Fender Supports



PROWLER

Figure 2. Veroboard layout.

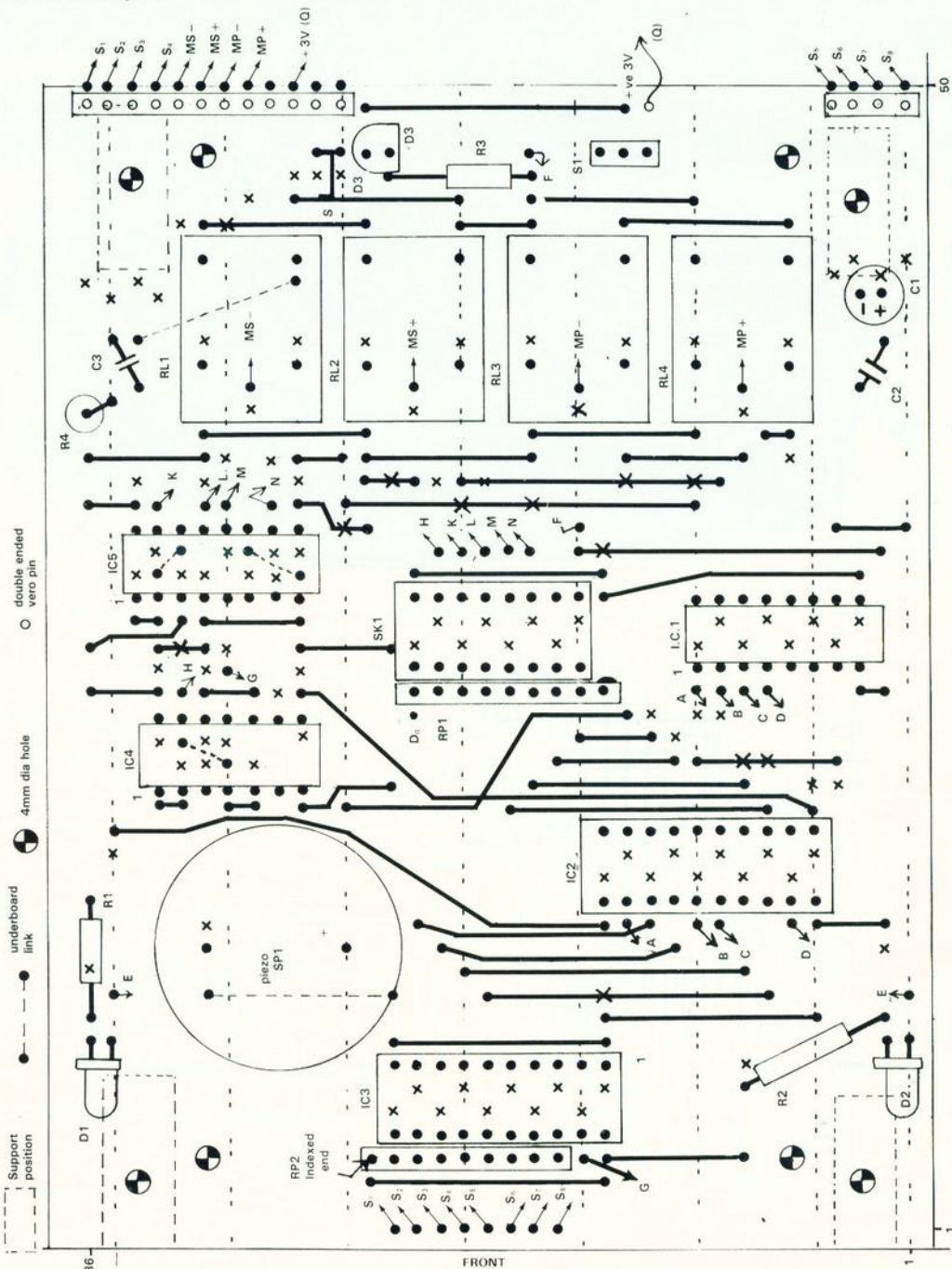
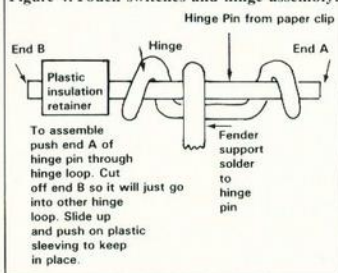


Figure 4. Touch switches and hinge assembly.



other links. Note the links on the copper side under ICs 4 and 5. Again fit most of the components and links before you make the track breaks.

The board is then reasonably full and the addition of more components is not envisaged. The four spare 4mm. holes by the hinge-mounting holes are for four pillars to support another board. If you keep to the layout shown the pillars will just fit.

Figures three and four show details of the sensor switches. The touch sensors need to be reasonably sensitive and commercial push switches all have too high a closure force. Lever microswitches would suffice but they are expensive and the last ones I used had stainless steel levers which need special solder to fasten any brackets. The switches drawn are very sensitive and inexpensive but take some time to make. The springing is performed by stick-on foam weatherseal as in figure five. The switches are very much bend-to-fit and need some adjustment of the various angles for the best springing.

The front and rear fenders are $\frac{1}{2}$ in. \times $\frac{1}{8}$ in. \times $3\frac{1}{2}$ in. balsa wood or similar and the side fenders $\frac{3}{4}$ in. \times $\frac{1}{8}$ in. \times 7 in. balsa or similar. The side fenders are mitred at each end, so as not to protrude below the tracks. The exact size of the fenders is not critical but what is important is that they should be a loose fit on their supports, so that if one end moves in and opens its switch the other end remains in position and its switch stays closed.

The photographs and figure six should be used as a guide for the placing of the switches. The exact location is not important.

Figure 5. Touch sensors.

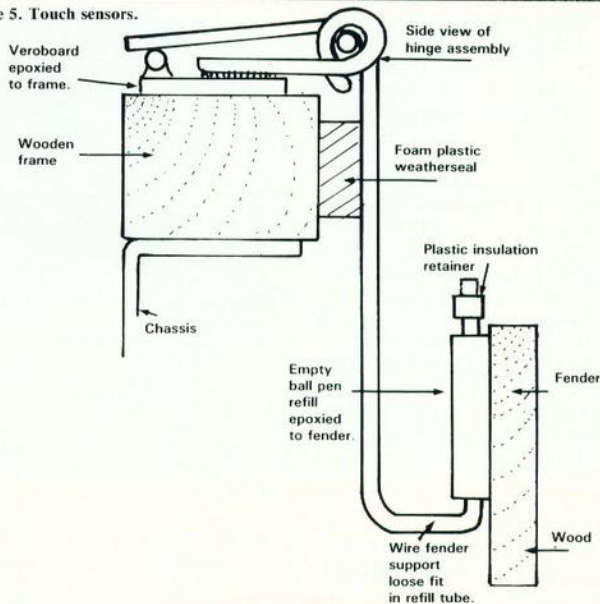
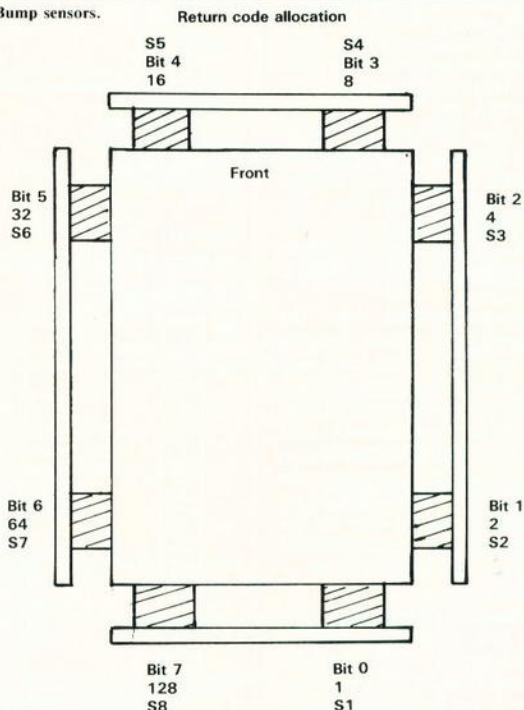


Figure 6. Bump sensors.



PROWLER

First make up the assemblies on the Veroboard scraps, then epoxy the assemblies to the Prowler frame. Stick on the foam plastic blocks and then insert the fender supports. Wire together all the loopy parts of each switch and connect them to the 0V end of the battery compartment.

On the rear strip of each switch is a length of copper wire; they should be connected to the two sockets which will plug on to the two board-mounted plugs at each rear corner. The right-side switches should be connected to the right-side socket and the left-side switches to the left-side socket.

Figure seven shows the new pin allocation of SK1 and figure eight shows the pin-outs of the new ICs used.

Reading and writing information from and to Prowler is then a little more complicated than simply PEEKing and POKEing or INing and OUTing. Lines A₀ to A₄ and R/W of SK1 should be connected to lines D₀ to D₅ of an output port, while D₆ to D₇ of SK1 should be connected to D₀ to D₇ of a bi-directional port, such as those on the AY-3-8910 sound generator IC or the 8255 PIA IC.

To read from Prowler all that is necessary is to output on the address port 17 which is the board address = one, plus the R/W line high = 16. Then read from the data port. The 74LS245 octal buffer on the touch-sense lines is enabled whenever that is done.

To write information into the 74LS273 octal latch which controls the motor and lights and horn is a little more complicated. The 273 is a D-type latch, which means that information is stored in the latch only when pin 11 CP changes from low to high. That happens only when the latch is de-selected. So to write information one must set up data on the data port and then set up the relevant board address — in this case = one — on the address port.

The address decoding logic will then cause WR to go low, which is connected to pin 11 — CP — of the 74LS273 octal latch. Then if a different address is set up on the address

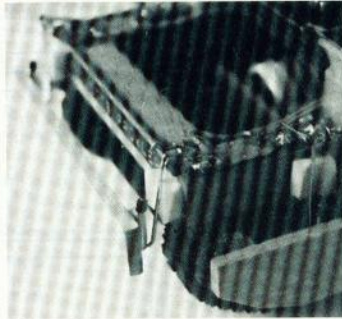
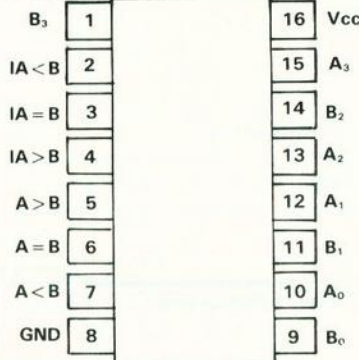


Figure 8a.



74LS85 four-bit magnitude comparator.

Pins 2, 3, 4 are cascade inputs for 4-bit comparison. Connect pins 2, 4 to GND and pin 3 to Vcc

Figure 8c.

74LS273 octal D-type flip flop pin-out.

(Master Re-set)

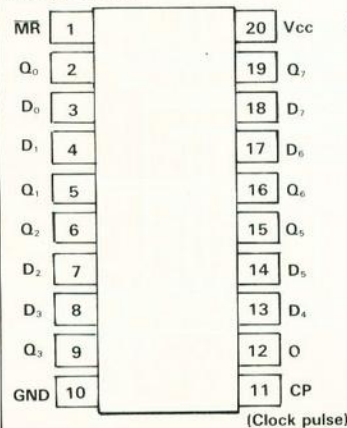


Figure 7. SK1 pin allocation.

D ₀	1	16	5V
D ₁	2	15	R/w
D ₂	3	14	A ₃
D ₃	4	13	A ₂
D ₄	5	12	A ₁
D ₅	6	11	A ₀
D ₆	7	10	Spare
D ₇	8	9	0V

Figure 8b. 74LS00 quad nand.

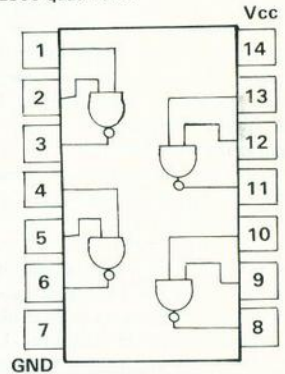
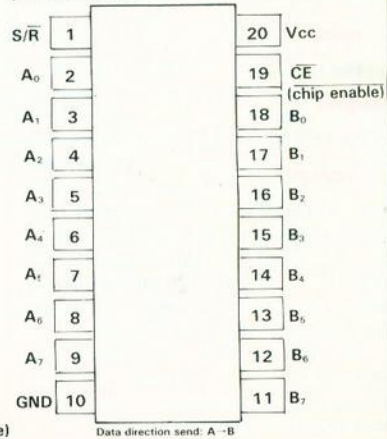


Figure 8d.

74LS245 octal transceiver tri-state pin-out.

(Send/Receive)



Data direction send: A - B

port, or the R/W line output of the address port goes high, the WR line to the '273 will go high and the data will be latched into it.

Figures nine and 10 should make this clearer. Address zero is a useful address for use with dummy writes, since it is not proposed to use that address on Prowler. All other boards will have addresses from 2 to 15.

I have not yet written software which will allow Prowler to avoid obstacles but, on running into something, backing off and turning through a small angle randomly left or right and a random number of degrees works with Zeaker.

When something is detected you could sound the horn and flash the lights, as well as going into the avoid routine.

Those who have built or are building Prowler may write with suggestions for improvement. There must be many of them, or if you are building some add-on for Prowler, again please write. If all boards have the eight corner holes as indicated on the circuit layout, any board can be arranged to stack on top of any other board. Also if add-on boards have on them two sockets wired as SK1, one socket can take the umbilical from the computer and the other socket can be used to daisychain, using a short 16-way DIL jumper assembly, down to the board below.

In future articles we will look at software for Prowler and some add-on boards with light sensors, sound chips, speech chips and sound sensors.



Figure 9.

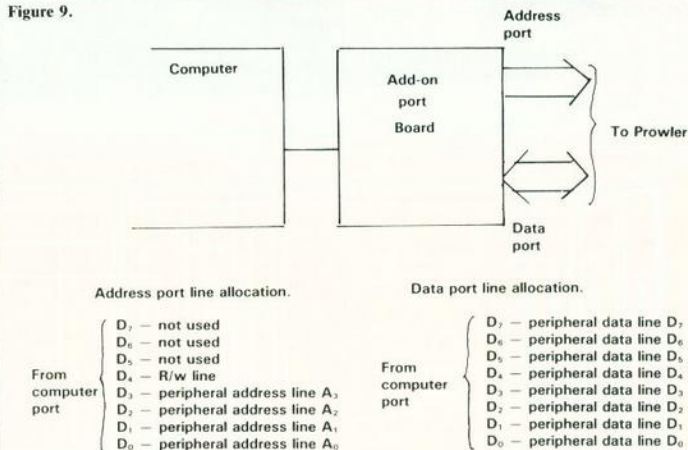


Figure 10. Computer/Prowler information exchange.

PARTS LIST

- IC3 74LS245
- IC2 74LS273
- IC5 74LS85
- IC4 74LS00
- C3 0.1
- R4 22K
- 4 off Minicon 0.1 4 way socket housing *
- 4 off Minicon 0.1 4 way straight plug *
- 16 off Minicon terminal *

*[Maplin]

Paper Clips, Scraps of Veroboard;
2in. x 7in. x 1/4 in. balsa sheet; empty plastic
refill from ball pen; white foam plastic
draught excluder strip.

	To read data	Comments
Step 1	Set up on the address port "Board address" + 16	16 is the value of the R/w line high, indicating a READ
Step 2	Read data	changing data can be read
Step 3	Read data	continuously
	To write data	Comments
Step 1	Set up data on the data port	
Step 2	Set up on the address port "Board address"	
Step 3	Either set bit 4 of the address port high or Alter bits 0 to 3 of the address port to select another board	De-selects the board and latches data high

Getting carried away with great success

DO YOU have trouble with flying leads? Do you need to carry your Spectrum around? If so, why not build a low-cost portable computing centre in a briefcase? The case can hold every piece of Sinclair hardware available, plus cassette player — figure one. The PCC has been designed ergonomically for easy operation. The connecting leads fit under the packing material so that there will be no chance of tangles. Grooves have also been left so that if any piece of equipment fails, it will be simple to remove it without dismantling the unit.

The first difficulty you will encounter is to find a case big enough and at the correct price. You will find a suitable cassette carrying case,

Many Sinclair users like to carry their Spectrums around. John Kenny shows how to make a case which will allow you to do this without having leads getting in the way.

Materials

Bag of polystyrene ceiling tiles — 87 pence.
 Glue, Copydex.
 Felt, self-adhesive.
 Cassette carrying case — £8.95.
 Total cost about £11.
 Stiff card.
 Wallpaper paste.
 Black paint spray; remember cellulose lacquer paint attacks and dissolves polystyrene.

Tools

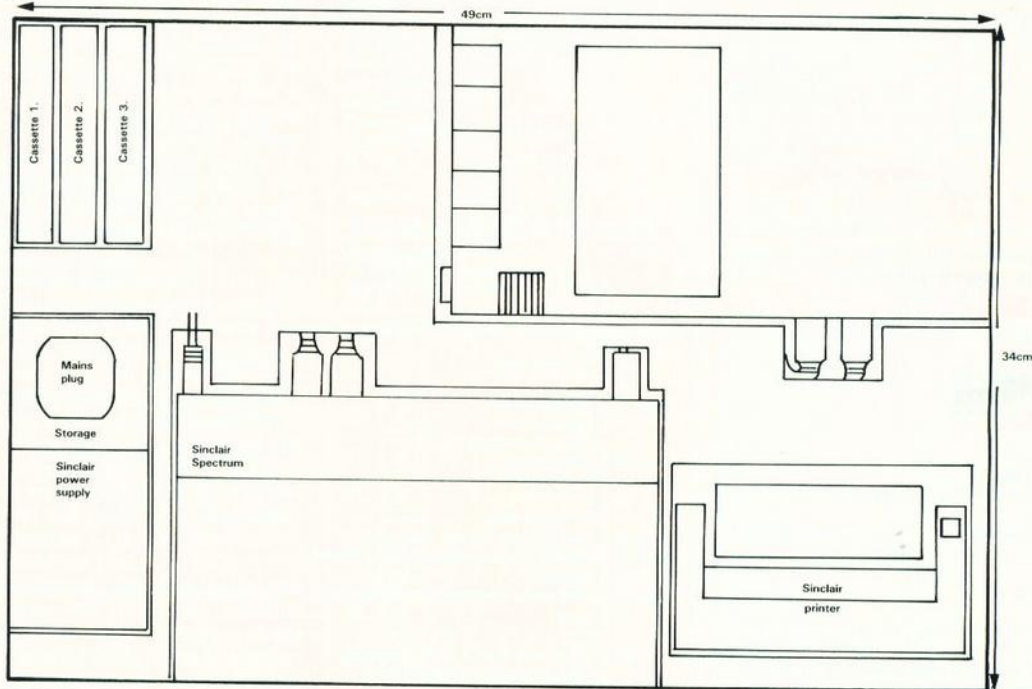
Sharp knife. Scissors.
 Ruler. Small paint brush.

49×39cm. in W H Smith record departments. The second problem would be to find a packing material which would be easy to work with and therefore would need no special tools; it would also need to be strong enough to hold the Spectrum and its peripherals safely.

Polystyrene ceiling tiles seemed to be the kind of material needed. That material, besides being inexpensive, can be cut and shaped with a sharp knife easily.

First remove the plastic cassette holders from the bottom of the case and cut out three sections — figure three. Measure the inside dimensions of the case and cut a piece of card to fit — it will provide a convenient base on which the polystyrene material can

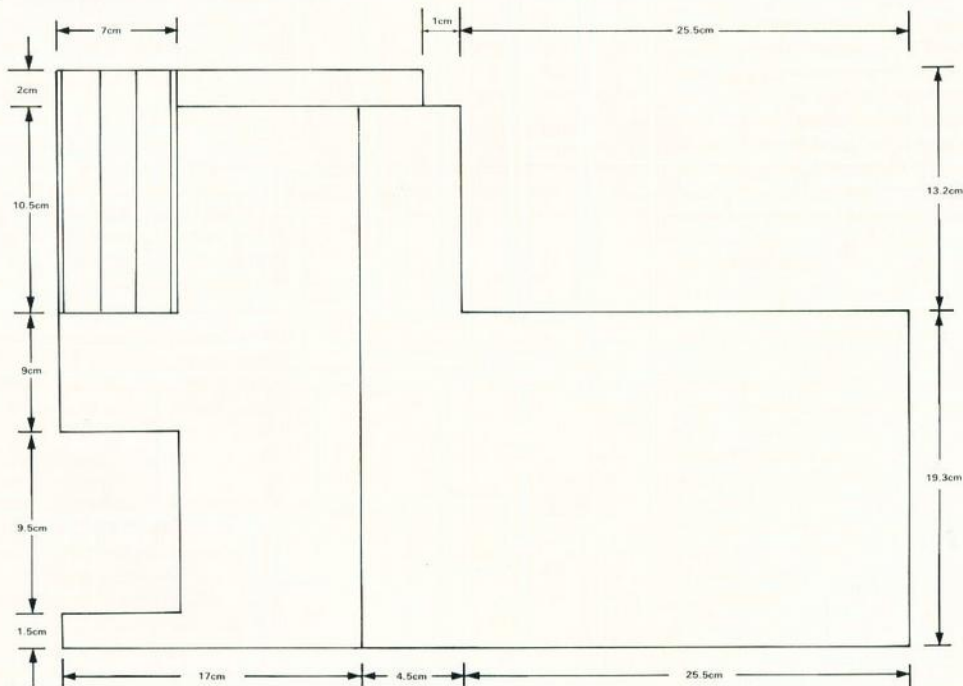
Figure 1.



SPECTRUM CASE

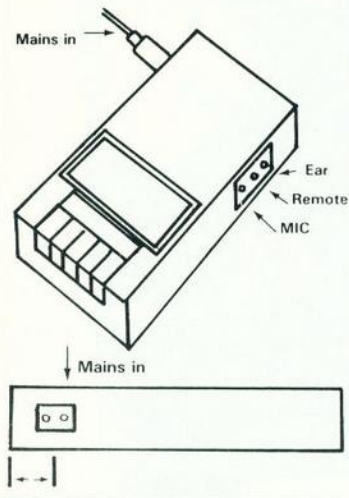


Figure 5.



SPECTRUM CASE

Figure 2.



be constructed. Place the card at the bottom of the case but do not glue it because you will need to remove the insert for spraying later.

Take the three cassette sections and glue them to the top left-hand corner of the base — figure five. If you should have the same difficulties as in figure two — to have the mains, the Ear, Mic and REM sockets on opposite sides of the recorder — you should cut a hole in the rear of the case, as shown in figure 2a.

Proceed by removing the battery cover and dismantling the cassette recorder, feeding the mains lead from the power supply through the battery compartment, and solder it to the mains input of the cassette recorder. If you do not feel able to do that, if the mains socket is on the side of the recorder which will be next to the printer, plug-in the mains lead and tape it securely in place. If the socket is on the other side, you can plug in the mains lead through the hole in the rear of the case. The power supply lead can then be taped to the underside of the recorder, to prevent the lead moving under the recorder and making it unstable — figure four.

Having done that place the recorder into the top right-hand corner of the case, with the pushbuttons facing inwards. Do not replace the battery cover. Having the pushbuttons in-

wards allows you to type and press the buttons at the same time — figure one.

Place the power supply at the bottom of the left-hand corner, leaving a 1cm. gap from the front of the case — figure one. The next step is to cut the polystyrene to size. In this project there are eight levels of polystyrene.

To build the contours, start by glueing the base level to the card, work your way to level six — see photograph. Having reached level six, you need to place the piece marked "C", of level six, into place first — see photograph. Then place the Spectrum into place and push tight; that ensures a neat fit.

Leave the Spectrum in that position and glue the other pieces round it; then repeat this procedure to level eight. When you have reached level eight you can leave the insert to dry. You can use some card for the top cover and then felt can be glued on top of it. To make the felt look neat, cut it so that it overlaps the card

Figure 3.

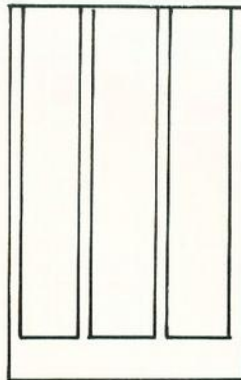


Figure 6.

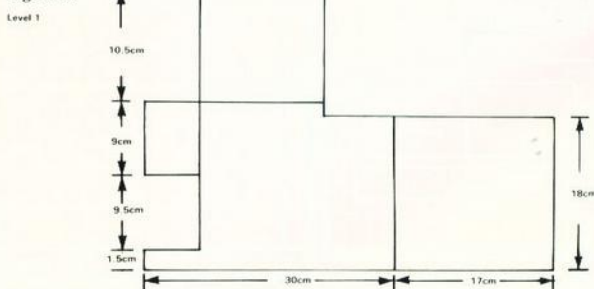
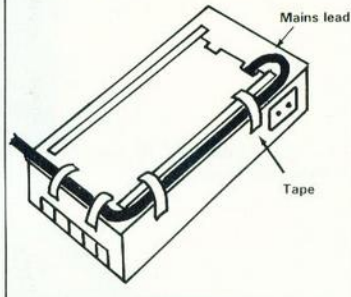


Figure 4.



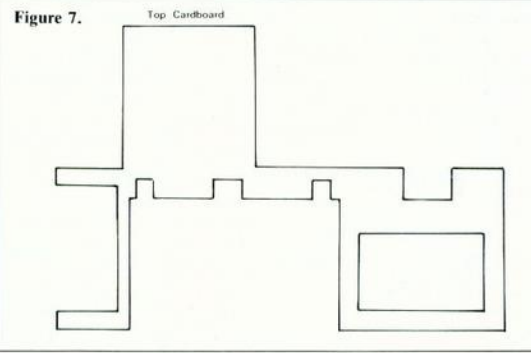
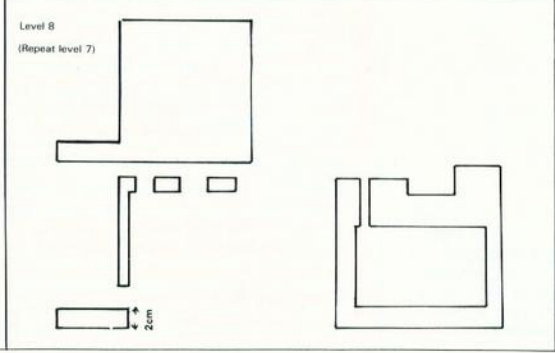
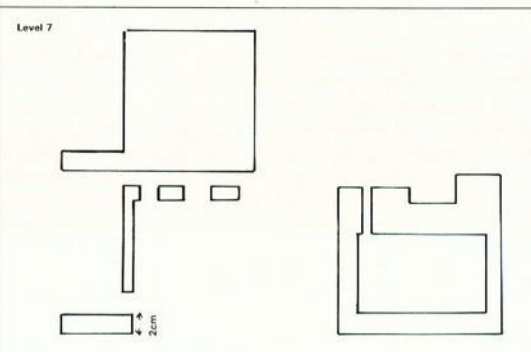
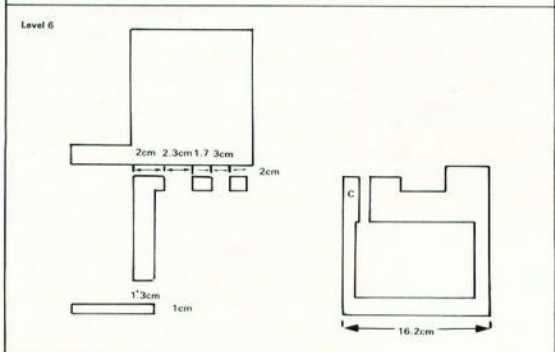
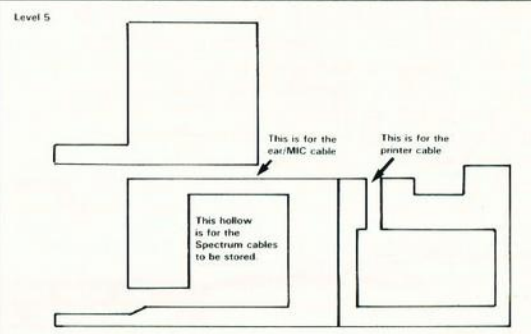
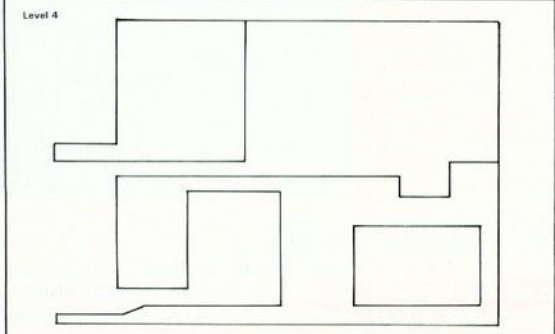
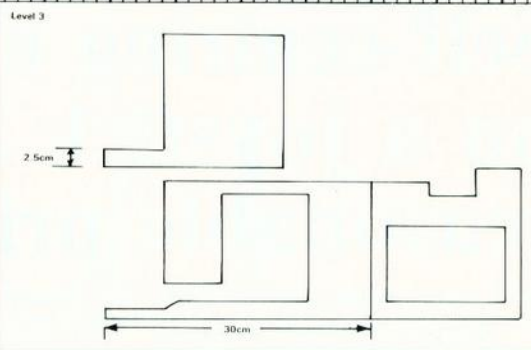
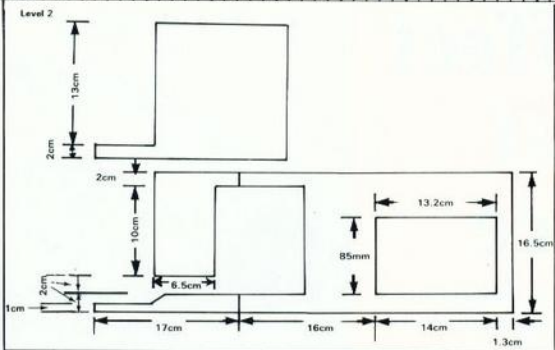
slightly; then bend it under the card to provide a hem.

When the insert is dry, remove it from the case. The only problem with using polystyrene is it crumbles easily; to prevent that use an old railway modellers' technique of covering the polystyrene with strips of newspaper. Cut 2in. strips of newspaper, paste them and leave to soak. Layer the strips of paper over the insert, making sure to press the paper into all corners. That not only prevents the polystyrene crumbling but makes the structure stronger. Leave to dry; it will probably need to be left overnight; when it is completely dry, spray it.

Fit the insert into the case and place all your equipment in position. The felt-covered card can then be put into place, hiding all the wires, and giving the case a professional finish.

You then have your PCC. To add the finishing touch I used different-coloured letter stickers. I positioned them on the outside right-hand bottom corner of the case — see photograph.

SPECTRUM CASE



JOYSTICK

Self-centring effect on a joystick at reasonable price

Using many parts obtained from old electrical equipment, Brian Lee has made this games peripheral which can be used on both the Spectrum and ZX-81.

THERE ARE many commercial joysticks available but for constructors who wish to make their own, this design offers a relatively cheap alternative. To keep down the cost, parts of the prototype were obtained from scrap. For example, the grommets and sheet aluminium were from old electrical equipment.

The design provides four direction-switching buttons and a fire button. The assembly detail is shown in figure one. The stick (A) is a length of Meccano screwed rod and it is mounted flexibly in a grommet (F) fitted to the aluminium baseplate (C). That plate is secured to the box lid by four bolts and spacers (E). The large washer (D) operates the four microswitches (B) which are bolted to the box lid.

This arrangement gives a short

stick travel with a very positive self-centring effect provided by the return action of the switches. All dimensions quoted are to suit the components specified and, if alternative parts are used, some alteration may be necessary. It is recommended that Meccano nuts are used on the stick assembly, since the slim Meccano spanners make the adjustment easier in the confined space.

The large washer on the joystick should be $\frac{3}{4}$ in. diameter and a big Meccano washer will suffice but, if available, one with slightly more thickness, say 2mm., would be better. Due to the rocking action of the stick, the washer slides up and down the face of the microswitch plunger as it operates.

To make the action smooth and avoid undue wear, the edges of the washer should be rounded as shown



in figure four. That is best done using an electric drill and a fine file, then emery cloth, finishing with a very fine grade to obtain a polished finish. Hold the washer as shown in figure four, using an old bolt, as the thread may be damaged in the drill chuck.

Figure three shows the dimensions of the microswitches. If another type is to be used, ensure that it has a flat face to bolt to the box lid and that the terminals are clear of the other components. One other point to bear in mind is that if the length of the switch is much greater than that shown, the corners of adjacent switches will foul — see plan view in figure one. To overcome that, a bigger washer would be required and the dimensions, perhaps even of the box width, altered accordingly.

To achieve a crisp switch action with no sloppiness in the movement, the position of the microswitches is critical and care should be taken with the marking and drilling. If the switches are first mounted on a piece of scrap Formica, it can then be used as a drilling template for both the box lid and the baseplate, thus ensuring good alignment.

First cut the Formica to make a square with 50mm. sides, then locate the centre by drawing diagonals from corner to corner. After centre-punch-

COMPONENTS LIST

Case

Bimbox 112 — Bim 003/13 — size as in figure 2.*

Fire button

Push to make switch. Maplin FH59P.*

Microswitches (4 off)

Omeron Licon switch; see figure 3.*

Multi-core cable

$\frac{3}{4}$ metre, 10-core.*

Grommets

1 to suit cable diameter.

1 with $\frac{1}{8}$ in. hole.

Meccano

1 screwed rod 2in. long — near equivalent 4BA.

7 nuts.

1 large washer $\frac{3}{4}$ in. diameter.

2 small washers.

Other bolts and nuts

8 bolts 8BA $\frac{1}{2}$ in. long.

8 nuts 8BA $\frac{1}{2}$ in. long.

4 bolts 6BA 1in. long.

4 nuts 6BA 1in. long.

Baseplate

16swg aluminium sheet 50×50mm.

Spacer tube

3/16in. bore brass or alloy tubing.

75mm. long — see text.

Knob

Cap from tube of glue, toothpaste or similar.

*See Shopping List page.

Shudehill Supply Co stocks the Bimboxes, microswitches and push switch. Difficulty was found with the 10-core cable. **Cricklewood Electronics** has 12-core at 80 pence each plus VAT and p&p. per metre — minimum.

Maplin sells the BA bolts, nuts and washers in packs of 10 of each but they may be cheaper at electrical hardware stores. If Meccano is not available, Maplin has 4BA screwed brass rod in 6in. lengths. Bubble packs of assorted-sized grommets can be obtained from car accessory shops, DIY shops and the like.

JOYSTICK

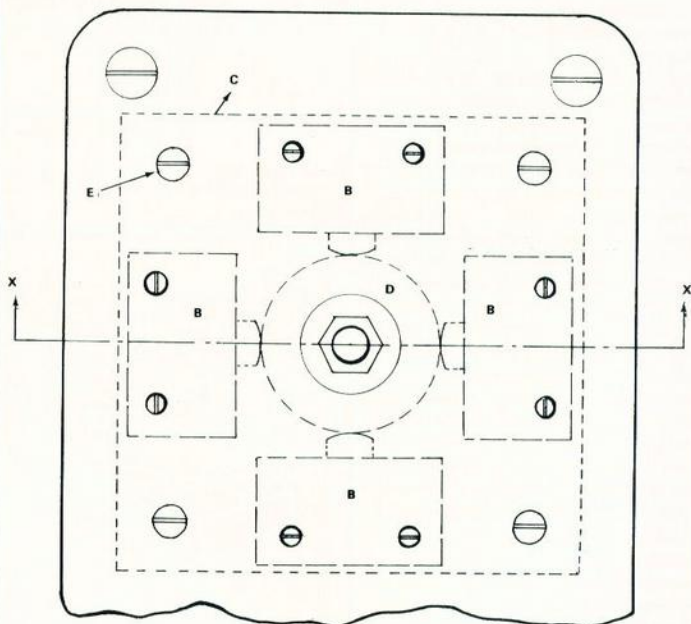
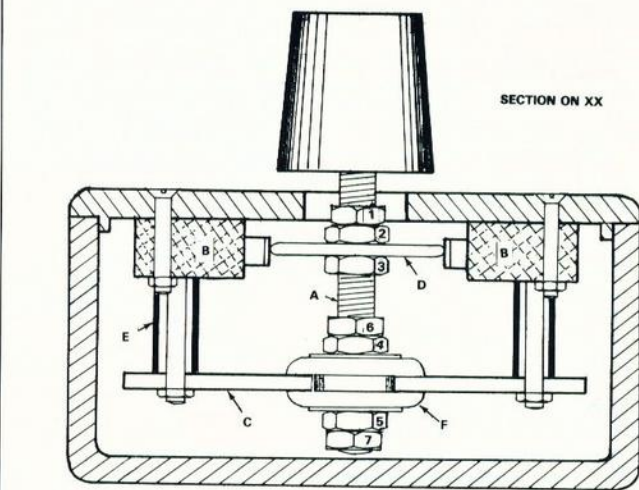
Figure 1.



ing, drill a 5/32 in. hole at that point. Using the screwed rod and nuts, fit the washer as shown in figure five and clamp the switches as shown, so that the plungers are fully-extended but hard against the washer. Miniature G-clamps were used for this but bulldog paper-clips or the type of clothespeg with a spring might suffice, with care, to hold each switch while the securing hole centres are marked. Those holes should be made using a 3/32in. drill. The four corner holes should next be made in the template, using a 7/64in. bit. The positioning of them is not critical.

The baseplate is next made from 16 swg aluminium sheet. Cut it to the same size as the template, 50mm. x 50mm. Holding that and the template together securely, the centre hole and four corner holes should be drilled through the baseplate. To avoid later confusion, a corresponding upper face corner of the template and baseplate should be marked suitably at this stage.

The dimensions of the box are shown in figure two. To locate the holes in the box lid, first rule a pencil line down the centre, Y-Y in figure two, and mark the centres for the stick and fire button to the dimensions shown. Make a 9/32 in. hole for the fire button and a 5/32 in. hole on



JOYSTICK

the joystick centre. Fasten the template squarely to the box top, using a Meccano nut and bolt through the centre hole, and mark the box top to correspond to the identity mark on the template.

The four corner holes and eight switch holes should then be drilled in the box top. After removing the template, open-out the centre hole using a 7/16in. drill or round file, and countersink the 12 screwholes using a large twist drill if a countersink bit is not available. That should be done by turning the tool by hand.

The grommet to be fitted to the baseplate should have a hole about 1/8in. diameter to make the screwed rod a tight fit. Open-out the baseplate centre hole to suit and fit the grommet. The larger-cable grommet should be fitted in a hole drilled centrally in one end face of the box. The box used for the prototype had internal slots for circuit boards and the projecting parts in the area round the hole were cut off, using an old wood chisel, to make a flat seating for the grommet.

The four spacer tubes were made from 3/16in. bore brass tubing. It may be obtained from model engineering shops but a perfectly good alternative is to use the outer casing of a discarded Bic ballpoint pen. Cut the tubes as squarely as possible to 17mm. length.

The knob for the joystick is a plastic screw-cap from a tube of Britfix model cement. That cap is ideal, as it has a centre core into which a Meccano screw will just fit. Fill the hole with Araldite or some similar adhesive, screw in the rod, and leave until fully set. An open-type screw-cap can be used but more care is needed to ensure that the rod is held centrally while the adhesive sets. The rod should then be cut so that 31mm. projects from the base of the cap.

The main assembly and adjustment is best done before any wiring is connected. First fit the push switch, then bolt the four microswitches to the box lid, using 8BA bolts 1/4in. long. Referring to figure one, assemble the parts as follows:

Screw two nuts on to the rod and,

after passing it through the hole in the box lid, fit the large washer and one more nut. Position nuts two and three so that the large washer lies centrally between the microswitch plungers when there is a clearance of 2mm. between the knob and the box lid. Screw down nut one and lock nut two back against it. Secure the washer tightly with nut number three. Fit two more nuts and one small washer and

slide on the baseplate with grommet fitted. Fit the last washer and two more nuts loosely; then, with the identification marks on the baseplate and box lid lined-up, fit the corner bolts, spacers and nuts and pull up tight. Those bolts are 6BA 1in. long.

Position the joystick so that the large washer is near the top of the switch plunger faces as in figure one, then tighten nuts four and five

Figure 2.

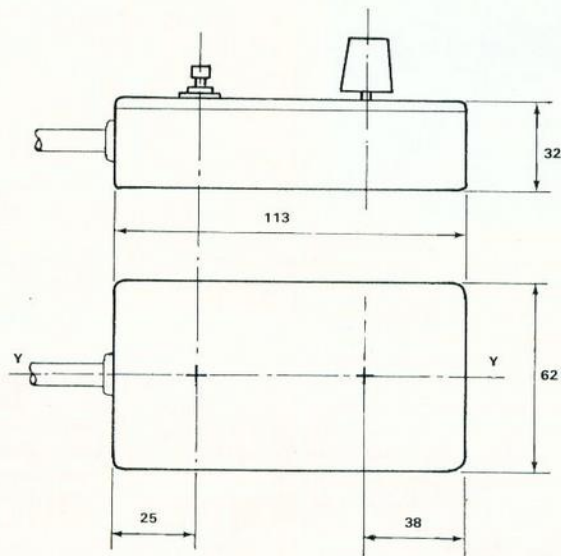
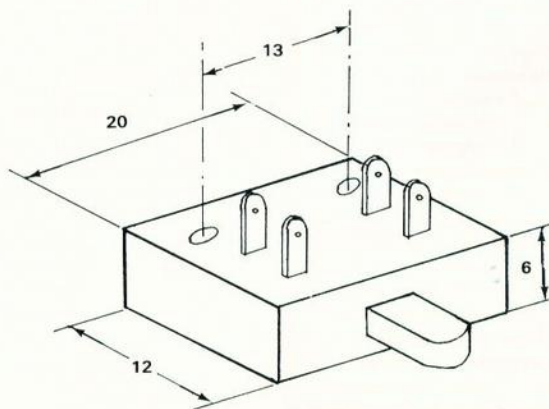


Figure 3.



JOYSTICK

against the grommet. Screw up nuts six and seven, then back off nuts four and five to lock tight against six and seven. Some trial and error is necessary with this adjustment, so that the stick movement is firm but at the same time snaps back to the centre position when released, with no binding.

The assembly should then be checked carefully to ensure that all four switches operate every time, that the stick re-centres sharply when released, and that there is no chance of the washer slipping off the edge of the switch plungers. A final check is to screw the lid on to the box and make sure that the end of the stick does not foul the box when operated.

When satisfied, remove the baseplate, leaving nuts four and six locked in their correct positions. The wiring can then be connected using 10-core cable if it can be obtained. Only eight-core was available for the prototype, so two lengths of thin flex were used in addition.

The microswitches specified have four terminals, two for push to make and two for push to break. Check with a meter or lamp and battery that the correct two are used for push to make. Connect the five switches to one end of the cable, then replace the baseplate and nuts and re-check the adjustment.

The other end of the cable should be passed through the box grommet and the lid fitted to the box, ensuring that no wiring is trapped. If the joystick is to be used with the interface described in the October–November issue, it is suggested that after stripping back the insulation on the outer end of the cable the wire strands of each core are soldered together to form a solid tag. That will make the frequent changing of terminals easier. The separate leads should be taped in groups of two and their functions labelled.

To finish the case, a square of thin card with a cut-out to clear the knob could be glued to the lid to cover the bolt-heads round the knob.

Figure 4.

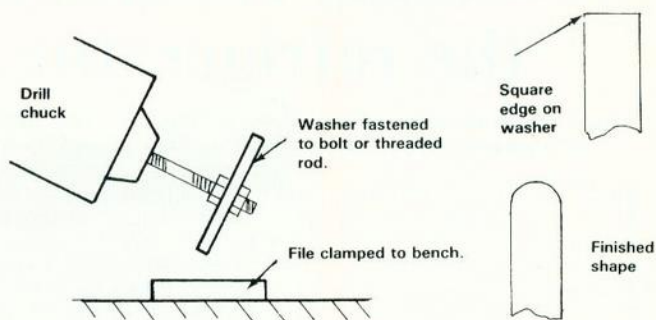
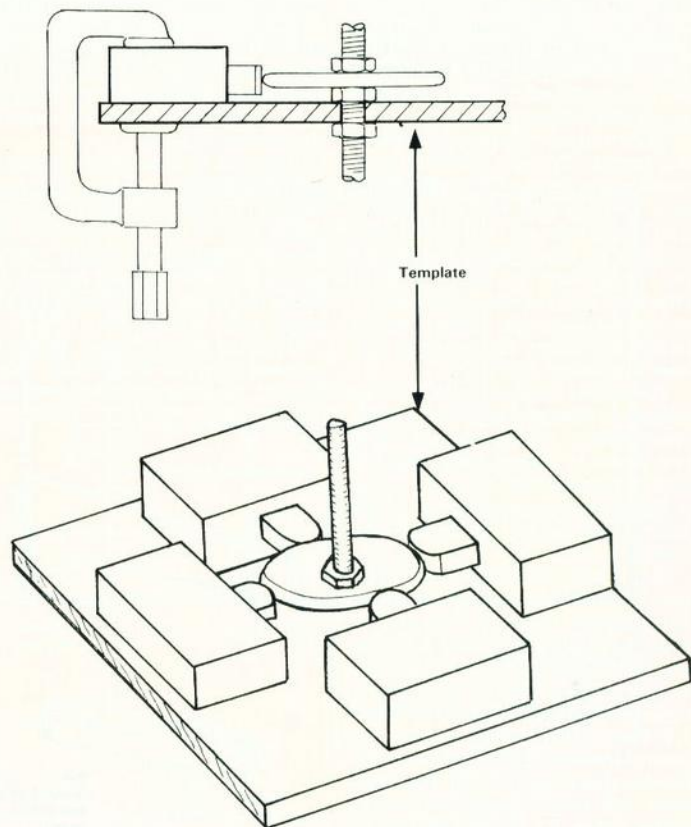


Figure 5.



Avoiding crashes caused by the refrigerator switch

Nothing is more annoying than losing a long program, once it has been typed-in, because of a power surge. This project by David Buckley overcomes that problem.

HOW MANY TIMES have you been working at your computer when the lights have either flickered or the refrigerator switched on and the computer has crashed just before you have managed to save that extra long program you had typed-in? All that can now be a thing of the past.

This project will allow a ZX-81 or Spectrum to continue working normally for anything from 20 minutes to an hour after the mains supply has failed completely. The exact length of time will depend on the number of add-ons to the machine and whether or not you use the printer.

Unfortunately, until we can obtain the pocket TV you will still need mains power for the TV — either that or a portable and 12V car battery. You could, however, still SAVE your program on tape without the TV but you would have to guess when to switch off the recorder. It is best to err on the long side rather than to switch off before the program has been completely SAVED.

The project consists of seven nickel cadmium rechargeable AA cells and a one-transistor trickle charger, plus two diodes to change from mains to battery automatically when the mains is disconnected or goes down. It fits between the power supply and the computer.

Figure two shows the circuit diagram. LED D4 is connected across the incoming power by R1 and so indicates whether the mains supply is on. The voltage across a LED is more or less independent of the current through it and for a red LED is about 1.6 volts. That voltage is used to control transistor TR1 which supplies the charging current for B1. The transistor will turn on until the voltage across either R2 or R2 and R3 in

parallel is equal to the voltage across D4, less the base emitter voltage drop of the transistor.

The base emitter voltage is about 0.8V and so with only R2 in circuit about 5mA will flow and with S1 closed, putting R3 in parallel with R2, about 50mA will flow. The currents are only approximate because the voltage across the LED and the base emitter voltage drop of the transistor vary slightly with the current flowing.

The current flowing through D4 is governed by the Sinclair power supply output voltage which is about 15V with no load dropping down to as low as 8V when powering the computer plus several add-ons.

When the Sinclair power supply is on the computer, current will flow through D1 and S2; D2 is reverse-biased due to the difference in the input voltage and the battery voltage and so no current flows through it. Hence the battery is connected to the supply only through TR1.

When the Sinclair power supply is switched off Vin drops to 0 volts, then D1 becomes reverse-biased and

D2 forward-biased, so current for the computer is supplied from the battery through D2 and S2. All that happens very quickly so there is no interruption to the computer supply and it does not crash.

D3 prevents the battery pushing current the wrong way through TR1 when Vin is at 0V. D5 monitors the output voltage and so indicates whether the computer is supplied with power. Red and green LEDs lit means that the computer is running from the mains and the battery is being trickle-charged. Only the green LED lit means the computer is being supplied from B1. S2 is incorporated so that you can switch off the supply without having to pull out any plugs and is useful for re-setting the computer.

Nickel cadmium AA cells normally have a capacity of about 500mAh which means they can supply 50mA for 10 hours. When discharged at higher currents the capacity will be slightly less. Nickel cadmium cells should be charged for 15 hours at the 10-hour rate, which for AA cells is 50mA, so to charge the batteries from flat S1 should be set to 50mA.

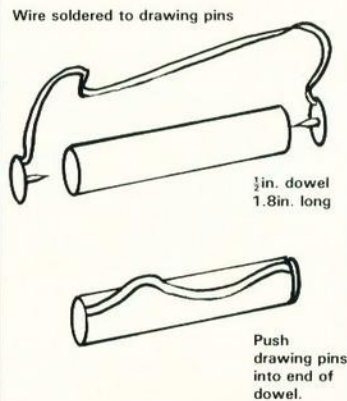
When cells are fully-charged they can be trickle-charged at the 100-hour rate without harm and that keeps them fully-charged. For AA cells the 100-hour rate is 5mA and so, when the batteries are fully-charged, setting S1 to 5mA will trickle-charge them at the 100-hour rate.

Only seven AA cells are used because, in normal use, Vin should be greater than the battery voltage. Each A cell is about 1.2V, which gives 8.4 for the battery.

In the prototype, D1 and D2 are 1N4001 one-amp diodes but since the Spectrum can take more than one amp it is better to use those specified.

As with all projects, you should

Figure 4. Dummy cell.

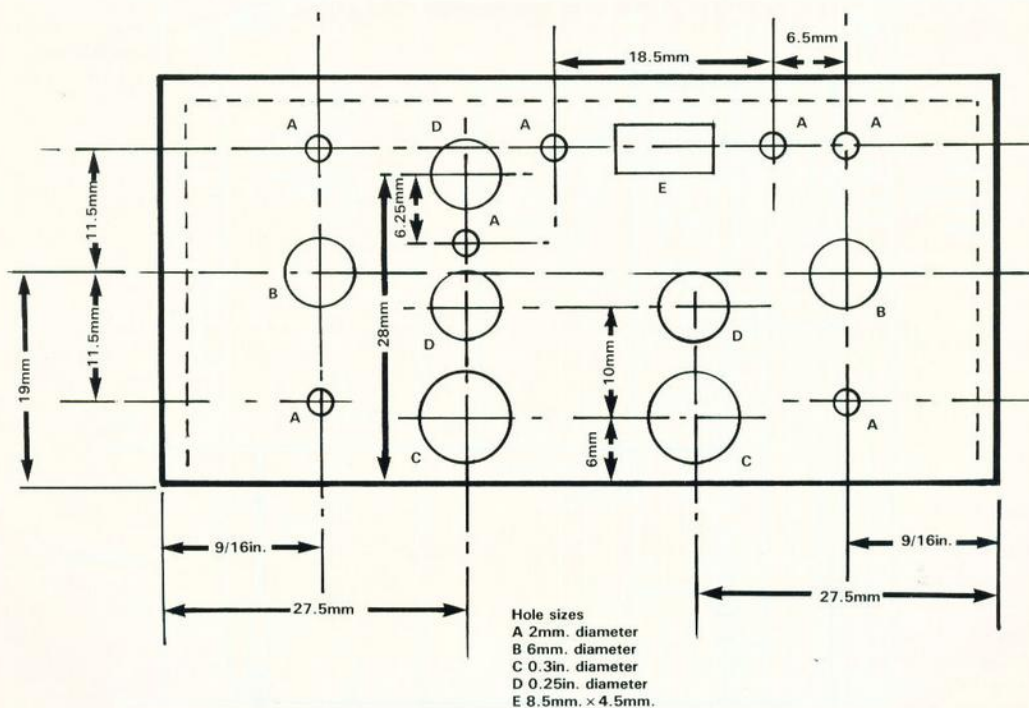




COMPONENTS LIST

- D1, D2 1N5400 3Amp diodes*
 - D3 1N914 75mA diode
 - D4 Red LED 0.2in.
 - D5 Green LED 0.2in.
 - TR1 BC212
 - R1, R4 1K 1/4 watt
 - R2 150 R
 - R3 15 R
 - B1 7 off AA nickel cadmium
 - Box 100x76x41mm. — black plastic [Ambit 21-06044]
 - Feet — 4 small stick-on.
 - Veroboard 36-strip x 50-hole.
 - AA Cell holder — 4-cell holder, 2 off.
 - Battery clips on flying leads, 2 off.
 - 3.5mm — jack socket — 2 off [MS components 1010]
 - S1 Single-pole slide switch.
 - S2 Single-pole miniature toggle.
 - DC power socket, 2 off, 2.1mm. inner. [Ambit 10-00160]
 - DC power plug — 1 off, 2.1mm. inner [Ambit 10-00161]
 - Jack plug — 1 off, 3.5mm.
- * See text.

Figure 1. Holes in box front.



BATTERY SUPPORT

obtain all the parts before you start construction because some of them may be a slightly different size from those quoted in the article.

The same consideration means that it is best to leave cutting the Vero tracks until after all the components are soldered in place. In that way it is easier to tell where a track break should go and if one of the components is of an unusual size you can move one of the track breaks to accommodate it, rather than finding you have broken the tracks where you wanted to solder a component.

The construction is straightforward. First chisel-off all the board guides on what will be the front end of the box and chisel-off the central board guides at the other end. Figure one shows the layout of the front end of the box. I make no excuse for using metric and Imperial dimensions on the same drawing; 9/16in. is easier to measure than 14.3mm. and LED

holders are made to fit a 1/4in. hole — 6.35mm. — rather than a 6mm. hole.

The Veroboard is cut from a 36-strip x 50-hole piece, the offcut being used for the box divider. You will find the Veroboard just wide enough to fit against the back edge of the box and leave room at the front for the lip on the 3.5mm. jack sockets. Cut holes in the corners to suit the screw-

holes in the box corners. When the box is assembled the lid, which will be the bottom, will no longer fit flush but will leave a 1 mm. groove. The Veroboard will then be clamped firmly between the two halves of the box.

Although the circuit layout is widely-spaced, there is not much room on the front panel for all the components and so if you are unsure of your abilities it would be better to use the next size of box.

After mounting all the components on the front panel, wire them, linking one end of D1 to the input sockets and the other to the circuit board via a flying lead. Similarly with D5 to the output sockets. Note the polarity of the ZX-81 and Spectrum plugs; figure seven gives details.

Switch S2 should be wired so that on is down; that way if you catch the switch accidentally you are unlikely to switch it to off.

When you have wired everything

Figure 5. Box divider.

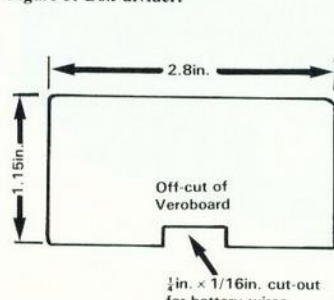
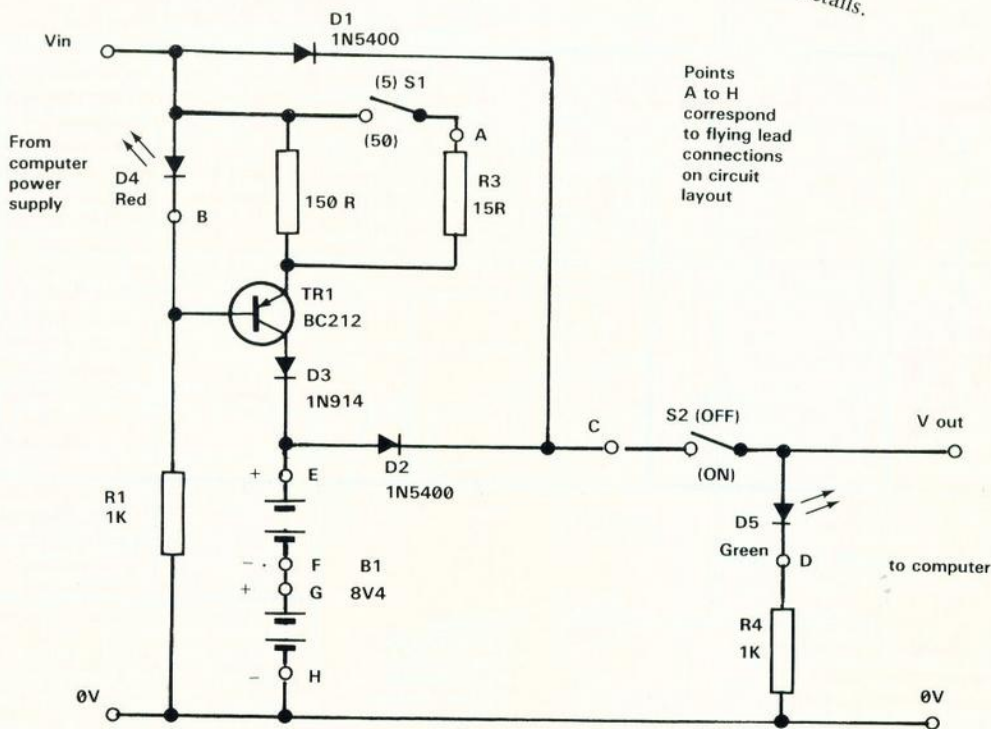


Figure 2. Circuit diagram.



BATTERY SUPPORT

together and checked everything insert the AA cells and the dummy cell into the holders and assemble into the box. The battery clips should be vertical at the back of the box with the battery wires running underneath them along what will be the top of the box. The battery holders are held in place by the box divider, shown in figure five. Instead of fitting that divider between the board guides, insert it just to the back of the front set of guides and it will hold the batteries in place.

Remember that charged nickel cadmium cells should be handled with caution. If you short one a good deal of current will flow and the cell may explode; it will at least become very hot and probably be damaged internally.

There are output sockets on the front and a switch S2 to guard against accidental damage when the unit is not connected to the computer.

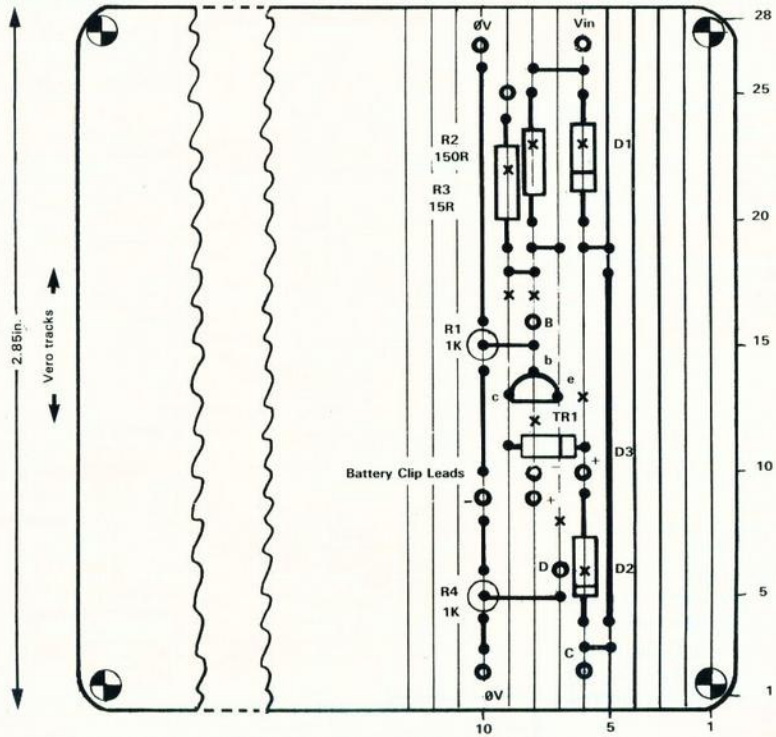
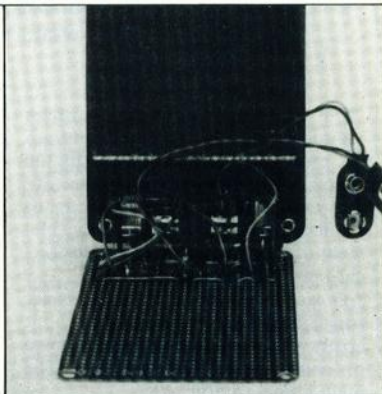
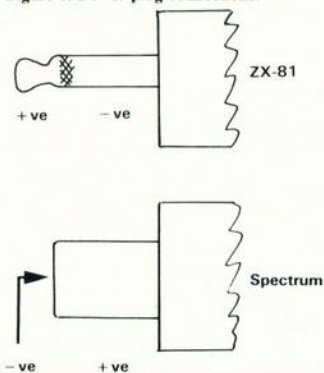
not connected to the computer. If you

have a ZX-81 you could omit the Spectrum-type power sockets and, similarly, if you have a Spectrum you could omit the jack sockets. If you use both, if you make up a lead with a Spectrum power connector on one end and a 3.5 mm. jack plug on the other, one way round it will plug into

the Spectrum and the other way it will plug into the ZX-81.

If you do not mind taking the unit apart you could use it to charge seven or eight AA cells for other equipment, such as a tape recorder or radio.

Figure 6. Power plug connections.



The good author's guide to explaining projects

IF YOU WISH to submit articles to *Sinclair Projects* we would appreciate it if you adhere to the following rules. Although they are not exclusive it would help us to evaluate projects if there is some element of compatibility between different presentations.

It would also make it much easier for us to publish the articles without errors as there would be less chance of confusion about meanings. The main points to note are:

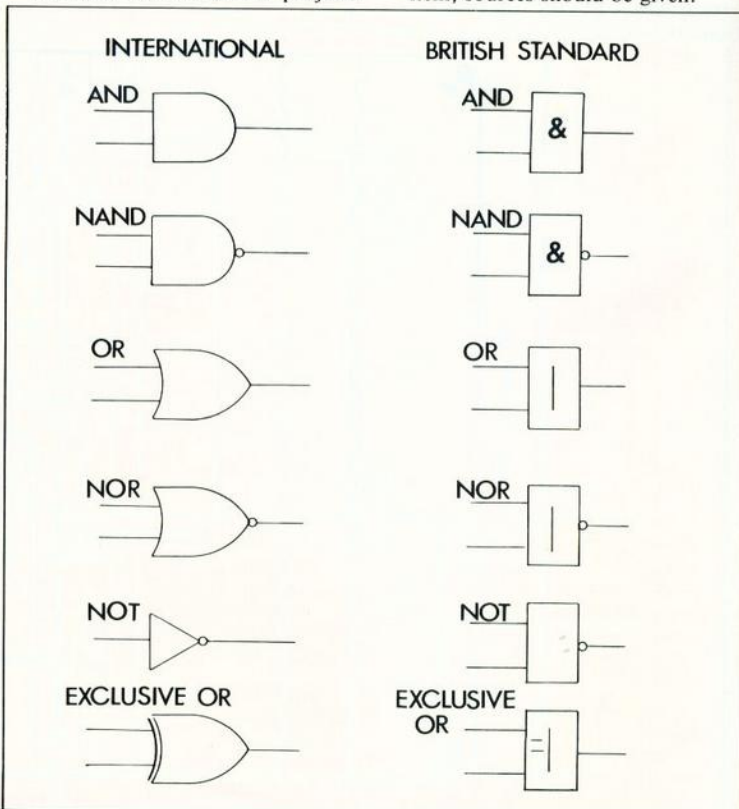
- All manuscripts should be typed with double-line spacing.
- Logic symbols should follow international standards.
- Circuit symbols should follow international standards.
- Circuit diagrams should have the values of the components shown, not a reference to a component table.
- Parts of integrated circuits should be designated with a note on the diagrams—IC5 - 74LS14, for example.
- All circuits should be designed for construction using standard Veroboard. Any printed circuit board designs are likely to be returned for conversion. Submission of a project on a PCB will not exclude future publication.
- Any constructional detail which is unusual or slightly complicated should be illustrated with simple hand-drawn diagrams, showing how it can be implemented.

For those who are familiar with British Standards logic symbols, they are shown here, along with the international symbols.

- Where projects are designed to plug into the rear of the computer they should be built on the 36 strips \times 50 holes size of Veroboard with the board vertical and an extender card at the rear to allow other projects to be stacked. For Spectrum projects the connector should be central on the board with four strips spare at each side and one row of holes spare beneath the connector. For ZX-81 projects

the connector should have two rows of holes spare beneath it with seven spare strips at the right-hand side. Where that is impracticable, boards may be remote and connected by ribbon cable to a socket and extender card assembly.

- Components should be available to hobbyists through the normal retail channels and where a component is not a widely-stocked item, sources should be given.



User-defined functions improve sound effects

The audio-output effects on the Spectrum are limited and most solutions have difficulties. Robert Stafford provides a sophisticated answer.

AS ANY Spectrum owner will know, the BEEP command is very limited as a method of producing sound effects. One method of producing better sound effects for a Basic program would be to write machine code subroutines but, as the Spectrum USR function provides no method of passing values from the Basic calling program to the machine code subroutine, many sound effects subroutines would be needed for one program.

That method could, therefore, be ruled out as wasteful of memory, both in the amount of code and the data statements needed to hold it in the Basic program.

There is, however, a method of passing values from a Basic program to a machine code subroutine, using a user-defined function — UDF.

DEFADD, the system variable at address 23563 — 5COB hex — is described on page 173 of the Spectrum manual as "Address of arguments of user-defined function if one is being evaluated", so if the subroutine is called while a UDF is being evaluated, the values required will have been evaluated by the interpreter and stored in memory, at the address pointed to by DEFADD.

The next problem is how to load the numbers into the registers used by the machine code. Figure one shows how the numbers are stored in the computer memory. X, Y and Z are the variable names used in the definition of the function, rather than the

names used when the function is called. OE — = 14 decimal — is the code which indicates a number and the next five bytes are the Spectrum representation of the value.

Assuming the value is an integer in the range —65536 to 65535 the value is in two's complement form in the third and fourth bytes of the number — see page 197 of the manual, para-

graph four. How can this be used to produce sound effects? Some idea of how the Spectrum produces sound would be useful. It is done by sending a series of clicks to the speaker. The subroutine which does it is in ROM at address 949 — 03B5 hex. When it is called the content of register pair HL controls the time between clicks and so controls the pitch. Register pair

Figure 2.

Label	Mnemonic	Decimal	Hex	Comment
	PUSH IX	221 229	DD E5	Save IX to avoid corrupting BASIC on return. (23563) = DEFADD
	LD IX,(23563)	221 42 11 92	DD 2A 0B 5C	
	LD B,(IX + 4)	221 70 4	DD 46 04	
	LD C,(IX + 5)	221 78 5	DD 4E 05	Load no. of repeats
	INC C	12	OC	
LOOP1:	PUSH BC	197	C5	
	LD B,(IX + 36)	221 70 36	DD 46 24	
	LD C,(IX + 37)	221 78 37	DD 4E 25	Load no. of decrements
	INC C	12	OC	
	LD H,(IX + 13)	221 102 13	DD 66 0D	
	LD L,(IX + 12)	221 110 12	DD 6E 0C	Initial pitch.
LOOP2:	PUSH BC	197	C5	
	LD D,(IX + 21)	221 86 21	DD 56 15	
	LD E,(IX + 20)	221 94 20	DD 5E 14	Duration.
	PUSH HL	229	E5	
	PUSH IX	221 229	DD E5	Save contents of registers before calling subroutine.
	CALL 949	205 181 3	CD B5 03	Call subroutine
	POP IX	221 225	DD E1	
	POP HL	225	E1	Retrieve data from stack.
	LD d,(IX + 29)	221 86 29	DD 56 1D	
	LD E,(IX + 28)	221 94 28	DD 5E 1C	Decrease of pitch.
	ADC HL,DE	237 90	ED 5A	Increase in HL decreases pitch.
	POP BC	193	C1	
	DJNZ LOOP 2	16 229	10 E5	
	DEC C	13	OD	Another decrement?
	JR nz,-5	32 251	20 FB	
	POP BC	193	C1	
	DJNZ LOOP1	16 209	10 D1	
	DEC C	13	OD	Another repeat?
	JR nz,-5	32 251	20 FB	
	POP IX	221 225	DD E1	
	RET	201	C9	Return to Basic.

Figure 1.

(X OE xx xx xx xx xx, Y OE yy yy yy yy yy, Z etc . . .) (DEFADD)

SOUND EFFECTS

DE contains the number of clicks or the duration of the note.

To produce interesting sound effects, what parameters are required? Obviously the initial pitch and the note duration are required but that would be no better than the BEEP instruction. So two other parameters are needed — an increase or decrease in pitch together with the number of times the increase or decrease is to be implemented. The fifth and final parameter is the number of times the total sound is to be repeated.

I decided to enter the parameters into the function in the order number of repeats; initial pitch; duration of each note; decrease of pitch; number of decrements.

The subroutine will accept negative values, so if you want the pitch to increase enter a negative decrease.

Figure two shows the machine code subroutine. Program one is the loader and also defines the function used to

call the subroutine. The code is relocatable but remember to change the defined function as well.

For a 48K Spectrum, change the addresses 32533 to 65301, 32534 to 65302, and 32599 to 65367.

Program two demonstrates how

the subroutine can be used and a few of the sounds which can be produced.

The best way to discover and understand what can be done is to experiment but, before you do so, save the program, because it is possible to set it going with sounds which could take hours to finish.

Program 1.

```

9995 STOP
9996 FOR C= 32534 TO 32599: READ
A:POKE C,A:NEXT C
9997 DATA 221,229,221,42,11,92,221,
70,4,221,78,5,12,197,221,70,36,221,
78,37,12,221,102,13,221,110,12,197,
221,86,21,221,94,20,229,221,229,
205,181,3,221,225,225,221,86,29,
221,94,28,237,90,193,16,229,13,32,
251,193,16,209,13,32,251,221,
225,201
9998 DEF FN M(R,P,D,I,N)=USR 32534
9999 RETURN
  
```

Program 2.

```

10 CLEAR 32533:GOSUB 9996
20 FOR C=1 TO 5:LET L=FN
M(1,256,256,16,10)+FN
M(1,416,256,-16,10):NEXT C
30 LET L=FN M(20,700,30,-4,8)
40 LET L=FN M(20,256,30,10,20)
50 LET L=FN M(60,1000,10,300,2)
60 LET L=FN M(20,256,2,-1,250)
70 LET L=FN M(1,256,5,1,512)
80 LET L=FN M(2,5000,2,3,15)
90 GOTO 20
  
```

If you're a *serious* Sinclair user — why don't you stop playing games?



If you need a new challenge that does'nt involve saving the universe from destruction, beating off green monsters or flying a spaceship — we can bring you down to earth with stimulating, practical projects for the ZX81 and Spectrum in **Sinclair Projects** magazine!

In recent issues we have shown how to use your Sinclair for controlling your central heating . . . improving the graphics . . . build a printer interface . . . and many more ideas that tax your ability and ingenuity.

Sinclair Projects is published every two months as a glossy, instruction-packed magazine that gives you all the encouragement you need to exercise your talent and take a serious look at what your Sinclair can do for you.

Each issue can contain as many as FIVE step-by-step projects — yet it's yours for JUST 95p. So if you want a break from playing games, make sure you order **YOUR Sinclair Projects** from your newsagent today — or fill in the form below and we will send it direct to you, six times per year.

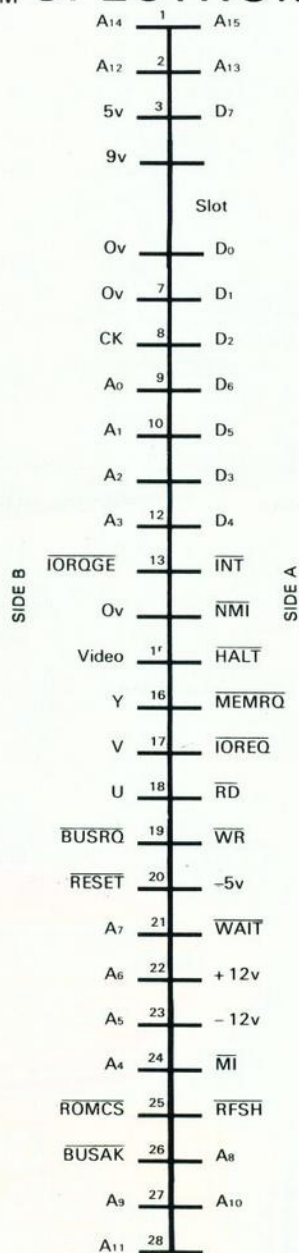
Mail to: ECC Publications Limited, 196-200 Balls Pond Road, London N1 4AQ Yes — I'd like to subscribe to
Sinclair Projects (6 issues — price £6.60 including P&P) I enclose a cheque for £ _____
 Please charge my credit card: Card name _____ Address _____ Number _____
 Name _____ Signature _____ Date _____

NB This offer applies to UK subscribers only. Overseas rates available on request.

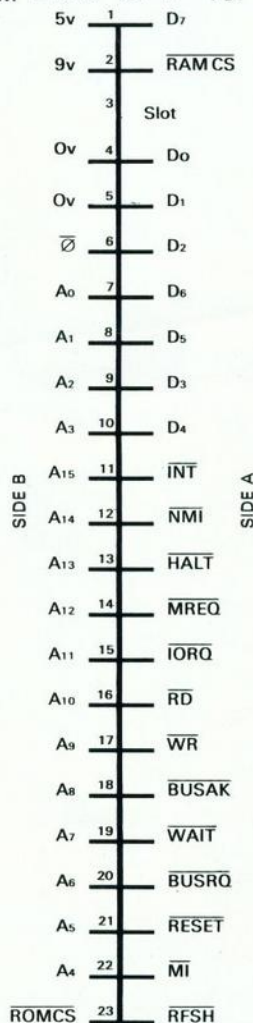
EDGE CONNECTOR

Edge Connector signal allocation

BOTTOM SPECTRUM TOP

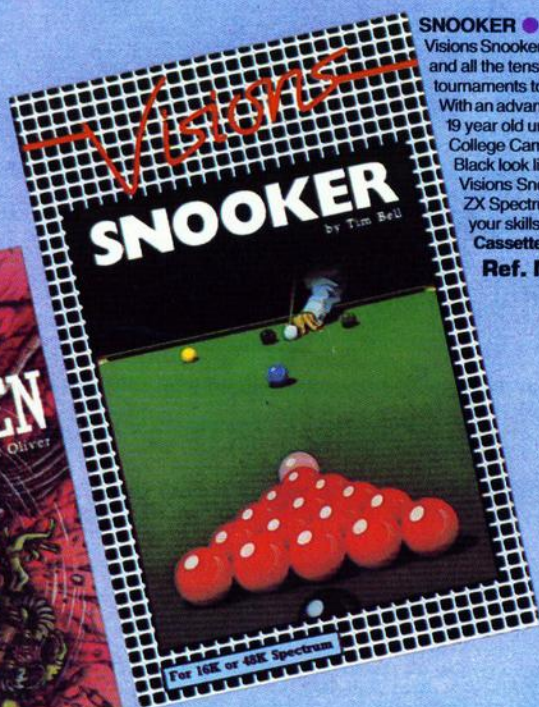


BOTTOM ZX-81 TOP



ALL THE BEST F

Here's a sure-fire way of making certain this Christmas is packed full of fun for you and your friends. We've searched for brilliant new program sources throughout the U.K. and North America to find an exciting collection of new games — and business programs — many of which cannot be bought by mail order from any other source! These are our latest exclusive offerings. Make sure you place your order now to receive them in time for Christmas.



SNOOKER ●

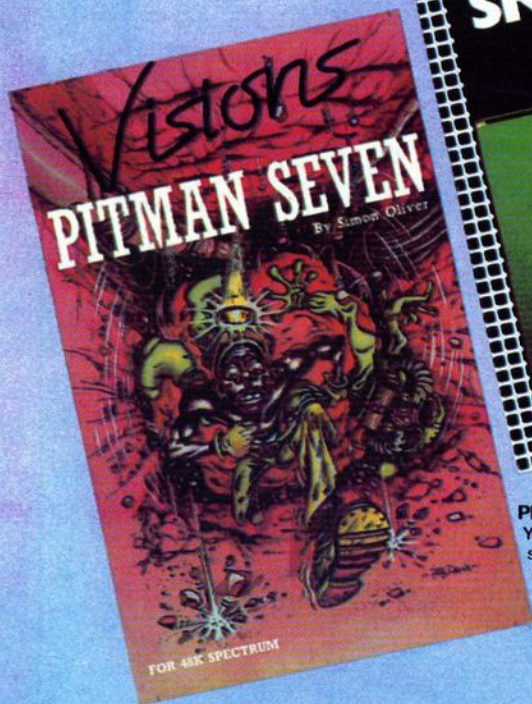
Visions Snooker brings all the excitement and all the tension of big time tournaments to your TV set.

With an advanced program written by a 19 year old undergraduate at Queens College Cambridge, it makes Pot Black look like a load of old balls.

Visions Snooker for the 16K ZX Spectrum. It's an exciting test of your skills on the cue.

Cassette price: £8.95.

Ref. No: 2-53



PITMAN SEVEN ●

Your mission is to rescue two teams of seven desperate men, trapped underground on level five. You must bring each man to the surface, surviving the dangers you meet en route.

ZX Spectrum 48K.

Cassette price: £6.95.

Ref. No: 2-52

GREAT VALUE! TREMENDOUS SELECTION! PLUS A FREE OFFER EVERY TIME!

Fill in the order form right away — we're guaranteeing fast delivery, quality and satisfaction (after all, we want you to come back for more!)

The Software Workshop, Yew Tree, Selborne, Hants GU34 3JP

FREE BLANK C15 C
WITH EVERY TWO C

Remember there's no
cassettes you receive if
why not get together
members and

GUAR

Order with complete
not entirely satisfi
your purchase rel
days and we will p

FOR CHRISTMAS!

And here's a further selection of the latest games, the best-value software for your ZX-81 or Spectrum.

ZX81 Software

1-01 Stock Market

Buy and sell your way to millions! 16K RAM

£3.95

1-02 Football League

First division fun for the soccer enthusiast. 16K RAM

£3.95

1-03 Test Match

Match your wits alongside the superstars. 16K RAM

£3.95

1-12 Avenger

Avoid missiles and bombs to become the ruler. 16K RAM

£4.95

1-13 Protector

Defend your own ship from oncoming attackers. 16K RAM

£4.95

1-31 Comp-U-Share

Investment management program for unit trusts, shares and loan stocks. Complete documentation included. 16K RAM

£9.95

Spectrum Software

2-13 Sentinel

Guard your mother ship against alien attacks. 48K RAM

£4.95

2-14 Meteor Storm

Spectrum version of the ever-popular arcade game. 16K or 48K RAM

£4.95

2-15 Star Trek

Popular space program brought to life by excellent graphics. 48K RAM

£4.95

2-21 Frogger

Manoeuvre the frog across the road avoiding heavy traffic. 48K RAM

£5.95

2-22 Crazy Balloons

Guide the balloons round the maze without bursting. 48K RAM

£5.95

2-23 Arcadia

The expert's version of the popular 'Invaders' game. 16K or 48K RAM

£5.95

2-24 Golf

The finest of golf handicap games. 48K RAM

£5.95

2-25 Test Match

More exciting than the real thing! 48K RAM

£5.95

2-26 Derby Day

This favourite has to be a winner. 48K RAM

£5.95

2-41 Comp-U-Share

See 1-31 under ZX81. 48K RAM

£9.95



SHEER PANIC

Mining for Magnetic Quartz is a hazardous business. You have to ensure that there is plenty of oxygen to breathe, fight off the local monsters with only a shovel and counter interference with your consciousness.

ZX Spectrum 16K or 48K

Cassette price: £5.95.

Ref. No: 2-51

COMPUTER CASSETTE TAPES YOU ORDER!

To the number of free tapes you order justifies them — so friends or user group the freebies?

WARRANTY

Confidence. If you are with the quality of it to us within 7 days we will replace a replacement.

To: The Software Workshop, Yew Tree, Selborne, Hants GU34 3JP

I wish to order the following programs. I understand that:

- * I will receive a FREE blank cassette with every 2 programs ordered
- * I can return products within seven days if not entirely satisfied and receive a replacement.

Ref No	Qty	Title	Price

Postage, packing and handling: add 45p for the first cassette, and 25p for each additional cassette. Non-UK orders add extra 50%

Total

I enclose a cheque/postal order for _____

Name _____

Address _____



(Allow 28 days MAXIMUM FOR DELIVERY)

The Galaxy's **FIRST** ever computer comic!

Zooming into touchdown at WH Smiths, John Menzies and other good newsagents now
and every fortnight... only 40p.

Order your copy TODAY!

Bursting with great new comic strips... exciting stories... astounding facts...
big prizes... competitions... fascinating quizzes... star personalities.
And that's just the start of Britain's newest, brightest, most fun-packed comic ever!

LOAD RUNNER

It's the only comic for the age of the computer -
it puts the rest back with the dinosaurs!



**LOAD
RUNNER**

**Only
40p**

AVAILABLE NOW

and every fortnight... order your copy **TODAY!**