

# sinclair projects

95p

SIX GREAT PROJECTS TO IMPROVE YOUR MACHINE

Financial decision-making



Printer Interface  
Radio Teleprinter  
Input/output Port

Spectrum Control Console  
Machine code logical operations

# TEC Telford Electronics & Computing

## The ZX8100 Deal

Send your ZX81, and for £39.50 (plus £2.50 p&p)  
you will get back a computer 100 times better

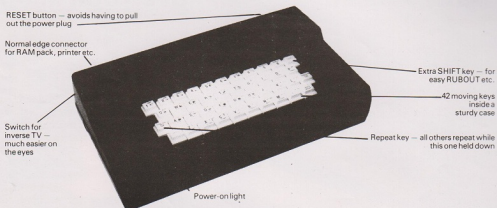

All the above features for less than the amount some others charge for a keyboard you have to solder yourself. Optional extras are:

- 2 Atari-compatible joystick sockets plus sample game.....£9
- \*Your 16K RAM pack fitted inside case.....no charge, but see below
- \*Our 16K RAM pack supplied & fitted inside case.....£25
- Two-slot motherboard.....£16
- Three-slot motherboard.....£20
- \*I/O board supplied & fitted inside with connectors at back.....£22
- Video output socket for computer monitor.....£2
- Character-graphics board.....£30
- \*These items require a motherboard to be ordered at the same time, and will take up one slot each.

There is a 6-month guarantee given against any fault or defect on the ZX81 main board as well as any items fitted by TEC (Excludes normal wear & tear).

### WANTED

Used ZX81's - up to £25 paid.  
Write or call for details.

### ALSO

Visit our showrooms at 26 Bradford St, Shifnal,  
Shropshire. For Oric's, software, books,  
components etc. etc.

To: **TELFORD ELECTRONICS & COMPUTING**  
26 Bradford Street,  
Shifnal, Shropshire

From .....

ZX8100 conversion ..... **£39.50**

Opt. Extras: .....

**p&p £2.50**

**TOTAL** .....

Send your 16K RAM if you want it fitted.

# Sinclair Projects

## 6 MONEY MAKER

A software project which helps the taking of major financial decisions

## 10 PRINTER OUTLINE

We take a close look at the ZX Printer

## 12 RADIO TELEPRINTER

A way to get the international news direct on your television

## 20 SPECTRUM CONSOLE

How to hide all those unsightly wires

## 24 INPUT/OUTPUT PORT

A new use for the cassette player port

## 30 MACHINE CODE GUIDE

An easy way to overcome the major problems of learning machine code

## 34 RS232 INTERFACE

A cheap way to allow you to connect your ZX-81 to a large printer

## 43 LETTERS

Your comments on our first issue

## 46 EDGE CONNECTOR

Our regular page illustrating the connections from both the ZX-81 and the Spectrum

## 47 UPDATE

We look back at our first issue and make some additions and corrections

## FROM THE EDITOR

**W**ELCOME to the second edition of *Sinclair Projects*. We hope that you find this more stimulating than the first one. Although a number of problems in the first issue meant that some diagrams were omitted, we hope that we have overcome those problems. Thank you to all those who wrote to offer valuable advice on how the magazine could be improved; there is obviously a need for a magazine such as this, as the response was beyond our expectations.

In this issue we are concentrating on a number of projects which, although slightly less hardware-based than those in the last issue, still provide the constructor with plenty to do. For example, we look at how we can use a ZX-81 to run a radio teleprinter. That will allow those with an appropriate receiver to intercept signals from news-agencies such as Reuters and TASS, without having to wait for the morning papers. We also look at a very simple input/output port which uses the cassette interface.

For those of you who are disenchanted with all the bits and pieces needed to get a Sinclair system going but do not want to pay £30 or more for a console to put them in, we offer a very simple control console for you to make.

Finally, on the construction side, we look at an interface, mainly in software, which will let you use commonly-available RS232 printers with Sinclair computers.

On the software side an interesting article on financial decision-making is coupled with a series of demonstration programs which illustrate the logical operations of the Z-80 processor. We also look at the inner workings of the ZX printer.

This marvellous list of items is supplemented by your letters an update on our first issue and our usual page illustrating the edge connections of the ZX-81 and the Spectrum. If you would like to contribute articles to *Sinclair Projects* we intend to publish guidelines for their writing in a future edition.

Editor Nigel Clark Consultant editor Robin Bradbeer Technical assessors Richard Larkin, Peter Whittle, Dave Buckley, Bazyle Butcher  
Production editor Harold Mayes MBE Design Elaine Bishop and Bill Scolding Editorial director John Sterlicchi Advertisement director  
Simon Horgan Advertisement manager John Ross Advertisement Executive Annette Burrows Editorial/production assistant Margaret  
Hawkins Managing director Terry Cartwright Chairman Richard Heise

Sinclair Projects is published bi-monthly by ECC Publications Ltd. It is in no way connected with Sinclair Research Ltd.

Telephone all departments: 01-359 7481. If you would like to contribute to any of the *Sinclair User* group of publications please send programs, articles or ideas for hardware projects to Sinclair User and Projects, ECC Publications, 30-31 Islington Green, London N1 8BJ. We pay £50 per 1,000 words for each article used.

© Copyright 1983 Sinclair Projects ISSN 0264/0449. Printed and typeset by Cradley Print PLC, Warley, W. Midlands. Distributed by Spotlight Magazine Distribution Ltd, 1 Benwell Road, Holloway, London N7. 01-607 6411.

# Sinclair ZX Spectrum

**16K or 48K RAM...  
full-size moving-  
key keyboard...  
colour and sound...  
high-resolution  
graphics...  
From only  
£125!**

First, there was the world-beating Sinclair ZX80. The first personal computer for under £100.

Then, the ZX81. With up to 16K RAM available, and the ZX Printer. Giving more power and more flexibility. Together, they've sold over 500,000 so far, to make Sinclair world leaders in personal computing. And the ZX81 remains the ideal low-cost introduction to computing.

Now there's the ZX Spectrum! With up to 48K of RAM. A full-size moving-key keyboard. Vivid colour and sound. High-resolution graphics. And a low price that's unrivalled.

## Professional power— personal computer price!

The ZX Spectrum incorporates all the proven features of the ZX81. But its new 16K BASIC ROM dramatically increases your computing power.

You have access to a range of 8 colours for foreground, background and border, together with a sound generator and high-resolution graphics.

You have the facility to support separate data files.

You have a choice of storage capacities (governed by the amount of RAM). 16K of RAM (which you can upgrade later to 48K of RAM) or a massive 48K of RAM.

Yet the price of the Spectrum 16K is an amazing £125! Even the popular 48K version costs only £175!

You may decide to begin with the 16K version. If so, you can still return it later for an upgrade. The cost? Around £60.



## Ready to use today, easy to expand tomorrow

Your ZX Spectrum comes with a mains adaptor and all the necessary leads to connect to most cassette recorders and TVs (colour or black and white).

Employing Sinclair BASIC (now used in over 500,000 computers worldwide) the ZX Spectrum comes complete with two manuals which together represent a detailed course in BASIC programming. Whether you're a beginner or a competent programmer, you'll find them both of immense help. Depending on your computer experience, you'll quickly be moving into the colourful world of ZX Spectrum professional-level computing.

There's no need to stop there. The ZX Printer—available now—is fully compatible with the ZX Spectrum. And later this year there will be Microdrives for massive amounts of extra on-line storage, plus an RS232/network interface board.



## Key features of the Sinclair ZX Spectrum

- Full colour—8 colours each for foreground, background and border, plus flashing and brightness-intensity control.
- Sound—BEEP command with variable pitch and duration.
- Massive RAM—16K or 48K.
- Full-size moving-key keyboard—all keys at normal typewriter pitch, with repeat facility on each key.
- High-resolution—256 dots horizontally x 192 vertically, each individually addressable for true high-resolution graphics.
- ASCII character set—with upper- and lower-case characters.
- Teletext-compatible—user software can generate 40 characters per line or other settings.
- High speed LOAD & SAVE—16K in 100 seconds via cassette, with VERIFY & MERGE for programs and separate data files.
- Sinclair 16K extended BASIC—incorporating unique 'one-touch' keyword entry, syntax check, and report codes.



# um

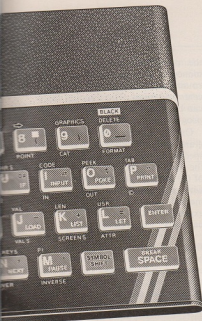

## ZX Spectrum software on cassettes - available now

The first 21 software cassettes are now available directly from Sinclair. Produced by ICL and Psion, subjects include games, education, and business/household management. Galactic Invasion... Flight Simulation... Chess... History... Inventions... VU-CALC... VU-3D... 47 programs in all. There's something for everyone, and they all make full use of the Spectrum's colour, sound and graphics capabilities. You'll receive a detailed catalogue with your Spectrum.

## RS232/network interface board

This interface, available later this year, will enable you to connect your ZX Spectrum to a whole host of printers, terminals and other computers.

The potential is enormous. And the astonishingly low price of only £20 is possible only because the operating systems are already designed into the ROM.

# sinclair

Sinclair Research Ltd, Stanhope Road,  
Camberley, Surrey GU15 3PS.  
Tel: Camberley (0276) 685311.

## The ZX Printer - available now

Designed exclusively for use with the Sinclair ZX range of computers, the printer offers ZX Spectrum owners the full ASCII character set - including lower-case characters and high-resolution graphics.

A special feature is COPY which prints out exactly what is on the whole TV screen without the need for further instructions. Printing speed is 50 characters per second, with 32 characters per line and 9 lines per vertical inch.

The ZX Printer connects to the rear of your ZX Spectrum. A roll of paper (65ft long and 4in wide) is supplied, along with full instructions. Further supplies of paper are available in packs of five rolls.



## The ZX Microdrive - coming soon

The new Microdrives, designed especially for the ZX Spectrum, are set to change the face of personal computing.

Each Microdrive is capable of holding up to 100K bytes using a single interchangeable microfloppy.

The transfer rate is 16K bytes per second, with average access time of 3.5 seconds. And you'll be able to connect up to 8 ZX Microdrives to your ZX Spectrum.

All the BASIC commands required for the Microdrives are included on the Spectrum.

A remarkable breakthrough at a remarkable price. The Microdrives are available later this year, for around £50.



## How to order your ZX Spectrum

**BY PHONE** - Access, Barclaycard or Trustcard holders can call 01-200 0200 for personal attention 24 hours a day, every day. **BY FREEPOST** - use the no-stamp needed coupon below. You can pay by cheque, postal order, Access,

Barclaycard or Trustcard.

**EITHER WAY** - please allow up to 28 days for delivery. And there's a 14-day money-back option, of course. We want you to be satisfied beyond doubt - and we have no doubt that you will be.

To: Sinclair Research, FREEPOST, Camberley, Surrey, GU15 3BR.

Qty	Item	Code	Item Price £	Total £	Order
	Sinclair ZX Spectrum - 16K RAM version	100	125.00		
	Sinclair ZX Spectrum - 48K RAM version	101	175.00		
	Sinclair ZX Printer	27	59.95		
	Printer paper (pack of 5 rolls)	16	11.95		
	Postage and packing: orders under £100	28	2.95		
	orders over £100	29	4.95		
				Total £	

Please tick if you require a VAT receipt

\*I enclose a cheque/postal order payable to Sinclair Research Ltd for £ \_\_\_\_\_

\*Please charge to my Access/Barclaycard/Trustcard account no. \_\_\_\_\_

\*Please delete/complete as applicable \_\_\_\_\_

Signature \_\_\_\_\_

PLEASE PRINT

Name: Mr/Mrs/Miss \_\_\_\_\_

Address \_\_\_\_\_

\_\_\_\_\_

\_\_\_\_\_

\_\_\_\_\_

\_\_\_\_\_

\_\_\_\_\_

\_\_\_\_\_

\_\_\_\_\_

\_\_\_\_\_

\_\_\_\_\_

MEG812

FREEPOST - no stamp needed. Prices apply to UK only. Export prices on application.

# Planning the cash for better decisions

*Despite its size the ZX-81 can be made into a useful business tool. David Nowotnik details how this can be done*

**M**OST PEOPLE consider the options carefully before deciding how and on what to spend their income. It is usually only in business decisions that a financial plan is made, considering carefully the probable income/expenditure and hence profit, resulting from various courses of action.

Those plans often require many repetitive calculations to derive a final figure which indicates whether or not a project appears financially viable. Computers now provide considerable help in carrying-out the calculations and so speed the decision-making process. While the Sinclair ZX-81 cannot match the convenience and flexibility of more expensive micros, there is no reason why it cannot also carry-out the repetitive business calculations and present the results in a form which may be used in making decisions.

A program called Investment Appraisal uses the technique of discounted cashflow and allows the ZX-81 to become a modest business machine.

When we want to decide whether a project is worth considering, a financial plan is made on the cashflow expected from that project. That is, for each year of the project, all items of income and expenditure are estimated and the net cash flow for each year is calculated.

A simple approach in making the final decision would then be to sum all the individual net cashflows to derive a figure which indicates whether the project will or will not show an overall profit.

In real terms, the approach is unrealistic as it ignores the time value of money. That may sound confusing but consider that, in most cases, we will want to invest money now to

make a profit in the future. Say the investment is £1,000 this year and the profit we expect to derive from our project in five years is also £1,000. A 100 percent return sounds good but it is over five years. In the same period, we could have put the money in a building society and without all the problems of producing and selling a product, made almost as much.

The way in which the individual annual cashflows of our financial plan can be adjusted for their time value is by the technique of discounted cashflow. To consider how it works, say we invested £100 at 10 percent interest. At the end of one year we would have £110. So we could say that £110 in one year's time is worth £100 now, i.e., the discounted value of £110 in the second year of the project is £100. In that way, all cashflows of our financial plan can be discounted to year one, so that their time value is eliminated.

The ZX-81 program Investment Appraisal appears in figure one. The first part of the program sets up the matrix for all the data, then allows for entry of that data. When the program is RUN, the project name and term are the first two pieces of information required. The project term is, usually, the development time plus the product life, in years.

The next piece of information required is the number of income/expenditure items. That is the total number of items which will contribute to the individual annual cashflows—e.g., sales, overheads, production costs, development, advertising. The final piece of information required on the first page is the factor for discount. Arguments for the choice of discount factor are complex but a simple solution would be to choose a figure which reflects

the percentage cost of borrowing money to finance the project. Discount factors of between 10-25 percent are typical. The discount factor can be altered, if desired, later in the program.

On the second page of the program, you will be asked to name the specific income/expenditure items. In the remaining pages of the first part of the program the table is completed with entry of all the data, i.e., numerical values for all the income/expenditure items for all the individual years of the project.

The unit of this data is not specified; it could be £ or £'000. Whatever is selected as the unit, all data is expected to be integer. There is little point in decimal-point accuracy in values which are predicted. Essentially they are a mixture of sales forecasts, historical data, and experience. Items of income should be entered as positive values; items of expenditure should be negative.

Once the data entry is complete, a year-by-year cashflow forecast will be produced. That will include the discounted cashflow, and the cumulative discounted cashflow which is the sum of all the annual cashflows up to the year shown on the screen.

In many projects, the initial CDCF will be negative as development outweighs net income. When CDCF becomes zero, the break-even point has been reached. CDCF on the final year of the project provides a guide of the overall profitability of the project. The 32-column format of the ZX printer does not allow the complete table of results to be printed in one attempt. Instead, each page of results on the screen may be copied, then scissors plus Sellotape used to obtain a table of results if required, say, for a report.

When the results sequence has been completed, several options are available. The results display can be repeated, the data modified, or the program plus data saved on tape. The ability to modify the data allows for "what if" tests to be made; e.g., what if the production costs are 10 percent greater than expected? What if additional sales are generated? That

flexibility allows the decision-maker to test the project at the possible extremes of variation from that expected. Results are available within seconds on the computer, which would take minutes or hours calculated manually.

The save program and data facility are added for convenience; the de-

cision-maker may want to re-examine the figures at a later date and avoid the tedious re-entry of data.

Although much of the foregoing considers projects over several years, many projects for which a financial assessment is required may last only a few months. The technique of discounted cashflow is equally valid in

these cases; interest still has to be paid on money borrowed to finance the project.

In this situation, the program Investment Appraisal can be used in much the same way, reading months count factor instead of an annual figure.

### Figure 1

```

50 LET M#="" IS THIS O.K.? <Y/
N>
60 LET N#="" INVESTMENT APPRA
ISAL
65 LET O#=""
70 LET ZR=0
80 LET T1=21
90 CLS
100 PRINT ,,N#;AT T1,ZR;" ENTER
PROJECT NAME "
110 INPUT P#
120 LET P#=(P# TO 15-(LEN P#)*2
)>##
130 PRINT AT 3,ZR;P#;AT T1,ZR;"
ENTER PROJECT TERM (YRS) "
140 INPUT T
150 PRINT AT 7,ZR;"PROJECT TERM
":T;" YRS";AT 20,ZR;"ENTER THE
NUMBER OF COST/REVENUE ITEMS "O
#K TO 20)
170 INPUT R
180 PRINT AT 9,ZR;"NO. ITEMS RR
E "R;R;AT 20,ZR;O#;" ENTER THE DI
SCOUNT FACTOR (O/O)"
190 INPUT F
200 PRINT AT T1,ZR;M#
220 GOTO 220+5*(INKEY#="C")-130
*(INKEY#="N")
225 DIM ACT,R+1)
230 DIM B#(R,14)
240 CLS
250 PRINT ,,N#,,,P#,,,;"ENTER TH
E NAMES OF THE COST/ REVENUE
ITEMS",,
260 FOR I=1 TO T
270 PRINT I
280 INPUT C#
290 LET B#(I)=C#
300 PRINT B#(I)
310 NEXT I
320 PRINT AT T1,ZR;M#
330 GOTO 330+10*(INKEY#="N")+70
*(INKEY#="Y")
340 GOSUB 5000
350 PRINT AT T1,ZR;"ENTER THE N
EW NAME OF "X
360 INPUT X#
370 PRINT AT 7*X,16;(X#+O#*X TO
)
380 LET B#(X)=X#
390 GOTO 320
400 FOR I=1 TO T
410 CLS
420 PRINT ,,N#,,,P#,,,;" ENTER D
ATA FOR YEAR "I,,,
430 FOR J=1 TO R
440 PRINT J;" "B#(J);TAB 16;
450 INPUT Y
460 PRINT Y
470 LET A(I,J)=Y
490 NEXT J
500 PRINT AT T1,ZR;M#
510 GOTO 510+40*(INKEY#="Y")+10
*(INKEY#="N")
520 GOSUB 5000
530 GOSUB 5050
540 GOTO 510
550 IF I=T THEN PRINT AT T1,ZR;
" DATA ENTRY COMPLETE "
560 NEXT I
570 FOR J=1 TO 50
580 NEXT J
590 FOR I=1 TO T
600 CLS
610 PRINT ,,N#,,,P#,,,;"CASH FLO
W FORECAST, YEAR "I,,,
620 LET Y#0
630 FOR J=1 TO R
640 LET Z=LEN STR# A(I,J)
650 PRINT B#(J);TAB (30-Z);A(I,
J)
660 LET Y#Y+A(I,J)
670 NEXT J
680 LET Z=LEN STR# Y
690 PRINT "CASH FLOW";TAB (30-Z
);Y
700 IF I>1 THEN GOTO 740
710 LET CDF#ZR
720 LET DF#1
730 GOTO 760
740 LET CDF#A(I-1,R+1)
750 LET DF#DF#100/(100+F)
800 LET Y#Y*DF
810 LET Z=LEN STR# INT Y
820 PRINT "DISCOUNT C/F";TAB (3
0-Z);INT Y
830 LET CDF#CDF+Y
840 LET A(I,R+1)=CDF
850 LET Z=LEN STR# INT CDF
860 PRINT "C.D.C.F.";TAB (30-Z);
INT CDF
870 PRINT AT T1,ZR;" COPY, OR
NEWLINE FOR NEXT PAGE "
880 GOTO 880+10*(INKEY#="C")+30
*(INKEY#="CHR# 110)
890 PRINT AT T1,ZR;O#
900 COPY
910 NEXT I
920 CLS
930 PRINT ,,N#,,,P#,,,;"
OPTIONS="1,,,"2. SAVE ON TAPE
",,,"3. MODIFY THE DATA",,,"4.
STOP"
940 PRINT AT T1,ZR;" SELECT
1,2,3, OR 4 "
970 GOTO 970-300*(INKEY#="1")+1
0*(INKEY#="2")+70*(INKEY#="3")+6
0*(INKEY#="4")
980 CLS
990 PRINT "SET YOUR TAP RECORD
ER AS FOR SAVE. PRESS NEWLINE
WHEN READY."
1000 GOTO 1000+10*(INKEY#="CHR# 1
10)
1010 SAVE "INVESTMENT"
1020 GOTO 920
1030 STOP
1040 CLS
1045 PRINT ,,N#,,,P#,,,;" MOD
IFY THE DATA",,," SELECT ",
",,,"1. CHANGE INDIVIDUAL ITEMS",
",,,"2. PERCENTAGE CHANGE",,,"3. CH
ANGE DISCOUNT FACTOR",,,"4. RETU
RN"
1050 GOTO 1050+350*(INKEY#="3")+
130*(INKEY#="4")+10*(INKEY#="2")
+210*(INKEY#="1")
1060 CLS
1070 PRINT ,,N#,,,P#,,,;"
PERCENTAGE CHANGE"
1080 FOR I=1 TO R
1090 PRINT I;TAB 5;B#(I)
1100 PRINT AT T1,ZR;"SELECT WHIC
H ITEM TO CHANGE"
1120 INPUT K
1130 IF K<1 OR K>R OR K<>INT K T
1130-IF K<1 OR K>R OR K<>INT K T
HEN GOTO 1120
1140 PRINT AT T1,ZR;O#;AT T1,ZR;
" ENTER PERCENTAGE CHANGE TO "K
1150 INPUT G
1160 PRINT AT 20,ZR;" PERCENTAGE
CHANGE TO "K; " IS "IG
1170 PRINT AT T,ZR;O#;AT T1,ZR;H
ZR;"O,K"
1180 GOTO 1180+10*(INKEY#="N")+4
0*(INKEY#="Y")
1190 PRINT AT 20,ZR;O#;O#
1200 GOTO 1110
1210 PRINT AT 20,ZR;O#;O#;AT T1,
ZR;"O,K"
1220 FOR I=1 TO R
1230 LET A(I,K)=A(I,K)+INT ((G/I
80)*A(I,K))
1240 NEXT I
1250 GOTO 920
1260 FOR I=1 TO T
1270 CLS
1270 CLS
1280 PRINT ,,N#,,,P#,,,;"CHANGE I
NDIVIDUAL ITEMS, YR "I,,,
1290 FOR J=1 TO R
1300 PRINT J;" "B#(J);TAB 16;A(I,
J)
1310 NEXT J
1320 PRINT AT T1,ZR;" ANY CHANGE
$7 (Y/N) "
1330 GOTO 1330+10*(INKEY#="Y")+5
0*(INKEY#="N")
1340 GOSUB 5000
1350 GOSUB 5050
1360 GOTO 1320
1380 NEXT I
1390 GOTO 920
1400 CLS
1410 PRINT ,,N#,,,P#,,,;"PREVIOUS
DISCOUNT FACTOR = "F;AT T1,ZR;
" ENTER NEW DISCOUNT FACTOR"
1420 INPUT F
1430 PRINT AT T1,ZR;O#;AT 10,ZR;
1440 GOTO 1440-40*(INKEY#="N")+0
*(INKEY#="Y")
1450 GOTO 920
4990
5000 PRINT AT T1,ZR;"ENTER THE I
TEM TO BE CHANGED "
5010 INPUT X
5020 IF X>R OR X<1 OR X<>INT X T
HEN GOTO 5010
5030 PRINT AT T1,ZR;"ENTER THE N
EW VALUE OF "X
5060 INPUT Y
5070 PRINT AT 7*X,16;(STR# Y+O#
< TO 14)
5080 LET A(I,X)=Y
5090 PRINT AT T1,ZR;M#
5100 RETURN
9000 SAVE "INVESTMENT"
9010 RUN

```

# MORE IDEAS THAN MORE PROGRAMS THAN LESS MONEY THAN

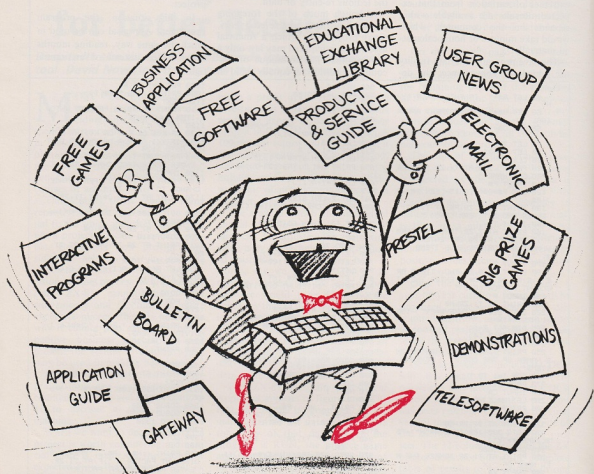

**PROGRAMS FOR EDUCATION, HOME, BUSINESS, AND GAMES – FOR  
SINCLAIR, BBC, RESEARCH MACHINES, APPLÉ, COMMODORE,  
ACT SIRIUS, TRS-80, IBM, ICL, and more each month. . .**

#### HOW THE MICRONET 800 SERVICE WORKS.

Most micros connect by a standard DIN plug and coaxial cable to an adaptor. They're portable, so you can use the system wherever you put your computer and telephone.



Simply dial Miconet's number and enter your subscriber number into the keyboard. A 'welcome to Miconet' message appears on the screen. You're on-line to one of the world's largest databases.

#### PRESTEL

#### MICRONET 800's

thousands of ideas – packed pages – games, education, business software, club news and information.

When you have all the information you need – or you've finished 'downloading' software to your computer's memory – just switch off the telephone link at your keyboard and replace the receiver.



# IN A THINK-TANK. IN A SOFTWARE HOUSE. IN YOU'D EXPECT.

Whether you bought your computer for games, business, or education, you can spend a lot of time wondering what to do with it. And then spend a lot of money on packaged games and applications software.

NOW you can bring your computer to life – economically – by joining the amazing new MICRONET 800 service: a vast database with hundreds of FREE games, plus business and education software, computer news, special offers and 'big prize' opportunities for you to compete against the system – and win!

MICRONET 800 is packed with ideas and information. And there's no waiting – you get programs straight down the phone line! Updates on operating systems... school and college programs

... gobble man... invaders... business packages. They're constantly renewed. And hundreds of them are free: you simply turn on your micro, dial up MICRONET 800 and LOAD.

Sounds expensive? Here's the surprise! All you pay for is a low-cost adaptor (in most cases just £49) to link your computer to your telephone, plus a MICRONET 800 subscription of about £1 per week. Then, via your computer and telephone line you will be able to access over 30,000 ideas-packed 'pages' of the MICRONET 800 service, and call down the software you want to your own computer! Look at just a FEW of the services already available on Micronet for you to call on:

- **Free Telesoftware:** Indexed by subject and by name of micro, a huge selection can be loaded down onto your computer.
- **Educational Exchange Library:** Schools and colleges are already preparing to display programs written by students and teachers, so many can benefit from them easily and economically.
- **Applications Guides:** Quick-reference guide by subject and by micro name shows you available applications software. You can move from the guide to further details held on the system if you wish.
- **Demonstrations:** Check through the features of the software packages that interest you – privately and without obligation. Order only if you're sure it's what you need.
- **Purchase 'Downloadable' Software:** Many 'telesoftware' programs can be bought from the system and loaded down direct to your micro. But

don't worry – there's plenty of warning if any MICRONET service you're planning to use carries a charge.

- **Electronic Mail:** A mailbox service on Prestel allows you to exchange messages with other Prestel or Micronet users. Messages are held securely and only you can collect them.
- **Bulletin Board:** For an additional subscription you can operate your own bulletin board – club news, for example, like tips, swap-shop for second-hand items and so on.
- **Phone-In:** If you're away from your computer but need to send a message to another Micronet user – call the Micronet 800 service by phone and we'll send the message for you.
- **Prestel:** Over 200,000 pages of information on British Telecom's established service. Facts and advice on finance, business, entertainment, features

- and even direct bookings for travel, holidays, etc.
- **Product and Service Guide:** A constantly updated reference source – covering product comparisons, software reviews, dealership and price details and all the 'best buy' information.
- **Action Advertising:** Includes features, just like a magazine, including jobs and classified ads. If you've read an article that interests you, through MICRONET you can find out about the manufacturer, the dealers, the prices, and even order the product via your micro!
- **User Group News:** The Amateur Computer Club and many others like ALCC, BASUG, ICPUJ, TUG, TRS 80 UG, will maintain their news and reference service on Micronet.
- **Big Prize Games:** Micronet offers a range of games and quizzes to keep you entertained and involved – and there'll be big prizes too!

## SOUNDS FANTASTIC? THAT'S JUST THE START!

MICRONET 800 is a completely new service and we'll be adding to it all the time. Find out more about what Micronet 800 has in store for

you: return this coupon TODAY and we'll send you a FREE FACTS FOLDER on Micronet 800 services and details of how you can join!



The logo for Micronet 800 features the word 'micronet' in a lowercase, sans-serif font, with '800' in a larger, bold, sans-serif font below it. The text is overlaid on a grid of red and black lines that form a stylized, abstract pattern.

**IT BRINGS YOUR  
COMPUTER TO LIFE!**

Send to: MICRONET 800, Petersham House, 57a Hatton Garden, London EC1B 1DT.

Yes, I am interested in the MICRONET 800 service. Please keep me in touch with developments and send me details of the low-cost Micronet 800 adaptor.

I am interested in earning money on software I develop for the system.

I am interested in: Home uses  Business uses  Educational uses

Name \_\_\_\_\_

Address \_\_\_\_\_

Telephone \_\_\_\_\_

Type of computer \_\_\_\_\_

**POST  
TODAY**

# Taking an educated look inside the ZX printer

*Sinclair Research's printer is one of the cheapest hard-copy devices on the market. At the moment it can only be used on Sinclair machines—the ZX-81 and the Spectrum—but it would be useful if it could be interfaced with other companies computers. Here John Connor describes how the machine works on the basis of both printed information and guesswork.*

THE ZX PRINTER is one of the cheapest hard-copy devices available. It would obviously be useful to be able to interface it to non-Sinclair computers. So it is useful to describe the printer operation and interface. One warning—much of the detail is from the printer manual but there is educated guesswork for some things, especially the pin-outs.

The printer uses thermo-sensitive paper and has two styli on a continuous belt. The belt and paper feed roller are driven by the same motor; the belt, presumably is angled upwards across the paper to compensate for the paper movement. The styli are on opposite sides of the belt, so that while one is printing the other is moving round for the next line. It follows that the printer has no such thing as a 'carriage return'.

The styli generate individual dots on the paper. The position and horizontal width of a dot is controlled entirely by the timing and duration of power applied to the stylus; that, in turn, is entirely software-controlled by the host computer. Thus the printer naturally is suited to graphics but will need some kind of external character generator for text.

The printer interface appears as a standard Z-80 I/O port with an address of FB (hex). Timing diagrams for read and write are in figure one.

Write bit assignments:

- D7 (msb): '1' stylus on (print)
- '0' stylus off (blank)
- D2 : '1' stop motor
- '0' start motor
- D1 : '1' motor slow
- '0' motor normal speed.

Data latched till next write; can produce continuous line by leaving stylus on. D1 and D7 low on power-up or after pressing feed button; D2 high after feed.

Read bit assignments:

- D7 : '1' stylus on paper
- D6 : '0' printer connected
- D0 : Encoder pulses; low to high transition defines start of print column.

D0 and D7 latched on going high till write to printer re-sets them. For valid timing, follow every detected high with a write. D7 is high whenever stylus is on.

The Sinclair manual says that each pen is on the paper for 32ms at full speed and off it for 16ms. In fact, the

individual stylus must be off the paper longer than it is on; i.e., on for 16ms and off for 32ms. Taking that and the stylus inter-lacing into account, D7 will have the timing shown in figure two.

D0 is fed by an ENCODER disc giving 256 pulses across the printable width allows 4mm. margins. The minimum period between successive pulses is 60µs at full speed. They key to using the printer is using D0 pulses to align dots on successive lines. D0 timing is shown in figure two.

There are two basic areas for generating text—generating a dot matrix representation of a line of characters, as for a VDU; and writing the dots to the printer with precise synchronisa-

Figure 1: Printer I/O

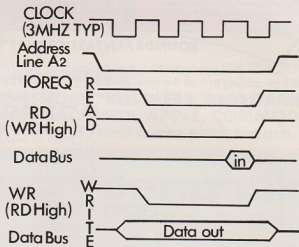

tion to preserve the character shapes.

The dot matrix rows could be produced by pure software; by access to the output of the VDU character generator—that seems possible on the BBC machine—or by making a hardware character generator.

A natural representation would be  $8 \times 8$  for each character, giving 32 characters per line;  $6 \times 8$  should also be possible, giving 42 characters per line.

Writing dots to the printer must be done in tight time sync to the encoder translations. Timing jitter will appear as jitter in the horizontal dot position; 30ms will shift a dot by half a dot column, so it cannot use interrupts except in a 'wait for interrupt' loop. The basic algorithm for a row of dots will be:

Detect stylus on paper (D7 high); detect encoder pulse (D0 high); write high (print) or low (no print) to stylus—this also re-sets D0 and D7 ready for next translation; write low to stylus; go back to detect encoder

PINOUT								
Pin	Top	Bottom	Pin	Top	Bottom	Pin	Top	Bottom
1	D7	5V pos.	9	D3	A2	19	—	A7
2	—	9V pos.	10	D4	A3	20	—	A6
3	S L O T	—	11-14	—	—	21	—	A5
4	D0	OV	15	$\overline{\text{IOREQ}}$	—	22	—	A4
5	D1	OV	16	$\overline{\text{RD}}$	—	23	—	—
6	D2	CLOCK	17	$\overline{\text{WR}}$	—	—	—	—
7	D6	A0	18	—	—	—	—	—
8	D5	A1	—	—	—	—	—	—

pulse until there have been 256 pulses; look for stylus off paper (D7 low); get set up next row—if last two rows before stopping set motor to slow (D1 high) so that stylus will stop off paper when printer is stopped; if not, last row go to detect stylus, or stop.

The first two can be done with polling loops. The loop duration will produce its own jitter relative to the asynchronous transitions on D0 and D7, so the loops should be as short as

possible. The third and fourth are best done using the same instructions for dot and no dot, i.e., no branches. You may need NOPs between those to ensure the stylus is on for long enough.

If you do not have a Z-80 system you will have to arrange to generate the signals shown in figure one, either using your existing bus signals plus logic or by programming a PIA or equivalent port.

Figure 2: D0/D7 timing

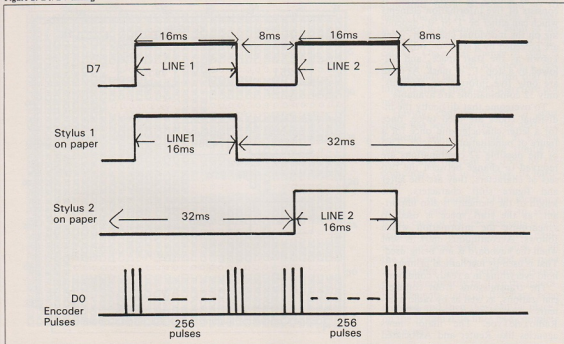

# Getting the latest news by ZX-81

To permit reception of radio teletype signals on a ZX-81 four separate problems have to be overcome. In this article John Eggleton gives, in detail, the instructions needed to find the solutions and build an interface which allows the ZX-81 to translate the Murray code used by teleprinters with the television replacing the normal paper.

THE SYSTEM still in use to transmit printed information telegraphically was invented in 1874 by Emile Baudot. At each end of a link is a teleprinter, capable of converting the key depressions into a code. That code is then converted into audio tones and transmitted by radio to the distant terminal, where the reverse process takes place.

It is important to understand the formation of the Murray code character as shown in figure eleven. It consists of five information elements which can either be '1' or '0', depending on the individual character. They are preceded by a start '0', otherwise known as the start space, and followed by a stop '1', or mark. As there are only five information elements, only 32 combinations are available.

To overcome that difficulty the individual codes are used twice, once for a letter character and once for a figure or punctuation character. Two of the possible 32 combinations are reserved to change between the two sets of characters; they are the letter and figure shift characters. The length of the elements is also important, as the start space is used to synchronise the information which follows. A continuous mark is sent when the keyboard is not being used. That is used by mechanical printers to hold everything in a ready condition.

The transmissions from commercial stations, as well as by radio amateurs are known as RTTY—RadioTeleType. The major news agencies like Reuter and Associated

Press, broadcast almost continually using this form of transmission. Those sources can be monitored easily using the hardware and program described in this article, with radio amateurs being found easily around 14,080kHz during most of the day. The RTTY transmission produces its own particular sound, consisting of two audio frequencies alternating

Figure 1: Hex loader.

```
10 REM (170 characters long)
20 FOR I=16528 TO 16684
30 INPUT HS
40 LET D=CODE HS (1)-28
50 FOR J=2 TO LEN HS
60 LET D=16*D+CODE HS (1)-28
70 NEXT J
80 POKE I,D
90 NEXT I
```

Figure 2: Checking program.

```
15 DIM HS (2)
20 FOR I=16514 TO 16684
30 LET C=PEEK I
40 LET D1=C
50 FOR J=2 TO 1 STEP -1
60 LET D2=INT (D1/16)
70 LET HS (J)=
CHR$ (D1-16*D2+28)
80 LET D1=D2
90 NEXT J
100 PRINT I; " = "; HS (1); HS (2)
110 FOR Z=1 TO 100
120 NEXT Z
130 SCROLL
140 NEXT I
```

Figure 3: Top of PCB.

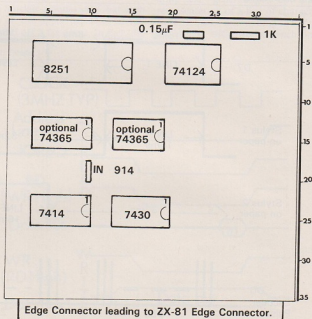



Figure 5:

	7	6	5	4	3	2	1	0	Hex	Port
Sinclair	1	1	1	1	1	0	1	0	FB	Printer
I/O	1	1	1	1	1	1	0	1	FD	Fast mode
Ports	1	1	1	1	1	1	1	0	FE	Slow mode
	1	1	1	1	1	1	1	1	FF	Tape
8251	0	1	1	0	0	0	1	1	63	Data
Port	0	1	1	1	0	0	1	1	73	Control

With any extra port, bits 0 and 1 must both be logical '1' because only partial decoding is used for the slow and fast modes. Likewise, bits 2 and 3 should be logical '0' to avoid conflict with the printer and tape ports.

continuously while characters are sent and a single tone during conditions of no information.

Nowadays mechanical printers have been replaced by VDUs and some systems have dispensed with Murray code and use ASCII instead. The system which is described uses the ZX-81 1K to translate Murray code with the TV replacing the tele-

printer paper, therefore making it much quieter. It is now possible to have the news direct from the correspondents in the living room using a ZX-81. Figure seven shows a block diagram of the complete system.

To permit reception of RTTY signals on a ZX-81 or any other computer, four separate problems have to be overcome.

Figure 4: Veroboard.

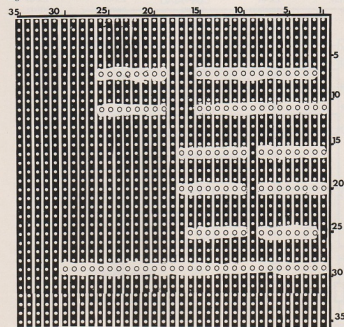

**Audio to logic level conversion.** The RTTY signal output at the ear-phone jack of a receiver consists of two tones. In the amateur case the mark tone is 1,275kHz and the space tone is 1,445kHz. Unfortunately a computer cannot distinguish between the tones and so conversion is necessary.

The circuit needed to perform the conversion consists usually of a filter which ensures that only the two tones are used, followed by a detector circuit. The detector in most cases is a Phase Locked Loop (PLL) with the frequency of operation adjusted to one of the two frequencies in use.

The demodulated output of the circuit is then high or low depending on whether the PLL is in lock—i.e., frequency in equals frequency of PLL—or out of lock—i.e., frequency in equals other frequency in use. A number of circuits are available to achieve this, one of which can be found in the Teleprinter Handbook published by the Radio Society of Great Britain.

**Start of character detection.** While the sending keyboard is not active a continuous mark is sent and so to detect the start of a character all that is needed is to sample the input to the computer looking for a space or logical '0'. Once that change of state is detected it is usual to check a few milliseconds later to confirm that the input is still a space and therefore not noise.

Having confirmed that a start space has been received, the next five elements will arrive later at known time intervals. Therefore timing is needed and this can be done by the computer, or as in this case, by hardware.

**Serial to parallel.** The incoming Murray code character is in serial form; each of the five elements is sent sequentially. Inside a computer, characters are dealt with in parallel, as all the elements or bits needed are used at the same time. Therefore it is necessary temporarily to store the incoming elements until all five have been received and then they can be placed on the system data lines as a complete character.

# RADIO TELEPRINTER

There is another difficulty, for instance that the letter 'a' is not the same in Murray code as it is in ZX-81 code and so translation is required.

**Display results.** Once the ZX-81 character has been formed from the original Murray one, all that remains to be done is to call the appropriate routine in the ZX-81 ROM. The display should also be examined to place NEWLINES where appropriate and scroll the display when the screen is full. That is because a teleprinter page is about 60 characters wide compared to the 32 of the ZX-81.

To deal with these four problem areas, a mixture of hardware and software is utilised which can again be split into three areas.

**Terminal unit.** This is the device which changes the incoming tones into logic levels. Any design on the market can be used so long as it

produces logic levels at the output. Two such circuits can be found on page 93 of June 1981 *Personal Computer World* or on page 62 of September, 1979 *Wireless World*. The lead from the device to the computer should be kept reasonably short to avoid noise being induced into the circuit.

**8251 port.** The heart of the solution is the chip and interfacing to the ZX-81 is minimal. The 8251 is a Universal Asynchronous Receiver Transmitter—UART—and is very flexible, having the added advantage of requiring only +5V to power it. As its name suggests, it is capable of transmitting as well as receiving and therefore with some addition to the hardware and software it will be possible to transmit RTTY from the ZX-81 keyboard.

The 8251 is a programmable device

and as such requires two words to set it up; the machine code initialisation routine achieves this. The mode word is set up for one-and-a-half stop bits, no parity, five-bit character length and 64 times baud rate.

The baud rate indicates the speed of the incoming information and in this case the hardware clock input on TxC pin 9 and RxC pin 25 is 64 times the chosen input speed. In the case of amateur transmissions, the baud rate is 45.5 and commercial ones are 50 and 75. The clock produced by the 74LS124 is varied by means of a 20k multi-turn potentiometer to enable various speeds of transmission to be copied.

The command word is set for error re-set and receive enable, all other options being off. Once the 8251 has been programmed it remains so until powered down or it is re-set.

Figure 6:

Numbers	Letters	Hexadecimal				Decimal
		Murray code	ZX-81 numbers	ZX-81 letters	ZX-81 numbers	
3	E	01	1F	2A	31	42
L/F	L/F	02	EE	EE	238	238
—	A	03	16	26	22	38
SPACE	SPACE	04	00	00	0	0
"	S	05	0B	38	11	56
8	I	06	24	2E	36	46
7	U	07	23	3A	35	58
C/R	C/R	08	76	76	118	118
WRU	D	09	EE	29	238	41
4	R	0A	20	37	32	55
BELL	J	0B	EE	2F	238	47
,	N	0C	1A	33	26	51
%	F	0D	EE	2B	238	43
:	C	0E	0E	28	14	40
(	K	0F	10	39	16	48
5	T	10	21	39	33	57
none	Z	11	EE	3F	238	63
)	L	12	11	31	17	49
2	W	13	1E	3C	30	60
£	H	14	0C	2D	12	45
6	Y	15	22	3E	34	62
0	P	16	1C	35	28	53
1	Q	17	1D	36	29	54
9	O	18	25	34	37	52
?	B	19	0F	27	15	39
@	G	1A	EE	2C	238	44
FIGS	FIGS	1B	EE	EE	238	238
.	M	1C	1B	32	27	50
/	X	1D	18	3D	24	61
=	V	1E	14	3B	20	59
LETTERS	LETTERS	1F	EE	EE	238	238

EE = code for no direct ZX-81 equivalent.

As the other I/O ports of the ZX-81 are not fully-decoded it is important to ensure that there is no conflict of addresses, and figure five shows how that is achieved. The 8251 requires two I/O ports to operate, one for control and the other for normal data transfer.

The chip is enabled by  $\overline{CS}$  pin 11 when the 74LS30 output goes low, which corresponds to an address of either 63H or 73H. A4, which determines whether it is 63H or 73H, is connected to C/D pin 12 and that puts the 8251 into the control or data mode.

The data bus is connected directly to ZX-81 data lines, as are the RD & WR lines. The re-set has to be inverted as the 8251 expects that line to remain low; that is done by part of the 74LS14. The clock line is connected to  $\emptyset$  of the ZX-81; that is because that 8251 is a dynamic device. A gate

on the 74LS14 is used to buffer the 8251 from the terminal unit and has a limiting diode on its input.

All the other pins are not used and not connected. The circuit can be built on Veroboard and the supply taken from the +5V on the ZX-81 edge connector.

**Driving program.** The programming necessary to receive RTTY by way of the 8251 is written in machine code and a listing is given in figure nine. Figures one and two give the only Basic programming needed. One is in the form of a hexadecimal loader and figure two can be used to check that the machine code has been entered correctly.

Once the machine code has been POKED into the REM statement in line 1 and it has been checked it should then be SAVED.

Machine code programming is needed for two reasons. First, the

8251 is not on the ZX-81 memory map and so it is not possible to send or receive instructions by PEEK and POKE commands. The second reason is that a 50 baud character takes a total time of 150msec to receive, which is too fast for Basic.

If it were used, characters would be lost while the ROM Basic interpreter was still determining what the next line number should be. The whole machine code program is re-locatable except for the underlined values which require altering if the program is placed elsewhere in memory. The program is split into four separate areas:

**Look-up table.** The first 14 bytes of the REM statement are not used by the program but are there so that the look-up table starts at a round hexadecimal figure. If the table is placed elsewhere in memory, say in EPROM in the 8-16K area, it is essential that

Figure 7: Block diagram.

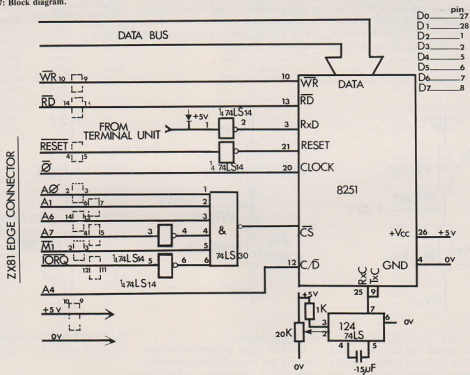

# RADIO TELEPRINTER

the top pair of the hexadecimal address of the look-up table remain the same throughout the table—40H in this case. That is because the value is stored in the H register and is used together with the L register to form an address. The relationship between address, Murray code and ZX-81 characters is given in figure five.

**Initialise.** This routine sets up the 8251 for use by sending the two words AYSNC and READIN to the control port (73H). It also ensures that the ZX-81 is in the slow mode and it puts the look-up table address into the HL register pair.

**Control routine.** This collects in the A register a ZX-81 character from the Murray routine and checks to see if it is a NEWLINE. Then it checks the character position on the screen, first by column and then by line, taking action as required. To fetch the information use is made of the fact that the IY register in the ZX-81 is always 4000H, which is the start of RAM and the variable area in particular.

If the screen is full it is SCROLLED by calling the Sinclair ROM routine. The POP and PUSH is needed either side of the SCROLL because those

registers are used in this routine.

**Murray decode.** This routine overcomes the three problems of detecting when a character is ready, remembering whether a figure or letter shift has been sent and, finally, conversion between Murray and ZX-81 codes. When a character has been assembled inside the 8251 it signals the program by raising bit 1 of the status word to a high. All that is then needed is to loop continuously reading the status word, inspecting that flag until it is set; at that point the program moves on to read in the assembled Murray code character. The character is then checked to see if it is the letter shift (1FH) or figure shift (1BH).

If it is one of those, the appropriate value is loaded into the L register, which contains the lower part of the look-up table address. If it is not, conversion from Murray code value to ZX-81 is performed by adding the Murray code value to the sum as a pointer to a position in the look-up table and extracting the value found at that location. A final check is made to ensure that it is not an error code (EEH) before returning to the control routine.

To run the program all that is required is the direct command RAND USR 16592. Control will then be passed to the machine code and the only way to return to Basic is to pull out the power plug. Ensure therefore that a copy of the program is on tape before running. The screen will then clear and random characters appear at the top left, running across the screen, if pin 1 of the 74LS14 is continuously and rapidly taken to OV, thereby simulating a Murray character.

Set the 20K multi-turn potentiometer, which should be of the clockface

## Components

- 1 × 8251
- 1 × 74LS30
- 1 × 74LS14
- 1 × 74LS124
- 1 × 1k $\pm$ 5% resistor
- 1 × 20k multi-turn variable resistor
- 1 × 1N914 diode
- 1 × 0.15 $\mu$ F tantalum capacitor
- Veroboard
- Verowire
- 23-way edge connector

Figure 8:

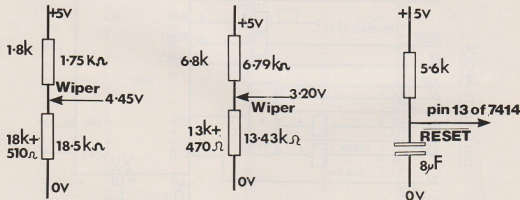

These are the actual values measured across the 20K pot. The ringed fixed preferred values could be used instead, if operation on only one

speed was required.

In some cases it might be wise to connect the Reset line to a power-on reset circuit, as shown, rather than

the ZX-81 Reset line to ensure correct operation of the 8251.



Figure 9: Machine code program.

Dec	Hex	Data	Assembler	Comment
16514	4082	00,00,00,00,00,00 00,00,00,00,00,00		
16523	4090	EE,2A,EE,26,00,38,2E,3A		:look up table
16536	4098	76,29,37,2F,33,2B,28,30		
16544	40A0	39,3F,31,3C,2D,3E,35,36		
16552	40A8	34,27,2C,EE,32,3D,3B,EE		
16560	40B0	EE,1F,EE,16,00,0B,24,23		
16568	40B8	76,EE,20,EE,1A,EE,0E,10		
16576	40C0	21,EE,11,1E,0C,22,1C,1D		
16584	40C8	25,0F,EE,EE,1B,18,14,EE		
<b>Initialise</b>				
16592	40D0	3E,83	LD A, AYSNC	:mode for 8251
16594	40D2	D3,73	OUT A (73)	
16596	40D4	3E,14	LD A, READIN	:command 8251
16598	40D6	D3,73	OUT A (73)	
16600	40D8	CD,28,0F	CALL SLOW	:sinclair ROM
16603	40DB	21,90,40	LD HL,4090	:HL = look up add.
<b>Control routine</b>				
16606	40DE	CD,09,41	START: CALL MURRAY	:fetch character
16609	40E1	FE,76	CP,76	:is it newline?
16611	40E3	28,1F	JRZ,LB4	:yes—jump
16613	40E5	F5	PUSH AF	:save character
16614	40E6	FD,7E,39	LD A (IY + 39)	:A: = col count
16617	40E9	FE,03	CP,03	:end of line?
16619	40EB	20,0C	JRNZ, LB2	:yes—jump
16621	40ED	FD,7E,3A	LB1: LD A (IY + 3A)	:A: = line count
16624	40F0	FE,03	CP,03	:bottom line?
16626	40F2	20,0B	JRNZ, LB3	:yes—jump
16628	40F4	E5	PUSH HL	:save table add.
16629	40F5	CD,0E,0C	CALL SCROLL	:sinclair ROM
16632	40F8	E1	POP HL	:fetch table add.
16633	40F9	F1	LB2: POP AF	:fetch character
16634	40FA	CD,F5,07	LB5: CALL PRINT	:sinclair ROM
16637	40FD	18,DF	JR START	
16639	40FF	F1	LB3: POP AF	:fetch character
16640	4100	3E,76	LD A,76	:A: = newline
16642	4102	18,F6	JR, LB5	
16644	4104	3E,00	LB4: LD A,00	:replace newline
16646	4106	F5	PUSH AF	:with space so that
16647	4107	18,E4	JR LB1	:scroll will work
<b>Murray decode</b>				
16649	4109	DB,73	MURRAY: IN A (73)	:read status 8251
16651	410B	E6,02	AND, 02	:char. complete flag
16653	410D	28,FA	JRZ MURRAY	:no—jump
16655	410F	DB,63	IN A (63)	:fetch char. 8251
16657	4111	E6,1F	AND, 1F	
16659	4113	FE,1F	CP,1F	:murray letter?
16661	4115	20,04	JRNZ NUMB	:no—jump
16663	4117	2E,90	LD L, 90	:start look up
16665	4119	18,EE	JR MURRAY	:letters table
16667	411B	FE,1B	NUMB: CP,1B	:murray figs?
16669	411D	20,04	JRNZ LET	:no—jump
16671	411F	2E,B0	LD L, B0	:start look up
16673	4121	18,E6	JR MURRAY	:figs table
16675	4123	E5	LET: PUSH HL	:convert from
16676	4124	85	ADD A,L	:murray
16677	4125	6F	LD L,A	:to ZX81
16678	4126	7E	LD A (HL)	:code.
16679	4127	E1	POP HL	
16680	4128	FE,EE	CP,EE	:is it error code?
16682	412A	28,DD	JRZ MURRAY	:yes—jump
16684	412C	C9	RET	

# RADIO TELEPRINTER

type, to 3.30 for 45.5/50 baud or 1.00 for 75 baud transmissions. Then connect the terminal unit, connect to a receiver and tune into a RTTY broadcast.

Some practice is necessary for the proper balance but if an oscilloscope is available, connect it to the output of the terminal unit and tune for an equal mark/space ratio. If the display

is still unintelligible, switch to the other sideband on the receiver and try again. After a short time it should be possible to tune the signal by ear and dispense with the oscilloscope.

Figure 10:

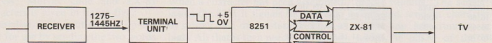
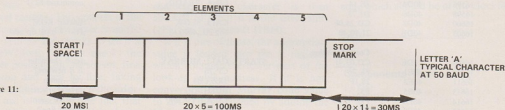

Figure 11:



## Keyboard with Electronics for ZX81

A full-size, full-travel 43-key keyboard that's simple to add to your ZX81 and requires no soldering in the ZX81.

Complete with the electronics to make "Shift Lock", "Function", and "Graphics 2" single key selections making entry far easier.

Powered from ZX81's own standard power supply - with special adaptor supplied. Two-colour print for key caps.

Amazing low price for complete build-it-yourself kit, only £19.95 incl. VAT and carriage.

Order As LW72P

Full details in the June 1982 issue of "Electronics - The Maplin Magazine" on sale at all good newsagents price 60p. In case of difficulty send 60p to address below, or £2.40 for annual subscription (4 issues).

### MAPLIN

Electronic Supplies Ltd

P.O. Box 3, Rayleigh, Essex SS6 8LR. Tel (0702) 552911

Retail shops at

159 King St., Hammersmith, London W6. Tel: 01 748 0926

284 London Rd., Writtlecliff-on-Sea, Essex. Tel: (0702) 554000

Lynton Square, Perry Barr, Birmingham. Tel: (021) 356 7292

(Shops closed Mondays). All mail to Rayleigh address.

## MICROSPHERE

MICROSPHERE COMPUTER SERVICES LTD  
72 ROSEBERY ROAD - LONDON N10 2LA  
TELEPHONE 01-883 9411

**OMNICALC** (48K Spectrum) - The very best spreadsheet analysis program you can buy for the Spectrum. Uses include financial planning, home budgets etc. - in fact any work with figures.

Up to 99 columns or 250 rows \* supports ALL the mathematical functions \* All input is prompted \* Separate headings always available so you know precisely where you are! \* Extensive repeat facilities reduce the time spent in setting up models Allows conditional expressions (for tax bands etc) and RND (for simulations) \* Totalling and sub-totalling facilities \* Complete with comprehensive manual. £9.95

**ZX-SIDEPRINT** (Spectrum and ZX81 versions) - Don't be limited to 32 characters on a line with your Sinclair printer. Using ZX-SIDEPRINT you can print sideways to give any line-width. It is easy to add to existing programs, includes routines to take print lines direct from the screen, and can even print in lower case from a ZX81! (State version rpd) £4.95

**CREVASSE + HOTFOOT** (Spectrum 16K) - Two original games using the Spectrum's abilities to the full. In CREVASSE you are on the ice-cap with chasms opening and closing all around you. Can you make it across the perilous ice? In HOTFOOT you must help a rabbit get to the carrots in the fields around its burrow. But the fields are dangerous, and the plumper the rabbit the greater the danger. The only safety (and the only way to score!) is to get back to the burrow. Now.....where was it? £4.95

**EVOLUTION** (48K Spectrum) - Starting from the primeval soup, can you retrace the course of evolution and end up with man? Can you keep the earth's eco-systems in balance, respond to climatic changes and survive the odd cataclysm? It should be easy... after all it has been done before! £6.95

**CASSETTE LABELS** - If you write programs yourself, or want to find a special gift for someone who does, why not have your own cassette labels printed complete with logo? Prices start at only £4.95 for 50 labels or £7.95 for five C20 cassettes with labels fitted. Send s.a.e for design and order form.

# FLET-ELEC

DIFFICULT CALCULATIONS? WE CAN HELP

ESTIMATING £25-00

15th EDITION I.E.E. REGS (made easy) £20-00

LIGHTING CALCULATIONS £15-00

VOLT DROP £4-95

TRUNKING SIZE CALCULATING £4-95

LABOUR RATE CALCULATING £4-95

STUDENT, VOLT DROP & LIGHTING CALCULATIONS £4-95 each



## ZX81 COMPUTER PROGRAMS FOR THE ELECTRICAL INDUSTRY

ALSO AVAILABLE FOR - SPECTRUM - VIC 20 - COMMODORE PETS SHARP MZ 80A - APPLE II - BBC MICRO: PRICES ON REQUEST

FLET-ELEC  
COMPUTER PROGRAMS  
TEL 0934 1852576

EASTLONS  
JUBILEE LANE  
LANGFORD  
BRISTOL BS18 7EJ

## NOW AVAILABLE FROM

# HILTON COMPUTER SERVICES LTD

The P.B.S. Bank reconciliation is believed to be the first such program to be available for the Sinclair ZX81, the ZX Spectrum and Dragon.

Just look at some of its features:

- Automatically matches bank statement items with transactions recorded in your "Personal Banking System."
- List all outstanding items such as uncleared cheques, funds received but not advised to you, bank charges — highlights all discrepancies. No more scratching around to try and find out why your statement balance is different to what you expected.
- Full search facilities allowing on-screen correction of any item.
- Saves and loads data to and from tape (ZX81 version), at double speed. Exchanges data with the main P.B.S. program. No need to save programs.
- Single key operation — uses m/c keyboard scan for single letter commands (ZX81 version).
- Extremely easy to use. No jargon to wade through before you get started. Demonstration program included.
- All item lists, searches (with totals), etc., can be output to your ZX printer.
- Full instructions included.
- Unique after sales maintenance provided.
- Operates in conjunction with "Personal Banking System" (Full input and correction facilities plus automatic posting of standing orders on due dates).

So banish the headaches, make life easier for yourself, send £15 for the Personal Banking System plus P.B.S. bank reconciliation and users manual.

Existing clients need only send £5 for the P.B.S. bank reconciliation which will operate with their present P.B.S.

The Personal Banking System (as reviewed in Popular Computing Weekly — 1st July) is available separately for £9.95 for cassette and user manual. ZX81 P.B.S. owners can order the Spectrum version for just £5.

Please specify whether ZX81 (16K) or ZX Spectrum (48K) or Dragon.

Guaranteed software available from:  
Hilton Computer Services Ltd  
14 Avalon Road, Orpington, Kent, BR6 9AX.

Your P.B.S. is never out of date!

# THE SPECTRUM 'ADD-ON'

ONLY £19.50 + VAT

COMPLETE YOUR SPECTRUM

with our Multi-purpose Sound Generator and Joystick-port Board!! With one low-cost purchase you can obtain the following outstanding improvements to your ZX SPECTRUM:

- THREE CHANNEL sound effects. PROGRAM three independent sounds with music, gun shots, explosions etc.
- AMPLIFICATION of the standard sound output.
- PROVISION of JOYSTICK PORTS to allow simple connection of one or two suitable joysticks (see below).

The 'ADD-ON' uses the amazing AY 3-8910 SOUND Chip, which gives you an enormous range of sound effects. The output and volume of each channel can be separately controlled, with gun shots, explosions, drums etc., produced under the 'sound envelope'. MOST IMPORTANT TO NOTE — the CHIP is processor independent. This means that sounds can continue to be produced without any noticeable effect on the speed of your program!!

The 'ADD-ON' contains its own speaker and amplifier chip and is supplied with a cassette containing sound demonstration routines and some sample sounds.

The 'ADD-ON' simply plugs straight onto the back of your SPECTRUM. No soldering is required.

The 'ADD-ON' is offered at the incredibly low price of £19.50 + VAT.

COMPLETE YOUR SPECTRUM NOW!!

JOYSTICK KITS £3.95 + VAT

To complement our exciting new 'ADD-ON' for the SPECTRUM we are offering low cost Joystick Kits. Each one contains a potentiometer joystick, a fire button and a suitable connector.

NEW ORIGINAL SPECTRUM SOFTWARE from PROGRAM POWER using the 'ADD-ON' to great effect!!

CABMAN (Machine Code) £3.95 + VAT

You are the owner of a fleet of yellow taxis. A rival firm competes with you, trying to steal your fares and run you off the road, if they can. Ten skill levels determine the number of opposing taxis, the speed at which they drive and the amount you earn per completed journey. MAXIMISE your earnings before you lose your entire fleet. This program is FIRST CLASS.

ATTENTION MACHINE CODE PROGRAMMERS!

We can now offer SPECTRUM versions of the ASSEMBLER and DISASSEMBLER programs from ACS Software. The ZX81 versions have proved extremely popular.

ULTRAVIOLET (Assembler) ----- 16.95 + VAT  
INFRARED (Disassembler) ----- 15.95 + VAT

### BOOKS

SPECTRUM  
Over the Spectrum ----- 16.95  
Cambridge Colour Collection ----- 16.95

ZX81  
Mastering Machine Code on your ZX81 --- (7.50)  
NOT ONLY 30 Programs ----- 16.95  
Getting Acquainted with your ZX81 --- (5.95)  
49 Explosive Games for the ZX81 ----- 15.95  
Making the most of your ZX81 ----- (5.95)  
Byteng Deeper into your ZX81 ----- (4.95)  
The Explorer's Guide to the ZX81 ----- (4.95)

MICRO POWER

8 & REGENT STREET  
CHAPEL ALLERTON  
LEEDS LS7 4PE  
Tel: 0532 683186

All programs are now available at all good dealers or direct from MICRO POWER LTD.

Please add the price of P & P + VAT at 15%.

BBC, DRAGON & ACORN DEALERS



WRITTEN BY PROGRAMMERS!  
WE PAY 20% ROYALTIES FOR DRAGON, SPECTRUM, BBC, ATOM PROGRAMS

PROGRAM POWER

# Spectrum console tidies vast numbers of annoying trailing leads

*When Bruce Binder received his Spectrum he was delighted by its capabilities but found the number of loose wires a problem. Here he details his solution by building a special unit to house his machine and the other items he hopes to add to it.*

WHEN I received my Spectrum I was delighted with it once I had it set up but like so many of the micros there are always wires trailing all over the place. I decided to design a control console to house it and all the other items I hope to add to it. First, let me say that this project will not cost a fortune. In fact, most of the timber was offcuts from my workshop. The measurements may have to be adjusted to suit the dimensions of the tape deck you are using.

I started with a piece of  $\frac{1}{2}$ in. blockboard  $27\frac{1}{2}$ in.  $\times$   $11\frac{1}{2}$ in. Looking down on the board I marked the location of the power pack in the top right-hand side. A hole  $2\frac{1}{2}$ in.  $\times$   $3\frac{1}{2}$ in. is cut with the sides of the hole sloping inwards so that the power pack fits in like a wedge. The hole should be  $1\frac{1}{2}$ in. down and  $2\frac{1}{2}$ in. in from the edge. Next to that I fitted a small terminal block to handle all the power cables—see circuit diagram.

The next thing is to construct the first of the hinge-up panel units; the angle of slope of the panel is governed by the height of the ZX power pack. I found 3in. sufficient but if

your tape unit is taller you will have to adjust accordingly if you want the line of the console to follow through.

Once that has been decided, cut out three triangular pieces from  $\frac{1}{2}$ in. blockboard—see Figure three. One of them will have two holes cut in it to accommodate the input/output feeds from the tape unit and a bigger hole for the mains feed to the tape unit. Once again you may have to adjust to suit your tape deck. Next is the back piece. It is of  $\frac{1}{2}$ in. ply, 3in.  $\times$  18in. I cut one large hole of 1in. and a small one for the mains cable—I used a curly cable from Habitat. Then pin and glue the two end-pieces to the back and check for square. At the front I used a piece  $\frac{1}{2}$ in.  $\times$   $\frac{1}{2}$ in. by 18in. long with pin and glue put to one side to stick.

For the top I used  $\frac{1}{2}$ in. ply. Cut to size approximately  $19\frac{1}{2}$ in.  $\times$  12in. and on it mark the position of the Spectrum. If you look on the underside of the Spectrum you will see a lip running down each side. Cut the hole to that width, about  $8\frac{1}{2}$ in., then it will fit neatly. At the top cut the hole a good  $1\frac{1}{2}$ in. bigger than the Spectrum so that all the plugs have plenty of

room. To the right and left of that I drilled two 1in. holes for power cables. Once all holes are cut and you have tried the Spectrum for size, pin and glue into place. Then place the completed unit on the base board so that it lines up with the front, back and right-hand side. On the back you can mark the positions for the hinges and screw into place.

The top switch panel took a little time to make because of all the funny angles. I did not want it to look just like a box on top, so I made the front panel slope back by  $\frac{1}{2}$ in. at the top and the whole unit tapers down to the back. The construction is much the same as the bottom unit—two end-pieces, a top, and a back.

The front panel is a little more involved. As most panel-mounted switches are designed only to go through thin-gauge metal and will not go through  $\frac{1}{2}$ in. ply, I had to cut out the ply to the correct size and a piece of Formica to match. Then I worked-out the positions of all the switches but before sticking the Formica to the ply I cut the holes in the ply big enough for the switches, body and all to go through, then drilled the fixing





Figure 1:

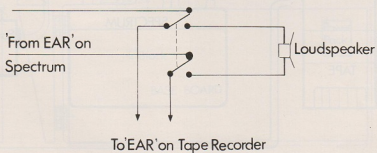
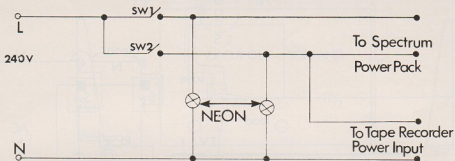

# SPECTRUM CONSOLE

holes for the switches in the Formica.

When they are stuck together you have the thin panel to take the switches but supported by the ply for strength. The switches can be bought from any good electronics shop. Those required are a double-pole change-over one-off, two single-pole on-off for tape and computer power, two neons (240V), one press to break push-button, a  $1\frac{1}{2}$ in. 8ohm speaker and one terminal block.

The front panel is screwed to two strips of wood  $\frac{1}{2}$ in.  $\times$   $\frac{1}{2}$ in. glued at an angle inside the top unit. When you have completed the construction work of the top unit, place it on top of the bottom unit so that it lines up with the left-hand side and back. Then mark the second set of hinge positions but do not fit hinges yet, as the thickness of the Formica on the bottom unit will make a difference.

When all glue is dry, sand ready for laminating. If laminating is not your forte you could use a Fablon material. Do not laminate the back of the unit—it only makes it more difficult to cut holes later. It is best painted matt black. When you have fitted the hinges on the top unit cut a slot between them to allow the TV cable to pass through.

All that is then left to do on the top unit is to drill the speaker holes in the left-hand end-panel. That is best done by putting masking tape over the Formica. Draw two circles, mark the holes and drill. The tape prevents the drill slipping on the Formica.

The tape unit I used had the output on the left-hand side and the power feed on the right, so putting the tape unit tight to the left-hand side of the bottom panel left me with about 2in. on the left, just sufficient to take the

third of the triangular pieces with space for the jack plugs.

To make it easy to remove the tape unit the whole of the end section hinges down sideways. I will not go into much detail for that part of the console, as it all depends on the tape unit used.

The wiring is reasonably straightforward. Starting with the power feeds, the curly mains cable is passed through the lower back panel and strapped down; the live and neutral are fed in to the terminal block. From the other side of the live terminal a feed is taken to the poles of the two on/off switches. The other side of the switches are run back to the next two spare terminals on the terminal block.

Cut down the cables on the ZX power pack and tape unit mains lead and attach them to the same two terminals. Run the two neutrals into

Figure 2:

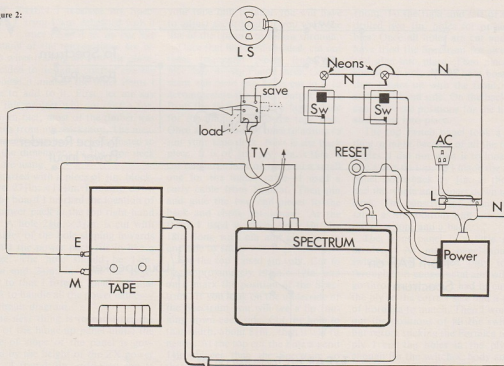

# SPECTRUM CONSOLE

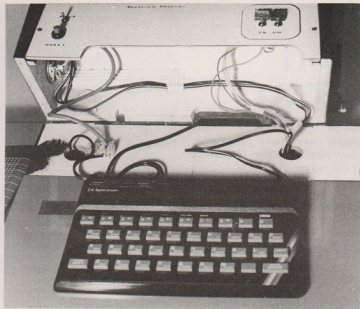

the incoming neutral terminal. Take two other wires from the output side of the switches and link to the neons, then a lead from the other side of the neons to neutral. That completes the power side of things.

In the re-set button, take the low-voltage output lead from the ZX power pack. Cut off one of them and solder it across the press button, so that if the computer is completely hung-up, pressing that button momentarily cuts off all power to the Spectrum.

When you are saving a program on tape it is necessary to pull out the earphone plug from the Spectrum because when the tape unit is recording the earphone output acts as a monitor. The save-load switch does the same as pulling-out the plug but instead of letting the feedback go into thin air, it feeds it into the speaker so that you can hear the data transfer.

Figure 3:

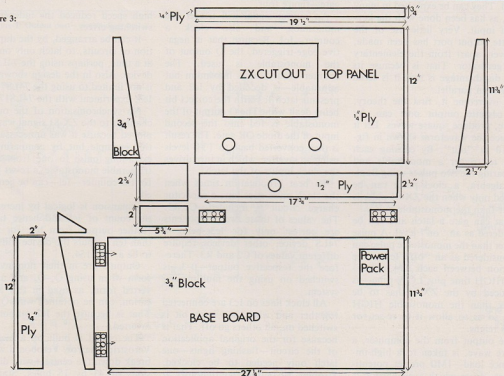

# Making another useful port for the ZX-81

*Since the ZX-81 was introduced people have added peripherals. Most have used the rear socket but here Stephen Huckstepp shows how the cassette output port can be used.*

**A**DDING PERIPHERALS to the ZX-81 can prove to be a cumbersome and daunting task with all those connections to be made to the rear socket, especially if the printer and/or RAM pack is to be used, too. So what can be done?

The ZX-81 is already equipped with three ports, two in and one out, for the cassette recorder and keyboard. They can be exploited in many ways, as has been done with the keyboard input. Very little use of the cassette output port has been made, however, apart from the elementary tone generator. That is because its main disadvantage is that it is serial rather than parallel.

To overcome it, first the theory. The cassette output port can, by nature, produce square waves. Let it produce the waveform shown in figure 10 as "out". By causing each pulse to trigger a monostable and comparing the two pulses using Boolean algebra, a clock-pulse can be formed only when the ZX-81 pulse is longer than the monostable pulse.

That can gate a latch and can be considered as an "on" level. A pulse shorter than the monostable pulse can be considered as an "off" level. The duration between each new pulse—i.e., HIGH time plus LOW time—as produced by the ZX-81 has to be longer than the monostable HIGH time, so as to allow it to re-set, or chaos ensues.

The output from the computer, a square wave, is taken to a high-impedance load—1M $\Omega$  pre-set potentiometer—from which a proportion is

tapped-off and amplified, using a pair of BC184L transistors. The choice of transistors is not compulsory and various configurations of BC107-9 and 2N3704 have been tried in the prototype stage. The inverting amplifier then feeds a schmitt trigger buffer, made from two inverters. That then feeds the monostable—Ic4—and one input of a diode OR gate—figure four.

An output signal will trigger the monostable and also clock a counter—Ic1. Because that is negative edge-triggered, the Q output of the monostable is used. The counter—four counts maximum but adjustable—is decoded by Ic2 and presents latch Ic3 with the correct bit being dealt with. The Q output of the monostable is fed into the second input of the diode OR gate. The result is then converted back to TTL levels using an inverter, which in turn drives the clock inputs of the latch.

To beat propagation times when the clock pulse goes low, a capacitor charge circuit is included—C2, R3. The values of those two components are correct only for Ic3 being a 74LS device; other devices require different values of C2 and R3. Therefore the respective output—0-3—is switched on using the multiplexing system.

All clock lines on Ic3 are connected together and when one latch bit is switched on, all others go off. That is because for the original application of the circuit—flashing lights—one latch only needed to be clocked. Strobing all outputs continuously at



high speed reduced the independent switching effect.

It can be arranged, by the duplication of circuits, to latch only one bit at a time, perhaps using the 74LS273 device. Also in the design shown one is not limited to using the 74LS75 for Ic3; experiment with the 74LS173.

No synchronisation of the output channels to the ZX-81 signal was employed because it was unnecessary in this example but by comparing an extra-long pulse to one from a re-triggerable monostable, a re-set pulse for the counter—Ic1—can be generated.

Expansion is logical by increasing the count of Ic1 and hence taking further outputs from Ic2; for more than ten outputs the device will have to be a 74LS154.

Outputs are in their non-inverted form when using  $\bar{Q}_a$ - $\bar{Q}_d$  and an inverted form, as used in this application, can be obtained with  $\bar{Q}_a$ - $\bar{Q}_d$ . That is because the Ic2 outputs are inverted.

The circuit is built on a piece of Verostrip—narrow Veroboard with a break down the centre—with dimensions of 43 by 15 holes. Start by



# INPUT OUTPUT PORT

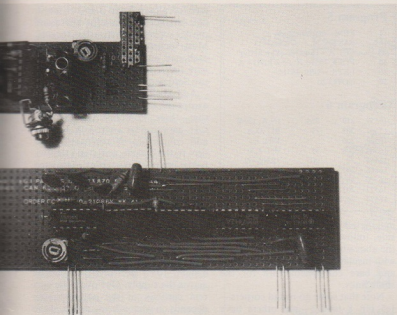

## Program 1

```

1  REM—any character, 62 of them
110 FOR F = 16514 TO 16528
120   SCROLL
130   PRINT F; "(space)";
140   INPUT I
150   POKE F, I
160   PRINT PEEK F
170   NEXT F
  
```

## Program 2

```

16514 211 255   OUT (255), A
16516 6 0      LD B, 0
16518 0        NOP
16519 16 253   DJNZ-1
16521 219 254  IN A, (254)
16523 6 32    LD B, 32
16525 0       NOP
16526 16 253  DJNZ-1
16528 201     RET
  
```

## Program 3

```

1  REM—machine code
10  FAST
20  POKE 16517,0
30  POKE 16524,32
40  LET L =USR 16514
50  POKE 16517,128
60  POKE 16524,160
70  LET L =USR 16514
80  GOTO 20
  
```

Figure 1: Output port—circuit diagram

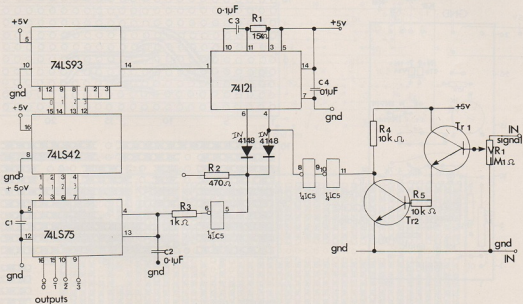

# INPUT OUTPUT PORT

## Program 4

16514	17	17	17	LD DE, 4369
16517	6	16		LD B, 16
16519	122			LD A, D
16520	211	255		OUT (255), A
16522	163			AND E
16523	230	240		AND 240
16525	40	5		JRZ +7
16527	14	128		LD C, 128
16529	13			DEC C
16530	32	253		JRNZ -1
16532	14	128		LD C, 128
16534	13			DEC C
16535	32	253		JRNZ -1
16537	219	254		IN A, (254)
16539	122			LD A, D
16540	163			AND E
16541	230	240		AND 240
16543	32	5		JRNZ +7
16545	14	128		LD C, 128
16547	13			DEC C
16548	32	253		JRNZ -1
16550	14	32		LD C, 32
16552	13			DEC C
16553	32	253		JRNZ -1
16555	203	3		RLC E
16557	16	216		DJNZ -38
16559	21			DEC D
16560	122			LD A, D
16561	230	15		AND 15
16563	32	208		JRNZ -46
16565	201			RET

## Program 5

1	REM—machine code
10	FAST
20	LET A = 16 * INT (15 * RND)
30	POKE 16516, 10 + 5 * RND + A
40	LET L =USR 16514
50	GOTO 20

## Program 6

16559	219	254	IN A, (254)
15561	203	71	BIT 0,A
16563	200		RET Z
16564	203	95	BIT 3,A
16566	32	205	JRNZ-49
16568	203	34	SLA D
16570	48	201	JRNC-53
16572	203	226	SET 4,D
16574	24	197	JR -57

making all the breaks on the underside, followed by the insertion of all the above-board links—26 of them—with insulated wire for the long links and bare component wire for the short links.

Note that some go round corners—Ic5 pin 8 to D2—and others have multiple connections made to them—Ic2 pin 8 to GND (in) to Tr2 emitter,

and Ic5 pins 1,3 and 7 to Ic4 pin 7. One link goes between the board and the IC sockets—when using sockets. Most sockets have a notch beneath each end and they can contain the wire link comfortably. Alternatively use Soldercon IC pins.

Add sockets and all components except the integrated circuits, noting that three components—R1, R3, C3—have to clear a wire link. Finally, add connectors—Veropins—to connect to the outside world and the five below-board links using insulated wire. Then insert all integrated circuits the correct way round.

The power supply—that is independent of the ZX-81 PSU so as not to overload it—was one which happened to be spare and was fully-regulated and smoothed at 5V. If the supply you use is not smoothed, place a 470uF 10V electrolytic capacitor across the supply. Obviously the current capacity of the power supply depends on what is being driven at the outputs, through buffers if necessary.

The ZX-81 cassette output is a sine

Figure 2: Music interface—top of PCB

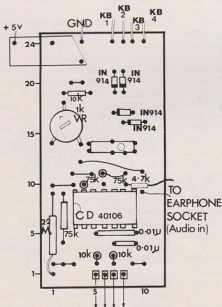

Figure 3a: Music interface—Wiring Diagram

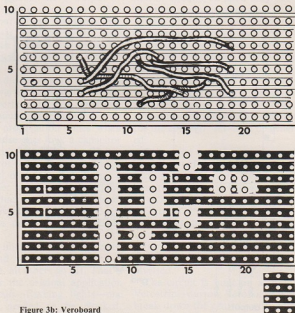

Figure 3b: Veroboard

# INPUT OUTPUT PORT

wave of a low magnitude, resulting from the alterations made to the square wave by R27/29 C11/12 inside the computer. Thus a change has to be made. There are two ways and one is shown in figure seven. All the circuitry to the right of the R29-C12 junction is removed and placed in a small adaptor made up of a 3mm. jack plug and socket. The new output is taken from R29, by putting a short link across the C12 position.

When using the output port, the port input is plugged straight into the MIC output. For saving a program, the adaptor is plugged into the computer and tape into the adaptor. Note that the automatic protection built into the computer if the incorrect plugs are put into the wrong sockets is now no longer there for the MIC socket. There is some protection evident. Whether or not it is sufficient has not been tested, so be cautious when plugging and unplugging.

Alternatively, two connections can be made to ground and the junction of R29-C12 can be run to an extra

Figure 6

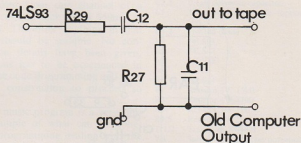

Figure 7

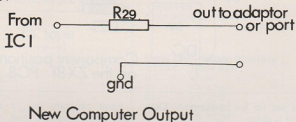

Figure 4: Output port—top of PCB

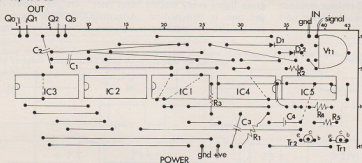
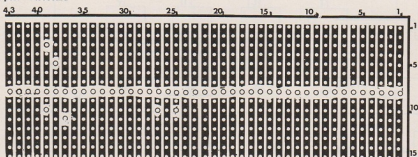
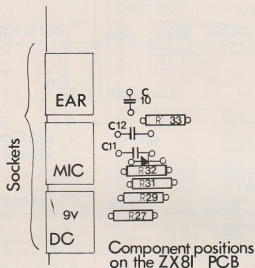

Figure 5: Output port—Veroboard



# INPUT OUTPUT PORT

Figure 8



socket just for use by the port. That method is safer.

Once all alterations are complete, connect everything including power and four outputs, e.g., a light emitting diode and a 1k $\Omega$  resistor connected to 5V. Do not switch on the port power supply yet.

Enter program one, a machine-code entry program, and, using it, input the numbers listed in program two. Then enter the Basic lines in test program three and RUN. The program lights every second lamp once the unit is switched-on. Adjusting pre-set Vrl—its position is not criti-

cal—will ensure this. If not, switch-off and check for faults.

By BREAKing the program and RUNning again, it is possible, because of no synchronisation, to light alternate LEDs.

Once everything is working, it is possible to move to a more useful program. Change line 110 to:

```
110 FOR F = 16514 TO 16565
and enter the data listed in program four by RUNning line 110.
```

That program in machine-code looks at the last four bits in location 16516, where each bit is a respective output. If a bit is high (1), that output is switched-on, and vice versa if it is low (0). Therefore the decimal number 240—16  $\times$  15 and binary 1111—is all outputs on, and zero—16  $\times$  0 and binary 0000—is all outputs off. There is also a duration counter in the first four bits of 16516. Enter lines 20-50 of program five and that will turn on a random four bits—line 20—for a random time—line 30—when RUN. That gives a random pattern of flashing lights if still connected to the test LEDs.

The limits of that output port are endless. Model railways can be automated or there can be communication with other computers via a parallel

Figure 10: Timing Diagrams

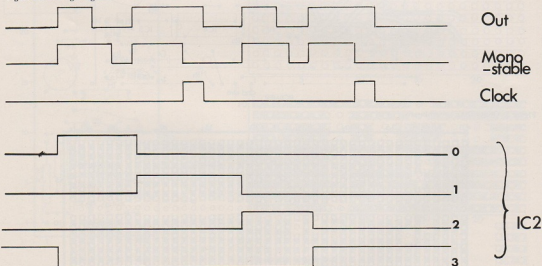



# INPUT OUTPUT PORT

input. For example, by building the input described in figure two, the light outputs can be synchronised with music. Do not erase program five but change line 110 to:

```
110 FOR F = 16559 TO 16575
```

and enter the data and program six by RUN 110.

Erase lines 20-60 and enter the command:

```
POKE 16516, 17
```

Then connect the music interface once the program is running; it hangs up the keyboard otherwise. Pressing BREAK will still allow one to escape from the program. Adjust the pre-set

so that the lights do not fly about too much when in use. In testing, a signal was taken from one channel of a stereo cassette deck giving 550mV at "0"dB. Therefore anything in that range should be suitable. No construction details have been given, since one has to be experienced in machine code programming and electronics construction to proceed so far.

This music program is a very simple example of what can be done. More programming dealing with the analysis of the music and the sequencing of the lights can make this unit far superior to anything else available.

## Parts List—Output port

C1.4	0.1 $\mu$ F ceramic capacitor
C2.3	0.1 $\mu$ F polyester capacitor
C5	470 $\mu$ F 10V electrolytic—optional, see text
D1,2	1N4148 diode
IC1	74LS93
IC2	74LS42
IC3	74LS75
IC4	74121
IC5	74LS14
R1	Resistor $\frac{1}{2}$ W 15k $\Omega$
R2	Resistor $\frac{1}{2}$ W 470 $\Omega$
R3	Resistor $\frac{1}{2}$ W 1k $\Omega$
R4,5	Resistor $\frac{1}{2}$ W 10k $\Omega$
Tr1,2	Transistor BC184L
Vr1	Sub-miniature preset potentiometer 1M $\Omega$

## Miscellaneous

IC sockets (3  $\times$  14 pin, 2  $\times$  16 pin)  
Veropins (8)  
Power supply (5v regulated)  
3 $\frac{1}{2}$ mm. jack plug and socket—optional

## Parts List—Music Interface

D1,2,3,4	1N914 diode
IC1	40106
R1	$\frac{1}{2}$ W 4.7k $\Omega$
R2	$\frac{1}{2}$ W 10k $\Omega$
R3,4,5	$\frac{1}{2}$ W 75k $\Omega$
R6	$\frac{1}{2}$ W 2.2M $\Omega$
Vr1	Sub-miniature pre-set potentiometer 1k $\Omega$

Figure 9

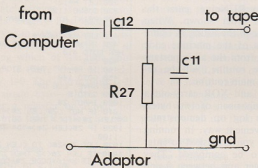
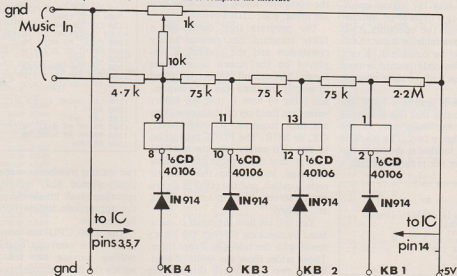

Figure 11: Music Interface

This diagram does not show the modifications made by the author, but the basic circuit only. Follow the Veroboard wiring diagrams to construct the complete circuit, with Cs and Rs to complete the interface



# Operating logically to improve Basic

David Nowotnik explains how to overcome two problem areas when using machine code to speed up the working of hardware projects. The programs apply to the ZX-81 but can be adapted for the Spectrum.

MANY OF the machine language instructions can be compared to the simple Basic commands e.g., LD can be compared to POKE or LET, RET with RETURN. That helps considerably in learning but there are some which are more difficult to comprehend.

Logical operators—AND, OR, XOR—and the shift and rotate instructions can be troublesome. To help overcome that hurdle, two programs will help the understanding of those concepts. The ZX-81 listings for the programs are shown in figures two and four.

The first program—figure two—demonstrates how the logical operators combine two bytes to get another value. Although the operators AND and OR are available in Basic, XOR is not. So, to be consistent, a very simple machine code routine is used to carry-out each of the three possible operations.

The routine is held in a REM line and it is advisable that this is entered first, before the main part of the program in figure two. The machine code loading routine is shown in figure one. Enter the program in figure

one, then, on RUNning, enter the values in the order shown. When complete, type-in the listing in figure two. All lines of the machine code loader, apart from the all-important machine code routine, will be replaced by the main routine.

AND, OR, and XOR carry-out a bit-by-bit comparison of two bytes. The program log op demonstrates that in a convenient way. In running the program, you are asked to enter two values to be compared. They must be integer and between 0 and 255. You may enter the values in decimal or hexadecimal; add the suffix D or H to the value entered to let the computer know which base you are using, e.g., 23D, FOH.

The program then carries-out a fairly standard hex/decimal/binary conversion and the number is displayed on the screen in all three forms. The second number is treated in exactly the same way. The important thing to note is that the binary values are lined-up on the screen. You are then requested to enter AND, OR, or XOR. The POKE instruction in line 270 enters into the machine code routine the appropriate machine language instruction; the machine code is called, and the result is shown on the screen, again in hex, decimal, and binary.

You will see how the result is calculated by checking through the binary result with the tables in figure three. Those tables show the result of combining two bits. Work through the

Figure 2

```

140 PRINT AT 4.5;"DEMONSTRATION
150 PRINT AT 4.5;"OF LOGICAL OP
ERATORS"
170 LET N=6
180 GOSUB 1000
190 POKE 16514,X
200 PRINT AT 10.0;"FIRST OPERAN
D "
205 LET N=10
210 GOSUB 1000
220 POKE 16515,X
230 PRINT AT 21.4;"AND OR XOR -
SELECT"
240 INPUT A#
250 IF NOT (A#="AND" OR A#="OR"
OR A#="XOR") THEN GOTO 240
260 LET A=(A#="AND")*166+(A#="O
R")*182+(A#="XOR")*174
270 POKE 16522,A
280 RAND USR 16516
290 PRINT AT 21.8;"
300 PRINT AT 12.5;"A#="
310 LET X=PEEK 16515
320 LET N=12
330 GOSUB 1128
400 PRINT AT 21.0;"ANY MORE (Y/
N)?"
410 LET A#="INKEY#
420 IF NOT (A#="Y" OR A#="N") T
HEN GOTO 410
430 CLS
440 IF A#="H" THEN STOP
450 GOTO 140
500 SAVE "LOG OP"
520 GOTO 5
1000 INPUT Z#
1010 IF NOT (Z#<LEN Z#)="H" OR Z
#<LEN Z#="D") THEN GOTO 1000
1020 IF (Z#<LEN Z#)="D" THEN GOTO
1100
1030 LET Z#<Z# TO (LEN Z#-1)
1040-IF LEN Z#<2 THEN GOTO 1000
1050 LET X=16*CODE Z#<CODE Z#<2)
-476
1060 IF X<0 OR X>255 OR X<>INT X
THEN GOTO 1000
1090 GOTO 1200
1100 LET X=VAL (Z# TO (LEN Z#-1
))
1110 IF X<0 OR X>255 OR X<>INT X
THEN GOTO 1000
1120 LET Z#<CODE (INT (X/16)*20)
+CODE (X-16*INT (X/16)*20)
1200 PRINT AT N,12;Z#;" "X
1210 PRINT AT 6,12;"H D"
1220 LET Y=X
1250 LET Y#="00000000"
1260 FOR I=6 TO 1 STEP -1
1270 IF X<>INT (X/2) THEN LET
Y#<Y#1
1280 LET X=INT (X/2)
1290 NEXT I
1295 LET X=Y
1300 PRINT AT 6,21;"BINARY"
1310 PRINT AT N,20;Y#
1320 RETURN
    
```

Figure 1

```

1 REM
5 FOR I=16514 TO 16524
10 SCROLL
15 PRINT I
20 INPUT A
25 POKE I,A
30 PRINT A
40 NEXT I
    
```

two starting numbers, comparing vertically-aligned bits, and the corresponding result bit should agree with the appropriate logical operation in figure three.

The Z-80 CPU has nine instructions which carry-out operations involving moving bits left or right within the internal registers or RAM.

Figure 3: AND, OR and XOR

```

AND
0 AND 0=0
0 AND 1=0
1 AND 1=1

OR
0 OR 0=0
0 OR 1=1
1 OR 1=1

XOR
0 XOR 0=0
0 XOR 1=1
1 XOR 1=0
    
```

How they differ can be very confusing. The purpose of the program 'Shift/Rotate'—figure four—is to demonstrate exactly how each one works. Type-in the program as listed, then RUN. You will get a menu asking which of the nine you would like to have demonstrated. Press a key, 1-9. The instructions 1-7 involve a single byte—which represents either a register or a byte in RAM—and the CARRY flag. Enter a

value for the byte—0 to 255, in decimal only—and 0 or 1 for the CARRY flag. Then watch the screen. You will see a slow-motion display of the bits in the register/byte and CARRY moving about to create new values. The program also converts the new binary value in the register to decimal. Trying each instruction in turn will demonstrate the differences. If you select 8 or 9, you will obtain the machine language instructions which shuffle the value in the A register and a byte in RAM.

Enter again, in decimal, the two values for the register and byte, and the program will do the rest, moving the bits around in slow motion and calculating the two results of the operation.

When you have outgrown the need to have all these instructions demonstrated, you should find that both programs will still be of value. They serve as useful calculators for these machine language instructions, so when writing a machine code program you can use them to check that

Figure 5

```

300 GO TO 500
310 POKE 32000,X
320 POKE 32001,X
330 POKE 32000,A
350 RANDOMIZE USR 32000:
500 CLEAR 51000
510 LET X=32000
520 FOR A=0 TO 255
530 READ A:POKE I,A
540 NEXT A
550 DATA 0,0.30,125.46,0.126,35
560 GO TO 140
    
```

your use of the instructions produces the desired effect.

As a final note for Spectrum owners, the program 'Shift/Rotate' can be entered unchanged, although you may want to add a little colour. Because the program storage area is not a convenient place to store machine code on the Spectrum, "log on" will have to be altered slightly, with the machine code held above RAMTOP.

For the Spectrum, do not use the routine in figure one to enter the machine code routine. Instead enter the program as listed in figure two, with the changes and additions listed in figure five. The program can be started with RUN.

Figure 4

<pre> 50 GOSUB 9000 100 CLS 105 PRINT AT 2,1;B# 110 PRINT AT 6,2;"SELECT :-" 125 PRINT 130 PRINT " 1. " ;A#(1) 132 PRINT " 2. " ;A#(2) 134 PRINT " 3. " ;A#(3) 135 PRINT " 4. " ;A#(4) 137 PRINT " 5. " ;A#(5) 138 PRINT " 6. " ;A#(6) 139 PRINT " 7. " ;A#(7) 140 PRINT " 8. " ;A#(8) 143 PRINT " 9. " ;A#(9) 150 IF INKEY#="" THEN GOTO 150 155 LET C=CODE INKEY#-28 160 IF C&lt;1 OR C&gt;9 THEN GOTO 150 170 CLS 180 GOSUB (&lt;X200&gt;) 190 GOTO 100 200 GOSUB 2000 210 GOSUB 4000 220 GOSUB 4400 230 GOSUB 6000 240 RETURN 405 GOSUB 2000 405 GOSUB 4000 410 GOSUB 4500 415 GOSUB 5000 420 GOSUB 6000 425 RETURN 600 GOSUB 2000 610 GOSUB 4500 620 GOSUB 4700 630 GOSUB 5000 640 GOSUB 6000 650 RETURN 800 GOSUB 2000 905 GOSUB 4500 910 GOSUB 4750 920 GOSUB 5000         </pre>	<pre> 830 GOSUB 6000 840 RETURN 1000 GOSUB 2000 1005 GOSUB 4300 1010 GOSUB 4800 1015 GOSUB 5000 1020 GOSUB 6000 1030 RETURN 1200 GOSUB 2000 1205 GOSUB 4500 1210 GOSUB 4850 1220 GOSUB 5000 1230 GOSUB 6000 1240 RETURN 1400 GOSUB 2000 1410 GOSUB 4900 1420 GOSUB 4500 1430 GOSUB 4950 1440 GOSUB 5000 1450 GOSUB 6000 1460 RETURN 1600 GOSUB 6100 1605 GOSUB 6400 1610 GOSUB 7000 1615 GOSUB 6900 1620 RETURN 1800 GOSUB 6100 1805 GOSUB 6500 1810 GOSUB 7000 1815 GOSUB 6000 1820 RETURN 2000 PRINT AT 1,1;B# 2005 PRINT AT 4,2;A#(C) 2007 PRINT AT 7,12;"REGISTER" 2010 PRINT AT 8,11;"1620 RETURN" 1800 GOSUB 6100 1805 GOSUB 6500 1810 GOSUB 7000 1815 GOSUB 6000 1820 RETURN 2000 PRINT AT 1,1;B# 2005 PRINT AT 4,2;A#(C) 2007 PRINT AT 7,12;"REGISTER" 2010 PRINT AT 8,11;"1620 RETURN" 2015 IF D&lt;0 OR D&gt;255 OR D&lt;&gt;INT D THEN GOTO 2100 2100 GOSUB 4100 2115 PRINT AT 9,12;Y# 2120 PRINT AT 8,0;C# 2125 PRINT C# 2127 PRINT AT 9,2;D# 2130 PRINT AT 15,0;"ENTER CARRY" 2135 INPUT E# 2140 IF NOT (&lt;E=1 OR E=0&gt;) THEN GO TO 2135 2145 PRINT AT 15,0;C#;C#(C) TO 5); TAB 15;E 2147 PRINT AT 15,2;E 2150 GOSUB P 2155 RETURN         </pre>
--	--

# MACHINE CODE GUIDE

```

4000 FOR I=1 TO 25
4010 NEXT I
4020 RETURN
4100 LET Y#="00000000"
4102 LET D#D
4105 FOR I#0 TO 1 STEP -1
4110 IF D/2<INT(D/2) THEN LET
Y#(I)="1"
4115 LET D=INT(D/2)
4220 NEXT I
4225 RETURN
4300 PRINT AT 9.12;CHR#(CODE Y#
+128)
4310 GOSUB P
4320 PRINT 9.12;" " AT 9.6;CHR#
(CODE Y#+128)
4330 GOSUB P
4335 FOR I#2 TO 8
4340 PRINT AT 9.(10+I);Y#(I)+" "
4345 FOR J#1 TO 10
4350 NEXT J
4355 NEXT I
4360 GOSUB P
4365 RETURN
4400 PRINT AT 9.6;" " AT 9.19;CH
R#(CODE Y#+128) AT 15.16;CHR#(
CODE Y#+128)
4405 GOSUB P
4410 PRINT AT 9.19;Y#(1) AT 15.1
6;Y#(1)
4415 LET Y#=#Y#2 TO >Y#(1)
4420 GOSUB 5000
4425 RETURN
4500 PRINT AT 15.16;CHR#(E+156)
4505 GOSUB P
4510 PRINT AT 15.16;" " AT 9.19;
4515 GOSUB P
4520 PRINT AT 9.6;" " AT 15.16;C
HR#(CODE Y#(1)+128)
4525 GOSUB P
4530 PRINT AT 15.16;Y#(1) AT 9.1
9;CHR#(E+28)
4540 LET Y#=#Y#2 TO >CHR#(E+28)
)
4550 RETURN
4600 PRINT AT 9.19;CHR#(CODE Y#
(8)+128)
4605 GOSUB P
4610 PRINT AT 9.19;" " AT 9.24;C
HR#(CODE Y#(8)+128)
4615 GOSUB P
4620 FOR I#7 TO 1 STEP -1
4625 PRINT AT 9.11+I;" "+Y#(I)
4630 FOR J#1 TO 10
4635 NEXT J
4645 NEXT I
4650 GOSUB P
4655 RETURN
4660 GOSUB P
4665 RETURN
4700 PRINT AT 9.24;" " AT 9.12;C
HR#(CODE Y#(8)+128) AT 15.16;CH
R#(CODE Y#(8)+128)
4705 GOSUB P
4710 PRINT AT 9.12;Y#(8) AT 15.1
6;Y#(8)
4715 LET Y#=#Y#(8)+Y#(7)
4720 RETURN
4750 PRINT AT 15.16;CHR#(E+156)
4755 GOSUB P
4760 PRINT AT 15.16;AT 9.12;CHR#
(E+156)
4765 GOSUB P
4770 PRINT AT 9.24;" " AT 15.16;
CHR#(CODE Y#(8)+128)
4775 GOSUB P
4780 PRINT AT 9.12;CHR#(E+28) AT
15.16;Y#(8)
4785 LET Y#=#CHR#(E+28)+Y#(7)
4790 RETURN
4800 PRINT AT 9.6;" " AT 15.16;C
HR#(CODE Y#+128)
4810 GOSUB P
4815 PRINT AT 9.23;"Inverse 0"
4820 GOSUB P
4825 PRINT AT 9.23;" " AT 9.19;" "
0"
4830 GOSUB P
4835 PRINT AT 9.19;"0" AT 15.16;
Y#(1)
4840 LET Y#=#Y#2 TO >+"0"
4845 RETURN
4850 PRINT AT 9.24;" " AT 15.16;
CHR#(CODE Y#(8)+128)
4855 GOSUB P
4860 GOTO P
4865 GOTO P
4870 PRINT AT 9.6;" " AT 9.12;"0"
)
4875 GOSUB P
4880 PRINT AT 9.12;"0" AT 15.16;
Y#(8)
4885 LET Y#="0"+Y#(7)
4890 RETURN
4900 PRINT AT 9.12;CHR#(CODE Y#
+128)
4905 GOSUB P
4907 PRINT AT 9.6;CHR#(CODE Y#+
128)
4910 GOSUB P
4915 PRINT AT 9.12;Y#
4920 GOSUB P
4925 RETURN
4930 PRINT AT 9.24;" " AT 15.16;
CHR#(CODE Y#(8)+128)
4935 GOSUB P
4937-GOSUB P
4940 PRINT AT 9.6;" " AT 9.12;CH
R#(CODE Y#+128)
4950 PRINT AT 9.12;Y#(1) AT 15.1
6;Y#(8)
4955 LET Y#=#Y#(1)+Y#(7)
4960 RETURN
5000 LET X#0
5005 FOR I#0 TO 1 STEP -1
5010 LET X#X+(CODE Y#(1)-28)*X#2
(8-1)
5020 NEXT I
5030 PRINT AT 9.22;"# " X
5040 RETURN
6000 PRINT AT 21.2;"PRESS ANY KE
Y TO CONTINUE"
6010 IF INKEY#="" THEN GOTO 6010
6020 RETURN
6100 PRINT AT 2.1;#8
6105 PRINT AT 4.2;#8(C)
6115 PRINT AT 8.11;"#graphic E,#r
aphic 7#9,#graphic R"
6120-PRINT AT 9.11;"#graphic 5,#P
C#49,#graphic B"
6125 PRINT AT 10.11;"#graphic W,#r
aphic 6#9,#graphic O"
6130 PRINT AT 11.12;"76543210"
6135 PRINT AT 13.16;"#A"
6140 PRINT AT 14.11;"#graphic E,#r
aphic 0#9,#graphic R"
6145 PRINT AT 15.11;"#graphic 5,#r
FACE#9,#graphic B"
6150 PRINT AT 16.11;"#graphic W,#r
aphic 6#9,#graphic O"
6155 PRINT AT 17.12;"76543210"
6160 GOSUB P
6165 PRINT AT 9.0;"INPUT (HL)"
6170 INPUT D
6180 IF D<0 OR D>255 OR D<>INT D
THEN GOTO 6170
6185 GOSUB 4100
6190 PRINT AT 9.0;C#+" " AT 9.2
1;D
6197 PRINT AT 9.12;Y#
6200 LET Z#Y#
6205 PRINT AT 15.0;"INPUT A"
6210 INPUT D
6215 IF D<1 OR D>255 OR D<>INT D
THEN GOTO 6210
6220 GOSUB 4100
6225 PRINT AT 15.0;C# AT 15.12;Y
# AT 15.2;D#D
6235 LET X#128
6330 LET R#=#CHR#(CODE Z#+X)+CHR
#(CODE Z#+2)+X)+CHR#(CODE Z#+3
)+X)+CHR#(CODE Z#+4)+X)
6335 LET S#=#CHR#(CODE Z#+5)+X)+
CHR#(CODE Z#+6)+X)+CHR#(CODE Z
#+7)+X)+CHR#(CODE Z#+8)+X)
6340 LET T#=#CHR#(CODE Y#+5)+X)+
CHR#(CODE Y#+6)+X)+CHR#(CODE Y
#+7)+X)+CHR#(CODE Y#+8)+X)
6345 RETURN
6400 PRINT AT 15.16;T#
6405 GOSUB P
6410 PRINT AT 15.16;" " AT 15.
6415-GOSUB P
6420 PRINT AT 9.12;R#
6425 GOSUB P
6430 PRINT AT 9.12;" " AT 15.1
6;R#
6435 GOSUB P
6440 PRINT AT 9.16;" " AT 9.12
;Z#5 TO )
6445 GOSUB P
6450 PRINT AT 15.23;C# AT 9.16;T
#
6455 LET T#=#Z#5 TO )
6460 LET R#=#Y#5 TO )
6465 LET Y#=#Y#5 TO 4)+Z#(4)
6470 LET Z#=#T#+R#
6472 GOSUB P
6475 PRINT AT 9.12;Z# AT 15.12;Y
#
6480 RETURN
6500 PRINT AT 15.16;T#
6505 GOSUB P
6510 PRINT AT 15.16;" " AT 15.
6515 GOSUB P
6520 PRINT AT 9.16;S#
6525 GOSUB P
6530 PRINT AT 9.16;" " AT 15.1
6;S#
6535 GOSUB P
6540 PRINT AT 9.12;" " Z#(4) TO
4)
6545 GOSUB P
6550 PRINT AT 15.28;C# AT 9.12;T
#
6555 LET T#=#Z#5 TO )
6560 LET R#=#Y#5 TO )
6565 LET Y#=#Y#(4) TO 4)+T#
6570 LET Z#=#R#+Z#(4)
6572 GOSUB P
6575 PRINT AT 9.12;Z# AT 15.12;Y
#
6580 RETURN
7000 LET X#0
7005 FOR I#0 TO 1 STEP -1
7010-LET X#X+(CODE Z#(1)-28)*X#2
(X#-1)
7020 NEXT I
7030 PRINT AT 9.23;"# " X
7040 LET Y#0
7045 FOR I#0 TO 1 STEP -1
7047 LET X#X+(CODE Y#(1)-28)*X#2
(X#-1)
7050 NEXT I
7055 PRINT AT 15.23;"# " X
7060 RETURN
9000 DIM A#(9,8)
9010 LET A#(1,1)="RLCA/RLC"
9020 LET A#(2,1)="RLA/RL"
9030 LET A#(3,1)="RRC/ARR"
9040 LET A#(4,1)="RRA/RR"
9050 LET A#(5,1)="SLA"
9060 LET A#(6,1)="SRA"
9070 LET A#(7,1)="RLD"
9080 LET A#(8,1)="RRD"
9100 LET B#="DEMONSTRATION OF SH
9110 LET C#=" "
9120 LET P#000
9130 RETURN

```



# It may repel extra-terrestrials, but can it switch on the light in the loo?

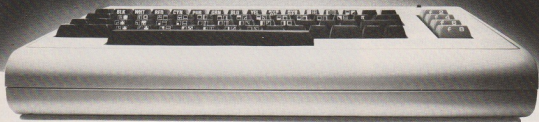

If you're getting bored playing games and running simple programs Electronics and Computing Monthly can show you how to put a lot of fun back into your micro. With the addition of some easy-to-build electronic circuits, your computer could drive much more than a TV screen.

Like your Scalextric, or train-set. It could control the lights in your house, the central heating system, talk to the budgie while you're out and water the houseplants when you're away.

And you can build all these things yourself—the simple circuits for pennies rather than pounds. Each month Electronics and Computing magazine shows you how to

expand your micro and gives you new ideas for computer fun. Project by project we add another dimension to your computer.

On the cover of the latest issue are the circuit cards for 10 projects, and on the inside we show you what you can do with them. All you need is a hot soldering iron and a cool 75p.

## WHERE ELECTRONICS AND COMPUTING INTERFACE



# High quality printing at a reasonable cost

**A**LTHOUGH the Sinclair printer is excellent value at £60, it has a number of limitations which make it less than ideal for protracted heavy-duty use. The metallised paper which it uses becomes expensive if you need reams of output instead of just the odd program listing, and the 32-column format is not really suitable for word processing. In addition, the print quality tends to deteriorate from time to time, which can play havoc with machine code listings where absolute accuracy is vital.

The interface described was designed for use with a KSR 33 terminal which fortunately was acquired for £50, although they are generally sold at prices around the £100 mark. During 1960s and 1970s the KSR 33 was one of the mainstays of the computer industry and consequently many of them are available second-hand. They are rather slow and noisy by today's standards but produce clear upper-case print on 8.5mm. plain paper in up to 80-column format and are fairly robust.

If you are fortunate enough to own something more sophisticated in the way of printers, this interface should still be suitable provided that it uses an RS232C ASCII code input.

Construction cost should be less than £8, the most expensive item being a suitable rear edge connector adaptor to enable you to use the interface in conjunction with the RAM pack and other expansions. The software enables you to produce complete program listings, or listings between selected line numbers and to output messages and variables to the printer under program control in any desired column setting.

The task of converting parallel data to serial format is carried-out by software, which outputs one bit at a time

*Although the ZX-printer is comparatively cheap it has its limitations for heavy use. John Cussons shows how to make a RS 232 interface to allow a better printer to be used with the ZX-81 with at least 4K RAM.*

on the least significant bit of the data bus (DO). With reference to figure one, this data is stored in a latch formed by two cross-coupled NAND gates, IC2(8,9,10) and IC2(11,12,13). Gates IC1(1,2,3) and IC1(4,5,6) are address decode logic, requiring that IORQ, WR and A2 be simultaneously low to produce a 'low' output on IC1(4). That 'low' allows gates IC1(8,9,10) and IC1(11,12,13) to gate data and 'not data' signals through to both halves of the latch—gate IC2(1,2,3) acts as an inverter to provide the 'not data' signal.

IC3 is an op-amp which converts the 0V and 5V logic levels to +10V and -10V as required by the printer.

The most straightforward method of construction is to use 0.2in. Veroboard, the layout illustrated being on a piece 3.5in. by 3.75in. That is a fairly generous size to make construction easier and you could probably condense the layout on to a much smaller board if required.

It is best first to solder the two ICs to the board, followed by VR1 and the two resistors, since they can then be used as a guide to the correct location of the PVC insulated wire links. That sequence has the disadvantage that the ICs could be overheated when soldering nearby links, so care should be exercised. If you do not wish to take the risk, the ICs could be replaced by DIL sockets into which the ICs are plugged only when construction is complete.

All the tracks which pass beneath

the three ICs should be cut to avoid shorting IC pins and another track cut should be made between VR1 upper connection and IC3 pin 2 in the position marked.

Inputs from the ZX-81 are on the left hand side and they should be taken to the appropriate points on the edge connector adaptor. Multicore cable is ideal for it but might be difficult to obtain in short lengths, in which case you could use a bundle of separate wires held neatly together with insulating tape or cable ties. The connections should be kept short, 1ft. or less, since they are effectively an extension of the CPU bus which is sensitive to electrical noise.

Two connections on the right hand side, 'data out' and 'common', go to the printer. The standard RS232C connector is a 25-way 'D' type plug, and 'data out' should be taken to pin 3, 'common' to pin 7.

The +10V and -10V power supplies for IC3 are only nominal values, since an RS232C interface should function in the range -3V:0:+3V to -15V:0:+15V. A pair of small 9V batteries therefore would make a suitable power supply; alternatively you could make up a mains power supply. Whatever you use the 0V rail should be connected to the 'common' track.

In the case of the KSR 33, +10V and -10V are available on the selector magnet drive board and they could be brought-out externally and connected to the interface. That should be undertaken, however, only by an experienced constructor with access to the printer technical manual.

Potentiometer VR1 provides a reference level for IC3 and that should be adjusted so that the voltage on IC3 pin 3 is +2.5V.

The program consists of 1,049 bytes of machine code which initially

# RS232 INTERFACE

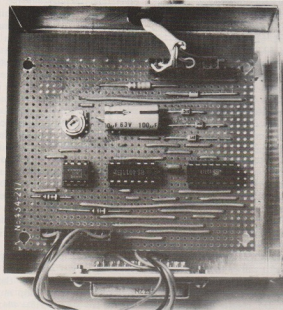

```
9900 PRINT "INPUT STARTING
ADDRESS"
9010 DIM Y$(3)
9020 INPUT A
9030 FOR X=A TO 17559 STEP 5
9040 SCROLL
9050 LET CS=0
9060 PRINT AT 20,0;" "
9070 FOR Y=1 TO 5
9080 INPUT Y$
9090 PRINT Y$;" "
9100 POKE A,VAL Y$
9110 LET A=A+1
9120 LET CS=CS+VAL Y$
9130 NEXT Y
9140 PRINT "(,CS,)"
9150 PRINT AT 21,0;"IS THE CHECK
SUM CORRECT?(Y OR N)"
9160 LET B$=INKEY$
9170 IF B$<>"N" AND B$<>"Y" THEN
GOTO 9160
9180 PRINT AT 21,0;"
9190 IF B$="N" THEN GOTO 9230
9200 NEXT X
9210 PRINT AT 21,0;"LOADING COMP
LETE"
9220 STOP
9230 PRINT AT 20,0;" "
9240 LET A=A-5
9250 GOTO 9050
10 SAVE "PRINTER DRIVE"
20 POKE 16369,123
30 LET L=USR 16514
40 PRINT "PRINTER DRIVE ROUTIN
LOADED OK. ENTER "NEW" COMMAN
D TO RESET RAMTOP."
50-STOP
```

is resident in a REM statement in line, then down-loaded to above RAMTOP. There is an 'organiser' routine for program listings and another for writing under program control, called LISORG and RITORG. The organisers work by making calls to a common set of subroutines, performing 'housekeeping' tasks such as stack control where necessary.

Conversation of Sinclair codes to ASCII codes is done with the aid of two look-up tables, one for upper-case characters and one for lower-case—the latter is not used for the KSR 33, which produces upper-case print only. A more detailed description of the various routines is in the appendix.

To load the software, enter a REM statement at line number 1 containing 44 dummy characters—Xs, Ys or anything else. The total length of the line is then 50 bytes, allowing five bytes for the line overhead—two for line number, two for line length and one for final NL character—and one byte for the REM code. Use the edit facilities to produce a copy of this line and repeat until you have a total of 20 lines numbered 1 to 20. Enter line 21 with 49 dummy characters, then use

the following direct commands:

POKE 16511,27

POKE 16512,4

That effectively converts the 21 lines you have entered into a single large REM statement with 1,049 bytes of space available for machine code storage; when listed it will still appear to be separate lines and the cursor may finish occasionally in the middle of it, but do not worry about that.

A word of caution at this point; when editing programs containing REM statements bigger than 768 bytes, never delete the line immediately following the REM statement, since that causes the ROM to be caught in an endless LIST/CLS loop and the only way of recovering is to pull out the power supply jack plug.

You should then enter the loader program—program 1—and use it to enter machine code into the REM statement from the decimal listing—figure four. The numbers in brackets after each block of five bytes are checksums and they should not be entered but simply compared to the checksums produced by the loader. After each block the program will output: "Is the checksum correct? (Y or N)". Pressing Y allows you to enter the next block and pressing N erases the last block and allows you to re-enter it.

Once all the machine code is entered, key-in the Basic section of the printer drive routine, lines 10 to 50—program 2. The machine code loader can then be deleted and the completed routine saved on tape using the command GOTO 10.

The format for using the printer is a program line with a USR call to either LISORG or RITORG, followed immediately by a REM statement containing appropriate arguments. FAST mode must always be entered before calling LISORG or RITORG.

The listing

```
10 LET L=USR 31930
```

```
20 REM 0,9999, will list the entire
Basic program in memory. If you
wish to list only part of a program,
insert the appropriate start and finish
line numbers in the REM statement.
Note that both commas must be
present in this statement—it is very
```

# RS232 INTERFACE

easy to omit the final comma which will result in an incorrect listing.

Graphics characters in the listing will be replaced by spaces, so that you have the opportunity to draw them by hand should you desire. Printer output for program listings is in 32 columns, the same as the TV screen. Although more columns could be used, it is easier to check listings against the screen if both use the same format. Sinclair ZX-81 Basic does not allow multi-statement lines, and most lines are consequently short; an 80-column output, therefore, would consist mainly of short lines with an occasional long line, which looks very untidy.

Terminating a program listing manually can be done by holding-down the Break key; printing then finishes at the end of the current line.

General-purpose output to the printer, such as strings, variables, messages, must first be written to the display file, then copied to the printer as follows:

```
500 LET L =USR 31690
501 REM 60,10,
```

Here line 500 calls RITORG, while line 501 sets the number of columns to 60 and copies the first 10 characters of the display file top line. If you wanted to copy the complete top line you should use:

```
501 REM 60,32,
```

The limit to the size of the second argument is 768 characters, i.e., the size of the complete display file. Using that value is equivalent to the Copy command.

Calling RITORG at address 31690 causes the printhead position to remain unchanged between calls—i.e., a carriage return/line feed occurs only when the specified number of characters have been printed. To start each print output with a CR/LF, line 500 should be amended to:

```
500 LET L =USR 31698.
```

There may be occasions on which the number of characters to be sent to the printer is unknown. Loading argument two in the REM statement with a large value is one way of dealing with it, but the print may then contain unwanted trailing spaces. To solve the problem the 'E' character is

used as a field limiter, e.g.:

```
600 CLS
610 PRINT AT 0,0;X;CH$ 12
620 LET L =USR 31690
630 REM 60,768,
```

That program will not copy the complete screen; instead, print output is terminated when all the characters of variable X have been printed. It is possible to alter the particular character used for limiting by entering in command mode:

```
POKE 31775,Y
where Y is the code of the desired character.
```

Outputting blank lines to the printer for the purpose of spacing can be achieved by:

```
1010 LET L =USR 31698
1020 REM 0,5,
```

Those two lines cause two CR/LFs to be output. Setting the first argument to zero causes the second argument to be interpreted as the desired number of CR/LFs, up to a maximum of 255. Note that RITORG must be called at address 31698 to use this facility.

The drive routine was written specifically for a KSR 33 operating at 110 baud, equivalent to 10 characters per second—11 bits/char. To drive

different printers some software modifications may be required.

The baud rate is determined by the DELAY subroutine which is called-up after outputting each bit of a character. DELAY consists of two nested loops, an inner one which is executed 35 times and an outer one which is executed nine times. Those values produce the required 9.1msec delay for 110 baud operation but can be changed to give different baud rates, using the outer loop for coarse tuning and the inner one for fine tuning. The following calculations illustrate this:

Total no. of times inner loop is executed is  $9 \times 135 = 1,215$ .

This corresponds to 9.1msec delay, thus inner loop execution time is  $9.1 \times 1,215 = 7.5\mu$  sec.

For a 300 baud rate, say, the required bit time is  $1/300$  sec. = 3.333msec. Thus the number of times the inner loop must be executed is  $3,333 \div 7.5 = 444$ .

That could be achieved with an outer loop value of five, and an inner value of 89, or an outer value of six and an inner value 74. Which of the many possible combinations you choose is arbitrary but the inner loop

Figure 1: Veroboard.

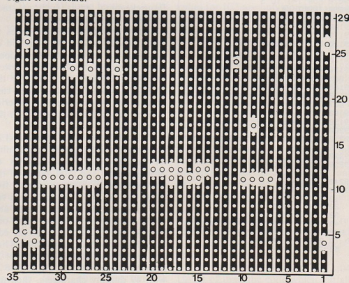



will require some final adjustment to match the printer exactly, since the calculations are only approximate. The final trimming is done on a trial-and-error basis. Note that the range for the loop values is 1 to 255.

To alter the inner loop, POKE location 17370 and for the outer POKE location 17376. To down-load the modification to RAMTOP use the command RAND USR 16514.

The software includes no provision for setting parity; the first three bytes of the character output routine—CHOUT—merely set the parity bit to 1. Should you require to set odd or even parity, those three bytes should be replaced by a call to a subroutine. Most printers have settable parity—i.e., odd, even or none—and the last option should be chosen if available.

A carriage return/line feed combination on the KSR-33 is achieved by outputting decimal 10 to the interface but some printers may execute only a line feed in response to it. If that occurs check your printer manual; you may find that the CR/LF combination response is available as a hardware option, either on switches or wire links.

If you are unfortunate you might

have to modify LISORG and RITORG to output a CR character—decimal 13—after each LF character—decimal 10. To find the locations where that is necessary, check the listings for the instruction LD A,10 followed by CALL 32275.

Look-up tables are used by the translation subroutine, STRANS, to convert Sinclair codes to ASCII. There are two tables, one for upper- and one for lower-case, both 64 bytes long. STRANS adds the Sinclair code to the table base address; the resulting address then contains the ASCII equivalent code.

Location 32725 contains a flag, CSFLAG, which determines whether or not the lower-case table should be used by STRANS. If CSFLAG is not equal to zero, both tables are used; inverse characters in the display file are then output to the printer as upper-case and normal characters as lower-case.

If CSFLAG is zero, however, only the upper-case table is used, both inverse and normal characters being printed as upper-case. To use lower-case, therefore, you must enter the command POKE 32725,1.

## Appendix

Each of the programs following has two addresses, a REM address at which it is initially resident and a RAMTOP address which it occupies after down-loading; to convert between those addresses add or subtract 15164. The disassembled program listing gives REM addresses. A few of the instructions, those prefixed ED or CB, are not disassembled, since the program used to produce the listings requires that they be done manually.

## DOWNLOADER

16514–16525; 31678–31689 12 bytes.  
Simple routine using the Z-80 LDIR instruction to transfer the rest of the routine to RAMTOP.

## RITORG

16526–16636; 31690–31800; 111 bytes.

Organiser program for copying display file to printer.

## LCLUT

16637–16700; 31801–31864; 64 bytes.

Table used to convert Sinclair code to ASCII lower-case. Identical to upper-case table (UCLUT) except that the addresses corresponding to letter codes have contents incremented by decimal 32—hex 20. Some printers may have slight variations from standard ASCII, particularly punctuation marks.

## CSHIFT

16701–16749; 31865–31913; 49 bytes.

Routine to enter UCLUT or LCLUT address into the Sinclair translation routine — STRANS. CSHIFT is not used directly by the organisers but is called-up by the subroutine which loads Sinclair characters into the output buffer—SCLOAD. Uses location 32725 as CSFLAG. If CSFLAG is zero, only UCLUT is used.

## LISTING COMPLETE

16750–16765; 31914–31929; 16 bytes.

Sixteen-byte memory area containing above message, which is output after completing a program listing.

## LISORG

16766–16960, 31930–32124; 195 bytes.

Figure 2: Top of PCB.

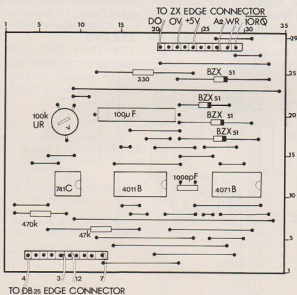

# RS232 INTERFACE

Main organiser routine for program listing.

## SCLOAD

16961-16994; 32125-32158; 34 bytes.

Subroutine to load Sinclair characters to the output buffer—32757-32767. Loads only a single character at a time, which must be in the A register when SCLOAD is called. If A register contains a keyword code, however, the complete expansion is loaded to the buffer. If A register contains a graphics code, loads a single space to buffer; control codes and unused codes are loaded as a Sinclair '?' character; otherwise the character is loaded unchanged. Uses subroutines EXPAND and CSHIFT. Returns with a count in the B register of the number of characters loaded to the buffer—normally one unless a keyword expanded.

## GETARG

16995-17092; 32159-32256; 98 bytes.

Subroutine to obtain two arguments from the REM statement following the USR call to LISORG OR RITORG. Uses location 32746 to flag first or second argument. Returns with binary value of first argument in 32747 and 32748, value of second in 32749 and 32750. Uses Subroutine DECADE for multiplication by 10.

## CHOUT

17093-17130; 32257-32294; 38 bytes.

Outputs a single character to the

interface at address FB. The character must be in the A register when CHOUT is called. Outputs one start bit, eight data bits and two stop bits—(mark) on the least significant bit of the data bus. Uses DELAY to produce correct bit timings.

## DUN

17131-17162; 32295-32326; 32 bytes.

Program used by LISORG to terminate listings. When called DUN outputs 20 CR/LFs followed by the message 'Listing complete', then executes a 'dummy' POP to return program control to the Basic interpreter. Uses CHOUT and DELAY.

## BINASC

17163-17240; 32327-32404; 78 bytes.

Subroutine which takes a binary value in the DE register pair and converts it into its ASCII equivalent in the output buffer. Returns with a count of the number of ASCII characters in the B register. Uses location 32745 as a leading zero suppression flag.

## PRINT

17241-17322; 32405-32486; 82 bytes.

Prints the ASCII contents of the output buffer, which should be either a single character or a keyword expansion. Number of characters to be printed should be in the B register on entry. Corrects keyword spacing by checking B; if B is greater than one and the first character in the buffer is

a space, will suppress this if the last character printed was also a space.

Formats printed lines by reference to COLSET and PCOUNT. COLSET (32754) is the number of columns specified in the REM statement—loaded in by the organiser; PCOUNT (32755) is the number of characters which remain to be printed in the current line and is updated by PRINT before returning. Should PCOUNT go to zero, PRINT outputs a CR/LF and re-sets PCOUNT to equal COLSET. Uses DELAY when printing CR/LFs.

## LOCLIN

17323-17364; 32487-32528; 42 bytes.

Used by LISORG to locate the first line to be listed, by searching the program file for a match with the binary line number stored in location 32747 and 32748. Returns with the address of the line start in the HL register pair. Calls DUN to return to Basic if line not found.

## DELAY

17365-17382; 32529-32546; 18 bytes.

Produces time delays in 9.1m sec; increments according to the value in the B register—i.e., if B = 10 on entry provides a 91m sec delay. Used to set the 'Bit time' for serial output and also for time delays after outputting CR/LFs.

## EXPAND

17383-17435; 32547-32599; 53 bytes.

Figure 3: Circuit diagram.

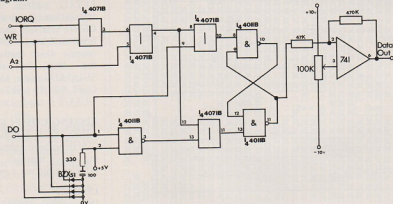

Takes a keyword code in the A register and loads the expanded code along with appropriate leading and trailing spaces to the output buffer. Uses monitor routine 2421 (decimal) to locate the expanded form from within the monitor tables.

## CHECK

17436-17464; 32600-32628; 29 bytes.

Called by CSHIFT to check the nature of a character in the A register. Sets or re-sets the carry and zero flags before return to differentiate between printable characters, graphics characters, keyword codes or control codes.

## STRANS

17465-17479; 32629-32643; 15 bytes.

Translates the output buffer contents from Sinclair to ASCII. Number of characters to be translated must be set into the B register before entry.

## DECADE

17480-17495; 32644-32659; 16 bytes.

Multiplies the initial contents of the DE register pair by 10 to the power C, where C is the content of the C register on entry. Increments C before return so that multiplication in the sequence 1, 10, 100 and the like can be achieved simply by preserving the C register value between calls.

## UCLUT

17496-17559; 32660-32723; 64 bytes.

Table used to convert Sinclair codes to ASCII for upper-case output.

## PARTS LIST

- IC1 - 4071B quad 2 input OR gate.
- IC2 - 4011B quad 2 input NAND gate.
- IC3 - 741 operational amplifier.
- R1 - 47k 1/2-watt resistor.
- R2 - 470k 1/2-watt resistor.
- VR1 - 100k miniature skeleton pre-set, horizontal mounting.

### Miscellaneous

- 0.1in. pitch Veroboard, 3.5in, by 3.75in.
- Edge connector adaptor to use interface with RAM pack.
- Socket to match printer plug.
- 2 14 pin DIL sockets. } for IC mounting-- optional.
- 1 8-pin DIL socket. }

## DOWNLOADER

33	142	64	HL	16526
17	202	123	DE	31690
1	12	4	BC	1036
237	176		16523 (ED)	
201			16525 RET	

## RITORG

24	0		16526 JR	0
62	51		16528 LD	A 51
50	203	123	16530 LD	(31691) A
0			16533 NOP	
205	159	125	16534 CALL	32159
33	235	127	16537 LD	HL 32747
126			16540 LD	A (HL)
254	0		16541 CP	O
32	21		16543 JR	NZ 21
35			16545 INC	HL
35			16546 INC	HL
70			16547 LD	B (HL)
4			16548 INC	B
24	12		16549 JR	12
197			16551 PUSH	BC
62	10		16552 LD	A 10
205	1	126	16554 CALL	32257
6	20		16557 LD	B 20
205	17	127	16559 CALL	32529
193			16562 POP	BC
16	242		16563 DJNZ	-14
201			16565 RET	
50	243	127	16566 LD	(32755) A
62	10		16569 LD	A 10
205	1	126	16571 CALL	32257
6	20		16574 LD	B 20
205	17	127	16576 CALL	32529
205	159	125	16579 CALL	32159
58	235	127	16582 LD	A (32747)
50	242	127	16585 LD	(32754) A
237	75	237	16588 (ED)	
42	12	64	16592 LD	HL (16396)
126			16595 LD	A (HL)
3			16596 INC	BC
24	32		16597 JR	32
126			16599 LD	A (HL)
197			16600 PUSH	BC
229			16601 PUSH	HL
254	118		16602 CP	118
32	4		16604 JR	NZ 4
225			16606 POP	HL
35			16607 INC	HL
229			16608 PUSH	HL
126			16609 LD	A (HL)
254	12		16610 CP	12
32	3		16612 JR	NZ 3
225			16614 POP	HL
193			16615 POP	BC
201			16616 RET	
205	125	125	16617 CALL	32125
197			16620 PUSH	BC
205	117	127	16621 CALL	32629
193			16624 POP	BC
205	149	126	16625 CALL	32405
225			16628 POP	HL
35			16629 INC	HL
193			16630 POP	BC
11			16631 DEC	BC
120			16632 LD	A B
177			16633 OR	C

32	219	16634 JR	NX -37
201		16636 RET	

## CSHIFT

229		16701 PUSH	HL	
245		16702 PUSH	AF	
58	213	127	16703 LD	A (32725)
254	0		16706 CP	O
32	12		16708 JR	NZ 12
33	148	127	16710 LD	HL 32660
34	122	127	16713 LD	(32634) HL
241			16716 POP	AF
225			16717 POP	HL
205	88	127	16718 CALL	32600
201			16721 RET	
241			16722 POP	AF
254	166		16723 CP	166
56	12		16725 JR	C 12
254	192		16727 CP	192
48	8		16729 JR	NC 8
33	148	127	16731 LD	HL 32660
34	122	127	16734 LD	(32634) HL
24	6		16737 JR	6
33	57	124	16739 LD	HL 31801
34	122	127	16742 LD	(32634) HL
225			16745 POP	HL
205	88	127	16746 CALL	32600
201			16749 RET	

## LISORG

33	213	127	16766 LD	HL 32725
54	0		16769 LD	(HL)0
33	242	127	16771 LD	HL 32754
54	32		16774 LD	(HL)32
43			16776 DEC	HL
43			16777 DEC	HL
43			16778 DEC	HL
54	0		16779 LD	(HL)0
6	5		16781 LD	B 5
62	10		16783 LD	A 10
197			16785 PUSH	BC
205	1	126	16786 CALL	32257
6	20		16789 LD	B 20
205	17	127	16791 CALL	32529
193			16794 POP	BC
16	242		16795 DJNZ	-14
205	159	125	16797 CALL	32159
205	231	126	16800 CALL	32487
229			16803 PUSH	HL
58	239	127	16804 LD	A (32751)
254	0		16807 CP	O
32	10		16809 JR	NZ 10
62	10		16811 LD	A 10
205	1	126	16813 CALL	32257
6	40		16816 LD	B 40
205	17	127	16818 CALL	32529
225			16821 POP	HL
86			16822 LD	D (HL)
35			16823 INC	HL
94			16824 LD	E (HL)
35			16825 INC	HL
229			16826 PUSH	HL
205	71	126	16827 CALL	32327
197			16830 PUSH	BC
33	243	127	16831 LD	HL 32755
62	28		16834 LD	A 28
128			16836 ADD	A B
119			16837 LD	(HL)A

# RS232 INTERFACE

62 5	16838 LD	A	5	225	16956 POP	HL	209	17069 POP	DE
144	16840 SUB	B		192	16957 RET	NZ	122	17070 LD	A D
71	16841 LD	B	A	195 223 124	16958 JP	31967	145	17071 SUB	C
24 7	16842 JR		7				32 215	17072 JR	NZ -41
62 32	16844 LD	A	32				58 234 127	17074 LD	A (32746)
197	16846 PUSH	BC					254 2	17077 CP	2
205 1 126	16847 CALL		32257				32 3	17079 JR	NZ 3
193	16850 POP	BC		<b>SCLOAD</b>	16961 CALL	31865	225	17081 POP	HL
16 247	16851 DJNZ		-9	205 121 124	16964 LD	A D	167	17082 AND	A
193	16853 POP	BC		122	16965 LD	HL 32757	201	17083 RET	
205 149 126	16854 CALL		32405	33 245 127	16968 LD	B 1	62 2	17084 LD	A 2
225	16857 POP	HL		6 1	16970 JR	Z 7	50 234 127	17086 LD	(32746) A
94	16858 LD	E (HL)		40 7	16972 JR	C 2	225	17089 POP	HL
35	16859 INC	HL		56 2	16974 LD	(HL)A	35	17090 INC	HL
86	16860 LD	D (HL)		119	16975 RET		24 177	17091 JR	-79
237 83 240 127	16861 (ED)			201	16976 LD	(HL)0			
35	16865 INC	HL		54 0	16977 RET				
126	16866 LD	A (HL)		201	16978 RET				
254 126	16867 CP	126		56 3	16979 JR	C 3			
32 18	16869 JR	NZ 18		54 15	16981 LD	(HL)15		<b>CHOUT</b>	
17 6 0	16871 LD	DE 6		201	16983 RET		203 255	17093 (CB)	
25	16874 ADD	HL DE		205 35 127	16984 CALL	DE 32547	245	17095 NOP	
68	16875 LD	B H		17 245 127	16987 LD	DE 32757	175	17096 PUSH	AF
77	16876 LD	C L		237 82	16990 AND	A	211 251	17097 XOR	A
42 240 127	16877 LD	HL (32752)		69	16991 (ED)		6 1	17098 OUT	251 A
167	16880 AND	A		201	16993 LD	B L	205 17 127	17100 LD	B 1
237 82	16881 (ED)				16994 RET		241	17102 CALL	32529
34 240 127	16883 LD	(32752) HL					6 8	17105 POP	AF
96	16886 LD	H B					211 251	17106 LD	B 8
105	16887 LD	L C					197	17108 OUT	251 A
126	16888 LD	A (HL)		<b>GETARG</b>			17110 PUSH	BC	
237 91 240 127	16889 (ED)			175	16995 XOR	A	6 1	17111 LD	B 1
27	16893 DEC	DE		111	16996 LD	L A	205 17 127	17113 CALL	32529
237 83 240 127	16894 (ED)			103	16997 LD	H A	203 47	17116 (CB)	
71	16898 LD	B A		34 235 127	16998 LD	(32747) HL	193	17118 POP	BC
122	16899 LD	A D		34 237 127	17001 LD	(32749) HL	16 243	17119 DJNZ	-13
179	16900 OR	E		34 234 127	17004 LD	(32746) HL	203 199	17121 (CB)	
40 17	16901 JR	Z 17		42 41 64	17007 LD	HL (16425)	211 251	17123 OUT	251 A
120	16903 LD	A B		17 5 0	17010 LD	DE 5	6 2	17125 LD	B 2
229	16904 PUSH	HL		25	17013 ADD	HL DE	205 17 127	17127 CALL	32529
205 125 125	16905 CALL		32125	22 0	17014 LD	D 0	201	17130 RET	
197	16908 PUSH	BC		74	17016 LD	C D			
205 117 127	16909 CALL		32629	6 7	17017 LD	B 7			
193	16912 POP	BC		16 2	17019 DJNZ	2			
205 149 126	16913 CALL		32405	55	17021 SCF		<b>DUN</b>		
225	16916 POP	HL		201	17022 RET		6 20	17131 LD	B 20
35	16917 INC	HL		126	17023 LD	A (HL)	197	17133 PUSH	BC
24 202	16918 JR		-54	254 26	17024 CP	26	62 10	17134 LD	A 10
35	16920 INC	HL		40 4	17026 JR	Z 4	205 1 126	17136 CALL	32257
237 91 12 64	16921 (ED)			20	17028 INC	D	6 20	17139 LD	B 20
235	16925 EXX	DE HL		35	17029 INC	HL	205 17 127	17141 CALL	32529
167	16926 AND	A		24 243	17030 JR	-13	193	17144 POP	BC
237 82	16927 (ED)			229	17032 PUSH	HL	16 242	17145 DJNZ	-14
235	16929 EXX	DE HL		43	17033 DEC	HL	33 170 124	17147 LD	HL 31914
204 39 126	16930 CALL	Z 32295'		126	17034 LD	A (HL)	6 16	17150 LD	B 16
86	16933 LD	D (HL)		214 28	17035 SUB	28	126	17152 LD	A (HL)
35	16934 INC	HL		213	17037 PUSH	DE	205 1 126	17153 PUSH	BC
94	16935 LD	E (HL)		22 0	17038 LD	D 0	193	17154 CALL	32257
235	16936 EXX	DE HL		95	17040 LD	E A	35	17157 POP	BC
68	16937 LD	B H		229	17041 PUSH	HL	16 247	17158 INC	HL
77	16938 LD	C L		205 132 127	17042 CALL	A 32644	241	17159 DJNZ	-9
42 237 127	16939 LD	HL (32749)		58 234 127	17045 LD	A (32746)	201	17161 POP	AF
167	16942 AND	A		254 2	17048 CP	2		17162 RET	
237 66	16943 (ED)			32 9	17050 JR	NZ 9			
220 39 126	16945 CALL	C 32295		42 237 127	17052 LD	HL (32749)		<b>BINASC</b>	
235	16948 EXX	DE HL		25	17055 ADD	HL DE	175	17163 XOR	A
43	16949 DEC	HL		34 237 127	17056 LD	(32749) HL	50 233 127	17164 LD	(32745) A
229	16950 PUSH	HL		24 7	17059 JR	7	71	17167 LD	B A
205 187 2	16951 CALL		699	42 235 127	17061 LD	HL (32747)	79	17168 LD	C A
124	16954 LD	A H		25	17064 ADD	HL DE	33 245 127	17169 LD	HL 32757
173	16955 XOR	L		34 235 127	17065 LD	(32747) HL	229	17172 PUSH	HL
				225	17068 POP	HL	33 232 3	17173 LD	HL 1000



# RS232 INTERFACE

235	17176 EXX	DE HL	43	17297 DEC	HL	205 117 9	17403 CALL	2421
167	17177 AND	A	126	17298 LD	A (HL)	10	17406 LD	A (BC)
237 82	17178 (ED)		254 32	17299 CP	32	203 127	17407 (CB)	
56 8	17180 JR	C 8	200	17301 RET	Z	203 191	17409 (CB)	
12	17182 INC	C	62 0	17302 LD	A O	119	17411 LD	(HL)A
62 1	17183 LD	A 1	50 244 127	17304 LD	(32756) A	3	17412 INC	BC
50 233 127	17188 JR	(32745) A	201	17307 RET		35	17413 INC	HL
24 243	17190 ADD	HL DE	58 244 127	17308 LD	A (32756)	40 246	17414 JR	Z -10
25	17191 LD	A (32745)	254 1	17311 CP	I	241	17416 POP	AF
58 233 127	17194 CP	0	32 191	17313 JR	NZ -65	254 216	17417 CP	216
254 0	17196 JR	Z 14	126	17315 LD	A (HL)	200	17419 RET	Z
40 14	17198 PUSH	HL	32 186	17316 CP	32	254 219	17420 CP	219
229	17199 POP	HL	35	17318 JR	NZ -70	200	17422 RET	Z
225	17200 POP	HL	24 184	17320 INC	HL	254 220	17423 CP	220
4	17201 INC	B		17321 JR	-72	200	17425 RET	Z
121	17202 LD	A C	<b>LOCLIN</b>			254 221	17426 CP	221
198 48	17203 ADD	A 48	17 125 64	17323 LD	DE 16509	200	17428 RET	Z
119	17205 LD	(HL)A	26	17326 LD	A (DE)	254 193	17429 CP	193
35	17206 INC	HL	103	17327 LD	H A	175	17431 RET	C
229	17207 PUSH	HL	19	17328 INC	DE	216	17432 XOR	A
59	17208 DEC	SP	26	17329 LD	A (DE)	119	17433 LD	(HL)A
59	17209 DEC	SP	111	17330 LD	L A	35	17434 INC	HL
225	17210 POP	HL	237 75 235 127	17331 (ED)		201	17435 RET	
14 0	17211 LD	C 0	167	17335 AND	A	<b>CHECK</b>		
22 0	17213 LD	D 0	237 66	17336 (ED)		245	17436 PUSH	AF
203 123	17215 (CB)		48 22	17338 JR	NC 22	203 119	17437 (CB)	
40 4	17217 JR	Z 4	19	17340 INC	DE	40 8	17439 JR	Z 8
30 100	17219 LD	E 100	26	17341 LD	A (DE)	203 127	17441 (CB)	
24 211	17221 JR	-45	79	17342 LD	C A	40 13	17443 JR	Z 13
203 83	17223 (CB)		19	17343 INC	DE	175	17445 XOR	A
40 4	17225 JR	Z 4	26	17344 LD	A (DE)	63	17446 CCF	
30 10	17227 LD	E 10	71	17345 LD	B A	209	17447 POP	DE
24 203	17229 JR	-53	235	17346 EXX	DE HL	201	17448 RET	
203 75	17231 (CB)		9	17347 ADD	HL BC	209	17449 POP	DE
40 4	17233 JR	Z 4	35	17348 INC	HL	203 186	17450 (CB)	
30 1	17235 LD	E 1	235	17349 EXX	DE HL	122	17452 LD	A D
24 195	17237 JR	-61	42 12 64	17350 LD	HL (16396)	254 11	17453 CP	11
225	17239 POP	HL	167	17353 AND	A	192	17455 RET	NZ
201	17240 RET		237 82	17354 (ED)		183	17456 OR	A
<b>PRINT</b>			32 224	17356 JR	NZ -32	201	17457 RET	
58 243 127	17241 LD	A (32755)	241	17358 POP	AF	254 43	17458 CP	43
87	17244 LD	D A	205 39 126	17359 CALL	32295	48 239	17460 JR	NC -17
33 245 127	17245 LD	HL 32757	27	17362 DEC	DE	175	17462 XOR	A
16 58	17248 DJNZ	58	235	17363 EXX	DE HL	209	17463 POP	DE
4	17250 INC	B	201	17364 RET		201	17464 RET	
88	17251 LD	E B	<b>DELAY</b>			<b>STRANS</b>		
126	17252 LD	A (HL)	197	17365 PUSH	BC	33 245 127	17465 LD	HL 32757
205 1 126	17253 CALL	32257	6 9	17366 LD	B 9	126	17468 LD	A (HL)
1 239 127	17256 LD	BC 32751	197	17368 PUSH	BC	17 57 124	17469 LD	DE 31801
175	17259 XOR	A	6 135	17369 LD	B 135	131	17472 ADD	A E
2	17260 LD	(BC)A	0	17371 NOP		95	17473 LD	E A
66	17261 LD	B D	0	17372 NOP		26	17474 LD	A (DE)
16 19	17262 DJNZ	19	0	17373 NOP		119	17475 LD	(HL)A
62 10	17264 LD	A 10	16 251	17374 DJNZ	-5	35	17476 INC	HL
205 1 126	17266 CALL	32257	193	17376 POP	BC	16 245	17477 DJNZ	-11
1 239 127	17269 LD	BC 32751	16 245	17377 DJNZ	-11	201	17479 RET	
2	17272 LD	(BC)A	193	17379 POP	BC	<b>DECADE</b>		
0	17273 NOP		16 239	17380 DJNZ	-17	12	17480 INC	C
6 40	17274 LD	B 40	201	17382 RET		65	17481 LD	B C
205 17 127	17276 CALL	32529	<b>EXPAND</b>			16 1	17482 DJNZ	I
58 242 127	17279 LD	A (32754)	245	17383 PUSH	AF	201	17484 RET	
71	17282 LD	B A	33 245 127	17384 LD	HL 32757	235	17485 EXX	DE HL
35	17283 INC	HL	254 217	17387 CP	217	41	17486 ADD	HL HL
80	17284 LD	D B	40 8	17389 JR	Z 8	84	17487 LD	D H
67	17285 LD	B E	254 218	17391 CP	218	93	17488 LD	E L
16 219	17286 DJNZ	-37	40 4	17393 JR	Z 4	41	17489 ADD	HL HL
122	17288 LD	A D	254 222	17395 CP	222	41	17490 ADD	HL HL
50 243 127	17289 LD	(32755) A	56 4	17397 JR	C 4	25	17491 ADD	HL DE
62 1	17292 LD	A 1	6 0	17399 LD	B 0	84	17492 LD	D H
20 244 127	17294 LD	(32756) A	112	17401 LD	(HL)B	93	17493 LD	E L
			35	17402 INC	HL	24 242	17494 JR	-14



# Good idea is damaged by a number of errors

AS AN OWNER of a ZX-81, I have bought *Sinclair User* since its first issue, in the hope that you would deal with add-ons for home construction. So I was delighted to read about the advent of *Sinclair Projects*; it sounded just what I wanted. So I was disappointed, not by the contents but by the mistakes.

Page 14, figure 5. IORQ and RD transposed; RD is pin 18.

Page 16, figure 2B. Pin C is common to both joysticks; therefore the lead from the top left should go to pin C and the wiper to pin B.

Page 20, figure 1. MBEQ on the connector should be MREQ. The 74LS373 is omitted from the parts list and the 74LS04 is omitted from the cost list.

Page 22, line 5, 3682 is incorrect.

Page 27, figure 7. The motor when in reverse will run until the battery runs down. Many figure numbers do not agree with those in the text.

Page 28, figure 12. I suggest this is added to the soldering article and entitled How not to Solder. Figure 11 looks as if they are removing the solder bridges shown in figure 12. Figure 14—connections to 12-way connector strip are incorrectly marked.

Please ask Dave Buckley where he can get edge connectors for £2.25 and extender cards for 25p; I should be interested. Incidentally, Watford seems the

**We have received a large number of comments and interesting points about our first issue. Here David Buckley answers many of the more important questions raised.**

cheapest for 74LS373 at 60p plus VAT.

**D. S. Anthes,  
Bridport,  
Dorset.**

● *Thanks for your comments. Unfortunate production problems meant that unchecked diagrams were published. Regarding the edge connector, £2.25 was the Maplin catalogue price in September. In the new catalogue it is £2.39. The extender card was obtained from Technomatic; unfortunately it now seems to be discontinued.*

## Soldering on

THERE IS great need for a magazine to cater mainly for owners of Sinclair computers, so news of the *Sinclair Projects* was welcome and the first issue eagerly anticipated. But there are problems, more specifically soldering for a perfect finish—a mixture of good and bad advice and no photographs of good and dry joints.

Joystick controller—Why do I have to read two inches of text to discover that it is for the Spectrum?

Word processor, very good; but then Randle Hurley is good.

Latch Card Errors in text, e.g., where is 741s373 in parts list and 741s04 in cost. What is a KB914? Diagram is poor and the de-

scription of circuit operation is poor.

Christmas lights—diagrams poor; T1 T2 T3 and T4 have some odd connections. The use of mains equipment in the manner shown is to be discouraged; mains and low voltage equipment, not specifically insulated for mains operation such as the ZX-81, should not share the same PCB. Optical separation would be better.

Graphics generator,—again poor diagrams. No circuit of connections between RAM and ROM. Some ZX-81s have a 1K RAM, so what do I do? The logic circuit uses too many components, the requirement can be achieved with two ICs, a 74LS30 and a 74LS10 and also not give two positions in the memory map for the CHRS RAMCS.

Eprom blower—diagram titles incorrect; logic circuit poor.

**F. A. Richards  
Arrington,  
Hertfordshire.**

● *Thank you for your letter which contains some valid points. Regarding some of them, dry joints do not always look dry and the sketch was intended to depict a good solder fillet. People who can solder will develop their own style but beginners do not need clear style—they need clear*

*instructions which, if followed, will produce a sound joint.*

There is a limit to the amount of circuit explanation which can be included in an article; figure two and table one give a complete picture of the theory and practice for operating the Latch Card. The input and outputs of opto-isolators share the same PCB in the way the connections to relays do, so where is the advantage except in speed of operation?

The Graphics Generator figure nine is the program in the centre column. Those with a 1K RAM chip will have to wait for a future article. If you built your ZX-81 from a kit and have the circuit diagram the changes are obvious but are too lengthy to detail. Regarding the component count, almost any circuit can be improved either by head-scratching or using the latest super-whizz-bang chip; for the hobbyist the most important thing is that it can be built easily and if it does what the designer intended.

Most people would not wish to solder on the ZX-81 board and so add-ons for £1 or £2 are difficult to devise.

Thank you for your suggestions, which we will bear in mind for future issues.

## Graphic

AT LAST, a completely different type of magazine and if you can keep up the range of projects in subsequent issues, you are sure to have a best-seller.

I built the ZX-81 character generator from the first issue and can describe it as unbelievable, especially as it costs less than £5, including

*Continued on page 44*

# LETTERS

Continued from page 43

everything from solder to ICs.

I encountered several problems in construction which perhaps caused others to hesitate building the project. I have listed them:

A lack of a wiring/cutting diagram for the board. There are no track-cuts except between IC pins.

I found it necessary to cut the track on either side of pin 20 of the ROM. Also, the connection to ROMCS would not work when connected to pin 23B of the edge connector—I had to fasten it to the right-hand side of R28, the resistor above the heatsink.

After that modification the circuit worked. Honestly, the effect of this board

just has to be seen to be believed. Keep up the good work.

**David Oram,  
Liversedge,  
West Yorks.**

● *Thank you for your praise of the project. I cannot agree with your comments except about the lack of a wiring/cutting diagram. You state that all track cuts are between IC pins but the two track cuts necessary are between the ICs and the rear edge connector. Cutting the track on the R28 side of ROM pin 20 will prevent the ULA controlling the ROM and the ZX-81 will never work.*

*Are you sure you cut the track between pin 20 and R28 and not one of the adjoining tracks to pins 5 and 6?*

*The article says that the ROMCS output from the CHR5 circuit should go to ROM pin 20; connecting it to the edge connector 23B will not work, since one of the track breaks is between ROM pin 20 and edge connector 23B.*

## Latch card

I WAS very interested on reading the Latch Card project. As I understand it the Latch Card effectively gives the ZX-81 output ports from anyone of the memory locations 36832 to 36863.

Being something of a novice I wonder if you would be able to offer advice, as I also wish to input signals to memory location? The application of such a device would be for sequence circuit testing by

switching to send a signal/pulse to each circuit to be tested.

**P W Beddoes,  
Uxbridge, Middlesex.**

● *To input signals to the computer you could use basically the same circuit using the RD line instead of the WR line at the edge connector, swapping the Q<sub>0</sub>-Q<sub>2</sub> and D<sub>0</sub>-D<sub>2</sub> lines to the 74LS373, connecting pin 11 directly to +5V instead of to the 1K resistor and connecting OE pin 1 to the output of the 74LS133 leaving the inverter, 1K resistor and diode connected as before.*

*If you can afford to wait, a future project will be a more versatile input/output memory-mapped port with 24 lines of input/output (three bytes).*

## MAIL ORDER ADVERTISING British Code of Advertising Practice

Advertisements in this publication are required to conform to the British Code of Advertising Practice. In respect of mail order advertisements where money is paid in advance, the code requires advertisers to fulfil orders within 28 days, unless a longer delivery period is stated. Where goods are returned undamaged within seven days, the purchaser's money must be refunded. Please retain proof of postage/despatch, as this may be needed.

### Mail Order Protection Scheme

If you order goods from Mail Order advertisements in this magazine and pay by post in advance of delivery, Sinclair User will consider you for compensation if the Advertiser should become insolvent or bankrupt, provided:

- (1) You have not received the goods or had your money returned; and
- (2) You write to the Publisher of Sinclair User summarizing the situation not earlier than 28 days from the day you sent your order and not later than two months from that day.

Please do not wait until the last moment to inform us. When you do write, we will tell you how to make your claim and what evidence of payment is required.

We guarantee to meet claims from readers in accordance with the above procedure as soon as possible after the Advertiser has been declared bankrupt or insolvent (up to a limit of £4,250 per annum for any one Advertiser so affected and up to £10,000 per annum in respect of all insolvent Advertisers. Claims may be paid for higher amounts, or when the above procedure has not been complied with at the discretion of Sinclair User, but we do not guarantee to do so in view of the need to set some limit to this commitment and to learn quickly of readers' difficulties).

This guarantee covers only advance payment sent in direct response to an advertisement in this magazine (not, for example, payment made in response to catalogues etc. received as a result of answering such advertisements). Classified advertisements are excluded.

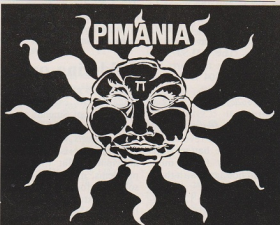

THE ADVENTURE GAME THAT'S FOR REAL !!!!

£6,000 PRIZE! FREE HIT SINGLE! 48K ZX SPECTRUM  
(16K ZX81 VERSION NOW AVAILABLE)

Will you be the first to locate the Golden Statue of Pi in time and space, and be rewarded with the coveted? Emulator crafted by the winner of the Six Years Diamond International Award, from gold, diamond and the most precious of the earth's riches.

PIMANIA - where synophones turn into hangflogs, where music inserts modvies and where the Pi Man rules supreme! He'll talk with you, he'll betray you, he'll betray you, he'll even do the Hokay Kokay! Animated cartoon graphics! Full musical score! Spectacular colour and sound effects! Includes free hit single "Pimania", with vocals by Cleo Sincice and the Pi-Men!

It could take you a week to play, it could take you a lifetime! PIMANIA, "the best evidence that computer gaming has come of age... an adventure enthusiast's dream!" (Computer & Video Games)

An investment at £10 (48K Spectrum) £8 (16K ZX81)



Automata Ltd. (S) 1  
65A Osborne Road  
Purtonmouth PO5 3LR  
England



# What Shall I Do With it Now?

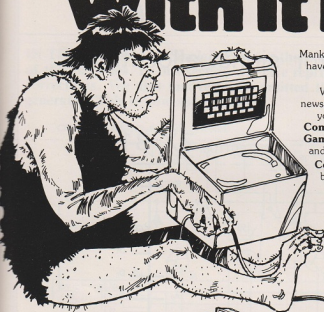

And starting this issue, The Seventh Empire, which invites you to take on the rest of **Computer & Video Games'** readership in our version of a Star Wars type conflict. With a Colour Genie computer going to the best space commander.

There's news and reviews of professional games programs, news and tips on arcade games, plus Britain's best guide to TV games centres.

If you own a Spectrum, ZX81, Texas 99/4a, Atari, BBC, Atom, Sharp, Dragon, Vic or can put your hands on any kind of computer, you'll find something for you in **Computer & Video Games** the magazine that brought micros down to Earth!

Mankind's been a long time discovering microcomputers. If you have just discovered them, you may well be feeling about as lonely as the first human to fall out of the trees.

While he could hardly scamper along to his prehistoric newsgent for a copy of Practical Biped and Walking Monthly, you are luckier . . . Luckier because February's issue of **Computer & Video Games** has a **Free 48 page Book of Games** stapled to it. It is packed with games programs and ideas for your new micro.

**Computer & Video Games** takes the loneliness out of being a micro owner. It has pages of programs written by people like yourself who are gradually evolving along the programming path, with pointers and tips.

It has a Mailbag section where you can approach experts to help sort out any problems you may have.

**Computer & Video Games** also takes the jargon out of computing, offering easy to understand articles with examples and series which build your knowledge the fun way, like Warpath and Machine Code.



I would like to subscribe to **Computer & Video Games** (12 issues). I enclose a cheque for £10.00 (U.K. only) payable to **Computer & Video Games**.

Please post in a sealed envelope to:  
**Computer & Video Games**  
Subscription Dept  
Competition House  
Farndon Rd  
Market Harborough  
Leicestershire

To guarantee receiving a copy of **Computer & Video Games** every month, just clip the coupon and send with your cheque for a 12 month subscription.

Name \_\_\_\_\_

Address \_\_\_\_\_

Telephone \_\_\_\_\_

Signature \_\_\_\_\_



## Edge Connector signal allocation

### BOTTOM SPECTRUM TOP

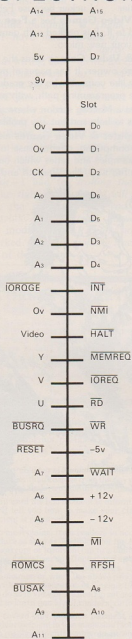

### BOTTOM ZX-81 TOP

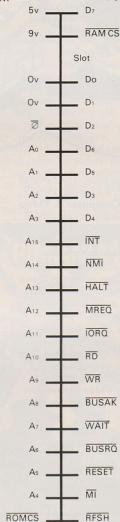

IN THE first issue of *Sinclair Projects* there were a few unfortunate errors in some of the diagrams. In this section we have reprinted the diagrams with the necessary corrections. We also inadvertently omitted the Veroboard layout in the graphics generator. This is now shown below.

CHRISTMAS LIGHTS: Power-card schematic

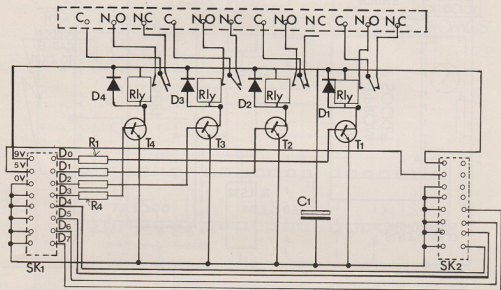

EPROM BLOWER: PCB layout for large board

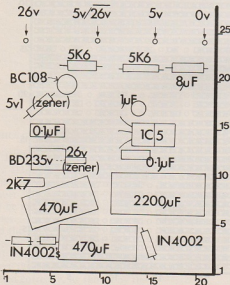

Veroboard

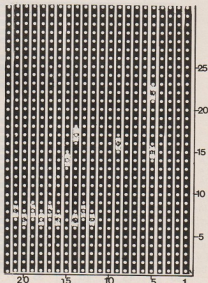

# UPDATE

## EPROM BLOWER

Component lay-out for the small board of the eeprom blower. The dotted lines denote the lines of the cuts on the underside of the type of Veroboard which was used. The lines are equally spaced with four holes between them. They are not shown as such because the components are not drawn to scale.

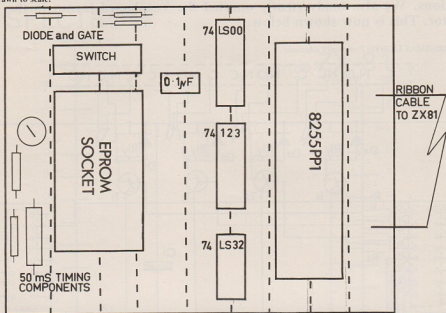

## CHRISTMAS LIGHTS: Veroboard

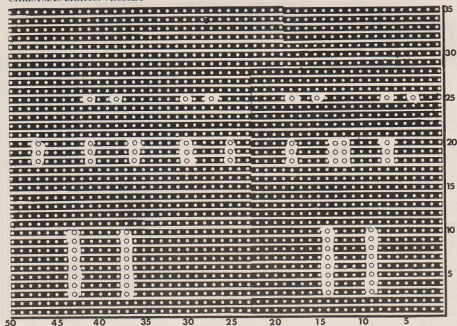



## GRAPHICS GENERATOR: PCB layout

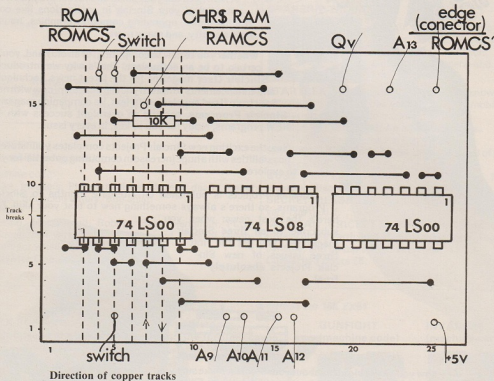

## GRAPHICS GENERATOR: Adaptation for ZX-81s with single 4118 RAM chip

VERY FEW ZX-81s were made with a single 4118 RAM chip. The following modifications to the article in the December issue of *Sinclair Projects* should be made for those with these machines.

Bend the address pins A0 to A8—pins 8, 1, 7, 22, 6, 23, 5, 4, 3—upwards until they are at right angles. Re-insert the IC, ensuring that it is orientated correctly, as shown by the

identifying notch.

Using fine insulated single-core wire and a fine-tipped soldering iron, link the RAM IC to the address pins A0 to A8 of the ROM, as follows:

RAM IC pin	ROM IC pin	Address line
3	23	A8
4	1	A7
5	2	A6
23	3	A5
6	4	A4
22	5	A3

7	6	A2
1	7	A1
8	8	A0

Then continue as detailed previously.

Some 2114 RAM chips are soldered into the PCB. In this case, unless you are very good at de-soldering ICs, it is best to cut out the ICs with wire cutters, clear the holes of any leads, solder in some IC holders and then insert some new 2114s.

# We've got big ideas about you and your Sinclair



Because we know you're always looking for new ideas to make the most of your Sinclair computer, we're making sure you never run out of steam!

Just announced – and due out in December – is **Sinclair Projects** magazine, full of fascinating schemes to tax your skills and reveal the practical potential of your Sinclair in applications like controlling lights, upgrading computer graphics, household security, and many more.

Whether you're new to computing, or an old hand, you're certain to be an enthusiast. That's why we introduced **Sinclair User** magazine for the latest news, techniques and enhancements to match your enthusiasm (now with new 'Spectrum User' supplement!) Next, its companion magazine, **Sinclair Programs**, became an overnight success with 40 NEW programs, ready for you to key, in every issue.

Now the exciting new **Sinclair Projects** completes your store of possibilities with a huge increase in computing potential for you to explore.

**Sinclair Projects** is published on alternate months to **Sinclair Programs**, so there's **always** something new to test your skill. But here's the best news: when you subscribe to all three **Sinclair** magazines, you get the first **three** issues of new **Sinclair Projects** **absolutely free!**



We know you've got big ideas about your Sinclair. Make sure you live up to them with **threefold** computing pleasure. Fill out the order form now and we'll send you the first ideas-packed **Sinclair Projects** – hot off the press.

Mail to: ECC Publications Limited; 30-31 Islington Green, London N1 8BJ

## Sinclair User / Spectrum User; Sinclair Programs; Sinclair Projects

Yes – I'd like to subscribe to:

- Sinclair User (12 issues – price £9.00) including special 'Spectrum User' supplement in each issue.
- Sinclair Programs (6 issues – price £6.60)
- Sinclair Projects (6 issues – price £6.60) Remember you get the first three issues FREE if subscribing to all three magazines!
- I enclose a cheque for £ \_\_\_\_\_ (deduct £3.30 from total cost if subscribing to all three publications)
- Please charge my credit card Card name \_\_\_\_\_ Number \_\_\_\_\_

Name \_\_\_\_\_

Address \_\_\_\_\_

Signature \_\_\_\_\_ Date \_\_\_\_\_

NB This offer applies to UK subscribers only. Overseas rates available on request.

# MICHAEL ORWIN'S ZX81 CASSETTES

THE BEST SOFTWARE (BY VARIOUS AUTHORS) AT LOW PRICES

## QUOTES

"Michael Orwin's £5 Cassette Two is very good value. It contains 10 stolid well designed games which work, offer plenty of variety and choice, and are fun."

From the ZX Software review in Your Computer, May '82 issue.

"I had your Invaders/React cassette . . . I was delighted with this first cassette."

P. Rubython, London NW10

"I have been intending to write to you for some days to say how much I enjoy the games on 'Cassette One' which you supplied me with earlier this month."

E.H., London SW4

". . . I previously bought your Cassette One and consider it to be good value for money!"

**Richard Ross-Langley**  
Managing Director  
Mine of Information Ltd.

## CASSETTE 1

(eleven 1k programs)

machine code:

React, Invaders, Phantom aliens, Maze of death, Planet lander, Bouncing letters, Bug splat.

Basic:

I Ching, Mastermind, Robots, Basic Hangman. PLUS Large screen versions of Invaders and Maze of Death, Ready for when you get 16k.

Cassette One costs £3.80

## CASSETTE 2

Ten games in Basic for 16k ZX81

Cassette Two contains Reversi, Awari, Laser Bases, Word Mastermind, Rectangles, Crash, Roulette, Pontoon, Penny Shoot and Gun Command.

Cassette Two costs £5.

## CASSETTE 3

8 programs for 16k ZX81

### STARSHIP TROJAN



Repair your Starship before disaster strikes. Hazards include asphyxiation, radiation, escaped biological specimens and plunging into a Supernova.

**STARTREK** This version of the well known space adventure game features variable Klingon mobility, and graphic photon torpedo tracking.

**PRINCESS OF KRAAL** An adventure game.

**BATTLE** Strategy game for 1 to 4 players.

**KALABRIASZ** World's silliest card game, full of pointless complicated rules.

**CUBE** Rubik Cube simulator, with lots of functions including 'Backstep'.

**SECRET MESSAGES** This message coding program is very txlp qexi jf.

**MARTIAN CRICKET** A simple but addictive game (totally unlike Earth cricket) in machine code. The speed is variable, and its top speed is very fast.

Cassette 3 costs £5.

## CASSETTE 4

8 games for 16k ZX81

**ZX-SCRAMBLE** (machine code) with 3 stages.

Bomb and shoot your way through the fortified caves.



**GUNFIGHT**

(machine code)



**INVADERS**

(machine code)



**ANTIDOTOS**  
THE FUNGLOIDS ARE GROWING AND WHEN THEY REACH THE SKY THEY PRODUCE DEADLY SPORES. YOU CONTROL A FLYER AND YOUR MISSION IS TO DESTROY THE FUNGLOIDS BY DROPPING ANTI-FUNGUS BOMBS ON THEM.

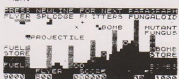

**GALAXY INVADERS** (machine code)

Fleets of swooping and diving alien craft to fight off.

**SNAKEBITE** (machine code)

Eat the snake before it eats you. Variable speed.

(very fast at top speed).

**LIFE** (machine code)

A ZX81 version of the well known game.

**3D TIC-TAC-TOE** (Basic)

Played on a 4 x 4 x 4 board, this is a game for the brain. It is very hard to beat the computer at it.

7 of the 8 games are in machine code, because this is much faster than Basic. (Some of these games were previously available from J. Steadman). Cassette 4 costs £5.

Recorded on quality cassettes, sent by first class post, from:

Michael Orwin, 26 Brownlow Rd., Willesden, London NW10 9QL (mail order only please)

# COMPETITION-PRO JOYSTICK

PRECISION GAME CONTROL!



For  
**ZX SPECTRUM**  
Complete with  
stylish interface unit  
simply plug in for  
instant arcade  
action.

**ONLY  
£25.00  
inc. VAT**

#### Outstanding Features

- Super strong nylon and steel construction, built to last.
- A total of 8 directions plus 2 large fire buttons.
- Arcade proven moulded leaf switches ensure incredible reliability.
- Complete with self contained boxed interface which simply plugs into the Spectrum expansion port (with or without printer).
- Easily programmed in BASIC or M/C

These arcade games, designed exclusively for the Joystick by leading software houses, are now available for Spectrum:

Time Game	M/C	48K	£6.95
Meteroids	M/C	16K	£4.95
Spooky Man	M/C	16K	£4.95
Cosmos	M/C	16K	£4.95

Watch this space for new software!

I wish to order:

Quantity	Item	Price
	Post & Packing	£1.00
	Total (VAT inclusive)	

Cheques/Postal orders should be made payable to Kempston (Micro) Electronics

Name \_\_\_\_\_

Address \_\_\_\_\_

Post to Kempston (Micro) Electronics, Dept  
180a Bedford Road, Kempston, Bedford MK42 8BL

**KEMPSTON**  
MICRO ELECTRONICS

180a Bedford Road, Kempston, Bedford MK42 8BL