

SEGA[®] COMPUTER

September/October Issue 1985

The Official Sega User Club Magazine

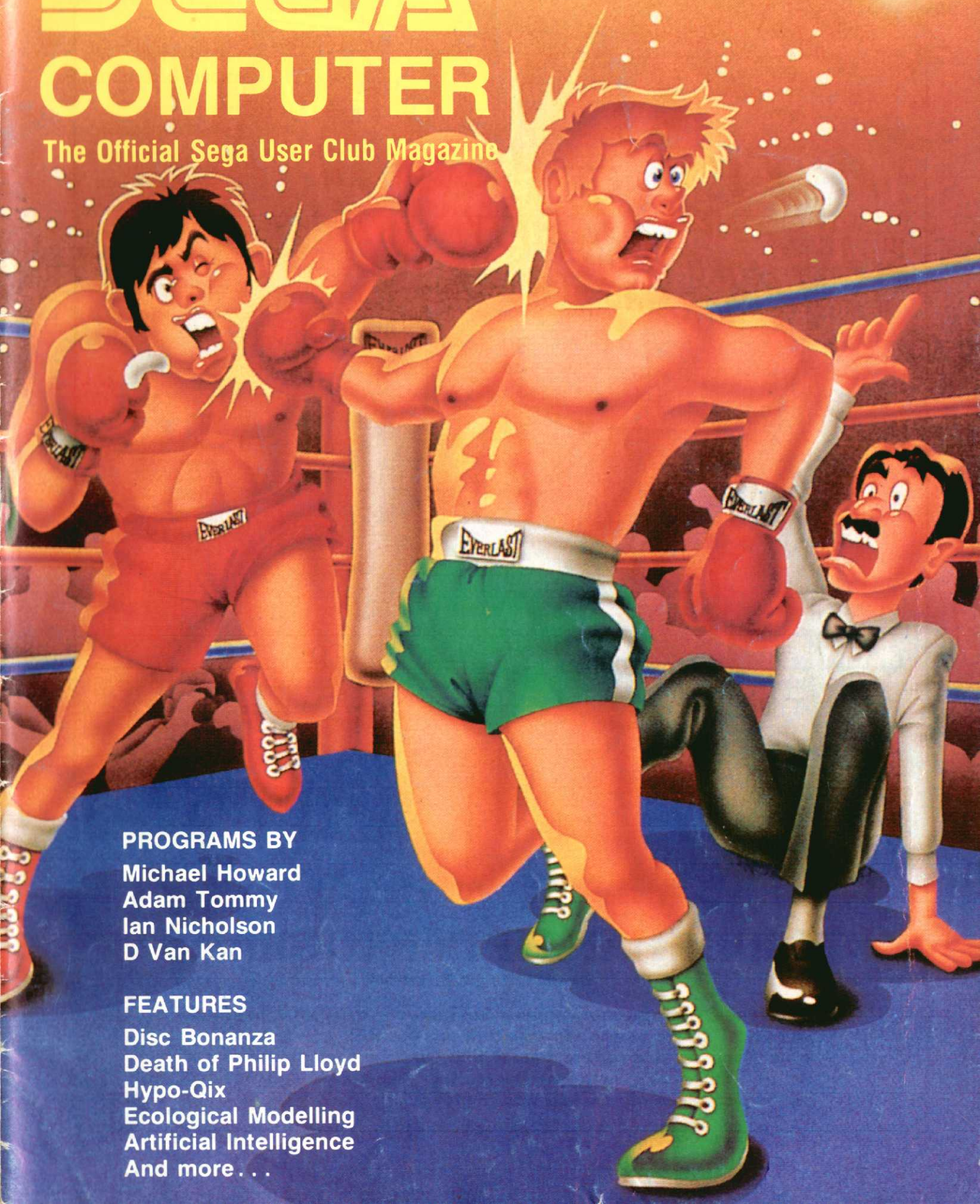

PROGRAMS BY

Michael Howard
Adam Tommy
Ian Nicholson
D Van Kan

FEATURES

Disc Bonanza
Death of Philip Lloyd
Hypo-Qix
Ecological Modelling
Artificial Intelligence
And more . . .

NOW AVAILABLE
FROM YOUR
GRANDSTAND
STOCKISTS
for \$24.95

HERE IT IS.....
MORE THAN FIFTY
PROGRAMS FOR THE
SEGA
SC-3000 !!

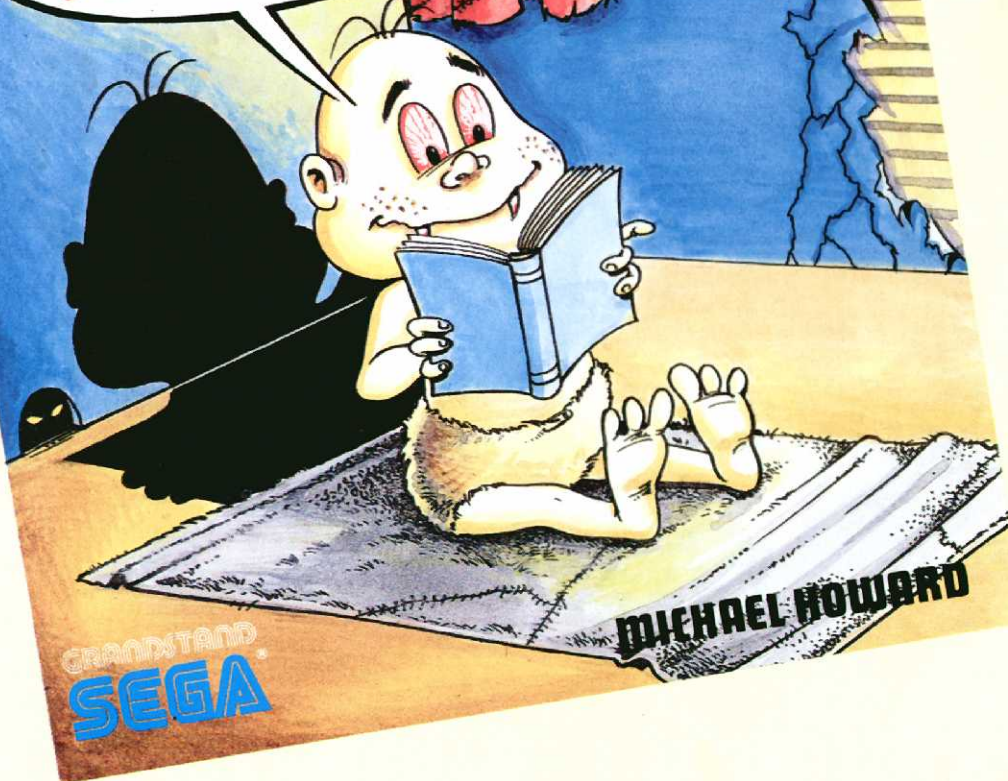

MORE THAN FIFTY PROGRAMS

By MICHAEL HOWARD

So you want some more programs to key into your Sega? Well, this book has over Fifty for you to tap out covering everything from games to education, machine code and basic, short and long. (all programs will run on a 16k or 32k cartridge). Pages of programs, each one dissected and explanations of how and why it works!

INTRODUCTION

Dear Readers

It is encouraging to see that our fame is spreading across the Tasman and I welcome all you Aussie Sega owners to our club.

Indeed we have heard of several fights breaking out amongst local area user club members trying to get their hands on a copy of this magazine at their meetings. Steps are being taken to make this publication more available over there, so don't despair.

In this month's issue we have some quality programs for you to type in. The Death of Philip Lloyd being a cluedo type game, and Jet Ranger for all you flight simulation fans. There are also a few useful programs that have been converted to run on SF-7000 disc drive systems. All in all a very informative issue.

Happy Programing!



S Kenyon
DIVISIONAL MANAGER

Contents

Readers	2
Contact Page	2
The Death of Phillip Lloyd	3
More on the Joystick and Machine Code	8
Software	12
First Steps into Artificial Intelligence	13
Disc Bonanza	14
Purple People Eaters Versus Man	16
Hypno-Qix	19
Program of the Month, Jet Ranger	20
Flashing Lights	23
Machine Code Routines	24
Review	30
Hill St Blues	31
Quick	32

OVERSEAS SEGA USER'S CLUBS

Camden Sega User's Club
Contact Steve MacDonald
2 Coolalie Ave
Camden 2570
Australia

LOCAL SEGA USERS CONTACTS

AUCKLAND CENTRAL SEGA USERS CLUB

C/o 287 Broadway Furniture
Newmarket
Contact: George Shaw
Ph. 547-543

B.O.P SEGA USERS CLUB

Sega 102B Hinewa Road
TAURANGA
Sec P. J. McDonald
Ph 64826 a/h
Tauranga

CHRISTCHURCH USER'S CLUB

Contact Graham Rudman
29 Primrose Street
CHRISTCHURCH 5

GISBORNE AREA USER'S CLUB

Trevor Gardiner
Ph. 83-068 HM
or 87-175 WK

HAMILTON SEGA USER'S CLUB

P.O. Box 1548 Hamilton
President: Mr Colin Bell 73-826
Secretary: Mrs Anne Thrush Ph 437-312
Meetings held fortnightly on Monday at Waikato
Technical Institute in Room F129.

HASTINGS AREA USER'S CLUB

Contact: Robin
8 Liverpool Crescent
Flaxmere
Hastings
Ph 798-116

NAPIER SEGA USERS CLUB

Sec E.P. Lins
41 Higgins Street
NAPIER

PUKEKOHE SEGA USERS CLUB

C/o 4 Roose Avenue
Pukekohe
Contact: Selwyn
Ph. Pukekohe 86-583

ROTORUA SEGA USERS CLUB

C/- 61 Devon Street
ROTORUA

TOKOROA SEGA USERS GROUP

C/o 1 Pio Pio Place
TOKOROA
Contact Geoff Phone Number 67-105
Tokoroa

SOUTH CANTERBURY USERS CLUB

P.O. Box 73 Timaru New Zealand
President: Geoff McCayghan
Secretary: Lloyd Van Der Krogt
Contact Phs: 60-756, 61-412 TIMARU

SOUTH COROMANDEL USERS CLUB

P.O. Box 183
WHANGAMATA
Contact: Sid
Ph. 58-775 Whangamata

SOUTH TARANAKI MICROCOMPUTER SOCIETY

D.M. Beale
7A Clive Street
HAWERA

WELLINGTON USERS CLUB

Contact: Shaun Parsons
P.O. Box 1871
Postal Central
Wellington
Ph 897-095 a/h
Ph 727-666 work

The above are contact names and addresses for Sega Users Clubs. If you wish to have your club advertised write to Sega Users Club P.O. Box 2353, Auckland.

If you have set up a local area user's club and you would like us to publish the details concerning your club please send them to us and we will publish the information for no charge.

READER'S LETTERS

DEAR EDITOR

I have been recently doing a little programming with the use of sprites, and have come up against a brick wall!! My problem is this . . . how many sprites can you have on the screen at once?

Grant Philips
Auckland

EDITORS REPLY

The Sega allows a very powerful method of sprite use . . . it is a lot more powerful in fact than most other computers, here is how it works. . . You can have 32 sprites on the screen at any given time, the sprites on the screen can be chosen from a "bucket" of 256 sprites. The result of this is that you may define all 256 sprites and have 32 out of that 256 on the screen at once . . . here is a demo program . . . it will show you that there are indeed 256 sprites.

```
10 SCREEN 2,2:CLS
20 FOR A=0 TO 255
30 A$=HEX$(RND(8)*255)
40 FOR B=0 TO 2:A$=A$+A$:NEXT B
50 BLINE (20,40)-(45,50),,BF
60 PATTERN S#A,A$
70 SPRITE 0,(20,20),A,1
80 CURSOR 20,40:PRINT A
90 NEXT
```

DEAR EDITOR

I am having a little trouble with the sound on my brilliant Sega. When I make some "white noise" by using channel 5, and then use "tone" by using channel 4, the white noise disappears . . . could you please help me?

PS: the last magazine was simply superb! Keep up the programs.

Philip Tottle
Titirangi, Auckland

EDITORS REPLY

When creating sound, you can use sound channels, 1, 2 and 3 and 4 or 5, in other words 1,2 and 3 can be used as often as you like, but you can use these in conjunction with channels 4 OR 5 . . . not both.

DEAR EDITOR

Firstly, I would like to say what a great change has happened to this magazine, it is now really professional and very helpful . . . thanks. The RS-232 section was very enlightening. Now to my problem. I am the owner of an SF-7000 Disc Unit and would like to know if it is possible to disable the RESET key, thus preventing younger ones from

pressing it by accident and upsetting demo programs.

Michael Bluenun
Mosgiel

EDITORS REPLY

To disable the RESET on the SF-7000 unit, enter POKE &H66,&C9 at the start of your program. Note this will not work on the non Disc unit.

DEAR EDITOR

I would like to know if there is the possibility of a Machine Code book coming out for the Sega, as I've got BASIC all worked out and would now like to venture into machine code to write some games.

Vicky Absword
Tauranga

EDITORS REPLY

Just about every person out there has been wanting to know about a book on machine code and the answer in short is YES . . . very soon in fact!! Michael Howard, is at this very moment in time, working on one . . . so watch this space!

CONTACT PAGE

Steve Monk
4 Browne St
Kawerau

Andrew Stoddart
45 Belford St
Waverly
Dunedin
Ph 43-337

Darryl Gore
36 Browning St
Cambridge
Ph 8556

D.G. Stembridge
44 Mossburn Grove
Kelson
Lower Hutt

Hillary and Geoff McLeod
34 Price St
Invercargill
Ph 57859

Andrew Mckenzie
c/o Colyton School
RD 5 Feilding Rd
Colyton

Brian Kelly
Robert Road
Otatara No 9 R.D.
Invercargill
ph. 331-473

Neil Bryce
131 North Street
Timaru
ph. 88-434

Fredrick Curd
64 College St
Palmerston North

The Death of Philip Lloyd



This program is one of those "Cluedo" style games where you play the lead detective and must find the murderer of Philip Lloyd.

The story goes something like this . . . Philip decided to throw a huge party after getting a job . . . I mean he was sick to death of just playing backgammon and table tennis, so he invited a few of his mates over for a few drinks. The party was going really well when all of a sudden a loud scream was heard . . . someone had found the body of Philip . . . not very alive, dead in fact!!

This is where you come in . . . you are a lonely detective, looking for a case to answer . . . when all of a sudden the phone rings . . .

I'm not telling you what happens next . . . but the program is like a book . . . in that there are a few chapters to it.

Okay, here is how to play it. Run the program, and after a short pause you will see part of a story appear on the screen, you will then hear a beep . . . whenever you hear a beep, that means the computer has paused to allow you to see the story on the screen . . . when you have read the stuff on the screen just press a key.

When you arrive at the house you can ask all the suspects a maximum of two out of three questions . . . the questions are . . .

- 1) where were you at the time of the murder?
- 2) how many people were with you at the time of the murder?
- 3) what time did you hear of the death?

You must now remember that the murderer will lie, so watch out for inconsistencies in the replies from suspects

The program is fairly straight-forward to use as it is menu driven, but the program plot is fairly complex, and don't forget there is a new story each time you play the game. Happy sleuthing!!!

```

10 CLS
20 DIMA(8,8)
30 PRINT"Chapter 1"
40 R=3:GOSUB1700
50 X=Z:GOSUB1710
60 PRINT"It is ";A$;" as you enter the"
70 R=3:GOSUB1700
80 X=Z+3:GOSUB1710
90 PRINT"squad room tonight.", "The ";A$
100 R=3:GOSUB1700
110 X=Z+6:GOSUB1710
120 PRINT"and the ";A$;" had blown a fus
e"
130 R=3:GOSUB1700
140 X=Z+9:GOSUB1710
150 PRINT"?";A$;"?", "You moan, "How did I"
160 PRINT"lumber myself with night duty.
".But worse was yet to come, you could
feel it in your ";
170 R=3:GOSUB1700
180 X=Z+12:GOSUB1710
190 PRINTA$
200 PRINT"You settle at your desk & idly
thumb"
210 R=3:GOSUB1700
220 X=Z+15:GOSUB1710

```

```

230 PRINT"through a copy of ";A$:PRINT"Y
our thoughts turn to the boss ,'I bethe'
s having"
240 R=3:GOSUB1700
250 X=Z+18:GOSUB1710
260 PRINTA$;"..lucky thing.!"
270 R=3:GOSUB1700
280 X=Z+21:GOSUB1710
290 PRINT"You pull out a ";A$;" & fumble
for":PRINT>Your matches when ";
300 GOSUB2120
310 PRINT"the phone rings."
320 GOSUB2120
330 PRINT"Hello",crackles the line.Is t
hat the police?".
340 R=3:GOSUB1700
350 X=Z+24:GOSUB1710
360 PRINTA$;" ,You reply":PRINT" There's
been a murder at the manor, come quickl
y".
370 PRINT>Your migraine starts to come on
but before you can say anything,the
line goes dead."
380 GOSUB2120
390 CLS:PRINT"Chapter 2"
400 PRINT>You pull your weary bag of bon
es out of the chair & take your "
410 R=3:GOSUB1700
420 X=Z+27:GOSUB1710
430 PRINTA$;" out of the drawer"
440 PRINT"The lift is out of order,so yo
u take":PRINT"The stairs down to the car
."
450 R=3:GOSUB1700
460 X=Z+30:GOSUB1710
470 PRINT" This ain't gonna do my ";A$:P
RINT"much good!",You mutter."
480 R=3:GOSUB1700
490 X=Z+33:GOSUB1710
500 PRINT>You climb into your ";A$
510 PRINT"....you put your foot hard dow
n on thegas.As you pull away down the ro
ad,youreflect on the standard questions
thatsuspects in a murder case are asked.
"
520 PRINT
530 PRINT"Where were you at the time of
murder?"
540 PRINT"How many others were with you?"
"
550 PRINT"What time did you here of the
murder?"
560 PRINT
570 PRINT>You realise that time is short
& you will only be able to ask each su
spect two questions"
580 PRINT"But you know the murderer will
lie"
590 GOSUB2120
600 CLS:PRINT"Chapter 3"
610 PRINT>You pull up outside the manor
& the butler takes you to the scene of
the murder"
620 PRINT"All the suspects are waiting,s
even of them.You take their names."
630 RESTORE1870:FORA=OT06:READA$:PRINTA$;
"6";A$:NEXT
640 GOSUB2120
650 PRINT>Your next move is to make a qu
ick sketch of the manor in your note
book"

```

```

660 R=4:GOSUB1700
670 D=Z
680 ONZGOTO690,700,710,720
690 K$="X":R$="Kitchen":GOTO730
700 D$="X":R$="Dining room":GOTO730
710 L$="X":R$="Living room":GOTO730
720 S$="X":R$="Study"
730 PRINT:PRINT"-----"
----"
740 PRINT"I          I          I"
750 PRINT"I      Study      I Living room I"
760 PRINT"I";TAB(6);S$;TAB(13);"I";TAB(2
0);L$;TAB(27);"I"
770 PRINT"I-----I-----I"
780 PRINT"I          I          I"
790 PRINT"I Dining roomI      Kitchen      I"
800 PRINT"I";TAB(6);D$;TAB(13);"I";TAB(2
0);K$;TAB(27);"I"
810 PRINT"-----"
820 PRINT"All you've to do now is find t
he      culprit."
830 GOSUB2120
840 FORI=1TO8:FORJ=1TO8:A(I,J)=0:NEXTJ,I
850 R=7:GOSUB1700
860 M=Z
870 FORS=1TO7
880 IFS=MTHEN940
890 R=4
900 GOSUB1700
910 IFZ=DTHEN900
920 A(S,Z)=1
930 A(S,5)=Z
940 NEXTS
950 FORJ=1TO4:A(B,J)=0:FORI=1TO7:A(B,J)=
A(B,J)+A(I,J):NEXTI,J
960 FORS=1TO7
970 IFS=MTHEN990
980 A(S,6)=A(B,A(S,5))-1
990 NEXTS
1000 FORK=1TO4
1010 IFK=DTHEN1090
1020 R=3:GOSUB1700
1030 FORS=1TO7
1040 IFS=MTHEN1070
1050 IFA(S,5)<>KTHEN1080
1060 A(S,7)=Z
1070 NEXTS
1080 NEXTK
1090 R=4:GOSUB1700
1100 IFA(B,Z)<2THEN1090
1110 A(M,5)=Z
1120 R=2:GOSUB1700
1130 IFZ=1THEN1220
1140 A(M,6)=A(B,A(M,5))
1150 S=1
1160 IFS=MTHEN1180
1170 IFA(S,5)=A(M,5)THEN1200
1180 S=S+1
1190 GOTO1160
1200 A(M,6)=A(S,7)
1210 GOTO1290
1220 A(M,6)=A(B,A(M,5))-1
1230 S=1
1240 IFS=MTHEN1260
1250 IFA(S,5)<>A(M,5)THEN1280
1260 S=S+1
1270 GOTO1240
1280 A(M,7)=A(S,7)
1290 CLS:PRINT"Chapter 4"
1300 PRINT"You are in the ";R$

```

```

1310 PRINT"ready to question the suspect
s"
1320 L=1
1330 X=40+L
1340 GOSUB1710
1350 PRINTA$;"-----":PRINT"enters the r
oom & sits down"
1360 R=3:GOSUB1700
1370 X=58+Z+((L-1)*3):GOSUB1710
1380 PRINTA$
1390 T=0:FORG=1TO2
1400 INPUT"You ask question #";Q
1410 IFQ<1ORQ>3THEN1400
1420 IFQ=TTHEN1510
1430 T=Q
1440 ONQGOTO1450,1490,1500
1450 X=A(L,5)+36
1460 GOSUB1710
1470 PRINT"I was in the ";A$;" "
1480 GOTO1520
1490 X=A(L,6)+48:GOSUB1710:PRINT"Beside
me was ";A$;" " :GOTO1520
1500 X=A(L,7)+55:GOSUB1710:PRINT"The ti
me was ";A$;" " :GOTO1520
1510 PRINT"You've already asked me that
" :GOTO1400
1520 NEXTG
1530 IFL=7THEN1590
1540 PRINT:PRINT"You ask yourself,"Can I
name The murder-erer?" (Y/N)"
1550 B$=INKEY$:IFB$="Y"THEN1590
1560 IFB$<>"N"THEN1550
1570 L=L+1:IFL=8THEN1590
1580 PRINT:GOTO1330
1590 PRINT"Chapter 5"
1600 PRINT"All the suspects are present
and you accuse....."
1610 INPUTB$
1620 X=40+M:GOSUB1710
1630 IFLEFT$(B$,3)=LEFT$(A$,3)THEN1660
1640 PRINT"You are about to make the arr
est,when":PRINTA$;" breaks down & confes
ses"
1650 PRINT>Your deduction is wrong & you
arrest the real murderer":GOTO1690
1660 PRINT"You arrest the murderer & ref
lect that"
1670 X=48+L:GOSUB1710
1680 PRINT>Your deduction is correct aft
er ";A$:PRINT"suspects."
1690 PRINT:PRINT:PRINT"..THE END..":END
1700 Z=INT(RND(8)*R)+1:RETURN
1710 RESTORE:FORY=1TOX:READA$:NEXTY:RETU
RN
1720 DATA cold & damp,hot & sticky,wet &
windy
1730 DATA coffee was cold,beer was warm,
beer was flat
1740 DATA fridge,TV,fan
1750 DATA oh dear,#%+!?è,beep!
1760 DATA water,bones,bum
1770 DATA Health & Efficiency,The Beano,
a Sega magazine
1780 DATA a game of The House!,a vasecto
my,a booze up
1790 DATA cigar,cig butt,cigarette
1800 DATA"Well it ain't a brothel!"
1810 DATA "Why do you want to know?"
1820 DATA "Sorry it's my day off"
1830 DATA sawn-off shotgun,spud gun,rock
et launcher

```



```

1840 DATA hernia,rupture,gammy leg
1850 DATA old Anglia,Mini,fast Lamborghi
ni
1860 DATA kitchen,dining room,living roo
m,study
1870 DATA Miss Lustie,Riff-Raff (the but
ler),Lady Wallop
1880 DATA Dr.Kuttitoff,Mr P.Brains,Merli
n (the cat),Vanessa (the vampire)
1890 DATA none,one,two,three,four,five,s
ix,seven
1900 DATA 7:02,7:04,7:06
1910 DATA She's perverted & knows it
1920 DATA She has buck teeth & acne
1930 DATA She crosses her legs & flashes
her thighs
1940 DATA He sits nervously & scratches
his bum
1950 DATA "He belches & says,"Pardon"
1960 DATA He furtively checks his fly
1970 DATA She sighs deeply
1980 DATA Her weight busts the chair
1990 DATA She says "Come up & see me som
etime"
2000 DATA He spills his drink on his tro
users
2010 DATA You notice he is wearing no un
dies
2020 DATA "You're a big boy "-he says
2030 DATA He wipes his monocle
2040 DATA He stammers "I never touched h
er"
2050 DATA He squirms in his chair
2060 DATA He starts to purrrrrrr
2070 DATA He licks himself
2080 DATA He says"MMeeoooww!!"
2090 DATA She has blood on her neck
2100 DATA A starts to clean her fangs
2110 DATA "She says,"I have given the ma
ster much pleasure!". "
2120 FORI=0TO2:BEEP:NEXT
2130 IFINKEY$="" THEN2130
2140 RETURN
2150 RESTORE:FORA=1TO100:READA$:PRINTA;"
";A$
2160 IFINKEY$="" THEN2160
2170 NEXT

```

AUSTRALIAS # 1 TAPE NOW IN N.Z

**VORTEX BLASTER
32K only**

**14 other
titles available**

SEGA'S FIRST TALKING PROGRAMME

\$28.95

(Includes Postage and Packaging)



**POSEIDON SOFTWARE
C/P.O. 784
HAMILTON**



Name

Address

Enclosed — cheque,
money order

Charge my

No

Expiry Date.....

Signature

MORE ON THE JOYSTICK AND MACHINE CODE

By Ian Nicholson

INTRODUCTION

A previous article described a method to control movement of a sprite across the screen using a machine code utility. It was necessary to write the utility in machine code as the equivalent in BASIC would have been too slow in operation.

One of the exercises at the end of the above mentioned article was to make the sprite move up and down as well as left and right.

This article will show you how to move the sprite in any of the eight available directions. You will be also shown how to detect the operation of the fire button and collision of sprites all in machine code.

The machine code of the program which will produce sound effects resulting from the operation of the fire button and collision of sprites. An overall description and dissection of the program is also given.

Explanation of the Basic Program

The BASIC program is in the main self explanatory using REM statements, however, further explanation is necessary on a few points.

Line 20 (POKE &H8169, &HC6) sets end of memory pointer to &HC6FF. This prevents the BASIC program from interfering with the machine code routines (as can happen if extra commands are added to the BASIC program). The top of memory pointer is set just below the start of the machine code routine.

Line 40 (RESORE 70) makes sure that the READ statement in Line 60 reads the data in line 70.

Lines 50 and 60 pokes the machine code data contained in line 70 into memory locations &HC700 to &HC74F inclusive. Note that the &H is not necessary in the DATA statements as this is taken care of in line 60.

Lines 80 to 310 poke in machine code routines as indicated in the REM statements within the program. Note that these could have been condensed into fewer lines but would make understanding more difficult.

Lines 330 and 340 set the patterns for the two sprites used within the program.

Line 350 selects SCREEN 2 (the graphics screen).

Line 360 sets SPRITE 6 at location (50, 70) with colour 1 (black).

Line 370 similarly sets SPRITE 0 to location (99, 99).

Line 390 calls the machine code routine which was poked in from line no's 50 onwards. This enables you to move SPRITE 0 with the aid of a joystick plugged into port 1 and also detects the collision of two sprites as well as responding to the fire button. An explanation is given later.

Line 410 (OUT &HDF, &H92) passes control from the joystick back to the keyboard. Note that the program returns from the machine code routine to this point on either the left hand fire button being pressed or on a collision between sprites.

Line 420 looks at the value placed in memory location &HC7F0 during the operation of the machine code routine. The value placed depends on whether the fire button has been pressed or a collision between sprites occurred. If the value is 16 (10 HEX) this indicates that the left hand fire button has been activated and the program advances to line 470 to make a gunshot noise. Otherwise the program continues to line 450 to make a collision noise.

On completion of either sound the program returns to line 390 to recall the machine code routine.

Explanation of the Flow Diagram

Figure 1 shows the machine code part of the program to move the sprite in any direction as well as detecting if the fire button has been pressed or a collision between sprites taken place.

A brief explanation is as follows. (for a more detailed explanation see the previous article)

1. From BASIC a call is made to the machine code routine.
2. On entry to machine code the computer is initialised to read the condition of the joystick and fire button states.
3. If no action has taken place from the joystick then the program simply rotates about the first loop.
4. On a change of state from the joystick the program is set further in motion until the state of the joystick is recognised by one of the decision boxes.
5. From the appropriate decision box the program branches out to the right to obtain the current X and Y values; increasing or decreasing them as appropriate.

6. On exit from the above a check is made to determine if a collision between the two sprites has occurred.
7. If collision has taken place then a return to BASIC is made and the appropriate noise made.
8. On a state of no collision the program then enters a delay loop to slow the movement of the sprite down, otherwise its speed would be excessive.
9. The program now returns to sample the state of the joystick again.

Note that if the fire button had been pressed then the program will advance down to the lower decision box where on exit from the "YES PORT" will return the program to BASIC to make a gunshot noise.

Machine Code

To allow the program to work with either the IIIA or IIIB memories the machine code is inserted from &HC700 onwards.

The code has been written in a form such that is grouped in small sections to correspond to each block of the flow diagram. Additional comments are written against the machine code listing. These correspond to the comments within the boxes of the flow diagram.

Hopefully this exercise has given you a further insight on how machine code programming can be used to further your use of the SEGA computer.

For those of you so inclined, you could try to rewrite the noises, which are written in BASIC into machine code routines and incorporate this into the machine code used within this article.

Finally, a word of caution. Make certain that the machine code contained within the DATA statements is typed in exactly as listed otherwise when the program is run a crash is likely. You have been warned. Happy computing.

C700	3E9B	LD A,9B	}	INITIALISATION TO READ JOYSTICK
C702	D3DF	OUT (DF),A		GET VALUE FROM JOYSTICK
C704	DBDC	IN A,(DC)		HAS ANY ACTION OCCURED
C706	FEFF	CP FF		IF NOT JUMP TO C704
C708	28FA	JR Z C704		HAS JOYSTICK MOVED →
C70A	FEF7	CP F7		JUMP TO C718 IF NOT
C70C	200A	JR NZ C718		GET X VALUE OF SPRITE
C70E	CDC0C7	CALL C7C0		INCREASE X
C711	3C	INC A		MOVE SPRITE
C712	CDE0C7	CALL C7E0		JUMP TO COLLISION ROUTINE
C715	C3A1C7	JP C7A1		HAS JOYSTICK MOVED ↗
C718	FEF6	CP F6		JUMP TO C72D IF NOT
C71A	2011	JR NZ C72D		GET X VALUE OF SPRITE
C71C	CDC0C7	CALL C7C0		INCREASE X
C71F	3C	INC A		MOVE SPRITE
C720	CDE0C7	CALL C7E0		GET Y VALUE OF SPRITE
C723	CDD0C7	CALL C7D0		DECREASE Y
C726	3D	DEC A		MOVE SPRITE
C727	CDE0C7	CALL C7E0		JUMP TO COLLISION ROUTINE
C72A	C3A1C7	JP C7A1		HAS JOYSTICK MOVED ↑
C72D	FEFE	CP FE		JUMP TO C73B IF NOT
C72F	200A	JR NZ C73B		GET Y VALUE OF SPRITE
C731	CDD0C7	CALL C7D0		DECREASE Y
C734	3D	DEC A		MOVE SPRITE
C735	CDE0C7	CALL C7E0		JUMP TO COLLISION ROUTINE
C738	C3A1C7	JP C7A1		HAS JOYSTICK MOVED ↖
C73B	FEFA	CP FA		JUMP TO C750 IF NOT
C73D	2011	JR NZ C750		GET X VALUE OF SPRITE
C73F	CDC0C7	CALL C7C0		DECREASE X
C742	3D	DEC A		MOVE SPRITE
C743	CDE0C7	CALL C7E0		GET Y VALUE OF SPRITE
C746	CDD0C7	CALL C7D0		DECREASE Y
C749	3D	DEC A		MOVE SPRITE
C74A	CDE0C7	CALL C7E0		JUMP TO COLLISION ROUTINE
C74D	C3A1C7	JP C7A1		HAS JOYSTICK MOVED ←
C750	FEFB	CP FB		JUMP TO C75E IF NOT
C752	200A	JR NZ C75E		GET X VALUE OF SPRITE
C754	CDC0C7	CALL C7C0		DECREASE X
C757	3D	DEC A		MOVE SPRITE
C758	CDE0C7	CALL C7E0		JUMP TO COLLISION ROUTINE
C75B	C3A1C7	JP C7A1		HAS JOYSTICK MOVED ↙
C75E	FEF9	CP F9		JUMP TO C773 IF NOT
C760	2011	JR NZ C773		

C762 CDC0C7	CALL C7C0	GET X VALUE OF SPRITE
C765 3D	DEC A	DECREASE X
C766 CDE0C7	CALL C7E0	MOVE SPRITE
C769 CDD0C7	CALL C7D0	GET Y VALUE OF SPRITE
C76C 3C	INC A	INCREASE Y
C76D CDE0C7	CALL C7E0	MOVE SPRITE
C770 C3A1C7	JP C7A1	JUMP TO COLLISION ROUTINE
C773 FEFD	CP FD	HAS SPRITE MOVED ↓
C775 200A	JR NZ C781	JUMP TO C781 IF NOT
C777 CDD0C7	CALL C7D0	GET Y VALUE OF SPRITE
C77A 3C	INC A	INCREASE Y
C77B CDE0C7	CALL C7E0	MOVE SPRITE
C77E C3A1C7	JP C7A1	JUMP TO COLLISION ROUTINE
C781 FEF5	CP F5	HAS SPRITE MOVED ↘
C783 2011	JR NZ C796	JUMP TO C796 IF NOT
C785 CDC0C7	CALL C7C0	GET X VALUE OF SPRITE
C788 3C	INC A	INCREASE X
C789 CDE0C7	CALL C7E0	MOVE SPRITE
C78C CDD0C7	CALL C7D0	GET Y VALUE OF SPRITE
C78F 3C	INC A	INCREASE Y
C790 CDE0C7	CALL C7E0	MOVE SPRITE
C793 C3A1C7	JP C7A1	JUMP TO COLLISION ROUTINE
C796 FEEF	CP EF	HAS LH FIRE BUTTON PRESSED
C798 C200C7	JP NZ C700	JUMP TO C700 IF NOT
C79B 3E10	LD A,10	LOAD A REG WITH 10
C79D 32F0C7	LD (C7F0),A	C7F0 LOADED WITH A (10)
C7A0 C9	RET	RET TO BASIC
C7A1 DBBF	IN A,(BF)	COLLISION ROUTINE
C7A3 E620	AND 20	"
C7A5 FE20	CP 20	"
C7A7 C2B0C7	JP NZ C7B0	"
C7AA 3E20	LD A,20	"
C7AC 32F0C7	LD (C7F0),A	"
C7AF C9	RET	RET TO BASIC
C7B0 010003	LD BC,0300	DELAY ROUTINE
C7B3 0B	DEC BC	"
C7B4 3E00	LD A,00	"
C7B6 B8	CP B	"
C7B7 20FA	JR NZ C7B3	"
C7B9 C300C7	JP C700	JUMP TO C700
C7BC 00	NOP	NO ACTION
C7BD 00	NOP	"
C7BE 00	NOP	"
C7BF 00	NOP	"
C7C0 21013B	LD HL,3B01	3B01 HAS X VALUE OF SPRITE 0
C7C3 CD322C	CALL 2C32	CALL ROUTINE TO FIND VALUE AT 3B01
C7C6 DBBE	IN A,(BE)	PUT VALUE INTO A REGISTOR
C7C8 C9	RET	RETURN TO NEXT INSTRUCTION
C7C9 00	NOP	NO ACTION
C7CA 00	NOP	"
C7CB 00	NOP	"
C7CC 00	NOP	"
C7CD 00	NOP	"
C7CE 00	NOP	"
C7CF 00	NOP	"
C7D0 21003B	LD HL,3B00	3B00 HAS Y VALUE OF SPRITE 0
C7D3 CD322C	CALL 2C32	CALL ROUTINE TO FIND VALUE AT 3B00
C7D6 DBBE	IN A,(BE)	PUT VALUE INTO A REGISTOR
C7D8 C9	RET	RETURN TO NEXT INSTRUCTION
C7D9 00	NOP	NO ACTION
C7DA 00	NOP	"
C7DB 00	NOP	"
C7DC 00	NOP	"
C7DD 00	NOP	"
C7DE 00	NOP	"
C7DF 00	NOP	"
C7E0 CD442C	CALL 2C44	ROUTINE TO MOVE SPRITE
C7E3 D3BE	OUT (BE),A	MOVES SPRITE ON SCREEN
C7E5 C9	RET	RETURN TO NEXT INSTRUCTION

Flow diagram of Machine Code Routine

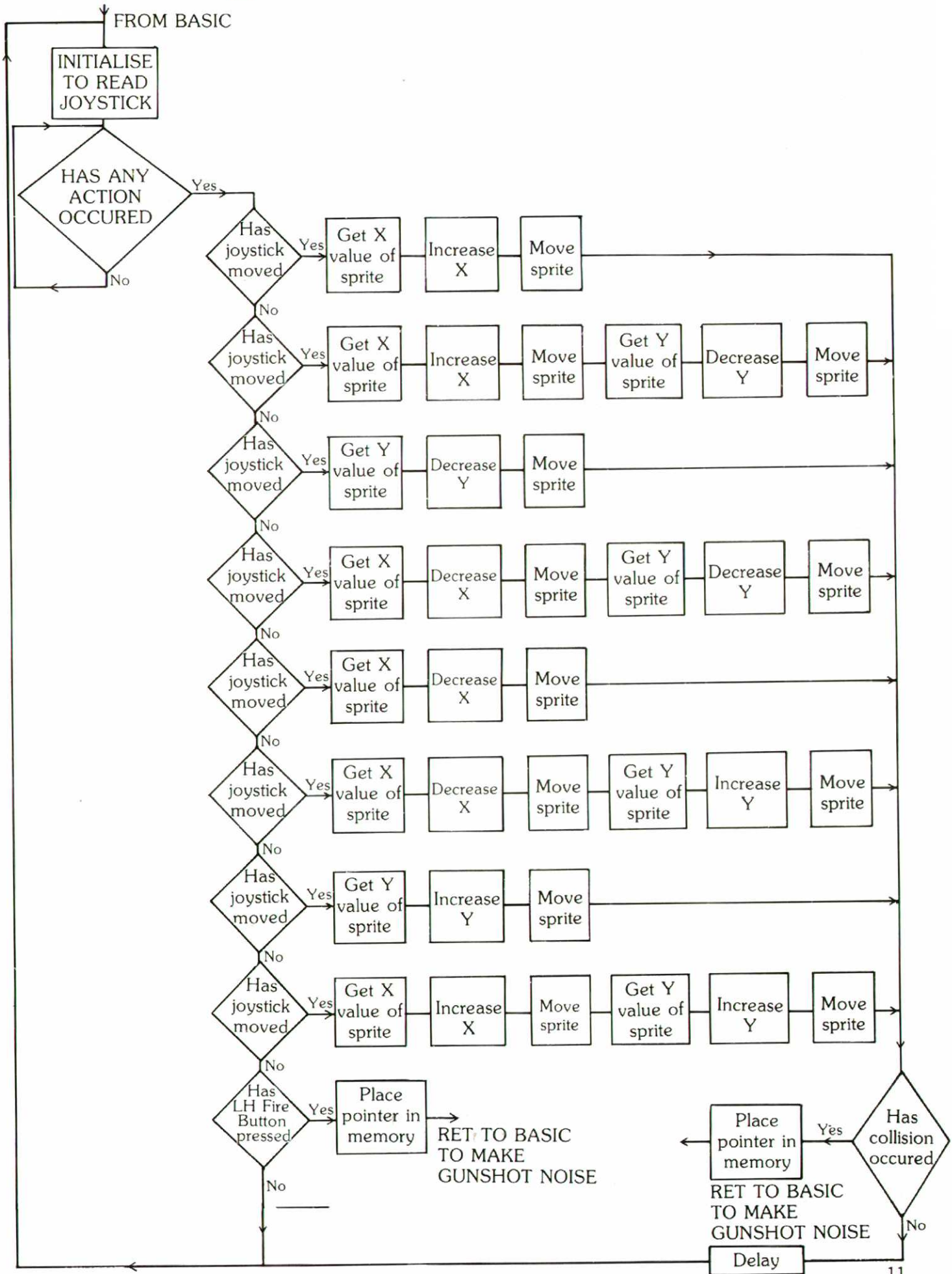

GRANDSTAND COMPUTERS LTD



If you are having any problems obtaining any of the pieces of software please contact Grandstand Computers enclosing a cheque or postal order.

SOFTWARE

CARTRIDGES

	PRICE
<input type="checkbox"/> BASIC LEVEL IIIB	\$175
<input checked="" type="checkbox"/> MUSIC	\$125
<input type="checkbox"/> N/SUB	\$39.95
<input checked="" type="checkbox"/> SAFARI HUNTING	\$39.95
<input type="checkbox"/> BORDER LINE	\$39.95
<input checked="" type="checkbox"/> CONGO BONGO	\$39.95
<input checked="" type="checkbox"/> YAMATO	\$39.95
<input checked="" type="checkbox"/> STAR JACKER	\$39.95
<input checked="" type="checkbox"/> CHAMPION TENNIS	\$39.95
<input checked="" type="checkbox"/> MONACO GP	\$39.95
<input type="checkbox"/> CHAMPION BASEBALL	\$39.95
<input type="checkbox"/> SINBAD MYSTERY	\$39.95
<input checked="" type="checkbox"/> VIDEO FLIPPER	\$39.95
<input type="checkbox"/> PACAR	\$39.95
<input type="checkbox"/> POP FLAMER	\$39.95
<input checked="" type="checkbox"/> CHAMPION GOLF	\$49.95
<input type="checkbox"/> EXERION	\$49.95
<input type="checkbox"/> SAFARI RACE	\$49.95
<input type="checkbox"/> LODERUNNER	\$49.95
<input type="checkbox"/> BOXING	\$54.95
<input type="checkbox"/> ORGUS	\$49.95
<input type="checkbox"/> FLICKY	\$59.95

HOME/PERSONAL/FINANCE CASSETTES

<input checked="" type="checkbox"/> FILE SYSTEM	\$19.95
<input checked="" type="checkbox"/> CHEQUE BOOK RECONCILIATION	\$19.95
<input type="checkbox"/> LOAN & MORTGAGE CALCULATION	\$19.95
<input type="checkbox"/> ACCOUNTS RECEIVABLE	\$30.00
<input type="checkbox"/> ACCOUNTS PAYABLE	\$30.00
<input type="checkbox"/> 32K WORD PROCESSOR	\$30.00
<input type="checkbox"/> PERSONAL RECORD KEEPER	\$30.00
<input type="checkbox"/> 16K EASY WRITER	\$19.95
<input type="checkbox"/> GRAPH AND CHART	\$19.95
<input type="checkbox"/> HUCAL	\$99.97 disc only spread sheet
<input type="checkbox"/> SEGA BASE	\$99.97 disc only database
<input type="checkbox"/> LOGO	\$72.22 disc only language

BOOKS

*TEACH YOURSELF BASIC GAMES PROGRAMMING	\$39.95	(Book and Cassette)
MORE THAN 50 PROGRAMS FOR THE SEGA SC-3000	\$24.95	
*SEGA BEGINNERS GUIDE	\$14.95	
*SELECTED BACK ISSUES OF SEGA MAGAZINE	\$ 6.95	

GAME CASSETTES

	PRICE
<input checked="" type="checkbox"/> TOWERS OF HANOI	\$19.95
<input type="checkbox"/> HANGMAN	\$19.95
<input checked="" type="checkbox"/> CITY-LANDER	\$19.95
<input type="checkbox"/> CUBE-IT	\$30.00
<input type="checkbox"/> BUGALOO	\$19.95
<input type="checkbox"/> LASER BLAST	\$19.95
<input type="checkbox"/> MUNCHMAN	\$30.00
<input type="checkbox"/> ENTERPRISE ESCAPE	\$19.95
<input checked="" type="checkbox"/> MARSMOBILE	\$19.95
<input type="checkbox"/> MARS ADVENTURER	\$19.95
<input type="checkbox"/> EMPIRE	\$19.95
<input type="checkbox"/> KALAH	\$19.95
<input type="checkbox"/> CHESS	\$19.95
<input type="checkbox"/> DEATH SATELLITE	\$19.95
<input checked="" type="checkbox"/> BIT BYTE	\$19.95
<input type="checkbox"/> THE HOUSE	\$30.00
<input type="checkbox"/> THE PYRAMID	\$19.95
<input type="checkbox"/> CODE BREAKER	\$19.95
<input type="checkbox"/> BACKGAMMON	\$19.95
<input type="checkbox"/> LUMBER JACK	\$19.95
<input type="checkbox"/> TRAMPMAN	\$19.95
<input type="checkbox"/> SEGA GAMES PACK I	\$19.95
<input type="checkbox"/> HELP!	\$19.95

EDUCATIONAL CASSETTES

	PRICE
<input type="checkbox"/> ROCKET MATHS	\$19.95
<input type="checkbox"/> LEARNING ALPHABET	\$19.95
<input type="checkbox"/> WATCH ME DRAW	\$19.95
<input checked="" type="checkbox"/> SPELLING	\$19.95
<input type="checkbox"/> ADDITION	\$19.95
<input type="checkbox"/> SUBTRACTION	\$19.95
<input type="checkbox"/> MULTIPLICATION	\$19.95
<input type="checkbox"/> SPRITE EDITOR	\$19.95
<input type="checkbox"/> MUSIC EDITOR	\$19.95
<input type="checkbox"/> TYPING TUTOR	\$19.95
<input type="checkbox"/> LEARNING TO COUNT	\$19.95
<input type="checkbox"/> SHAPE & COLOUR QUIZ	\$19.95
<input type="checkbox"/> MUSIC CARTRIDGE DEMONSTRATOR	\$19.95
<input type="checkbox"/> SEGA GRAPHIC DESIGNER	\$19.95
<input type="checkbox"/> GEOGRAPHY QUIZ I	\$19.95
<input type="checkbox"/> GEOGRAPHY QUIZ II	\$19.95
<input type="checkbox"/> MATHS HANG UP	\$19.95

I enclose payment

Cash Cheque Postal order Visa Bankcard

NAME CARD NUMBER

ADDRESS

..... CARD EXPIRY DATE.....

SIGNATURE..... CHEQUE NO.....

GRANDSTAND COMPUTERS LTD P.O. BOX 2353 AUCKLAND

First Steps into Artificial Intelligence

M Howard

The actual of concepts of AI are extremely complex . . . well let's face it, the human mind (with the possible exception of mine) is a very complex affair and any attempts at trying to simulate it are always going to be hard to understand.

So hopefully this simple . . . but interesting program will introduce you to some of the concepts of AI.

The program acts as a database (well sort of any way!) . . . it starts off by asking you to think of an animal. It then asks you if the animal you have thought of is a cat. If it is then press "Y" else press "N". If you typed "N" then you are asked to enter the name of the animal you thought of and a way of telling the difference between it and a cat. EG;

```
Animal thought of . . . dog
Is it a cat?
No
What was it? . . . dog
Give a question that is true for a dog and false for a cat.
does it bark?
```

From here you can set up what is called a binary tree of data, by setting up lots of questions and answers by simply answering "Y" or "N" and ending up with a great big data base. Experiment with the program a little . . . but don't forget this was one of the first AI programs ever . . . so don't expect too much!!

```
10 DIMA$(1024)
20 A$(1)="CAT"
30 N=1
40 PRINT"Think of an animal"
50 IFA$(2*N)<>" "THEN120
60 PRINT"Is it a ";A$(N);"?"
70 GOSUB170:IFFTHENPRINT"I got it!!":GOTO30
80 A$(2*N)=A$(N)
90 INPUT"Well what is it ";A$(2*N+1)
100 PRINT"Give me a question that would
be true for a ";A$(2*N+1);".....":PRINT"B
ut false for a ";A$(2*N)
110 INPUTA$(N):GOTO30
120 PRINTA$(N);"?"
130 GOSUB170
140 N=2*N+F
150 IFN<512THEN50
160 END
170 X#=INKEY$:IFX#<>"Y"ANDX#<>"N"THEN170
180 F=0:IFX#="Y"THENF=1
190 RETURN
```



DISC BONANZA

As many people know, the price of the SF-7000 disc unit has dropped to \$695 and as you can guess the quantity of sales has taken off drastically . . . so to help all those with the SF-7000, a few of the Machine Code programs that have appeared in previous magazines have been converted to work on the Disc system. So with no more waffle here's a list of programs . . .

Sprite Mover

This program allows you to move all the sprites about the screen in any direction and at any speed. Touse it, just enter in the program, RUN it and wait for a short while, you'll then see 32 sprites all move about the screen. Refer to Jan/Feb issue for more details.

```
10 DATA 11,4,0,21,0,3B,DD,21,0,F1,E,DO,6
,20,F3,DD,35,1,20,28,DD,7E,0,DD,77,1,CD,
6F,0,DB,BE,DD,86,2,B9,20,3,DD,86,2,CD,69
,0,D3,BE,23,CD,6F,0,DB,BE,DD,86,3,CD,69,
0,D3,BE,2B,19,DD,19,10,CE,C9
20 FOR A=&HF000 TO &HF041:READA$:POKEA,VA
L("&h"+A$):NEXT
30 FOR A=&HF100 TO &HF160 STEP4
40 POKE A,1
50 POKE A+1,1
60 POKE A+2,(253+INT(10*RND(1)))MOD 256
70 POKE A+3,(253+INT(10*RND(1)))MOD 256
80 NEXT
90 SCREEN 2,2:COLOR1,14,,15:CLS:PATTERN
S#0,"FF818181818181FF"
100 FOR S=0 TO 31
110 SPRITE S,(120,90),0,RND(1)*16
120 NEXT
130 CALL &HF000:GOTO 130
```

SP-400 Printer Dump

This one will let you copy the Hi-re screen to the SP-400 printer plotter. Refer to June issue.

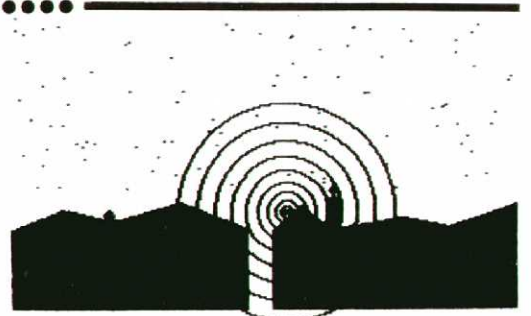

```
10 DATA0,0,0,ED,5B,0,FO,CD,14,01,FE,0,CO
,ED,5B,0,FO,1C,AF,BB,20,A,14,3E,CO,BA,20
,4,32,2,FO,C9,ED,53,0,FO,C3,3,FO
20 FORA=&HF000TO&HF026:READA$:POKEA,VA
L("&h"+A$):NEXT
30 LPRINTCHR$(18):POKE&HF000,0:POKE&HF00
1,0:POKE&HF002,0:CALL&HF003
40 LPRINT"M";PEEK(&HF000);", ";191-PEEK(&
HF001):LPRINT"J1,0":CALL&HF00D:GOTO40
```

Hi-Resolution Scrolling

These two programs will let you scroll information on the Hi-res screen a pixel at a time . . . producing brilliant effects. Refer to June issue for more info.

Right Hi-Res Scrolling..Disc Version

```
10 DATA 0,3E,0,32,0,F0,D0,3C,32,0,F0,C9
20 DATA E5,CD,69,0,D3,BE,0,E1,C9
30 DATA E5,CD,6F,0,DB,BE,0,E1,C9
40 DATA F3,6,20,C5,CD,15,F0,CB,3F,F5,47,3
A,0,F0,FE,0,28,2,CB,FB,f1,CD,1,F0,78,CD,
C,F0,C1,11,8,0,AF,ED,5A,10,DE,C9
50 DATA 6,8,21,0,0,C5,E5,AF,32,0,F0,CD,1E
,F0,E1,23,C1,10,F2,C9
60 DATA 6,6,C5,CD,44,F0,C1,10,F9,C9
100 T=0:RESTORE:FORA=&HF000TO&HF061:READ
A$:B=VAL("&H"+A$):T=T+B:POKEA,B:NEXT:IFT
<>12557THENPRINT"Error":END
1000 A$="9876543210987654321098765432109
87654321"
1010 SCREEN 2,2:CLS:FORA=1TOLEN(A$):CURS
OR0,0:PRINTMID$(A$,A,1):CALL&HF058:NEXT
1020 FORA=0TO41:CALL&HF058:NEXT
```

Left Hi-Res Scrolling Disc Version

```
10 DATA 0,3E,0,32,0,F0,D0,3C,32,0,F0,C9
20 DATA E5,CD,69,0,D3,BE,0,E1,C9
30 DATA E5,CD,6F,0,DB,BE,0,E1,C9
40 DATA F3,6,20,C5,CD,15,F0,CB,27,f5,47,3
A,0,F0,FE,0,28,2,CB,C0,f1,CD,1,F0,78,CD,
C,F0,C1,11,8,0,AF,ED,52,10,DE,C9
50 DATA 6,8,21,F8,0,C5,E5,AF,32,0,F0,CD,1
E,F0,E1,23,C1,10,F2,C9
60 DATA 6,6,C5,CD,44,F0,C1,10,F9,C9
100 T=0:RESTORE:FORA=&HF000TO&HF061:READ
A$:B=VAL("&H"+A$):POKEA,B:T=T+B:NEXT:IFT
<>12717THENPRINT"Error":STOP
1000 A$="Hello this is a test..123456789
0....."
1010 SCREEN 2,2:CLS:FORA=1TOLEN(A$):CURS
OR247,0:PRINTMID$(A$,A,1):CALL&HF058:NEX
T
1020 FORA=0TO40:CALL&HF058:NEXT
```

Flip!

!qil7

This silly program will . . . no I won't tell you! Just enter it type in RUN followed by a NEW then CALL &HF000 and see what happens. CALL &HF000 to set things back to normal.

```
10 DATA F3,21,0,18,1,0,8,C5,E5,CD,6F,0,D
B,BE,E,0,6,6,17,CB,19,10,FB,E1,E5,C5,CD,
69,0,C1,79,D3,BE,E1,C1,23,B,78,B1,20,DE,
C9
20 FOR A=&HF000 TO &HF029:READA$:POKEA,V
AL("&H"+A$):NEXT
```



Purple People Eaters versus Man

an exercise in ecological modelling

M Howard

Computers are designed for serious as well as entertainment purposes . . . well this program is SERIOUS . . . Okay no need to cringe or hide behind the chair!! The program can in fact be quite funny and enjoyable to watch . . . here is what it does.

You firstly select a number of Purple People Eaters . . . those who don't yet know what a PPE is ought to be ashamed!! and then select a number of humans. These bodies are then placed in an "Ecological Chamber". From now on the following rules apply:-

- 1) Lots of humans lead to lots of PPE's, because PPE's eat humans (obvious really) . . .!!
- 2) Lots of PPE's lead to humans dying out, as they all get munched!
- 3) Lots of PPE's lead to no humans, thus leading to no PPE's, because if there are no people to chew on then the PPE's die out!
- 4) Too few PPE's lead to an explosion in the population of humans, but too many humans die out due to lack of food and space.
- 5) Etc etc etc etc

As you can see this program can end up giving quite complex results due to it's many rules and regulations.

Okay, now how do you run the program? Well it's really easy, firstly enter the number of humans and numbers of PPE's you wish to experiment on. Then just wait a while whilst the computer generates the original mode. From now on you just select the option displayed after each generation. These options include:-

- 1) Generate a new cycle.
- 2) Quit and make a new experiment.
- 3) Draw up a histogram.
- 4) Draw up a table of data.

And they are all fairly self explanatory so I won't bother explaining them. Any way, I hope you like the program and find it of good use. But remember two things:

A) If the program appears to be doing nothing then look at the values next to the PPE and people population indicators . . . if there are no numbers then the Sega is working out the next generation . . . If, on the other hand, there are some numbers there . . . press a key giving on the menu!

B) Don't go about killing too many PPE's or you'll have a spokesmonster on your back from the SPCPPE (Society for the Prevention of Cruelty to Purple People Eaters!!!)

```
10 DIMA(125),F(200),S(400):DEFFNR(X)=INT
(RND(8)*X)
-----
20 CLS:PRINTTAB(7);"Ecological modelling
"
30 PRINT
40 INPUT"Enter number of people (1-50) "
;F:IFF>50ORF<1THEN40
50 PRINT:INPUT"& PPE's (1-20) ";S:IFS>20
ORS<1THEN50
60 PRINT:PRINT"Press a key"
70 IFINKEY$=""THEN70
80 CLS
90 GOSUB790
100 FORJ=1TOF
110 R1=FNR(100)+11:IFA(R1)THEN110
120 A(R1)=100:NEXTJ
130 FORJ=1TOS
140 R1=FNR(100)+11:IFA(R1)THEN140
150 A(R1)=3:NEXTJ
160 C=1:GOSUB170:GOTO240
170 I=11:S=0:F=0
180 FORJ=4TO13:FORK=3TO12:CURSORK,J
190 IFA(I)=0THENPRINT " ":GOTO220
200 IFA(I)<100THENPRINT"P":S=S+1
210 IFA(I)=100THENPRINT"M":F=F+1
220 I=I+1:NEXTK,J
230 F(C)=F:S(C)=S:RETURN
```



```

240 A$=INKEY$: IFA$="" THEN240
250 SCREEN 1,1
260 IFA$=" "ANDQ<58THEN310
270 IFA$="H"THEN670
280 IFA$="E"THEN20
290 IFA$="T"THEN590
300 BEEP2:GOTO240
310 CURSOR21,5:PRINT " "":CURSOR22,6:PRIN
T" "
320 FORI=11TO110
330 IFA(I)=100ORA(I)=0THEN440
340 X=INT((A(I-10)+A(I+10)+A(I-1)+A(I+1)
)/100)
350 IFA(I-10)=100THENA(I-10)=0
360 IFA(I+10)=100THENA(I+10)=0
370 IFA(I+1)=100THENA(I+1)=0
380 IFA(I-1)=100THENA(I-1)=0
390 A(I)=A(I)+X-1
400 F=F-X
410 IFA(I)<6THEN440
420 A(I)=3
430 R1=FNR(100)+11:A(R1)=3
440 NEXTI
450 FORI=11TO110
460 IFA(I)=100THENA(I)=0
470 NEXTI
480 F=F+INT(F/2)
490 IFF=0THEN540
500 IFF>100-STHENF=100-S
510 FORJ=1TOF:R1=FNR(100)+11
520 IFA(R1)=0THENA(R1)=100
530 NEXTJ
540 C=C+1:Q=C
550 GOSUB170
560 CURSOR21,3:PRINTC-1:CURSOR20,5:PRINT
S:CURSOR21,6:PRINTF
570 FORI=1TO10:A(I)=0:A(I+110)=0:NEXTI
580 GOTO240
590 CLS:PRINT" PPE vs MAN",,,
600 PRINT" C P M"
610 C=2:F=0
620 PRINTC-1;TAB(6);S(C);TAB(11);F(C)
630 C=C+1
640 IFC>0THENPRINT"End":FORI=0TO400:NEXT
:GOSUB790:C=C-1:GOTO240
650 IFINKEY$="" THEN650
660 GOTO620
670 SCREEN 2,2:CLS:CURSOR90,3:COLOR12:PR
INT"PPE's vs MAN"
680 LINE(20,20)-(20,90),1:LINE(10,80)-(2
54,80):LINE(20,190)-(20,120):LINE(10,180
)-(254,180)
690 CURSOR13,82:PRINT"0":CURSOR13,182:PR
INT"0":CURSOR8,20:PRINT"20":CURSOR8,120:
PRINT"70"
700 COLOR13:CURSOR110,82:PRINT"PPE's":CO
LOR4:CURSOR113,182:PRINT"MAN"
710 FORI=1TOQ
720 IFF(I)>70THENF(I)=70
730 IFS(I)>20THENS(I)=20
740 LINE(20+4*I,79)-(22+4*I,79-(3*S(I)))
,13,BF
750 LINE(20+4*I,179)-(22+4*I,179-(.857*F
(I)),4,BF
760 NEXT
770 COLOR12:CURSOR75,100:PRINT"PRESS. . sp
c,H,T,E"
780 GOTO240
790 CLS:CURSOR2,3:PRINT"!-----!":CU
RSOR15,3:PRINT"Cycle#":FORI=4TO13:CURSOR

```

```

2, I: PRINT " !": NEXT: CURSOR2, 14:
PRINT " !-----!": CURSOR2, 0: PRINT "PPE"
S vs MAN"
800 CURSOR0, 15: PRINT "spc-Next cycle", , "H
-Histogram", , "T-Table of data", , "E-Next
Experiment"
810 CURSOR21, 3: PRINTC-1: CURSOR15, 5: PRINT
"PPE's"; S: CURSOR15, 6: PRINT "People"; F: RET
URN

```

PPE'S vs MAN

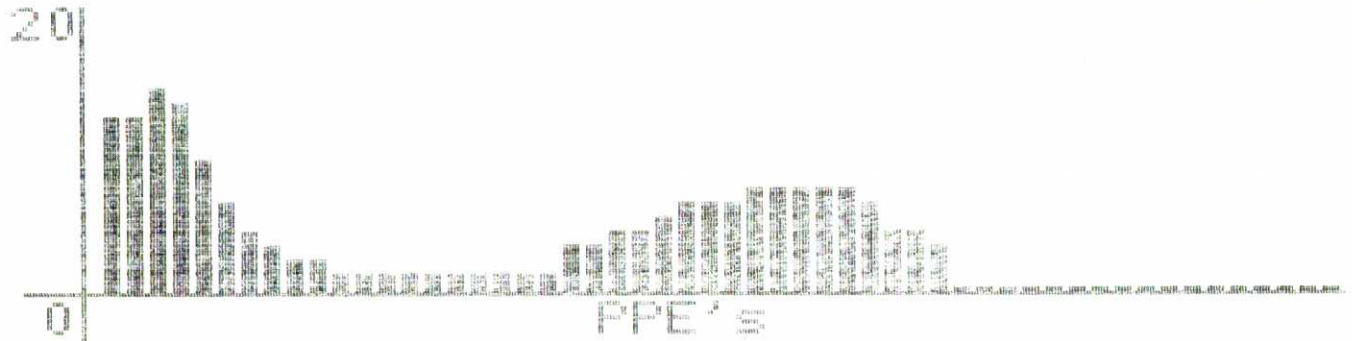

MAN vs PPE'S



An example of the Histogram

THREE GRAPHIC ADVENTURES FROM AUSTRALIA

"CASTLE OF FEAR"

"ORB OF POWER"

"CASTAWAY"



**\$25.95
each**

(Includes Post and Packaging)



**POSEIDON SOFTWARE
C/P.O. 784
HAMILTON**



Name

Address

Enclosed — cheque, postal order

Charge my

No

Expiry Date

Signature



Hypno-Qix

M Howard



The following program is great for those lazy days when you feel like zonking out in front of the computer and having your mind blown!!

As it stands, it is very simple . . . a line will bounce around the screen at great speed and makes lots of nice sounds as it hits the walls . . . to stop it either wait 11 second or press a key at any time.

As the main body of the program is machine code . . . both ROM and Disc versions are given. All the best, just RUN the program and off you go . . .!!

Disc version

```
10 DATA 0,0,0,0,0,0,0,0,0,8,ED,5F,A6,D3,7F,
3E,10,32,FF,FE,1A,ED,44,12,8,C9
20 DATA 3A,FF,FE,FE,20,28,6,D3,7F,3C,32,F
F,FE,2A,4,FO,ED,5B,6,FO,3E,1,6,0,CD,9C,0
,6,4,11,0,FO,21,4,FO,7E,FE,9,DC,8,FO,23,
13,10,F6,6,2,21,5,FO,11,1,FO,7E
30 DATA FE,BA,D4,8,FO,23,23,13,13,10,F4,6
,2,21,4,FO,11,0,FO,7E,FE,F9,D4,8,FO,23,2
3,13,13,10,F4,6,4,21,4,FO,11,0,FO,4E,1A,
81,77,23,13,10,F8,3A,49,AC,FE,10,DO,CD,6
8,1,FE,0,CA,19,FO,C9
40 T=0:FORA=&HFO00TD&HF08C:READA$:V=VAL(
"&h"+A$):POKEA,V:T=T+V:NEXT:IFT<>14066TH
ENPRINT"Error":STOP
50 DEFFNR(X)=INT(RND(8)*X):V=0
60 FORA=&HFO00TD&HF003:POKEA,FNR(6):IFFN
R(10)>5ANDPEEK(A)THENPOKEA,256-PEEK(A)
70 NEXT:X=RND(-1)
80 POKE&HF004,FNR(210)+20:POKE&HF005,FNR
(96)+20:POKE&HF006,FNR(210)+20:POKE&HF00
7,FNR(96)+20
90 S=RND(8)+RND(8):T=110:FORA=0TD10:SOUN
D1,T,15:S=S+S:T=T+S:NEXT:FORA=15TD0STEP-
1:SOUND1,,A:NEXT
100 SCREEN2,2:COLORFNR(14),15,,FNR(15):C
LS:TIME$="00:00:00"
110 CALL&HF019:SOUND0:GOTD60
```

Rom Version

```
10 DATA 0,0,0,0,0,0,0,0,0,8,ED,5F,A6,D3,7F,
3E,10,32,FF,FE,1A,ED,44,12,8,C9
20 DATA 3A,FF,FE,FE,20,28,6,D3,7F,3C,32,F
F,FE,2A,4,FO,ED,5B,6,FO,3E,1,6,0,CD,F1,3
9,6,4,11,0,FO,21,4,FO,7E,FE,9,DC,8,FO,23
,13,10,F6,6,2,21,5,FO,11,1,FO,7E
30 DATA FE,BA,D4,8,FO,23,23,13,13,10,F4,6
,2,21,4,FO,11,0,FO,7E,FE,F9,D4,8,FO,23,2
3,13,13,10,F4,6,4,21,4,FO,11,0,FO,4E,1A,
81,77,23,13,10,F8,3A,8E,94,FE,10,DO,CD,B
6,42,FE,0,CA,19,FO,C9
40 T=0:FORA=&HFO00TD&HF08C:READA$:V=VAL(
"&H"+A$):POKEA,V:T=T+V:NEXT:IFT<>14396TH
ENPRINT"Error":STOP
50 DEFFNR(X)=INT(RND(8)*X)
60 FORA=&HFO00TD&HF003:POKEA,FNR(6):IFFN
R(10)>5ANDPEEK(A)THENPOKEA,256-PEEK(A)
70 NEXT:X=RND(-1)
80 POKE&HF004,FNR(210)+20:POKE&HF005,FNR
(96)+20:POKE&HF006,FNR(210)+20:POKE&HF00
7,FNR(96)+20
90 S=RND(8)+RND(8):T=110:FORA=0TD10:SOUN
D1,T,15:S=S+S:T=T+S:NEXT:FORA=15TD0STEP-
1:SOUND1,,A:NEXT
100 SCREEN2,2:COLORFNR(14),15,,FNR(15):C
LS:TIME$="00:00:00"
110 CALL&HF019:SOUND0:GOTD60
```

Program of the Month

JET RANGER

Danny Van Kan

Do you love to blast away innocent little planes? If so then this great program is for you . . . ! All you do is enter the program EXACTLY as listed . . . that includes the REM's at the start of the program as this is where the machine code is stored. To operate you simply type in RUN, wait a small while then off you go . . . The controls are simple . . . You use a Joystick, left and right and fire . . . simple.

```
10 REM AAAAAAAAAAAAAAAAAAAAAAAAAAAAAAAAAAAAAAAAAA
AAAAAAAAAAAAAAAAAAAAAAAAAAAAAAAAAAAAAAAAAAAAAAAA
AAAAAAAAAAAAAAAAAAAAAAAAAAAAAAAAAAAAAAAAAAAAAAAA
AAAAAAAAAAAAAAAAAAAAAAAAAAAAAAAAAAAAAAAAAAAAAAAA
AAAAAAAAAAAAAAAAAAAAAAAAAAAAAAAAAAAAAAAAAAAAAAAA
AAAAAAAAAAAAAAAAAAAAAAAAAAAAAAAAAAAAAAAAAAAAAAAA
AAAAAAAAAAAAAAAAAAAAAAAAAAAAAAAAAAAAAAAAAAAAAAAA
AAAAAAAAAAAAAAAAAAAAAAAAAAAAAAAAAAAAAAAAAAAAAAAA
AAAAAAAAAAAAAAAAAAAAAAAAAAAAAAAAAAAAAAAAAAAAAAAA
20 REM AAAAAAAAAAAAAAAAAAAAAAAAAAAAAAAAAAAAAAAAAA
AAAAAAAAAAAAAAAAAAAAAAAAAAAAAAAAAAAAAAAAAAAAAAAA
AAAAAAAAAAAAAAAAAAAAAAAAAAAAAAAAAAAAAAAAAAAAAAAA
AAAAAAAAAAAAAAAAAAAAAAAAAAAAAAAAAAAAAAAAAAAAAAAA
AAAAAAAAAAAAAAAAAAAAAAAAAAAAAAAAAAAAAAAAAAAAAAAA
AAAAAAAAAAAAAAAAAAAAAAAAAAAAAAAAAAAAAAAAAAAAAAAA
AAAAAAAAAAAAAAAAAAAAAAAAAAAAAAAAAAAAAAAAAAAAAAAA
AAAAAAAAAAAAAAAAAAAAAAAAAAAAAAAAAAAAAAAAAAAAAAAA
AAAAAAAAAAAAAAAAAAAAAAAAAAAAAAAAAAAAAAAAAAAAAAAA
30 REM AAAAAAAAAAAAAAAAAAAAAAAAAAAAAAAAAAAAAAAAAA
AAAAAAAAAAAAAAAAAAAAAAAAAAAAAAAAAAAAAAAAAAAAAAAA
AAAAAAAAAAAAAAAAAAAAAAAAAAAAAAAAAAAAAAAAAAAAAAAA
AAAAAAAAAAAAAAAAAAAAAAAAAAAAAAAAAAAAAAAAAAAAAAAA
AAAAAAAAAAAAAAAAAAAAAAAAAAAAAAAAAAAAAAAAAAAAAAAA
AAAAAAAAAAAAAAAAAAAAAAAAAAAAAAAAAAAAAAAAAAAAAAAA
AAAAAAAAAAAAAAAAAAAAAAAAAAAAAAAAAAAAAAAAAAAAAAAA
AAAAAAAAAAAAAAAAAAAAAAAAAAAAAAAAAAAAAAAAAAAAAAAA
AAAAAAAAAAAAAAAAAAAAAAAAAAAAAAAAAAAAAAAAAAAAAAAA
40 GOSUB 890
50 DIMA$(6,16)
60 GOTOB00
70 MAG3:SCREEN 2,2:CLS:PRINT CHR$(16):RE
STORE
80 COLOR15,5,(0,0)-(255,191),5
90 PATTERNS# 0,"00000000000040F07E"
100 PATTERNS#02,"000000000000000001F"
110 PATTERNS#04,"0307071F3F3F0F01"
120 PATTERNS#06,"00B0C0C0F0F8FEE0"
130 PATTERNS#8,"0101030204040F3F"
140 PATTERNS#9,"FFFFFFF87030F1F01"
150 PATTERNS#10,"0000B0B04040E0F8"
160 PATTERNS#11,"FEFEFEC280E0F0"
170 COLOR14:CURSOR40,4:PRINT"JET RANGER
by MEGA SOFT"
180 CURSOR100,180:PRINT "SCORE : 0"
190 COLOR10,4,(35,0)-(190,14)
200 COLOR10,4,(95,176)-(190,191)
210 LINE (32,0)-(190,14),10,B
220 LINE (88,176)-(190,191),10,B
230 SC=0
240 PATTERN#48,"709898ABC8C8C870"
250 PATTERNS#32,"2430B4221B0F1FBF"
260 PATTERNS#33,"1F172541900101"
270 PATTERNS#34,"8000C4B4D1E0F0FB"
280 PATTERNS#35,"E09008000201"
290 PATTERNS#28,"f f80B080B0B0B0B0B0"
300 PATTERNS#29,"8080B080B080ff"
310 PATTERNS#30,"c040404040404040"
```

```

320 PATTERNS#31, "4040404040c0"
330 PATTERN#39, "000000000000000000"
340 PATTERNS#16, "070C3F3360C1C0C0"
350 PATTERNS#17, "643D"
360 PATTERNS#18, "FB64268501C14593"
370 PATTERNS#19, "CCB0"
380 PATTERNS#13, "40e0e04040e0a0"
390 PATTERNS#15, "20707020207050"
400 PATTERNS#20, "0003000C1F3E3F3F"
410 PATTERNS#21, "1B"
420 PATTERNS#22, "0098DBFAFE3EBA6C"
430 PATTERNS#23, "30"
440 FOR I=5 TO 11 STEP 2
450 A=INT(RND(1)*254)+1:B=INT(RND(1)*254)
460 SPRITEI,(A,B),16,14
470 SPRITEI+1,(A,B),20,15
480 NEXT
490 FOR I=15 TO 29 STEP 2
500 A=INT(RND(1)*254)+1:B=INT(RND(1)*254)
510 SPRITEI,(A,B),16,14
520 SPRITEI+1,(A,B),20,15
530 NEXT
540 SPRITE0,(120,158),8,1
550 SPRITE1,(INT(RND(1)*255),0),8,1
560 SPRITE2,(120,191),12,10
570 POKE&H9A08,0
580 POKE&H9A0A,0
590 OUT127,228
600 OUT127,245
610 CALL&H984F
620 IF PEEK(&H9A0A)=&H35 THEN 750
630 GOTO 640
640 POKE&H9A08,0
650 VPOKE&H3B08,191:VPOKE&H3B09,VPEEK(&H3B01)
660 IFVPEEK(&H3B04)>150THEN610
670 SC=SC+25:CURSOR140,180:PRINTCHR$(5):CURSOR140,180:PRINTSC
680 VPOKE&H3B06,32:FORI=0TO3:VPOKE&H3B07,6:VPOKE&H3B07,10:NEXT
690 GOSUB730
700 VPOKE&H3B06,16:VPOKE&H3B07,14
710 SPRITE1,(INT(RND(1)*255),192),8,1
720 GOTO 590
730 OUT127,228:FORA=240TO255:OUT127,A:FORI=0TO8:NEXT:NEXT:RETURN
740 N=127:OUTN,159:OUTN,191:OUTN,223:OUTN,255:OUTN,231:OUTN,240:FORB=0TO15:FORA=192 TO 207:OUTN,A:OUTN,B:OUTN,240+B:NEXT:NEXT:RETURN
750 COLOR15,1,(75,96)-(190,109)
760 LINE (72,95)-(192,110),10,B
770 PRINT CHR$(17):COLOR15:CURSOR80,100:PRINT"GAME OVER"
780 OUT127,&H0F
790 FOR I=0 TO 500:NEXT :VPOKE&H3B00,208:FORI=0TO999:NEXT
800 SCREEN 1,1:CLS
810 COLOR4,15
820 CURSOR 5,6 :PRINT"Type in the skill level":PRINT
830 PRINT :PRINT "          *1é Easy"
840 PRINT :PRINT "          *2é Impossible"
850 PRINT :INPUT A
860 IF A=1 THEN POKE&H9AC0,0:POKE&H9AC1,0:POKE&H9AC2,0:GOTO 70
870 IF A=2 THEN POKE&H9AC0,&HCD:POKE&H9AC1,&H0D:POKE&H9AC2,&H98:GOTO 70

```

```

880 GOTO 850
890 RESTORE 930:FOR I=&H9808 TO &H98FA:R
EAD A:POKEI,A:NEXTI
900 RESTORE 980:FOR I=&H9908 TO &H99E3:R
EAD A:POKEI,A:NEXT
910 RESTORE 1030:FOR I=&H9A60 TO &H9AD5:
READ A:POKEI,A:NEXT
920 RETURN
930 DATA &H0,&H0,&H8C,&H3B,&HEE,&HF3,&H3
E,&H1,&H32,&H8,&H98,&H3E,&H20,&H32,&H9,&
H98,&H21,&HC,&H3B,&H22,&HA,&H98,&H2A,&HA
,&H98,&HCD,&H32,&H2C,&HDB,&HBE,&H3C,&H32
,&HC,&H98,&H2A,&HA,&H98,&HCD,&H44,&H2C,&
H3A,&HC,&H98,&HD3,&HBE,&H21,&HA,&H98
940 DATA &H34,&H34,&H34,&H34,&H2B,&H35,&
H20,&HDE,&H2B,&H35,&HFB,&HCB,&HE,&H1,&H6
,&H1,&H10,&HFE,&HD,&H20,&HF9,&H18,&HC4,&
H0,&H0,&H0,&H3E,&H3C,&H32,&H26,&H98,&H3E
,&HC,&H32,&H19,&H98,&H3E,&HA,&H32,&H14,&
H98,&HCD,&HD,&H98,&H3E,&H16,&H32,&H14
950 DATA &H98,&HCD,&HD,&H98,&H3E,&H20,&H
32,&H14,&H98,&HCD,&HD,&H98,&HF3,&H21,&H4
,&H3B,&HCD,&H32,&H2C,&HDB,&HBE,&HD6,&HCO
,&HC2,&H8E,&H98,&H21,&H5,&H3B,&HC3,&H90,
&H9A,&HED,&H5F,&HCB,&H27,&HD3,&HBE,&HFB,
&HC3,&H8F,&H99,&H26,&H98,&H3E,&H4,&H32,&
H19
960 DATA &H98,&H3E,&H1,&H3A,&H8,&H9A,&HD
6,&H1,&HC2,&H8,&H99,&H0,&H0,&H0,&H0,&HC3
,&HA5,&H99,&H3B,&HCD,&H32,&H2C,&HC6,&H6,
&H32,&H9,&H9A,&H21,&H8,&H3B,&HCD,&H32,&H
2C,&HDB,&HBE,&H47,&H3A,&H9,&H9A,&H90,&HF
B,&HC2,&HE6,&H98,&HF3,&H21,&HC,&H3B
970 DATA&HCD,&H44,&H2C,&H3E,&HD1,&HD3,&H
BE,&HC3,&H60,&H9A,&HEF,&HEE,&H20,&HCB,&H
21,&H8,&H3B,&HCD,&H44,&H2C,&H3E,&HCO,&HD
3,&HBE,&H3E,&H0,&H32,&H8,&H9A,&HFB,&H3E,
&H3D,&H32,&H26,&H98,&H3E,&H8,&H32,&H19,&
H98,&H3E,&H1,&H32,&H14,&H98,&HCD,&HD,&H9
8,&HC3,B,&H99
980 DATA &HCD,&H18,&H49,&H3A,&H61,&H94,&
HD6,&H10,&HCC,&H2A,&H99,&H3A,&H65,&H94,&
HD6,&H20,&HCC,&H50,&H99,&H3A,&H66,&H94,&
HD6,&H20,&HCC,&H65,&H99,&HC3,&H52,&H98,&
H0,&H0,&H3A,&H8,&H99,&HD6,&H1,&HCB,&H3E,
&H1,&H32,&H8,&H9A,&HF3,&H21,&H1,&H3B,&HC
D
990 DATA &H32,&H2C,&HDB,&HBE,&HC6,&H3,&H
21,&H9,&H3B,&HCD,&H44,&H2C,&HD3,&HBE,&HF
B,&HC9,&H0,&H0,&H0,&H0,&H0,&H0,&H0,&H0,&
H3E,&H3D,&H32,&H26,&H98,&H3E,&H1,&H32,&H
19,&H98,&H3E,&H1,&H32,&H14,&H98,&HCD,&HD
,&H98,&HC9,&H0,&H0,&H3E,&H3C,&H32
1000 DATA &H26,&H98,&H3E,&H1,&H32,&H19,&
H98,&H3E,&H1,&H32,&H14,&H98,&HCD,&HD,&H9
8,&HC9,&H6,&HFF,&HDB,&HBF,&HE6,&HEF,&HEE
,&H20,&HCB,&H10,&HF7,&HC3,&HD6,&H98,&H41
,&H41,&H41,&H41,&H41,&H41,&H41,&H41,
&H3E,&H3C,&H32,&H26,&H98,&H3E,&H4,&H32,
&H19
1010 DATA &H98,&H3E,&H1,&H32,&H14,&H98,&
HCD,&HD,&H98,&HC3,&HCO,&H9A,&H41,&HF3,&H
21,&H4,&H3B,&HCD,&H32,&H2C,&HDB,&HBE,&H0
,&H32,&H9,&H9A,&H21,&H8,&H3B,&HCD,&H32,&
H2C,&HDB,&HBE,&H47,&H3A,&H9,&H9A,&H90,&H
FB,&HCA,&HC4,&H98,&HF3,&H21,&H4,&H3B,&HC
D
1020 DATA &H32,&H2C,&HDB,&HBE,&H3D,&H32,
&H9,&H9A,&H21,&H8,&H3B,&HCD,&H32,&H2C,&H
DB,&HBE,&H47,&H3A,&H9,&H9A,&H90,&HFB,&HC

```



```

2, &HE6, &H98, &HC3, &HC4, &H98
1030 DATA &HF3, &H21, &H5, &H3B, &HCD, &H32, &
H2C, &HCD, &HDO, &H9A, &H21, &H9, &H3B, &HCD, &H
32, &H2C, &HDB, &HBE, &H90, &HF2, &H79, &H9A, &H
C3, &HD6, &H98, &HD6, &H34, &HO, &HFA, &HBO, &H9
A, &H98, &H41, &H41, &H41, &H41, &H41, &H41, &H4
1, &H41, &H41, &H41, &H41, &H41, &H41, &H41, &H4
1, &H41
1040 DATA &HCD, &H44, &H2C, &HED, &H5F, &HCB,
&H27, &HD3, &HBE, &H3A, &HA, &H9A, &H3C, &H32, &
HA, &H9A, &HD6, &H35, &HCB, &HC3, &HBE, &H98, &H
41, &H41, &H41, &H41, &H41, &H41, &H41, &H41, &H
41, &H41, &H3A, &HB, &H9A, &H3C, &H32, &HB, &H9A
, &HC9, &HD6, &H98, &H41, &H41, &H41, &H41, &H41
, &H41
1050 DATA &HCD, &HD, &H98, &HC3, &H9B, &H98, &
H41, &H41, &H41, &H41, &H41, &H41, &H41, &H41, &
H41, &H41, &HDB, &HBE, &HD6, &H1A, &H47, &HC9

```

★ ★ ★ Flashing lights ★ ★ ★

The following piece of code is another one of those stupid programs that I tend to write when I'm bored!!

All it does is flash 8 big sprites on the screen in time to some data you are feeding in through the cassette port, the data fed in may be music if you want a disco light effect!!

Here is how to use it. Firstly enter the program as it stands, (don't forget if you have a Disc Drive to use the second lot of data), now feed in your data into the

cassette IN port. If you have a SP-400 printer plotter connected then switch it OFF!! Now RUN the program, and after a short delay you'll see the sprites all flashing in time with the music or data (when you turn the cassette on of course!!) . . . Voila!

Note . . . you can alter the position of the sprites to wherever you like, because they are positioned in BASIC by lines 20-80.

Hope you like it!!

```

10 DATA 2, 4, 6, 7, A, 8, D, C, 6, 8, E, 0, DB, DD, FE,
FF, 20, 2, CB, C1, CB, 21, 11, 0, 4, 1B, 7A, B3, 20, F
B, 10, EC, DB, DD, FE, FF, 20, 2, CB, C1, C5, 6, 8, 78
, E, 0, CD, 98, 42, 10, FB, C1, 6, 8, 21, FF, EF, CB, 4
1, 23, C5, 20, 6, 7E, 4F, 78, CD, 98, 42, C1, CB, 39,
10, EF, 11, 0, 4, 1B, 7A, B3, 20, FB, C3, 8, FO
20 FORA=&HFOOOTD&HF054: READA$: POKEA, VAL (
"&h"+A$): NEXT
30 SCREEN 2, 2: COLOR 1, 1, 1: CLS: MAG 3
40 PATTERNS#0, "7FFFFFFFFFFFFFFFFFFFFF"
50 PATTERNS#1, "FFFFFFFFFFFFFFFFFFFF7F"
60 PATTERNS#2, "FEFFFFFFFFFFFFFFFFFFFF"
70 PATTERNS#3, "FFFFFFFFFFFFFFFFFFFFE"
80 X=1: FORA=1 TO 2: FORB=1 TO 4: SPRITEX, (45*B
, A*50), 0, 0: X=X+1: NEXT B, A
90 CALL &HFOOB

```

Disc Modifications

```

10 DATA 2, 4, 6, 7, A, 8, D, C, 6, 8, E, 0, DB, DD, FE,
FF, 20, 2, CB, C1, CB, 21, 11, 0, 4, 1B, 7A, B3, 20, F
B, 10, EC, DB, DD, FE, FF, 20, 2, CB, C1, C5, 6, 8, 78
, E, 0, CD, AE, 0, 10, FB, C1, 6, 8, 21, FF, EF, CB, 41
, 23, C5, 20, 6, 7E, 4F, 78, CD, AE, 0, C1, CB, 39, 10
, EF, 11, 0, 4, 1B, 7A, B3, 20, FB, C3, 8, FO

```



Machine Code Routines

Once again, here is the next exciting instalment in the "Machine Code for those who want to know" series. This time around I'll give you a whole host of Machine Code routines. They are all fairly self explanatory and should pose no real problem to those amongst you who wish to get into machine code.

Note that the only version you need be interested in are the ROM:PAL ver 1.0 and the Disk ver 1.0p. Note the latter is for those with the SF-7000 disc drive.

Also note that Michael Howard is working on a really easy to understand book on machine code for the Sega, and this will be available shortly. So keep your eyes peeled and watch this space!

Text screen display

(Common to all ROM and Disk versions)

- (1) NAME OF LABEL: DSPTX
- (2) ENTRY POINT: 39E5H (ROM:JAP ver 1.1)
39E5H (ROM:USA ver 1.0a)
39E5H (ROM:PAL ver 1.0)
0084H (Disk ver 1.0p)
0084H (Disk ver 1.0j)

(3) PURPOSE OF THIS PROGRAM:

To display the text screen.

- (4) INPUT DATA: None
- (5) OUTPUT DATA: None
- (6) CALLING SEQUENCE:
Called by CALL instruction
- (7) REGISTER
CHANGES: None
- (8) FLAG CHANGES: None

Graphics screen display

(Common to all ROM and Disk versions)

- (1) NAME OF LABEL: DSPGRP
- (2) ENTRY POINT: 39E2H (ROM:JAP ver 1.1)
39E2H (ROM:USA ver 1.0a)
39E2H (ROM:PAL ver 1.0)
0087H (Disk ver 1.0p)
0087H (Disk ver 1.0j)

(3) PURPOSE OF THIS PROGRAM:

To display the graphics display.

- (4) INPUT DATA: None
- (5) OUTPUT DATA: None
- (6) CALLING SEQUENCE:
Called by CALL instruction
- (7) REGISTER
CHANGES: None
- (8) FLAG CHANGES: None

Text screen back colour set

(Common to all ROM and Disk versions)

- (1) NAME OF LABEL: TXTBCL
- (2) ENTRY POINT: 39D0H (ROM:JAP ver 1.1)
39D0H (ROM:USA ver 1.0a)
39D0H (ROM:PAL ver 1.0)
008AH (Disk ver 1.0p)
008AH (Disk ver 1.0j)

(3) PURPOSE OF THIS PROGRAM:

To set a back colour of the text screen.

- (4) INPUT DATA: A = Colour code (0 - 15)
- (5) OUTPUT DATA: None
- (6) CALLING SEQUENCE:
Called by CALL instruction
- (7) REGISTER
CHANGES: None
- (8) FLAG CHANGES: None

Text screen character colour set

(Common to all ROM and Disk versions)

- (1) NAME OF LABEL: TXTCCL
- (2) ENTRY POINT: 39D3H (ROM:JAP ver 1.1)
39D3H (ROM:USA ver 1.0a)
39D3H (ROM:PAL ver 1.0)
008DH (Disk ver 1.0p)
008DH (Disk ver 1.0j)

(3) PURPOSE OF THIS PROGRAM:

To set a character colour of the text screen.

- (4) INPUT DATA: A = Colour code (0 - 15)
- (5) OUTPUT DATA: None
- (6) CALLING SEQUENCE:
Called by CALL instruction
- (7) REGISTER
CHANGES: None
- (8) FLAG CHANGES: None

Graphics screen "0" colour set

(Common to all ROM and Disk versions)

- (1) NAME OF LABEL: GRPCCB
- (2) ENTRY POINT: 39D6H (ROM:JAP ver 1.1)
39D6H (ROM:USA ver 1.0a)
39D6H (ROM:PAL ver 1.0)
0090H (Disk ver 1.0p)
0090H (Disk ver 1.0j)

(3) PURPOSE OF THIS PROGRAM:

To set a back ("0") colour of the graphics screen.

- (4) INPUT DATA: A = Colour code (0 - 15)
- (5) OUTPUT DATA: None
- (6) CALLING SEQUENCE:
Called by CALL instruction
- (7) REGISTER
CHANGES: None
- (8) FLAG CHANGES: None

Graphics screen "1" colour set

(Common to all ROM and Disk versions)

- (1) NAME OF LABEL: GRPCCL
 - (2) ENTRY POINT: 39D9H (ROM:JAP ver 1.1)
39D9H (ROM:USA ver 1.0a)
39D9H (ROM:PAL ver 1.0)
0093H (Disk ver 1.0p)
0093H (Disk ver 1.0j)
 - (3) PURPOSE OF THIS PROGRAM:
To set the colour of character, dots or lines ("1") of the graphics screen.
 - (4) INPUT DATA: A = Colour code (0 - 15)
 - (5) OUTPUT DATA: None
 - (6) CALLING SEQUENCE:
Called by CALL instruction
 - (7) REGISTER
CHANGES: None
 - (8) FLAG CHANGES: None
-

Text screen scroll

(Common to all ROM and Disk versions)

- (1) NAME OF LABEL: SCRTXT
- (2) ENTRY POINT: 39F4H (ROM:JAP ver 1.1)
39F4H (ROM:USA ver 1.0a)
39F4H (ROM:PAL ver 1.0)
0096H (Disk ver 1.0p)
0096H (Disk ver 1.0j)
- (3) PURPOSE OF THIS PROGRAM:
To scroll a specified block of the text screen up by one line.
- (4) INPUT DATA:
A = Upper limit of block to be scrolled
L = Lower limit of block to be scrolled

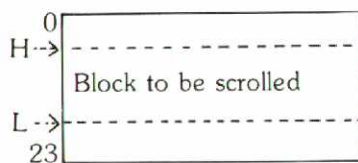

- (5) OUTPUT DATA: None
 - (6) CALLING SEQUENCE:
Called by CALL instruction
 - (7) REGISTER
CHANGES: None
 - (8) FLAG CHANGES: None
-

Dot plot in graphics screen

(Common to all ROM and Disk versions)

- (1) NAME OF LABEL: PLOTPT
- (2) ENTRY POINT: 39EEH (ROM:JAP ver 1.1)
39EEH (ROM:USA ver 1.0a)
39EEH (ROM:PAL ver 1.0)
0099H (Disk ver 1.0p)
0099H (Disk ver 1.0j)
- (3) PURPOSE OF THIS PROGRAM:
To plot or erase a dot in the graphics screen.
- (4) INPUT DATA:
D = Y (vertical) coordinate (0 - 191)
E = X (horizontal) coordinate (0 - 255)
A = (0:Erase)
(1:Plot)

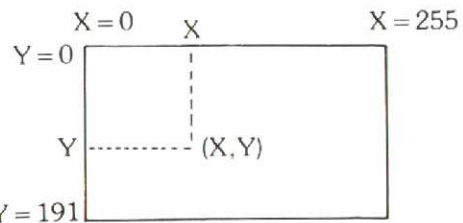

- (5) OUTPUT DATA: None
 - (6) CALLING SEQUENCE:
Called by CALL instruction
 - (7) REGISTER
CHANGES: None
 - (8) FLAG CHANGES: None
-

Line draw/erase in graphics screen

(Common to all ROM and Disk versions)

- (1) NAME OF LABEL: PLOTLN
- (2) ENTRY POINT: 39FIH (ROM:JAP ver 1.1)
39FIH (ROM:USA ver 1.0a)
39FIH (ROM:PAL ver 1.0)
009CH (Disk ver 1.0p)
009CH (Disk ver 1.0j)
- (3) PURPOSE OF THIS PROGRAM:
To draw or erase a line in the graphics screen.
- (4) INPUT DATA:
D = Start Y (vertical) coordinate 0 - 191
E = Start X (horizontal) coordinate 0 - 255
H = End Y (vertical) coordinate 0 - 191
L = End X (horizontal) coordinate 0 - 255
A = (= 0:Erase)
(< > 0:Draw)
B = Mode (= 0:Dot connection)
(< > 0:Side connection)

(Dot connection)

Used when drawing a line with the LINE statement.

(Side connection)

Used when painting the enclosed region with the BF specification in the CIRCLE or BCIRCLE statement.

- (5) OUTPUT DATA: None
 - (6) CALLING SEQUENCE: Called by CALL instruction
 - (7) REGISTER CHANGES: None
 - (8) FLAG CHANGES: None
-

Sprite colour set

(Common to all ROM and Disk versions)

- (1) NAME OF LABEL: SSPRCL
- (2) ENTRY POINT: 42D8H (ROM:JAP ver 1.1)
42D8H (ROM:USA ver 1.0a)
42D8H (ROM:PAL ver 1.0)
00AEH (Disk ver 1.0p)
00AEH (Disk ver 1.0j)
- (3) PURPOSE OF THIS PROGRAM:
To set a sprite colour for a specified surface.
- (4) INPUT DATA:
A = Plane No. (0 - 31)
C = Colour code (0 - 15)
- (5) OUTPUT DATA: None
- (6) CALLING SEQUENCE:
Called by CALL instruction

(7) REGISTER

CHANGES: None

(8) FLAG CHANGES: None

Sprite name set

(Common to all ROM and Disk versions)

- (1) NAME OF LABEL: SSPRNA
- (2) ENTRY POINT: 42D5H (ROM:JAP ver 1.1)
42D5H (ROM:USA ver 1.0a)
4295H (ROM:PAL ver 1.0)
00BIH (Disk ver 1.0p)
00BIH (Disk ver 1.0j)
- (3) PURPOSE OF THIS PROGRAM:
To set a sprite name for a specified surface.
- (4) INPUT DATA: A = Plane No. (0 - 31)
C = Sprite name (0 - 255)
- (5) OUTPUT DATA: None
- (6) CALLING SEQUENCE:
Called by CALL instruction
- (7) REGISTER
CHANGES: None
- (8) FLAG CHANGES: None

Sprite position set

(Common to all ROM and Disk versions)

- (1) NAME OF LABEL: SSPRPS
- (2) ENTRY POINT: 42D2H (ROM:JAP ver 1.1)
42D2H (ROM:USA ver 1.0a)
42D2H (ROM:PAL ver 1.0)
00B4H (Disk ver 1.0p)
00B4H (Disk ver 1.0j)
- (3) PURPOSE OF THIS PROGRAM:
To set a character colour of the text screen.
- (4) INPUT DATA: A = Plane No. (0 - 31)
D = Y (vertical) position 0 - 191
E = X (horizontal) position 0 - 255
- (5) OUTPUT DATA: None
- (6) CALLING SEQUENCE:
Called by CALL instruction
- (7) REGISTER
CHANGES: None
- (8) FLAG CHANGES: None

Text screen clear

(Common to all ROM and Disk versions)

- (1) NAME OF LABEL: TXTCLR
- (2) ENTRY POINT: 430BH (ROM:JAP ver 1.1)
430BH (ROM:USA ver 1.0a)
430BH (ROM:PAL ver 1.0)
00BAH (Disk ver 1.0p)
00BAH (Disk ver 1.0j)
- (3) PURPOSE OF THIS PROGRAM:
To clear the text screen.
- (4) INPUT DATA: None
- (5) OUTPUT DATA: None
- (6) CALLING SEQUENCE:
Called by CALL instruction
- (7) REGISTER
CHANGES: None
- (8) FLAG CHANGES: None

Graphics screen 8-bit plot

(Common to all ROM and Disk versions)

- (1) NAME OF LABEL: PLOTB8
- (2) ENTRY POINT: 4A27H (ROM:JAP ver 1.1)
4A27H (ROM:USA ver 1.0a)
4A27H (ROM:PAL ver 1.0)
00EDH (Disk ver 1.0p)
00EDH (Disk ver 1.0j)
- (3) PURPOSE OF THIS PROGRAM:
To plot a 1-byte (8-bit) pattern in the graphics screen.
- (4) INPUT DATA: D = Y (vertical) position 0 - 191
E = X (horizontal) position 0 - 255
A = Pattern



(When A is 31H)
- (5) OUTPUT DATA: None
- (6) CALLING SEQUENCE:
Called by CALL instruction
- (7) REGISTER
CHANGES: None
- (8) FLAG CHANGES: None

Graphics screen character plot

(Common to all ROM and Disk versions)

- (1) NAME OF LABEL: PLOTCH
- (2) ENTRY POINT: 4A2DH (ROM:JAP ver 1.1)
4A2DH (ROM:USA ver 1.0a)
4A2DH (ROM:PAL ver 1.0)
00F3H (Disk ver 1.0p)
00F3H (Disk ver 1.0j)
- (3) PURPOSE OF THIS PROGRAM:
To plot a character pattern in the graphics screen.
- (4) INPUT DATA: D = Y (vertical) coordinate 0 - 191
E = X (horizontal) coordinate 0 - 255
A = Character code
- (5) OUTPUT DATA: None
- (6) CALLING SEQUENCE:
Called by CALL instruction
- (7) REGISTER
CHANGES: None
- (8) FLAG CHANGES: None

Graphics screen character size set

(Common to all ROM and Disk versions)

- (1) NAME OF LABEL: GRPCSZ
- (2) ENTRY POINT: 4A30H (ROM:JAP ver 1.1)
4A30H (ROM:USA ver 1.0a)
4A30H (ROM:PAL ver 1.0)
00F6H (Disk ver 1.0p)
00F6H (Disk ver 1.0j)
- (3) PURPOSE OF THIS PROGRAM:
To set a size of character to be displayed in the graphics screen.
- (4) INPUT DATA: A = (0:Standard size)

(1:Double size)

- (5) OUTPUT DATA: None
 - (6) CALLING SEQUENCE:
Called by CALL instruction
 - (7) REGISTER
CHANGES: None
 - (8) FLAG CHANGES: None
-

Graphics screen cursor position read

(Common to all ROM and Disk versions)

- (1) NAME OF LABEL: GRPCRD
- (2) ENTRY POINT:
4A33H (ROM:JAP ver 1.1)
4A33H (ROM:USA ver 1.0a)
4A33H (ROM:PAL ver 1.0)
00F9H (Disk ver 1.0p)
00F9H (Disk ver 1.0j)

- (3) PURPOSE OF THIS PROGRAM:
To read the current cursor position in the graphics screen.

- (4) INPUT DATA: None
- (5) OUTPUT DATA:

A = Y (vertical) position 0 — 191
E = X (horizontal) position 0 — 255

- (6) CALLING SEQUENCE:
Called by CALL instruction
 - (7) REGISTER
CHANGES: D, E
 - (8) FLAG CHANGES: None
-

Graphics screen cursor position set

(Common to all ROM and Disk versions)

- (1) NAME OF LABEL: CRPCWT
- (2) ENTRY POINT:
4A36H (ROM:JAP ver 1.1)
4A36H (ROM:USA ver 1.0a)
4A36H (ROM:PAL ver 1.0)
00FCH (Disk ver 1.0p)
00FCH (Disk ver 1.0j)

- (3) PURPOSE OF THIS PROGRAM:
To set a cursor position in the graphics screen.

- (4) INPUT DATA:
A = Y (vertical) position 0 — 191
E = X (horizontal) position 0 — 255
 - (5) OUTPUT DATA: None
 - (6) CALLING SEQUENCE:
Called by CALL instruction
 - (7) REGISTER
CHANGES: None
 - (8) FLAG CHANGES: None
-

Graphics screen back-colour set

(Common to all ROM and Disk versions)

- (1) NAME OF LABEL: GRPBCL
- (2) ENTRY POINT:
4A3FH (ROM:JAP ver 1.1)
4A3FH (ROM:USA ver 1.0a)
4A34H (ROM:PAL ver 1.0)
0105H (Disk ver 1.0p)
0105H (Disk ver 1.0j)

- (3) PURPOSE OF THIS PROGRAM:
To set a black colour for a specified block of graphics screen.

- (4) INPUT DATA:
A = Colour code
D = Vertical position of upper-left corner 0 — 191
E = Horizontal position of upper-left corner 0 — 255
H = Vertical position of lower-right corner 0 — 191
L = Horizontal position of lower-right corner 0 — 255

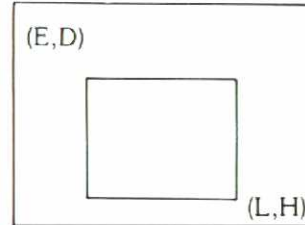

- (5) OUTPUT DATA: None
 - (6) CALLING SEQUENCE: Called by CALL instruction
 - (7) REGISTER CHANGES: None
 - (8) FLAG CHANGES: None
-

Graphics screen clear

(Common to all ROM and Disk versions)

- (1) NAME OF LABEL: GRPCLR
- (2) ENTRY POINT:
4A42H (ROM:JAP ver 1.1)
4A42H (ROM:USA ver 1.0a)
4A42H (ROM:PAL ver 1.0)
0108H (Disk ver 1.0p)
0108H (Disk ver 1.0j)

- (3) PURPOSE OF THIS PROGRAM:
To clear the graphics screen.

- (4) INPUT DATA: None
 - (5) OUTPUT DATA: None
 - (6) CALLING SEQUENCE:
Called by CALL instruction
 - (7) REGISTER
CHANGES: None
 - (8) FLAG CHANGES: None
-

Graphics screen block erase/paint

(Common to all ROM and Disk versions)

- (1) NAME OF LABEL: GRPERS (Block erase)
GRPBFS (Block paint)
- (2) ENTRY POINT:
(GRPERS) 4A4BH (ROM:JAP ver 1.1)
4A4BH (ROM:USA ver 1.0a)
4A4BH (ROM:PAL ver 1.0)
010EH (Disk ver 1.0p)
010EH (Disk ver 1.0j)

- (GRPBFs) 4A96H (ROM:JAP ver 1.1)
4A96H (ROM:USA ver 1.0a)
4A96H (ROM:PAL ver 1.0)
4E72H (Disk ver 1.0p)
4A72H (Disk ver 1.0j)

- (3) PURPOSE OF THIS PROGRAM:
To erase or paint a block of graphics screen.

- (4) INPUT DATA:
D = Vertical position of upper-left corner 0 — 191
E = Horizontal position of lower-right corner 0 — 191
H = Vertical position of lower-right corner 0 — 191
L = Horizontal position of lower-right corner 0 — 255

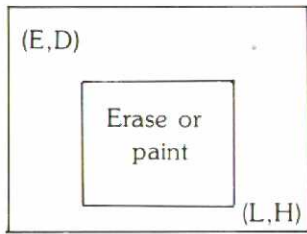

- (5) OUTPUT DATA: None
 (6) CALLING SEQUENCE:
 Called by CALL instruction
 (7) REGISTER
 CHANGES: None
 (8) FLAG CHANGES: None

Graphics screen back drop colour set
 (Common to all ROM and Disk versions)

- (1) NAME OF LABEL: GRPDCL
 (2) ENTRY POINT: 4A4EH (ROM:JAP ver 1.1)
 4A4EH (ROM:USA ver 1.0a)
 4A4EH (ROM:PAL ver 1.0)
 0111H (Disk ver 1.0p)
 0111H (Disk ver 1.0j)
 (3) PURPOSE OF THIS PROGRAM:
 In the graphics screen, to set a colour of back drop.
 (4) INPUT DATA: A = Colour code
 (5) OUTPUT DATA: None
 (6) CALLING SEQUENCE: Called by CALL instruction
 (7) REGISTER CHANGES: None
 (8) FLAG CHANGES: None

Graphics screen point read
 (Common to all ROM and Disk versions)

- (1) NAME OF LABEL: READPT
 (2) ENTRY POINT: 4A5IH (ROM:JAP ver 1.1)
 4A5IH (ROM:USA ver 1.0a)
 4A5IH (ROM:PAL ver 1.0)
 0114H (Disk ver 1.0p)
 0114H (Disk ver 1.0j)
 (3) PURPOSE OF THIS PROGRAM:
 To read the pattern generator table for a specified point
 in the graphics screen.
 (4) INPUT DATA:
 D = Vertical position 0 — 191
 E = Horizontal position 0 — 255
 (5) OUTPUT DATA: A = (0:bit "0")
 (1:bit "1")
 (6) CALLING SEQUENCE:
 Called by CALL instruction
 (7) REGISTER
 CHANGES: None
 (8) FLAG CHANGES: None

Listout
 (Common to all ROM and Disk versions)

- (1) NAME OF LABEL: PUTLST
 (2) ENTRY POINT: 4A8AH (ROM:JAP ver 1.1)
 4A8AH (ROM:USA ver 1.0a)

4A8AH (ROM:PAL ver 1.0)
 012FH (Disk ver 1.0p)
 012FH (Disk ver 1.0j)

- (3) PURPOSE OF THIS PROGRAM:
 To list out text contents.
 (4) INPUT DATA: DE = Start line No.
 HL = End line No.
 (5) OUTPUT DATA: None
 (6) CALLING SEQUENCE:
 Called by CALL instruction
 (7) REGISTER
 CHANGES: None
 (8) FLAG CHANGES: None

One-character key entry
 (for INKEYS function)
 (Common to all ROM and Disk versions)

- (1) NAME OF LABEL: INKEYS
 (2) ENTRY POINT: 42F6H (ROM:JAP ver 1.1)
 42F6H (ROM:USA ver 1.0a)
 42F6H (ROM:PAL ver 1.0)
 0168H (Disk ver 1.0p)
 0168H (Disk ver 1.0j)
 (3) PURPOSE OF THIS PROGRAM:
 To receive one character of key entry.
 (4) INPUT DATA: None
 (5) OUTPUT DATA:
 A = Character code (00H for no entry)
 (6) CALLING SEQUENCE:
 Called by CALL instruction
 (7) REGISTER
 CHANGES: None
 (8) FLAG CHANGES: None

Beep output
 (Common to all ROM and Disk versions)

- (1) NAME OF LABEL: BEEPOT
 (2) ENTRY POINT: 4A18H (ROM:JAP ver 1.1)
 4A18H (ROM:USA ver 1.0a)
 4A18H (ROM:PAL ver 1.0)
 016BH (Disk ver 1.0p)
 016BH (Disk ver 1.0j)
 (3) PURPOSE OF THIS PROGRAM:
 To output a beep.
 (4) INPUT DATA: A = Control
 (= 0) Turn beep off
 (= 1) Turn 1760-Hz on
 (= 2) Turn 1760-Hz on for
 125 msec, then turn it off
 (= 3) Turn on consecutive
 beeps of 880 Hz, 1760 Hz,
 880 Hz and 1760-Hz, each
 for 62 msec, then turn beep
 off
 (5) OUTPUT DATA: None
 (6) CALLING SEQUENCE:
 Called by CALL instruction
 (7) REGISTER
 CHANGES: None
 (8) FLAG CHANGES: None

One-line key entry

(Common to all ROM Disk versions)

- (1) NAME OF LABEL: INKEYL
 - (2) ENTRY POINT: 4A48H (ROM:JAP ver 1.1)
4A48H (ROM:USA ver 1.0a)
4A48H (ROM:PAL ver 1.0)
016EH (Disk ver 1.0p)^o
016EH (Disk ver 1.0j)
 - (3) PURPOSE OF THIS PROGRAM:
To receive one line of key entry.
 - (4) INPUT DATA: None
 - (5) OUTPUT DATA: [KEYBUF] 256 = Key entry image (oDH for final code)
DE = KEYBUF (beginning address)
 - (6) CALLING SEQUENCE:
Called by CALL instruction
 - (7) REGISTER CHANGES: DE
 - (8) FLAG CHANGES: None
-

Cassette tape input scan

(Common to all ROM and Disk versions)

- (1) NAME OF LABEL: WVSCAN
 - (2) ENTRY POINT: 39FDH (ROM:JAP ver 1.1)
39FDH (ROM:USA ver 1.0a)
39FDH (ROM:PAL ver 1.0)
0171H (Disk ver 1.0p)
0171H (Disk ver 1.0j)
 - (3) PURPOSE OF THIS PROGRAM:
To count the time elapsed until the input waveform from cassette tape changes.
 - (4) INPUT DATA: D = Previous waveform input (MSB)
C = Counter value
 - (5) OUTPUT DATA: D = Current waveform input
C = Counter value
 - (6) CALLING SEQUENCE:
Called by CALL instruction
 - (7) REGISTER CHANGES: A, D, C
 - (8) FLAG CHANGES: All
-

Cassette tape leader field find

(Common to all ROM and Disk versions)

- (1) NAME OF LABEL: LEADSR
- (2) ENTRY POINT: 3A00H (ROM:JAP ver 1.1)
3A00H (ROM:USA ver 1.0a)
3A00H (ROM:PAL ver 1.0)
0174H (Disk ver 1.0p)
0174H (Disk ver 1.0j)
- (3) PURPOSE OF THIS PROGRAM:
To find the leader field recorded on cassette tape. Upon finding it, control returns from this routine.
- (4) INPUT DATA: None
- (5) OUTPUT DATA: None
- (6) CALLING SEQUENCE:
Called by CALL instruction
- (7) REGISTER CHANGES: A
- (8) FLAG CHANGES: All

Cassette tape input/output time delay

(Common to all ROM and Disk versions)

- (1) NAME OF LABEL: CDELAY
 - (2) ENTRY POINT: 3A03H (ROM:JAP ver 1.1)
3A03H (ROM:USA ver 1.0a)
3A03H (ROM:PAL ver 1.0)
0177H (Disk ver 1.0p)
0177H (Disk ver 1.0j)
 - (3) PURPOSE OF THIS PROGRAM:
To delay the time of cassette tape input/output
 - (4) INPUT DATA: C = Delay time
Delay time = $53 + (14^{\circ}\text{C}) \text{ states}$
State = 279.365 nsec
 - (5) OUTPUT DATA: None
 - (6) CALLING SEQUENCE:
Called by CALL instruction
 - (7) REGISTER CHANGES: None
 - (8) FLAG CHANGES: All
-

One byte read from cassette tape

(Common to all ROM and Disk versions)

- (1) NAME OF LABEL: BYTERD
 - (2) ENTRY POINT: 3A06H (ROM:JAP ver 1.1)
3A06H (ROM:USA ver 1.0a)
3A06H (ROM:PAL ver 1.0)
017AH (Disk ver 1.0p)
017AH (Disk ver 1.0j)
 - (3) PURPOSE OF THIS PROGRAM:
To read one byte of data recorded on cassette tape.
 - (4) INPUT DATA: None
 - (5) OUTPUT DATA: A = Read data
 - (6) CALLING SEQUENCE:
Called by CALL instruction
 - (7) REGISTER CHANGES: A
 - (8) FLAG CHANGES: All
-

One bit write to cassette tape

(Common to all ROM and Disk versions)

- (1) NAME OF LABEL: ONE OUT ("1" output)
ZEROUT ("0" output)
- (2) ENTRY POINT: ONEOUT
3A09H (ROM:JAP ver 1.1)
3A09H (ROM:USA ver 1.0a)
3A09H (ROM:PAL ver 1.0)
017DH (Disk ver 1.0p)
017DH (Disk ver 1.0j)
ZEROUT
3A0CH (ROM:JAP ver 1.1)
3A0CH (ROM:USA ver 1.0a)
3A0Ch (ROM:PAL ver 1.0)
0180H (Disk ver 1.0p)
0180H (Disk ver 1.0j)
- (3) PURPOSE OF THIS PROGRAM:
To record one bit on cassette tape.
- (4) INPUT DATA: C = Delay time
- (5) OUTPUT DATA: None
- (6) CALLING SEQUENCE:
Called by CALL instruction
- (7) REGISTER CHANGES: A, C
- (8) FLAG CHANGES: All

Leader field write to cassette tape

(Common to all ROM and Disk versions)

- (1) NAME OF LABEL: LEADWR
- (2) ENTRY POINT: 3A0FH (ROM:JAP ver 1.1)
3A0FH (ROM:USA ver 1.0a)
3A0FH (ROM:PAL ver 1.0)
0183H (Disk ver 1.0p)
0183H (Disk ver 1.0j)
- (3) PURPOSE OF THIS PROGRAM:
To write a leader field onto cassette tape.
- (4) INPUT DATA: None
- (5) OUTPUT DATA: None
- (6) CALLING SEQUENCE:
Called by CALL instruction
- (7) REGISTER CHANGES:None
- (8) FLAG CHANGES: None

One byte write to cassette tape

(Common to all ROM and Disk versions)

- (1) NAME OF LABEL: BYTEWR
- (2) ENTRY POINT: 3A12H (ROM:JAP ver 1.1)
3A12H (ROM:USA ver 1.0a)
3A12H (ROM:PAL ver 1.0)
0186H (Disk ver 1.0p)
0186H (Disk ver 1.0j)
- (3) PURPOSE OF THIS PROGRAM:
To write one byte of data onto cassette tape.
- (4) INPUT DATA: A = Data to be written
C = Delay
- (5) OUTPUT DATA: None

(6) CALLING SEQUENCE:

Called by CALL instruction

(7) REGISTER CHANGES:None

(8) FLAG CHANGES: None

(9) SETTING TIME DELAY PARAMETER C:

The value of parameter C to be inputted is determined as follows:

[For input after call of LEADWR routine]

$$C = (1168 - S1)/14$$

Where S1 denotes the number of statements executed after the LEADWR routine is called, excepting the CALL instruction execute stage.

[For input after call of BYTEWR routine]

$$C = (1203 - S2)/14$$

Where S2 denotes the number of statements executed after the BYTEWR routine is called, excepting the CALL instruction execute state.

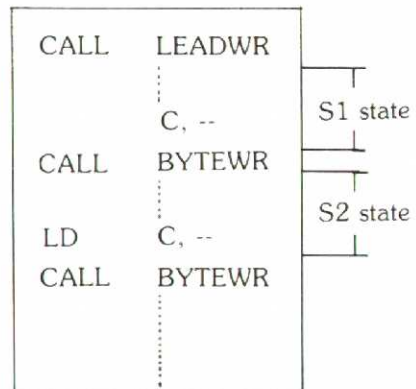

REVIEW

The House!

— disk only

At last, the classic machine code graphic adventure game is available on disc! You take the part of the intrepid adventurer, Sidy Spuerspook, who is out to explore nearly 300 rooms of The House, and hopefully murder Vanessa Ze Vampire in the meantime! But as with many games, this is not as easy as it seems, as Vanessa has many allies, called yes you guessed it, Purple People Eaters! The worst things since mouldy bread, these monsters are quite good at murdering people for no apparent reason! They are just very violent in the extreme!

The object of the game, as already mentioned is to try and get hold of Vanessa Ze Vampire, and hopefully killing her, but this is only possible after you have found a crucifix, and The House has only one!!!

The game is quite complex and is fun to play, and is streaked with a mean sense of humour . . . If you have a disc drive . . . then buy this game!!

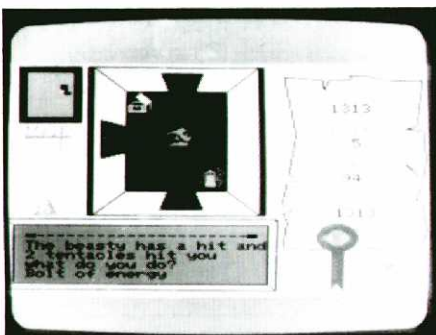

It is available for \$39.95 on disc from:

User Tronics Developments Ltd
P.O. Box 29124
Greenwoods Corner
Epsom
Auckland 3

Please make cheques/MO payable to M. Howard

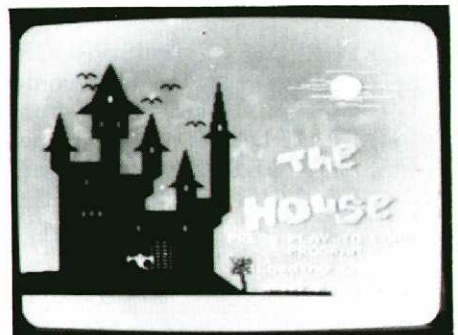

Hill St. Blues the theme music

If, like me, you don't really like Hill St. Blues, but love the music, then this program is for you...

To use it, just type it in and then type RUN . . . and just sit back and listen to the brilliant rendition of the music we all know so well.

```
10 CLS:CURSOR 8,10:PRINT "Hill Street Bl
ues"
20 V=8:M=1
30 FOR I=1 TO 24
40 READ T1,T2,T3,DE
50 SOUND 1,T1,V:SOUND 2,T2,V:SOUND 3,T3,
V:FOR D=1 TO DE:NEXT D
60 NEXT I
70 RESTORE 210
80 FOR I=1 TO 57
90 READ T1,T2,T3,DE
100 SOUND 1,T1,V:SOUND 2,T2,V:SOUND 3,T3
,V:FOR D=1 TO DE:NEXT D
110 NEXT I
120 IF M=2 THEN GOTO 340
130 M=2:GOTO 70
140 DATA 392,466,622,100,349,466,587,50,
392,466,622,160,20000,20000,20000,10
150 DATA 392,466,622,100,349,466,587,50,
392,466,622,160,20000,20000,20000,10
160 DATA 392,466,622,100,349,466,587,50,
392,466,622,120
170 DATA 349,20000,587,120,349,20000,523
,120,349,20000,587,190
180 DATA 196,262,311,80,175,233,294,60,1
56,208,262,200
190 DATA 262,311,392,80,233,294,349,60,2
08,262,311,200
200 DATA 311,392,523,80,294,349,466,60,2
62,311,415,200,208,262,311,200
210 DATA 392,466,622,100,349,466,587,50,
392,466,622,160,20000,20000,20000,10
220 DATA 392,466,622,100,349,466,587,50,
392,466,622,160,20000,20000,20000,10
230 DATA 392,466,622,100,349,466,587,50,
392,466,622,100
240 DATA 349,20000,587,40,349,20000,523,
40,349,20000,587,40
250 DATA 392,466,622,100,349,466,587,50,
392,466,622,160,20000,20000,20000,10
260 DATA 523,622,784,100,20000,20000,698
,50,415,523,622,90,20000,20000,587,50
270 DATA 20000,415,523,40,20000,20000,58
7,40,392,466,622,100,349,466,587,50
280 DATA 392,466,622,200
290 DATA 349,440,523,100,20000,20000,587
,50,349,523,622,100,20000,20000,523,40,2
0000,20000,587,40,20000,20000,622,40
300 DATA 466,622,784,100,20000,20000,698
,40,494,622,784,75,20000,20000,698,40,20
000,20000,622,40,20000,20000,698,40
310 DATA 659,784,1047,100,20000,20000,93
2,50,554,659,880,75,20000,20000,554,10,2
0000,20000,20000,2,20000,20000,554,10,20
000,20000,659,10
320 DATA 20000,20000,784,30,20000,740,88
0,85,20000,659,784,85,20000,587,740,180
330 DATA 196,233,294,80,196,262,311,60,1
```

```

96, 294, 349, 160, 20000, 20000, 20000, 2, 208, 2
62, 311, 80, 208, 311, 392, 60, 208, 294, 349, 160
340 RESTORE 430
350 FOR I=1 TO 4
360 READ T1, T2, T3, DE
370 SOUND 1, T1, V: SOUND 2, T2, V: SOUND 3, T3
, V: FOR D=1 TO DE: NEXT D
380 NEXT I
390 FOR I=8 TO 0 STEP -1
400 SOUND 1, 196, I: SOUND 2, 233, I: SOUND 3,
311, I: FOR D=1 TO 75: NEXT D
410 NEXT I
420 END
430 DATA 196, 233, 311, 100, 175, 233, 294, 60,
196, 233, 311, 140, 175, 233, 294, 60

```



Every once in a while you may wish to sort some data into alphabetical or numerical order. Well that's fine, but the major problem is that many people use a method known as "Bubble Sorting" . . . and the problem with bubble sorting is that it is exceedingly slow. This program called "Quicksort" is just that . . . quick!!! I'm not going to explain how it works because it is quite complex . . . just take it from me . . . it works and works very well!!

NOTES

- 1) Lines 10-70 set up an array of random numbers. Call the routine at line 1000 onwards then print out the sorted array.
- 2) Data in the array starts at location 1 ie; no 0
eg; a(1),a(2),a(3) . . . a(30)
NOT a(0),a(1),a(3) . . . a(30)
- 3) The variable N holds the number of data elements to be sorted in the array. In this case it is set to 30.
- 4) The actual quicksort starts at line 1000.
- 5) The speed of a bubble sort, sorting 50 random numbers is 1 min 16 seconds. The speed of a quicksort, sorting 50 random numbers is 12 seconds!!!!

```

10 DIM A(30)
20 FOR C=1 TO 30:A(C)=INT(RND(B)*1000):N
EXT C
30 N=30:GOSUB 1000
40 FOR C=1 TO 30
50 PRINTA(C)
60 NEXT
70 GOTO 70
1000 M=40:DIMSL(M),SR(M)
1010 S=1:SL(1)=1:SR(1)=N
1020 L=SL(S):R=SR(S):S=S-1
1030 I=L:J=R:X=A(INT((L+R)/2))
1040 IFA(I)<XTHENI=I+1:GOTO1040
1050 IFX<A(J)THENJ=J-1:GOTO1050
1060 IFI>JTHEN1080
1070 W=A(I):A(I)=A(J):A(J)=W:I=I+1:J=J-1
1080 IFI<=JTHEN1040
1090 IFI>=RTHEN1110
1100 S=S+1:SL(S)=I:SR(S)=R
1110 R=J
1120 IFL<RTHEN1030
1130 IFS<>O THEN1020
1140 RETURN

```

TEACH
YOURSELF

STILL
AVAILABLE

BAS
PROG

FOR USE WITH
16 OR 32K SEGA

SEGA[®] Beginners Guide

Practical advice on all aspects of using the Sega Computer Peripheral attachments, and software takes the frustration out of getting to know your SEGA COMPUTER.



GRANDSTAND
SEGA[®]



The Fuel for thousands of Sega Users up and down the country
 No serious Sega owner should be without

The complete range of the official Sega User Club magazines.
 Are you missing any?

