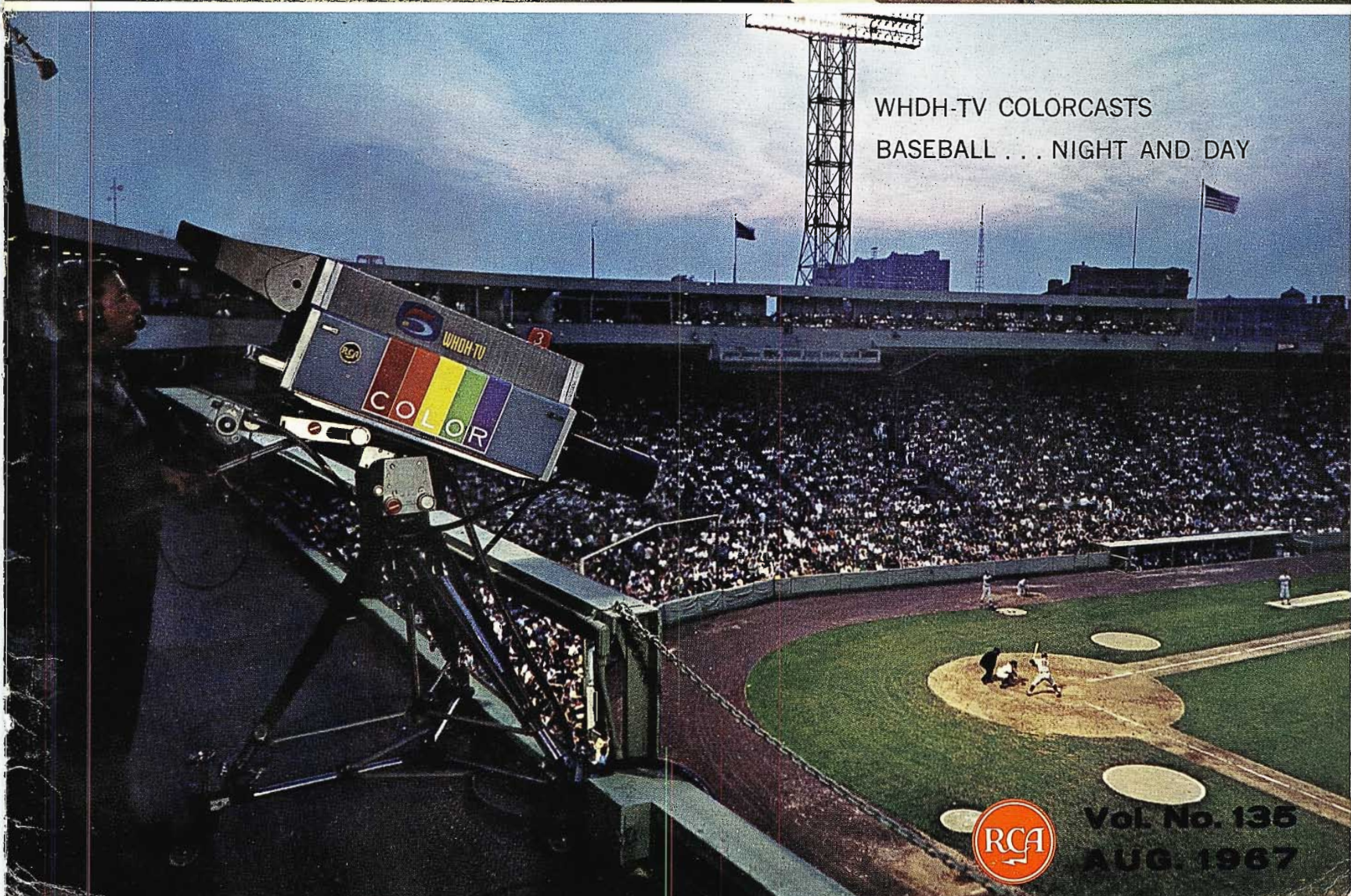


# BROADCAST NEWS



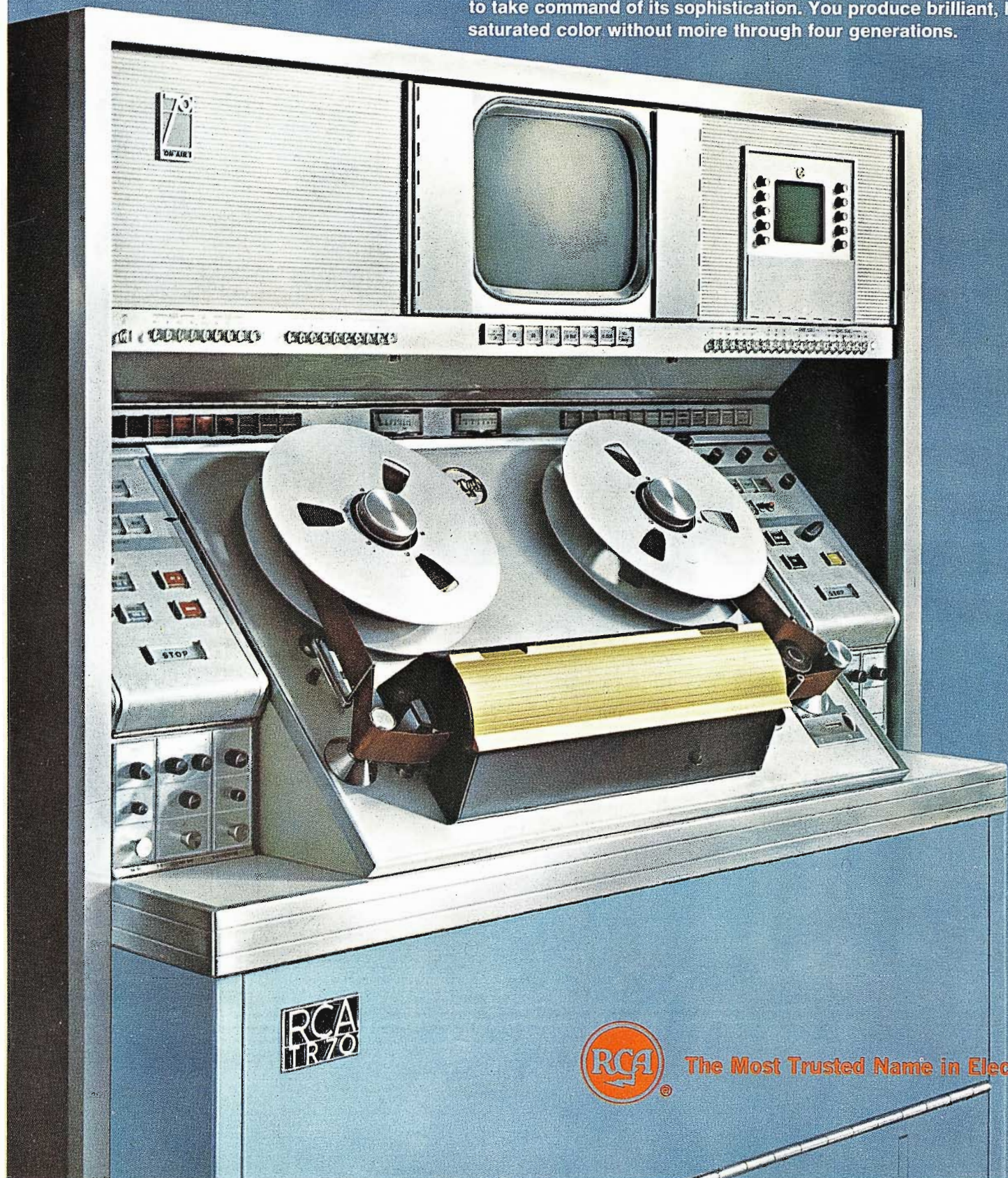
WHDH-TV COLORCASTS  
BASEBALL . . . NIGHT AND DAY



Vol. No. 136  
AUG. 1967

# HOW TO GET THE VERY BEST COLOR TAPE PICTURES

... WITHOUT THE PENALTY OF COMPLICATED OPERATION. Features of the TR-70 not available on other machines—automatic indicators, total instrumentation, grouped controls—make it easier to take command of its sophistication. You produce brilliant, highly saturated color without moire through four generations.



RCA  
TR-70



The Most Trusted Name in Electronics

Vol. No. 135

August, 1967

# BROADCAST NEWS

*published by*

**RADIO CORPORATION OF AMERICA**  
BROADCAST & COMMUNICATIONS PRODUCTS DIVISION, CAMDEN, N. J.

*issued bi-monthly*

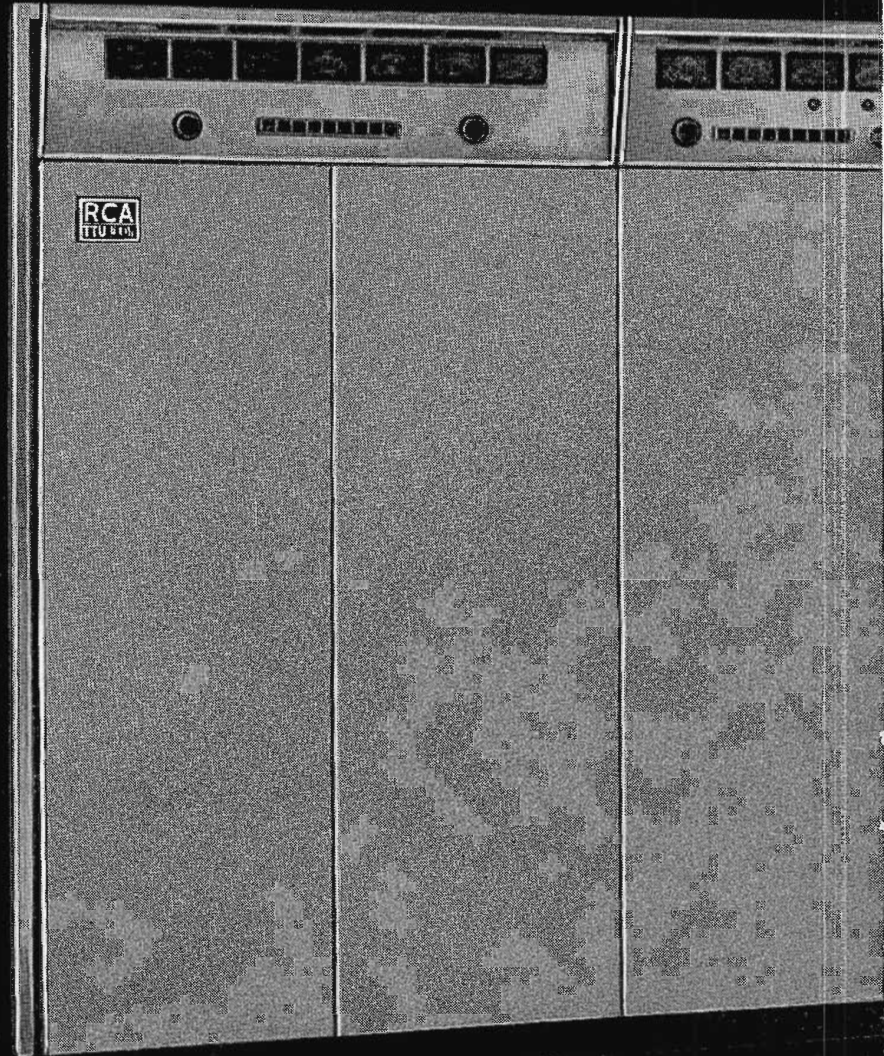
PRICE *in U.S.A. - - - - - \$6.00 for 6 issues*  
*outside U.S.A. - - - \$7.00 for 6 issues*

## CONTENTS

	Page No.
Modern TV System Trains Soldiers at Ft. Monmouth . . . . .	4
The Vee-Zee Panel as a Side-Mounted Antenna . . . . .	20
Baseball in Color — Day and Night — at WHDH . . . . .	26
CBC Color TV at Expo 67 . . . . .	34
TR-70 "Cavec" Accessory . . . . .	44
New Solid-State Color-TV Relay System . . . . .	50
WOW-TV Installs Newest 25KW TV Transmitter . . . . .	62

# 110 KW transmitter for

Up to 5 megawatts  
ERP tailored to indi-  
vidual requirements.



## Diplexed Power Amplifiers...

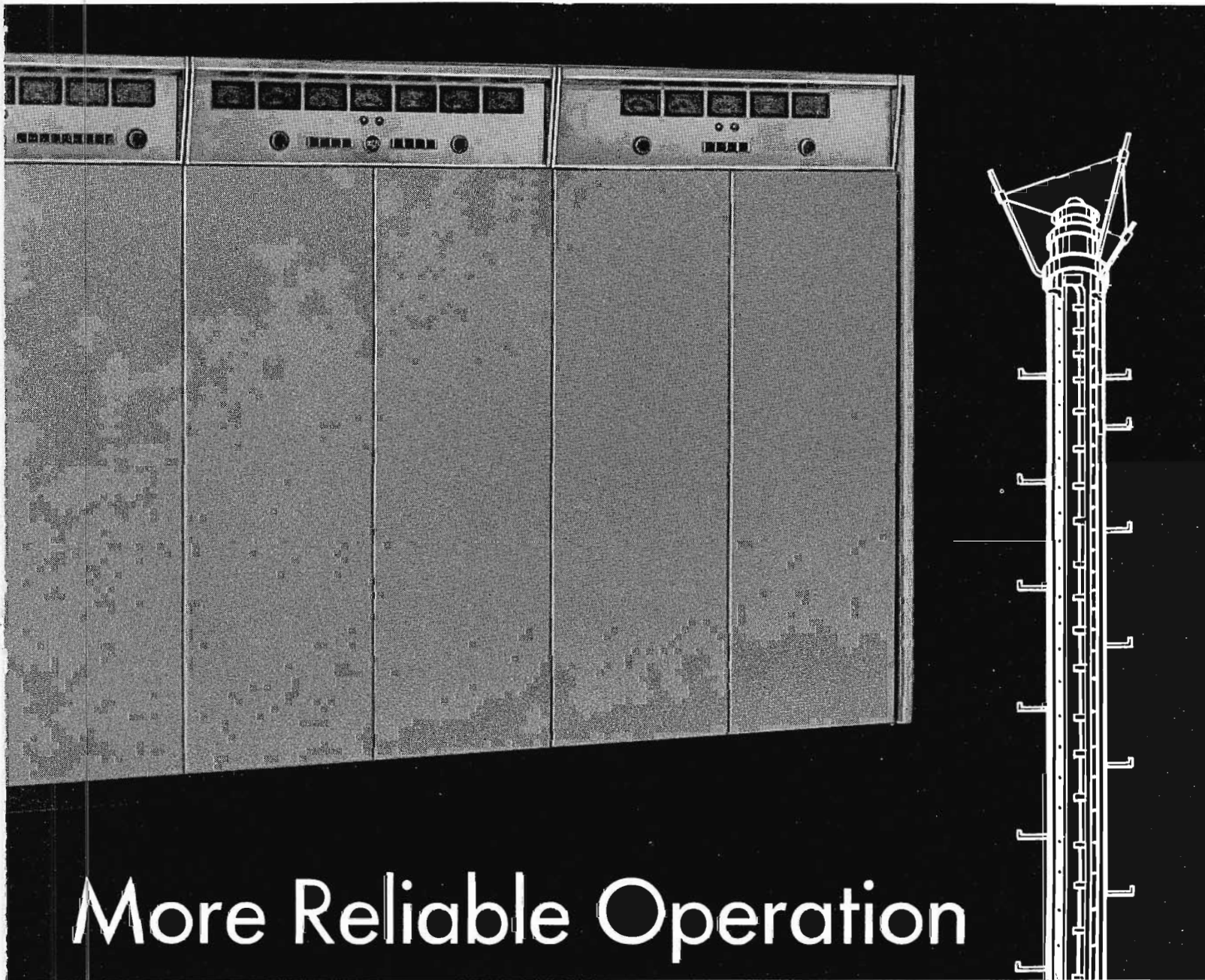
This 110KW transmitter, combined with the right RCA antenna, provides RCA's most powerful transmitter-antenna package, affording up to 5 million watts ERP.

**RELIABLE OPERATION** The diplexed visual power amplifiers assure the utmost in reliability. One amplifier is always ready to back up the other.

**NEW TYPE KLYSTRONS** Unique, integral-cavity vapor cooled klystrons are a high power development of those used in the proven RCA TTU-30A and TTU-50C Transmitters. Reliability and long life are major advantages, with faster warm-up time, less weight and retuning among other points of superiority.

**VAPOR COOLING EFFICIENCY** Vapor cooling is much more efficient than water cooling. This results in reduced operating expense. Lower input power is required.

# maximum power UHF



## More Reliable Operation

**WALK-IN DESIGN** New design techniques and walk-in cabinetry result in smaller size and easy maintenance. This means direct savings in installation and operation and will minimize building expense.

**ANTENNA CHOICES** Only RCA offers a choice of Pylon, Zee-Panel, and Vee-Zee Panel Antennas for use with the new TTU-110A high power UHF Transmitter.

**COMPLETE LINE OF UHF TRANSMITTERS** Integral-cavity vapor cooled Klystron transmitters 30KW, 55KW and 110KW. Also air cooled 2KW and 10KW transmitters. (The 2KW is easily expanded to a 10KW.)

For more information, call your RCA Broadcast Representative. Or write RCA Broadcast and Television Equipment, Building 15-5, Camden, N. J. 08102.

### YOU GET SO MUCH MORE FROM RCA

RCA offers the only full-line of broadcast equipment. RCA's depth and breadth of engineering skills and improved products, ensuring better performance, are your assurance of greater value. From RCA you get matched system design, overall warranty responsibility, single supplier coordination and complete engineering service.



THE MOST TRUSTED NAME IN ELECTRONICS

# MODERN TV SYSTEM OF U.S. ARMY SIGNAL SCHOOL TRAINS EXPERT "SOLDIER COMMUNICATORS"

Broadcast TV Equipment, Improved Teaching Methods  
and Professional Showmanship at the  
Hands of Experienced Talent, Provide Around-the-Clock  
Program Lessons for Thousands of Students

A meteoric rise in utilization of the U.S. Army Signal Center and School Television facility at Fort Monmouth, New Jersey, in the past year made it one of the largest and most active of Army television systems. During the twelve months of 1966, WFM-TV, the school's closed-circuit TV station, was in operation 15,832 hours and produced 1,064 programs. More than 10,000 students received training through television.

## Mass Education by TV

Again this year an expanding role for WFM-TV is planned, with some 19,000 students consisting of enlisted men and

commissioned officers of the U.S. and allied countries expected to receive training through TV. Programs produced will again number a thousand or more. Signal School classrooms will be provided with 24 hour service, five days a week.

"The motivation behind our extensive use of ETV at Fort Monmouth," said Major Frank Peterson, Chief, TV Division, "is our goal to produce the best trained 'soldier/communicator' in the world. Thanks largely to educational television we are meeting this goal. Much of the credit for the outstanding job being done by Signal Corps trainee replacements arriving in posts and units

throughout the world is due to the improved training techniques made possible through ETV.

"Our TV staff approaches the problem of maintaining individual appeal—while producing large numbers of TV programs in support of three shifts of classes—with the idea that educational TV need not be dull or uninteresting. To be completely informative, it has to be dynamic and visually exciting. Showmanship, we reason, is conducive to good learning."

## Large-Scale ETV Station

The USASCS facility is equipped and

FIG. 1. Studio scene during a course in basic electronics which employs two-instructor teams to increase class attention-holding power.





FIG. 2. Mobile van with cameras, TV tape and microwave link makes remote pickups for instruction and troop entertainment.

FIG. 3. Brigadier General Thomas Matthew Rienzi, Commanding General, U. S. Army Signal Center and School, welcomes visitor Ed Tracy, Division Vice President, RCA Broadcast Sales Department.

staffed to function much like a large television station. By Army regulations, however, its output is restricted to closed circuit, on-the-Post transmission and to the exchange of TV tapes and film with the many other military installations using similar facilities for instruction.

The TV system supports the Army Signal School's conventional classroom and self-tutoring instruction and is manned by the Television Division, Office of Academic Operations. The staff comprises four officers, 16 civilians and 46 enlisted military personnel, many with backgrounds in engineering, dramatic arts, motion picture photography and broadcast programming and production.

WFM-TV presently uses 21 RF channels for closed-circuit transmissions. Broadcasts are made from two professionally equipped studios to 500 classrooms and conference rooms, three theaters with large screen television projectors, and to 35 receivers in Patterson Army Hospital. Virtually the entire post can be reached by TV at any one time for briefings or special programs, or in the event of mass mobilization.

TV equipment consists of standard image orthicon studio cameras, television tape re-



orders, TV film recorders and multiple film chains. A new mobile TV studio allows visual pickup from any distant classroom and transmission by cable or microwave to WFM-TV headquarters for taping and distribution.

### Creativity in TV Teaching

"Television holds the promise of becoming an indispensable tool in education," according to Murray V. Tesser, Deputy Chief of the TV Division. "Actually the problem of education in an increasingly complex environment is one that affects us all. We must constantly search out new methods of dealing with abstractions—new ways of demonstrating and of clarifying scientific principles—new ways of 'bringing the student to the point of discovery,' which is in the end the purpose of education. Television is meeting this challenge through use of what we call 'multi-visual stimuli.'

"We discovered that television, for example, could demonstrate the invisible properties of electricity through use of an optical technique employing polarized light. Magnetic graphics, or 'slap-ons' as we call them, replace the writing on the chalk board which took time and meant loss of the students' attention. We found that one instructor tended to lose effectiveness over a fifty-minute period. The solution was use of two-instructor teams in a 'Huntley-Brinkley' format. Of course, television is always right in there with its unique ability to give the entire class a front-row seat in practical demonstrations. If the equipment is small, the camera magnifies it. If it is 'one of a kind,' television proves mass communication benefit by showing it to hundreds of students at once."

### Variety of Subjects

Subjects taught at USASCS cover a wide field of study, from equipment maintenance and fundamentals of electricity for enlisted students, for example, to "Career Courses" in Administrative Leadership, or "Specialist Courses" in Automatic Data Processing Systems, Satellite Communications, and Audio-Visual Photography and Production, Radar and Radio.

In the first four weeks (or about half of the Basic Electronics Course) about 50 percent of the material is devoted to televised lessons.

### College-Level Course

A course which has very high recognition among colleges and universities is the "Calculus Review" presented by USASCS, although no college credits are given. This 36-hour math refresher is designed for scientists



FIG. 4. Nine TV film chains are used to distribute training films to classrooms.

and engineers who wish to "bone up" in certain areas either for undergraduate study or special assignments. According to Dr. Ransohoff, Electronic Command Education Officer of USAECOM, this course has succeeded in ironing out the "bell curve." It is anticipated in the future that other similar programs will be produced.

### Training Films Viewed on TV

Most of the Signal School's training films, whether produced by the TV Division or obtained from other sources, are viewed in classrooms via TV. The TV receiver is easy to operate and permits the students to view live programs as well. Furthermore, students are in lighted classrooms where they can take notes, so the TV receiver presentation of films is ideal. The TV system has also proved convenient in enabling instructors and supervisors to preview new training films as soon as they are received.

### News, Orientations, Education by TV

News programs, character guidance presentations, orientations of new students and visitors, educational developments and command addresses are seen by students, staff and faculty via TV. Newscasts, professionally done by trained students, are telecast throughout the day. Character guidance presentations are made regularly by the Post chaplains. Medical and health messages are often presented in a light vein by student productions.

Taped addresses by high ranking local

and visiting military personnel are frequently prepared for viewing throughout the Post and for distribution to other educational TV centers. Often, slide, chart and background projection material is integrated into one taped program for scientific briefings, thus saving valuable time and personnel.

The trend at the Signal School has been toward more extensive use of TV during off-duty hours. Plans call for equipping troop housing areas for presenting courses in mathematics, physics, the languages; and special military activities.

### TV Repair and Maintenance

The Audio-Visual Division of the Department of Specialist Training conducts a 25-week course for TV repair and maintenance technicians. The course, which offers training to Army, Air Force, and Navy is for all ranks and all grades. It proceeds from the simplest vidicon TV system through receiver repair, I.O. cameras, film chains, and microwave relay systems to an RCA color camera system, color receivers, TV tape and new solid state equipment.

Students must qualify in the maintenance and repair of typical equipment used in Armed Forces TV facilities. At the end of each phase of instruction, both written and performance troubleshooting tests are given for evaluating the progress of each student. Graduates of the course are sent to various military television sites and centers through-



## How Closed-Circuit Television Is Used

- Supplementary Instruction
- Complete Instruction
- Programmed Instruction
- Orientations
- Information
- Staff and Faculty Hour
- Briefings
- Instructor Training
- Training Films
- Film Previews
- General Education

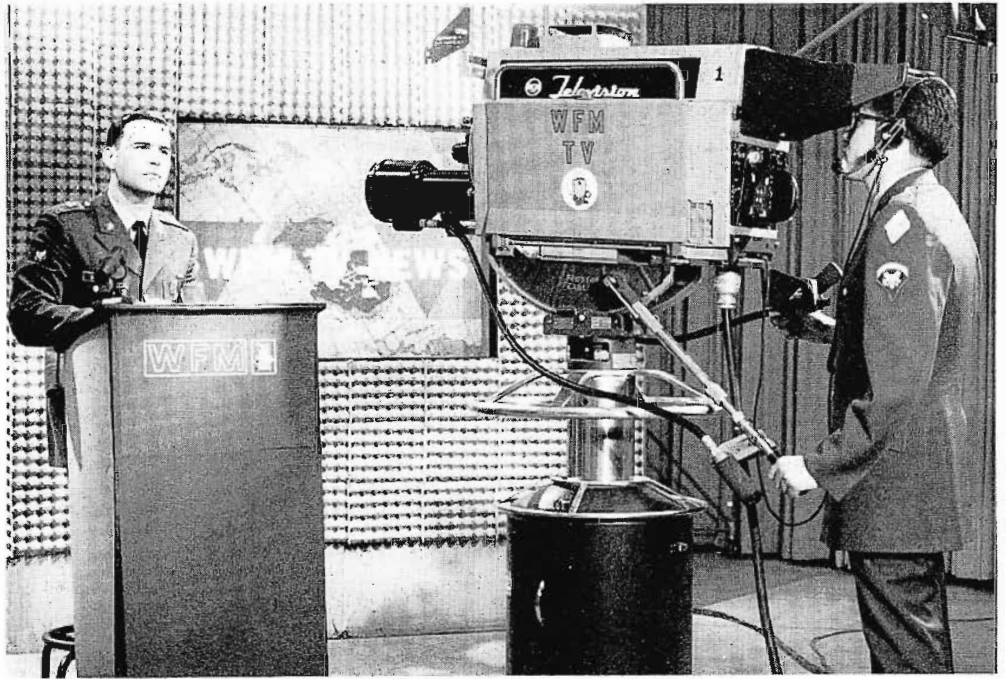


FIG. 6. Daily newscasts are a regular part of the School's closed-circuit broadcast curriculum.

FIG. 5. Use of two cameras to produce the split screen effect shown on the monitor at the right and seen by the students in classrooms is one of the "multi-visual stimuli" teaching techniques employed.





FIG. 7. In TV repair course, Greg Lentzakis (left) Chief Instructor, assists student in the proper use of test equipment.

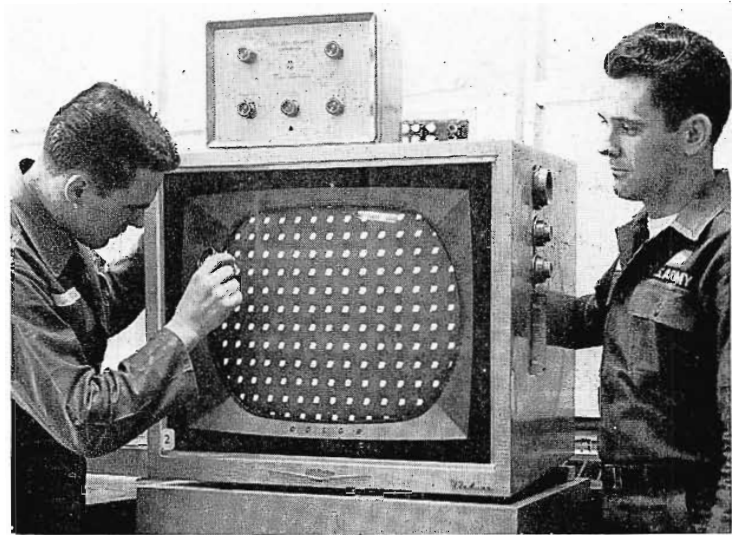


FIG. 8. Students learn to test color equipment.

out the world, such as: Armed Forces Radio and Television Service; U.S. Continental Army Command production and playback centers; aboard aircraft carriers for associated training and combat missions; and at military weather television networks, medical centers, missile centers, for White House assignments; and in research and development centers.

#### Instructor Training by TV

"Oh some power the gift to gie us to see ourselves as others see us. It would from many a blunder free us."

This plea, by Scottish poet, Robert Burns, has indeed been answered with an Instructor Training Course sponsored by the Instructional Methods Division of USASCS, Dr. Joseph Frank, Chief. Here, replays of TV tapings made of the instructor-trainee's classroom teaching have in reality permitted him to see himself as others see him. During class, a remotely controlled PK-301 vidicon camera scans the front of the classroom through a porthole in the rear wall. Camera movements are limited to pan and tilt with no special effects, and the camera operator is required to concentrate on the instructor-trainee, not on the material being taught. At the conclusion of the lesson, the tape is replayed in a conference room and critiqued by the IMD instructor as well as by the instructor-trainee and classmates.

While the instructor-trainees know they are being televised and taped, few are consciously aware of the process. There is little evidence of the stage fright or overacting that is common to staged productions. The Instructor Training Program, which prob-

ably represents the first use of the immediate playback feature of tape for instruction, has been in use at the Signal School since 1960 and has been unusually effective in the training and evaluation of instructors.

Mr. S. J. Ripandelli, Assistant Chief of the Instructional Methods Division, attributes the success of the program to the realistic circumstances under which the video tape is recorded. "First of all," he said, "the camera is out of sight. Secondly, the instructor-trainee is actually teaching class. Finally, there is the reinforcement of the classroom critique by the immediate playback of the video tape recording."

Instructional Methods Division has two classrooms which are used for training instructors in TV presentation techniques. These classrooms are equipped with vidicon TV cameras and are served by a centrally located control room.

The television camera is used by IMD in its briefings and presentations for scientists and senior administrators. It is also used to assist fully trained instructors who wish to concentrate on self-improvement. Dry run tapings are scheduled so that the experienced instructor can see himself. The television camera records the action without becoming an intruder in the classroom.



FIG. 9. Class in TV camera operation and maintenance.

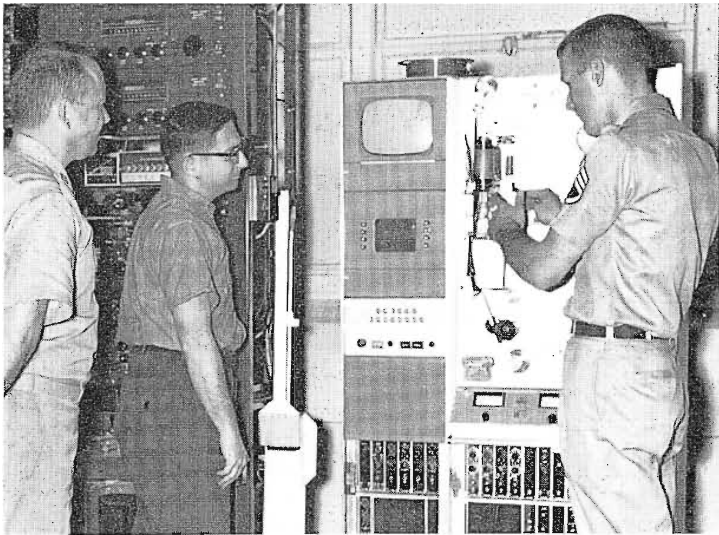


FIG. 10. The TV repair course is a tri-service operation, with students from the Army, Navy and Air Force.

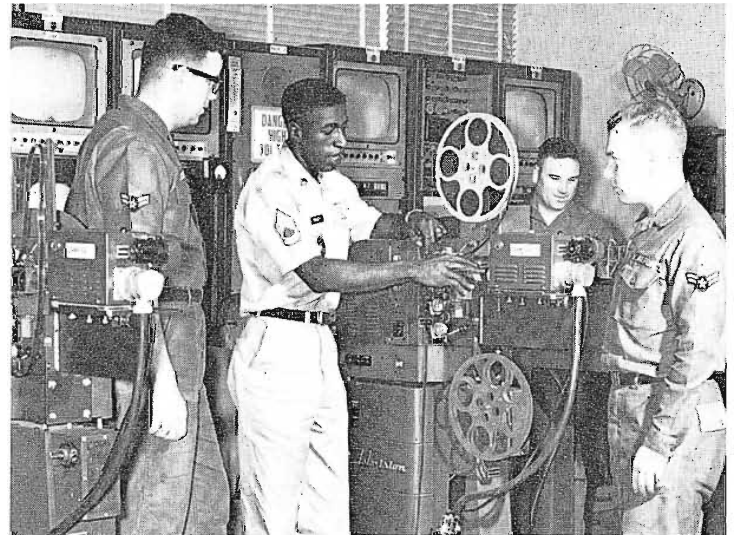


FIG. 11. Students work with TK-21 and TK-22 film cameras.

Instructor training courses run 8 hours per day, 5 days per week—for a total of 10 days or 80 hours. IMD has designed instructor courses in "TV Script Writing" and courses covering the "Philosophy of Educational Television."

#### WFM-TV Services and Staff

The WFM-TV closed-circuit TV system provides educational television facilities and services to meet instructional needs of the various academic divisions and other official organizations of the Signal School and Fort Monmouth.

WFM-TV is manned by the Television Division, Office of Academic Operations, which also provides production "know how" to assist academic personnel in planning, staging and presenting their lessons through the video medium.

The Division encompasses administration, engineering and production branches and is staffed by a nucleus of civilian TV specialists and a majority of military personnel, many with previous experience in commercial television. Others are trained in the Signal School technical courses or on-the-job in the TV Division. Considering its size and complexity, WFM-TV operates with a minimum staff.

The Chief, TV Division is in charge of all divisional personnel and activities. He reviews all new programs for matters of policy, and assigns personnel and facility resources necessary for each program.

The Program Director is Chief of Programming. He works with agencies and other divisions in planning their programs, and in obtaining special training aids or other re-

FIG. 12. J. J. Flanagan, Instructor, displays TV microwave equipment, part of TV operation, repair and maintenance course.

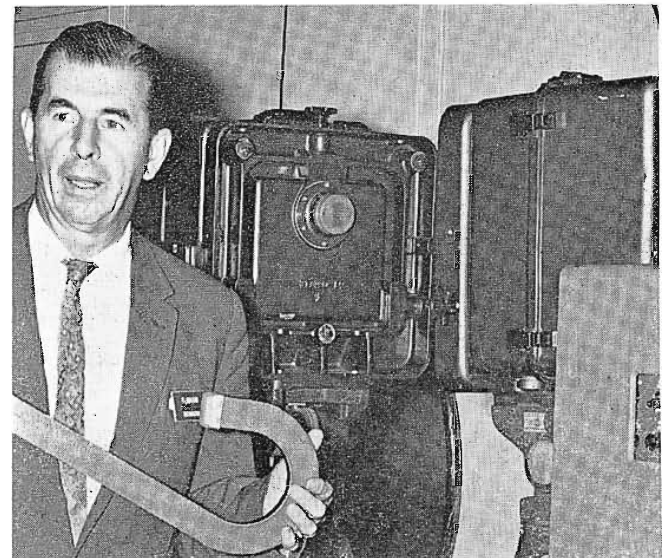
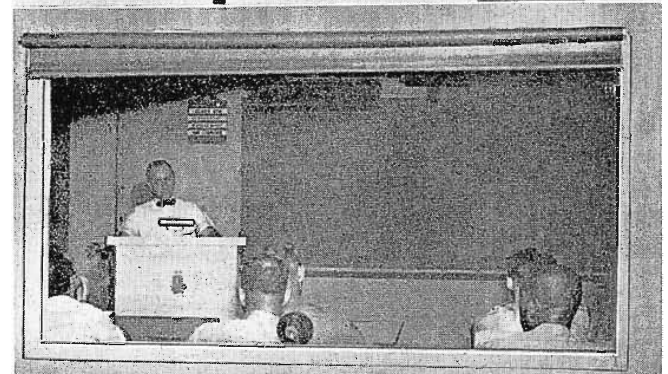
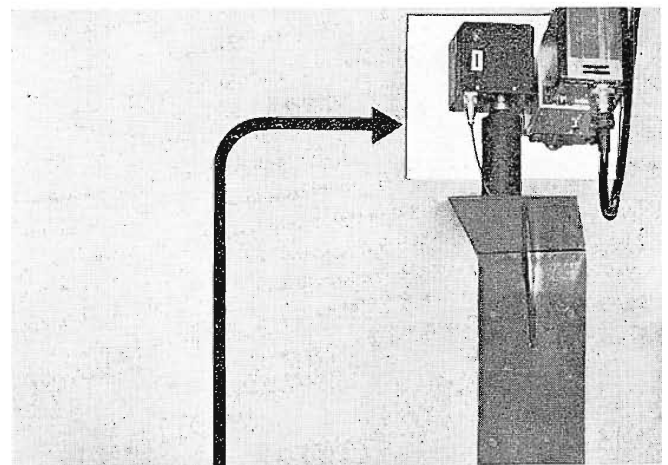


FIG. 13. Placement of "see yourself" PK-301 remotely controlled vidicon camera used for training instructors in improved teaching.



sources for their programs. He also supervises the scheduling of studio facilities and programs for viewing in the School or elsewhere on Post.

The Broadcast Supervisor assists the Program Director in scheduling programs for transmission to classrooms.

### Engineering Branch

Under the direction of the Chief Engineer, the Engineering Branch of the TV Division, staffs 37 persons and is responsible for the design, installation, operation and maintenance of the entire closed-circuit TV system, and for the procurement and training of technical directors, cameramen, film projectionists, video control operators, and other technical operating personnel.

Obtaining technical personnel is a problem and the turnover is high; the average stay at the TV center is only 15 months. Many students get their First-Class telephone tickets before they leave.

Duties and responsibilities of Engineering Branch personnel are as follows:

The Chief Engineer is Chief of the Engineering Branch. He assigns and supervises all technical personnel associated with the operation and maintenance of WFM-TV equipment facilities. Distribution and receiving equipment is maintained by the Post Signal Officer.

The Technical Director, working closely with the Producer-Director, operates the video switching and fading facilities in the studio control room. He sets up visual effects and switches scenes on cues from the director. He also supervises technical quality of pictures in control room by video camera control operation.

The Video Engineer controls the quality of the pictures transmitted by all TV equipment, aligns cameras, and assists in lighting prior to the program.

The Video Tape Engineer works closely with the TD to insure the highest quality tape recordings and to control technical quality of tapes in accordance with industry standards and USCONARC (U.S. Continental Army Command) regulations. He also controls and maintains the USASCS tape library, issuing tape dubs to other schools when so directed.

The Kinescope Film Recorder and Processor Technician controls the quality of all locally produced kine recordings and film processing. He works closely with the TD and lighting director to insure maximum quality of recordings.

The Audio Engineer controls the quality of all sound on the program, sets up microphones, maintains correct volume levels, op-

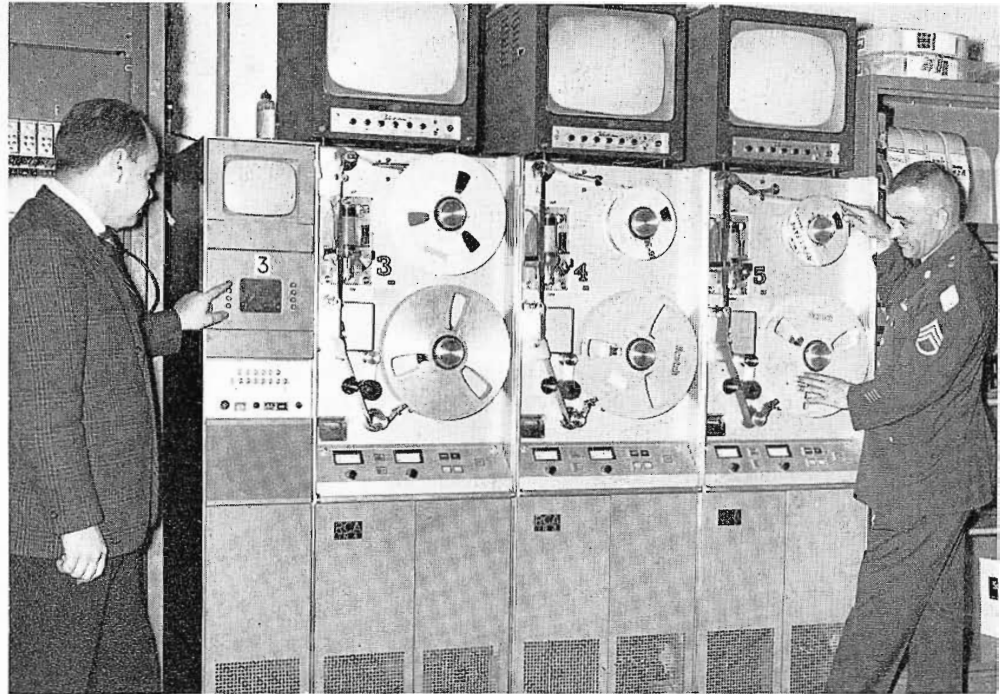


FIG. 14. TR-4 tape recorder and two TR-3 playback machines being checked out in the video tape room.

erates turntables, the audio console, tape machines and film sound controls.

The Production Branch, led by a Production Officer, staffs 23 people and trains program directors, script writers, studio floor-men, narrators, artists, illustrators and others necessary to the production of TV programs. The duties and responsibilities are as follows:

### Traffic Branch

The Traffic Branch, headed by a television coordinator and two assistants, is the master file and index center for all WFM-TV closed-circuit programs. The system, in ad-

dition to maintaining a central file of all programs produced and broadcast, also makes it possible for the Branch to issue a "TV Guide" each week listing programs scheduled to be broadcast on WFM-TV by channel, subject, title and running time. Advanced requests by the various departments and branches served by WFM-TV for specific programs can be filled in as little as three minutes.

### Production Branch

The Production Officer is Chief of the Production Branch. He assigns and super-

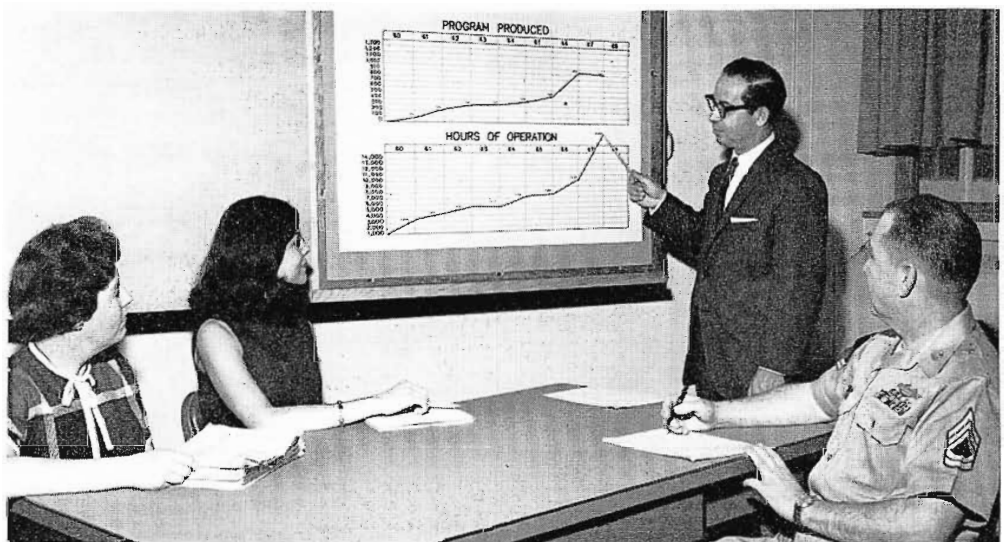


FIG. 15. Murray V. Tesser, Deputy Chief, TV Division, discusses production volume with Mrs. Michael Celli, TV Coordinator, Mrs. David Jones, Secretary, and Sgt. First Class Rost.



FIG. 16. Major Frank J. Peterson, Chief, TV division, explains use of TK-60 I.O. camera to German and Canadian liaison officers assigned to the U.S. Army Signal Center and School.

FIG. 17. School film equipment includes multiplexed TP-66 projectors and TK-22 camera.

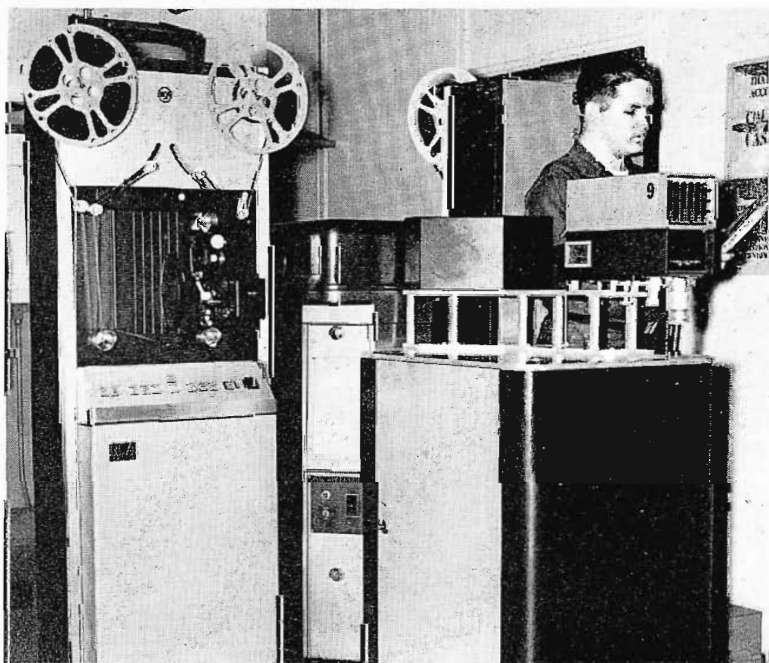


FIG. 18. Audio engineer in control room rides gain during program rehearsal.





FIG. 19. The TV Division maintains a complete graphic arts department to prepare teaching aids.

vises all production personnel and facilities. He assigns studio equipment, props and other devices that the program requires, and reviews all production details of the program.

The Producer-Director advises in planning and preparing scripts, visual aids and materials. He stages the program, conducts rehearsals and advises on techniques of good production. He is in charge of the program and all TV personnel assigned to it.

The Floor Manager is the director's assistant in charge of the studio. He is responsible for having all scenery, props and equipment in place. He gives cues for movement during the program.

The Cameramen maneuver cameras into position for good picture composition; they focus, change lenses, and take cues from the director.

### TV "Professionalism"

"One of the secrets to effective teaching at the Signal School is that we find ways of adding to the interest and enjoyment of the program," said Mr. Tesser. "Through showmanship, we try for student 'involvement.' A tight shot of a musician's hand fingering the strings of an electric guitar as it sings out a popular song, demonstrates what happens to the signal when it is fed through different classes of amplifiers. Our staff strives for professional quality in pictures and programming—comparable to broadcast station productions. We are equipped with I.O. studio cameras and other TV equipment capable of the best pictures, so that the quality of capabilities of our programming is not limited. We learned that for a production to have its maximum effect, it had to look good and



FIG. 20. Artists check visual aids for transmission.

FIG. 21. Members of the production department discuss a new program sequence.



sound good. Born and raised in the TV era, our students were satisfied with nothing less." Mr. Tesser has an extensive background experience in educational and commercial broadcasting.

**WFM-TV Facilities**

Studio, control and programming facilities of WFM-TV are located on one floor in a wing of Myer Hall, which also houses headquarters and administration offices.

There are two studios, each with a control room, a film-projection room, tape and kinescope recording room, master control, art and production departments, film-viewing area, and storage areas for scenery and props.

TV material originating in WFM-TV can be transmitted simultaneously to a total of 600 TV receivers located in remote classroom areas and to three large-screen TV projectors in theaters and auditoriums throughout the Post.

**21-Channel System**

Transmission to receivers and large-screen projectors is over a 21-channel RF distribution system utilizing approximately 18 miles of coaxial cable, one of the largest such closed-circuit systems in use by any ETV facility. Seven channels feed Myer Hall and school brigade dayrooms. Twelve channels feed the Department of Command Communications and radar classrooms. Two channels feed IMD.

At the sending end, program video and audio information from the TV switching system in master control modulates RF transmitters which feed a 72-ohm, double-shielded coaxial cable with approximately

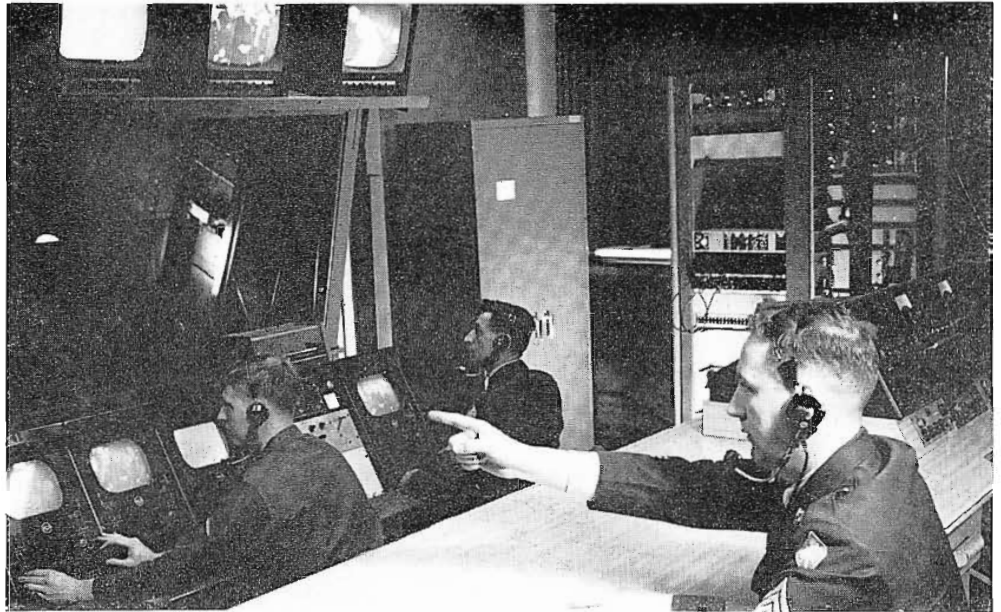


FIG. 22. Program director cues beginning of news broadcast.



FIG. 23. Video engineers at control console observe pictures on camera controls and overhead monitors, perform switching.



FIG. 24. Members of WFM-TV production department confer before program goes "on-air." Production team includes writers, educators, artists, cameramen, floormen, and technical director.

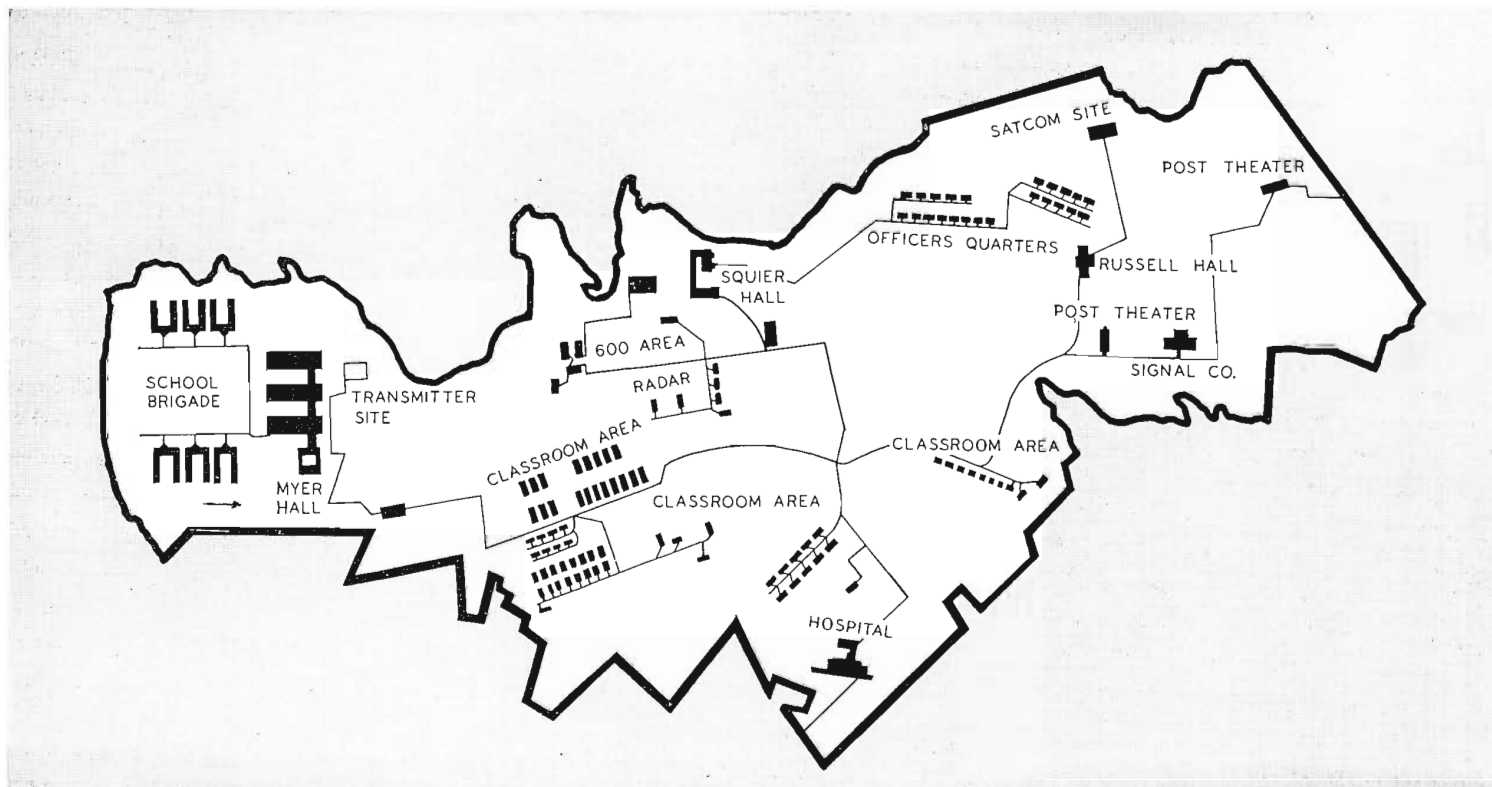


FIG. 25. Closed circuit TV system at Fort Monmouth. Myer Hall is site of WFM-TV, headquarters and administration offices.

one-volt of RF on each TV channel. At the receivers, the cable is wired to the RF front ends (modified for 72-ohm input), permitting selection of the desired RF channel for viewing. Broad-band, distributed type amplifiers are inserted at intervals in the distribution cables to maintain signal strength.

One additional RF channel is provided as a "house monitor" channel and is wired to selected administrative offices. Also available is a microwave system linking the Signal Corps Research and Development Laboratory, three miles away.

#### Broadcast TV Equipment

Major TV units of WFM-TV comprise nine live camera chains, nine 16mm TV film projectors, a slide projector, five TV tape machines, kinescope recorder and film processor, monoscope camera, step generator and off-air TV receiver. These facilities provide several video program sources in every TV medium.

#### TV Mobile Unit

A mobile TV unit equipped with two TK-31 field cameras, a video tape recorder, TV microwave link and associated equipment provides TV production and taping support for schools at Fort Dix, New Jersey and Fort Hamilton, New York. Tapes and kine recordings are supplied by USASCS.

Mobile pickups for classroom instruction and student entertainment programs are relayed back to TV headquarters by the microwave link.

#### Studios and Control Rooms

The main studio, Studio A, is 22 by 50 feet equipped with three TK-11B studio cameras, rear screen projection equipment, and extensive lighting facilities. It is used for live pickup of presentations by Post personnel and instructors. Flip charts, animations or other devices may be used in whole or in part for informational and instructional programs.

Prompter units for the cameras aid personnel in making their presentations from prepared scripts. Rear screen equipments project transparencies, film strips, opaques and similar materials on a 9 by 12 foot screen for camera pickup and integration into the program. This equipment also permits optical animations and wipes. "Limbo" (separation) shots are made on a black section of the acoustic curtains in the studio.

The Studio A control room contains the camera controls, a TS-11A video switcher and special effects generator, TV monitors, a BC-6 audio console, turntables, and two audio tape recorders. The switcher permits instantaneous selection of camera, fading or

dissolving between pictures and superimpositions.

Studio B is 22 by 40 feet and also has a separate control room looking into the studio. This studio contains two TK-60 4½-inch image orthicon camera as well as lighting and audio facilities. It is used primarily for newscasts and special programs when Studio A is in use. The control room contains camera controls, a TS-11A switcher, turntables, a BC-6 audio console and audio and video patch facilities.

#### Instructor Training Classrooms

The two instructor training classrooms, where student instructors' TV teaching techniques are observed while they teach their classes, are located at opposite ends of a control room which looks into both classrooms.

Microphones mounted to pick up the instructor's voice and special lighting are the only equipment facilities in the instructor training classroom. The control room contains two PK-301 vidicon cameras, each equipped for remote pan and tilt, two rack-mounted TV master monitors and two audio tape recorders. Duplication of control room equipment permits both classrooms to operate simultaneously. Video output of these classrooms is fed to TV Tape Recording studio (via Master Control).



## Equipment Employed in Ft. Monmouth CC-TV System

### STUDIO A AND CONTROL ROOM

- 3—TK-11 Studio I.O. Camera Chains
- 1—Taylor-Hobson Studio Varatol II
- 3—Teleprompter Systems
- 2—21-inch Video Monitors
- 1—Telepro 6000 Rear Screen Projector
- Eastern and Century Lighting
- Century Dimmer Consoles
- Sound-Proof Audio Booth
- 1—TS-11A Video Switcher
- 4—WP-15B Power Supplies
- 4—TM-6C Master Monitors
- 5—TM-7AC Preview and Line Monitors
- 1—BC-6C Audio Consolette
- 2—Audio Turntables
- 2—Audio Recorders
- 1—Multiplexer Remote Control Panel
- 1—Special Effects Generator
- 1—PK-301 Vidicon Camera

### STUDIO B AND CONTROL ROOM

- 2—TK-60 4½-inch I.O. Camera Chains
- 2—TK-60 Studio Control Units
- 1—Taylor-Hobson Studio Varatol V
- 1—TS-11A Video Switcher
- 1—Multiplexer Remote Control Panel
- 1—BC-6C Audio Consolette
- 3—WP-16B Power Supply
- Eastern and Century Lighting
- Century Dimmer Console

### CLASSROOM & AUDITORIUM RECEIVERS

- 5—PT-100 Theatre-Size TV Projectors
- 650—21 and 24-inch Classroom TV Receivers (Modified for 72 Ohm Input)

### FILM PROJECTION ROOM

- 1—TK-22 Vidicon Film Camera
- 8—TK-21C Vidicon Film Cameras
- 2—TP-6DC 16mm TV Projectors
- 1—TP-7A Slide Projector
- 1—TP-15 Universal Multiplexer
- 5—TP-16F 16mm TV Projectors
- 5—TM-7BC Film Line Projectors
- 9—TM-6C Master Monitors
- 1—Multiplexer Remote Control Panel
- 4—WP-15B Power Supplies
- 4—WP-16B Power Supplies
- 2—TP-66 16mm Projectors

### MASTER CONTROL ROOM

- 1—Video/Audio 20/20 Input/Output Switcher
- 1—Master Monitor
- 16—24" TV R.F. Line Monitors
- 1—Off-Air Demodulator
- 1—FM Tuner
- 1—TM-8 Video Monitor
- 1—Audio Tape Recorder
- 2—B15A VU Meter Panel
- 19—Modulators/RF Transmitters
- 2—Sync Generators
- 16—TA-24 D.A.
- 1—TK-1C Monoscope Camera
- 1—WP-15 Power Supply
- 1—PK-301 Vidicon TV Camera
- 1—TK-202 Vidicon TV Camera
- 10—Solid State Power Supplies
- 1—Generator Test Package—10 Step, Multi-burst, etc.

### INSTRUCTOR TRAINING STUDIO

- 2—PK-301 Vidicon TV Cameras (with Remote Pan & Tilt)
- 1—TG-21A Studio Sync Generator
- 2—TM-35 Master Monitors
- 2—BN-6B Transistor Portable Remote
- 2—Audio Tape Recorders

### VIDEO TAPE RECORDING STUDIO

- 2—TRT-1A TV Tape Recorders with Pix Lock
- 2—TR-3 Playback Units
- 1—TR-4 TV Tape Recorder with Electronic Editor
- 1—16mm Kinescope Recorder
- 1—Viscomat 16mm Film Processor
- 5—TM-7C Video Monitors

### TV-56A TV MOBILE UNIT

- 2—TK-31 I.O. Field Cameras
- 2—TK-31 Field Camera Control Units
- 1—TS-30D Switcher
- 1—TG-12A Sync Generator
- 1—Complete Microwave Link
- 1—TR-5 Video Tape Recorder
- 2—TM-9 Video Monitors
- 1—TM-6 Master Monitor
- 3—TY31A Power Supplies
- 1—WP-15B Power Supply

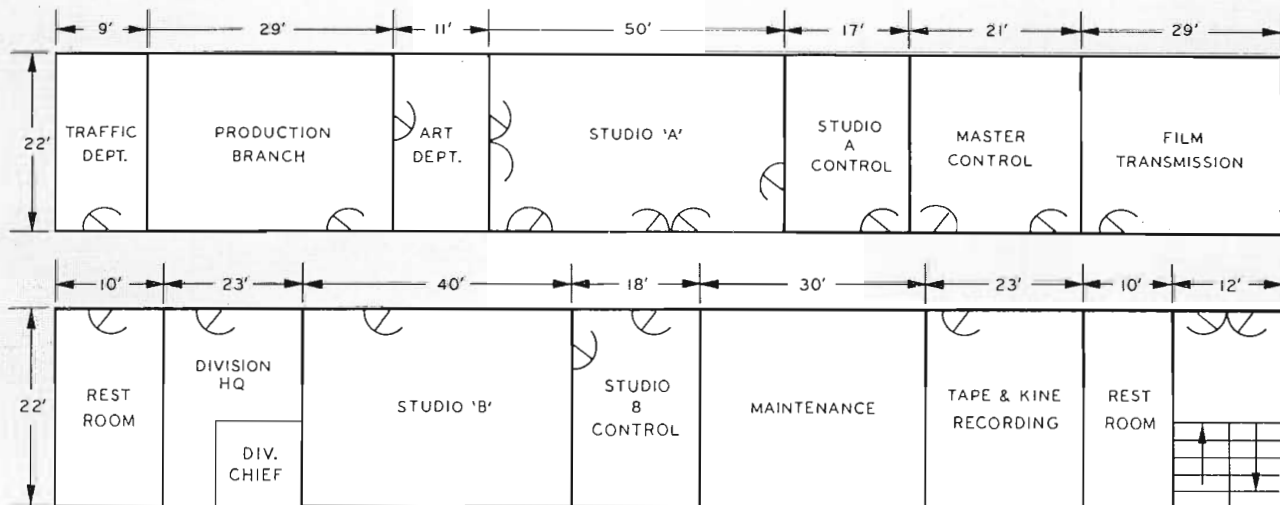
### TV INSTRUCTION CLASSROOMS

- 8—TK-14 Field Type Cameras
- 2—TS-30 Field Switchers
- 8—TG-12 Field Sync Generators
- 2—TM-6C Master Monitor
- 1—TVM-1A Microwave System
- 2—BC-3C Audio Consolettes
- 2—TK-22 Vidicon Cameras
- 2—TK-21 Vidicon Cameras
- 1—TR-2 (Colorized) Video Tape Recorder
- 1—TR-4 Video Tape Recorder

### COLOR TV INSTRUCTION STUDIO & CONTROL ROOM

- 1—TK-41 Color TV Camera
- 2—TM-21B Color TV Monitors
- 1—TK-41 Camera Control Console
- 1—Audio Consolette
- 8—21-inch Color Receivers

FIG. 26. Floor plan, WFM-TV television facilities.



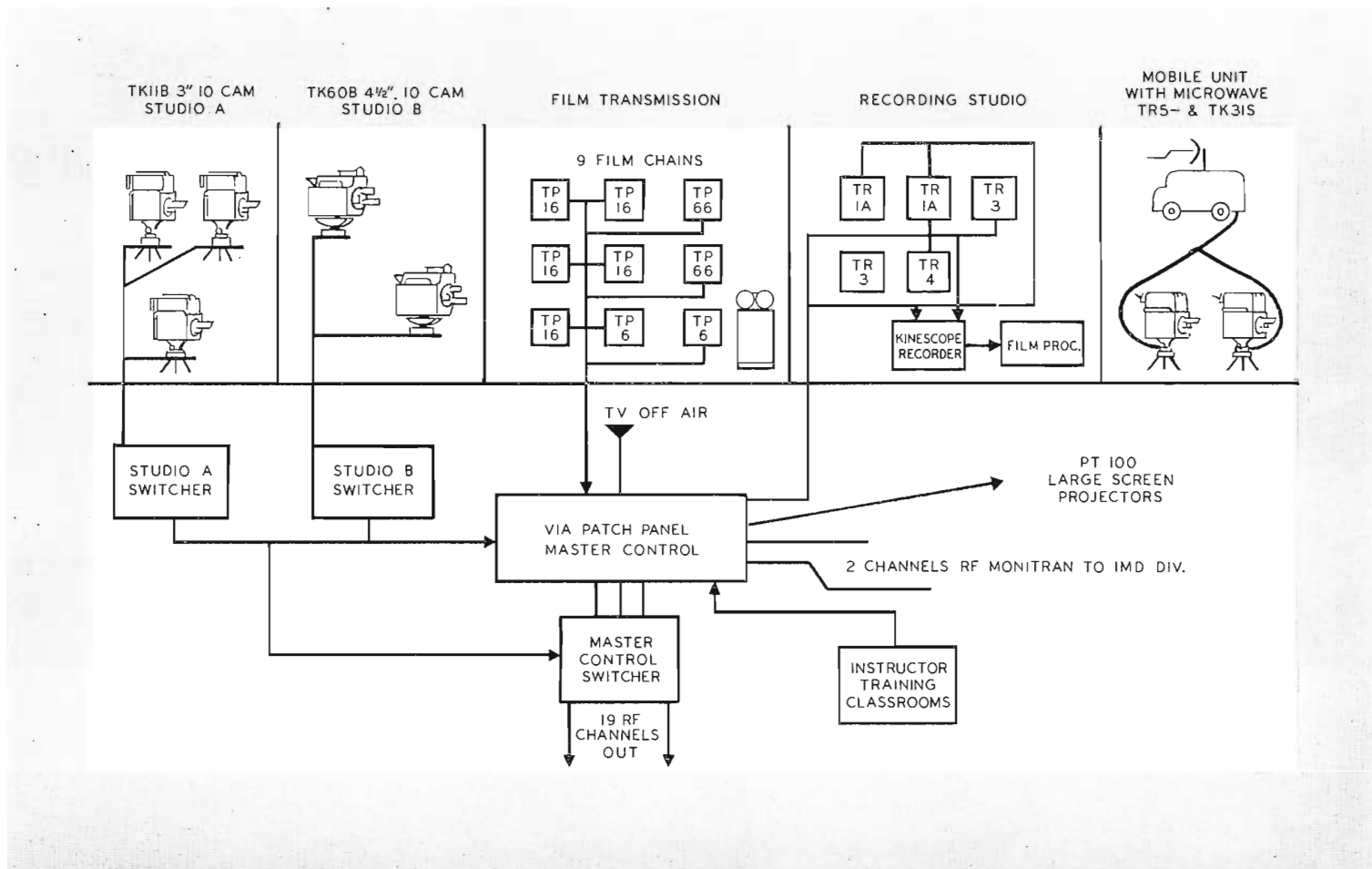


FIG. 27. Block diagram of WFM-TV technical facilities.

FIG. 28. TK-60 camera controls, film remote control and master monitors in Studio B control room.



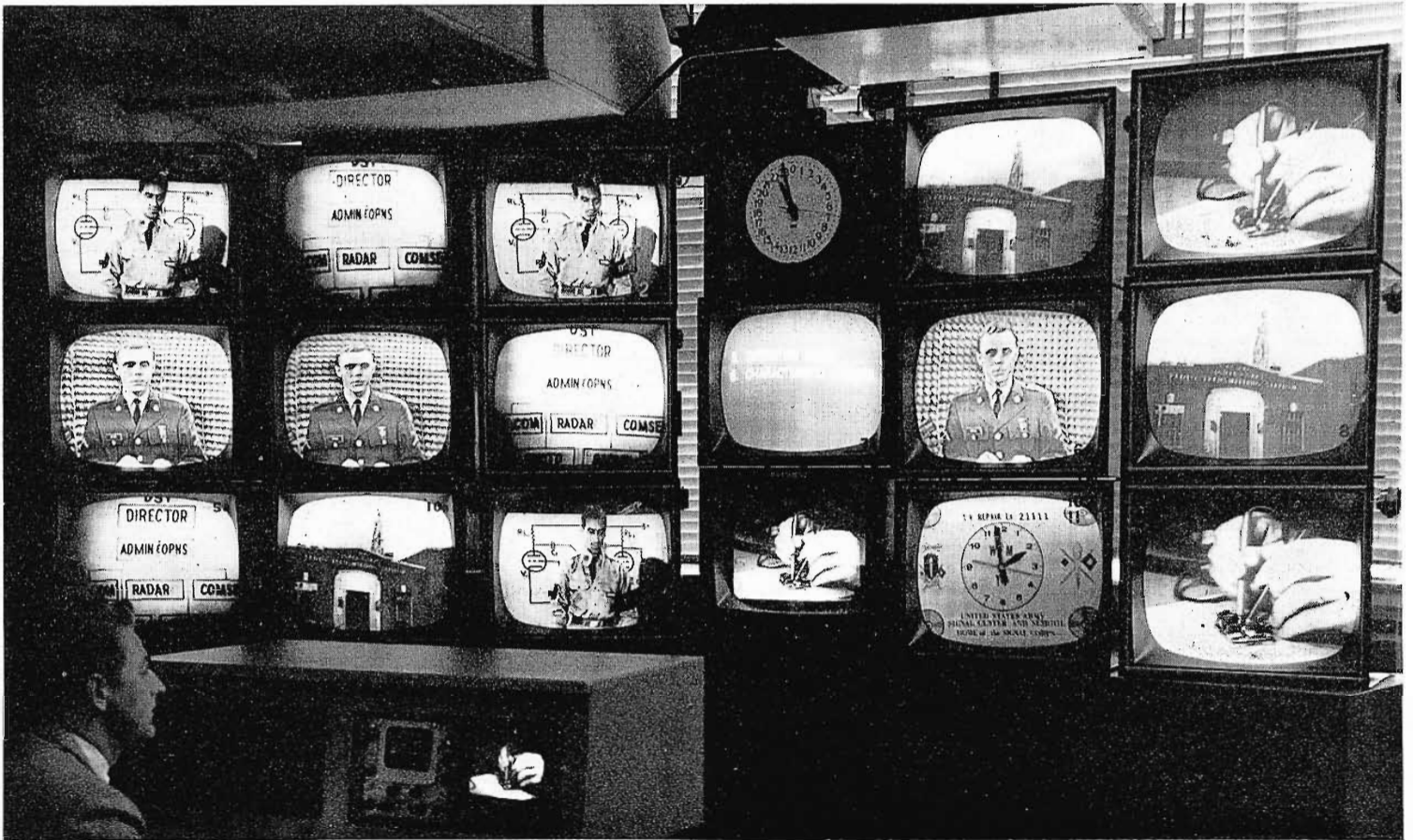


FIG. 29. Master control for the multi-channel WFM-TV closed circuit system.

### TV Tape Film Processing

The taping studio contains two TRT-1A TV tape recorders, two TR-3 TV tape players, one TR-4 TV tape recorder with electronic editing, a 16mm kinescope recorder and 16mm Viscomat film processor. One of the TR-3 players is soon to be modified to TR-4 status by adding the record accessory. The studio tapes training programs, troop entertainment shows, remote pickups from the TV mobile unit and honor guard ceremonies, as well as occasional presentations by outstanding visiting instructors. Useful life on one of the RCA tape heads has exceeded 1,000 hours.

Most of the TV material produced by WFM-TV is recorded on TV tape, either for storage or immediate playback. Film recording and processing is used when extra copies are needed either for exchange with other Post facilities or for playback on TV projection equipment. Tape and film recordings

are usually made simultaneously to provide first generation copies.

### Master Control

Master control facilities are located in a room 21 by 22 feet and consist of 16, 24-inch TV receivers used as RF line monitors, an off-air pickup TV receiver, TK-1C Monoscope camera for test pattern I.D., a step (gray scale) generator, a video switcher, modulator/transmitters to produce the RF channels, an audio tape recorder, and a microwave link. A PK-301 vidicon camera distributes a continuous "clock signal" over the system which is used as a time check between program control and instructor. Another continuously available signal for use in emergencies is a "standby sign" produced by a TK-202 vidicon camera.

Master control is the center of all program selection and switching to desired dis-

tribution channels. Guided by a "master schedule," the operator selects from incoming video programs, and routes them at designated times to the proper RF channels or to the recording studio. Switching is accomplished by a 20 x 20 custombuilt solid state relay system which provides simultaneous switching of video and audio.

USASCS video system now utilizes the complete RCA TA-24 pulse distribution system as well as a modular test package that provides multi-burst window,  $\sin^2$  pulse and gray scale for system evaluation.

### Color TV Instruction Studio

The Signal School maintains a professionally equipped and operating color TV studio and control room which is used exclusively for training students in the operation and maintenance of color TV receivers and studio equipment.

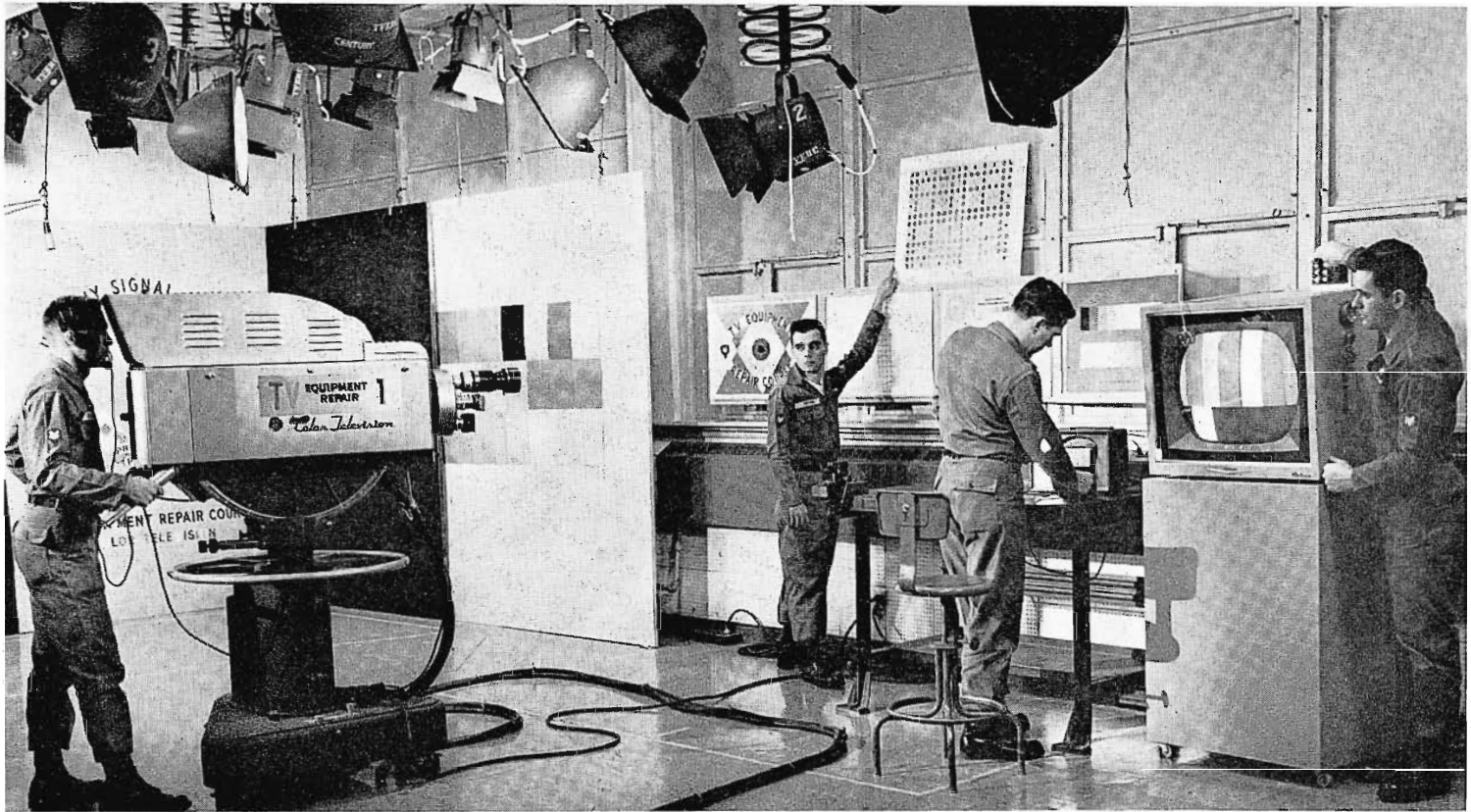


FIG. 30. View into operating color studio used to train students in operation, repair and maintenance of color TV equipment.

Equipment for this purpose consists of a TK-41 color TV camera, two TM-21B color TV monitors, TK-41 camera control console, eight 21-inch color TV receivers, audio console and audio turntable.

Students, many of whom have been trained by the facility for operation and maintenance of military color TV systems throughout the country, are taught the fundamentals of color TV theory, set-up and adjustment of color TV camera systems, studio lighting for color productions, and equipment repair and maintenance.

#### Selecting TV Program Participants

Sponsoring organizations are expected to provide technical advisers and/or television instructors (participants) for all TV programs which the organization wishes to present. In instructional programs, the technical adviser assists in the planning and preparation of program content; the same individual or another in the organization presents the program on TV. Programs to be used in several courses or for several divisions require joint planning by technical advisers from each of the academic areas.

Certain factors are considered in selecting participants: How well he knows his subject; classroom teaching experience; TV

personality requirements such as reasonably good speaking voice, warmth, good grammar and good diction; and whether he will have time to participate in the planning and preparation. TV techniques can be learned by most experienced classroom instructors in relatively short time.

#### How WFM-TV Produces an ETV Program

When the academic division has completed general plans for its TV program and has selected technical advisers and instructors, or participants to work with TV Division personnel, detailed preparation of the ETV program begins.

1. The sponsoring division prepares, with the help of a TV staff writer, a written script so that the TV director and crew members can follow the presentation. For instructional programs, the script is normally a good outline, with instructions regarding demonstrations, use of visuals, planned movement and important cue lines.
2. The script is then discussed with the producer-director to be sure all the information he requires is included.
3. The script is then "blocked," or marked by the TV director for cameras, lenses, cues, etc.

4. Necessary graphics and visual materials are then prepared by a TV Division illustrator. Complex materials are prepared by the Training Aids Division.

5. Program is rehearsed and taped. The program is then scheduled for transmission and documented in a weekly TV program schedule which gives the MOS (Military Occupational Specialty), the time at which the subject matter will be shown, and the channel on which it can be seen.

#### Advantages of TV in Instruction

TV provides the following technical advantages not readily available in normal classrooms:

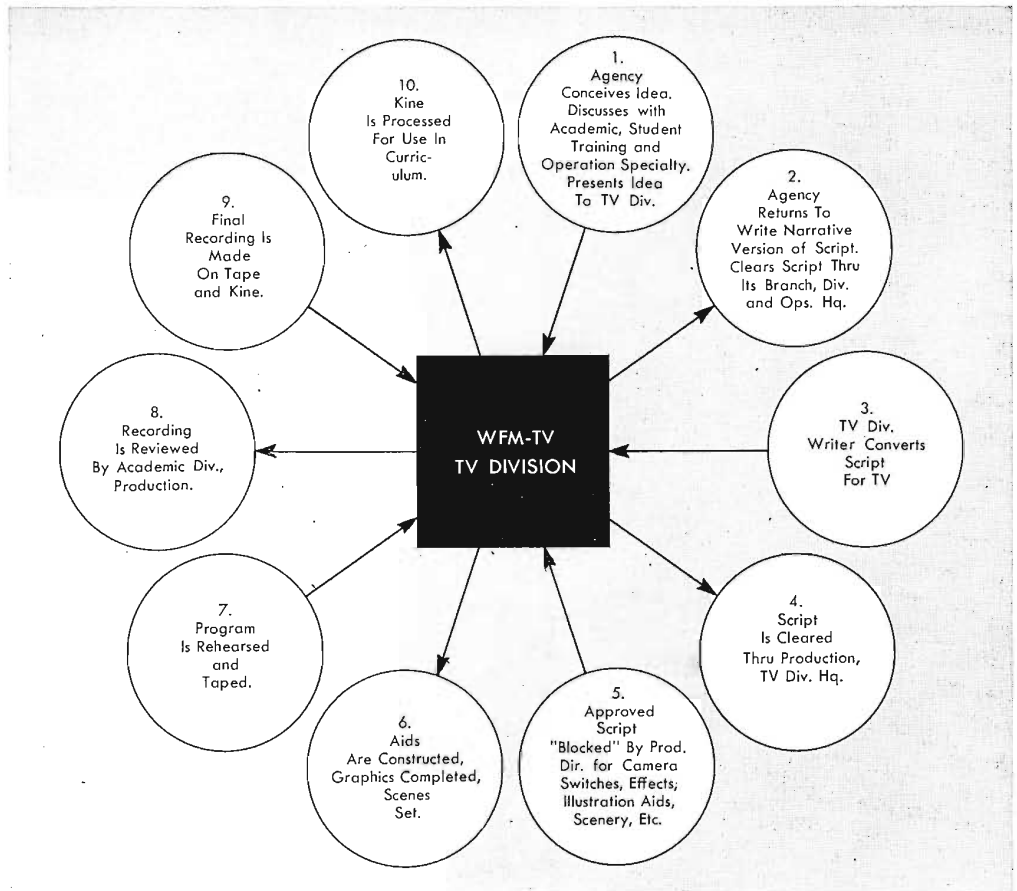
Gives close-up magnification of small objects so that each student has a "front-row" seat.

Changes perspective instantly from wide angle to close-up.

Allows comparison of two or more illustrations at the same time.

Eliminates distraction; directs student's attention to essential detail.

**FIG. 31.** Steps in the evolution of a typical WFM-TV program.



Allows use of actual pieces of small equipment for illustration rather than large and costly "mock-ups."

Brings "live" or recorded views of equipment and demonstrations from remote locations into lighted classrooms.

Allows integration of films, slides, graphics, special training aids into TV presentations.

Saves time and effect of moving personnel to theatres to view films, or to remote locations for demonstrations. Saves time of setting up film projection equipment.

TV provides enrichment of training.

Increases use of visual and training aids.

Provides a common grounding of all students in certain fundamental subject areas.

Gives classroom instructors an opportunity to observe presentation techniques of other instructors, and to observe students while they are watching a TV presentation.

Allows the instructor more time to teach applications of complex subject matter initially presented by TV.

**Future Plans**

A major step in the future expansion of WFM-TV is a study on conversion to color. Certain types of military instruction, particularly electronics circuitry with its color coding, lend themselves to color. Additional equipment, monochrome or color will be solid state wherever possible.

Plans call for additional tape facilities for the mobile unit, additional cameras and for complete air conditioning of Studio B and control room. Studio A is presently air conditioned.

By the end of fiscal 1968, WFM-TV expects to produce more than one thousand programs and help train more than 19,000 students.

**HISTORY OF TV AT USASCS**

- 1951 U.S. Army Signal School acquired a field-type, image-orthicon TV camera for experimental training by TV. TV classroom instruction in radio electronics was begun on 27 September.
- 1952 The School acquired a second TV camera, and added TV courses in radio, radar, photography, wire and fundamentals.
- 1953 The School instituted a program of expansion to include new facilities in Myer Hall, a three-channel closed-circuit distribution system, two new image-orthicon cameras, two 16mm film projection systems and a 16mm kinescope film recorder.
- 1956 Educational Television Division was established to produce instructional and informational TV programs.
- 1958 TV system further expanded with addition of three image-orthicon cameras, four 16mm vidicon film projection chains, new audio system, directors' consoles, studio accessories and 7-channel RF distribution system.
- 1959 Dedication on 6 February of Signal School Closed-Circuit Television System, WFM-TV. Staff and functions of TV Division increased.
- 1960 Addition of two TV tape recorders, and air conditioning of a studio and control room.
- 1961 Addition of two 16mm vidicon film projection chains and multiplexer system with two professional film projectors.
- 1963 Addition of two complete studio TK-60 camera chains and two 353-C audio tape recorders.
- 1964 The system acquired an Audimax II, a TK-21C film chain, a transistor interphone system, a Varatol V zoom lens with close-up adapter. There was also a permanent installation of camera cable throughout the Myer Hall complex, including the auditorium for remote pick-up.
- 1965 Addition of 150 more receivers, special effects generators and switcher, test package, MP-3 Polaroid copymaker and a TK-22 vidicon camera.
- 1966 Acquisition of two solid-state sync generators, and switching system, 12 additional channels to the existing closed-circuit TV system, two TR-3 video tape players, and one TR-4 Tape Recorder with electronic splicing accessory, 16mm Kodak film processor, two TP-66 film projectors and one TK-22 Vidicon camera.
- 1967 Acquisition of a mobile television unit with three RCA camera chains.

# THE "VEE-ZEE" PANEL AS A SIDE-MOUNTED ANTENNA

by R. N. CLARK and A. L. DAVIDSON  
*RCA Antenna Engineering Center*

EDITOR'S NOTE: This theoretical treatise covering the design and development of the RCA "Vee-Zee" Panel as a side mounted antenna is presented here to supplement the information given in the previous article "New Vee-Zee and Zee Panel Type UHF Antennas" by A. J. Galinus, *BROADCAST NEWS*, Vol. 134, June, 1967.

The side-mounted panel antenna is becoming more popular in the television industry as the number of high tower structures and multiple installations increases. This article describes the development of the Vee-Zee panel antenna that is particularly well suited for mounting on both existing and future tower structures.

The problem of achieving an acceptable horizontal pattern, particularly in the UHF band, is magnified because standard tower sizes are of the order of several wavelengths wide. The technique of skewing the panels is an efficient means of reducing the number of panels to a minimum and still obtaining a good circularity.

The typical panel antenna horizontal pattern may be approximated by  $E = E_{\max} (\cos \theta)^p$ , where  $p$  is generally greater than 2. When  $p$  equals 2,  $E$  is 50 percent of  $E_{\max}$  when  $\theta$  is  $\pm 45^\circ$ . At least four of these panels around a tower would be needed to produce a good circular pattern.

If the single panel had a horizontal pattern of approximately  $E = E_{\max} \cos \theta$ ,  $E$  would be 50 percent of  $E_{\max}$  when  $\theta$  is  $\pm 60^\circ$ . In this case three panels around a tower will produce a good circularity when properly mounted. The Vee-Zee panel has been developed specifically for the above three-panel array. The primary concern is in the development of a panel with this desired horizontal pattern and with the application of this panel in an array where the tower size is established and is several wavelengths wide.

## The Zig-Zag Panel Antenna

At this point it may be of interest to consider the operation of the zig-zag antenna. A model of a zig-zag panel antenna

is shown in Fig. 3 in a four-panel array. The element can be considered as a long lossy transmission line with the loss being primarily the radiation from the element. As shown, the element is fed at the center and the far ends are open circuited. They may also be grounded at an appropriate point. The primary requirement of the element is that each segment be 180 electrical degrees long, as shown in Fig. 4. Considering a traveling wave along the element, if the currents of any two adjacent segments are added together, the resultant is approximately equivalent to the standing wave on a half wavelength dipole. The equivalent dipole would be positioned at the center of the zig-zag segments and have a current at the center equal to twice the traveling wave current. It should be emphasized at this time that the current in the zig-zag antenna designed by RCA is a traveling wave current, and hence the zig-zag antenna has all of the advantages applicable to that type of antenna. This traveling wave current in each segment of the zig zag has a horizontal and a vertical component, as shown. The horizontal components add and the vertical components cancel in the horizontal plane. Only one to two percent of the radiated power is lost in vertical polarization in a good zig-zag antenna design.

Proceeding along the element away from the feed point, the traveling wave current decreases. The rate of current decay is a function of the radiation from the element, which is a function of the element to panel spacing. For a good design, proper spacing is determined by the number of segments in the element. If the radiation from the element is too great, the current at the far ends will be low, and this will result in a low vertical aperture efficiency and a low panel gain. A low rate of radiation will result in a high current at the far ends, which will be reflected back toward the generator. When the element spacing and, hence, the radiation resistance along the length of the element is set so the reflected energy at the feed terminal is negligible, a gain typical of a traveling wave-fed antenna is obtained. For example, a panel ten wavelengths long will give a power gain of between 7 and 10 in an omnidirectional array. The aperture

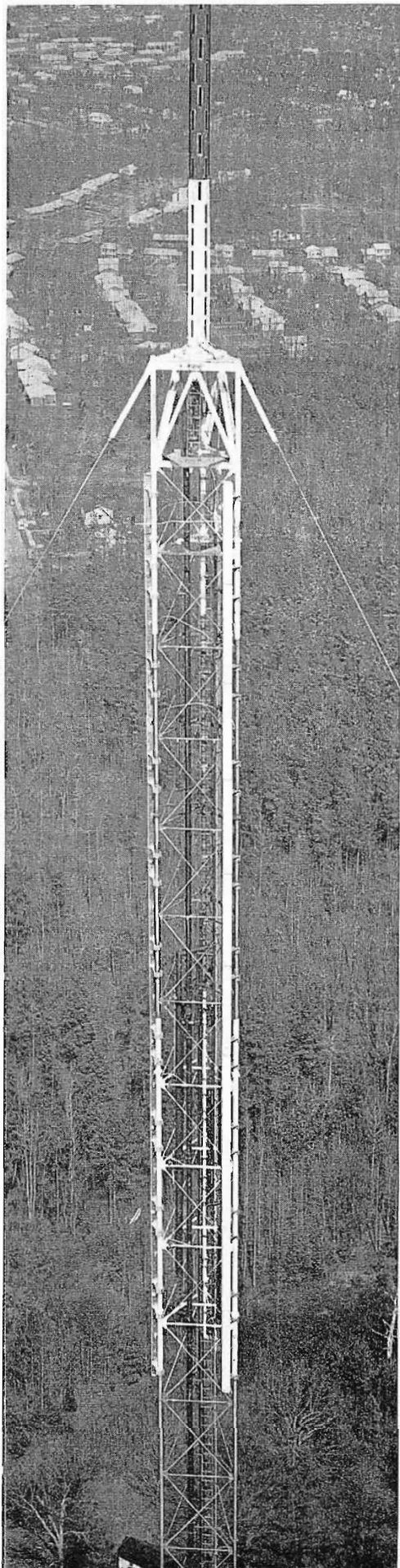


FIG. 1. Channel 57 Vee-Zee Panel Antenna of WCWV-TV mounted on sides of tower.

efficiency is increased by reducing the current decay along the element. As stated previously the current at the far ends is high. In order to eliminate the reflection toward the feed point, the element is terminated by an end-loading radiator. This has been developed to provide a proper impedance match for the element and to radiate the remaining energy.

The useful frequency range of a zig-zag panel is a function of the number of half wavelength segments in the element. The phase of each segment with respect to the phase at the feed point is determined directly by the number of interim segments and the frequency. To decrease the number of feed points, the panel is fed at the center. This more than doubles the gain per feed point that could be obtained with an end-fed element, considering the pattern stability as the limiting factor. Measurements have been made which determine the useful bandwidth of the zig-zag panel.

The advantages of using the zig-zag element in a panel antenna are numerous. Since the element, as designed, operates as a long lossy transmission line properly terminated, the impedance bandwidth is excellent. This is due to its traveling-wave

nature. The traveling wave also makes the antenna immune to adverse weather conditions and contributes to the stable radiated field because of its naturally smooth vertical pattern. The simplicity of the element lends itself to easy construction. Also, the fact that there is only one feed point for a considerable vertical aperture means that the feed system complexity and thus the cost is greatly reduced. Beam tilt and null fill for an array are easily accomplished, and a high gain per wavelength is easily obtained by adding the end loading radiator as discussed.

### The Skewed Panel Array

A brief look at the skewed panel array is helpful in a discussion of the *Vee-Zee* panel development. This treatment is mainly concerned with omnidirectional applications, but with appropriate modifications the principles apply also for directional usage. From this discussion it will be clearer just what is needed in the single panel. Fig. 5 gives the plan view of a three panel array skewed from the radial position. Large arrows indicate the direction of maximum radiation from each panel,  $R/\lambda$  is the distance of the apparent phase center of the panels from the center of the array in wavelengths. The electric

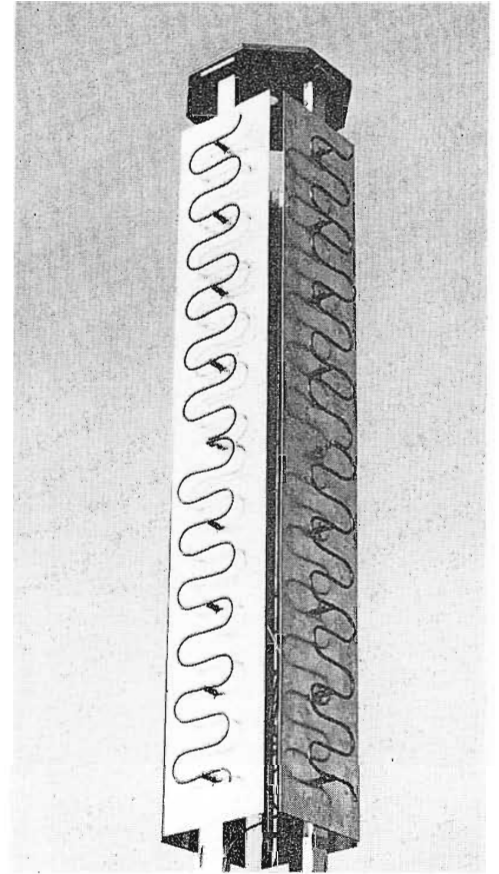


FIG. 3. Four flat panels in array.

FIG. 2. Three Vee-Zee Panels mounted around a 7.5-foot test tower.

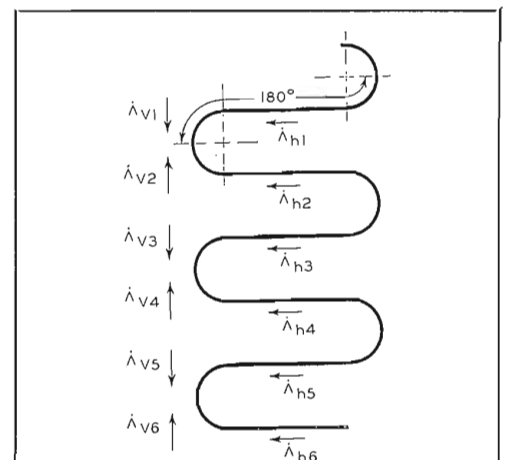
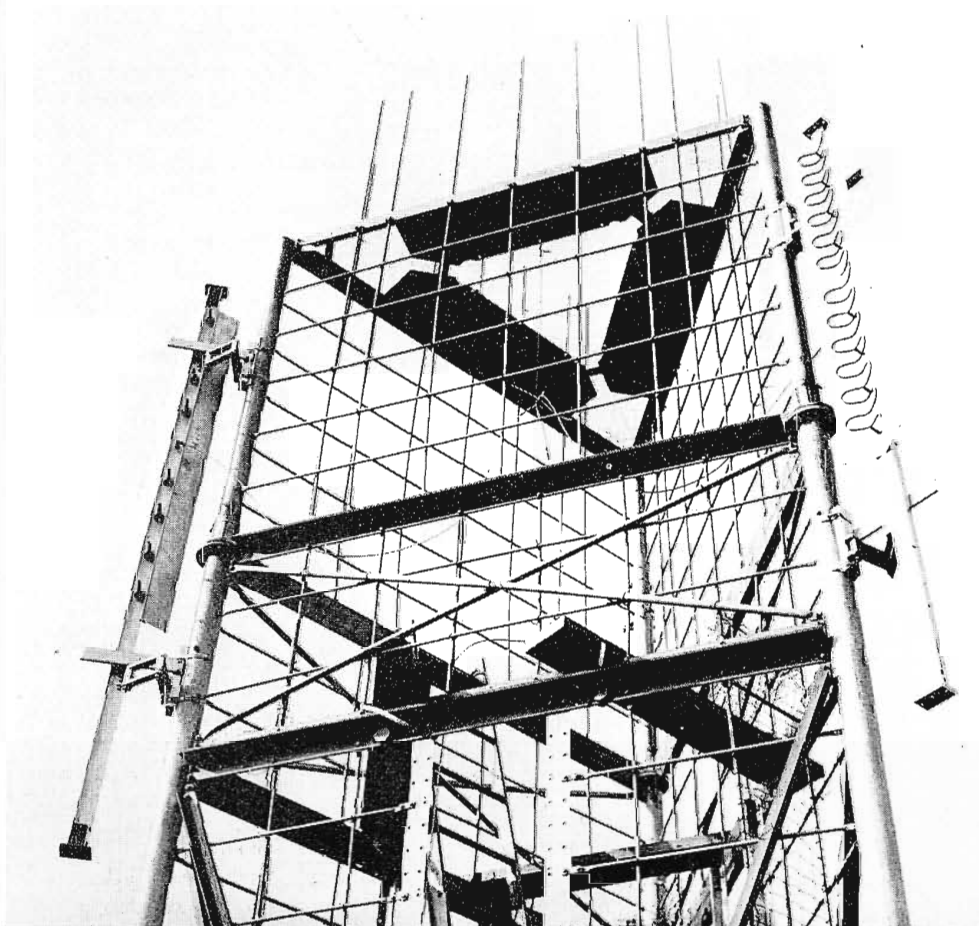


FIG. 4. Zig-zag element showing currents in segments.

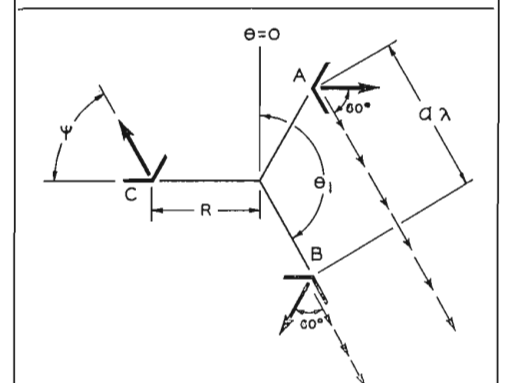


FIG. 5. Three skewed panels.  $a=n+\Delta$ ,  $\Delta=0, 1/3$  or  $-1/3$ ;  $n$ =integer,  $\psi$ =skew angle.

field of the array is the vector sum of the fields from the individual panels.

$$E(\theta) = E_A(\theta) + E_B(\theta) + E_C(\theta).$$

Defining horizontal circularity as the ratio of maximum field strength to minimum field strength in the horizontal array pattern, the following is given without a rigorous derivation. In general, three factors determine horizontal circularity. They are the magnitude of the E-field of the individual panels, the relative phase between the E-field components of adjacent panels, and the rate of change of this phase.

First consider the magnitude of the E-field of the individual panels. Because of its practical nature, a  $\cos \theta$  pattern in front of the panel and near zero elsewhere will be used. At an angle of  $\pm 60^\circ$  from the main beam direction, for example at  $\theta_1$ , in Fig. 5, the field of the single panel would be approximately 50 percent of the main beam. This gives a half voltage beamwidth of  $120^\circ$ .

The second consideration is the relative phase between the field components. The effect of this is of concern mainly near the half voltage points of the individual panels. One example of this angle is again  $\theta_1$  in Fig. 5. This phase is made up of the space phase, the feed phase, and the phase of the single-panel pattern. Measurements indicate that the phase of the individual panel pattern is relatively constant over the main beam; hence, it can immediately be neglected for this discussion. As shown in Fig. 5 at  $\theta_1$ , the half voltage points of the patterns of the individual panels should add approximately in phase. This is accomplished by setting the correct physical spacing. In Fig. 5 it is found that the equation  $a = n + \Delta$ ,  $n$  must always be an integer, and  $\Delta$  must be either 0,  $1/3$ , or  $-1/3$ . This requires the feed to be either in phase or rotating phase. For each of

these cases an optimum spacing exists. This optimum is slightly greater than the spacing given by

$$R/\lambda = a/(\sqrt{3} \sin \psi).$$

The third factor is the rate of change in the space phase of the individual panels. This is again of concern near the half voltage points of the single panels. The optimum, in practice, appears to be zero. When the skew angle is near  $90^\circ$  the rate of change has been found to be a minimum. This is also kept small by making the spacing,  $R/\lambda$ , as small as possible.

Since, in general,  $90^\circ$  is the optimum skew angle consider the array positioned around the triangular tower in Fig. 6. To show how to select the correct  $R/\lambda$  consider this example, mindful that two things that must be given are the tower size and frequency of operation. For the example, use a 7.5 foot tower and a frequency of 800 MHz. Tower sizes do not include the legs, which may have a diameter of the order of  $1/2$  foot. The feed system of the panel will also take some room. Allow an extra  $3/4$  foot for this. This gives an overall triangle size of  $8 3/4$  feet on each side. From this,  $R$  is calculated to be 5.05 feet. At 800 MHz a wavelength is 1.23 feet long. From the equation given previously,  $a$  can now be determined and becomes 7.11. This is the smallest that  $a$  can be and still fit on the tower under consideration. But to make the circularity optimum, as discussed previously,  $a$  must be a multiple of  $1/3$ ; hence,  $a$  must be  $7 1/3$ . Working backward,  $R/\lambda$  is found to be 4.23. This parameter will be used to determine the best circularity for this tower size and frequency, as will be described later.

#### Why Only Three Panels

At this point the relative merits of the *Vee-Zee* three-panel skewed array over the four flat-panel skewed array around the

same large tower will be discussed. From the pattern point of view, the main consideration is the difference in interference to the main lobe by the adjacent panels and tower. Figure 7 illustrates the situation. Note the smaller intercepted angles in the three-panel array. Hence, both shadow and reflection effects would be minimized with the three-panel array. Experimental development has substantiated the superiority of three-panel array in this respect. Further, towers being triangular, a three-panel array is easier and more economical to mount. Of course, three panels instead of four results in economical antenna and feed-system fabrication.

#### Vee-Zee Panel Development

In the three-panel skewed array, a good individual panel pattern, as described, would be a  $\cos \theta$  pattern between  $\pm 90^\circ$ , and close to zero elsewhere. This would give a half voltage beamwidth of  $120^\circ$ . The flat zig-zag panel antenna has approximately a  $(\cos \theta)^2$  pattern with half voltage beamwidth of  $90^\circ$ . In order to broaden the half voltage beamwidth, it was necessary to modify the panel. One way of doing this is to bend the panel and the element into the *V* shape shown in Fig. 8. Along with the half voltage beamwidth, the radiation toward the rear is a very important factor with the large panel arrays. Proper panel and element parameters were developed experimentally to achieve required pattern characteristics with respect to both beamwidth and minimum rearward radiation. The descriptive name of *Vee-Zee* panel came about naturally when one considers the unique shape of the element and panel.

#### The Three-Panel Array

Thus far the development of only a single *Vee-Zee* panel has been considered. Consider the array patterns shown in Fig. 9. These patterns are calculated using a single-panel pattern of  $\cos \theta$  for the main

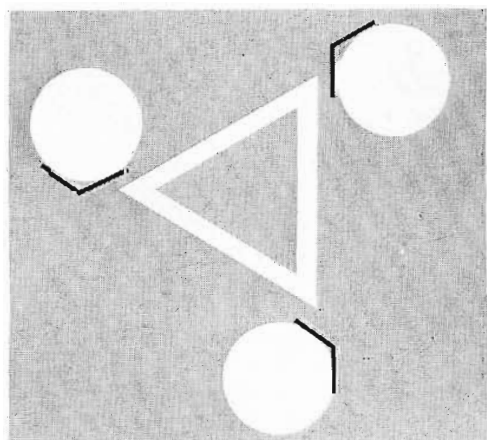


FIG. 6. Three panels skewed 90 degrees.

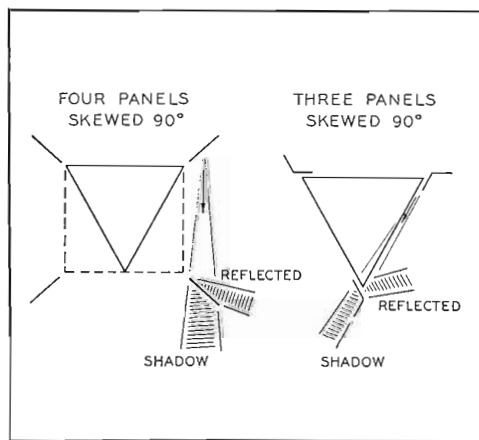


FIG. 7. Arrays showing shadows and reflections.

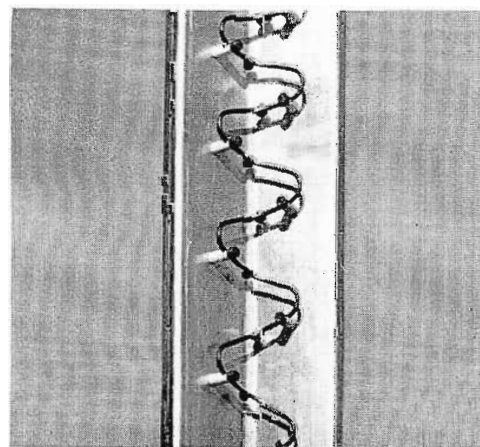


FIG. 8. Zee Panel bent into V-shape.



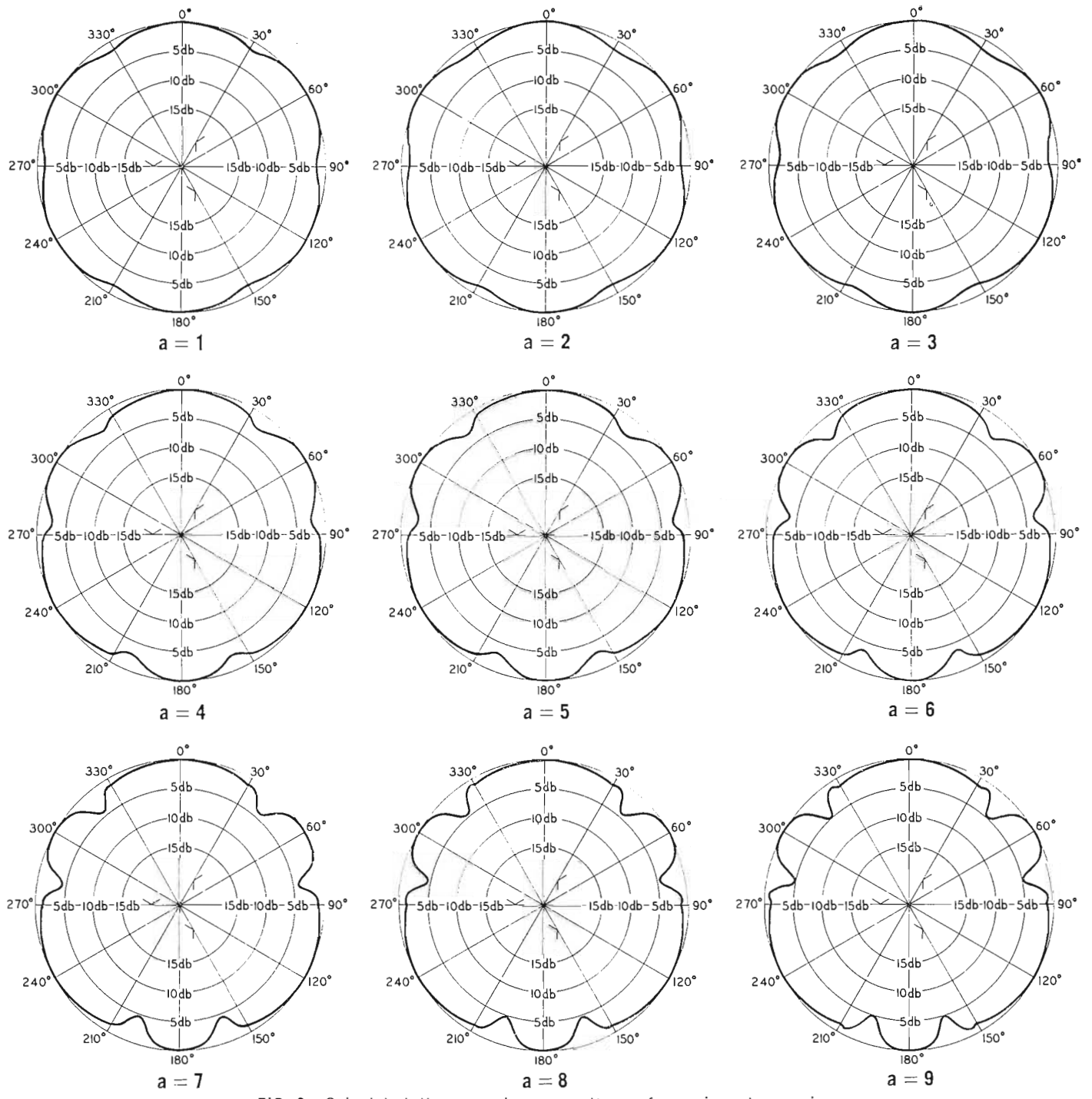


FIG. 9. Calculated three-panel array patterns for various tower sizes.

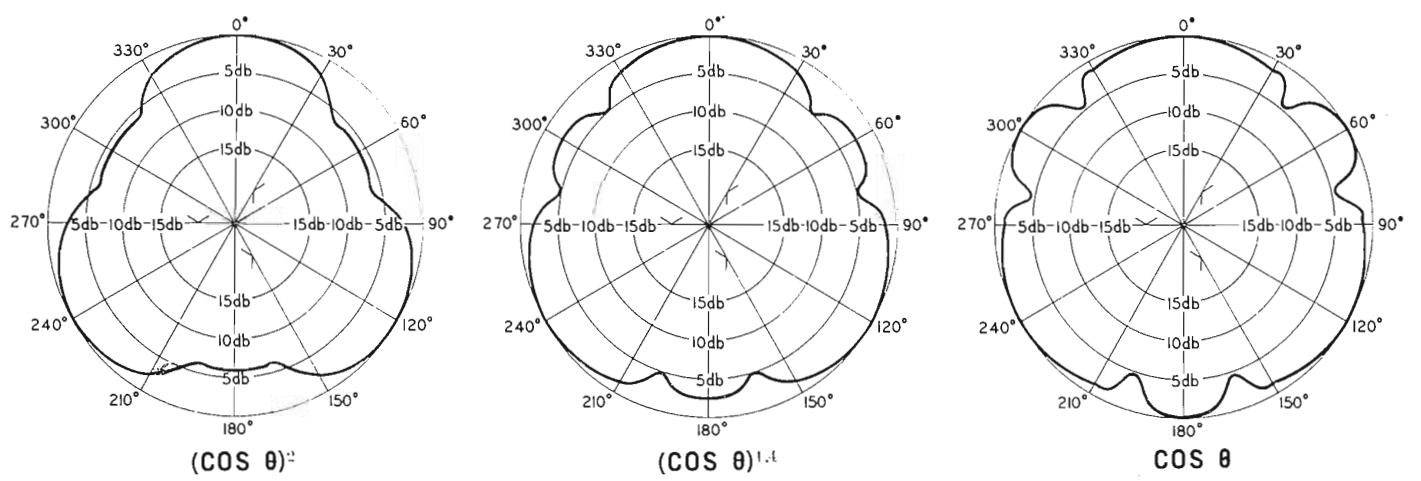


FIG. 10. Calculated three-panel array pattern using  $(\cos \theta)^p$  single panel pattern for  $a=8$ .

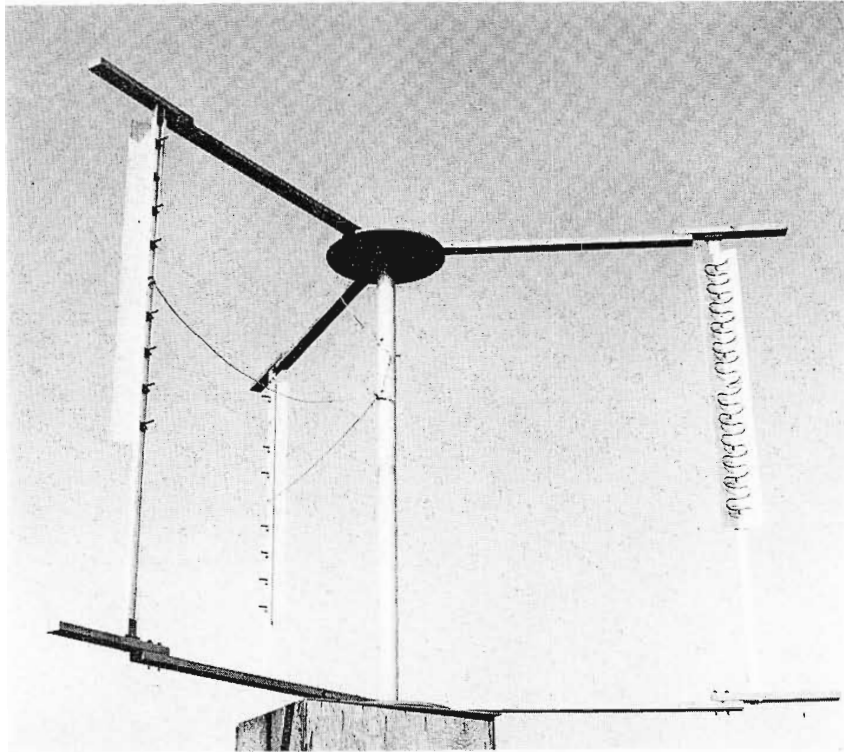


FIG. 11. Three Vee-Zee Panel models mounted around a small pole.

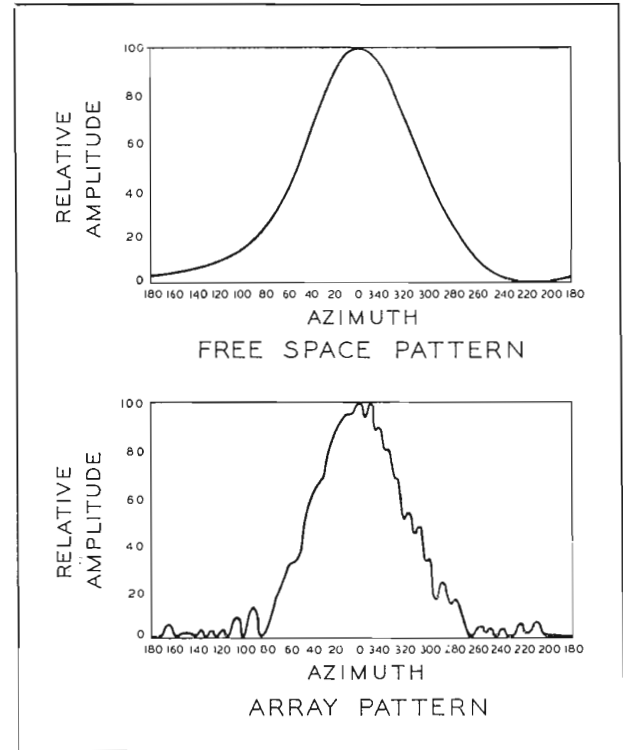


FIG. 12. Vee-Zee single-panel patterns.

lobe and zero back radiation. They are given to show the effect of spacing the panels farther apart, that is, increasing  $a$ . Figure 10 shows how the array pattern changes as the beamwidth of the single panel increases. Again, these are calculated patterns using a single panel pattern ( $\cos \theta$ ) in front, and no back radiation. Notice the better circularity obtained, and the better rms value of field intensity as the beamwidth increases. An array was constructed using the Vee-Zee panel developed previously. This array is shown in Fig. 11. The pole in the center is needed for mechanical stability, but electrically its contribution to the patterns is negligible. Figure 12 shows the effect on the single-panel pattern of putting it in the array. The ripples superimposed on the pattern in free space are caused by reflections from the adjacent panels. Note that radiation to the rear is kept to a minimum in the free-space pattern which, consequently, results in the least amount of interfering serrations in the array pattern. Patterns of the full array are shown in Fig. 13. Notice the effects mentioned previously on these patterns and that the circularities are not as good as those of the calculated patterns. For better agreement the  $\cos \theta$  equation used in the calculations would have to be modified to better represent the horizontal pattern of the actual developed panel. Also, the back radiation, as well as the reflections from the other panels, would have to be included in the calculations. Also note

that the pattern circularly improves with decreasing  $a$  or  $R/\lambda$ . This means that the panels used in an actual installation should be mounted on the tower with  $R/\lambda$  as small as possible, considering physical mounting details.

As a summary, Fig. 14 gives the circularity of a three panel array. Shown are measured and calculated circularities of the three-panel skewed array and measured circularities of a three-panel radial array. The circularity of the radial array becomes excessive even at small values of  $R/\lambda$ . A curve of the circularity of the calculated patterns shown previously, and one taking into account some of the reflections and details discussed previously, are shown. Note the close correlation between this curve and the measured circularities. As to the previously cited example of the 7.5 foot tower and 800 MHz frequency, the circularity to be expected can now be determined. At  $R/\lambda$  of 4.23 in Fig. 14 the circularity would be about  $\pm 3.9$  dB.

Figure 2 shows the array when it is mounted on a tower. Note that the tower has relatively closed sides. This tower produces additional reflections that tend to change the horizontal pattern. Patterns taken both on and off the tower using the same panel spacing,  $R/\lambda$ , are shown in Fig. 15; notice that the circularity has not changed. Other values of  $R/\lambda$  have been measured on tower structures, but no appreciable change in circularity from the

free-space circularity of the same  $R/\lambda$  were observed. The installation of Fig. 1 achieved a circularity of  $\pm 2.9$  dB while the measured curve of Fig. 14 indicates  $\pm 2.8$  dB. It would be difficult to predict the effect of every tower, since they are all different. In general, however, one would not expect any tower to produce more variations than those illustrated, since the towers are more open.

### Conclusion

In this article substantial data has been presented to assist in predicting the performance of the Vee-Zee panel when using it in an array of three panels around a tower. The Vee-Zee panel antenna has been developed specifically as a single feed point, high-gain radiator. To achieve higher gains than are obtainable with a single layer, the panels can be stacked. The Vee-Zee antenna is well suited for both top-mounted and side-mounted applications and for both omnidirectional and directional use. It can be used on both existing as well as proposed tower structures. Its simplicity of design makes it ideal in situations where minimum weight and wind-loading are required. It has an excellent impedance bandwidth which is derived from its traveling wave nature. Beam tilt can easily be accomplished electrically by properly phasing the elements, and mechanically by tilting the panels. Also, the impedance is extremely stable under adverse weather conditions.

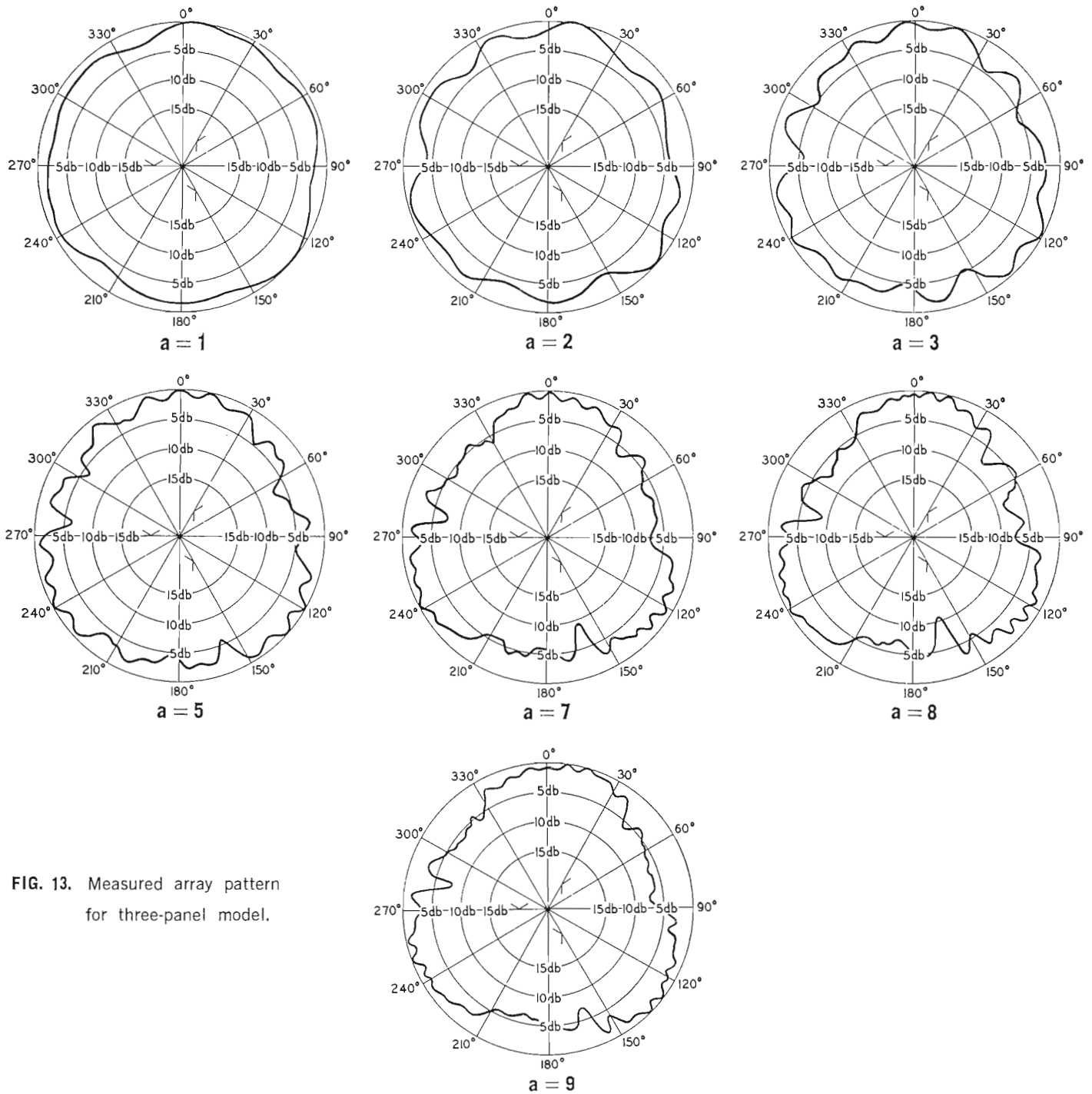


FIG. 13. Measured array pattern for three-panel model.

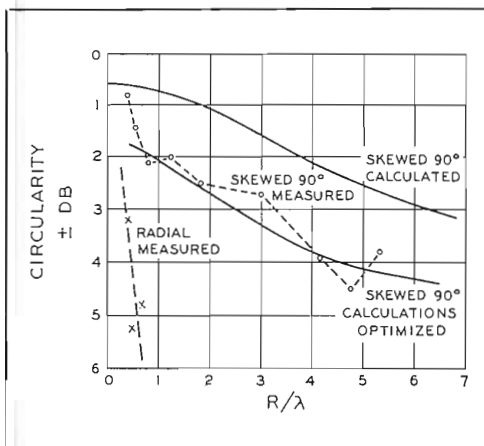


FIG. 14. Curves of circularity vs  $R/\lambda$ .

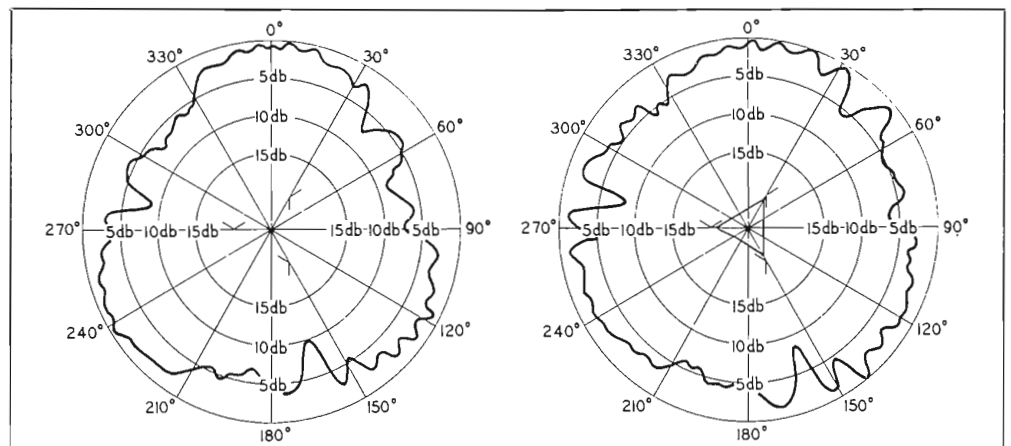


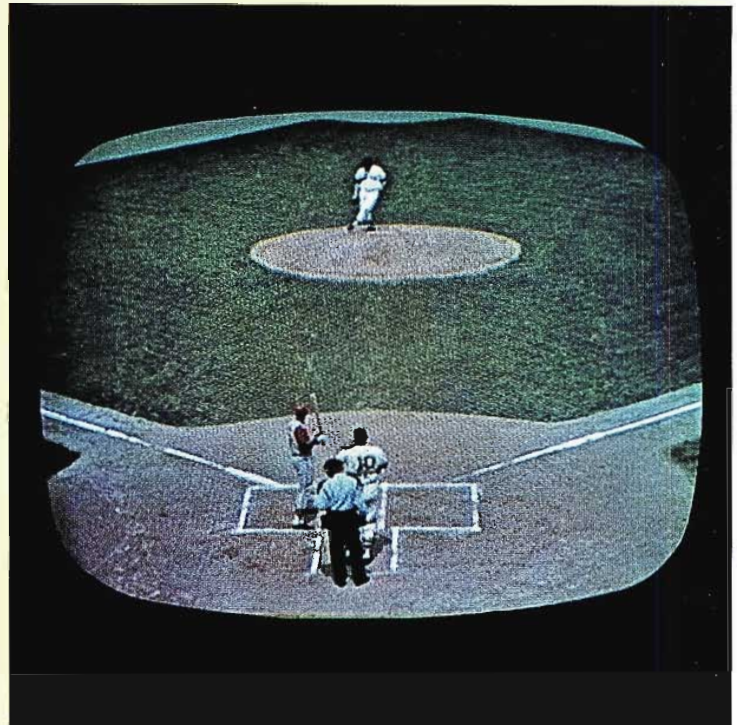
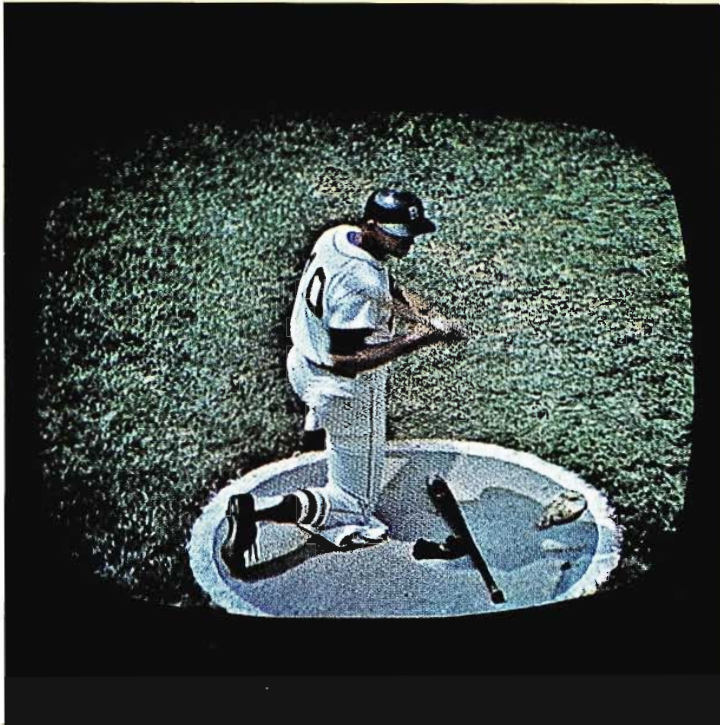
FIG. 15. Effect of presence of tower.

# BASEBALL IN COLOR... NIGHT AND DAY AT WHDH-TV, BOSTON

Four TK-43 "Big Tube" Cameras  
Pack an Extra Wallop in Red Sox Baseball Colorcasts

by PHILIP BALDWIN,  
*Vice President, Engineering,  
WHDH-AM, FM, TV*

DAY GAME SCENES . . . photographed directly off the monitor exhibit sharpness and detail of WHDH-TV's TK-43 color baseball pictures. All the scenes are unretouched and taken from high band tape recordings of Red Sox games.



The 1967 baseball season is past the seventh inning stretch. At Fenway Park four TK-43 color TV cameras have run up a grand total of nearly 1000 hours of baseball telecasting—both day and night games. In a season that had all the earmarks of an environmental test—ranging from the just-above-freezing days of April through the long hot summer—reports of excellent picture performance are a credit to both operating personnel and equipment.

WHDH-TV has completed most of the 30 scheduled home park originations (at least 14 are scheduled to be nighttime colorcasts). We have provided color feeds to stations in all other American League cities with the exception of Kansas City: WPIX-TV, New York; WJBK-TV, Detroit; WJZ-TV, Baltimore; WJW-TV, Cleveland; WGN, Chicago; KTLA, Los Angeles; WTCN, Minneapolis; and WTOP, Washington. Comments from engineers on the receiving end of the feeds have been very favorable, and they've all asked which cameras we were using.

#### Night Games Particularly Impressive

Color pictures from nighttime feeds

have created the most comment. Color is excellent, and the sharpness and detail outstanding. This holds even for our center field camera which picks up all the color and detail of the spectators sitting in the stands behind home plate. Sensitivity, under nighttime lighting conditions, has also been excellent. Average foot-candle readings as measured by our engineers (subject to camera lens) range as follows: 120 foot-candles at home plate, 100 around the infield, dropping off sharply to 60 in the outfield. Up against the deep left field wall, we've measured as little as 40 foot-candles. Having set up our TK-43 to handle this range, video operators find it relatively easy to maintain good color quality throughout the action of the game.

It is interesting to note the variable conditions encountered in a typical night contest. Normally gametime is about 7:30 or 8 P.M. In midsummer this means that the field may be illuminated by considerable daylight in the early innings. Later a combination of daylight and field light. Still later, field light alone. Handling the change in color temperature under these conditions requires close cooperation of

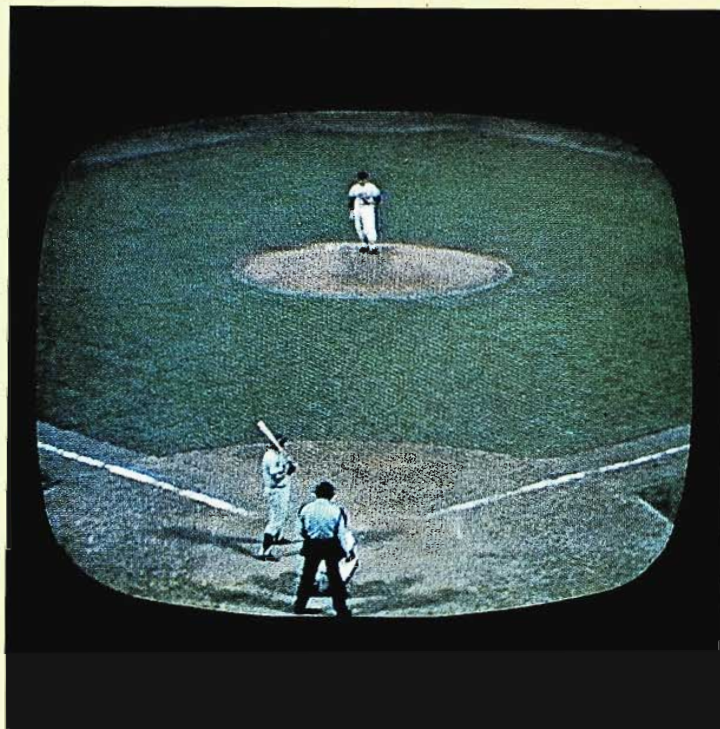
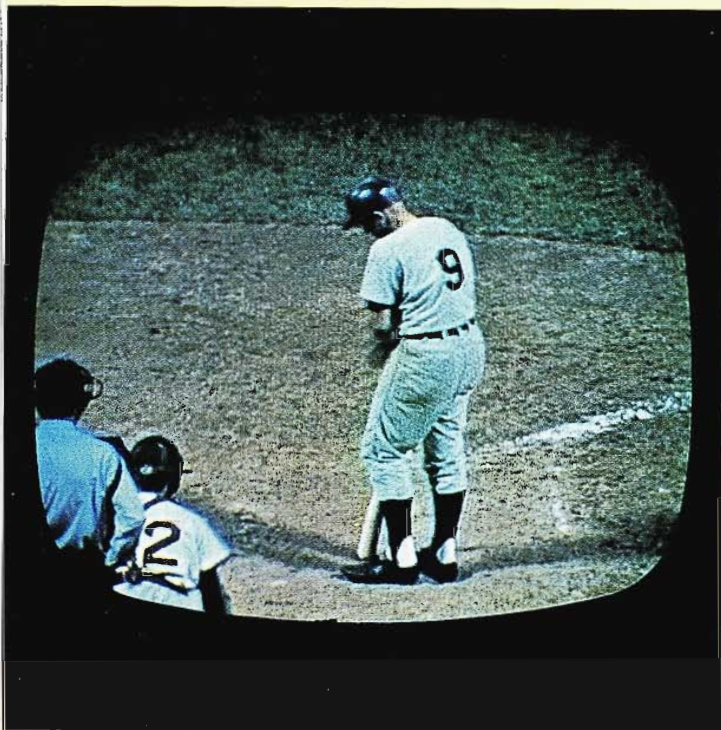
cameraman and videoman. One by one, as cameras are temporarily off-the-action, blue channel gain is turned up and red channel gain turned down. Thus the transition from dusk to dark can be made with good color balance.

The crew schedule for color nightgames is quite similar to that of former black-and-white pickups. Crew calls average 8 to 9 hours. Men report to the station at 3 P.M. and arrive at the ball park about 3:30. The next two hours are used to install lenses, fire up control equipment in the truck, and perform initial camera check-out. Break for supper from 5:30 to 6:30 and another hour with the cameras till gametime. After an exciting evening of baseball, the crew checks out at the station about midnight.

#### Day Game Advantages

Of course, we are also pleased with the results we are getting on daygames, which make up a little over half of our schedule. The ability of the camera to handle a great range of conditions—from bright sunlight to shadow—gives us the kind of brilliant color pictures we strive for. We find this dynamic range gives the video-

NIGHT GAME SCENES . . . also photographed off monitor. Note double shadow thrown by field lights. All scenes were photographed with 2¼ by 2¼ Rolieflex on high-speed daylight Ektachrome film; exposure, 1/8 second at f5.6.



man a headstart in following the action of the game wherever the camera lens may carry it. And pictures are sharp, with the kind of resolution and detail that makes the sponsors happy.

#### Camera Lineup

Four TK-43's have summertime assignments at Fenway Park. Game coverage is handled by three with a fourth serving as a spare. Camera locations are shown in the overall photo of the stadium (below)—one on a ramp suspended from the top tier of seats along the first base line, two in the press box behind home plate and one in a ground level enclosure in center field. Camera control is located outside the park in a truck serving as a temporary mobile unit. A complete 4-camera mobile unit is now being built. Camera and camera control equipment will be installed at the conclusion of the baseball season.

#### Preparations for Baseball Coverage

We received our TK-43 cameras on April 1, 1967 and did our initial colorcast of the season's opener on April 11. We had been using TK-42's in our Studio "B" since January, 1967, and personnel had adapted quite well to "big tube" operation (we had been operating TK-41's for almost ten years). In early March, the station played host to a group of about 40 engineers in an RCA conducted one-day seminar. Here about 15 members of our technical staff received instruction in camera setup and operation—generally geared to how to get best color picture performance from TK-42's and TK-43's. This experience was invaluable . . . and coupled with further RCA assistance in handling the first nightgame, gave our staff a headstart in handling what has now

become a very successful baseball colorcasting season.

#### Ten Years in Color

Colorcasting at WHDH-TV dates back to our on-air date in November, 1957. From the very beginning all locally originated programs (with the exception of remotes) were televised in color. At that time a complete complement of color equipment was installed—live cameras, film systems and video tape recorders. On this beginning WHDH-TV has since updated existing equipment and added new equipment to keep constantly abreast of latest technological developments to provide Boston area viewers with a source of finest color TV pictures.

#### Blend of Old and New

Studio "A" is the home of two TK-41 color cameras, modified over the years to their highest state of performance. Two of our first local color programs, "Bozo

the Clown" and "Romper Room" originate here. The cameras and the programs began their association nearly ten years ago, and they are all still going strong.

Studio "B" houses two new TK-42 color cameras, in residence since January, 1967. News, Weather, Sports and segments of the award winning "Classroom Five" series originate here. It is also headquarters for production and taping of local commercials. Just about all tape productions originate with TK-42's.

Color pictures from the two types of cameras are quite compatible, both having the kind of image-orthicon brilliance and sharpness that we hold as a high standard of quality. While video operation is somewhat different, our operators have no difficulty in handling control assignments for both studios. In fact all video control is centralized in an area near master control (see the photo on page 30).



Since our two studios are adjacent to one another, we are able to use any combination of TK-41's and TK-42's in either location. For special productions we have used the cameras side-by-side with good results. With reasonable production care to avoid scene-to-scene comparison, color pictures from the two types of cameras match quite well.

#### Station Break Switching

In any discussion of station operation, we like to take the opportunity to mention the use of our TSA-3 Preset Switcher. Installed about two and a half years ago, the TSA-3 is one of the best color equipment investments we have ever made. We use the equipment in the conventional manner to handle station break assignments. This has delighted master control operators during "panic periods." The equipment has been linked directly to our TS-40 switching system, so that it may also

simplify handling of complicated production switching often encountered in taping commercials. The linkage also permits operators to take over manually and return to preset conditions at will.

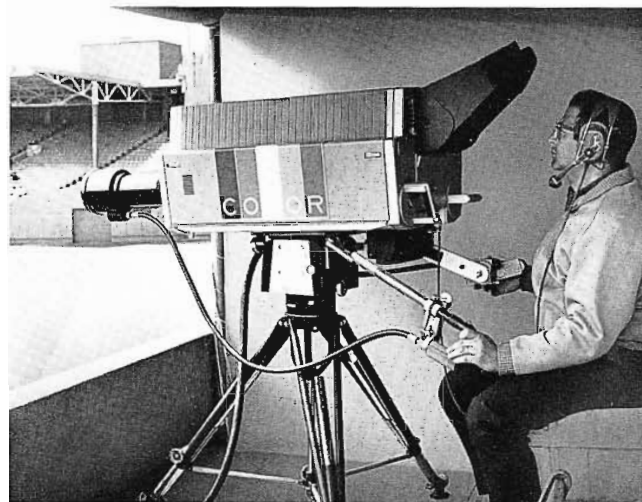
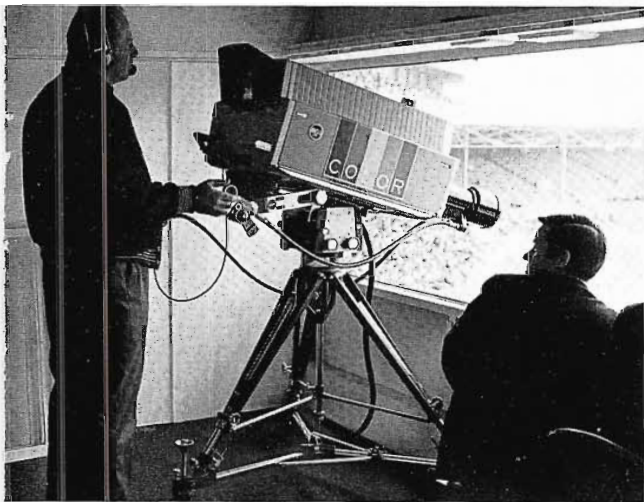
We give the TSA-3 our unqualified endorsement. We hardly know how we got along without it.

#### Unique "Classroom Five"

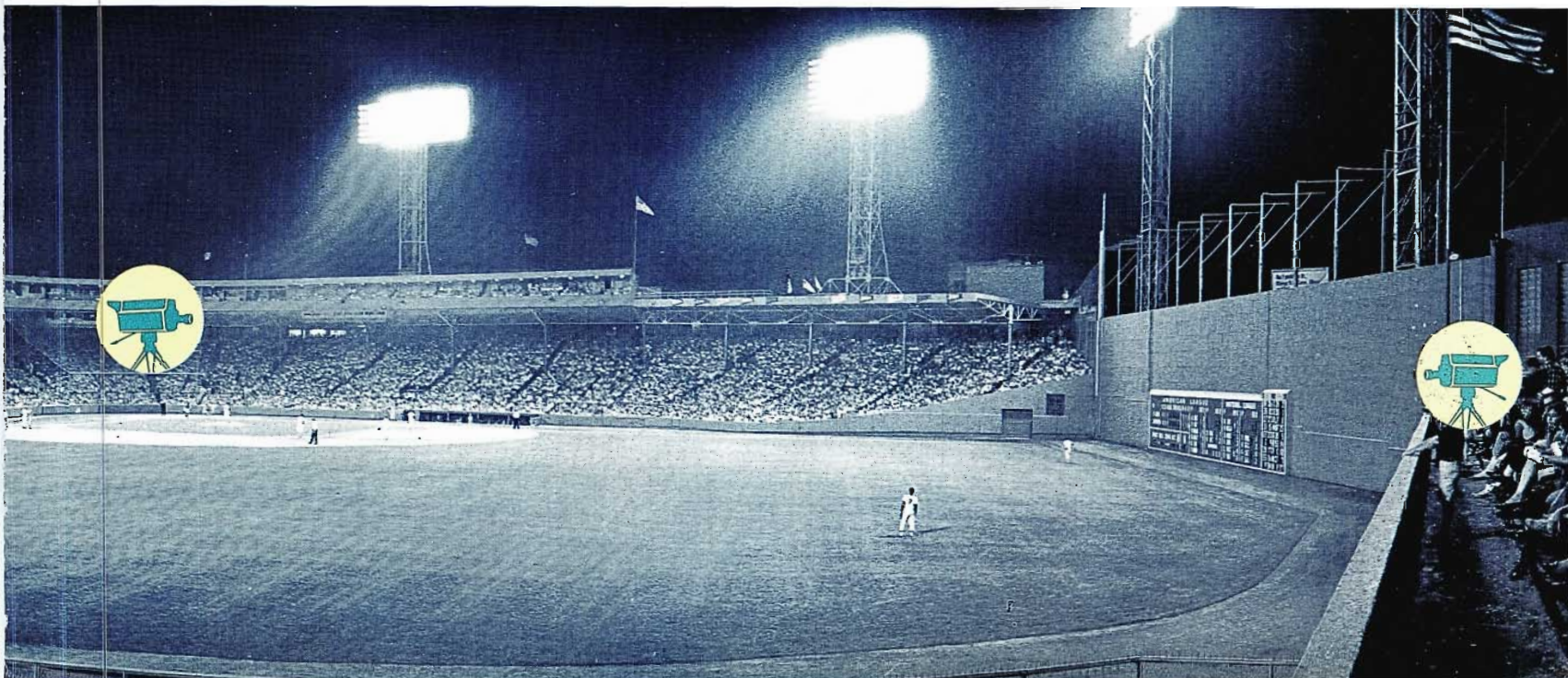
Last fall WHDH-TV initiated a series of educational colorcasts specifically produced for, and directed to, in-school education at the high school and junior high school level. The program, entitled "Classroom Five" presents leading authorities in the field of education in daily series of half-hour color presentations planned to augment regular school curriculum. These programs originate live and on tape from WHDH-TV studios—and soon also from a specially-designed mobile unit to include two additional TK-43 cameras.

The purpose and goals of "Classroom Five" are best stated in the words of WHDH-TV President, George E. Akerson in announcing the advent of this new educational series:

"We are convinced that while significant strides have been made in the field of educational broadcasting, there remains a tremendous opportunity for a commercial television station to present interesting, provocative and significant programming aimed directly at the high school and junior high school student during in-school hours. We feel we have a unique opportunity, not only to present informative and instructional programs on a wide variety of subjects, but to present programs on local school projects that have an unusual local impact in communities within our coverage area. For example, we feel that an unusually successful local science project in one school system, when



FENWAY PARK AT NIGHT . . . illustrates conditions under which night games are colorcast. Photos above show locations of three TK-43 cameras—first-base, press-box and center-field. Camera positions are keyed into view of stadium, below.



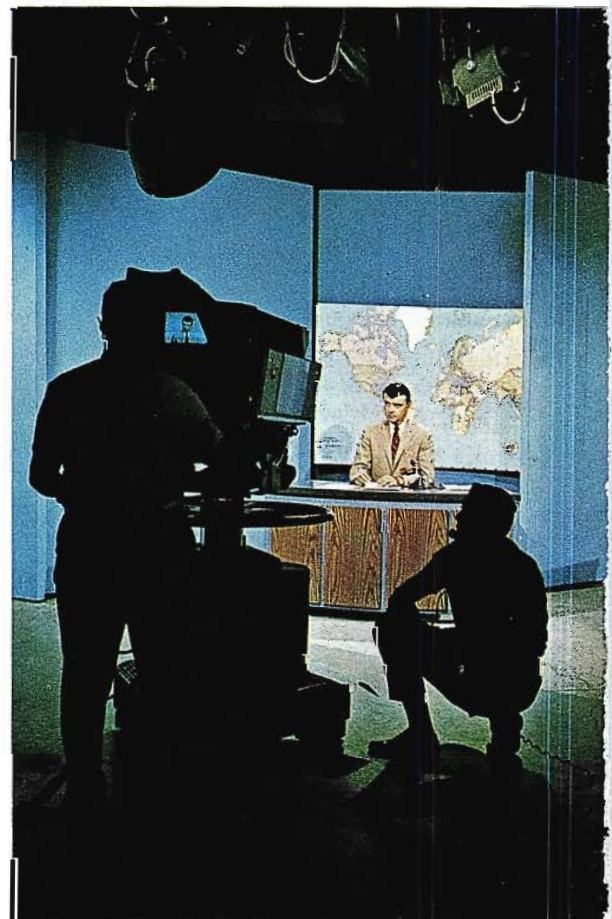
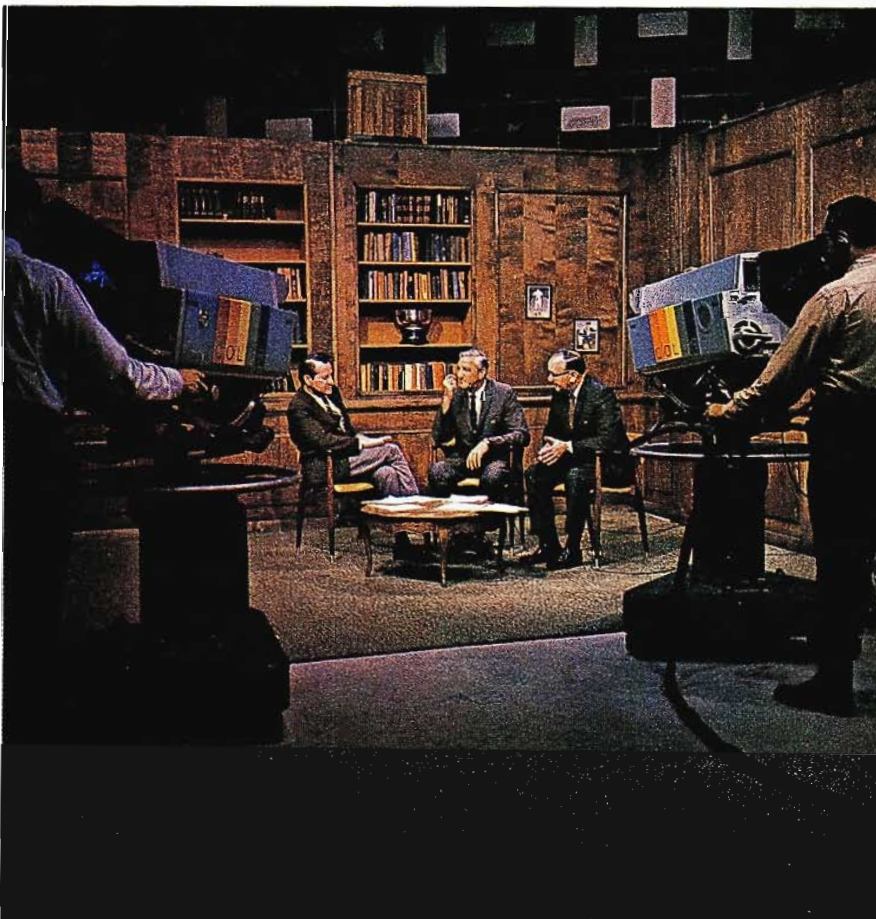
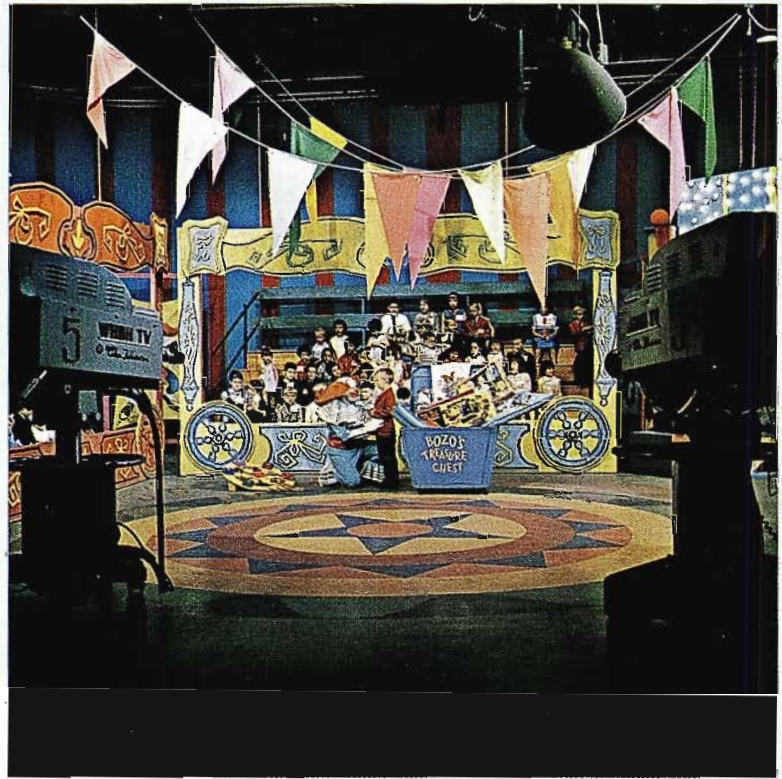
presented "live and in color" via our new mobile equipment, could be of vital interest not only to students in other areas but to educators and parents as well.

"We plan to draw on the complete facilities of our modern broadcasting plant and to augment these physical facilities with the participation and help of many of the most famous names in education, government, science and research. We hope to carry to the young people of New England information in the form of exciting television programming that will spark their imagination and assist them not only in their current school work but their college days ahead."

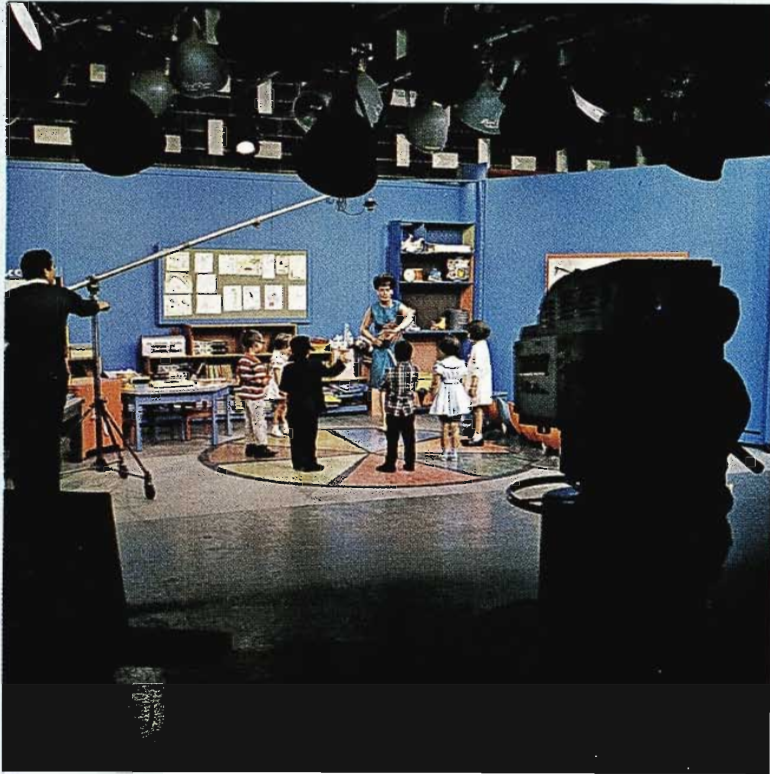
### Two New Mobile Units

Two new deluxe mobile busses to handle an upsurge of color remote activity are about to be delivered. RCA is just putting the finishing touches on them now in Camden. These units have been designed as a mobile team to operate either independently or together to handle the most complicated of remotes.

The first, and largest bus, includes four TK-43 color cameras and associated control, audio and video (TS-40) switching system, with its own air conditioning and







**TK-41's STILL IN SERVICE . . .** on programs initiated nearly ten years ago when WHDH-TV went on-air as an all-color station. "Bozo the Clown" (left) and "Romper Room" (center) began association with TK-41's in 1957. Ten years later in Studio "A", both the programs and two TK-41's are still going strong.



**TK-42's FOR STUDIO "B" . . .** where "Baseball Closeup" (left), "24th Hour News" (center) and "Classroom Five" (right) originate. "Classroom Five", a unique concept in local television, is discussed further in the article. Equipment for Studio "B", also headquarters for taping color commercials, includes two TK-42's.

**CONTROL AREA HIGHLIGHTS...** include use of TSA-3 Preset Switcher at the master control position (right) to handle both station break switching and various studio production duties. The photo below shows centralized camera controls for both TK-41's and TK-42's. The illuminated panels in the center of the photo are custom-built remote control panels for studio lighting—Studio "A" on the left and Studio "B" on the right. The photo, far right, pictures a "Tele Title" insert amplifier in action. This is used to key in color action titles in baseball coverage, announce "rain-outs", handle scores and other speedy insert jobs.





power generating plant. A floor plan diagram showing the layout of this bus is found on these pages. Summertime assignment for this bus will be color baseball from Fenway Park.

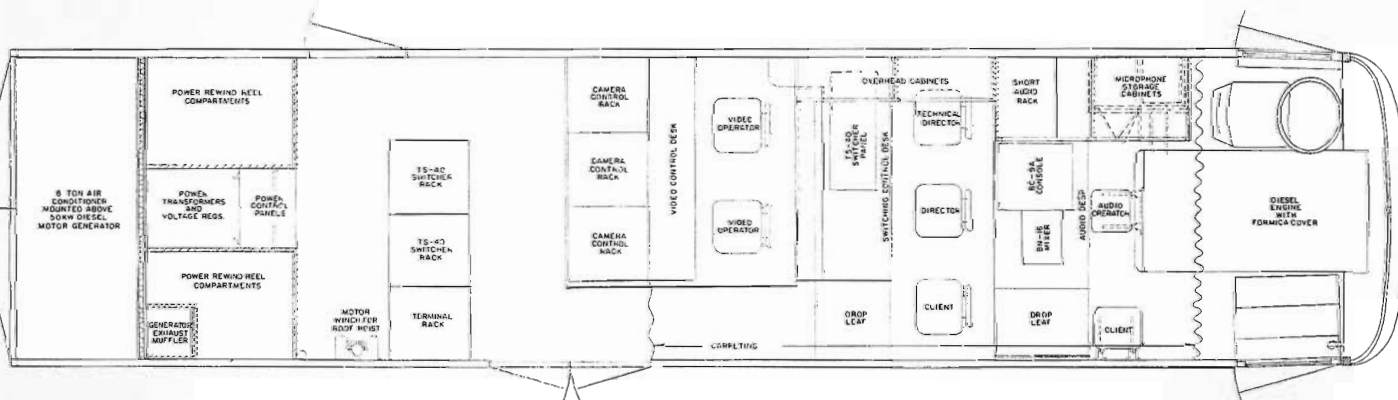
A second bus will serve as a complete mobile tape unit. It is equipped with two high-band color TV tape recorders and two TK-43 color cameras together with independent audio and video switching and power generating equipment. Assignments are already planned for this unit to tape a number of remote pickups for "Classroom Five" when it returns to the air this fall.

**Why Did WHDH-TV Select Big Tube Cameras?**

Because we saw them demonstrated . . . and we liked the pictures. Ten years of color experience has strengthened our desire for the finest, sharpest pictures available. It was this desire that led to our purchase of eight "big tube" color cameras—six TK-43's and two TK-42's—for all our live work, studio and remote.

Here at WHDH-TV we hold picture quality in the highest regard . . . and we work hard to get it.

**FLOOR PLAN . . .** of WHDH-TV mobile bus now being built. Equipment for four TK-43 color cameras will be installed after the current baseball season.



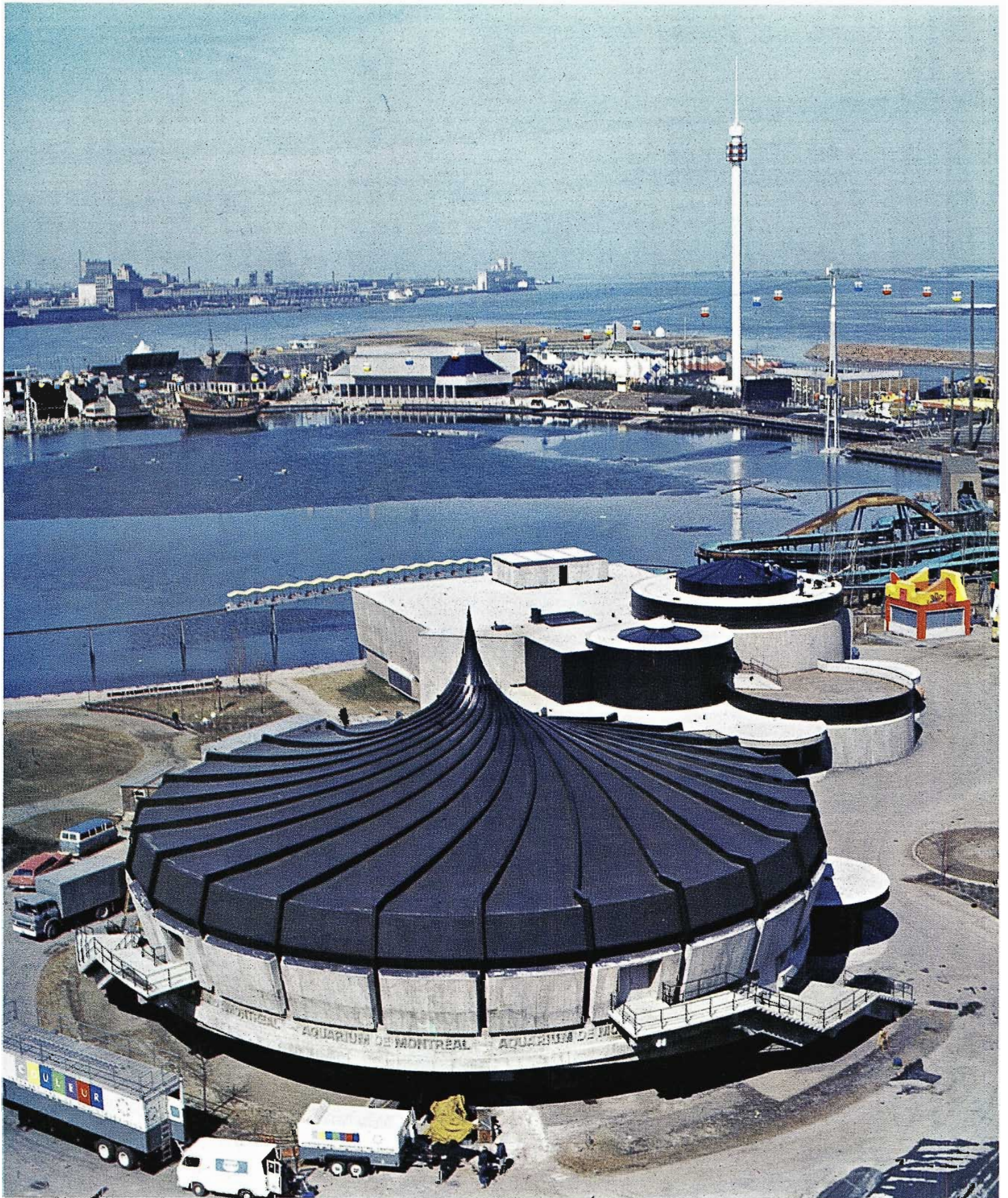


FIG. 1. Alcan Pavilion and Dolphin Pool on La Ronde together form Montreal Aquarium. Note at lower left RCA-Victor Color TV Trailer with two power supply units. (Photo: Courtesy ALCAN)

FIG. 2. Mobile pickup of the "Magic Tom" show in colorful setting of La Ronde.

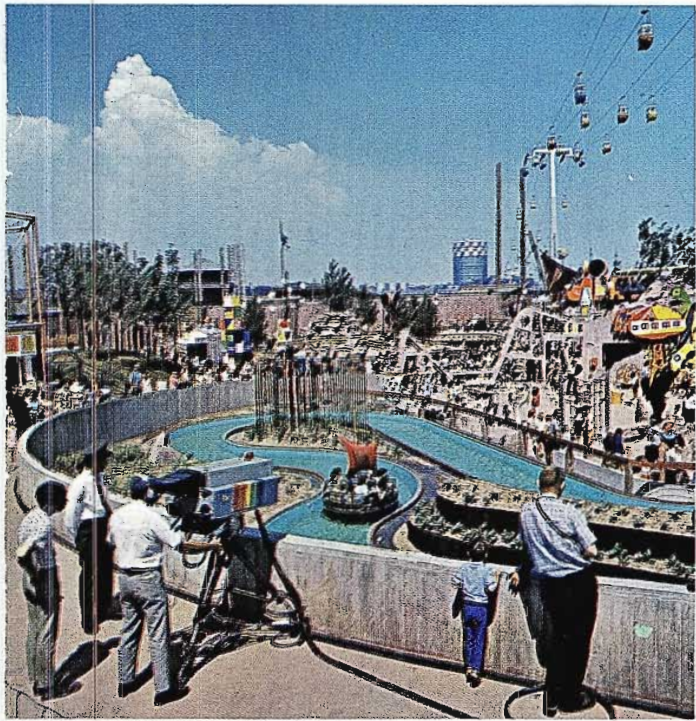
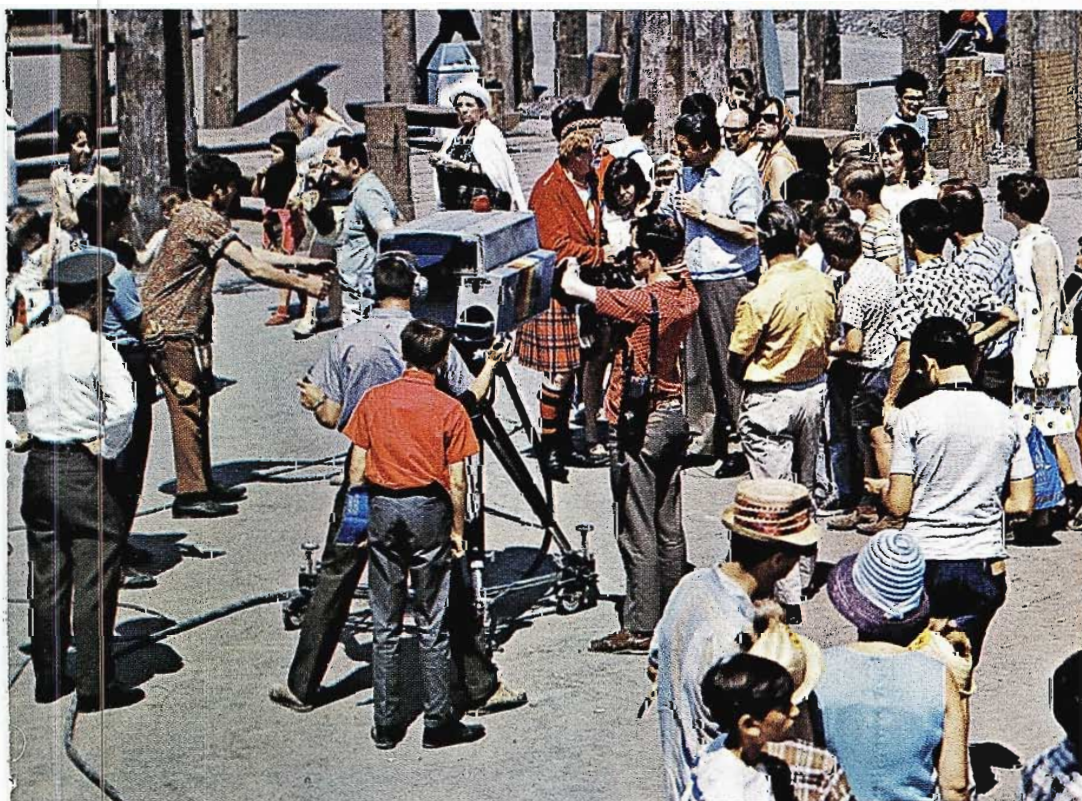


FIG. 3. CBC Color Mobile unit on location at La Ronde—the amusement area of EXPO.

## CBC COLOR TV AT EXPO 67

Two RCA Color Mobile Units and Two Full Color Studios  
Using 11 TK-42 Cameras, Explore Man and His World

by K. G. CHISHOLM, *RCA Victor Company, Ltd., Montreal*



Broadcasting, and especially TV Color Broadcasting, is playing a large role at Expo. Several of the participating nations are using color TV in various forms to charm and instruct their visitors. The Canadian Federal Government through the Canadian Broadcasting Corporation, has built a truly magnificent studio complex, known as the International Broadcasting Centre. Staffed by selections from coast-to-coast CBC locations, the Centre's director is Mr. J. W. R. (Bob) Graham; his co-director is Mr. Yves Vien.

The purpose of the Centre is two-fold:

(1) To provide a service centre for all types of broadcasting to countries participating in Expo, including Canada and the United States.

(2) To act as one of the Expo exhibits by allowing the public to see televised programs in progress from elaborate and spacious walkways which pass through both TV studios 20 feet above floor level.

FIG. 4. TK-42 Color Cameras were used to broadcast this regular feature of CFCF-TV.



Fast Action of World Champion  
Soccer Team at Autostade is  
Captured in Color By TK-42 Cameras

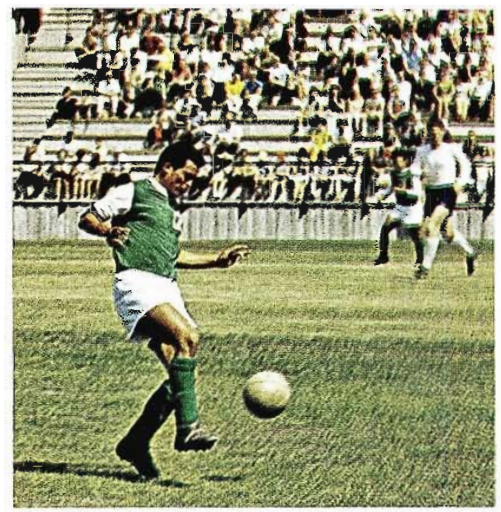


FIG. 5. To get the big view of the game one TK-42 was stationed on the roof of the press box.



A typical remote pickup is a soccer match for CTV, the Canadian privately-owned English language network. Although CBC is the sole instrument for broadcasts at Expo, CTV have program rights to sports type programs emanating from the grounds. Most of the sports programs take place in the new 25,000-seat stadium, designated "AUTOSTADE". The soccer views shown here were taken during a "round-robin" series of games between England, the present world professional title holder, and Russia, Mexico, West Germany, Belgium, and Austria. Soccer has been an increasingly popular sport in Canada and during recent years has received impetus from the large number of new citizens arriving from Britain and Europe.

#### Emphasis on Remotes

Television production which started at the beginning of 1967, some four months prior to the opening of Expo 67, has been proceeding at full capacity ever since at

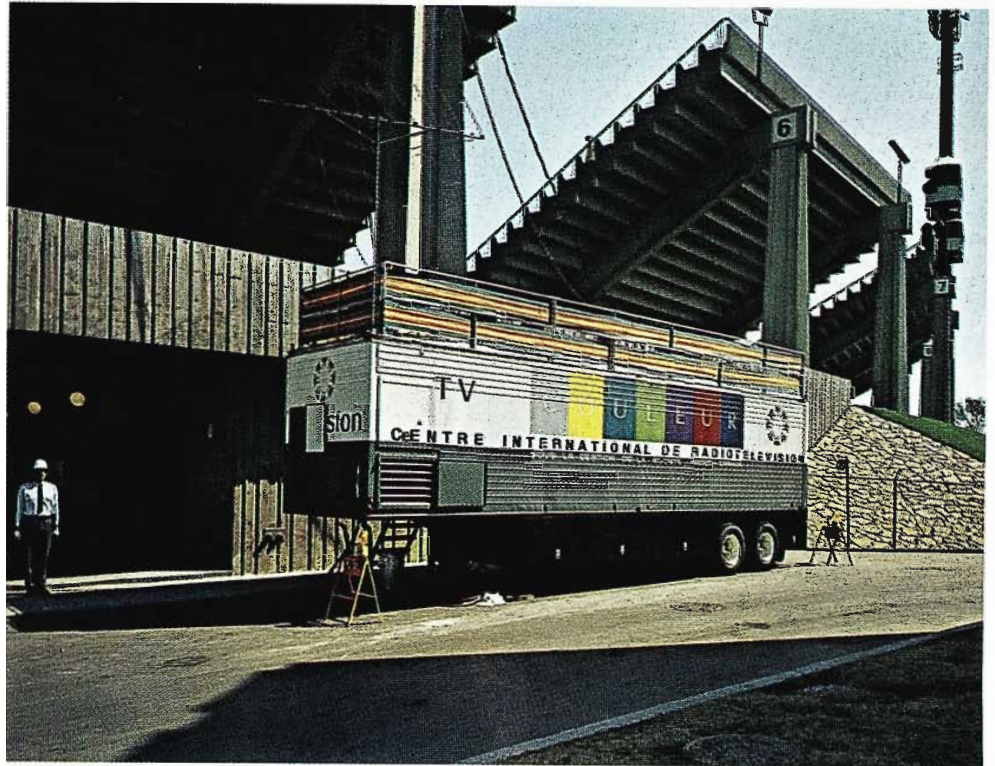


FIG. 6. An air-conditioned RCA Victor trailer, built for CBC, contained the control room for the three camera pickup.



FIG. 7. Close-up action was captured by a TK-42 camera on the field.

both studios and from the five mobile van facilities which make up the production capability at IBC (Our Dec. 1966 issue of Broadcast News described two of the mobile units in some detail.)

We are advised by Mr. Charles Kirkman, technical director of IBC, that the crews are so busy that it is difficult to free any of the mobile units for their scheduled weekly overhaul, and a glance at the weekly schedules sheets confirms the scope of the programming. If the vans are not bringing remote material from every conceivable section of the Fair for CBC itself, they are

doing shows for individual stations, or for the Canadian privately-owned network, represented in Montreal by CFCF-TV; again many shows are being fed to the U.S. networks and to networks overseas.

#### World-Wide Programming

In fact, all networks and broadcast stations of the countries represented at Expo 67 have used the Centre's facilities for radio or television, or both, at various times. On opening day live pictures from IBC were seen throughout North America, Japan and Europe including Russia. Another notable broadcast was a nine-hour

continuous live broadcast, via Satellite, from IBC to Australia.

One example of a special individual show was the Ed Sullivan show handled by an RCA Victor mobile van from the beautiful new Expo Theatre, with pre-recorded inserts done from mobile units throughout the grounds. The show was fed to CBS, and through CBS to CBC in Canada.

Another U.S. network show—the "TODAY SHOW" was also picked up in the Theatre and around the grounds and fed to the NBC network during the week of July 16-22.

International Broadcasting Centre  
 Houses Modern Facilities  
 For Colorcasting



The main facilities include two TV studios and six interview-type radio studios, a tape centre and a film room, all with individual control positions plus a combination radio and TV master control room.

TV Studio No. 1 measures 70' x 110' x 60' high with movable seating for an audience of 250. It is the largest existing CBC studio and is equipped with three TK-42 color cameras.

TV Studio No. 2 is 55' x 40' x 60' high, and is equipped with two RCA TK-42 color cameras.

Many regular Canadian TV shows are produced at the IBC facilities. The CTV Sunday night show "W-5" was aired from Studio No. 1 every week up until the middle of July. Two CBC shows, the French and English versions of "EXPO THIS WEEK" are fed to the network every week. Another weekly show by Mayor Drapeau "THIS IS EXPO" is carried over a selected list of stations via tapes. "FLASHBACK" and "FRONT PAGE CHALLENGE" popular CBC programs appear weekly over the full network from IBC. In total, an average of about 35 TV shows per week have been produced, from studios or mobile units.



FIG. 8. Interview color show emanating from Studio 2 in the International Broadcasting Centre.

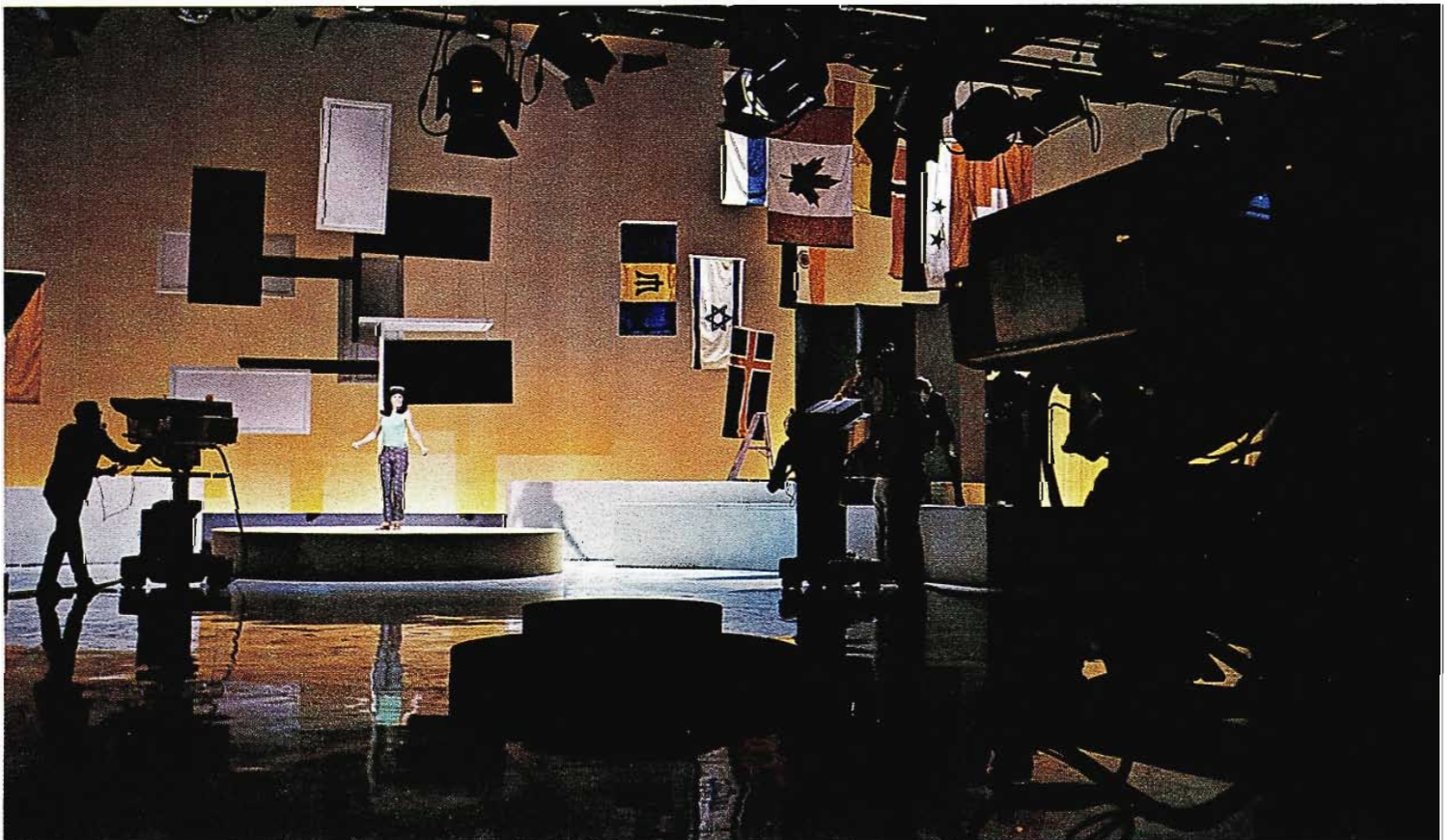






FIG. 9. Teenage "go-go" color show from Studio 1 in the IBC.

FIG. 10. Studio 1, one of the largest color studios in the world, 70 by 110 ft., with facilities that include three TK-42 Cameras.



Color TV Pickup of Canadian  
Open Golf Championship at  
Montreal Using 11 TK-42 Cameras

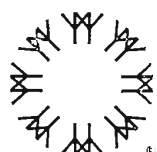


FIG. 11. Three TK-42 color cameras were used at the 18th hole. Each was located at a strategic point to pick up the action.





FIG. 12. Three Color TV Mobile Units, similar to this one near the 18th hole, were used by CBC to cover the event thoroughly.

FIG. 13. The 50 kW diesel power unit.

The \$200,000 Canadian Open during June this year, held at Montreal Municipal Golf Course, succeeded in attracting virtually every one of the world's "name" golfers. For this project, one of the color-equipped IBC vans joined others from the CBC headquarters in Toronto and Montreal to give very fine coverage from many vantage points. The IBC unit is depicted herewith, strategically parked at the eighteenth hole, where much of the action took place both during and immediately after the show. Three TK-42 cameras unobtrusively deployed around the eighteenth green and fairway were controlled from this van. Narrative was simultaneously done in English and French, a common practice with CBC especially in Montreal. The English program was fed to CBS in the U.S.A. Three RCA Victor-built vans equipped with a total of eleven TK-42 color cameras were used.



Annual Parade In Montreal  
Covered In Color By  
Both Day and Night Remote

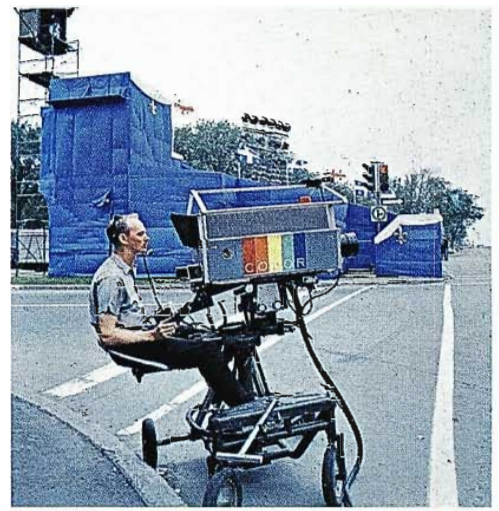


FIG. 14. Grandstand arrangements for Montreal parade. Note that "weather" is expected.



The annual French-Canadian holiday (fete) of St. Jean de Baptiste is topped off by an elaborate two-and-a-half hour parade along Sherbrooke Street in Montreal. This year the parade was broadcast live over the French-Canadian network during the evening of Saturday, June 24th and a CBC van from CBC Montreal, similar to the RCA Victor-built Expo vans was used to bring into play a total of four TK-42 cameras. A notable feature was that all power for lighting and equipment was self-generated by CBC; altogether 620 KVA of 60 cycle power was available from this source. Our views show some of the cameras and lighting banks being installed prior to the parade.

**Broadcasting Building**

The International Broadcasting Centre building, studios and equipment met their budgetted cost of \$10,000,000. with over 60% of the cost allotted to new technical equipment. The building, of modern appearance with overtones of ancient Greece, is an extremely handsome structure, 170 feet by 200 feet situated on the MacKay Pier section of Montreal Island. It is close to the entrance gates to Expo, half outside the Expo grounds proper, so that it is possible to enter it without going through the Expo gates, and half inside the site to accommodate the large number of visitors which has appeared every day since the Show opened. The visitors are conducted in orderly fashion by an attractive and intelligent staff of hostesses over the several spacious walkways where a clear one-way view



FIG. 15. Since the parade proceeds into night-time, a huge battery of floodlights were set up.

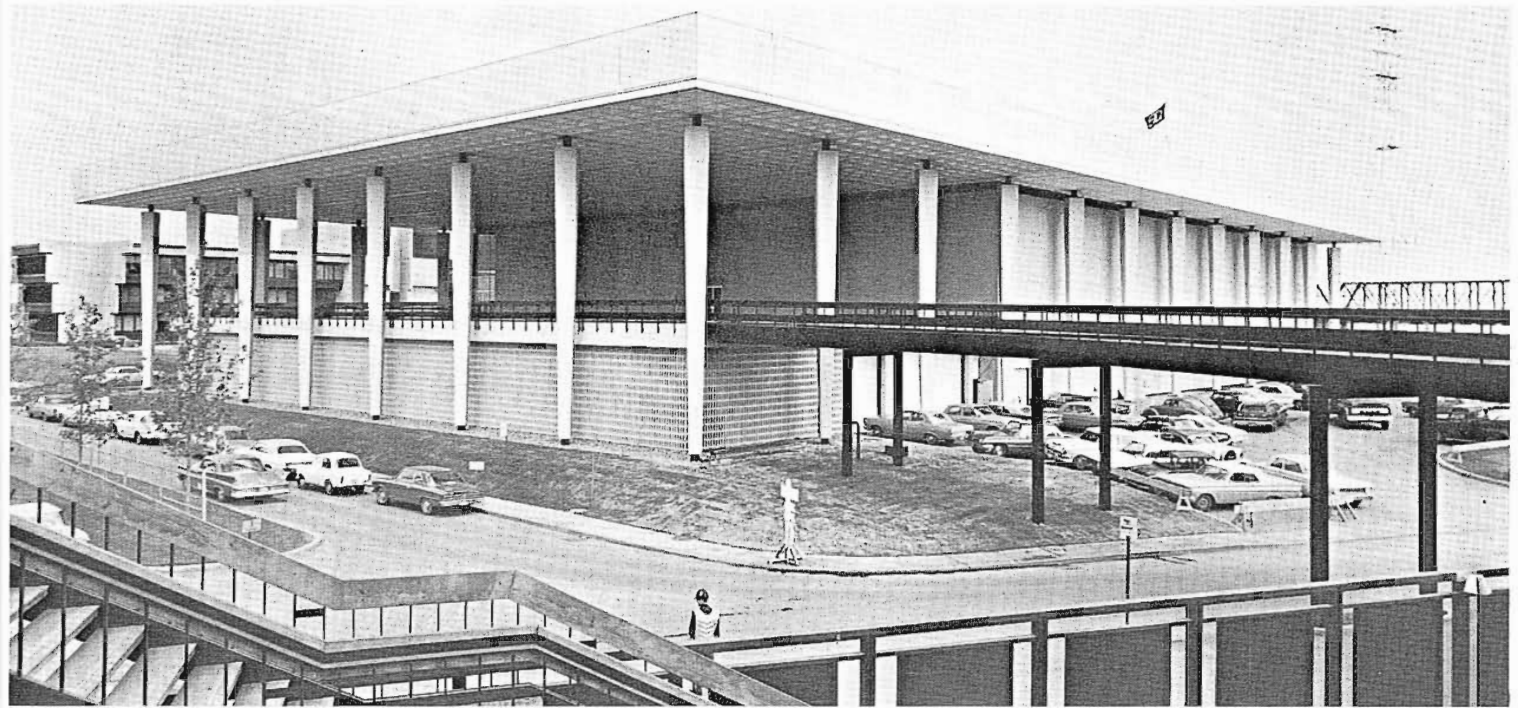


FIG. 17. The International Broadcasting Centre has facilities for radio and television which are graciously made available to broadcasters for production of shows for transmission to their home countries.

can be had of the production facilities. News and broadcast specialists who have arrived from just about every country in the world are given special attention.

#### Lighting Arrangements

A unique feature of the TV control rooms at IBC is the special method used for illuminating the front surface of the monitor cabinet wall facing the operator. A specially developed luminous paint, when excited with filtered ultra-violet light produces visible light output of the required temperature (6740 degrees K) for minimum glare, maximum visibility, and facility in color matching. Lighting capacity in the two TV

studios is 300 watts PSF. In both studios the lighting units can be changed either from the overhead cat-walk or from floor mounted ladders. In the fly section of Studio No. 1, motorized battens allow the lighting fixtures to be moved with a total vertical travel of over 35 feet.

Electronically controlled switches enable the light intensity to be adjusted with linear exactitude from "off" to "full on". Lighting controls for the color studios are located in the studio control rooms.

#### Master Control

Master control is made up of 52 standard equipment racks and a 5-section control

console. The TV master switcher is a 14-input by 10-output audio and video unit. The TV cue and monitor facilities are equipped with a 22-input by 29-output audio and video switcher. Cameras, tape units, film chains, and other video program sources are brought to rack patch-panels.

#### Special Arrangements for Broadcasters

CBC has staffed three mobile units that are available by appointment for all broadcasters. There are both monochrome and color units, with cameras and tape recorders, for production of either 525 or 625 line programs.

Anytime broadcasters outside Canada require a radio voice report or interview, the CBC international foreign language section has been available to fulfil requests.

Radio and television production services are co-ordinated through an overall "Director of Production", who has "host" directors to give visiting teams, national or foreign, advice and assistance as required.

Arrangements can be made by the Broadcasting Centre for assisting free-lance camera crews.

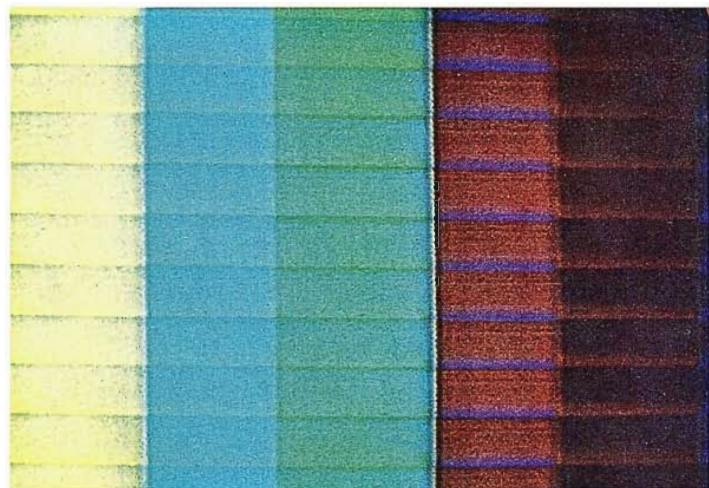
Offices, telephones, typewriters, etc. . . . as well as stenographic service, mailing, duplicating, telex and other facilities are available for visitors working on productions with the Broadcasting Centre.

To sum up the story of TV broadcasting at Expo, the eleven TK-42 color cameras are accepting their designated tasks with "flying colors".



FIG. 16. Four TK-42 Cameras were on the grounds, above the stands, and in the air, and although the day was dark, the pictures were bright.

## BEFORE-AND-AFTER USE OF "CAVEC" ACCESSORY AS SHOWN BY OFF-THE-MONITOR COLOR BAR DISPLAYS



**FIG. 1.** Velocity Error Display

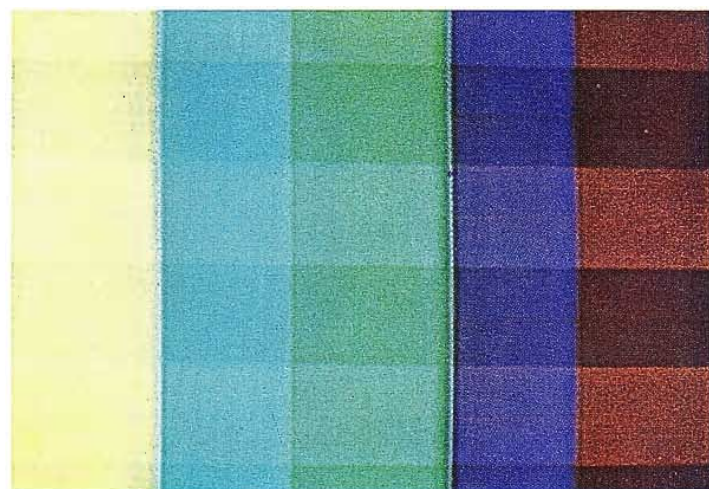
*These color bars were photographed directly from the video monitor and printed here without retouching. The white and blue bars missing from the left and right sides of the display reproduced poorly, and were eliminated to avoid confusion.*

**EFFECT**

IMPROPER HUE  
HUE BANDING

**CAUSE**

VARIATIONS IN HEAD  
SCANNING VELOCITY  
DIFFERENT MACHINE  
TAPE TENSIONS  
INCORRECT GUIDE HEIGHT  
ADJUSTMENT  
DIFFERENT MACHINE  
FIXTURE POSITIONS



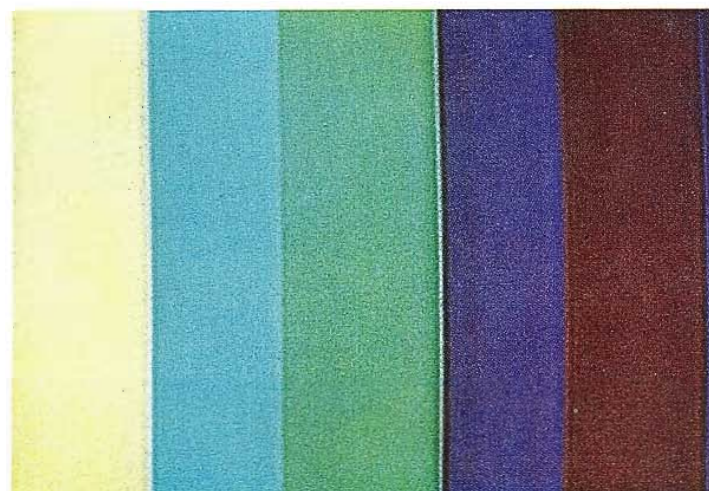
**FIG. 2.** Saturation Error Display

**EFFECT**

VARIATIONS IN COLOR  
SATURATON OR VIVIDNESS  
SATURATION BANDING

**CAUSE**

CHANGES IN CHROMA  
AMPLITUDE BETWEEN  
HEADS  
TAPE IMPERFECTIONS  
TAPE-TO-HEAD CONTACT  
FLUCTUATIONS



**FIG. 3.** CAVEC Corrected Display

All evidence of color errors have disappeared in this display of corrected color signals. Line by line, the electronic circuitry of CAVEC has corrected for the velocity errors of Fig. 1 and the chroma amplitude errors of Fig. 2. Correction as illustrated in Fig. 3, is automatic and effective for practically any magnitude of error.

# TR-70 "CAVEC" ACCESSORY ASSURES CONSISTENT, HIGH QUALITY COLOR TAPE REPLAYS

by PETER A. DARE  
*Television Tape Merchandising*

New Plug-in Module  
with I-C and Computer  
Logic Circuitry  
Completely Eliminates  
Color Hue and  
Saturation Banding

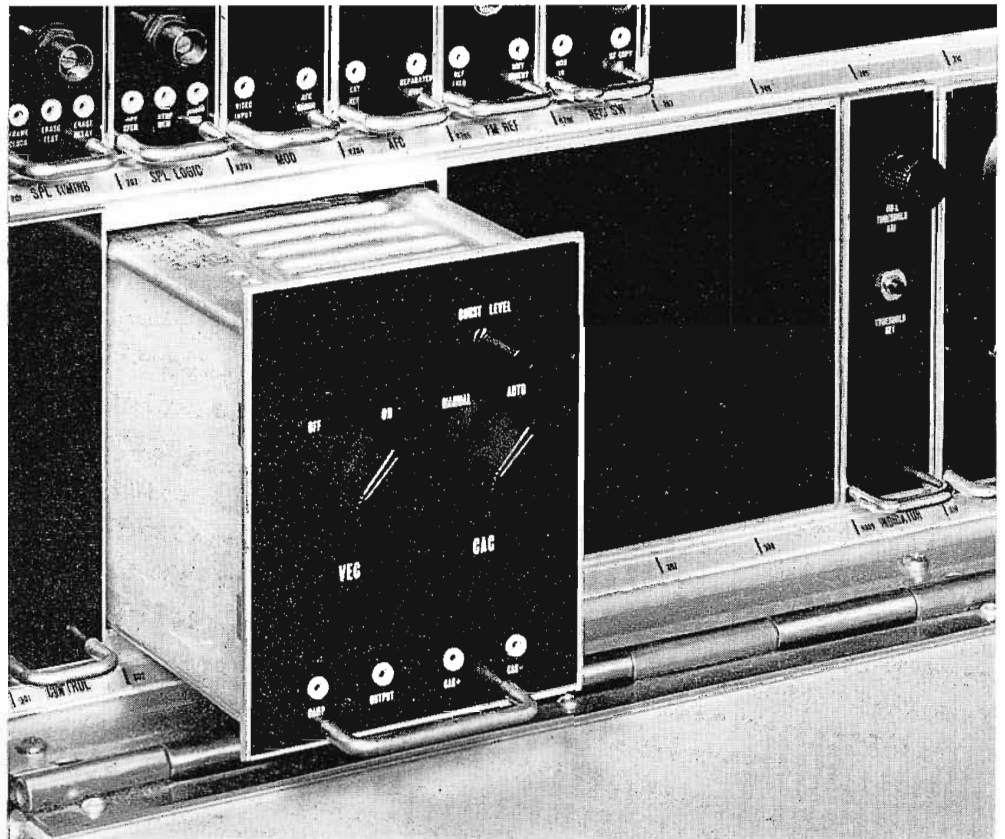


FIG. 4. CAVEC (Chroma Amplitude and Velocity Error Corrector) installed in module bank below tape deck.

The RCA Chroma Amplitude and Velocity Error Corrector, known as "CAVEC," is a new TV tape accessory designed to eliminate the familiar saturation and hue errors often seen when replaying color tapes. CAVEC is most beneficial to anyone who needs to produce multiple copies of programs, or who receives large numbers of outside tapes and desires to maintain consistent quality of replay. It permits inter-splicing of tapes recorded on different headwheels without the need for changing channel equalizer settings. Even on PAL color standards, where the system may be more immune to phase errors, CAVEC will prove desirable when making dubs and

normal replays, especially in situations where simple PAL decoders are employed. Choice of 3.58 MHz or 4.43 MHz sub-carrier operation is accomplished through the normal machine logic.

#### Color Banding Compensation

The two major types of errors for which CAVEC compensates are hue shifts and saturation variations. These errors are produced by mechanical and operational deficiencies that cannot be eliminated by normal machine adjustment. These deficiencies are inherent in this type equipment and have existed since the introduction of quadruplex tape. It is only during

color operation that their effects on tape quality become apparent in the form of color banding, as seen in Figs. 1 and 2. Banding usually occurs during the passage of one head over the tape surface, this corresponding to 16 or 17 line intervals.

Hue banding is commonly referred to as velocity error. It results from differences in head scanning velocity between the record machine and the playback machine. This can be caused by many small factors, some of which might be different tape tension between record and replay machines, different positions of some of the fixtures on the tape transport or incorrect guide height adjustment.

Chroma or saturation banding is the result of differences in head-to-head frequency response, tape surface variations and tape-to-head contact differences. The effect is a change of chroma amplitude between the heads, as well as a saturation change within any one head. In simple terms, the chroma amplitude varies from one line to the next. This requires compensation on a line-by-line basis. Manually it is possible to correct for only individual head scan or 16 line intervals, thus the correction is only an averaging for line to line errors. Electronic compensation, however, is capable of correcting the actual error, line by line.

### New TV Techniques

While formulating the design of CAVEC, it was estimated that over 700 transistors would be required (nearly half as many as in the TR-70). This, of course, posed a problem of space and eventually dictated use of integrated circuits and new module construction.

The new module took the form of a frame which will hold up to 35 small circuit boards. One of these boards is shown in Fig. 6. There are eight I-C's on this card representing about 65 transistors. Interconnection between the small circuit boards is achieved by "back plane" wiring and wire wrap techniques that can be programmed to permit computer control as well as complete self checking against assembly errors.

### Dual Correction

Correction for hue shifts and for saturation changes are two entirely different processes that are carried on with CAVEC at the same time as indicated by the functional block diagram of Fig. 8. Those familiar with computer logic design will recognize parts of CAVEC circuitry. However, to much of the TV industry, the techniques and nomenclatures may be new.

### Velocity Error Correction

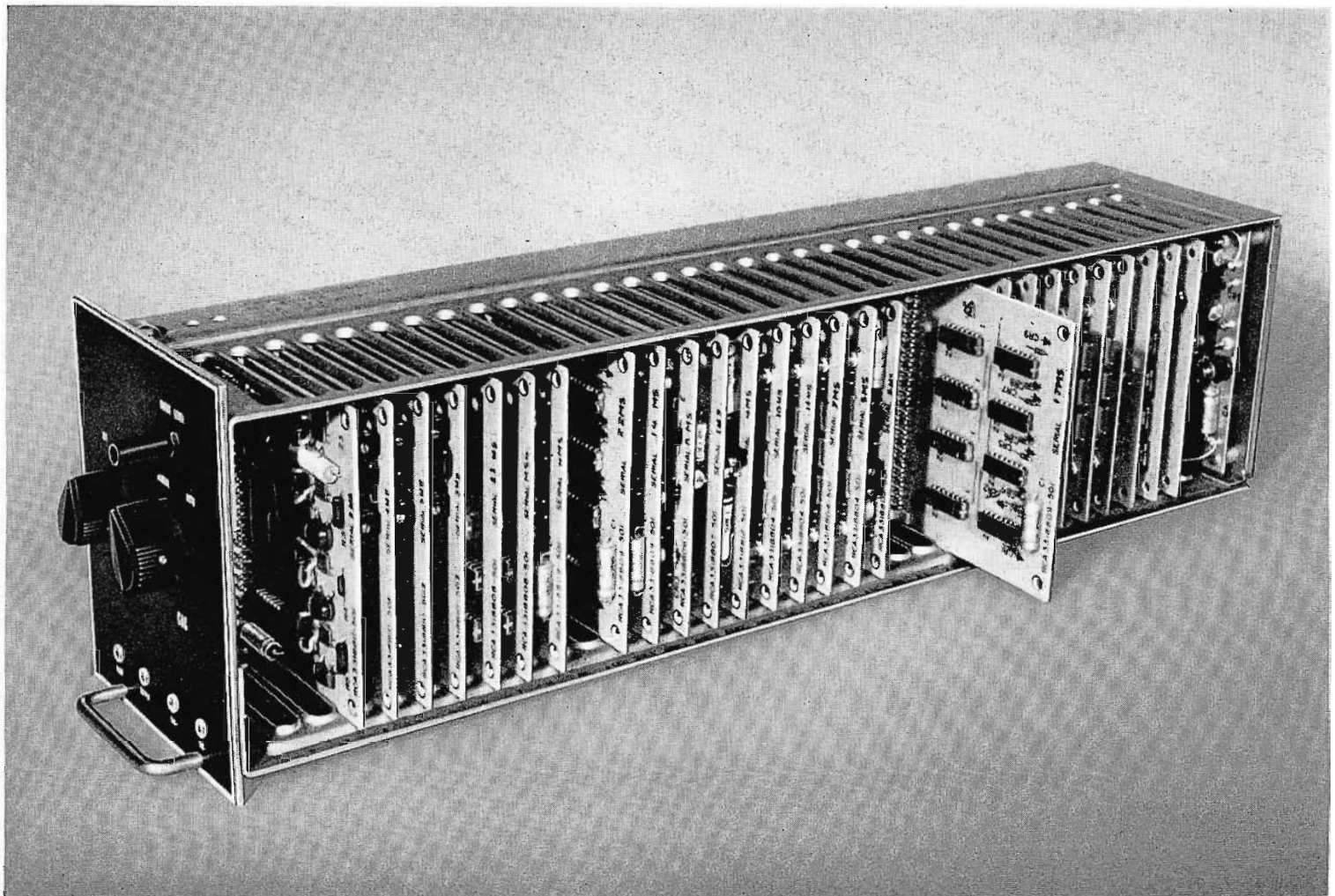
The action of correcting for hue shift, or velocity error in a typical tape playback

system having monochrome as well as color automatic timing corrector circuitry (MATC and CATC) is depicted in Fig. 9. The velocity error corrector measures the differences in timing error from line to line, then generates ramps proportional to the differences and adds these ramps to the original monochrome ATC error signal. This results in continuous rather than staircase correction as illustrated. MATC and CATC signals are both necessary since they indicate the error at the beginning of each TV horizontal line. These error signals are stored in a 64 element store for a period of one complete head revolution. Through a process of "reading" and "writing," the stored error signals are used to form the continuous error signal that modulates the ATC delay line one head revolution after the error signal was derived.

### Chrominance Amplitude Correction

Saturation changes produced by chrominance amplitude errors are corrected by first sampling the color bursts and then

FIG. 5. Modular plug-in frame and solid state plug-in circuit boards provide ease of inspection and service.





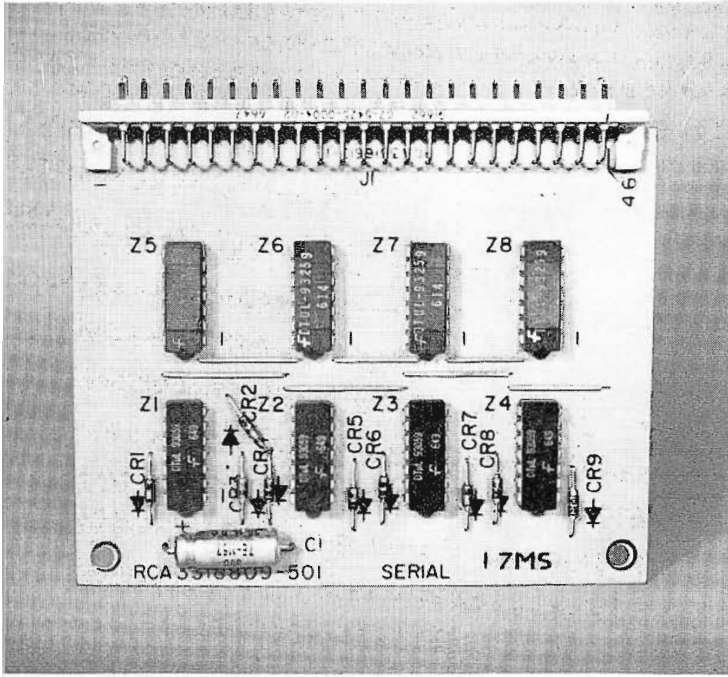


FIG. 6. Front view of plug-in board showing integrated circuitry that contains up to 65 transistors per card.

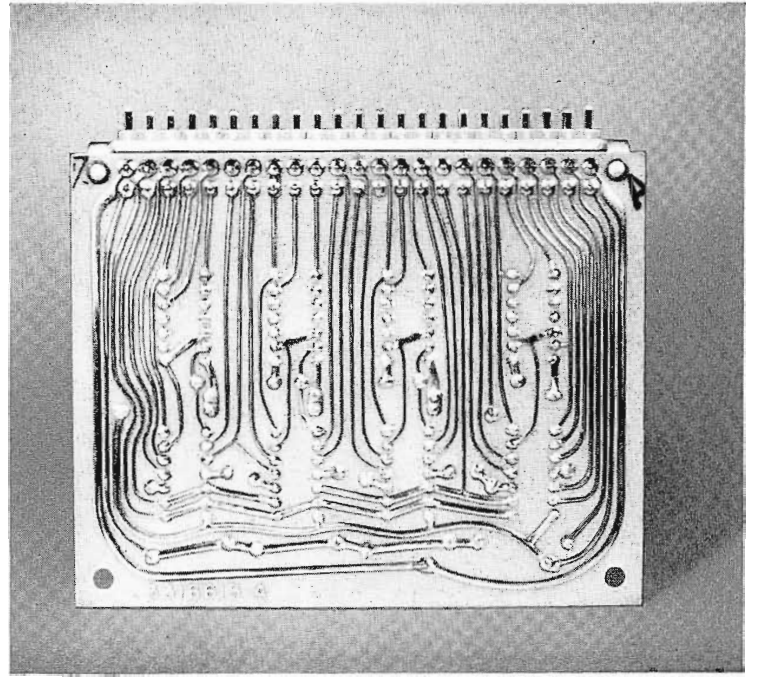


FIG. 7. Wiring interconnections on rear of circuit board.

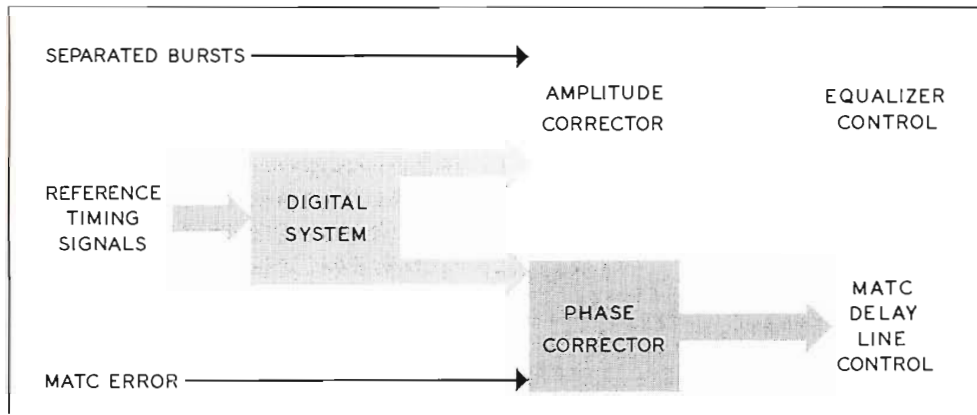


FIG. 8. Block diagram showing principal functions of CAVEC.

FIG. 9. Block diagram of velocity error corrector circuitry.

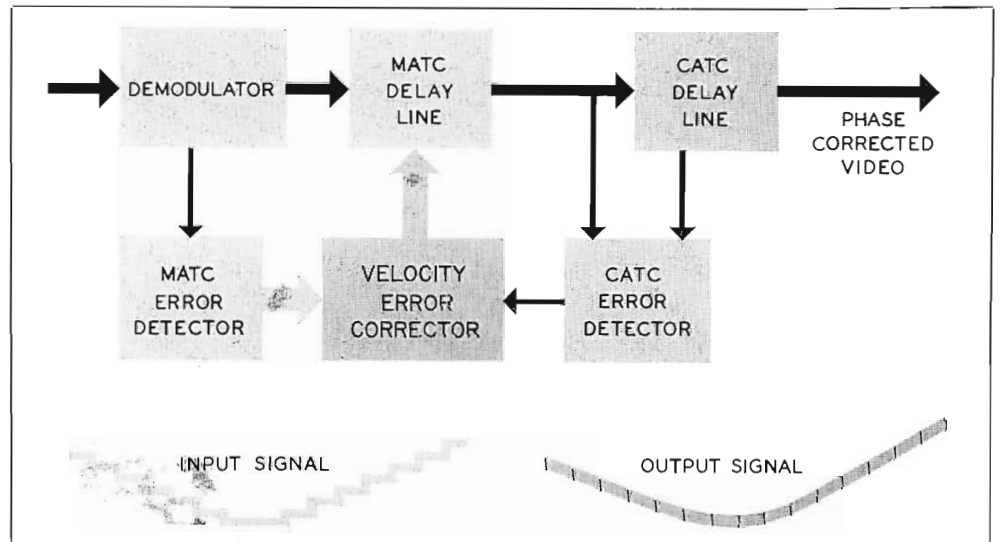




FIG. 10. Super deluxe TR-70—pinnacle of TV tape performance and operating convenience.

comparing the level to a reference. The error signal derived from this comparison is used to control the FM equalization of the playback signal (see Fig. 11). As a simple analogy, the Chrominance Amplitude Corrector may be compared to an automatic gain control loop in that it attempts to maintain burst level constant. In this loop, however, gain control is exerted by varying the FM equalization of the tape playback system. This causes a change in the sideband-to-carrier energy of the burst in the FM domain and results in demodulated burst level control. In this system, instantaneous burst levels are corrected on a line by line basis.

Adequacy of chrominance amplitude correction depends upon the magnitude of instantaneous burst level deviations from the line-by-line average, and upon the ability of the burst level to represent the FM equalization requirements for all chrominance information. Tests show that the same degree of chrominance correction is achieved for all colors in the color bar test signal as is achieved for the burst itself, as long as there are no differential gain variations from channel to channel. Also, instantaneous variations of burst amplitude are averaged out by the viewer and in no way degrade color correction as long as these signals are not distorted by the chrominance amplitude corrector.

### Digital Timing System

The dual role of line-by-line control in each of the correction mechanisms is a switching function that operates on a time base provided by the integrated circuit digital system diagrammed in Fig. 12. Comprising 71 I-C, dual in-line chips of the DTL (Diode Transistor Logic) family and eight transistor stages, this system operates in support of analog switching circuitry by setting the time as well as drive to these switches. Four machine timing signals are utilized. The  $4 \times 2$  and  $2 \times 1$  signals form a two wire logic identification of head switching in the quadruplex headwheel of the tape recorder. The tape horizontal and tape vertical signals are developed from tape playback, and respectively, they identify the beginning of each horizontal line and the vertical interval. One of the two X-Y decoders is used to drive the chrominance amplitude corrector memory, the other drives the velocity error corrector memory.

### Splicing Simplified

CAVEC will permit the splicing together of two sections of program material recorded on different headwheels. Normally, if this were done, a change in the individ-

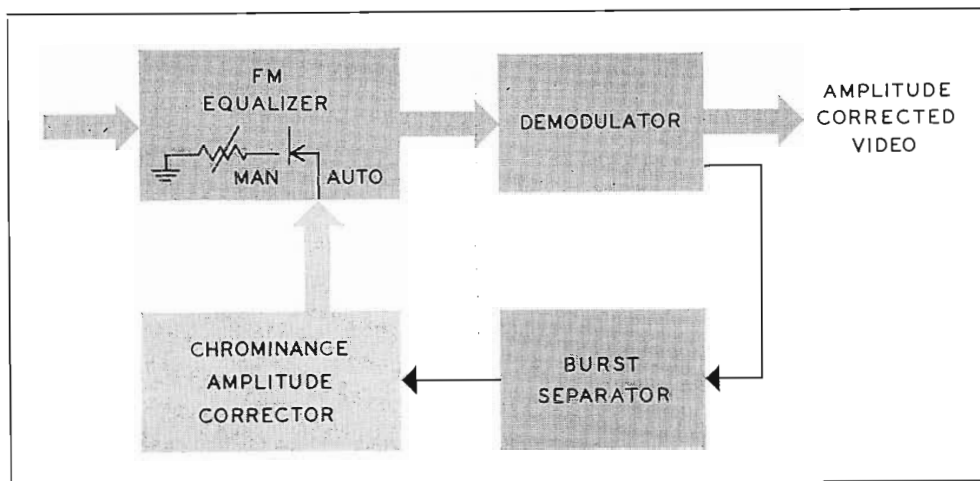


FIG. 11. Block diagram of chrominance amplitude corrector circuitry.

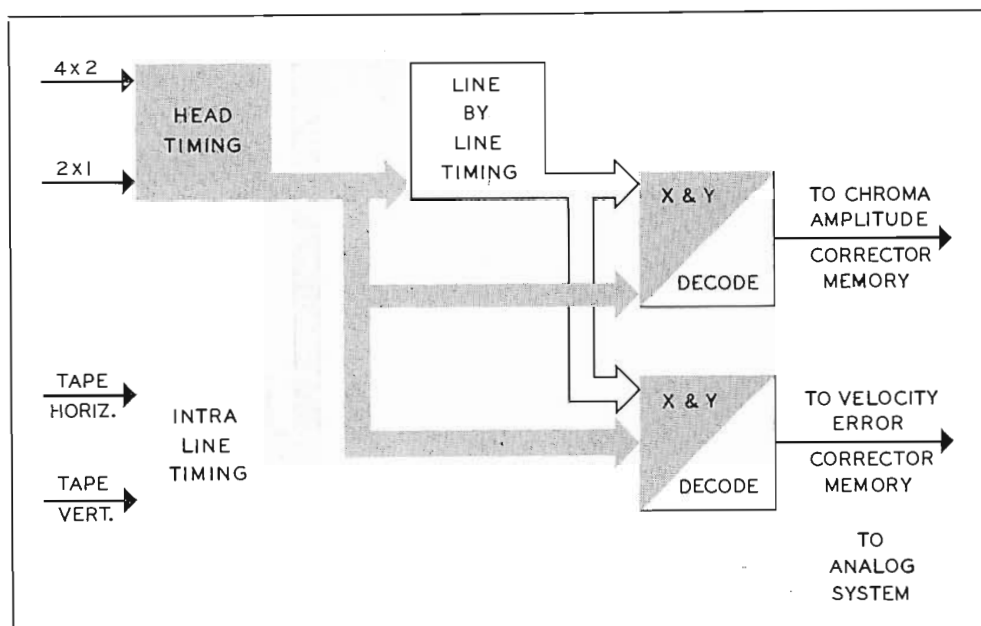


FIG. 12. Block diagram of digital switching system.

ual head channel equalizer settings would be necessary at the splice point. With CAVEC, the re-equalization is performed automatically within a fraction of a second.

### Simple Installation and Set-up

CAVEC can be installed on any RCA high band machine with slight modification to the FM equalizer and CATC.

To use CAVEC, only two switches have to be actuated by the operator. CAVEC waveform presentation guides the operator as to how much range of electronic correction is being used. CAVEC has exhibited excellent stability over a several month period of evaluation, requiring no readjustment and maintaining the usual high standard of performance. There are no day-to-day adjustments and only one operational control. A small circuit board

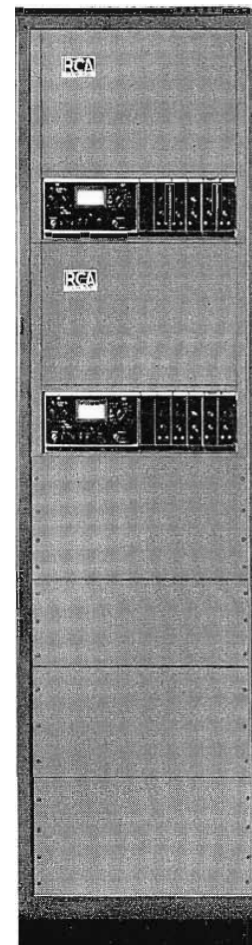
extender is provided for use in servicing any of the 32 circuit boards in the module.

### Conclusion

A solid state electronic unit designed to compensate for hue and saturation errors, CAVEC reduces the burden carried by the TV tape machine operator, especially in handling substandard tapes. It provides him with a means to insure that color tape replays are of consistent high quality regardless of where the tape was recorded. CAVEC utilizes advanced integrated circuits which are economical of space and power and which exhibit great stability and reliability. The new device is certain to be accepted by TV tape users and viewers alike as making not only a very worthwhile but possibly an indispensable contribution to TV tape recording.



FIG. 1. TVM-6A Solid State TV Relay System packaged for both portable and rack-mounted use.



## NEW SOLID-STATE COLOR-TV RELAY SYSTEM

Wide Choice of Accessories in Plug-In Modular Form, Makes the TVM-6 a System That Suits Individual User Requirements

by L. H. FOLLET, JR.

*Television Relay Equipment  
Merchandising*

Three years of intensive planning and effort have culminated in the introduction this year of the all new solid-state TVM-6A Television Relay System. The RCA "New Look" TVM-6A illustrated in Fig. 1 incorporates a new dimension in TV relay link design, containing so many new performance and operating features that it will literally take months for its users to

EDITOR'S NOTE: The information in this article was presented in a paper delivered on June 15, 1967, to the SMPTE.

uncover them all. Highlighting its solid-state design are such exclusive features as multiple channel audio subcarrier capability, high quality off-air transmitter video and audio monitoring, integrated test signals that enable high-speed alignment and performance checkout without additional test equipment. In addition a wide variety of optional accessories combine to make the TVM-6A industry's most versatile TV relay system.

### System Description

The TVM-6A Microwave system consists of four major units: Transmitter RF Chassis, Transmitter Control, Receiver RF Chassis and Receiver Control.

Each control unit is composed of a module housing or "nest" which houses plug-in modules. Each RF chassis is a wired unit containing a number of removable sub-chassis. Interconnecting control and video cables are used between each control

unit and its RF chassis. The packaging of the TVM-6A makes it ideally suited to any of three modes of operation—portable, remote or rack-mounted.

**Portable**

In the portable mode, the transmitter and receiver control units are each mounted in attractive, sturdy carrying cases. The transmitter and receiver chassis are mounted in weather-proof field enclosures which quickly attach to tripod mounted parabolic antennas, as shown in Fig. 1.

**Remote**

In the remote application, (Fig. 2), the control unit is rack-mounted and the RF chassis is located on a studio roof or tower to facilitate RF transmission. In this application, the equipment is actually half rack mounted and half portable. It is permissible to use inter-connecting cables up to 500 feet in length. Intercom circuitry is included in both controls and RF chassis so that communication between them is possible. Both the transmitter and receiver are designed so that any necessary tuning adjustments may be made remotely from the control unit.

**Rack-Mounted**

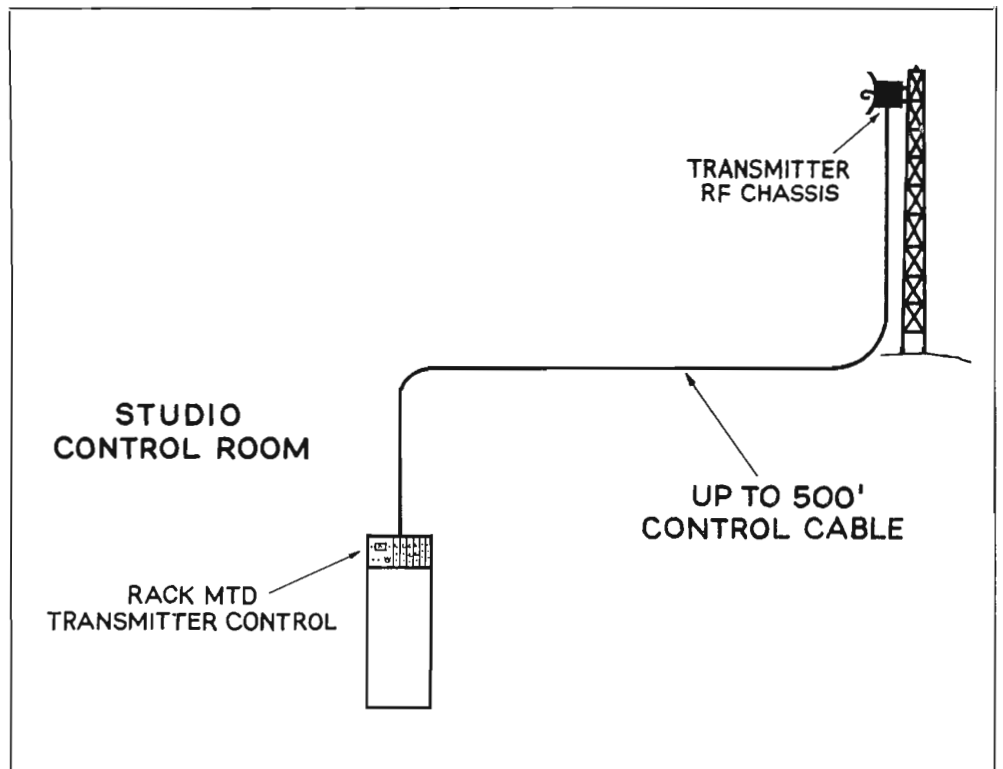
In the rack mounted application, both the RF chassis and control unit are mounted in a rack, with the control unit directly below the RF chassis. The required antenna connections are provided by a run of waveguide. In this application, a removable front panel and trim strips are provided for each RF chassis to make its appearance compatible with modern studio equipment.

For RF multiplexing, transmitters and/or receivers are rack-mounted directly above one another. Multiplexing filters and isolators are an integral part of each transmitter and receiver permitting in-rack combining with only a single output from each rack. Each transmitter and receiver RF chassis occupies only 10½ inches of rack space, and the corresponding control units each occupy 5¼ inches of rack space.

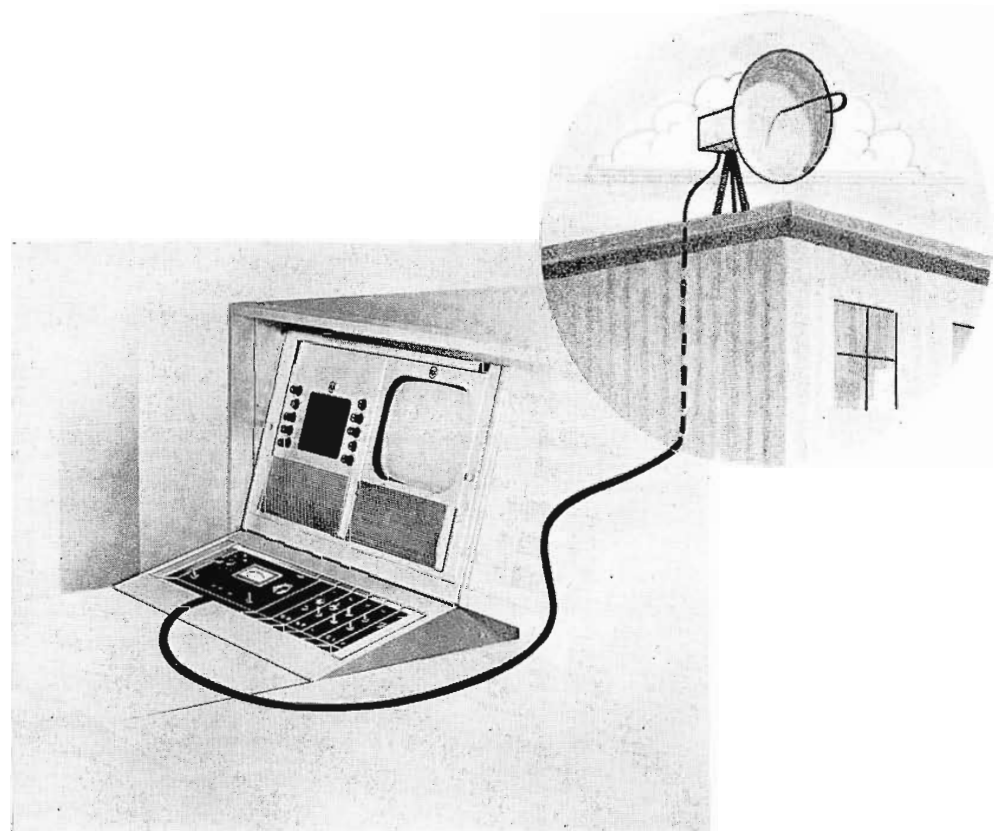
**Console Mounting**

Still another mode of operation is console mounting of the TVM-6A control units. The transmitter control unit is mounted into the studio master control console. It includes a TO-4 Waveform Monitor and a TM-19 Picture Monitor, arranged as shown in Fig. 3.

This operating mode enables the operator to remotely control the on-off operation of the transmitter RF chassis packaged



**FIG. 2.** Diagram illustrating remote application. Control unit mounted in studio with RF chassis mounted remotely on tower or roof top. Built-in equalization provided in equipment for up to 500 feet of control cable. No waveguide is used.



**FIG. 3.** TVM-6A control unit mounted in studio or transmitter console position providing flexibility for operator. Waveform and video monitors are provided in standard RCA console housing allowing utilization of TVM-6A off-air monitoring capability.

in a weather-proof field enclosure mounted on the parabolic antenna, located on the studio roof or tower. The operator can adjust audio levels as well as preview the outgoing signal at the monitor position.

No waveguide is required for this installation and instant touch control is provided for signal levels enhancing operating convenience, appearance and basic system capability. The same performance capability can be achieved for the TVM-6A Receiver Equipment located at the TV transmitter site.

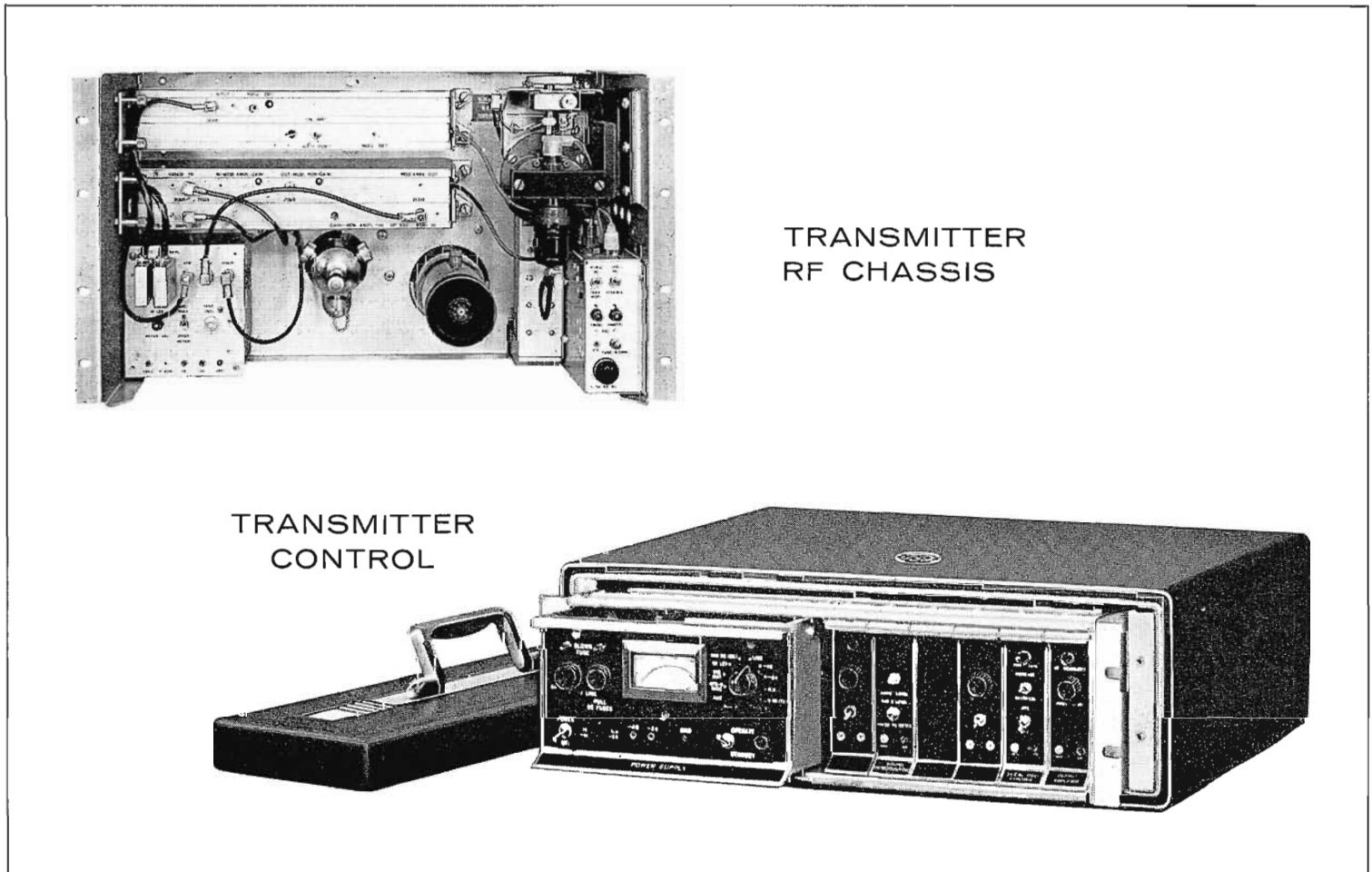
**Operating Frequencies**

The TVM-6A Transmitter and Receiver are both tunable over the entire 5925 to 7425 MHz range. Three klystrons, a VA-259A, VA-259B and VA-259C are required in the transmitter to provide this coverage. Similarly, in the receiver, coverage is provided by 3 local oscillator (L.O.) sources.

See Table 1 listing operating frequency bands for associated klystrons and local oscillators.

TABLE 1 - OPERATING FREQUENCY BANDS		
KLYSTRON FREQUENCY RANGE		
Type No.	Operating Frequencies	Frequency Band
VA-259-A	5.9 - 6.5 GHz	Common Carrier
VA-259-B	6.5 - 7.125 GHz	Broadcast
VA-259-C	7.1 - 7.8 GHz	Government
LOCAL OSCILLATOR (L.O.) FREQUENCY RANGE		
	*L.O. Frequencies	Frequency Band
*Local oscillator frequency is 70 MHz below signal for normal operation.	5865 - 6445 MHz	Common Carrier
	6445 - 7045 MHz	Broadcast
	7000 - 7600 MHz	Government

FIG. 4. Transmitter RF chassis and transmitter control units showing placement of operating elements. Change of sub-chassis units is easily performed and operating controls and adjustments on both units are convenient.



### Transmitter Features

A TVM-6A Television Relay Transmitter contains two major units, the transmitter RF chassis, and the transmitter control, including plug-in modules. The transmitter provides a normal power output of one watt. Solid state circuitry is utilized throughout with the exception of the klystron tube. The transmitter RF chassis contains the klystron tube and two independent power supply modules required for operating the klystron, modulating amplifier and local control panel (see Fig. 4).

The transmitter control unit is comprised of a control "nest" which houses the low voltage power supply and the klystron control module. The nest is so designed that these two modules plus the optional accessory modules can easily be inserted, giving the control unit extreme flexibility, in addition to providing functional design and attractive overall appearance.

The optional accessory modules includes a choice of three audio sub-carriers of 6.8 MHz, 7.5 MHz, and 8.3 MHz, and an input amplifier and patch modules. The patch modules must be supplied in sufficient quantity to fill up all remaining slots not otherwise occupied by other operating modules.

The input video signal, after amplification to a nominal 20 volt level by the modulator amplifier, is fed directly to the klystron repeller electrode.

The modulation amplifier is a wideband video amplifier with a gain of about 30 dB. A separate gain control is provided to vary the amplitude of the video signal. Maximum deviation can be achieved with input signal levels as low as 0.7 volts peak-to-peak. For added convenience, a modulation monitor test point provides access for measuring input voltages.

In the TVM-6A, 8 MHz peak-to-peak deviation is used with recommended CCIR pre-emphasis. The combination of these two factors helps achieve improvements in system linearity and signal-to-noise ratio (about 6 dB better than the TVM-1).

A video test/mod switch, located on the HV junction box, provides the transmitter RF chassis with a 60 Hz test modulation voltage. In the test mod position, transmitter output frequency and deviation can be measured by observing the characteristic wavemeter absorption marks or pips on a CRO when the klystron is modulated. Frequency and deviation may also be checked using the wavemeter and observing the panel meter mounted on the transmitter control unit. A directional coupler diverts a small fraction of the RF energy

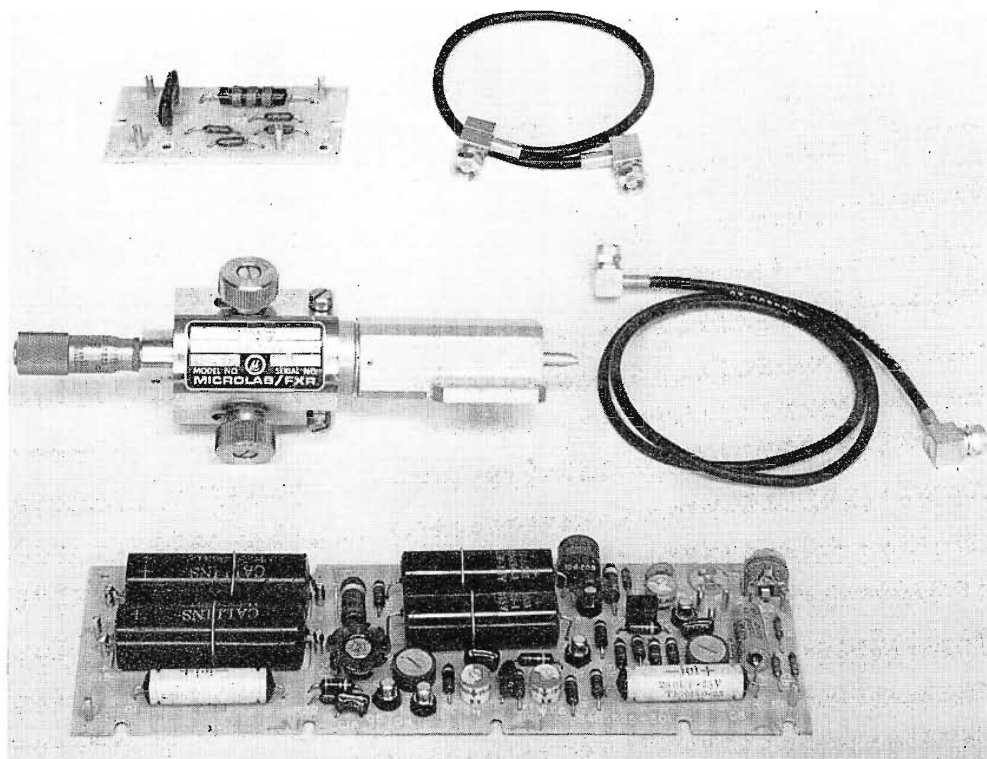


FIG. 5. Functioning elements of TVM-6A off-air monitoring system showing precision calibrated waveguide discriminator cavity (left center) and video component boards. Installation of the transmitter off-air monitor in a TVM-6A transmitter provides fully demodulated and restored signals. The monitor is a separate receiver within the transmitter.

to give an indication of klystron power output.

### System Accessories

The RCA type TVM-6A Television Relay Systems are supplemented by a line of accessory items designed for use in either permanently rack mounted or portable applications. These items are offered to further implement and expand the basic system capability. Since the need for these units is subject to the requirements of individual installations, they are made available on an optional basis. They are readily integrated and may be added to existing installations as the need occurs.

### Transmitter Accessories

#### 1. Off-Air Monitors

##### (a) Video

Featured in the TVM-6A, is the time proven high quality transmitter off-air visual monitor. This accessory provides a convenient means of monitoring transmitter performance at the output of the transmitter. A high quality video amplifier is used making exact critical measurements of differential gain and amplitude response possible.

The items required for the video "off-air" monitoring function are

a waveguide discriminator cavity, de-emphasis network, video amplifier, and cable (Fig. 5). If desired, the video monitor signal may be connected by coaxial cable to the transmitter control nest. This is recommended for all remote mode applications.

##### (b) Audio

A new and unique feature of the TVM-6A enables the operator to monitor the audio sub-carrier being transmitted. This is accomplished at the transmitter by simply inserting a sound demodulator module into any of the three sound modulator slots in the transmitter control nest, as shown in Fig. 6.

The "off-air" audio signal from the monitor amplifier in the RF chassis is fed by a coaxial cable to the transmitter control unit, and a sound demodulator is installed in the control nest in one of the vacant sound modulator slots. The sound demodulator then provides an audio output for monitoring the sound sub-carrier being transmitted. Normally a sound demodulator module is not included in the transmitter control nest, unless off-air audio monitoring is used.

## 2. Transmitter AFC

For some services, microwave transmitters are required to hold a frequency accuracy of  $\pm 0.02\%$ . Transmitter AFC is available, in module form, to improve the operating stability of the klystron to  $\pm 0.02$  percent. Normally, without AFC, the transmitter frequency tolerance is  $\pm 0.05$  percent. The AFC circuit requires the use of the waveguide discriminator and an AFC amplifier unit. The AFC amplifier output voltage is added to the klystron repeller voltage to provide the required frequency correction.

## 3. Transmitter Control Nest Optional Accessories

The transmitter control nest contains the low voltage power supply, and klystron control module, an input amplifier, up to three sound modulators or demodulators and an output amplifier. Figure 4 shows the low voltage power supply, klystron control module and the essential optional plug-in modules in the control nest, which may be used in various combinations.

### (a) Input Amplifier

The module is intended for use as the video input unit for the transmitter and is designed to accept input video signals at 75 ohm unbalanced or 124 ohm balanced impedances, provide level control, metering, cable equalization and a sawtooth test signal. The choice of input impedance is made by a jumper change within the amplifier.

A front panel control on the input amplifier adjusts the level of the video signal. A built-in sawtooth generator provides a test signal for use in level setting. This is an important feature where quick and accurate field alignment is required.

The standard input amplifier contains the low-pass filter which rejects the three aural sub-carriers when used in the system. An alternate variety of the input amplifier is available without the low pass filter when sound diplexing is not used.

### (b) Sound Modulator

These modules are required when audio signals are to be carried over the system. The units are capable of receiving a wide range of modulating frequency levels at 150 or 600 ohm input impedances. They accept an audio input at 0 dBm level and frequency modulate a sub-carrier in the 6.8 MHz to 8.3 MHz region for transmission with the video signal. The control nest is wired for a maximum of three sound modulator modules with a choice of three specific subcarriers at 6.8, 7.5 and 8.3 MHz. A deviation of 100 KHz is used, with 75 microsecond audio pre-emphasis. Subcarrier and audio signal voltages are supplied to the low voltage supply for signal level metering. The unit contains front panel controls for adjusting modulation and subcarrier levels and test jacks are available for checking sound sub-carrier and video line levels.

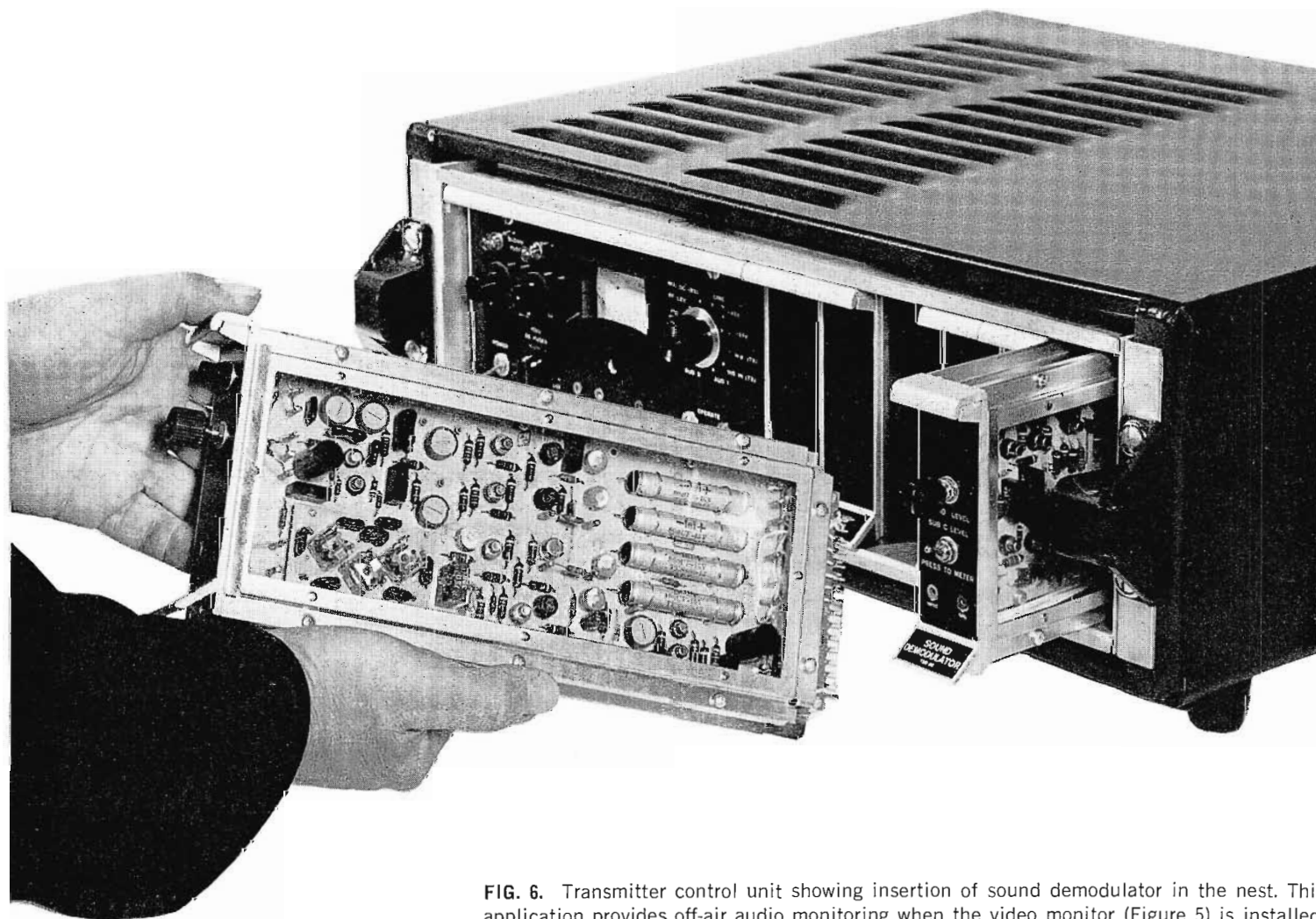


FIG. 6. Transmitter control unit showing insertion of sound demodulator in the nest. This application provides off-air audio monitoring when the video monitor (Figure 5) is installed.



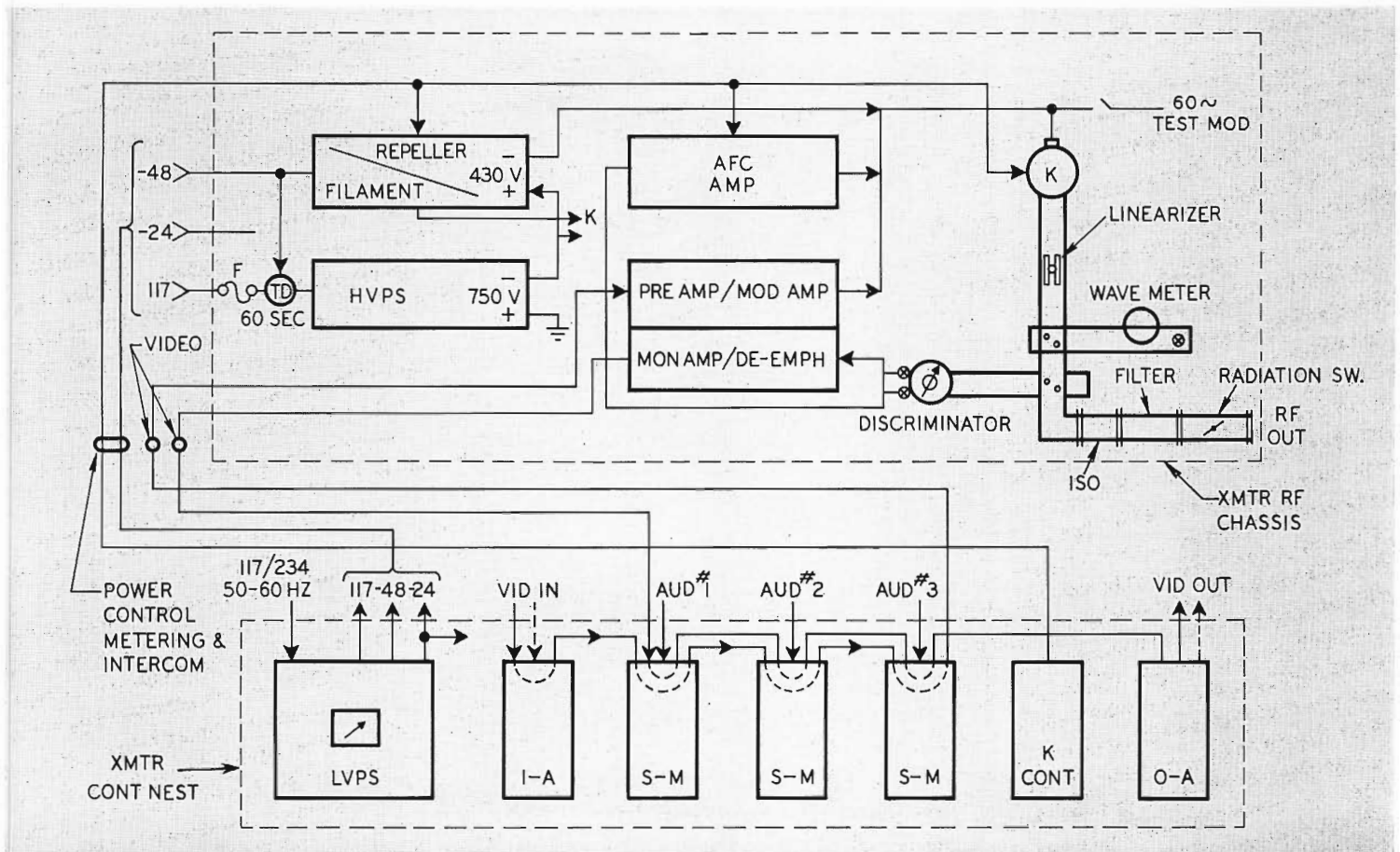


FIG. 7. Transmitter block diagram showing outline of both the RF chassis and the control units. Monitoring of all key program levels is provided by panel meter mounted on the LVPS. Control nest provides space for optional sound modulators or other accessories. Interconnecting cables between both units carry all power, control, metering and intercom circuits.

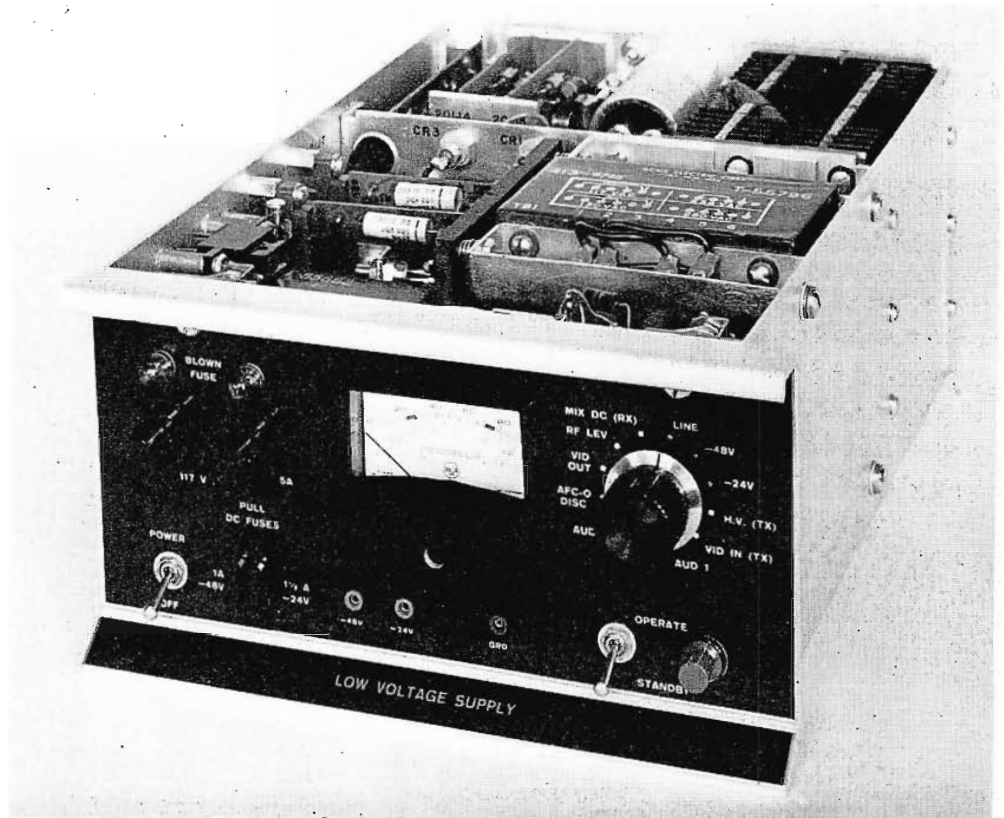


FIG. 8. The low voltage power supply (LVPS) furnishes -24 VDC and -48 VDC to operate all functioning low voltage elements in the system except the klystrons. The LVPS is directly interchangeable between the transmitter and the receiver and serves as the main metering center for all test and program levels in the system. The LVPS is stabilized to maintain  $\pm 15\%$  primary line voltage regulation over an ambient temperature range of  $-30$  to  $+50^\circ$  Centigrade.

## Receiver Features

The TVM-6A Television Relay Receiver consists of two major units, a receiver control nest, including plug-in modules and a receiver RF chassis. The receiver is designed for the reception of the video signals in the frequency range of 5.925 to 7.425 GHz.

The receiver control nest requires two plug-in units, low voltage power supply and local oscillator control module. The LVPS is identical to the LVPS used in the transmitter and is directly interchangeable with it. The unit supplies  $-24$  and  $-48$  volts DC to the receiver RF chassis and to the other plug-in modules in the control nest. It also provides metering for the various receiver circuits and optional accessories. The unit operates from either 117 or 234 VAC. (See Fig. 8).

The local oscillator (L.O.) control module contains controls for electrically and mechanically tuning the solid state local oscillator located on the receiver RF chassis, from the receiver control nest. As with the transmitter, control cables can extend up to 500 feet for remote tuning.

The receiver control nest provides space for three sound demodulators, plus the output amplifier, and required patch modules. Each unoccupied control nest module space must be filled with a video patch module (see Fig. 9).

The receiver RF chassis contains the balanced mixer, I-F amplifier, demodulator (consisting of discriminator, de-emphasis and video amplifier) and AFC amplifier. The RF chassis is connected to the control nest by a multiconductor cable containing all power, control, metering and intercom connections.

The incoming RF microwave signal is directed into one arm of the waveguide balanced mixer and the output of the local oscillator is directed into the other. The RF signal is converted to a 70 MHz intermediate frequency by beating with the tunable local oscillator (Fig. 11). Normally, the local oscillator output frequency is below the incoming frequency, but in order to avoid image interference, one can operate the local oscillator *above* the incoming frequency. When this is done, the video polarity is reversed. A unique method to reinstate proper polarity is by the

NORMAL/INVERT switch located on the demodulator unit. Placing the switch in the INVERT position reverses the discriminator diodes and enables the receiver to operate with the L.O. frequency above the incoming signal.

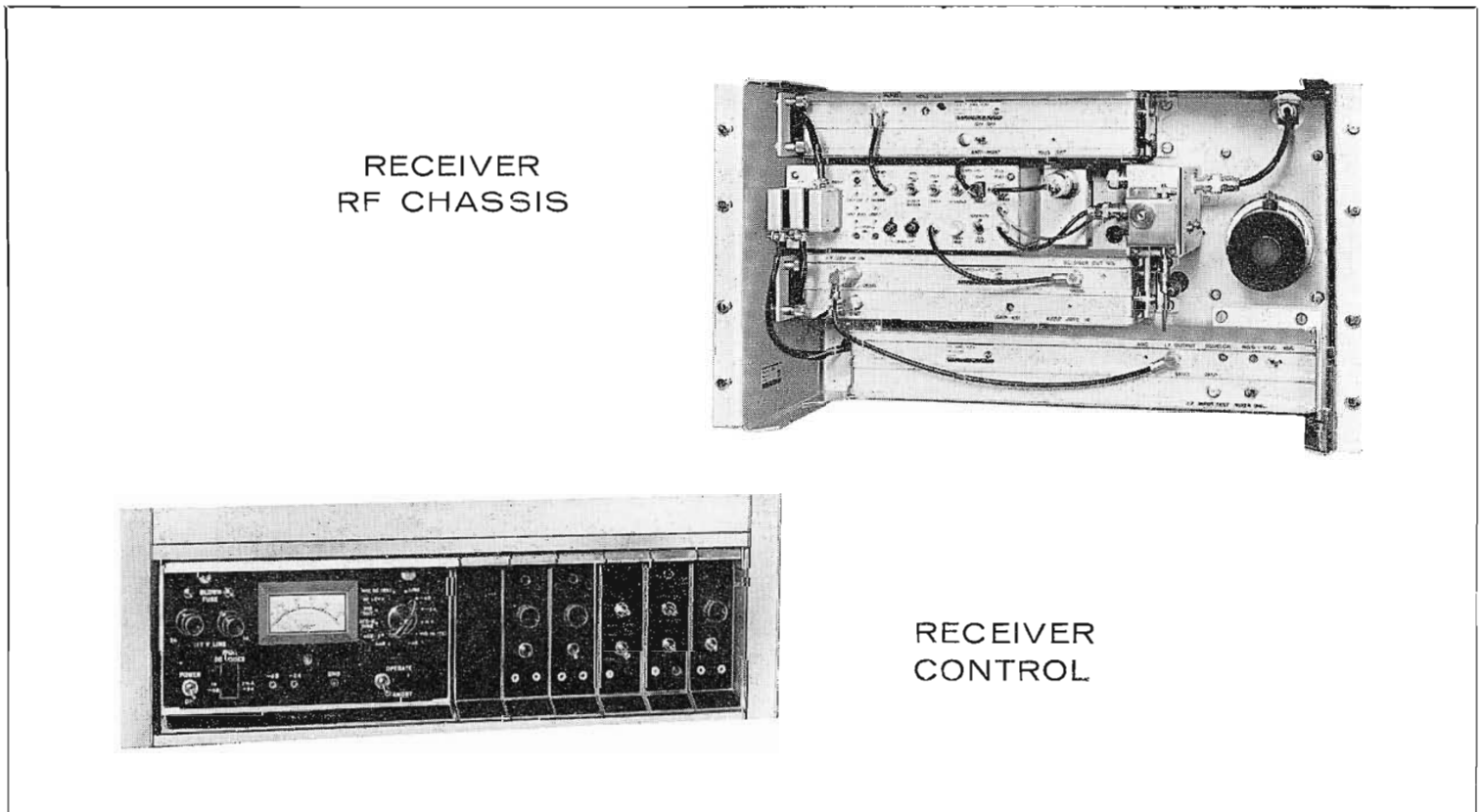
A desirable feature of the receiver is that under low signal input conditions the IF amplifier is muted by a built-in squelch circuit eliminating the noise that would otherwise be present at the receiver output. By turning off the signal level to the demodulator, the error voltage to the receiver AFC amplifier is reduced to zero. This will prevent the AFC amplifier from pulling the local oscillator frequency over to an adjacent channel carrier. The input level at which the amplifier squelches is adjustable and can be set as desired by the operator.

Provision is made through the INPUT TEST jack on the receiver RF chassis for applying modulation to the local oscillator to check receiver performance independent of video areas in the transmitter.

To assist the receiver tuning, the wave-meter may be mounted on the mixer plumb-

**FIG. 9.** TVM-6A receiver RF chassis and receiver control units. Control unit provides space for seven plug-in modules including the LVPS and the klystron control module, which are required, plus five optional slots for accessory modules. Shown are three sound modules (demodulators), an output amplifier, and a video patch module.

Patch modules are required to fill all vacant slots not otherwise occupied by operating modules. Receiver RF Chassis with operating sub-chassis units shown from top to bottom—AFC amplifier; receiver junction box; video demodulator and I.F. amplifier. Also shown is the tunnel diode amplifier (TDA) module in the receiver RF chassis.



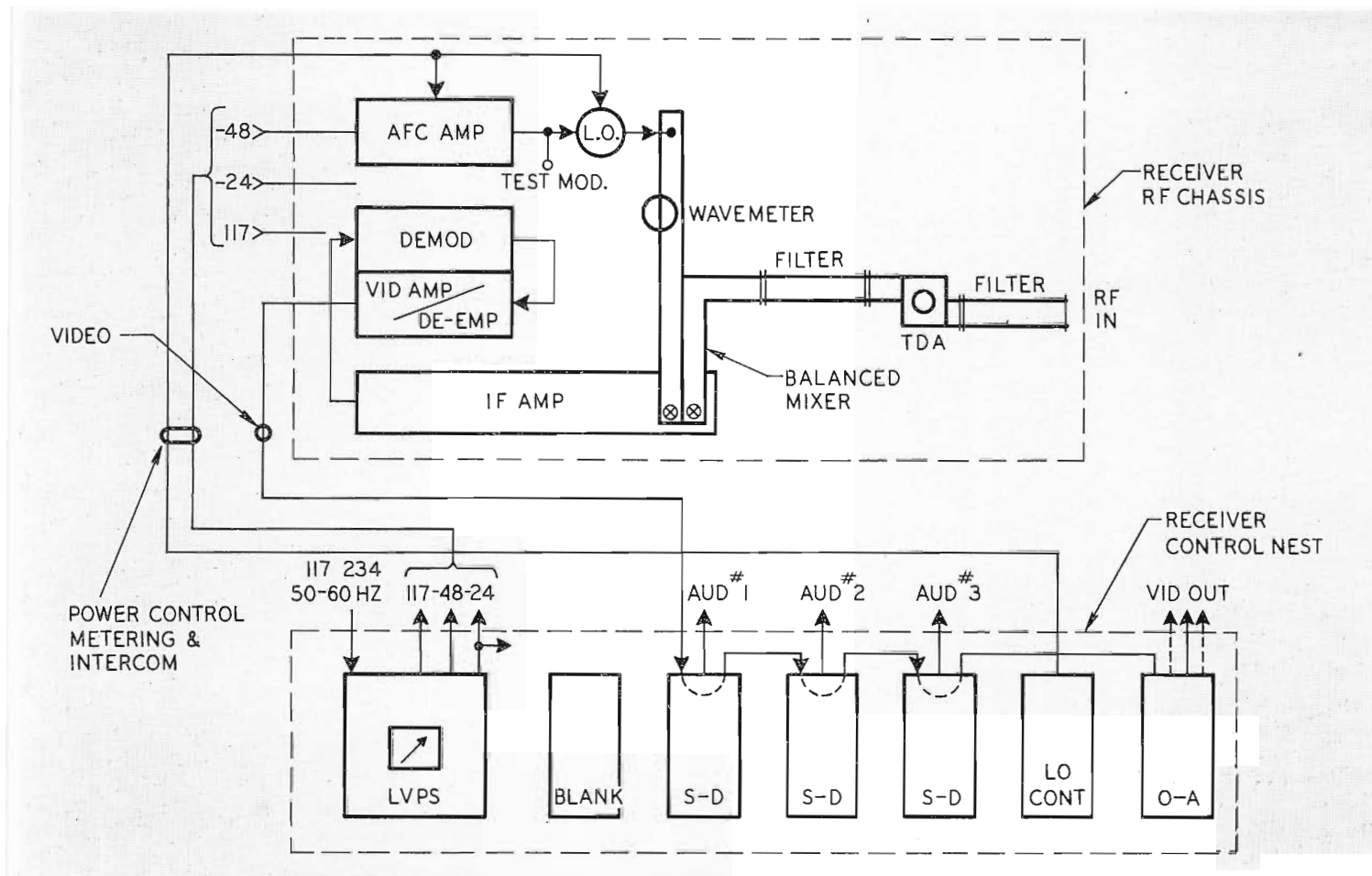


FIG. 10. TVM-6A receiver block diagram showing components in the RF chassis and control units.

ing. This enables the local oscillator to be set precisely on frequency. The test meter on the low voltage power supply provides the indication that will show when the L.O. is tuned to the correct frequency. A test point on the receiver RF chassis may also be used for this purpose.

Video output signal from the video amplifier in the demodulator is available at a UHF connector on the RF chassis, and is also available at the control unit.

### Receiver Accessories

#### 1. Tunnel Diode Amplifier

An optional tunnel diode amplifier can be added to the TVM-6A Receiver RF chassis. By the use of this pre-amplifier the receiver noise figure is improved from 11 to 6 dB. This amount of noise figure improvement is roughly equivalent to tripling the transmitter power output in terms of added fade margin. The TDA unit is *not* tunable, and requires both pre-tuned, pre-selection and post selection filters.

#### 2. Receiver Control Nest Optional Accessories

##### (a) Sound Demodulator

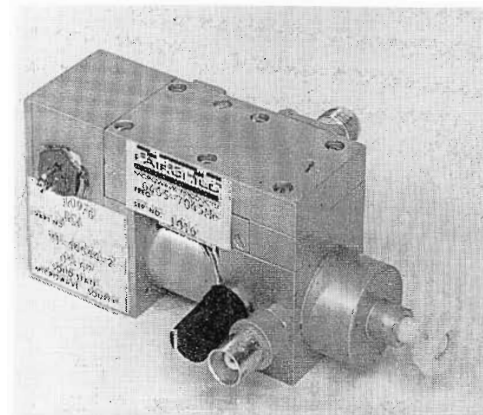
The function of the sound demodu-

lators is to demodulate the audio sub-carrier in the baseband signal. The audio output signal is fed to three pin connectors on the rear of the receiver control nest. Standard 75 microsecond de-emphasis is included in each demodulator and a maximum output level is  $+18$  dBm to a 150/600 ohm load. Metering of the received sub-carrier and audio output levels is provided for each of the three demodulators by observing the panel meter reading in the low voltage power supply.

##### (b) Output Amplifier

This unit provides a second 75 ohm unbalanced output, a 124 ohm balanced output, and cable equalization for up to 500 feet. Video level metering is provided by observing the panel meter reading on the low voltage power supply in the control nest. When one or more sound channels are applied, a filter located in the output amplifier will exclude the sound sub-carriers from the video output signal.

FIG. 11. Solid state local oscillator (LO) source used in the TVM-6A receiver. This non-thermionic device eliminates the need for a klystron tube. The LO source requires a nominal low voltage bias to operate. Mixer signal is generated by a crystal oscillator driving a varactor diode multiplier mounted in a tunable cavity.



Two additional optional modules that may be used are the low power/low signal indicator that provides an indication of low received RF signal. The other is the video presence indicator, this unit senses the video signal at the receiver control nest.

**Receiver Control Nest**

The usual arrangement of the plug-in modules in the control nest from left-to-right is as follows: Low voltage power supply, low power/low signal indicator, three sound demodulators, local oscillator tuning control and output amplifier. All except the low voltage power supply unit and local oscillator module are optional accessories and may or may not be used. The video presence indicator may be used in one of the sound demodulator locations. Location #2 is recommended. All unused positions in the nest must be occupied by video patch module.

Figure 10 is a block diagram of the TVM-6A receiver showing the arrangement of modules and accessories.

**Performance**

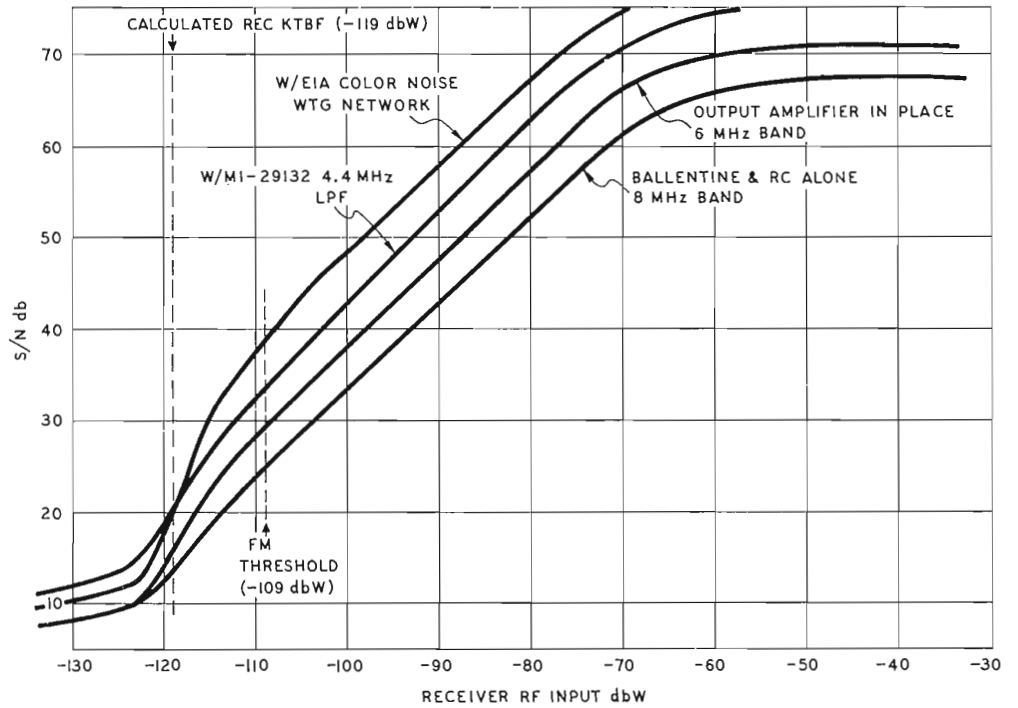
A high degree of performance capability can be achieved by maintaining the microwave system within a fade margin tolerance of about 30 dB, which is normally adequate to go through the fading season without interruption of program service.

Certain conditions may cause the fade margin to vanish due to antenna misalignment, a drop in power output of the transmitter, or a reduction of the receiver noise figure. An excellent operating procedure is the periodic measurement of signal-to-noise ratio, which will assure the broadcaster that the fade margin has not deteriorated.

Adherence to a few significant operating adjustments will make it relatively easy to achieve top performance. To obtain the best results from the TVM-6A, adjustments can be performed as follows:

1. Center the transmitter klystron tuning for peak-to-peak klystron deviation of 8 MHz.
2. Align antennas to produce good signal-to-noise and ample fade margin.
3. Center the receiver tuning for maximum peak-to-peak video output and minimum differential phase.
4. Maintain proper modulation and receiver output levels.

The operator should avoid any deliberate off-setting of one equipment with respect to any deficiency in another. It is best to know that both the transmitter and



**FIG. 12.** Typical TVM-6A receiver signal-to-noise performance. Video S/N is in terms of peak-to-peak signal to RMS noise. Receiver RF input is in terms of decibels below one Watt. This plot is highly useful in determining proper antenna alignment and for making periodic measurements of receiver sensitivity.

**TABLE 2 - POWER CONSUMPTION IN WATTS**

Basic Transmitter (no accessories) .....	190
Transmitter AFC .....	11
Input Amplifier .....	3
Sound Diplexer Modulator .....	3
Low Power Indicator .....	7
Video Presence Indicator .....	4
Field Enclosure (cooling fan) .....	7
Transmitter Monitor .....	None
<hr/>	
Basic Receiver (no accessories) .....	85
Output Amplifier .....	10
Sound Diplex Demodulator .....	3
Low Signal Indicator .....	2
Tunnel Diode Pre-Amplifier .....	None

receiver are set precisely on center frequency thus providing the maximum performance and range for the microwave system.

**Video S/N Performance**

The curves shown in Fig. 13 are plotted data taken on the TVM16A equipment. They show typical video signal-to-noise ratios resulting from a very wide range of RF inputs to the receiver. Hum and sound subcarrier leakage are excluded from the noise measurements. Signal-to-noise ratios are displayed with noise measured by the Ballentine 314 VTVM and with emphasis networks in place in the equipment. The information is useful in system planning.

**Power Consumption**

In both the transmitter and receiver RF chassis, control units and power supplies silicon diode rectifiers and solid state circuitry are used to provide high reliability with lower power consumption and heat dissipation. The primary power consumption ratings, shown in Table 2, are applicable for either 117 volt or 234 volt, 50/60 Hz operation.

**FCC Application**

Microwave frequencies in the TV Auxiliary Broadcast Services, listed in Part 74.602, Sub-Part F, include Band B 6875-7125 MHz which are within the frequency range covered by the TVM-6A Television Relay System.

The instructions in Fig. 13 will provide the license applicant with basic technical information required to prepare FCC Form 313 in Fig. 14. This sample application contains all required technical data relating to TVM-6A.

**Conclusion**

There are many features of the TVM-6A which fulfill the requirements for a television microwave system. Contributing significantly are the many packaging capabilities of the equipment and the supplementary use of accessory items. These items are offered to provide the user a means to expand the basic system capability and to obtain the fine performance which the TVM-6A is capable of providing.

Superb color performance is assured by highly stable solid-state circuitry used throughout the transmitter and receiver. Easy operation and maintenance provide the utmost in performance reliability. Excellent phase shift and linearity with fast warm-up time, light weight and long life are among other points of superiority.

Specifically designed to meet the most sophisticated requirements for television service, the TVM-6A is the TV Relay System of the future.

# TVM-6A SYSTEM

**TVM-6A and TVM-6A-F Transmitter Technical Information Called for in FCC Application for Authorization in the Auxiliary Radio Broadcast Services (FCC Form 313)**

**1. (a) Type of Station** (specify appropriate one)

- Television Pick-up
- Television S-T-L
- Television Inter-city

**(b) Kind of authorization requested for new station**

Prepare 3 copies of the 313 Form. Mark new station box and answer all paragraphs. Prepare 3 additional copies of the 313 Form. Mark license box. Answer paragraphs 1, 2, 3, and 7.

**2. Frequencies**

Select desired channel.	
6875 - 6900	7000 - 7025
6900 - 6925	7025 - 7050
6925 - 6950	7050 - 7075
6950 - 6975	7075 - 7100
6975 - 7000	7100 - 7125

**3. If station is to be operated by remote control** or it is to be unattended, it will be necessary to include the information called for by Section 74.634 or Section 74.635, respectively.

**4. Antenna System**

**Description** (Specify appropriate one)

**For Permanent Installation**

5925-6525 Mc	RCA Parabola Type	Size, Ft.	Gain, dB
	MI-26395A-1	4	37
	MI-26395A-2	6	40
	MI-26395B-1	4	37
	MI-26395B-2	6	40
	MI-26495A-1	8	42.5
	MI-26495A-2	10	44.5
	MI-26495B-1	8	42.5
	MI-26495B-2	10	44.5

6525-7125 Mc	RCA Parabola Type	Size, Ft.	Gain, dB
	MI-26395A-3	4	37
	MI-26395A-4	6	40
	MI-26395B-3	4	37
	MI-26395B-4	6	40
	MI-26495A-3	8	42.5
	MI-26495A-4	10	44.5
	MI-26495B-3	8	42.5
	MI-26495B-4	10	44.5

For Mobile Application	RCA Parabola Type	Size, Ft.	Gain, dB
	MI-26182-3	4	37
	MI-26182-4	6	40
	MI-26182-5	2	30

For S-T-L and Inter-city stations, the direction of radiation of the main lobe of the transmitting antenna should be shown in degrees to the nearest minute.

If the antenna is to be mounted on an AM antenna or on a new tower near an AM antenna, it will be necessary to provide a drawing showing the location with the distances indicated and information indicating that the AM antenna resistance will not be altered.

**5. Type Number**

- TVM-6A
- TVM-6A-F (If unit includes automatic frequency control.)

**FIG. 13.** Complete instructions for completing FCC Form #313 (Application for Authorization in the Auxiliary Broadcast Services). Use instructions in conjunction with Fig. 14.

<p>FCC Form 313 Dec. 1963</p> <p style="text-align: center;">Form Approved. Budget Bureau No. 52-R100.12</p> <p style="text-align: center;">FEDERAL COMMUNICATIONS COMMISSION WASHINGTON, D. C. 20554</p> <p style="text-align: center;">APPLICATION FOR AUTHORIZATION IN THE AUXILIARY RADIO BROADCAST SERVICES</p> <p style="text-align: center;">APPLICANT SHOULD NOT USE THIS BOX</p>		<p style="text-align: center;">FILE NO.</p> <hr/> <p>Name of applicant (See Instruction E)</p> <hr/> <p>Post-office address (Number, street, city, State)</p> <hr/> <p>1. Purpose of this application (Indicate below)</p> <p>(a) Type of station .....</p> <p>(b) Kind of authorization requested:</p> <p><input type="checkbox"/> New Station    <input type="checkbox"/> Modification of Existing Authorization <small>(Construction Permit)</small></p> <p><input type="checkbox"/> License            <input type="checkbox"/> Renewal of License</p> <p>(c) Modification of existing authorization:</p> <p>Call .....</p> <p>Change frequency . . . . . <input type="checkbox"/></p> <p>Replace equipment . . . . . <input type="checkbox"/></p> <p>Change power . . . . . <input type="checkbox"/></p> <p>Install different antenna system . . . . . <input type="checkbox"/></p> <p>Other modification (explain below) . . . . . <input type="checkbox"/></p> <p>(d) Renewal of license:</p> <p>Call .....</p> <p>Have there been any changes since the date of the last authorization? . . . . . Yes <input type="checkbox"/> No <input type="checkbox"/></p> <p>If so, indicate the changes in the appropriate paragraphs in this form.</p> <p>(e) Broadcast station or stations with which station is to be used:</p> <p>Call .....</p>	
<p style="text-align: center;">INSTRUCTIONS</p> <p>A. This form is to be used for Remote Pick-up, Broadcast STL, Television Remote Pick-up, Television STL, or other stations coming under the Auxiliary Radio Broadcast Services (see Part 74 of the Rules). This form is to be used only by licensees or permittees of existing Standard (AM), FM, Television, and International Broadcast Stations.</p> <p>B. Complete all paragraphs if for a new station or for modification of construction permit or license; complete paragraphs 1, 2, 3, and 7 if for a license; complete paragraphs 1, 2, and 7 if for renewal of license.</p> <p>C. Prepare and file two copies (three for Television), with the Federal Communications Commission, Washington D.C. 20554</p> <p>D. Number exhibits serially in the spaces provided in the body of the form and date each exhibit.</p> <p>E. The name of the applicant must be stated exactly as it appears in the authorization for the broadcast station with which the auxiliary station is to be used.</p> <p>F. This application shall be personally signed by the applicant, if the applicant is an individual; by one of the partners, if the applicant is a partnership; by an officer, if the applicant is a corporation; by a member who is an officer, if the applicant is an unincorporated association; by such duly elected or appointed officials as may be competent to do so under the laws of the applicable jurisdiction, if the applicant is an eligible government entity; or by the applicant's attorney in case of the applicant's physical disability or of his absence from the United States. The attorney shall, in the event he signs for the applicant, separately set forth the reason why the application is not signed by the applicant. In addition, if any matter is stated on the basis of the attorney's belief only (rather than his knowledge), he shall separately set forth his reasons for believing that such statements are true.</p>			
2. Facilities requested			
FREQUENCIES	POWER <sup>1</sup>	TYPE OF EMISSION <sup>2</sup>	COMMUNICATION BAND WIDTH (KC) <sup>3</sup>
SPECIFY CHANNEL	1.5 WATTS (nominal)	F5 (for video only)	18,000
(see attached)		OR F9* (if sound diplexing is used)	21,000
<sup>1</sup> For amplitude modulation television (A5), give maximum antenna input power during synchronizing pulses. If particulars are not fully described above, such as aural and visual carrier frequencies for television and type of emission, etc., supply this information below:			
* VIDEO AND _____ DIPLEXED SOUND CHANNELS			
<sup>2</sup> Use emission symbols listed in Part 2 of Commission's Rules. <sup>3</sup> Communication band width is the actual band width of the emission plus twice the frequency tolerance. (See appropriate service rules for permissible band width.)			
3. Location of proposed transmitter			
(a) For stations with fixed location		(c) For portable or mobile operation	
STATE	COUNTY	CITY	Area in which station is to be used
STREET AND NUMBER (or other description of location)			
NORTH LATITUDE	WEST LONGITUDE		
(b) Receiving point		4. Antenna system	
STATE	COUNTY	CITY	(a) Description (including manufacturer and type number, if any)
			SEE ATTACHED
STREET AND NUMBER (or other description of location)			Is a directional antenna system to be used? . . . . . Yes <input type="checkbox"/> No <input type="checkbox"/>
			If "Yes," specify antenna gain in the main lobe of radiation, preferably in terms of free-space field in millivolts per meter for 1 kilowatt at 1 mile.
			SEE ATTACHED
Direction of radiation of the main lobe of the transmitting antenna in degrees, measured in a clockwise direction with true north as zero azimuth. (If more than one antenna is used, give direction for each.)			

FIG. 14. Page one and two of FCC Form #313 shown typically filled out.

<b>4. Antenna system—Continued</b>		<b>7. Transmitting apparatus proposed to be installed</b>		
b. Supply the following for fixed installations only:		Manufacturer	Type No.	Maximum rated power output
Over-all height above ground level in feet	Over-all height above mean sea level in feet	RCA	SEE ATTACHED	1.5 WATTS (nominal)
Description and height of supporting structure (Differentiate between structure now existent and that to be erected.)		Oscillator: DETAILS ON FILE		
		Type of circuit		Frequency
		Tubes:		
		Make	Type	Number
		Last radio stage:		
		Tubes		
		Make	Type	Number
		Normal total plate current in last radio stage	Plate voltage	Method of modulation
Is supporting structure to be used in common for the antenna system of another class of station? If the answer is "Yes," give—		<b>8. Frequency and modulation</b> DETAILS ON FILE		
Yes <input type="checkbox"/> No <input type="checkbox"/>		For what percentage of modulation or swing is the transmitter designed?		
Class of station(s)		What is the guaranteed frequency tolerance in percent?		
Call letters		Describe means incorporated in the transmitter for maintaining the frequency tolerance stated above. A DIRECT READING		
If the over-all height above ground exceeds 150 feet, attach as Exhibit No. .... a sketch of vertical plan, showing heights of significant portions.		RESONANT CAVITY WAVEMETER WITH ACCURACY EXCEEDING .02% IS INTEGRAL PART OF RCA TRANSMITTER.		
<b>5. If cost involved exceeds \$1,000, submit as Exhibit No. .... a statement itemizing cost and a balance sheet of the applicant as at the close of a month within 90 days of the date of the application.</b>		What external means will be employed by the applicant to insure that the assigned frequency is maintained with the tolerance specified by the Commission's Rules?		
<b>6. If this application is for a television remote pick-up or television STL station incorporating an aural transmitter, the information requested in paragraphs 7 and 8 should also be supplied for the aural transmitter on an additional sheet.</b>				

THE APPLICANT hereby waives any claim to the use of any particular frequency or of the ether as against the regulatory power of the United States because of the previous use of the same, whether by license or otherwise, and requests an authorization in accordance with this application. (See Section 304 of the Communications Act of 1934).

THE APPLICANT represents that this application is not filed for the purpose of impeding, obstructing, or delaying determination on any other application with which it may be in conflict.

THE APPLICANT acknowledges that all the statements made in this application and attached exhibits are considered material representations, and that all the exhibits are a material part hereof and are incorporated herein as if set out in full in the application.

**CERTIFICATION**

I certify that the statements in this application are true, complete, and correct to the best of my knowledge and belief, and are made in good faith.

Signed and dated this .....day of....., 19.....

WILLFUL FALSE STATEMENTS MADE ON THIS FORM ARE PUNISHABLE BY FINE AND IMPRISONMENT. U. S. CODE, TITLE 18, SECTION 1001.

.....  
(NAME OF APPLICANT)

ENCLOSE APPROPRIATE FEE WITH APPLICATION, IF REQUIRED. DO NOT SUBMIT CASH. MAKE CHECK OR MONEY ORDER PAYABLE TO FEDERAL COMMUNICATIONS COMMISSION. (SEE PART 1, VOLUME 1 OF FCC RULES TO DETERMINE WHETHER A FEE IS REQUIRED WITH THIS APPLICATION.)

By .....  
(SIGNATURE)

Title .....

<b>Exhibits</b> furnished as required by this form:			
Exhibit No.	Para. No. of Form	Name of officer or employee (1) by whom or (2) under whose direction exhibit was prepared (show which)	Official title

# WOW-TV INSTALLS NEWEST RCA 25-KW VHF TRANSMITTER

Pioneer Station in Omaha Employs  
TT-25EL Transmitter With New Superturnstile Antenna  
to Improve Color Coverage

by GLENN FLYNN  
*Director of Engineering,  
Meredith WOW, Inc., Omaha, Nebraska*

Historically, WOW-TV has always utilized the latest in RCA-designed equipment. When WOW-TV began broadcasting in August, 1949, an RCA TT-5 television transmitter was used. Later RCA TT-25AL amplifiers were added to provide full power of 100 kW visual and 50 kW aural. When the TT-6AL driver transmitter be-

came available, it was substituted for the TT-5. Now WOW-TV has again installed the latest model RCA VHF transmitter, the TT-25EL.

Although much younger than sister station WOW Radio (on the air in 1923), WOW-TV is a pioneer. In 1949, WOW-

TV became the first TV station in five midwestern states to begin regular telecasting. It was also the first midwestern television station to reach maximum power (1953), the first locally with a network colorcast (1953), and the first with video tape facilities.

FIG. 1. Standing in front of their new RCA TT25-EL Transmitter, Glenn Flynn, Director of Engineering, on the left, and Howard Stalnaker, Vice President, General Manager, Meredith WOW, Inc., discuss the completion of their new transmitting facility.

## The Author

Glenn Flynn, who is called by his first initial "G", has been with the WOW stations for over thirty years, as technical operations supervisor and chief engineer. He is now director of engineering and building operations for WOW-TV, Radio and FM. Mr. Flynn designed the new transmitter building and the downtown WOW studio facilities. For over thirty years, Mr. Flynn has been an amateur radio operator.

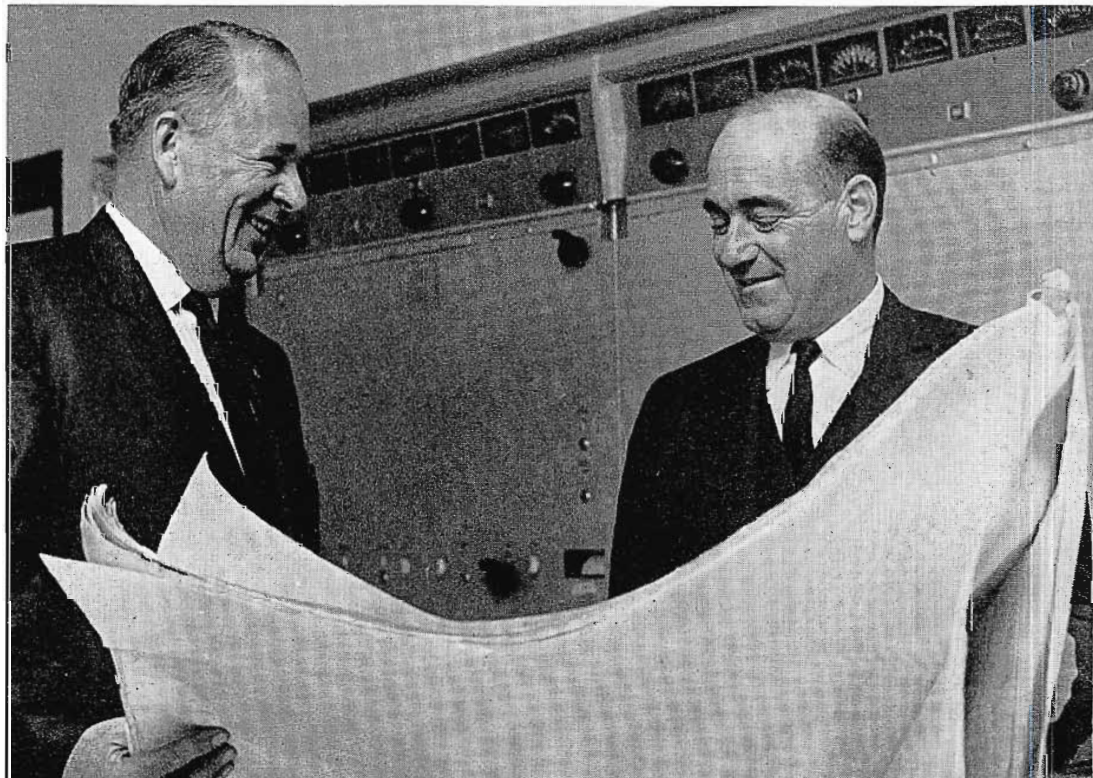






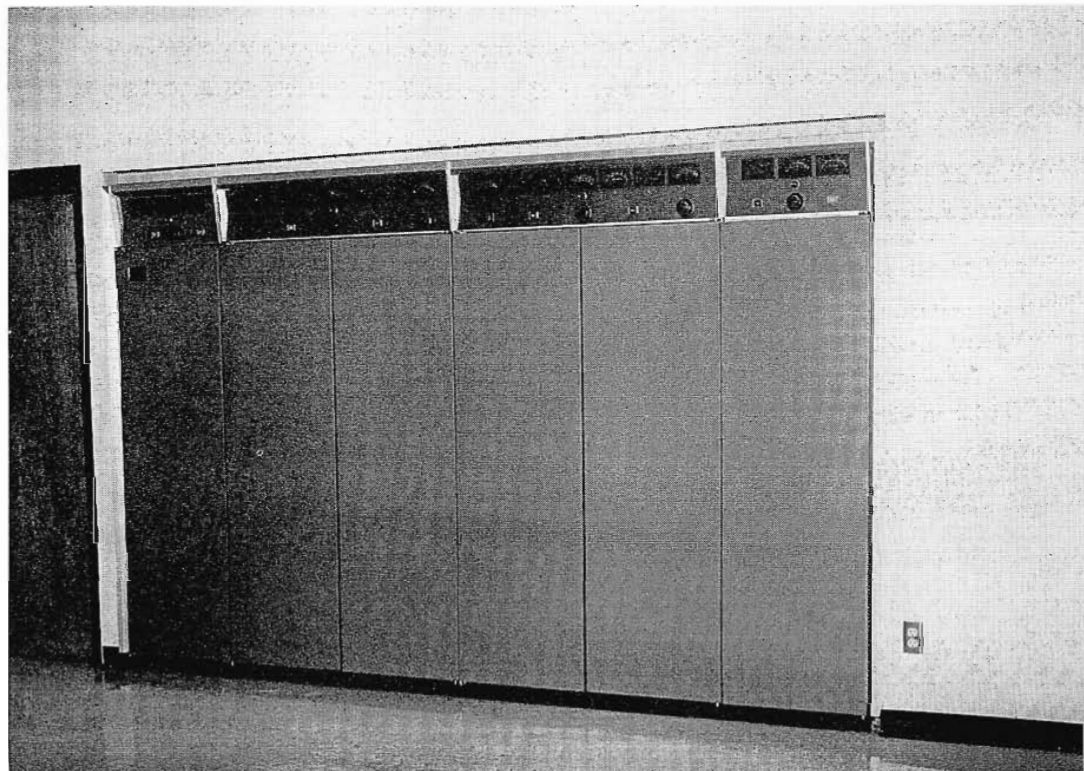
FIG. 2. This is the new WOW-TV transmitter building and tower completed in November, 1966 and houses the RCA TT25-EL VHF Transmitter. It's on a "tower farm" at 72nd and Crown Point outside of Omaha. Located at this same location are two other new towers for stations KMTV and KETV.

FIG. 3. View of the neat looking curtain wall installation of the TT25-EL Transmitter. The interior of the building is painted to match the attractive RCA New-Look colors of the transmitter and is excellent from an architectural and decorating point of view. Space is provided in the new transmitter building for future FM transmitter and television standby transmitting equipment.

### Motivations and Objectives

What motivates a television station to invest in a new transmitting facility. WOW-TV had two incentives: The "color-television explosion" created demands for more stable and efficient transmitting equipment. Full-color WOW-TV also wished to modernize the technical transmitting facilities and to increase coverage.

WOW-TV became the first to install RCA's new model VHF transmitter, the TT-25EL. Also included in the new WOW-TV facilities is a new RCA TF-6BM Superturnstile Antenna mounted on a new 1,358-foot Dresser-Ideco tower. WOW-TV chose the RCA Superturnstile Antenna because of its excellent characteristics, good performance record, and low cost. (The new tower also provides for a future circularly polarized FM antenna.)



The new building, shown in Figure 2, was constructed to house the new transmitter. The interior of the transmitter building is painted to match the RCA New-Look colors of the transmitter, and is excellent from an architectural and decorating point of view. Space is provided for a future FM transmitter and future television standby transmitting equipment. The WOW-TV transmitter blower motor is located in the basement. This means quieter operation in the transmitter room. It is also easier to service the blower, and makes more room available in the transmitter enclosure.

**Results**

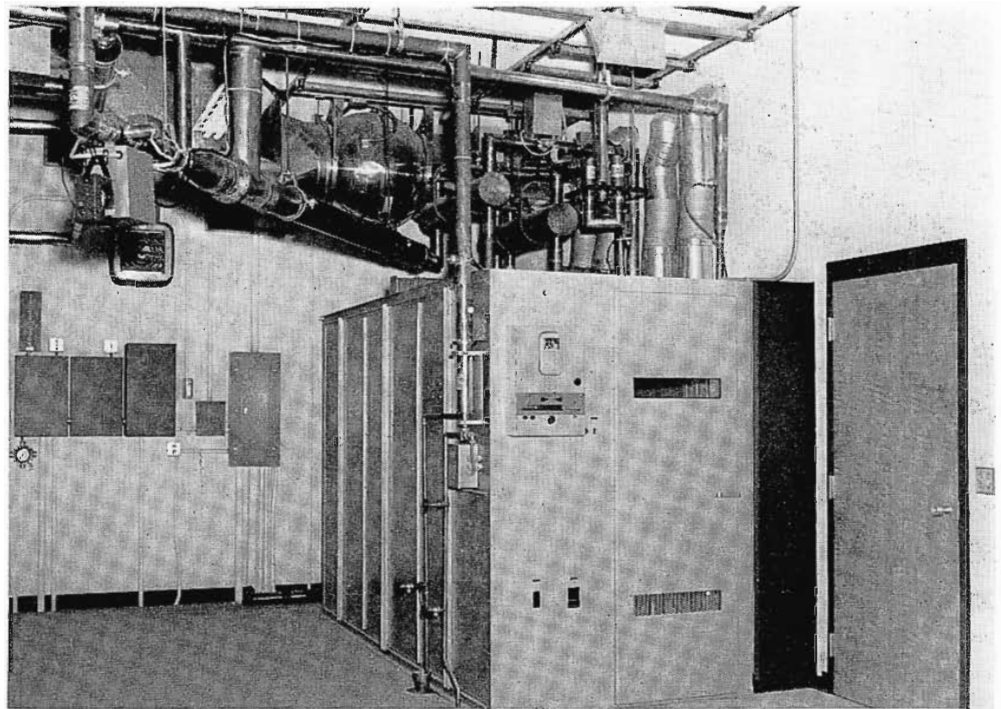
Construction of WOW-TV's new transmitter facilities began in July, 1966. At the same time, two other Omaha stations, KMTV and KETV, started construction for new facilities and towers. The three stations started telecasting from their new transmitting facility location simultaneously at 7:00 a.m. Friday, November 25, 1966. The towers are all located on the same 55-acre plot of ground, spaced 720 feet apart.

In addition to providing a better quality picture more efficiently, the new facility increases the number of homes served by WOW-TV by a considerable percentage. The Grade B coverage area of the station has been extended an additional number of miles in all directions. Signals are microwaved from the WOW-TV studios at 3501 Farnam Street, Omaha, to the new transmitter at 72nd and Crown Point, just outside the city limits and northwest of Omaha. Provision has been made for remote control of the transmitters when permitted by the FCC.

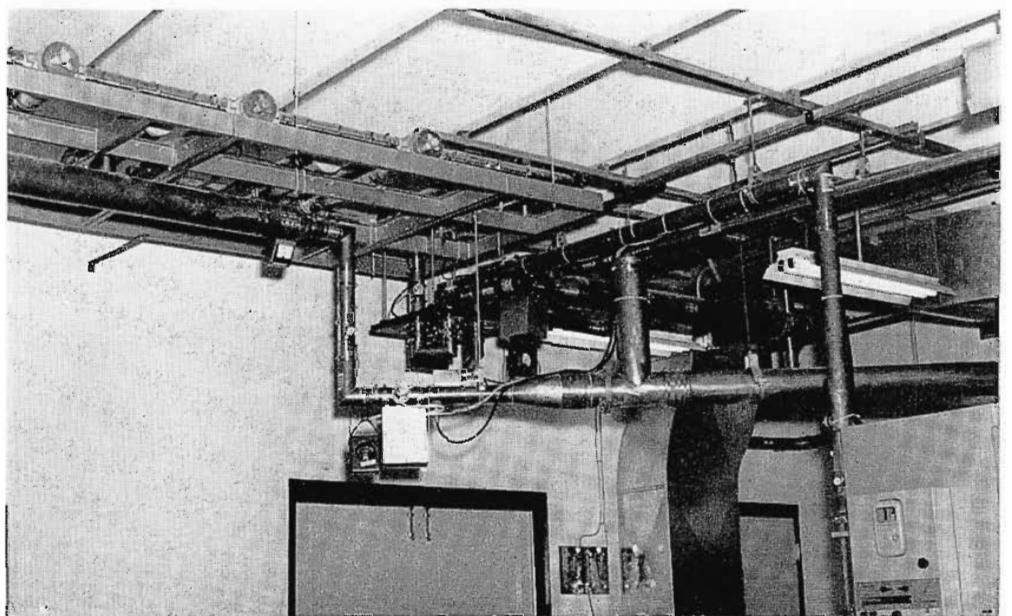
**Conclusion**

The reason WOW-TV chose the RCA TT-25EL for the modernization of their transmitting facility is for the reliable and efficient operation the transmitter provides for the broadcasting of color TV signals.

Mr. Al Maller, WOW Transmitter Supervisor, visited RCA's factory and testing facility at Meadow Lands, Pa. while the transmitter was being checked-out as a complete unit during final test to insure that it was operating at design specifications. The TT-25EL met all published specifications and is operating at WOW-TV with more than satisfactory results.

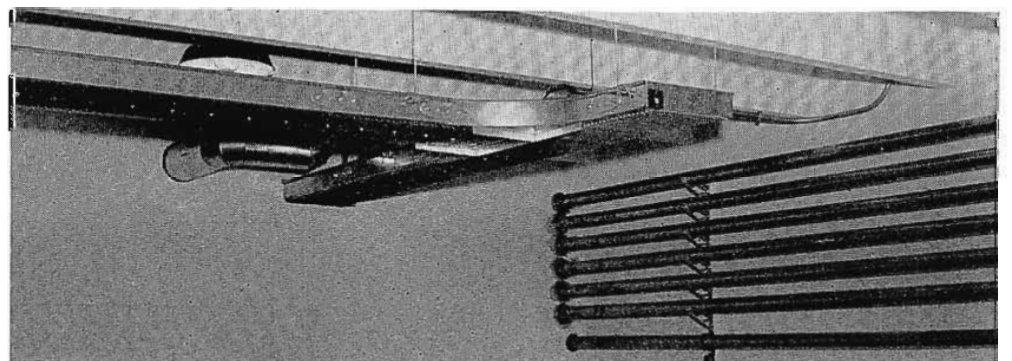


**FIG. 4.** This view shows the rear of the transmitter with the transmitter enclosure, hybrid couplers, visual low pass filter, tower light indicator panel and other vital parts.



**FIG. 5.** This view of the RCA transmitter shows the side band filter, ceiling mounted visual low-pass filter, co-ax patch panel and gassing system for exterior coax run. All this was installed at the new WOW-TV transmitter building.

**FIG. 6.** All wiring including electrical is by means of cable trays located just below the main floor of the building at the new WOW-TV transmitter building.



**RCA**  
**BC-7**

*Closest to Custom in a Production Console!*



## **RCA Transistorized Console** for Dual-Channel AM/TV and FM Stereo

Take a good look at this smart new model. Here's that "custom" appearance to satisfy the proudest management; "custom" quality and flexibility to please the most discriminating engineers...all in a production-model!

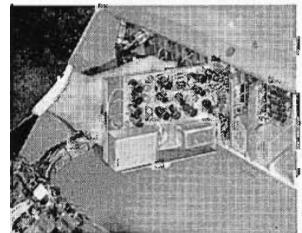
**CUSTOM STYLING**—Striking new lines in blue and silver bring a color accent to control rooms. Color-coded operating controls are engineered to avoid errors. Only 39" long, it is compact and self-contained...to satisfy new or existing arrangements.

**CUSTOM QUALITY**—The BC-7A is fully transistorized for long-term reliability. All amplifiers have input and output transformers...precise impedance matching for both program and monitoring circuits. You get quality stereo monitoring (10 watts out-

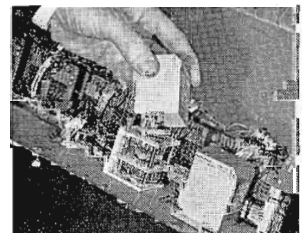
put), quality gain controls, quality leaf-type key switches on all program circuits.

**CUSTOM FLEXIBILITY**—You have interchangeable plug-in modules...preamplifiers, isolation/balancing units, program amplifiers, monitoring amplifiers, cue amplifier and power supply—all in one self-contained unit. You get three-mode operation...selector switch to instantaneously convert from dual channel, parallel or stereo operation.

We can't name them all here, but we believe you will agree that this is the kind of customized styling, quality, and flexibility you want. Let your Broadcast Representative show you all the features that make this console your best buy. Or write RCA, Broadcast and Television Equipment, Bldg. 15-5, Camden, N.J.



Plug-in flexibility... preamplifiers for low-level sources... isolation/balancing units for high level sources.



High quality mixers...ganged step-type attenuators when in stereo... individual step-type when in dual channel use.



**THE MOST TRUSTED NAME IN ELECTRONICS**

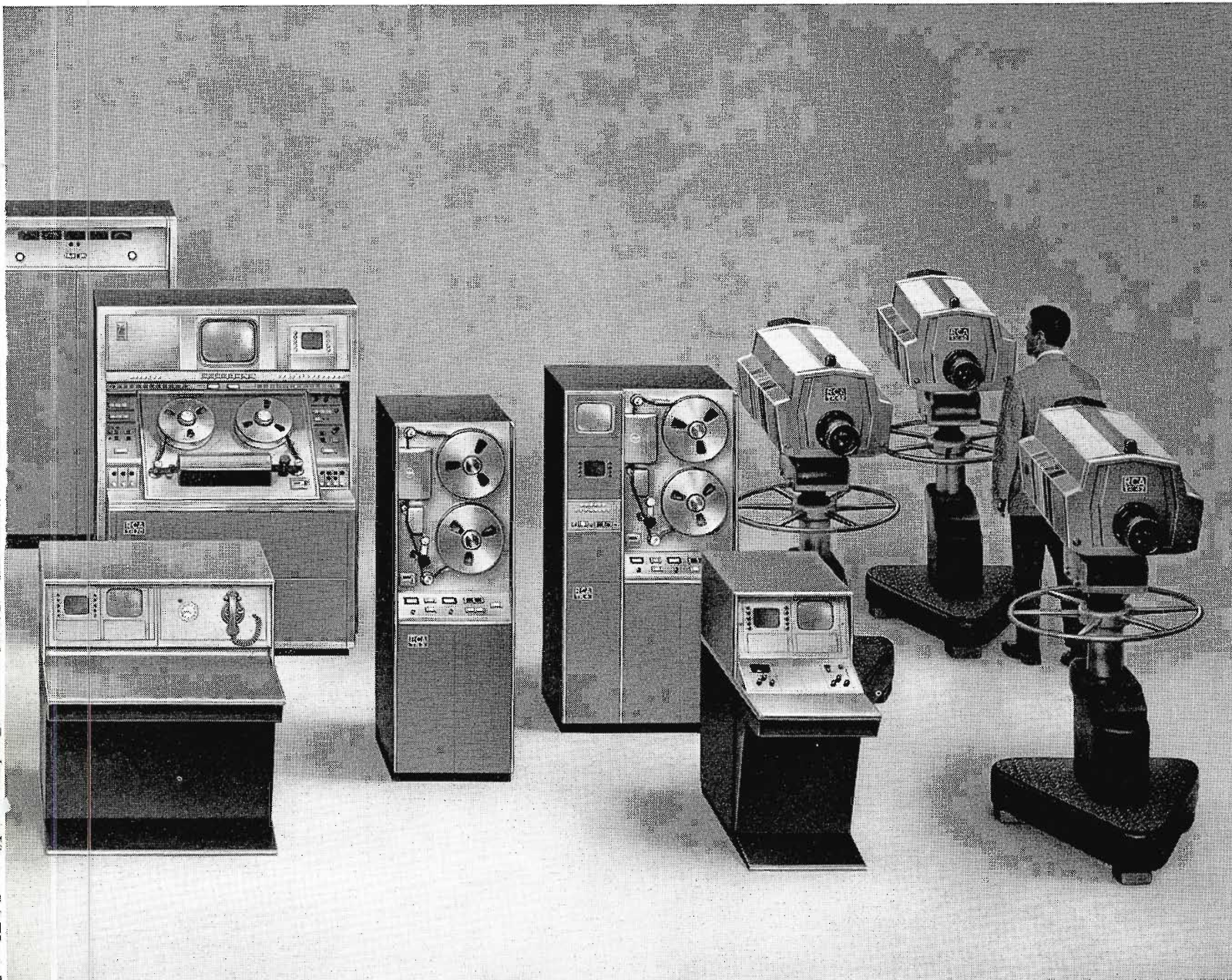
RCA  
NEW  
LOOK



FILM CAMERAS AND PROJECTORS ■ TV TAPE EQUIPMENT ■ TRANSMITTERS

# RCA...the

*"MATCHING" MEANS A BETTER INVESTMENT*



CONTROL CONSOLES, SWITCHING AND EFFECTS ■ LIVE CAMERAS

# matched line

The "Matched Line" is the end result of a multi-million-dollar engineering program to produce a new generation of broadcast equipment. RCA Matched Equipment reflects the newest in styling, performance and operation.

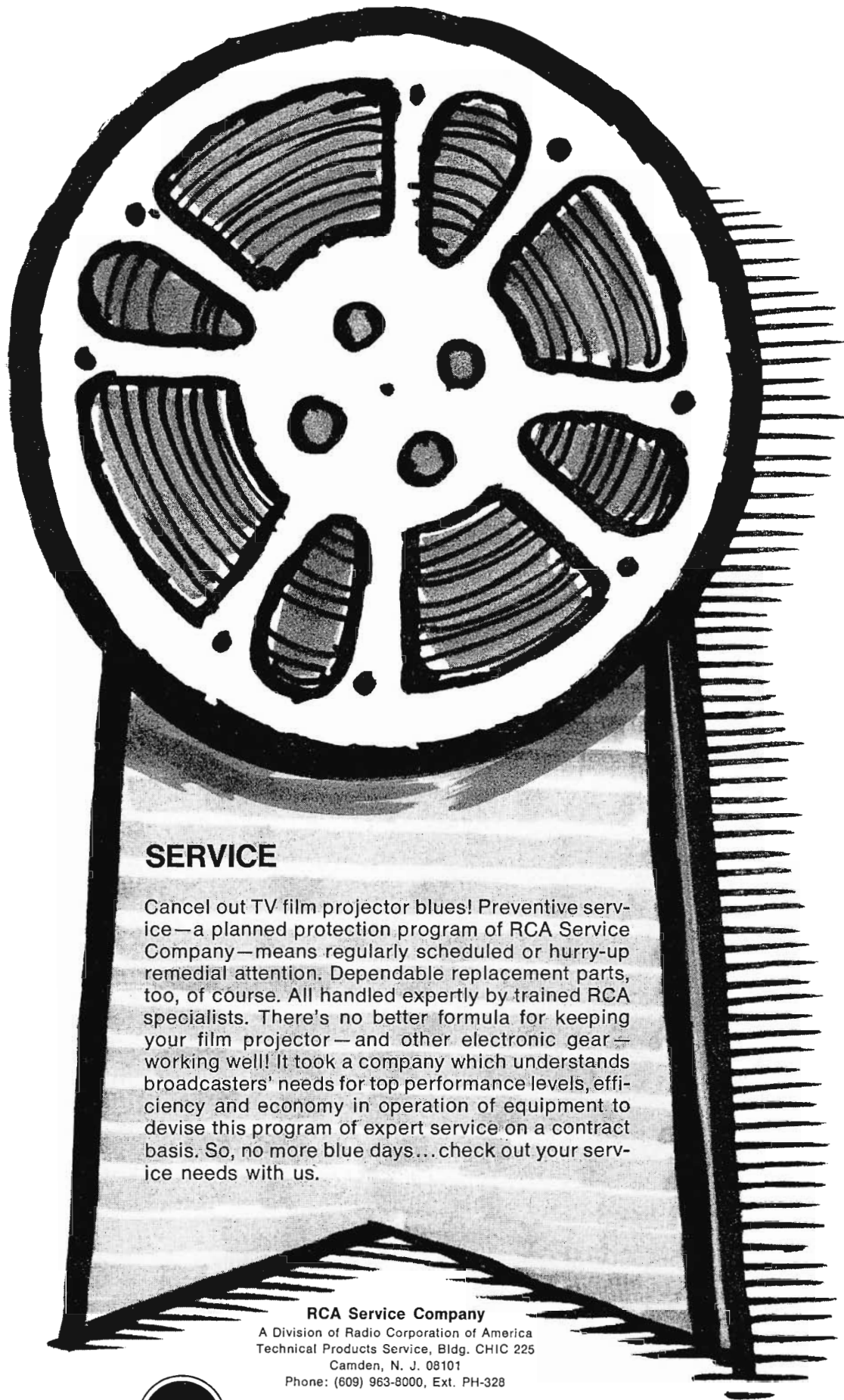
Matching means equipments that are designed to provide the ultimate in performance when used together... equipments that are designed and styled to fit together efficiently, and to provide the finest, most modern appearance for the whole station. It means installations that are compact, yet easily expandable, that offer greater reliability, and that provide for easy operation and maintenance. It means simplicity in ordering, easier follow-up and guaranteed satisfaction... from one factory, one ultimate source of responsibility, one set of designers and engineers. And it means equipment that is designed for tomorrow, assuring a better investment.

If owning equipment that performs and looks better together, and lasts longer, appeals to you, why not consider RCA's Matched Line? From "big tube" cameras, advanced quadruplex recorders, film and slide projectors... to transistorized switching, controls, transmitters and antennas, the RCA Matched Line is a good thing, all the way, for you.

*See your RCA Broadcast Representative. Or write RCA Broadcast Television Equipment, Building 15-5, Camden, N. J.*



**The Most Trusted Name in Television**



## SERVICE

Cancel out TV film projector blues! Preventive service—a planned protection program of RCA Service Company—means regularly scheduled or hurry-up remedial attention. Dependable replacement parts, too, of course. All handled expertly by trained RCA specialists. There's no better formula for keeping your film projector—and other electronic gear—working well! It took a company which understands broadcasters' needs for top performance levels, efficiency and economy in operation of equipment to devise this program of expert service on a contract basis. So, no more blue days... check out your service needs with us.

### RCA Service Company

A Division of Radio Corporation of America  
Technical Products Service, Bldg. CHIC 225  
Camden, N. J. 08101  
Phone: (609) 963-8000, Ext. PH-328



The Most Trusted Name in Electronics

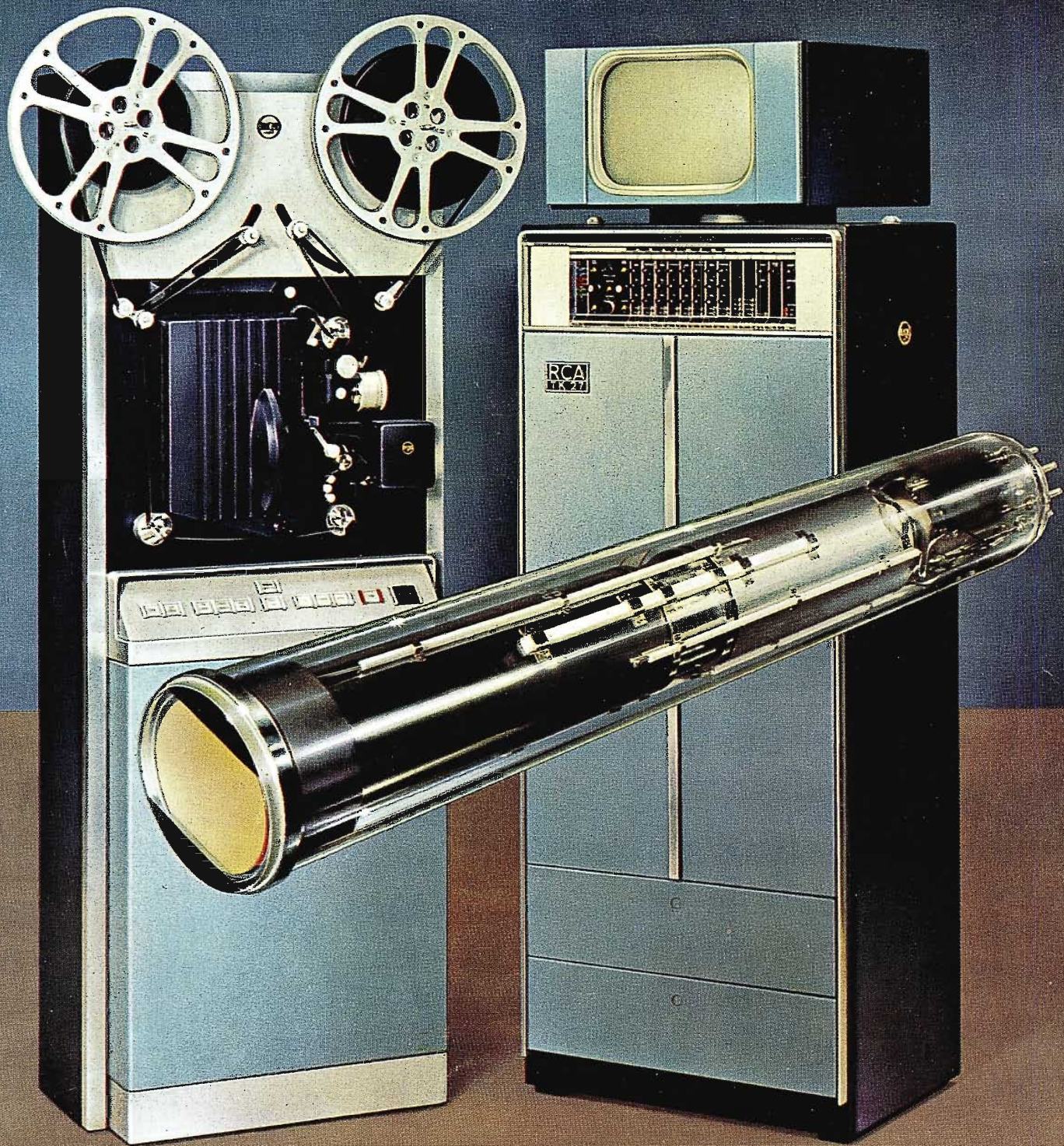
# MAKES EVERY PICTURE SPARKLE!

FOR LIVE PICTURES...TK-42—world's most exciting camera! The secret's in the BIG black tube ... Combined with three color tubes it means sharpest pictures, purer colors, more exciting contrasts. A "matched" equipment from RCA.



The Most Trusted Name in Electronics

# "BIG TUBE" COLOR FILM SYSTEM



FOR COLOR FILMS...TK-27—BIG tube film system...makes the big difference in your color film pictures...maintains color quality, automatically compensates for film and slide variations. A "matched" equipment from RCA.



The Most Trusted Name in Electronics