

BROADCAST NEWS

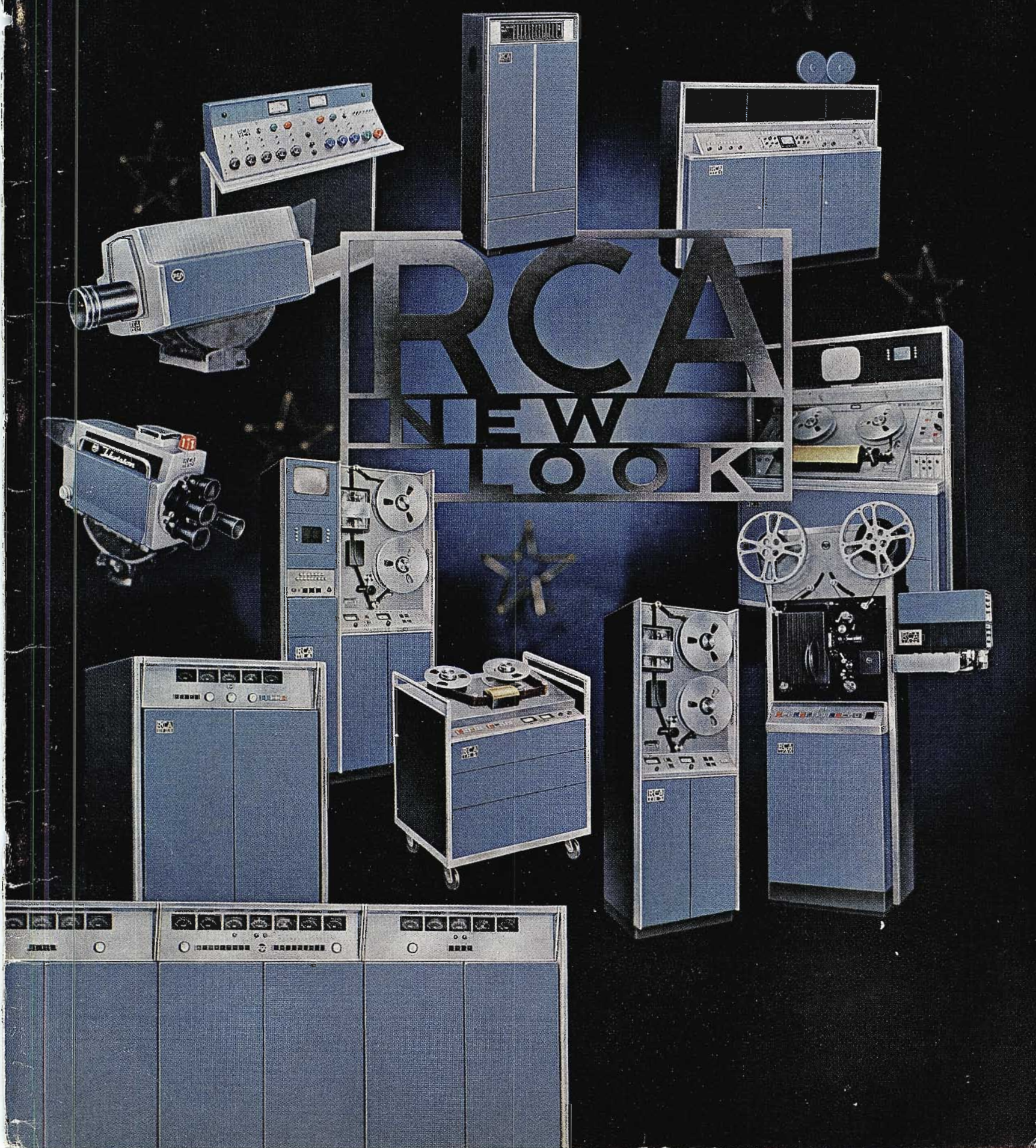



The Mark of the Finest in TV Tape Recorders



The TR-22, with its excellence of design and brilliance of performance, attracts attention wherever it's in operation. Fully transistorized, it does away with problems of power, heat and space, reduces maintenance. It provides highest standards of quality and reliability. Any studio can benefit from this symbol of the finest in TV Tape.



The Most Trusted Name
in Television

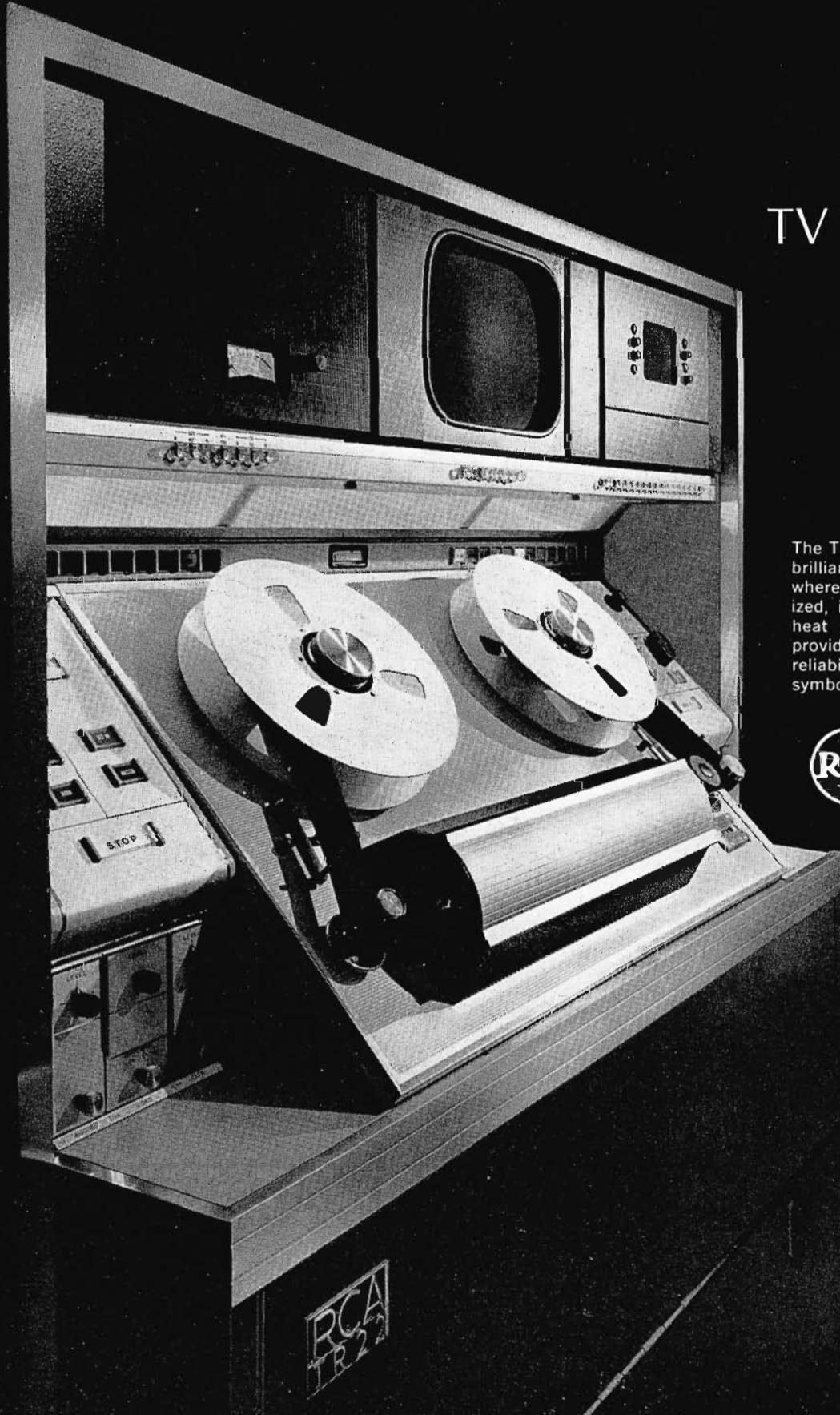

BROADCAST NEWS*published by***RADIO CORPORATION OF AMERICA**
BROADCAST & COMMUNICATIONS PRODUCTS DIVISION, CAMDEN, N. J.*issued quarterly*PRICE *in U.S.A. - - - - - \$4.00 for 4 issues*
*outside U.S.A. - - - \$5.00 for 4 issues***C O N T E N T S**

| | Page |
|--|------|
| INTRODUCTION TO THE RCA NEW LOOK | 2 |
| THE MEANING OF THE NEW LOOK | 6 |
| ENGINEERING IN THE NEW LOOK | 16 |
| STYLING OF THE NEW LOOK | 22 |
| NEW CONTROL CONSOLES | 26 |
| A WHOLE NEW LINE OF FM TRANSMITTERS | 28 |
| NEW 4-CHANNEL LIVE COLOR CAMERA | 32 |
| NEW 4-VIDICON COLOR FILM CAMERA | 36 |
| NEW GENERATION TV CAMERA | 40 |
| NEW MONOCHROME FILM SYSTEM | 44 |
| NEW GENERATION TV FILM RECORDER | 48 |
| FOUR TRANSISTORIZED TV TAPE MACHINES | 52 |
| AN ALL-NEW LINE OF UHF TRANSMITTERS | 56 |
| NEW TRANSISTORIZED AUDIO EQUIPMENTS | 62 |

*As We Were
Saying*

THIS IS THE WEEK THAT IS, convention week, that is—and here we are, not only with our biggest show ever, but also with this special convention issue of BROADCAST NEWS. We had said we would never do it again—get out a convention issue. And we meant it, or thought we did. Getting ready for the big show is a back-breaking job in itself—without taking on the sweat of putting an issue to bed.

But we were carried away by our own enthusiasm. We've been working on this "new look" idea for some four years. It took a lot of effort to get the program started, and more to get it up to speed—but now we're rolling, and here come those beautiful new equipments. Our enthusiasm is unrestrained. And when the boss

said, "we ought to have a special issue," we took off into the blue—"new look" blue, that is.

So, this issue is "new look" from front to back. And we hope you like it half as much as we do.

BUT FEAR NOT, this is no precedent. Just for this once we're putting on a 60-minute commercial—like those new-model programs in the fall. But next issue we'll be back to the standard hour of entertainment with six minutes of commercial. We already have several outstanding station stories on tap—and we have more lined up. Also coming up is a series of stories on what stations of the future might look like—real far-out stuff. 'Til then, as the old maestro did say, forgive us, forgive us.

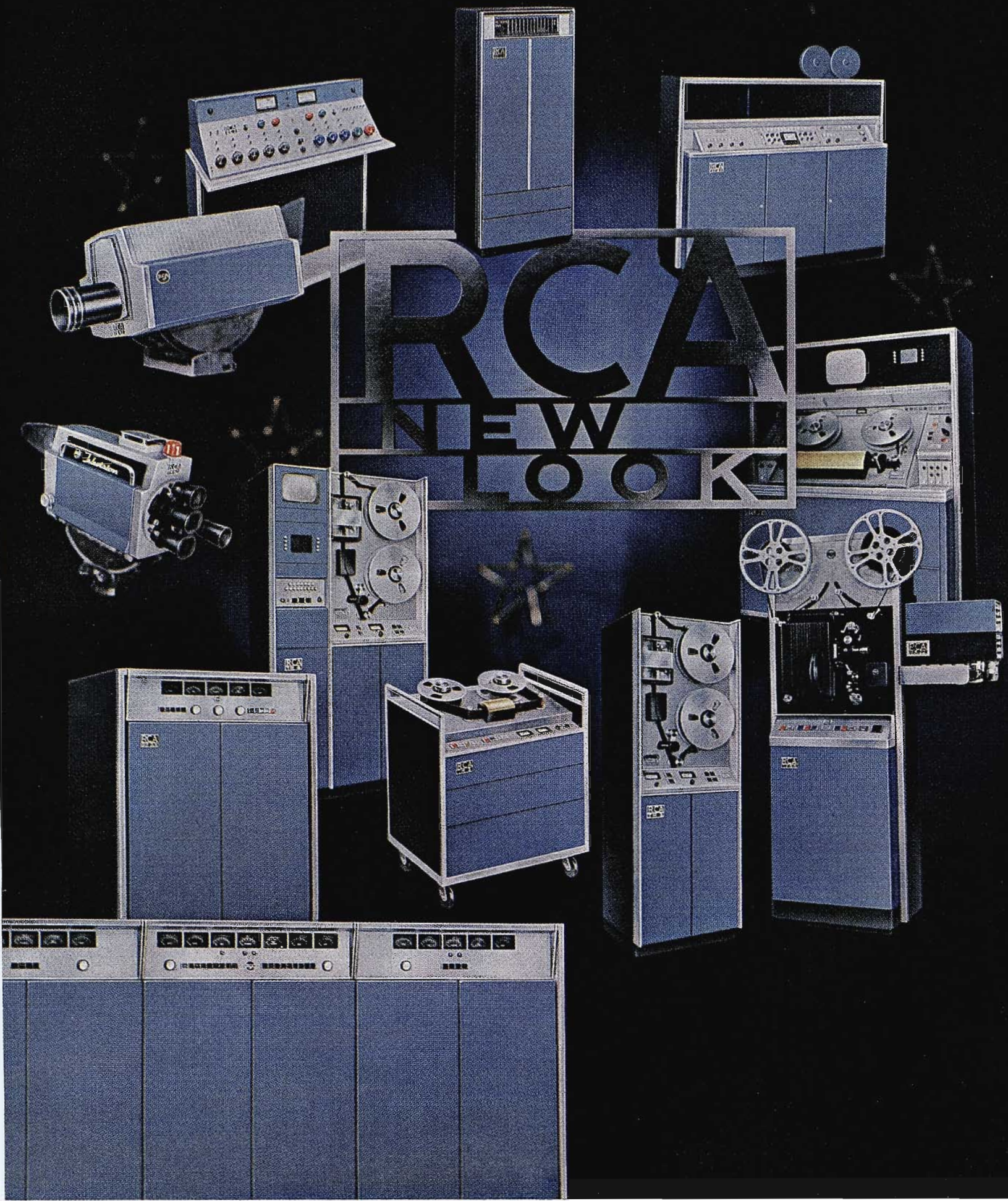

1964

RCA "New Look" equipments which will be shown at the 1964 NAB Convention are shown in this montage from our front cover. Included are three brand-new tape recorders, completely new live and film color cameras, new monochrome film equipment, a complete line of new FM transmitters and a complete line of new UHF transmitters. These equipments are the first wave of RCA's total new look concept.

Introduction to the

by CHARLES H. COLLEDGE

Division Vice President and General Manager

RCA Broadcast and Communications Products Division



In this issue of BROADCAST NEWS we introduce a *program* we call the "RCA New Look." We purposely emphasize the word *program* because we believe that only by thinking of it as a program can you grasp the full significance of what we are doing. And only by having a related "new look" program of your own can you take full advantage of the developments which will stem from our program.

What is this "RCA New Look" program? Basically it is a *program for completely redoing our whole line* of broadcast equipment. And when we say "redoing" we do not mean just changing the color, or the appearance, or the construction. Nor do we mean just transistorizing, or modularizing, per se. What we mean is that we have thrown everything out and started from scratch to design a whole new line of completely new — and very different — equipment units.



CHARLES H. COLLEDGE has been general manager of RCA's broadcast equipment business since 1958—and Division Vice President in charge of both broadcast and communications products since 1962. Previously he had been Vice President of Facilities Operations for NBC. He joined NBC in 1933, as an engineer and has been active since in all aspects of broadcasting—including supervision of RCA's Field Color Test operations in Washington from 1949 to 1951. He served during the war with the Electronics Division, Bureau of Ships, and was a Lt. Commander on the staff of Admiral Blandy during the first atom bomb tests at Bikini.

This radical "changeover" in our equipment line is a sharp break with our past practice in three important respects: (1) in the past we have updated our designs by successive small changes — this time the changes are "revolutionary"; (2) formerly we updated equipment units individually—this time we are doing everything simultaneously; (3) before we redid our line over a five-to-ten-year period—now we are redoing the whole line in a two-year period.

At this point it becomes fair to ask—why all this seeming rush? The old policy of gradual updating was liked by everyone. It enabled us to maintain a constant engineering and production load. It allowed the stations to grow gradually (by adding a piece at a time) and to keep constantly updated (by replacing a piece at a time). Why the big—and sudden—change?

The answer is in two parts.

First, as to why the big change. The answer to this is that we finally reached a point where it was no longer practical to incorporate the new developments into our old designs. There have been many important—almost revolutionary—developments in electronics in the past few years. Transistors, silicon diodes and other solid-state devices, modularization, printed-circuit boards, stabilization and numerous advances in circuitry have appeared in a rapid succession. The overall effect of these developments has been to completely change our concepts of equipment design. Moreover, the physical changes have been so great (for example, some transistor equipments are only one-tenth the size of their tube predecessors) that there has been no choice but to break with past design and create a whole new generation of equipment.

Now, as to the second part of the question—why the seeming rush? The answer is that it only seems that way. Actually we started on this program about four years ago. And we showed our first new look product—our TR-22 Tape Recorder—at the NAB Convention in Washington in 1961!

The TR-22 was a good place to start, because it encompassed almost every conceivable circuitry problem that could put this type of program to the test. We learned a great deal about transistorizing, took advantage of what we learned and, I think, have every right to be extremely proud of our TR-22. Much preliminary work and planning was required in designing the TR-22 because we wanted to standardize modules and components wherever practicable. As a result, many modules in our new family of TV Tape Recorders—the TR-22, TR-3, TR-4, and TR-5—are interchangeable. Similarly, many modules in our new camera family—TK-42, TK-27, and TK-22—will have the same type of module interchangeability.

While we were working on the TR-22, and on other equipments that we had not yet announced, the need for a major "transistorizing" program became so apparent that some of our customers asked why it was taking us so long to move. Were we less cognizant than others of the possibilities? No, we were not! Were we slower to switch? Yes! Because we had in mind the basic interests of the industry (which, long-range, are the same as ours).

Like everyone else we were enthralled from the start with the possibilities of transistors. However, because broadcast equipment must provide maximum reliability we moved very cautiously in incorporating these new components into our equipment. It was just as well. Poor quality, lack of standardization, and high prices harried those who transistorized too soon. Moreover, some of the first-announced transistor types were later withdrawn—leaving as orphans equipments into which they had been incorporated. Ready availability of replacement parts has always been a must in our equipment policy. Thus we felt we should not incorporate any component unless there were at least two sources of supply. Still another difficulty of early transistor days was the fact that there were no suitable



1961

At the NAB Convention in Washington in 1961, RCA displayed the first major piece of broadcast equipment to be completely transistorized—the TR-22 Deluxe TV Tape Recorder. In developing and perfecting the TR-22 RCA engineers solved most of the basic circuitry problems faced in transistorizing video equipment. Since then they have been engaged in using this know-how to develop RCA's completely new all-transistorized "new look" equipment.

transistor types for many circuit requirements. Thus it was not possible (until very recently) to completely transistorize most equipments. Hybrid equipments (part tubes, part transistors) could be built. But using even a few tubes negates most of the advantages of transistors—i.e., getting away from heat, high plate voltage, conventional panel construction, etc. Thus there were many good reasons why we moved into transistorization very slowly.

However, the situation gradually changed. Transistor quality improved, prices came down, many new types appeared. About four years ago we finally decided that the day when we could produce all-transistorized equipment of very high performance was within sight. As noted above, the TR-22 Tape Recorder was our first all-transistorized "new look" equipment. Based on our success with the TR-22 (as indicated by its overwhelming acceptance in the industry) we decided that the time had come to transistorize our whole line. So we made our plans and went to work. It was an enormous task. It has taken time. And it has required the expenditure, over the past several years, of very large sums of money. This expenditure will continue at an even greater rate during 1964. But the happy result of this tremendous engineering program will be an almost completely new line of broadcast equipment from studio to antenna. Some of these new products are available now; more will appear at the NAB Convention; a few will

not be available until later this year. But by year-end all will be ready for shipment—and the RCA "new look" in broadcast equipment will be an accomplished fact.

The "key" to the great importance of these new-look equipments is the fact that they are so different from anything that has gone before. They are, with a very few exceptions, all "solid-state." And they are designed to take maximum advantage of all-transistorized design. This means that, for the most part, they are modularized: they are smaller, differently shaped, and, in many cases, differently arranged, than previous equipment units. Because they are so much smaller, use so much less power, generate so much less heat, they lend themselves to much more compact equipment assemblies. This in turn means smaller equipment rooms, lower installation costs, reduced operating and maintenance costs.

We feel, very strongly, that the introduction of this new line of equipment marks a "milestone" in the technical progress of the industry. Because it is so important we have devoted this whole issue of BROADCAST NEWS to the new look. Articles that follow describe at further length the general features of the new look—and these are followed by short articles describing many of the equipments in the new line. Some of the new equipments are not shown—because the production models were not yet ready for photographing. They will be shown in forthcoming issues.

You will note that we speak about this new line of equipment in very glowing terms. We hope that you will not jump to the conclusion that this is all advertising hyperbole—that the new look is just a gimmick to sell equipment. That the "new look" will sell equipment—we surely hope. That we will push it—is certainly true. But this in no way dims the significance, technically—nor the importance, business-wise—to broadcasters. In fact, almost the opposite! With our tremendous stake in the broadcast business it should be obvious that we would not push the "new look" so hard if we were not convinced of its worthwhileness. Broadcasting and RCA are synonymous. Our top management shares our interest and enthusiasm. Many people are responsible for our new look and a great deal of credit goes to John Taylor who, over the years, has devoted his life to this business.

Our engineers, as I am sure you can see, have given a lot of thought and study as to how stations of the future will be set up and operated. The benefit of their experience, and the assistance of our "systems" people, is available to you in making your "new look" plans. I earnestly recommend that you avail yourself of their friendly help. Your RCA broadcast representative will be glad to make the arrangements. You will have the full support of our Engineering, Marketing, Production, and Service people. The RCA slogan is "The Most Trusted Name in Electronics." We mean it!



1962

At the NAB Convention in Chicago in 1962, RCA displayed a number of additional "new look" equipments in production and prototype stages. Among the latter was the first 4-channel color camera (TK-42X) shown anywhere (right, in above illustration). During the two years since then RCA engineers have worked to further perfect this camera, completely transistorize and modularize it, and integrate it with other "new look" equipments. At the 1964 Convention the production model will be shown.



1963

At last year's NAB Convention RCA displayed a laboratory model of its 4-channel film color camera (TK-27X)—and demonstrated what many believe to be the finest color film pictures ever produced. The production model of the TK-27 which will be shown at the 1964 Convention is not only transistorized and modularized—but, in addition, it uses the same modules as RCA's other new cameras—an important factor in standardization. It takes longer to build equipment this way, but it's better when you get it!



RCA
BIF 20E

© 1954 RCA

The Meaning of the



by JOHN P. TAYLOR

Manager, Marketing Services

RCA Broadcast and Communications Products Division

The picture opposite is symbolic of something that's happening in our broadcast equipment business—something surprising, interesting, pleasant, exciting—and important! It's not just new equipment. It's an exciting new spirit in our business. It's a new feeling of freshness, a new interest in inventiveness, a new pride in product, a new pleasure in planning. It's like going back to the early days of radio. It's like a rebirth of our business. It's happiness! It's the "RCA New Look."

The transmitter shown—the most beautiful transmitter we've ever seen—is our new 20KW FM Transmitter. It's as completely new inside as it is outside. We have a whole new line of FM transmitters just like it. We also have a whole new line of UHF television transmitters in the same styling—and they, too, are all-new inside. We have completely new, all-transistorized, 4-channel color cameras—both live and film. We have a whole new line of tape

recorders; new monochrome film equipment, new audio equipment, and the beginnings of a whole new line of video equipment. This, too, is the "RCA New Look."

These beautiful new equipments are largely transistorized, fully modularized, and they incorporate stabilized circuitry throughout. They are radically different from anything that has gone before—both in design and in appearance. And it is this complete newness—this feeling of starting from scratch, this throwing off of old shackles and shibboleths—that has so enthused our designers and engineers.

This new spirit of excitement is the first phase of the RCA new look program. The second phase is a great outpouring of new look equipment—the first wave of which is pictured in this issue. The third phase—just now getting underway—is a "new look" in station installations. There will be,

we feel sure, still a fourth phase. This will be a new look in station operating and maintenance procedures which will develop as these new equipments come into use.

As Mr. Colledge has pointed out in the preceding article, this new look program has tremendous significance not only for us but for the whole industry—and especially for those of our customers who are looking forward to expanding and improving their facilities.

In order to fully appreciate the importance of the new look program—and be forewarned of the "revolution in the control room" which it is about to trigger—it is necessary to understand the basic thinking behind it. To help you do so we will try to explain, in the following pages, what we mean by the new look, how the idea was born, why it is so timely, what we are doing about it—and what we think you should do about it.



JOHN P. TAYLOR has been closely associated with RCA's broadcast equipment activities for nearly 35 years. He joined the company as an engineer, transferred to sales, then advertising and, finally, marketing. In his present position he supervises all of the market research, styling, advertising, promotion, press relations, and sales services activities of the Division. He was one of the contributors to the first issue of BROADCAST NEWS in October 1931—and has been active in the preparation of every issue since that date.

WHAT IS THE NEW LOOK?

We have been using the term "new look" in a loose fashion. We expect that we will continue to do so—and that our customers will do so. It cannot be otherwise, for the new look, in its broadest sense, is a new direction—a new approach—to the whole broadcast equipment business. It involves all of our people, all of our products—and will involve, sooner or later, all of our customers. The new look has many facets. Let's consider some of them.

Is It A Slogan?

Yes, in the sense that it is a handy name for all of the things that make up the program, the term "new look" is a slogan. We searched for some trickier phrase—tried coining names, inventingonyms, so on. But nothing seemed to communicate the idea as well as "RCA New Look"—so we decided to stay with that.

But please note that the "new look" is not—at least, not primarily—a promotion gimmick. It is true that our advertising people have seized on the idea with great enthusiasm—and that they gave it the name "the RCA new look." But this happened *after* the program had been decided on and was well launched. You can expect our advertising and promotion people to push this new program—but they did not create it!

Is It New Appearance?

Yes, appearance is certainly a part of the new look. As the picture opposite and the articles which follow, indicate, the new equipments have a new—and very distinctive appearance. Our styling experts have truly outdone themselves. But, again, this was something that mostly happened *after* the program was launched.

It is a basic tenet of modern design that "form follows function." Thus, the appearance features which distinguish the new

equipments (compactness, clean lines, simplified controls, etc.) are, in large degree, a *result* of the basic features of these equipments. Our stylists created the new look appearance—but only as a part of the new look program.

Is It New Engineering?

Yes, new engineering is fundamental to the new look program. The new look is based on new components, new circuits, new concepts—incorporated in new designs. Some of these designs were partially formulated before the new look program was planned. In fact, the nature of these early designs suggested this program. However, it is important to note that engineering, too, is but a part of the program—it is not the program, per se. In the long run, equipment designs will be the *result* of basic directions in the program. Our engineers—although they will bear the major responsibility for carrying out the program—were not the originators of it.

Is It New Equipment?

Yes, obviously, a whole new line of equipment is an important part of the new look program. But again we say a *part*. For the new look is not—specifically—a group of newly designed equipments. And we say this in spite of the fact that most of this issue of BROADCAST NEWS is devoted to descriptions of "new look" equipments. These new equipments are, of course, the most immediate and tangible evidence of the new look—but, again, they are the *result* of the program, rather than the program itself.

No—It's A Program

No, the "new look" is not just promotion, or styling, or engineering or even products, per se—although it involves all of these. Rather it is an idea—or perhaps we should say, a program for implementing an idea.

The idea, simply stated, is that it is time to take a new look at the whole conglomeration of present broadcast equipment, time to pause and consider what a broadcast station installation would look like if we were to equip it with all-new equipment in which all of the units were newly designed to take maximum advantage of all the newest technological advances.

The obvious corollary to this is that it is time for us, as manufacturers, to stop modifying, stop updating, stop adding B's on A's, C's on B's, D's on C's—a process which has enabled us to evolve well proven, highly reliable equipment (the world's finest)—but which has tended to make it difficult for us to take full advantage of new developments (transistors, for instance). That it is time for you, as stations, to stop adding a unit here, replacing a unit there, growing piecemeal in Topsy-like fashion—a procedure that probably has been necessary in getting you through the early growing pains of station operation—but which has saddled you with an equipment setup that (if you are typical) is a real mess. That, in short, it is time for both of us to drop the piecemeal approach to better equipment and better operation—and to take a giant step that will enable us to use all of the new technological developments to the *maximum* degree.

It is obvious that such a program requires consideration not only of the basic design of equipment, but also of how the equipment will be installed and operated. Thus the new look—in its truest and broadest sense—is an industry new look. It is a new look at the total technical operation of today's broadcast stations. For you this means a long hard look at how you will operate in coming years. For us it means developing the equipment you will need to do it. The RCA New Look is our program for our part of the job.

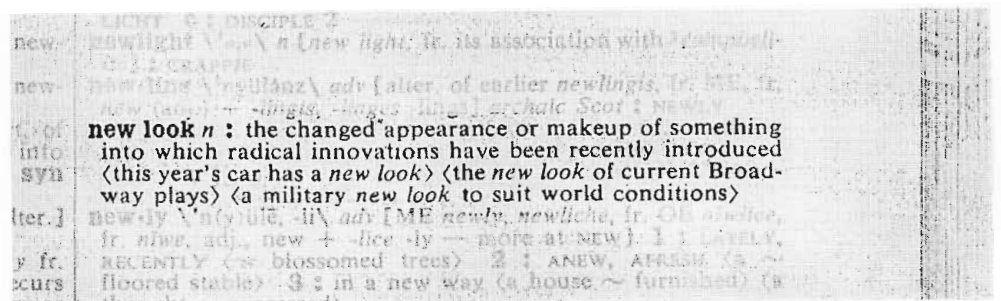

WHAT WEBSTER SAYS the new look means. The key words are "radical innovations . . . recently introduced." The definition is apt for radical innovations are the essence of the RCA New-Look equipments. And certainly they have "changed appearance" as well as changed "makeup."

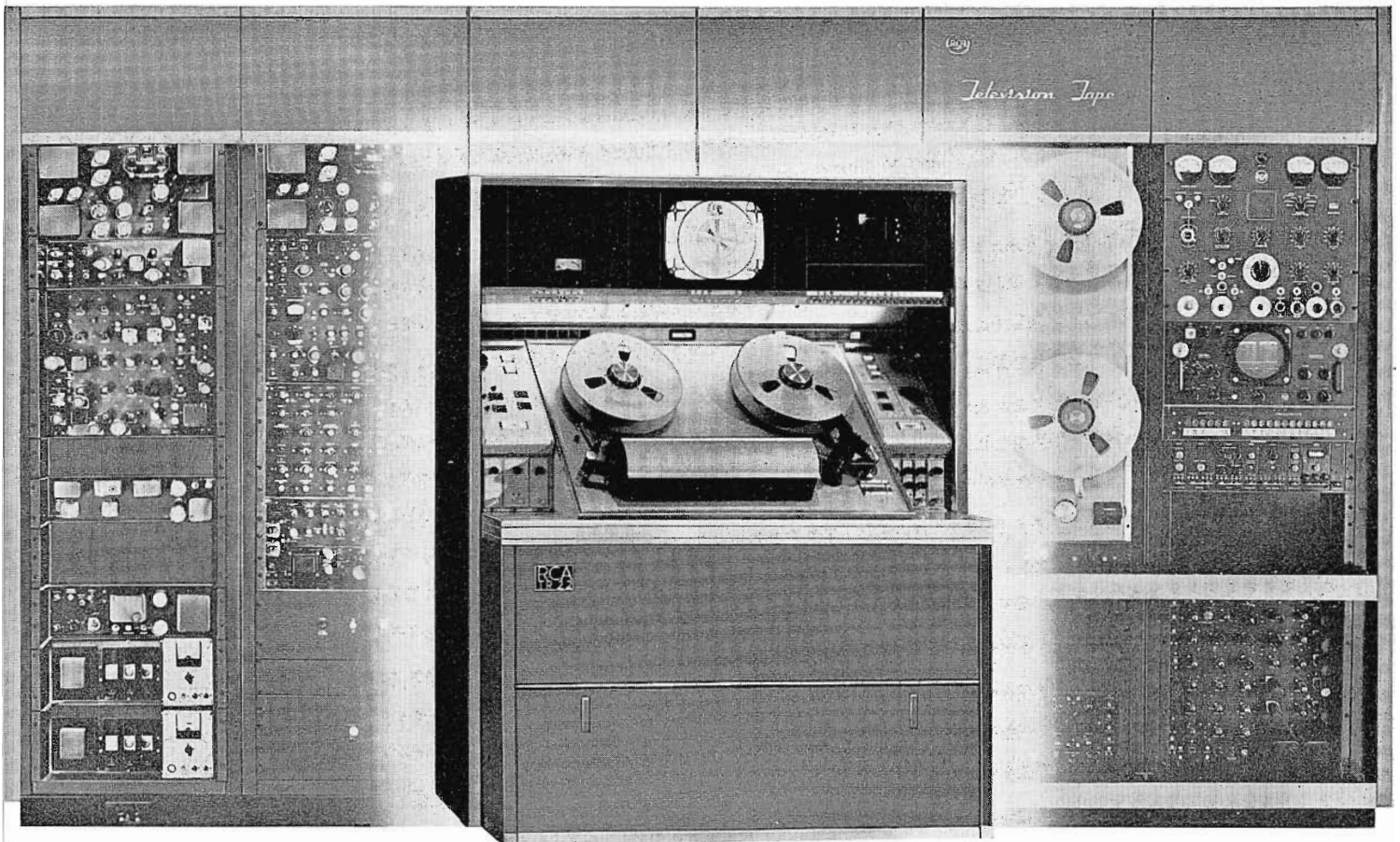

THE TR-22 RECORDER STARTED IT. First major RCA unit to be completely transistorized, the TR-22 is shown above superimposed on the TR-1B Recorder which preceded it. Fully equipped for color the TR-22 is less than one-third the size of the older model. It is a completely self-contained unit. Space for ATC, Color and Electronic Editing modules is provided within the unit. There are no external accessories under any mode of operation. Not only does this eliminate racks, and save space and wiring, it also brings all controls within easy reach. The startling differences between the TR-22 and older equipments brought the new-look idea into being.

HOW THE NEW LOOK IDEA WAS BORN

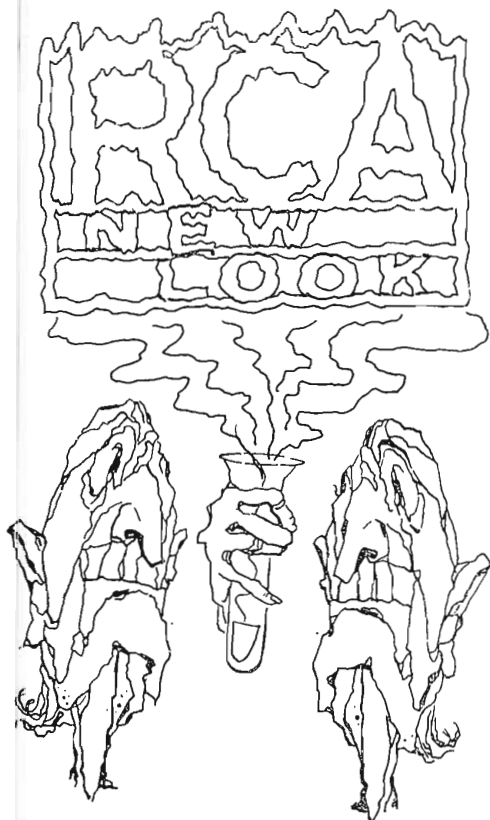

The new look idea was born with our first experience in transistorizing—but it was not born full-blown. It began as a small and rather tentative idea. And it grew by stages, more or less in parallel with our knowledge of what transistorization meant.

As everyone knows, most of our present-day equipment units have evolved, by successive small changes, through a long series of preceding designs. In general, each new design was a redesign of the preceding one. In many cases there were A, B, C, D—and more—models of the basic design (for example, the TK-11 Camera, which through many modifications was kept up-to-date for ten years). This updating process developed a highly standardized system of broadcast equipment. And most station engineers liked it because it enabled them to keep their equipment current by relatively minor modifications. It had the further advantage that as stations grew they could add new equipments and still have reasonable compatibility between old and new.

So everyone was pleased with “the system” and when transistors came along, we all assumed (at least at first) that we would simply substitute transistors for tubes and continue our accustomed procedure of gradual updating. But we soon found that there were a number of difficulties. First, we couldn’t just put transistors in tube sockets—the operating parameters were all different. Second, the existing voltages and power supplies were all wrong and had to be changed. Third, a wholly-different type of construction (modules and printed circuits) was indicated. Fourth, the space required was usually far less. Thus, it early became evident that the new transistorized units would be very different from anything that had gone before.

The new look idea began with this realization that the old order was dead. But the full implication was not immediately apparent. The feeling was that even if the new transistorized units were quite different inside, and smaller overall, they still

THE TK-22 CAMERA MADE IT PLAIN that a new era was at hand. All the parts of the TK-22 chain not located in the camera head will fit into one half of a 5¼-inch rack frame—as shown in the righthand rack of this illustration. By contrast the rack-mounted elements of the older TK-21 Camera chain (which the TK-22 replaces) required 35 inches of rack space—as shown in the lefthand rack in this illustration. The difference in space required (less than one-tenth as much) is so great that a new look at station layouts is obviously required.

could be mixed into older systems quite satisfactorily.

Then came our first completely transistorized major equipment, the TR-22 TV Tape Recorder. It was an immediate and tremendous success. And the disparity between the TR-22 and early designs, in performance, in reliability, in convenience, in ease of maintenance, as well as in size (see illustration, above)—was an eye-opener for everyone.

With the TR-22 the “new look” idea began to grow. Transistorization, obviously, was coming—for almost everything. But we still thought that we could change over gradually—one unit at a time—with no great disturbance to “the system.”

At the 1962 NAB we showed additional transistorized equipments—including the BC-7 Audio Console, the RT-21 Audio Tape Recorder, and the TFR-1 Film Recorder. All of these are “island units”—that is, they more or less sit by themselves and do not have auxiliary panels that must be mounted on racks or in consoles. Thus they could be mixed in with older installations with no obvious disparities—and with no great influence on the existing installation. Our gradual “changeover” seemed to be working.

But then came a new development. At the 1963 NAB we showed the prototype of our TK-22 Film Camera—and this time eyebrows shot up. Camera “chains” have notoriously taken up a lot of rack space. But with the new transistorized TK-22 all the parts of the chain not located in the camera itself will fit in one-half of a 5¼-inch high rack unit. The disparity between this and the 35 inches of rack space required by the TK-21 Camera is so great

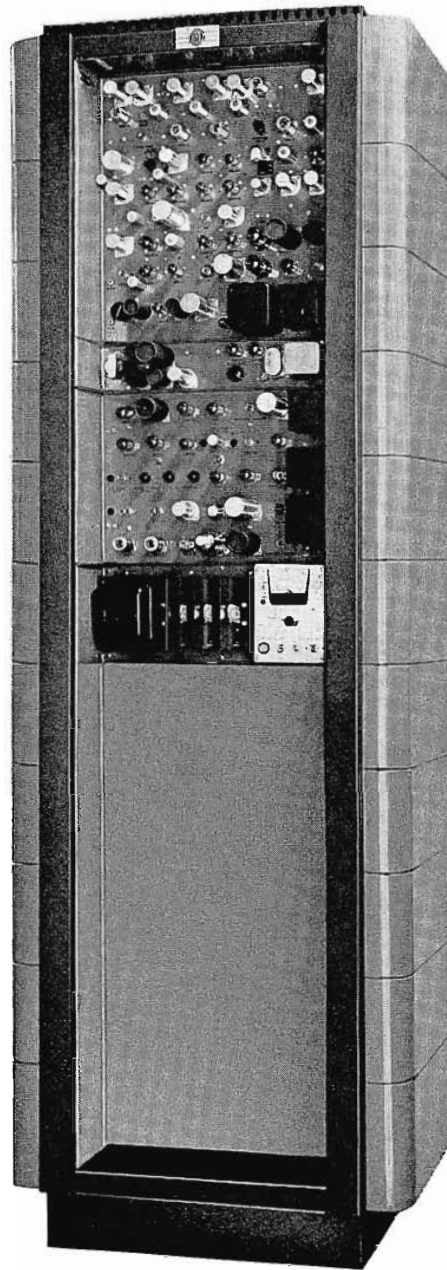

TK-21 Camera Chain

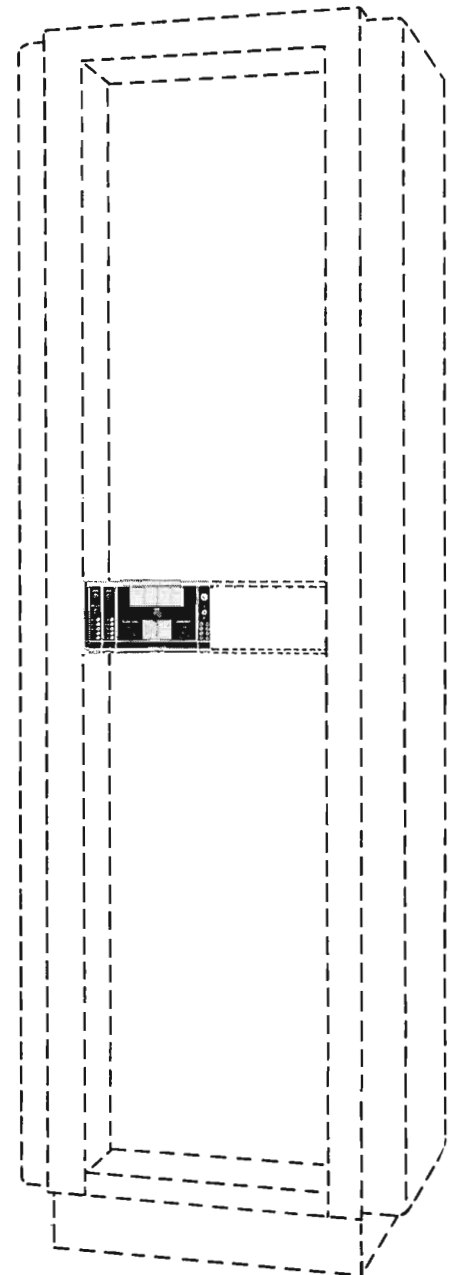

TK-22 Camera Chain

(see illustration) that one immediately has visions of ultimately getting rid of many, many racks in a typical station. In fact, the external modules of the TK-22 are so small that it may well prove desirable to mount them in the camera pedestal (see Pg. 11)—or perhaps in the control console.

At this point it became obvious that to take full advantage of all the possibilities of transistorization we ought to study all of the equipment units in the control room—and probably to redesign these equipments as a group rather than individually. This recognition of the need to redesign everything simultaneously was the next-to-final step in the development of the new look idea.

The final step, of course, was to decide that, if we were going to completely redesign the whole line, it made sense to take a new look at what the equipment needs of stations really were—not only for today’s conditions, but also for the changing requirements of the future. After all, a new line might be with us for five or even ten years. Better make it as forward-looking as possible.

Thus the “new look” idea—which began as an idea for modernizing a few individual units—gradually grew into the idea that now was the time to give a new look to the whole conglomeration of equipment that makes up the present-day broadcast station.

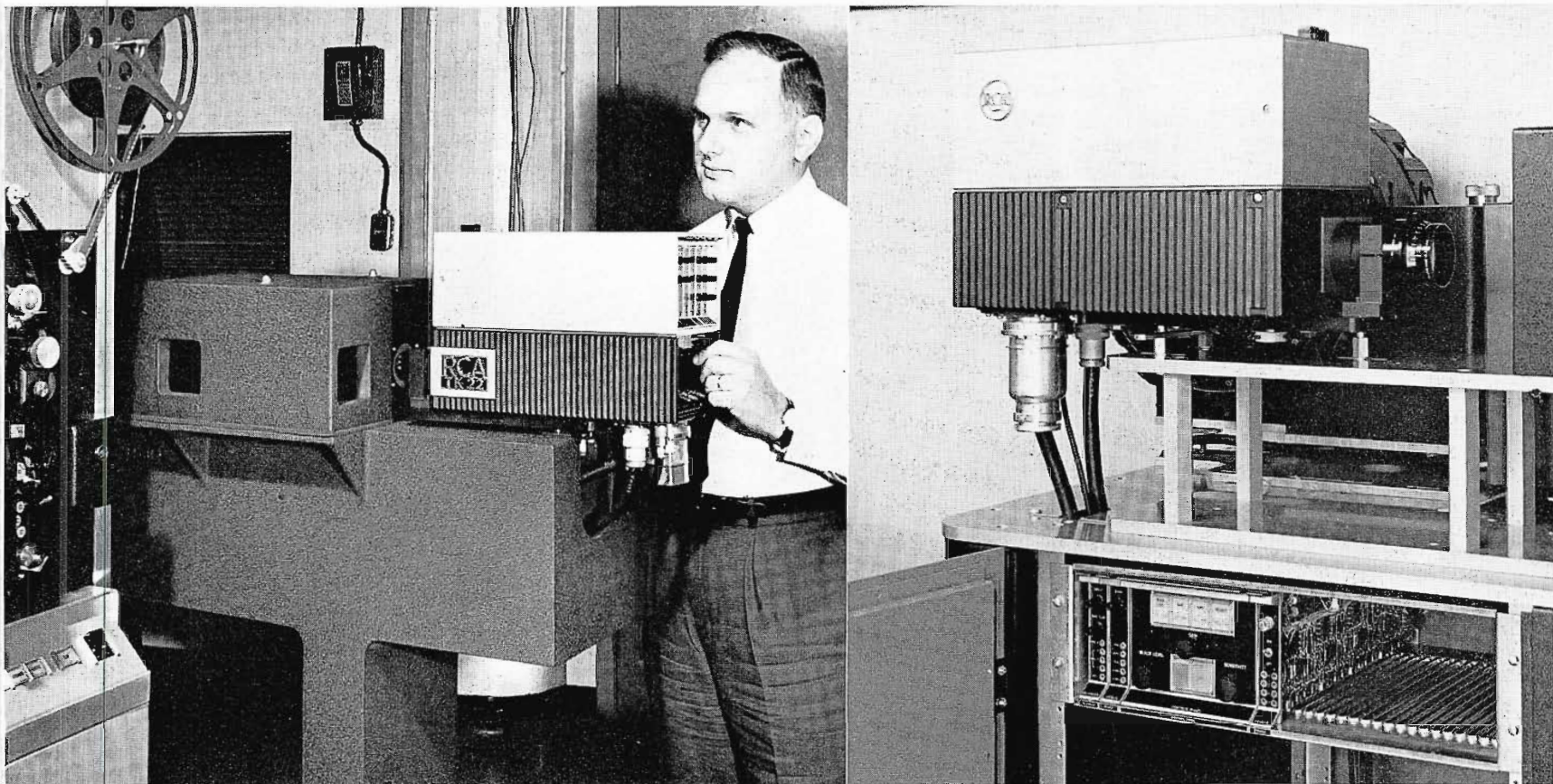

RACKS MAY BE ELIMINATED entirely in some stations of the future. The external modules of the TK-22 Camera (shown in the rack on the opposite page) require so little space that they may conveniently be mounted in the camera pedestal as shown in the righthand illustration above. In other installations they might be mounted in the film control console.

WHY IT IS TIME FOR A NEW LOOK

The radical changes inherent in transistorization and modularization were the primary reasons for the decision to take a new look at our whole equipment line. But we had not gone far with this new look before we realized that it was timely for several other reasons.

First, the previously mentioned practice of successively updating designs has gradually frozen us into industry "standards" which, in less polite circles, would be called ruts. (Consider, for example, our rack-and-panel construction, which goes back to "telephone" practice that predates radio broadcasting.) Even before the advent of transistors it was evident that we were near the point where we should make a clean break with tradition and start our new designs from scratch.

Second, the add-a-unit process of growing—which most stations followed during their formative years—has resulted for

most of them in a rather ill-assorted collection of equipment units. Most station installations today are a far cry from the well planned equipment assembly that their engineer would make if he were starting over.

Third, most TV stations are around ten years old. With much of their early equipment already written off, now is a good time for these stations to think in terms of new equipment. Obviously a "new look" is called for in planning a new installation.

Fourth, there is an obvious trend toward more and more automatic operation—if not full automation. Most present-day equipment is not sufficiently stable and reliable for automatic operation. And, more often than not, it is not fully equipped for remote control. So, this is another reason that now is a good time for most stations to take a "new look" at their equipment.

Fifth, many stations are facing the need to add to their tape recording facilities. Already crowded for space, they are hard put to find room for more equipment. The replacement of present equipment with transistorized equipment will free up considerable space (because of the fewer racks required).

Sixth, most stations are diligently searching for means to cut operating expenses. Transistorized equipments require far less power, need less air-conditioning, have lower maintenance costs, and are easier to operate. The saving in operating and maintenance costs is very appreciable—and may in itself justify all-new equipment.

There are probably other reasons why a "new look" at station installations is timely. But those listed above were sufficient to convince us that our new look program was very timely from our customers' viewpoint as well as our own.

space saving. The TR-22 module rack in the chart at bottom of Page 12 is 10½ inches high and 42 inches long. The modules it holds are equivalent to about four 84-inch racks of old-style equipments.

Another advantage of modular construction is the ease with which equipment units can be removed for test or repair at a convenient bench setup. (They may be checked without removing by using a handy module extender). In cases where spares are available they can be inserted in moments. Still another important advantage is the ease with which optional or newly developed accessory functions can be added to existing equipments. In the case of tape recorders this allows ATC, Color, Editing, etc. to be added largely by plugging in the necessary modules. Finally, there is the big advantage (in multiple equipment installations) of being able to interchange modules between units.

(5) Stabilization

Not so obvious externally as transistorization and modularization, but equally important now, and perhaps more important long-run, is the feature of stabilization which is incorporated in all of the new look equipments. In many other equipments (e.g., cameras) the operating parameters changed markedly as the equipment came up to operating temperature (making long warm-up periods mandatory). Even after reaching normal operating temperature there often was a gradual "drift." And, over a longer period, there were large changes as components aged. In the past it has been necessary to continually readjust manually to offset these changes. In the new look equipments RCA engineers have used low-drift, conservatively rated components and, in addition, have incorporated self-correcting circuits which "stabilize" the equipment immediately on turn-on—and keep it free from drift for long periods. Such "no-hands" operation is a necessity for automation—and is desirable for the semi-automatic "pre-set" type of operation which is gaining wide acceptance. It is also a near necessity for remotely controlled operations. Even for stations not interested in automaticity of any kind this stabilization is of value in that it can reduce "warm-up" periods from the hour or more now fairly common to a few minutes.

(6) Standardization

Another important feature of the new look equipments, briefly referred to above, is the large degree of standardization which has been attained. RCA engineers, taking advantage of the unique opportunity to

design groups of equipment almost simultaneously, have worked out a surprisingly large number of modules (and other parts) which are standard to whole groups of equipment. The use of similar modules in all four of the new look tape recorders is an example. These recorders share many other identical parts, as well. Similarly the new cameras (the TK-42, Live Color Camera, the TK-27 Film Color Camera, and the TK-22 Monochrome Film Camera) not only have largely identical plug-in

modules but also similar vidicon tube assemblies, pre-amps and other parts. This standardization reduces cost, makes quick replacement easy, and makes operating less confusing (because equipment arrangements and setups are similar). In many cases it will be convenient to maintain spare plug-ins for the most common units—interchangeability will make this economical to do. Some stations may prefer to return defective units to the factory rather than do their own repair.

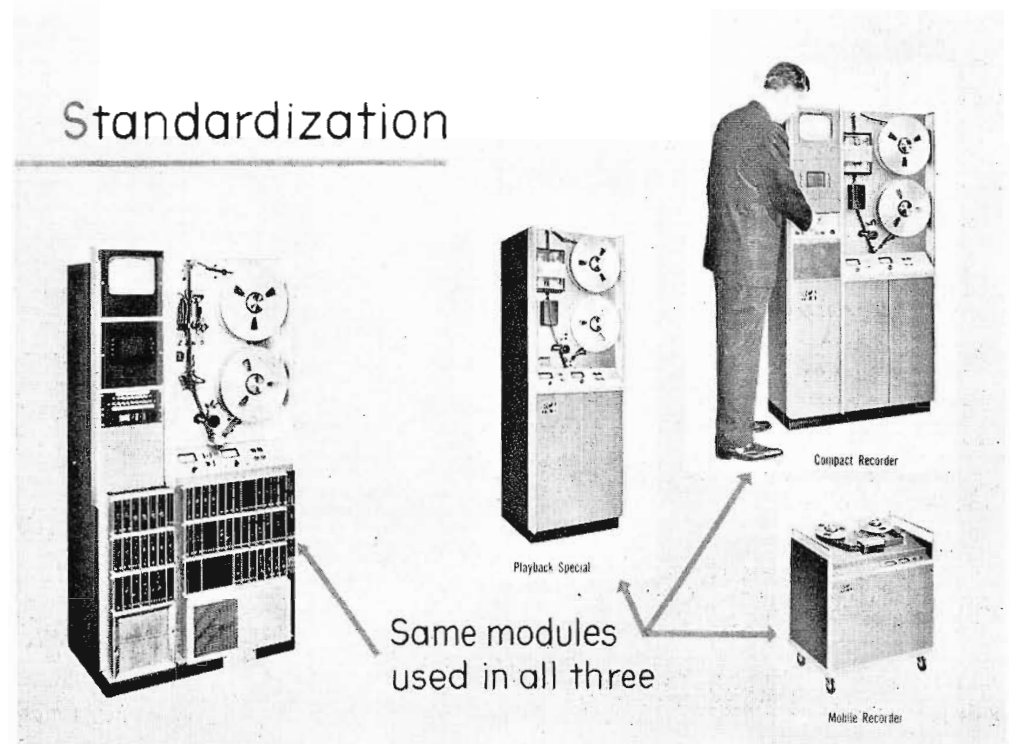
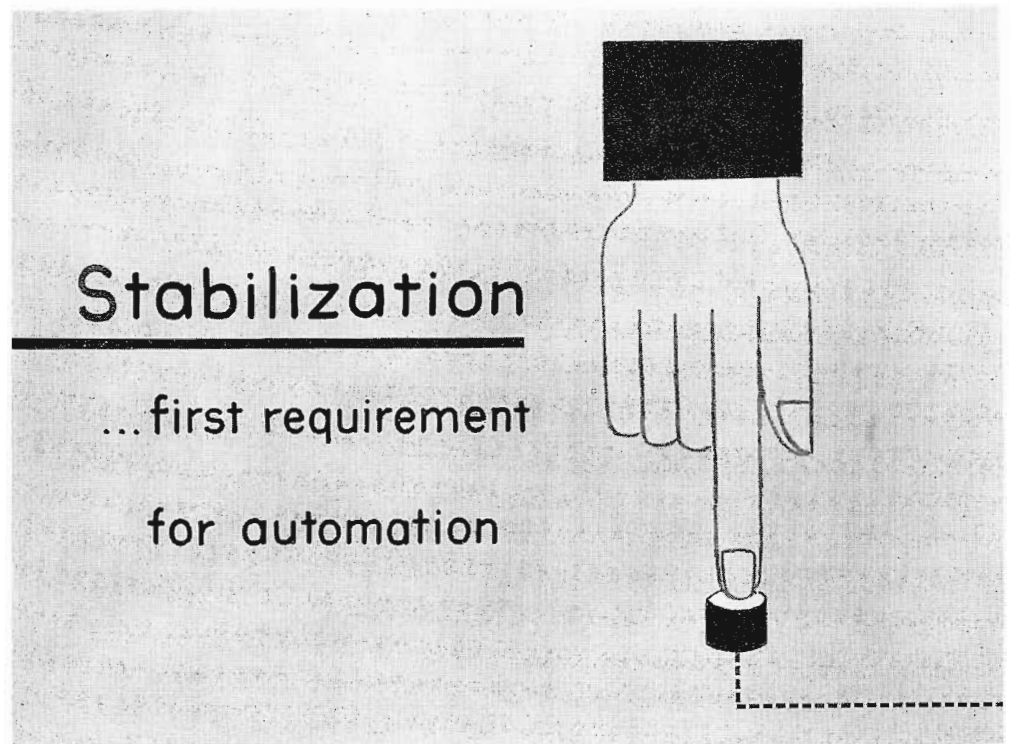

features of the



Transistorization

+ Modularization

+ Stabilization

+ Standardization

= a revolution
in the control room

THE IMPLICATIONS OF THE NEW LOOK

As the chart above indicates, the features of the new look add up to a revolution in the control room. No one who studies the full implications can come to any other conclusion. The differences between these equipments and old-style units are so great—not just physically, but also in what they do—that they bring a whole new era into being. Let's consider some of the possibilities.

New Equipment Arrangements

First and most obvious change that will occur is in the physical arrangement of equipment. Use of new look equipment composed entirely of transistorized plug-in

modules will eventually reduce the number of equipment racks in the control area by five-to-one (possibly even ten-to-one). Where a typical installation had twenty-five or thirty racks it may have only four or five. Because they require little space, and because the transistorized units exude little heat, it will probably be simplest to put these racks in a corner of master control—the former separate equipment room can be eliminated. (Racks still required for Telco lines, etc., can be put in some out-of-the-way place).

It is not inconceivable that some installations may go further—and eliminate all

racks. As noted on Pg. 13 the five small modules that make up the external units of the TK-22 Camera Chain can easily be mounted in the camera pedestal. Or they might be mounted in the control console. The new look console units (described on Pg. 26) have sufficient space in the base for several frames suitable for plug-in modules. Although there is some difference of opinion as to the desirability, it certainly will be possible in many cases to mount all of the video (or audio) equipments in the base of the control console. It would save not only racks and floor space but also wiring and installation costs. (Note, how-

EQUIPMENT & ENGINEERING

TRANSISTORS BRING A REVOLUTION

The solid state may bring an equipment replacement bonanza as television networks and stations spend, spend, spend

A revolution is ahead in the TV equipment world and its spark is a tiny, wafer-size object, the transistor.

Thanks to the advance in solid state devices, the station of the future, it's believed, will have equipment that is all transistorized. And that future, it's calculated, is coming within the next two to three years.

The benefits of transistorized gear are incalculable. It permits an apparatus that's smaller than the same equipment with tubes. It's more reliable, and it gives off less heat—permitting a less expensive air conditioning plant.

Already networks, station groups and independent outlets throughout the country have begun buying programs

station equipment may very well reach its zenith this fall and next winter and spring. By then several hundred of the older TV stations will have reached the 10-year mark and although equipment has been kept up to date in a modest way the time will have arrived for wholesale replacement with the newest items embodying what the engineers like to call the latest state of the art.

This means new cameras, both black and white and color; new tape recorders, new monitors, new amplifiers, new switching systems, new lighting systems.

Already the replacement market has come alive. In the last year—

- ABC bought 25 TV tape recorders and 80 audio recorders for all its o&o stations and its production centers at

program which saw this 10-year old station spend \$225,000 for a refurbishing that included replacing studio cameras, switching gear, tape recorder and new transistorized terminal equipment.

- In Oklahoma City, KWTW(TV) added two new film chains and replaced the switching system for two studios at a cost of \$150,000.

- In Charlotte, N. C., WRTV(TV) bought five 4 1/2-inch image orthicon cameras, three TV tape recorders, a film chain, 21 monitors, replaced its switching system and the driver section of its transmitter. For WRTV(TV) Florence, S. C., its sister station, it replaced all audio tape recorders and a film chain all added one TV tape recorder. All of this amounted to \$750,000. For the coming year there are additional equipment

ever, the word of caution on Pg. 21 anent the need for providing adequate ventilation, even for transistorized equipments).

New Operating Possibilities

It has been noted that the new look equipments provide a degree of stability exceeding anything previous. They take a long step toward a true "no hands" operation. This opens a number of possibilities. One, of course, is automation. Whether or not a station is fully automated will depend on a number of factors. However, it seems certain that there will be an increased degree of automaticity—be it simple station-break preset, deep-dish preset, or real-time automation. Similarly, the stability of the new equipments may make the old arrangement of a monitor and waveform scope for each camera unnecessary. One, or two, switchable positions may be sufficient. And the camera controls themselves, because they are smaller, may be differently grouped.

In all likelihood this will permit operation from a single video position. There are, obviously, many other possibilities for improving the efficiency of the operation.

New Maintenance Procedures

The reliability, the module construction, the interchangeability of modules and other parts, will eventually change many present concepts of maintenance. The old procedures, such as routine replacement of tubes, will go—transistors rarely fail. Eventually, a system of quick replacement of modules will meet most emergencies. The ordinary operator will probably not be expected to make immediate repairs. He simply runs the machine—if an emergency occurs, he switches to another machine, or channel, or perhaps replaces a module.

Repairs are left to skilled technicians—or modules are returned to the factory for repair, or replacement.

No one knows for sure just how all this will work out. However, it is significant that electronic data processing installations with thousands of plug-in boards are, today, being run during regular operating hours by people who are not technically minded. It is possible that in stations of tomorrow this day-to-day operation will be done by non-technical button pushers. The engineers of today will become the super-technicians whose job it is to keep the vastly more complicated systems running.

At the transmitter, of course, the continuing trend is to more and more remote control. It seems likely to continue—probably with more safety precautions and more things to monitor. All of the new look transmitters are fully equipped for remote-controlled operation—built in, not added on.

Reduced Installation and Operating Costs

The relative compactness of the new look equipments leads to several cost savings. There is, of course, the saving in space—space is precious in an old installation, costly in a new one. Consolidating equipment (in fewer racks, in the pedestal, in the console, etc.) saves cost of trenches, wiring, labor. New arrangements of equipment (e.g., one video position) may afford savings. Use of playback-only recorders will yield savings in recorder cost.

Because the new equipments require far less power, there will be an appreciable saving in power bills. And, because they produce little heat, the first cost and operating cost of air-conditioning will be less.

Finally, there is the very likely reduction in maintenance cost—both because of greater reliability and because of more efficient maintenance procedures.

WHAT STATIONS SHOULD DO ABOUT IT

The "new look" equipments are electronically interchangeable with old-style units—and hence can be mixed in with present installations. However, such an arrangement will not yield the full advantages attainable with all-transistorized systems. As long as there are some tube units in the equipment assembly, the problems of power supplies, heat, and space are still present. There may even be new problems because the heat from the tubes may cause the transistor units to drift.

By far the best way to use these equipments will be in completely transistorized

systems. Transistorization will reduce rack space required (for TV) by as much as five-to-one. Large-sized power supplies can be done away with. The low heat dissipation (plus fewer racks) may allow the racks to be placed in the control room—doing away with the equipment room. Modularization will make maintenance easy, and probably less expensive. Standardization of modules will make stocking of spare modules practical. Stabilization will permit more automaticity and reduce operating costs. And with all this will come better performance, greater flexibility, new uses for equipment.

What, then, should stations do now. We believe that you should study your equipment setup in the same way that we have studied our equipment line. We expect that you will come up with the same answer we did—namely, that a complete changeover is called for. For some this will mean doing as we are doing—i.e., throwing everything out and starting over from scratch. For others it will mean a program of gradual replacement. But either way we believe you should have a "new look" program for your facility, just as we have a "new look" program for our equipment line.

Engineering in the

by WENDELL C. MORRISON

Chief Engineer

RCA Broadcast and Communications Products Division



As preceding articles have pointed out, the new look is not one, but many, things. Nowhere is this more evident than in the engineering aspects. We have purposely set out to re-engineer our whole broadcast equipment line—which means all of the elements of the equipment chain which extends from the microphone/camera to the antenna. These equipment elements have certain common performance parameters—but in other respects they are very different in makeup and construction (e.g., cameras and transmitters). Thus, most of the features which make up the new look in cameras are different from those which distinguish the new look in transmitters.

Moreover, the features which are common have different degrees of relative importance. For example, consider the use of solid-state devices. In studio equipment the use of transistors is the single most important aspect of the new look. However, in transmitters the only important use of solid-state devices is in the power supplies.

Despite these differences, however, there are some facets of our approach to the engineering new look which are the same for all of our equipments. Before talking about design features specific to individual equipments I would like to briefly review these general features. This will be of considerable value because these features more or less define the philosophy of our ap-

proach to the new look design—and hence are helpful in understanding what we are trying to do.

The Keynote is Newness

In our engineering, as in other aspects of the new look, the keynote is newness. Thus, the goal of our program has been to incorporate every new advance (concept, component, or circuit) which would enable us to build a better product. And, to make sure that there would be no compromises in doing this, we purposely started each new design from performance specifications (rather than simply redoing the last previous design, as has been the custom). Thus, all of the new equipments have a complete newness—a newness that in some cases is startling.

New Components Are Proven

Lest there be some trepidation concerning the many new components we have utilized, let me point out that all of these components have been previously used, tested, and proved by our engineers in other equipment built by RCA. For example, the widespread use of transistors and the general principles of incorporating these into plug-in modules has been thoroughly tested in hundreds of large-scale electronic data processing equipments built and installed by RCA in the last five years. (And, for that matter, in our own TR-22 Recorder.) Similarly, although we have not

previously used klystrons in our broadcast transmitters, we have carried on experiments with klystrons from their first development. Thus our engineers are thoroughly familiar with the design of klystron gear. In fact, it is no exaggeration to say that one of the strong points of the new look program is the fact that our broadcast engineers have for the first time been truly free to make full use of new things developed and proven in other product areas.

Conservatism is Continued

It is also worth noting that, although we have incorporated “radical innovations” wherever possible, we have been guided in the use of these by the same conservative ratings that we have long applied to our broadcast equipment. Thus, our new equipments, like our old, are based on the realization that an engineering sample could be made which performed adequately, and still have some production units be unsatisfactory because of component tolerances combining to degrade performance. For this reason our designs are tested with components at the limits of our commercial tolerances so that the equipment will work under these extreme conditions.

Group Design

Group design is another one of the very important features of our overall program.



WENDELL C. MORRISON directs the overall engineering activities for the Broadcast and Communications Products Division and its product lines, including radio-TV broadcast equipment, microwave systems, scientific instruments, two-way mobile radio, radiomarine equipment and audio-visual products. Mr. Morrison joined the company in Camden, N. J., in 1940, and two years later became a research engineer at the RCA Laboratories in Princeton, N. J., where he was engaged in development work in such fields as UHF television transmitters, antenna pattern calculators, and color TV terminal and test equipment. In 1957, he returned to Camden as Manager, Engineering Plans and Services, and later was Assistant to the Chief Defense Engineer, RCA Defense Electronic Products. He became Chief Engineer of the Broadcast and Communications Products Division in the fall of 1963.

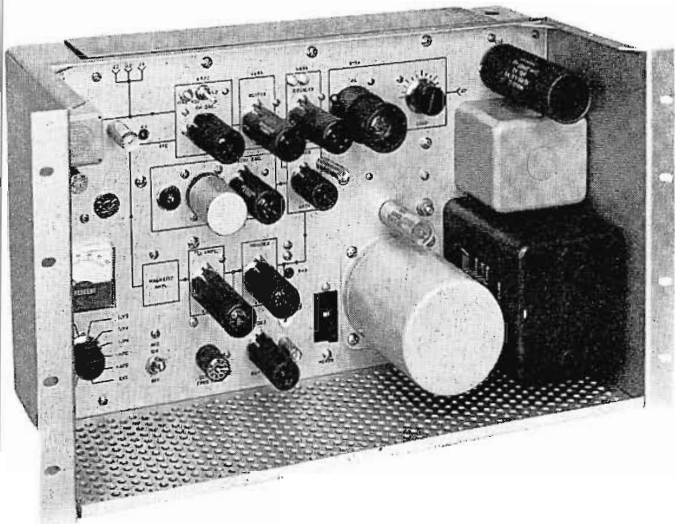

FIG. 1. New BTE-10C Exciter used in all new look FM Transmitters and in aural section of new look UHF-TV Transmitters. Simplicity, direct-FM accomplished with capacitive diodes, and freedom from spurious frequency generation are features.

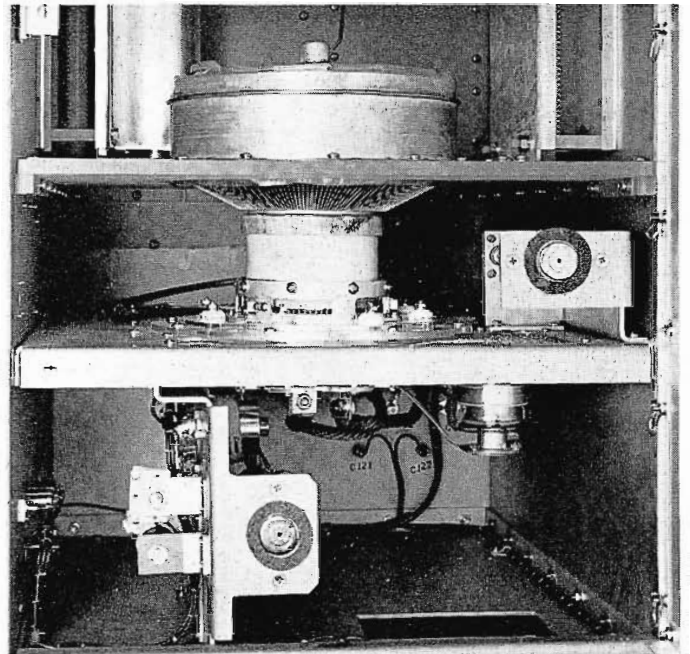

FIG. 2. Interior of IPA and Output Stages of new look FM Transmitters. Clean, open design plus simple circuitry make tuning easy, insure maximum reliability.

By group design we mean the simultaneous design of closely related groups of equipment items. Cameras are a typical group. By considering all of our camera designs simultaneously we have been able to standardize many of the modules, yokes, camera mountings, and other items. We could also relate arrangement, performance, operational setup, and maintenance to obtain many obvious benefits for the user.

Similarly grouped for design have been tape recorders, FM transmitters, and UHF transmitters. In the latter an extra advantage of this program to the user is the ease with which power can be increased subsequent to the original installation.

The limitations of space and time make it impossible to describe all of the technical advances of the new look equipments in this issue of BROADCAST NEWS. However, I would like to point out a few of the highlights. I will do this by equipment groupings because, in general, the equipments in each group have the same technical features.

The new look FM Transmitters not only look different (Pg. 5), they are different

FM Transmitters Use Capacitive Diodes for Simplified, Easily Tuned, Direct FM

—very different. They make use of an entirely new exciter unit, and a completely different tube lineup. The only thing retained from our old design is the use of "direct FM." This system—developed by RCA engineers, and used in all of our FM Broadcast Transmitters from the very first—has proved to be better than any of the numerous systems tried by others.

In our new FM Exciter (Fig. 1) frequency modulation of the oscillator is accomplished in a new way that has been brought to suitable performance standards by engineers of our transmitter group. In this new method the oscillator is directly modulated by capacitive diodes. There are no series or cascaded modulators—and there are only four r-f tubes (oscillator, buffer, doubler, and 10-watt output tube). Frequency stability is maintained by a

counter-detector circuit which drives a magnetic amplifier supplying d-c voltage to a capacitive diode controlling the frequency of the FM oscillator. The overall exciter arrangement is far simpler than any devised previously. It is also more stable and it eliminates the problems of spurious frequencies in multiplex transmission.

The intermediate amplifier and output stages (Fig. 2) which follow the exciter are also much simpler than in previous designs. All circuits—both in exciter and amplifier are single-tuned.

The overall effect of these design features is to make these new transmitters much simpler, far easier to tune, and more certain of providing high-fidelity performance even under the most difficult stereo and multiplex conditions.

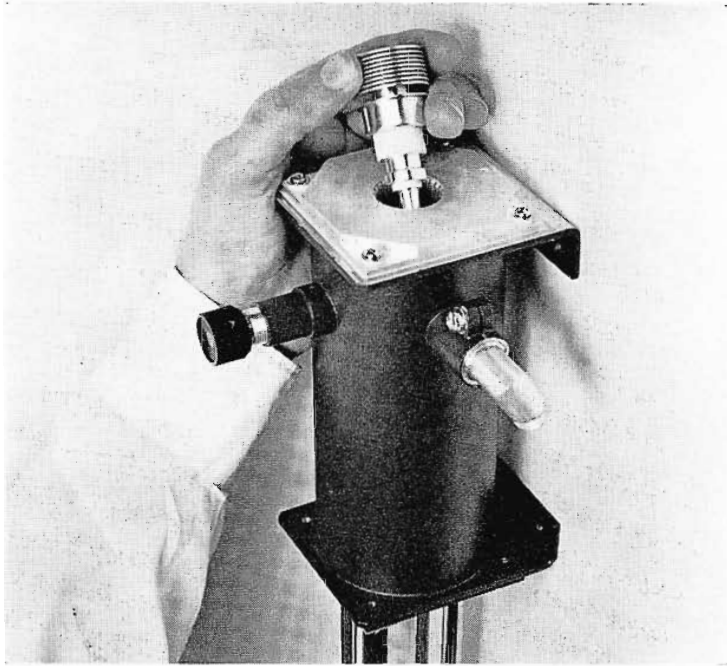

FIG. 3. Mixer stage assembly used in new look UHF Transmitters. Tube is the A-15228, a new ceramic pencil triode. It is modulated with low level video, puts out 1 watt of modulated visual carrier which is used to drive IPA stage using traveling wave tube.

UHF Transmitters Feature Traveling Wave Tubes and New-Type Vapor-Cooled Klystrons

The new look UHF Transmitters, too, are completely new—in appearance, in size, and in tubes and circuitry. There are a long list of new technical features of which we have space to describe only a few. Possibly the most striking are the use of new tube types, such as traveling wave tubes, and klystrons, use of low-level modulation, and of solid-state rectifiers.

There is a long-time trend toward simplification and reduction of number of stages in TV transmitter design. There are good reasons—including the need for greater reliability, more automatic (and remote-controlled) operation, ease of tuning, and reduced maintenance.

In our new UHF transmitters we have made notable progress in this direction by employing high-gain types of tubes to reduce the number of stages required. One example is the use of traveling wave tubes in the first r-f amplifier stage. These tubes provide a gain from 1 watt to 250 watts in a single stage. They are driven directly by the mixer stage in which grid modulation is accomplished by low level video. For 2-kw output the TWT drives an amplifier stage utilizing an A-2571. And for 10-kw we add an additional stage using two A-2571's in parallel. Thus for 2 kw there are just two r-f stages following the mixer, and for 10-kw just three. The A-2571's are air-cooled, coaxial type tetrodes.

The 30-kw is even more spectacular. It uses—for the first time in the U.S.—a new kind of klystron which is cooled by a liquid-vapor system in which water is allowed to boil at the tube collector. Operating at the boiling point permits reducing the size of the cooling system—less overall power is consumed.

Because of the high gain (35 db) of the klystron only 10 watts of drive is required. Thus, in our 30-kw a conventional amplifier provides sufficient gain and the TWT is not used.

It should be noted that the klystron we are using (Fig. 4) is of the integral-cavity type. This eliminates many of the troubles encountered with previous klystron transmitters. Since the cavities are part of the tube itself, the number of ceramic windows and ceramic-metal seals is cut almost in half. Because of all-metal body construction, these klystrons are extremely rugged and reliable. R-F fields are confined within the self-shielding structure of the tube thus eliminating unwanted coupling and simplifying shielding.

The integral-cavity klystrons are pre-tuned at the factory to the station's operating frequency. Thus, there are no cavities to assemble and adjust in the field. A tilt-tube mounting assembly (see Pg. 58) and a special dolly make tube changing very simple.

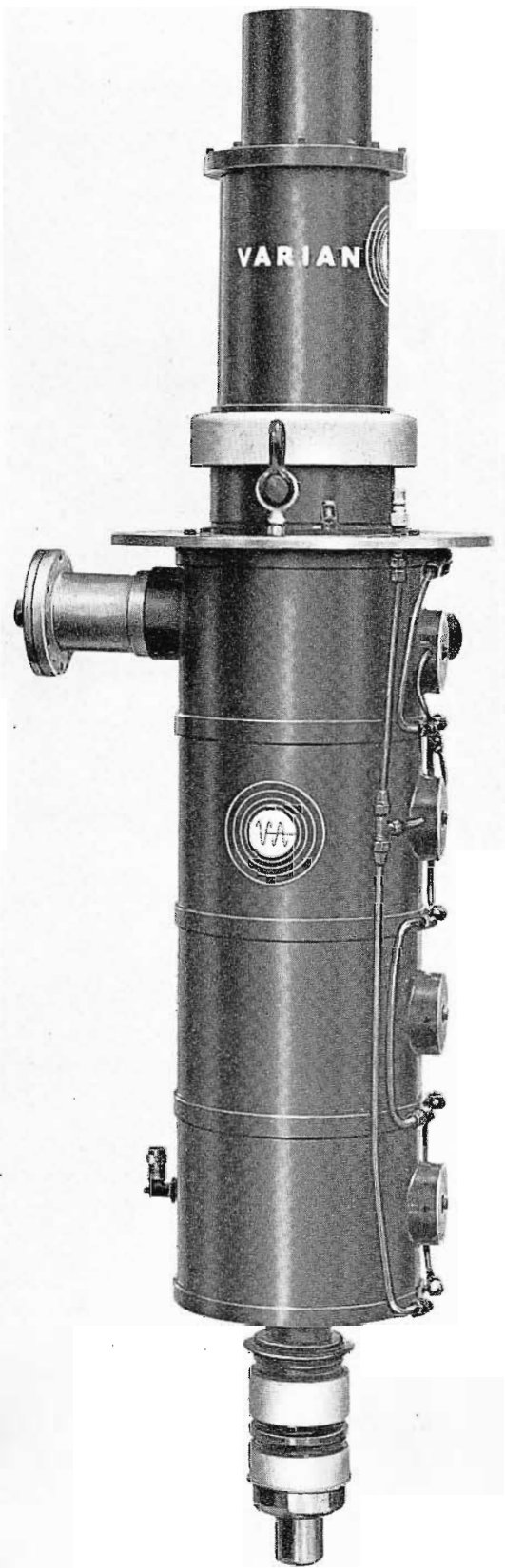

FIG. 4. New integral-cavity vapor-cooled klystron used in new look 30 KW UHF Transmitter. Because of smaller cooling system required it reduces overall power consumption by nearly one-fourth. Factory-tuned cavities and all-metal construction eliminate many troubles of earlier type klystrons.

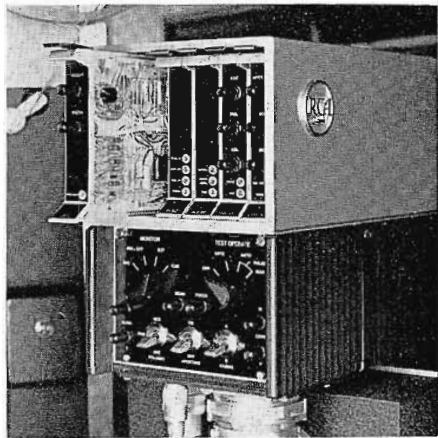

FIG. 5. Closeup of the new TK-22 Monochrome Film Camera showing standardized plug-in modules mounted in the top part of the camera case. Modules of this type are being used on all video equipment other than tape recorders.

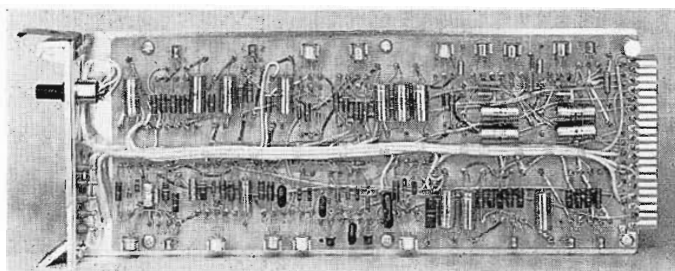

FIG. 6. Side view of one of the standardized plug-in units. Printed circuit board is mounted on metal plate to provide rigidity and protection, and to insure proper seating of contacts in receptacles. Front is formed of section of specially shaped aluminum extrusion.

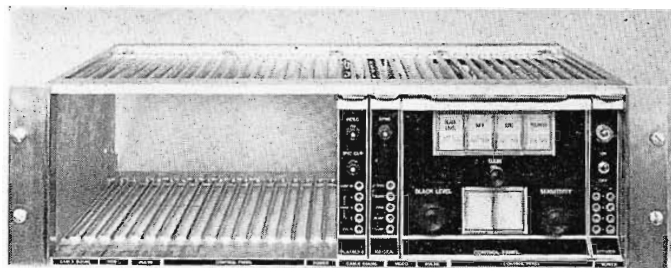

FIG. 7. Standard plug-in modules mount in a 5 1/4-inch-high rack frame, such as that shown here. Metal back-plate of module slides into slots in rack. Spring catch at top holds it firmly in place. Modules are widths which are multiples of 7/8-inch—frame holds sixteen single-width modules.

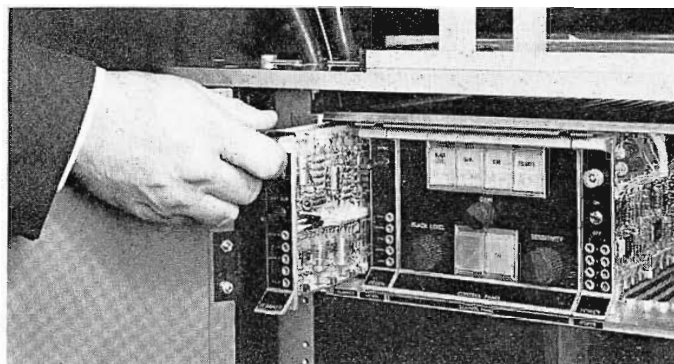

FIG. 8. Spring catch at top of module holds unit in place. Catch has been "human engineered" for easy release by pressure of thumb and forefinger, as shown here.

Studio Equipments Stress Transistorization

Nearly all of our new look studio equipments are "total solid state," and, in the case of these equipments, this is the predominating design consideration. Almost everything else follows from it. The most obvious corollary, of course, is the use of plug-in modules. As preceding articles have pointed out, we early found that traditional tube mounting arrangements (such as "bath tub" chassis) were incongruous for transistorized units. The data processing people led the way to plug-in modules, and we have benefited by their experience.

Plug-in modules have many advantages. They provide high "packing density"—i.e., they get a lot of circuits in a small space. They can easily be replaced, and then repaired later on the bench, (or returned to the factory for repair). They make it easy to add extras. And, perhaps most important of all, they lead naturally to standardization and cost saving.

During the past five years we have considered and tested many forms of plug-ins. And we have produced equipments using three or four widely different types. There was an obvious need to standardize but we took our time doing it because we wanted to be sure we had the best answer.

Meantime, we had built up a lot of experience with the modules in our TR-22 Tape Recorder—and it was all good. So we felt we were ready to establish a standard plug-in for our other video units.

The module construction we have standardized on is shown in the closeup of our TK-22 Camera (Fig. 5). A side view of one of these modules is shown in Fig. 6. Printed circuits are combined with pin-and-wire construction. The printed circuit board is attached to a metal plate which provides rigidity and protection. The metal plate is bent 90 degrees at the front and to its face is bolted a section of shaped aluminum extrusion. This has a protruding tip at top and bottom. When the module is placed in a rack-frame (Fig. 7), the tip is even with the front. Thus the front panel is recessed about 3/4-inch—providing protection for controls. The metal plate which backs the board slides into the slots in the frame, holding the module in place and insuring correct fit into the receptacles at the back of the frame. A spring catch at the top of the front panel holds the module firmly in place. The catch is released by squeezing between thumb and forefinger as shown in Fig. 8.

Modules may be of any width which is a multiple of 7/8 inches. Sixteen single-width modules will be mounted in the 5 1/4-inch-high frame, which in turn mounts in a standard 19-inch rack. Modules may also be mounted directly in equipment units—as in the TK-22 Camera shown in Fig. 5, or in a camera or projector pedestal, as shown in Fig. 8.

For the tape recorder line we are using modules which are similar in general construction but have a slightly different front arrangement. The reason for this is that the TR-22 modules were in use in larger quantities before the above standard was arrived at. Since we wanted all the recorder modules to be interchangeable, we decided to make all of these like those on the TR-22 Recorder.

The second very important part of the studio equipment design program is the standardization of specific modules—so that a processing amplifier module, for example, can be used in any camera. The importance of this has been stressed in the preceding article (see Pg. 13). It is also brought out in the discussion of cameras and tape recorders which follows.

FIG. 9. Closeup of rear of TK-22 Camera showing its bank of standardized plug-in modules. These are interchangeable with similar modules of the TK-42 and TK-27 Color Cameras. (Other pictures of the TK-22 are shown on Pg. 44.)

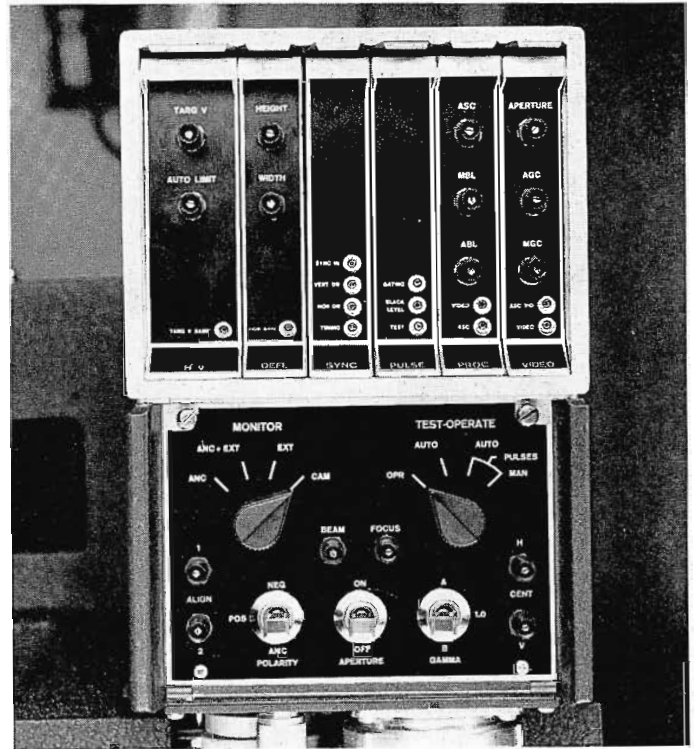
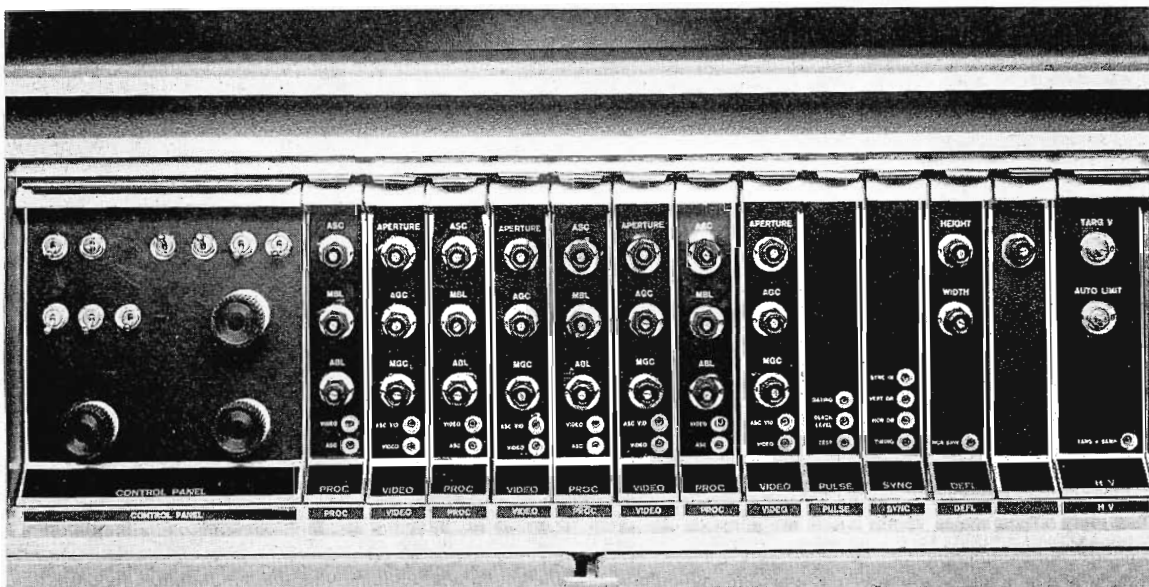

FIG. 10. The plug-in module bank of the TK-27 Color Camera. Note that the plug-in modules are the same type as those shown in Fig. 9, and are interchangeable with them. (Other pictures of the TK-27 are shown on Pg. 36.)



Color Cameras Feature 4 Channels, All-Transistorized Standard Modules

The new look color cameras—the new TK-27 Color Film Camera and the new TK-42 Live Color Camera—are both 4-channel designs in which the M-channel concept (i.e., separate luminance channel) has been brought to perfection by years of work. The concept itself, of course, is not new. In fact, a 4-channel camera was patented in 1944 by Dr. A. N. Goldsmith. The first really practical live camera of this type was shown by our engineers at the 1962 NAB Convention (see Pg. 5). A prototype 4-channel film color camera was shown in 1963 (see Pg. 5).

Before and since these dates our engineers have been working to further perfect the idea and to integrate it with our other new look equipments. This meant complete transistorization, use of standard type plug-ins, and as far as possible, standardization of plug-ins between cameras. That these have been fully achieved is indicated by Figs. 9 and 10. It will be noted that the six plug-in modules in the TK-22 Monochrome Film Camera are all used in the TK-27 Color Film Camera. Of course, the latter uses four sets of "Proc" and "Video" modules—one for each channel. The

TK-42 Live Color Camera also uses these same modules (as can be seen in illustration on Pgs. 34 and 35).

An unusual feature of the TK-42 Camera is the use of a built-in zoom lens. This avoids having a long lens sticking way out in front of the camera. It also eliminates the need for color-matching lenses.

There are many other interesting features of these color cameras. Some of these are pointed out in the articles which follow (Pgs. 32 and 36). Others will be described in a paper which Dr. Kozanowski and Mr. Sadashige will present at the NAB.

FIG. 11. In the TK-42 Color Camera the modules plug in from side and back as shown in this view. Most of these modules are the same as those used in the TK-22 and TK-27 Cameras shown opposite.

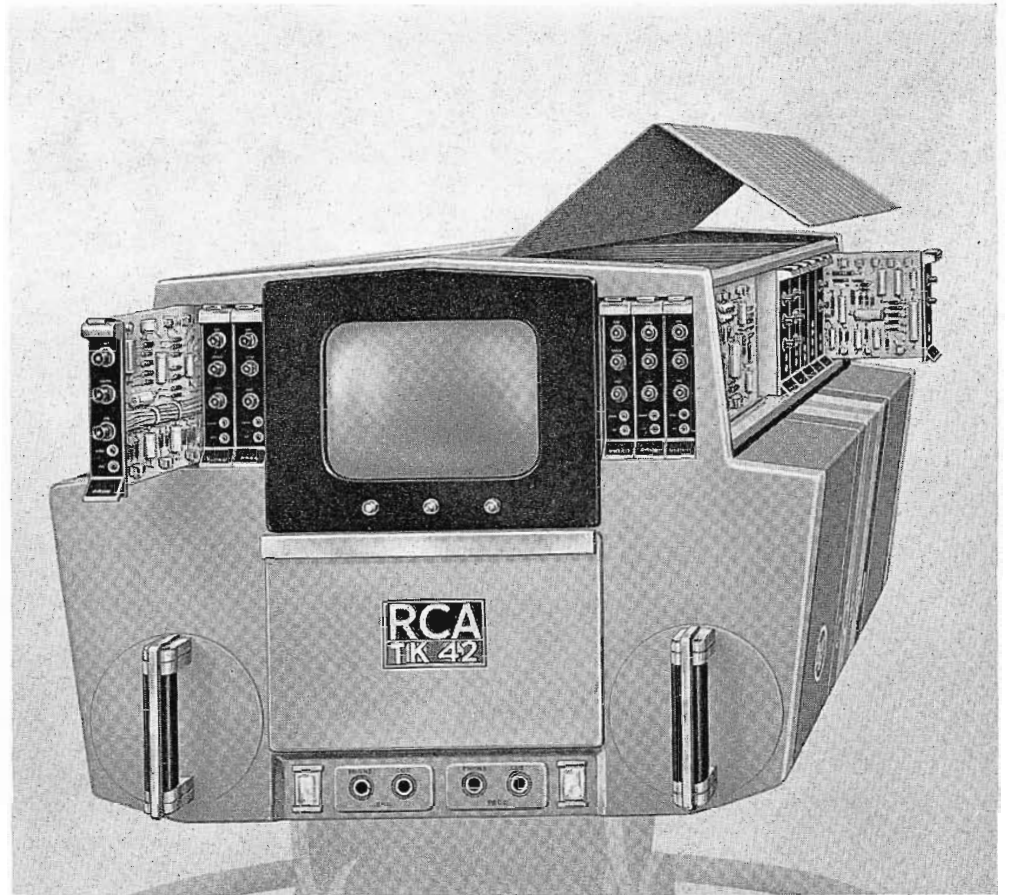

New Tape Recorders Use Same Transistorized Modules As TR-22 Model

In the area of television tape recorders the significant new look advance is the extension to new and less expensive models of the sophisticated transistorization and modularization techniques developed for our Deluxe TR-22 Recorder.

The new TR-3, TR-4, and TR-5 Recorders (Pg. 52) are an outstanding example of the benefits that will accrue from our so-called "module program." In the course of developing the TR-22 and all of its accessories (ATC, Electronic Splicing, etc.) we had occasion to develop almost every conceivable module needed for any tape recording operation. Thus, when it came to designing other recorders—less complete than the TR-22—we simply selected from modules already available the ones required for the more limited functions of the new machines.

The module program made it relatively easy to design new model recorders. It also meant that we could have, in these new lower-priced machines, the same high quality components as in our deluxe machines. Thus, they represent greater value for the money than would likely be the case if they were all individually designed. Additionally, there is the great advantage of stand-

ardization. In multiple recorder installations it may be desirable to have spare modules available, and their cost, since they fit all machines, will be reasonable. Finally, of course, there is the ease and convenience in maintenance of equipment—greatly facilitated by a standard arrangement of modules.

The new recorders incorporate numerous other new technical features—most of which are intended to save space, weight, and cost. Some of these "construction" features are illustrated in the product description on Pg. 52. Of particular note is a new lighter tape-transport deck used on the three new machines, also lighter frame and cabinet construction—especially in the TR-5 Mobile Recorder. The net result of these advances is to make available at reasonable cost, recorders which are smaller and less expensive but which in a limited-function way provide the same quality as our big TR-22 Recorder. This is a considerable technical achievement.

A Note About Heat

The use of transistors has enabled us to build equipment that is physically small, uses relatively little power, and is very reliable compared to vacuum tube equip-

ment. This means that much less space is required for terminal equipment, air-conditioning capacity is less, and equipment can be less accessible. Collectively this means a more efficient operation for the broadcaster.

A word of caution, however, is necessary regarding heat. Transistor circuits generate less heat than tube versions but the transistor is also more susceptible to heat damage. Therefore, the possibility of heat problems must not be ignored, particularly as a station makes the transition from tubes to transistors and is likely to intermix tube and transistor equipments in the same rack.

Summary

We have described, above, some of the many technical advances incorporated in our new look engineering program. The references have necessarily been brief. In forthcoming issues of BROADCAST NEWS we will present comprehensive articles on each of these equipments. In the meantime we are looking forward to seeing our broadcaster friends at the NAB Convention—and to showing them these new look equipments in actual operation.

Styling of the

by STEWART W. PIKE

Manager, Functional Design

RCA Broadcast and Communications Products Division



The "new look" of the new broadcast equipment is much more basic than any application of current styling to merely change the appearance for the sake of change, to induce obsolescence, or conform to a fashion trend. The "new look" is influenced and determined by the following basic factors:

1. Accelerated development of broadcast equipment spurred by introduction of transistors and smaller, more efficient components, etc., resulting in:
 - a. printed circuit boards instead of bulky chassis resulting in less heat, less volume and reduced floor-space requirements,
 - b. more efficient control areas requiring less personnel,
 - c. lower installation and maintenance costs because of less intercabling, use of fewer units of denser packing.
2. The evolution from a simple operation with a few essential but not necessarily related elements to vast intricate and complex systems involving many elements which must be carefully coordinated to integrate into the formation of the modern broadcast system. All the various parts must now be considered in their relation to all the other parts comprising the system.
3. New materials, processes, techniques

finishes, components, etc., establishing the product appearance, reflected in a practical, efficient external expression of the internal engineering combined with the overall expression of fitness in combination with basic human engineering requirements resulting in a product with a distinctive product-line identity that is easily recognized and remembered. The results of the consideration and inclusion of these basic factors are reflected in the appearance of the new line of broadcast equipment as follows:

The Transmitters are lower in height with the well defined, rugged look of an immobile unit—the *contemporary computer look*. The single, unified control area expresses minimum efficient external control requirements resulting from equally efficient internal and remote automation. The heavy aluminum trim, or frame, emphasizes the "rugged look" which, together with the textured vinyl "new blues" paint finishes, expresses the distinctive product identity.

The TV Tape Equipment falls into various categories according to features, size and mobility, all of which are reflected in their respective "new look." They all must retain the "rugged look" appropriate to each without sacrifice to the refinement or the quality custom fitness that is *specifically individual* to each category. As with

the transmitter this equipment is in a quality class with data processing equipment and is designed to share a *recognized appearance prestige in common*.

The Consoles offer more adaptability and flexibility in the accommodation both in number and configuration of controls and accessories and the possible arrangement of same. Greater variety and the accomplishment of a "custom look" is possible with less engineering and greater economy. As with the transmitters the console—though composed of multi-units—is tied together by a strong trim or frame that imparts the "rugged look" and unitizes the several units into one composition. As with all of the new products, the "new look" blues serve to add a fresh accent and identify the product line.

The TV Cameras, being more compact, make it possible to have more facilities included in the camera and this new feature must be reflected in the "new look." This "look" must also include a feeling of appropriate ruggedness that will not penalize the weight, extreme mobility and unobstructed viewing and handling during operation. These new cameras being quite articulate in expressing the inclusion of all the foregoing requirements, determine the distinctive form with an easily recognized identity.

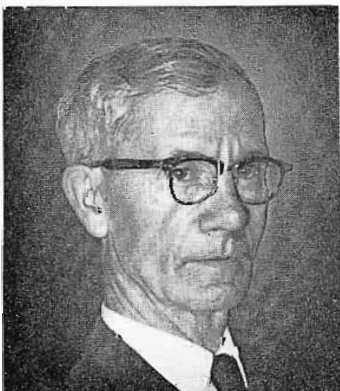

STEWART W. PIKE is the manager of the functional design group which has "styled" all of the "new look" equipments (as well as many other RCA products such as the electron microscope and the RCA Electronic Data Processing equipments). He joined the RCA design group just after the war, has been its manager for the past ten years. The responsibilities of his group include not just color and finish but also form, materials and human engineering considerations. On the opposite page, and the two following pages, are reproduced some of the styling sketches which they have done for the new equipments. In the commentary above, Mr. Pike points out (in designer gobbledegook) the highlights of the "new look" look. We have made no attempt to edit this, since we wanted to retain the feeling!

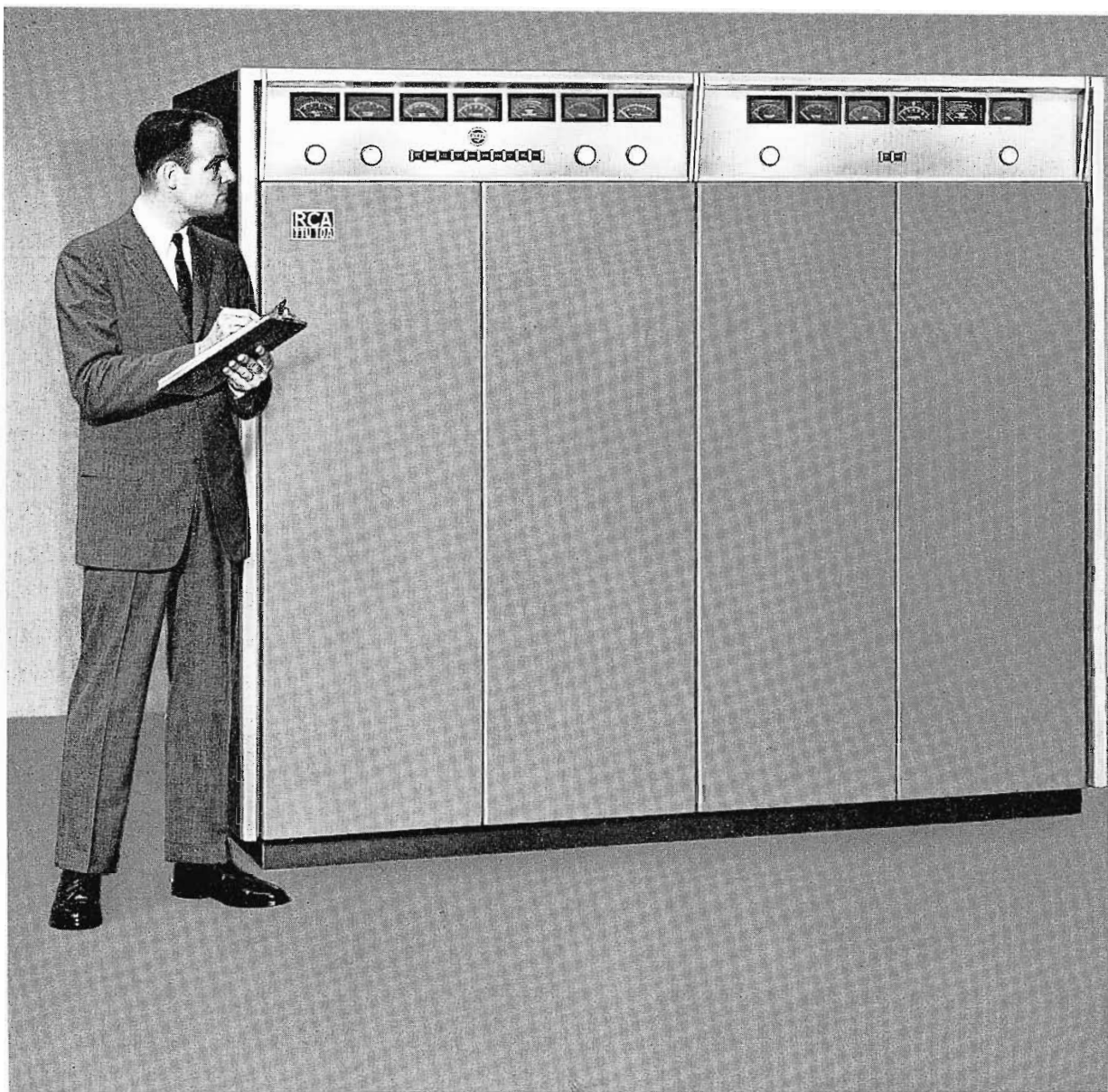

RIGHT—New Type TTU-10A, 10 KW UHF Television Transmitter.

BELOW—Styling sketch for special console built for 1964 NAB Exhibit.

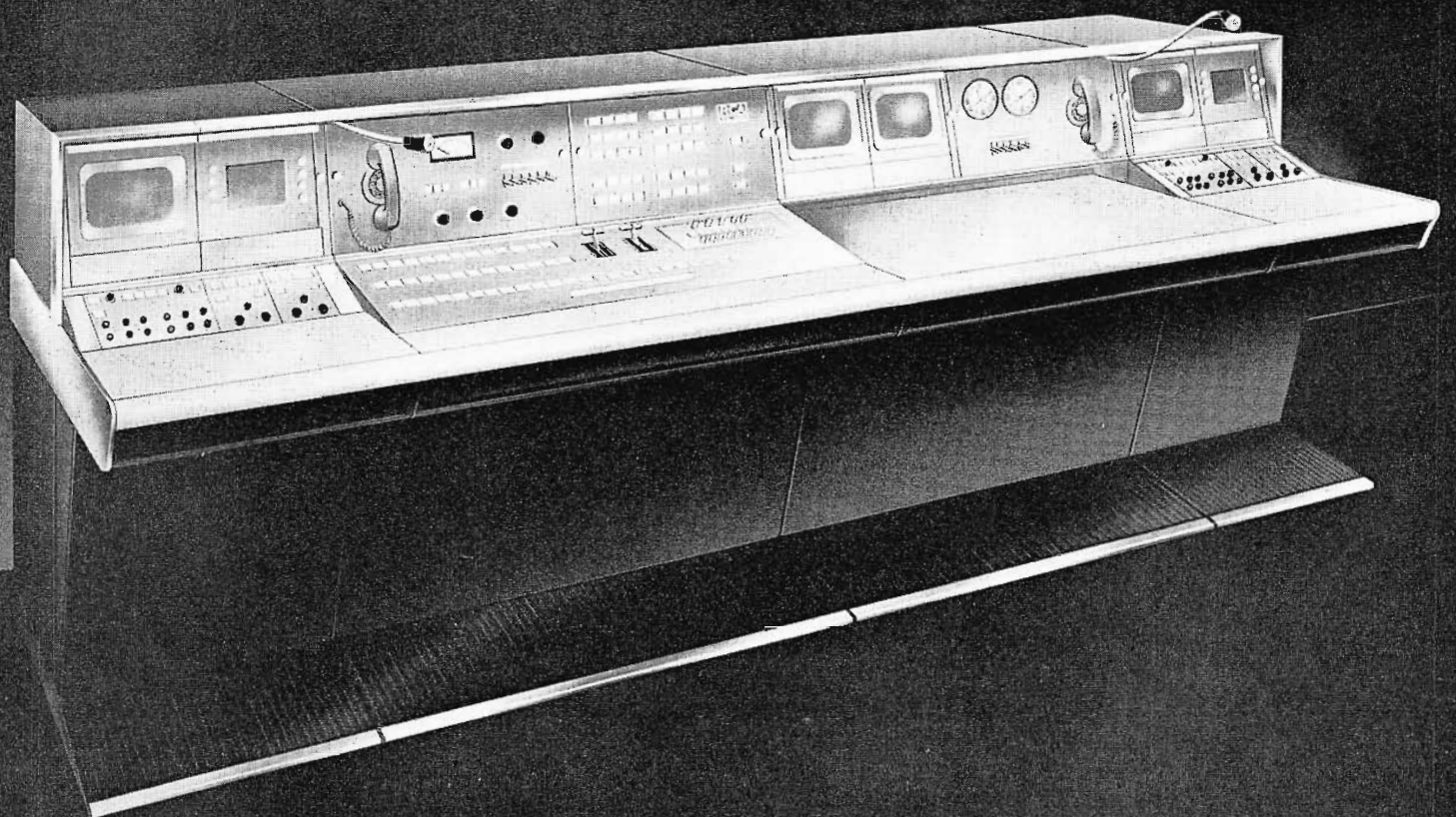

THE APPEARANCE FEATURES OF THE NEW LOOK

The new look equipments come in many shapes and sizes but they share certain distinctive appearance characteristics which give them a related product-line identity.

Some of these are:

New Look Colors, used in all equipments, are space-age blues—a light (horizon) blue in frontal areas, a dark (space) blue for side and rear of cabinets, as well as pedestals. Operating panels are aluminum or aluminum grey.

New Look Finishes on painted surfaces are heavy textured vinyl finishes which will stand heavy abuse, do not finger mark and do not collect dust. Where natural

metal is left to show, it is ordinarily coated with transparent epoxy.

New Look Trim which gives character to the equipment is mostly brushed aluminum. Unusually heavy “framing” is employed to give a feeling of ruggedness, as well as an identity that might be called the space-age look.

New Look Shapes are also important in imparting a certain distinctive feel to these equipments. Although their sizes and “form factors” vary widely, all units have a similar look—a square, clean, businesslike look which unmistakably relates them to each other.

New Look Controls, also, have a family look—achieved through similar meters, control knobs, push buttons and panel treatments. In each instance controls are grouped as much as possible in the most convenient operating location.

New Look Emblem is a final touch which distinguishes all these equipments. It is a cut-out aluminum rectangle within which are framed the letters RCA with the type number of the equipment just below. Needless to say, this is in addition to, not in place of the RCA monogram. We added the emblem because we felt that the users of these new equipments would be proud of them and would want them readily identified as “new look” equipments.

BELOW—Sketches for TK-22 Monochrome Film Camera, TK-42 Live Color Camera, and TK-27 Color Film Camera.

OPPOSITE PAGE — Sketches for TR-4 and TR-5 Tape Recorders, Video Console and TSA-3 Console.

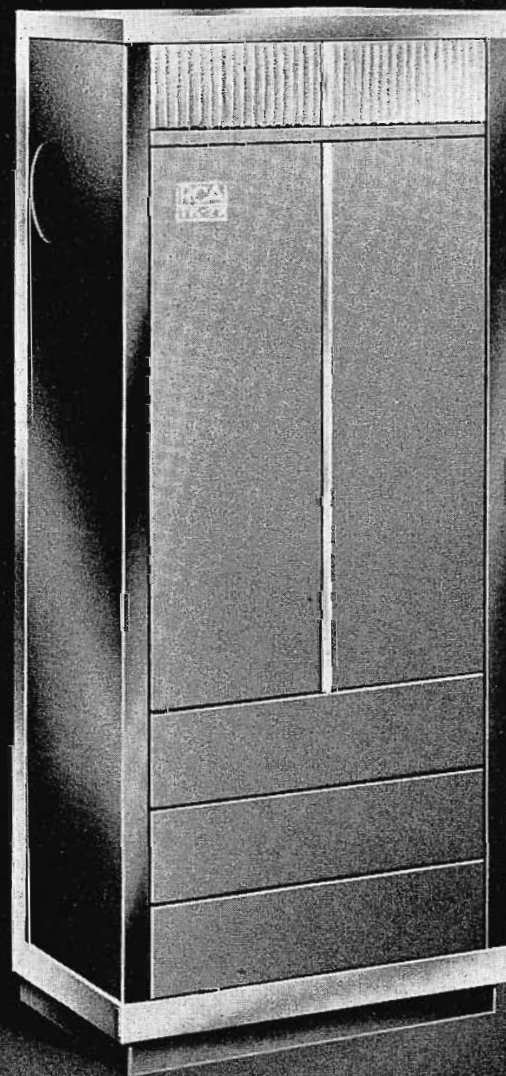
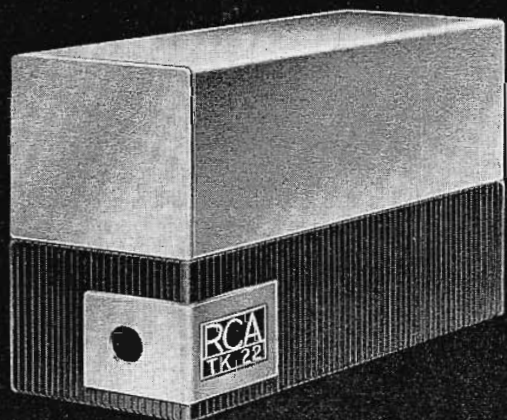

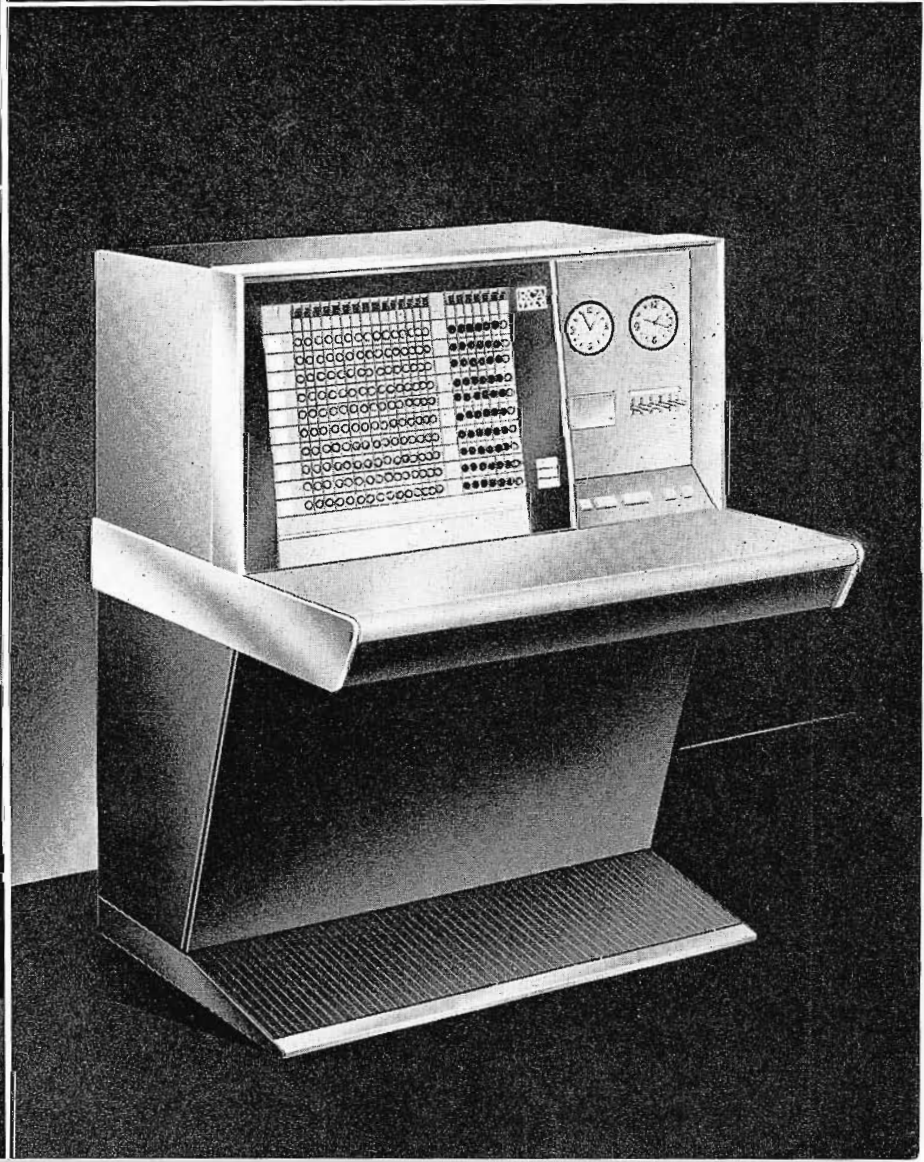
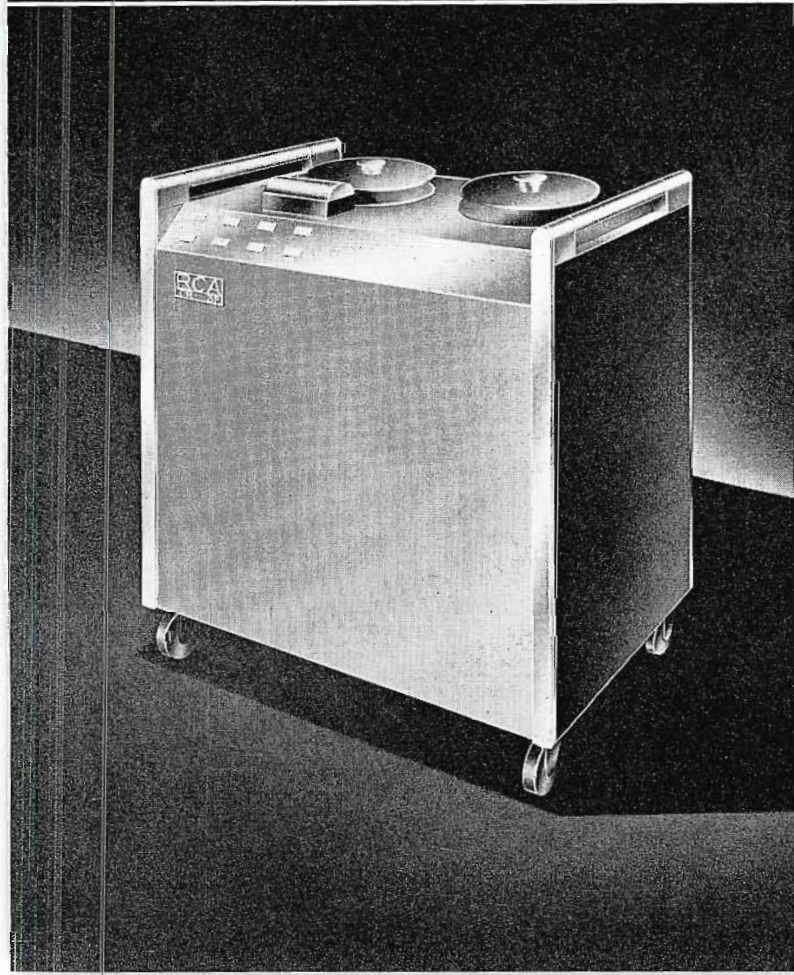
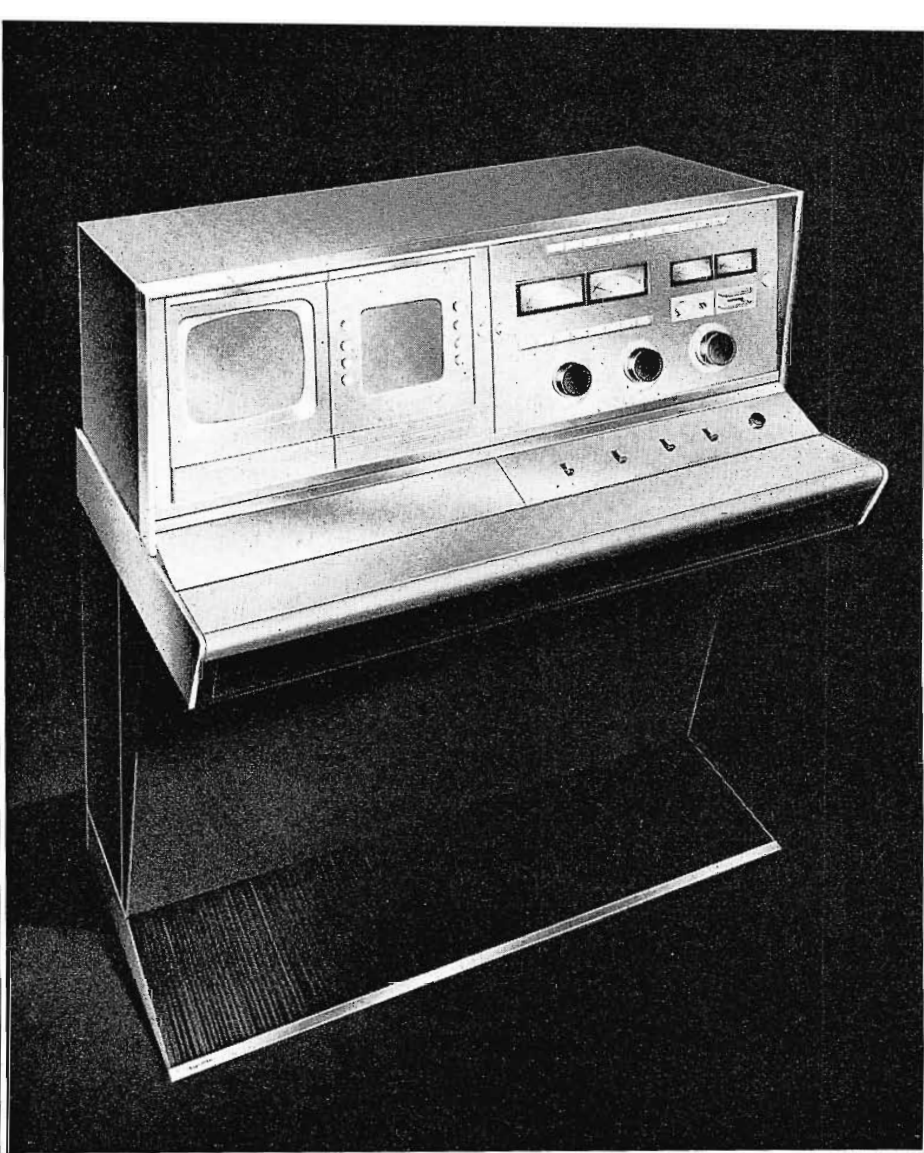



CONSOLE HOUSINGS

A whole new line of console housings has been designed especially for the new-look equipments. These housings have styling (color, finish, shape, trim) identical to that of the major new-look equipments, so that control positions assembled from them will have a matching custom-built look.

Flexibility sufficient to meet almost any conceivable requirement is provided by a large assortment of building pieces (see below) from which consoles can be assembled. The basic units in the system are one-width (20 inches) and two-width (40 inches) pedestal units which can be combined to form a console of any overall

length desired (see bottom of opposite page). Top sections have a gently sloped upper section which will mount standard 19-inch panels. Two types of slightly sloped angles for control panels are available—the shorter for camera controls, and the like, the larger for switchers, etc. Of course it is also possible to use the pedestals to support standard consolettes such as the BC-7 or BC-8. Or special top sections may be assembled as shown in drawings on the opposite page.

To give cohesiveness a one-piece trim strip on the front edge spans the width of the desk. A heavy aluminum strap, made

up of three standard pieces, frames the top and sides of the upper section. This gives the assembly a rugged, unitized look.

The pedestals are finished in dark (space) blue, the upper sections in light (horizon) blue. Horizontal strips of aluminum fastened to each end give a natural break between bottom and top sections.

All manner of consoles can be assembled from the basic building pieces shown in the exploded view below. Some of those being assembled for our NAB exhibit are shown on the opposite page. Artists' drawings of how these will look when finished are shown on the preceding page.

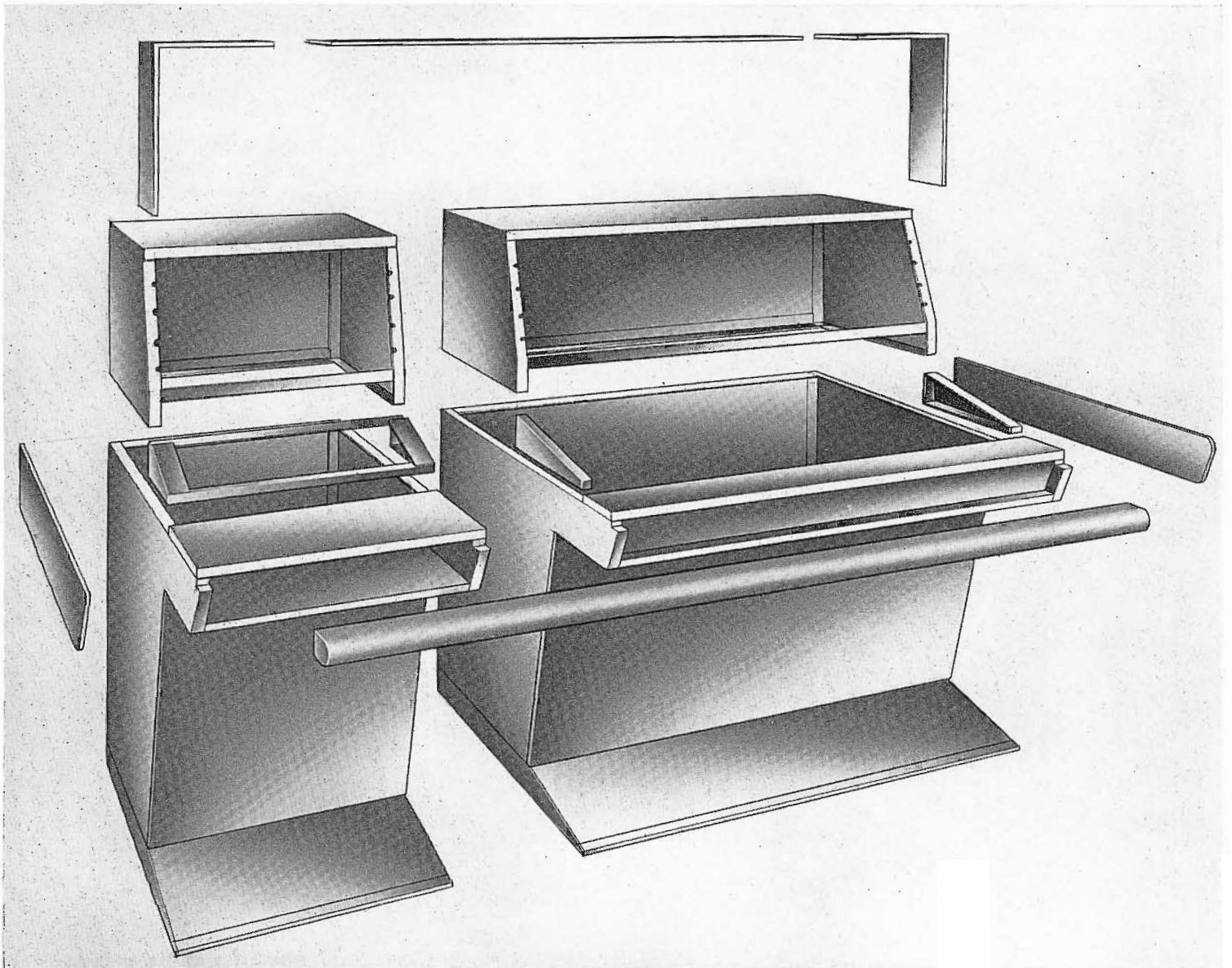

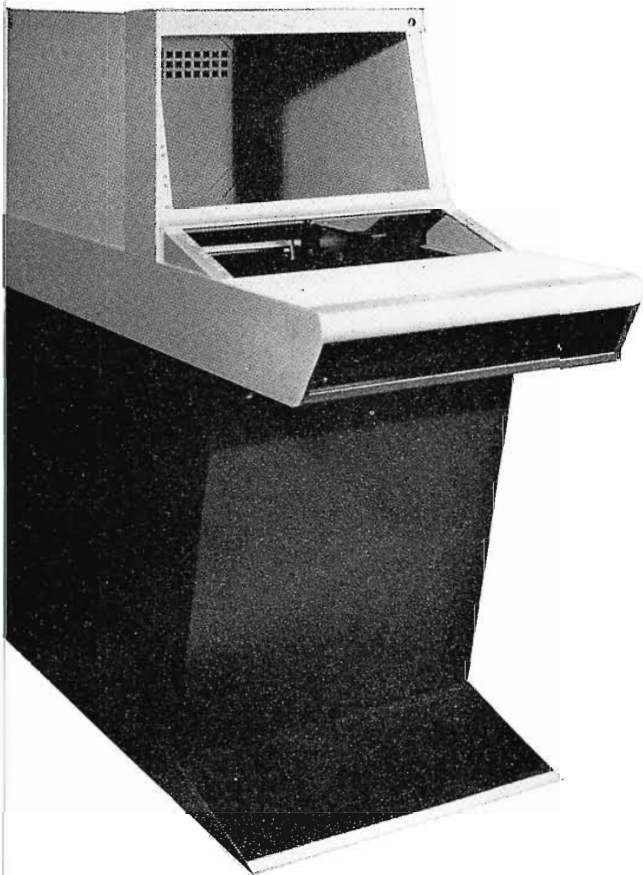

SINGLE-SECTION HOUSING with standard top section used for housing camera monitors, etc.

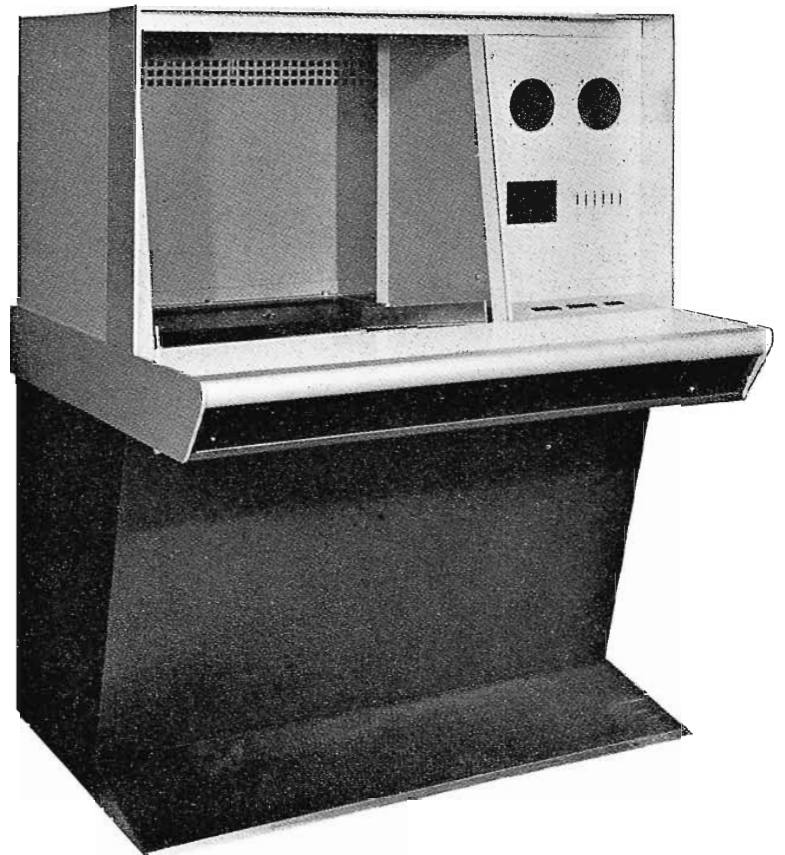

TWO-SECTION HOUSING. A styling sketch of this extra-height unit with TSA-3 Switcher installed is shown on Page 25.

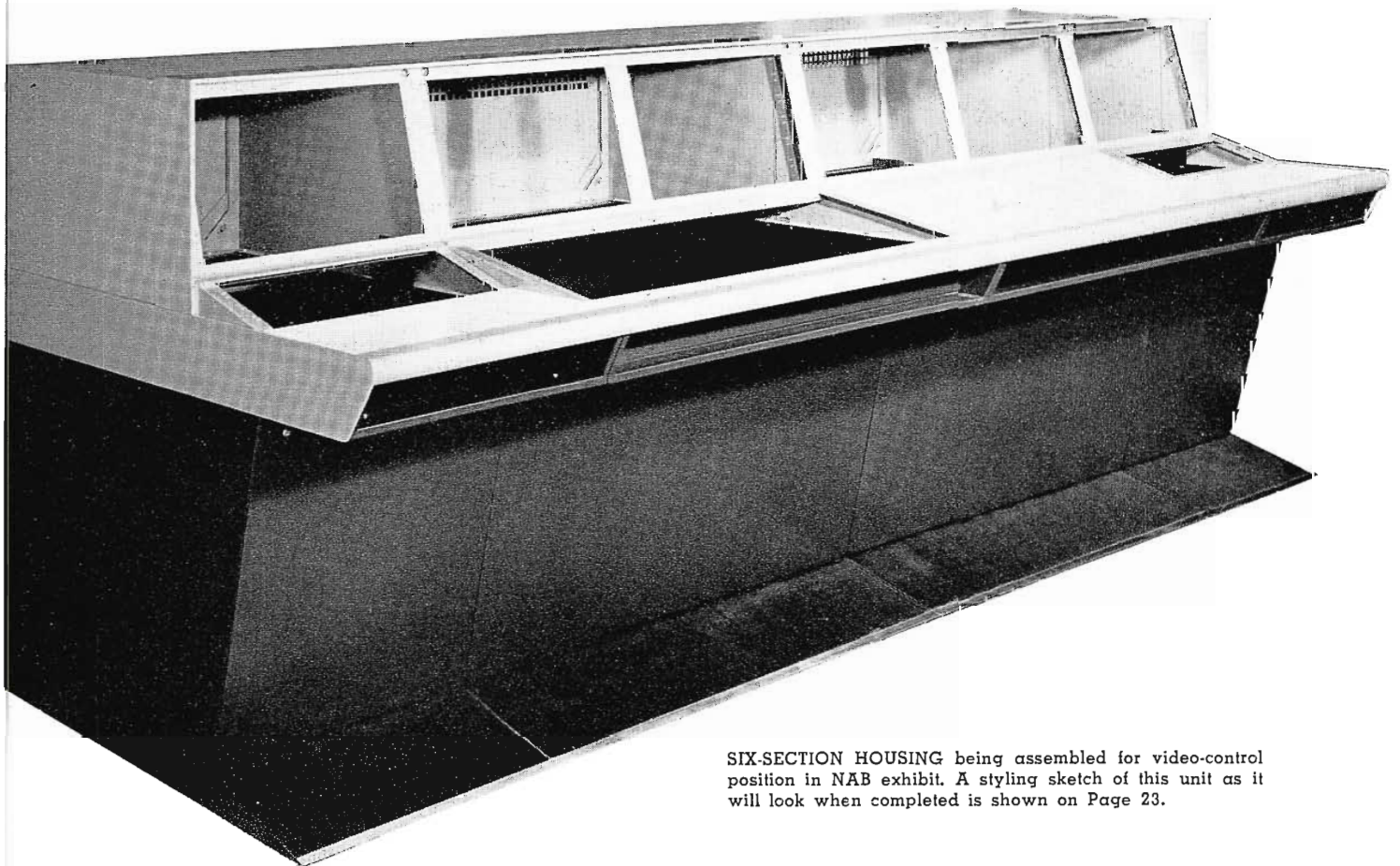

SIX-SECTION HOUSING being assembled for video-control position in NAB exhibit. A styling sketch of this unit as it will look when completed is shown on Page 23.



A WHOLE NEW LINE OF

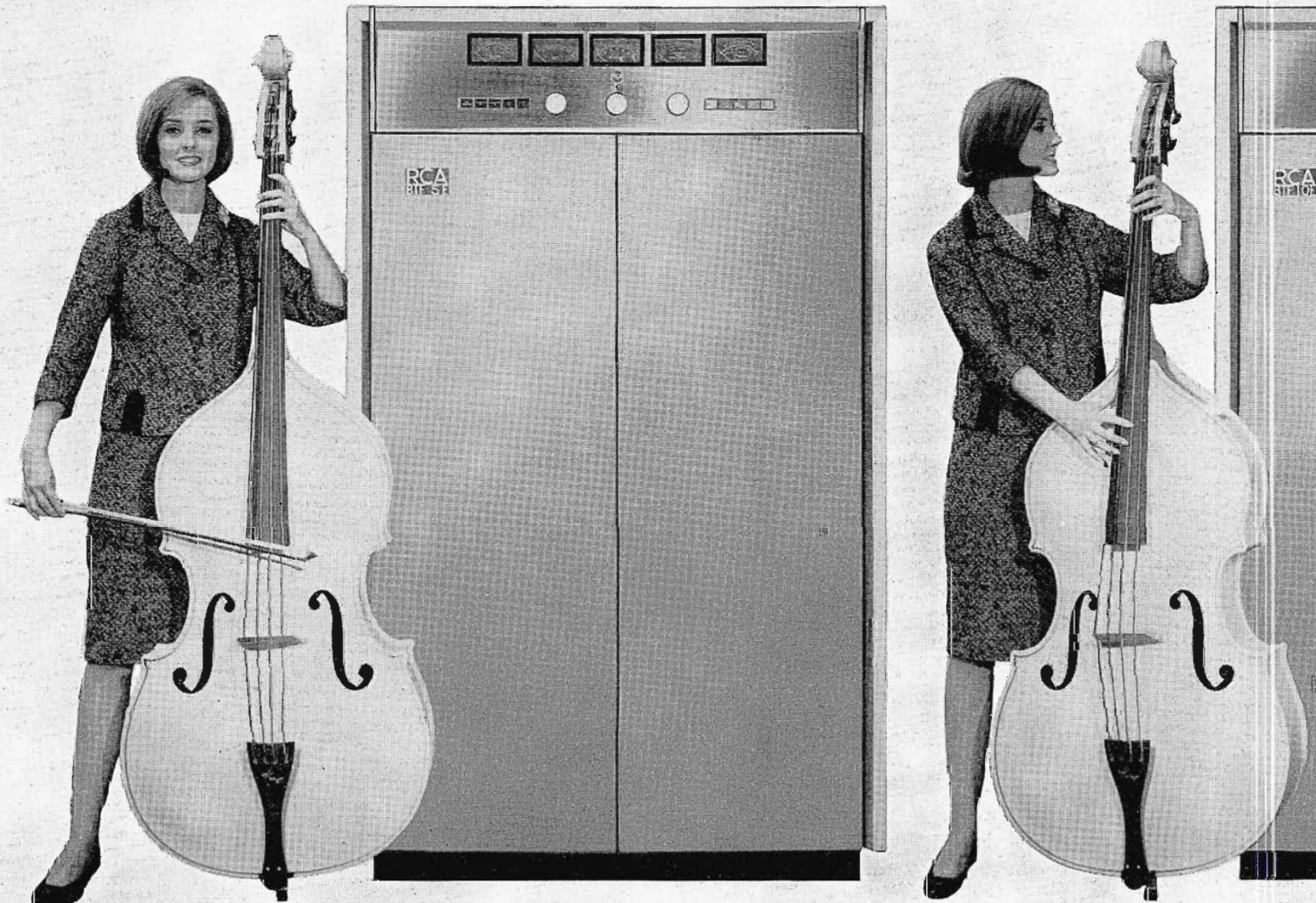

NEW BTF 5E 5KW

New Exciter, New Circuitry, New Styling, Together With RCA Direct-FM Design, Make These the Finest of FM Transmitters

The striking appearance of these exciting new FM transmitters (see color photo on page 6) only hints at the outstanding full-fidelity "sound" they deliver and the operational simplicity they afford. They also offer increased reliability and long life at low operating cost.

Designed since the advent of FM-stereo, these transmitters give excellent performance in stereo—with or without an SCA

subcarrier, since they are not conversions for stereo but actually designed for stereo duty.

The 5 and 10-kw systems (BTF-5E and -10E respectively) are field expandable to a full 20-kilowatt power capability at virtually no increase in floor space. Thus, the lower powered station can provide for future expansion without increasing floor area requirements. Further, the five-kilowatt system is expandable to 10 kilowatts

as well as to the 20-kw level. This ability is particularly valuable when adding vertically-polarized antenna systems.

Simplest FM Transmitter Ever Designed

Experience has shown that the less complicated a transmitter is the better its operating dependability. In line with this, these three new transmitters were designed for utmost simplicity without sacrifice of performance. For example, the exciter por-

FM TRANSMITTERS

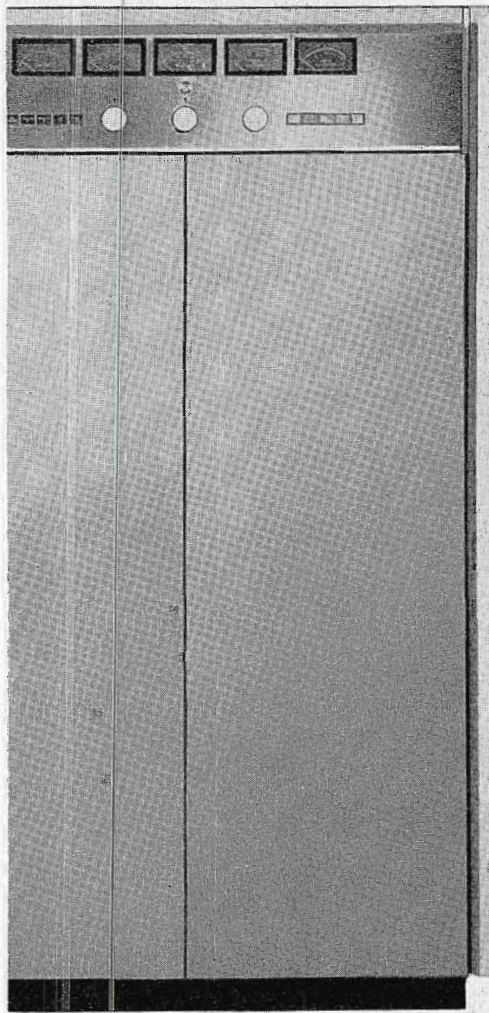

NEW BTF 10E 10KW

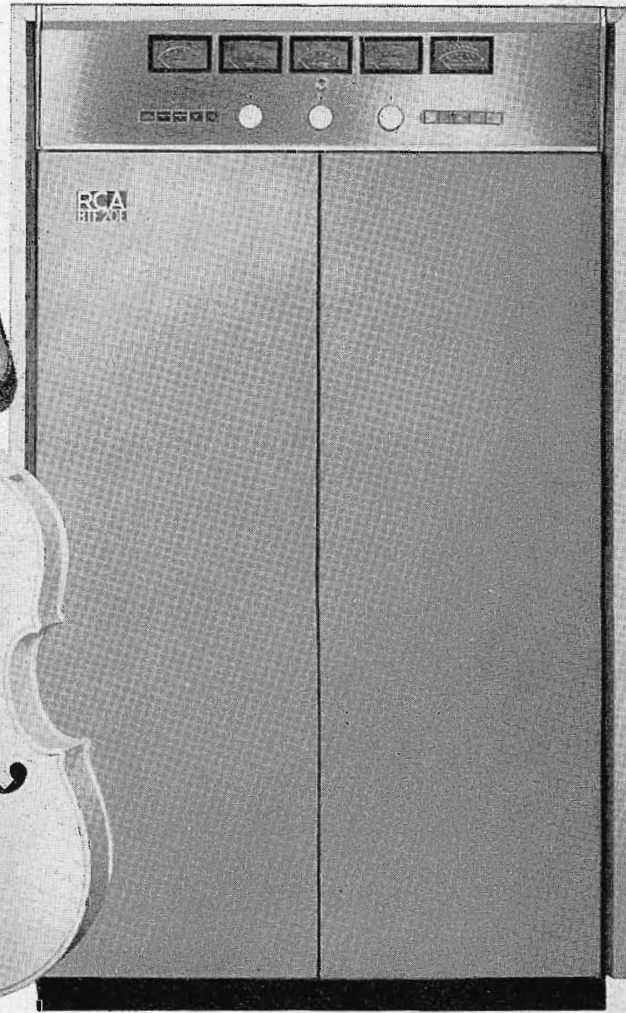

NEW BTF 20E 20KW

tion of these transmitters—often called the “heart” of the transmitter—uses only *nine* electron tubes to perform all of the functions that required 18 tubes in the predecessor unit. Of these nine, four serve in the r-f portion, an additional four in the automatic-frequency-control (AFC) section and, the ninth tube is a voltage-regulator type.

Direct FM System

Although the exciter is a true frequency modulated device, it avoids the use of reactance tubes as modulators. Capacitive diodes—an innovation of solid state electronics—frequency modulate the ultra-stable oscillator in the exciter.

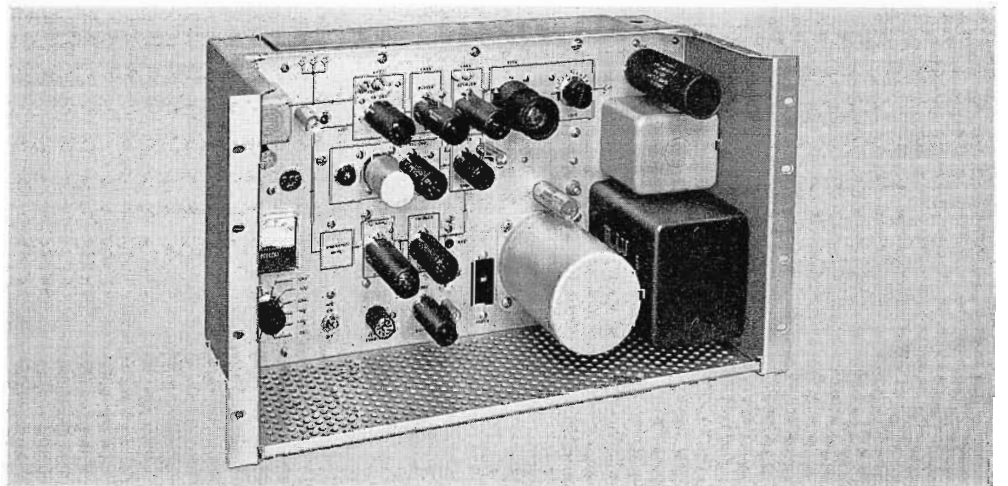

FIG. 1. The “heart” of the new FM transmitters. This direct-FM exciter uses a magnetic-amplifier AFC system for maximum reliability.

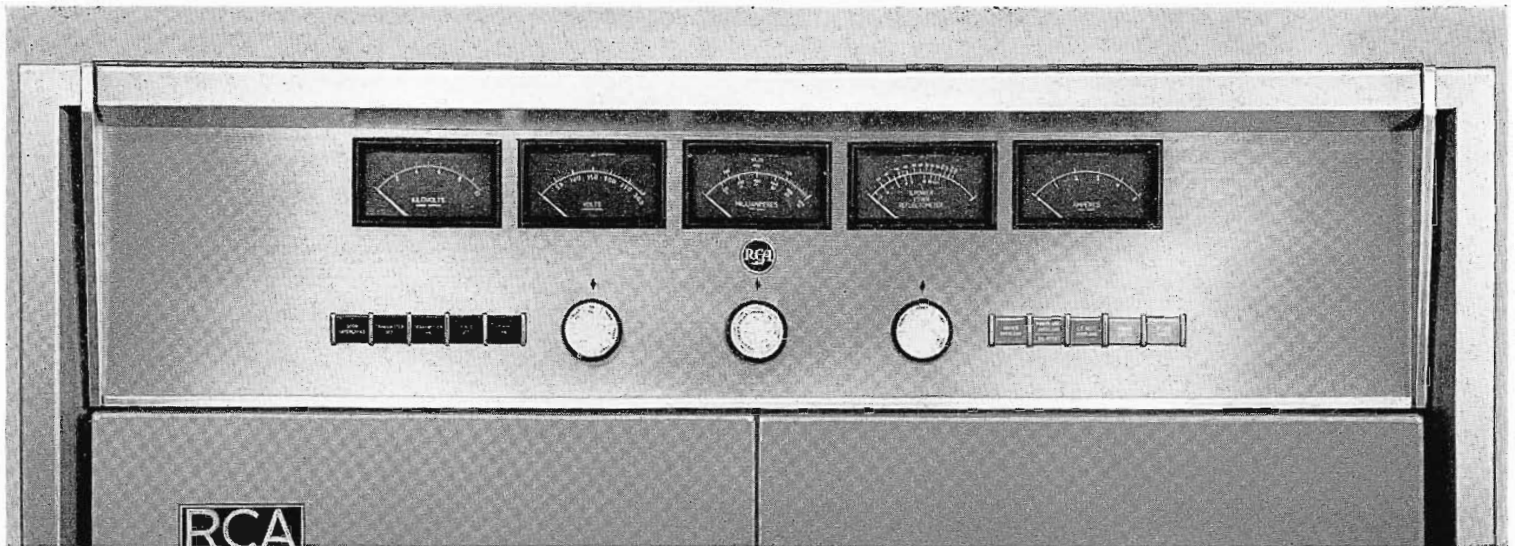

FIG. 2. The across-the-top control panel places the meters and control buttons at a convenient level. Tally lights indicate control functions.

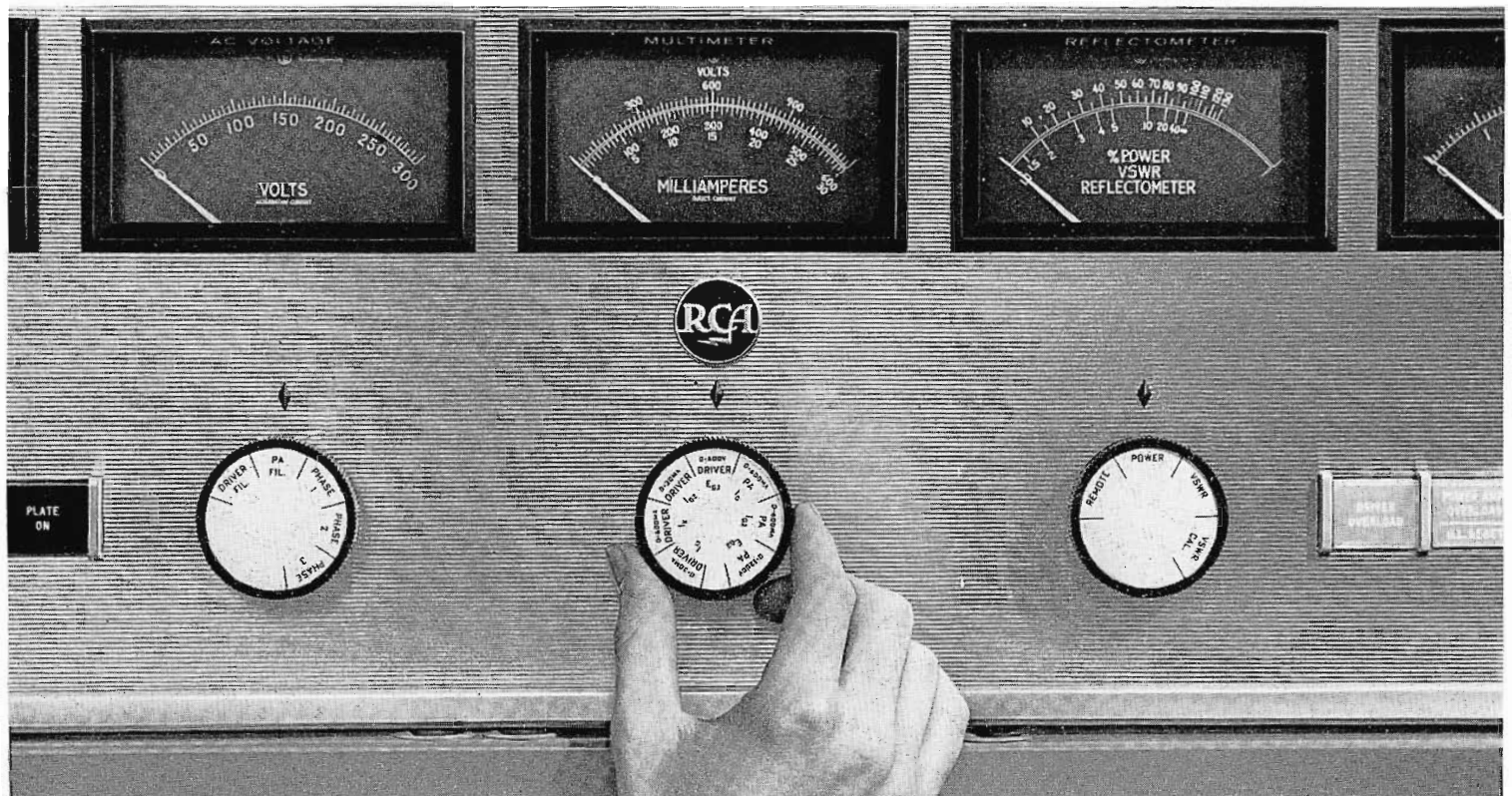

FIG. 3. White-on-black meter faces improve contrast between pointer and scale for easy reading. Large, smooth-turning knobs speed multimeter measurements.

Additionally, the oscillator operates at one-half the transmitter frequency—thus avoiding the tuning tedium of multiple frequency multiplier stages. Further, *direct-FM* modulation eliminates the critical modulation level adjustments that other modulation systems demand.

Precision Frequency Control

The AFC system of the exciter employs a magnetic amplifier control system. Should the modulated oscillator drift from its center frequency, a counter-detector circuit senses the drift and develops a so-called

“error” signal. Before this error signal can be used for oscillator control, it must be amplified. This is where the magnetic amplifier comes into play—a transformer-like device, the magnetic amplifier boosts the magnitude of the error signal some 40 db (100 times). This amplified signal then corrects the center frequency of the oscillator.

Simplified Two-Stage Amplifier

The power amplifier in the exciter delivers 10 watts of modulated r-f to the driver stage. This class “C” amplifier

raises the power level to 250 watts which, in turn, is delivered to the input of the final amplifier.

The tubes used in these amplifiers are both air-cooled ceramic tetrodes and both types have reputations for long life at top performance. This, of course, keeps control of operating costs.

Strict avoidance of critically tuned circuits contributes much to the stability and simplicity of the circuitry in the amplifier stages. The tuned circuits in the driver stage are *pi* networks using vacuum-

dielectric variable condensers as the tuning medium. Variable inductances—operating at ground potential for safety—tune the π networks in the final amplifier.

Expandable Power

The 5 and 10-kilowatt transmitters (the BTF-5E and 10E) are, in a sense, lower-power versions of the 20-kilowatt BTF-20E. This results in a tremendous advantage—field expandability of the 5 or 10-kw systems to a full 20-kilowatt power capability through easy conversion of the original transmitter. This means that a station, originally equipped with a BTF-5E or 10E, can increase power with a minimum of equipment obsolescence.

This feature is of particular importance to stations considering installation of a vertically-polarized antenna in addition to the usual horizontally-polarized system. Expansion from five to 20-kw increases the required floor area of the transmitter room by some five square feet. However, expansion of a 10-kw transmitter to 20 requires not one additional foot of occupied floor area.

Operational Simplicity

“Little more than pushing the ‘on’ button in the morning and the ‘off’ button at

night . . .” This was the goal of the engineering personnel assigned to the development project. As a result, these three transmitters offer operational features never before available on RCA FM transmitters: tally-light indication of transmitter operation; time-delay, automatic turn-on; motorized controls; self-correcting functions, etc.

In addition, all provisions for remote-control operation are standard equipment (relays, wiring, meter shunts, motorized controls, etc.).

The addition of an optional actuator device (BTR-11B, BTR-20B Remote Control) puts these provisions to work. Further, these provisions are a great aid in equipping the transmitter for automatic logging.

High-Voltage Power Supply External to Transmitter

Many station operators prefer that the bulky high-voltage power supply be external to the transmitter, in a separate enclosure, to permit installation in the basement, closet, attic or other unused area of appropriate volume away from the transmitter room. This, of course, reduces

the floor area dedicated to the transmitter and removes the dead weight of the plate transformer from the floor loading consideration.

The new series of transmitters improve this concept by locating the silicon rectifiers *with* the power transformer instead of within the transmitter cabinet. This results in increased accessibility in the transmitter and the rectifier cabinet for cleaning and other maintenance.

Silicon rectifiers are ideally suited for this type of duty because they can't be “frozen” out as can mercury-vapor-tube types. Thus, the place where the transmitter is installed need not be a heated area.

The Finest FM Transmitters Ever Designed

In summary, the 5E/10E/20E transmitters are the finest FM equipments developed to date: An exciter without peer; outstanding operational simplicity; modern cabinet styling; separate high-voltage power supply; readiness for remote control and automatic logging; self-correcting functions; true frequency modulation; power upgrading of the 5 and 10-kw systems—these are but some of the features of the new line of FM transmitters.

FIG. 4. Block diagram of the simplified direct-FM exciter. Modulation is applied at one-half carrier frequency. This contributes much to the long-term stability of the exciter's outstanding performance.

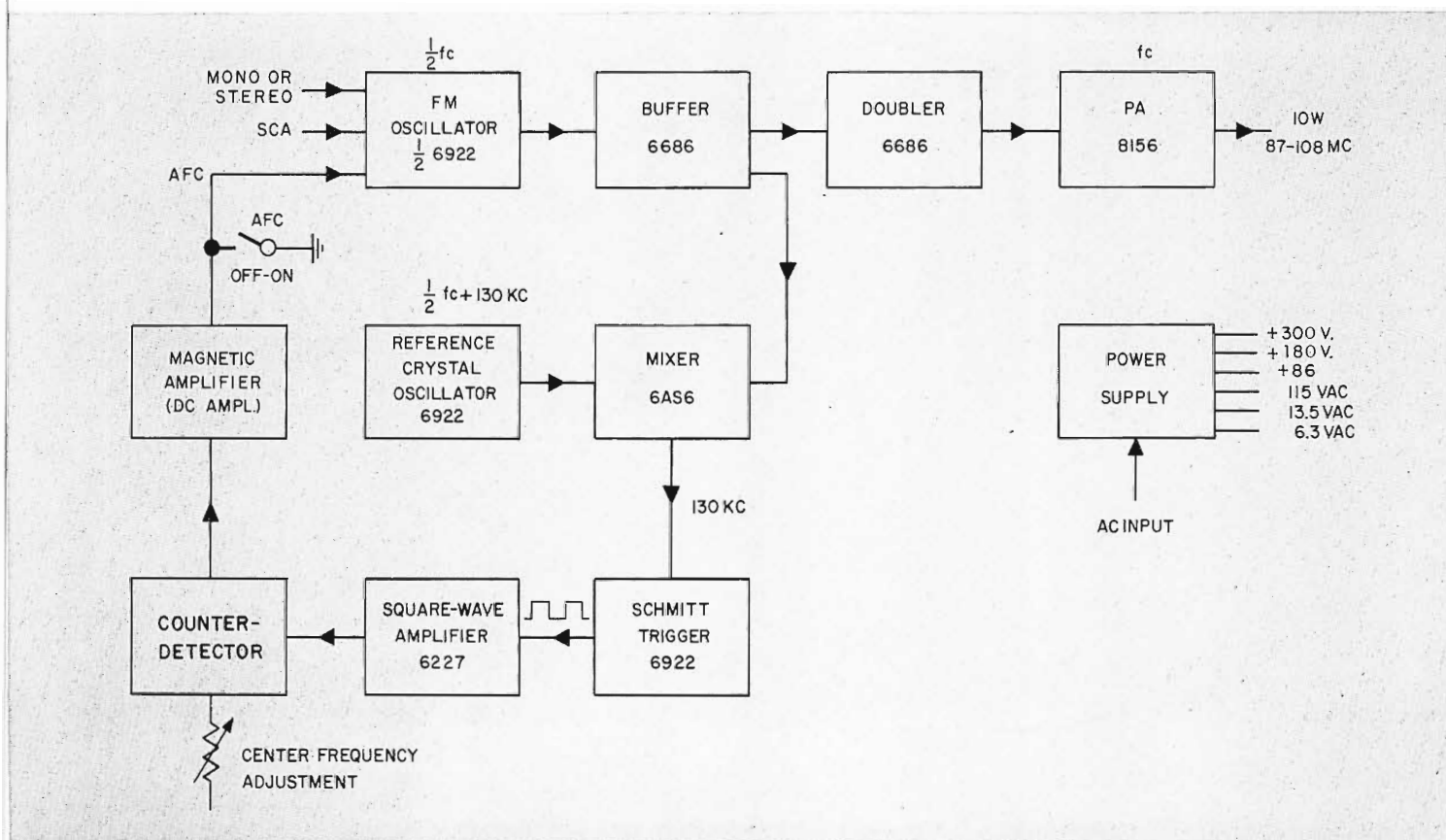



4-CHANNEL LIVE COLOR TV CAMERA

With Transistorized Standard Modules,
Functional Low Profile, Stabilized Circuits
For Sparkling Black and White and Living Color

Featuring many new concepts in color camera design, the TK-42 Live Color Camera is the outgrowth of the M-channel principle first introduced at the 1962 NAB Convention. Its design adds a monochrome (luminance) channel to the red, green, and

blue color channels found in conventional color cameras. The addition of this high quality monochrome information to the conventional color picture results in improved color detail, fidelity and registration—in the same manner as the black plate



FIG. 1. RCA TK-42 Live Color TV Camera features new low-profile styling. A built-in zoom lens with wide-angle adaptor, shown here, handle virtually all lens requirements for studio or field use.



How the Luminance Channel Produces Finest Color Pictures

A separate luminance (black-and-white) channel produces in effect the same results as the black plate in a four color printing process as demonstrated here. Note how addition of black to the three-color image sharpens the picture and produces more natural coloring.



Yellow image plus red image.



Yellow image plus red image plus blue image presents coloring similar to 3-tube cameras.



Black image, added to yellow, red and blue, sharpens picture and produces truer colors as with 4-channel color camera.



FIG. 2. Rear view of the TK-42 Color Camera. One group of plug-in transistor modules flanks the viewfinder. Another group is located along the side. "D" handles shown at the back control zoom and focus of the lens.

improves the three-color image in color process printing. At the same time, the luminance channel—which uses a 4½-inch image orthicon tube—provides sparkling black-and-white pictures in color transmission.

Latest Electronic Developments

In bringing the TK-42 from the laboratory to the product state, many new developments were incorporated. For ease of operation a zoom lens is built-in. This combined with low-profile styling greatly enhances maneuverability and the ease with which the camera can be made to perform a variety of production duties. Camera circuits are completely transistorized and take

the form of standard plug-in modules, most of which are interchangeable with those of other new RCA film cameras. Highly-refined stabilization techniques are used throughout the camera, permitting it to operate for long periods of time without adjustments.

Separate, High Resolution Luminance Channel

The TK-42 uses four pickup tubes. A 4½-inch image orthicon provides a separate high quality luminance (monochrome) signal while three electrostatically-focused 1-inch vidicon tubes provide the chrominance (color) signals. This separate luminance channel technique provides two very

important advantages over the earlier three tube cameras. The first is better pictures on black-and-white receivers because picture resolution is independent of the accuracy of registration of the red, green, and blue channels. Gray scale and overall quality is every bit as good as that of the finest 4½-inch I.O. black-and-white cameras. Secondly the resolution and contrast of color pictures are also enhanced by the high resolution luminance channel.

Fully-Transistorized Standard Modules

Transistors and other solid state components are used throughout the TK-42 Camera system to perform all circuit functions. The only exceptions are the four pickup tubes, and the viewfinder kinescope. Long term reliability, reduced maintenance, and a consistently high level of performance result. Transistorization also permits a major reduction in power consumption. The total power requirement of the camera chain excluding monitors is less than 500 watts. The camera and rack mounted auxiliary equipment employ plug-in modular design throughout. The entire rack mounted portion of the camera chain including the power supply occupies only 10½-inches of rack space. The compact simplified camera remote control panel may be either rack or console mounted. The majority of the modules in the TK-42 Camera and auxiliary equipment are interchangeable with modules in other RCA cameras, thus reducing spare module requirements to a minimum.

Built-in Zoom Lens System

Built into the camera is an extremely versatile, high quality zoom lens system. The basic lens and an accessory wide angle adaptor covers a range of focal length from 1.6 inches (40mm) to 40 inches. This extremely broad range of focal length does away with the need for a conventional lens turret and assortment of lenses. In addition, because a single lens system is used, there is no need for color matching lenses of various focal lengths as required on a single turret.

The lens system handles virtually any requirement in the studio or in the field. Its variable focal length (or zoom) characteristic permits the operator to "frame" any scene precisely within the desired field of view.

Convenient Zoom and Focus Control

Camera zoom and focus are controlled by two "D" handles located at the rear of the camera. These handles are also convenient for panning, tilting and dollying the camera. A wide angle adaptor is used

on the camera for operation at focal lengths from 1.6 inches to 16 inches (40 to 400 mm) in two ranges; 1.6 to 8 inches and 3.2 to 16 inches. Selection between the two zoom ranges is made by means of a smooth-acting lever at the rear of the camera. The zoom range may be changed while the camera is on-air without need to re-focus optically. When used without the wide angle adaptor, the zoom lens can be operated at focal lengths from 4 to 40 inches in two zoom ranges; 4 to 20 inches and 8 to 40 inches.

Compact, Low Profile Camera

The TK-42 Camera is styled with a functional low profile for ease of handling and operation. The center of the viewfinder kinescope is less than 7 inches above the optical axis of the taking lens. As a result, the camera operating height is kept at a minimum at all times with the viewfinder in a position normally at or near eye level of the camera operator. The low profile also results in a low center of gravity, thereby increasing the mechanical stability and making the camera easy to maneuver. Overall size and weight have been minimized through the use of solid state circuitry and compact, functional styling.

Plug-in Modular Construction

Standard plug-in modules are used both in the camera and in rack-mounted auxiliary equipment for compactness, easy access for service, and quick interchange of spares. The viewfinder is a separate module and is mounted on a sliding track so that it may be pulled out for inspection and maintenance. The plug-in transistorized module may be serviced by using the standard module extender which plugs into the module space and permits checking under operating conditions. Most of the modules used in the TK-42 Camera are identical with those of other RCA cameras such as the TK-22 Monochrome Film Camera and the TK-27 Color Film Camera. This minimizes the variety of circuits with which technical personnel need be familiar. Maintenance can be speeded by interchange of modules once a small number of module types are reserved as spares.

Stabilized, Self-Compensating Circuitry

Stabilizing techniques have been used extensively throughout the camera chain to assure uniformly high performance over long periods of time. A unique cooling and heating system maintains the optimum operating temperature of the four pickup tubes. Feedback stabilization circuits compensate for aging of components and for

changes in ambient temperature. Precise reference devices maintain critical control voltage and current at optimum value.

Simplified Pulse System

Horizontal and vertical drive pulses are derived from sync and are generated internally within the camera. In addition, the timing of the camera chain output signal is compared with sync timing to produce a control signal which advances the drive signals at the camera and compensates automatically for delay in the camera cable. This technique also compensates for delay in the colorplexing circuits and does away with the need for delay of drive pulses to monochrome cameras operating synchronously in the same system. A substantial

saving may thus be realized by eliminating pulse distribution amplifiers and delay lines from the station pulse system. Also built into the camera auxiliary equipment is a color bar test signal generator. The only input signals required for the camera chain are sync, blanking, color subcarrier, and burst flag signals.

Finest Pictures Without a Fuss

The TK-42 live color camera is entirely new, thoroughly engineered to produce the best obtainable monochrome and color pictures with the least effort. This camera brings to color television, for the first time, a degree of simplicity and convenience of operating previously associated only with the finest of monochrome cameras.

FIG. 3. Optical diagram of the TK-42 Camera shows beam splitting techniques used to direct the image to all four pickup tubes.

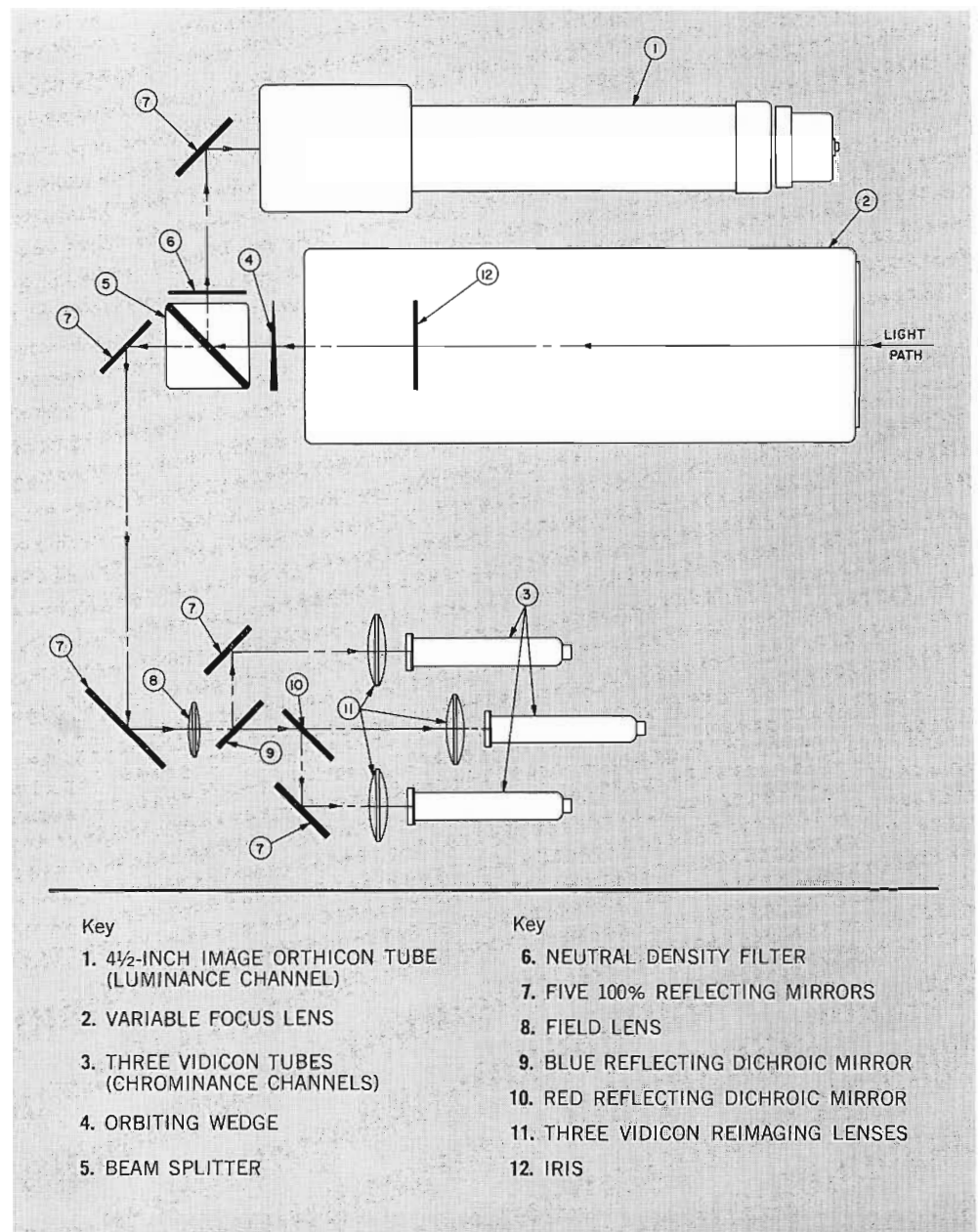



4-VIDICON COLOR FILM CAMERA

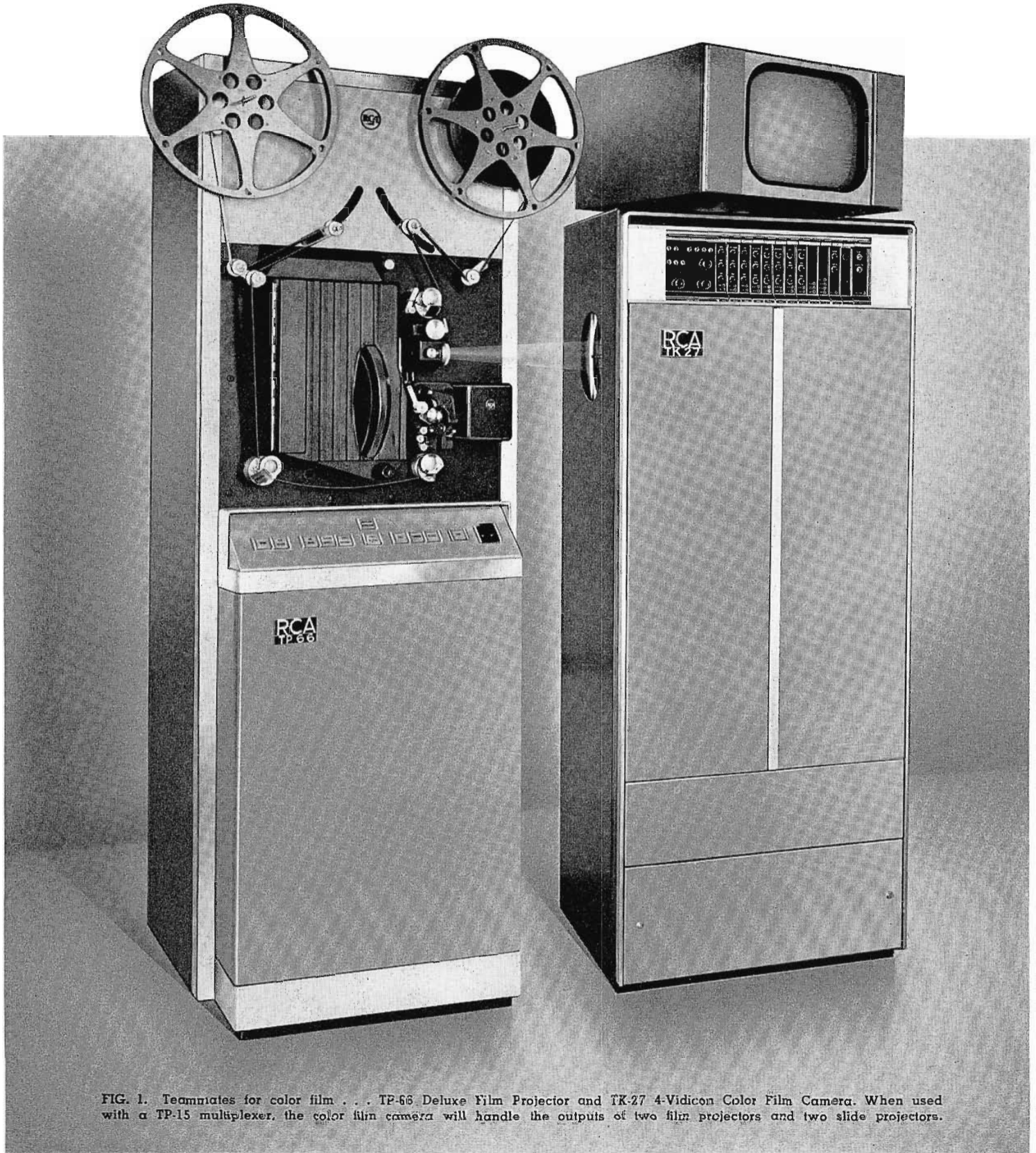

FIG. 1. Teammates for color film . . . TP-66 Deluxe Film Projector and TK-27 4-Vidicon Color Film Camera. When used with a TP-15 multiplexer, the color film camera will handle the outputs of two film projectors and two slide projectors.

Features 1½-inch Vidicon in Luminance Channel, Standard Transistorized Modules, and Super- Stabilization for Finest Color and Monochrome Pictures from TV Film and Slides

A major breakthrough in color film reproduction, the TK-27 4-Vidicon Color Film Camera is designed for highest quality presentation of color films and slides. The equipment is fully transistorized and employs a 1½-inch vidicon tube in its monochrome or luminance channel which is entirely separate from the red, green and blue signals delivered by one-inch vidicon tubes.

The four-tube principle provides results comparable to the four-color printing process in which the imposition of black on a combination of three primary colors enriches the hues and provides sharper defi-

nition in the finished picture. (This is illustrated on page 33 of the Live Color Camera article.) In the TK-27 picture quality is further enhanced by using a 50 per cent larger vidicon for the luminance channel.

Transistorized for Reliability

The TK-27 Color Film Camera is completely transistorized for utmost reliability, low power consumption and compactness. The only vacuum tubes used in the entire system are the four vidicons themselves. This exclusive use of semiconductors results in a new order of dependability, sig-

nificantly reducing maintenance requirements while maintaining a high order of performance. A further advantage of transistorization is low heat dissipation which results in reduced air conditioning requirements and the types of failures caused by high concentration of heat.

Standard Plug-In Modules

The camera and rack-mounted auxiliary equipment use plug-in modules. A number of modules are mounted in the camera along the top of the housing. Others are rack-mounted—occupying only 10½ inches of rack space. A compact, simplified remote

FIG. 2. Four tube principle . . . Three one-inch vidicon tubes are used in the red, blue, and green channels to provide the color (chrominance) signal. A 1½-inch vidicon is used in a separate channel to provide the monochrome (luminance) signal.



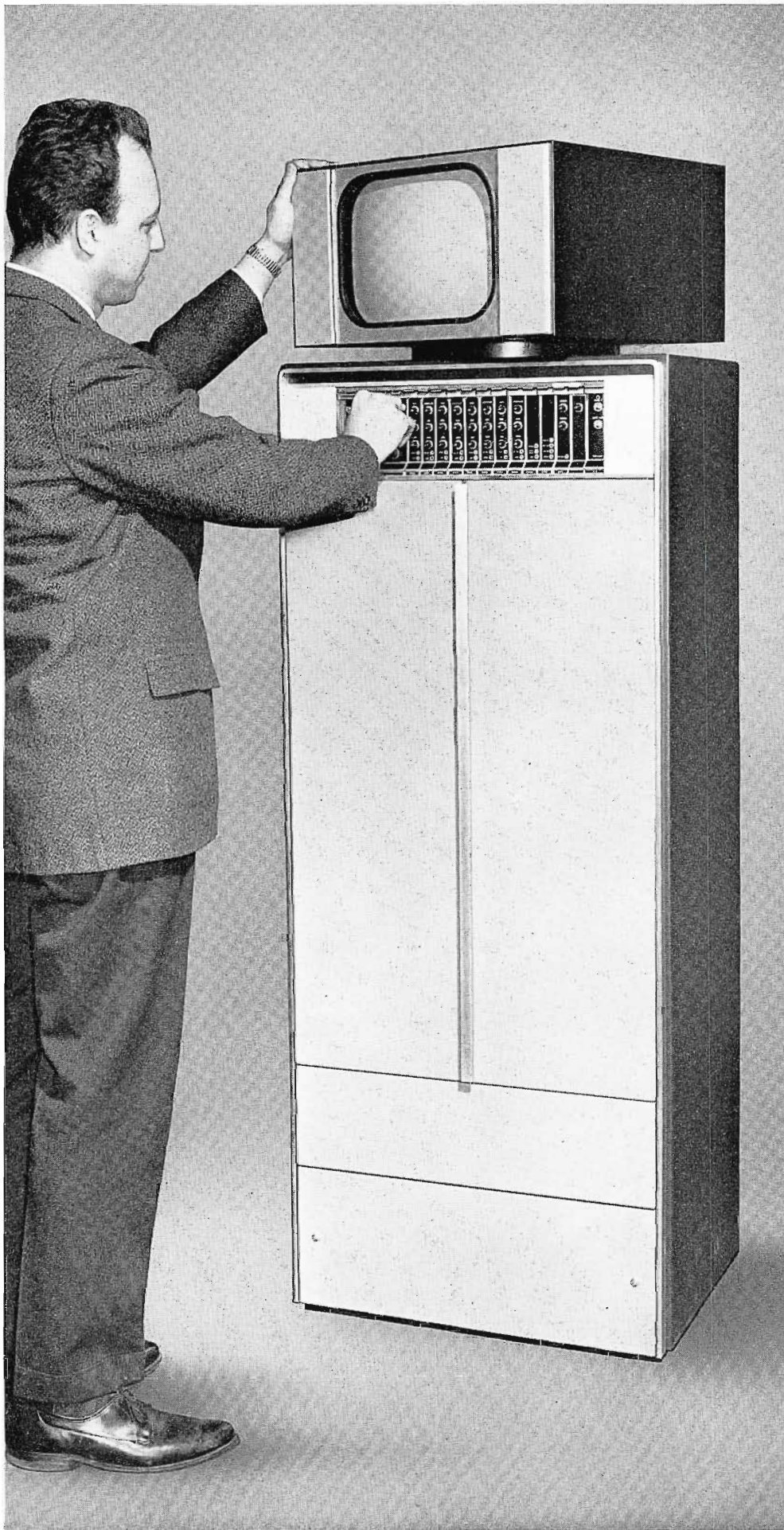

control panel (similar to that used with the TK-42 Live Color Camera) may be either rack mounted or installed in a console housing. The majority of modules in TK-27 camera chain are interchangeable with modules in other RCA cameras, i.e., the TK-42 Live Color Camera and the TK-22 Monochrome Film Camera. This permits keeping a small number of spares to speed and simplify maintenance.

Separate Luminance Channel with 1½-inch Vidicon

The new TK-27 4-Vidicon Color Film Camera employs a separate vidicon channel to generate the luminance (monochrome) portion of the color signal. (This is the same principle that is used in the TK-42 Live Color Camera.) Because the luminance channel provides all the picture detail, sharpness of reproduction is independent of the registration accuracy of the three chrominance (color) channels. Three one-inch vidicon tubes are used in these channels. A 1½-inch vidicon is used in the luminance channel to provide the utmost in overall performance. This is the same tube used in the TK-22 Monochrome Film Camera. Its high resolution capability (not only in terms of limiting resolution, but also in improved response to all picture detail information) results in unusually sharp pictures with excellent signal-to-noise ratio. The result is outstanding quality on both black-and-white and color receivers.

Electrostatic Focus, Magnetic Deflection Vidicons

All vidicons are of the electro-static focus, magnetic-deflection type. These are highly suited for use with transistor circuits. Negligible focusing power is required and deflection power is substantially lower than that of a magnetically focused tube. Generation of heat in the focus coil is eliminated and heat dissipation in the deflection coils is minimized—resulting in a high order of stable performance.

All-New Colorplexer

Incorporated in the camera chain is a solid state colorplexer of advanced design. Provision is included for quick test and setup of this unit using a new simplified technique. The test facility built into the system requires no external test equipment other than an oscilloscope for accurate adjustment of the colorplexer. Once set up, the stability of the transistor circuits hold their adjustment for long periods of time.

FIG. 3. Double duty monitor—Optional 14-inch monitor on lazy-susan permits convenient camera setup, pivots for use as film room continuity monitor.

Built-in Color Bar Generator

A solid-state color bar generator is also built into the system. This all-new unit provides full raster R, G, and B pulses at 0.7 volt level to facilitate adjustment of the colorplexer.

Functional Layout

The TK-27 Film Camera Chain is comprised of basically the Camera Housing, rack-mounted Camera modules, and a Remote Control Panel. The Camera is comprised essentially of four precision vidicon yoke assemblies and an associated optical system housed in a rugged cabinet-type structure. The component assemblies are mounted in a vertical configuration to achieve maximum utilization of space and easy accessibility to all components. See Fig. 4. The optical system consisting of a field lens, beam splitting prism, dichroic prism and front surface mirrors is precision aligned at the factory. Prism optics assure freedom from secondary deflections and are easily maintained for optimum performance at all times.

Plug-in Vidicon Assemblies

The plug-in vidicon assemblies are accurately indexed and may be quickly removed and replaced in a matter of seconds without the need for realignment. Relay lenses are independent of the vidicon assemblies and precisely aligned with the optical axis. These lenses are provided in focusing mounts making focus adjustments after replacement of a vidicon tube an easy matter.

Simplified Set-Up and Maintenance

Set-up controls which permit adjustment of beam, electrical focus, target, centering, size, linearity and beam alignment for each of the four vidicons are located in the camera unit and conveniently grouped for ease of adjustment.

Initial adjustment of the TK-27 Camera can be made quickly and, once made, further touch-up is rarely required. A simplified system of test pulses facilitates adjustment and provides a ready means for checking operation at a moments notice.

Lazy-Susan Monitor

The camera cabinet can be fitted with an accessory lazy-susan and 14-inch monitor so that the monitoring facility becomes an integral part of the camera housing. In this position the monitor is convenient for

camera setup and can also be pivoted to serve as continuity monitor in the film projection room.

Deluxe Color Film Camera

The TK-27 4-Vidicon Color Film Camera is superior in every facet of its design—styling, performance, reliability. The camera chain is compact, has simple local and remote operating controls, and features transistorized plug-in modules.

Operating and maintenance personnel will delight in the overall accessibility of the camera chain as well as its many new aids to operation: the plug-in vidicon assemblies which are replaceable without optical realignment, the precision yoke ad-

justments, the self-aligning vidicon tube mounts, the built-in test pulses for easy set-up and check-out of the camera, and the provisions for quick set-up and test of the colorplexer, to mention but a few.

Performancewise, high resolution, excellent signal-to-noise ratio, prism optics, flat focus field, and low power consumption mark the TK-27 as a leader. Complete solid state circuits (except for the four vidicon tubes) assure low heat dissipation, and provide ultra-stable, reliable operation. Together with the 1½-inch vidicon in the luminance channel, these features and facilities result in a film camera of incomparable value—producing color and black-and-white pictures of incomparable quality.

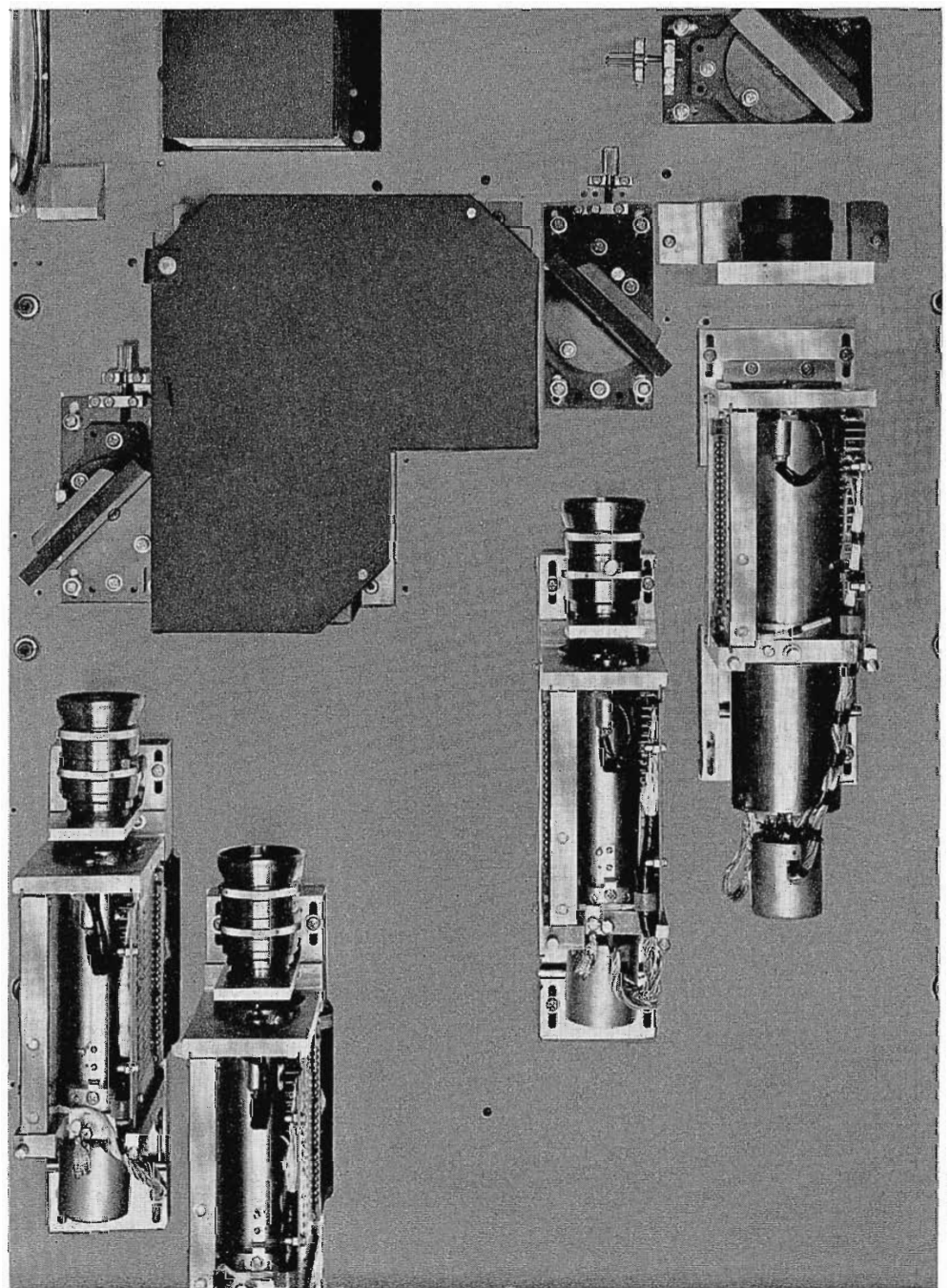
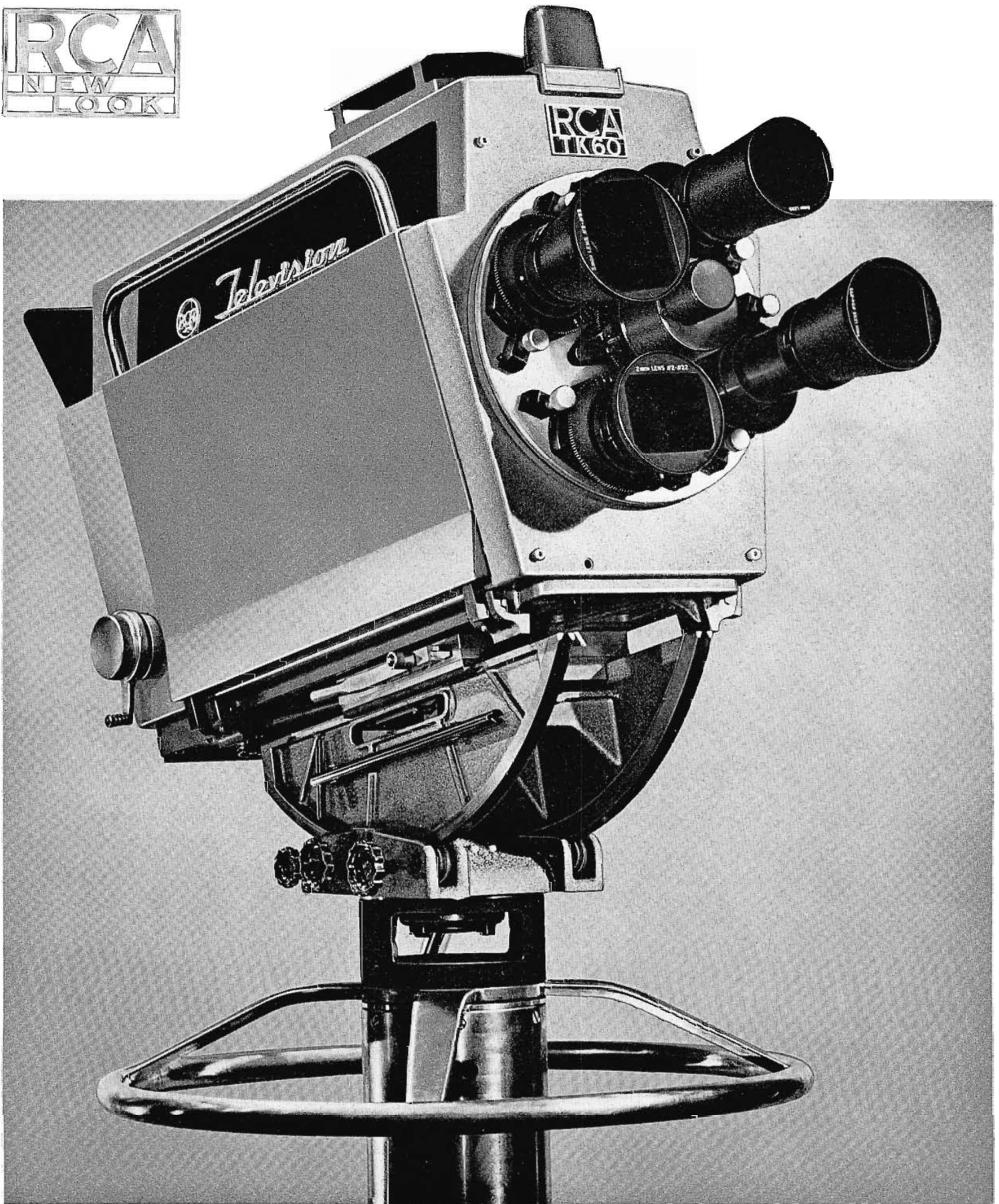

FIG. 4. Precision optical system . . . Inside the camera housing the optical system is fully accessible. Prism optics are used throughout for finest quality, easy maintenance.

NEW GENERATION TV CAMERA



New Tube and Modern Electronics Produce Vastly Improved Picture and Stabilized High Performance

The TK-60 4½ inch image orthicon camera is the leader of the line of new generation equipments designed by RCA for the broadcast industry, and has proved through widespread use the effectiveness of space-age design for broadcast requirements.

Big Picture Tube

In this camera, the new 4½ inch I.O. tube produces a higher quality picture than the older 3 inch tube. It's like using a larger size negative in photography to reproduce finer detail and to give greater contrast. The result is a clearer, crisper TV picture for programs and commercials.

Uniform Picture Quality

New developments in components and circuits assure unvarying picture quality over long periods of time without frequent adjustment or long warm-up periods. The camera produces a rehearsal quality picture in one minute after it's turned on and a program quality picture within 20 minutes. By means of self-compensating electronics, this program quality picture is automatically maintained throughout the day.

Simplified Control

Operation of the camera is simplified and maintenance made easier. The number of operating controls has been so sharply reduced that one man can control six cameras. Self-testing switches enable the camera to report where any trouble is located, and test points speed servicing when needed.

Self-Contained Features

Built-in aids to production enable the user to create effects smoothly without undue effort. These aids include built-in filter system, fast-change lenses, and special effects viewfinder. Combined with standard design of accessories and use of standard operating techniques, they make this new camera a model of efficiency. It is easy to use by experienced personnel, and produces high quality pictures without a great deal of effort.

How Better Pictures Are Made

Some of the outstanding advantages of the TK-60 Camera stem from use of the 4½ inch picture tube. The new concept in camera design is tailored specifically to bring the 4½ inch image orthicon to its highest capability. It is capable of producing pictures with measurably better resolution, lower noise, and improved gray scale. This means pictures with smoothness of texture and general high quality usually associated with a fine photograph.

The 4½ inch image orthicon operates on the same basic principle and has the same general shape as the well-known 3 inch type, but is larger in size. This difference is significant because it means a larger target area is scanned by the electron beam. It is this larger area that accounts for the increase in fine detail, by a factor of almost 2 to 1.

Another important feature is the relatively close spacing between the glass target and the mesh. There are several desirable

Produces Finest Pictures

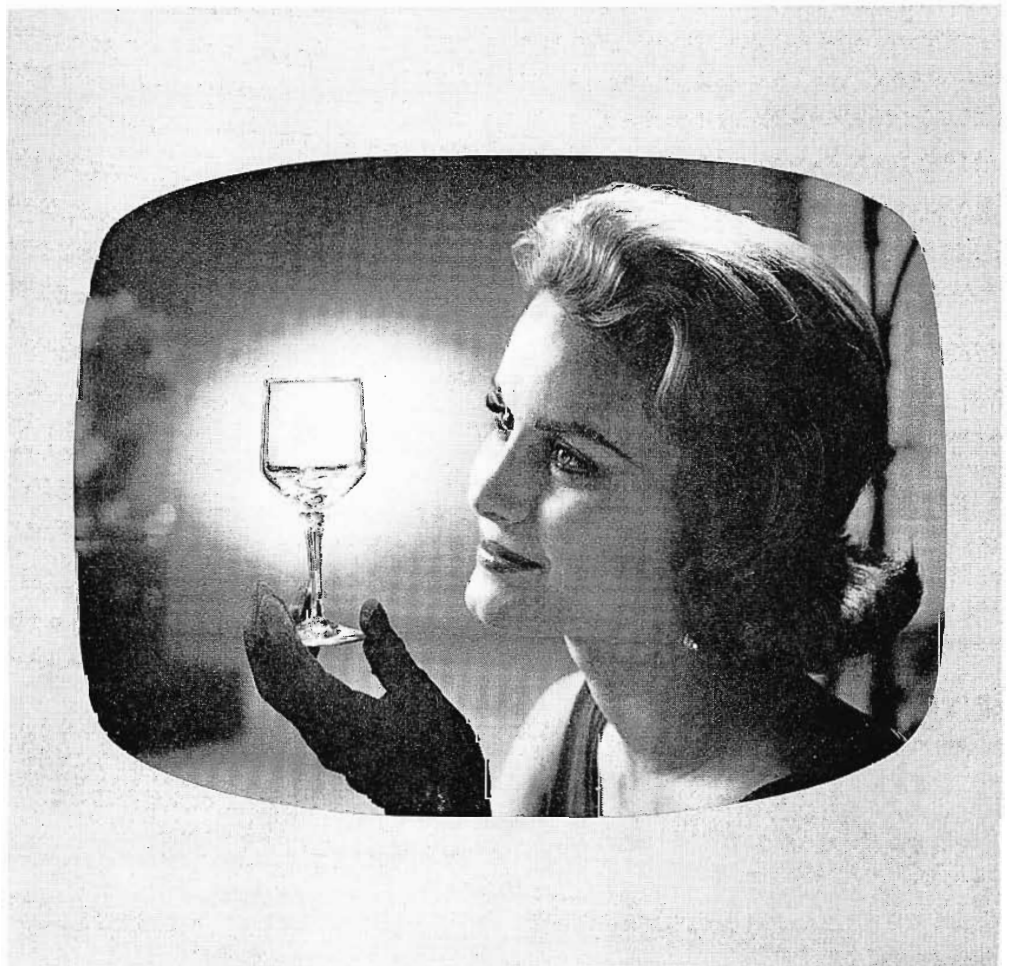

results. Signal-to-noise ratio is increased. The linear portion of the transfer characteristic is longer, permitting more accurate reproduction of the gray scale. Broad redistribution of secondary electrons is reduced, making it possible to eliminate the overshoots and halos usually seen in TV pictures.

All of these improvements—better detail and contrast, higher signal-to-noise ratio, better gray scale—are important contributions to better picture quality.

Modern Electronics Improves Operation

Extensive use is made of stabilized circuitry in every part of the camera chain, beginning with the voltages applied to the image orthicon and extending through all of the video amplifiers, deflection circuits and processing circuits. As a result, a great improvement has been achieved in stability of operation. This permits a major reduction in the number of operating controls and the amount of effort required for operation. Further, the frequency with which re-adjustment of set-up controls must be made and the amount of servicing required are also reduced significantly.

Reduced Number of Controls

In the TK-60 Camera chain there are actually only two operating controls. This simplification makes it possible for one video operator to handle as many as six cameras at one time.

It is important to emphasize that by virtue of the stable circuitry in the TK-60 Camera most of the controls usually found at the console are no longer considered operating controls. They have been removed from the operating panel, leaving only two controls for normal operation—CONTRAST and IRIS (exposure). This actually results in more uniform picture quality as well as simpler control.

Stabilized High Performance

The fundamental basis of the TK-60's high performance lies in the new space-age developments of circuit techniques and components that provide either built-in immunity to, or compensate for, normal drift in performance.

Common variations attributable to changes in temperature, line voltage, and aging of components have been eliminated almost completely by use of the new techniques.

Therefore, excellent performance is maintained over long periods of time without re-adjustment of controls.

In order to achieve this uniformly high performance precise regulating techniques are employed for:

1. Focus current and Voltage.
2. Photo Cathode Voltage.
3. Image Section Voltage G-6.
4. Dynode Voltages.
5. Beam Voltages.
6. Target Voltage.

Some of the new devices used for combating drift include Zener diodes, Zener diodes in ovens, corona regulators, and corona regulators in ovens.

Use is made of feedback techniques in video output stages, deflection systems and clamp circuits. These are further aids in maintaining stable signal levels, linearity, and low differential gain.

Additional automatic compensation employed in the TK-60 includes:

1. Self-regulating Power Transformer—for variations in line voltage from 95 to 130 volts.
2. Thorough Magnetic Shielding—for protection to 10 gauss.
3. Temperature Control—through thermostatically controlled heater.
4. Parameter Tracking.

As a result, the TK-60 produces no noticeable variation with normal temperature from the high standards of performance and does not exceed maximum variation with temperature extremes.

This means the TK-60 will give unvarying quality in pictures—hour after hour, day after day—by merely turning the camera on and off. No longer is it necessary to wait for long periods of warm-up, or to re-adjust at frequent intervals.

Uses Standard Procedures

The camera, although new in concept, employs standard design embodying the familiar practices of the industry. Built-in aids to production and versatility are incorporated. Procedures for set-up are far less complex than formerly. Although the small size control panel makes it possible to group six in a small space before a single operator, nevertheless, there is sufficient area on each panel for two intercom volume controls, electronic lens cap, and servo-controlled iris.

Standard design provides for either mounting the chain in regular consoles and racks for studio use, or incorporating the proc amp and power supply in a pair of

“suitcases” with TM-35 portable master monitor (and control panel) for field use.

Standard cables and connectors, quick-change lens mount, squeeze-type turret handle and focusing control make it easy for the experienced cameraman to use this new camera. Use of standard cables and accessory equipment also lessens cost of installation and operation.

Built-in Aids to Production

The large 8½ inch Viewfinder produces a brilliant 150 foot-lambert picture. Provisions are made so that the composite effects picture is seen on the viewfinder. Thus, the cameraman can manipulate the camera to best advantage. Processed signal display mode may also be punched up for a quality check on signal leaving the camera.

Built-in production aids, in addition to the versatile viewfinder, include: Deflection reversal, orbiter with immobilizer, filter disc system, large lens turret, and quick-disconnect wedge mount.

To simplify setup procedure, all these controls are centralized on a compact panel along one side of the camera interior. Once adjusted, the controls require no additional adjustment in normal day-to-day use. For further simplifying set-up, provision is made for built-in focus wobble, video level calibrator, calibrated gamma control, delay line aperture correction, and calibrated cable compensation.

Built-in Maintenance Features

Many electrical and mechanical features are found in the TK-60 to facilitate servicing. When routine checking and repair are needed, a number of self-testing circuits make the job easy.

Test switches are included in the camera and proc amp for testing one segment of the system at a time as a matter of routine or when trouble develops. In the camera, some 50 test points, using pin jacks, are available for either meter or CRO measurement of signal and power supply voltages in order to make fast checks on performance. In the proc amp 26 test points and the processor test switch speed servicing.

Mechanically, the swing-up chassis mounting gives inside-out accessibility to all parts and components—and all sub-assemblies are operable in this position. The swing-out yoke assembly makes it possible to remove and to replace the I.O. tube in a few minutes. It is not necessary to remove the turret or any assembly within the camera.

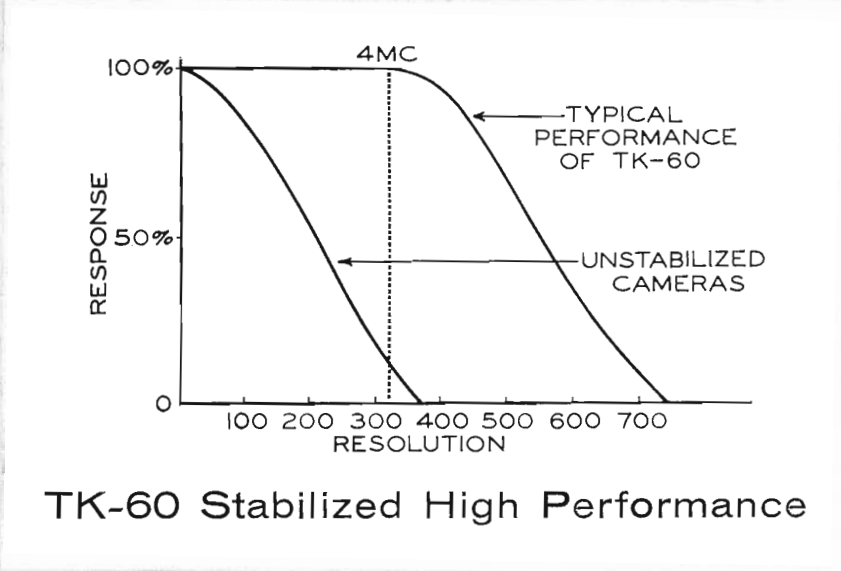

TK-60 Stabilized High Performance

Built-in Aids to Production

BIG, BRIGHT VIEWFINDER

6-POSITION FILTER CONTROL

BUILT-IN ORBITING

SCAN REVERSAL

DIRECT DRIVE LENS CHANGE

TRANSISTORIZED INTERCOM

SPECIAL EFFECTS ON VIEWFINDER

COUNTER BALANCED FOCUS

REMOTE IRIS CONTROL

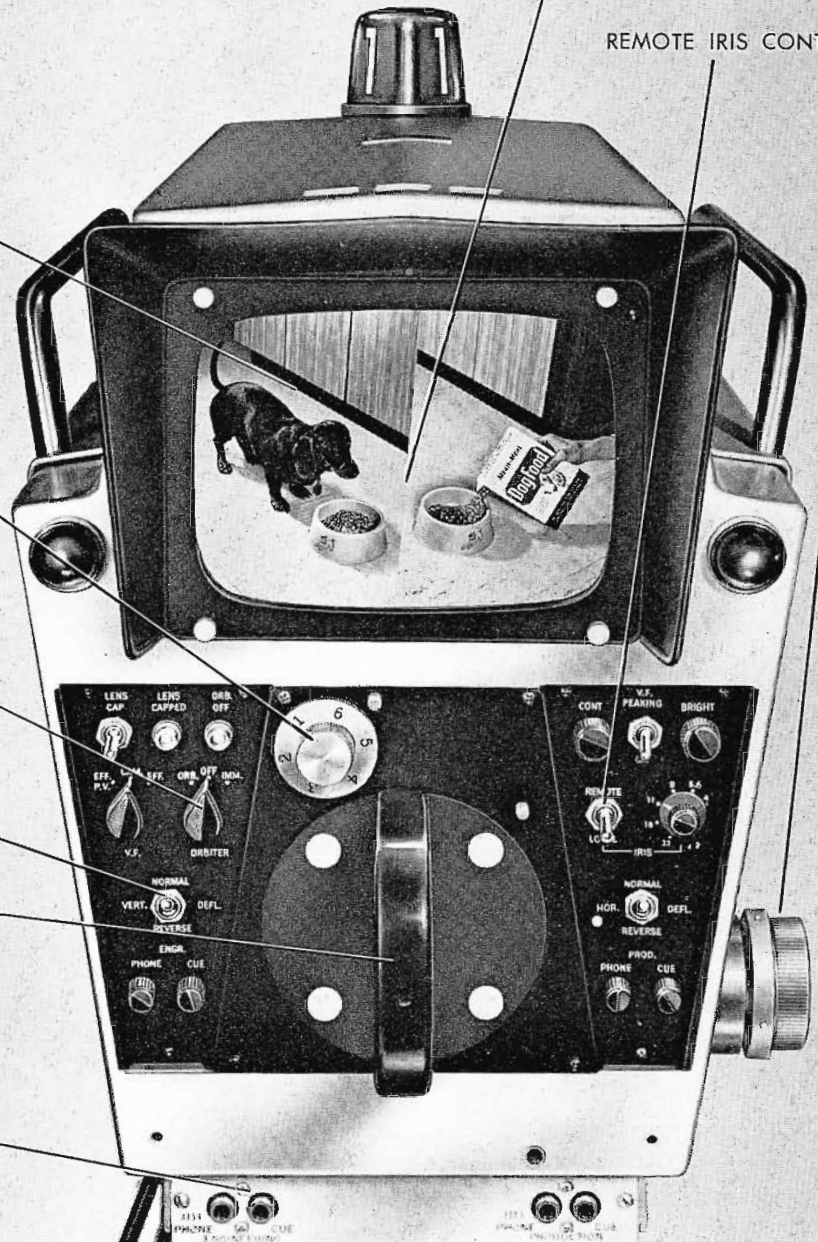

NEW MONOCHROME FILM SYSTEM



FIG. 1. New TP-66 projector shown in use with TK-22 film camera in special monoplex operation.

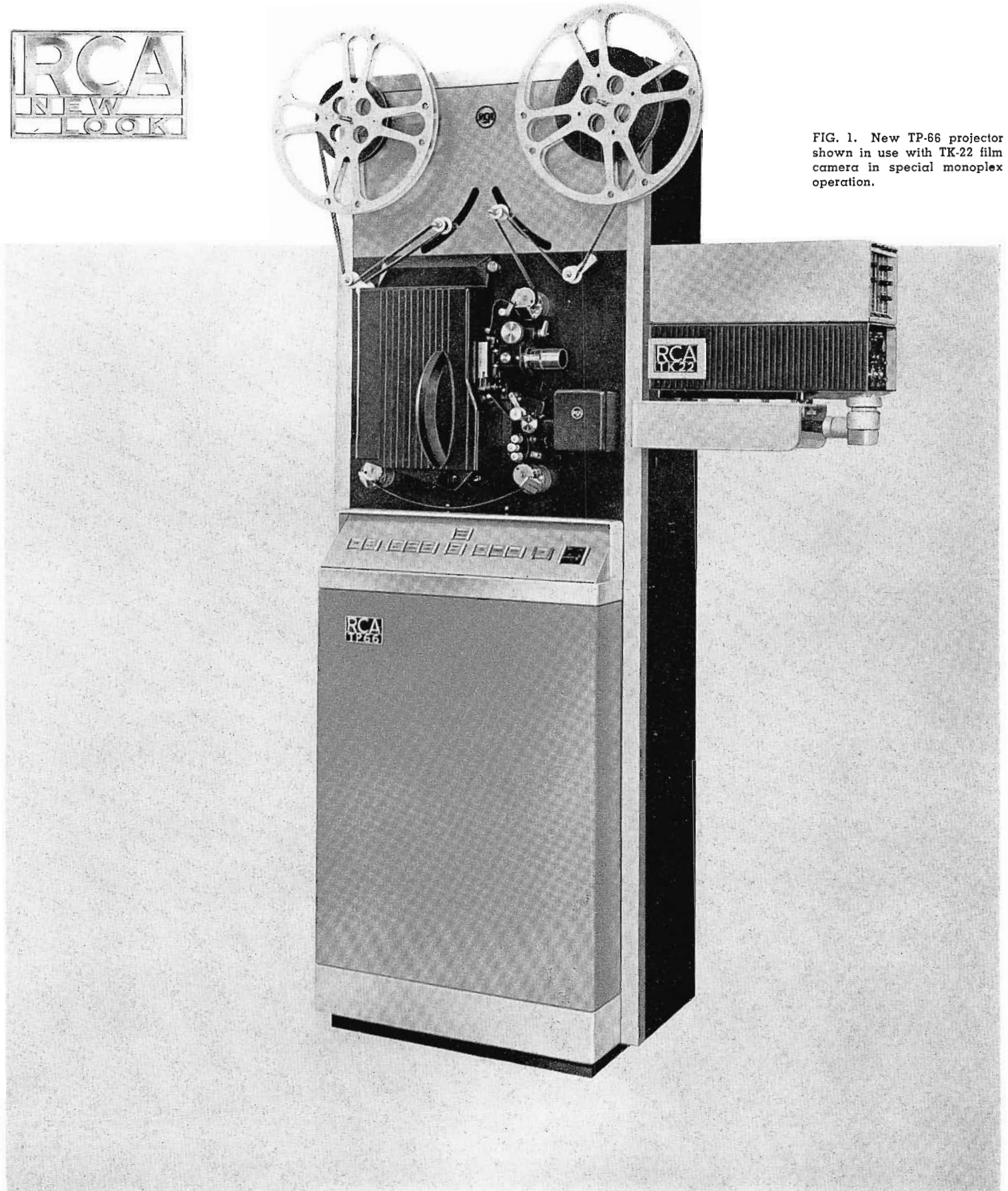

Automated 16 MM Projector

Plus All-Transistor Camera Achieve Ultimate In TV Film Performance

A new order of TV film picture quality and stability are now obtainable with the recent introduction of two major film equipments—the TP-66 16 mm projector and TK-22 film camera. Both units are completely transistorized, and the TK-22 utilizes a unique new vidicon developed just for use with transistor circuits.

Designed For Television

Designed and built specifically for television, the projector reflects the influence of user experience studies that were made and the “human engineering” that was applied—to better meet film programming’s faster pace, to reduce human error and increase program creativity.

Easy Installation

The new projector and film camera are easily “monoplexed” with the camera serving one projector as shown in Fig. 1, or multiplexed using two film projectors and a slide projector. Newly designed jigs and alignment fixtures simplify installation of both camera and projector.

Rapid Projector Start

Since projector sound is stable within 0.3 seconds, start and show buttons can virtually be pressed in one operation, eliminating one possible source of error. Also eliminated is the usual pre-roll period, now unnecessary.

Reverse Operation

Film motion can be reversed, a time saving feature when rehearsing “live” or tape shows with film inserts. Sound is automatically disabled at this time. Rewinding and rethreading are unnecessary.

Still Frame Projection

Single frames can be shown at full light level for extended periods of time. Permits previewing of first frame. Film is always completely protected by a filter that auto-

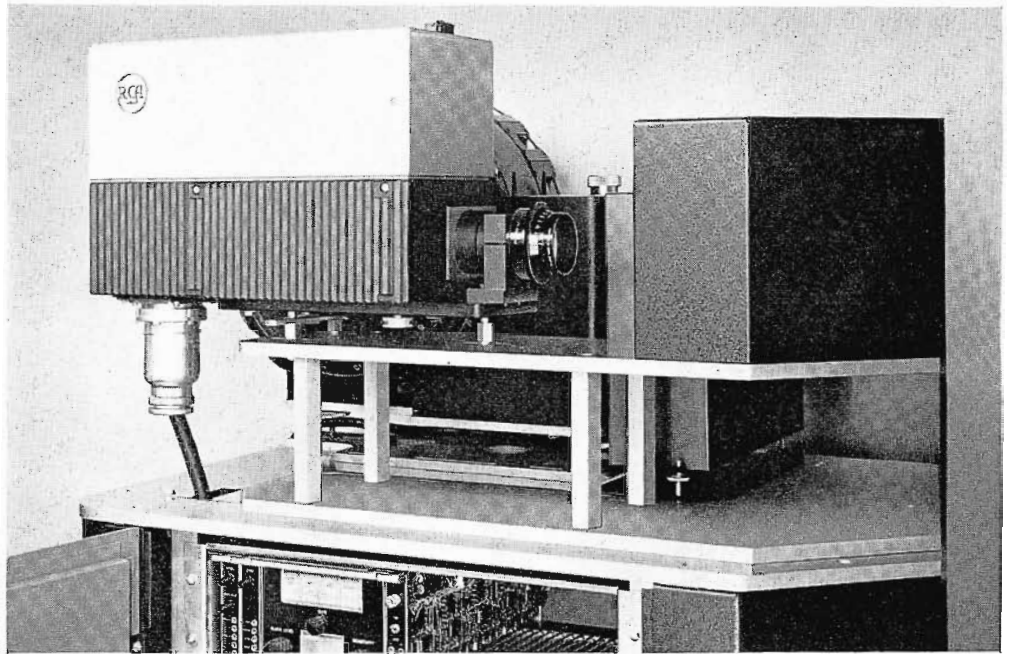
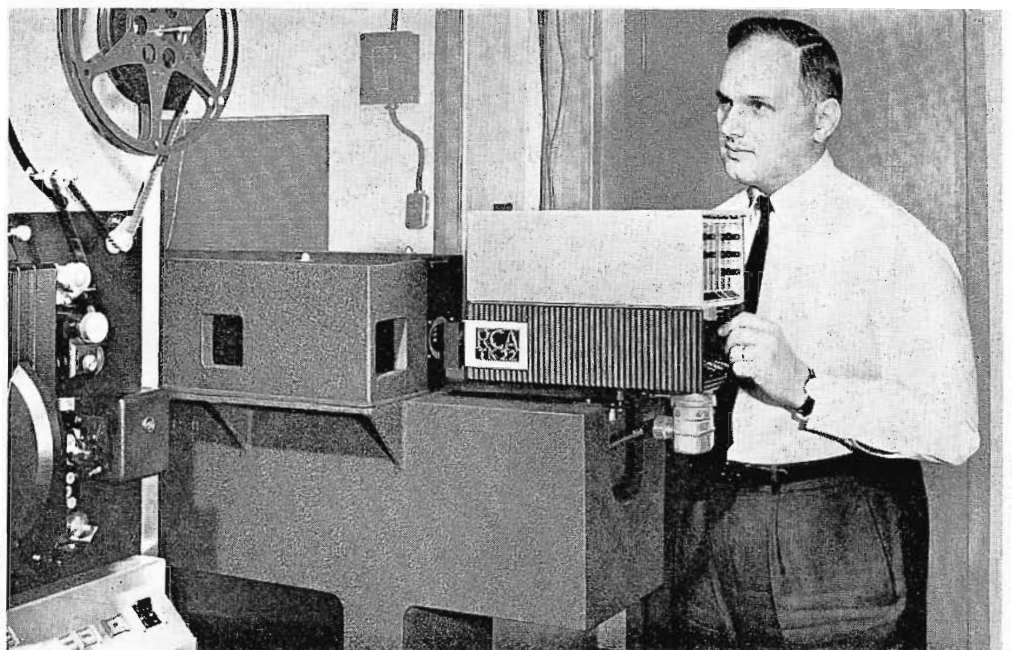

FIG. 2. TK-22 film camera mounted beside slide projector on a TP-15 multiplexer.

FIG. 3. TK-22 film camera mounted on TP-11 multiplexer.



matically moves into the light path during still frame projection.

Fast Wind and Rewind

Film winding and rewinding is fast and easy with the TP-66. Film is merely threaded over two sets of idler rollers. Winding in either direction is then controlled by operating either one of the two tensioning arms.

Automatic Cue

Films can be automatically stopped and cued-up, obviating manual threading and

cueing, and eliminating errors that might occur with visual cue marks. Automatic cueing can be overrun from the control panel.

Compatible with Color or Monochrome

Both projector and camera are compatible with existing RCA systems for both color and monochrome use. They can be installed together with either TP-6 or TP-16 series projectors and TK-26 or TK-27 color film cameras, and integrated with TP-15 or TP-11 multiplexer systems as required.

Simplified Camera Control

Camera control panel has only two operating controls — sensitivity and black level. Illuminated, momentary contact switches serve also as tallies. A remote control panel is available, designed for the standard 13-inch console housing.

Automatic Operation

The TK-22 achieves a degree of automatic operation heretofore unknown—by automatically maintaining control of sensitivity, black level, and gain. Manual control is also available at any time by push-buttons. Setup is extremely simple.

Programming Aids and Operational Reliability Are Features of TP-66 Projector

FIG. 4.

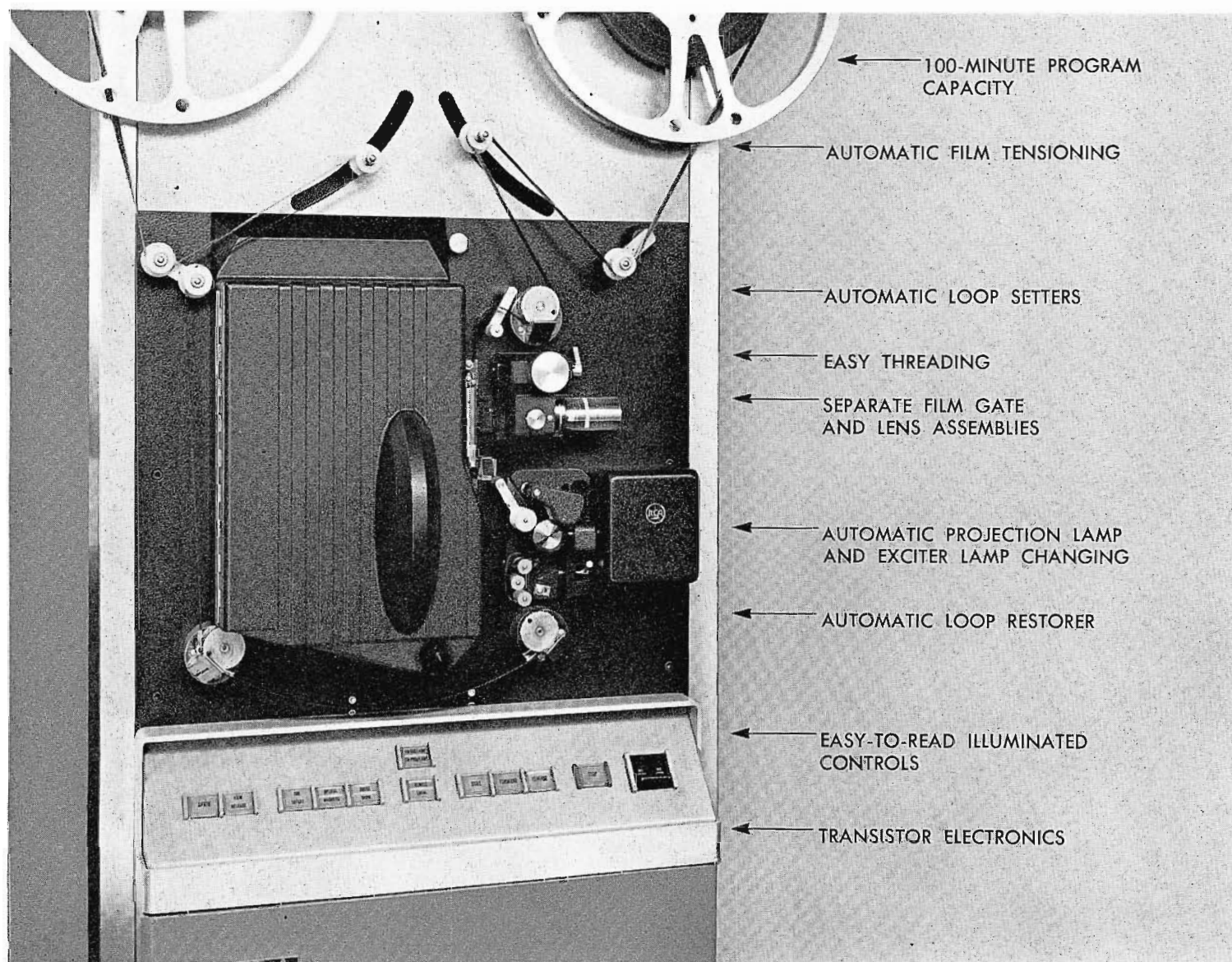

Switchable Standards

The camera consumes less than 35 watts—operates on voltages in the ranges of 90-130 volts or 180-260 volts ac, at 47-63 cps. A plug-in relay permits remote selection of either 525-line/60-field, or 625-line/50-field operation.

Better Picture Quality

Higher resolution, increased signal-to-noise ratio and utmost picture stability are features of the new film system. Resolution is 800 lines without aperture correction. Because of the excellent definition,

only a minimum of aperture correction is needed, resulting in still less noise.

Ultra Stable Performance

Low heat dissipation and high stability produce exceptionally fine picture quality over extended periods of time. No day-to-day adjustment is required, nor is extensive warm-up needed before camera is used "on-air."

Optical and Magnetic Sound

Optical sound is standard but magnetic

sound is available as an accessory. Magnetic sound, ideally adapted to production of news films and commercials, is easily installed. Then, both are selectable from the control panel.

Precision Camera Mount

New camera mount permits removal and replacement of camera on multiplexer without need for any mechanical alignment adjustments. Pins provide smooth control of lateral position and easy skew adjustment. A precision alignment jig greatly simplifies adjustment.

Fully Transistorized TK-22 Camera Offers Utmost Compactness and Stability

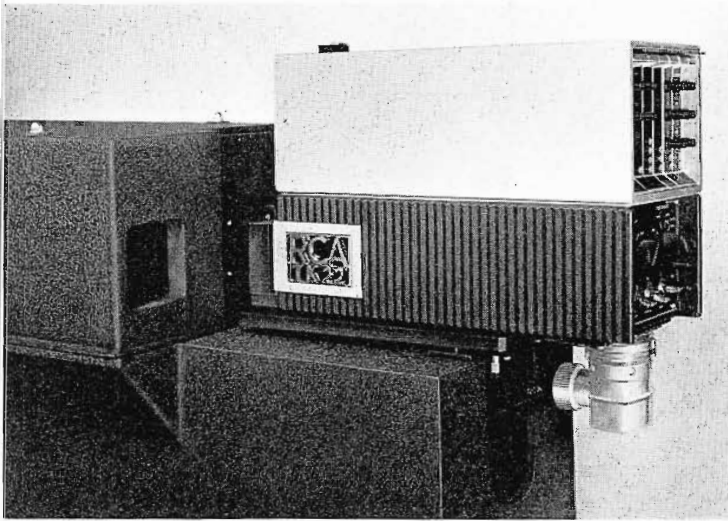

FIG. 5. TK-22 features sturdy, die-cast aluminum case. Camera generates H and V drive signals internally, eliminates generator required in previous designs.

FIG. 7. Only tube in camera is the 1½-inch vidicon pickup tube. New electrostatically focused tube gives higher picture quality, cool and stable operation.

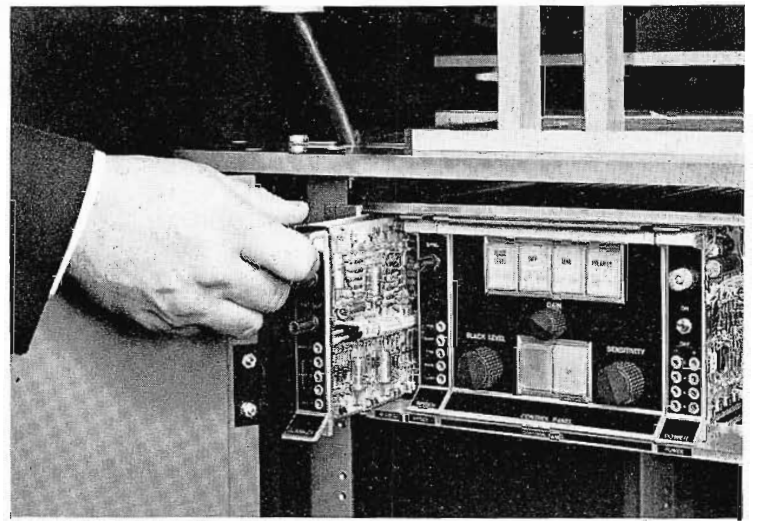
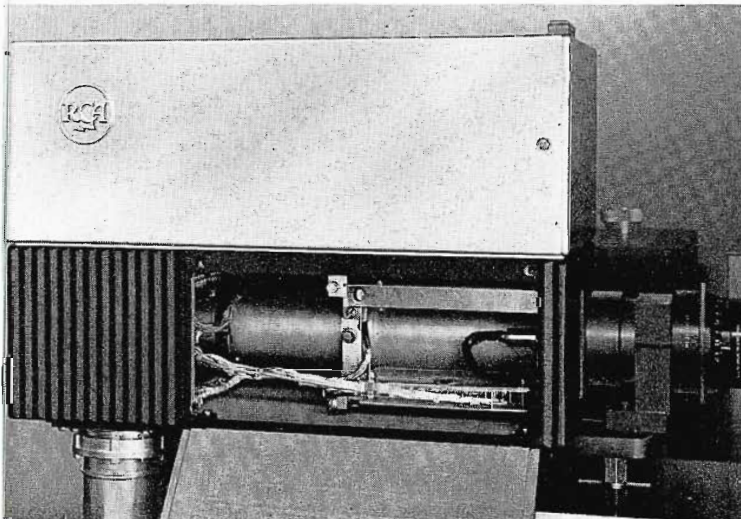
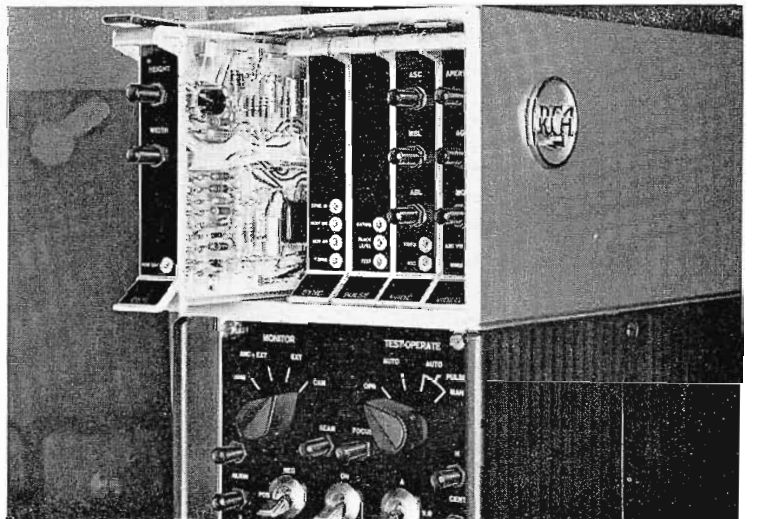

FIG. 6. Camera control features modular, plug-in design, requires only one-half of a 5¼-inch rack-mounting frame.

FIG. 8. Camera circuits are also plug-in modules. Adjustments require no attention after setup. A monitor feed is available at the camera. No high voltages are present in camera cable.





NEW GENERATION TV FILM RECORDER

New Design Concepts and Modern Electronics
Bring Professional Quality to Video Film Recording

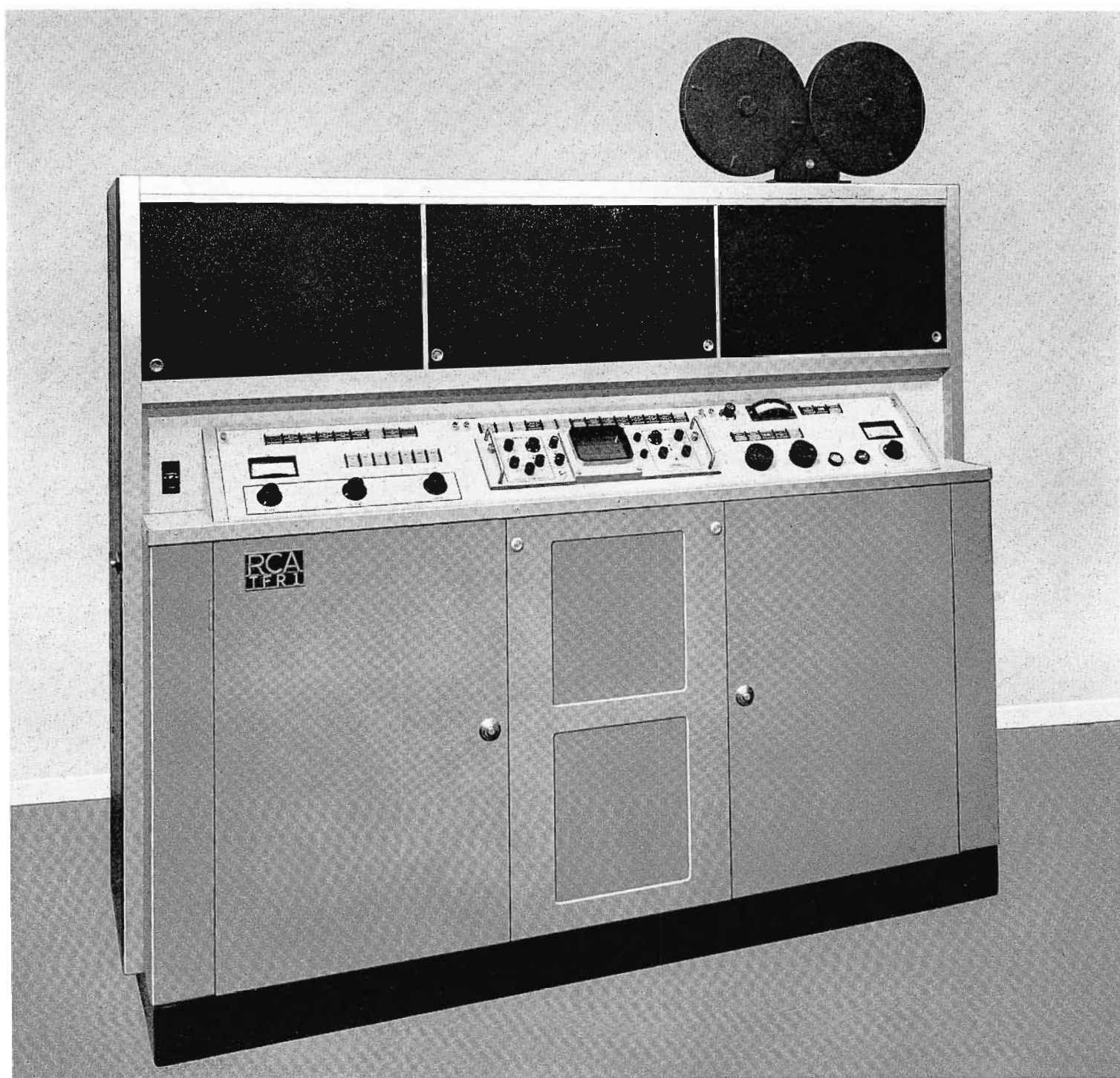

FIG. 1. RCA Professional TV Film Recorder, TFR-1.

The RCA Television Film Recorder is an entirely new development that, for the first time, consistently produces good quality 16mm films from TV picture sources—whether live, tape, network or film.

This is the result of two unique components: a new “subscreen” picture tube, and a new “clawless” camera—plus programmed controls and self-adjusting circuits that actually define high quality pictures, and then provide the means to maintain them.

This is the machine the industry has been waiting for. It replaces the old style, questionable quality “KINE” recorder. It produces professional quality films and is the first film recorder that can truly be called automatic.

The TFR-1 opens new avenues of profit for the broadcaster who installs this machine. Not only will he have a unique facility for increasing revenue, but through tape-to-film transfers can usually save on cost of commercials and programs. With the RCA Film Recorder there are potentials for new business, opportunities for new ideas, and possible savings on operating expenses.

Higher Resolution, Sharper Focus

Because of the new display tube characteristics, picture resolution is 800 lines at the center of the raster (at least 600 lines at the corners), an increase of 35 to 40 per cent over previous tubes. There is also a 2 to 1 increase in sharpness of focus due to controlled kinescope spot size.

No Shutter Bar

The new, precision-registration camera achieves almost absolute vertical steadiness with complete absence of shutter bar effects. Defects usually found in kinescope recording equipment cameras, such as vibration and loss of interlace disappear.

Excellent Gray Scale

Improved display tube compensation results in excellent gray scale rendition. Two forms of compensation are used, gamma and exponential. The gamma circuit compensates for various pickup tubes, while the exponential corrects for gamma errors of the display tube. Gray scale, therefore, is linear under all conditions.

“Subscreen” Display Tube

Figure 2 illustrates how the new tube differs structurally from other types, a feature that contributes to higher picture definition. In previous tubes, the phosphor has always been applied to the inside of

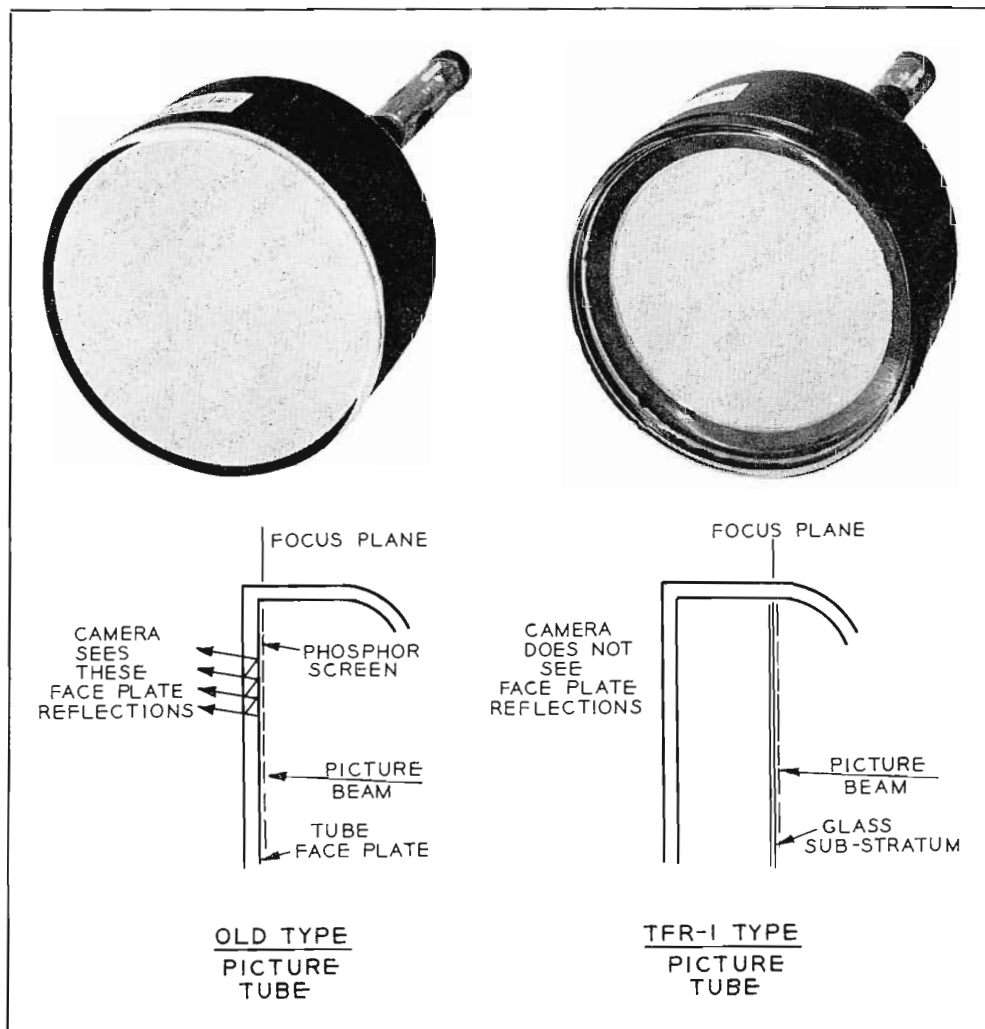

FIG. 2. Conventional display tube compared with new “Subscreen” display tube used in TFR-1.

the face plate. The glass, which is necessarily thick, causes a secondary distribution of light, a “halation”, at the focus plane of the screen, resulting in loss of resolution and degradation of the picture. The new TFR-1 display tube, however, employs a method of phosphor suspension on a substratum of glass (about the thickness of a postcard) mounted a short distance *behind* the face plate. This moves the image plane away from the thick glass face plate, eliminating light dispersion while increasing resolution capability.

Another significant change in the new tube is in the gun structure. A precision aligned electron gun produces a finite spot only 3 mils in diameter contributing further to image sharpness. Ample light output is assured by a highlight brightness of 160 foot lamberts.

Vibration Free, Clawless Camera

Of special interest is the new camera and its film pulldown mechanism, certainly unequalled anywhere for simplicity. There are no claws, and only one reciprocating

component weighting less than an ounce. The result is a vibration-free camera with a simplified film path—one that is simple to operate—easy to load and thread.

A second feature lies in shutter design. In ordinary cameras, shutter closing and opening takes place within one or two video lines. Timing is very critical and even minor variations in film can cause shutter bar effects. In the TFR-1 camera, however, the shutter is located in the optical path in such a way that the image on film is made to fade in and fade out over some 40 video lines. Thus, shutter action in performing the picture “splice” is much less critical. In fact, because of the feathering of the picture splice, a bar does not develop.

“Programmed” Controls

Much emphasis has been placed on instrumentation in the TFR-1 to aid recording engineers in evaluating and establishing desirable picture parameters and then duplicating selected values. One of these features is a test signal that automatically produces a multi-step variable density strip

after each setup. The result is a sensitometric reference at the beginning of each film for use by laboratory and recording engineers in establishing relationships of exposures to desired densities.

The control panels are shown in Fig. 4. Operating and setup functions employ illuminated pushbuttons which double as fault indicators. A waveform monitor provides for observation of the complete system as well as for rapid initial setup and adjustment. Supplementing this is an "auxiliary circuit by-pass"—a unique device by which engineers can shunt out key circuits such as gamma and exponential during setup, trouble shooting or maintenance.

"Self Adjusting" Electronics

Absolute light control is necessary for maximum utilization of the display tube's capabilities. To provide this, the TFR-1 incorporates an automatic luminance control, the equivalent of an "automatic exposure control," which sets both brightness and contrast. This eliminates the guesswork of manual adjustment.

Exposure control is automatically preset by the arrangement shown in Fig. 3. An "electric eye" looks at the display tube face, measures light output and determines if both brightness and contrast are correct

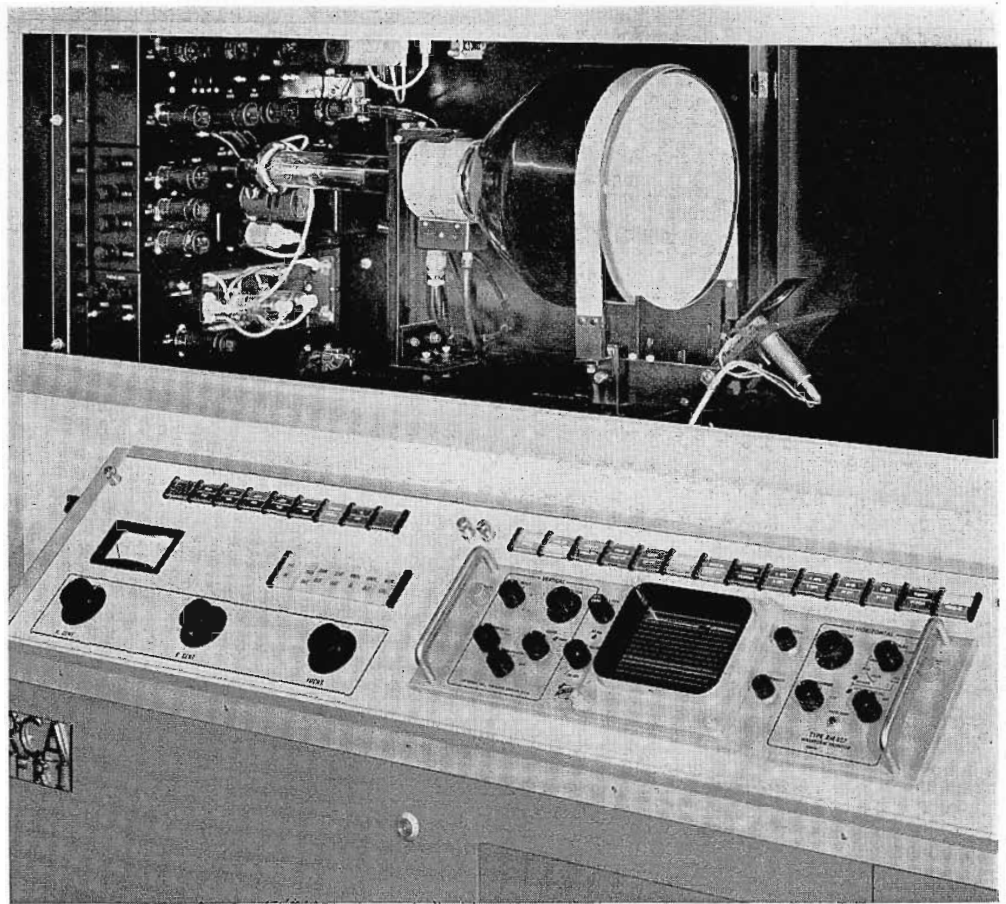

▲ FIG. 3. Upper compartment houses unique display tube and its light sensitive element—heart of the automatic exposure control circuit.

▼ FIG. 4. Controls of TFR-1 permit complete "programming" at initial setup for consistent, high quality recording.

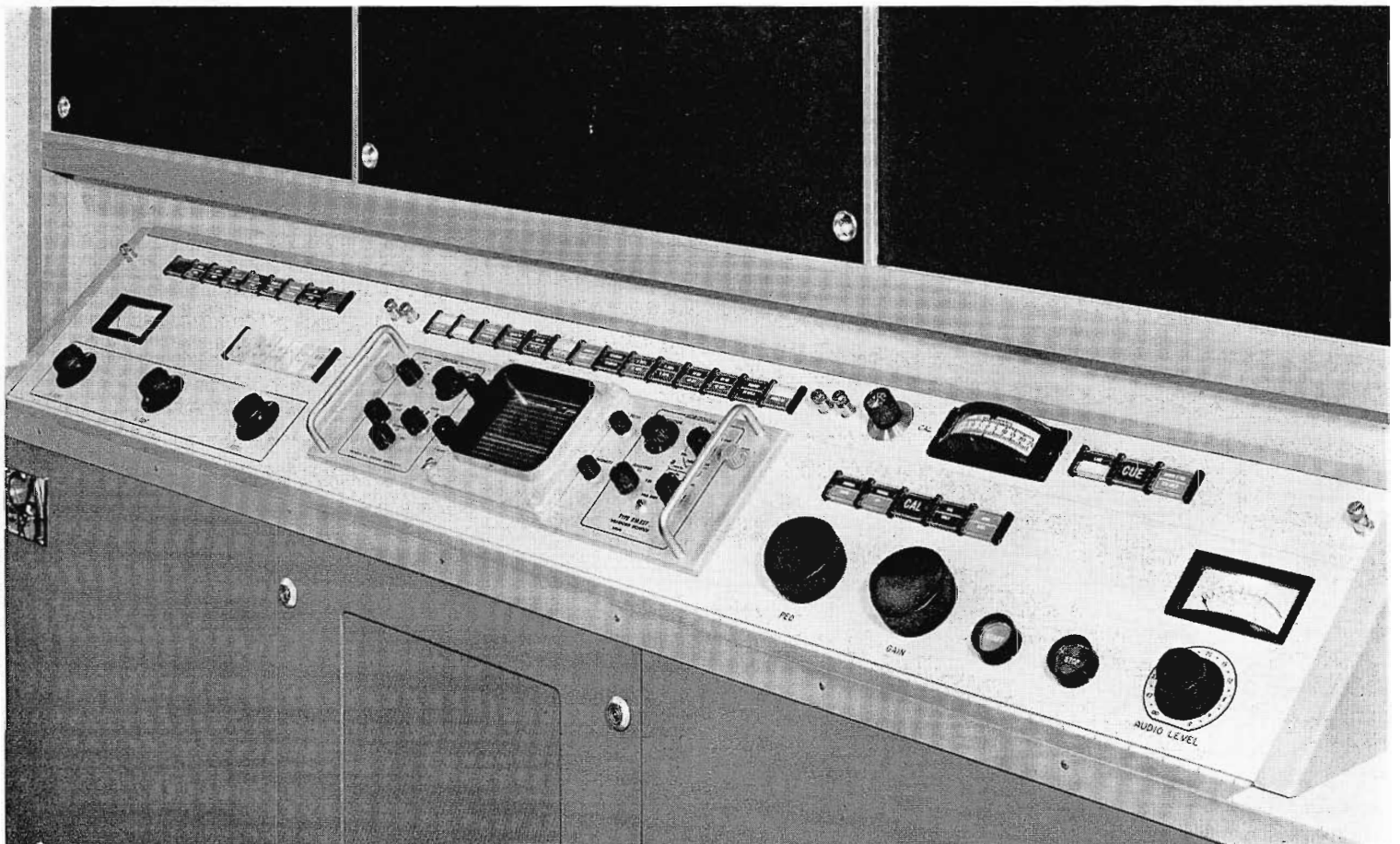

for the film stock and processing being used. If not, an error signal corrects bias and gain of the system for the desired tube output.

In setting the standards for white and for black, the photocell looks first at a half-black and then at half-white screen presentation on the tube (produced by a built-in generator).

Use of a neutral density filter determines the contrast range.

Dynamic Focus Control

Another automatic circuit, *dynamic focus control*, provides sharper focus in all areas of the image from low light to high light. This circuit uses a third video waveform that counteracts the defocusing effect due to the movement of the virtual cathode. Variations in beam current are utilized to modulate a video signal on the focus electrode to eliminate blooming effects under highlight conditions. Mixture of the three

focusing waveforms maintains the finite kinescope spot size constant from black to white and in all areas of the raster.

Pressurized, Dust-Proof Cabinet

TFR-1 equipment is completely enclosed in an air-pressurized, dust-proof cabinet housing the image display tube, camera, control panels and associated electronic circuitry. All components and circuits are easily accessible through hinged doors, swing-out panels, plug-in modules and sliding shelves. Power interlocks provide utmost safety.

Ease of Film Processing

Film processing no longer presents any problems. Eastmans Viscomat, a commercial quality processor that mates with the TFR-1, processes film to precisely controlled gamma at a speed of 36 feet per minute. In just 60 seconds after starting, processed and dry film begins to emerge. The Viscomat is fully automatic. There is no mixing of chemicals, no testing of solutions, no complex adjustments.

New Ideas Using Films

Introduction of the TFR-1 permits those with TV studio facilities to exploit the advantages of film in spreading out investment costs. One application might be the production of film commercials or promotional films. When too many programs are on tape, or tape inventory is running too high, these programs can be transferred to film, releasing the tape for service. Multiple film copies can also be the answer when it is necessary to telecast simultaneously in several markets and immediacy of release is not critical.

FIG. 5. Engineer demonstrates easy removal of waveform monitor. Complete accessibility of all components and circuits is a feature of the TFR-1.

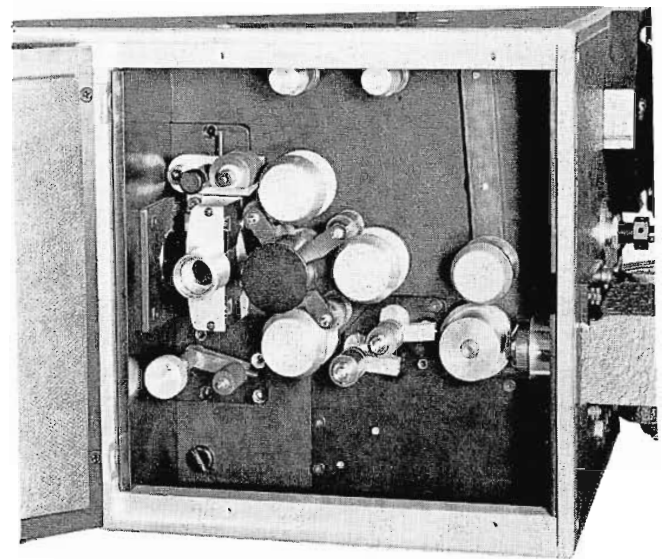
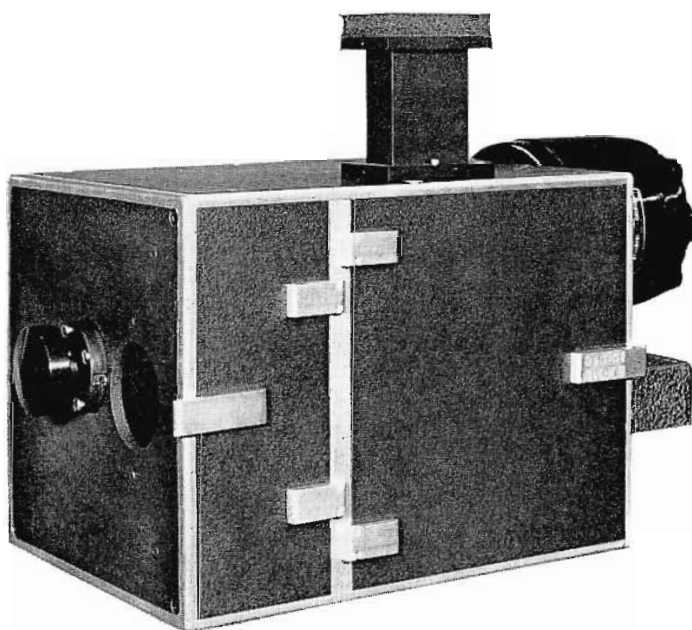
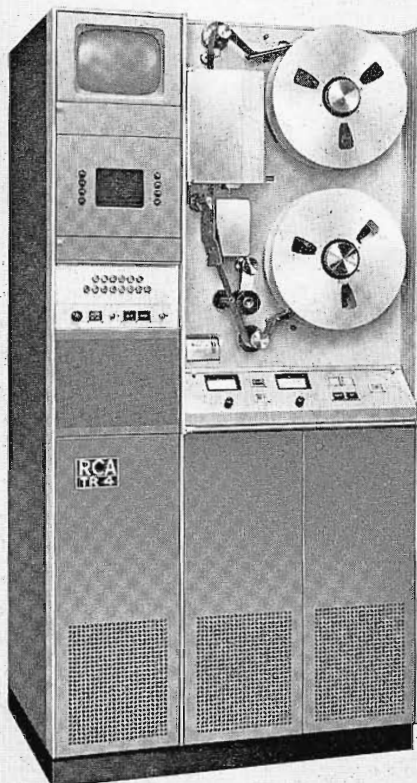

FIG. 6. "Clawless" Camera specially designed for use with RCA television film recorder. Eliminates the handicap of ordinary film cameras that were merely modified for TV use. No shutter bar with this new camera.



FOUR TRANSISTORIZED



COMPACT
RECORDER
TR-4



PLAYBACK
SPECIAL
TR-3

High-Performance
Quadruplex Equipments Are
Compact, Fully Transistorized and
Use Standard Modules

Four transistorized tv tape equipments—common in design but tailored to specific applications—promise to increase the effectiveness of today's tv tape operations. These include a *COMPACT RECORDER (TR-4)*, a *PLAYBACK SPECIAL (TR-3)*, a *MOBILE RECORDER (TR-5)*, and a *DELUXE RECORDER (TR-22)*, all providing the same kind of tapes (quadruplex) and the same proven superior quality recordings.

Compatible Quadruplex Design

This new line of recorders virtually talk to each other. That is, tapes made or played on any of them can be made or played on any other—as well as on all *standard broadcast* quadruplex recorders. They all feature fully transistorized circuits and use standard modular construction, first introduced in the TR-22. In fact, many of the modules employed are common to one or more of the equipments. Finally, and most essential, all these new recorders are capable of producing the highest standards of professional broadcast quality, notable in RCA tv tape designs.

TV TAPE MACHINES

MOBILE
RECORDER
TR-5

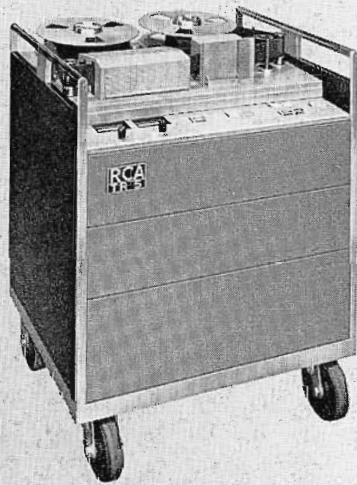

DELUXE
RECORDER
TR-22



Compact Recorder (TR-4)

This new recorder is fully transistorized and budget priced, ideal in installations where economy and picture quality are both important considerations. The equipment comprises a complete recording and playback package with suitable monitoring facilities—built-in picture and waveform monitors and other provisions to meter key circuits for proper setup of the equipment. The TR-4 includes numerous features which have become standard in RCA tv tape equipment. Air lubricated tape guides, magnetic tone wheel, solid-state control system, built-in switchlock and two-speed operation are but a few.

The basic machine is complete in a 33 by 22 by 66-inch cabinet, in which space is provided for a number of plug-in modularized accessories. These include pixlock, automatic timing control, cue record and playback, and electronic splicing. Available also in a switchable standards model, the TR-4 is the only recorder of its kind adaptable to color operation by the addition of transistorized plug-in modules.

Playback Special (TR-3)

In the same way projectors are used to "screen" film, this low-cost tape playback equipment can be used for top quality screening of tv tapes. Previewing, editing, and on-air playback of taped programs and commercials are handled with ease.

To the broadcaster, the TR-3 can serve as a valuable supplement to present tv taping facilities. In effect, it can provide an additional playback source—for on-air programs, client preview, editing and splicing—relieving busily-scheduled recording equipment at a relatively small cost. To advertising agencies, and station representatives, the TR-3 provides a means by which the many tapes passing through their hands can be checked, previewed and presented for clients. It offers for the first time a low-cost, highly-effective tv tape selling tool.

Careful design has resulted in a self-contained player whose performance meets professional broadcast standards. It is compatible with any quadruplex television tape recorder in the world. Advanced-design transistorized circuits in module form are

used throughout. It features built-in two-speed and switchlock operation. The player is completely flexible and can also accommodate a full complement of accessories including pixlock, automatic timing correction and color operation. These accessories, when added to the TR-3, plug in as an integral part of the machine in the spaces provided in its basic design.

This compact player measures only 22 inches wide, 66 inches high and 24 inches deep and can be readily moved on its built-in casters to any location. Its vertical styled construction requires less than 4 square feet of floor space, making it easily installed in conference, projection, and clients' rooms.

Mobile Recorder (TR-5)

For quality tape recording on location, this new recorder is a valuable facility for special events, news and on-location commercials. The TR-5 is the first compact, transportable recorder capable of producing tape in the studio or in the field which may be played back on any quadruplex recorder in the industry. It is the only such

Modular layout of the TR-4 showing the "record" group at left and "play" group at right.

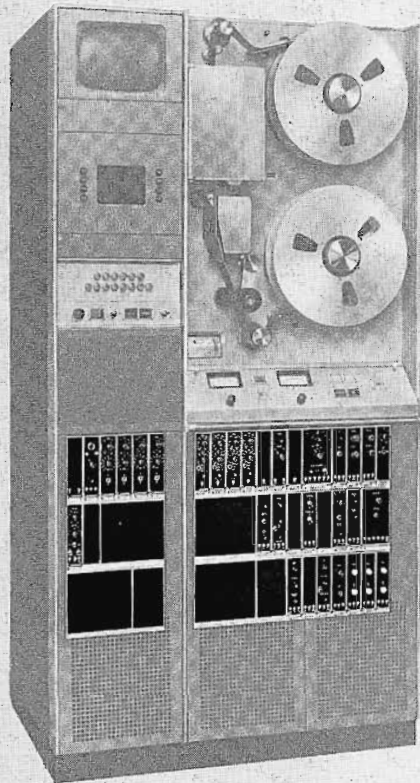

"Play" group of modules in the TR-3 are the same as those shown in the TR-4.

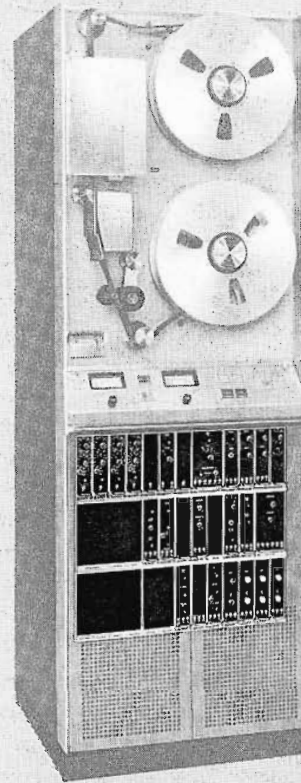

Interchangeable PLUG-IN Modules

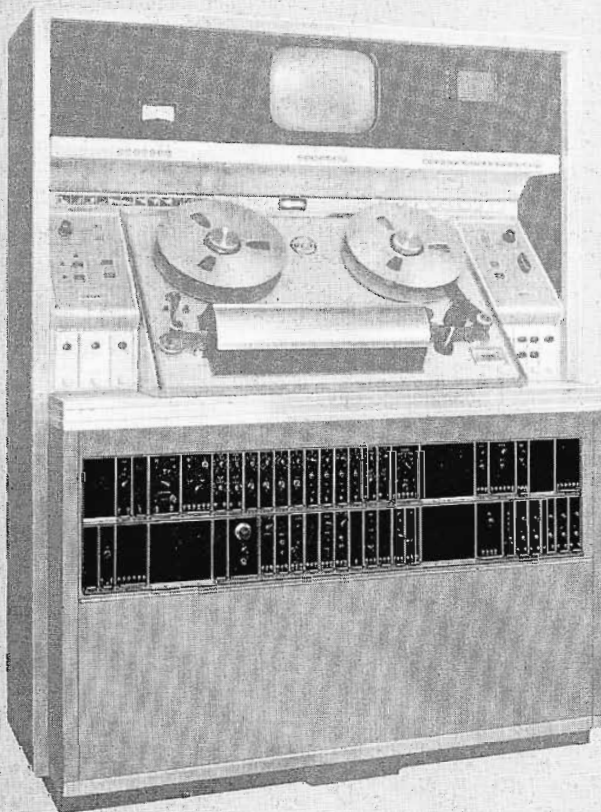

Modular layout of the deluxe TR-22. Many of these same modules are used in the TR-3, the TR-4, and the TR-5.

Modules of the TR-5 are basically the "record" type. However, playback facility for checking purposes is provided.

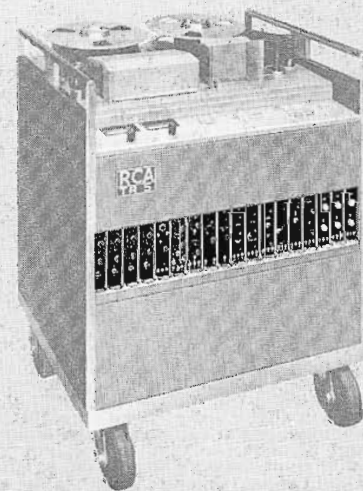

recorder capable of producing either color or monochrome tapes.

The TR-5 is contained in a small portable cabinet on casters measuring only 28 inches high (34 inches with casters), 28 inches wide, and 22 inches deep. This permits easy movement from one studio to another, or transportation in a station wagon for use on remotes.

Limited playback facilities permit on-the-spot cueing and previewing of tapes to assure that a satisfactory recording has been made. Playback performance is not suitable for direct on-air broadcasts since the TR-5 has no provisions for head switching, signal processing, and playback quadrature delay. However, the tapes produced are immediately playable on any quadruplex equipment.

Advanced transistorized modular circuits are used throughout assuring low cost and maintenance. The equipment is designed with built-in audio playback for earphone level monitoring. The TR-5 is also equipped with a built-in master erase head. Models are available for operation on either international switchable or domestic standards. Tape speeds of $7\frac{1}{2}$ or 15 IPS are provided and recording time of up to 96 minutes at $7\frac{1}{2}$ IPS are possible with the $10\frac{1}{2}$ -inch maximum tape reels.

Low cost coupled with professional performance in this compact recorder present new economies in the duplication of tapes. Multiple tape copies for distribution can be made with minimum equipment investment and the assurance of excellent broadcast quality.

Deluxe Recorder (TR-22)

Designed from the beginning as a deluxe equipment to which advances in the state of the art could be added, the TR-22 has earned an enviable record of acceptance. It is now being used by all three networks, by top tape producers, and in leading tv stations in the U.S. and abroad. Today, new features and accessories promise to make this equipment more useful than ever. Electronic editing, automatic timing correction for color tv, and two-speed operation are among the most recent developments which are proving the potential and versatility of this transistorized equipment.

The TR-22 was developed in a no-holds-barred contest with the electron to create a superior facility for the recording and playback of television tape. Today it is the established leader of a complete new line of tv tape equipment from RCA. It is distinguished as the line leader by its excellence in producing trouble-free, error-proof tape recordings and in obtaining highest quality reproduction from recorded tapes.

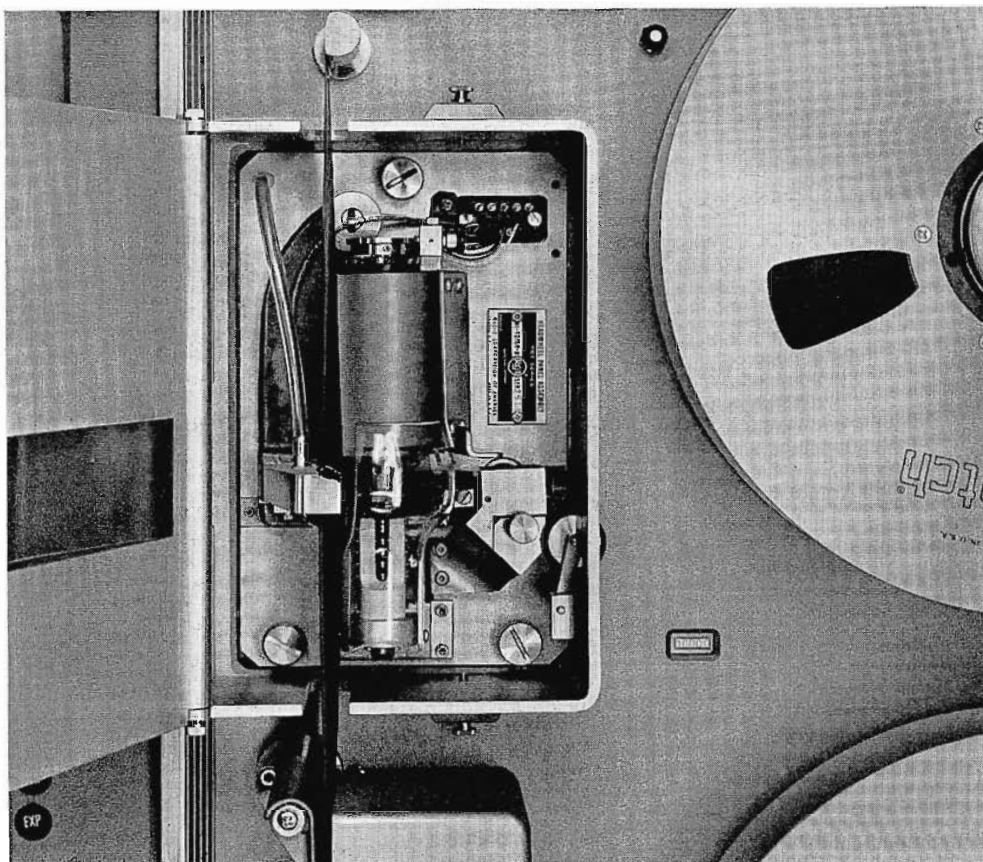

FIG. 1. Closeup of headwheel on TR-4 recorder. The headwheel is common to the complete line of tape machines.

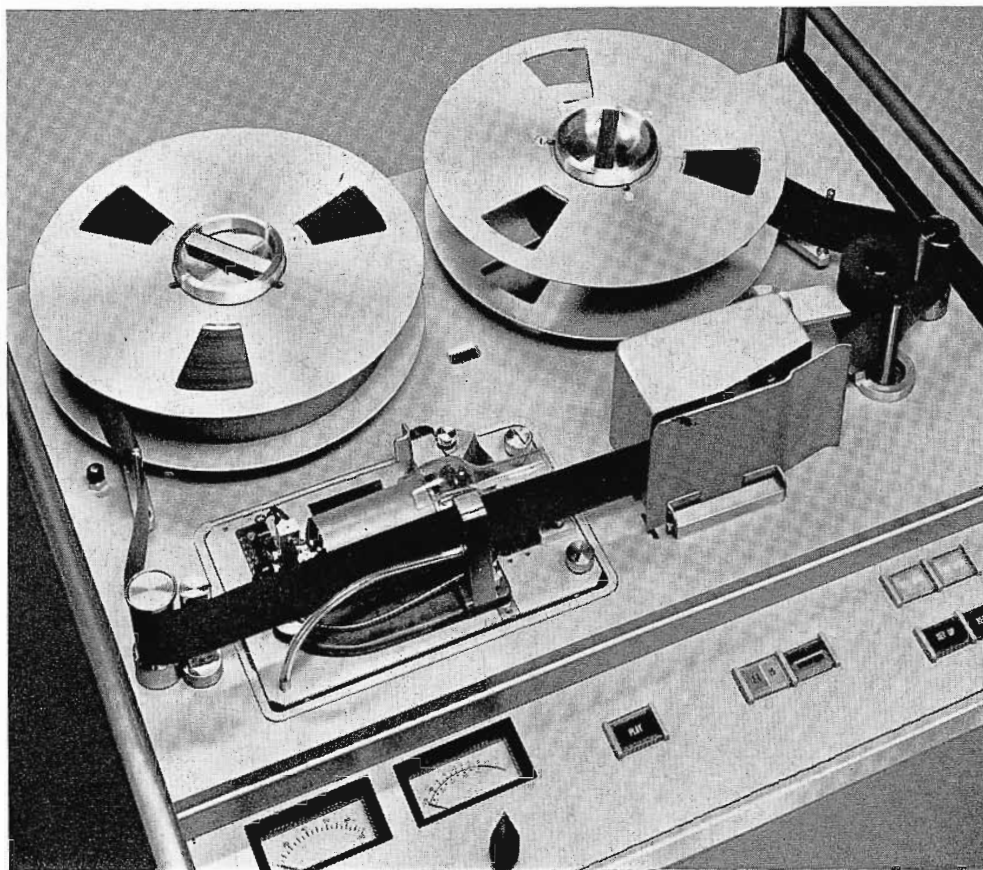
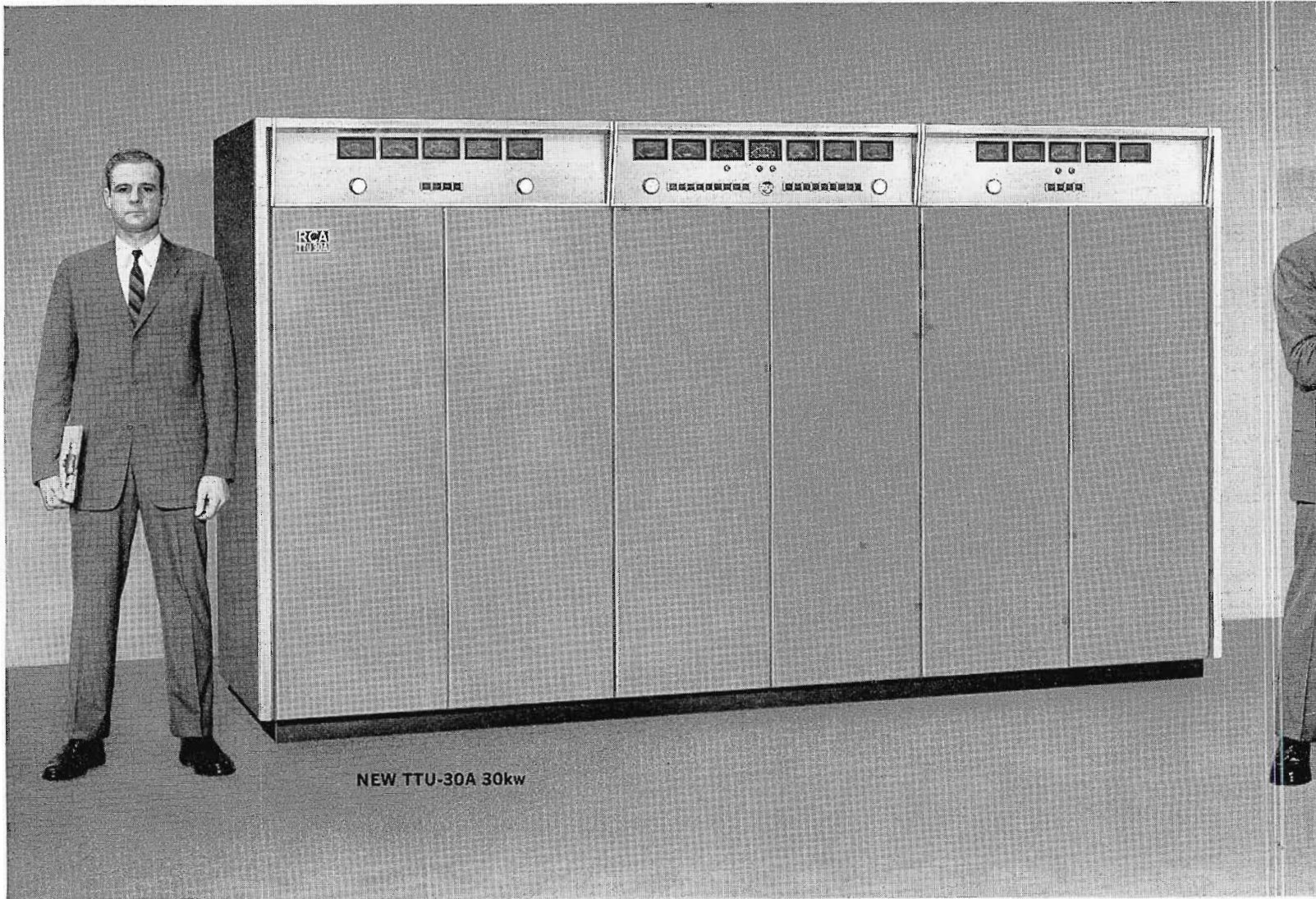

FIG. 2. Closeup of TR-5 tape deck with headwheel cover removed.



AN ALL-NEW LINE OF



Vapor-Cooled Integral-Cavity
Klystrons in 30-kw and Air-Cooled
Tetrodes in 2- and 10-kw, Lead to
Low Operating Cost and
High Efficiency

Representing a major forward step in UHF technology, the three new UHF-television transmitters pictured here are the most efficient UHF transmitters designed to-date.

The TTU-30A is a 30-kilowatt transmitter designed for 1,000,000-watt ERP. Combining top performance with operating economy, the TTU-30A uses new vapor-cooled klystrons.

The TTU-10A is an air-cooled 10-kw transmitter that, combined with a suitable antenna, delivers 250,000 watts of ERP. Air cooling eliminates the investment, maintenance and environmental requirements of the water-cooling system pre-

UHF TRANSMITTERS

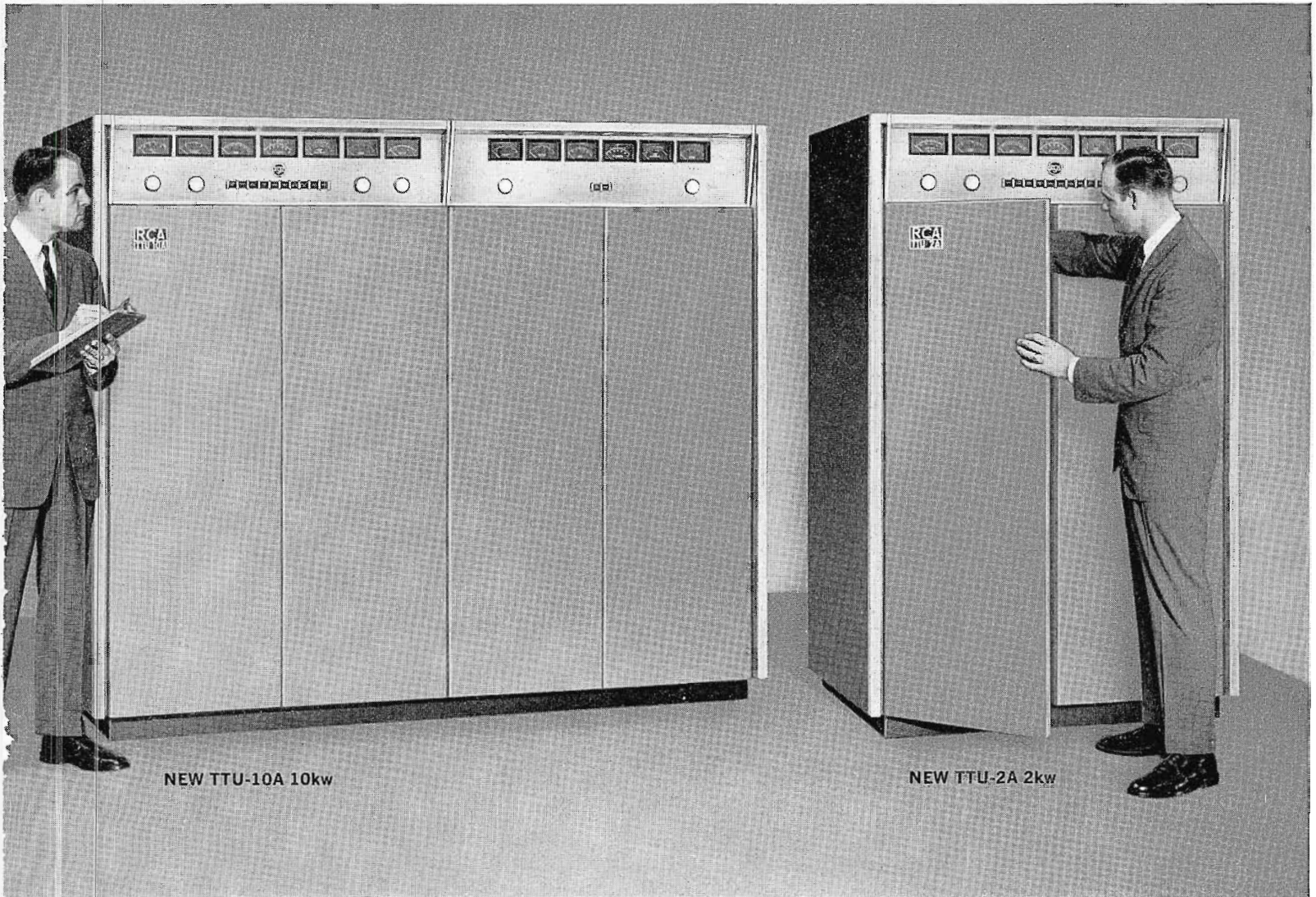

viously used in transmitters of this size.

The two-kilowatt TTU-2A is designed for the minimum power station with future plans for expansion to higher power. The two-kilowatt output is expandable to 10 kw through the relatively simple addition of a cabinet containing the amplifier equipment.

Space-Saving 30-Kw System

New from the inside-out, the 30-kilowatt TTU-30A transmitter significantly outperforms any predecessor transmitter yet it requires considerably less floor area than the 25-kw system it succeeds. Two of the important reasons for this are: the walk-in cabinet design and the use of vapor-cooled klystrons as power amplifiers.

The walk-in cabinet design provides greater accessibility than the so-called "cubicle" design yet the floor space requirements are only a fraction of those formerly required for a transmitter of this power capability.

Vapor-cooled klystrons contribute considerably to the size reduction since *steam* is the heat-transfer medium and steam condensers are smaller than water coolers of equal heat-exchanging capabilities.

Quick-Change Klystrons

As pointed out earlier, the TTU-30A uses klystrons as the aural and visual power amplifiers. Klystrons of considerable power-handling capabilities are inherently

bulky, however, smart engineering design—of both the tube and its "socket"—has greatly improved the method of tube replacement in this transmitter. The result is that either klystron—the aural or the visual—can be changed in approximately five minutes.

Integral-Cavity Klystrons

The TTU-30A employs klystrons engineered and manufactured by Varian Associates. Designated the VA-890, -891 or -892 (depending on the operating frequency), these klystrons are integral-cavity devices. Making the cavities integral with the tube permits factory pretuning of the klystron since the cavities always stay with

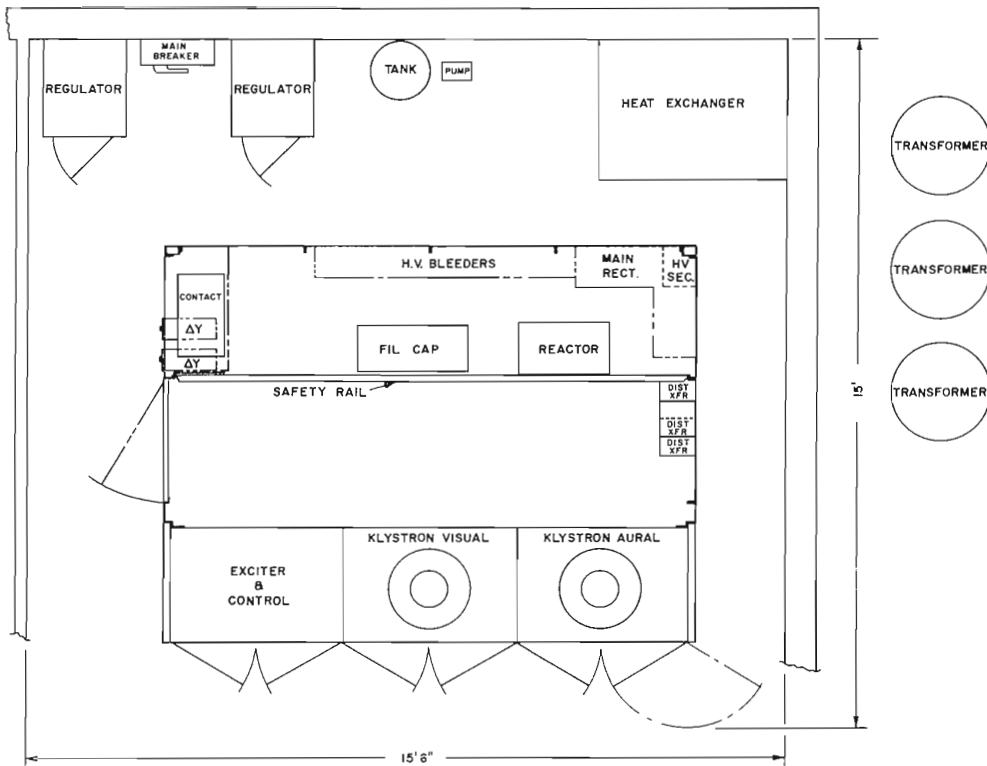

FIG. 1. The space-saving floor plan of the TTU-30A Transmitter. Note that this room measures approximately 15 by 15 feet. Placing the plate transformers indoors increases this somewhat.

TTU-30A Transmitter may be installed in virtually *any* room of appropriate width and length.

10-Kw in Small Space

The TTU-10A is a 10-kw transmitter of top performance characteristics with the floor-area requirements of older transmitters one-tenth as powerful. This new transmitter is completely air-cooled which eliminates the water-handling equipment of earlier transmitters.

The design of this transmitter separates the high-voltage power supply from the main transmitter cabinet. This, of course, reduces the size of the main cabinet and provides the convenience of locating the power supply in a basement, attic, closet or other normally unused space in the transmitter plant.

RCA engineers have improved the separate power transformer idea by locating the silicon rectifiers with the transformer as well as the plate contactor and other heavy-current control components.

Silicon rectifiers are particularly suitable

the tube. Further, factory pretuning eliminates the station-site preparation required by external-cavity designs.

Vapor-Cooling Increases Efficiency

Vapor-cooling systems offer several important advantages. Probably the most important is the essentially self-circulating nature of the system. This reduces the size of the circulating system required. The result is that the TTU-30A uses a much smaller circulating pump than conventional water-cooling systems and this results in a primary-power saving of some 10 kilowatts. Since this saving is cumulative, it grows with every hour of transmitter operation and, over the years, can amount to thousands of dollars in reduced operating costs.

Installs in 8-Foot Headroom

Until now, klystron-powered transmitters were notorious for their demands on headroom in the room which housed them. The TTU-30A, through an ingenious tube-change system, permits installation of the entire transmitter in a room with the "ordinary" 8-foot ceiling height. A "tilt-down" klystron-change system eliminates the gantry-crane dolly system, which, in turn, eliminates the unusual ceiling-height requirement of gantry systems. Thus, the

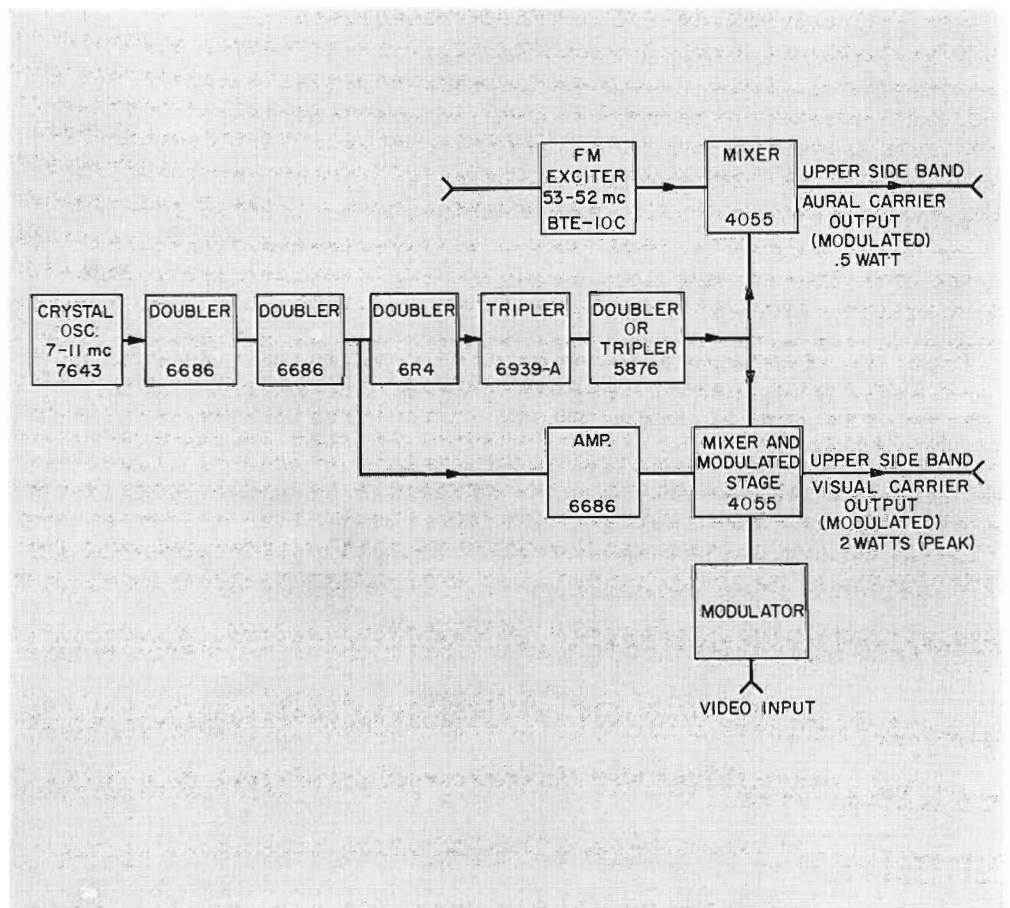

FIG. 2. Block diagram for the exciter/modulator portion of all three transmitters. Industrial tube-types offer extended life and increased reliability. The mixer and mixer/modulator stages use the "pencil" triode.

to out-of-the-way operation because of their excellent reliability and the fact that they cannot be "frozen-out" as can mercury-vapor rectifiers.

Since the heavy-current control components are also located in the external power supply, the conduit connecting the transmitter to the power supply need handle only low-current wiring.

Compact 2-Kw System

The TTU-2A is designed for the just-starting UHF station that seeks to keep transmitter investment and operating cost

at minimum but nonetheless looks forward to future expansion. This transmitter is the answer to both requirements: it is a high-quality, low-cost transmitter that offers future expansion to a 10-kw power capability. The increased power is an add-on feature so that the original transmitter remains substantially intact.

Drivers are Traveling-Wave Tubes

The TTU-10A and TTU-2A are unique in the industry in that they are the first commercial television-broadcast transmitters to employ traveling-wave tubes

(TWT's) as the driver amplifiers. TWT's have a long history of excellent reliability and long life in microwave-communications gear. At UHF frequencies, TWT's serve as high-gain (26 db), broadband amplifiers that operate *without tuning devices*. Thus, TWT amplifiers are the simplest power amplifiers ever devised.

Tetrode Power Amplifiers

The power amplifiers in the TTU-2A and -10A use air-cooled power tetrodes designed for long life with a minimum of maintenance. These tubes are modern,

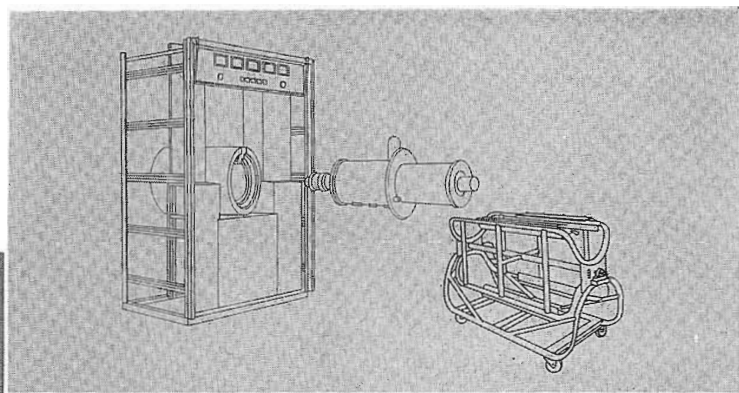
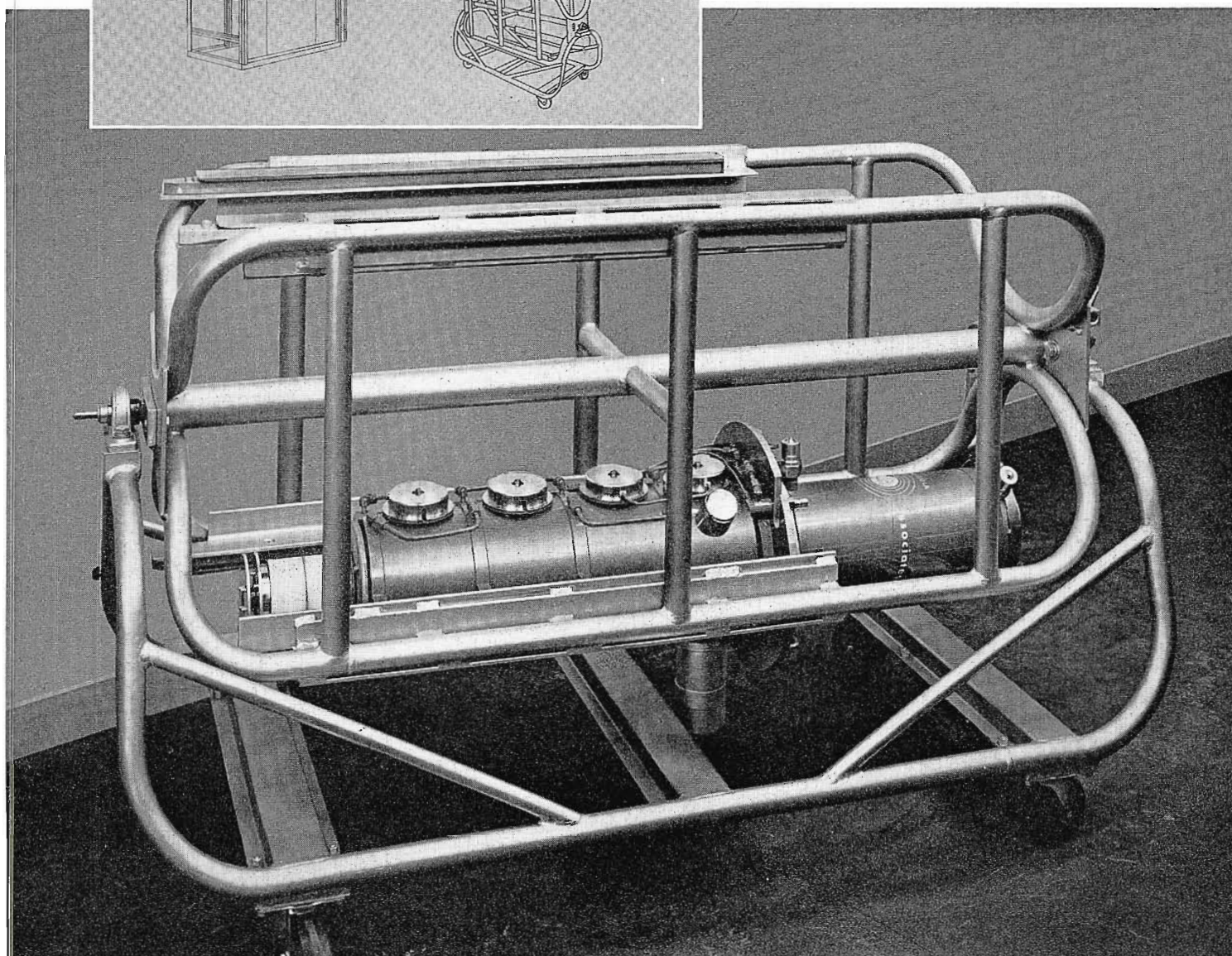

FIG. 3. Klystron tube change is accomplished in only a few minutes with this unique system. The klystron is shown in the carriage and the insert shown illustrates an exploded view of the tube-change system.



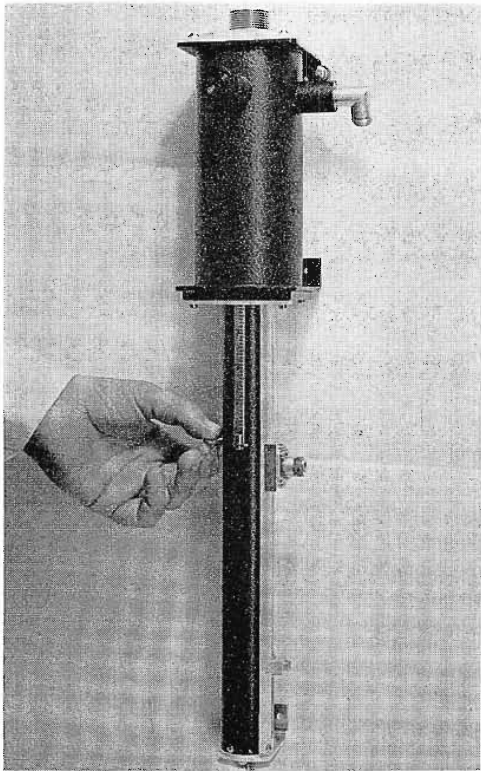

FIG. 4. The intermediate-power-amplifier cavity. Identical for both the visual and the aural channels, the entire unit is interchangeable. This reduces spare-parts inventories at the station site since one spare serves two functions.

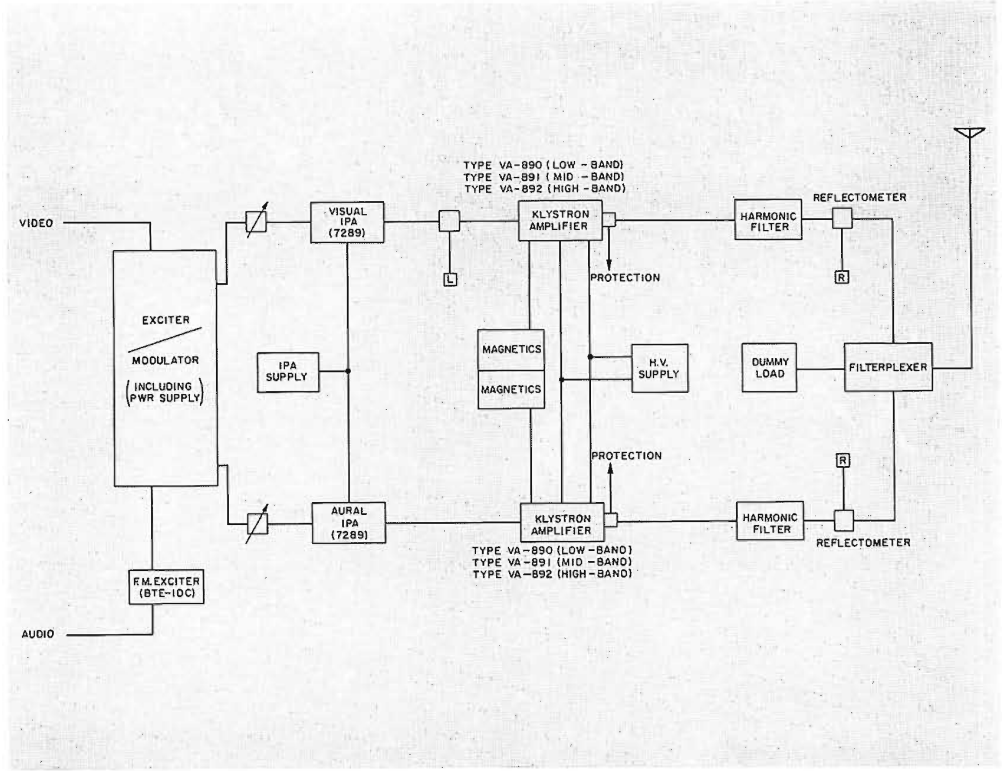

FIG. 5. TTU-30A block diagram. Note that the aural modulator is the direct-FM exciter used in RCA's three new FM transmitters. Note also that the exciter/modulator and the IPA stages operate from separate power supplies.

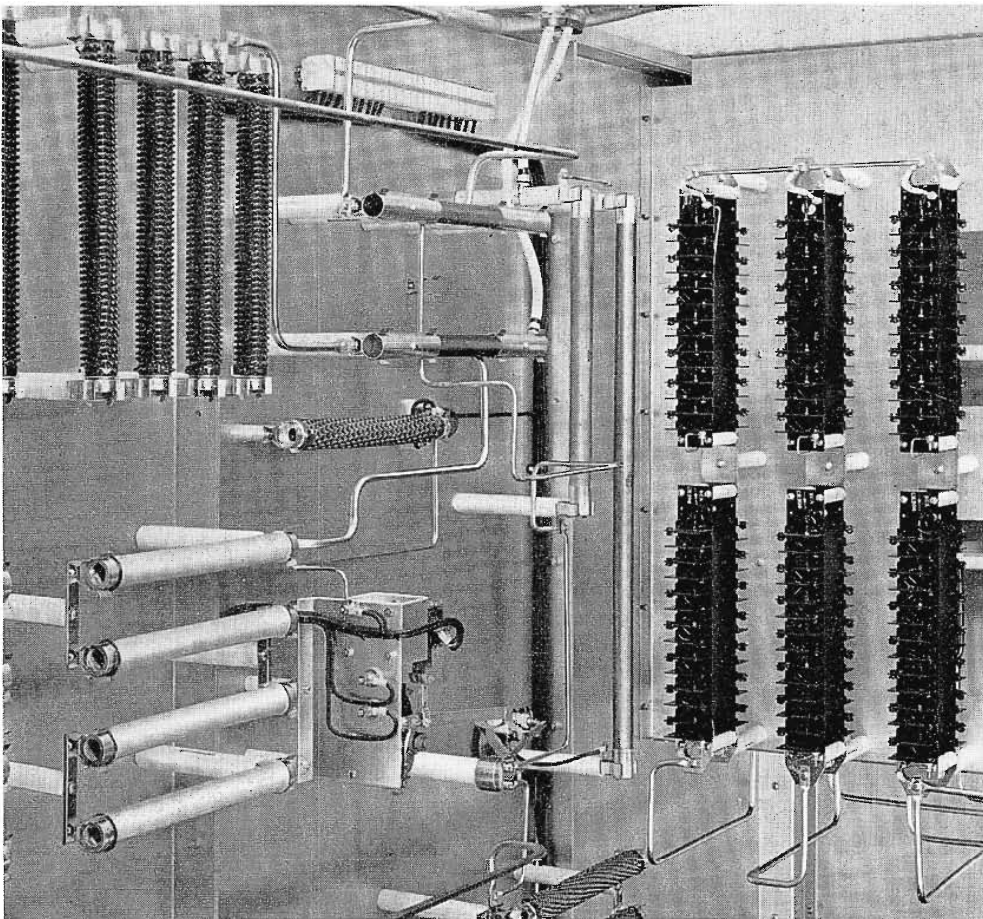

FIG. 6. View of the right-rear corner of the TTU-30A transmitter enclosure. The main rectifiers are at far right; the high-voltage rectifiers are enclosed (see floor plan). Components at left are the high voltage bleeder resistors.

ceramic-seal units engineered to deliver the highest possible efficiency at all points in their service life. In addition, the amplifier design provides for quick tube change so as to minimize lost air-time in the event of tube failure during air hours.

New, Low-Level Modulator

The three transmitters in this new line all employ a new visual exciter/modulator that applies the video modulation to the carrier at a level prior to driver input. This greatly simplifies the modulator and, as a result, sets a new standard of reliability.

Aural modulation is applied via the *direct-FM* method using the new Type BTE-10C FM Exciter described in the article on the new FM transmitters in this issue. (See page 28.)

Entirely Silicon-ized

The TTU-30A, -10A and -2A Transmitters use power supplies that employ long-life silicon rectifiers. These devices improve power-supply efficiency to reduce the costs of primary power and, at the same time, raise power-supply reliability to new standards.

Arranged in "modules," the rectifiers are designed for simple, quick replacement with a minimum of effort although, under normal conditions, the rectifiers never need replacement.

Ready for Remote Control

The TTU-30A, -10A and -2A are equipped with all of the provisions for remote control and automatic logging. The addition of the appropriate "actuator" devices (BTR-20B, -20C Remote Control and BTAL-1A Automatic Logging) puts these provisions to work. All of the internal

wiring, meter shunts, motorized controls, et al, used for remote control are included as standard equipment.

Operational Simplicity

Through imaginative engineering design, these three UHF transmitters have been made simple, easy and convenient to oper-

ate. Adequate tally-light indication, metering and control arrangements simplify transmitter operation to little more than a turn "on" in the morning to a turn "off" at night. This, coupled with the excellent reliability built into these transmitters, assures any broadcaster of the utmost in transmitter satisfaction.

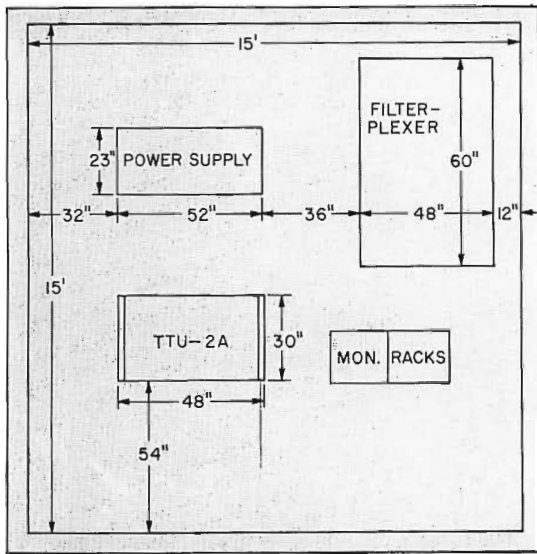

FIG. 7. Floor plan for the TTU-2A. Note the resemblance to the TTU-10A plan at right. The two-kilowatt TTU-2A is field expandable to 10 kilowatts.

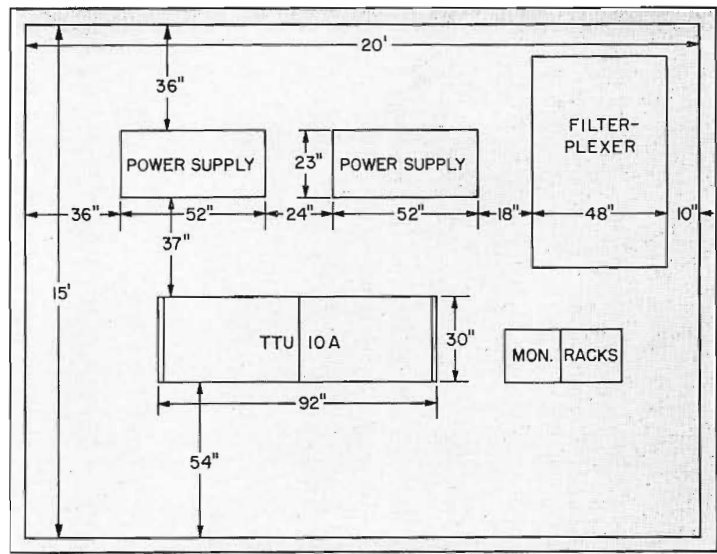

FIG. 8. TTU-10A floor plan. The separate power supplies need not be installed in the same room as the transmitter. Silicon-rectifier equipped, these may be installed in a basement, attic, closet or other location.

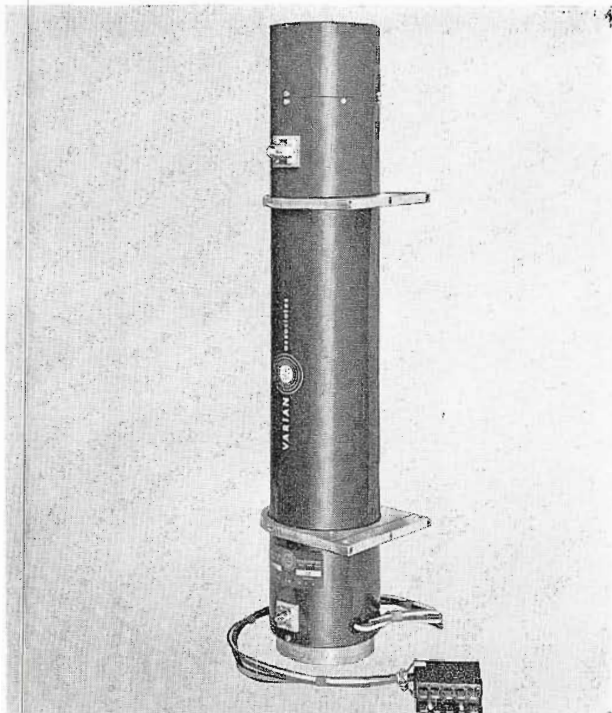

FIG. 9. The traveling-wave tube (TWT). The TTU-2A and -10A use TWT's as high-gain driver amplifiers.

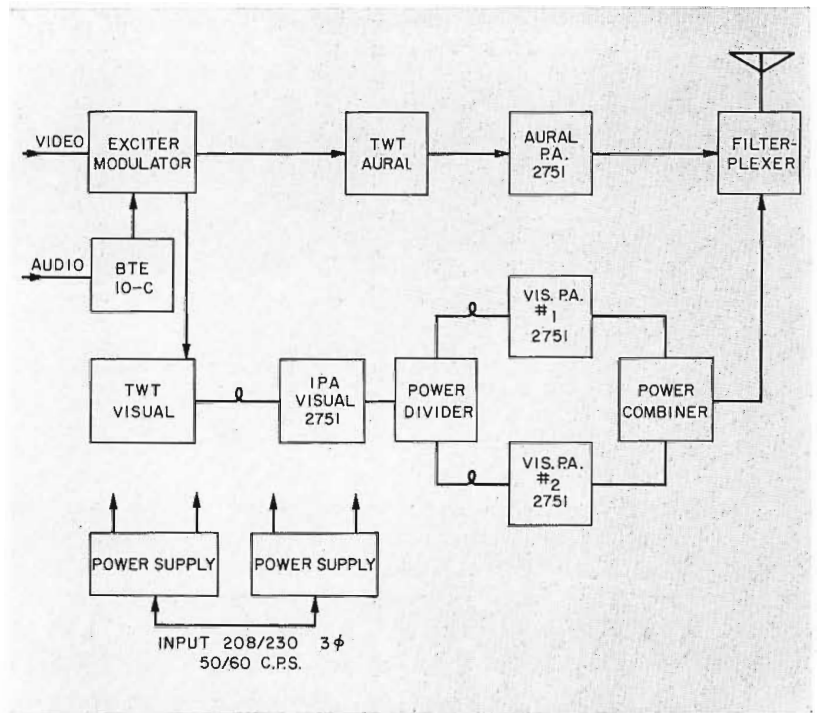
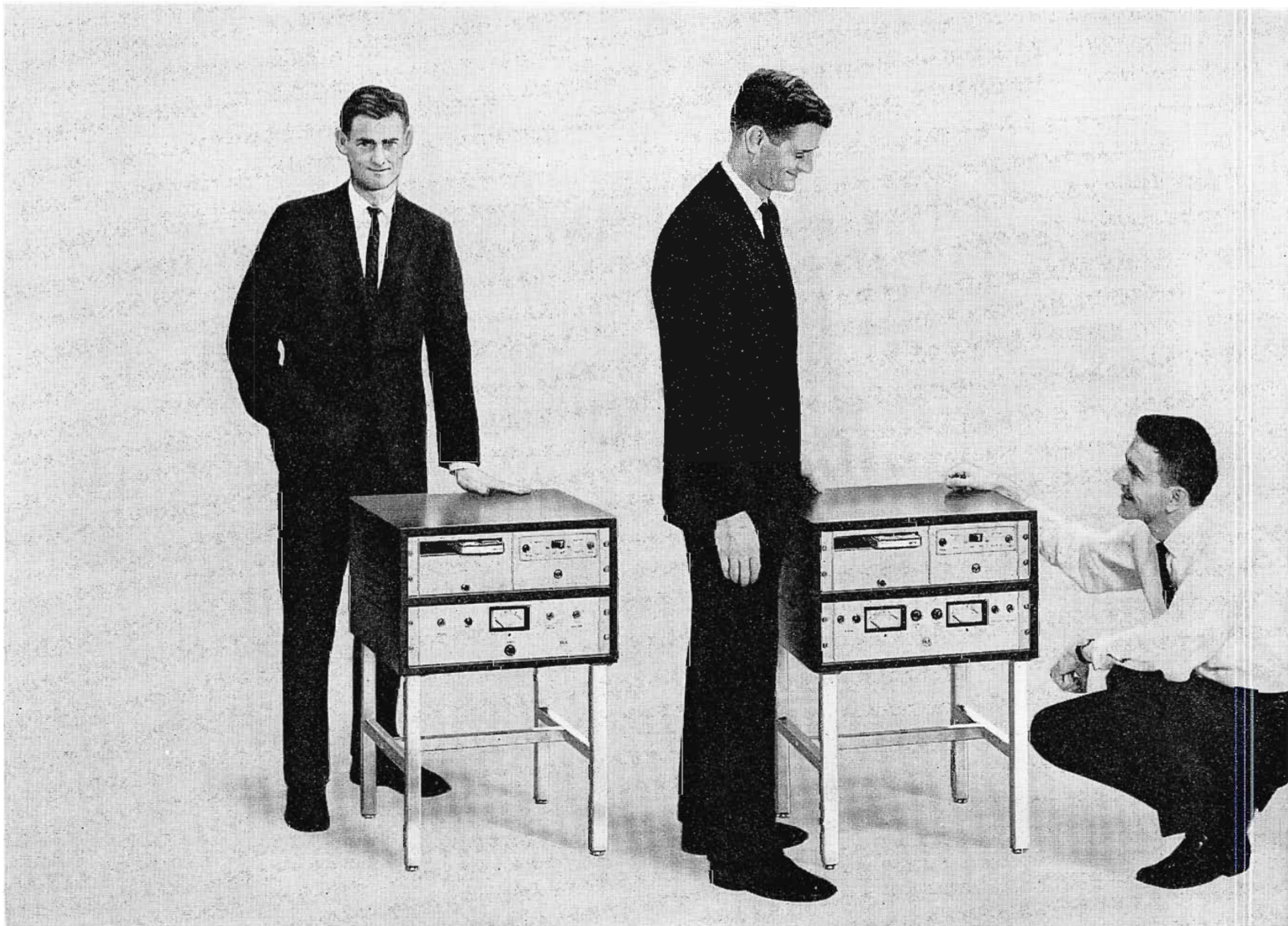

FIG. 10. TTU-10A block diagram. Note that the visual PA employs a diplexed arrangement of two 5-kw stages. This, among other things, permits the same tube type to serve in four places. This, of course, reduces spare-tube investment since only one type need be in inventory.



TRANSISTORIZED LINE



Monaural Cartridge Tape System, RT-17

Stereo Cartridge Tape System, RT-37

A complete line of transistorized audio recorders—both cartridge and reel types—headline new-look audio equipments. These include a Monaural Cartridge Tape System, RT-17; a Stereo Cartridge Tape System, RT-37; a Cartridge Playback System, RT-8 and a Professional Audio Recorder, RT-21. New studio consoles, the BC-7 for stereo and the BC-8 for monaural operations, offer a custom-like flexibility, highly adaptable to radio and tv operations.

Cartridge Tape Systems, RT-17 and RT-37

These two new transistorized equipments provide ideal facilities for recording pro-

grams and commercials—making them available for instant selection and playback. The RT-17 monaural system—with its silent automatic operation, compact modern styling, and high quality sound reproduction—adds new realism to broadcast material, from “quickie” spot announcements to complete programs. The stereo version, RT-37, adds still another dimension to the sparkling sound of this excellent performer.

Use of tape cartridges make cueing and threading of tape unnecessary. The desired cartridge is selected, placed in the playback unit, and instantly switched “on-

air” at the touch of the start button. Remote control permits recording or playback from any desired location. By means of a trip-cue tone—which can be placed anywhere on the tape—either of the cartridge tape systems can automatically trigger slide projectors or other equipment capable of being remotely started. An end-of-message cue can be used to activate additional playback units, reel-type recorders, etc., in a simplified form of automation. A third cue tone (automatically recorded each time the tape is started) re-cues each tape announcement so that it is ready for re-use.

OF NEW AUDIO EQUIPMENTS



Multi-Cartridge Playback System, RT-8

Professional Audio Recorder, RT-21

Multi-Cartridge Playback System, RT-8

Designed for playback of a number of pre-recorded tape cartridges, the RT-8 system can be operated manually, sequentially or by pulses supplied from an automation system. Each unit houses four plug-in cartridge decks, however, a number of units may be interconnected to provide 4, 8, 12, 16 or more playback decks in an operating system.

Three RT-8 models are available; one each for use with cartridges recorded on RT-7, RT-17, and RT-37 (stereo) systems. Plug-in cartridge decks, playback amplifiers and power supply modules are

identical to those used in RT-17 and RT-37 equipments.

An optional feature of the RT-8 is provision for recording a random trip cue to automatically activate slide projectors and other such devices.

Professional Audio Recorder, RT-21

This completely transistorized recorder is designed especially to meet the most critical requirements of professional audio recording. Many of its features, which provide utmost ease of operation, are the first of their kind.

Continuously variable speed control is

provided for quick and precise cueing of tapes. An optional fourth head (in addition to normal record, erase and playback heads) can be added for playback of dual quarter-track tapes, or for time delay broadcasts, or for special applications as desired. Rugged construction for smooth reeling and braking is also featured.

The RT-21 is available for stereo or monaural recording—the stereo version includes two identical transistorized record/playback modules. The modules are directly interchangeable from recorder to recorder; thereby maintenance can be speeded and simplified.

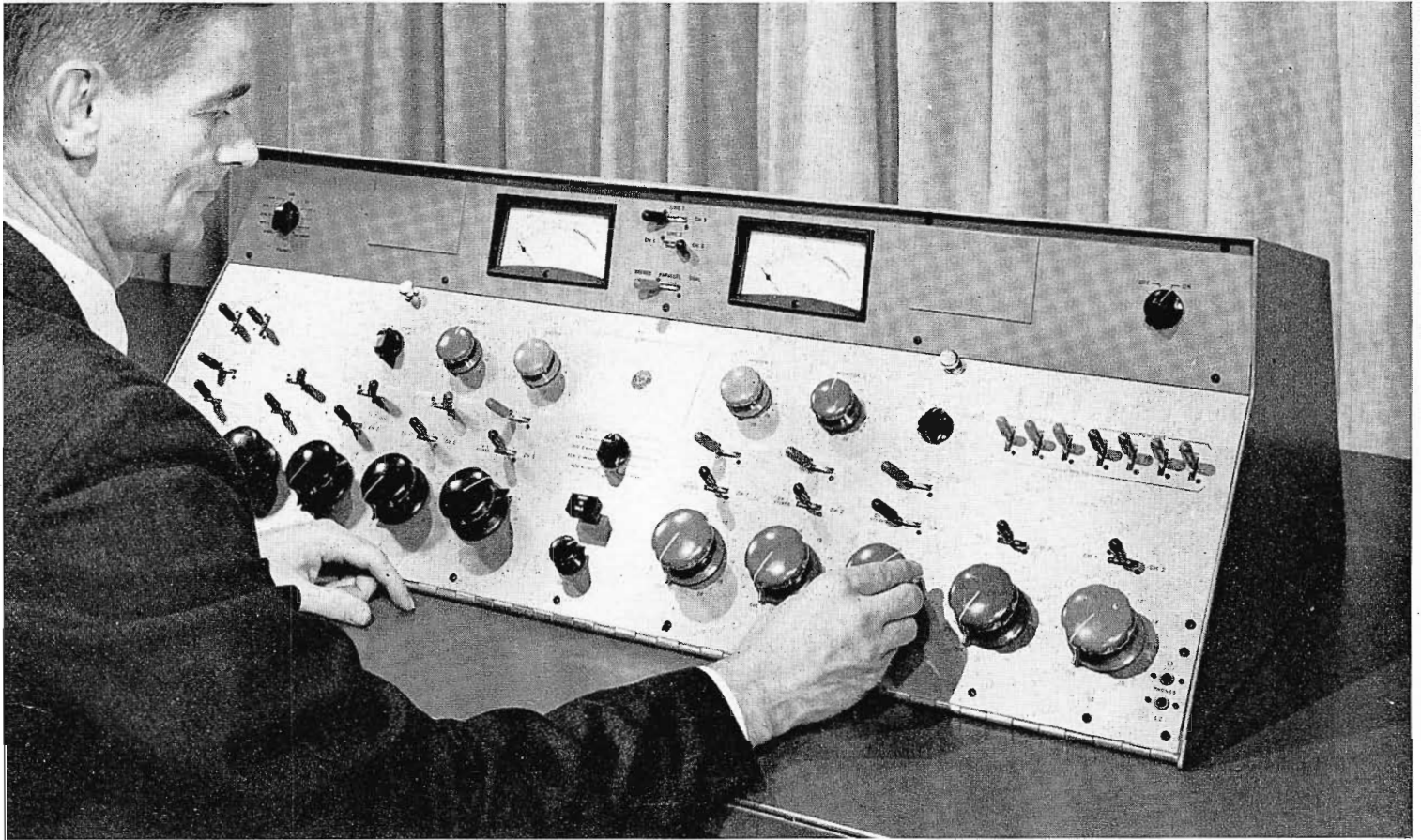

FIG. 1. Transistorized console, BC-7 for dual channel AM/TV and FM stereo.

FIG. 2. Flexibility to meet the needs of individual audio installations is provided in the BC-7 and BC-8 consolettes through the use of transistorized, interchangeable plug-in modules.

New Consolettes

Plug-in, unitized construction featuring standard transistorized modules, is the key to operational flexibility in the BC-7 and BC-8 consolettes. Both units use the same plug-in modules—preamplifiers, high level isolation units, program amplifier, monitor amplifier, AGC intercom amplifier and power supply. Both units feature custom-like flexibility. Both are human engineered with color-coded controls functionally arranged for easy, error-proof operation, and both use highest quality faders and other components for finest sound mixing.

The BC-7 includes 10 mixer positions to handle thirty program sources while the BC-8 includes 8 positions for 24 sources. Ganged, step-type attenuators are included in the BC-7 for use in stereo programming. The BC-8 is designed for monaural operation only.

These smart new models offer "custom" appearance to satisfy the proudest management, "custom" quality and flexibility to please the most discriminating engineers, and a "custom" sound for the finest audio installations.

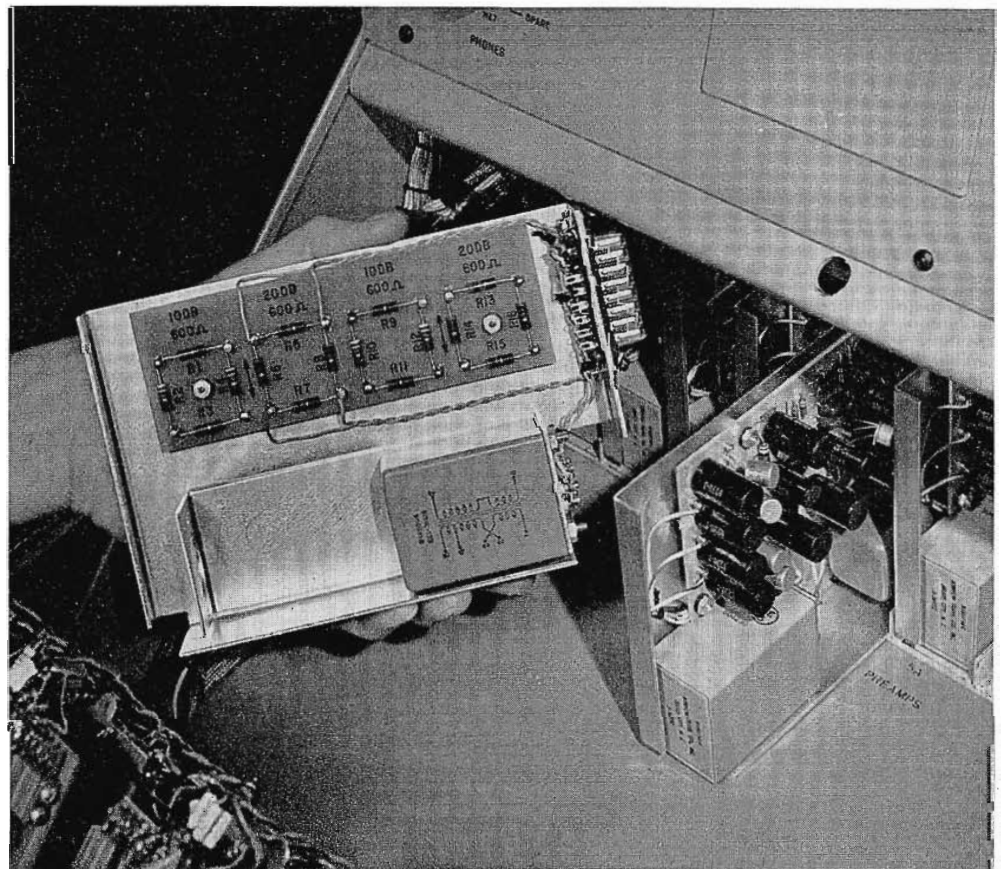



Mark of Deluxe Television

This is the camera you see wherever they insist upon the finest in television. More and more this deluxe 4½" I.O. equipment is becoming the symbol of TV leadership. Everyone is impressed with its "new look," its striking performance and its built-in aids to production. Your studio can benefit from this symbol of television distinction. To own it is to move up!



THE MOST TRUSTED NAME IN TELEVISION



RCA
NEW
LOOK