

RCA EXHIBIT AT WORLD'S FAIR
TO FEATURE COLOR TV STUDIO



BROADCAST NEWS



Vol. No. 118 OCT. 1963



The Mark of the Newest in TV Tape Recorders

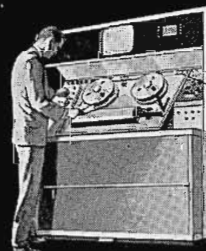

In the TR-22, RCA presents a "New Generation" of TV Tape Recorders... fully transistorized! It gives you new ease of operation, new space-saving economy and new reliability. The TR-22's are already in operation in the USA, Canada, and Europe... assuring superior picture quality.



The Most Trusted Name
in Television

RCA
TR-22

BROADCAST NEWS

published by

RADIO CORPORATION OF AMERICA
BROADCAST & COMMUNICATIONS PRODUCTS DIVISION, CAMDEN, N. J.

issued quarterly

PRICE *in U.S.A. - - - - - \$4.00 for 4 issues*
outside U.S.A. - - - \$5.00 for 4 issues

C O N T E N T S

	Page
COLOR SEMINAR PAPERS	8
PART I, INTRODUCTION TO COLOR TV TRANSMISSION	9
PART II, NETWORK COLOR TRANSMISSION	14
HIGH-BAND 25 KW TV TRANSMITTER	22
RCA EXHIBIT AT WORLD'S FAIR	26
WSBT-TV's 5-MEGAWATT UHF PYLON	38
KRAV PROGRAMS FM STEREO	42
NEW 16-MM TV FILM PROJECTOR	44
BC-7 STEREO/DUAL CHANNEL AUDIO CONSOLETTTE	50

As We Were Saying

WORLD'S FAIR FEVER is beginning to mount. The RCA Exhibit building shown on the cover and previewed in the article on Page 26 is nearing completion. By the time this issue reaches you, the installation of equipment will have begun. As you can see from the pictures, the RCA Exhibit is going to be "a thing of beauty" and a place of great interest for broadcasters as well as the public. In essence it is a modernistic color studio "in-the-round"—totally enclosed in glass. No sta-

tion engineer is going to rush home and build one just like it. But none is likely to pass it by. Too interesting!

The background of our "preview" article is a story in itself. It all began when Dick Edmondson, engineering manager for the exhibit, had a scale model of the operating areas built to check his planning. He furnished it with scaled models of the equipment units—and peopled it with figures,

Copyright 1963

All Rights Reserved Trademark(s) ®Registered. Marca(s) Registrada(s) Radio Corporation of America

PRINTED
IN
U.S.A.

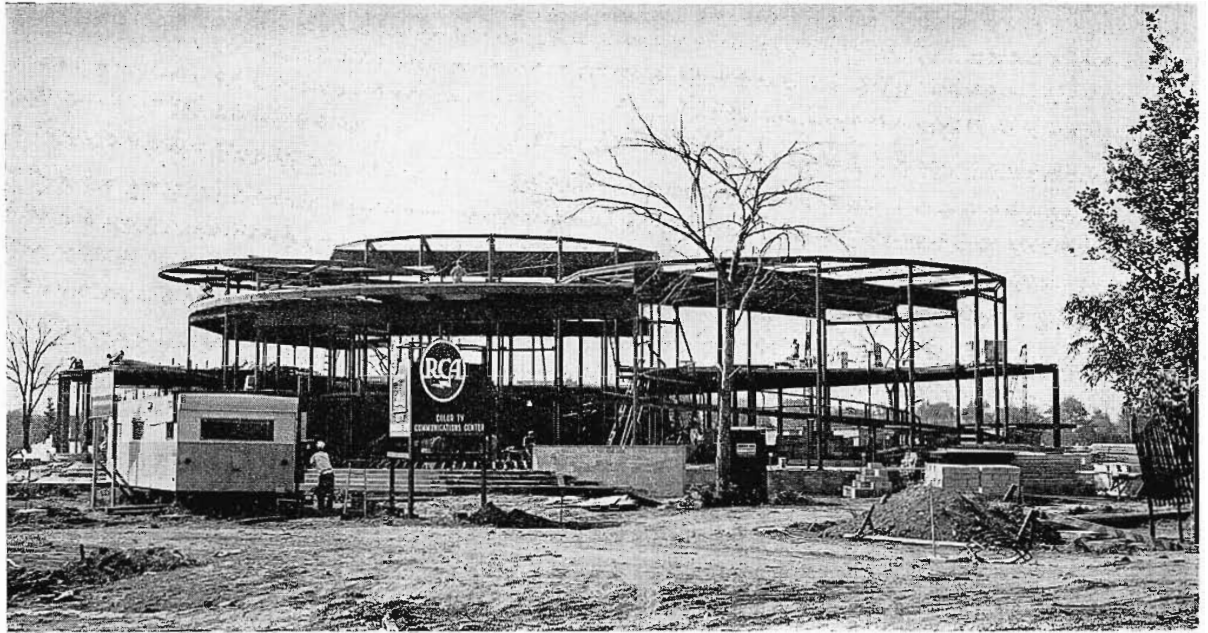

The RCA World's Fair Exhibition building during construction. Photo, made several months ago shows the unique circular design. (see pg. 26)

*As We Were
Saying*

also to scale. Before long all concerned—even the architects—were using it to check their planning. And we were eyeing it for a story! Then it turned out that Jim Toney, formerly V-P of our Radio & TV Receiver Division and now Director of RCA Fair activities, was a photography bug. Jim carted the model home, deposited it in the middle of his living room floor, climbed a ladder to get elevation, and shot the color pictures of the model we have used with the article. Final break came when we learned that the Fair Corporation had a large scale model of the fair grounds. To give us an “establishing shot” Jim and a photographer friend shot the pictures of the Fair reproduced on Pages 26 and 28. Added to the technical information furnished by Dick, and the notes on the general operation furnished by Jim, we had the makings of one of the best preview stories we have been able to do.

THIS IS RCA could well have been the title for our World's Fair story. That RCA should devote the major part of its FAIR operation to Color Television probably will not seem very surprising to those in the broadcasting industry. But it was not an easy decision for RCA management to make. Color TV represents something less than one-fifth of RCA's business. RCA is one of the world's leading communications companies . . . is one of the top suppliers of defense electronics equipment . . . is among the top manufacturers of electronic data processing equipment . . . is a leading recording company . . . the largest maker of tubes. Thus any one, or all, of these activities could have formed the basis for the RCA Exhibit. But there are other big communications companies, other large defense suppliers, other manufacturers of EDP equipment, other makers of tubes and records. They will be at the Fair, too—

and shouting for attention. At best, we'd be one of the mob. How to get out of the noise level—that was the nub. The suggestions went round and round—and came out simple. For in color television **only** RCA is big. In color we could say “this is RCA” and the message would be loud and clear.

So it was finally decided—and now comes our unique studio building with all that lovely, lovely equipment. We are pleased and we think broadcasters will be, too—for it shows where our heart is.

SPEAKING OF EQUIPMENT it is interesting to note that Dick Edmondson, who is doing the engineering for the RCA World's Fair Exhibit, was the instigator of the TS-100 Switching System which we showed at the 1962 NAB. The TS-100—like the Chrysler “Airflow” of 1936—was a bit ahead of its time. But it was one of the best “conversation pieces” we have ever shown, and this column continues to believe that some day we will produce it as a standard equipment.

Noteworthy in the TS-100 was the styling of the control console—which departed from old broadcast concepts to follow the new, clean lines of modern data processing equipment. And in doing so became so attractive that one knowledgeable competitor almost wept when he described it as the best-designed piece of broadcast equipment he had ever seen.

It was no accident—for Stew Pike, the manager of our Functional Design (Styling) Group, had been given a free hand to come up with something new and fresh—something attuned to the age of transistors, and plug-in modules, and sim-

“As We Were Saying” is continued on Page 58

TWO KEY POSTS FILLED IN RCA BROADCAST EQUIPMENT ACTIVITY

The appointments of two key executives in the RCA Broadcast and Communications Products Division were announced in October by C. H. Colledge, Division Vice President and General Manager. Adron M. Miller was named Manager, Broadcast Merchandising and West Coast Operations, and Wendell C. Morrison was appointed Chief Engineer.

Mr. Miller has been Manager of the Division's Film Recording and West Coast Operations facility in Burbank, California, for the past three years. He continues this responsibility in moving to the Camden, N. J. headquarters to take up the new assignment. In addition, he will direct the merchandising of radio and television broadcast equipment, scientific instruments and industrial TV systems.

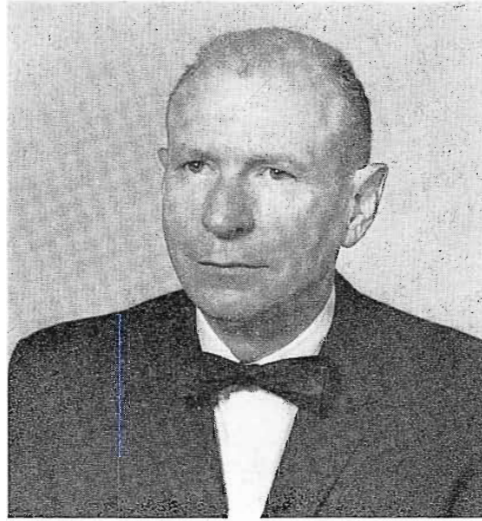

Adron M. Miller



Wendell C. Morrison



In 1946 Mr. Morrison appeared on a Broadcast News cover with Dr. G. H. Brown and the RCA Antennalyzer.

Before joining RCA in 1951 as a salesman of mobile radio and microwave communications equipment, Mr. Miller had been station director and chief engineer of WVLN, Olney, Illinois, and chief engineer of WMIX and WMIX-FM in Mount Vernon, Ill.

Mr. Miller became a broadcast equipment field representative and in 1956 was appointed Manager of Radio Broadcast Field Sales. Four years later he became Manager, Southern Field Sales, Broadcast and Television Equipment, the post he held at the time of his transfer to the Burbank facility.

Mr. Morrison will direct the overall engineering activities for the Broadcast and Communications Products Division and its product line, including radio-TV broadcast equipment, microwave systems, scientific instruments, two-way mobile radio, Radio-

marine equipment and audio visual products. He has been Assistant to the Chief Defense Engineer, RCA Defense Electronic Products, for the past two years.

Mr. Morrison joined the company in Camden, N. J. in 1940 after receiving bachelor's and master's degrees in electrical engineering from the University of Iowa. Two years later he became a research engineer at the RCA Laboratories in Princeton, N. J., where he was engaged in development work in such fields as UHF television transmitters, antenna pattern calculators, and color TV terminal and test equipment.

In 1957 Mr. Morrison returned to Camden as a staff engineer in the commercial product area. He became Manager, Engineering Plans and Services, of the former Communications and Controls Division in 1959 and held that post at the time of his transfer to the defense activity.

PAY YOUR MONEY AND GET COUNTED, FREE

Vehicles passing through "exact change" toll lanes on the Garden State Parkway are counted automatically by RCA electronic detection equipment recently installed by the New Jersey Highway Authority. The 42 "Ve-Det" units replaced pressure-pad treadles which previously performed the counting job.

The new detection systems are unseen by the motorist since they operate from a

wire loop embedded in the toll lane pavement. A vehicle passing over the wire loop causes circuit changes, sending a signal to a transistorized detector unit which in turn actuates paper tape recording equipment. In addition to making the vehicle count which serves to verify toll transactions, signals from Ve-Det units are used to re-set traffic signal lights to "red" after vehicles have passed through the toll collection points.

The RCA equipment was ordered after a six-month test, at the Raritan toll plaza, of its practicability. One factor in the Authority's decision was the relatively low cost of installation which was less than the annual cost of maintaining treadle-type equipment. The Ve-Det loop is inserted in a shallow slot which is sawed in the pavement by conventional highway maintenance machines. The slot is backfilled with grout or epoxy, and the buried circuit cannot be affected by snow, wear, resurfacing or other factors.

BURST CHART AN AID TO BROADCASTERS IN MEASURING CAMERA FREQUENCY RESPONSE

A burst chart has been developed as an aid to broadcasters in measuring accurately the frequency response of TV cameras throughout their entire optical and electronic systems. Copies are available at nominal cost from the Studio Equipment Merchandising Department, located in Building 15-7, RCA, Camden, N. J.

The chart is reproduced on heavy, non-

reflecting plastic stock and consists of groups of vertical lines which correspond to the various signal frequencies from .5 to 4 megacycles. When the camera is focused on the chart, the overall frequency response may be observed directly on a TV waveform monitor. Since it eliminates subjective evaluation, the burst chart method is regarded as superior to the use of a resolution chart.

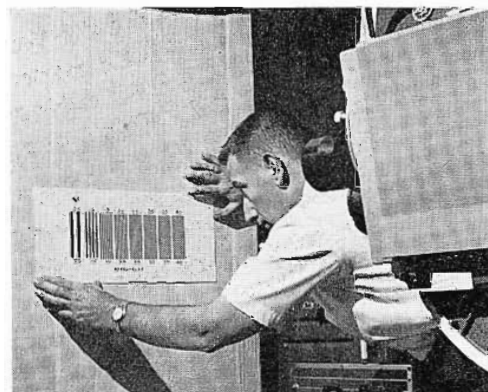

SMPTE GOLD MEDAL TO KOZANOWSKI FOR WORK IN TV EQUIPMENTS

Meet the 1963 winner of the David Sarnoff Gold Medal of the Society of Motion Picture and Television Engineers for meritorious achievement in television engineering: Dr. Henry N. Kozanowski, the doughty RCA scientist whom broadcasters long have associated with many of the most important advances in television cameras.

One of the true pioneers of television, Dr. Kozanowski is held in the highest respect by the industry and by his co-workers, yet he responds with no loss of dignity to the sobriquet "Hank." At the RCA Broadcast and Communications Products Division headquarters in Camden, N. J., he serves as Manager, TV Product Advance Development. This is a post calling for a rather uncommon posture. The head must be

poked well above the clouds, viewing a technological future that hopefully is bright, while the feet remain firmly planted on the bedrock of today's practicalities.

While not a tall man, Dr. Kozanowski carries off this "two-way stretch" with a certain aplomb, and with good humor. He is, perforce, divided Gaul-like, one part being seer, one part business man and one part coach. As coach he runs an engineering team that morning until night is out on the field advancing a ball called "state of the art." To all of these tasks Hank brings the drive and infectious energy that mark him as a do-er and a leader seeing a tough job through.

Broadcasters visiting RCA's exhibit at an NAB convention have seen the stocky Kozanowski figure hovering over a batch of new studio equipments on display for the first time. And they could hear him pour forth the merits of these creations by

the hour. In such a setting, Dr. Kozanowski can, if challenged, lay down a withering fire of technological savvy, causing an antagonist to reel back in confusion.

Dr. Kozanowski won his doctorate in physics at the University of Michigan in 1930 and that year was employed by Westinghouse. Five years later he joined RCA in Camden and shortly thereafter participated in the development of TV cameras and an airborne television transmitter.

During the war years of 1941-45 he played a major role in the development of airborne TV cameras which, with airborne transmitters, were used for experiments in surveillance and missile guidance. Dr. Kozanowski has been in the advanced development activity since 1946, and has been Manager since 1951.

His most significant engineering accomplishments are in the field of practical, high-performance television equipment. Many of the camera refinements Dr. Kozanowski introduced permitted optimum use of the iconoscope tube, widely employed for TV film pickup in the early days of commercial television.

Color TV too felt the fine Kozanowski hand. He proposed the use of a 3-vidicon camera for color film pickup at a time when the tide of professional opinion ran almost overwhelmingly in favor of a flying-spot-scanner approach. Three-vidicon cameras incorporating his developments are now in use in most stations originating color.

Dr. Kozanowski's biographer could list many other achievements, awards, writings, patents and special honors. But the main thrust of his RCA career is perhaps best summarized in the words of the citation which accompanied the David Sarnoff Gold Medal: "For sustained drive to improve the quality and practical operation of television studio and film camera equipment."

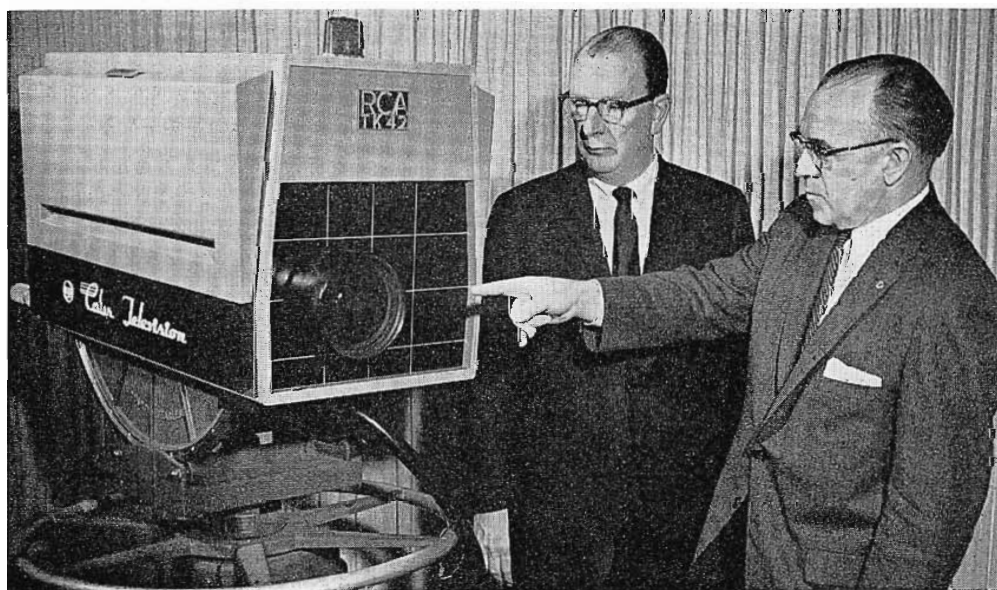

Dr. Kozanowski (right) shows experimental four-tube color camera to Charles H. Colledge, Division Vice President and General Manager. RCA-developed "M" channel concept was first shown at 1962 NAB convention.

ABC-TV NET BUYS 83 AUDIO RECORDERS

Existing audio tape recording equipment in the American Broadcasting Company's radio and TV stations is being replaced by RCA type RT-21B audio tape recorders. The network has ordered 83 units which will become standard throughout ABC facilities, according to Frank Marx, President, ABC Engineers.

The tape recording equipment was built at the RCA Camden, N. J., plant and is being shipped to ABC's five television stations: WABC, New York; WBKB, Chicago; WXYZ, Detroit; KABC, Los Angeles, and KGO, San Francisco, and its Pittsburgh radio station, KQV.

The RT-21B incorporates a number of electrical and mechanical improvements over the "A" model. These include a plug-in record equalizer, master bias oscillator system and a new brake hub arrangement which provides a larger braking surface for smoother braking action.



ABC-TV has standardized on the RCA RT-21 audio tape recorder, shown here in console mounting.

RUSH SHIPMENT OF AM TRANSMITTER HELPS FIRE-STRICKEN STATION GET BACK ON AIR

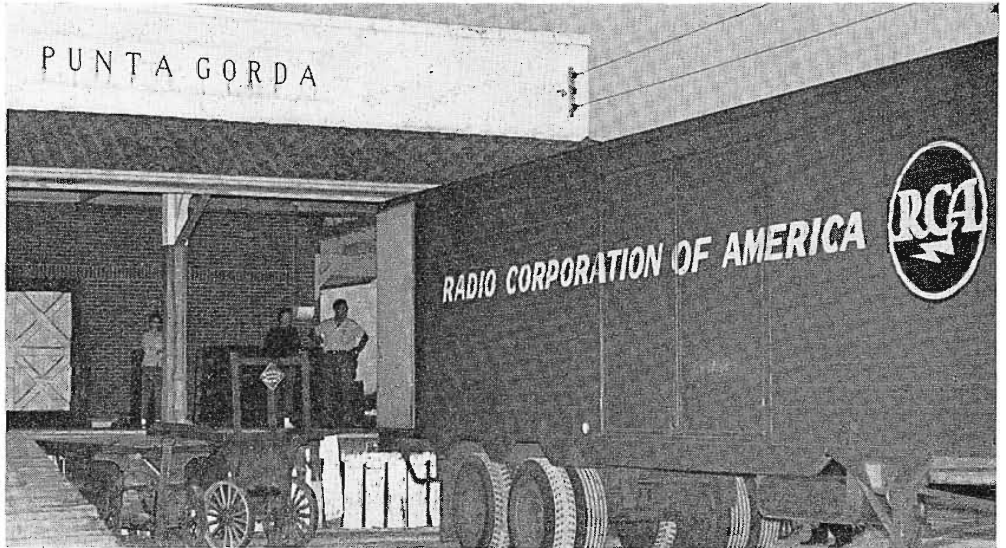

In a 40-hour through run from Camden, N. J., an RCA truck delivered a 1 KW AM transmitter to WCCF last May to help the Punta Gorda, Florida, station get back on the air promptly after a fire gutted its transmitter building and silenced its signal.

The transmitter order was received and loaded the same day, and in less than 72 hours after the equipment left the RCA plant, the station was ready to resume broadcasting.

Top photo shows the RCA van at the Punta Gorda railroad station which was

used as a transfer point because of its shipping dock height. In the lower view, Bill Setliffe (right), Chief Engineer for WCCF, receives keys to a temporary transmitter building from representative of the General Development Corporation, Florida builders, which loaned the structure during the emergency period. Charred remains of the burned building can be seen in the background. Since these photographs were taken, the transmitter building has been completely remodeled and WCCF operations again are normal.

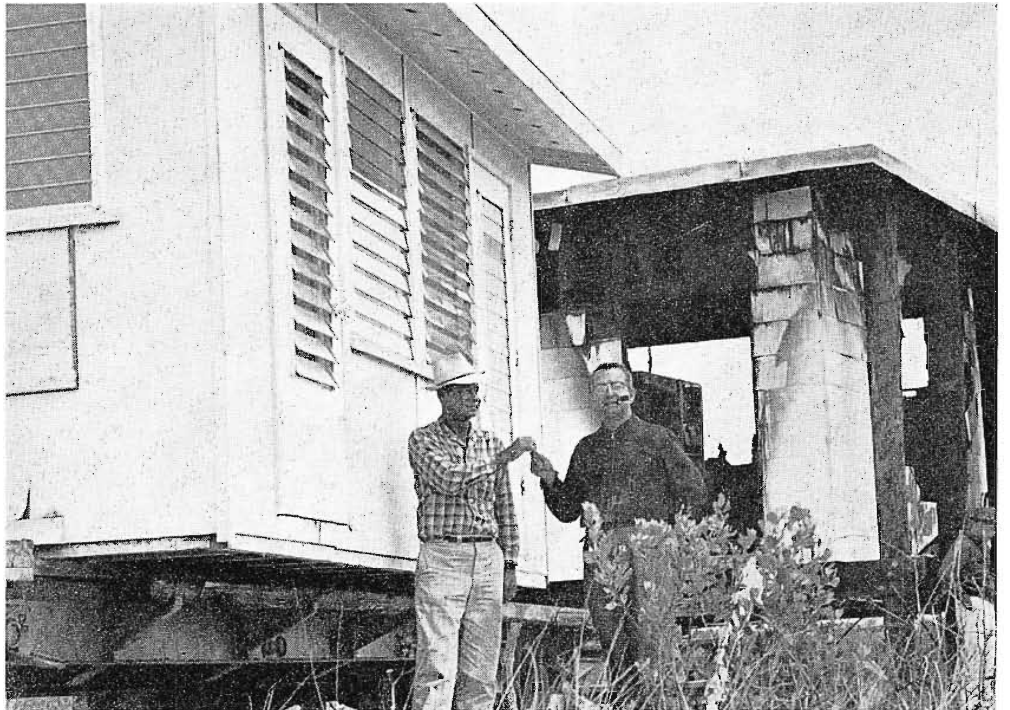

**SIX TV FILM RECORDERS
JAPAN-BOUND TO COVER
NEXT YEAR'S OLYMPICS**

The first production unit of RCA's new television film recording system (TFR-1) for the high-quality transfer of TV images to 16mm. film was shipped in August to NHK, Japan's largest TV network. It was assembled at the Film Recording and West Coast Operations facility in Burbank, California, and is one of six systems ordered by the Japanese network for producing syndicated film from TV coverage of the 1964 Olympic games.

The first TFR-1 for domestic use was delivered in mid-Fall to the Cathedral of Tomorrow, a non-denominational church in Akron, Ohio. The Cathedral distributes religious programs to Ohio area TV stations on both a "live" and film basis and will use the system for transferring TV studio monitor pictures directly to film.

Additional orders for TFR-1 systems have been received from the Navy Photographic Laboratory and the United States Information Agency, both in Washington, D.C.

The RCA equipment was introduced last year as a means of accomplishing the TV-to-film transfer with improved resolution and consistently higher quality results than are possible with current kinescope units. A newly-designed camera used in the system eliminates the "shutter bar" effect sometimes observed in kine recordings, and a new display tube presents the TV picture

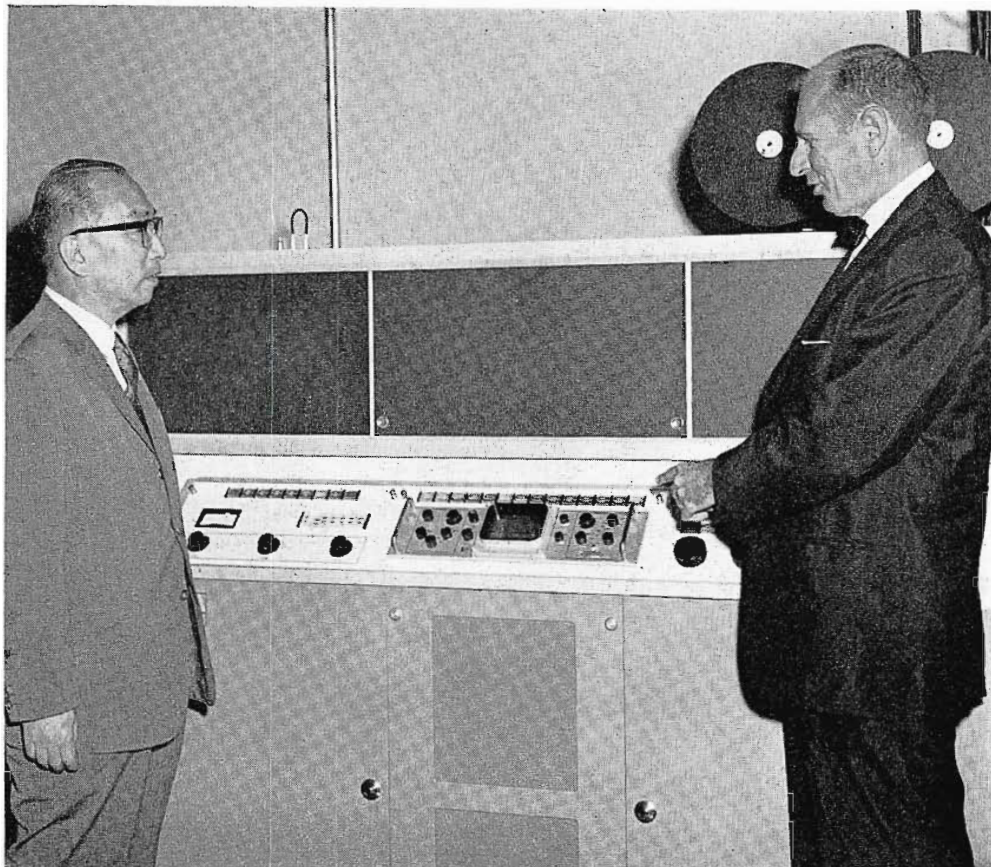

RCA's Adron M. Miller (right) shows TFR-1 to Y. Tanabe, General Managing Director for NHK.

on a flat sub-screen behind the heavy glass face of the tube. This latter technique avoids distortion and light dispersion and improves picture clarity and detail.

Accurate exposure control, for picture brightness and contrast, is performed automatically by comparing the display tube's

light output photo-electrically with an established standard. In addition to self-compensating circuits, the TFR-1 includes a signal source which automatically produces a 10-step variable density film strip for each production run as a guide to the film processing laboratory.

**WNBT, NEW YORK, IS FIRST
ETV-ER TO USE THE TR-22
TV TAPE RECORDER**

RCA's TR-22 television tape recorders are seeing yeoman service at WNBT, Channel 13 in New York, the first educational station in the nation to install the transistorized machines. Shown with the equipment are (left) John Lentz, Manager of Technical Operations, and G. Edward Hamilton, Vice President-Engineering and Assistant General Manager for the station. WNBT also uses a type TRT-1B machine and broadcasts about half its program day from tape, with the remaining air time divided about evenly between live and film programming. The TR-22 recorders are equipped for operation at either 15 or 7½ inches of tape per second.

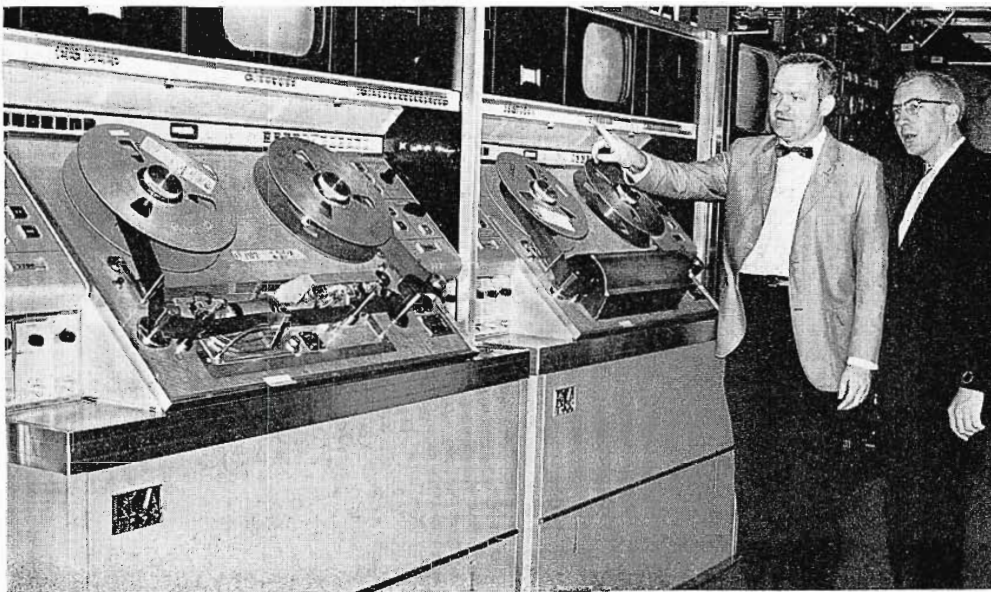

PRIVATE MICROWAVE OPERATORS ORDER RCA'S TOTAL SOLID STATE EQUIPMENT

Two leaders in their separate industries—the Atchinson, Topeka and Santa Fe Railway Company and the American Electric Power System—have ordered RCA's type CW-60 completely solid state microwave equipment for expansions of their private microwave networks.

The Santa Fe will use CW-60 gear for a new 600-mile section of its microwave system that ultimately will connect Los Angeles with its Chicago headquarters. The new section will carry message traffic between Amarillo, Texas, and Winslow, Arizona, and involves building and equipping 21 repeater and terminal stations.

Existing microwave facilities operated by the Santa Fe now connect Topeka with Amarillo, and Winslow with Los Angeles. The new 600-mile section will thus complete the communications link between Topeka and Los Angeles. The railway's microwave system is used primarily for administrative messages and dispatch service via voice and teletype channels and has been designed for the future handling of high-speed data.

Further east, American Electric Power will use the new CW-60 equipment in 26 repeater and terminal stations in new legs of its microwave system that will connect the headquarters of two operating divisions with a new AEP computer-information center at Canton, Ohio. The divisions are the Indiana & Michigan Electric Company at Fort Wayne, Ind., and the Appalachian Power Company at Roanoke, Va.

At Canton, which also is headquarters of the Ohio Power Company, another AEP operating division, computers will provide centralized customer billing and accounting as well as automatic load dispatching and other control of the AEP System.

The CW-60 equipment is the microwave industry's first to eliminate all tubes, including klystrons which are replaced by varactor cavities. It is compact—occupying about one-fourth the space required by tube-type equipment of comparable capacity—and provides greater frequency stability and ease of maintenance. Direct power supply is a 48-volt battery.

The new RCA equipment operates in the

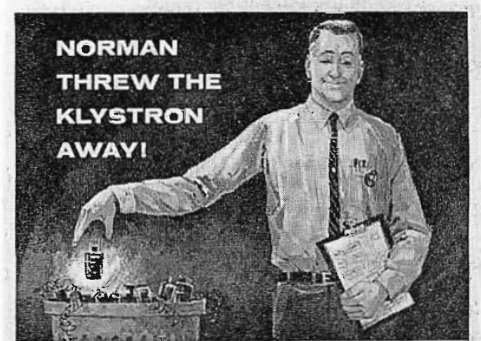

(When he says "TOTAL SOLID STATE MICROWAVE" he really means it!)

Norman is our Chief Microwave Engineer and he, with his team of designers, just overcame the last hurdle in the development of RCA CW-60 Total Solid State Microwave Equipment. Not only have they tossed out the Klystron, they have also eliminated heat sinks, platters, high voltage power supplies, motors, diodes, AFC loops, level stabilizers and other critical components that are subject to frequent outages. Instead of bottlenecks, the CW-60 provides crystal controlled heterodyne repeaters, extremely low power drain, high channel capacity, and 100 floor space in complete repeater station is housed in half a rack!

Find out what this new microwave equipment can do for you in your operation. Get the complete CW-60 Microwave story from your nearest RCA Microwave Representative, or send the coupon for specifications:

RCA Microwave P.O. Box 1 Columbus, N. C. 28002	RCA Microwave Mechanical Sales Plaza Chicago 94, Ill. 60709	RCA Microwave 2901 University Drive Dallas 7, Texas 75209	RCA Microwave 1700 N. Van Ness Hollywood 26, Cal. 91604
---	--	--	--

RCA The Most Trusted Name in Electronics
RADIO CORPORATION OF AMERICA

RADIO CORPORATION OF AMERICA
Microwave Equipment Dept. 28-000
Building 11-5, Columbia, S. C.
Please send me the new CW-60 Total Solid State Microwave brochure.

NAME _____ TITLE _____
COMPANY _____
ADDRESS _____
CITY _____ STATE _____

No mistaking the point in this CW-60 introductory ad; with tubes out it was solid state all the way.

6 kmc band and has a capacity of 300 voice channels. It is designed to conform with CCIR impedance and level standards, thus permitting the user a wide choice of multiplex equipment.

WJXT'S SLEEK MOBILE UNIT CARRIES TR-22

WJXT, Jacksonville, Florida, has put into service a TV mobile unit custom designed to carry the RCA TR-22 television tape recorder. This gives the station "deluxe broadcast equipment on wheels" and the ability to capture studio-like picture quality in tapes made anywhere the truck can roll.

When the TR-22 does a recording job, the tape is ready for immediate on-the-air playback on any other quadruplex recorder, and with no degradation in picture quality. Not every TV tape recorder can make this claim!

In the WJXT unit, the TR-22 is positioned behind the driver's seat, its console facing the rear, in a load area that is 16 feet long, 90 inches wide and 82 inches high. The TR-22 is but 55 inches wide; thus easy access to the cab is provided.

The custom unit also carries two air con-



ditioners, power regulation and distribution equipment, a rack for test equipment, work counters and storage cabinets for tools and supplies. TV cameras may be carried in the five-foot open area at the rear.

The special body is mounted on a Ford V-8 truck chassis. It features a distinctive step-roof design, a wiring trench system under the floor, three underside storage cabinets, a tape storage area, three reels for camera cables and a cable entrance panel with weather flap.

With a deluxe TR-22 TV tape recorder aboard, the new mobile unit will bring back studio-like picture quality in tapes made at the remotest remote. Interior view shows how recorder's compactness leaves plenty of extra space for cameras and other gear.



COLOR SEMINAR PAPERS TO BE PRINTED

First Two Papers On Following Pages —
Others to Follow In Succeeding Issues

More than 600 television station engineers and other technical personnel attended Color TV Transmission Seminars which RCA engineers conducted in five cities during June. The purpose of these seminars was to bring station engineers up to date on color transmission technology and to provide them with detailed information on how to get—and keep—a good color signal on the air.

The idea for these seminars came from the receiver people. What happened is that as color receiver sales became increasingly important to dealers, there were more and more complaints from these dealers about the quality and/or consistency of color transmission in some areas. Usually the stations involved attached the blame to the network, to the telephone lines, or to "tape." However, further investigation often located the fault in the local loop, in the station's microwave or terminal equipment and sometimes in the transmitter itself. And, of course, more often than not the trouble was a successive quality loss from step to step in the long chain from network studio to home receiver.

RCA and NBC engineers have investigated most of the reports of poor color that have been received during the past year. Some of the troubles proved to be due to sloppy operating or lack of proper maintenance. But—somewhat surprisingly—it was concluded that much of the trouble, particularly the pyramiding kind, resulted from a widespread lack of knowledge as to how to properly monitor color pictures, what kind of quality to expect from the network, and how to handle the color signal through the station.

The color seminars in June were planned as a first-step answer to this situation. They began with a brief review of the basic concepts of color transmission. Next came a discussion of what the network puts on the line—especially the test signals—and how these signals can be used. Following

this were three papers on the handling of the color signal in the station: first in the terminal equipment, second in the microwave link, and third in the transmitter.

Because the subject of color telecasting is so broad this first seminar was limited to color *transmission* considerations. In the near future we plan to hold a similar seminar on color *origination*.

We are under no illusion that these seminars will, in themselves, solve all of the problems. Nor even that they provide all the needed information. We do hope

they will spur station engineers into making themselves more expert in this area.

The material in the papers presented at the seminars was very detailed, with numerous slides to illustrate the narratives. Many engineers attending the seminars asked for reprints. We promised them this. And, since we think most station engineers will be interested, we plan to print all of the papers in BROADCAST NEWS. The first two papers will be found on following pages. The other three will appear in succeeding issues.

PAPERS PRESENTED AT RCA SEMINAR ON COLOR TV TRANSMISSION

- 1. INTRODUCTION TO COLOR TV TRANSMISSIONS J. W. Wentworth**
A brief review of the basic concepts in the generation of color TV signals with an introduction to test signals used for checking equipment
- 2. NETWORK COLOR TRANSMISSION H. C. Gronberg**
Test Signals used by the networks, possible signal impairment, how to monitor network signals, checking equipment, allowable distortion, where to look for trouble, etc.
- 3. HANDLING THE COLOR TV SIGNAL J. W. Wentworth**
Requirements for terminal equipment, switchers, stabilizing amplifiers, distribution systems—checking, monitoring, test equipment
- 4. MICROWAVE RELAYING OF COLOR TV SIGNALS J. B. Bullock**
Requirements, possible troubles, checking, test equipment, etc.
- 5. GETTING THE COLOR TV SIGNAL ON THE AIR R. B. Marye**
Transmitter specifications, requirements, for transmission lines and antennas, test equipment and how to use it, what to look for on the scope, where troubles may occur, checks at various points in the transmitter, routine maintenance, etc.

RCA COLOR SEMINAR

Part I: Introduction to Color TV Transmission A Review of Basic Concepts and Test Signals

by JOHN W. WENTWORTH

Manager, Educational Electronics

RCA Broadcast and Communications Products Division

To “set the stage” for the specific discussions of practical problems in handling color television signals, I have been asked to present a brief review of the basic concepts involved in the generation of color television signals and to provide a short introduction to each of the most popular test signals used for checking transmission equipment.

We then pass these signals through a group of filters which adjust the bandwidth of each signal component to match the requirement of the human eye. The monochrome signal we handle in exactly the same fashion that we handle standard monochrome signals. Somewhere in the broadcast system before the signal reaches the home receiver, there is inevitably a practical limitation in bandwidth, imposed by a transmitter, a tape recorder, or network transmission lines. As a practical matter, we have nominally 4 megacycles to work with as far as monochrome information is concerned. The I and Q signals are deliberately shaped by filters in the color encoding equipment. The nominal bandwidths are 1.5 mc for I, and a mere $\frac{1}{2}$ megacycle for Q. Very narrow band, low resolution chrominance information is all that is required to reconstruct a very satisfactory color image.

The band-shaped chrominance signals are then modulated on subcarriers of 3.579545 megacycles. If you’ve ever studied the principles of color television, you’re aware that this very precise subcarrier frequency must be harmonically related to the line and field scanning frequencies. By making the subcarrier frequency an odd multiple of $\frac{1}{2}$ the line frequency, we obtain a *frequency-interlaced* condition which lets us get away with a simple addition of the subcarrier signal to the monochrome signal. The I and Q signals are modulated in balanced fashion upon two carriers with a phase separation of 90 degrees, producing a subcarrier signal which varies in both phase and amplitude. The effect of the crosstalk which you might expect from the simple addition of the subcarrier to the monochrome signal turns out to be almost negligible as far as the final viewer is concerned, thanks to the frequency interlace effect. In parallel with the modulators, we also operate a burst keyer which puts out a sample of the subcarrier frequency. This keyer is controlled by burst flag pulses which cause the burst to occur in the back porch period right after every horizontal synchronizing pulse. We then add together a total of 5 signal components including the usual deflection sync pulses to form the complete color signal ready for transmission over the air. Of course, in a studio plant you’d normally have a complex system with more than one color camera chain, but this simplified diagram illustrates the basic principles that are involved.

Figure 2 shows the manner in which the 6 mc television transmission channel is used for both monochrome and color. It’s well known by now that in compatible color television, we manage to get extra mileage out of the same spectrum space that in the past we’ve used only for monochrome, but the price we pay for such spectrum conservation is the necessity of handling three independent signals in the upper part of the channel. Mere inspection of this diagram is enough to give a serious minded engineer pause about the difficulty of the task we face in handling a color signal compared to what is involved in handling a monochrome signal. We have filled up the spectrum more completely,

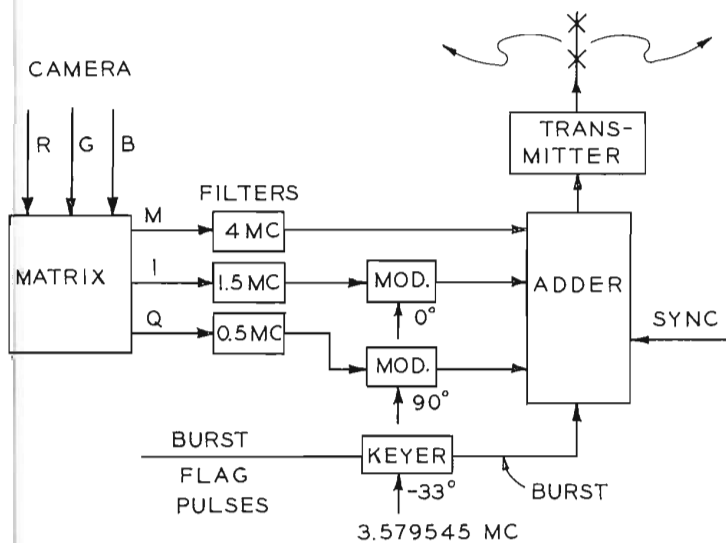
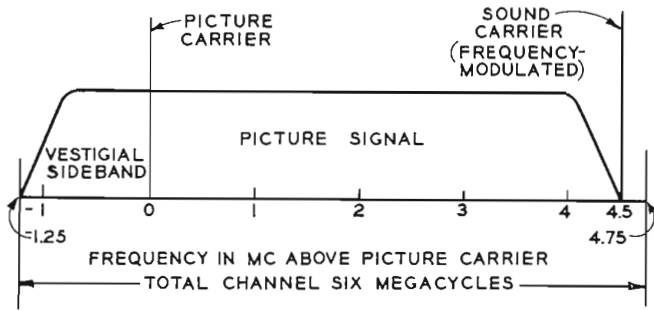

FIG. 1

Figure 1 provides a “visual summary” of the technical concepts involved in putting the signal together. Study of this diagram can help us to clarify our understanding as to why certain characteristics of the signal are exceedingly important. A color television signal must always provide three kinds of information. A color signal leaves the camera in the form of red, green, and blue video signals, conveying primary-color information about the scene to be transmitted. In a matrix network, we cross-mix the red, green, and blue signals to develop another set of three signals that we frequently call M, I, and Q. M stands for Monochrome, a particular mixture of red, green, and blue which is a very close approximation to the output of a monochrome camera chain. The M signal conveys brightness or *luminance* information. The I and Q signals we designate *chrominance* signals. They, too, are mixtures of red, green and blue and determine how the color to be reproduced in each area of the image differs from the neutral or gray condition along a pair of axes on the color diagram. The I and Q signals together give us all the chrominance information we need to establish the hue and saturation of each image area.



MONOCHROME TV CHANNEL

FIG. 2a

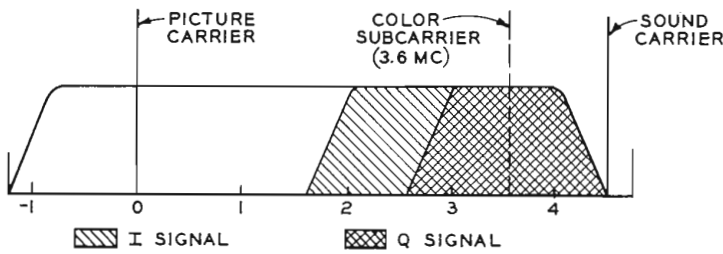

COLOR TV CHANNEL

FIG. 2b

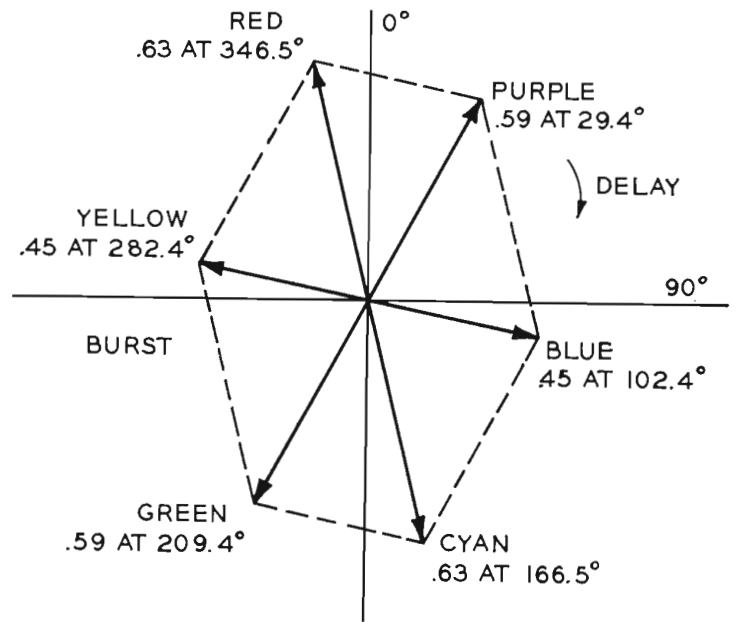

FIG. 3

and now have three signals which must remain independent if we are to reconstruct a proper color picture at the receiving end of the system. So we must be considerably more careful about how we handle the signal. You're aware, of course, that the I and Q signals are kept independent of each other by the two phase modulation technique, and the entire group of sidebands surrounding the color subcarrier are kept independent of the monochrome signal by virtue of so-called frequency interlace technique. It is still very important, however, that we pay close attention to what happens in the upper part of the frequency band, especially in comparison to the relatively lenient approach we can afford to take in the handling of a monochrome signal, since the very important chrominance information is confined to the upper part of the channel.

Table I

BASIC TRANSMISSION REQUIREMENTS

1. Uniform Frequency Response
2. Uniform Time Delay (Linear Phase)
3. Minimum Differential Gain and Phase

Table I summarizes the several basic transmission requirements. From mere inspection of the channel diagrams, you can quickly understand why it is that we must have very uniform frequency response. We must provide essentially the same response through the system for all parts of the color signal including that part transmitted in the upper portion of the video band. We must also be very much concerned about uniform time delay,

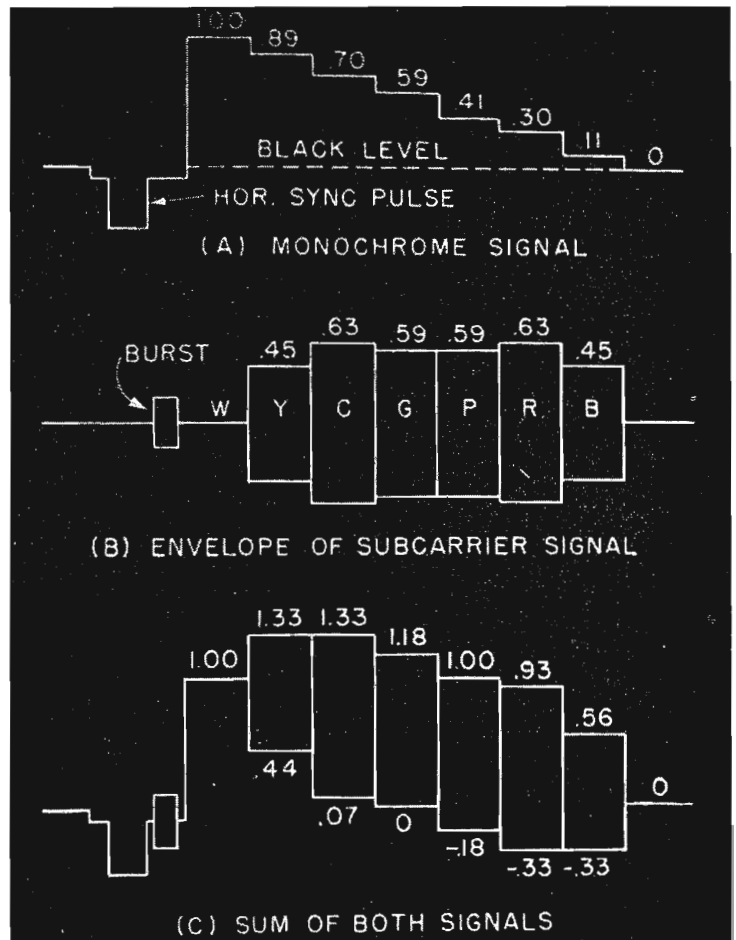

FIG. 4

or linear phase, over the entire video passband. The color signal is very complex, and in order to preserve its wave shape faithfully, we must make sure that all signal components arrive at the receiving end of the system with the same relative timing. This can only be done if the phase versus frequency characteristic is linear or if there's uniform time delay through the system for each and every frequency component.

We're also concerned about minimum differential gain and phase. We seldom talked about differential gain or phase in the early days of monochrome television, but they're very important in color for reasons that I think can best be made clear by considering Figures 3 and 4. Figure 3 is a vector diagram illustrating important characteristics of the subcarrier part of a color signal. As we noted earlier, the color subcarrier signal is formed by amplitude modulating, in suppressed carrier fashion, two carriers that are 90° apart in phase; the net result is the generation of a signal whose amplitude and phase are both subject to variation. It's common knowledge by now that the hue of a reproduced picture is determined directly by the phase of the subcarrier part of the signal. The saturation of each reproduced color is determined by the amplitude of the subcarrier signal. When anything happens to reduce the relative amplitude of the subcarrier part of the signal, the saturation will be decreased.

Keeping in mind that the subcarrier signal has a critical phase as well as a significant amplitude, let us consider Fig. 4, which shows the waveform sketch for a monochrome signal, the subcarrier part of the signal to be added to it, and the sum of both signals. Although the sketch happens to show a signal generated by a color bar generator, it illustrates the general principle with which we are concerned. Note that the monochrome signal is always somewhere between black level and reference white or unity. The signal levels represent various shades of gray up and

down the gray scale. The subcarrier signal shown at (B) in the diagram is modulated in both amplitude and phase. While it's not possible to show phase modulation realistically on a waveform sketch of this sort, you must recognize that each color interval is transmitted with a different phase position. The sketch also shows the color synchronizing burst required for control of the receiver oscillators which regenerate the carriers that are needed to demodulate the chrominance information from the complex modulated wave. It's very significant that when the subcarrier signal is added to the monochrome signal, the various components which make up the modulated wave may be transmitted in entirely different parts of the amplitude range. Some of the color information, particularly that associated with the bright colors such as yellow and cyan, is transmitted relatively close to the white level, while some of the information is transmitted relatively close to the black level. We must be sure that the chrominance information is not distorted as a function of the position it happens to occupy in the black-to-white amplitude range. We want the same transmission conditions for the very important subcarrier signal up near the white level as we find down near the black level. If we find differences in amplification or in phase shift, we have what can be called *differential gain* or *differential phase*. Either effect can cause serious distortions to the color signal.

Turning now to the subject of test signals, we are pleased to recommend very highly the booklet entitled *Television Signal Analysis*, which we understand has been sent out by the Bell Telephone System to virtually all chief engineers of television stations throughout the country. This very useful handbook on television signal analysis shows the most popular test signals used by broadcasters and the networks for checking the performance characteristics of equipment that handles both monochrome

TELEVISION SIGNAL ANALYSIS is a very useful handbook compiled under the direction of a Joint Committee of Television Network Broadcasters and the Bell Telephone System. It is published by the Long Lines Department of the American Telephone and Telegraph Company.

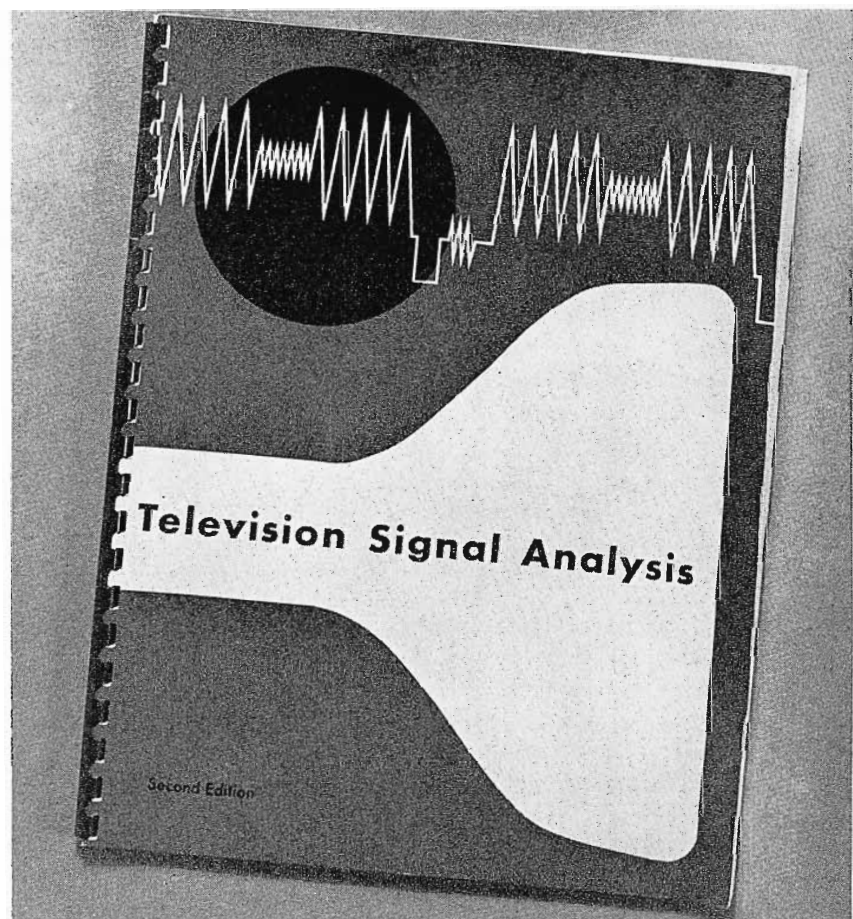

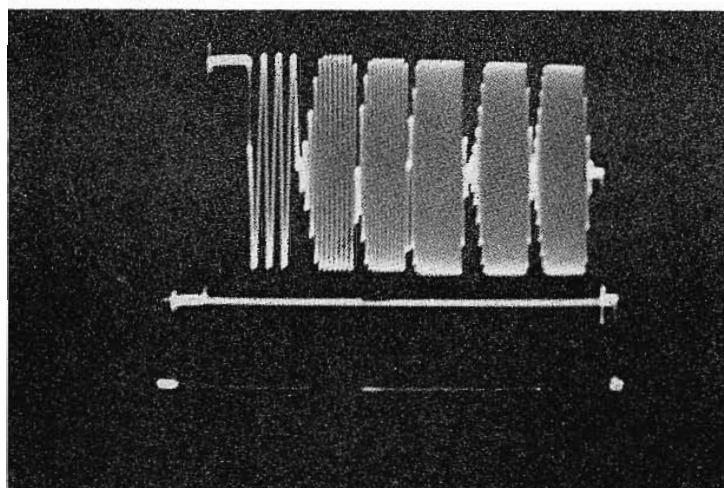

FIG. 5.

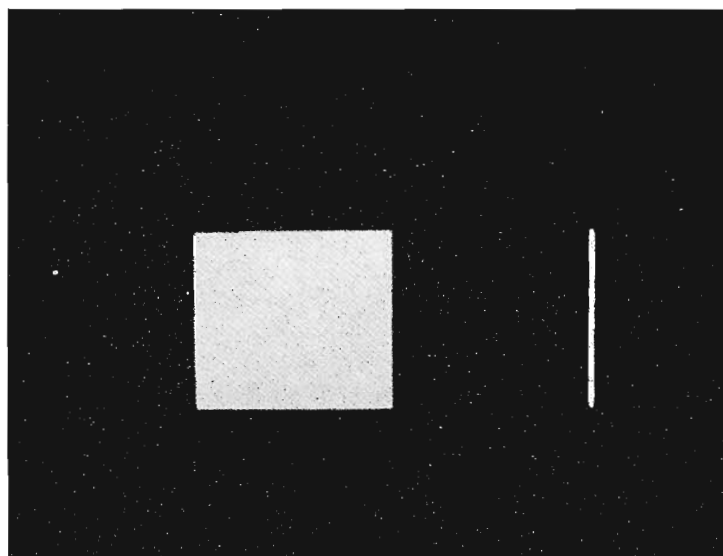

FIG. 6

and color signals. The manual is well illustrated with both kine-scope photographs and waveform photographs which show both normal signals and a wide variety of distorted signals resulting from typical malfunctions or defects. Each of the signals I shall comment upon in this talk, and which will be used by all speakers in this program to illustrate their topics, is discussed in considerable detail in *Television Signal Analysis*.

Figure 5 shows the so-called multi-burst signal, a waveform which permits you to make a very rapid spot check of the frequency response of any piece of television equipment. It's enough like a true television signal, with the usual sync and blanking pulses provided, that it will pass through all standard TV transmission gear with no modification of clamps or other special circuits. The signal is fairly straightforward. It begins with a white pulse which gives you an opportunity to check the basic level or response at the very low frequencies (effectively at line frequency and the first several harmonics thereof). The signal then provides a series of bursts or samples of various frequencies; these are normally set at 0.5, 1.5, 2, 3, 3.6 and 4.2 megacycles. We understand that some telephone company circuits are checked with a slightly different group of frequencies, but those cited are used by the networks and most local broadcasters. The equipment that generates the multi-burst signal is usually adjustable within reasonable limits, but there is obvious advantage in conforming to a recognized standard for most routine tests. The multi-burst signal is widely accepted as a useful test signal for spot checks of frequency response.

Figure 6 shows the kinescope appearance of the so-called "window" signal, which provides a patch of white on a black background. Modern signal generators that provide this signal also provide a secondary line off to the right in the kinescope display; this is the kinescope display of a sine-squared pulse. The sine-squared pulse is actually more useful on a waveform monitor than on a kinescope screen, but there is no particular problem in combining it with the window and making one signal do double duty. The combined signal is extremely useful for checking transient response at both low and high frequencies. A transient response test is actually a slightly indirect way of measuring time delay or a phase-versus-frequency characteristic. A transient response test permits you to examine an *effect* rather than a *cause*, but direct phase measurements are normally so difficult that transient tests are usually recognized as one of the easiest ways to accomplish the objective.

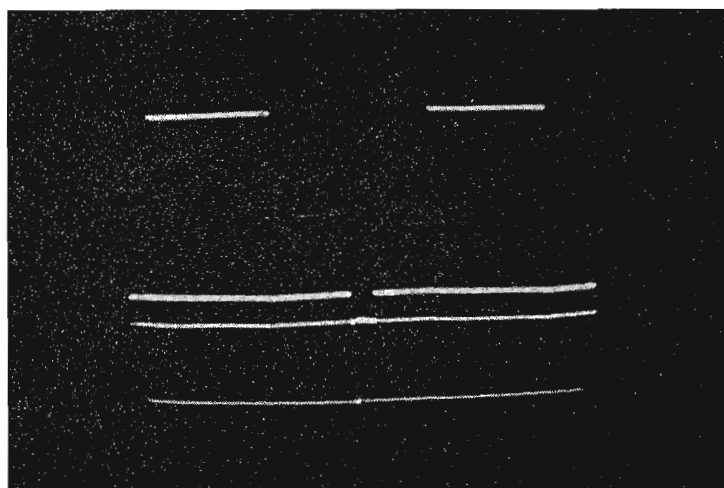

FIG. 7

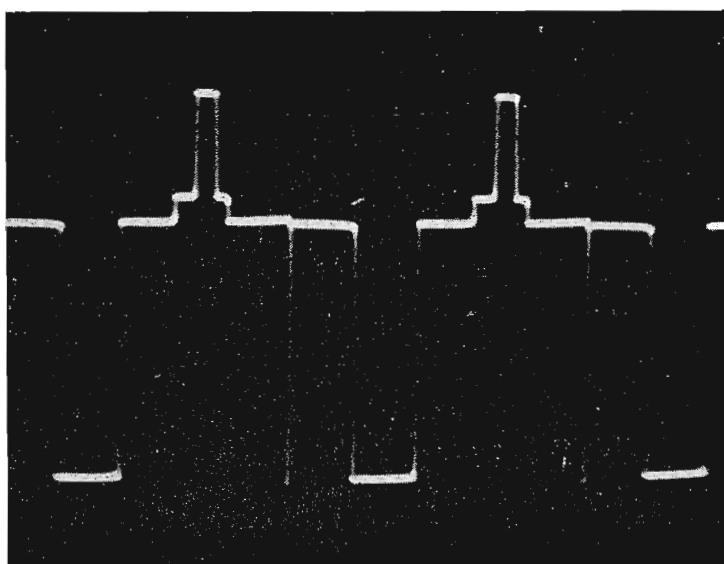

FIG. 8

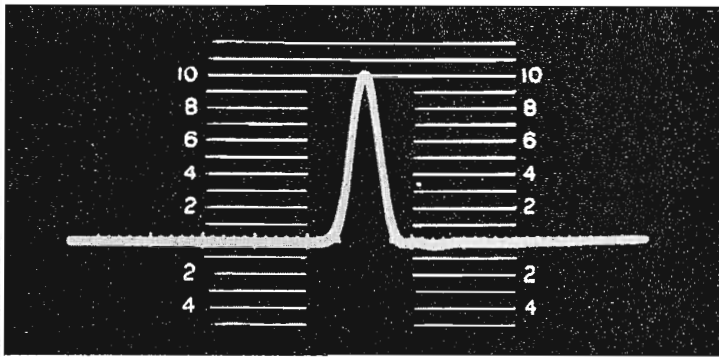

FIG. 9a

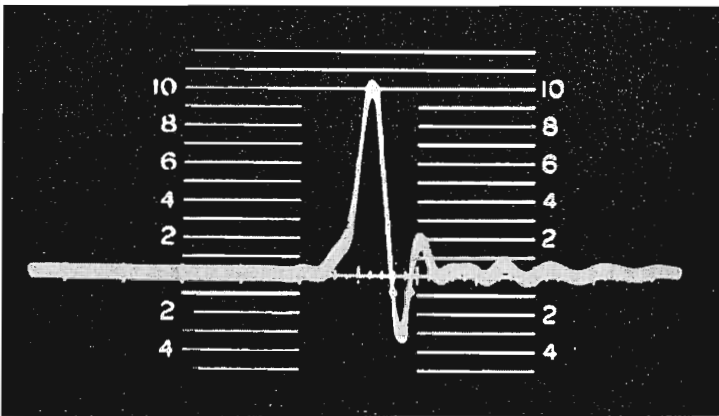

FIG. 9b

The window display on the picture tube is very useful for detecting cases of streaking or certain other gross defects that are quite apparent when you look at the display and fail to see a clear white window on a black background. The signal is also useful on a waveform monitor, where it can be examined on several different time scales. For example, Fig. 7 shows the vertical-rate display for the window signal. What you see is essentially a 60 cycle square wave, nicely fitted up with sync and blanking pulses so that it will go through all standard television facilities. This signal provides a very sensitive test for tilt at the very low frequencies; in other words, it provides a good test of the low frequency response of a TV system. On the horizontal time scale, as shown in Fig. 8, you can get a good view of the effects of disturbances in the vicinity of the line frequency or the mid-band region; such disturbances cause tilt, rounding, or other distortions in the wide pulse corresponding to the window. To the right of the broad pulse, you see a narrow spike corresponding to the sine-square pulse. One point that usually is of some significance is the absolute height of this pulse. If the frequency response of a circuit under test has rolled off significantly, chances are this spike no longer reaches the same level as the window. Still more useful information can be gleaned from the sine-squared pulse by expanding it horizontally on the waveform monitor to yield the type of display shown in Fig. 9. Mr. Gronberg will give you a little more information about the derivation of the sine-squared pulse, but we should note here that it is essentially a transient-test signal with a predetermined energy spectrum. The pulse most commonly used is 0.125 microsecond wide at the 6 db points, and has an energy spectrum that closely matches that of typical television picture signals. This sine-squared pulse should pass through most *studio* systems with no apparent distortion, although you should expect some distortion in network lines and other band-

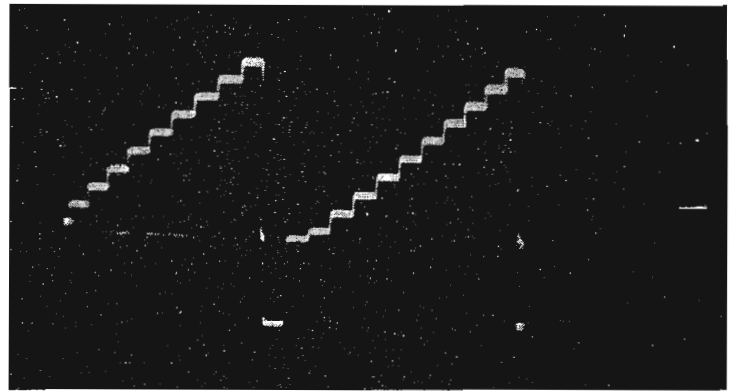

FIG. 10

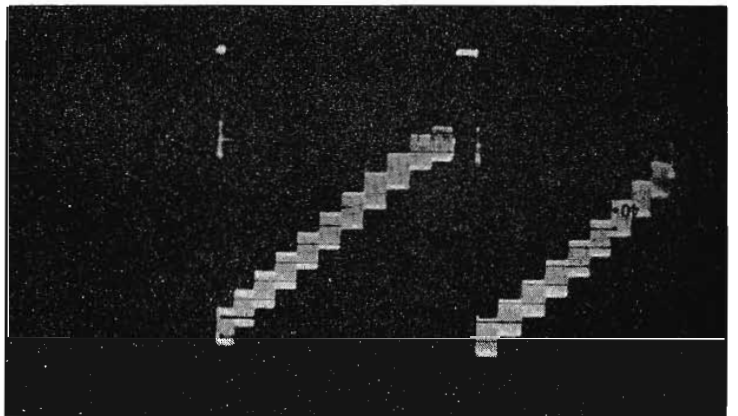

FIG. 11

limited devices or circuits. The sine-squared pulse permits you to detect both frequency response problems and, more importantly, phase response problems at the high end of the video band. Any time you get pronounced ringing effects or asymmetrical transients of any sort as in the bottom view of Fig. 9, you have clear evidence of a phase or envelope delay problem in your system. Some of these effects will be discussed in later sections as we get into the program.

Figure 10 shows the so-called "stair-step" signal, which gives you a means of checking the *linearity* of a transmission system. Simple stair-step signals have been used for quite a number of years as a means of checking compression in amplifiers; distortion can be detected by noting whether or not the steps are squeezed at either the white or the black end of the scale. A more advanced signal for checking *color* transmission facilities can be formed, as shown in Fig. 11, by superimposing a subcarrier signal on top of the staircase. In the receiving equipment used for differential gain and phase tests employing this signal, arrangements are made for filtering off the subcarrier component only, so that it can be examined for any possible disturbance resulting from the fact that the subcarrier was transmitted at various levels all the way up through the gray scale. If you have no distortion, you should see a clean envelope for the subcarrier signal. If you have a case of white compression, for example, you would expect the level of this signal to drop off toward the end of each horizontal interval. The receiving equipment used with this signal also permits you to make phase measurements of each individual section of this subcarrier signal to measure differential phase.

I hope that this preliminary review helps to clarify in your mind the basic problems involved in the transmission of color television signals, and the objectives of the several test signals commonly used for testing practical facilities.

RCA COLOR SEMINAR

Part II: Network Color Transmission How to Monitor and Use the Test Signals

by HOWARD C. GRONBERG
*Manager, TV Network Transmission
National Broadcasting Company, New York*

All of us have a common goal—namely, to see that TV shows, particularly those in color, reach the home viewers in the best possible condition. I am going to talk specifically about network transmission and, in general terms, about what we can do to maintain quality from the time the video signal leaves the TV Master Control Room until it has been radiated from the TV transmitter.

There are three general areas of responsibility for seeing that on-the-air color is good. First, the origination point; second, network transmission; and third, the local stations airing the program. No matter how good the program is originated, color can be harmed or even ruined by either the network facilities or the local TV station.

In the past, most complaints have blamed either the Telephone Company or the video tape machines. The Telephone Company has slowly but surely improved its network transmission. The networks have greatly improved the average quality of the video tapes.

Recent experiences indicate that many stations have not kept their TV plants up-to-date and are in need of newer equipment, more test equipment, and better routine maintenance.

It is very fortunate that many types of signal distortions do not always add. In many instances, on both network facilities and in broadcasters equipment, there is considerable cancellation. Otherwise, the handling of color signals by the Bell System and the TV stations would be much more difficult.

A few stations watch the network test signals and send in waveform photos on a regular basis. Other stations observe the signals on a hit-or-miss basis, while the remaining stations don't bother to look at the test signals. These latter stations are prone to complain of bad off-the-air pictures when they don't know whether the trouble is at the pickup, in network transmission, or in their station. They seem surprised when we ask them how the network test signals look.

To keep color degradation to a minimum, it is a *must* that video test signals be used on a regular basis. We cannot emphasize too strongly that stations must—

1. Monitor the weekly network tests and take waveform photos when trouble is noted.
2. Check the keyed-in test signals at least once a day. Preferably, this should be done at the output of the TV transmitter, as well as at the control rooms.
3. Make regular routine checks of their TV plants.

Network Test Signals

The three test signals most commonly used by the networks and the TV stations for local testing are the well known multi-

burst, stairstep, and window signals. There are a number of varieties of each signal to meet specific applications. As an example, the keyed-in test signals do not have vertical components as they occupy only one or two lines per field. The window signal may or may not be accompanied by a sine-squared pulse.

The only signal which may warrant a brief discussion is the sine-squared signal (Slide No. 1).

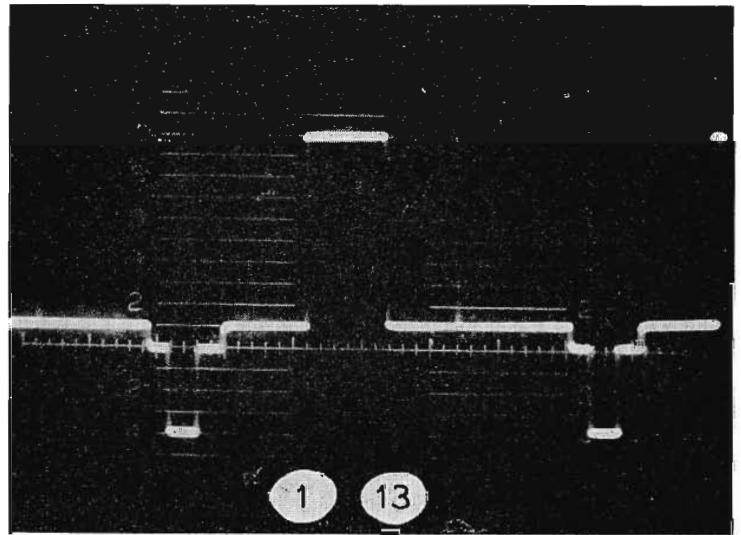

It consists of a standard white window and a pulse, both of which have sine-squared edges. The white window is primarily used for streaking tests and the pulse for ringing tests.

The window portion of the signal has a much slower rise-time than the pulse and usually contains no information beyond 4.0 mc. Therefore, it is an easy signal to transmit from a ringing standpoint.

The sine-squared pulse may be thought of as a single sine wave with the base line moved to the bottom. The next two slides illustrate this quite graphically. (Slide No. 2) A single cycle is indicated by the heavier trace.

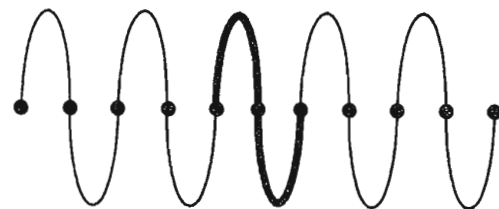

② DOTS = 0.125 μ S

(Slide No. 3) This slide shows the same cycle with the base line moved to the bottom.

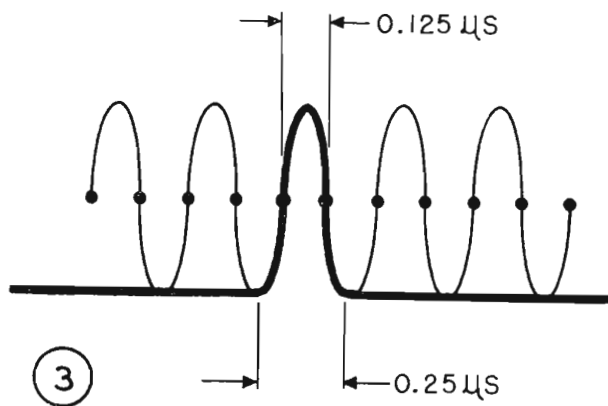

Although a sine-squared pulse could be produced this way, it is not practical from a design standpoint. Actually, it is produced by using a very narrow pulse which is widened and shaped by filters. Thus, one pulse and three sets of filters provide the $\frac{1}{4}$, $\frac{1}{8}$, $\frac{1}{16}$ microsecond pulses.

The energy contained in the $\frac{1}{8}$ microsecond pulse is 6.0 db down at 4.0 mc and doesn't reach zero until 8.0 mc. Due to the energy between 5.0 and 8.0 mc, some distortion to the pulse will be experienced on all network circuits and is to be expected. In other words, the network stations should expect to see some irregularity before or after the pulse.

The fourth signal which is becoming increasingly important is the color bar signal. This signal is quite helpful since it can be viewed on a color monitor or displayed on a vectorscope. As more and more stations originate color and therefore obtain vectorscopes, this signal will allow them to quickly check the hues and saturation of the incoming color bar signal from the network.

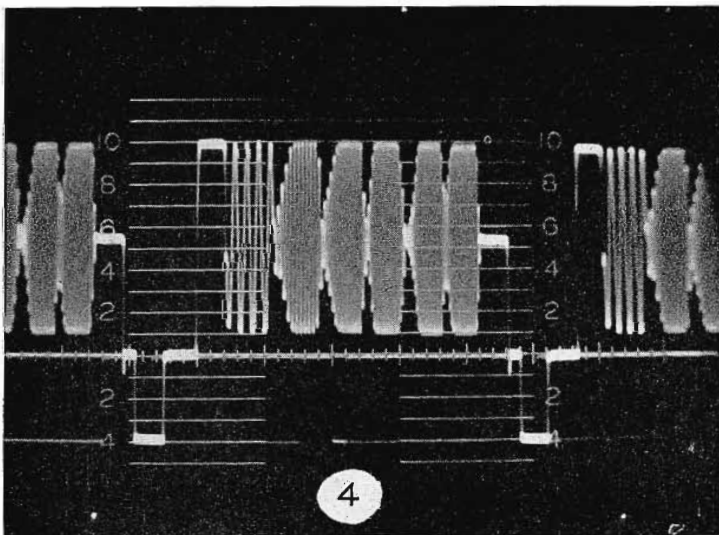

Test Signal Impairments

The multiburst signal leaves New York looking like this (Slide No. 4) and should not be overpeaked arriving at your control rooms. However, if it is rolled off not more than 10 IRE units, it is within commonly accepted limits. By 10 IRE units, I mean the 4.0 mc burst should not be less than 80 IRE units when the 0.5 mc burst is 90 units and the white bar is 100 units. (Slide No. 5)

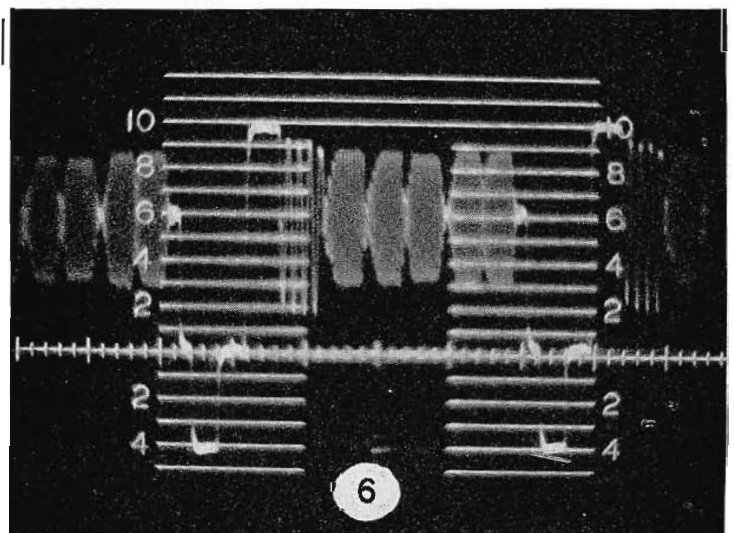
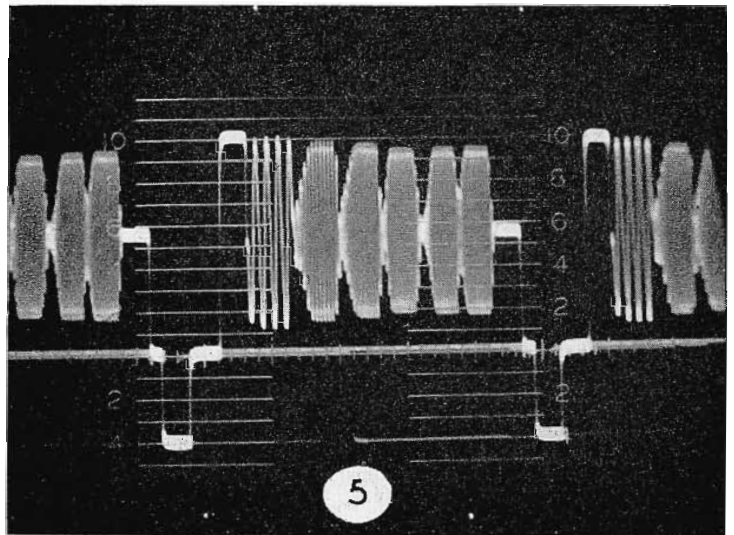

A condition which is not acceptable is shown by slide (No. 6). Although the high-frequency response as shown here is relatively flat, the level of the white bar indicates that there is a mismatch between the low frequencies and high frequencies. Another unacceptable condition is shown by this slide (No. 7) which illustrates an hour-glass response. There are two main objections to this type of response: (1) it accentuates ringing, and (2) it "softens" the monochrome rendition of color receivers.

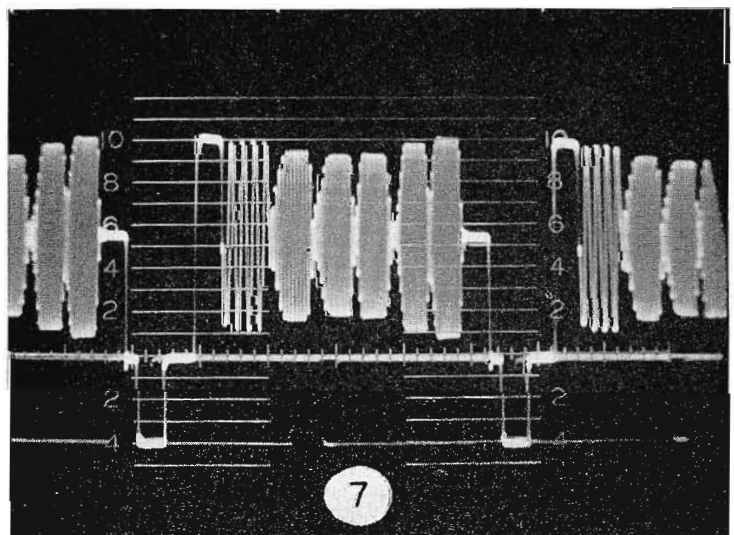

The stairstep signal leaves New York looking like this during the regular test periods (Slide No. 8)

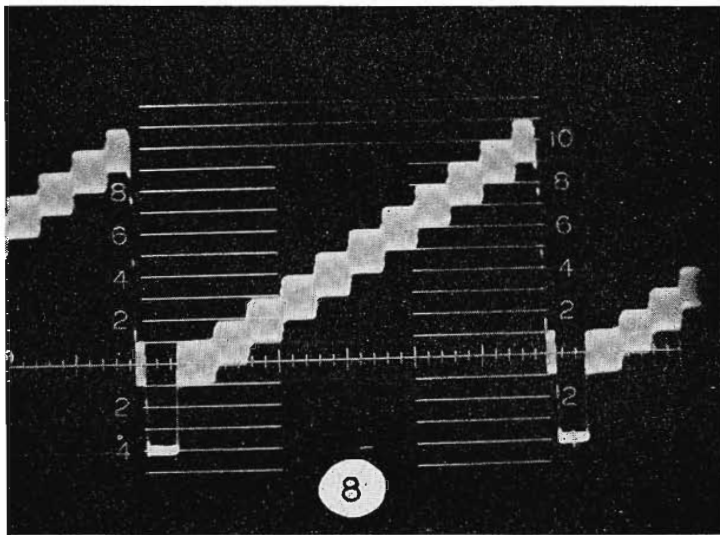

and like this when it is keyed in during vertical blanking (Slide No. 9).

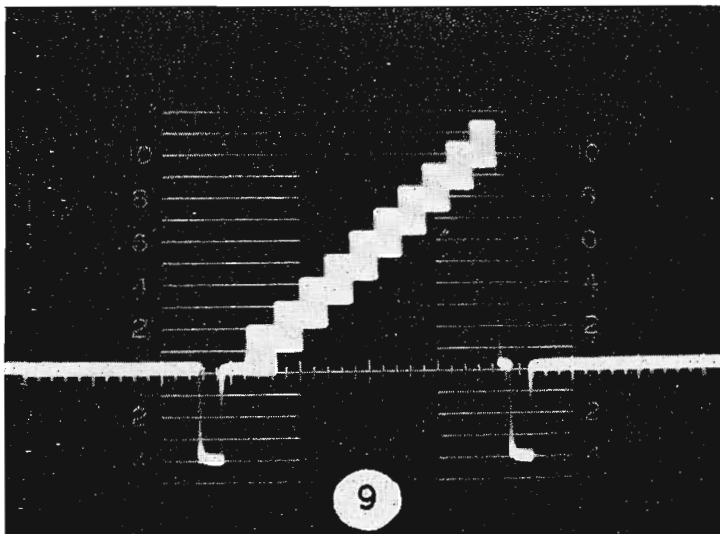

The actual stairs start late in this signal so the 3.5 mc sinewaves can start at the blanking level and still not interfere with the backporch burst during color shows (Slide No. 10).

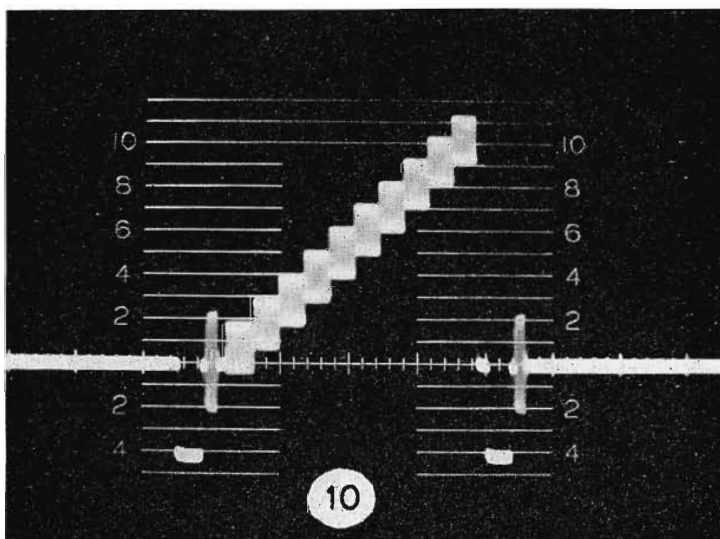

Taking waveform photos of the keyed-in test signals is no problem when using a CRO with a line selector, although it does take a little practice. However, photographing the keyed-in stairstep signal after it has gone through a high pass filter is another matter. One method which works fairly well is to use the sync output from a TA-9 stab amp and drive the CRO externally.

The stairstep signal has two important purposes: (1) to show differential gain which actually is nothing but a measurement of high-frequency gain measured in small increments between the blanking level and white level, and (2) the measurement of differential phase which actually is a measurement of hue shift in small increments between blanking level and white level.

Differential gain can be measured several different ways. The easiest way is to feed the received signals through a high pass filter and view it on a CRO. This slide (No. 11) shows the signal as it leaves New York as viewed through a high pass filter.

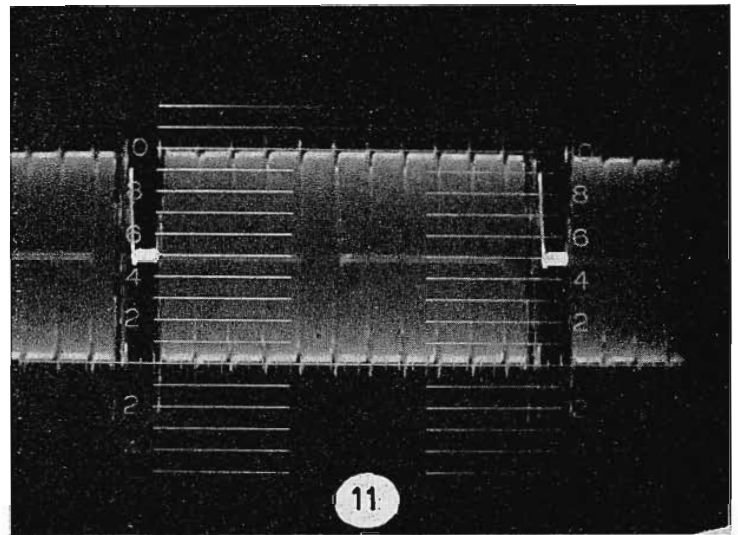

Ten per cent differential gain is shown by the next slide (No. 12). That is, 5 per cent at top, plus 5 per cent at bottom.

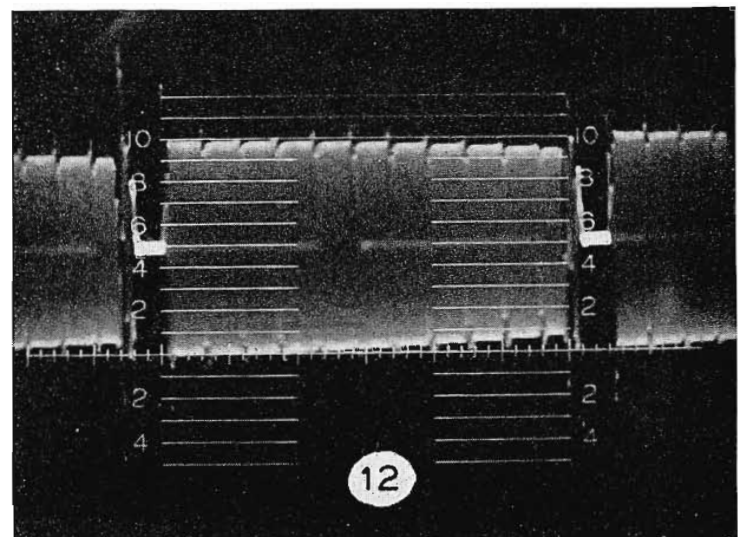

We attempt to keep the 2,300-mile video round robin at less than ten per cent. However, where a station on a leg receives network service over several circuit sections, a more practical limitation is fifteen per cent.

Differential phase is very important and must be kept to a low value if color is to be handled satisfactorily. We believe acceptable limits for network transmission are 4.0 degrees for stations on the video round robin and not more than 5.0 degrees for the remaining stations. Properly maintained, local video circuits will normally have less than 1.0 degree. These tolerances are for measurement made at the output of the Telco equipment.

Two manufacturers have recently introduced small transistorized units to measure differential phase. They are the Riker Industries (Model 970) and Telemets (Telechrome Model 3701-A1). It is probable that both units are transistorized versions of the original Telechrome 1004-B test receiver which has been a very good unit.

The sine-squared signal leaves New York as shown by the next slide (No. 13). Please note that the corners of window look fairly square.

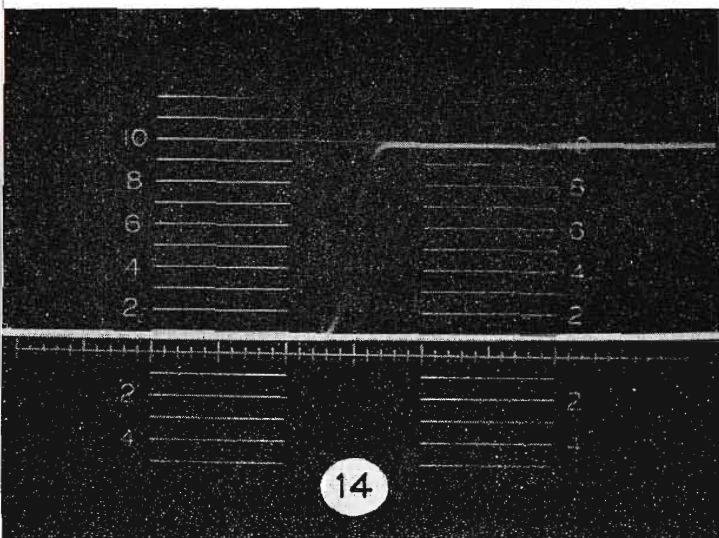
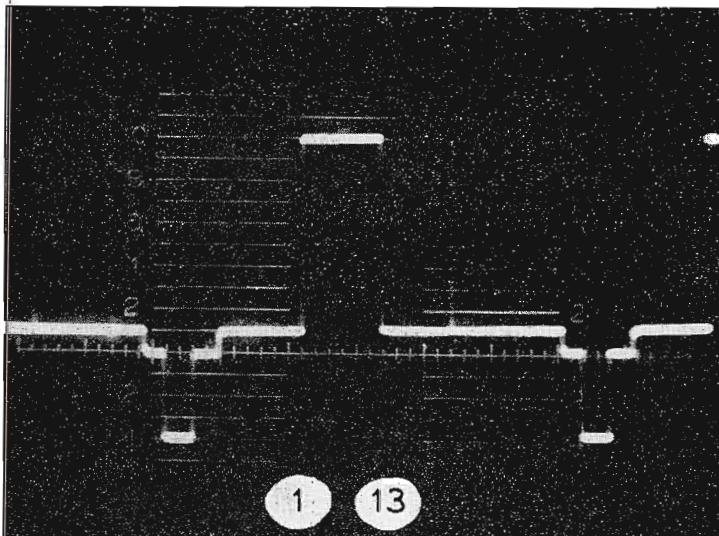

However, when the left side of the window is blown up, it appears slightly rounded and looks like a sine-wave (Slide No. 14).

Thus, overshoots do not normally leave the control room. Since there is no energy in the edges of the window signal above 4.0 mc, any appreciable ringing occurring at the top left corner means there is in-band trouble and should be reported.

The next slide (No. 15) shows a blow-up of the sine-square pulse. It has little if any overshoots.

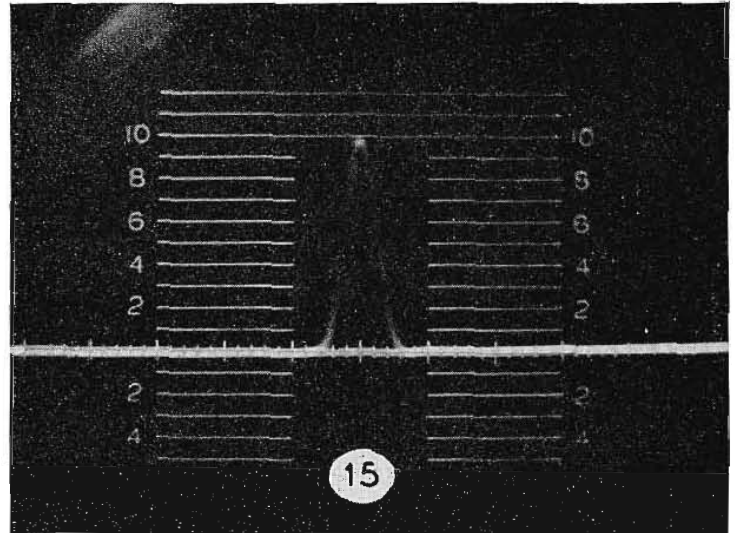

As viewed in your control rooms, the top of the window should be flat and not have excessively rounded corners. The sine-square pulse should not have excessive undershoots or overshoots.

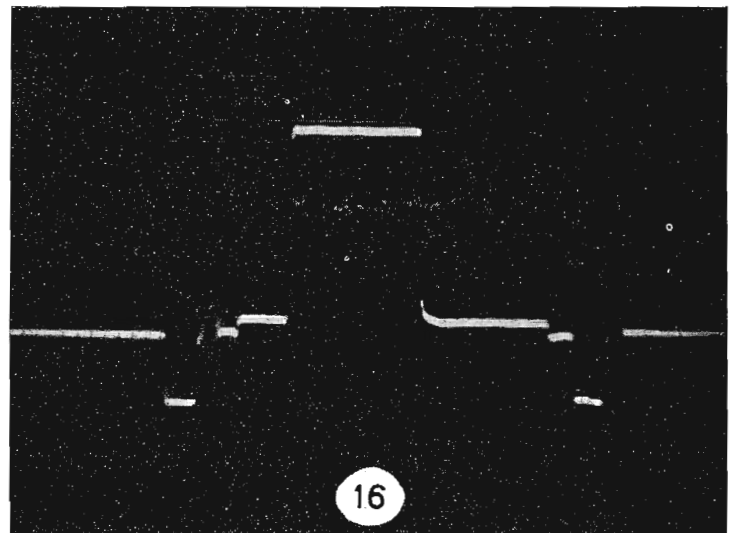

This slide (No. 16) shows the video round robin under average circumstances. The streaking as shown by the rounding of the corners can be more easily seen and photographed if the CRO is set on the IRE roll-off position. Note that the top left corner of the window is almost square but that there is some rounding of the bottom right corner. This is considered to be the present state of the art.

This slide (No. 17) shows moderate streaking.

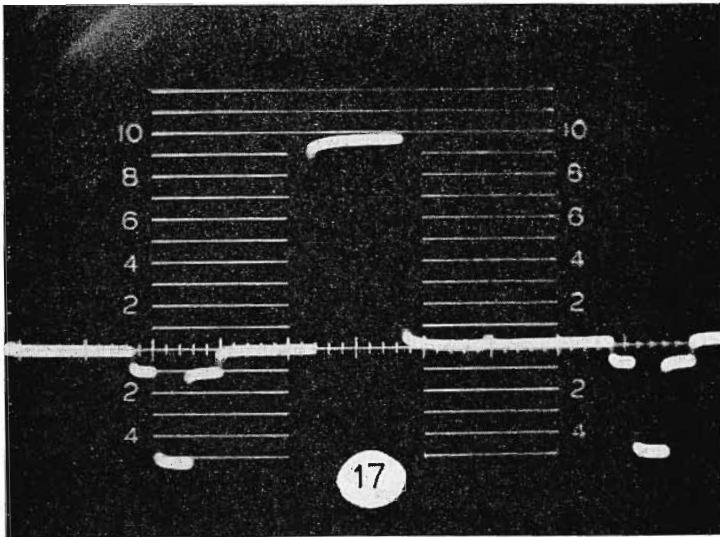

while this slide (No. 18) shows heavy streaking.

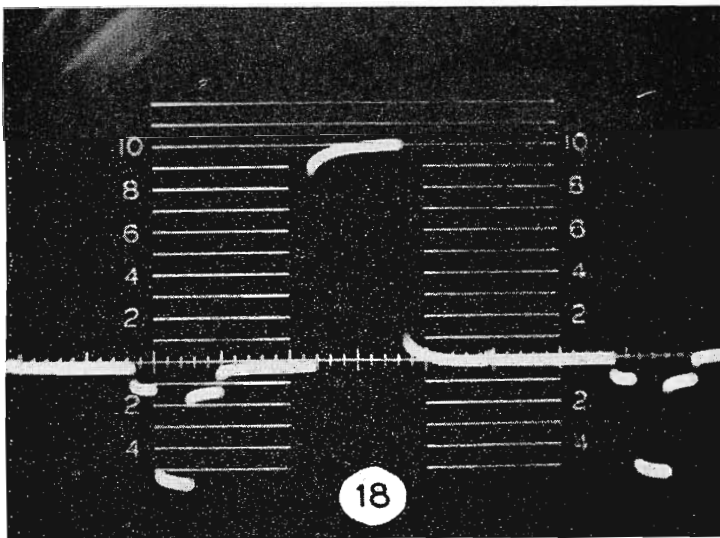

Both of these are excessive and indicate trouble. The slides we have just shown represent positive streaking (excessive lows). The next two slides are just the reverse of the last two slides and show negative streaking. (Slide Nos. 19 and 20.)

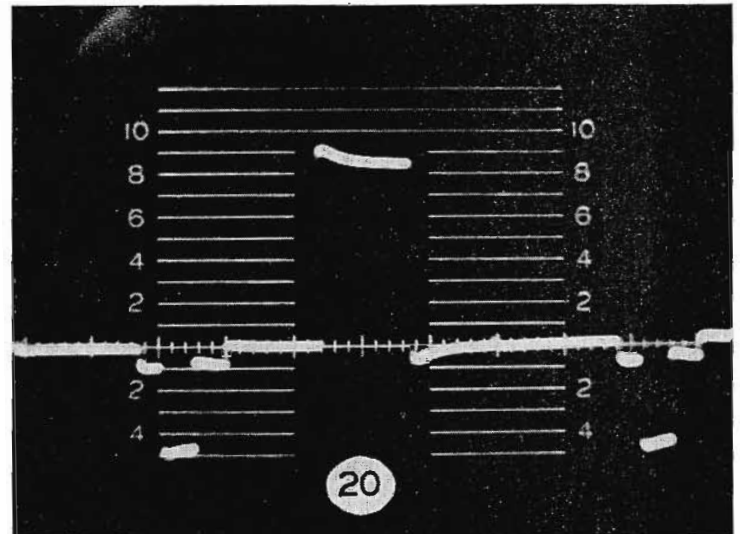
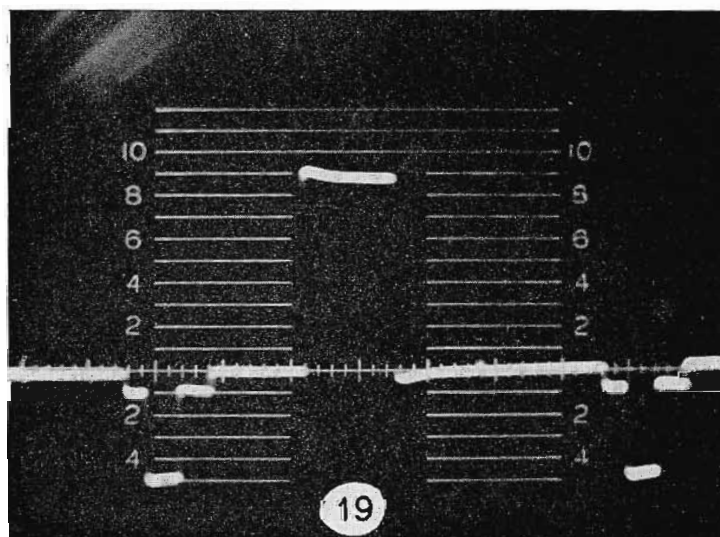

Don't forget your incoming local video loop. If you have long streaking or *any* length negative streaking, the chances are it is due to your local video loop.

Tolerances for ringing can be more easily defined than streaking. With the advent of the sine-squared pulse with its known rise time, we have been given a signal which gives reproducible results. The left side of the next slide (No. 21) shows the pulse as it leaves New York, and the right side shows the same pulse as it returns to New York after a trip around the video round robin.

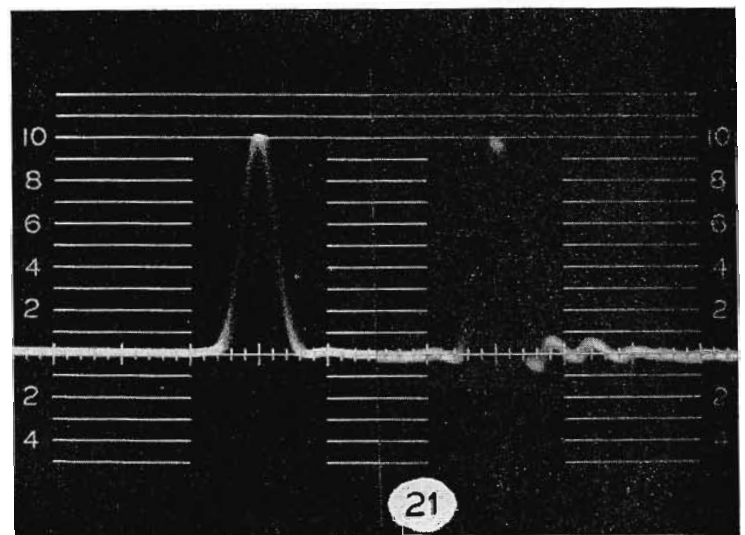

The easiest way to measure the pulse distortion is to adjust the CRO vertical gain and centering until the pulse is between zero and 100 on the IRE scale (Slide No. 22). Then adjust vertical centering until the most negative excursion is at zero and measure the top of the most positive excursion. The measurement will then be in per cent. (Slide No. 23). Photos taken for submission to Telco or your network representative should be centered as in Slide No. 22.

For this method of measurement, a tentative value of 20 per cent was adopted by NBC on April 1, 1961, and has proved to be a stiff tolerance for even stations fed from the backbone circuits. However, it can be met! Due to work under way by the Bell System, it is expected this value of 20 per cent will become increasingly easier to meet and eventually will be reduced. Slide Nos. 22 and 23 illustrate the preferred method of calibrating photos and measuring per cent ringing.

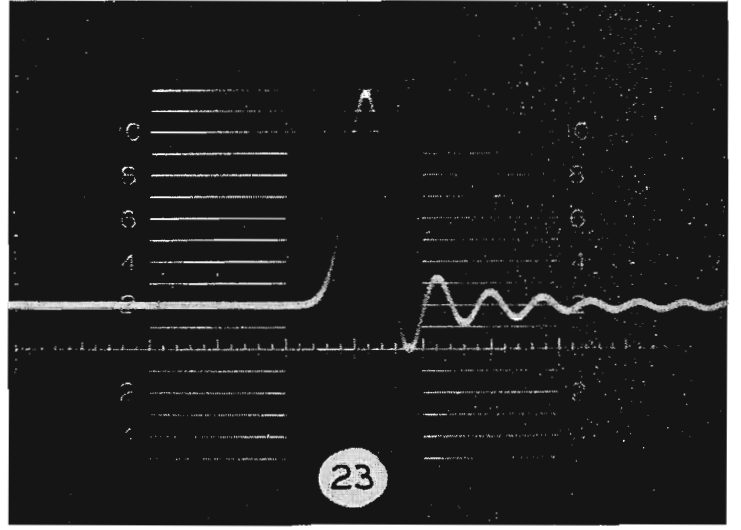
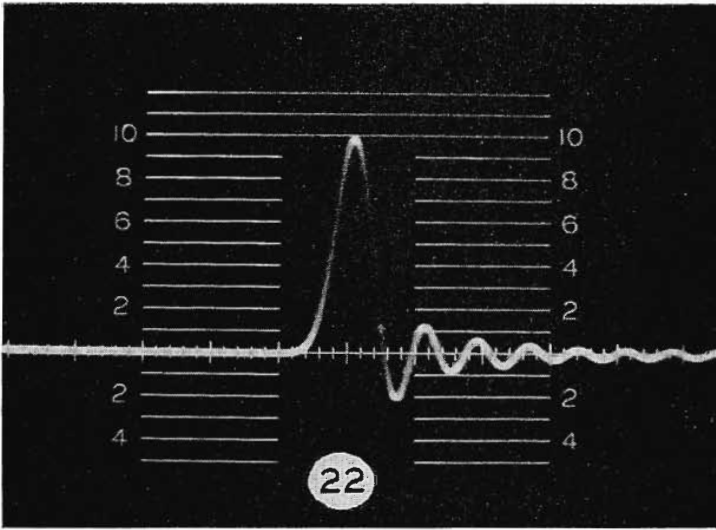

A few actual waveform photos taken recently show some of the many reoccurring problems. (Slide Nos. 23A, 24, 25, 26)

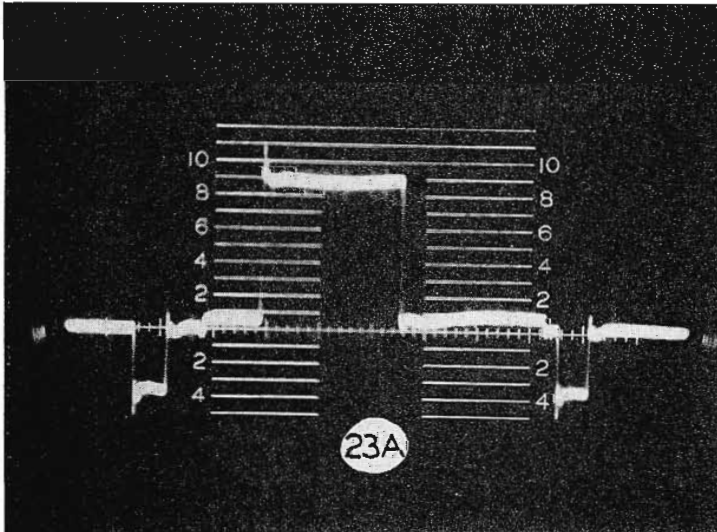

Slide No. 23A shows excessive spiking.

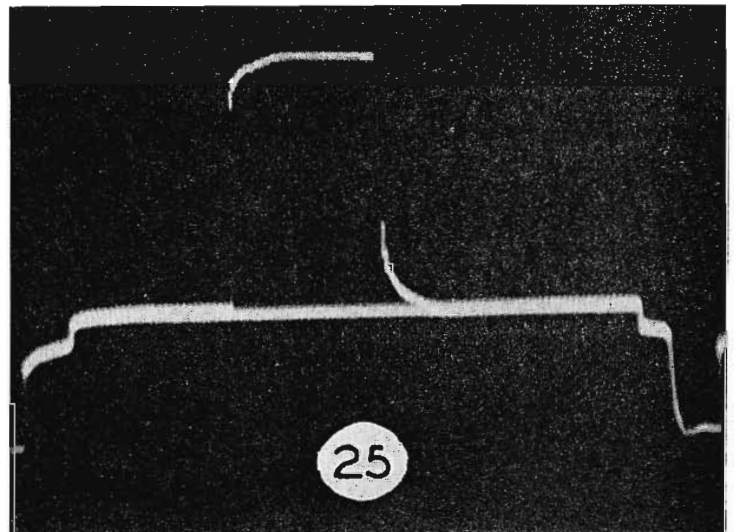

Slide No. 25 shows heavy positive-type streaking.

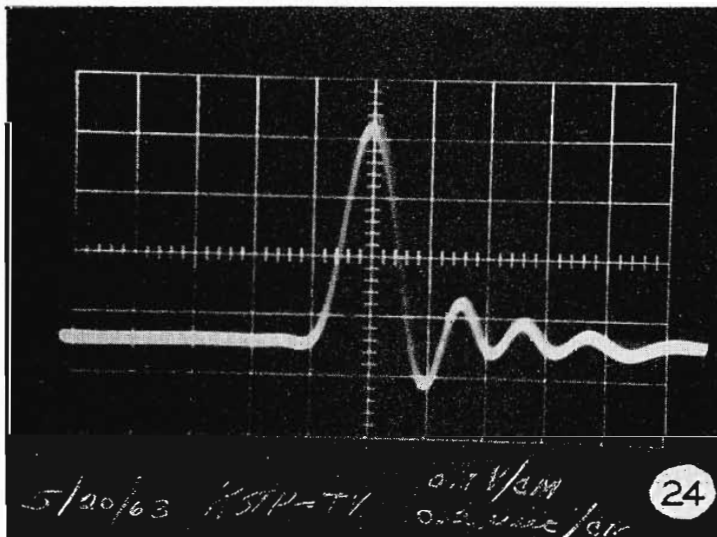

Slide No. 24 shows excessive ringing.

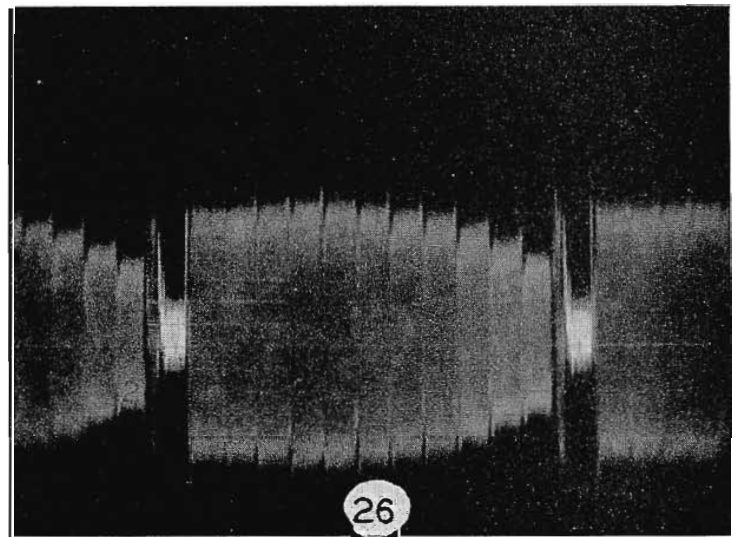

Slide No. 26 shows a large amount of differential gain.

An interesting photo is one sent from Indianapolis (Slide No. 27). It shows a usual ringing condition due to the L3 cable from Louisville to Indianapolis.

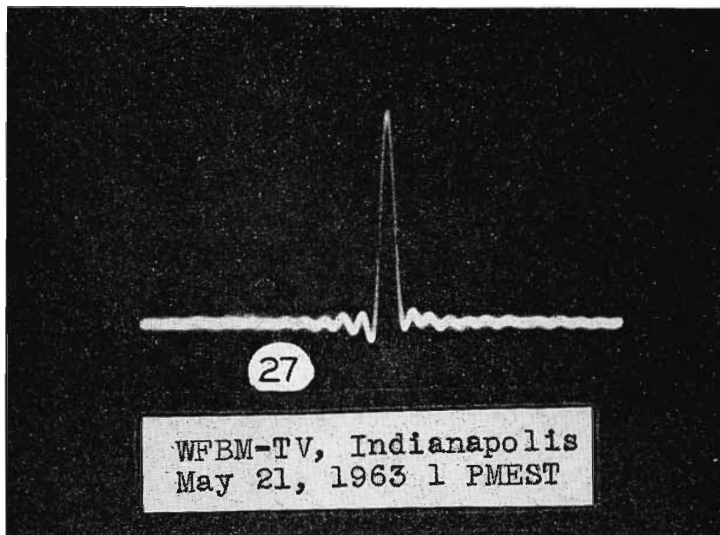

The next three photos (Slide Nos. 28, 29, 30) illustrate slightly better than average transmission. While not perfect, they do represent quite satisfactory transmission.

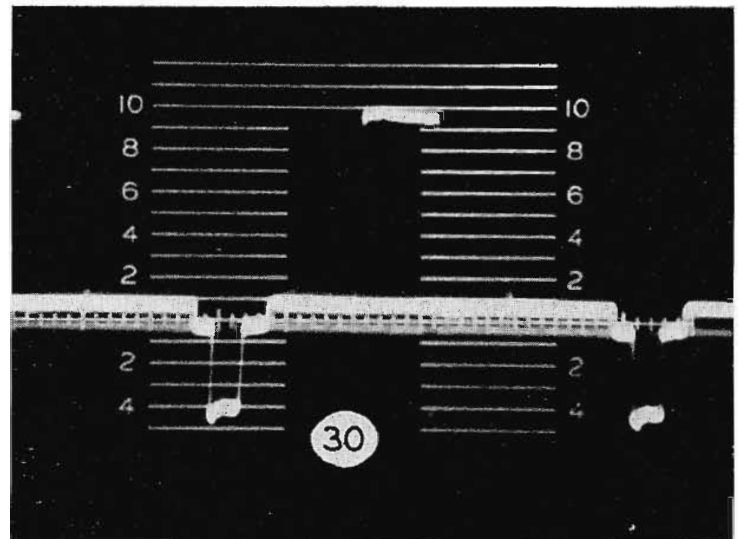
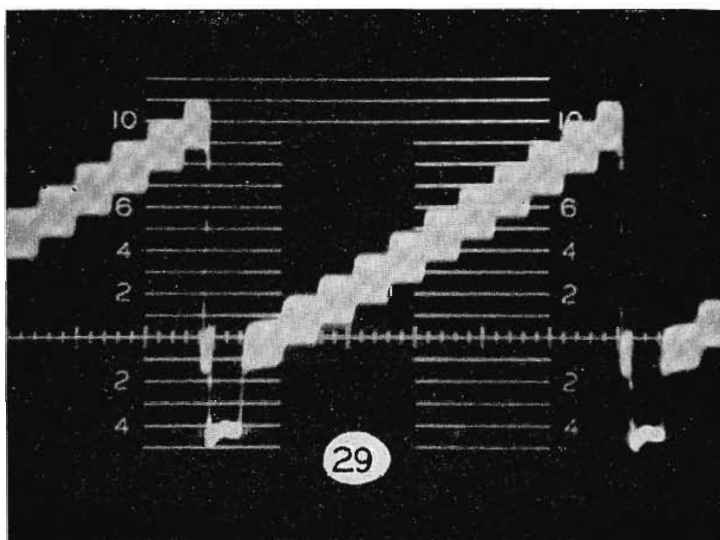
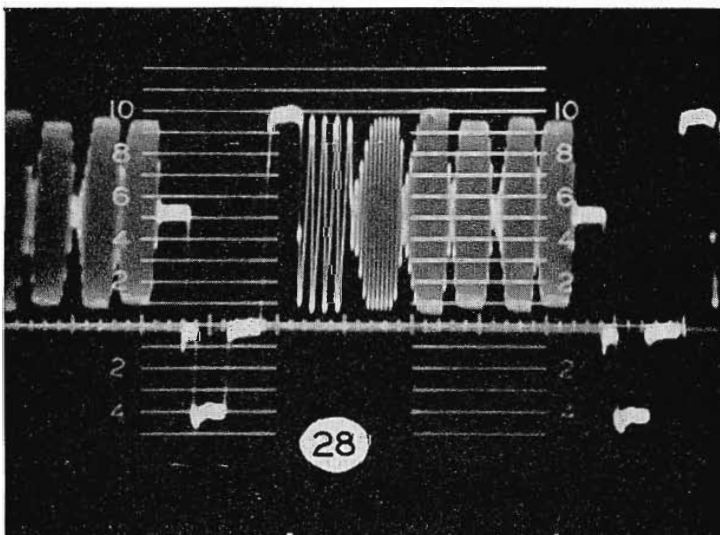

During the past year, we have discovered that colored outlines around the right side of objects were being experienced by a number of southern stations. Until quite recently, the stations believed these were a video tape phenomenon. However, it has now been established that the effect is due to network transmission, not the tape machines. It is due to out-of-band ringing being reduced in frequency to such a value that the ringing frequency will be within the chrominance pass band of the color receivers. When this happens, it will appear as several cycles of ringing on black and white receivers and as a colored outline on color receivers. The Bell System believes this to be due to a non-uniform delay characteristic of the microwave relay system.

Reporting Transmission Problems

When transmission impairments are noted, it is important that you notify the Telephone Company immediately. Don't wait! If possible, report the trouble while it is on the air. If the trouble continues, keep advising the Telephone Company as often as you feel the trouble warrants. Don't just sit and wait.

For instance, I was out in the field when DST started and heard 20 minutes of bad audio during one of our important evening shows. I was repeatedly told the trouble was located at the pickup. Upon calling New York, I learned it was o.k. there. Several phone calls later, it was admitted to be a telephone line problem. So be suspicious if a trouble persists.

If you do not receive a satisfactory answer or the impairment is not cleared in a reasonable time, then advise your network contact via TWX or telephone.

In addition to the verbal reporting, it is important and very helpful to us if you will take two sets of waveform photos of the network test signals. Send one copy to your Telephone Company contact (usually the Chief Testboardman or Video Supervisor) and send the other set via air mail to your network contact. Be sure to write on the back of the photos the station call letters, date, time, etc.

Chief Engineers should take the initiative and regularly visit the local TOC and become acquainted with their Telephone Company counterpart, usually the Chief Testboardman or Central Office Chief.

Checking Broadcasters Equipment

Experience has shown that if there is trouble in a TV plant it probably will be located in a stabilizing amplifier, STL link, TV transmitter, or associated input equipment.

I definitely recommend that converted TA5 stab amps, TA7A color stab amps, and colorized tenth watt microwave relay equipment be replaced or given the deep six treatment; They were good in their day—but their day has passed! The same thing holds for similar equipment made by other manufacturers.

Some stations use two stabilizing amplifiers, one at the control room and one at the transmitter. The stabilizing amplifier at the control room may be found to be in excellent shape while the one at the transmitter may be in trouble, or vice versa. One weak link in the chain can do a lot of harm to color. I recommend that if possible only one stab amp be used, probably at the transmitter. A variable gain amp on the incoming net feed will usually be satisfactory for control room use.

Stabilizing amplifiers should be completely routined every six months—*not just checked*.

Stations which are having trouble making video tapes of network signals due to horizontal timing errors following the vertical interval should check their stabilizing amplifiers and processing equipment. Slight timing errors on the network can be greatly emphasized by certain types of amplifiers, particularly those using regenerative clipping, and make the video tape unusable. It may be advisable to contact your manufacturing representative for modifications.

Receiver-type demodulators often give misleading results. They should be returned to the factory for re-alignment every two to three years, oftener if trouble is suspected. In fact, they shouldn't be trusted except when they are in agreement with the transmission line diode. It is preferable to use the transmission line diode when making differential gain and phase measurements.

The only way to be sure you are handling color programs satisfactorily is to set up a system of routine tests and see that they are carried out regularly. In addition to the usual daily check, a more comprehensive test should be made on a weekly basis. This test should be on an overall basis from the input to the control room to and through the TV transmitter. The three standard test signals—multiburst, stairstep, and window signals—should be used and waveform photographs taken at the transmitter output and given to the Chief Engineer. The amount of differential phase measured should be marked on the reverse side of the photo of the stairstep signal.

Since a large proportion of the distortion will usually be due to the transmitter, it is important that any degradation occurring in the control room and STL be held to a bare minimum.

Control rooms should be held to two degrees or less. The average transmitter can be held at 6.0 degrees. Some transmitters cannot meet this value; others can better it substantially. Certainly for good transmission, the overall differential phase should not exceed 10.0 degrees.

Differential gain should be held to 10 per cent if at all possible. If this value cannot be met, every effort should be made to meet it as closely as possible.

The amplitude-frequency response should be essentially flat; and to avoid ringing, it must not be peaked at the high frequency end. A roll-off tolerance of 10 per cent should be met if possible. However, from a practical standpoint, it may be difficult to meet a tolerance of less than plus or minus 10 per cent.

The window signal should not show any appreciable streaking, tilt, or spiking when using a good receiver-type demodulator at the transmitter. Low-frequency irregularities occurring on the top of the window signal should be of such a low amplitude as not to be visible in the received picture. Incidentally, the window and multiburst signals are excellent to use when checking video monitors for streaking and frequency response.

Color Monitoring

The following item was included in an engineering memo to all NBC Stations but applies to any station carrying color programs.

The recent increase in color programming and color bar transmissions during network test periods requires the use of good color monitoring equipment in control rooms.

There are two approaches to the problem of providing good color monitoring. One approach is to use a 21-inch color monitor. The other is to use a recent vintage color receiver and a video modulator of the I-F type. This latter approach is indicated where the cost of the video monitor might preclude its purchase. Also, the combination requires no modifications to be made to the receiver as the modulator is completely plug-in.

Final Remarks

It is the responsibility of the TV stations to see that they are transmitting color with a minimum of distortion. Many stations do not have adequate test equipment to properly routine their plants. Usually, this means that the station management is not convinced as to the necessity of spending money for test equipment or possibly the Chief Engineer has not been aggressive enough in convincing his management.

Routine maintenance doesn't necessarily cost more money, but it does call for careful planning, training, and efficient use of personnel.

It also is the responsibility of the TV stations to see that the incoming network signal is reasonably satisfactory. During last year's DST period, the B Network suffered very excessive hue shift for several weeks. If only one affiliated station had measured the differential phase and reported the trouble to us, it would have been remedied within a few hours. In other words—*don't blame the pickup for everything*; we have enough problems without being blamed for other people's problems.

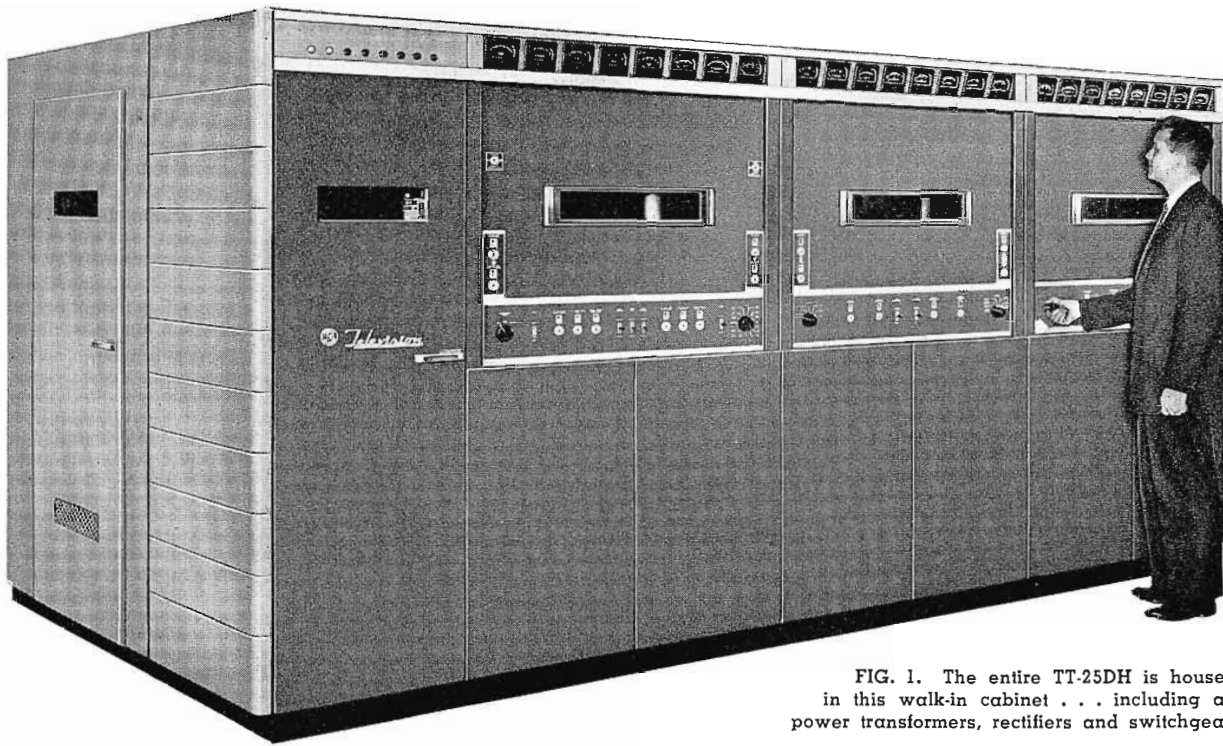

FIG. 1. The entire TT-25DH is housed in this walk-in cabinet . . . including all power transformers, rectifiers and switchgear.

NEW 25 KW HIGH-BAND VHF TELEVISION TRANSMITTER

TT-25DH Combines Top Performance with Low Operating Cost

by H. E. SMALL, *Broadcast Transmitter Engineering*

The new RCA Type TT-25DH Television Transmitter has the capabilities of a big transmitter while having the size and power consumption of a small transmitter. The reaction of veteran broadcast engineers is utter amazement at the small size and low power consumption, and what surprises them even more is that accessibility is far better than they have seen in large transmitters of equal power ratings.

Efficient Way to Maximum Power

The TT-25DH, in conjunction with an RCA type TW-15A Traveling Wave Antenna, presents an economical package that delivers the maximum ERP of 316 kw. This combination produces a sharp picture and uniform signal distribution throughout the service area. Absolutely nothing in the quality of the radiated signal has been sacrificed in this advanced design. In fact, some improvements in picture quality, which are especially noticeable in color transmission have been realized.

Requires Significantly Less Floor Area

Probably the most outstanding feature of the TT-25DH Transmitter is the little floor space which it occupies. The actual floor area required for this transmitter is approximately 60 percent of earlier 25-kw transmitters. In addition, the TT-25DH is

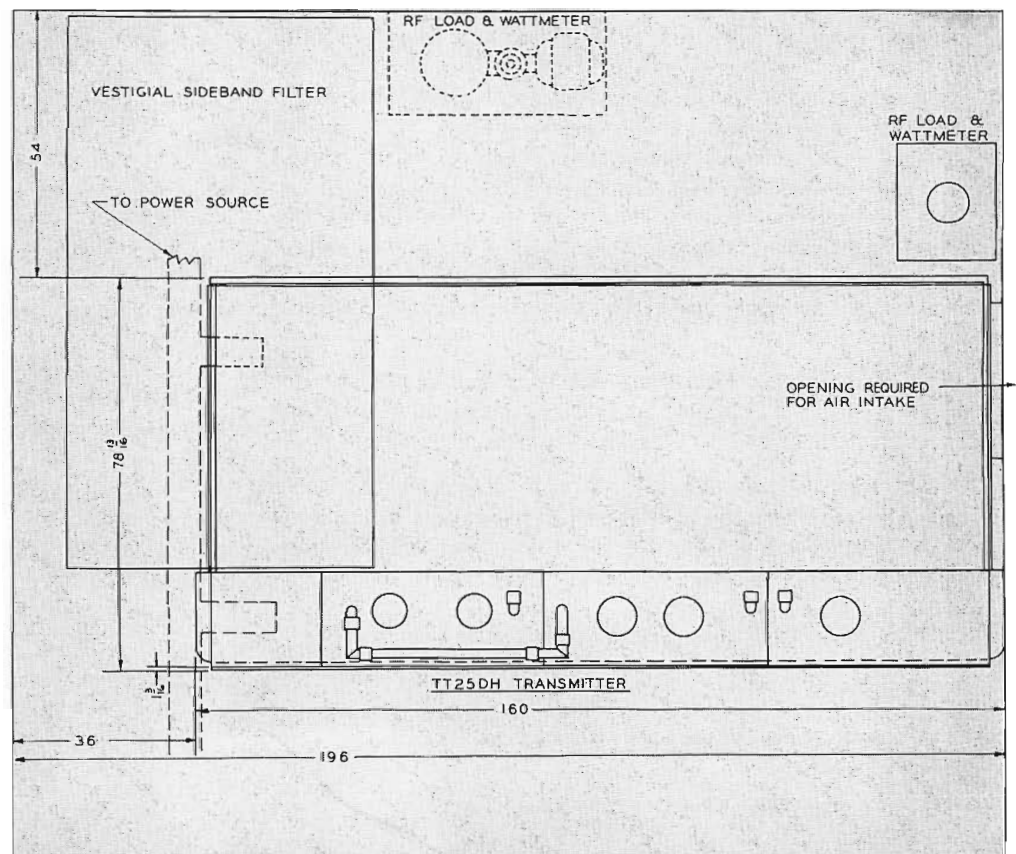

FIG. 2. Typical floor plan for the TT-25DH transmitter. Walk-in cabinet design reduces transmitter size without sacrifice of transmitter accessibility.

completely contained in one enclosure. There are no external transformers, blowers, or switchgear. This, of course, reduces the amount of interconnecting wire needed as well as eliminates many feet of wire trenches. Also, the walking space required around external components is eliminated; hence, it is possible to install two TT-25DH transmitters in the same area now occupied by most other 25-kw transmitters.

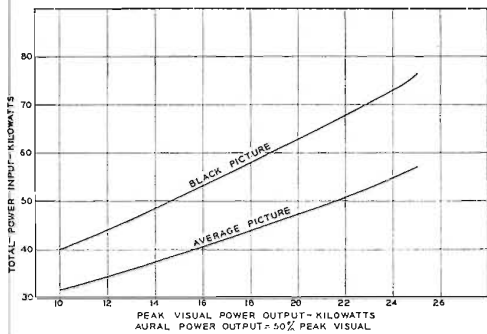

FIG. 3. Input-vs.-output power curve for the TT-25DH transmitter. Note that, at full power with an average-brightness picture, the TT-25DH draws only 60 kw of primary power.

Highly Efficient Circuitry Saves Power Expense

To the economy-minded station operator, trying to keep operating costs down, the large saving in power consumption is the biggest feature. The average power consumption of the TT-25DH is more than 30-kw below other 25-kw transmitters and more than 50-kw below the most efficient 35-kw transmitter presently available. A maximum power station operating 18 hours per day can realize a saving in power cost of approximately \$5500.00 per year by using the TT-25DH Transmitter and a high-gain antenna instead of a 35-kw Transmitter and a lower-gain antenna.

Minimum Tube Costs

In addition to the low power consumption, the cost of the TT-25DH tube complement is at least \$2000 below the tube cost for a 35-kw transmitter. This also represents a substantial saving in operating costs. It is estimated that the total saving in operating costs of the TT-25DH over a 35-kw transmitter would be in excess of \$7500 per year.

Silicon Rectifiers Increase Efficiency

The use of silicon diodes in all the power supplies of the TT-25DH contributes to the economy of operation as well as providing increased reliability. They also allow the transmitter to be operated at a lower ambient temperature than is possible with mercury-vapor-rectifier tubes. Under normal conditions, the silicon diodes never

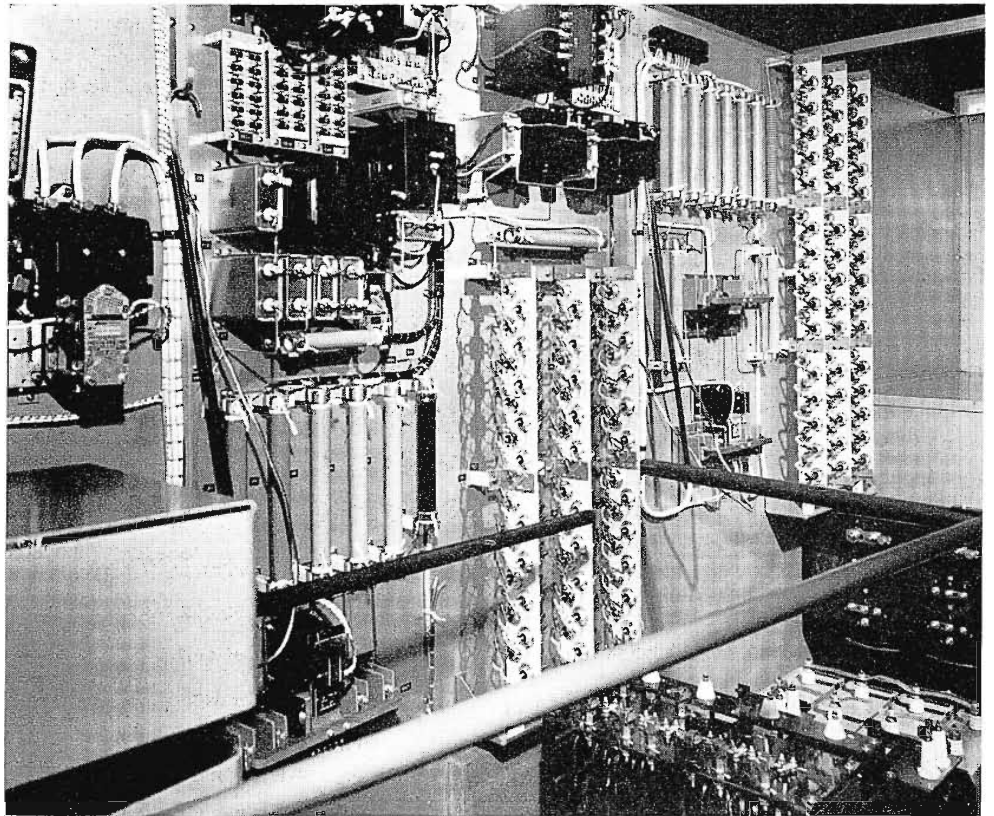
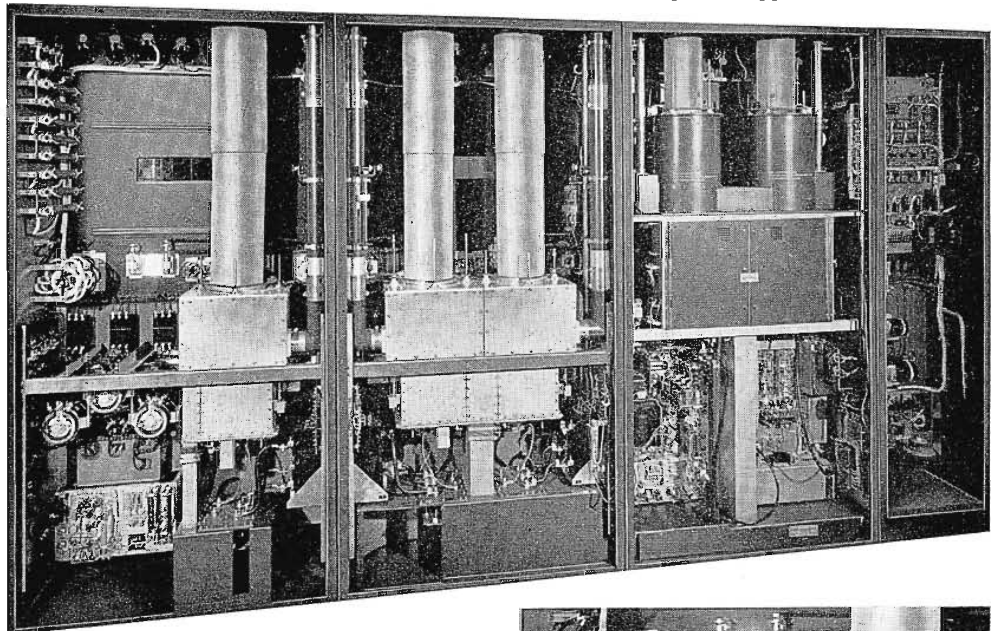

FIG. 4. The interior of the rear panel of the TT-25DH transmitter. Power components located on the floor; silicon rectifiers and other smaller components occupy the panel in full view.

FIG. 5. Rear view of the "front-row" cabinets. These contain all of the r-f circuits of the transmitter. Final amplifiers appear at left of center.



have to be replaced. This feature helps reduce operating costs and also reduces the possibility of lost air time. High-voltage transformer failures have resulted from mercury-vapor tube faults. This type of transformer failure is eliminated by the use of silicon diodes.

FIG. 6. Separate operation of the two visual power amplifiers is afforded by the power-change-over switch shown at upper left.

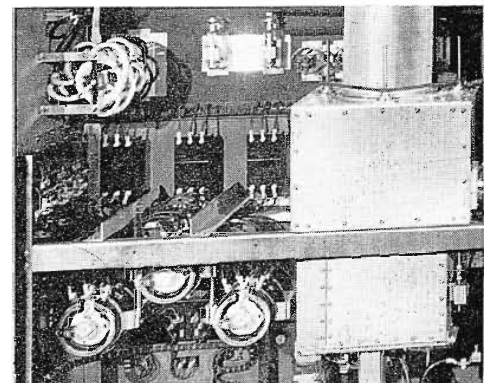

The use of common power supplies in the TT-25DH contributes to the high efficiency and small size of the transmitter.

High-Voltage Transfer Switch Standard Equipment

A high-voltage transfer switch is provided to facilitate the removal of plate and screen voltages from any of the three final amplifiers. This switch provides for quick removal of voltages in the event of a tube or circuit failure and also simplifies the tune-up procedure.

5-Kw Driver System

The TT-25DH Transmitter is basically an RCA TT-5BH¹ Transmitter driving a visual linear amplifier and an aural Class "C" amplifier to deliver 25 kw peak visual power and 13.6 kw aural power. A single

be 25 percent of normal. If the combining diplexer is by-passed, the output will be 50 percent of normal with only one amplifier in operation.

Another advantage is that a much better impedance match can be maintained on the driver output by driving the two amplifiers 90 degrees out of phase. Any reflections from the two amplifiers arrive back at the diplexer 180 degrees out of phase. Only half the difference in the reflected power goes back toward the driver and the remaining half goes to the reject load.

Improved Color Transmission

Since the two visual amplifiers are driven 90 degrees out-of-phase, a phasing section of line is added ahead of the combining diplexer so that they are combined in

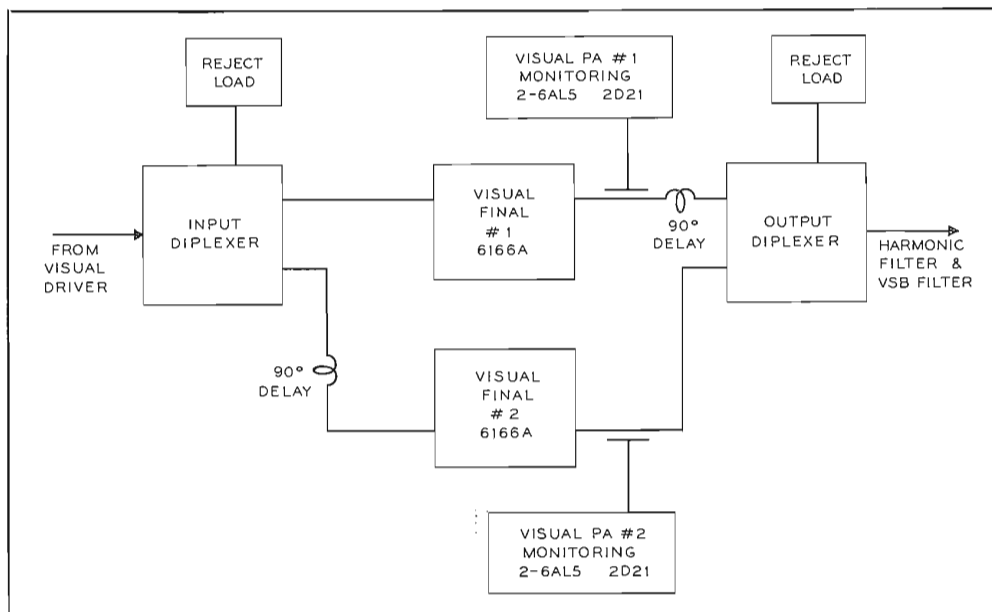

FIG. 7. Block diagram of the visual finals in the TT-25DH transmitter. Diplexing improves the reliability of the transmitter.

type 6166A tube is used in the aural power amplifier. Two 12.5 kw amplifiers, each employing a type 6166A tube, are diplexed externally to form the 25-kw visual power amplifier.

Advantages of Diplexed Amplifiers

There are several advantages in using two separate amplifiers instead of a single amplifier with two tubes. The greatest advantage is probably that should one amplifier fail, the other can still be operated. It is possible to continue operation on one amplifier without transmission-line switching. The output power, in this case, would

¹"New 5 KW VHF Television Transmitter" *Broadcast News*, Vol. No. 112, December, 1961.



FIG. 8. The Type 6166A ceramic tetrode. The TT-25DH uses three (one aural; two visual) of this tube type as power amplifiers. The aural operates Class "C", the visual, Class "B".

FIG. 9. Block diagram of the TT-25DH exciter. Tight-tolerance control of the aural/visual carrier separation improves color-TV performance.

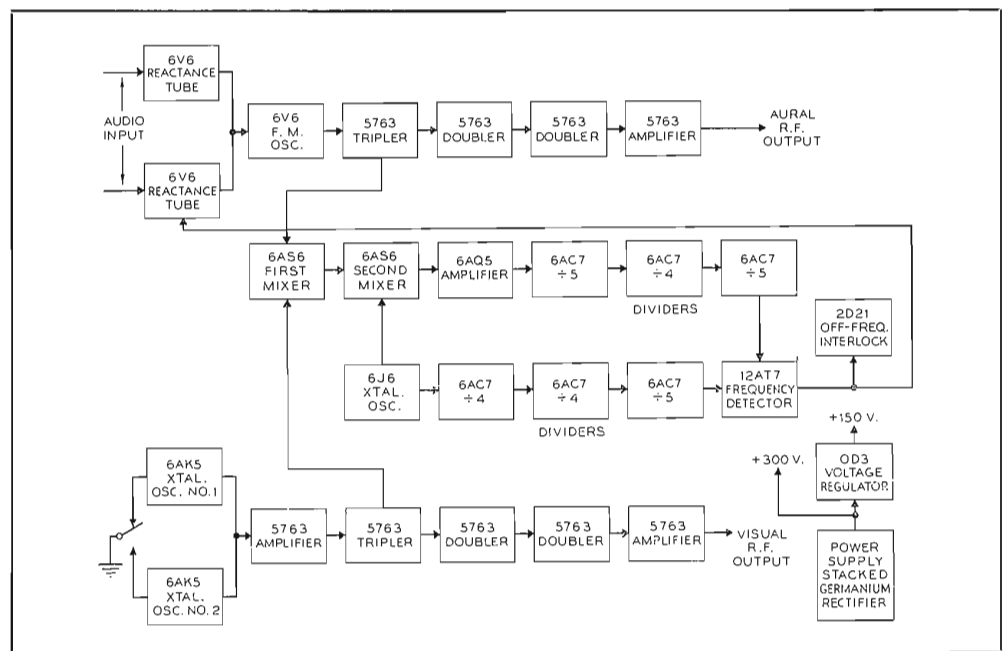

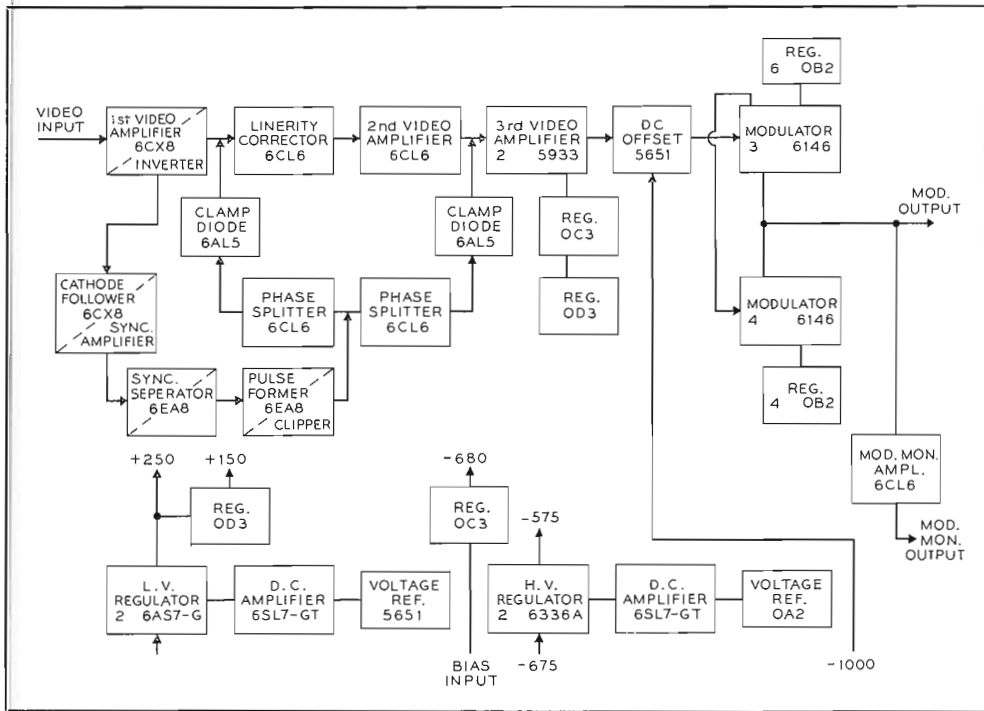

FIG. 10. Block diagram of the visual modulator used in the TT-25DH. Linearity-correction overcomes the gray-scale distortion to improve picture contrast and gray-scale rendition.

Very Low Hum Level

The extremely low hum level on the visual carrier is another feature of the TT-25DH which results in a noticeable improvement in color picture quality. Experience has shown that hum which is only 40 db down is objectionable in a color picture; hence, a specification of -45 db was set for the TT-25DH. Test results show that the actual hum level is well below this specified level.

Additional Features

There are many features which have become standard in the current RCA line of modern TV transmitters and which are included in the TT-25DH. Some of these features are: built-in remote control provisions, linearity correction in visual modulator, accurate intercarrier frequency control, and complete overload protection with convenient indicators for localizing troubles.

Top Performance and Economy

The new TT-25DH Transmitter offers the broadcaster the opportunity to save money on initial equipment costs, on building-space requirements, on installation costs and on operating costs. The dependability, accessibility, and ease of operation also represent great savings over a period of time. The improved picture quality is an added bonus at no extra cost. When remote control of television transmitters is approved, another great saving can be realized, since this transmitter is ready for remote control.

phase. A further advantage obtained from this arrangement is that any reflections which come back from the antenna and are reflected back toward the antenna from the output circuits, arrive back at the combining diplexer 180 degrees out of phase and are absorbed by the reject load. Thus, the possibility of retransmitted ghosts is greatly reduced. The quality of color transmission is particularly enhanced by this feature since ghosts are much more noticeable in a color picture.

Design Avoids Multiple-Tube Problems

One of the main problems encountered in a multiple-tube cavity is the unbalance between tubes caused by slightly different tube characteristics. This results in shortened tube life for the tubes which are carrying more than their share of the load. By using separate cavities, as does the TT-25DH, the tuning can very easily be adjusted to compensate for tube variations so that the load is shared equally between the two amplifiers.

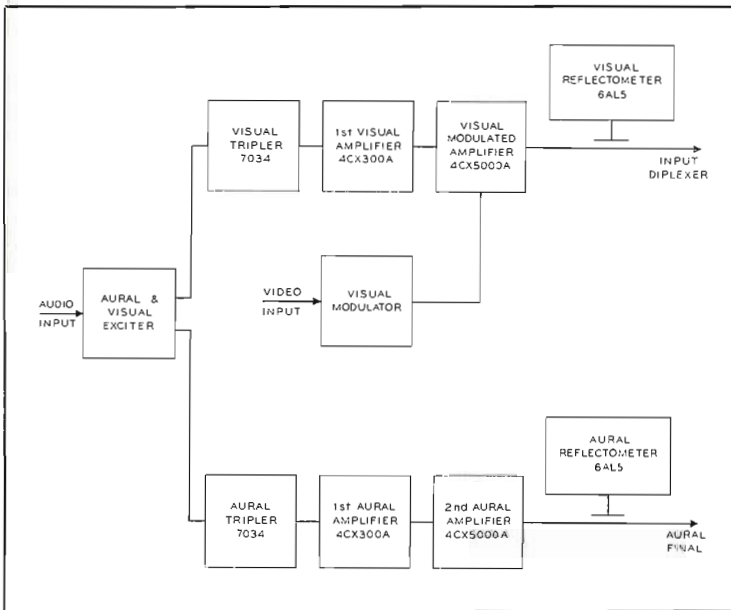

FIG. 11. Block diagram of the TT-25DH driver system. Capable of a full 5-kw visual output, the driver operates at approximately 60 per cent of capability in normal operation.

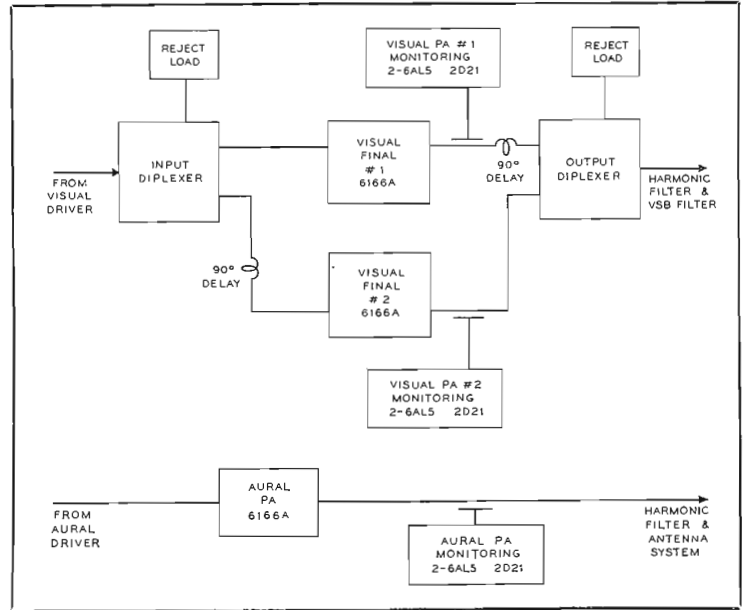
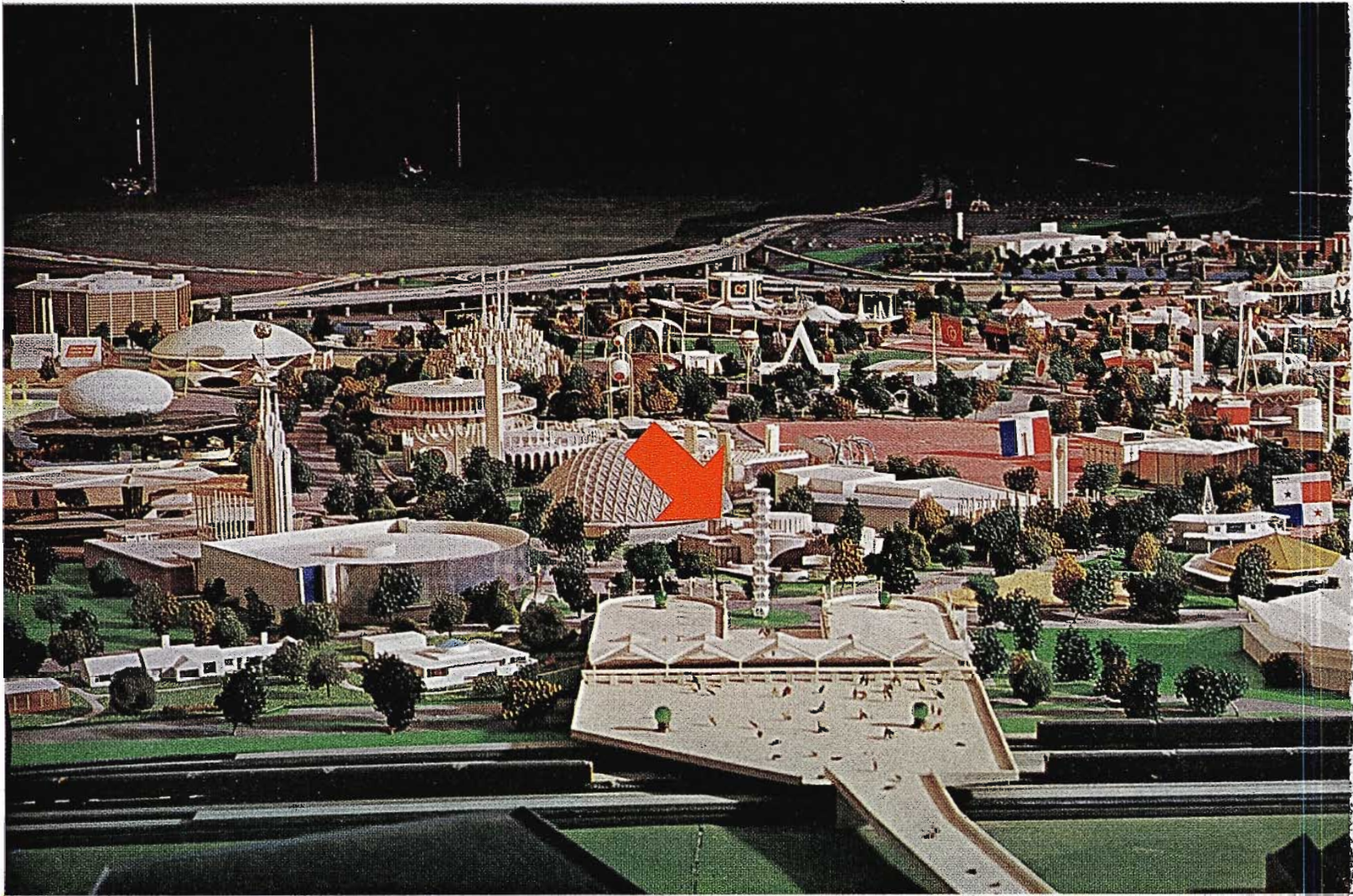

FIG. 12. Block diagram of the power-amplifier portion of the transmitter. Duplexed amplifiers increase transmitter reliability and better overall transmitter performance.



RCA AT THE FAIR

RCA Exhibit Building Designated by the Fair Corporation
As the Official World's Fair TV Communications Center

by J. M. TONEY, *Director*

R. H. EDMONDSON, *Mgr., Engineering*

RCA World's Fair Exhibit

Seventy million people (give or take a few million) will pass through the turnstiles to the New York World's Fair during the 1964 and 1965 seasons. More than half of them will enter through the gate nearest the Long Island Railroad and Subway station. And as they enter through this gate, the first thing to catch their eye will be the RCA Exhibit Building directly facing the entrance.

It will be a good place to start—for this RCA exhibit has been designated by the Fair Corporation as the Official World's Fair TV Communications Center. In this

fully equipped color TV studio visiting dignitaries will be received, special "events-of-the-day" will originate, and lost children will be televised. From it a Fair-wide closed-circuit color network will carry these studio programs—plus film and tape depictions of fair activities, and programs picked up by a roving mobile color TV unit—to receivers in locations throughout the fairgrounds.

Visitors to the RCA Exhibit will be able to see it all happen. The color TV studio and associated control room will be completely encircled by walls of glass. In this

giant "fish-bowl" every facet of the operation will be visible. Performers, camera men, prop boys, control room operators, directors and recording engineers—all will be in full view, all of the time. And while they watch the cameras in the studio, visitors can simultaneously see the picture on color TV sets at locations about the periphery of the studio. They can also see themselves in color, not only live but also as taped and played back for them after they have left the on-camera spot.

Making all of this practical and convenient for thousands of visitors per day re-

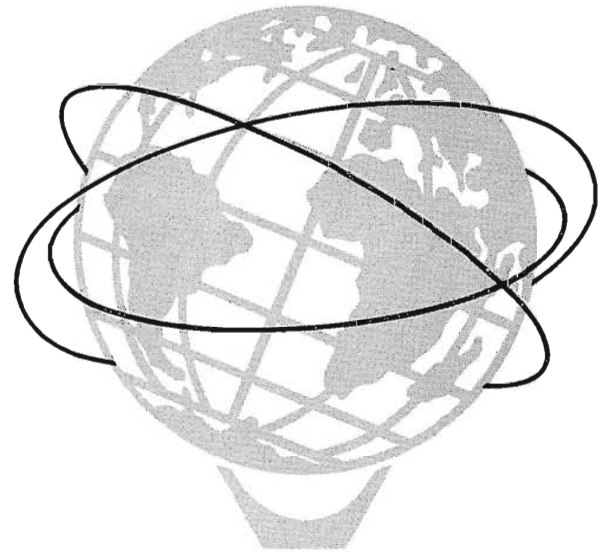
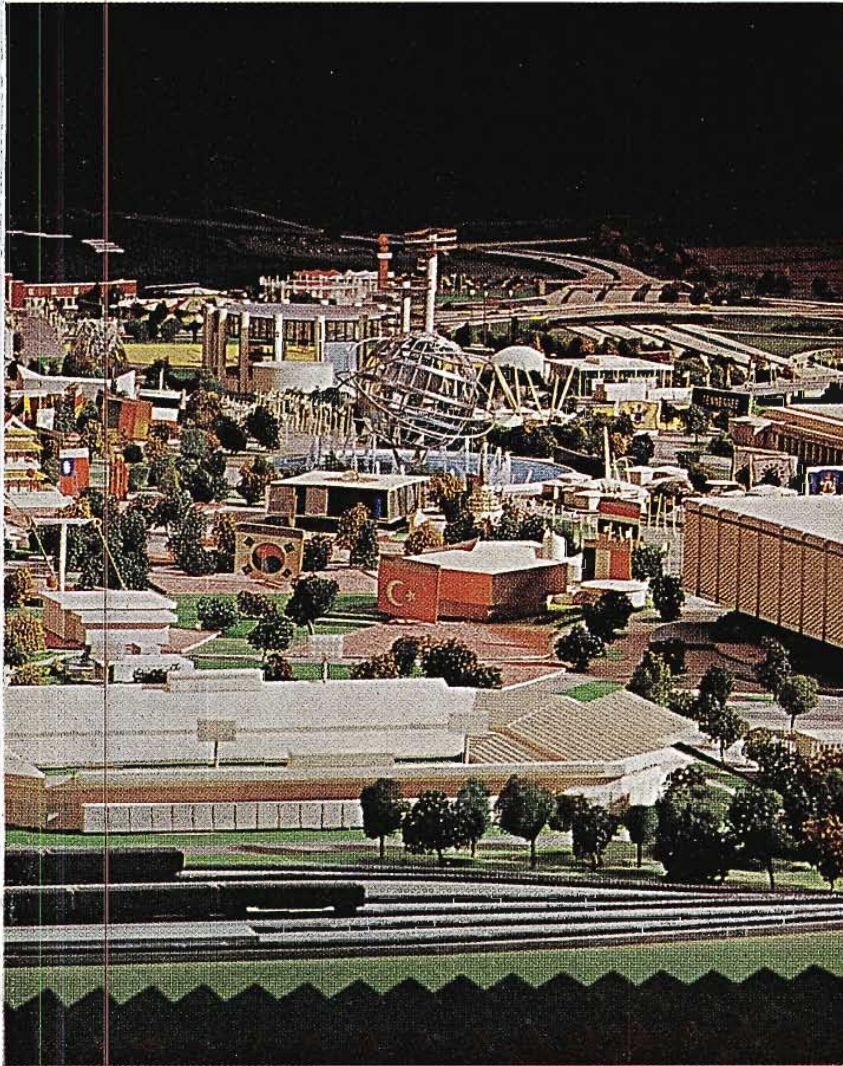

© 1961 New York World's Fair 1964-1965 Corporation

Left: This color photo of the official model of the 1964 New York World's Fair shows the strategic location of the RCA Exhibit Building (indicated by the red arrow). It directly faces the entrance gate from the Long Island Railroad Station (bottom of photo) and the overpass from the World's Fair subway station which is just off the bottom of the photo.

quired the design of a very special building. It had to be efficient and functional for the services to be performed—but, equally important, it had to give maximum consideration to visitor traffic flow. RCA engineers, designers and architects worked on the plans for over a year. As they neared finalization of their drawings, they built scale models of the building and of the studio, control room and reception areas. They furnished these with detailed models of the equipment, and peopled them with operators and visitors to scale. They arranged, re-arranged and re-arranged until they were satisfied that they had the optimum utilization of space and facilities. Then they started the building—a building which probably will be one of the most unusual exhibit buildings in the fair—and which certainly will be the most unusual TV studio building anywhere.

Photographs of the models, floor plans and diagrams, on this and following pages, show how this Alice-through-the-looking-glass building will look, how it will be arranged and how it will operate.



Above: Model of the RCA Exhibit Building as it will appear to visitors entering through the gate from the rail and subway stations. The building is made up of a number of cylindrically shaped functional areas. From the exterior these have the appearance of giant drums with sparkling white tops and gleaming copper sides. In addition to the exhibit-studio building RCA will have a Color Mobile Unit (right) to make TV remote pickups anywhere at the fairgrounds.

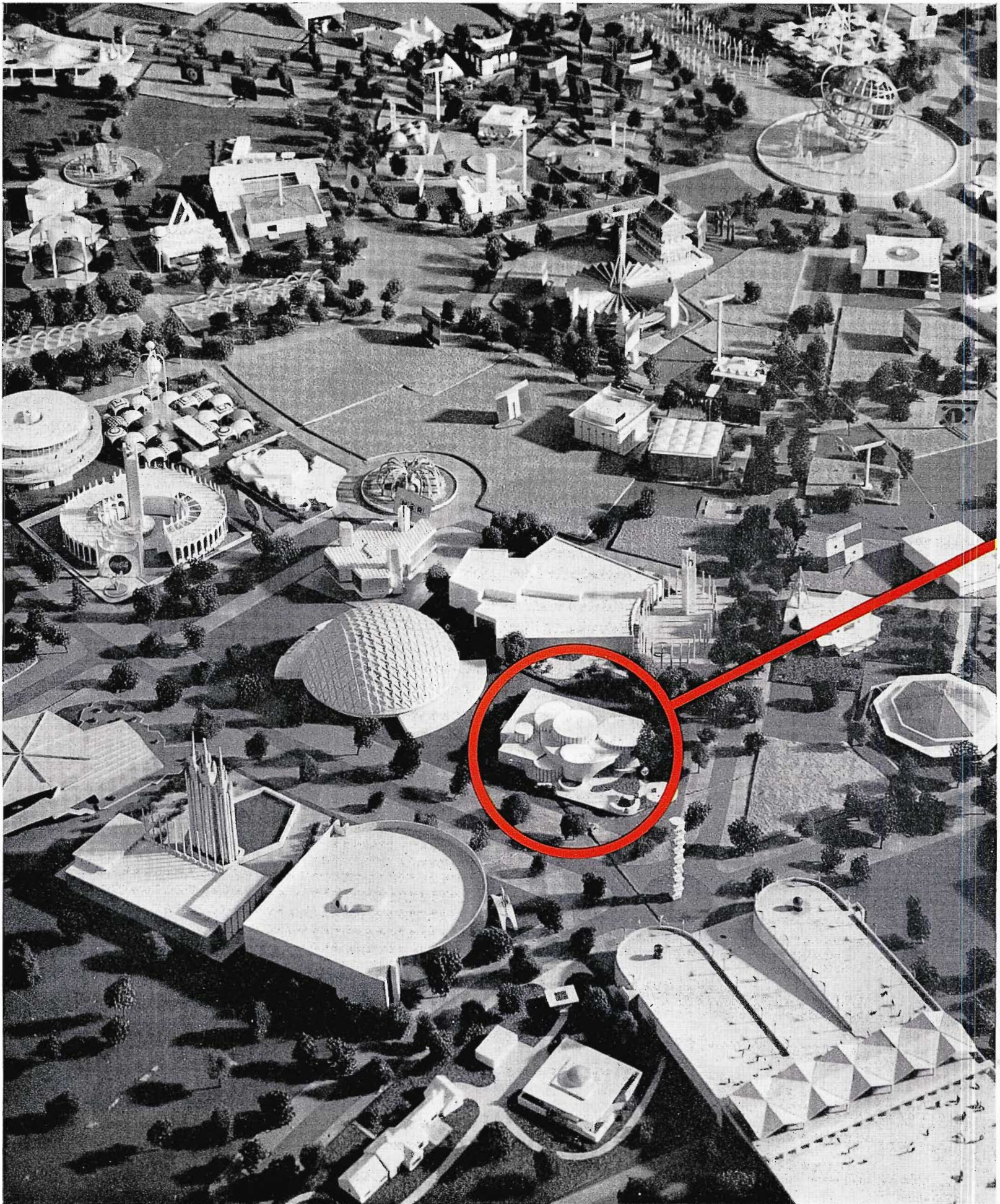

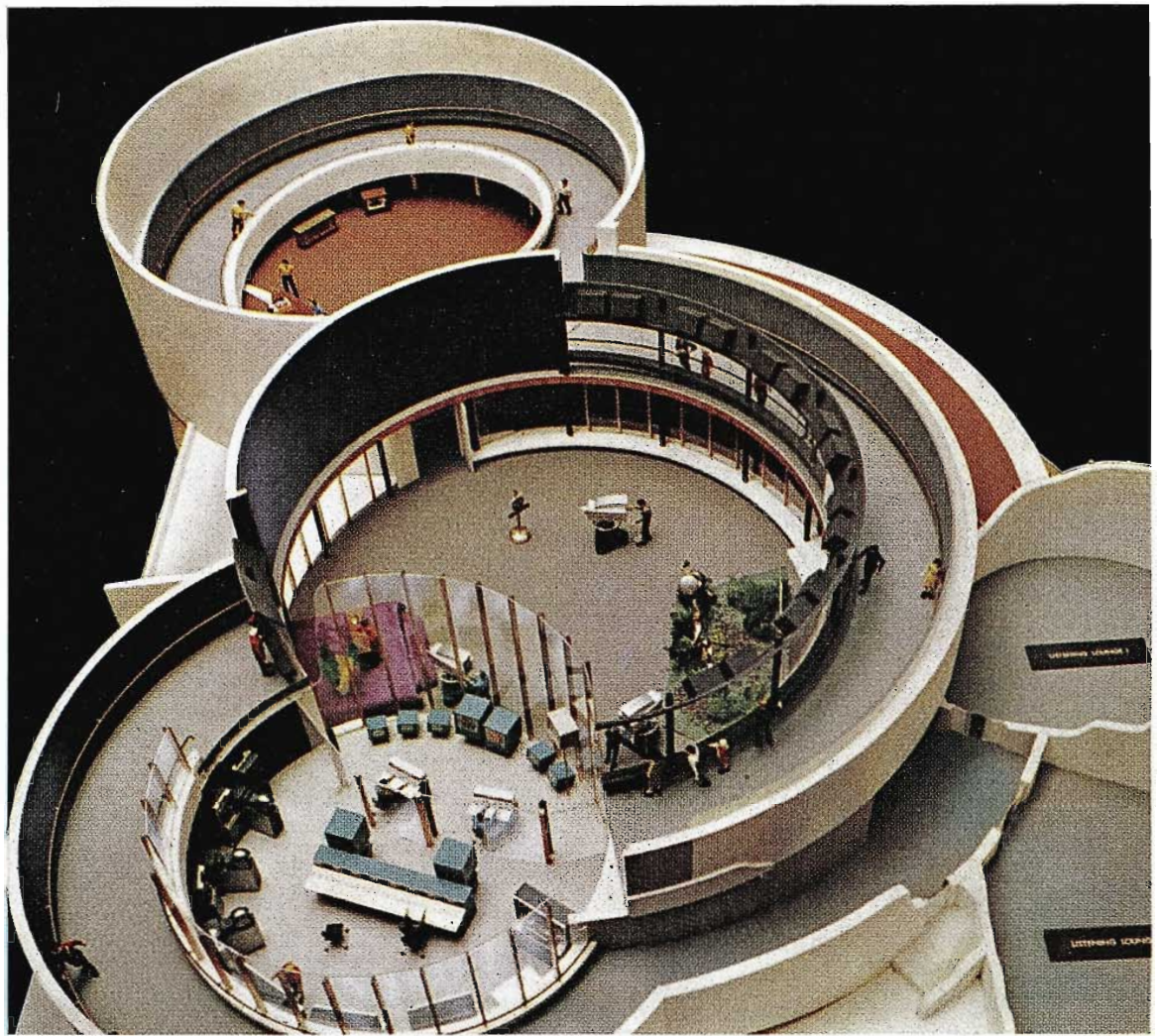
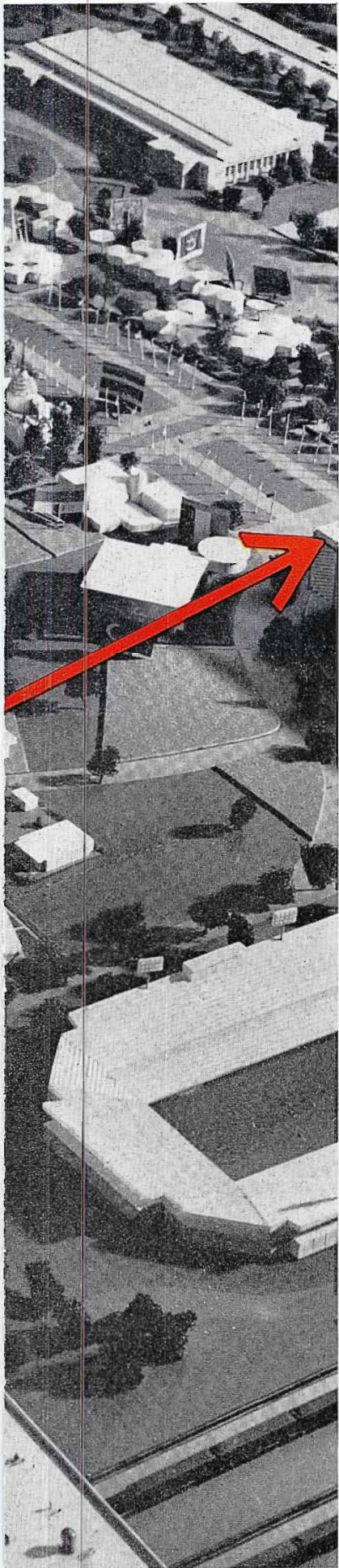

This elaborate Color TV Studio and Control Room is a feature of the RCA Exhibit Building (circled in red on opposite page).

TV Program Center in Centrally-Located RCA Exhibit Will Distribute Live, Tape and Film Color TV Programs by Closed-Circuit to 200 Points Throughout the Fairgrounds

The beautifully designed and equipped color studio facility shown above is the main feature of the RCA Exhibit. From this focal point in the centrally located RCA building video lines will radiate to every major exhibit and concession in the Fair. To this closed-circuit network will be fed continuous color TV programming . . . most of it Fair-oriented. Some of it will be "live" from the studio—some tape and film. It will include not only appearances of celebrities and other entertainment features but also information on exhibitors, buildings and special attractions of the day. It is felt that such a service will be of public interest, since very few Fair patrons will be able to spend the three weeks necessary to see all the Fair has to offer. The World's Fair Corporation itself will use five minute of every hour for announcements.

All told, more than 2000 hours of programming will be fed to the closed-circuit network during each season's operation. Much of this will be "live" from the RCA color TV studio. However, when the studio is being used for rehearsal, or the studio activity is not appropriate, the network will be fed from taped or filmed programs. To provide for this, very elaborate film and tape facilities have been included. Also planned is a mobile unit which, in addition to color cameras, will be equipped with color taping facilities. The mobile unit can pick up a program at any point on the grounds and send it by video cable (permanently installed to many points) or it can tape record for later feed to the closed-circuit network. Thus, programs from other exhibitors locations can be done "live," or they can be taped for re-use at intervals during the fair.

. . . A Color Television Studio Arranged So Visitors Can See Every Part of the Operation

Planning a TV studio so that visitors can see everything that goes on is a near impossibility—as every TV station engineer who has tried it well knows. Some stations have visitors galleries from which a select few can see most of the action. Some have auditorium-type studios where several hundred can see part of the operation. But what do you do when you expect up to ten thousand visitors a day—and you want all of them to see everything that goes on. That was the problem the designers of the RCA Exhibit Building faced. How they solved it is shown by the pictures of the building models on this page—and the floor plans on the opposite page. To begin with they designed a round studio, totally enclosed by glass. Ditto the control room. They intersected the two for good visibility between. Then they provided an elevated gallery all the way around the studio so that visitors could see down into the studio—rather than having to peer through cameras and props at floor level. At the end of the gallery they put a bridge over the control room and a ramp down around it—so that visitors can see every foot of it. They made the up-ramp into a reception area and added listening rooms for stereo and hi-fi and a small office space. They put walls around it, and that was their building—functional, efficient and intriguing, especially to broadcasters who may find in its design some ideas they can use. What they put in this building is shown on following pages.

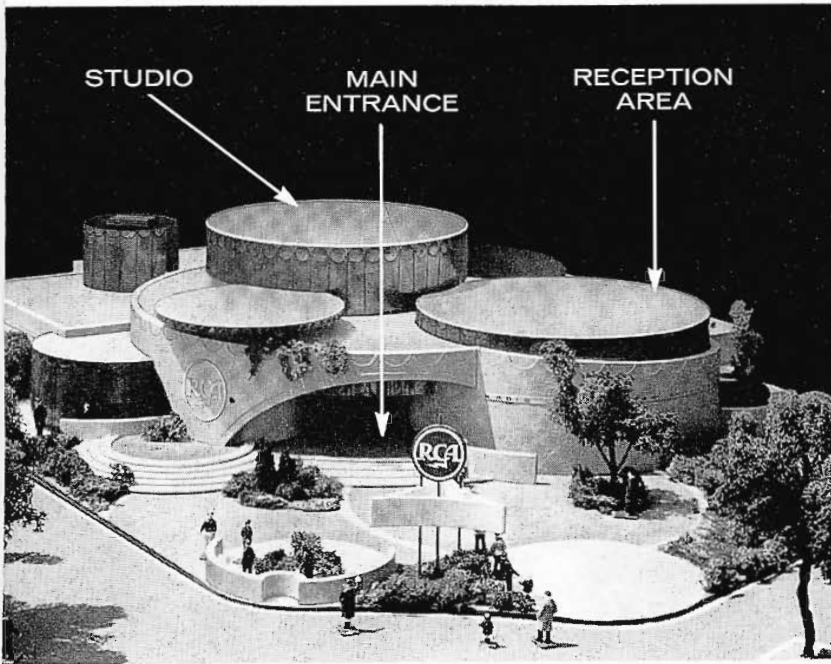

Above: The RCA Exhibit Building from the outside. The two biggest "drums" are actually the tops of the cylindrical studio and reception areas within the building.

Below: The same circular motif is carried out in both the external and internal designs. This is a view of the inside of the building model showing the studio area (center), the control room area (left), and the reception area (right). Corresponding floor plans are shown on the opposite page. For this photo the bridge over the control room was removed to give a better view of the floor area.

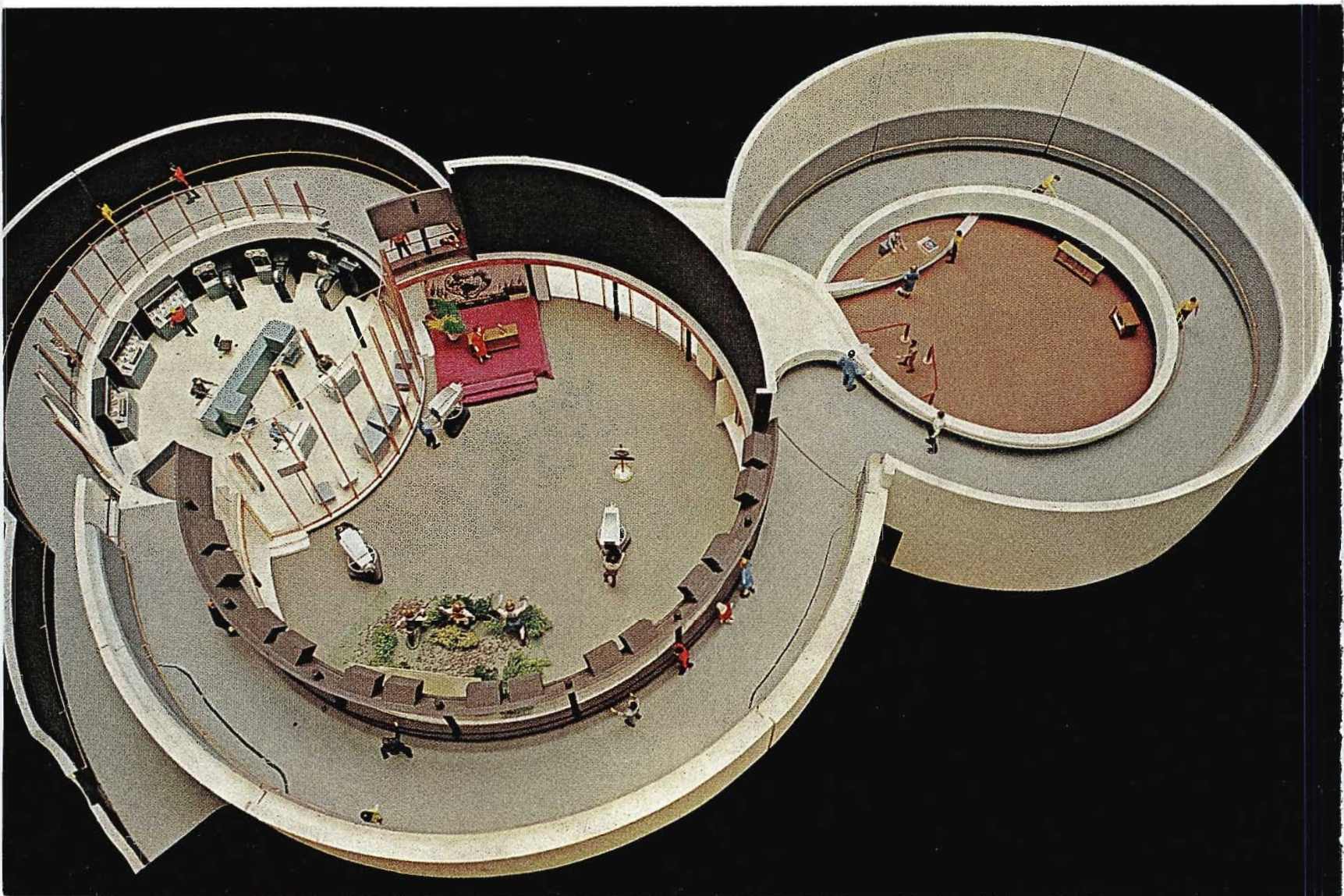

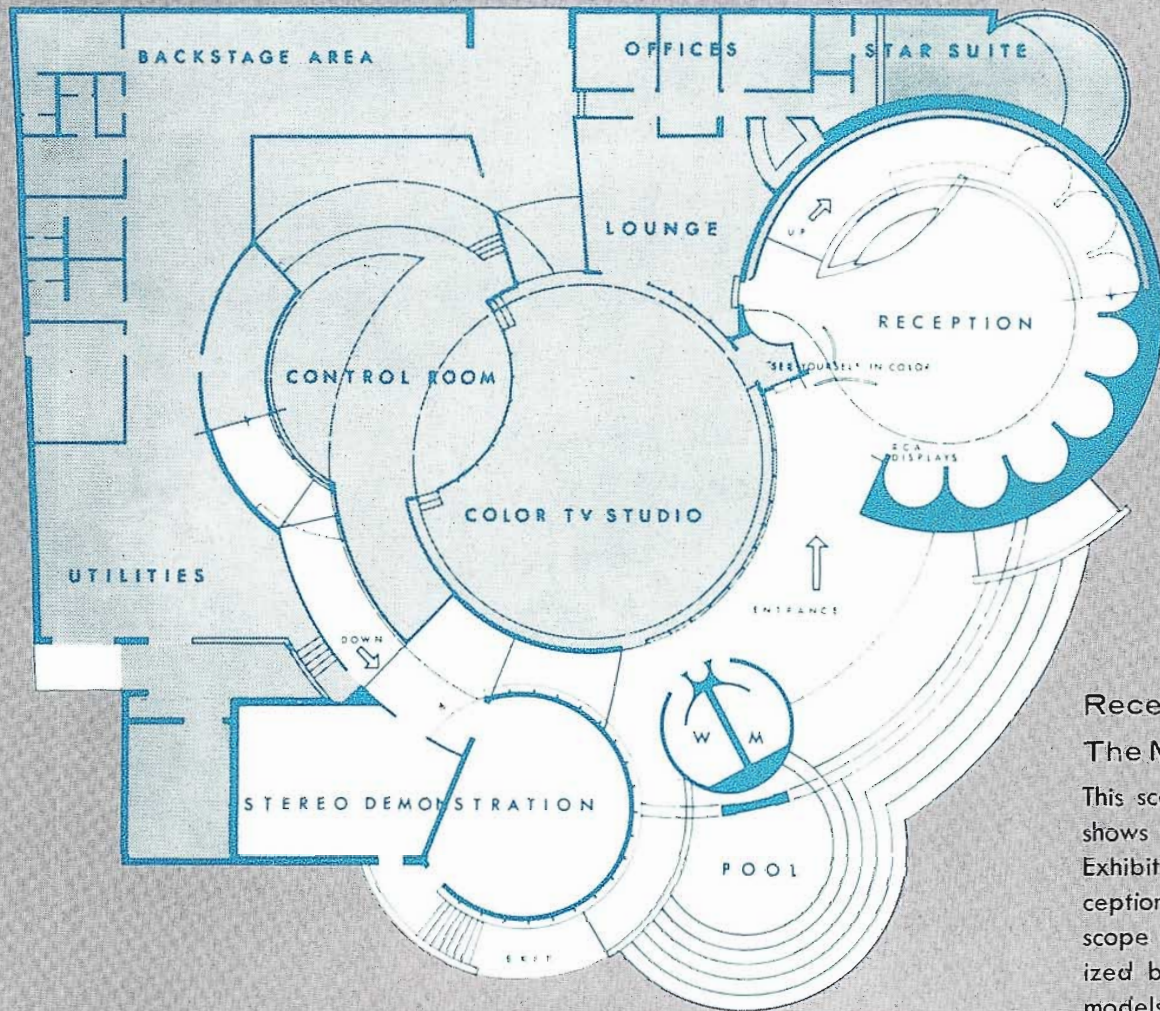

Reception Area Depicts The Many RCA Products
 This scale plan of the first floor shows how visitors to the RCA Exhibit will enter through a reception area in which the broad scope of RCA products is visualized by color illustrations, scale models and product exhibits.

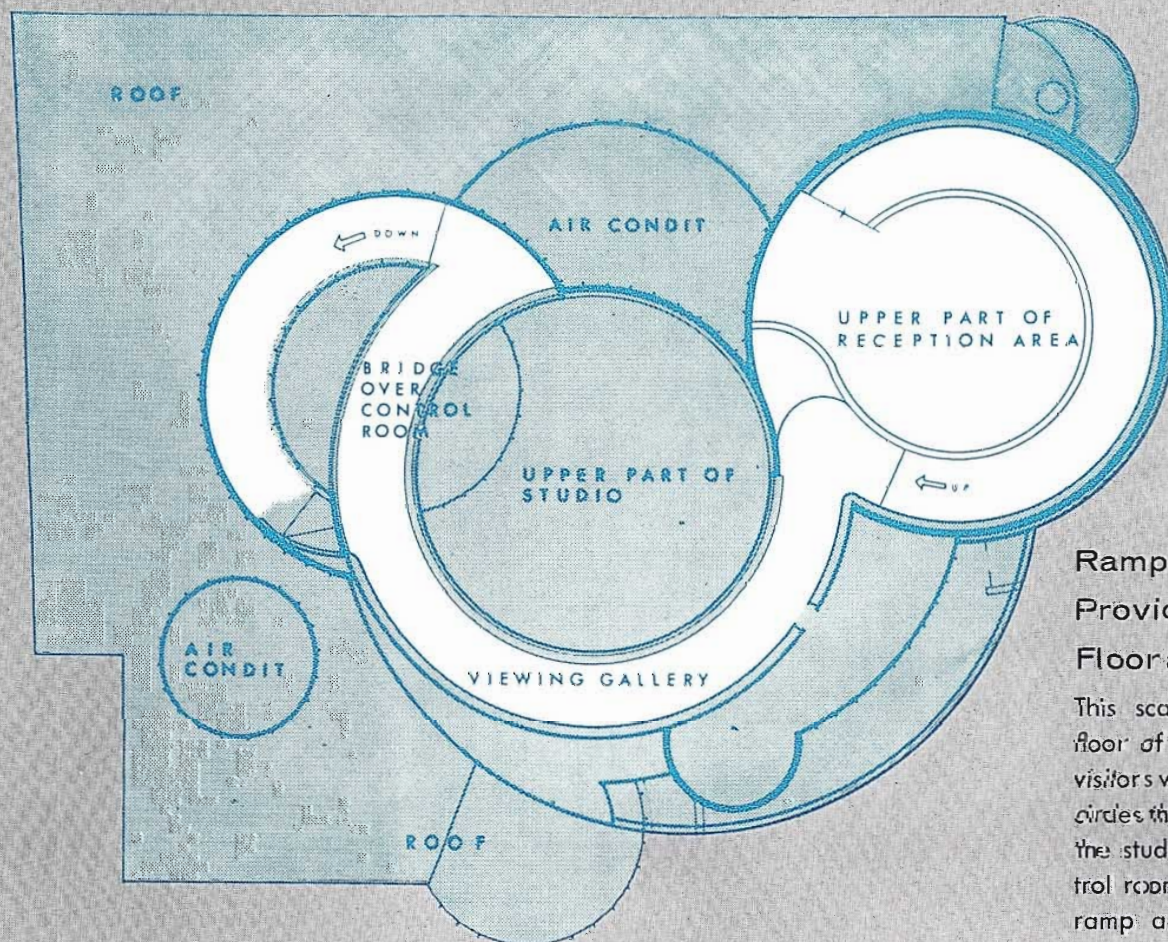

Ramp Leads to Gallery Providing View of Studio Floor and Control Room
 This scale plan of the second floor of the building shows how visitors will go up the ramp which circles the reception area, around the studio gallery, over the control room bridge, and down the ramp around the control room.

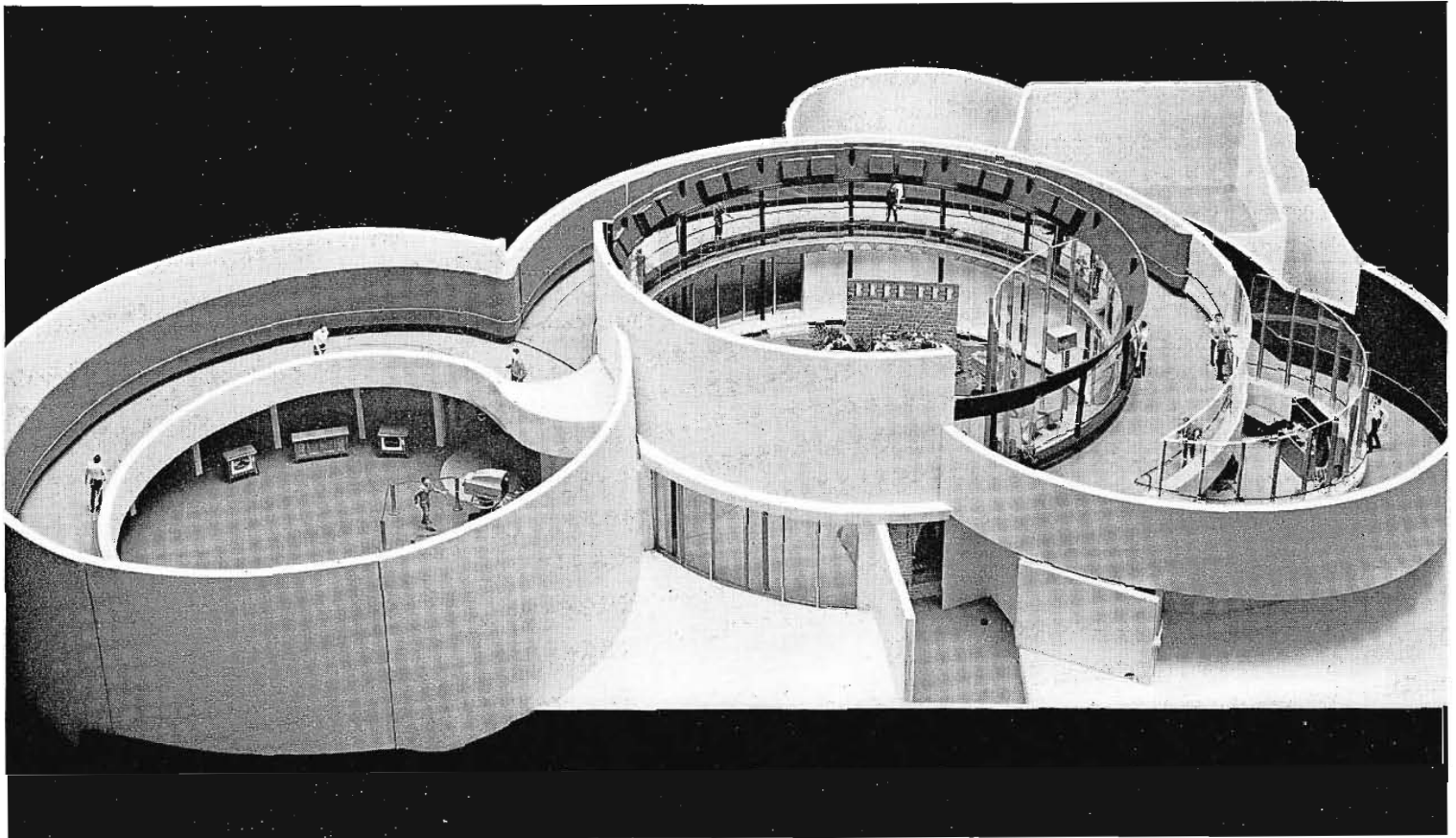

In this rear view of the interior of the building model the bridge over the control room is shown in place. Also visible here is the See-Yourself Color Camera just inside the entrance to the reception area (left center). Office sections of the building are not shown in this model.

Visitors Will See Themselves in Color – Live and Tape

The opportunity to see themselves on television is one few people can pass up. For years it has been the most popular feature of RCA exhibits the world over. At the 1964-65 World's Fair visitors will see themselves in color—and there will be an added attraction. Not only will they see themselves as they stand in front of the camera—they will also be able to see a “delayed” broadcast of their appearance. This will be accomplished by the use of two RCA TV tape recorders operating in tandem (see diagram at right). One will continuously record the picture from the “see-yourself” camera. The tape so recorded will pass through a “delay” path to the second recorder which will play back the picture at a fixed time interval (which may be adjusted from 5 seconds to a minute) after the recording. Thus the visitor having moved from the camera to the monitor position gets a second chance to see himself on color television. It should be intriguing—and it has the added advantage of providing an incentive that will keep traffic moving.

Right: Diagram of the see-yourself equipment set-up. Visitors see themselves on monitor while they are on-camera (top). Can see themselves again—by delayed tape—on a second monitor (bottom).

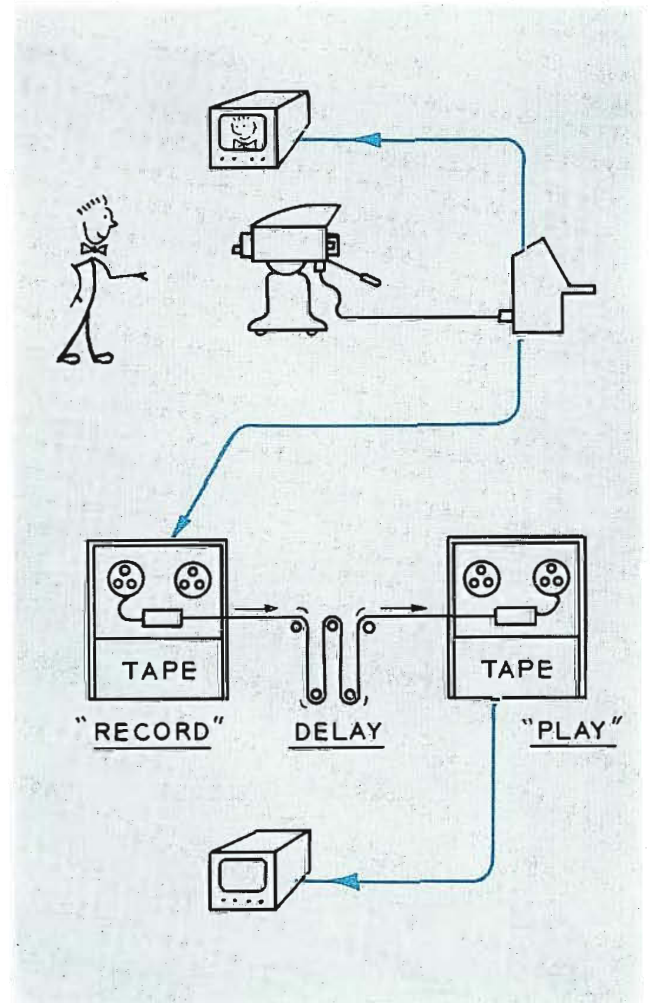

... Will Be Able to See
Action in Studio
While Watching Programs
on Color Monitors

From the studio gallery (right) visitors will get a panoramic view of the studio floor and control room and will be able to see all of the activities involved in the production of live color programs. Fourteen color receivers located above the observation windows around the studio form an electronic picture gallery. Some of the receivers will show the action originating in the studio to enable visitors to directly compare the fidelity of color TV with the live production. The other receivers will carry color film material, which will consist of a variety of short subjects designed to demonstrate the wide range of beauty and subtle colors which RCA color systems and receivers are capable of reproducing.

Can Walk Around Gallery
Encircling the Studio — and
Over Bridge Suspended
Above Control Room

As visitors move around the gallery, they can see down into the studio from various angles—so that all sets and camera positions become visible. At the end of the gallery they walk across a bridge above the control room. Windows on both sides of the bridge enable them to look down on the audio, video and directors consoles on one side, and the tape and film equipments on the other. From the bridge they descend by a ramp around the rear of the control room. This, too, is glass-enclosed. From here they can see the large “video control” console which is located beneath the bridge and the many monitors which show the several programs in progress simultaneously.

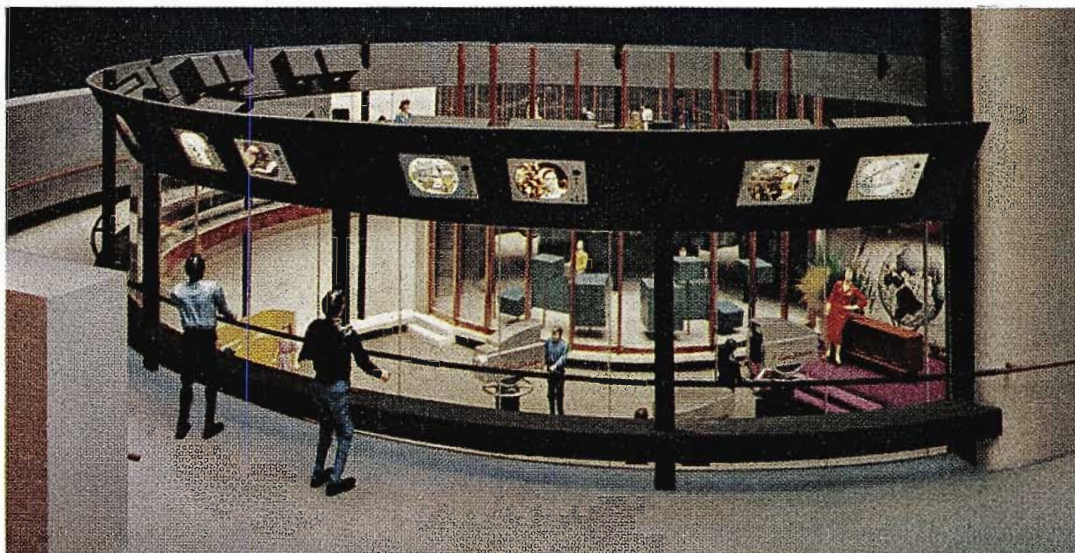

Above: View of the gallery which encircles the studio. Color receivers are located overhead.

Below: The bridge over the control room enables visitors to look down on the technical operations area.

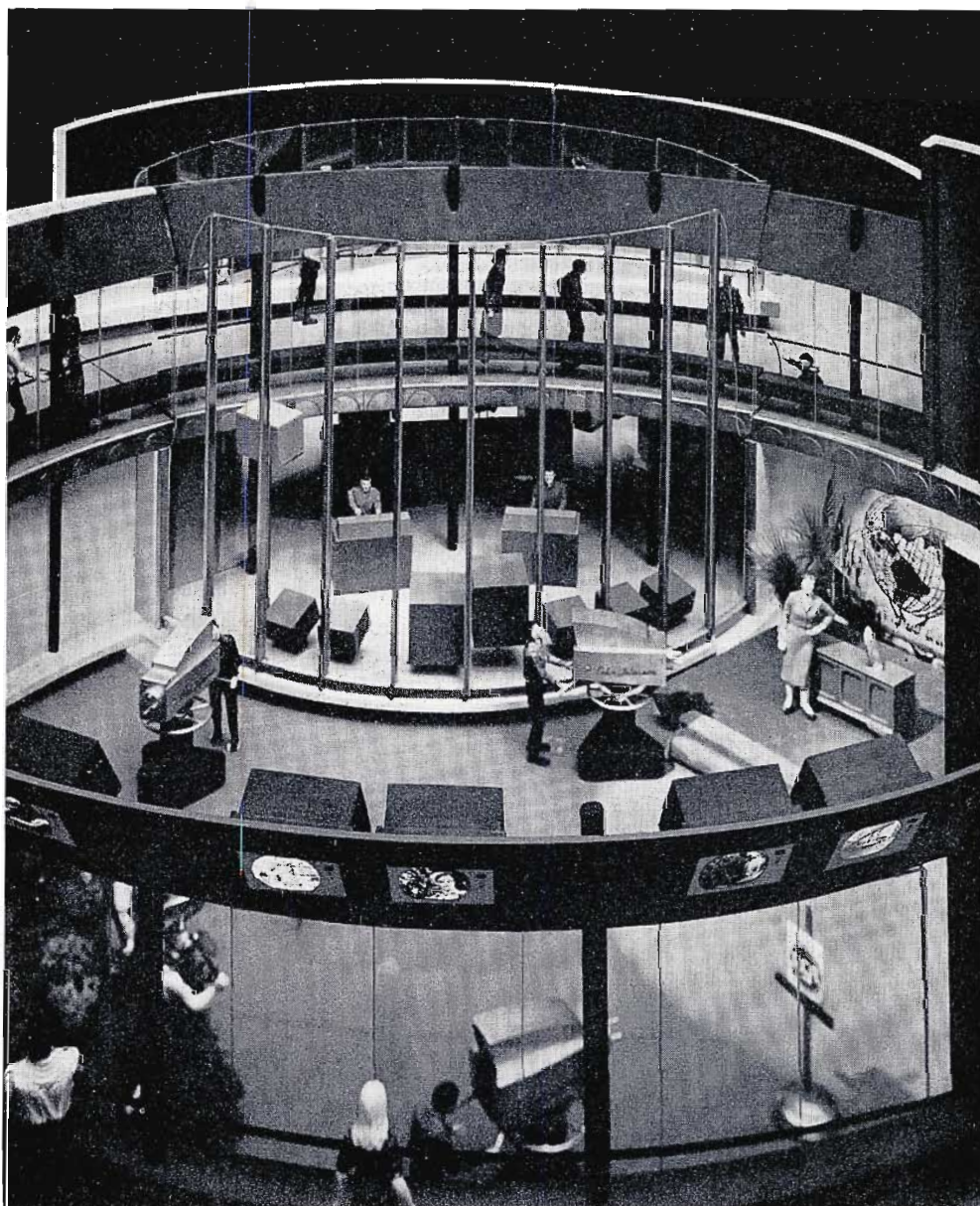



All of the control equipment is grouped in this area. The equipment room is under the ramp at left.

Control Room Handles Five Operations Simultaneously

The plan for operation of the RCA Color TV Exhibit envisions five types of activity. These are:

1. Live studio programs fed to gallery receivers (and, part time, to the Fair CC-TV system)
2. Film and tape programs fed to the CC-TV system when studio program is inappropriate
3. The see-yourself-on-color-TV set-up, including live and tape monitoring
4. Supplementary (film or tape) color programs fed to second set of gallery receivers
5. Tape recording of feed from mobile pickup unit.

Not all of these operations will run all the time. And, during much of the time, certain activities will be combined—for

example (1) and (2). However, there will be times when all five must run simultaneously—and, essentially, independently. In addition, there are very likely to be calls for special services not envisioned in the original plan.

Equipment Included

Providing for all of this activity requires a very considerable amount of equipment, the main items of which are:

- 4 Live color cameras
- 3 Film color cameras
- 4 Film projectors (16mm)
- 3 Slide projectors
- 3 Multiplexers
- 4 TV tape recorders
- TV monitors (color and black and white)

Audio equipment

- Video switching and distribution system
- Pulse generators and distribution system
- Studio interphone and audio monitoring
- Mobile Unit equipped with 3 live color cameras, 1 TV tape recorder and switching equipment

Location of Equipment

In order to have maximum flexibility in the use of this equipment it has all been made a part of a single system in which all inputs and outputs are switchable to any other input or output. Thus the output of any live or film camera, or any tape recorder, can be switched to feed any one of the four in-building activities. Also the Telco line from the mobile unit or other outside point can be similarly delegated.

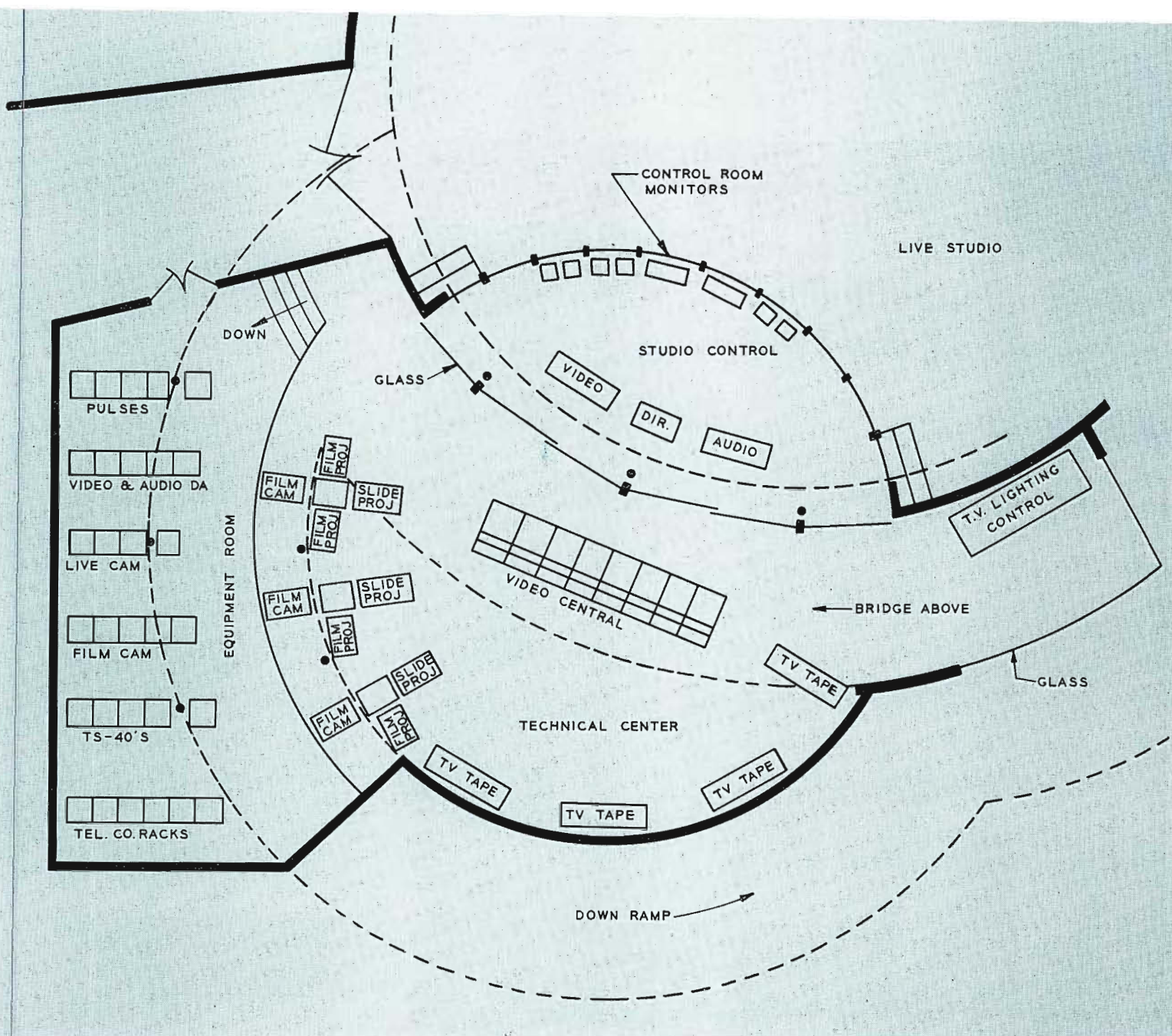

Floor plan of the technical area shown on the opposite page. Location of principal equipment items is indicated.

Centralized Technical Facilities Provide Flexibility

In order to get the maximum advantage from this flexibility the equipment is all located in one centralized technical area. This has the added advantage of enabling operation with a minimum staff. Although the overall activity is rather complex, the individual operations are relatively simple and in most instances operators can perform several functions simultaneously.

The technical area (photo above) is divided into three functional areas which are designated as the (1) the technical center, (2) the studio control room, proper, and (3) the central equipment room. The relation of these contiguous areas is shown on the floor plan (above).

The technical center and the studio control room occupy a circular area which is 35 feet in diameter. The studio control

room part of this area is acoustically isolated by sliding glass doors. The technical center extends under the "down-ramp" and opens into the equipment room. This arrangement groups all of the equipment close together, provides easy access between areas, and corresponds closely to operating traffic patterns.

Technical Center

The Technical Center is the primary operating and quality control area for all technical facilities.

Although the equipment is physically arranged to provide an effective display for the public, the arrangement has also been carefully planned to be highly functional and efficient in its operation.

Four Video Tape Recorders and three Film Chains are grouped around the Cen-

tral Video Control Desk and are readily accessible to the technicians who normally operate at the desk.

Since the modern line of RCA television equipment is built to operate dependably without constant attention by an operator, the same operators required for quality control can easily leave the Central Video Desk long enough to attend to the reloading of films, tapes, and slides.

At the Central Video Control position, the operators have access to the video control equipment associated with four live cameras and three film cameras.

In addition, remote control panels for four tape recorders and four TA-9A stabilizing amplifiers permit quality control of tape recordings and playbacks as well as adjustments to incoming service from the Telephone Company.

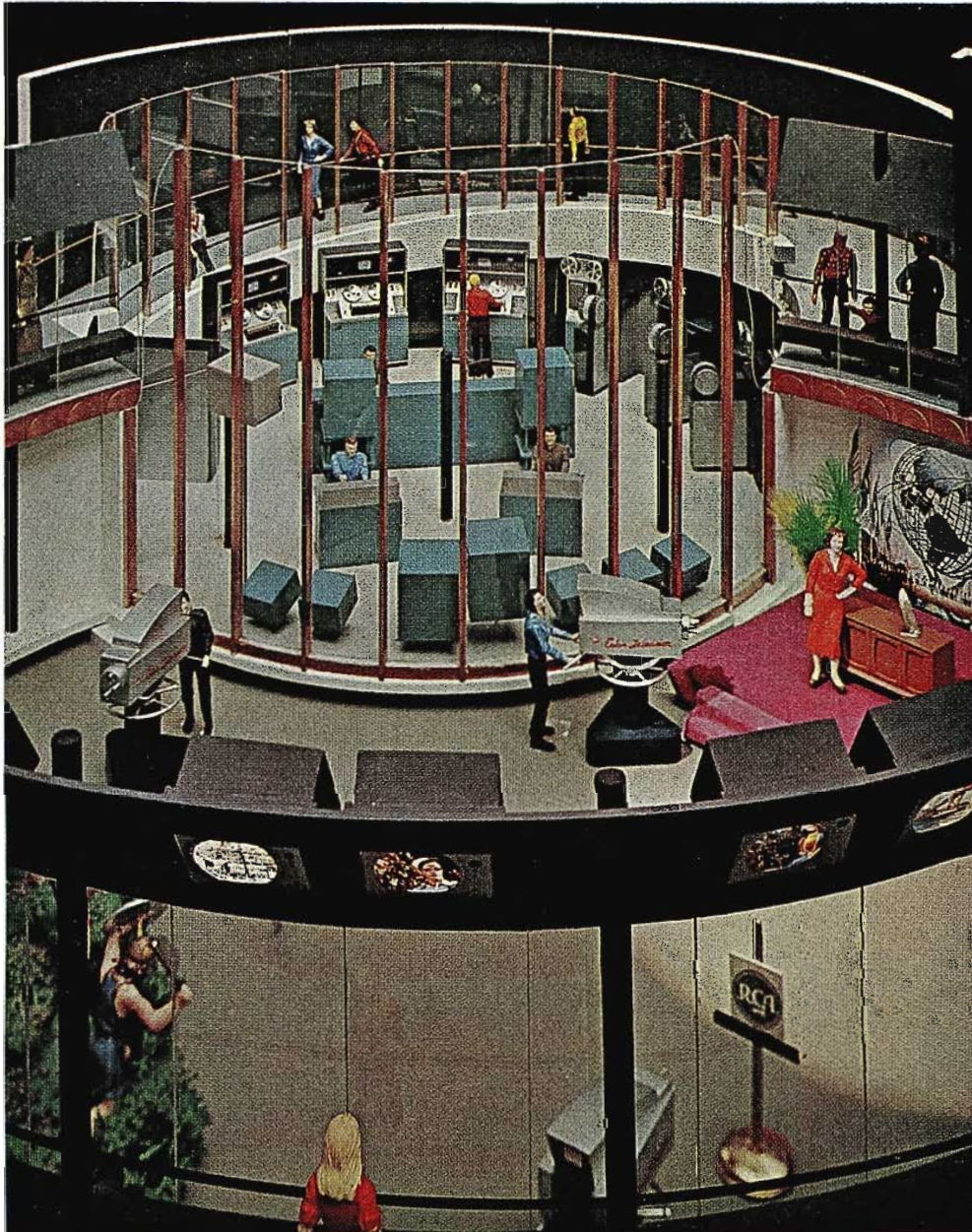

This photograph of the technical area of the model (with the "bridge" section removed) shows how visitors walking down the ramp at the rear will get another view of control-room activities.

Other control panels integrated into the Central Video Desk operate the main video and audio switching and distribution system, and remotely control the start, stop, slide change and multiplexer functions associated with the video tape and film equipment.

By operating these control panels, it is possible for the technician to select any of the live cameras, film projectors, slide projectors, video tape recorders, special test signals, or incoming "remote" programs (such as an origination from the Color Mobile Unit), etc. and switch them to any of the following:

- a. Six Primary Channels feeding the Telephone Company, the closed-circuit color TV system, and the color

receivers in the Studio Gallery. (Independent control of video and audio is possible only on these six channels.)

- b. Four Secondary Channels serving as "input selectors" for the video tape recorders.
- c. Four Monitoring circuits serving preview monitors and the "See Yourself" receivers.

or, he may execute lap dissolves, wipe effects, inserts, as well as croma key effects, using a "transition and effects" video and audio switcher.

Studio Control

The "Studio Control Room" is an acoustically isolated area having direct visual contact with the Technical Center and the

Live Studio. Its primary function is to serve as production control for the rehearsals and live programs originating in the studio. Three operating positions are provided.

1. Transition and Video Effects Switcher
2. Audio Console
3. Director's Desk

The Transition and Video Effects Switcher is identical to the one in Technical Center. It can select the same sources, control start, slide change, multiplexer, etc., and permits separate control of audio.

The Audio Console is provided for use when the complexity of the production requirements exceed the capacity of the simplified audio switcher. In most cases, however, the live productions will have simple audio requirements and not necessitate the use of the Console.

The Director's Desk is equipped with a "talk-back" microphone, an electric "stop clock," and production intercom circuits. It is available for productions requiring a director.

Equipment Room

The third section of the technical area is the equipment room which is located beneath and behind the down ramp, as indicated in the floor diagram (preceding page). In this area are some two dozen racks which house the camera amplifier chains, the audio and video distribution amplifiers, switching systems, incoming and outgoing line terminals, etc.

Lighting System

The studio will be equipped with a very complete and very flexible lighting system capable of handling a wide variety of lighting requirements—and of lighting several sets simultaneously when required. The entire system will be remotely operated from a lighting-control console which will be in sight of visitors as they come down the ramp.

This lighting system will utilize the latest solid-state SCR (Silicon Controlled Rectifier) dimmers and an automatic cold-patch board called the Saf-Patch which permits the operator to group his lights onto dimmers and then at the Lighting Preset Console to group the dimmers further into as many as 4 separate groups or scenes. Thus the operator has to operate only one lever or switch to light an entire scene. This system, which has the same operational flexibility and capability as those of the big network color studios on the East and West Coasts, was designed and built by Kliegl Brothers.

FIVE ACTIVITIES OF THE TECHNICAL OPERATION

1. Live studio programs fed to gallery receivers—and, part time, to CCTV network feeding receivers throughout fairgrounds
2. Film and tape programs fed to CCTV network when the studio program is unavailable or inappropriate
3. See-yourself on color TV for direct and delayed ("on tape") viewing
4. Supplementary (film or tape) programs fed to second set of gallery receivers
5. Tape recording (or live feed to CCTV network) of programs from mobile unit

I. LIVE STUDIO PROGRAMS

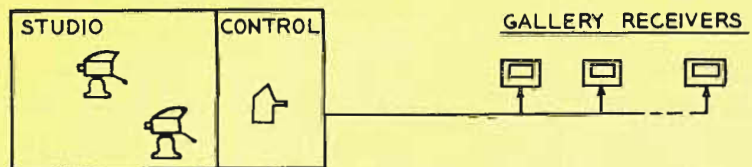

II. CLOSED-CIRCUIT

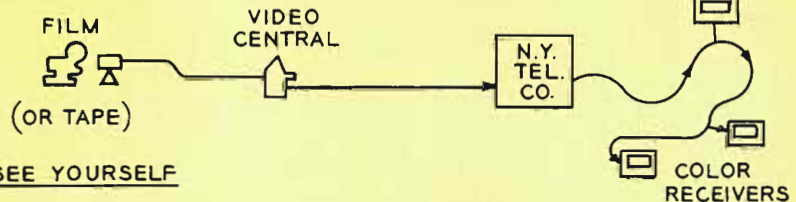

III. SEE YOURSELF

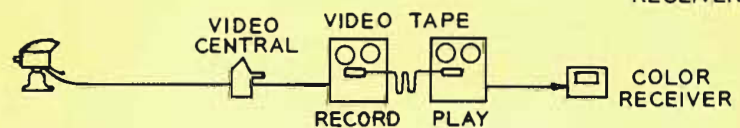

IV. SUPPLEMENTARY COLOR

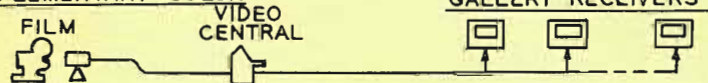

V. TAPE RECORDING FROM REMOTE PICKUP

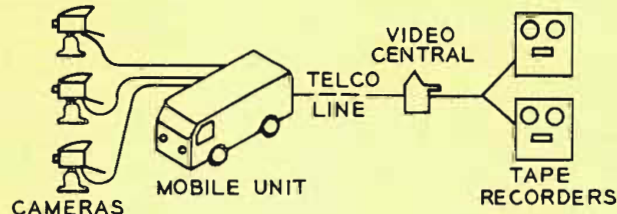

Summary—"In the Spirit of the Fair"

The RCA Exhibit Studio, equipped with the newest and finest in equipment, and staffed by an experienced and talented staff, will be uniquely fitted to originate color TV programs for distribution throughout the Fair. It will also be in a position to furnish the Fair, other exhibitors, advertisers and producers with convenient TV-origination facilities. And—while it performs these utilitarian functions, it will simultaneously be a mecca for millions of Fair visitors. Through the glass walls of this giant fish bowl most of them will see for the first time the inner workings of a color TV studio. If the researchers are right, many of them will be seeing color for

the first time. In 1939, they saw black-and-white TV for the first time—and went away talking about it. In 1964, they will see color television—if not for the first time, quite possibly for the first time under favorable conditions. And they will go away talking about it.

In announcing RCA's plans for the Fair, Dr. Engstrom, RCA President, said: "We feel that both the RCA exhibit and the Fair-wide color network are attuned to the spirit of the Fair itself in their blending of entertainment, culture, and information through the latest and most comprehensive means of communications. The Fair itself is, in essence, a great venture in communi-

cations that is designed to convey to millions the substance and excitement of life in the 1960's."

In replying, Robert Moses, President of the World's Fair Corporation, said: "We are particularly happy to welcome RCA at Flushing Meadows where they introduced black-and-white television to the American public at the 1939-40 World's Fair. The Color Television Communications Center will not only provide an important service to the anticipated 70 million visitors to the Fair, but will also play a prime role in promoting the Fair's theme, 'Peace through Understanding'."

WSBT-TV... ONE OF AMERICA'S OLDEST UHF STATIONS

South Bend Station Uses the World's First 5-Megawatt UHF Pylon Antenna



FIG. 1. WSBT-AM/FM/TV's roman brick building houses all of the station's operations except transmission.

WSBT-TV was already five years old when the first signals flashed from its transmitting antenna. It was 11:50 P.M., December 21, 1952 when WSBT-TV came on the air with a live telecast from studios in the South Bend Tribune Building. Even at this late hour, telephones at the transmitter building and the studio began to ring with calls of congratulations.

The gap between the 1947 creation of the WSBT-TV idea and the late 1952 start of programming was filled with planning, disappointments and fantastic effort.

In 1947 when planning began, there were no TV networks as we know them today. Only a few prophets had the courage to predict that the next five years would see television develop into one of the major influences in American life. The South Bend Tribune filed an application with the Federal Communications Commission for a VHF television channel. At about the same time, (December 4, 1947) an order for television equipment was placed with the Radio Corporation of America.

by **SCOTT N. HAGENAU**
Chief Engineer, WSBT AM-FM-TV

South Bend was allocated VHF Channel 1 by the commission; however, shortly thereafter, Channel 1 was deleted. The South Bend Tribune changed its application and filed for Channel 13. A hearing on this application was set for the spring of 1948. Action was never taken due to the "freeze" on all existing television channels by the FCC until a study of the demands for new channels could be made. Many months passed before the FCC announced that three channels in a new range, ultra high frequency, would be assigned to South Bend. On July 18, 1951 the South Bend Tribune applied for UHF Channel 34. Late in August (1951) the FCC "freeze" was lifted and the application approved. This action touched off a fantastic race against time. The Tribune's long standing order with RCA put it high on the Corporation's priority list for delivery of hard-to-get UHF-TV equipment.

Studio facilities for the newly established television station were located on the third floor of the South Bend Tribune building where WSBT Radio had long been located. Quarters were cramped and immediately the need was apparent for enlarged facilities. It was decided that space requirements for a television operation for our size market were unknown. It had been observed that stations are, generally, sized to a market. Observations indicated that in most cases space requirements are underestimated. Hence, the space available even though extended areas would be used, would still only meet the initial requirements. It was, therefore, decided that, although operation was confined to close quarters, operation of facilities on the third floor of the Tribune building would enable us to meet an early on-the-air date, and would allow us to better train a staff, and would provide sufficient time for this staff to study the requirements for a new building. This decision was not immediately and universally popular; however, as time went on, it was easy to see

that it was a wise one. Many valuable ideas were gained through our initial installation. At the time of the installation of equipment, we thought that there was no other way to accomplish the job, or perhaps the plant at that time was the last word in plant facilities. Experience since then has indicated many changes and resultant improvements. All of these improvements are found in our new building—Broadcast Center. The functional, yet attractive, red roman brick and poured concrete building was long in the planning stage. As a result, practically every possible step was taken to provide for ultra-modern broadcasting and telecasting facilities. Operation from Broadcast Center began on March 13, 1956. The two story structure with a full basement occupies most of the quarter block on the southwest corner of Jefferson and Lafayette Boulevards in downtown South Bend. A striking feature is the towering concrete frame windows lining the second story. The main TV studio contains 4,000 square feet of work area with Studio 2 supplying another 900 square feet.

WSBT-TV received one of the first commercially-built, Type TTU-1B 1-kw transmitters from RCA. The transmitter was one of four shipped on the same day. The other three stations were: WBRE-TV, WFPG-TV and WSBA-TV.

Geographically, South Bend is many miles farther from Camden than are the other three cities. To offset this disadvantage of distance, WSBT-TV was provided with the services of the design engineer for the RCA TTU-1B transmitter, Mr. Tom Gluyas.

We had sent one of our technical directors to Camden to coordinate the delivery of this transmitter. At each truck stop along the way, this engineer telephoned to advise estimated arrival time in South Bend, in order that crews would be on hand to unload, assemble and install the transmitter cabinets without a moment of lost time.

Likewise, we had sent another WSBT engineer to Dielectric Products in Raymond (Me.) to coordinate arrangements for the loading of the filterplexer needed to put the station on the air. We had chartered a freight-transport plane to fly the equipment non-stop to South Bend.

Our engineer telephoned to advise that he would be unable to accompany this equipment due to a technicality in the rules and regulations of the air-freight company. In a telephone conversation with the president of the airline, it was discovered that

passengers are forbidden on their freight aircraft, except for animal trainers. We immediately called our engineer waiting at the airport in Portland (Me.) and advised him to visit the closest pet or novelty shop and purchase a white mouse, cat or any other live animal which appeared to be in need of training. A few hours later the chartered aircraft complete with pilot, flight engineer and WSBT studio-engineer turned animal-trainer was winging its way to South Bend.

WSBT-TV began operation on Channel 34 with a visual effective radiated power of 17.5 kilowatts. The antenna, an RCA

TFU-24BM, was 540 feet above average terrain. The transmitter location is approximately $4\frac{1}{2}$ miles south of the City and is the highest elevation in the area. It is very suitable for a UHF antenna site since the terrain slopes downward in all directions. This undoubtedly contributes to WSBT-TV's excellent coverage.

Heretofore, residents of this market area had been forced to view television from VHF stations 74 (or more) airline miles distant. Even with high-gain antennas, these viewers were forced to look through snow, fades and tearing pictures due to low signal intensity, man-made noise, or

FIG. 2. WSBT-AM/FM/TV's antenna farm. The tall tower in center supports the RCA UHF-Pylon antenna. The four-tower array at far right radiates the 960-kc signal of WSBT-AM.

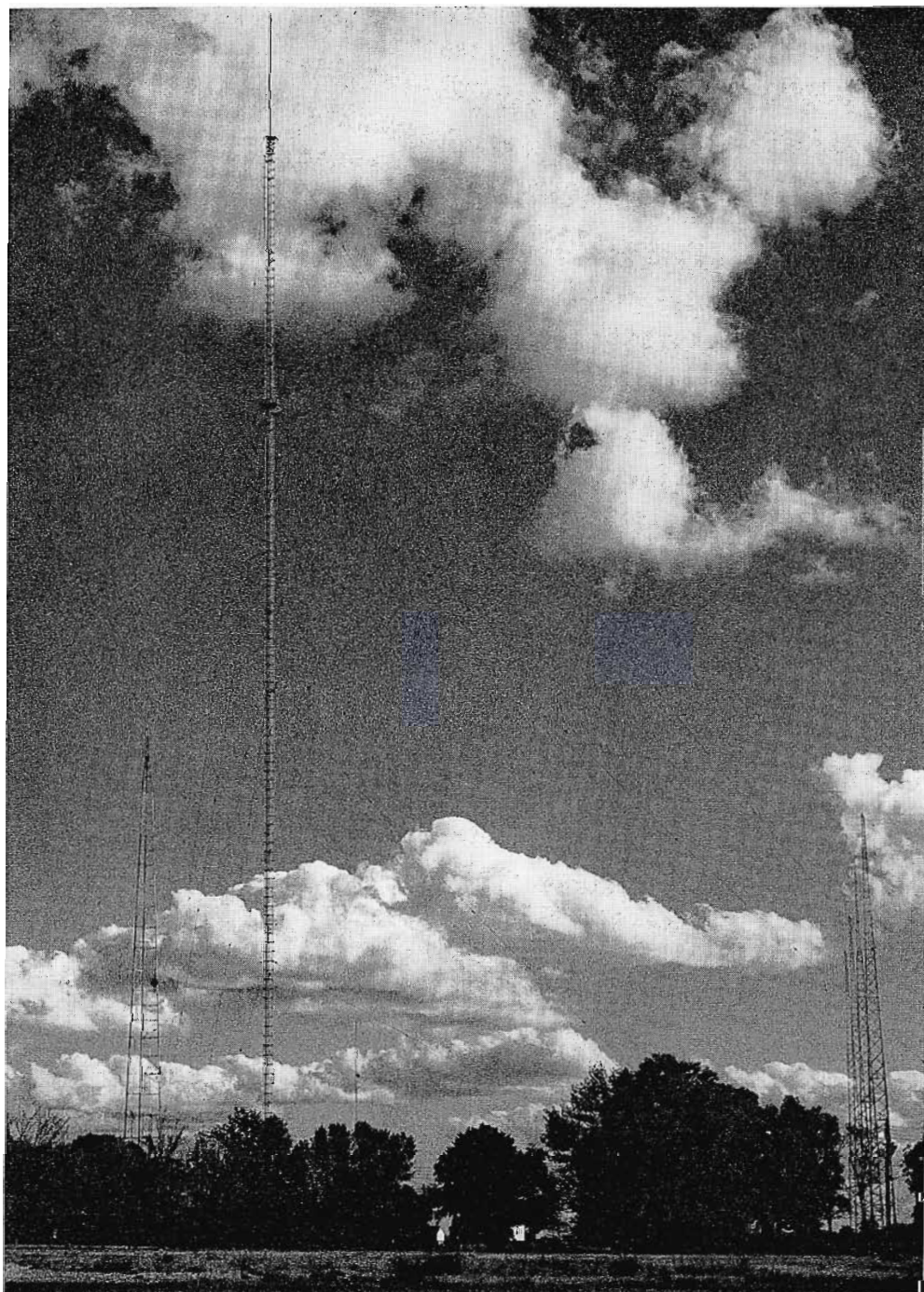

atmospheric conditions. It has been noted time and again, that in areas where man-made noise is present, UHF is much superior to VHF.

Almost immediately after the beginning of operation, WSBT-TV started considering purchase of an amplifier to increase its coverage area. On September 7, 1954—less than two years after the first day of operation—WSBT-TV increased its power to 230 kilowatts (ERP) with the installation of an RCA 12.5 kw power amplifier.

During 1957, it became quite apparent that we, together with the newer UHF stations in our area, could better serve the population of northern Indiana and southern Michigan by applying for low channels in the UHF spectrum to simplify the tuning of receivers. In January 1958, WSBT purchased and installed an RCA Channel 22 antenna (TFU-24DL).

Federal air space permission to construct a 1,000-foot tower had been approved as early as February 23, 1954. In the summer of 1961 it was decided to proceed with the construction of a tall tower and new high gain antenna. Early in October 1961, we met with the Antenna Engineering Manager, Mr. H. E. Gihring and other RCA personnel in Camden to discuss the possible design of an antenna capable of radiating the maximum permissible power of 5 million watts. It was also necessary to design a transmission line facility which would be capable of 110-kilowatt power input. After preliminary studies were made and reviewed, it appeared feasible to construct a slotted cylinder ultra-gain UHF antenna with a maximum beam-power-gain of 46. It was further determined that RCA's new $9\frac{3}{16}$ -inch Universal coaxial transmission line would be capable of handling this power level.

Full details of this new antenna are printed in "Broadcast News," Volume 116 (Feb. 1963) entitled "Selecting the Antenna for UHF Service" by Mr. Gihring.

As soon as the technical information was available, WSBT-TV filed an application with the FCC for an increase in power to a half megawatt. On December 29 (1961), the FCC approved the request and granted the necessary construction permit. A firm order was immediately placed with RCA for the new antenna, the associated transmission line and other hardware.

WSBT-TV could have utilized existing types of antennas and UHF amplifiers in order to increase effective radiated power; however, progress has been the keynote in the history of WSBT-TV. Over the years

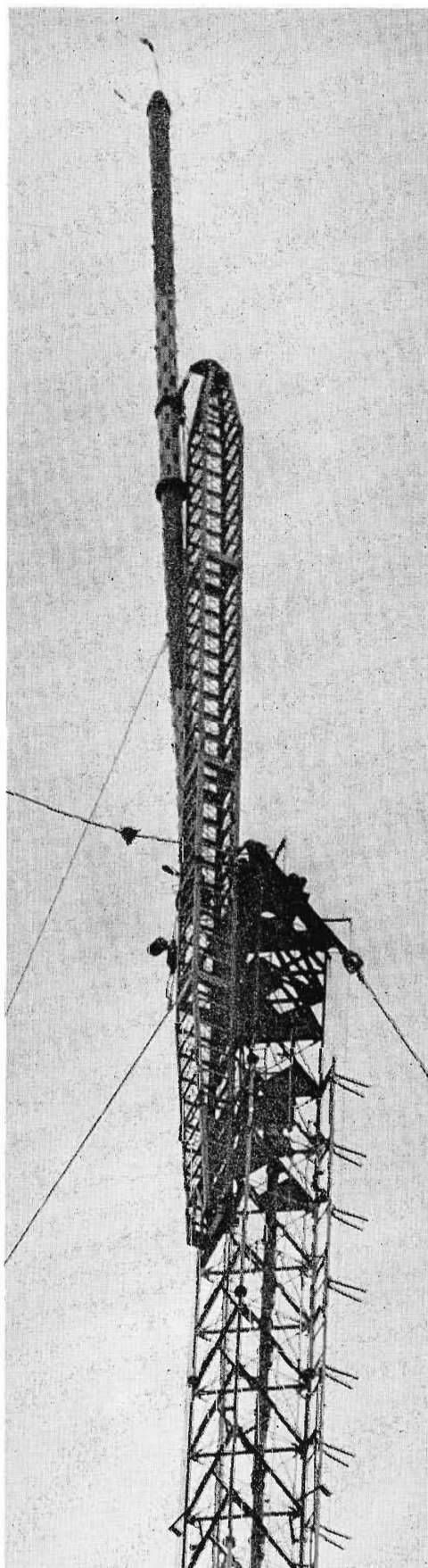

FIG. 3. The RCA TFU-46K as it went into place atop the tower. Capable of a power input of 110 kilowatts, the antenna delivers an ERP of 480 kw with a 12.5-kw transmitter. Driven with 110 kw of peak-visual power, the antenna would radiate 5 megawatts, ERP.

we have constantly endeavored to better serve the viewers in our area and at the same time increase the WSBT-TV service area with the addition of the latest and best equipment available.

A new Dresser-Ideco 932-foot tower was erected during the summer of 1962. The tower is $7\frac{1}{2}$ feet across a face and was erected in the very center of a tight AM array used by WSBT Radio (960 kc). As a novel part of this new tower, outriggered, tuning-skirt wires were fabricated and installed 2 feet away from each leg and insulated in order so that it would be possible, after completion of tower and antenna erection, to de-tune the new tower and antenna at 960 kc.

The $9\frac{3}{16}$ -inch transmission line to the main antenna is installed directly up the center of the tower. Next to this line is a run of $3\frac{1}{8}$ -inch Universal transmission line which feeds an RCA (TFU-6B) stand-by antenna mounted at the 700-foot level supported on a structure extending 10 feet away from the south face of the tower. On the other side of the $9\frac{3}{16}$ -inch transmission line is another vertical run of $3\frac{1}{8}$ -inch transmission line which feeds the WSBT-FM antenna mounted on the north face of the tower at the 880-foot level.

The new RCA type TFU-46K antenna was delivered on September 1, 1962. The line and the antenna was installed under the very capable supervision of Robert W. Bell, WSBT's Transmitter Supervisor, and Charles H. Lomas (of Charles H. Lomas Tower Service, Inc.) who served as RCA's representative.

WSBT-TV began operations on September 8 from "The Tower of Power". Since a system specification had been requested it appeared desirable to express the performance in terms of reflected signals which approach actual operating conditions as closely as possible. It was, therefore, decided that the over-all transmission line and TFU-46K antenna would be measured with the r-f pulse technique as described in an article entitled *Proposed Impedance Requirements of Television Antenna Systems* by Donald W. Peterson.* During the night of September 6, these r-f pulse measurements were made by Dr. M. S. Siukola of RCA. The measured amplitude of the far-end reflection was only 3.2 per cent. This is comprised of the effects of the ultra-gain antenna, the elbow complex and approximately 1,100 feet of $9\frac{3}{16}$ -inch transmission line.

* Broadcast News, Vol. 104, June 1959

Figure 3 shows the new antenna being hoisted into location by Furr and Edwards of Rome (Ga.). Note "Old Glory" waving jubilantly in the breeze from atop the lightning protector rod at the top of the antenna. The other flag seen was positioned by employees of Furr and Edwards and is, of necessity, a Confederate flag. The flags were removed the day after the antenna was positioned and presented to the author for placement in the archives as a constant reminder of this eventful day.

Figure 2 is a worm's-eye view of the WSBT antenna farm. The tower at the left is the old WSBT-TV tower with the new "Tower of Power" immediately to the right. At the far right are the four towers used in the WSBT-AM directional array.

Figure 4 shows the service contours of WSBT-TV as filed with the FCC. As a result of personal observations and mail reports of reception, we feel that the actual "good picture" coverage is much greater. Field-intensity measurements have not, as yet, been made.

The entire credit for the planning and installation goes to the WSBT-AM-FM-TV Engineering Staff who worked diligently, untiringly and with complete enthusiasm.

On many occasions during the past ten and one-half years of operation, we have been asked by visitors to this area why picture quality and interference-free reception are so much better than that to which they are accustomed in larger metropolitan cities. An honest effort is made to explain to the layman in non-technical language in a manner that he may understand. Since it is most difficult to explain this difference, we invariably finalize the discussion with the explanation, "Well, that's modern UHF television."

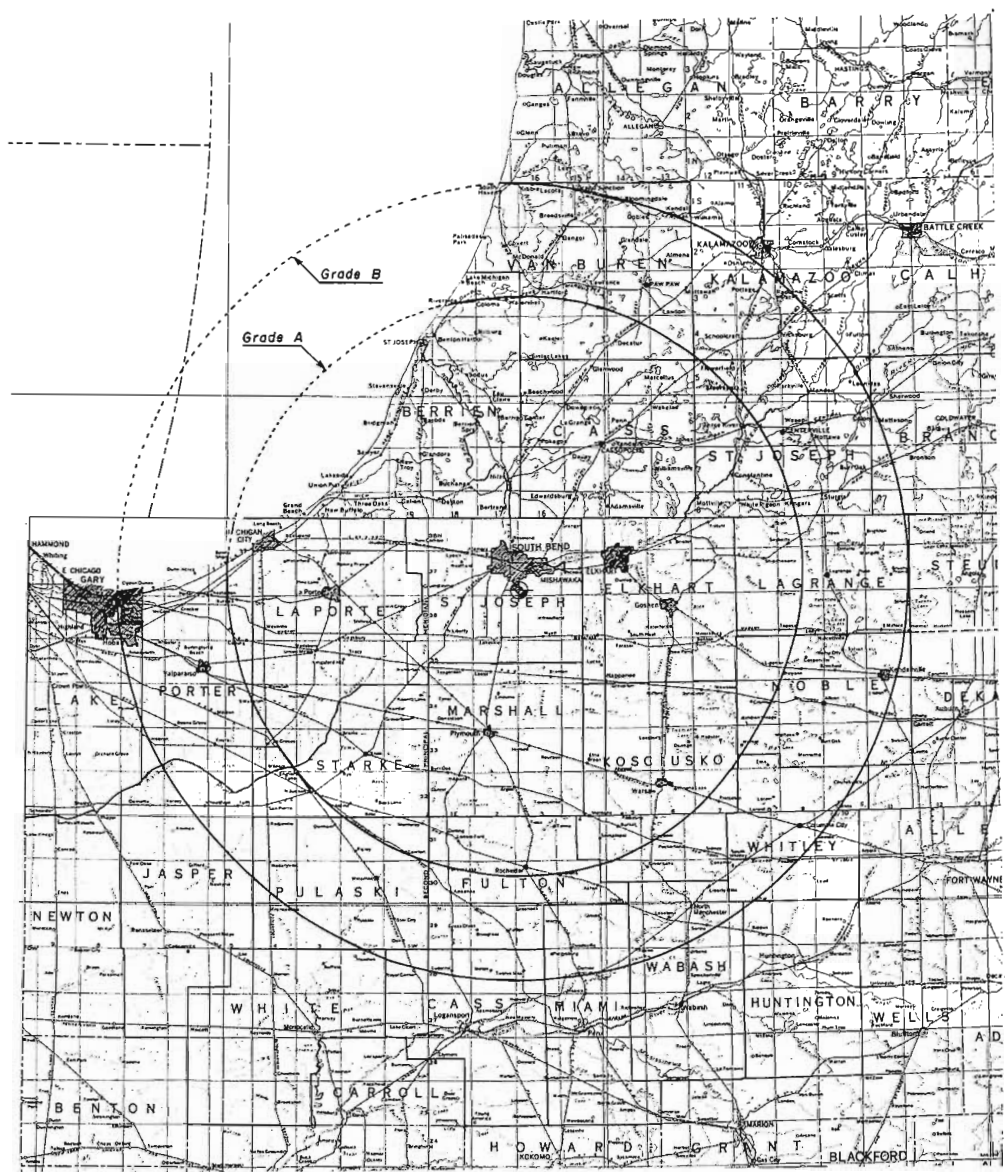

FIG. 4. Service-contour map for WSBT-TV. Dated December, 1961, the map shows the 21-county area served by the station.

FIG. 5. Ten-year-old photograph of the shipping day for the first four TTU-1B UHF-TV Transmitters to come off the production line. The four went to WBRE-TV, WFPG-TV, WSBA-TV and WSBT-TV.





FIG. 1. KRAV Studio A control. Announcer Robert Thomas takes a phone call from a listener. The picture window immediately beyond the BC-7 control console allows almost continual monitoring of the BTF-5D transmitter meters. Mikes are 77-DX velocities.

Broadcasting Co. as president. Chief Engineer Robert G. Hardie serves as the custodian of the station's technical excellence. Carl C. Smith is sales manager and Peter B. Wolcott serves as news director. Robert R. Thomas and Roy McKee serve as staff announcers.

Mr. Kravis has, for many years, been highly interested in FM broadcasting. After graduating from college (Oklahoma) he visited many operating stations in all parts of the world. The dream of building the finest FM station came true when the FCC issued KRAV's construction permit during the summer of 1962. At home, he has had an elaborate antenna system installed so

KRAV PROGRAMS STEREO 17 HOURS PER DAY

Tulsa's Newest FM Station, Mostly RCA Equipped
... Even Programs Commercials in Stereo

Serving the Tulsa countryside 17 of the 24 hours in every day with 20 kilowatts of effective radiated power, KRAV generates and radiates its stereo programming from the 19th floor of the First National Bank building in downtown Tulsa, Oklahoma. It is owned and operated by the Boston Broadcasting Company.

Music-and-News Format

The top-rated station in a four-station market, KRAV was an immediate success as a result of its consistently high quality in station "sound" as well as programming.

KRAV serves the market with—to use their own words—a "middle-of-the-road" music-and-news program format. Each musical program is one hour in length, opening with the news on-the-hour. An Associated Press teleprinter provides the source for national and international news.

The music between the hourly news ranges from classical to popular; jazz to folk and includes a considerable sprinkling of the musical literature that comes from the boards of Broadway and the sound stages of Hollywood.

KRAV Management

George R. Kravis, owner of the station, heads the management team of Boston

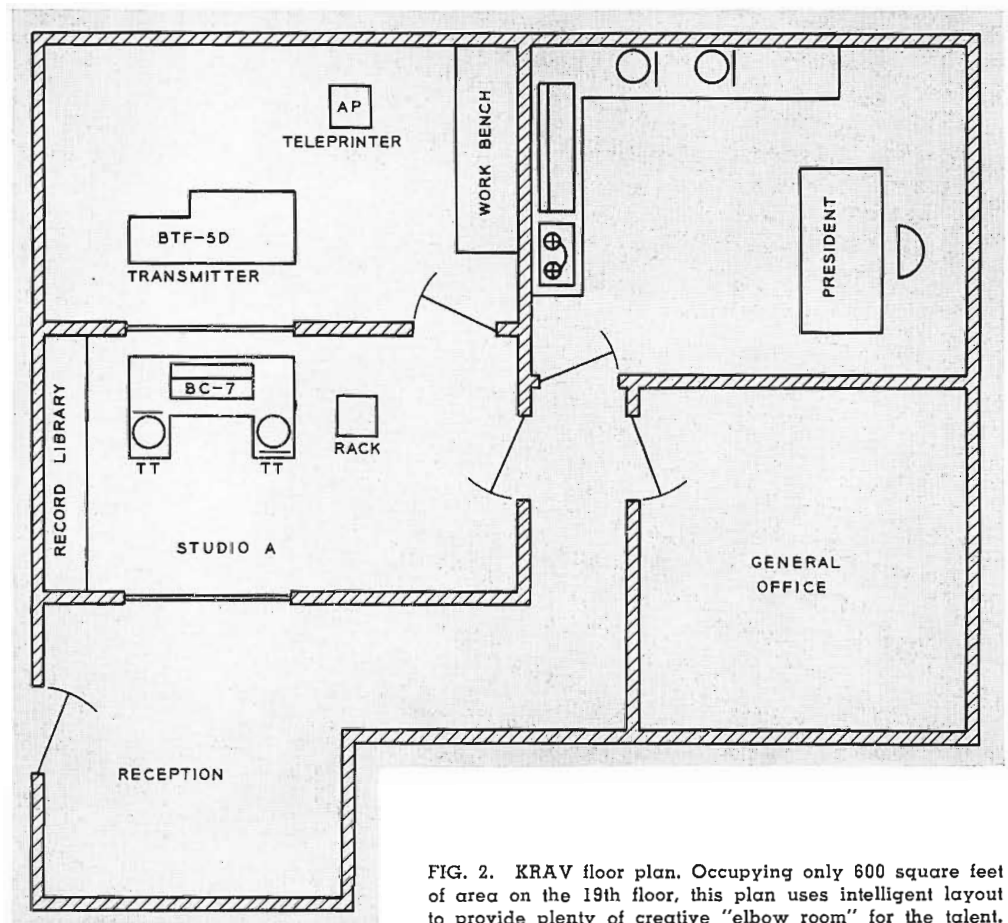

FIG. 2. KRAV floor plan. Occupying only 600 square feet of area on the 19th floor, this plan uses intelligent layout to provide plenty of creative "elbow room" for the talent.

that the programming of stations all over the country can be heard. Many of the programming innovations KRAV boasts were triggered while listening to some distant station's programs.

Well-Equipped Studios

Most of KRAV's programming originates in Studio "A" (see floor plan) where the BC-7 Stereo Console is the center of attraction.

Two 77-DX mikes pickup live audio while taped programming comes from an RT-21 reel-to-reel stereo-tape machine and two RT-7A Cartridge-Tape devices. Two turntables provide disc-playback facilities.

KRAV has built a 5000-album stereo library since first going on the air during November, 1962.

Transmitter Plant

KRAV's 20 kilowatts of quality power is the product of a 5-kw transmitter and a six-section BFA antenna.

The transmitter is a standard BTF-5D. Its direct-FM modulator contributes much to maintaining the low-distortion, high-quality sound of the station.

Stereo operation of the transmitter is provided by the addition of a BTS-1A stereo-subcarrier generator. This unit is mounted inside the transmitter cabinet.

The transmitter room is outfitted with oversize air-conditioning facilities. This extra capacity will permit future expansion of transmitter power to 10 or even 20 kw without an increase in air-conditioning capability.

Six-Section Antenna

The BFA-6 antenna increases the 5-kilowatt output of the transmitter to 20,000 watts, ERP. The six-section antenna is mounted on a self-supporting pole which stands on the roof of the building. The combination of building height and the length of the pole places the antenna 333 feet above average terrain. Listeners report excellent reception—with indoor antennas—up to 70 miles distant. Other listeners, obviously using high, outdoor antennas, report excellent reception as far away as 250 miles. KRAV has received excellent reports from the automobile FM radio segment of the market.

Print Media Announced On-Air Day

KRAV spent more than \$10,000 to announce the "opening day" of the station. The media included billboards, car- and store-card advertising, newspaper space (every page of every edition of the two Tulsa dailies for the first two days on-the-air) and space in the concert programs of the Tulsa Philharmonic Orchestra. KRAV advertising continues to appear in these media at less intensity than during the announcement days.

Equipped for Success

KRAV occupies only 600 square feet of area on the 19th floor of Tulsa's First National Bank building. However, this small floor area is overcome through intelligent layout and equipment selection. Station personnel have plenty of creative "elbow room" . . . doubtless a reason for KRAV's quick and continuing success.

KRAV's insistence on quality sound . . . stereo sound . . . is an important reason for the fact that the station is almost 100 per cent RCA-equipped.

FIG. 3. KRAV President George R. Kravis makes a change in the audio patch panel. Recorder at top is reel-to-reel RT-21A. The cartridge-tape devices, Type RT-7, are immediately beneath the patch panels.



FIG. 4. This six-section BFA-6 antenna delivers 20 kw ERP for KRAV, 333 feet above average terrain. The pole-mounted antenna provides excellent pattern circularity.

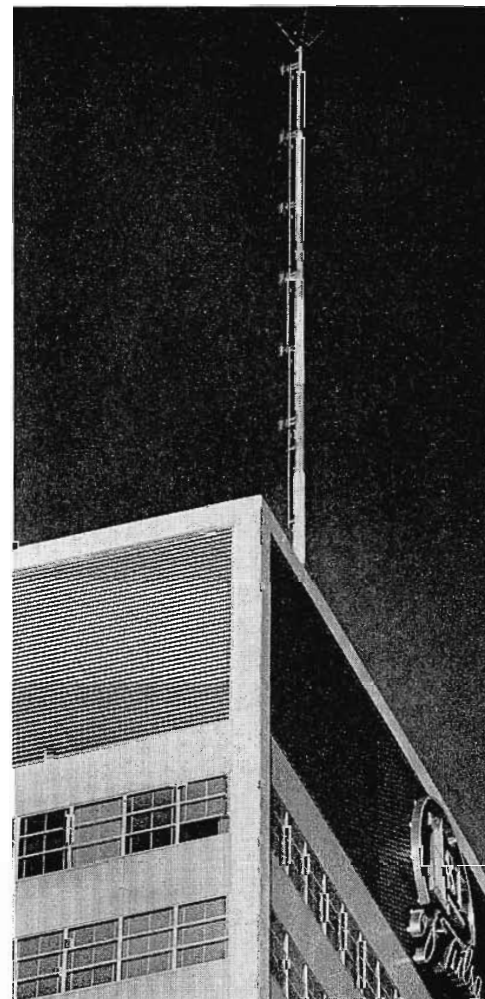

NEW 16MM TV FILM PROJECTOR TP-66

With Built-in Aids to Programming,
Unique New Design, and
New Features for Operational Reliability

by JOHN C. ADISON, *RCA Broadcast Studio Merchandising*

The new TP-66 Professional TV Film Projector uniquely meets the demands of today's stepped-up film programming. Designed specifically for fast-paced requirements, the projector includes many new features integrated into a wholly new design. Every effort has been directed to producing a superior quality projector for television. Aids to programming are built in, construction is ruggedized, all electronics are transistorized and automatic features are introduced.

BUILT-IN OPERATIONAL AIDS TO PROGRAMMING

Of the many new features introduced into the TP-66 Projector, perhaps the most important are those which ease the operational demands of today's trends in film programming. Features like rapid start, automatic cue, reversible operation, and automatic loop restoration help relieve operators of the urgent demands of the station break or panic-periods. The result is fewer operator errors, less lost time, and an opportunity to create new techniques in film programming.

PROGRAMMING FEATURES

Rapid Start

Starting time of the TP-66 Projector is virtually instantaneous. Sound is sufficiently stable for program use within 0.3 seconds from the start of the projector. A pre-roll period prior to switching the projector "on-air" is no longer necessary. Start and show buttons—for all practical purposes—can be activated in a single operation. This eliminates one more source of error during station break periods.

Reversible Operation

The projector can be operated in a forward or reverse direction. This feature makes possible repetition of a film segment without the need for rewinding and re-

threading the projector. This labor-saving feature is particularly useful during the rehearsal of "live" or "tape" shows in which film inserts are incorporated. The sound system is automatically disabled when the projector is being operated in the reverse direction.

Still-Frame Projection

A single film frame can be shown at full light level for extended periods of time. This feature permits the director to preview the first frame of any upcoming film.

Since the shutter does not rotate during still projection, it is necessary to attenuate the light level to conform to that provided in normal operation. A moveable heat filter, which also provides the proper light attenuation, is automatically placed in the light path. The shutter is indexed to assure that it is held in an open position during still frame projection.

FIG. 1. All new in construction and operating features, the TP-66 projector is designed to meet the requirements of today's fast-paced tv film programming.

FIG. 2. Large reel capacity permits up to one hour and forty minutes of film programming without re-threading.

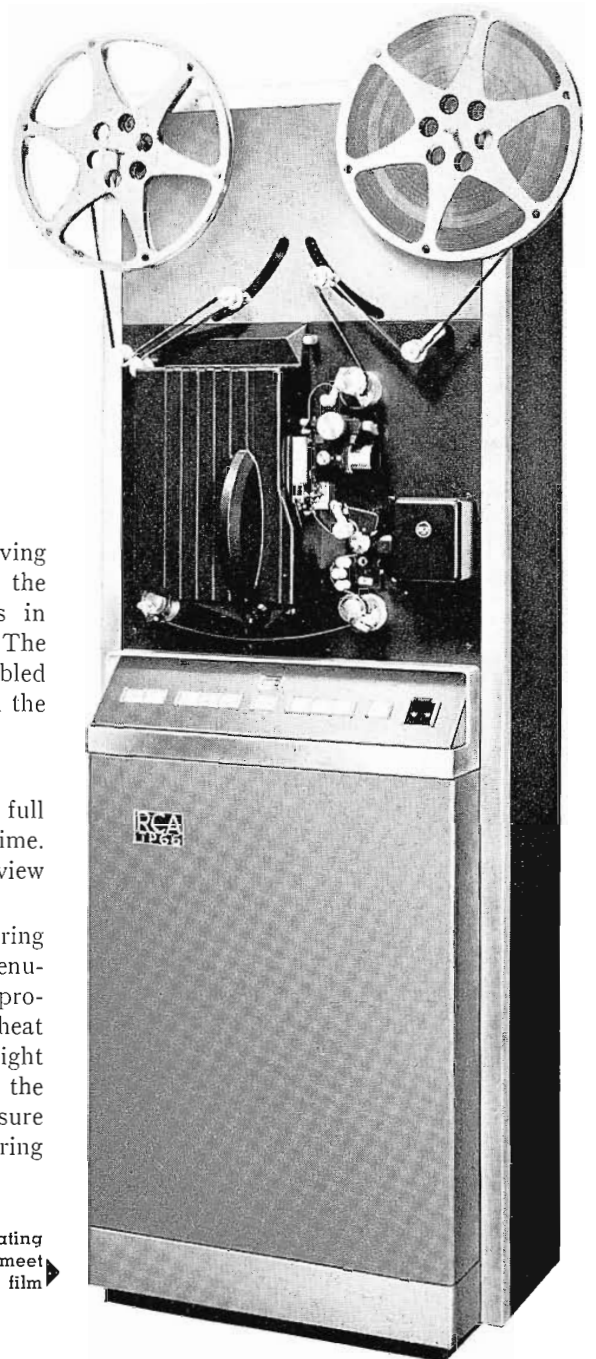
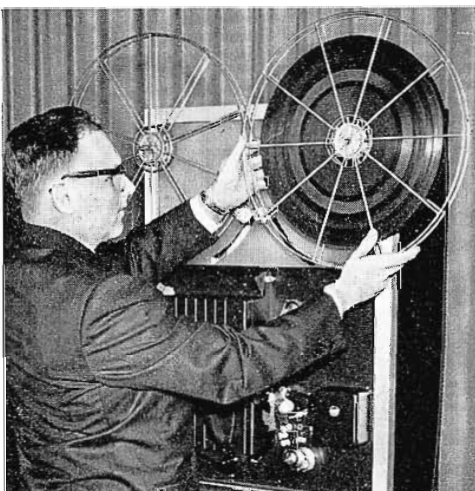

Large Reel Capacity

The accommodation of large 20-inch reels provides the film capacity needed for continuous film programming. Up to one hour and forty minutes of uninterrupted projection is possible. Film segments can be spliced together on a single large reel, as shown in Fig. 2, to save time and to avoid possible errors.

Automatic Cue

Films can be stopped and cued up automatically on the TP-66 Projector. This eliminates the need for manually threading and cueing individual films, and does away with the human errors that frequently occur when using visual cue marks. Precise, clean program transitions are assured. A

feature film may be programmed in advance to cue the beginning of the film as well as any number of stopping points to permit a station break or commercial inserts. The projector stops automatically at the end of each film segment, and cues up the next segment within one frame of the desired starting point.

The automatic cue system is activated by a small patch of conductive tape wrapped around the edge of the film between the sprocket holes at the frame to be cued. The feed sprocket assembly acts as the sensing device. Upon passing through this assembly, electrical contact is made between the insulated sprocket and the sprocket shoe, which is at ground potential. This action closes a relay, initiating the count-down cycle. After a short coasting period, a brake is applied to the drive motor, causing the film to come to a stop with the cue patch within one frame of the aperture.

The cue sensing system can also be used to bring the projector to a stop when running in the reverse direction. However, since the sensing device is located above the aperture, it would be necessary to start the machine again in the forward direction to properly cue up the film.

A cue defeat switch is provided at both the local and remote control panels, so that cue patches can be overrun if desired without stopping the projector.

Magnetic Sound System

The special advantages of magnetic sound tracks can be realized with the installation of the optional magnetic sound system. The design of the projector is such that special skills are not required to install the kit. A magnetic pick-up head is mounted within the periphery of the sound drum, and has its face concentric to and slightly below the surface of the drum. Contact between the magnetic head and the film is made by deflecting the sound track

portion of the film with an auxiliary pressure roller (located directly over the head gap). The pressure roller is actuated by a solenoid, which can be controlled from the local control panel or from a remote location. When the optical mode is in use, the auxiliary pressure roller is disengaged, and the film does not come in contact with the magnetic head.

A separate plug-in solid state amplifier module is used for reproduction of magnetic sound. The audio output line is automatically switched to the proper amplifier in accordance with the selected mode of operation.

Easy Threading

Projectionists will appreciate the human engineering that plays an important part in the design of the TP-66. Both supply and take-up reels have been placed at eye level to eliminate the need for stooping or bending while threading the projector.

The unusually wide self-aligning film gate and the logical and simple film path contribute to easy threading. See Fig. 4. The film gate and the projection lens mount are entirely separate assemblies. To open the gate for threading, the vertically pivoted film pressure shoe is moved forward through approximately a 30 degree arc, making the gate area easily accessible for insertion of the film.

A new spring-action reel key, and cam-action reel lock, facilitates placement of the reel on its shaft. No searching is required to engage the key in the reel slot.

As with any projector, film loops above and below the film gate must be correctly formed for proper operation of the projector. The TP-66 Projector is equipped with solenoid actuated loop setters which act as loop measuring guides while the projector is being threaded. These loop setting guides are engaged and disengaged automatically by means of a switch, actuated by the holdback sprocket shoe. When the sprocket

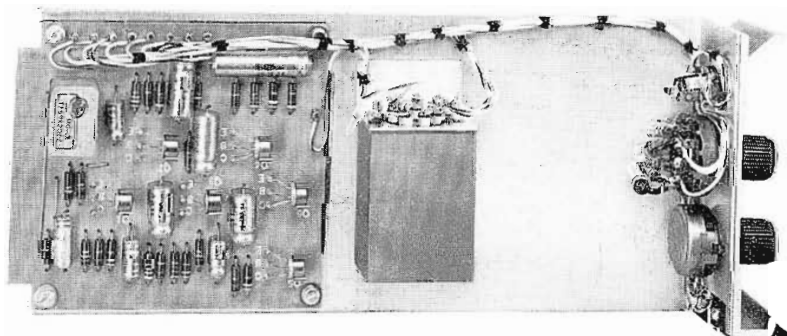

FIG. 3. The optical sound preamplifier is typical of the modular construction used in the TP-66. Complete transistorization eliminates the need for equipment warm-up, prior to operation.

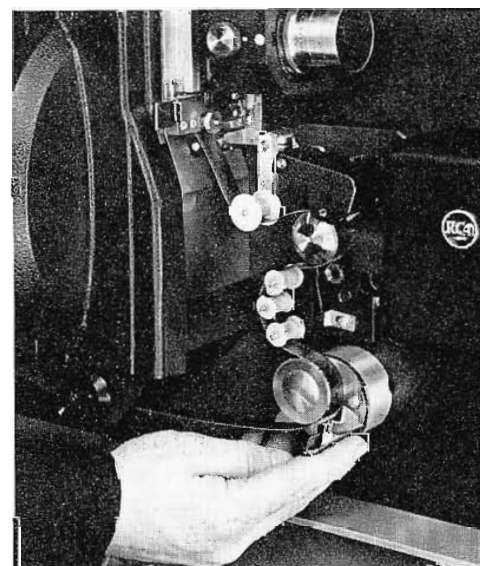
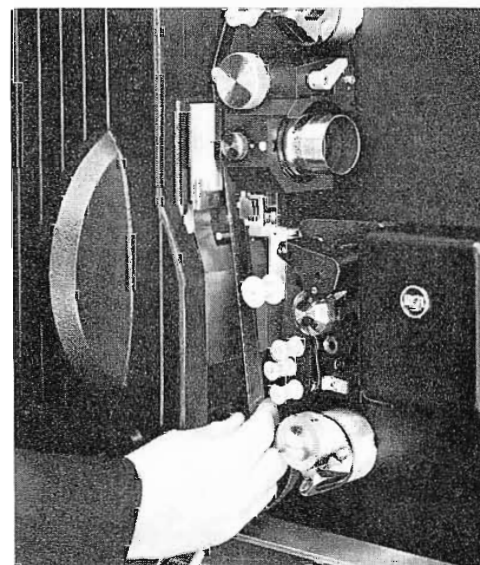
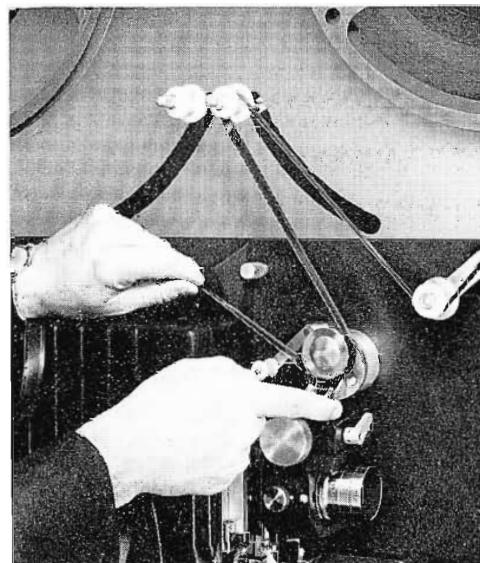

FIG. 4. Simple and logical film path makes threading the TP-66 Projector an easy matter. Loop setters (shown in position) act as measuring guides to assure correct loop size.

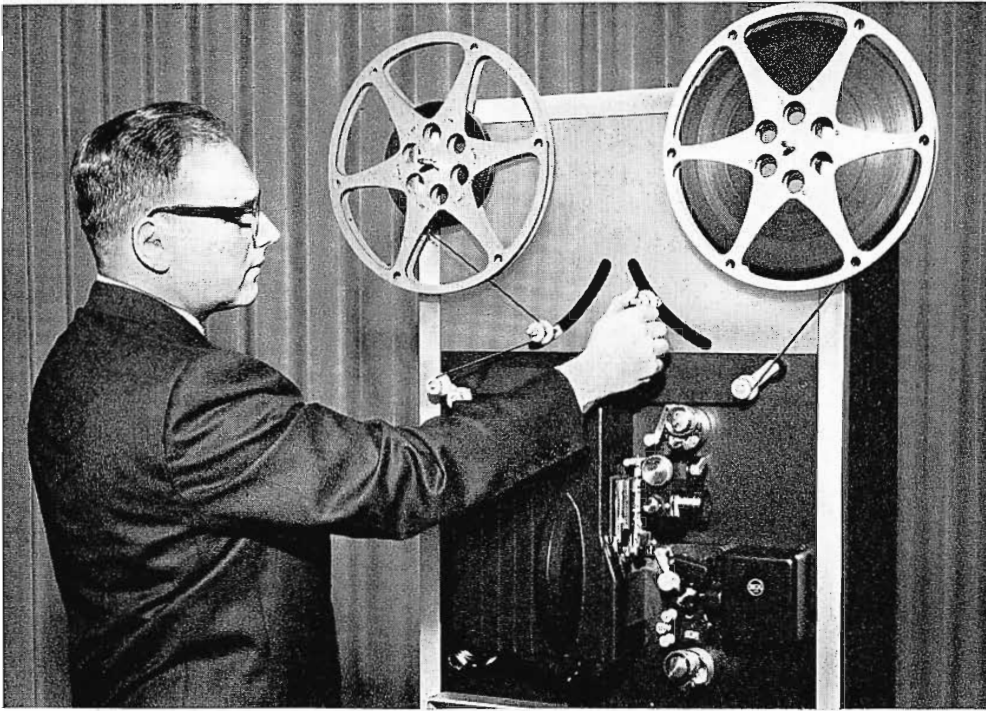

FIG. 5. Film may be wound or re-wound quickly on the TP-66. Manual operation of the tension arms controls the speed.

shoe is open for threading, the loop setters are placed into position.

Fast Wind and Rewind

Films can easily be rewound on the TP-66 Projector. In this operation, the film is merely threaded over the two sets of idler rollers. Winding in either direction is controlled by manual operation of the tensioning or sensing arms. See Fig. 5. Moving either of the arms in the direction of increased voltage will result in winding of the associated reel. Actual winding time is a function of reel diameter. A 100 foot reel can be rewound in approximately 45

seconds. The largest 20-inch diameter reel will require approximately 5¼ minutes.

Automatic Projection Lamp Change

When projection lamp failure occurs, a spare lamp is automatically moved into place and activated. The changeover mechanism consists of two projection lamps, mounted on a movable plate so that either of the lamps can be placed into operation on the optical axis. See Fig. 6. The plate moves either up or down depending on its initial position. An indicator lamp on the control panel gives constant indication of the condition of the stand-by lamp.

The projection lamps have a wafer stem keyed socket somewhat similar to an octal base tube socket. Easy access is provided for convenient and speedy replacement of lamps, even while the machine is running. The keyed base and socket assure proper alignment of the lamp upon replacement.

Automatic Exciter Lamp Change

Another contribution to the unusually high degree of overall reliability is an automatic exciter lamp change device. See Fig. 7. An indicator is provided to show when the changer is in its normal position. Removal of a single cover equipped with snap fasteners permits easy and rapid replacement of the defective exciter lamp.

Automatic Loop Restorer

Loss of loop, caused by torn sprocket holes or otherwise seriously damaged film, is instantly recovered by the automatic loop restorer built into the new projector.

FIG. 8. Loss of loop caused by defective film is instantly recovered by the automatic loop restorer, shown pulsed to its optimum loop position.

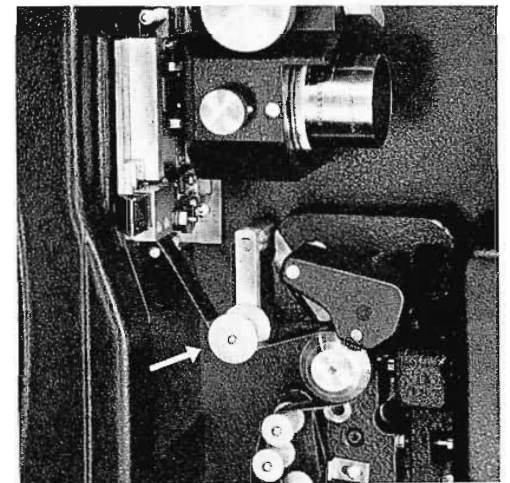

FIG. 6. Automatic lamp-change-mechanism places a new lamp into position within one second of lamp failure.

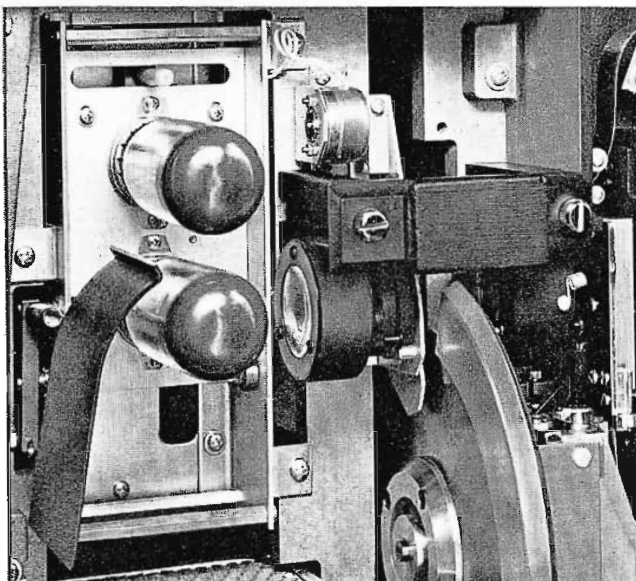
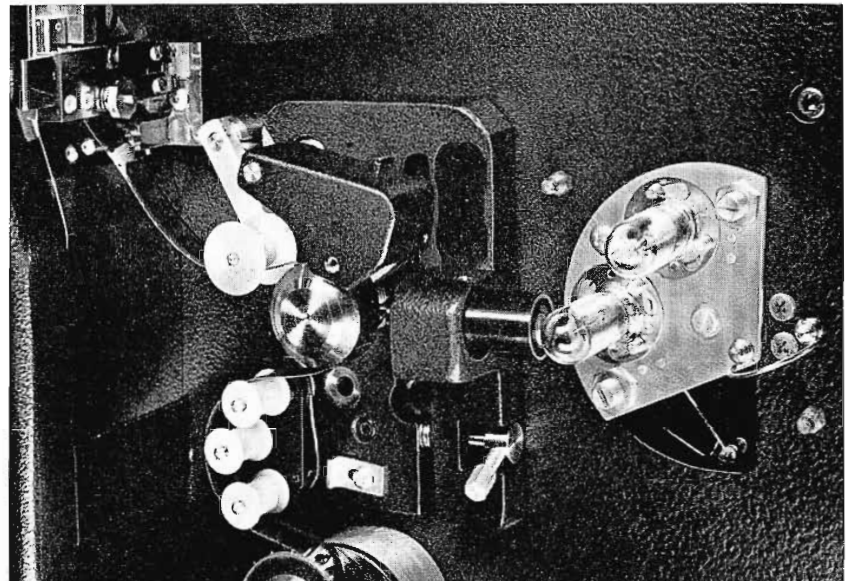

FIG. 7. Automatic exciter-lamp-changer, operating within one second, contributes to the high reliability of the TP-66 Projector.



This is a solenoid operated device, which upon sensing that loop loss has occurred applies a force to the film that causes film slippage to occur at the gate between pulldowns. When sufficient film has been recovered from the top loop to establish optimum lower loop size, a second sensing switch de-energizes the solenoid, and the loop restorer arm is free to return to its normal position. Sufficient compliance has been provided to avoid any possible damage to the film during claw engagement.

To assure uniformity of sound stabilization time each time the projector is started, the loop restorer is pulsed to its optimum loop position prior to the closure of the sound drum pressure roller. See Fig. 8.

CONSTRUCTION FEATURES

The TP-66 Projector is unique in its construction. The various modules and panels that comprise the projection system are housed in a rack-type structure. With the end covers removed, the frame is 22 inches wide, the same width as a standard cabinet rack. The basic simplicity of con-

struction provides a rugged, sturdy support which provides utmost accessibility to all components. See Fig. 9.

The unique rack-type construction allows the functions of the projector to be grouped and modularized. For instance, the main projection mechanism or film transport is contained on a single flat aluminum panel. All the various components that provide optical projection, sound pick-up, and film transport functions are located on this panel—which is removeable from the frame as a complete unit.

Above the transport panel is the reeling panel which contains separate take-up and supply reeling modules. Both reels are located at convenient eye-level height.

A sloping control panel is ideally positioned directly below the transport panel for utmost operating convenience. Standard width 19-inch rack mounting facility is provided in the lower section of the projector housing for the relay panel and the various amplifiers and power supplies used in the system. All these units except the 24 volt DC relay power supply and the relay panel mount in a plug-in module frame.

Precision Intermittent

A high degree of picture stability is achieved through the use of a precision claw type intermittent. Careful analysis has shown that this relatively simple type of pulldown mechanism offers the greatest opportunity for accurate film indexing. In the TP-66 intermittent assembly, there are only two mating parts which affect accuracy of position of the film. These precision parts are carefully controlled in manufacture and will provide consistently high performance, even after long use.

A three-tooth claw assures the uninterrupted passage of film having several torn

or damaged sprocket holes. The center tooth which actually engages the edge of the sprocket hole has a sapphire lining to insure long life. The sapphire insert is placed on the center tooth where it is least susceptible to accidental damage. Claw guides are of hardened tool steel to provide stable, maintenance-free operation over extended periods of time.

The intermittent has relatively few moving parts, and there are no gears within the assembly. The shutter is mounted directly on the intermittent cam shaft which is driven by means of a toothed belt at 720 rpm. A cycloidal cam contour provides smooth cam operation. All these design features contribute to the overall quiet operation of the intermittent mechanism.

The intermittent is easily removable for servicing. In most cases the assembly may be remounted on the projector without any re-adjustments; however, both lateral positioning and claw protrusion adjustments are easily accessible from the threading side of the projector. The intermittent mechanism runs in an oil bath for long life. The entire assembly is sealed through the use of "O" rings instead of ordinary gaskets, for ease of servicing and freedom from oil leakage.

The intermittent film motion time or pulldown time provided by the TP-66 Projector permits the utilization of a 50 percent application time shutter. This meets all requirements for non-synchronous operation in a color television system.

CONTROL FEATURES

The control system of the TP-66 Television Film Projector permits either remote or local operation as selected by means of a delegate switch located on the local control panel. See Fig. 10.

Remote Control Panel

A remote control panel provides control of projector functions from a remote location. Controls include "show," "forward," "reverse" and "still" projection, "stop," "optical/magnetic sound" and "automatic cue defeat."

All functions are controlled by momentary contact 24-volt control circuits. A 24-volt power source for this purpose is included as standard equipment in each projector.

Ready for Automation

The projector may also be controlled by 24 volt pulses derived from an automation system. Automation can therefore be implemented at any time without the need of providing "black boxes" or other external accessories.

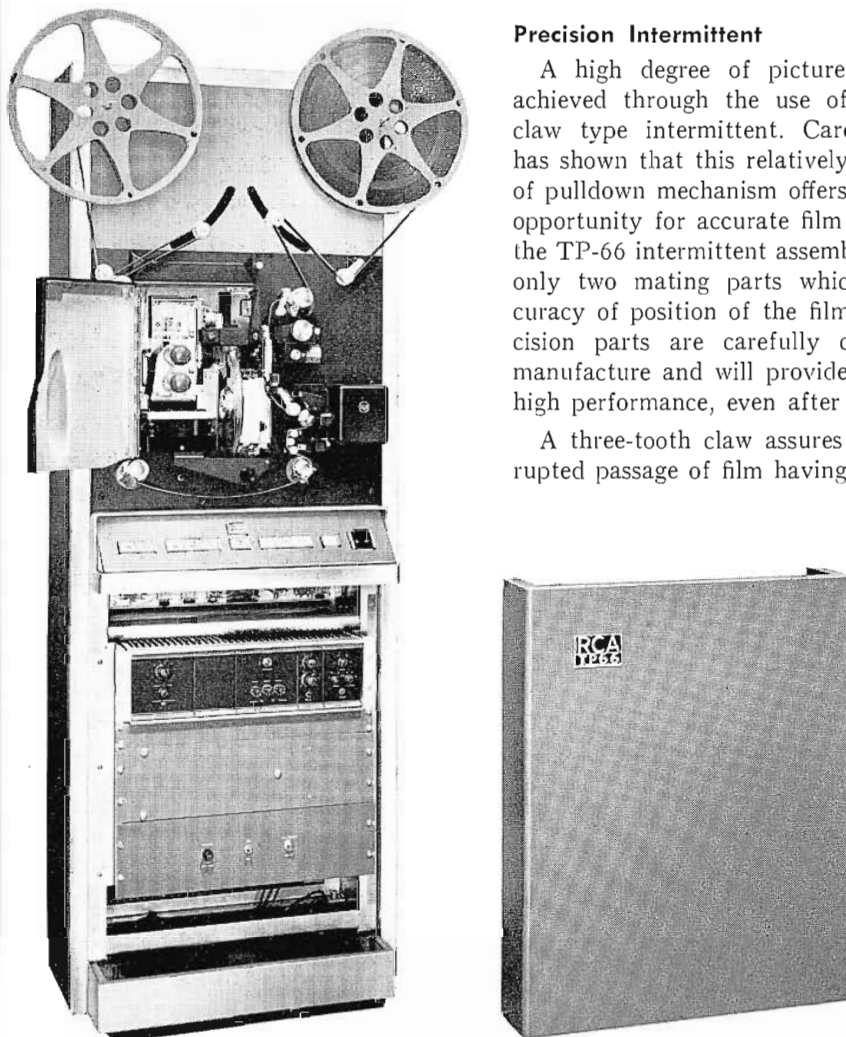

FIG. 9. TP-66 Projector with magnetically latched cover removed. The module frame (beneath control panel) houses plug-in amplifiers and power supplies.

Quiet Operation

The new TP-66 Television Film Projector is particularly quiet in operation. This is due in part to the utilization of a slow speed 1800 rpm drive motor, which is connected to the various sprockets, intermittent, and shutter through a system of toothed belts. This type of drive is considerably quieter in operation than a system using gears. A slow speed 720-rpm shutter driven directly by the intermittent cam shaft further contributes to the overall quiet operation of the projector. The intermittent mechanism itself, using a cycloidal pulldown cam is also designed to operate smoothly and quietly. During stand-by periods when still projector is being employed, only the whisper-quiet, axial-flow, projection lamp blower is in operation.

Low Heat Dissipation

The TP-66 Projector dissipates relatively little heat during operation. Because of the high efficiency of the optical system, a

500-watt projection lamp provides more than adequate light output for either a monochrome or color film camera system. The 6-watt exciter lamp used in the projector dissipates an insignificantly small amount of heat. Efficient solid-state amplifiers and power supplies contribute further to the cool operation of the projector.

Easy Installation

The new TP-66 Television Film Projector is entirely compatible with existing RCA film systems. It can be installed together with either TP-6 or TP-16 series projectors and integrated with TP-15 or TP-11 multiplexer systems as required.

Installation of the projector has been simplified by the use of a new alignment and leveling arrangement. The base of the projector consists of two castings; one bolts to the floor, the other to the bottom of the frame. Adjustment screws control the relationship between the two castings.

The projector is easily leveled and aligned, both transverse and parallel to the optical axis. The TP-66 Projector is supplied as an assembled and system tested unit, ready to be placed into operation.

Designed for Today's Television

An entirely new design for color and monochrome film operations, the TP-66 16mm Professional Film Projector uniquely fills the requirements of today's fast-paced film programming. In every detail it has been designed especially for television—based upon thorough investigation of user needs. As a result, the TP-66 meets the practical requirements of the television broadcaster—offering him the reliability and dependability of transistorized circuits, the versatility of new operating features to reduce error and increase program creativity, and the confidence that further requirements, such as color or automation can be met.

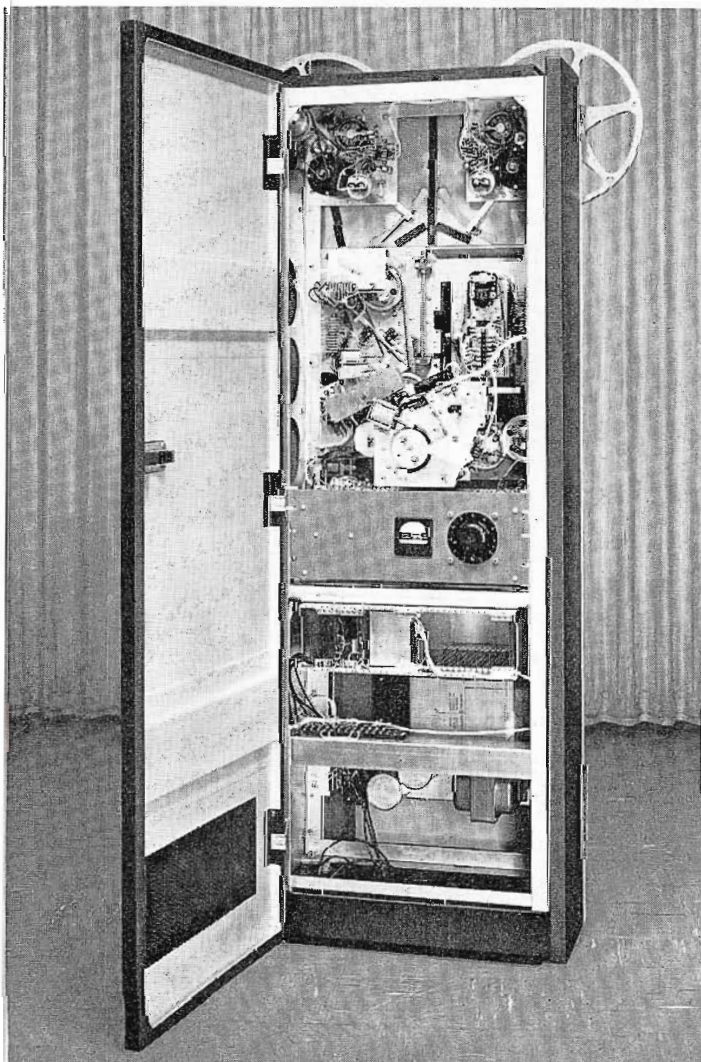

FIG. 11. Removable full length rear door provides instant and complete accessibility to the projector mechanism for inspection or service.

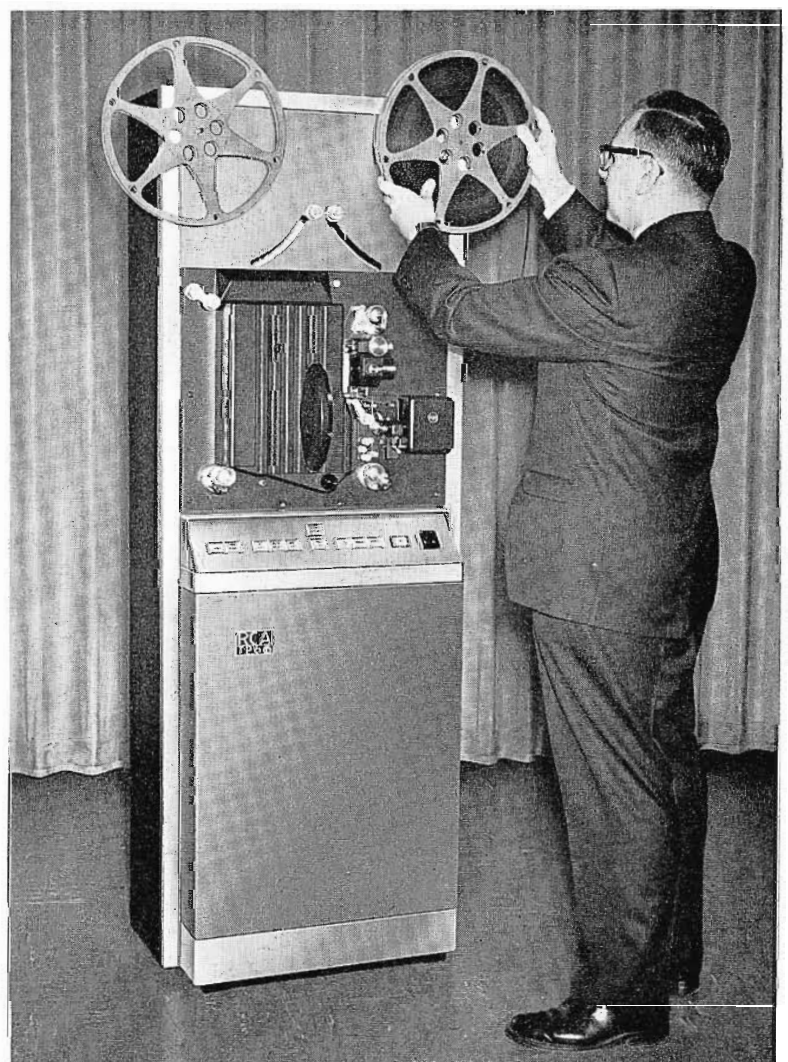

FIG. 12. The TP-66 Projector is easily threaded from a convenient standing position. Maximum convenience to the operator is assured by careful attention to the many factors involved in human engineering.



BC-7

STEREO/DUAL CHANNEL AUDIO CONSOLETTTE

by A. J. MAY
Broadcast and Television Engineering

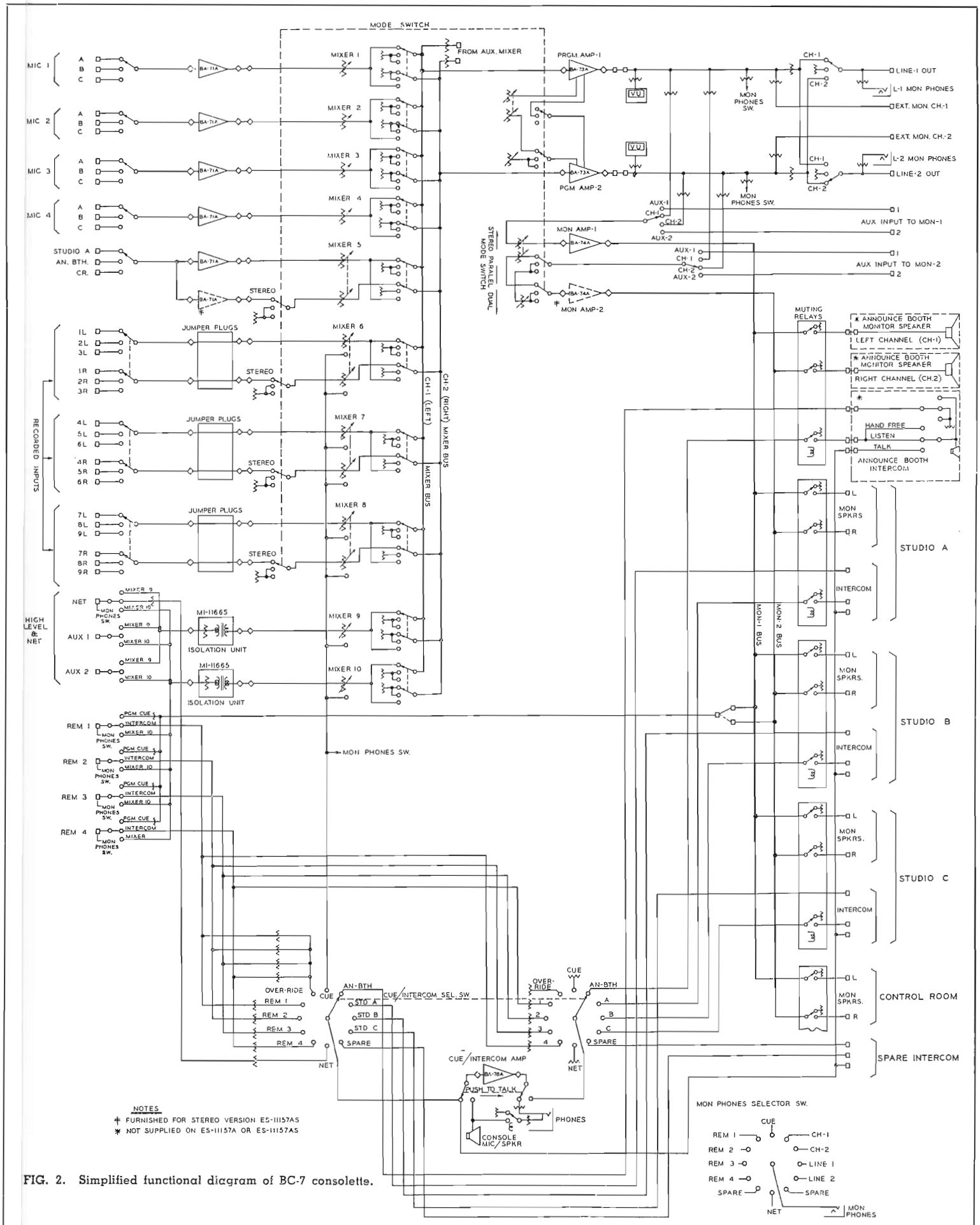

FIG. 2. Simplified functional diagram of BC-7 console.

Two output program line keys are provided. Each program line input has a three position selector switch to provide selection of signal from either program amplifier. The center (or "OFF") position, terminates the line.

Ten variable attenuators (mixers or faders) provide facilities for simultaneously mixing as many as ten input channels. Each mixer has a delegation switch that connects it to either the left channel or right channel mixer bus. Four of the mixers are dual mixers. In stereo operation, the left channel mixer bus and the right channel mixer bus are connected simultaneously when the mixer delegation key is placed in the "left" or channel No. 1 position. In monaural operation, the right channel section is terminated.

Within the console, a receptacle is provided for each mixer to accept various interchangeable plug-in units:

1. A *preamplifier*, for use with microphone sources,
2. A *high level isolation unit*, with strap adjustable attenuator, for line level sources, and
3. A *jumper plug* for direct input to the mixer.

In this manner, any or all mixers can accommodate a wide variety of sources.

Facilities are provided for two, independent, monitor amplifiers, each with a 2 db per-step attenuator and a 4-position input selector switch, by means of which each monitor may be connected to either program amplifier or to auxiliary sources. For stereo operation the two monitor gain controls are electrically ganged for simultaneous level control from a single knob. In monaural operation the second monitor amplifier may be used for audition or to "pre-view" the signal. (This second monitor may be omitted, or added later if desired. The combination of units selected depends upon the requirements of individual stations.) Note that facilities are provided for stereo monitoring through muting relays in all studios as well as the announce booth and control room.

A unique new feature has been included among the intercom facilities of the console. A separate amplifier with *automatic gain control* is provided for two-way communication with studio intercom stations and communication with remote lines. An intercom selector switch provides positions to also use the intercom amplifier for monitoring the mixer cue bus and network line, independent of other monitor facilities.

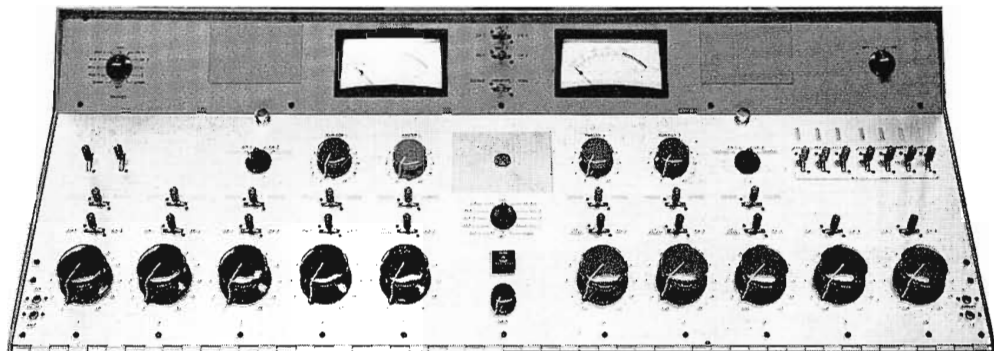

FIG. 3. Front view of console showing "human engineered" arrangement of controls.

Mixing Functions

As shown in Fig. 3, the 10 mixers (faders) are arranged across the lower portion of the panel in two groups of 5 equally spaced knobs. In a typical installation the left group of 5 mixers (black knobs) are used for microphone inputs, the 3 mixers to the right (blue knobs) are used for recorded inputs. Mixer No. 9 (green knob) is used for network and auxiliary lines; and mixer No. 10 (red knob) is used for remote lines.

Above the mixer knobs are *mixer delegation switches*, all of which have black handles, and *source selector switches*, all of which have colored handles. All source switches and mixer delegation switches are located immediately above the mixers with which they are associated.

In a typical installation the 4 switches with blue handles above mixers No. 1, 2, 3 and 4 would normally be used to connect the 4 microphones in studios A, B and C and corresponding labels would be

placed in the indentations adjacent to the switch positions. See Figs. 4 and 5.

Figure 6 is a close-up of one of the fader knobs (mixer No. 2) and its associated source selector and mixer delegation switches. By throwing the source selector switch of mixer No. 2 to the left position (normally labeled studio A) microphone No. 2 of studio A would be connected through its plug-in preamplifier to mixer No. 2. By throwing the corresponding mixer delegation switch to the left, the output of mixer No. 2 would be put on the left channel mixer bus.

Referring back to Fig. 4, microphones No. 1, 2, 3, 4 and 5 of Studio A are obtained on mixers No. 1, 2, 3, 4 and 5 when the corresponding source selector switches are thrown to the left position, labeled Studio A, see Fig. 5. In the same way, Studio B may have microphones which would be connected when the source selector switches are thrown to the center position.

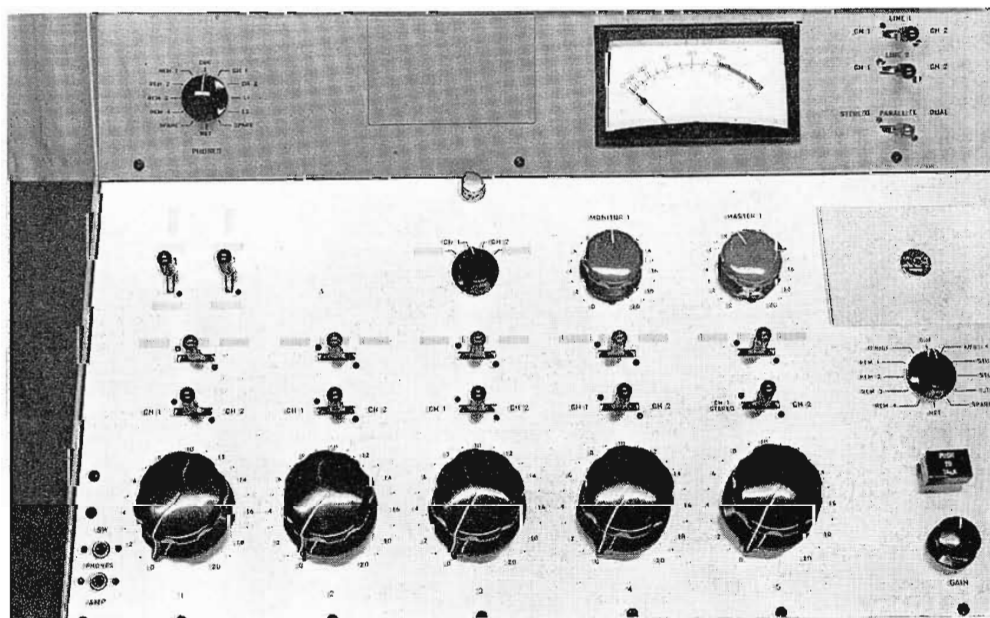

FIG. 4. Closeup of left console section.

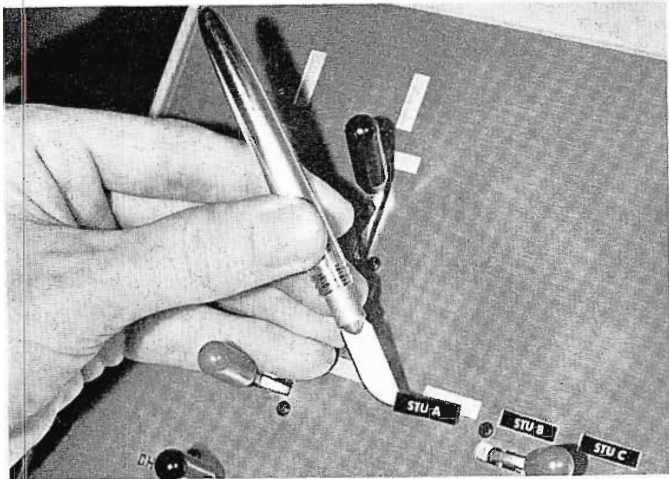

FIG. 5. Pressure sensitive metallic labels are supplied so that panel designations can be tailored to individual needs.

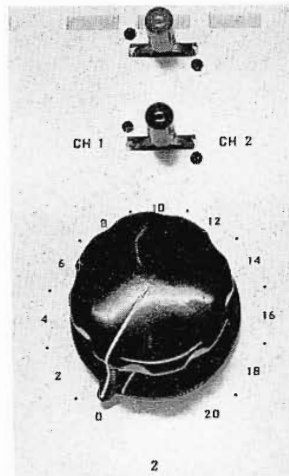

FIG. 6. Closeup of the feeder knobs and related switches.

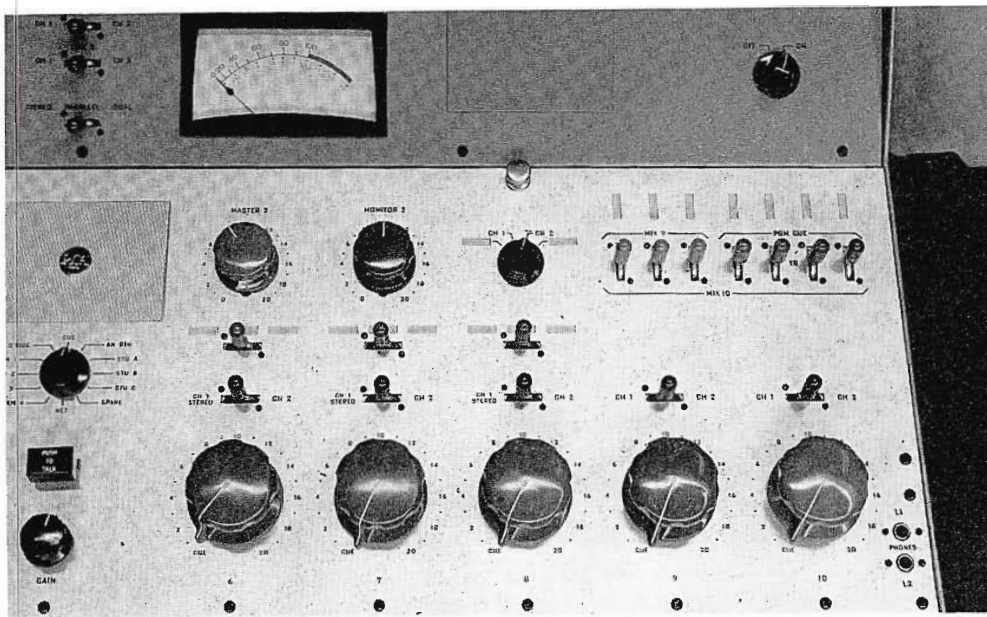

FIG. 7. Closeup of right console section.

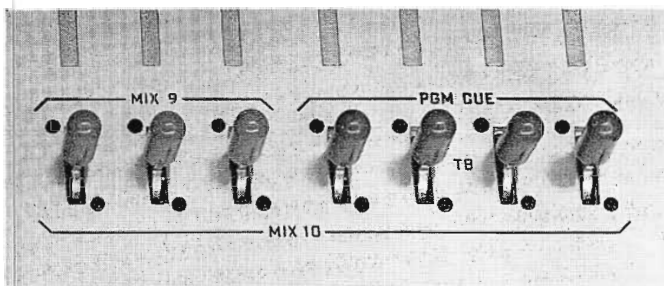

FIG. 8. Auxiliary source delegation switches. The three levers at left permit flexible input to either mixer number 9 or mixer number 10. The four levers at right are normally for remote lines.

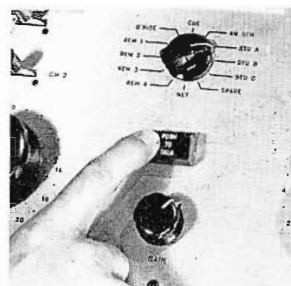

FIG. 9. Cue-intercom selector switch and control for push-to-talk microphone.

The source selector switch above mixer No. 5 has a red handle to indicate that the mixer has a double-section stereo attenuator. The No. 5 mixer position is unique, in that it normally has two preamplifiers arranged for stereo programming. In this manner the input selected supplies equal signal to both left-channel and right-channel

program amplifiers without upsetting the stereo relation of any stereo program material coming in on other mixers. The three sources normally assigned to this switch are Studio A (left); Announce Booth (center) and Control Room (right).

The three source selector switches with red handles above mixers No. 6, 7 and 8

as shown in Fig. 7, are normally used for Turntable, Reel Tape, Cartridge Tape, or Projector inputs. Here again red handles indicate dual-section stereo attenuators, which for stereo programming simultaneously adjust the level of both right and left channels. For monaural programming the right channel section of the stereo attenuators are terminated.

Above mixer No. 9 is a group of 3 lever switches with green handles. Each switch controls the delegation of a single source. Throwing the left hand green switch (normally labeled NET) to the up position connects the network line to mixer No. 9. The center position is an off position. Throwing the switch down puts the network on mixer No. 10. The two adjacent switches with green handles may normally be used for auxiliary lines for similar flexible input to either mixer No. 9 or mixer No. 10.

The 4 source-delegation switches with blue handles, in the upper right corner of the main panel, are normally assigned to Remote lines. These switches are shown close up in Fig. 8. Throwing a remote switch up, sends program cue to that remote location by feeding the output of a monitor amplifier through the remote line to an operator at a remote location. Throwing the switch down connects the remote line to mixer No. 10. In the center position (labeled TB for TALK BACK) the remote line is available for two-way communication with the console using the cue/intercom amplifier.

Cue/Intercom Functions

In the center of the main control panel (see Fig. 9) is a CUE/INTERCOM selector switch which is associated with the combination microphone/loudspeaker immediately above, and the PUSH-TO-TALK switch and GAIN control below.

The four positions at left of the CUE/INTERCOM switch permit two-way communication with any one of the remote lines. In the override position all remote lines can be monitored simultaneously. The four positions at right are for two-way communication with individual announce booth and studio intercom stations. The top position (CUE) is used to monitor the mixer cue bus and the bottom position (NET) is used to monitor the network line.

The plug-in cue/intercom amplifier employs AGC to maintain the output level of the amplifier—essentially independent of input level over above a 25 db range. Use of this AGC amplifier also prevents "blasting" over the cue and intercom lines.

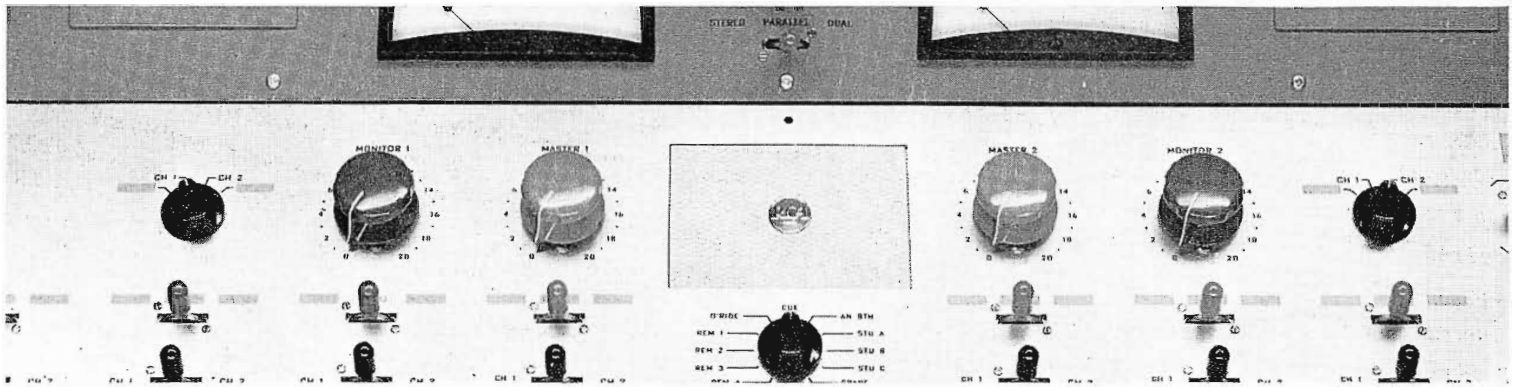

FIG. 10. Monitor and master control section.

Monitor and Master Controls

Immediately to the left of the intercom grill (see Fig. 10) is a red control knob (labeled MASTER-1) which controls gain of the left channel program amplifier for monaural operation. This also controls gain of both program amplifiers and stereo operation. The red knob at right of the intercom grill (labeled MASTER 2) controls gain of the right channel program amplifier for monaural operation and is disconnected from the circuit for stereo operation. For dual-channel monaural operation, the left channel may be used for a program channel and the right channel may be used for audition. Both master gain controls are 2 db per step attenuators.

The attenuator with a green knob (MON 1) at left of the intercom grill is a dual section 2 db per-step attenuator, which controls gain of only monitor amplifier No. 1 for monaural operation. This same attenuator controls gain of both monitor amplifiers for stereo operation. The attenuator with a green knob (to the right of the intercom grill) controls gain of monitor amplifier No. 2 for monaural operation and is disconnected from the circuit for stereo operation. Immediately adjacent to each monitor amplifier gain control is a 4-position monitor input selector switch. Each switch provides selection of left or right channel and 2 auxiliary inputs.

Two switches in the upper left section of the main control panel (see Fig. 4) are unwired auxiliary switches. These switches provide for any special needs of individual users.

Line-Out Switches

Selector switches for two outgoing program lines are in the center of the top panel, see Fig. 11. Throwing LINE 1 switch to the left connects outgoing line No. 1 to the output of the left-channel program amplifier through a 6 db isolation pad. Throwing it to the right connects it to the right channel program amplifier.

The center position terminates the line. The LINE 2 switch operates in a similar manner.

Mode Selector Switch

The lever switch with the red handle is a MODE selector switch. (Finger rests on mode switch in Fig. 11).

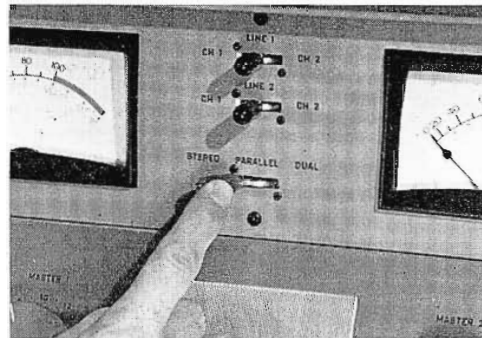

FIG. 11. Line-out and mode selector switches.

Throwing the mode switch to the left sets up the console for stereo operation, assigning CH 1 and CH 2 to the left and right channel respectively. This activates the right channel half of stereo mixers No. 5, 6, 7 and 8, transferring master and monitor gain controls for balanced right and left control.

When the mode switch is in the center position, two program amplifiers are internally connected in parallel after gain control. This effectively makes master No. 1 into submaster No. 1, and master No. 2 into submaster No. 2. Throwing the mode selector switch to the right, provides two independent channels (dual channel operation).

Monitor Phones Selector Switch

A monitor phones selector switch is located at the extreme left of the top panel, see Fig. 12. This provides a roving monitor phones facility to check key points independent of all other amplifiers. The monitor phones jack for this switch is located at the lower left corner of the main

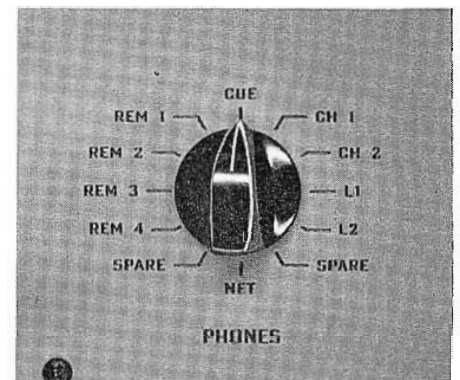

FIG. 12. Monitor phones selector switch.

panel. It is the top jack labeled SW (switch). The bottom jack of this pair, labeled AMP (amplifier), connects to the cue intercom amplifier. Normal-through contacts are provided so that inserting a phone plug substitutes headphones for loudspeaker in the intercom section.

The pair of phone jacks located at the lower right corner of the main panel (see Fig. 13) provide direct monitoring of two outgoing lines. This arrangement also permits the use of stereo headphones with a double phone plug for stereo monitoring of the two balanced outgoing lines.

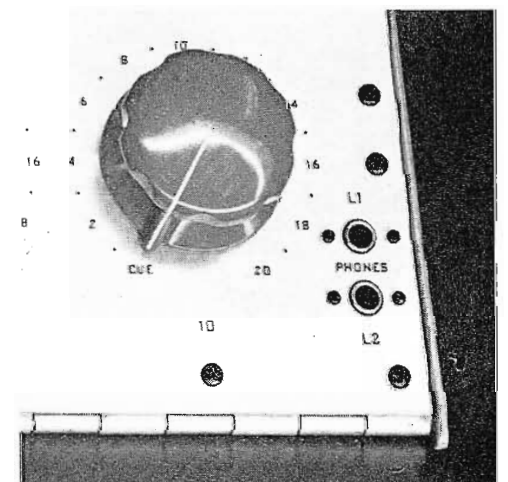

FIG. 13. Pair of phone jacks permit stereo monitoring of two outgoing lines.

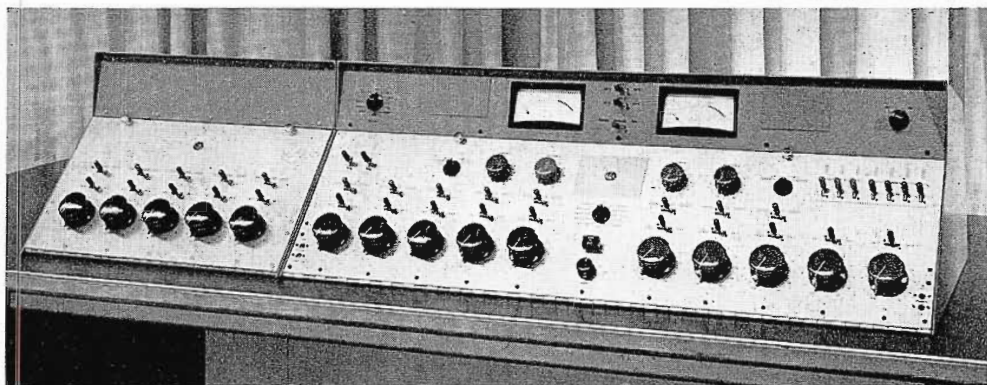

FIG. 14. BCM-2A Auxiliary Mixer (left) provides five additional mixing faders—matches consolette.

FIG. 15. BC-7 with front panel lowered shows accessibility to internal plug-in units.

Compact, Extremely Accessible Unit

By means of transistorization and the use of interchangeable plug-in units, a remarkable amount of user flexibility has been built into this compact consolette. Thirty-one permanently wired sources, with provision for simultaneous mixing of ten pre-selected program inputs, can be handled. All this facility, including power supplies, is provided in a self-contained consolette— $39\frac{1}{4}$ inches wide, $12\frac{1}{2}$ inches high and 20 inches deep. Further facilities can be provided by adding a matching BCM-2A Auxiliary Mixer, see Fig. 14. This equipment provides five additional mixing faders (15 more program sources) per unit. Note how well these units are matched in appearance and placement of controls.

The BC-7 is constructed for utmost accessibility as evidenced in Figs. 15 and 16. This allows simplified maintenance and enhances the flexibility provided by the interchangeable plug-in units.

FIG. 16. BC-7 with rear cover removed showing plug-in monitoring amplifiers and accessibility to terminal block.

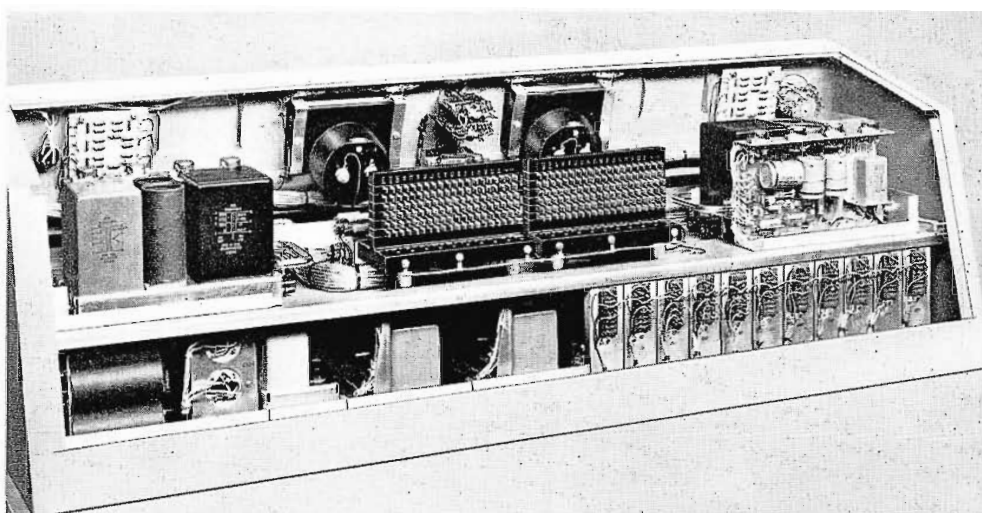
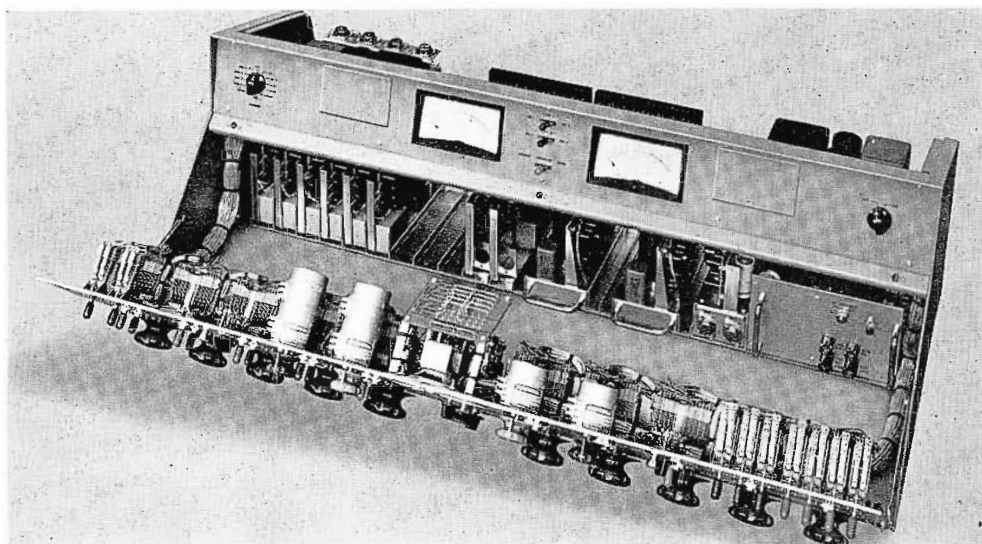
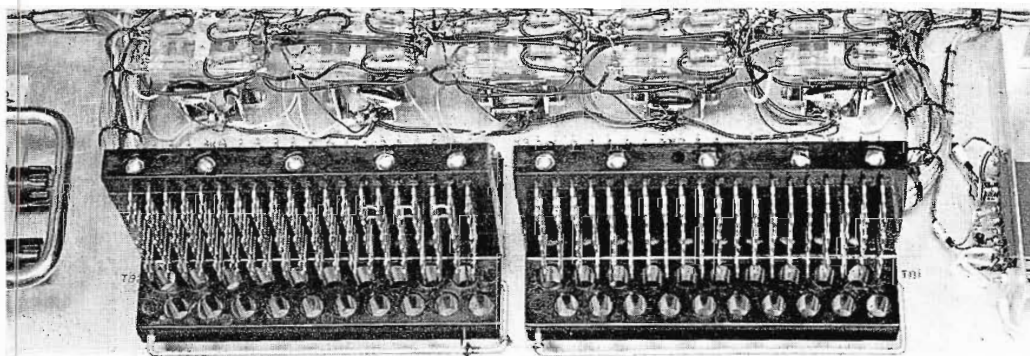
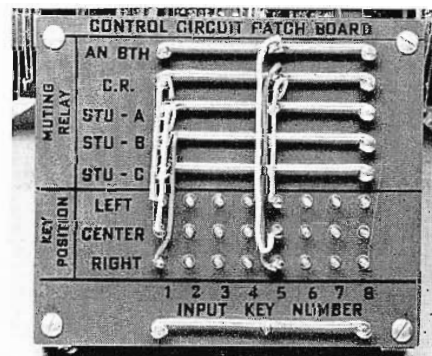

FIG. 17. Closeup of terminal block which handles connection of all incoming sources.



Other aids to flexibility are part of the construction of the console. Figure 17 shows the terminal block where all incoming sources are wired into the console. This type of jumper block construction simplifies wiring and facilitates inserting jacks into key circuits for patching in sound effects filters and dialog equalizers, etc. Also a control circuit delegation board, shown in Fig. 18, facilitates the delegation of muting and warning light relays for eight mixer positions.

FIG. 18. Control circuit delegation board.



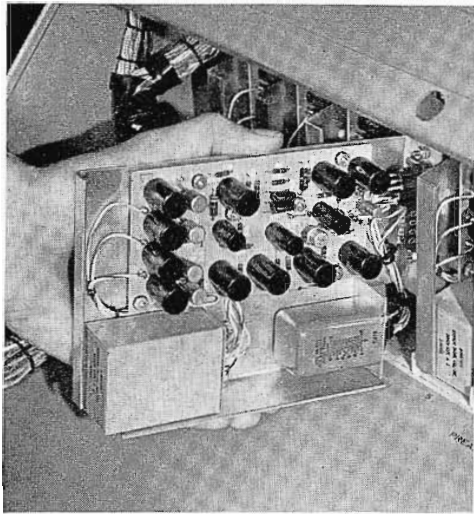

FIG. 19. Preamplifier unit.

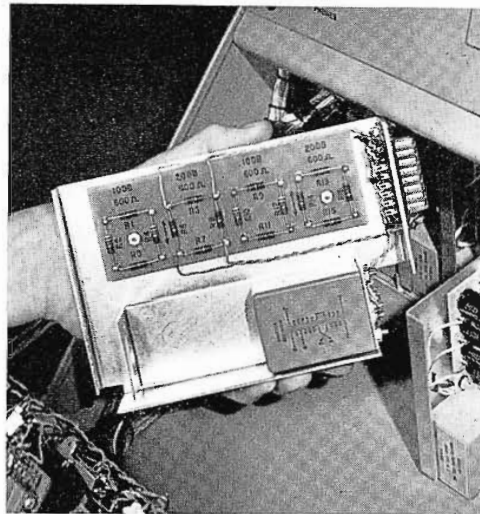

FIG. 20. High level isolation unit.

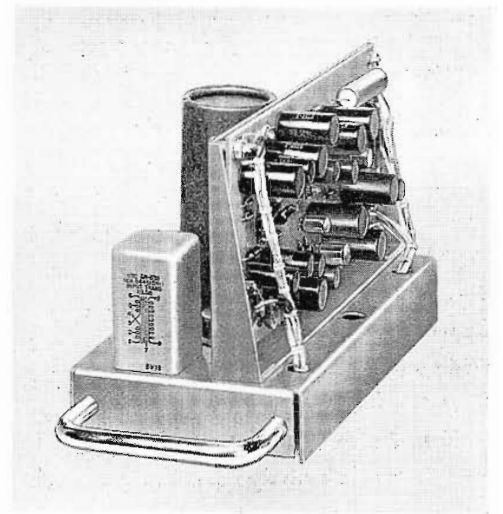

FIG. 21. Program amplifier.

Interchangeable Units

Plug-in units available for use with the BC-7 consolette include: pre-amplifier, high level isolation unit, program amplifier, AGC intercom amplifier, monitor amplifier, and power supply.

Preamplifier

The preamplifier, Fig. 19, is a 6-transistor plug-in device complete with both input and output transformers. It has a gain of 40 db, however it may be strapped for 46 db. The rated output is +18 dbm with less than 1/2 percent distortion from 50 to 15,000 cps; noise level is -122 dbm referred to input. The preamp provides source impedances of 37 1/2, 150 or 600 ohms and load impedances from 150 to 600 ohms.

Isolation Unit

The high level isolation unit, Fig. 20, provides isolation and strap-adjustable attenuation up to 60 db, in 10 db steps. Terminals provide convenient arrangement

for changing resistors to provide any specific attenuation desired.

Program Amplifier

The program amplifier, Fig. 21, has a gain of 92 db, +24 dbm output capability, with both input and output transformers to take high peak levels without distortion.

AGC Intercom Amplifier

The AGC intercom amplifier, Fig. 22, has a built-in power supply. Its output changes approximately 1/2 db for each 5 db change in input over about a 25 db input range. Output level is nominally set by AGC at 1 watt; however, the output capability is several times this.

Monitor Amplifier

The monitor amplifier, Fig. 23, has a 10-watt output for high quality stereo monitoring. It features a self-contained power supply, 63 db gain, and less than 1 percent distortion from 50 to 15,000 cps. It has transformer input for 150 to 600

ohm sources; transformer output for load impedances of 4/8/16/150/600 ohms.

Power Supply

The power supply, Fig. 24, provides operating power for 10 preamplifiers and isolation units, 2 program amplifiers, 5 speaker muting relays, as well as reserve power for operating 5 additional optional auxiliary relays.

Designed Like Custom Equipment

In summary, the BC-7A Stereo/Dual-channel Consolette with transistor circuitry provides a self-contained audio system of broadcast quality for stereo or monaural mixing, switching and monitoring, plus independent AGC amplifier for intercom and cuing. Plug-in units and functional grouping of controls offer a wide choice in assignment of inputs and contribute to the high degree of flexibility obtained. These advantages make this consolette adaptable to requirements normally met only with custom-built equipment.

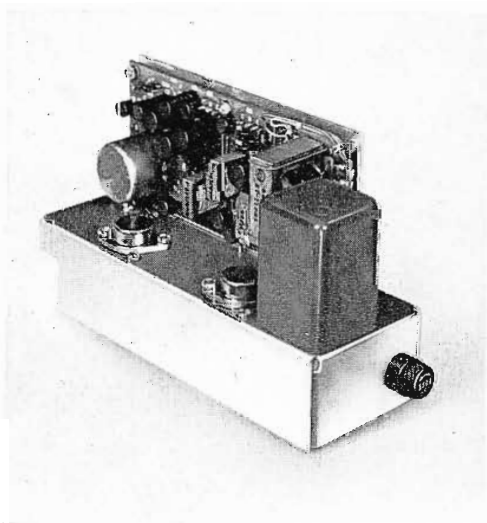

FIG. 22. AGC intercom amplifier.

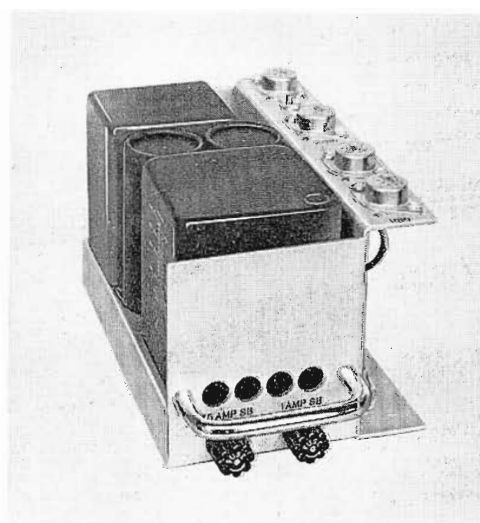

FIG. 23. Monitor amplifier.

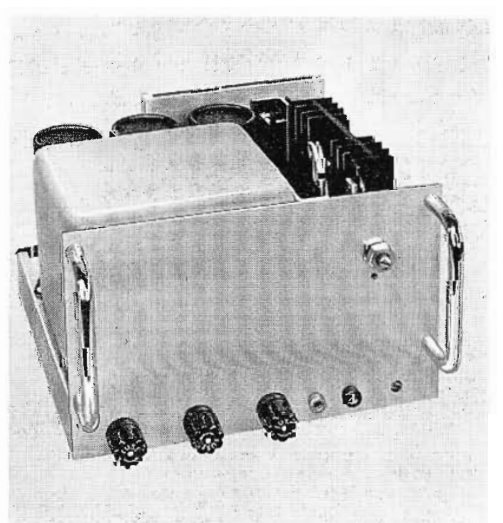

FIG. 24. Power supply.

What Station Men are saying about THE RCA "TRAVELING WAVE" ANTENNA

**At WMTW-TV, Poland Springs, Me.
Parker Vincent, Chief Engineer, says:**
"We decided on our Travelling Wave TV Antenna for the specific purpose of operation under the severe icing conditions we encounter on Mt. Washington (N.H.). We could not operate without it. Aside from the special properties of strength and ability to operate within a radome, the field of the antenna is very uniform."

**At KROC-TV, Rochester, Minn.
Robert W. Cross, Chief Engineer, says:**
"During installation and erection of our Travelling Wave Antenna, I was most favorably impressed with the mechanical simplicity and ease of assembly. Subsequent electrical check-out of the antenna and its 1300-ft. transmission line proved it to have the lowest VSWR of any system encountered."

**At KTSM-TV, El Paso, Texas
Karl O. Wyler, President, says:**
"I believe that KTSM-TV was one of the first stations to order the RCA Travelling Wave Antenna. It has been in service on Range Peak since December 1959, and we are completely pleased with its performance. We like it because there is practically no maintenance, no bolts to tighten, and fewer inspections. Overall efficiency is very good."

**At WLOS-TV, Asheville, Greenville, Spartansburg
Mitchell Wolfson, President, says:**
"WLOS-TV is extremely well satisfied with the Travelling Wave Antenna installation. Physical and electrical advantages met every promise and the increased signal strength throughout the station's 82-county, 6 state area exceeded all expectations."

**At KGIN-TV, Grand Island, Nebraska
D. Raymond Taylor, Chief Engineer, says:**
"Field strength measurements show that the signal far exceeds the predictions of the FCC 50/50 Field Strength Curve. Reports from viewers on the fringe area substantiate these measurements. The standing wave ratio is very good and no ghosting is present."

**At KOAM-TV, Pittsburg, Kansas
Leo S. Stafford, Chief Engineer, says:**
"I have viewed KOAM-TV from some 85 miles away and was amazed at the picture quality. The antenna has increased our area coverage by 63 percent, while at the same time it gives us 316 ERP on less transmitter power. This reduces primary power requirements and increases tube life."

Favorite Antenna of High-Band Stations!

CH 7	CH 8	CH 9	CH 10	CH 11	CH 12	CH 13
CJAY	KGHL	KLRN	KROC	CHCH	KCND	CKCO
KCMT	KSWS	KTSM	KXTV	KCBD	KEYC	KMSO
KOAM	WKBT	WAFB	WCBB	KGIN	KFVS	KOVR
WNAC	WMTW	WWTW	WIS	WBAL	KNMT	KSOO
WPBN	WOOD		WLBN	WLWA	KTVH	WGAN
WTRF	WQAD		WPTT		KVAR	WIBW
WXYZ	WXGA				WEAT	WJZ
					WMEB	WLOS
					WPRO	WOKR

If you want more facts about this VHF High-Band Antenna, your RCA Broadcast Representative can help you. Or write RCA Broadcast and Television Equipment, Building 15-5, Camden, New Jersey.



The Most Trusted Name in Television

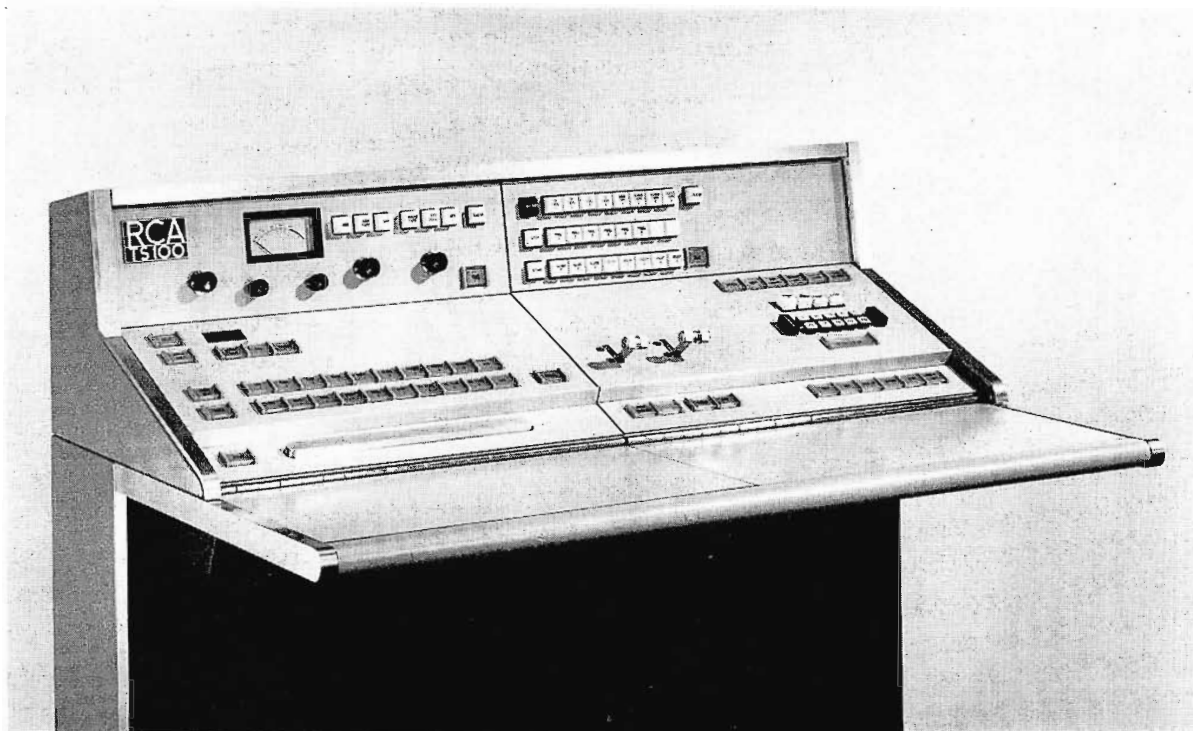

Prototype TS-100 Switcher—portent of future design.

(Continued from Page 2)

plified controls, and (eventually) automation. Stew, with our styling consultant John Vassos, had evolved the design concept for the RCA 501 Electronic Data Processing equipment—and had followed that concept in succeeding equipments to make the modern RCA EDP line the best styled line of equipment in the electronics field. In the TS-100 he hoped to establish a new—and equally successful face for RCA Broadcast Equipment. (And of that we will hear more later.)

As We Were Saying

Now Dick and Stew are working together again. This time to design the custom-built control consoles for the RCA Fair Exhibit. And with that intriguing thought we will leave the Fair—for now.

REPEAT orders, as the man says, are the real measure of product success. It's particularly true in this broadcasting business. Our customers' engineers are competent and tough-minded critics. They may, and often do, order our new products before these products are out of the laboratory. They do so because they want to try these shiny new gadgets—and because they have confidence in us. This is good—and we like it. But we like it even more when—after trying the new product for some months—they order additional quantities. The first orders are based on confidence in the manufacturer. The repeat orders are based on confidence in the product, per se. They are the proof-of-the-product.

RECENT REPEATS have been especially gratifying for two reasons. First, because they are for products about which there was originally some

controversy. Second, because they came from stations, or station groups who are noted for having some of the best technical staffs in the business.

One example is recent orders for our 50 KW AMPLIPHASE Transmitter. When we introduced this transmitter, there was considerable discussion in the industry concerning the unusual modulation system employed. Inevitably, invidious comparisons were made ad infinitum—and ad nauseam. But most of our customers had enough confidence in us to go along. Among these were the Hearst stations (for WBAL, Baltimore) and the Storer stations (for KGBS, Los Angeles). Both groups, albeit, have very highly rated technical staffs. We are happy, therefore, to report that both groups have now reordered—Hearst for **WISN, Milwaukee** and Storer for **WGBS, Miami**. (Q. E. D.)

A similar situation is occurring in reorders for the TK-60 4½-inch I.O. Camera. This, too, was a controversial item—at first. We had taken a rather long jump forward (really a little ahead of the so-called "state of the art") in order to get a truly stabilized camera. There were skeptics. Fortunately there were also broadcasters who were looking two jumps ahead—as we were. They liked the idea of the TK-60—and they ordered. A lot of headaches have gone over the dam in the meantime. But now the reorders are pouring in.

Among the early orders for TK-60's were those of ABC, of Westinghouse (for WBZ), of Time-Life (for WOOD, Grand Rapids), of Wometco (for WTVJ, Miami), of MGM and of Sports Network. Among the recent reorders are those of ABC, of

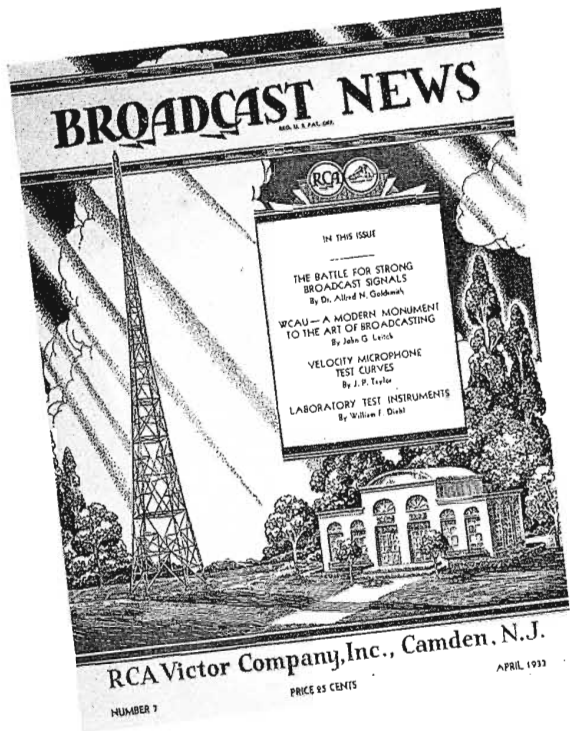

The Armchair Engineer first appeared in BROADCAST NEWS for April, 1933—with a story of the then-new 44A Velocity Microphone.

As We Were Saying

THE ARMCHAIR ENGINEER sign-off occasionally used by this column has been noted by a number (well, anyway a couple) of people who have wondered where we got it. Truth is, it's an ancient (if not very venerable) title conferred on this sometime editor more than thirty years ago. The Armchair Engineer first appeared in BROADCAST NEWS for April 1933 (see above). The title had been given us some months previously by the Engineering Department. They didn't mean it as a compliment!!*

It had been our wont (then as now) to unabashedly tell them how to do their job. And it was their way of putting us in our place. But we didn't mind—we sort of liked "our place," and we've gone on liking it over the years. So that's all there is to it.

IDIOTISM, we learn from a letter in the *Saturday Review*, means "a current deviation or departure from the strict syntactical rules or usages of a language." The letter writer quotes the Century



Westinghouse (for KPIX), of Time-Life (for WOOD), of Wometco (for WTVJ), of MGM, and of Sports Network. ABC will shortly have 42 of the TK-60's in operation—more 4½-inch I.O. cameras in actual use than anyone anywhere. (Q. E. D. again.)

Dictionary as authority. Loose or unusual use of words, or even use of newly coined words is one of the worser (sic) forms. Use of hyphens, dashes and parentheses in place of more approved punctuation is another. Since (because?) this column (writer, editor, idiot?) is often guilty (culpable?) of perpetrating such deviations, the discovery of the name of the game was a bit of a shock.

Not that it should have been. Years ago we had an English teacher who was inordinately (very?) fond of a simple tale about Noah (Webster, that is) and his wife. Seems that when the old lady came upon Noah kissing the maid, she exclaimed: "Why, Noah, I'm surprised." To which Noah replied: "No, dear, you are astonished; it is I who am surprised."

Well, idiotism or not, this column will continue to be written in semi-English, neo-Pennsylvania Dutch, pseudo-New Yorkerese, Alice-in-Wonderland fantasy or even, on unconscious occasions, in Websterese. We will now and then be guilty of split infinitives, un-syntax, mis-punctuation and even of using what one famous (but we can't remember his name) writer has called "non-words." Our job is to "communicate" ideas and impressions. We will continue to do so as best we can.

Along Madison Avenue With Kaselow

Ikonogenic Therapy Has a Go at TV

tives for resort and travel ad-
-effective immedi-
-manga-

52 (PROGRAMING)

BROADCASTING, September 16, 1963

By Joseph Kaselow

"Much of television advertising is anti-aniconic, lacks an 'individuating' identity, needs a 'deep massive Ikonogenic therapy' and should eliminate all unfranchised sources of noise if it is ever to reach maximum effectiveness."

Well, we've hear TV commercials called a lot of things but when you call them anti-aniconic—smile!

At first blush you might think the above quotation was the mouthing of one of our friends in the motivation research game. Not so. It comes from the other marketing magician, the industrial designer, a species that is rapidly making the motivation research boys' jargon seem as simple as McGuffey's Reader.

The speaker in this instance was one Crawford Dunn, of Dallas, who heads an industrial design firm called Ikonogenics, Inc., which exposes a new concept of image control that goes by the company name. Mr. Dunn, a non-formalist, didn't buy a TV set, so he caught the

With fitting disdain, Mr. st
Dunn threw out all of it
WPAB-TV's graphics and v
slides and made more than
2,000 new ones with the
accent on simplicity and
clarity of style. He designed
new sets — "aniconic" or
"zero-noise" sets, which
blend so well into the back-
ground that you are almost
completely unaware of them
while the announcer hits you
with the commercial.

Mr. Dunn also worked ove
the letterheads, brochure
ad campaign plans and eve
designed the style of cloth
to be worn by local WBA
TV personalities.

As for TV commercials,
has this to say: "Too m
of them are so cluttered
it's amazing that any r
sage at all gets through.
when you present com
cials with plots, you're
ting away from adver
and into entertaining."

Well, some people
said lately they pref
commercials to the pro
The idea is even spi
to the advertisers.

Crandall, who opera
own advertising ag
Dallas, has permit
Dunn to re-design th
to ma

WBAP-TV builds image around 'Ikonogenics'

On Oct. 15, WBAP-TV Fort Worth-Dallas will unveil what it calls "the first complete, original design of a television schedule." Roy Bacus, WBAP-TV general manager, explained the new concept as "more to see and less to look at."

What WBAP-TV has done, Mr. Bacus said, was utilize the principle of "Ikonogenics," a term coined by industrial designer Crawford Dunn.

The Ikonogenics concept calls for complete control of all images that a corporation presents to the world. In the case of the Texas station it began with altering "the concept of what 'communications' meant," Mr. Bacus said.

"The initial step was to stop treating TV as radio with a picture. We set about the challenging task of imagining what TV should be like, not related to any other communications medium, and then set about making it like that," Mr. Bacus explained.

WBAP-TV's use of Ikonogenics will show up in "every phase of station

operation down to the most minute details," according to Mr. Bacus. "This theory will be presented in our visuals, graphics, sets, letterheads, logos, station advertising, program titles, and even our music will be carefully tailored to the image induction pattern."

Mr. Dunn emphasized that clean lines, minimum messages and attractively designed material will be highlights of his presentation. He feels that one of the major mistakes made by broadcasters is in the signal-to-noise ratio.

Many of the graphics used by TV stations are so cluttered (noise), and attempt to carry so many messages in too short a period, he noted, that they actually act as a deterrent to getting the station's message across.

Noise, in his description of the term for television, "is the amount of extraneous material appearing in graphics used by local TV stations and in local commercials and programming."

In the case of WBAP-TV "we began

thinking in terms of what could be done rather than what could not be done," Mr. Dunn said. "We spent countless hours in analysis of what was on the air and then began to lay out our new designs for the station. We abandoned all previous theories on hues, value and chrome.

"We found that our task would be a process of distilling off all the extraneous visual and aural data and refining what was left and what was actually communicative."

According to Mr. Dunn, one of the biggest single innovations in the program was use of design talent at the top of the organization to focus on all the elements of the broadcast day and "create a total interrelated presentation that was unified and integral."

The sales curve of the station will not affect the program, Mr. Bacus said. "It's what we feel should be done. It's the first move on the part of TV to improve its image not just to its audience but to the industry and the general public as well."

IKONOGENICS is the latest thing in TV station scheduling—and WBAP-TV, one of our favorite stations, is the first to have it. According to the story in **Broadcasting**, WBAP-TV has unveiled what it calls "the first complete, original design of a television schedule." Roy Bacus, WBAP-TV's general manager, says it is based on the principle of "Ikonogenics," a term coined by industrial designer Crawford Dunn. Mr. Dunn's firm, Ikonogenics, Incorporated, is responsible for WBAP-TV's new look.

Ikonogenics is a word we liked right off. Our unknown famous writer (see pg. 59) might call it a non-word. But how could a set of letters with so much portent not be a word. (Our Webster says a word is a "series of sounds communicating an idea.") What idea does Ikonogenics communicate? Well, we admit that when we first saw it, we thought someone had found a use for those old ike chains—especially since the copy contained several references to "signal-to-noise." But no, Ikonogenics has nothing to do with iconoscopes—although it is concerned with images.

Mr. Dunn defines Ikonogenesis as the process of image creation. The image he refers to is the image (of a company, or a product, or a service) which "exists only in the minds of individual persons who have received, decoded, evaluated and stored information about that company." The **process** by which the image is formed in the mind of the individual cannot be controlled. You cannot command an individual to have a good image

of your company—or a bad image—or even no image. But you can control (to a degree) the **information** about your company which is presented to the individual as "input" to the thought processes by which he forms his image of your company. This "information input" consists of many things. It includes what he reads about you in the newspapers and magazines, what he hears on radio, sees on television. It includes your advertising, your promotion literature, your catalogs, your letters, what others say about you. It may include contacts with your employees and experience with your product or service. If you are a radio or TV station, it certainly includes your programs—and your commercials. It is Mr. Dunn's thesis that all of these many pieces of information input are intrinsically ikonogenic—i.e., intrinsically image-inducing. The science of ikonogenics might, therefore, be described as the control of all these image-inducing presentations. The hoped-for result is the forming of a true and favorable overall image in the minds of the individual recipients.

The sophisticates will say that there is nothing very new about this. It is essentially the "corporate-image concept" that public relations and advertising men have been preaching for years. Mr. Dunn has just given it a catchy name and undertaken to make a science out of it. All this—they will say—has been done before.

True enough—but Mr. Dunn does it better. And, along the way, he makes some points which are very intriguing.

As We Were
Saying

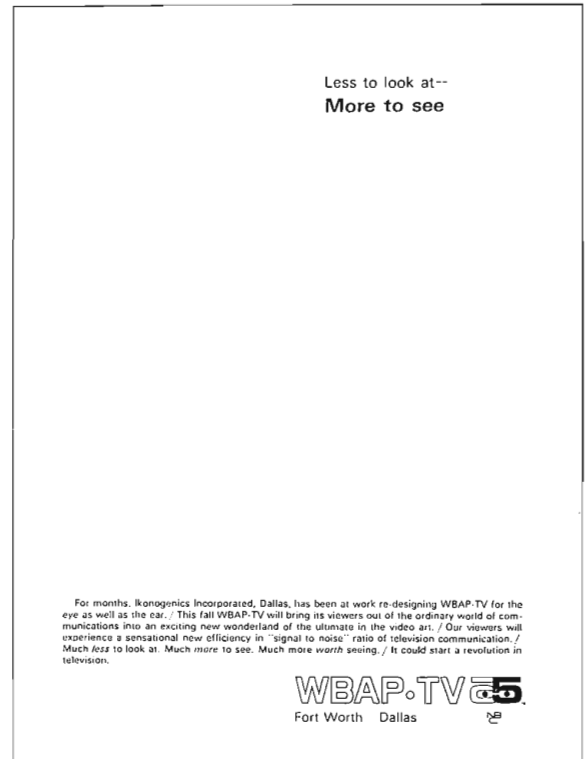
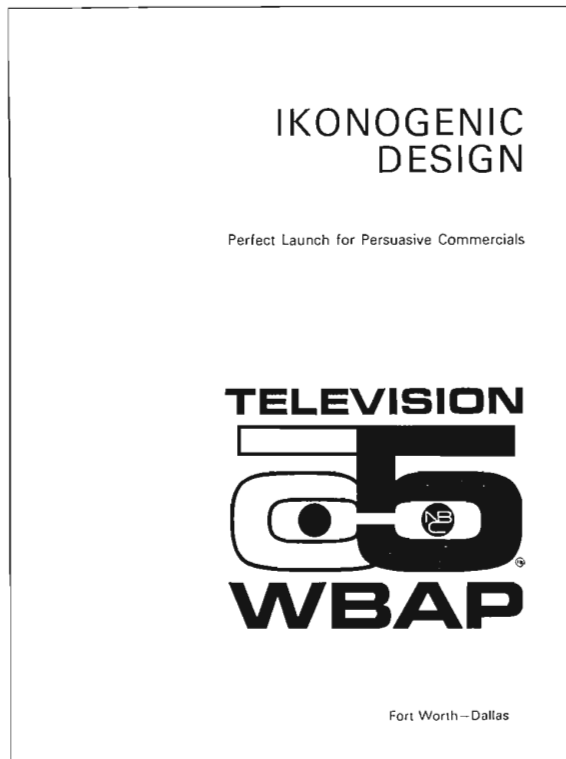

Two of WBAP-TV's trade ads reflecting the ikonogenic influence.

*As We Were
Saying*

THE IKONOMATRIX (i.e., ikonogenic matrix) is what Mr. Dunn calls the sum of all the information inputs. He divides it into two parts. One part is the **predicative** ikonomatrix—which is the information a company presents **about** its products, services and practices. This is the area in which public relations and advertising operate. And, obviously, this is an area in which a company can control the information inputs. Mr. Dunn points out that many companies who think they are doing a good "corporate-image" job do not extend their thinking beyond this predicative area.

What these companies miss is the second part of the ikonomatrix—what Mr. Dunn calls the **essential** ikonomatrix. It consists of the **actual** products, services and practices of the company. In this area the information inputs are based on first-hand experience with the product or service, on word-of-mouth information from a friend who has had such experience, on published reports of product performance, etc. Obviously, you can control this part of the information input only by actually **being** the company you want people to think you are. It is in his emphasis on this second part of the ikonomatrix, and his insistence on the control of every last bit and piece of the total information input, that Mr. Dunn stands out from the run-of-the-mill image conceivers. And, as it turns out, this enlarged (and, perhaps we should add, enlightened) concept is particularly applicable to radio and TV stations.

AS APPLIED to a TV station the Ikonogenics concept calls for the complete control of all images that the station presents to the world. WBAP-TV's use of Ikonogenics, according to Mr. Bacus, will show up ". . . in every phase of station operation down to the most minute details . . . our visuals, graphics, sets, letterheads, logos, station advertising, program titles, and even our music will be carefully tailored to the image induction pattern." Of course, for such a program to be fully effective it had to be preceded by some soul searching as to what the basic image pattern should be.

WBAP-TV STARTED their ikonogenic thinking by reviewing their concept of what "communications" meant. As Mr. Bacus explains it, "We set about the challenging task of imagining what TV should be like . . . and then set about making it like that."

One of the biggest single innovations in the program, according to Mr. Dunn, is the use of design talent at the top of the organization to focus on all the elements of the broadcast day and "create a total interrelated presentation that is unified and integral." To further strengthen the presentation he proposes to increase the "signal-to-noise" (sic) ratio. In his jargon the signal is the message, and the noise is the extraneous material appearing in the station's graphics (sets, slides, etc.). Thus plain backgrounds, uncluttered sets and slides of simple design will be used to

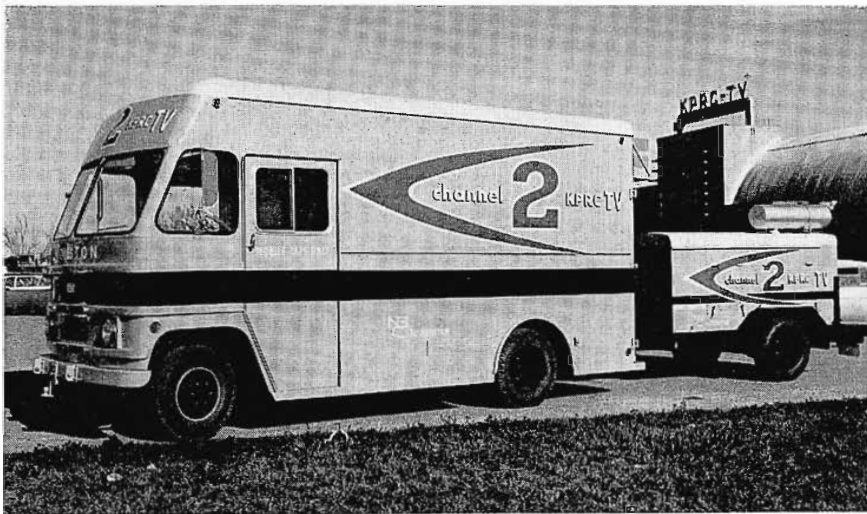

KPRC-TV, Houston, Mobile Unit features permanently-installed RCA TRT-2 Recorder for compatible quadruplex TV Tape recording in the field.



make the message stand out. And the messages themselves? According to Mr. Dunn they will be shorter—and there may even be fewer of them!

The sales curve of the station will not affect the program, Mr. Bacus says: "It's what we feel should be done. It's the first move on the part of TV to improve its image not just to its audience but to the industry and general public as well."

*As We Were
Saying*

MOST INTRIGUING part of this ikonogenics bit is not the effect it has on the recipient but what it does to the perpetrator. The end-result of all-out ikonogenic control is sort of surprising when you first think of it. And yet it's simple and obvious. If you want the public (your customers, clients, sponsors) to have an image of you as a certain kind of company, and if you control **all** of the elements of the ikonomatrix with that objective

in mind, you will most surely end up actually being the kind of company you want your customers to think you are. As Mr. Dunn points out, a company can, in time, be absorbed into its own "disguise."

OUR OWN IMAGE considerably pre-dates Mr. Dunn—but it is not as pre-ikonogenic as he might think. In fact we suspect that we are the unwitting end-result of an ikonogenic process that began more than 30 years ago. Perhaps it's a bit quixotic, but we feel that we have actually become the company that we want people to believe we are.

It all started back in 1930, when I. R. Baker was appointed manager of RCA's broadcast sales. Bake was a former engineer—as were most of us who worked with him. We wanted very much to have our engineer friends think of us as the company that built the best broadcast equipment—and provided the most help to its broadcast customers. Everything we did—everything that was a part of our ikonomatrix—was attuned to that objective. And we wanted it so much that before long we became, in fact, that company.

It was a happy development—for us and for our customers. And it worked so well that over the years it became a way of life—a tradition which young men joining our business soon learned and carried on. Thus it has given us an "esprit de corps." And, it has given our business a continuity, a feeling of responsibility, a position of prestige—an image—an ikonogenic image, if you will, of which we are proud. And, because we want our customers to continue thinking of us as this kind of company, we will go on being this kind of company. Thus endeth the lesson!

MERRY CHRISTMAS,
The Armchair Engineer



Hey, Sam, what's the best substitute for a

大トホニ無キナカニ

Reproduced by Courtesy of RADIO-ELECTRONICS

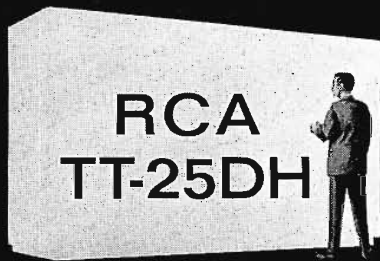

**RCA
TT-25DH**

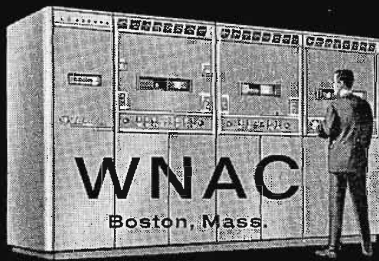

WNAC
Boston, Mass.

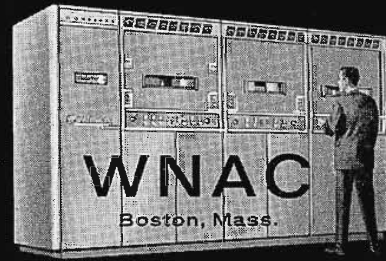

WNAC
Boston, Mass.

PREFERRED BY THE NATION'S



KCMT
Alexandria, Minn.

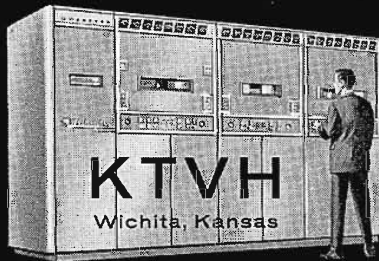

KTVH
Wichita, Kansas

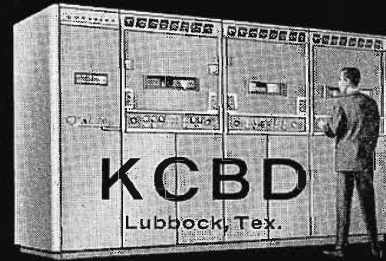

KCBD
Lubbock, Tex.

FINEST TELEVISION STATIONS

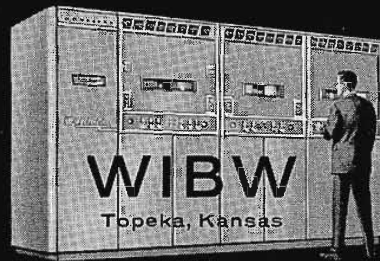

WIBW
Topeka, Kansas



WNBE
New Bern, N. C.

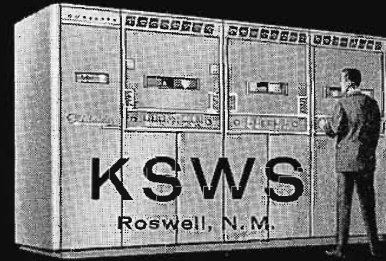

KSWS
Roswell, N. M.

FOR HIGH-BAND OPERATION

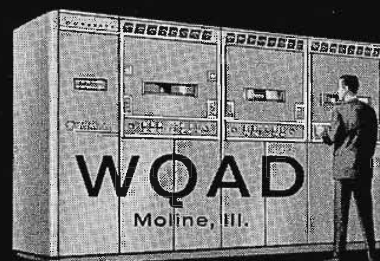

WQAD
Moline, Ill.



WMEB
Orono, Me.



WMEM
Fresque Isle, Me.

It's the new RCA 25-kw TV Transmitter (Ch. 7-13) offering new excellence of performance, reliability and low operating cost

The popularity of this modern 25-kw transmitter stems from its fine performance for high-band VHF service. That's why so many TT-25DH's have been ordered since first shown at the 1962 NAB Convention.

This transmitter is capable of full 316-kw ERP when coupled with a modern high-gain antenna such as the RCA "Traveling Wave."

WNAC will be using two of these operating in parallel to produce 50-kw for its new transmitter installation.

The TT-25DH transmitter is completely modern, using silicon rectifiers, and a minimum number of operating tubes. It is designed for remote control operation. Small space requirements, low power cost, and high reliability are among its many other modern features. It is an ideal transmitter for the high-quality, maximum-power VHF station. It will add prestige to yours.

For more facts about this new transmitter, see your RCA Broadcast Representative, or write RCA Broadcast and Television Equipment, Bldg. 15-5, Camden, N.J.



The Most Trusted Name in Television

RCA SERVICE

keeps all your
AM, FM, TV
equipment
in top
condition!



Antenna System Measurements

Your audience demands a superior signal which requires top performance from all your station equipment. RCA Broadcast Service is planned

to assure you of meeting this objective. More than 30 years in the broadcast industry have provided a background of solid service experience.

TAKE ADVANTAGE OF THE FOLLOWING SERVICES OFFERED BY RCA:

- Video Tape Recorder Service • TV Camera Overhaul • TV Transmitter Overhaul**
- Installation Supervision • Microphone and Pick-Up Repairs • Transmitter Performance Measurements • Antenna Inspection Measurements • Console Repairs • Microwave Service**
- TV Projector Service • Custom Fabrication • Teletypewriter Maintenance**

This is the type of protection broadcasters have relied on for years, the kind of protection you can count on . . . contract or per-call . . . from the experts in the service business, RCA Service Company. To guard performance of all your equipment . . . simply telephone one of the

following field offices: Atlanta (phone 799-7291), Chicago (WE 9-6117), Camden (GL 6-7984), Hollywood (OL 4-0880). Or contact Technical Products Service, RCA Service Company, A Division of Radio Corporation of America, Bldg. 203-1, Camden 8, N.J.



The Most Trusted Name in Electronics

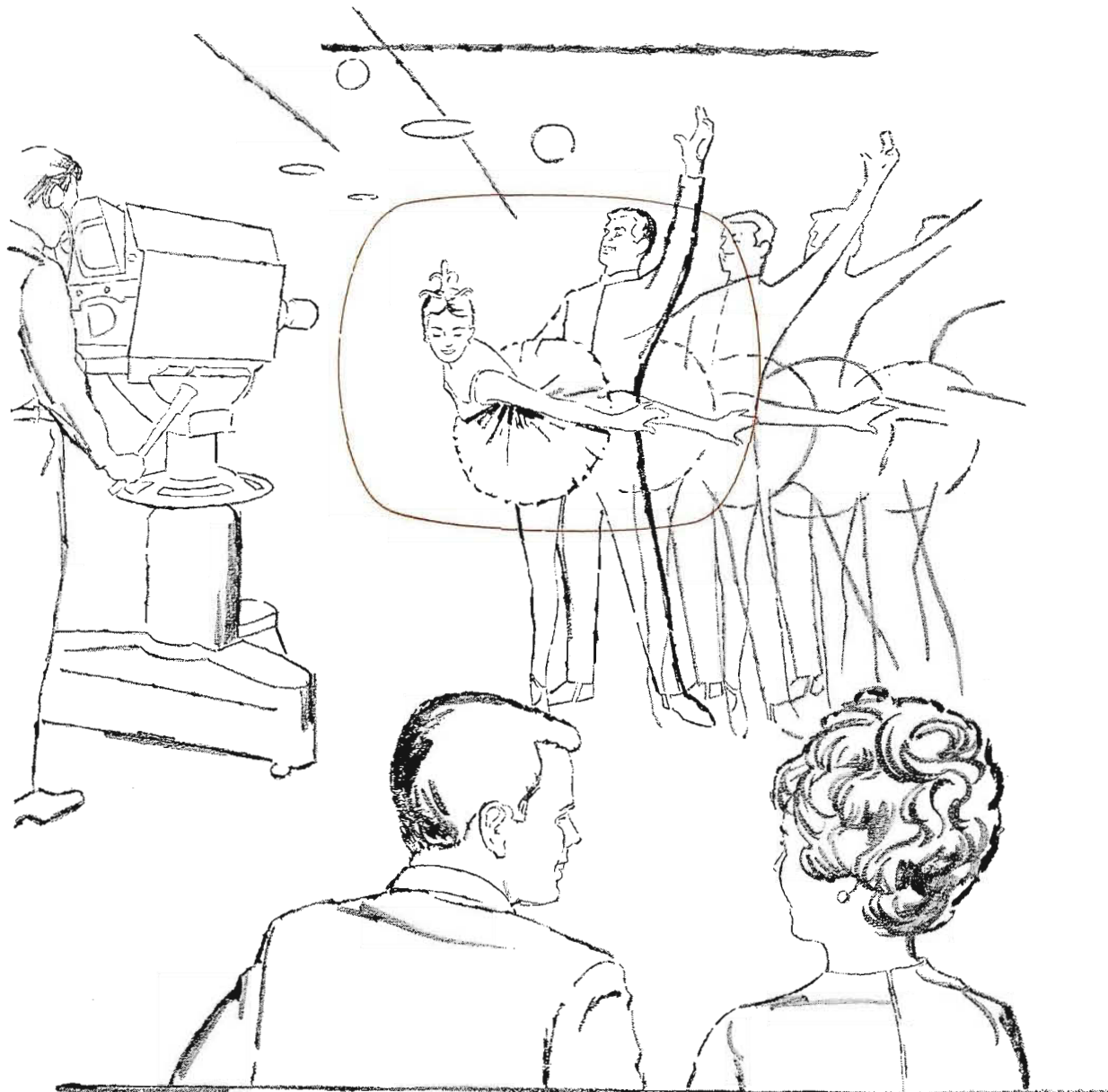

RCA-7295B

Now RCA Brings High Fidelity to Image Orthicons

Now! An RCA Image Orthicon with picture pickup fidelity so high, it's like bringing your audience right into the studio.

That's RCA-7295B...a new 4½" type unilaterally interchangeable with the 7295 and 7295A. Tighter performance limits and additional tests and inspections at RCA have refined processes and materials to such an extent that performance of this TV Camera Tube rivals that of any Image Orthicon on the market.

With this 4½" Image Orthicon, you get the ultimate in flexibility for high fidelity pickup in black-and-white TV. Because you get: improved background uniform-

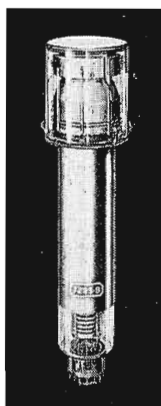

ity, higher signal output levels, better signal uniformity, higher signal-to-noise ratio, improved detail response, reduced microphonics, and stable sensitivity.

All these improvements had to come in a tube from RCA—a leader in TV Camera Tube development since the early days of television. Ask locally about a complete line of RCA Orthicons for color and black-and-white telecasting. SEE YOUR AUTHORIZED DISTRIBUTOR OF RCA BROADCAST TUBES.

RCA ELECTRONIC COMPONENTS AND DEVICES, HARRISON, N. J.



The Most Trusted Name in Television

For name and address of your local distributor write or call your nearest RCA Distributor Products Sales Office—New York, N. Y.: 36 W. 49th St., MUrray Hill 9-7200; Needham Heights 94, Mass.: 80 "A" St., Hillcrest 4-8480; Washington 7, D. C.: 1725 "K" St., S.W., FEderal 7-8500; Atlanta, Ga.: 134 Peachtree St., N.W., JAckson 4-7703; Cleveland, Ohio: 1621 Euclid Ave., CHerry 1-3450; Chicago, Ill.: Merchandise Mart, 467-5900; Dallas 7, Texas: 7901 Carpenter Freeway, MEIrose 1-3050; Kansas City 14, Mo.: 7711 State Line, EMerson 1-6462; Los Angeles 22, Cal.: 6801 E. Washington Blvd., RAYmond 3-8361.



Mark of Deluxe Television

This is the camera you see wherever they insist upon the finest in television. More and more this deluxe 4½" I.O. equipment is becoming the symbol of TV leadership. Everyone is impressed with its "new look," its striking performance and its built-in aids to production. Your studio can benefit from this symbol of television distinction. To own it is to move up!



THE MOST TRUSTED NAME IN TELEVISION

