



All-Transistor RCA Tape Recorder, Type RT-21

Ideal for Stereo or Monophonic Recording

You'll Appreciate These Convenience Features:

- Continuously variable cue speed control
- Easy access to all components
- Tape lifters DC solenoid operated
- Sapphires used to lift and guide tape
- Interlocked record operation
- 3¾ and 7½ in/sec tape speed provided (15 in/sec available)
- Half track recording with full or quarter track optional. Rack or console mounting.

"Convenience" features make operating the RT-21 Transistor Tape Recorder a pleasure. Many new RCA developments are included in this truly professional audio recorder which is the first audio recorder to include continuously variable cue speed control. Remote control of all operating functions greatly improves operator flexibility. Basic recorder is supplied in two sections—a transport tape panel and a control panel, permitting custom or standard rack mounting. A portable carrying case is also available. Duplicate record-playback amplifier is available for two or four track stereo recording.

*For complete information write to
RCA, Dept. PD-264, Building 15-1, Camden, N.J.
In Canada: RCA VICTOR Company,
Ltd., Montreal. Another fine new product
from the Broadcast and Television Equipment
Division of RCA.*



The Most Trusted Name in Radio
RADIO CORPORATION OF AMERICA

BROADCAST NEWS

published by

RADIO CORPORATION OF AMERICA
BROADCAST & TELEVISION EQUIPMENT DIVISION, CAMDEN, NEW JERSEY

issued quarterly

PRICE *in U. S. A. - - - - \$4.00 for 4 issues*
outside U. S. A. - - - \$5.00 for 4 issues

C O N T E N T S

	Page
WMCT BRINGS THE FINEST IN BROADCASTING TO MEMPHIS	4
LATEST RCA EQUIPMENTS DEMONSTRATED AT 1961 NAB CONVENTION	11
RADOME ENCLOSED ANTENNA AT WMTW	18
NEW KPHO TRANSMITTING PLANT	22
HOW TO GET COLOR TV PICTURES FROM BLACK AND WHITE ART	26
THE RCA COLOR SYNTHESIZER SYSTEM	28
RECORD-SETTING 136-MILE COLOR MICROWAVE LINK	32
NEW 50-KW AMPLIPHASE AM TRANSMITTER	36
VHF TELEVISION TRANSLATOR	40
NEW PROFESSIONAL TAPE RECORDER	43
COMPLETE LINE OF RCA EQUIPMENT FOR FM STEREO	46
HOW THE APPROVED FM STEREO SYSTEM WORKS	48

Taking Up Where We Left Off

WE RESUME, with this issue, the publication of BROADCAST NEWS in the manner to which you had once become accustomed. What we refer to, of course, is the fact that in the past couple of years we have been experimenting somewhat with our approach to editorial content—and, to a lesser degree, with format. Without going into the reasons, we'll simply note that the changes were not popular. So we bow to reader demand (and it's a pleasure!) Starting right now we re-

turn to our original concept of BROADCAST NEWS. As stated in our first issue (October 1931), this is "to provide a pleasant and convenient medium for the exchange of ideas and information . . . among those responsible for the success of the Broadcasting Art."

NO CODE of ethics governs the number or length of the "commercials" we can (or should) insert in the otherwise objective pages which follow. Nor

*As We Were
Saying*

do we propose to establish any rules. We believe you will agree with us that "information" about new equipment items is helpful to our readers. If we honestly, although perhaps a little immodestly, believe that these items are more important because they are by RCA, we are sure that you will forgive us. No dividing line, or identifying mark, will delineate the objective from the non-objective viewpoint. We believe our readers are old enough to know where the entertainment stops and the commercials begin.

ANOTHER WARNING, while we're at it. New readers should recognize (old readers will know) that we have certain pet subjects for which we keep beating the drums. Most of these are obvious—things like color and automation (see note below). We make no apology for our enthusiasms. These are things in which we believe—strongly! And they are things which we feel sure will be good for the industry—as well as ourselves. So, beat on we must!

"AUTOMATION" EXPLANATION is required. Everyone (including ourselves) is using the term loosely—and thereby raising hackles, which is unfortunate. To us "automation" is not, per se, a method of replacing men with machines. Rather it is a handy (perhaps too handy!) catchword to identify a long-time program we have been calling our "M-S-I Plan." This is a three-phase program. First phase is Modernization—which, simplified, means adaptation or replacement of present equipment with equipment designed for automatic operation. This includes such things as self-cueing and quick-start projectors, stabilized camera and control circuits, etc. These are required for automation—but are obviously desirable in any station, automated or not. The second phase of the program is Simplification—which means, in brief, the simplifying of operating procedures (as made possible by automatic equipment). This, too, is desirable whether or not a station aims to take the ultimate step in automation. The final phase of the program is Integration—which, simply stated, means tying together all station operations—both business and technical. In this phase a memory device (presumably a computer-type device) will tie station programs, commercial schedules, spot availabilities, logging, bookkeeping and billing together to obtain the maximum in station efficiency. The three phases, tied together, are what we call "total automation."

AUTOMATION VARIATIONS are countless. Not only does equipment vary—but even the approach philosophy. What confuses the most is that something many people are calling automation is really just "deep-dish" preset. Equipment of this type usually provides for automatic operation during the "panic period"—and sometimes for "all-day" operation on a press-the-cut-bar-to-start basis. In some cases it is modified for real time operation. According to one school of

thought this is the way to get into automation by easy stages. The purists, however, feel that it is better to start with a complete automation concept—and to install (initially and in all in-between steps) only such equipment as will be used in the final "total automation" kind of operation. We can do it either way. You pay your money, and you take your choice.

TOTAL AUTOMATION obviously requires a lot of studying and planning. And it will certainly benefit by experience. We hope to present a series of articles which will help station people in making their plans. Meantime, for those in a great rush, we can offer the personal help of our dyed-in-the-wool automation expert, Dick Edmondson. Dick came to us from NBC where he was a key member of the facilities group which installed automation equipment at WBUF Buffalo and WRC-TV Washington. He has probably given more time and study to the subject than any engineer in this industry. His ideas and experience are available to help you with your advance planning.

OLD FRIENDS are best, they say. We've been fortunate that many of the best-known and best-operated stations in the business have been our "old friends" for a long time. Through the years these stations have stayed with us, gaining prestige when we were right, suffering with us when we stumbled. It is their confidence in us that makes it possible for us to say that "most of the best stations use mostly RCA equipment." It is fitting, therefore, that one of these stations, WMCT in Memphis, should be the subject of the lead story in this issue.

General Manager, "Hank" Slavic; Chief Engineer, Ed "Pop" Frase, and the other folks at WMCT are some of our favorite people. At WMCT you find the air of the Old South combined with the spirit of the space age. RCA equipment fits such a station—and we're proud to have it there. The article in this issue will prove that WMCT is a well-equipped station—but in reflecting the charm and graciousness of WMCT, it falls far short. For that you'll just have to visit them.

NAB REPRISE is played (in pictures) starting on page 11. We always have difficulty deciding how much space to give to the NAB story. Many of our readers, of course, were there—and, to them, its old hat. On the other hand we'd like to have those who missed it know what they missed. Maybe the pictures will give them an idea. In our Convention display, as in **BROADCAST NEWS**, we've gone back to our old style—viz. lots of equipment, plenty of space, and surroundings as comfortable as possible. Every year we try to make our display bigger and better. This year we had the ballroom of the Shoreham all to ourselves. It will be tough to top that next year. But you can bet we'll try.

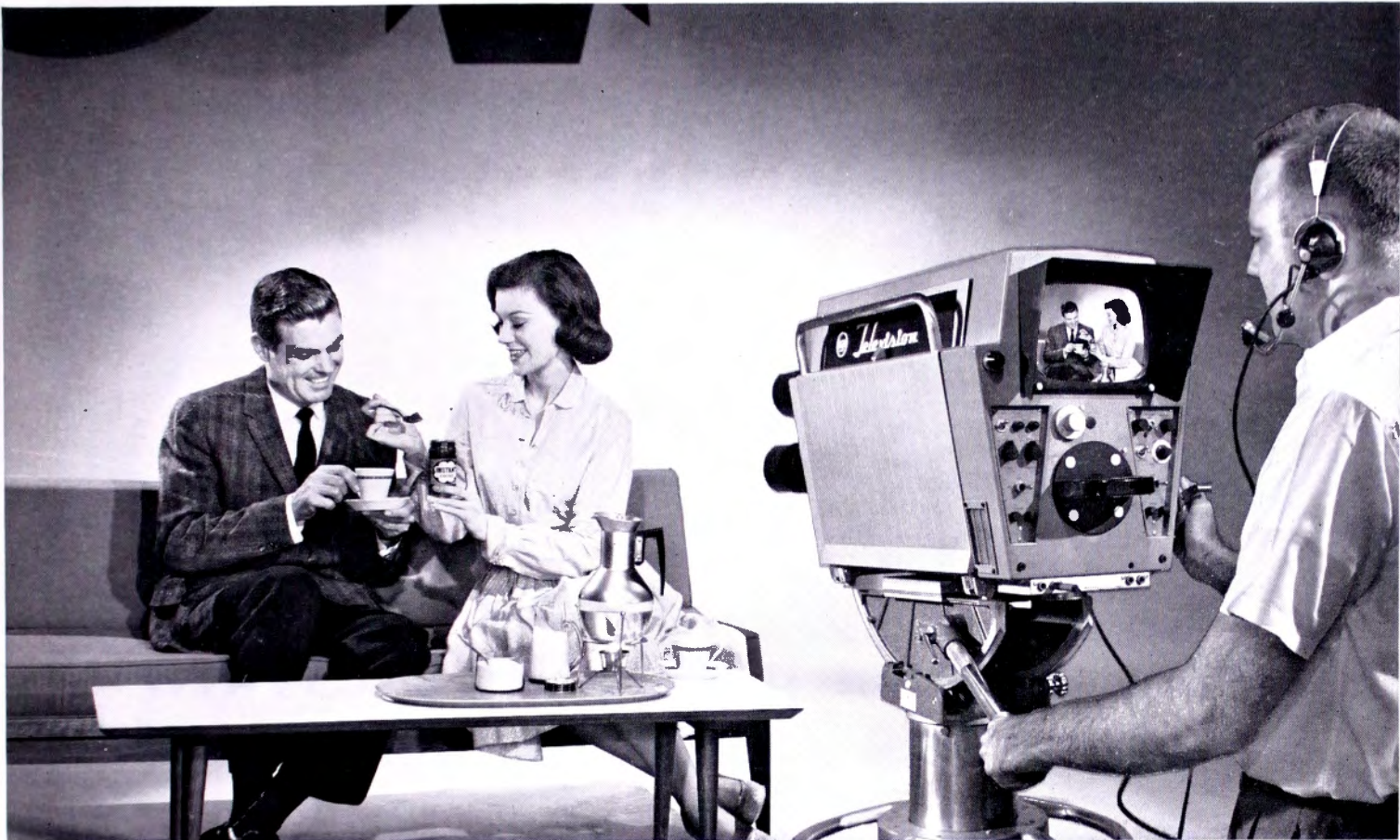

New TK-12 Monochrome Camera by RCA Provides Finer Product Detail... Better Brand Identification

Pictures of products and people come up clearer and sharper than ever with this new RCA camera. It gives you better definition for better product detail . . . it provides improved rendition of gray scale for improved brand identification. The 4½ inch I.O. tube means 50% larger image for greater picture detail. And lighting can be used more creatively to provide added emphasis on product features, thus improving the quality and believability of your live or tape commercials.

For instance, your lighting can either be arranged for overall effect, or to emphasize the product for best brand identification. Furthermore, you can vary

the emphasis at will and the camera will pick up all the wanted details and faithfully reproduce them. Advertisers will welcome the well-lighted, highly detailed pictures that can compete with the best magazine photography. Give your station a competitive edge with the TK-12 Camera. See your RCA Representative or write, RCA Broadcast and Television Equipment, Dept. P-22, Bldg. 15-1, Camden, N. J.
RCA Broadcast and Television Equipment, Camden, N.J.



The Most Trusted Name in Television
RADIO CORPORATION OF AMERICA

Finer Detail for Better Brand Identification



Improved Gray Scale to Dramatize Product Features



FIG. 1. New studio and office building of WMC Broadcasting Company, Memphis, Tenn. Modern, million dollar plant realizes dream of many years. This showplace was dedicated by Governor Ellington on January 30, 1959.



WMC, WMC-FM, AND WMCT BRING THE FINEST IN BROADCASTING TO MEMPHIS AND THE MID-SOUTH

by E. C. "POP" FRASE, JR.

Chief Engineer, WMC Broadcasting Company, Memphis, Tenn.

The Showplace of the South, WMCT, was dedicated January 30, 1959 by The Honorable Buford Ellington, Governor of Tennessee. The ceremony was attended by executives from Scripps-Howard, NBC, RCA, government officials, and many clients and agency friends of the station.

The ultra-modern, million-dollar plant utilizes a host of the latest electronic developments available to the broadcast industry. Some statistics may illustrate the vastness of the operation: 29,000 square

feet of floor space; two huge studios, one large enough to accommodate a regulation basketball game with an entrance large enough to accommodate a bus, fire engine, or combine; a 156-ton air conditioning system; are a few of the plant's many features.

A Dream Come True

This new plant realized a dream of many years to bring to Memphis and the Mid-South the very best in technical facilities. After several years of studying and plan-

ning, these dreams were drawn into blueprints by The Austin Company of Cleveland, Ohio. The resulting construction not only takes into consideration present needs but allows for expansion in several directions.

Stations WMC, WMC-FM, and WMCT are owned by the WMC Broadcasting Company. The stations are NBC affiliates, having joined the radio network January 23, 1927, and the television network December 11, 1948. Station WMC began op-

FIG. 2. H. W. Slavick, Vice-Pres. and Gen. Mgr.



FIG. 3. Earl Moreland, Manager WMCT.



FIG. 4. E. C. "Pop" Frase, Jr., Chief Engineer.



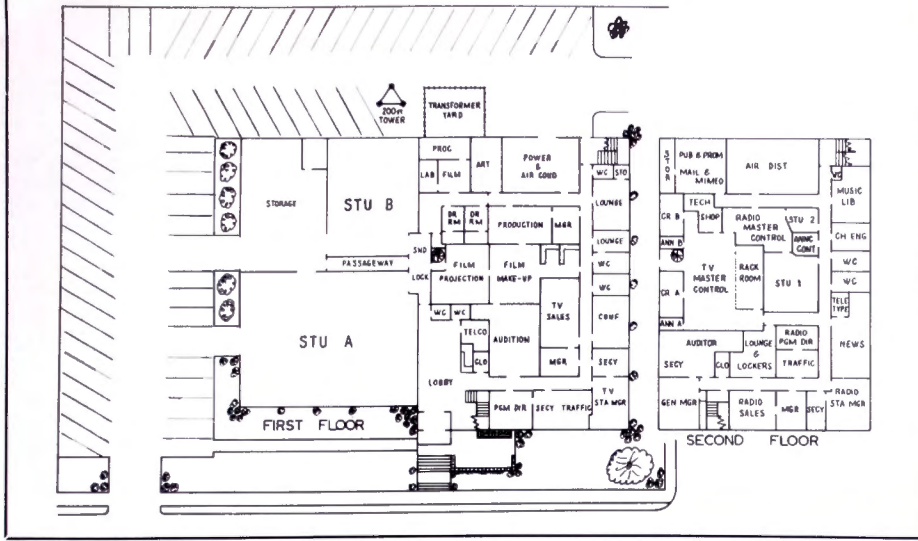

FIG. 7. Simplified floor plan of new building.

erations on January 20, 1923; WMC-FM on May 22, 1947; and WMCT December 11, 1948. All three are true pioneers in the broadcasting industry.

Transmitter Plant

The transmitter location is about eight miles from the studio. Two RCA microwave units relay the picture to the transmitter while four Telco lines carry the various sounds. The AM transmitter is an RCA 10F, 5-KW day and night, on 790 KC. A four-element directional antenna system is used after sundown.

A RCA 50-KW BTF-50A FM transmitter into an eight-bay antenna gives WMC-FM an effective radiated power of 300 KW, one of the most powerful in the country. Two multiplex subcarriers are now in operation utilizing a BTE-1B exciter with two BTX-1A subcarrier generators. The frequencies are 42 and 67 KC for background music and storecasting respectively. Audio termination equipment for subcarrier programs is located at the transmitter.

The television transmitter is a RCA TT-25 having recently been modified to a

CL model by the addition of a new TT-6AL driver. The old TT-5 driver was moved into an adjoining room and set up as an auxiliary. The auxiliary unit feeds its own TF-3A antenna, 358 feet high. This 358-foot structure is also used as the radiator for WMC when CONELRAD operation (640 KC) is in effect.

The main TV antenna is an RCA TT-6BM located atop the main AM radiator, with an over-all height of 1092 feet. The FM antenna is located at a height of 975 feet on the same structure. The top 452 feet of this structure is insulated from the bottom section which is the main radiator of the AM four-element directional array. It might be interesting to note here that WMC was one of the first stations in the United States to utilize a directional array for nighttime broadcasting.

Television Studios

The physical dimensions are 50 by 70 feet for Studio A, and 35 by 50 feet for Studio B. Both have 27-foot ceilings. Kleigl surveyed the layout and prescribed the necessary lighting. In A there are 102 fix-



FIG. 8. Transmitter building is located eight miles from studio. Main and auxiliary towers are shown.

FIG. 9. Studio tower, showing STL microwave dish and passive reflector. At top of tower is a remotely controlled, panning microwave receiving dish for remote pick-ups.

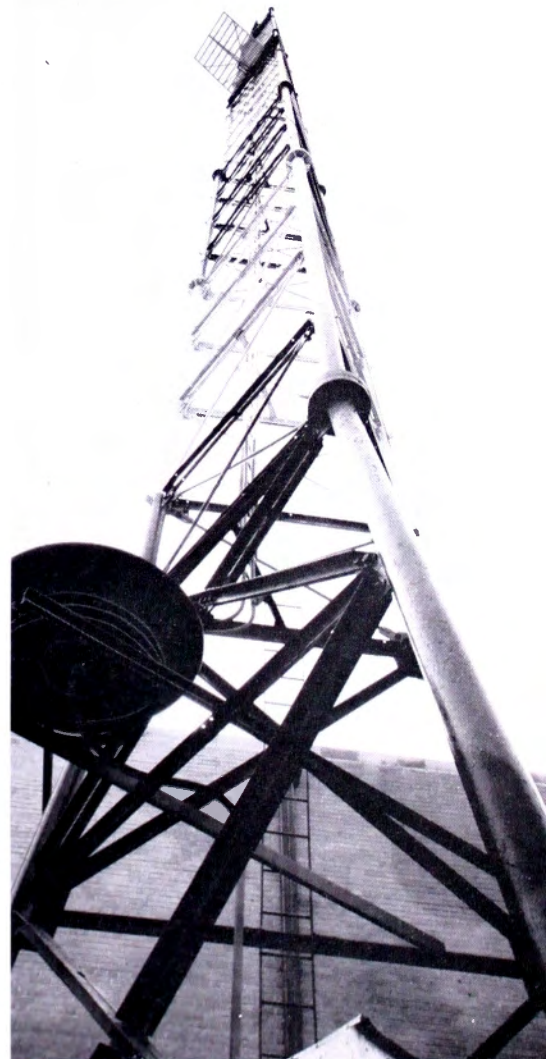

FIG. 5. Robert A. "Buddy" Frase, Supervisor, WMCT.



FIG. 6. Stan Torgerson, Manager of Radio, WMC and WMC-FM.





FIG. 10. Production of local live television commercial in Studio A.

FIG. 11. Studio B, showing local program in progress, in conjunction with Fire Prevention Week.

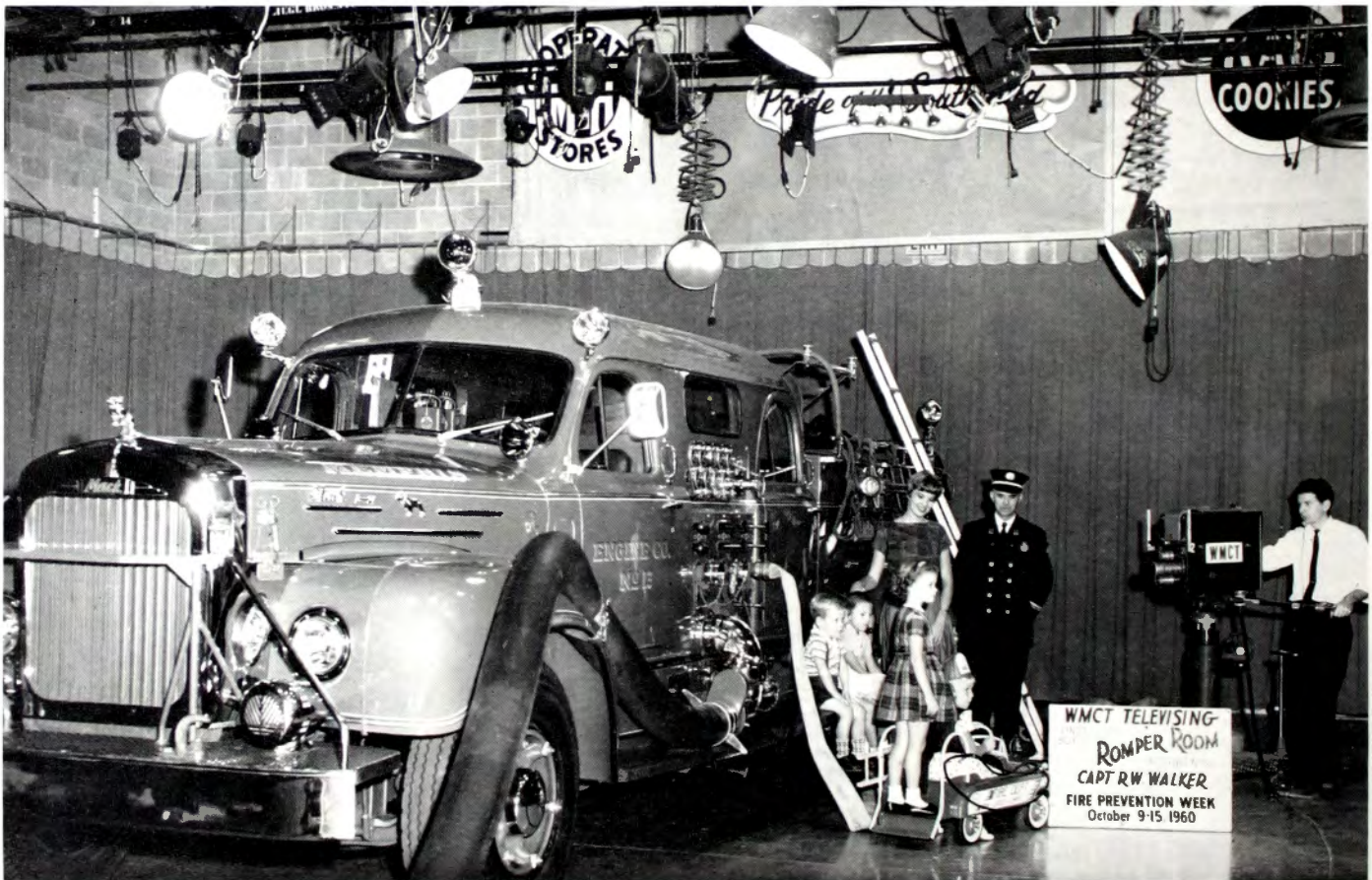

tures and 52 in B. This will accommodate several sets in each studio. Primary wiring has been brought into the studios to double the lighting when color originating equipment is added.

Two TM-8 monitors are pantagraph-suspended in each studio for video monitoring. Two television tape recorders, an automobile turntable, rear screen projection equipment, and a complete operating kitchen are a few of the principal production aids. A six-foot passageway from the storage room to the sound lock provides sound isolation between the studios.

Adjoining both studios is the 35-by-50-foot prop storage room, also with 27-foot ceiling, which can be converted into a studio if the need ever arises.

Film Arrangements

The offices of the TV Manager, Program Manager, Sales Department, Traffic, and Production personnel are all located conveniently on the first floor. Since the production personnel are directly responsible for receiving and preparing film for air, the film makeup department is located adjoining the production office. And next to film makeup is the projection room.

Film Room

Here we use two TK-21C vidicon film cameras with automatic sensitivity controls. One camera operates in conjunction with a TP-15 multiplexer, two TP-6CC projectors and a TP-3C slide projector. This system has space allocated for the addition of a TK-26 Color Film Chain.

The other film chain operates with a TP-11 multiplexer, two TP-6DL projectors and a TP-7 slide projector. There is sufficient room to allow for expansion if additional projection equipment is needed. One last point to mention is the forced-air system employed to clean the projectors. A hose-and-nozzle is conveniently located at each projector, making the task easier. This, of course, insures clean film on the air.

Photo Lab

Also on the first floor are the film lab and art department. Charles Y. Caldwell, who made all the photographs for this article, is in charge. Principally, this department deals with shooting commercials, film and slides, and processing them. A Houston 16mm processor is in daily use and approxi-

mately one-quarter million feet of film are processed annually. (This figure includes film shot for the news department.)

Television Control

On the second floor, 1750 feet are allocated to the TV Control area. This has been divided into seven rooms with Master Control as the hub. There are two sub-control rooms, each with its own announce booth and each controlling its own studio. Both the subcontrols are identical in size and layout: A BC-3C consolette and a BCM-1A mixer are used, giving 16 mike outlets into the studio. Turntables, tape, both film systems, net, remotes and the announce booth mikes also feed into the consolette.

Two audio monitors are incorporated in each subcontrol room. One is the monitor output from the BC-3C consolette; the other is fed by a distribution system (to be described later) that normally carries program (line) sound. An integral part of each subcontrol is the feedback amplifier system, to feed either turntable sound or program sound into the live studio.

Video equipment includes the switcher and special effects control panels, and eight

FIG. 12. TV film room. Roy Morris (left), projectionist, is seated at control console. J. C. Clayton, crew chief, observes projector. Facilities include two complete film chains.

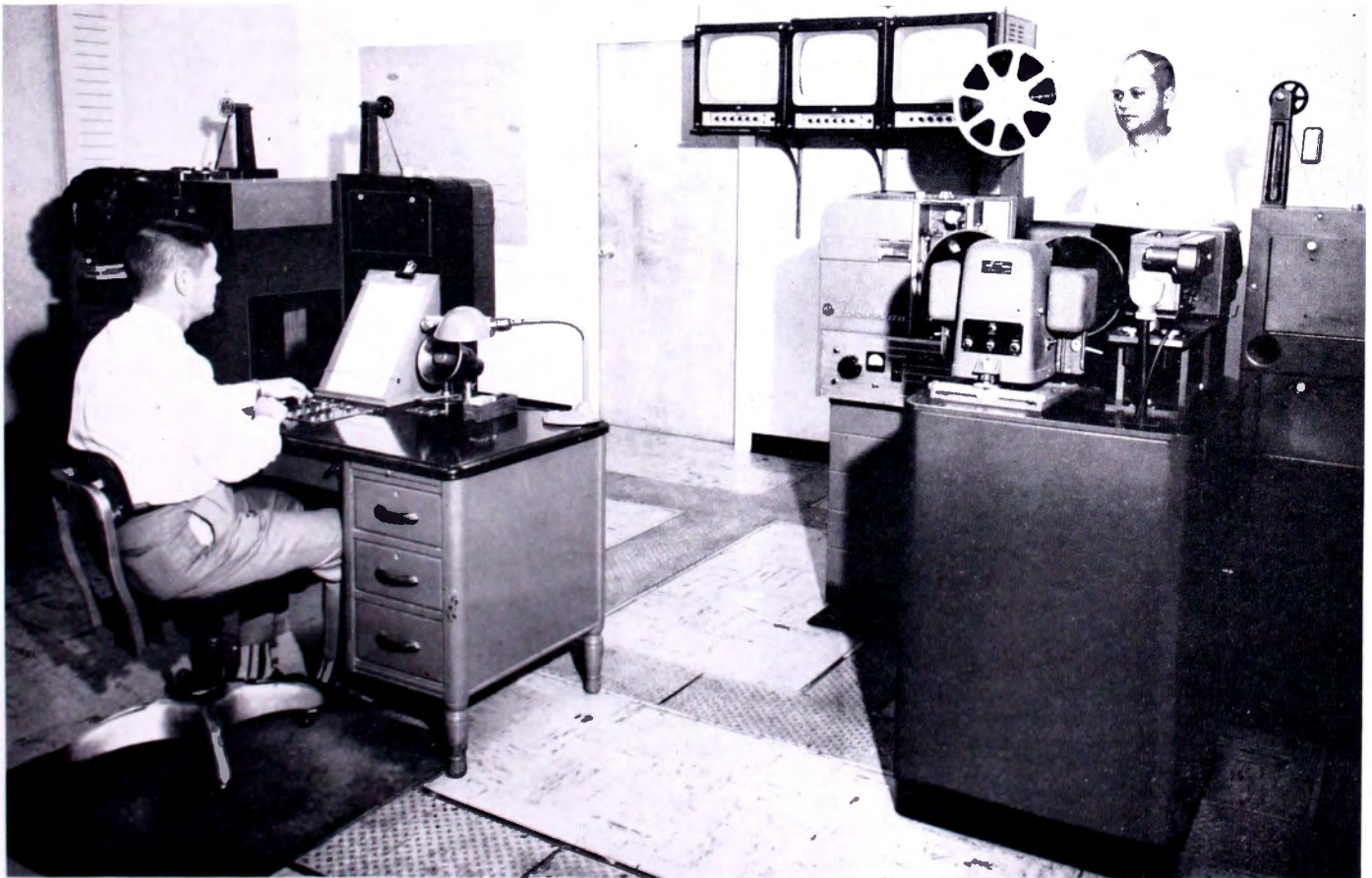

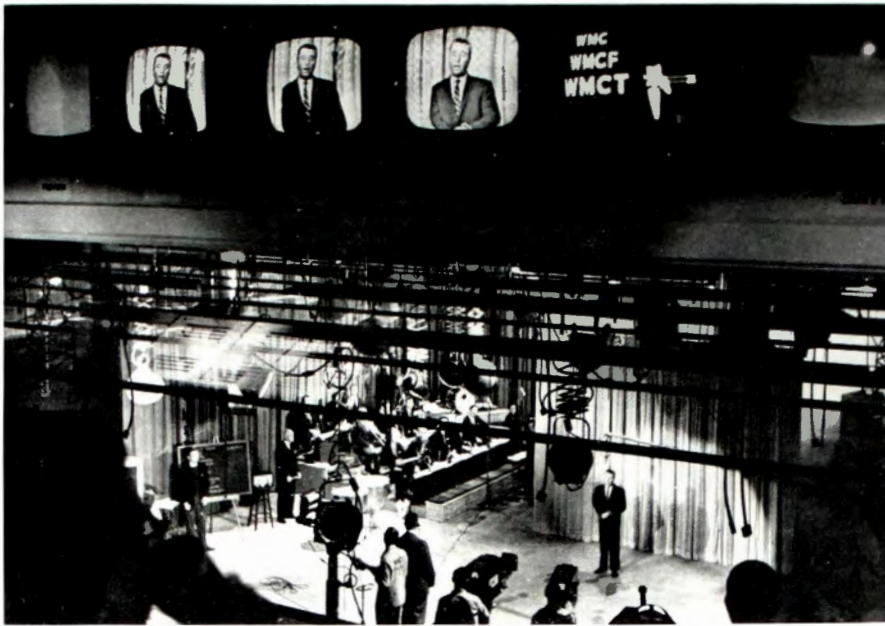

FIG. 13. View into studio A from sub-control A during a live show.

TM-7AR monitors. The three camera monitors in Subcontrol A are for the three TK-11 cameras in Studio A, while the three camera monitors in Subcontrol B perform the same function for Studio B.

Video System

Master Control has control of all video signals. The Master Console houses controls for four TK-10A and two TK-11A studio cameras, two TK-21C film cameras, a TM-6C line monitor, intercom and remote control panels, and a TS-2A switcher for the TM-6C test monitor. There is also the master control panel for the TS-40 switching system. The racks containing the operating video equipment open into the master control room, while the power supplies are mounted in a second row of racks insulated from master control and well ventilated.

Transistorized Switching

When WMCT first decided to build new facilities back in 1957, it was evident that the old TS-10A switcher would have to go. Transistor switchers on the drawing boards at RCA were the answer. Some substitutions were made at the new location until the new TS-40 Transistorized Switcher arrived December, 1959. Details of the TS-40 systems are as follows:

- 12 non-composite inputs that multiple to four busses (TAKE, PREVUE, MIX A and MIX B)
- 6 composite inputs that multiple to two output lines (two of these inputs are the output from the "TAKE" and "PREVUE" busses with sync added)

2 non-composite inputs on the "TAKE" and "PREVUE" busses for the "MIX" and "EFFECTS" inputs

2 non-composite inputs on the "MIX" busses for supering NET and REMOTE signals

The system is controlled by any one of three custom-built control panels. All of these inputs and busses mean that the switcher will accommodate six monochrome and two color studio cameras, two monochrome and one color film camera, two video tapes, net, remote and test signals. Two output lines allow for simultaneously airing one program while rehearsing or taping another.

Audio System

The audio console in Master Control is a BC-2B consolette with modified control circuits. One input has been wired for each studio for emergency use only since all



FIG. 14. TV Master Control. At left, Paul Wilson and George Alsobrook are at the video controls. At right, Mac Hix is at master audio console. Sub-control A is in front of video console. Master panel for TS-40 Switching System is at right end of video console.

FIG. 15. Close-up of master control panel of TS-40 Transistorized Switching System. Note TM-6 Master Monitor with TS-2 Switcher; also remote controls for TA-9 Stab Amps and Sync-Gen changeover switching. Master intercom is at left.

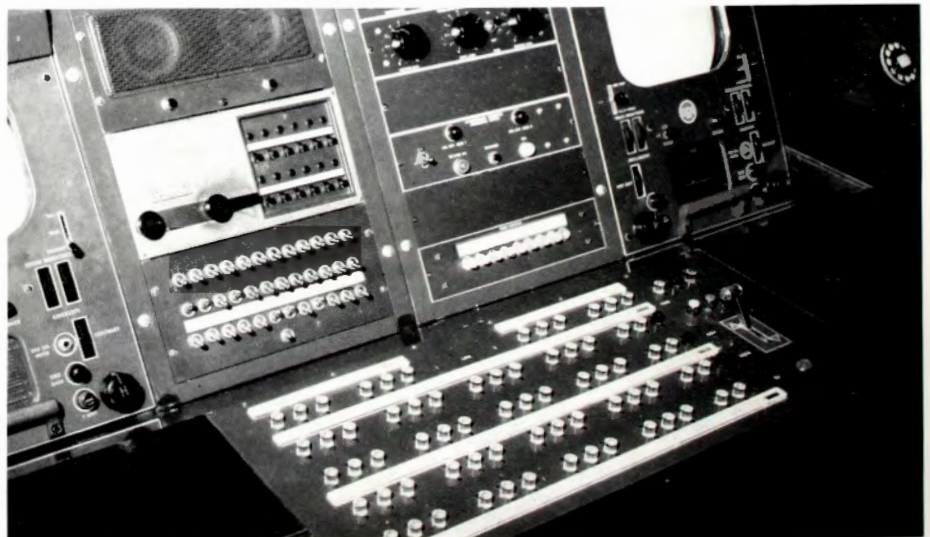

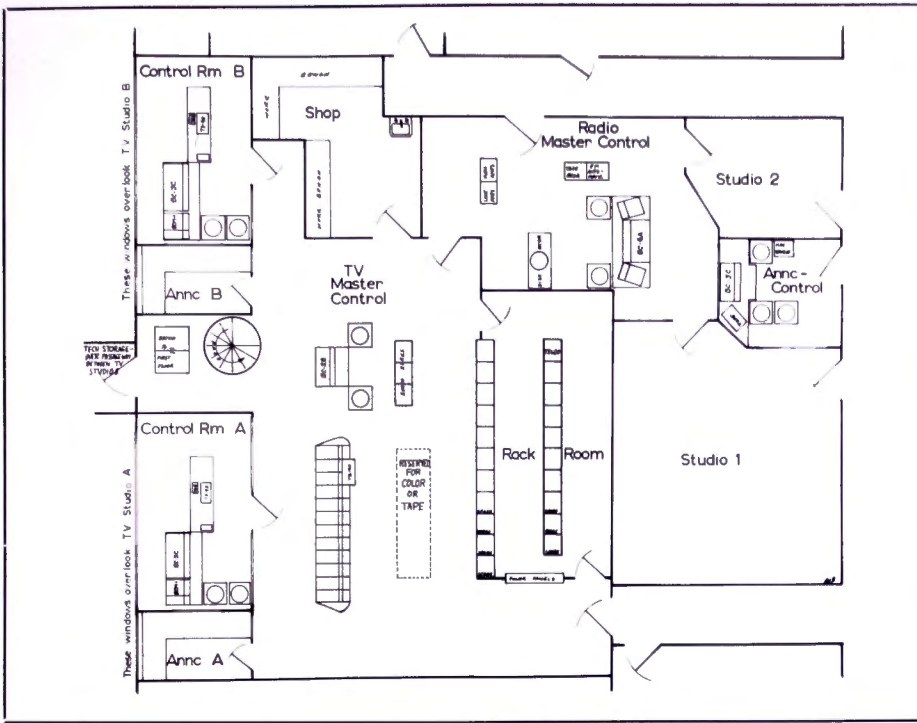

FIG. 16. Simplified floor plan of engineering area for radio and television.

studio shows generally work only into a subcontrol room. Each announce booth also has a mike into the Master Console. Other inputs include the two film chains, net, turntables, tape and remote lines.

The Master Console is primarily used for recording and testing. All audio line equipment is in Master Control and includes such features as five BA-21A amplifiers to distribute net, film and tape sound to the three consoles; an audio delegate switching system; a BA-25A AGC line amplifier; monitoring facilities and a unique speaker muting system.

The delegate switching system is a 3-way remote-controlled relay switch that selects the console to feed the AGC amplifier and thence to the line. It also delegates tally voltage so that "On Air" lights do not function unless a particular console is actually on the air.

Another speaker muting system is interconnected to enable either subcontrol console to mute the speakers and operate "On Air" lights in both studios. Another feature allows either subcontrol console to

FIG. 17. Sub-control A. In foreground is a panel for TS-40 Switcher. Joe McCrady is operating BC-3 Console. In background is announce booth A.



FIG. 18. Rear view of video racks, showing use of lay-in ducts for a-c wiring. Note also the use of Spirap for lacing cables.

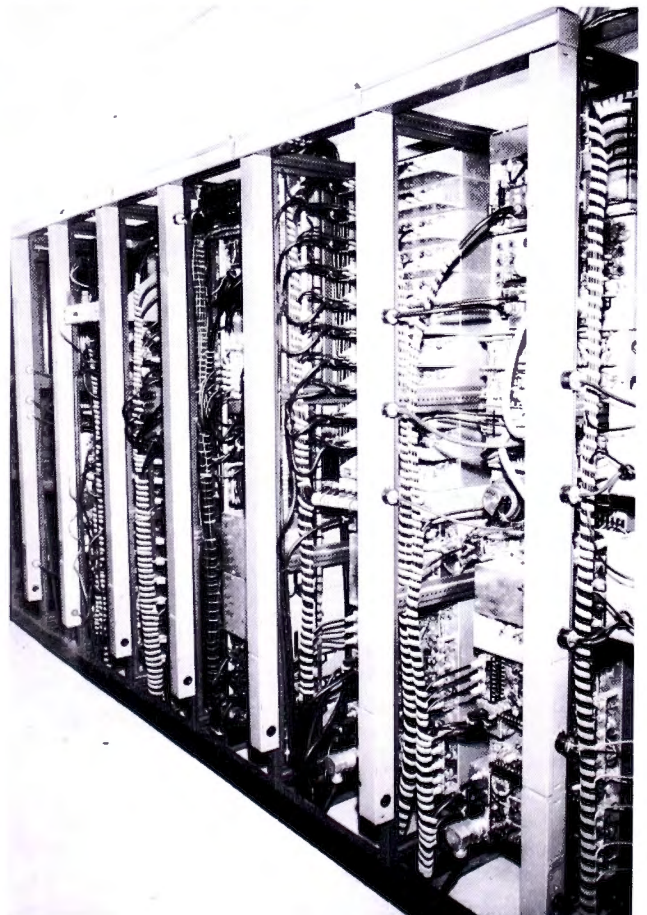



FIG. 19. Radio master control, showing BC-6 Dual Console. Announce-control room is seen through window.

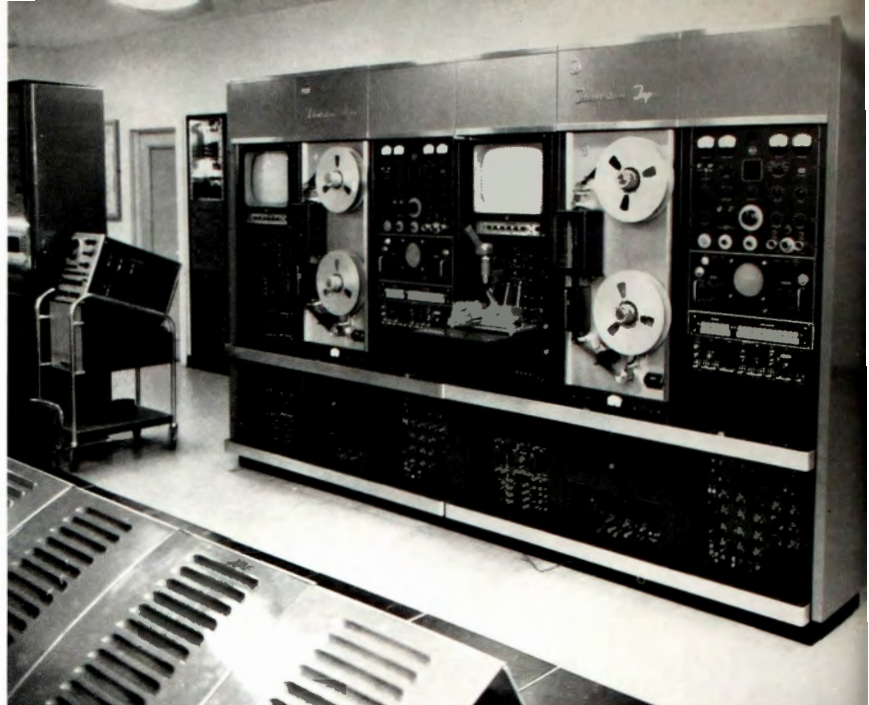

FIG. 20. Two RCA TRT-1B TV Tape Recorders, recently installed in Master Control area.

mute the speakers and operate "On Air" lights in the opposite studio. If anything other than the normal is employed, microphones may be patched from one studio to the opposite control room console.

House Audio Monitoring System

The main component in the monitoring system is a constant impedance 6 input, 10 output switcher. This, of course, allows us to feed any one of six sounds to ten different locations, greatly simplifying rehearsals and client auditions.

Intercom System

Intercom facilities are provided between all engineering, programming and production areas as well as to principal offices, delivery doors and to the top and bottom of the microwave tower. Five complete intercom systems are linked together to provide this network of communication. In addition to the intercom system, a complete interphone system is provided between Master control, Subcontrols, camera and floor personnel.

Radio System

The heart of the Radio Master Control is a BC-6C dual channel console. Line 1 drives the regular plant line, while line 2 drives the spare line. Line 2 is bridged by two tape recorders, a disc recorder and a spot tape recorder. Also in Radio Master Control is the automation equipment that feeds the 50-KW FM main carrier.

An announce-control room adjoins Radio Master Control with a BC-3C console as the control console. Other facilities in the announce-control room include three BQ-2C turntables, two 5-channel spot tape

players and a tape recorder. The announce-control room can feed the plant line allowing the Master Control Room to be utilized primarily for recording.

Two small studios located on the second floor accommodate most radio shows and recording sessions. In the event a show is too large for the radio studios, either TV studio may be used by feeding the output from either TV Subcontrol console into a remote input in Radio Master Control.

The General Manager's office is on the second floor along with his secretary and the auditor's office. Other offices on this floor include the Radio Station Manager and his staff of salesman and program personnel, the news room, music library, chief engineer and the publicity and promotion department.

An elaborate air conditioning and heating system had to be installed to take care of the varied needs of so large a radio and television plant. The studios must be cooled

all year around, the control rooms require cooling almost all the time (but never require heating) and the offices require both heating and cooling. A Trane Centrovac and a Cleaver Brooks Boiler supply the necessary cold and hot air. Here the elaborate portion of the system takes over, distributing heat to one office, cooling to another, and moderate temperatures to still others. Four massive air-handling units feeding 16 separate zones make this distribution possible. Control of the entire system is pneumatic by Johnson Service.

Of necessity this has been a very brief description of the facilities of WMC, WMC-FM, and WMCT, the "Showplace of the South." Even before this goes to press, there will be changes and improvements as there have been constantly since 1923. Tape, color, transistors, etc., are changing the industry almost daily and WMC, WMC-FM, and WMCT will continue to be pioneers to up-date the industry.

FIG. 21. Mobile television unit of WMCT.



Broadcasters who visited RCA at the 1961 NAB Convention in Washington D.C., May 7-10, had the opportunity to see first hand the most comprehensive display of radio and tv broadcasting equipment ever assembled. The entire ballroom of the Shoreham Hotel was turned into a panorama of progress in broadcasting—demonstrating the newest and latest in the RCA line of broadcast equipment.

Color television equipment, a complete family of tape recorders, equipments for tv automation and FM stereo broadcasting were the highlights of newest developments. The following pages present a picture story of the exhibit.



Latest RCA Equipments DEMONSTRATED AT 1961 NAB CONVENTION



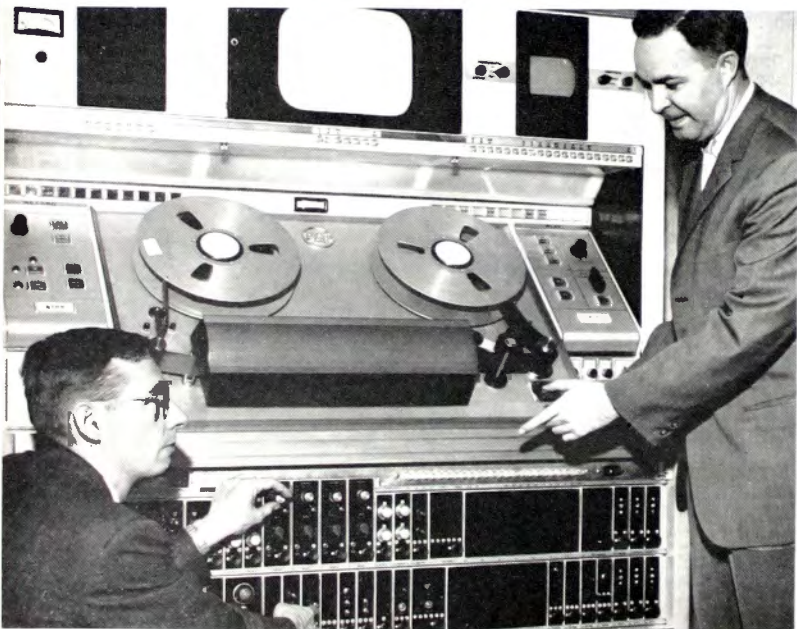

FIG. 1. New transistor design TV Tape Recorder, TR-22, is the top-of-the-line equipment in RCA's growing family. Use of solid state components makes possible significant savings in size, weight and power consumption. The TR-22 is completely self-contained in this compact new console.

FIG. 2. New Slant-Track Closed Circuit Recorder, MR-700. Using a different principle from the other recorders in the family, this recorder records information on slant angle across the tape. Only two recording heads are used. Tape speed is cut in half—thereby using only half as much tape to record.

RCA's Growing





Family of TAPE RECORDERS

Everything for tv tape operations was exhibited in the area shown above. Included were systems for broadcast use—a new Transistor Design Console Model, TR-22 and new standard TRT-1B Models for both color and monochrome use. Also introduced were two new recorders for closed-circuit use; the Slant-Track Recorder, MR-700, and the Compatible TV Tape Recorder, TR-11.

New RCA Tape production accessories were demonstrated in operation. These include Switch Lock, Pix-Lock and Automatic Timing Control. Use of Switch Lock permits instantaneous tape-to-tape switching free of roll-over. Pix-Lock provides this same convenience plus the facility of producing tape-to-tape fades, dissolves and special effects. Automatic Timing Corrector (ATC) eliminates residual jitter, scalloping, skewing and quadrature timing errors in the tv tape signal.

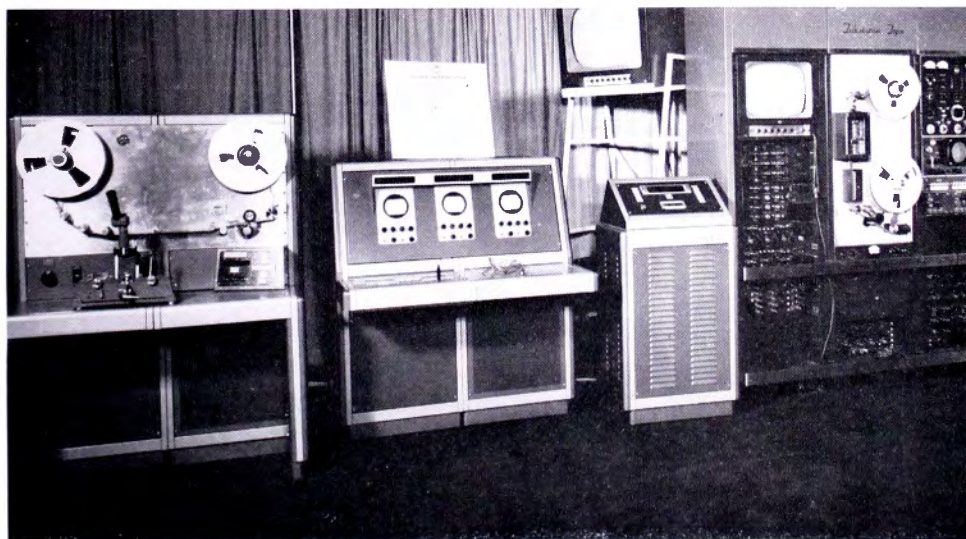

FIG. 3. New TV Tape Editor—developed for NBC by engineers of RCA's Astro-Electronics Division. It facilitates editing of tape programs with a speed and accuracy comparable to present film editing techniques. The television editor may select, view, compare and evaluate groups of frames in tape programs and then select the exact beginning and ending frame of the sequence he wishes to remove or alter.

Everything For FM STEREO



FIG. 4. Everything for the FM stereo system is the theme of this display. It includes RCA studio stereo equipment, the stereo subcarrier generator, and the full line of FM transmitters.

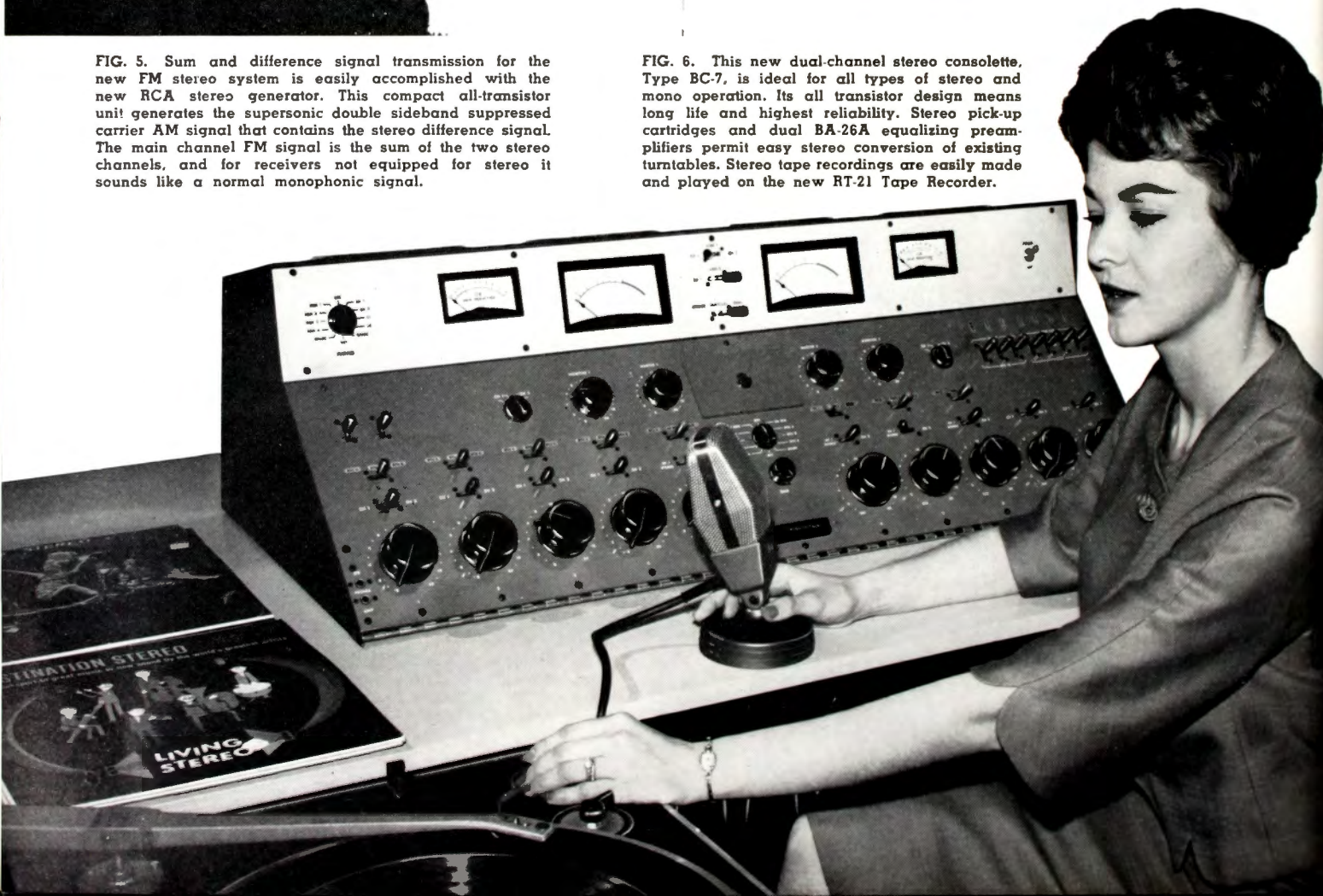

FIG. 5. Sum and difference signal transmission for the new FM stereo system is easily accomplished with the new RCA stereo generator. This compact all-transistor unit generates the supersonic double sideband suppressed carrier AM signal that contains the stereo difference signal. The main channel FM signal is the sum of the two stereo channels, and for receivers not equipped for stereo it sounds like a normal monophonic signal.

The first stereo subcarrier generator offered for sale was the center of attraction at the RCA stereo display. Many of these pre-production models were sold to stations eager to begin stereo broadcasting as soon as possible. The full line of post-war RCA FM transmitters can be used for stereo operation without change. RCA's new FM transmitter line offers the ability to transmit an SCA subchannel in addition to stereo.

Audio equipment for stereo featured everything needed to originate stereo programs. Turntables, pickups, preamplifiers, tape recorders, and consolettes specially designed for stereo were shown. The new stereo equipment easily integrates with existing monophonic equipment, and the stereo gear offers excellent monophonic performance when stereo is not being used.

FIG. 6. This new dual-channel stereo consolette, Type BC-7, is ideal for all types of stereo and mono operation. Its all transistor design means long life and highest reliability. Stereo pick-up cartridges and dual BA-26A equalizing preamplifiers permit easy stereo conversion of existing turntables. Stereo tape recordings are easily made and played on the new RT-21 Tape Recorder.



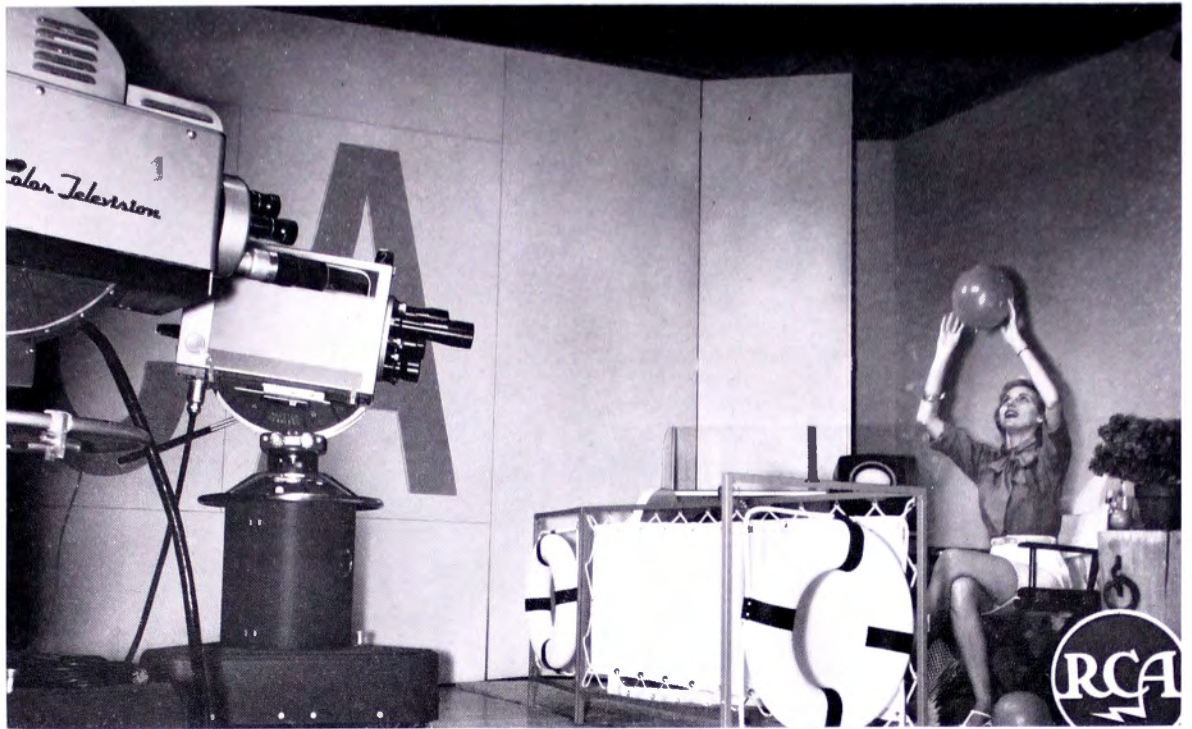

FIG. 7. New Studio Color Camera, TK-41C and new 4½-inch Image-Orthicon Monochrome Camera, TK-12, pick up activity from the live studio and distribute color and monochrome pictures to displays throughout the exhibit.

Newest TV Camera Developments For COLOR and MONOCHROME

The stage of the Hotel Shoreham ballroom was converted to a live tv studio. Highlighted here were the new TK-41C Color Studio Camera and the new TK-12 Monochrome Studio Camera. TV pictures originated here were distributed to a battery of tv tape recorders, switching and special effects equipment, monitors and color tv receivers that filled the busy ballroom.

Both of these new tv cameras are representative of the latest developments in the camera art. Significant improvements have been made in picture quality. These are coupled with the new operational advantages—fast warmup, ultra-stability and reduction of setup routine and maintenance.

FIG. 8. Model demonstrates just how easy it is to get finest pictures from the TK-12 Camera. Since operational requirements are vastly simplified, cameramen can concentrate on the ultimate picture for best results.

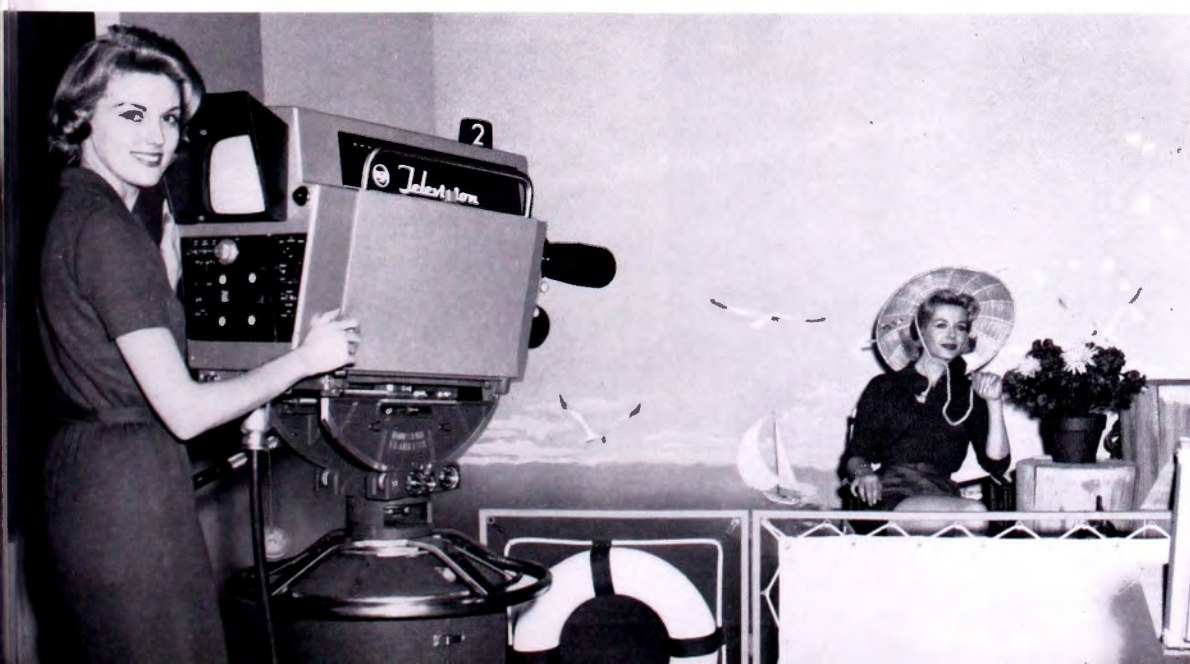

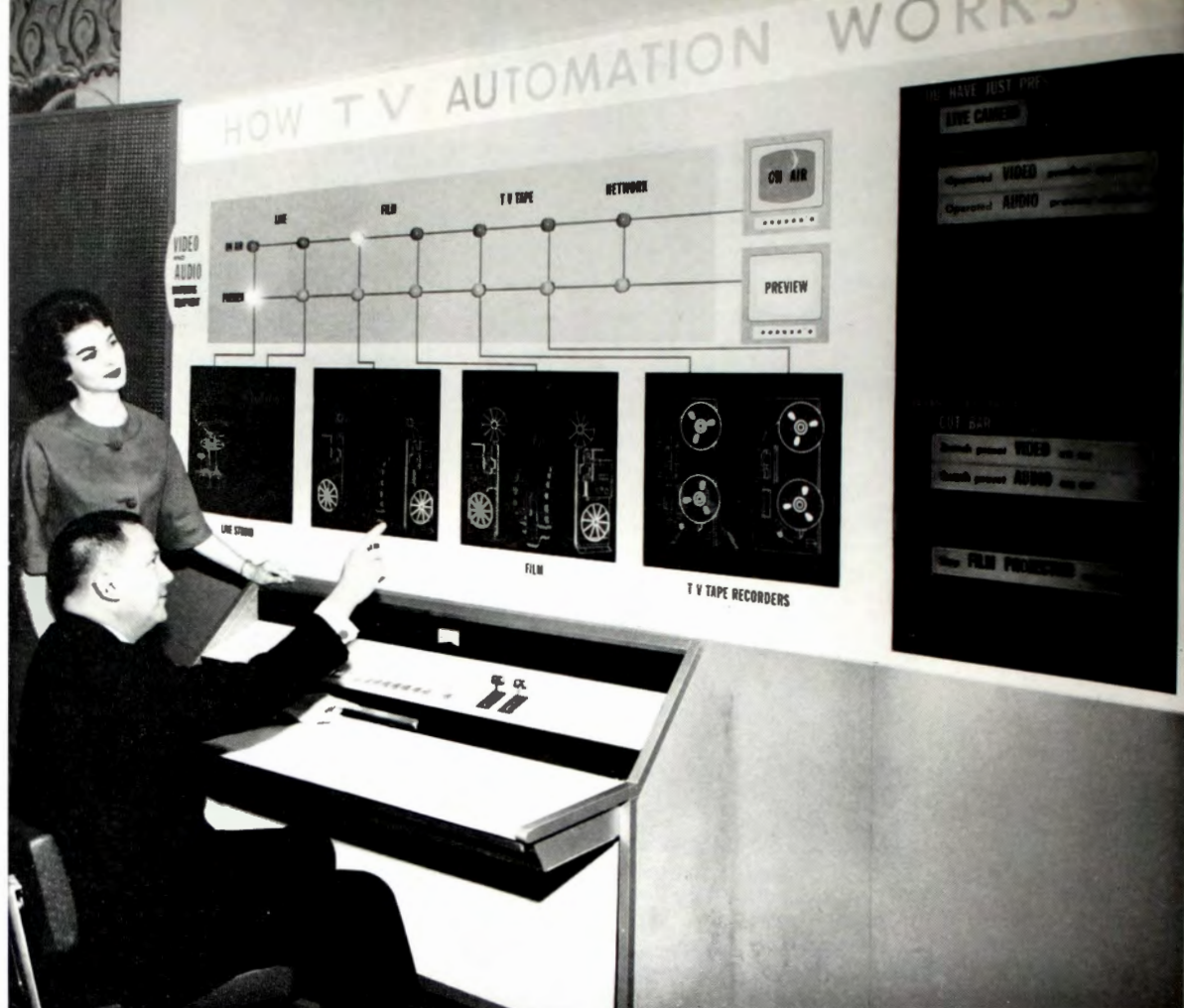

FIG. 9. "How TV Automation Works" is depicted by this display. The simplified control materially reduces the number of operations required to program a station's equipment sources, saving valuable operation time and paving the way to "total" automation.

TOTAL TV Automation Demonstrated



A preview look at a fully-automated television station, with both programming and station business procedures under complete control of a computer, was shown. This was visualized by a three-step process—first, modernization of technical equipment; next, simplification of operational controls; and finally, integration of all station operations.

Some of RCA's most recent equipments—automatic sensitivity control of film projectors, semi-automatic live cameras, random access audio tape cartridges with automatic cue and an "automatic announcer"—to fit this automation scheme—were introduced.

FIG. 10. The "automatic announcer" shown here combines the RT-7 Cartridge Tape Recorder with the TP-7 Slide Projector. The combination will present a complete sequence of slides which are synchronized with and activated by a recorded announcement.



FIG. 11. New 5 kw TV transmitter for high band operation, the TT-5BH is the same size as present RCA 2 kw units. This new compact 5 kw unit is ideal for driving higher power amplifiers and as a standby transmitter. For low power operations, the TT-5BH is an ideal companion for a high gain antenna.



FIG. 12. A full line of transistor amplifiers now includes amplifiers for these important functions; preamplification, remote monitoring, program, recording, and isolation.

OTHER NEW EQUIPMENTS

Many other equipments in RCA's complete line of "everything for the broadcaster" were shown for the first time. These included new transistor audio amplifiers, audio tape recorder, audio tape cartridge system, audio consolette, radio automation equipment, automatic logging equipment, and various new audio accessories.

New additions to the transmitter line included a deluxe 5/10 kw AM Transmitter, a 20 kw FM Transmitter and a compact 5 kw TV Transmitter.

The TV microwave equipment line displayed two new additions. These include newly designed systems for use on 2,000 and 13,000 megacycle bands.



FIG. 13. Exhibited here is everything for TV microwave. Two new systems; one for use on 2,000 megacycles, another for use on 13,000 megacycles, round out a complete RCA TV microwave equipment line (including the 7000 megacycle equipment, Type TVM-1B).

RADOME-ENCLOSED ANTENNA PROVIDES UNINTERRUPTED SERVICE FOR WMTW-TV

Traveling Wave Antenna, in Fiberglass Radome, Overcomes Icing Problems on
"Misery Mountain" to Effect Wide Coverage and Continuously High-Quality Picture

by PARKER H. VINCENT
Chief Engineer, Mt. Washington TV, Inc.

Early in 1960 Mr. John W. Guider, President and General Manager of Mt. Washington TV, Inc., requested his engineering department to investigate the possibility of obtaining an antenna which would overcome the severe icing problems encountered at the WMTW-TV transmitter

site on Mt. Washington. This is the highest peak east of the Mississippi River and north of the Carolinas, and statistically has the world's worst weather. Winds over 60 miles per hour are the normal condition and velocities exceeding 100 miles per hour are common. Extremely high natural wind

velocities have been experienced; in fact velocities as high as 231 miles per hour have been recorded. In addition, the most severe icing conditions known are experienced on Mount Washington. Ice often forms at the rate of six inches per hour on exposed vertical surfaces of the tower and antenna.

FIG. 1. An overall view of the WMTW installation atop Mt. Washington. The new Traveling Wave Antenna with its radome is shown on the right. WMTW's old antenna is in the center and at the left there are four pole mounted sections of an RCA BFA series of FM antennas. The height of Mt. Washington is shown in contrast to surrounding mountains.

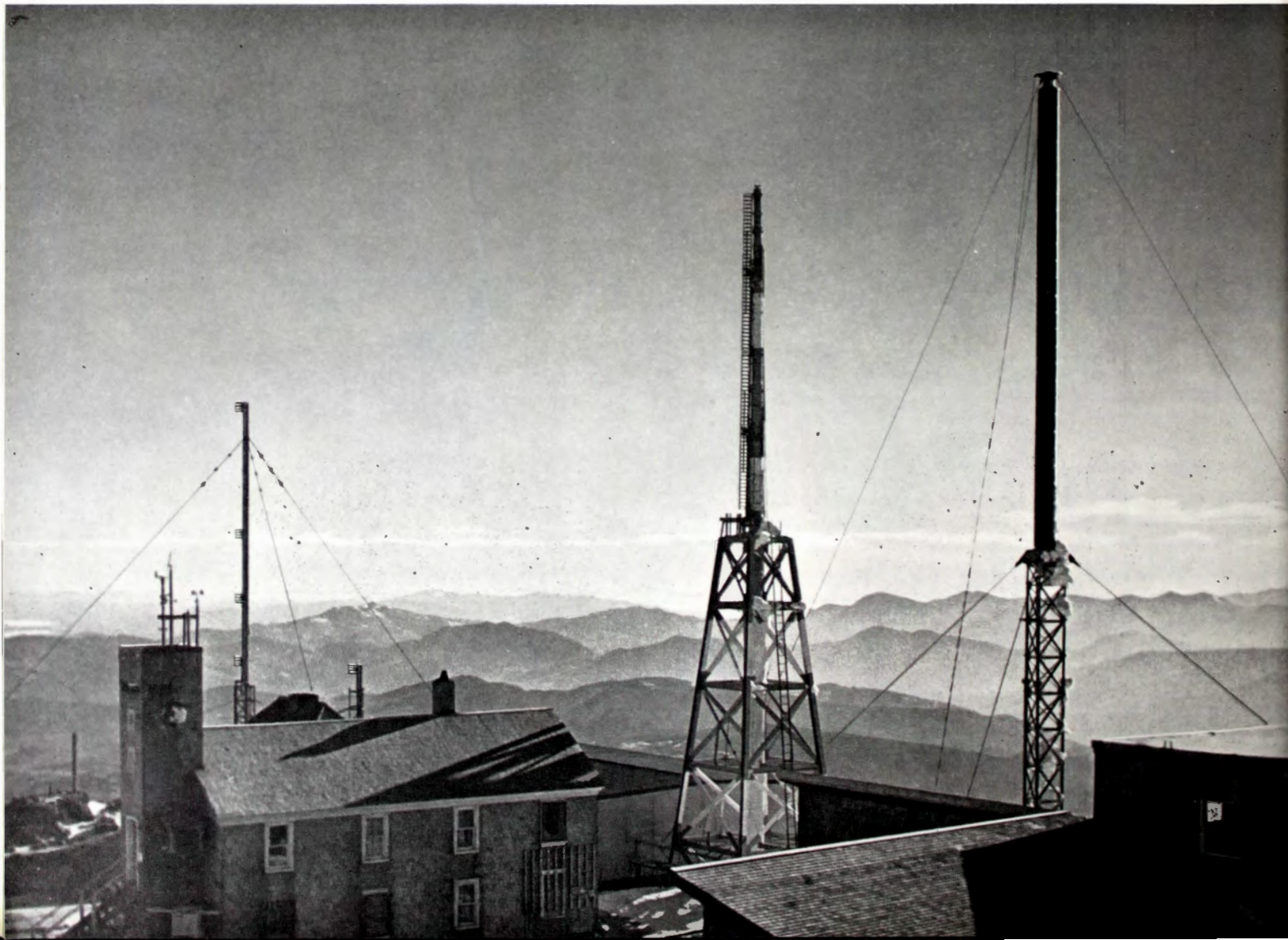

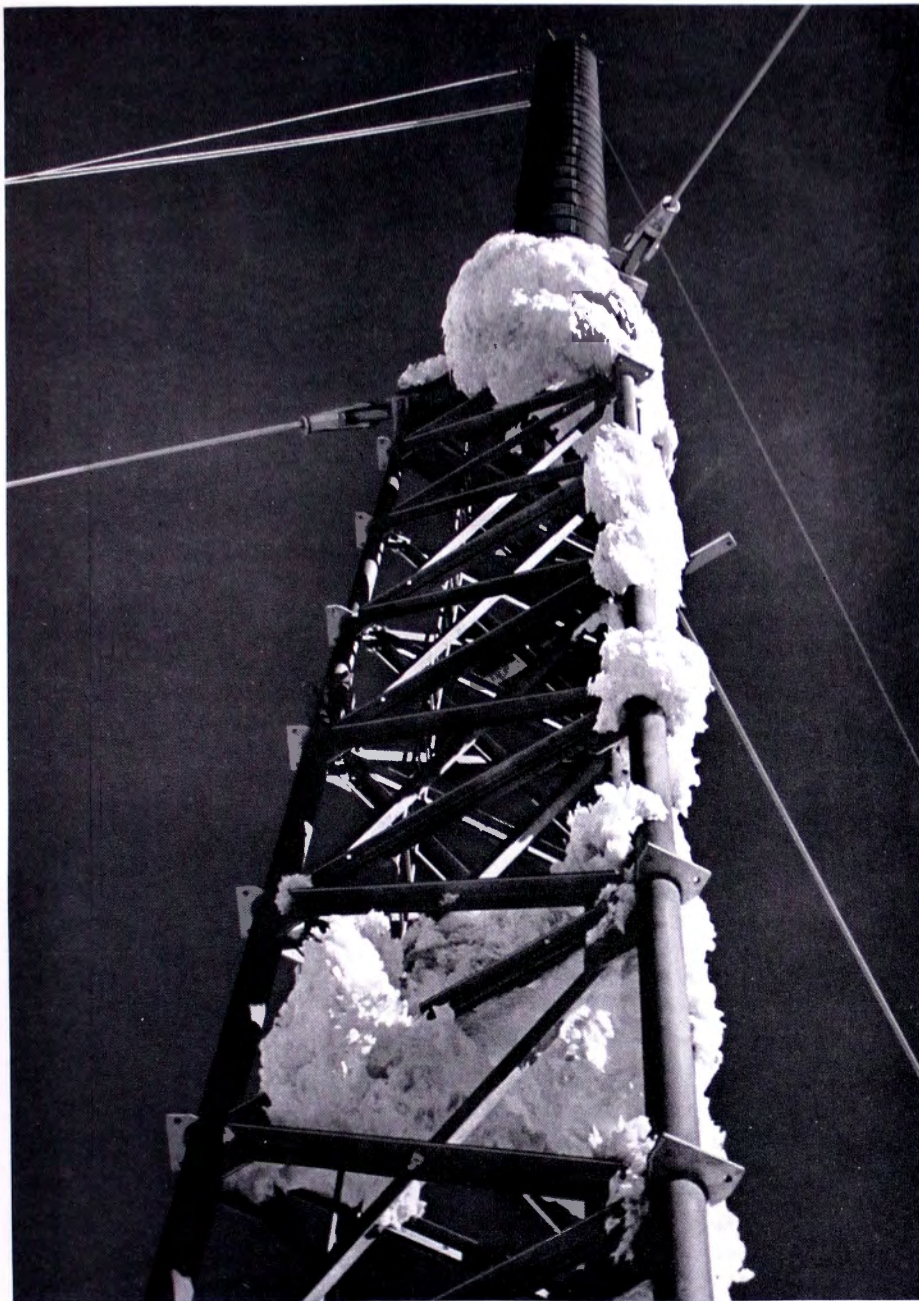

FIG. 2. A close up of the Traveling Wave Antenna. Note top guy arrangement required to support the tower and antenna against extremely high winds. Contrast, ice accumulation on tower with complete freedom from ice on antenna enclosure. This is typical.

Icing Problems

Some time ago WMTW-TV commenced operation with an antenna from which the ice was melted electrically. All active elements of the antenna were de-iced with calrod type heaters, from which 200 kilowatts of electricity could be dissipated by the heating system operating at maximum. It was discovered, however, that under extreme conditions, ice could form faster than it could be melted by the de-icing system. This condition resulted in either

severe loss of coverage or picture degradation. After some particularly severe storms it was necessary to de-ice the antenna by sending a man up to chop the ice off before normal operation could be resumed. One man was seriously injured chopping the ice by hand.

Special Antenna Needed

Much experience was gained under the infinite variety of weather conditions encountered in six years of operation. Dis-

cussions were entered into with RCA to determine whether the traveling wave antenna could be adapted for use under such severe conditions. From the combined experience of the WMTW-TV engineering staff and RCA's antenna engineering group, a proposed design was adopted, consisting of a modified traveling wave antenna with a gain of eight, made in two center-fed sections and enclosed in a fiberglass radome.

Tight Schedule

Work on the initial design was commenced in April of 1960 with the finished antenna scheduled to be delivered on or before September 31, 1960. Since October 15th was considered the latest possible date the erection of the antenna on the mountain could be completed, this made for an extremely difficult schedule.

Work was begun on the tower foundations on Mt. Washington in late June. The tower was designed and manufactured by Dresser-Ideco to RCA specifications. This tower is known by those who worked on it as "the mighty mouse." It is 50 feet high, uniform cross-section guyed tower. The foundations (for a tower of this size) are enormous, consisting of over 300 tons of concrete.

No contractor could be found to bid on these foundations, so this job was done by the WMTW-TV engineering department. Ready mixed concrete could not be used since trucks could not negotiate Mt. Washington. Frequently working in winds of 60 to 80 miles per hour and with visibility of less than 30 feet, the bulldozing, dynamiting, and construction of forms went forward. During the course of transporting the concrete aggregate up the mountain, one truck was lost over the edge and a number of them suffered expensive breakdowns. After a heroic effort the forms were completed by the first week in August, and the Racine Tower Construction Company began erection of the steel.

Design Coordination

Meanwhile the Camden plant of RCA went forward with the construction of the actual antenna. Since this was a custom antenna with a radome involved, its construction presented many unusual features. During this phase of the job, close touch was maintained between the WMTW engineering staff and the RCA engineering staff. It was absolutely necessary that the antenna be delivered on schedule, otherwise an entire year would be lost. It is impossible to ascend Mt. Washington after October 15th except by using snow vehicles. The complete antenna was shipped in two sections, each about 30 feet long and weighing



FIG. 3. WMTW Chief Engineer, Parker H. Vincent (right) and Transmitter Supervisor, Alden Doughty plan each step of the Mt. Washington operation.

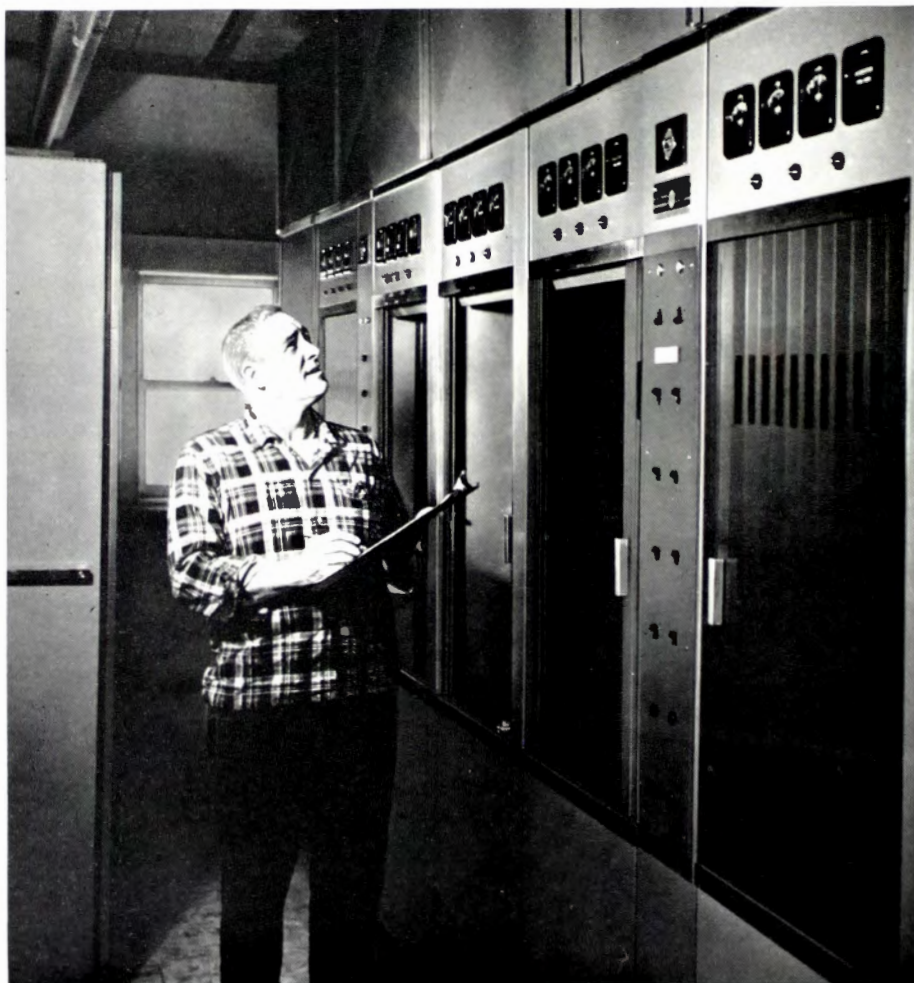

FIG. 4. Transmitter Supervisor Doughty is shown at the TT-25AH Transmitter. All power to operate transmitters is produced by diesel generators located in the WMTW building.

about five tons. It would have been impossible to transport the antenna by any other means than by truck.

The antenna was delivered on schedule and was landed on top of the mountain without incident.

Fighting the Elements

A book could be written about the weather difficulties experienced before the antenna was finally set in place. Winds from 60 to 100 miles per hour, snow and ice storms, and days on end when the visibility was 20 to 30 feet were experienced by the erection crew. One thing operated in our favor, however. Comfortable quarters were available on the mountain to house RCA engineer Bill Schoffner, Emile Racine and the erection crew, and the WMTW staff. A fulltime chef was on duty during this period and the rough weather was made more bearable with plenty of good food.

Construction Difficulties

The antenna was hoisted onto the tower in two sections. The day the first section was hoisted the weather was clear and the wind was down. During the course of this operation, clouds moved in and snow began to fall so that before the antenna was in place one could not see the 50 foot level of the tower from the ground. The weather remained bad for nearly a week before the second section could be put into position. Much the same experience was had this time, with the hoist starting under favorable conditions but completed with visibility nearly zero. Communication between the man on the tower and the man on the winch was entirely by telephone.

How close we came to the deadline was demonstrated by the fact that after the job was completed, the erector's trucks had to be helped part of the way down the mountain with the snow tractor. By this time there was two feet of snow on the summit and transportation by wheeled vehicles was at an end for the season.

TW Antenna Meets Specifications

The new Traveling Wave Antenna was placed in regular service on November 1st, 1960. Field intensity measurements have shown that it has more than lived up to expectations. Through the entire winter of 1960-61 the antenna has delivered a perfect signal through snow, sleet, and ice. The radome has shown a remarkable ability to keep itself free from ice accumulations, due in part to its smooth surface and in part to its dark color which absorbs what little heat the winter sun gives off to aid melting. No heating elements are employed.



FIG. 5. Transmitter operators, Wilfred Mank (right) and John Jacobsen (left), perform routine maintenance on the TVM-1A Microwave equipment that brings the WMTW signal to the transmitter from the Poland Springs Studios 50 miles away.



FIG. 6. Once a week supplies are taken up to the transmitter crew on Mt. Washington. After October 15, the snow cat provides the only possible means of transportation. Here the snow cat is shown at the 4½ mile point on the auto road—Mt. Madison is in the background.

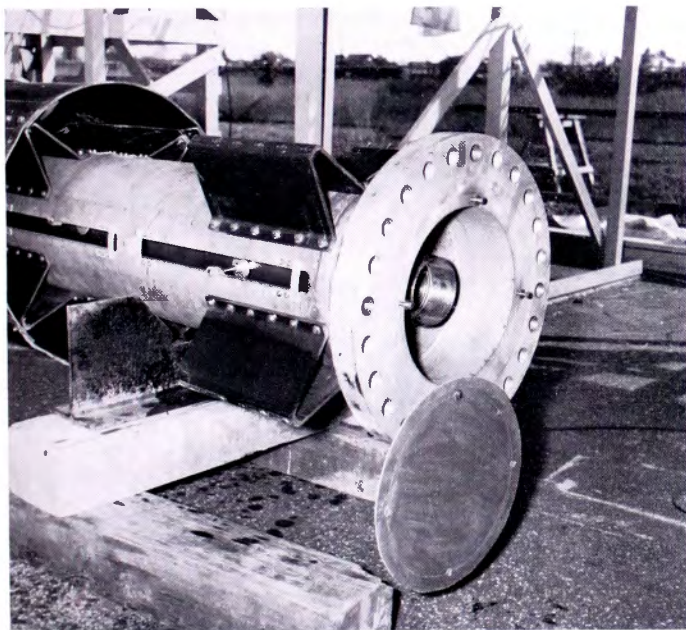

FIG. 7. This is a section of the Traveling Wave Antenna with a portion of the radome removed. Triangular sections of fiberglass are used to support the fiberglass outer shell. The fiberglass used is approximately ½-inch thick. Black was selected as the color since it absorbs heat which helps to melt ice. The slot structure of the antenna is also shown and in this case there was no need to cover the slots.

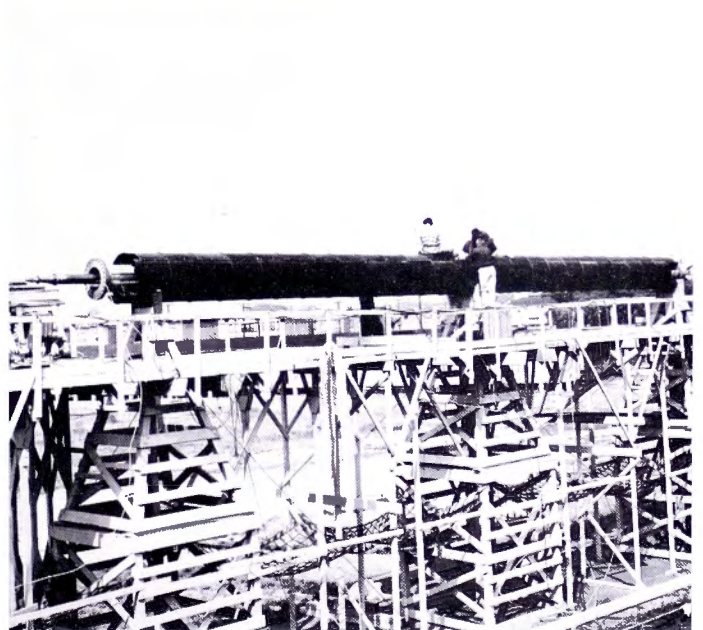

FIG. 8. Since this was a custom-built Traveling Wave Antenna it was completely tested before leaving the RCA factory. The fiberglass radome produced little or no effect on the antenna's radiation.

Improved Service

The TV installation on Mt. Washington can be pointed to with pride by the RCA organization. This combination of TT-25 transmitter and traveling wave antenna is putting a city grade signal into Portland, Maine, 65 miles away. It is also bringing high quality programs to a little served

area within a radius of roughly 100 miles from Mt. Washington.

Local programs originate at the RCA equipped studios in Poland Spring, Maine, 50 miles from the transmitter at Mt. Washington. Network programs and regional origination from the WMTW Boston studios are transmitted direct to Mt. Wash-

ington (140 air miles) over an RCA TVM-1A 4-hop microwave system.

As a result of the success of this project, the aim and purpose of Mr. Guider and his associates, who guide the destinies of WMTW, have been achieved and the antenna problem of "Misery Mountain" has been overcome.

NEW KPHO-TV TRANSMITTING PLANT

Dual Facilities and Conservative Operation
Assure Uninterrupted TV Programming

by GEORGE McCLANATHAN, *Director of Engineering,* } *KPHO and KPHO-TV*
as told to STEVE SHANON, *Director of Promotion,* }

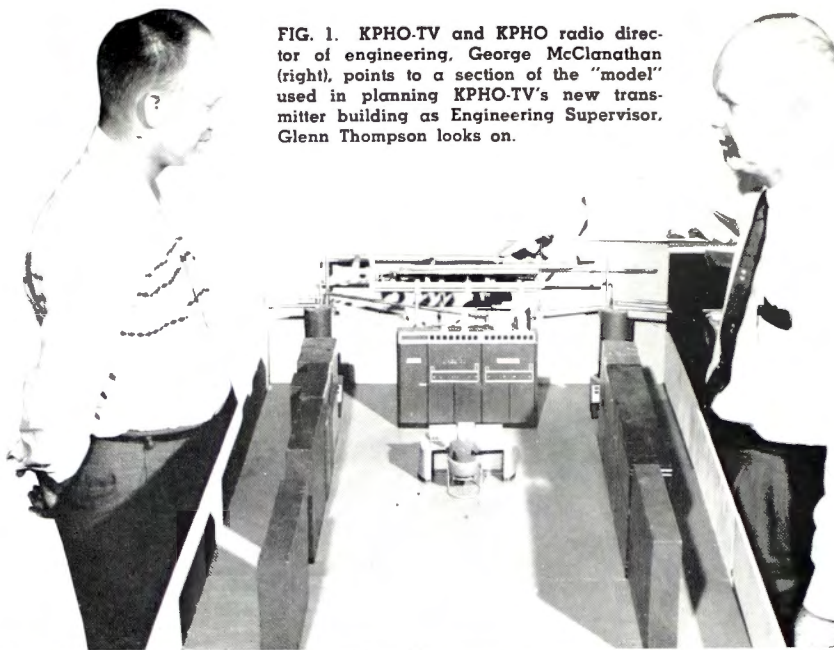

FIG. 1. KPHO-TV and KPHO radio director of engineering, George McClanathan (right), points to a section of the "model" used in planning KPHO-TV's new transmitter building as Engineering Supervisor, Glenn Thompson looks on.

The maximum power TV transmitter plant now operated by KPHO-TV is located on South Mountain eight and a half miles south of downtown Phoenix. This modern, up-to-date, and well equipped transmitting plant replaces its preceding counterpart with an increase in power of seven times and an antenna height 1500 feet above the old antenna.

The design of the plant took place over a period of more than two years, since no consideration was left unstudied. As the final plans were formulated a scale model of the complete installation was built. This assisted in the determination of detail, especially where dimensions were critical.

Planning With Models

The model came about as a force of necessity in designing the transmission lines layout. There are so many layers of over-run, that doing such a layout on a flat print would be extremely difficult. To determine how all the transmission lines would fit in, KPHO-TV started constructing a model of the side band filter and the transmission layout in physical lengths. A quarter-inch dowel was used to represent a three and one-eighth inch transmission line, and one-eighth inch dowel to represent a one and five-eighths inch line. The completion of this model actually determined what the size of the building would be to house the transmitter itself.

Site Selection

KPHO-TV worked with the terrain rather than bucking it, that is, it was desired to get a site in which the ground level was as high as possible in order to get maximum antenna height and also to have an area where it was possible to excavate sufficiently to place a building on the side of a sharply sloping hill. The terrain also dictated to a certain extent the dimensions of the building in that the building is a good deal longer than it is wide. Not the least consideration was the adequate road access to the site.

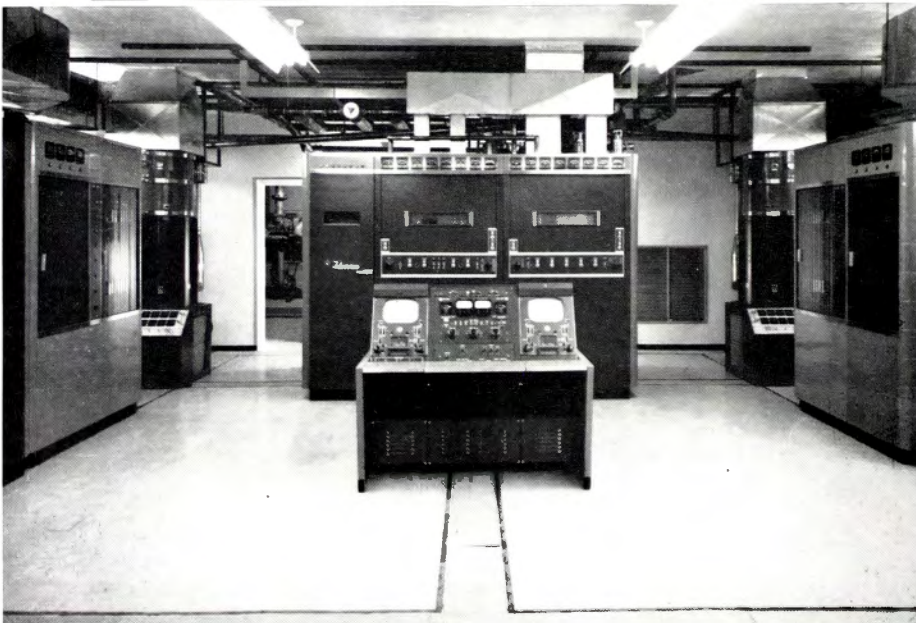

FIG. 2. Interior view of KPHO-TV completed transmitter building showing the control console and the TT-25CL Transmitter in the transmitter building atop South Mountain, 8½ miles south of Phoenix.

Self-Supported Tower

The new steel tower is supported on three legs set on reinforced concrete pads, 11 by 11 by 2½ feet, buried 15 feet below the surface. On top of these pads is a 13 foot column of reinforced concrete, on top of which rest the levelling plates of the antenna. The levelling plates are essentially at ground level. From here rises the 300 foot, self-supporting tower. At the 300-foot level a TF-6BM six-bay superturnstile antenna is mounted. Total overall height is 387 feet above ground level. Above average terrain the tower radiation center measures 1770 feet. The height above sea level is 2990 feet. It is the tallest, by some 50 feet, of any tower on South Mountain.

The Plant

The transmitter building comprises a main equipment room 50 by 30 feet in the center of the building. Two 17 by 15 foot rooms are at one end of the building, one housing emergency generating and power distribution equipment, the other containing all air filtering and blower equipment.

At the extreme south end of the building there are three 10 by 10 foot rooms, one of which is a shop and parts storage department, one of which is used as an office, but can also be used as an audio studio, and the third room is a kitchen area where a combination stove-refrigerator-sink arrangement provides a few of the comforts of home for the operator.



FIG. 3. Exterior view of transmitter building atop South Mountain looking north toward the Coolidge-Casa Grande Valley. Two microwave dishes on the roof link with the KPHO studios, and one can be used for remotes. Transmission line is run from the top of the building to the tower.

In the main room are housed the main and standby transmitters with ten racks of equipment. There is space remaining for addition of future equipment. There is also an area where emergency program facilities will be located, such as standby film equipment to provide against the loss of studio facilities.

RF Patching

Among the technical improvements is an extensive rf patch panel system. It consists of three 7-line rf patch panels, at the back of the driver, another one at the back of the visual amplifier, and the third one at the back of an aural amplifier. Should the visual power amplifier fail, it

FIG. 4. Interior view of KPHO TV transmitter building showing input, monitoring and test equipment racks and console. The aural PA section of the TT-23CL can be seen in the corner. The visual PA is located in the opposite corner of the room.

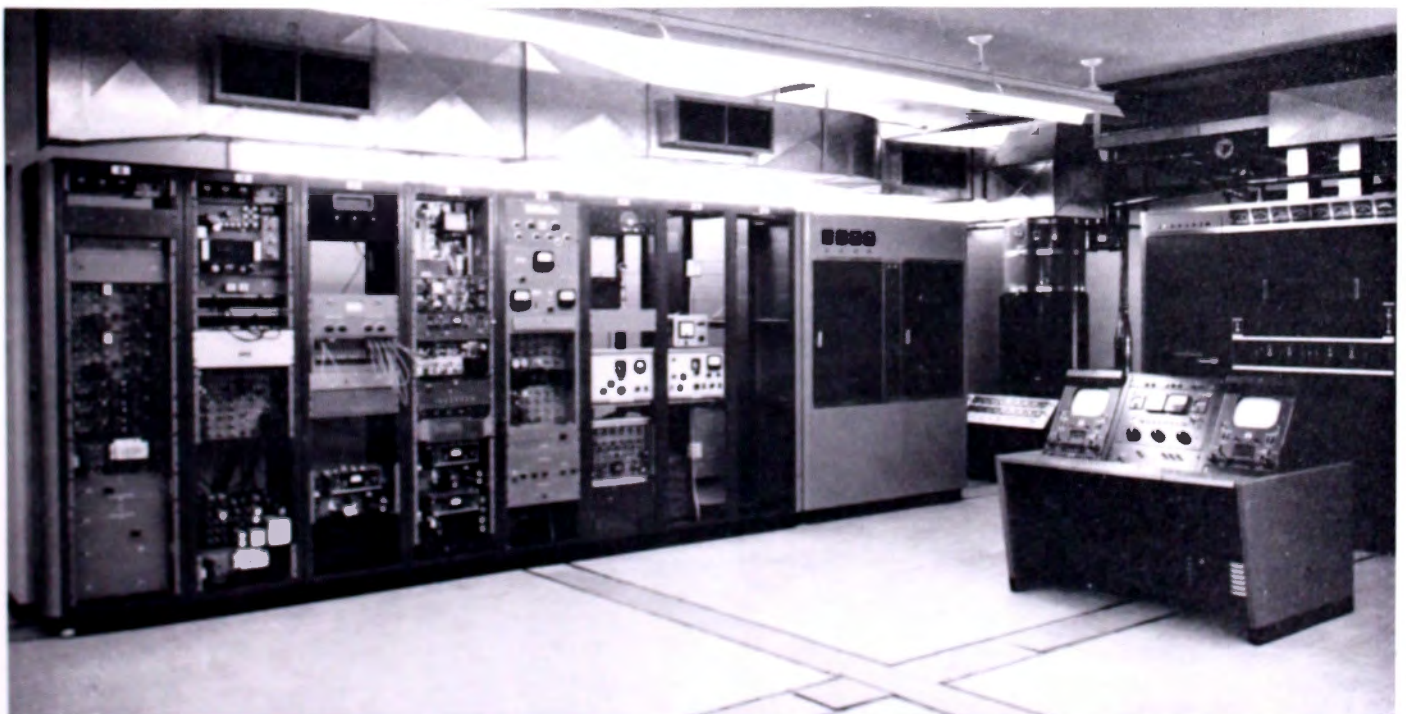

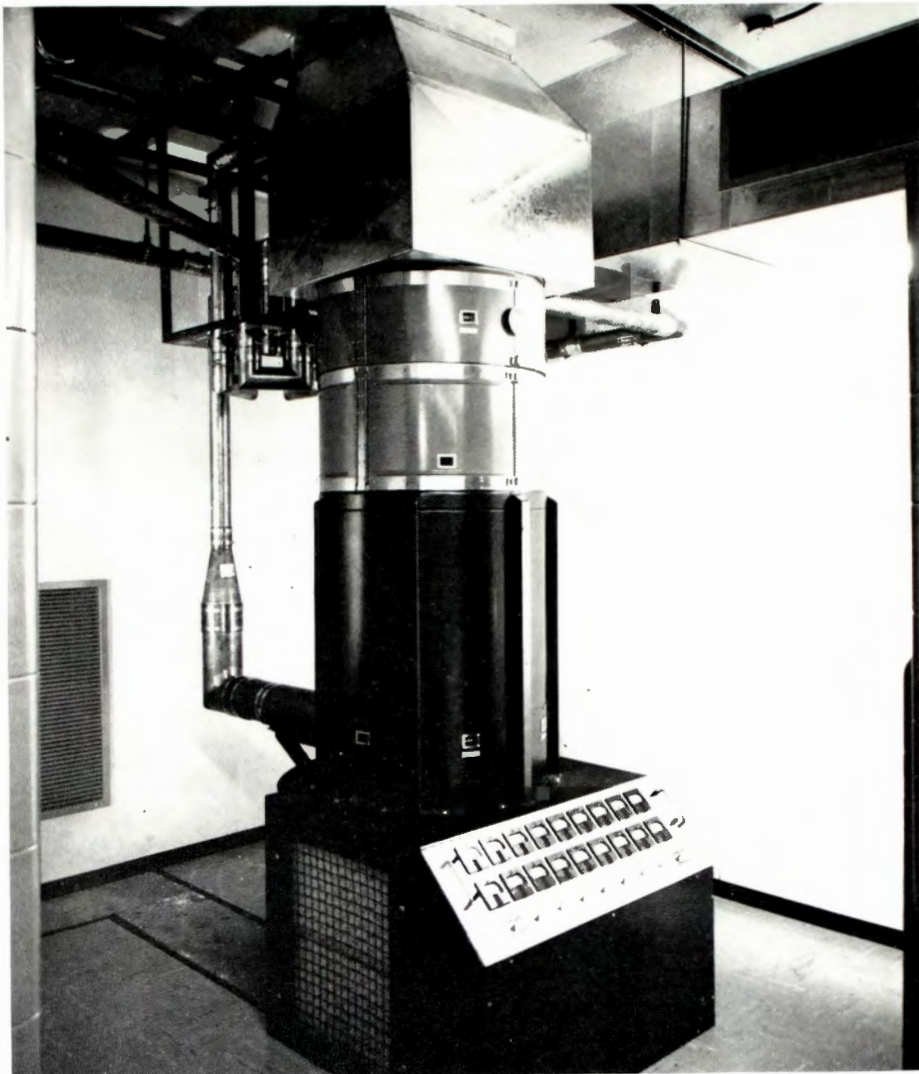

FIG. 5. This is visual power amplifier for the TT-25CL, note the power patch at the rear of the unit.

is bypassed in several seconds and the visual driver then directly feeds the antenna. Alternatively, the standby transmitter will work into the same patch panel, thus, were the driver to fail, the standby driver could be patched into the visual power amplifier and carry on with full 100,000 watts of radiated power. This same facility exists on the aural side.

The patch panel cross-connects to such an extent that any transmitter output can be easily connected back to the dummy load for test purposes. Thus this water-cooled device remains stationary and never has to be moved, as in some installations.

Conservative Operation

KPHO-TV has a safety factor capability in the use of its TT-25CL Transmitter. The power amplifiers, for instance, are capable of 25,000 watts output. However, with the six-bay antenna, only 17,000 watts of this power is needed to get full 100 kilowatts of ERP. This means the equipment is operating at only two-thirds rating.

This, of course, puts a very limited burden on the TT-25CL transmitter which among other things, results in low operating costs. Furthermore KPHO-TV believes it also results in a very long life and very reliable operation. The same thing is true of the driver, a TT-6AL 6 KW transmitter, operating at about half its rated power. The net result is that everything is loafing along so easily that there is no strain of operation.

FIG. 6. Rear and side view of aural power amplifier showing the manual rf power patch arrangement in more detail.

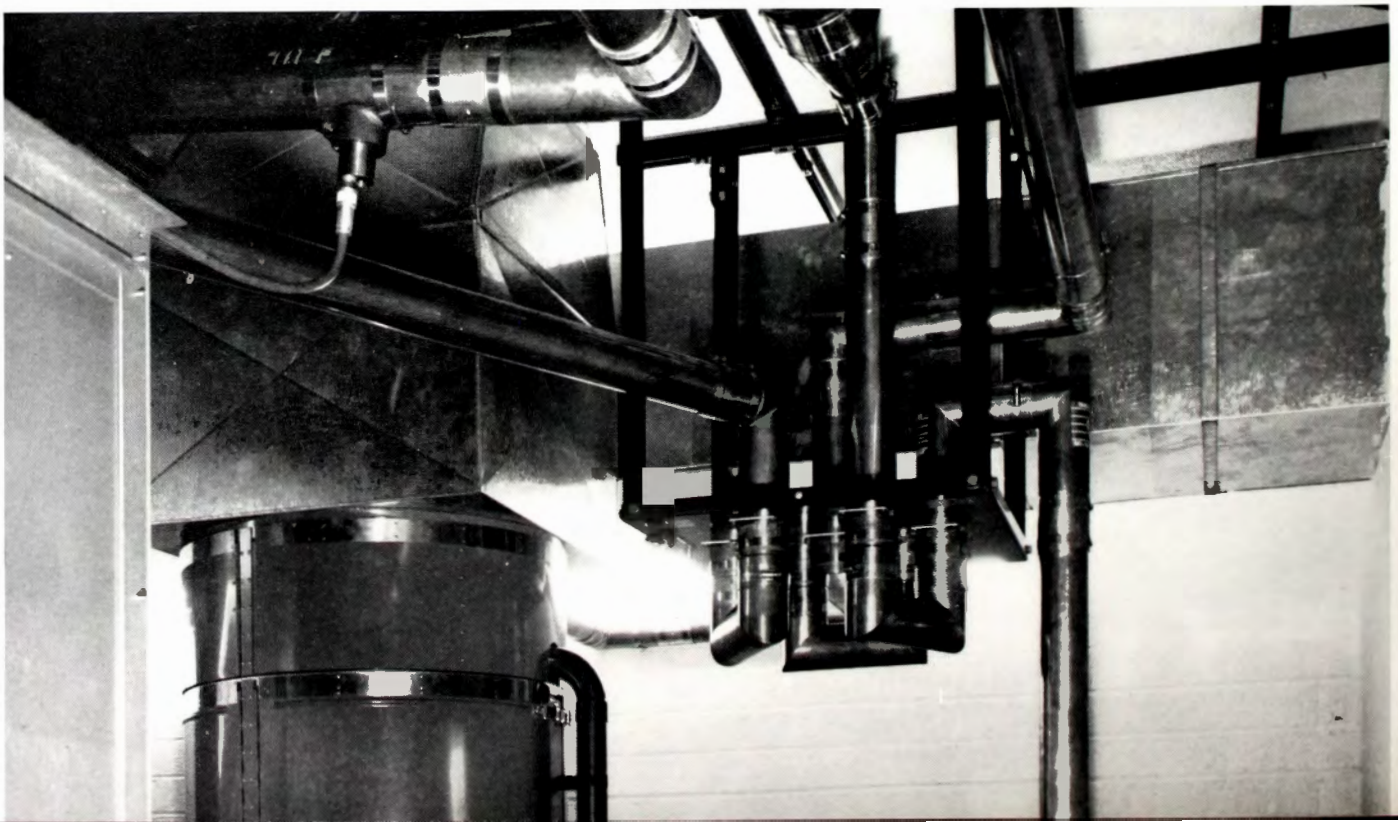

Duplicate Facilities

KPHO-TV is able to provide uninterrupted programming since it has complete standby facilities, including a standby driver transmitter, standby antenna, dual microwave systems from studio to transmitter, and three sources of power.

Two sources of power are commercial and the third is a 260-hp Caterpillar diesel-engine which drives a 187-kva power generator. There is an automatic change-over switch so no manual operation has to occur when putting the emergency power source into operation. The automatic changeover switch senses the voltage on all incoming commercial power phases and should any drop to 70 percent of normal, it automatically starts the diesel generator and switches it over to the main building distribution, disconnecting the other source line.

Air Conditioning

Two separate air systems have been installed. One of these is the building cooling for the comfort of the operator, and the other is for the cooling of the equipment. The building cooling has a recirculating air system with 20 tons of refrigeration to keep the room comfortable. Outside air is brought in to cool the equipment. All equipment cooling blowers are located in one room called a "blower" or "Plenum room" and under-floor ducts distribute the

air to equipment. Since maintenance is best accommodated with clean air, very special means have been taken for filtering. This system was selected over the electronic filtering method because of reliability under heavy dust conditions.

A 5500 gallon reservoir has been included in the building, thus the operating staff is not burdened by daily transportation of water to the transmitter site.

Outstanding Facility

There are few TV installations that compare with the KPHO-TV layout, in space, facilities, and standby equipment.*

All reports on extended coverage reveal that KPHO-TV's signal is extremely satisfactory. Furthermore, 90 percent or more of the reports show a far superior picture in clarity and quality. KPHO-TV's programs are now being enjoyed as far west as Blythe, California, as far north as Page, Arizona, as far south as Nogales, Arizona, and as far east as Silver City and Lordsburg, New Mexico.

* It is interesting to note that KPHO-TV personnel were directly responsible for the general building design, for choice of equipment, and total transmitter and equipment layouts, including the rf patching arrangement.

KPHO-TV was aided in building details by an architect, but the total layout of the operation is that of the station. Working on the project were Howard Zile, Glenn Thompson, engineering supervisor; Don Lewis, TV engineer and Carl Hassell.

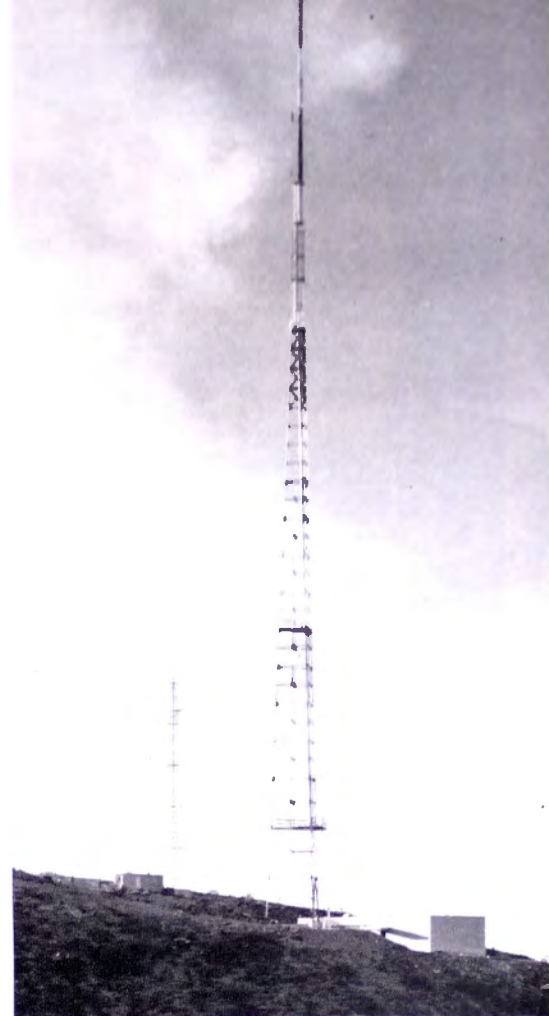
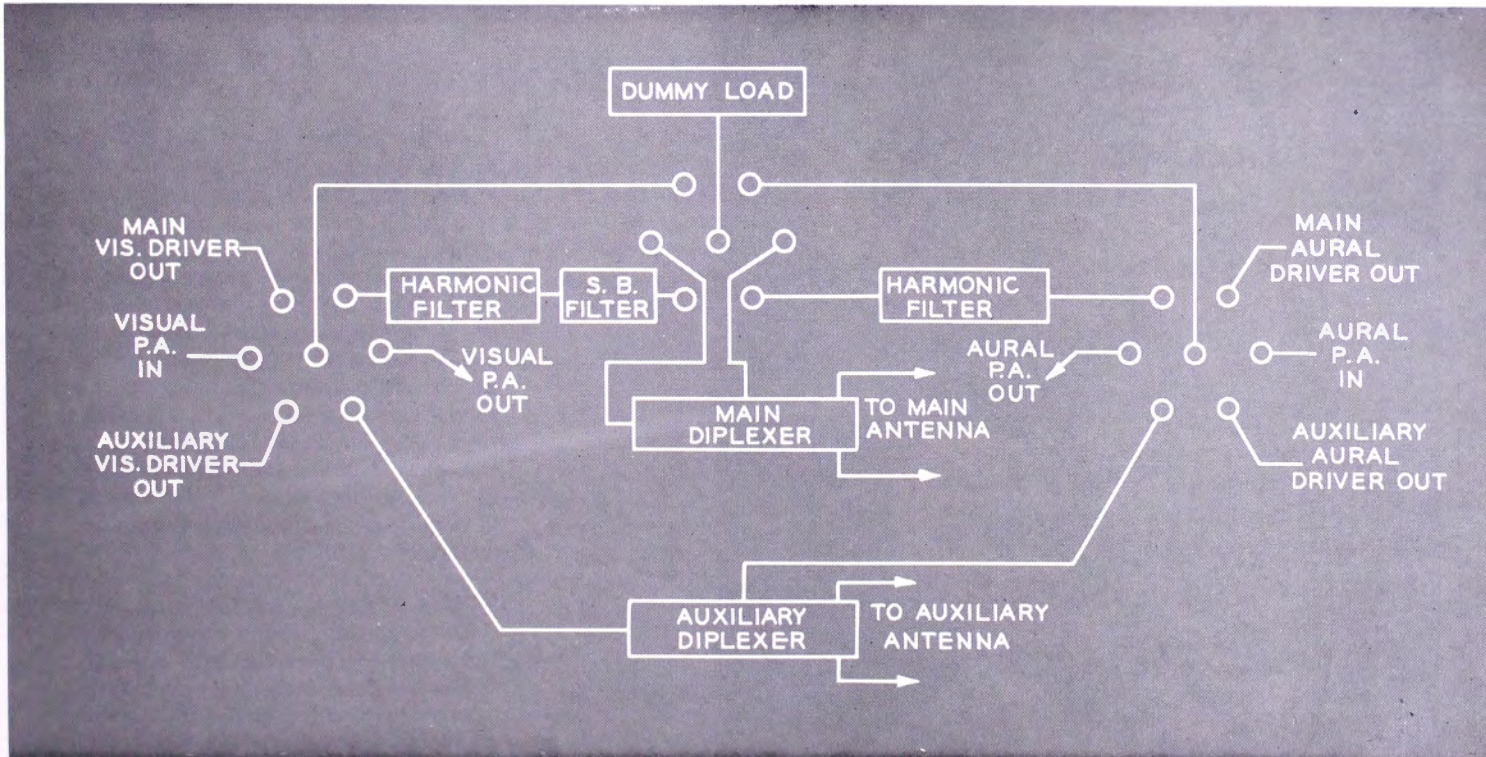

FIG. 8. New 300-foot self-supporting KPHO-TV tower on top of which is mounted a TF-6BM six-bay antenna providing a total overall height of 387 feet above ground, 1770 feet above average terrain. Height above sea level is 2990 feet.

FIG. 7. This is a simplified drawing of the rf power patching system designed by KPHO's engineering department.





STATION IDENTIFICATION



PROGRAM TITLES



COMMERCIALS



HOW TO GET from



Today with about 370 television stations equipped to transmit network color programs, the technique of color synthesis—getting color pictures from black-and-white subject material—is of increasing interest. These color equipped stations, many of whom have their own live and film color origination equipment, are finding this method convenient to simply and economically produce station ID's, program titles, special announcements and commercials in color. They no longer have to cut back to monochrome during station breaks in color shows, since they can now be available with little more care or preparation than black-and-white.

Color Synthesizer Equipment

The equipment necessary to achieve these techniques is termed the RCA Color Synthesizer. Most of the items are already installed in the color equipped station. Generally, color synthesis techniques utilize

COLOR TV PICTURES

BLACK and WHITE artwork

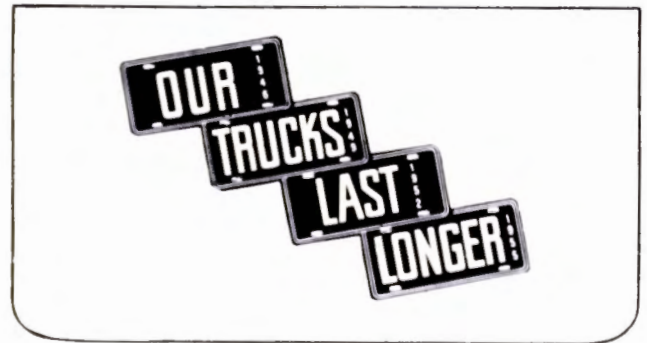
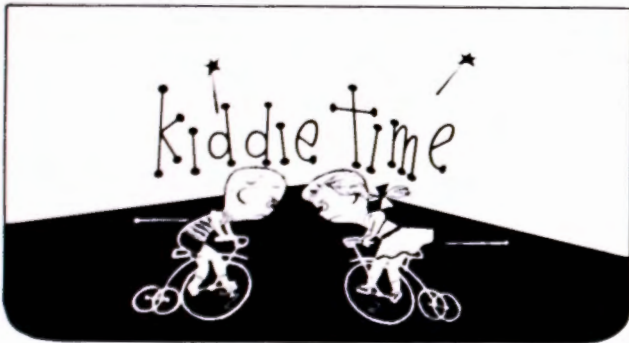

a source of monochrome camera signal (either film or live) from the station's existing equipment. The video signal (from the camera) is combined with a blanking signal (from the sync generator) and fed to two or more inputs of an RCA Colorplexer. The result is that one color is electronically added to the black portions of the picture, while another is added to the white portions. A complete technical description of the Color Synthesizer appears on the following pages.

First Demonstrated in 1955

The Color Synthesizer equipment described on these pages was first demonstrated in 1955 at the NAB Convention. For demonstration purposes a combination of show cards and a TK-21 Vidicon Film Camera Chain were used as a source of monochrome signal. An assortment of the cards is shown here to point up the art techniques which are most suitable. A bold

treatment with the absence of very fine detail or gray scale rendition is most satisfactory. Any traces of gray scale are likely to produce unpredictable results. White subject material on a black background produces the best picture source, since it is most easily lighted evenly and shaded properly in the camera. Since reversing the polarity of the video signal will reverse the colors in the final picture, this white-on-black technique can be standardized without losing any of the possible color combinations. Or if the original art is prepared black-on-white, slides can be made from negative photostats. This method will also keep down preparation costs, and allow some existing artwork—ID's and commercials to be used.

Varied Picture Sources

Any film or live picture source can be used with the Color Synthesizer equipment. For instance it may be practicable to use

an old iconoscope film chain with a 2 by 2-inch slide projector or Telop as a source of slide and opaque material. This could be set up exclusively for color synthesis purposes. A TK-21 vidicon film chain as a source for slides and opaques is probably most suitable; however, a live camera may be used along with flip cards. It will be a small task to set up any one of these sources for color synthesis use when desired.

56 Possible Combinations

The chart on page 31 shows all of the 56 color combinations when using the Color Synthesizer. Trial and experimentation will reveal some of the most pleasing combinations. Those that have been found to be most practical are outlined in black on the chart. Typical examples of some of the bolder treatments is shown page left. Almost infinite possibilities will suggest themselves, as uses for the Color Synthesizer are limited only by the imagination.

RCA COLOR SYNTHESIZER

and how it works

by C. R. MONRO

Broadcast and Television Engineering

The Color Synthesizer signal is made by exactly the same process as used for the familiar Color Bar signal. Video signals fed into various combinations of one, two, or all three of the inputs of an RCA Colorplexer will produce patterns of color in the output signal. Proper combinations of pulses from a Color Bar Generator are colorplexed to form the three primary colors and their three mixture colors. In the same way, a monochrome signal from a camera may be fed into a colorplexer to yield a result in two colors—one representing white in the picture and one representing black. An all-white signal (blanking) and an inverted video signal may also be used to increase the number of two-color combinations possible.

The diagram, Fig. 1, outlines the way these various signals are used. At the left is a subject—in this case a simple piece of artwork showing a white block on a black background. The monochrome signal (+V) represents the output of a monochrome camera used on this subject. The inverted signal (-V) is the same picture, electrically inverted in a separate amplifier. The blanking signal (BL) is regular mixed blanking, reduced to the same amplitude as the picture signal.

As an example, these signals are fed to the red, green, and blue inputs of a colorplexer. Note now the three signals. In the center area, representing the artwork, signal is now present in both the red and the green channels. Therefore, the colorplexer puts out a red-green or yellow signal for this area. In the background, signal is present in both the green and blue channels and the colorplexer provides a green-blue or cyan background area signal.

How It Works

The number of different color combinations which are possible depends, of course, on the equipment available. First, the three signals just described provide 30 combinations with only patch facilities available. Second, if isolated switching is available to permit connection of one signal simultaneously to two of the colorplexer inputs, then 24 more are possible. Figure 2 indicates these combinations of primary and mixture colors.

Equipment Used

The photographs, Figs. 3 and 4, show some of the equipment used in an early demonstration of the Color Synthesizer. Figure 3 shows the title cards used as a source of monochrome pictures. The small camera, in this case, is a TK-21 Vidicon camera, operating normally with the light supplied by two spot lights. The picture source is, of course, not limited to this method. Any conventional camera arrangement such as normally used for 2 by 2 or opaque slides may also be used. Figure 4 shows the remainder of the equipment used, as it was located in the racks.

The actual circuit, in simplified form, is shown in Fig. 5. The three TA-3 Distribution Amplifiers provide the necessary isolation for feeding the TS-2 Switchers. The single line on the diagram actually represents three separate leads from each of the amplifiers, one going to each of the switchers. The TA-3 provided for polarity inversion is the only non-standard unit in the whole system. It has been modified to add one tube for a simple inversion stage at the input. Blanking must then be added to the inverted signal to establish proper black level. This is done with the regular

sync addition circuits provided. Figure 6 is a schematic of these modifications. It should be noted here that this blanking addition process is critical as to timing. For this reason black background material is recommended. If white appears at the edges of a picture before inversion, then the added blanking must exactly cancel the blanking in the original picture. Any differences in timing or width will appear as severe transients. Also, the picture with black background will be easier to light evenly and to shade properly in the camera chain.

The attenuator shown is simply a potentiometer used to reduce the regular four volt blanking distribution level to video level for use as a white picture.

It may now be seen that either monochrome video (+V), inverted video (-V), or blanking (BL) may be fed to any or all of the colorplexer inputs in any combination.

Results with This Equipment

As mentioned before, 54 color combinations are possible with this equipment layout. In fact two (2) more possibilities may be added by pushing all three buttons for either +V or V. This results in a return to monochrome, a good check on colorplexer and monitor balance. A chart of all these combinations is shown in Fig. 7.

Of course all of these combinations may not be practical for everyday use. First, some color combinations may not be artistically pleasing for on-air color service. Second, colors whose luminance values are similar may not yield adequate contrast on monochrome receivers. The color combinations enclosed in double-line boxes on Fig. 7 are probably most desirable.

FIG. 1. Simplified diagram showing how artwork is processed so that monochrome, blanking, and inverted signals led to the colorplexer will produce a color picture.

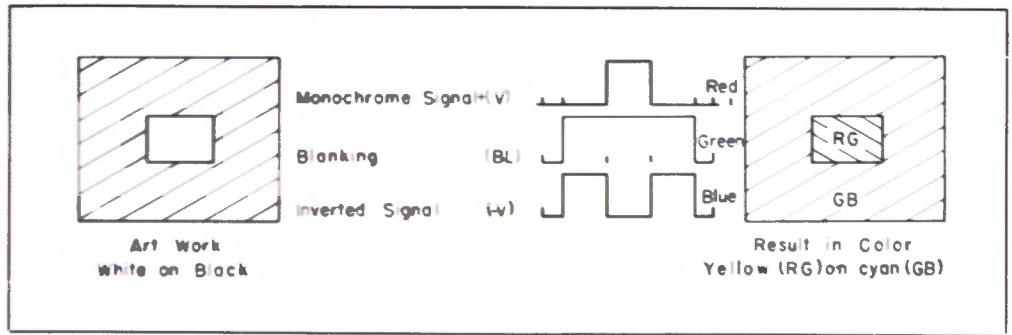

Signals	FACILITIES			
	Patching ¹		Isolated Switching ²	
	Art	Background	Art	Background
+V	Primary	Black	Mixture	Black
+V, BL	Mixture	Primary ³	White	Primary or Mixture
+V, -V	Primary	Primary	Primary ⁴	Mixture
-V	Black	Primary ³	Mixture	Primary ⁴
-V, BL	Primary	Mixture	Black	Mixture
			Primary	White
			Mixture	White
+V, -V, BL	Mixture	Mixture	Mixture	Mixture

¹ Patch facilities—one colorplexer input at a time. ² One primary color is also used in the mixture.

² Isolated Switching to permit simultaneous connection to one, two, or all three colorplexer inputs. Also includes all combinations for patch facility method. ³ Primary is not used in mixture.

FIG. 2. Chart illustrating the relation between possible color combinations and the signals and selection facilities available. Both patching and isolated switching methods are out lined.

FIG. 3. For demonstration purposes, this combination of show cards and TK-21 Camera was used. The TK-21 may also be used normally with slides and opaques, or a live studio camera can be used with flip cards.

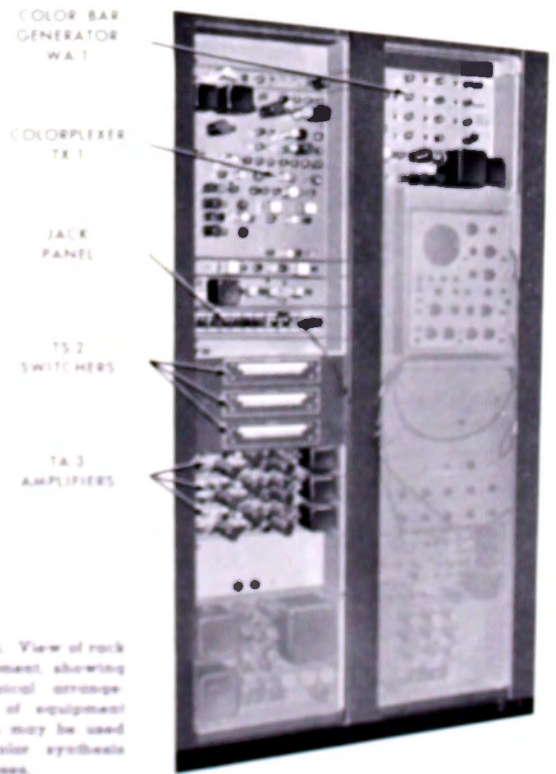

FIG. 4. View of rack equipment, showing a typical arrangement of equipment which may be used for color synthesis purposes.

In order to avoid subcarrier overshoots, just as is done in the color bars, the input signals to the colorplexer should be run at 75% level. Referring again to the block diagram, Fig. 5, the video level at the camera output should be 0.7 volt to agree with present color camera practice. The input to the blanking amplifier should also be set at 1.0 volt with the attenuator. Then all three TA-3's should be adjusted for

75% gain to provide 0.5 volt output signals. The colorplexer is normally adjusted for standard station level output. All of this means that color combinations containing white actually contain only 75% white.

In the diagram, Fig. 5, only three of the nine TS-2 Switcher inputs are used. The remaining inputs are available for an additional technique. For instance a

regular color bar or color camera simultaneous output can be fed directly to the switcher group. By this means, pressing three buttons in the same input will make the colorplexer available for additional tests on regular color operation as may be required. In this manner a colorplexer already in use with any one of a station's color camera chains may be shared with the Color Synthesizer.

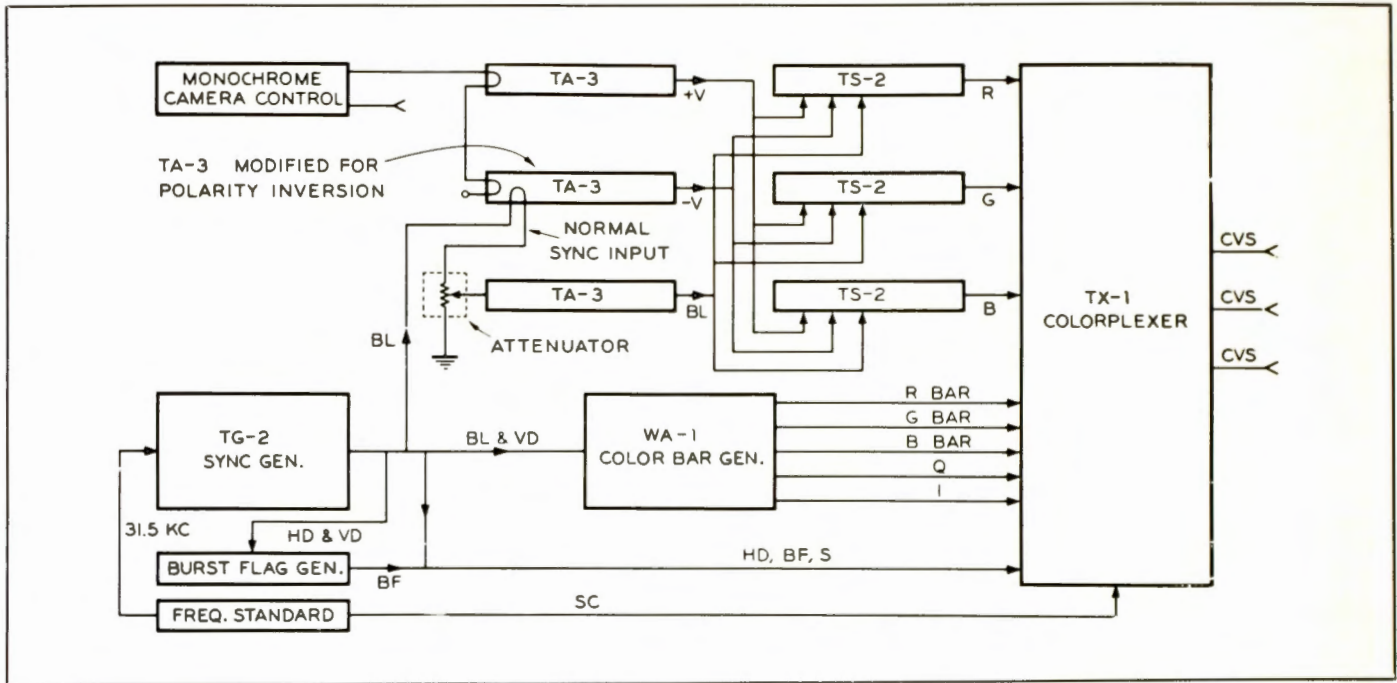
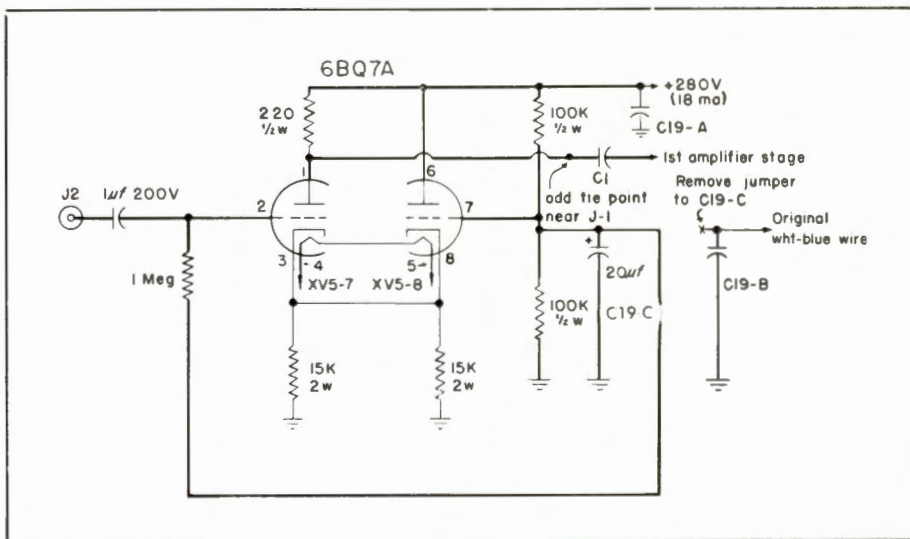

FIG. 5. Simplified block diagram of typical equipment items which can be employed in color synthesis.



- CODE:
- BF—Burst Flag
 - BL—Blanking
 - HD—Horizontal Drive
 - VD—Vertical Drive
 - S—Sync
 - SC—Subcarrier
 - R—Red
 - B—Blue
 - G—Green
 - V—Video
 - CVS—Colorplexed Video with Sync

FIG. 6. Schematic of Polarity Inversion Modification for TA-3 Distribution Amplifier.

1. Locate a 9-pin tube socket on a bracket beside J-3.
2. Connect 6BQ7A as shown above.
3. One other change is required in the blanking addition circuit: For MI-26157 type amplifiers, remove R50; for MI-26157-A type, short R-47.

Chart illustrating all of the 56 possible color combinations

ART	BACKGROUND								COLORPLEXER INPUT
COLORS		Yellow	Cyan	Green	Purple	Red	Blue	Black	
White		BL BL +V	+V BL BL	+V BL +V	BL +V BL	BL +V +V	+V +V BL	+V +V +V	R G B
Yellow	BL BL -V		+V BL -V	+V BL NO	BL +V -V	BL +V NO	+V +V -V	+V +V NO	R G B
Cyan	-V BL BL	-V BL +V		NO BL +V	-V +V BL	-V +V +V	NO +V BL	NO +V +V	R G B
Green	-V BL -V	-V BL NO	NO BL -V		-V +V -V	-V +V NO	NO +V -V	NO +V NO	R G B
Purple	BL -V BL	BL -V +V	+V -V BL	+V -V +V		BL NO +V	+V NO BL	+V NO +V	R G B
Red	BL -V -V	BL -V NO	+V -V -V	+V -V NO	BL NO -V		+V NO -V	+V NO NO	R G B
Blue	-V -V BL	-V -V +V	NO -V BL	NO -V +V	-V NO BL	-V NO +V		NO NO +V	R G B
Black	-V -V -V	-V -V NO	NO -V -V	NO -V NO	-V NO -V	-V NO NO	NO NO -V		R G B

RECORD-SETTING 136-MILE COLOR MICROWAVE LINK

Carries TV Programs Over Great Salt Lake
To Station KID-TV

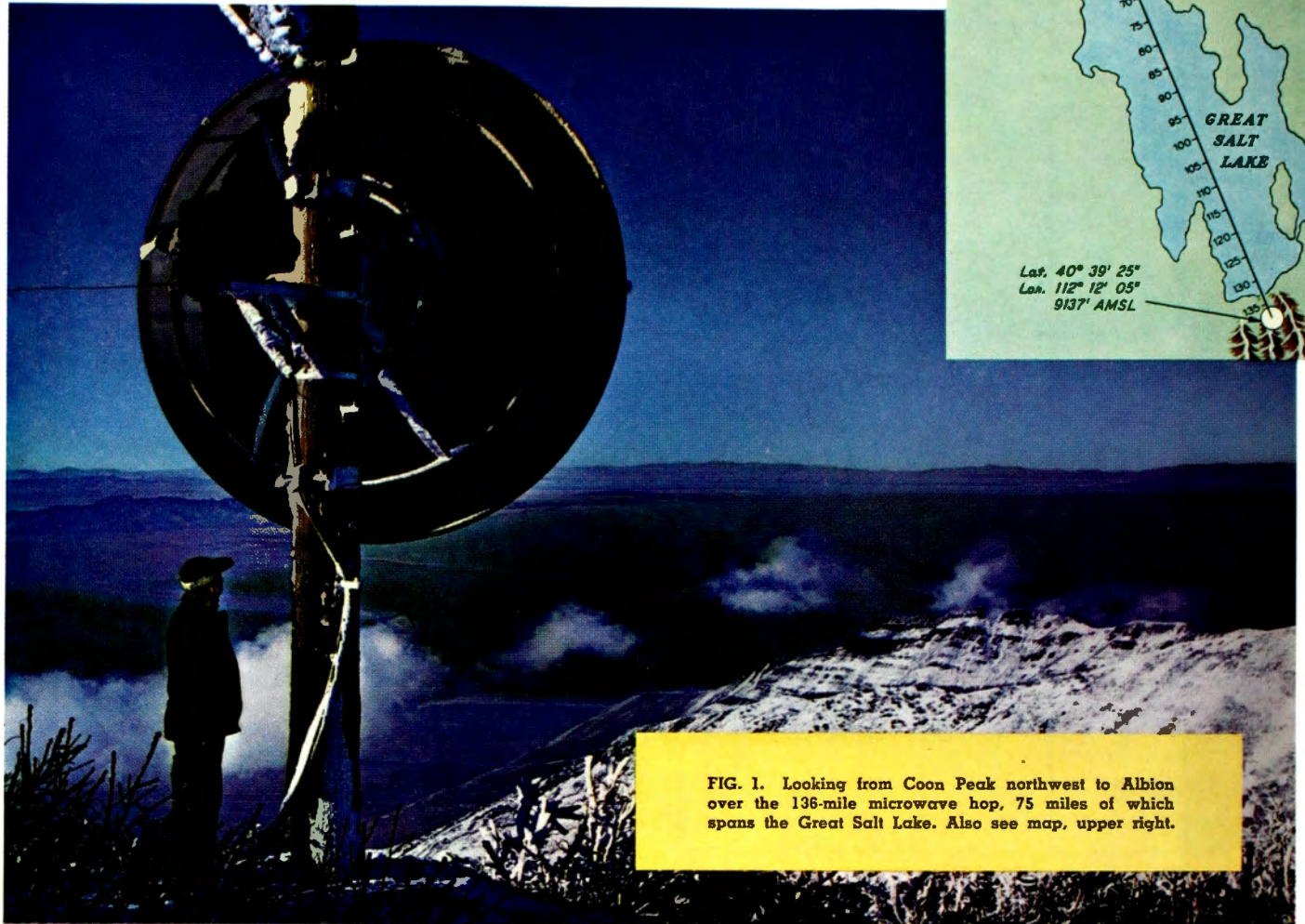

FIG. 1. Looking from Coon Peak northwest to Albion over the 136-mile microwave hop, 75 miles of which spans the Great Salt Lake. Also see map, upper right.

by L. H. FOLLET, JR., *Broadcast Microwave Equipment*

From a mountaintop location near Salt Lake City, Utah, television programs are being beamed the length of Great Salt Lake, then over rugged terrain, a total distance of 225 miles, to serve Station KID-TV in Idaho Falls, Idaho. This is accomplished by a two-hop RCA microwave system, one hop of which is 136 miles, the other hop, 89 miles.

The 136 mile microwave hop from Salt Lake City to Albion, Idaho, is believed to be the longest point-to-point television microwave relay ever accomplished. High quality results being obtained on this hop

are all the more impressive because the signal travels 75 miles over salt water—one of the worst enemies of microwave relay. Also color performance is being achieved throughout the system.

Completes Overall Program

According to the plan, microwave station facilities would be provided at strategic locations between Salt Lake City and Idaho Falls, in order to relay the programs directly from their source rather than utilize "off-air" signals which were previously used. It was felt that a direct microwave relay interconnection was the best approach

to securing reliable, high quality programs for transmission by KID-TV.

The Salt Lake microwave link was engineered by RCA specialists working in conjunction with Melvin B. Wright, General Manager, Skyline Advertising and Sales, Inc. and Carroll Secrist, Chief Engineer, Station KID-TV. Installation of the 136-mile hop completes the overall plan to provide clear network television signals from Salt Lake City to the KID-TV transmitter in Idaho Falls.

Future expansion is under consideration which will eventually extend high quality

television programs elsewhere into Idaho as well as northward into Montana.

Microwave Brings Picture Improvement

Prior to the Salt Lake installation, Station KID-TV, late in 1959, installed an RCA Type TVM-1A microwave link from Albion Peak, 22 miles southeast of Burley, Idaho to the transmitter site on East Butte, 34 miles west of Idaho Falls, Idaho. Once established, this 89 mile microwave path brought about an immediate improvement to both the picture quality and program reliability of KID-TV. It was to become a key link in the expansion program.

Two 10-foot diameter parabola antennas were installed along with the TVM-1A microwave relay equipment. Throughout the first few months of operation, it became evident that this path was to become highly successful. Considerable improvement was realized in the "off-air" signal strength at Albion.

The Albion microwave site, however, was still 136 miles (line-of-sight) from the network program facilities at Salt Lake City. To complete the plan, the remaining 136 miles between Salt Lake City and Albion were linked with one more vitally important microwave system.

Tough Problem to Tackle

Probability of success in the 136-mile hop depended on two considerations: first, path propogational reliability might be limited

due to the extreme path distance (136 miles), and second, the beam would have to cross the entire length of the Great Salt Lake (75 miles). Over-water microwave paths are normally critical in that strong reflections are likely to occur from the water surface. These reflections if not blocked may arrive at the receiver antenna and cause severe cancelling effects to the main beam, since they normally undergo a phase reversal during the reflection. Salt water reflections are usually stronger than those from most other earth surfaces and for this reason, alternate microwave routing around such surfaces is usually recommended wherever possible.

Path Analysis Undertaken

Extensive studies of this proposed path were made by RCA microwave specialists in order to ascertain its practicality. United States Geodetic Survey (USGS) maps for the area were studied along with accurate altimetric measurements for all critical areas of the path. A study of the prevailing area weather conditions was made, while countless recordings taken from other cross-water paths were referred to for indications of possible fade depth which might be expected from highly reflective water surfaces.

The microwave beam emanating from the transmitter atop Coon Peak would begin its cross-water route at the base of the mountain, six miles away. For the next 75 miles the microwave beam would cross the Great

Salt Lake, cutting across the salt flats at the north end of the lake, and traveling through a 5400-foot pass in the Raft River Mountains bordering Utah and Idaho finally reaching its destination across the Raft River Valley in Albion.

FIG. 2. Carroll Secrist, Chief Engineer, KID-TV, makes last minute adjustments to TVM-1B microwave receiver at the Albion receiving location.



FIG. 3. Receiving location at Albion, Idaho. Parabola at the right faces Coon Peak, 136 miles distant. Parabola at the left faces East Butte, 89 miles away.



Favorable Path Conditions

Notwithstanding the path length of 136 miles, two important considerations seemed favorable for the success of the path:

1. The generally high elevation with constant low percentage of relative humidity and continuous prevailing wind conditions along the path, making the possibility of dielectric inversions of the atmosphere responsible for "inverse bend" types of fading extremely remote, and

2. The strong cancelling reflections associated with this path (estimated at a probable 40 db) occurring at the extreme north end of the Great Salt Lake would be blocked by a 5400-foot pass in the Raft River Mountains 35 miles south of the Albion receiving location.

New TVM-1B System Installed

When the path studies had been completed, RCA shipped one of the first models of the new Type TVM-1B Microwave Re-

lay System to the respective sites for installation. Under the supervision of Carroll Secrist, Chief Engineer of Station KID-TV, two more huge 10-foot parabolas antennas were installed, one at Coon Peak and the other at Albion. Dual signal level recorders were installed at Albion, connected across the receiver's AGC line, and the equipment was turned on.

Excellent Test Results

After final antenna orientation had been completed, the non-faded signal level at the input to the receiver was measured at -70 dbw. This rf input level produced a video signal-to-noise ratio at the output of the TVM-1B microwave receiver of 64 db PP/RMS (measured over 4.5 mc bandwidth). With signal level data being supplied constantly by the two recorders at Albion, see Fig. 5, it soon became evident that the 136 mile link was performing according to calculations and that no deterrent reflections from the Great Salt Lake

were being received. They were being masked by the mountain pass as predicted.

A noticeable reduction in the average depth of multipath fading was evidenced by the recording charts during the parabola alignment (see Fig. 6) when the polarity of the antenna feeds were rotated from the horizontal plane to the vertical plane. This reduction amounted to about 3 db from the average received signal level.

It was also noted from the graph recording that the amount of multipath signal variation (frequency of occurrence) on the 136 mile path was substantially equal to that of the 89 mile path. The maximum fade depth experienced for both paths was about 30 db.

Greater-Than-Expected Gains

During certain periods, actual gains in signal strength above the free space (non-faded) calculations were observed. These gains ranged in amplitude from a few db to a maximum well above 10 db in some cases. (see Fig. 7). At one time, for a period of about 3 minutes, the signal level rose to a level 18 db above its normal value. This condition can be accounted for by the phenomenon called "trapping" or "ducting". Trapping is a condition whereby RF energy from a microwave transmitting parabola deviates from its normal free space dispersion pattern and follows a preformed dielectric contour through the atmosphere to the receiver. These atmospheric ducts vary in regard to their effect on the strength of the microwave signal depending upon their particular structure and elevation.

Other late afternoon recordings taken from the Albion receiver showed that in some cases, the average received signal rose about 6 db over the normal level and lasted from about five minutes to several hours. During these periods, the depth of multipath fading was greatly reduced resulting in a marked increase in signal stability, see Fig. 8.

Fully Operational 225-mile System

Late last year, after several months of continuous recordings had been studied of the receiver signal levels, the long path was declared ready for use and the dual recorders were removed from the Albion receiver. The resultant 136 mile path from Salt Lake to Albion in series with the 89 mile path from Albion to East Butte is now fully operational over a total of 225 line-of-sight miles, giving excellent results in terms of quality and reliability for both color and monochrome signals.

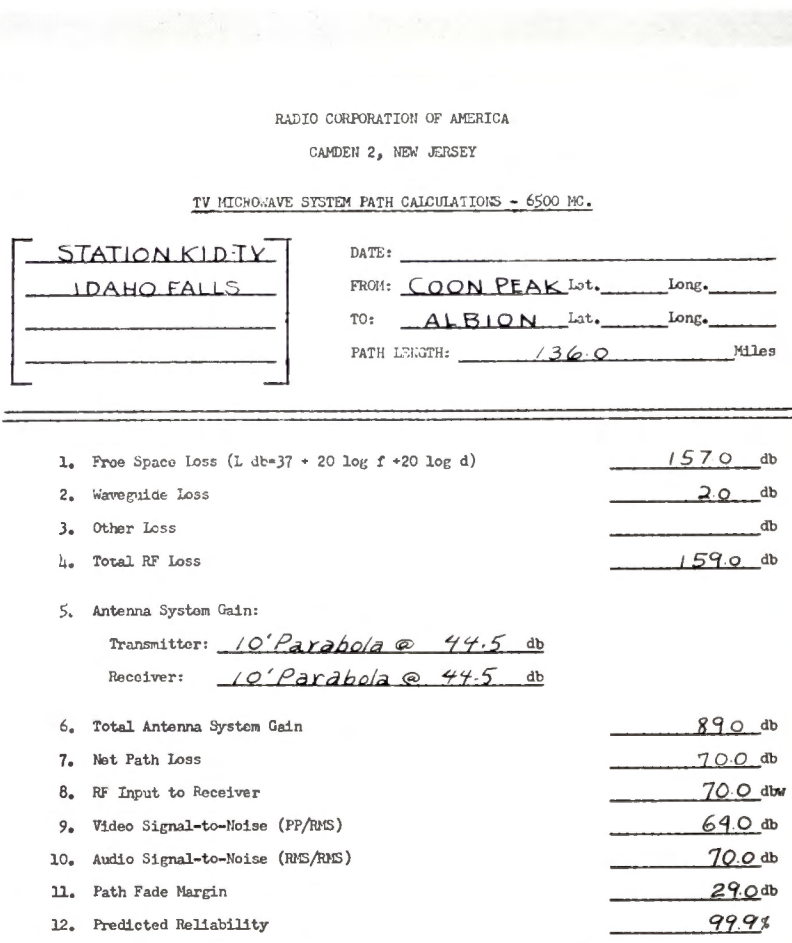
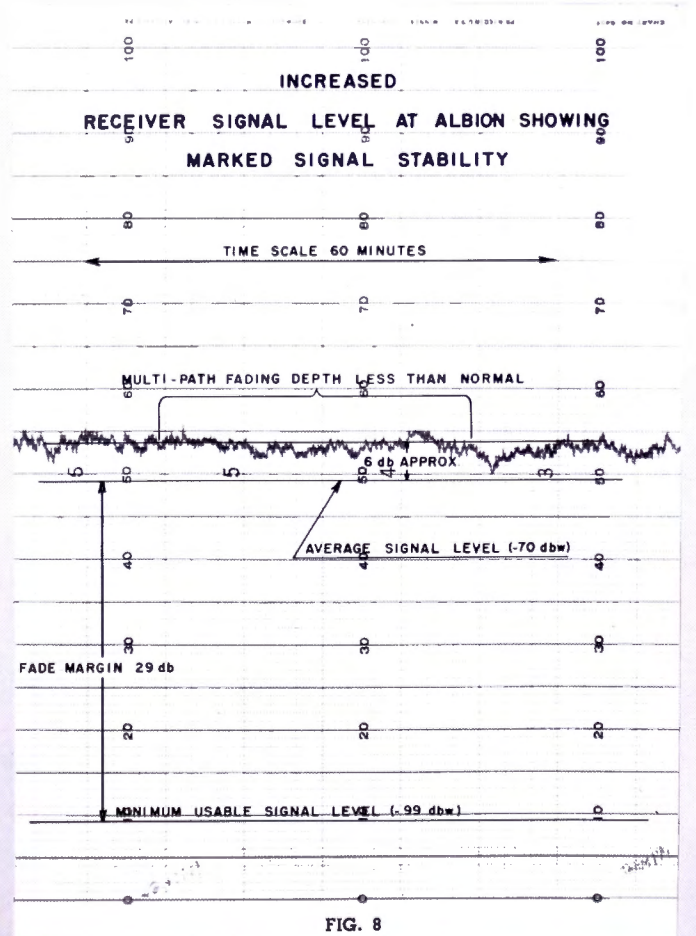
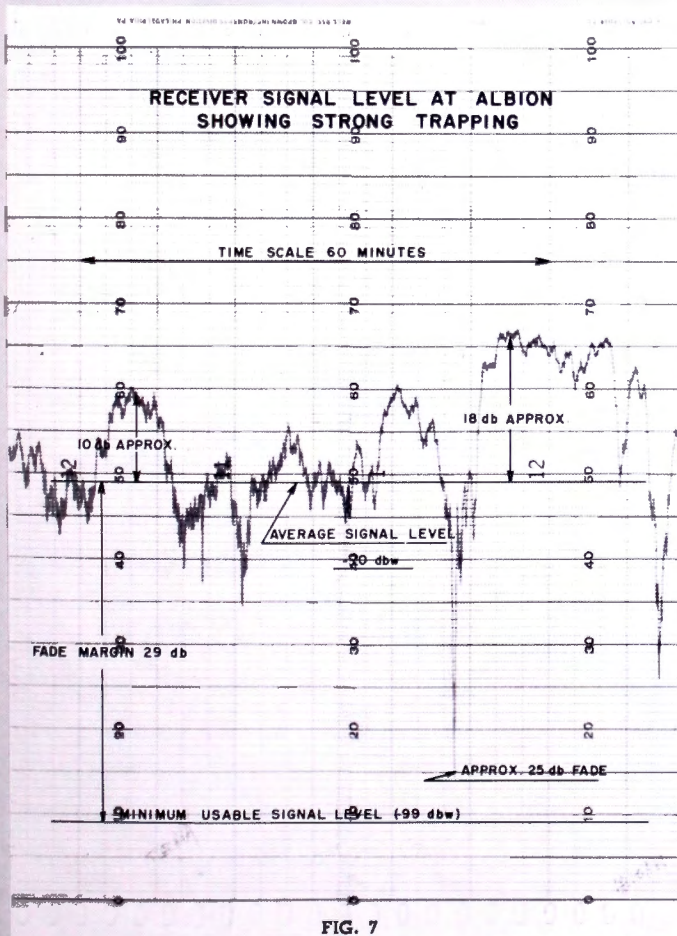
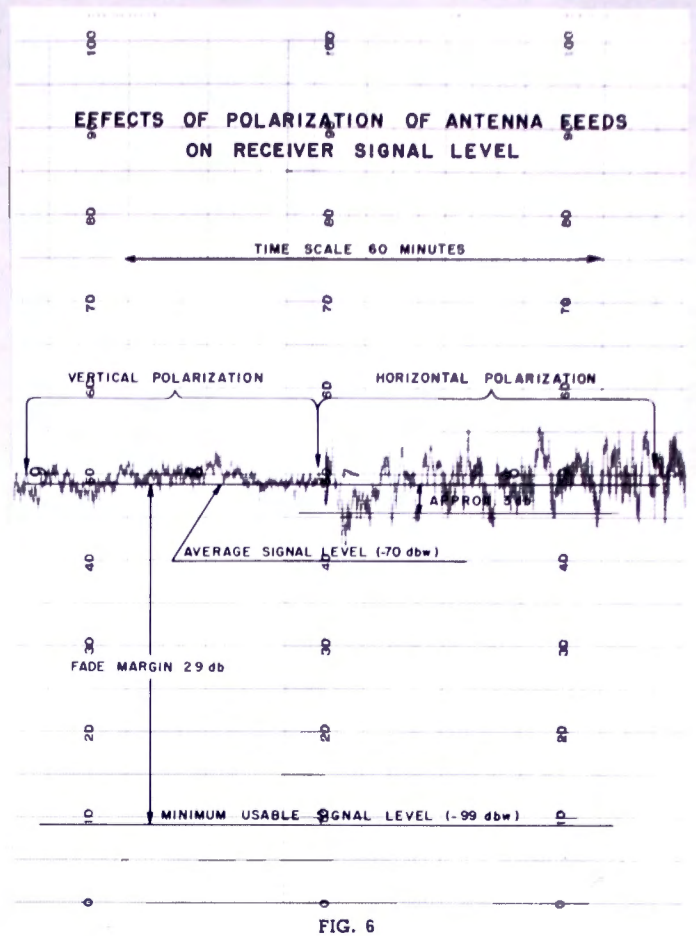
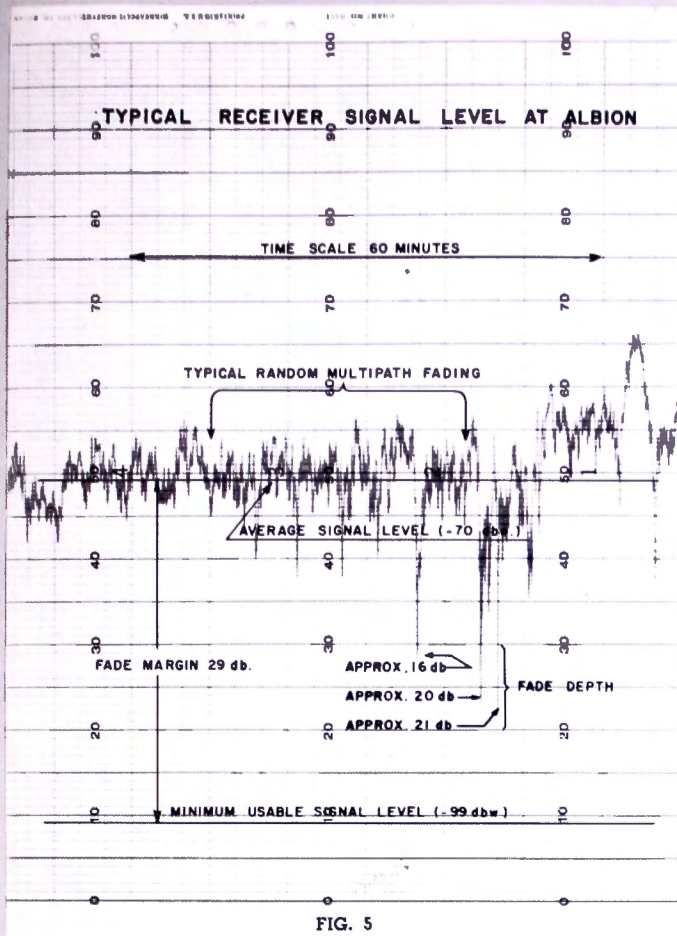

FIG. 4. Path calculation for 136-mile path.



FIGS. 5, 6, 7, 8. Samples of signal level data supplied by two recorders installed at Albion.

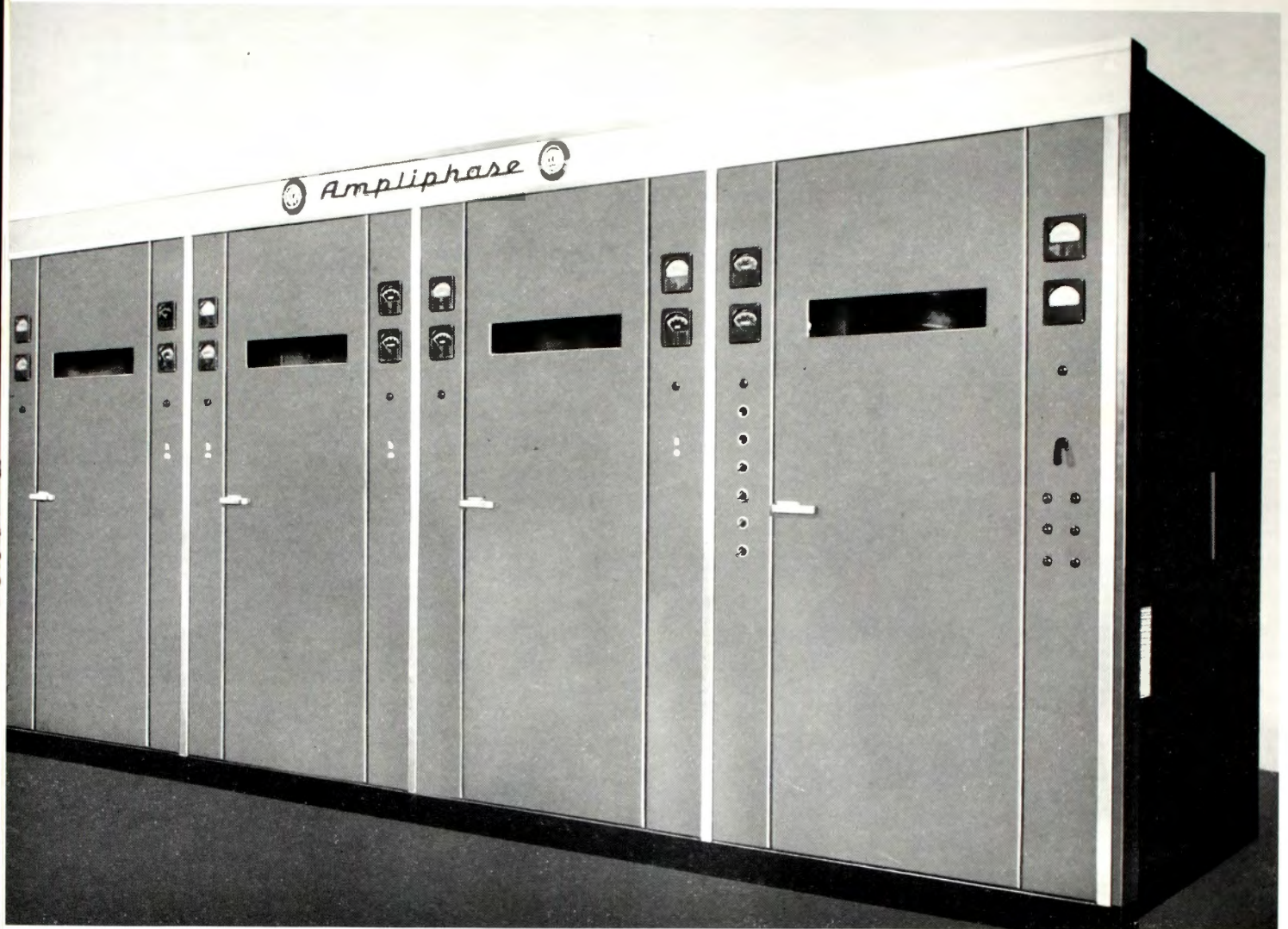

FIG. 1. Here is the new Ampliphase transmitter, type BTA-50H. Four compact cabinets occupy only 75 square feet of floor space.

NEW | **50 KW AMPLIPHASE AM TRANSMITTER**

Type BTA-50H Combines High Performance
and Reliability with Low Operating Cost

Introduced in 1956, the *Ampliphase* concept is now proving its value in over 20 of the nation's top stations. Early this year a new model of the *Ampliphase* transmitter, type BTA-50H, was introduced. The BTA-50H has been installed in several stations where its performance is proving even better than previous models. This new transmitter offers several distinct advantages; such as, new lightweight PA tubes, improved driver tubes, silicon rectifiers, and an extremely stable exciter. In addition, each new *Ampliphase* transmitter is being completely tested at the factory to assure proper operation upon installation at the station.

The Ampliphase Transmitter

In the *Ampliphase* system RF is generated in the 807 crystal oscillator stage at carrier frequency. This signal is then amplified and separated into two channels differing in phase by 180 degrees. Each signal is then passed through d-c modulator stages adjusted to produce a phase difference of approximately 135 degrees between the two channels. Modulation is applied to each rf channel by a variable resistance type of phase modulator. The outputs of the modulated stages are then fed into amplifier stages using type 1614 tubes which in turn drives class C amplifiers using 4-250 tetrode tubes. The output from the 4-250 stage in each channel drives a 4CX5000A tube which in turn drives the final amplifier tube, type 6697, to well over 25 kw output in each channel. Each power amplifier has a conventional pi-network type of tank circuit with a common output shunt element. The combined output capability of the two power amplifiers is well in excess of 50 kw. A completely shielded two section low pass filter is incorporated in the output circuit in conjunction with two series-tuned shunt connected traps which provide sufficient filtering action to easily meet or exceed present FCC requirements.

Improved Power Tubes

A single 4CX5000A ceramic, air-cooled tube is used in each driver stage of the two rf channels. The 4CX5000A tubes are operated well below their maximum ratings to provide long, trouble-free operation. A single type 6697 tube is used in each power amplifier in the two rf channels. The type 6697, rated at 35 kw plate dissipation, is required to dissipate approximately 14 kw under average modulation conditions, thus assuring long tube life. Because of the small physical size of the 6697 (actual weight 29 lbs.), one person can easily and quickly replace this tube.



FIG. 2. Easy access to all tubes and tuning controls is through the front doors. The cubicle on far right contains the new silicon rectifiers, next is one of the PA stages. On the far left the other PA stage and next to it the exciter and driver stages.

FIG. 3. Close-up of the new PA stage. Note the new lightweight 6697 tube.

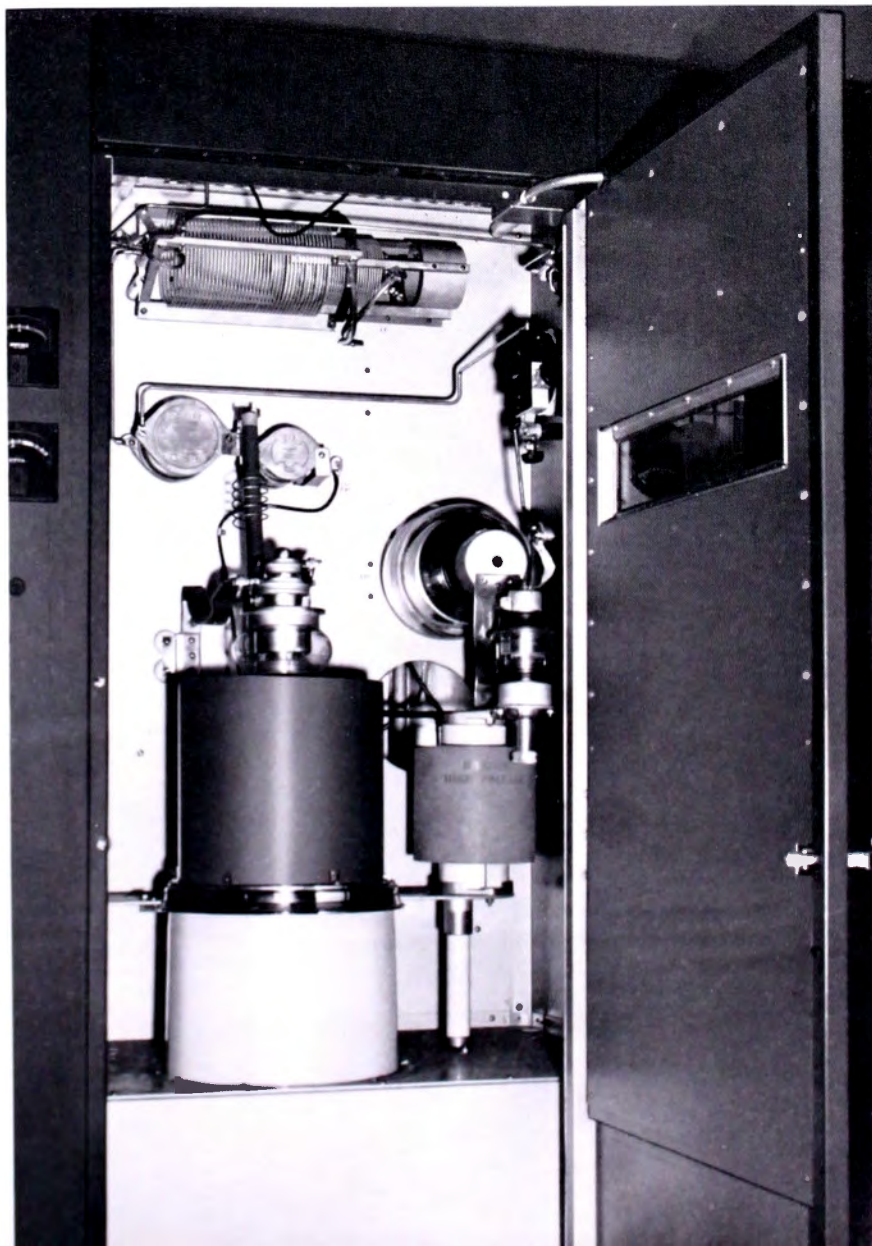

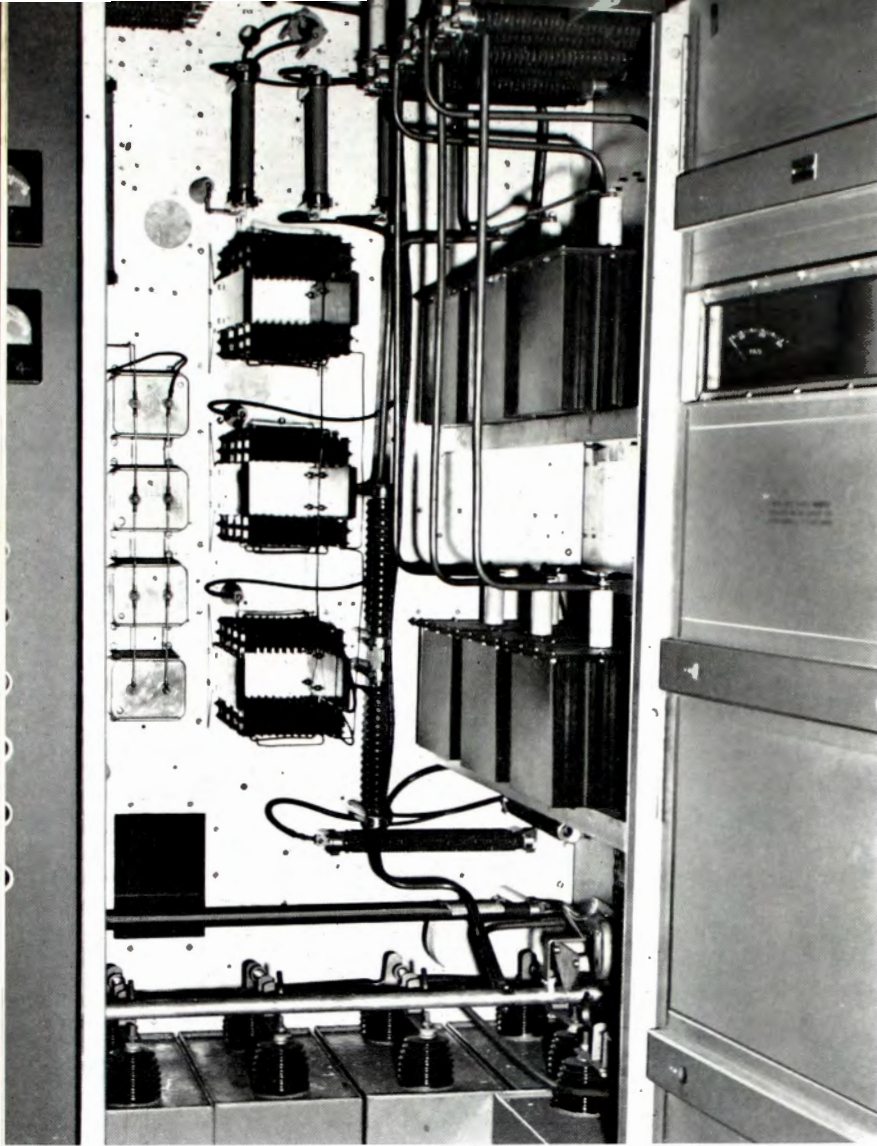

FIG. 4. The new silicon rectifiers are mounted vertically inside the cubicle. Filter capacitors are at the bottom of the cabinet.

Finest Sound

Low audio requirements in the *Ampliphase* system eliminates the need for large costly transformers, reactors, and modulator tubes. Extended range frequency response is easily attainable. The high modulation capability of the *Ampliphase* system means a louder sounding signal and improved coverage.

Solid State Rectifiers

Silicon rectifiers are used in all high voltage, bias and low voltage power supplies in the BTA-50H. The high voltage plate supply rectifiers are immersed in oil to eliminate corona and other environmental hazards. Solid state rectifiers permit the transmitter to operate in ambient temperatures as low as -20 degrees centigrade which makes remote operation in unheated buildings feasible.

High-Speed Overload Protection

Two types of overload protection are used in this transmitter. The current types (instantaneous and time delay) are connected directly in the tube circuits and rectifier ground leads. Thermal magnetic circuit breakers are used as back up protection and as disconnect switches. The transmitter circuitry is arranged so that an overload will either lock out the plate supply circuit or allow a single reclosure that will reset if there are no further overloads. In either case, when a lockout position has been reached, the overload circuit can be reset by means of an overload reset con-

FIG. 5. Rear access to the BTA-50H is very easy. Rear panels are removed to permit servicing and maintenance.

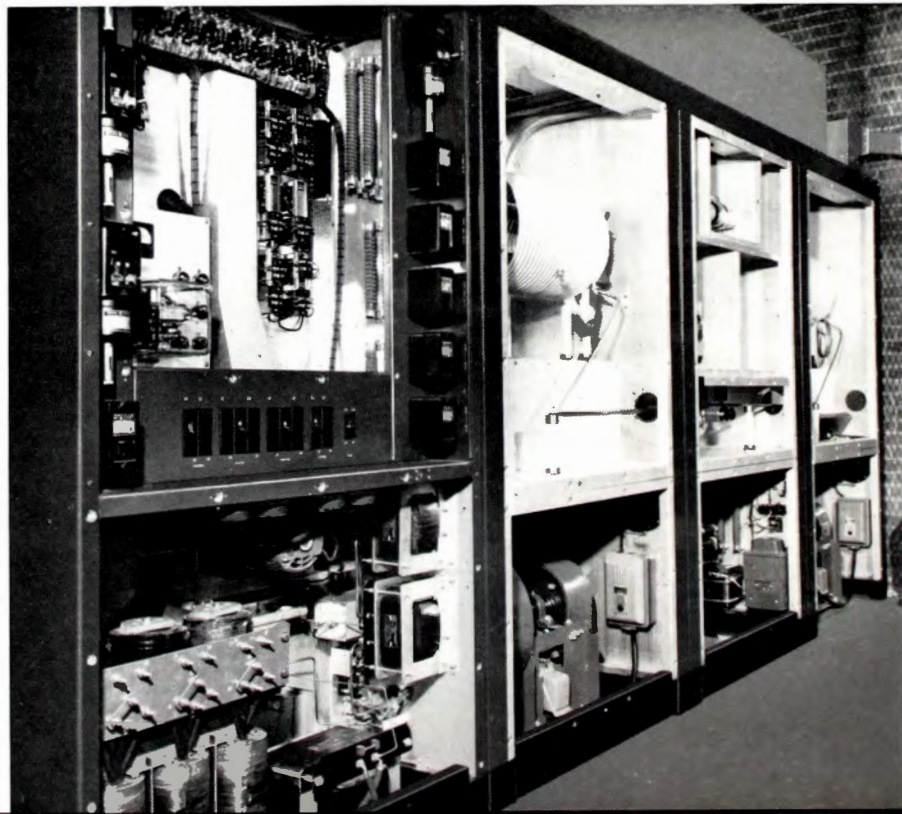

trol. Principal overload relays are equipped with indicating flags that indicate which overload relay has operated even after the overload has cleared. A reflectometer is installed in the output transmission line which offers automatic protection should greater than normal change in load occur.

Ideal For Remote Control

All BTA-50H metering and control facilities are terminated in convenient locations to permit straight forward wiring to remote control units. Auxiliary functions, such as remote control switching to a stand-by transmitter, dummy load, auxiliary power supply, etc., can be furnished.

Minimum Building Requirements

Outstanding among the features of the *Ampliphase* transmitter is the small floor space required (see floor plan, Fig. 6). Compactness without sacrificing accessibility is a space saving feature of the BTA-50H transmitter. In fact, the BTA-50H occupies no more space than older 5 and 10 kw transmitters.

Tuned and Tested On Frequency

Each BTA-50H Transmitter is assembled and tested on the customer's frequency prior to shipment. Most components are shipped installed in the transmitter cabinets resulting in reduced installation time. Complete measurement data including meter readings and dial settings obtained during factory test are supplied to the customer. This results in a simplified tune up procedure after installation.

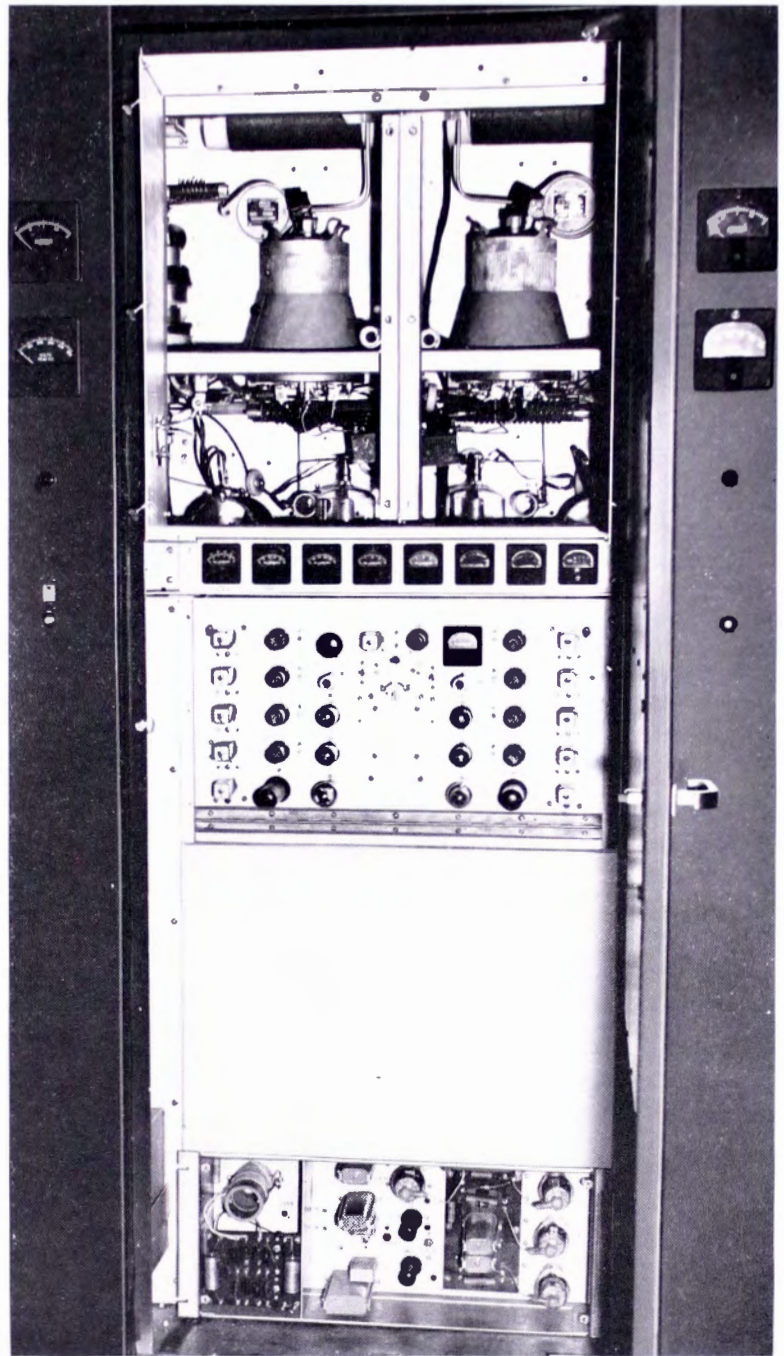
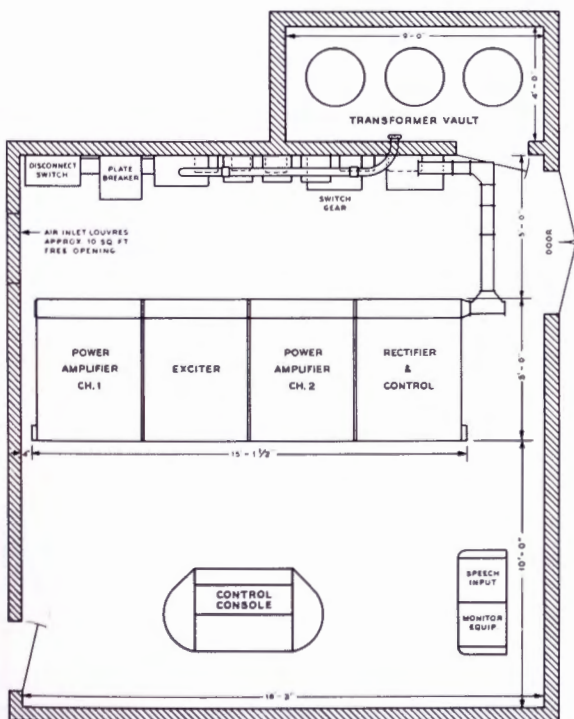

FIG. 7. The drive cabinet shown here contains (from top to bottom); the 4CX5000A driver stage, the 4-250A stages, the exciter modulators, and at the bottom the crystal oscillator.

FIG. 6. The typical floor plan shown here is ideal for operations with an operator on duty; however, if remote control is used the building requirements can be greatly reduced.

VHF TELEVISION TRANSLATORS

Provide High Quality TV Signals to Hard-To-Reach Communities

by R. S. JOSE

Broadcast Transmitter Engineering

Translator equipment offers an inexpensive method of extending television coverage into isolated, weak-signal areas. The new RCA Type TRV equipment, combined with high-gain yagi antennas, is excellent for this purpose, translating tv signals without noticeable effects on the signal. This stable, high-performance equipment presents excellent picture quality. Moreover, excellent linearity of the equipment makes it ideal for translating both color and monochrome signals.

Single and Double Conversion

RCA type-accepted translators are available to translate any VHF channel to any other VHF channel. Depending on the frequency relationship of the input and output channels, either single conversion or, double conversion (by way of an intermediate channel) is employed. The Type TRV-1A1 Single Conversion Translator is used for translating between low and high bands or vice versa. The TRV-1A2 Dual Conversion Translator is used for translations within the low band or high band regions.

The components of the Translator are illustrated in Fig. 1, and typical arrangements and interconnections are shown. Depending on the number of conversions, either one or two converter units are employed; otherwise, the systems are exactly the same basic elements.

Referring to the block diagram Fig. 1, the transistorized preamplifier and its power supply are shown in dashed blocks. These are accessory items for use at great distances from the translated station, or with very high towers and extremely long transmission lines. If used, the preamplifier normally is mounted at the antenna with the coax lead-in serving to supply the dc voltages to the unit as well as to transfer the amplified tv signal.

Identification Keyer

The requirement for International Morse identification of the translator (or series

of cascaded translators) is handled by the identification keyer. Completely transistorized, its amplitude modulates the incoming signal with a coded 12-kc signal during the identification period (normally every half hour). The percentage of modulation is held low to prevent disruption of the received picture signal. The high frequency used and normal limiting in the discriminator keeps the disturbance out of the received sound. The identification is accomplished within 20 seconds, and in this time, three sets of call letters can be sent.

The preamplifier following the identification keyer is tuned to the input channel. Because it incorporates a cascode input stage, the noise figure is kept low. The

stages following the cascode use the distributed amplifier principle and the design is such that aging or replacing tubes has a secondary effect on the amplitude response of the unit. Under normal circumstances the gain of the unit is under the control of agc, but a maximum of 35 db low channels, 45 db high channels is available.

Excellent Stability

The converter (or converters) which come next, are completely transistorized. Each includes an input channel filter and input transformer, a mixer, a crystal-controlled beating oscillator, and another filter and impedance matching transformer on the output channel. Each of these four components are mounted on individual etched circuit boards, and plug into a base board which distributes the power and signal appropriately. As in the case of the transistorized preamplifier the dc power and rf signal are carried on the coaxial cable.

The oscillator is extremely stable, since it uses an overtone crystal that always operates on the low side of the input channel to prevent inversion of the relative sound-picture frequencies. The degree of stability is evidenced by measurements on two converter units. In one, the nominal

FIG. 1. Single and double conversion translator systems are shown here (left to right, respectively). Each has provision for an identification keyer.

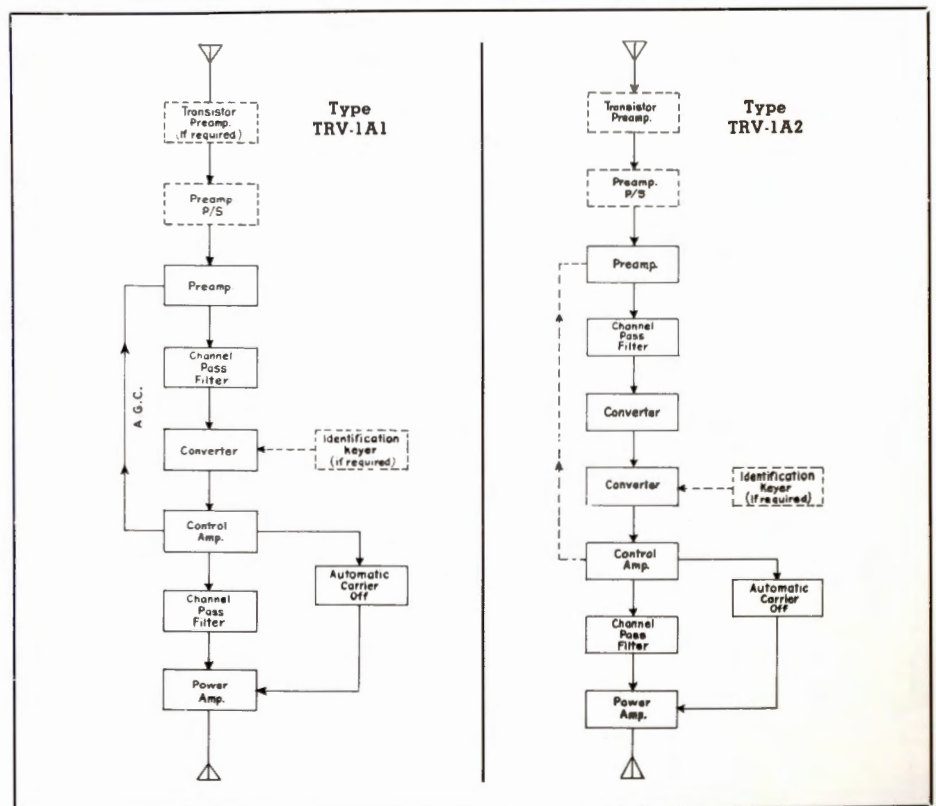

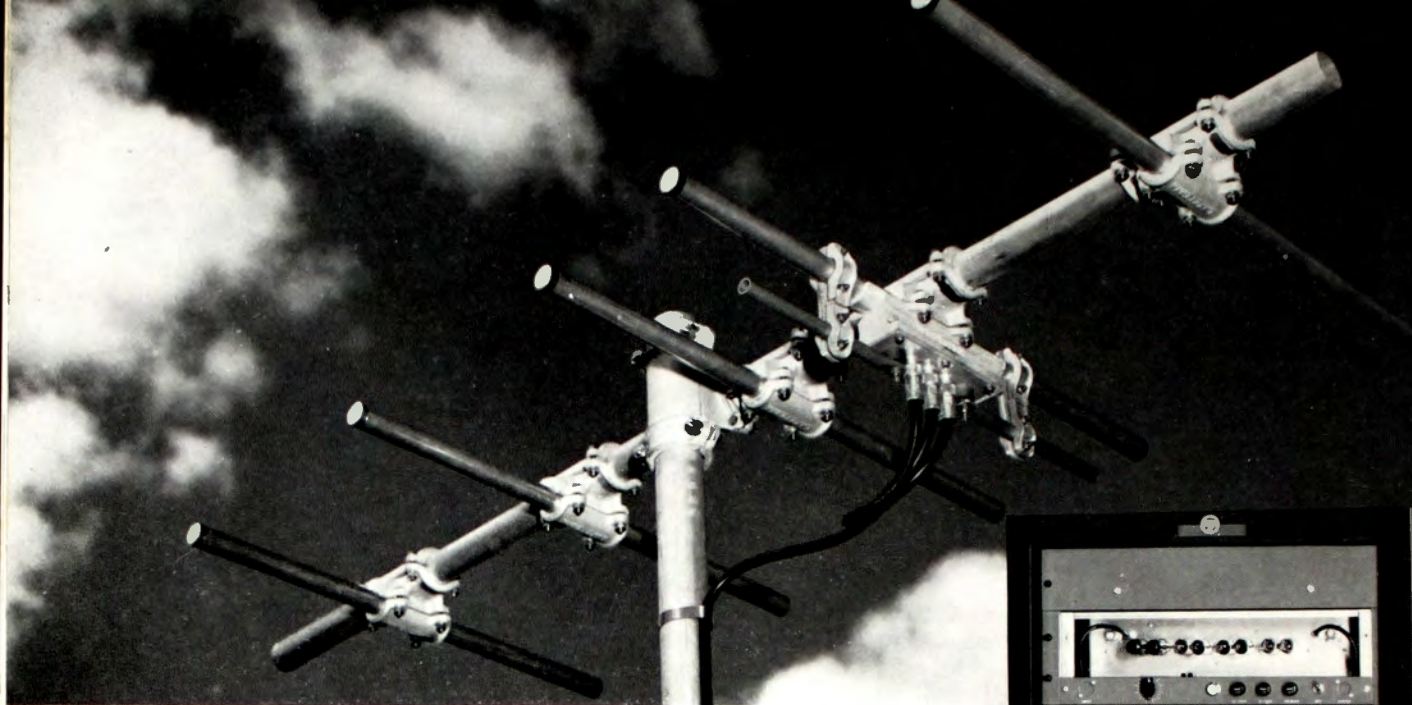

FIG. 3. High-gain yagi antennas assure uniform coverage of translated signals. A single bay unit is shown here. Higher gains are possible if several bays are stacked.

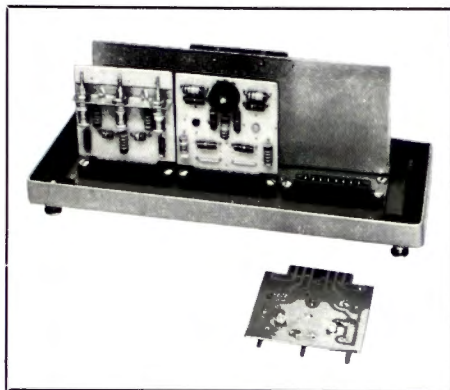

FIG. 4. This is one of the subchassis units of the translator equipment. The printed circuit boards are easily removed for servicing without disturbing wiring.

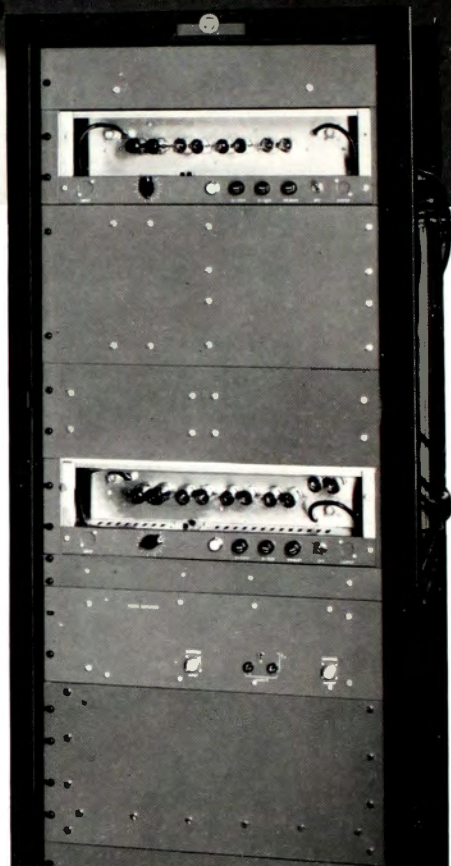

FIG. 5. The TRV-1A translator equipment occupies approximately half of a standard rack. It is designed for continuous unattended operation.

CONVERSION REQUIREMENTS BETWEEN ANY TWO CHANNELS

		RECEIVING CHANNEL												
		2	3	4	5	6	7	8	9	10	11	12	13	
TRANSMITTING CHANNEL	2		DC	DC	DC	DC	DC	DC	SC	SC	SC	SC	SC	
	3	DC		DC	DC	DC	SC	DC	DC	DC	DC	SC	SC	
	4	DC	DC		DC	DC	SC	SC	SC	SC	DC	DC	DC	
	5	DC	DC	DC		DC	SC	SC	SC	SC	SC	SC	SC	
	6	DC	DC	DC	DC		DC	SC	SC	SC	SC	SC	SC	
	7	DC	SC	SC	SC	DC		DC	DC	DC	DC	DC	DC	
	8	DC	DC	SC	SC	SC	DC		DC	DC	DC	DC	DC	
	9	SC	DC	SC	SC	SC	DC	DC		DC	DC	DC	DC	
	10	SC	DC	SC	SC	SC	DC	DC	DC		DC	DC	DC	
	11	SC	DC	DC	SC	SC	DC	DC	DC	DC		DC	DC	
	12	SC	SC	DC	SC	SC	DC	DC	DC	DC	DC		DC	
	13	SC	SC	DC	SC	SC	DC	DC	DC	DC	DC	DC		

SC—Single Conversion DC—Double Conversion

Unattended Operation

This VHF television translator equipment is designed to fill in weak spots in a station's normal coverage pattern. It can be used to upgrade low signal areas at the fringe range or rural areas where it is desired to produce higher quality, noise-free reception. This approach is simpler and less expensive than a community antenna system. The translator equipment is extremely reliable and operates completely unattended. It is installed in or near the area requiring additional signal strength.

THE RT 21-A TRANSISTOR TAPE RECORDER

... A New Professional
Audio Instrument
Perfect for Stereo and
Monophonic Operation

The new RT-21A professional tape recorder is a high quality recording and reproducing instrument. Designed specifically for stereo operation, this new recorder offers excellent frequency response with very low distortion and cross talk. Advanced mechanical design combined with all transistor circuitry makes the RT-21A perfect for highest fidelity operation.

The unit has stabilized electronic functions, high signal-to-noise ratio, good frequency response, low flutter and wow. Rapid tape threading and ready access to all components makes the RT-21A easy to operate and maintain. It utilizes dual-half-track or full-track, as well as the quarter-track heads, thus allowing stereo and monaural applications. Provisions have been made for an optional fourth head.

The basic tape recorder is supplied in two sections: the tape transport panel, and the amplifier module with control panel assembly. Both can be mounted in a standard 19-inch wide rack, console cabinet, or portable carrying case. A remote-control unit containing duplicate control-chassis functions is also available.

Easy Operation

The control panel features an interlocked record operation. Magnetic tape may be easily threaded in the RT-21A Tape Recorder without removing the head cover. Tape guiding and lifting is accomplished with small sapphire rods. Solenoids will lift the tape away from all magnetic heads whenever the machine is in the fast forward or fast-reverse mode of operation to minimize head wear.

Quiet operation of the tape lifters is achieved through the use of nylon and stainless steel for the two impact surfaces. Air damping is provided for slow release of the pinch roller from the capstan shaft to prevent excessive noise. The continuously variable cue speed permits the operator to listen to the audio during final curing. The tape is lifted off the erase and record heads during the cue mode.

Three safety features are included in the equipment: fail-safe braking system, tape



FIG. 1. This is the stereo version of the RT-21A Tape Recorder with two record/play amplifiers mounted side by side. The control unit is on the right. The tape transport unit (above the amplifier panel) is very functional. Straight line tape threading is accomplished without disturbing the head cover.

break switch and record interlock. The fail-safe brake will be engaged when a power failure occurs, thus avoiding tape breakage or spillage. Should the magnetic tape break, the tape-break switch will cause the brake solenoid to drop out, thereby stopping the reel motors. The record interlock system requires that the tape be stopped before the record function may be started.

Another relay interlock in the recorder prevents selection of a low-speed mode

after a high speed mode without first going through the stop mode. This prevents breakage or spillage which would result if the start mode could be selected after the fast forward, fast reverse, or cue mode.

The speed selector switch, in addition to changing the number of poles used in the capstan motor, also selects the proper equalization of the record and playback amplifiers. The result of the various interlocks is a practically foolproof operation of the tape recorder.

Tape Transport System

To accomplish low flutter and wow, the supply reel motor has almost constant torque in a direction opposite to that of the moving tape. This provides the required tension in the tape for proper contact pressure between the magnetic heads and the tape. Although the supply reel motor provides nearly constant torque, there are other factors contributing to the flutter and wow. In order to minimize these variations in tape speed, a tape-driven stabilizer is located directly under the supply reel motor. The high inertia of the flywheel, when combined with low friction of the preloaded, precision ball bearings, results in stabilization of tape speed variations. The associated supply tension arm minimizes tape slippage over the stabilizer head.

Although the tape transport is designed to handle both 7-inch and 10½-inch reels, using reels of the same size permits the most satisfactory brake operation. Low concentric hub and knob assemblies were designed for mounting either the 10½-inch or 7-inch reels to the supply and take-up reel motor shafts. With the hub-and-knob, collet-type assembly in place, the 10½-inch reel can be slipped on and off easily without removing any part of the assembly, while for use of the 7-inch reel, the hub is not required.

Capstan Motor

The capstan motor is designed to provide maintenance-free operation. This hysteresis-synchronous motor has permanently lubricated precision ball bearings of quality compatible with the low flutter requirements of the machine. The motor operates from 115 volts-ac, 60 cycles (the unit can also be supplied for 50-cycle operation) with a synchronous rotor torque of 12 oz-in minimum. The capstan shaft is made of stainless steel with a hard-chrome plate to provide a hard, smooth surface for tape handling. All motors are balanced under 0.004 oz-in through the speed range of 0 to 1000 rpm.

The capstan shaft drives the tape directly, using 24 poles at 3.75 ips and 12 poles at 7.5 ips. This provides optimum performance, particularly at 3.75 ips where flutter and wow are normally excessive with motors having fewer poles and speed-reduction mechanisms. As a result, the RT-21A will handle ¼-inch-wide tape on 7-inch or 10½-inch reels with flutter and wow of less than 0.25 per cent at 3.75 ips, 0.15 per cent at 7.5 ips, and 0.1 per cent at 15 ips.

Differential Brake System

The RT-21A braking system is designed to provide an inexpensive, maintenance-free brake. It applies greater braking torque to the supply reeling hub than to the take-up reeling hub. Simple construction results in fewer parts than other braking mechanisms of this type which provide differential braking action.

The brakes use compliance loops combined with conventional spring-biased band-type brakes. The bands are arranged in mirror-image fashion on the two brake hubs and are interconnected by a floating rigid-bar assembly.

When the brake bands are brought into contact with the brake hubs, the rotational energy of the brake hub, which supplies the tape, is transmitted from the brake band associated therewith through the rigid-bar assembly to the other brake band, which operates with the brake hub that takes up the tape. The band assemblies associated with the reeling brake hubs that supply and take up the tape expand and contract so that the bands and the interconnecting bar assembly are displaced. The brake band associated with the reeling

take-up brake hub is self-relieving, since in its displaced position less braking is applied; the brake band associated with the supply brake hub is self-energizing in its displaced position, since more braking is applied. Differential braking action is thus produced. As greater braking torque is applied to the reeling supply brake hub than to the reeling take-up brake hub, proper tension is maintained in the tape to prevent the throwing of tape loops.

When the tape is emptied from the supply reeling hub or when the supply reeling hub is stopped, forces are no longer supplied through the rigid bar assembly to the brake band associated with the take-up reeling hub. Accordingly, the supply hub brake is not displaced toward the take-up reeling hub and full braking torque is applied to the take-up reeling hub. The take-up reeling hub is then rapidly brought to a stop. This minimizes the whipping and tearing of the end portion of tape as it is reeled onto the reeling take-up hub.

All Transistor Circuitry

The electronic circuits are completely transistorized and mounted on printed circuit boards. Each record-reproduce unit

FIG. 2. The rear of the RT-21A provides easy access to the transport panel for routine maintenance. The amplifier and control chassis are easily removed.

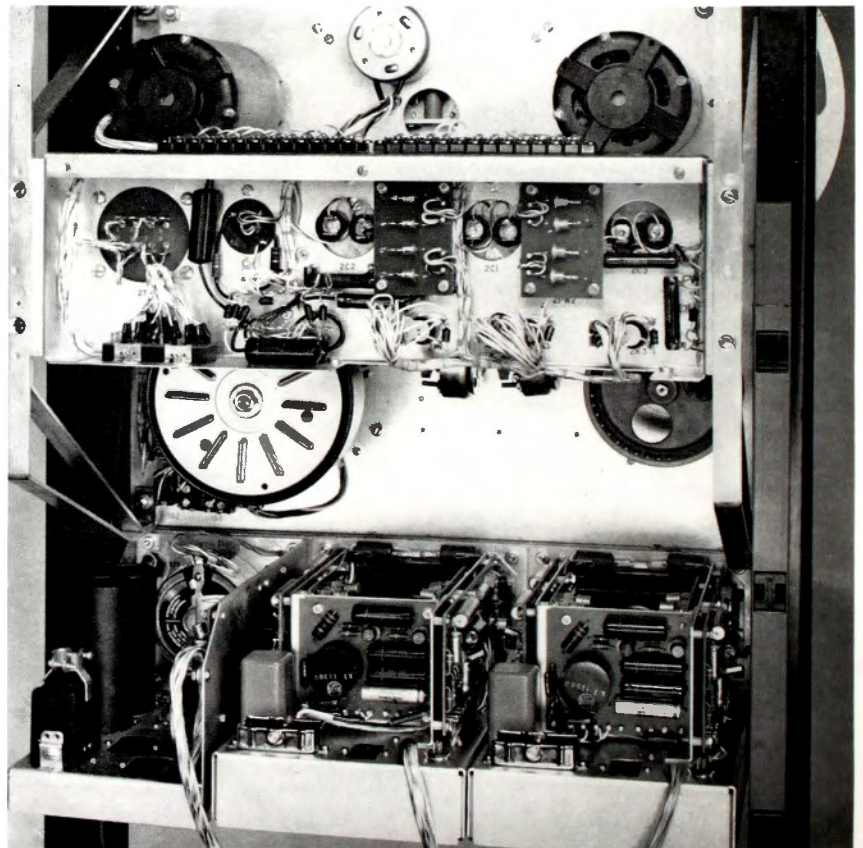



FIG. 3. Mounted in this rugged carrying case the RT-21A can be used for recording at remote locations or it can be easily moved within the station.

and each control unit is self-contained on a modular chassis. These are called the Amplifier and the Control module, respectively. The modules can be removed from the recorder with little effort.

Stable Power Supply

The control module contains the transport function (which will be discussed later) and a -30 -volt regulated dc supply that supplies power to the circuits in the amplifier module. The supply consists of a solid-state bridge rectifier, filter capacitors, and regulator. The ac power is obtained from the secondary of the main transformer in the relay chassis on the transport. The regulator uses four transistors and one voltage-reference Zener diode.

The operation is of the usual series-regulator type: The output voltage is compared to a voltage reference, and the error voltage is amplified by dc amplifiers. This in turn causes an increase or decrease in the voltage drop across the series regulator in a direction to oppose a voltage change across the output terminals.

Recording Circuits

The record channel consists of three printed-circuit boards, a gain control, two transformers, an equalization network, and a metering circuit. One transformer is used for matching either a 150- or 600-ohm line to the input preamplifier.

The first and second printed circuit boards are identical amplifiers and are connected via a gain control on the front panel. The preamplifiers use a low noise n-p-n

transistor in the first stage and a p-n-p transistor in the second stage in a direct-coupled, second-collector-to-first-emitter, negative-feedback pair. This feedback, together with local emitter negative feedback, provides for good temperature and gain stability, along with good transistor interchangeability.

The third printed circuit board is a unity-gain, parallel-connected series amplifier using four transistors; it is connected to an output line-matching transformer. The record amplifier will deliver 100 milliwatts into 600 ohms. The output transformer also drives a parallel RC equalization network, bias trap, and the record head. The RC equalization network provides for a constant record current plus the necessary peaking that compensates for the high-frequency losses in the recording process. Proper tape equalization is automatically selected by the speed change switch.

An 80-kc bias and erase oscillator is also included in the amplifier module. One output of the oscillator is fed through a capacitor which resonates with the inductance of the erase head to provide for maximum erase current. The other output is fed through a large series resistor directly into the record head where it is added to the audio signal being recorded. The oscillator and record amplifier are isolated from each other by an 80-kc parallel-tuned LC bias trap between the output of the record amplifier and the output of the bias oscillator.

Playback Circuits

The playback channel consists of the playback head, three printed-circuit boards, a gain control, a transformer, and a metering circuit. The head is connected between the bias network and the base of the low-noise n-p-n input stage of an equalized preamplifier. The dc current through the head is less than 15 microamperes and does not result in magnetization of the head or erasure of a recorded tape. Other than this difference in the input connection, the design of the preamplifier is of the same design as the two preamplifiers in the record channel.

This type of input connection eliminates loading of the head by the relatively low-resistance base bias network. The input stage itself does not appreciably load the head, even at the high frequency end of the spectrum because of the dual voltage feedback which results in a high input im-

pedance. The feedback network also contains the equalization necessary to reproduce a standard NAB recorded tape.

The second printed-circuit board is a three-stage feedback-voltage amplifier. The first and second amplifier boards are connected via a gain control on the front panel. The three-stage amplifier is of the capacitance-coupled type, with each stage having its own bias network. Local feedback is used in each stage combined with a feedback network from the third to first emitter. This type of feedback and biasing provides for good temperature and gain stability along with good transistor interchangeability. The third board is identical to the third board of the record channel, as is the output transformer; therefore, the playback channel will also deliver 100 milliwatts into 600 ohms.

The output of the record and playback channels can be monitored with the VU meter on the front panel. Provisions have also been made so that the bias and erase current can be monitored with the same VU meter.

Magnetic Heads

The record half and full track heads have a 500-microinch gap. The two playback heads have a 100-microinch gap. Also available is a playback head with a 200-microinch gap for $7\frac{1}{2}$ and 15 ips.

The distance between the centers of all the head gaps and the head plate on which the heads and tape lifter assemblies are mounted is a controlled, fixed dimension. Inasmuch as the tape path is determined by the two take-up tension arms, the head-plate is adjusted to provide alignment of tape over head gaps by three knurled nuts located behind the head-plate. After this adjustment is made it should never have to be changed; the only adjustment thereafter to the heads is azimuth. This is accomplished by two screws, one on each side of the head mounting block. These screws provide a fine rotating mechanical adjustment to the heads to obtain maximum efficiency.

Ideal For Stereo

The RT-21A is a high quality recording instrument designed specifically for broadcast use. Many of its advanced performance features have been borrowed from the RCA family of television tape recorders. Now that stereo broadcasting is feasible, the RT-21A is an excellent low-cost method of originating stereo programs.

COMPLETE LINE OF RCA EQUIPMENT FOR FM STEREO SYSTEMS

Stereo Control Console—The new BC-7 Dual Channel Console provides complete stereo or monophonic mixing, switching, monitoring, and cue/talkback. All transistor design of the BC-7 features plug-in amplifiers for ease of service. When used for stereo operation the master and monitor gain controls are ganged together for ease of operation. Smooth action, dual mixer controls are used in all stereo mixing positions. The BC-7 offers five stereo mixing positions or 10 mono positions.

Full fidelity performance (± 1.5 db 30-15,000 cps) assure highest quality stereo broadcasting. The BC-7 is ideal for every station requiring a dual channel console for mono or stereophonic use.

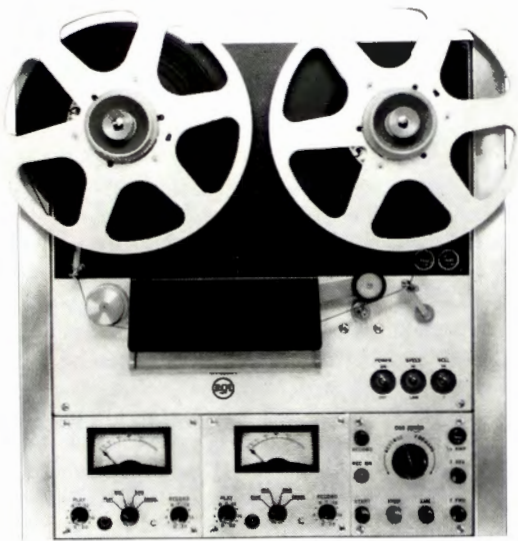
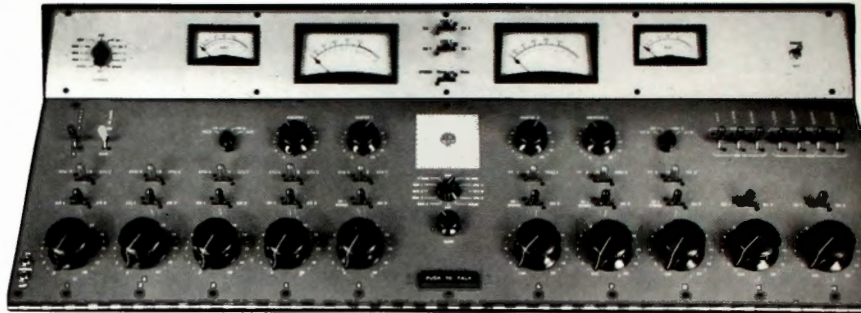

New Stereo Tape—All transistor design makes the new RT-21 Tape Recorder ideal for stereo, and its two module amplifiers assure highest fidelity recording and reproduction. Dual half track heads are used for stereo operation; however, quarter track or full track heads are also available. Easy speed change, interlocked record operation, easy threading, and variable cue speed are only a few of the advanced performance features of the RT-21. Constant torque motors are used to assure uniform speed, and mechanical braking operates immediately in the event of power loss to prevent tape damage. Sapphire tape lifters and guides reduce wear and permit smooth tape movement.

High fidelity performance combined with operator oriented controls makes the RT-21 a most flexible stereophonic broadcast tape recorder.



Standard turntables, such as the 16-inch BQ-2 or the 12-inch BQ-51, are excellent for stereo operation when used with the new RCA stereo pickup cartridge and lightweight tone arm. Dual BA-26 transistor turntable preamplifiers provide amplification and equalization of the stereo signals to feed the stereo control console.

Finest Stereo Package
Includes Everything from
Microphones to Antennas

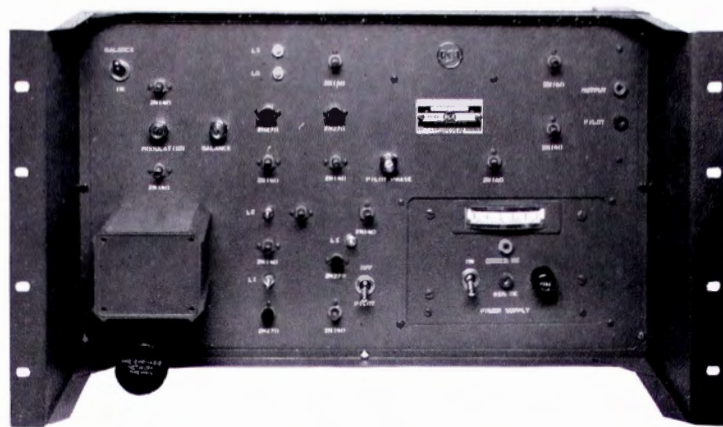

Stereo Generator—The heart of the new stereo system is the double sideband generator, type BTS-1A. This unit produces the double sideband suppressed carrier AM signal used to transmit one of the stereo channels. The BTS-1A is a compact, economical approach to FM stereo; the BTS-1A offers full fidelity frequency response over the entire audio range and complies with the FCC rules on stereophonic transmission.



FM Transmitters—All RCA FM transmitters are designed to accommodate the new stereo signals and an SCA multiplex subchannel. Power ranges of 1, 5, 10, 20, 25, and 50 kw are available. Each of the new FM transmitters has been carefully designed for highest fidelity operation with the proven reliability of RCA transmitters.



Effective June 1, 1961, all FM stations may employ stereophonic transmission provided they give 10 days' notice (to the Commission and District Engineer), install type-accepted equipment and conform to the technical standards set forth in the new FCC ruling (see Appendix on Pg. 52).

In the approved system the main FM carrier is modulated by a combination of the left and right ($L + R$) stereo channels. A subcarrier at 38 kc is suppressed and amplitude modulated by the difference signal between left and right channels ($L - R$). The stereo information is carried on the left-minus-right channel. If the left-plus-right and the left-minus-right signals are added at the receiver, a left channel signal is provided. If the left-plus-right and the left-minus-right are subtracted, the right channel is obtained.

By modulating the main channel with the $L + R$ signal, a listener not equipped for stereo reception will receive a full monophonic program. Those equipped with stereo adapters will, of course, receive the full stereo effect. Another feature of this stereo system is that it permits use of one SCA multiplex subchannel in addition to the stereo subchannel.

Basically, this system is quite simple and most FM broadcasters will have no difficulty making the necessary modifications and additions to their equipment layout. It is best to begin by getting a thorough understanding of how the system works, the reasons for the specified standards and the requirements for meeting them. The following material has been prepared to help FM operators get started.

How Stereo Is Transmitted

In stereophonic transmission two microphones are placed in front of the program source. These two microphones may be spaced from 10 to 50 feet apart depending on the size of the orchestra. The one seen by the audience on the left is designated the left-channel microphone, and the one on the right side is the right-channel microphone. Left and right channels as shown in Fig. 1 are fed into a matrixing network.

The matrixing network has two outputs. One output is the left-plus-right where both channels are added in phase. The other output is the left-minus-right where the polarity of the right channel is reversed and then left and right channels are added together to produce a difference signal. The left-plus-right channel, after a time delay, is fed into the main channel input of the FM exciter (see Fig. 2). The left-minus-right channel is first fed into a stereo sub-

HOW THE APPROVED FM STEREO SYSTEM WORKS

carrier generator such as the RCA BTS-1 (see Fig. 3). A separate left-plus-right bridging output is provided to feed the AM transmitter with a monophonic signal to permit duplicate programming.

The RCA BTS-1 Stereo Subcarrier Generator has two outputs: First, a double-sideband-suppressed-carrier signal centered on the carrier frequency of 38 kc; second, a carrier-pilot signal output at 19 kc,

standard RCA Subcarrier Generator adjusted to provide a 67 kc subcarrier. This subcarrier, modulated by the multiplex signal, is fed to the second subchannel input of the BTE-10B Exciter.

The total modulating spectrum of the exciter is shown in Fig. 4. The modulating waveform consists of left-plus-right information shown under (A). The 19 kc pilot carrier is shown under (B) and the double sideband information carrying the left-minus-right channel is shown under (C). A possible frequency-modulated SCA channel is shown under (D).

One should remember that these four signals are only added, they are not mixed in the sense that is normally used with an r-f mixer. It is an additive process which could be accomplished by feeding the four signals into a common resistor. This waveform will then modulate the main carrier.

One may ask why a double-sideband-suppressed-carrier system was chosen to carry the left-minus-right information. The great advantage of the double-sideband signal is the fact that with no left-minus-right information there is no signal to modulate the exciter, and for this reason the left-

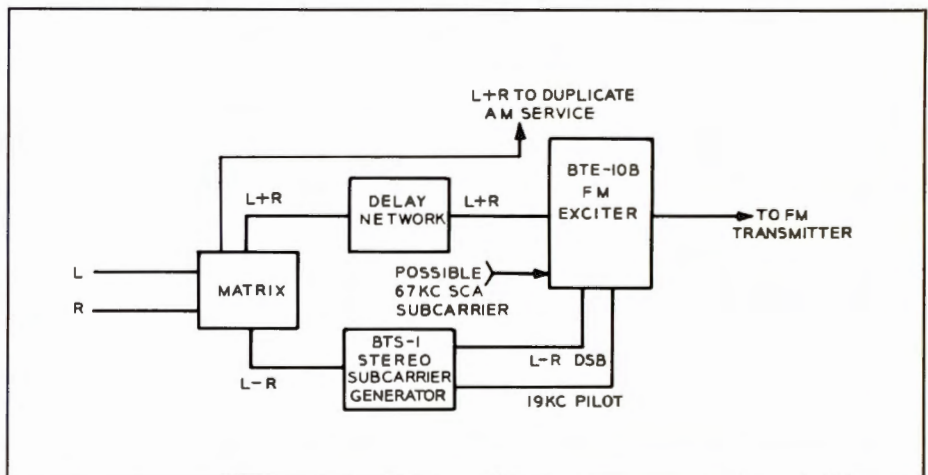

FIG. 1. Block diagram shows essential elements of new FM stereo system.

exactly half the carrier frequency. The double-sideband-suppressed-carrier signal is fed directly into the main channel of the BTE-10B FM exciter. The 19 kc pilot signal is fed into one of the two subchannel inputs provided in the BTE-10B exciter. The double-sideband signal and the 19 kc carrier-pilot signal then frequency modulate the main FM channel along with the normal $L + R$ main channel modulation.

If it is desired to transmit an SCA multiplex channel in addition to stereo, the audio input for this channel is fed to a

plus-right can modulate the exciter up to 90 per cent. Therefore, the loss of signal-to-noise in the main channel is only 1 db. If a regular amplitude-modulated or frequency-modulated signal had been used, the unmodulated carrier would occupy space even if there were no left-minus-right information. This would have required greater sacrifice in main channel signal-to-noise. Another advantage claimed for this system is that the type of adapter required for reception of the stereophonic information will not permit reception of an

SCA channel by the general public. Thus the likelihood of pirating SCA background music is reduced.

How Stereo Is Received

The composite signal previously described goes through the transmitter and antenna to the listener's receiver. At the output of the discriminator in a conventional FM tuner three signals will be present: First, the left-plus-right information, occupying a frequency space of from 30 to 15,000 cycles; second, the left-minus-right information occupying a space from 23 to 53 kc; and third, a pilot tone at 19 kc. If the station is engaged in SCA service, there will be an additional signal occupying the space from approximately 59 to 75 kc (see Fig. 4).

The signals from the FM tuner are processed in the following fashion: The left-plus-right channel, which is recovered directly in the receiver discriminator, is fed through a de-emphasis network to the matrix. The de-emphasis network will sufficiently attenuate the 19 kc pilot carrier and the double-sideband information and the possible SCA subcarrier to not overdrive any of the following amplifier stages.

The left-minus-right double-sideband information is extracted by a bandpass filter (23-53 kc) (see Fig. 5). The 19 kc pilot tone is extracted by another filter. After sufficient amplification this pilot signal is doubled in frequency and added to the double-sideband information. The adding process has to be such that the amplitude of the derived 38 kc carrier is several times the maximum possible amplitude of the two sidebands. This signal is fed into an envelope detector.

The output from the detector is the left-minus-right signal. This signal is de-emphasized and in turn both left-plus-right and left-minus-right are fed into a matrix, which is the reverse of the matrix at the transmitter. In the receiver matrix the left-plus-right and the left-minus-right signals are added to provide a left-channel signal. At the same time the left-minus-right signal is subtracted from the left-plus-right signal to obtain the right signal. Thus the output of the matrix provides independent left- and right-channel information for dual audio amplifiers and speakers.

A possible receiver matrix is shown in Fig. 6. There are two adders consisting of tubes V1 and V2. The left-plus-right channel is fed into both adders in the same phase and amplitude. The left-minus-right channel, however, is fed with 0 degrees

phase to one and 180-degree phase to the other mixer. One tube adds the two signals while the other subtracts, and thus 2R and 2L are recovered, viz.:

$$\begin{array}{r} \text{Add} \\ L + R \\ L - R \\ \hline 2L \end{array} \qquad \begin{array}{r} \text{Subtract} \\ L + R \\ -(L - R) \\ \hline 2R \end{array}$$

Why Matrixing

The discussion above indicates the means by which the separate left and right stereo signals are recovered from the receiver matrix. At this point one may well ask why all this bother with matrixing. The main reason is compatibility (i.e., making the system such that the listener not interested or equipped for stereo still gets a usable signal). This would not be the case if only left or right information were carried on the main channel. Due to the placement of the microphone a substantial amount of information would (in some cases) be lost to a listener receiving only the left, or only the right, channel. Matrixing, however, provides this listener with a left-plus-right information which contains all the essential components that are transmitted.

How Matrixing Works

Figure 7 shows the output of the transmitter matrix for different types of input.

In Fig. 7A with a sine wave input into the left channel, there is no input into the right channel. The output is a sine wave half the input magnitude from the left-plus-right and the left-minus-right channels, all three signals in phase.

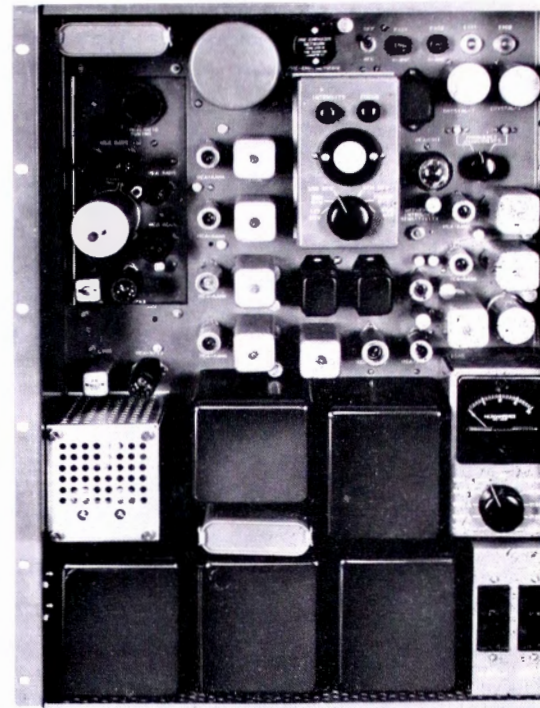

FIG. 2. RCA Type BTE-10B FM Exciter.

If a sine wave is fed into the right channel only, the output again is a sine wave of one-half the input magnitude from the left-plus-right channel in phase with the primary signal and a sine wave of one-half magnitude from the left-minus-right channel but with opposite phase (polarity) relative to the input signal (see Fig 7B).

If both left and right are fed with a sine wave in phase, there will only be an output from the left-plus-right channel with two times the magnitude of the input signal. There will be no output at the left-minus-right channel (see Fig. 7C).

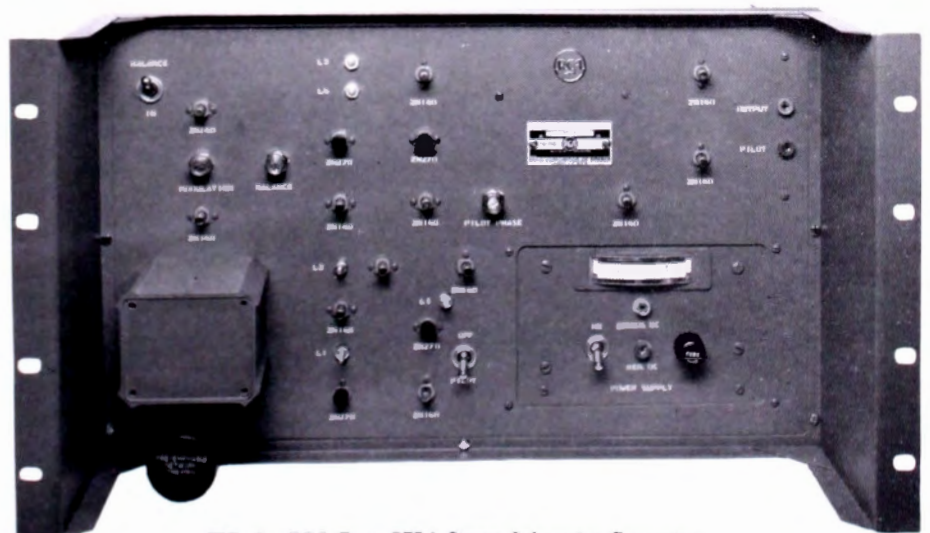

FIG. 3. RCA Type BTS-1 Stereo Subcarrier Generator.

Finally, Fig. 7D shows an input into the left and right with the same frequency, same amplitude but opposite polarity. This provides an output signal from the left-minus-right channel, which is in phase with the left channel. There will be no output from the left-plus-right channel.

The conditions shown under Figs. 7A and 7B are not possible under a practical operating condition. They can, however, be obtained by using an audio generator feeding left or right. However, conditions in Figs. 7C and 7D are possible. Conditions

ways (assuming the distance between the microphones and the instrument is large relative to the distance between the two microphones), the voltages out of both microphones can be of essentially the same magnitude and opposite phase. This corresponds to the condition shown in Fig. 7D.

Modulation Considerations

It will be helpful in understanding the stereo system to consider how the several types of signals shown in Fig. 7 will modulate the transmitter.

of a sine wave only (a condition shown in Fig. 7A), the output of the BTS-1 stereo subcarrier generator will consist of two sidebands of a certain magnitude being spaced from the 38 kc carrier by the modulating frequency. The amplitude of the two sidebands will vary in direct proportion to the magnitude of the left-minus-right signal. If there is no left-minus-right signal, there are no sidebands. The 38 kc carrier has to be suppressed sufficiently to not modulate the main carrier more than 1 per cent.

This means that if there is no left-minus-right modulation, there is no output from the BTS-1 subcarrier generator. Under the conditions shown in Fig. 7A, therefore, there will be an equal modulation percentage caused by the left-plus-right channel and by the left-minus-right channel. The left-plus-right and left-minus-right DSB signals will each modulate the main carrier 45 per cent, so that the sum of the two signals will modulate the main carrier 90 per cent. The 10 per cent remaining is reserved for the 19 kc pilot carrier.

Condition 7B will cause the same modulation percentages as 7A. Left-minus-right polarity is reversed. In 7C the left-plus-right channel will modulate the main carrier 90 per cent. Since there is no output from the left-minus-right, there is no modulation due to the double sideband signal. The only signals present under this condition are a 10 per cent 19 kc pilot carrier and 90 per cent left-plus-right channel signal.

Under the conditions shown in Fig. 7D no modulation is present due to the left-plus-right signal but the left-minus-right signal will now have two sidebands of sufficient magnitude to modulate the main carrier 90 per cent. There will also be 10 per cent modulation by the pilot carrier.

The peak deviation of the main carrier by the left-plus-right and by the left-minus-right is 90 per cent. However, the 90 per cent peak deviation is never caused by left-plus-right or left-minus-right at the same time. The sum of the two will always be not more than 90 per cent.

Requirements for Stereo-Plus-SCA

If it is desired to use an SCA channel in addition to stereophonic transmission, all modulation percentages must be decreased by 10 per cent. This means the maximum left-plus-right or left-minus-right modulation may be 81 per cent. The pilot

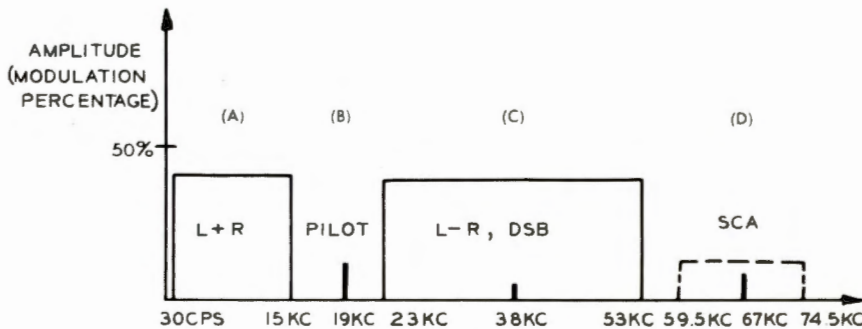

FIG. 4. Total modulating spectrum covered by exciter.

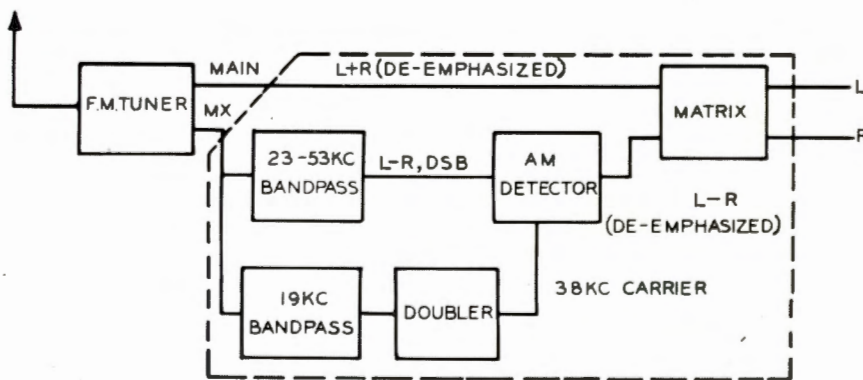

FIG. 5. Block diagram showing how FM stereo is received.

shown in Fig. 7C would arise where a musical instrument is placed at an equal distance from both microphones. Being an equal distance away from the left and the right microphones, the sound emanating from the instrument would arrive at the two microphones in phase with equal magnitude. This will only cause an output from the left-plus-right channel. There will be no output from the left-minus-right channel. If the instrument is placed side-

As previously noted, the output of the matrix is a left-plus-right signal (which is slightly delayed) and a left-minus-right signal. The left-plus-right signal is fed directly into the audio input of the exciter. The left-minus-right signal is fed to the stereo subcarrier generator. In the stereo subcarrier generator a double-sideband-suppressed-carrier AM signal will be produced.

If the left-minus-right channel consists

carrier is 9 per cent and the SCA subchannel is 10 per cent.

An additional requirement is imposed upon the SCA subchannel. Previously any SCA component appearing in a frequency band from 30 to 15,000 cycles had to be attenuated at least 60 db. Now, when a station is engaged in stereophonic broadcasting, components from the SCA subchannel should not exceed a limit of -60 db, over a frequency range from 30 cycles to 53 kc. This will require additional filtering in the SCA subcarrier generator output.

The permissible SCA channel will be at a center frequency of 67 kc. The maximum deviation possible is ± 7.5 kc with a maximum modulating frequency of approximately 8 kc. Higher modulating frequencies will be cut off by the high pass filter (required to keep the components to a level of -60 db, from 50 to 53,000 cycles to comply with FCC rules) in the output of the SCA subcarrier generator.

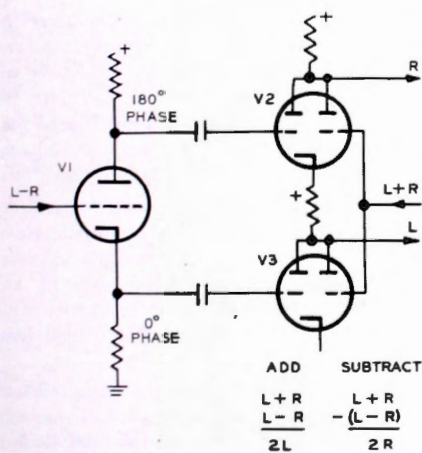

FIG. 6. Typical receiver matrix for FM stereo.

Discussion of FCC Regulations

The FCC's ruling on stereo transmission is reproduced in the Appendix on Pg. 52. The statements under paragraph 1 and 2 are self-explanatory. Paragraph 3 sets forth the requirements for stereo-plus-SCA. These have been discussed above.

Paragraph 4(c) may need some explanation. If the requirement under 4(c) should not be met, in other words, if the second harmonic should cross the time axis with a negative slope, the left-minus-right in-

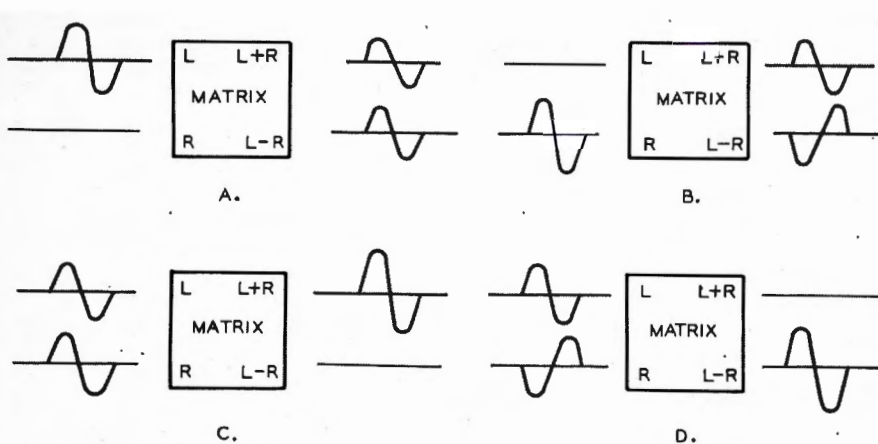

FIG. 7. Output of the transmitter matrix for different types of input.

formation would be reversed in polarity. This would essentially mean that the left and right channel information would be reversed. The left information would be coming out of the right side speaker and vice versa. The same reasoning applies to the requirement under 4(k)—namely, that the relationship of the left-plus-right relative to the left-minus-right must be maintained. If the deviation would be upward in some transmitters and downward in others, it would mean that with the same receiver sometimes the left and right channels would be reversed.

These requirements show that one has to be careful to maintain the proper polarities in the left and the right and the left-plus-right and the left-minus-right channels as well as in the interconnection between the stereo subcarrier generator and the exciter. For this reason polarized plugs should be used everywhere in the system.

Paragraphs 4 (l) and 4(m) spell out the technical requirements for channel separation.

When the left-plus-right channel and the left-minus-right channels are added in the receiver matrix, complete separation of the left and the right channels will be obtained only if the left-plus-right and the left-minus-right channels have the same frequency response and all frequencies contained in both these channels arrive at the receiver matrix at the same time (with proper phase). If there are departures from the equal frequency response curve or from the equal phase curves, it will not be possible to completely compensate left-plus-right and left-minus-right. Channel separation will suffer.

The new rules specify that the frequency response of the left-plus-right and the left-

minus-right channels shall be within ± 3.5 per cent (± 0.35 db) relative to unity. If there is a steady state signal into the left channel only, there will be a signal of the same frequency one-half the amplitude in the left-plus-right and left-minus-right channels. When these two components arrive at the receiving matrix, the phase difference between the left-plus-right and the left-minus-right should not exceed ± 3 degrees for any frequency between 50 and 15,000 cycles. This requirement necessitates a delay network that is adjustable within certain limits. One should remember that these requirements for frequency response and time delay in the left-plus-right and the left-minus-right channels are to insure proper separation between the left and the right channels.

The "note" following 4(m) indicates a method of checking channel separation. It says, in effect, that if there is a certain signal in the left channel only, the signal recovered at the receiver in the right channel should be attenuated by at least 29.7 db over a frequency range of from 30 to 15,000 cycles. If this separation is obtained, no further measurements are required. Otherwise, it must first be determined whether the lack of separation is due to insufficient frequency response or excessive time difference.

Paragraphs 4(n) and 4(o) indicate an additional requirement as far as the transmitter is concerned: Crosstalk from the left-plus-right into the left-minus-right. This figure should be better than the requirement for the separation. The requirement for crosstalk from the left-plus-right into the left-minus-right or vice versa is 40 db relative to 90 per cent modulation of the other channel.

APPENDIX
FCC Ruling on FM Stereo Broadcasting
(Pertaining to Part 3 of FCC Regulations—
Radio Broadcast Services)

1. New Section 3.297 is added to read as follows:
3.297 Stereophonic Broadcasting.

FM broadcast stations may, without further authority, transmit stereophonic programs in accordance with the technical standards set forth in 3.322: *Provided, however,* That the Commission and the Engineer in Charge of the radio district in which the station is located shall be notified within 10 days from the installation of type-accepted stereophonic transmission equipment or any change therein, and: *Provided further,* that the Commission and the Engineer in Charge shall be notified within 10 days from the commencement of stereophonic operation, scheduled hours of such operation or any change therein.

2. Section 3.310 is amended by adding the following paragraphs:

3.310 Definitions.

(t) *Cross-talk.* An undesired signal occurring in one channel caused by an electrical signal in another channel.

(u) *FM stereophonic broadcast.* The transmission of a stereophonic program by a single FM broadcast station utilizing the main channel and a stereophonic subchannel.

(v) *Left (or right) signal.* The electrical output of a microphone or combination of microphones placed so as to convey the intensity, time and location of sounds originating predominately to the listener's left (or right) of the center of the performing area.

(w) *Left (or right) stereophonic channel.* The left (or right) signal as electrically reproduced in reception of FM stereophonic broadcasts.

(x) *Main channel.* The band of frequencies from 50 to 15,000 cycles which frequency modulate the main carrier.

(y) *Pilot subcarrier.* A subcarrier serving as a control signal for use in the reception of FM stereophonic broadcasts.

(z) *Stereophonic separation.* The ratio of the electrical signal caused in the right (or left) stereophonic channel to the electrical signal caused in the left (or right) stereophonic channel by the transmission of only a right (or left) signal.

(aa) *Stereophonic subcarrier.* A subcarrier having a frequency which is the second harmonic of the pilot subcarrier frequency and which is employed in FM stereophonic broadcasting.

(bb) *Stereophonic subchannel.* The band of frequencies from 23 to 53 kilocycles containing the stereophonic subcarrier and its associated sidebands.

3. Section 3.319 is amended to read as follows:

3.319 Subsidiary Communications Multiplex Operations: Engineering Standards.

(a) Frequency modulation of SCA subcarriers shall be used.

(b) The instantaneous frequency of SCA subcarriers shall at all times be within the range of 20 to 75 kilocycles: *Provided, however,* That when the station is engaged in stereophonic broadcasting pursuant to 3.297, the instantaneous frequency of SCA subcarriers shall at all times be within the range 53 to 75 kilocycles.

(c) The arithmetic sum of the modulation of the main carrier by SCA subcarriers shall not exceed 30 per cent: *Provided, however,* That when the station is engaged in stereophonic broadcasting pursuant to 3.297, the arithmetic sum of the modulation of the main carrier by the SCA subcarriers shall not exceed 10 per cent.

NOTE: Inasmuch as presently approved FM modulation monitors have been designed to meet requirements for modulation frequencies of from 50 to 15,000 cycles, the use of such monitors for reading the modulation percentages during SCA multiplex operation may not be appropriate since the subcarriers utilized are above 20,000 cycles.

(d) The total modulation of the main carrier, including SCA subcarriers, shall meet the requirements of 3.268.

(e) Frequency modulation of the main carrier caused by the SCA subcarrier operation shall, in the frequency range 50 to 15,000 cycles, be at least 60 db below 100 per cent modulation: *Provided, however,* That when the station is engaged in stereophonic broadcasting pursuant to 3.297, frequency modulation of the main carrier by the SCA subcarrier operation shall, in the frequency range 50 to 53,000 cycles, be at least 60 db below 100 percent modulation.

4. New Section 3.322 is added to read as follows:
3.322 Stereophonic Transmission Standards.

(a) The modulating signal for the main channel shall consist of the sum of the left and right signals.

(b) A pilot subcarrier at 19,000 cycle-plus or minus 2 cycles shall be transmitted that shall frequency modulate the main carrier between the limits of 8 and 10 per cent.

(c) The stereophonic subcarrier shall be the second harmonic of the pilot subcarrier and shall cross the time axis with a positive slope simultaneously with each crossing of the time axis by the pilot subcarrier.

(d) Amplitude modulation of the stereophonic subcarrier shall be used.

(e) The stereophonic subcarrier shall be suppressed to a level less than one per cent modulation of the main carrier.

(f) The stereophonic subcarrier shall be capable of accepting audio frequencies from 50 to 15,000 cycles.

(g) The modulating signal for the stereophonic subcarrier shall be equal to the difference of the left and right signals.

(h) The pre-emphasis characteristics of the stereophonic subchannel shall be identical with those of the main channel with respect to phase and amplitude at all frequencies.

(i) The sum of the side bands resulting from amplitude modulation of the stereophonic subcarrier shall not cause a peak deviation of the main carrier in excess of 45 per cent of total modulation (excluding SCA subcarriers) when only a left (or right) signal exists; simultaneously in the main channel, the deviation when only a left (or right) signal exists shall not exceed 45 per cent of total modulation (excluding SCA subcarriers).

(j) Total modulation of the main carrier including pilot subcarrier and SCA subcarriers shall meet the requirements of Section 3.268 with maximum modulation of the main carrier by all SCA subcarriers limited to 10 per cent.

(k) At the instant when only a positive left signal is applied, the main channel modulation shall cause an upward deviation of the main carrier frequency; and the stereophonic subcarrier and its sidebands signal shall cross the time axis simultaneously and in the same direction.

(l) The ratio of peak main channel deviation to peak stereophonic subchannel deviation when only a steady state left (or right) signal exists shall be within plus or minus 3.5 per cent of unity for all levels of this signal and all frequencies from 50 to 15,000 cycles.

(m) The phase difference between the zero points of the main channel signal and the stereophonic subcarrier sidebands envelope, when only a steady state left (or right) signal exists, shall not exceed plus or minus 3 degrees for audio modulating frequencies from 50 to 15,000 cycles.

NOTE: If the stereophonic separation between left and right stereophonic channels is better than 29.7 decibels at audio modulating frequencies between 50 and 15,000 cycles, it will be assumed that paragraphs (l) and (m) of this section have been complied with.

(n) Cross-talk into the main channel caused by a signal in the stereophonic subchannel shall be attenuated at least 40 decibels below 90 per cent modulation.

(o) Cross-talk into the stereophonic subchannel caused by a signal in the main channel shall be attenuated at least 40 decibels below 90 per cent modulation.

(p) For required transmitter performance, all of the requirements of Section 3.254 shall apply with the exception that the maximum modulation to be employed is 90 per cent (excluding pilot subcarrier) rather than 100 per cent.

(q) For electrical performance standards of the transmitter and associated equipment, the requirements of Section 3.317 (a) (2), (3), (4) and (5) shall apply to the main channel and stereophonic subchannel alike, except that where 100 per cent modulation is referred to, this figure shall include the pilot subcarrier.

Filed April 24, 1961

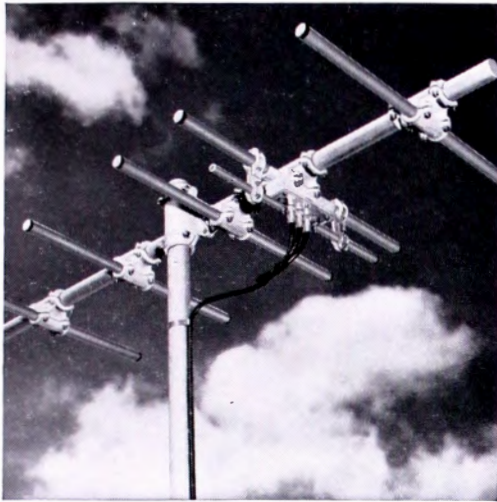

Cover
the
Hard-
to-Get
Spots

with the **RCA VHF Translator System (TRV-1A)**

- Operates unattended
- One-watt output on all VHF channels
- Low intermodulation distortion
- Improves coverage of TV signals
- Handles both monochrome and color signals
- Equipment is self-contained, including power supply
- Mounts in standard 19" rack



The Most Trusted Name in Television
RADIO CORPORATION OF AMERICA

A dependable method for improving coverage in certain areas. Translates signals from one VHF channel to another. Consists of individual channel amplifiers, converters and filters necessary for complete system. Designed for unattended operation. Single- and double-conversion units are available. Special identification keyer is available to transmit call letters every half hour.

Wide-spaced Yagi antennas are used for both receiving and transmitting. Developed to provide high gain, maximum co-channel rejection. Offers exceptional mechanical strength. For additional gain, antenna may be stacked with custom phasing of the harness to provide increased co-channel interference rejection. Ideal for high tower and mountain top installations where wind velocities may exceed 100 mph.

Write for details. RCA Broadcast and Television Equipment, Dept. WC-22, Bldg. 15-5, Camden, N.J.

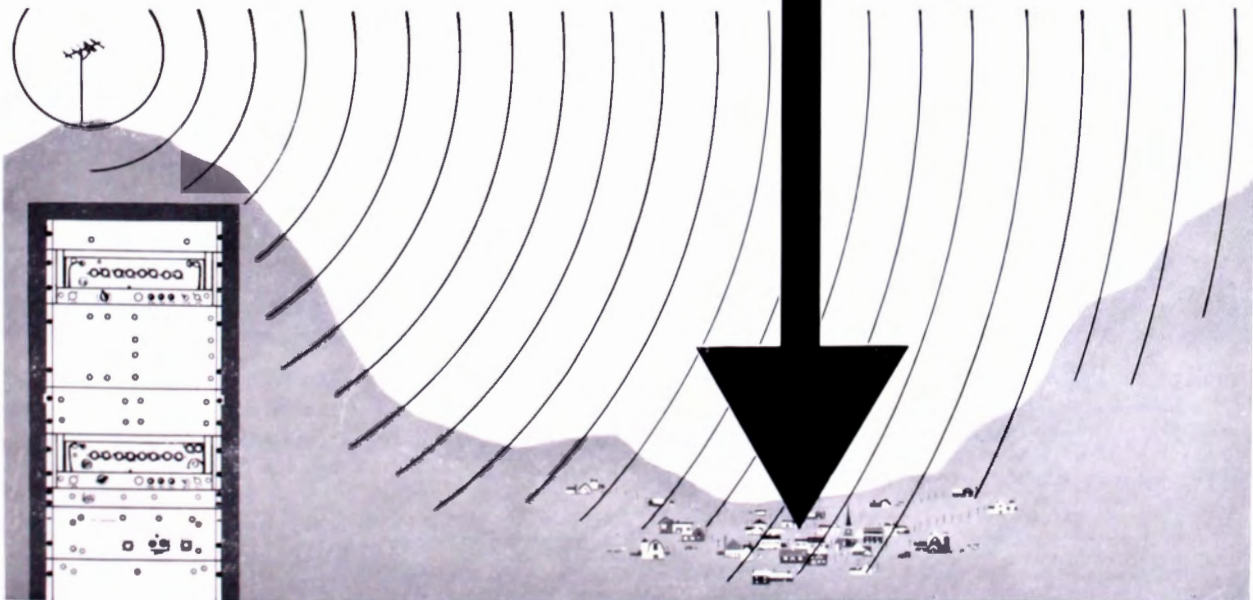

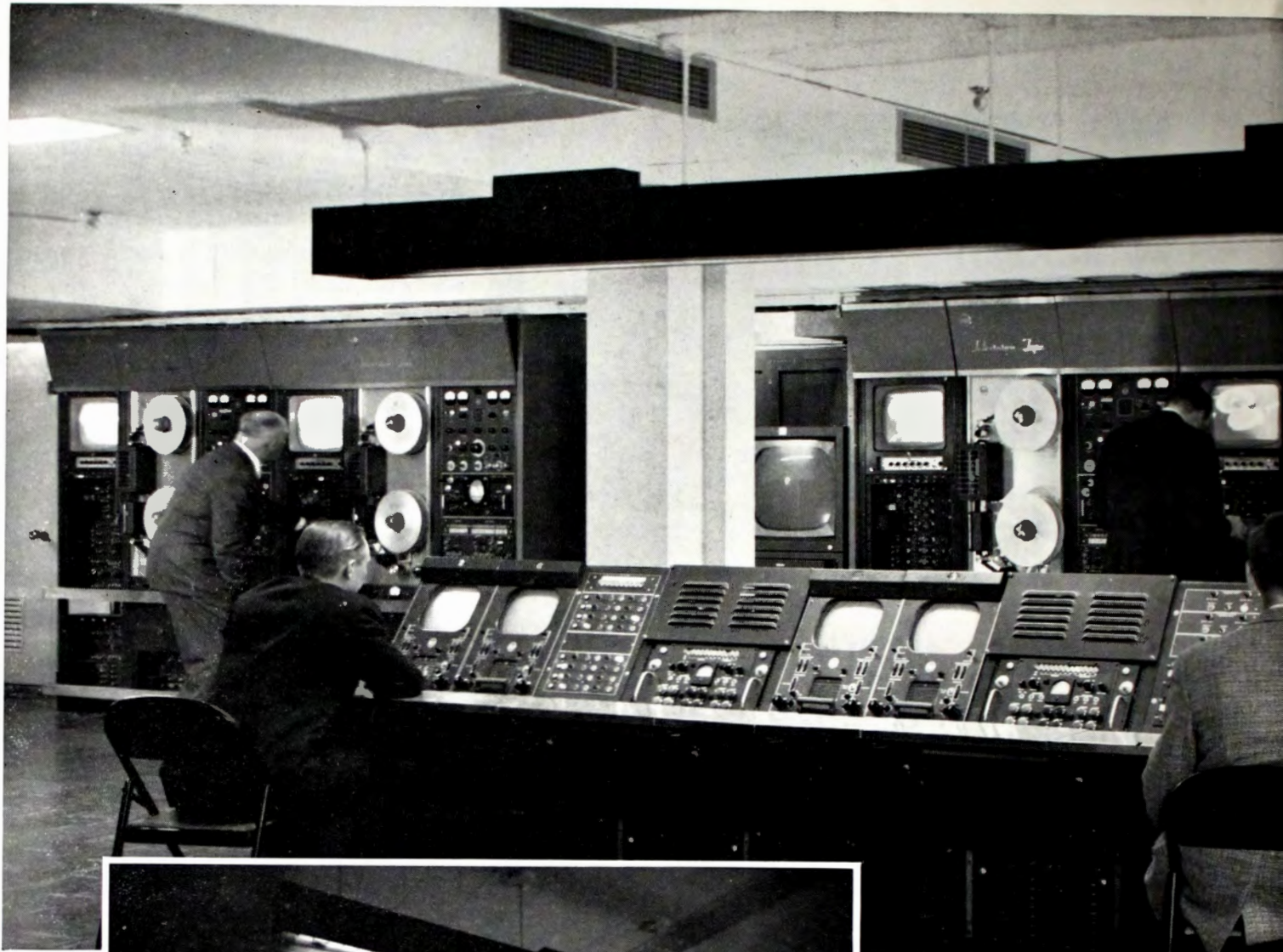

SERVICE PAR EXCELLENCE. Unparalleled tape editing service is furnished by Reeves' eight RCA TV Tape Recorders for clients who give them their toughest jobs. It means the finest electronic editing from a variety of sources—tape, slides, films. The producer has at his command every technical convenience possible. He can count on top quality... the economy of single-camera, scene-by-scene shooting... plus flexibility and simplicity in electronic mixing.

You, too, can get the superb pictures that will produce repeat business from your clients, plus the technical excellence that will make the tough jobs less arduous. Call the RCA Representative—with confidence, for the best in matched equipment and service. Or write to RCA, Broadcast and Television Equipment, Dept. U-278, Building 15-1, Camden, N. J.

BUSINESS BUILDER. Reeves reports they have built their business through the superiority of results they get with RCA TV Tape Equipment. Key to this is the RCA "Pix-Lock." Using this new equipment they can assure roll-free pictures in switching and provide commercially perfect fades, dissolves and a full range of special effects. In addition "Pix-Lock" improves original picture quality of tapes they receive for editing. These amazing electronic facilities allow them to turn out the most salable tapes with the greatest production facility and technical perfection.



“We get the tough jobs because we have RCA TV Tape!”

...says Bob Byloff, Reeves Studios, New York

“We’re often called upon to edit a production that picks up film clips and tapes from several sources, combining them with tape, film and live pickup. The technical excellence of RCA TV Tape Equipment gives us an edge on the really complicated assignments. We find our RCA TV Tape facilities give us the ability to actually improve on the quality of tapes, regardless of origin. With RCA TV Tape, no job is too tough to tackle!”

More and more producers and stations are now using RCA

TV Tape Systems. They get superior results from a completely matched line of equipment. The system includes TV Tape Recorders, Studio Cameras, Film Cameras, Projectors, Monitors, Switching and Special Effects . . . matched both electrically and mechanically to work together. RCA makes it feasible to get everything from a single reliable source . . . equipment that is built and operated according to proved broadcast procedures . . . backed up by top engineering counsel and service everywhere.



The Most Trusted Name in Television
RADIO CORPORATION OF AMERICA

INCREASED POWER = INCREASED SALES

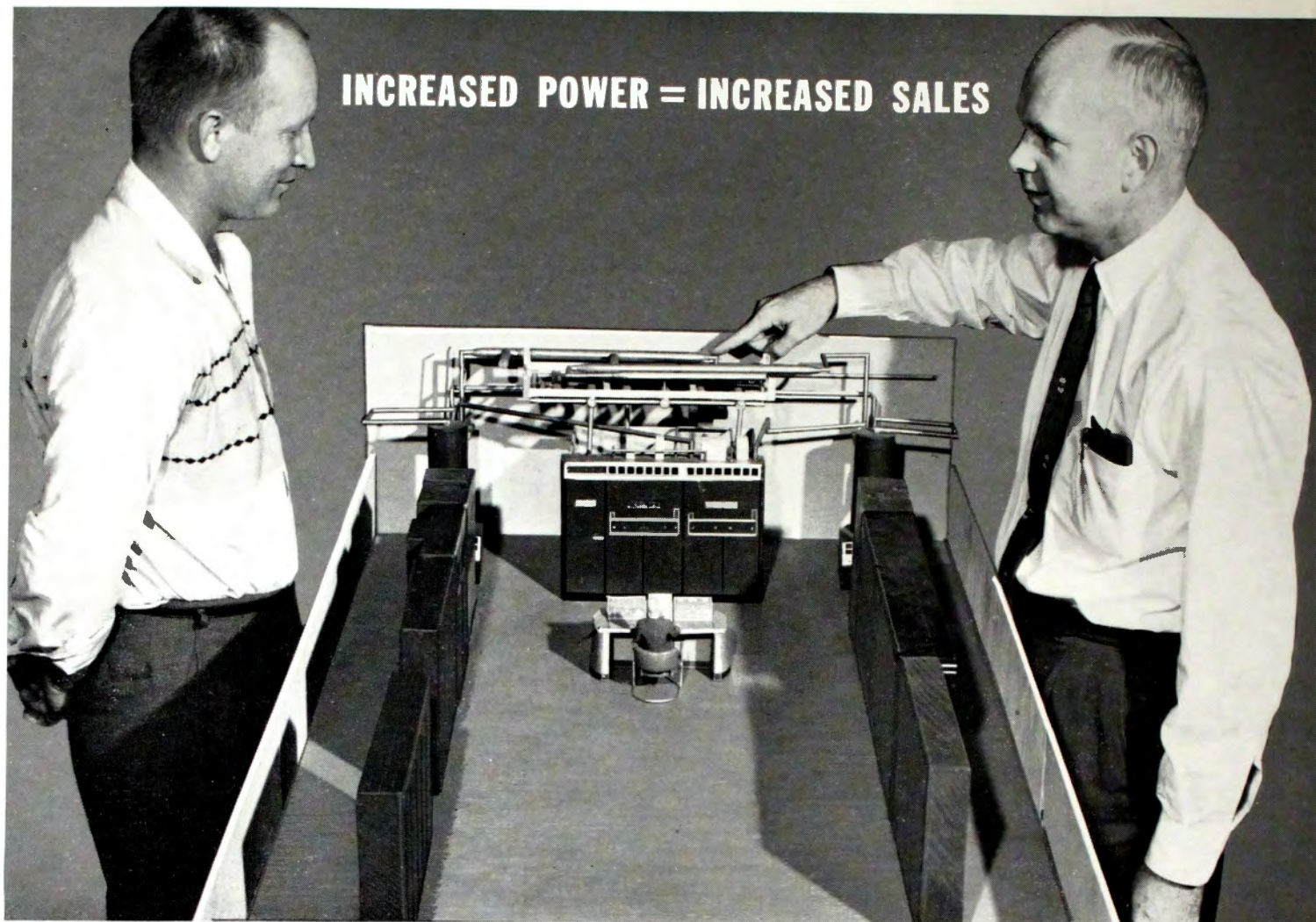

KPHO-TV and KPHO radio director of engineering, George McClanathan (right), points to a section of the "model" used to construct KPHO-TV's new transmitter building as Engineering Supervisor, Glenn Thompson, looks on

RCA High-Power Transmitter-Antenna Combination— Extends Coverage—Improves Picture Quality

... says George McClanathan, Director of Engineering, KPHO-TV

"We've completely modernized our transmitter plant and stepped up KPHO-TV's sales power with a new high-power RCA transmitter. The improved facilities started paying for themselves at once—by increasing sales. And even though operating at maximum power, we are obtaining very low operating costs, because of the way we did it."

The new power amplifier is capable of 25,000 watts output. However, the new RCA six-bay superturnstile antenna needs less than 20,000 watts of this power to get full 100 kilowatts of ERP. This puts a very light load on the transmitter, which results in low operating costs, long life, and very reliable performance.

All reports on extended coverage show that KPHO-TV's

signal is extremely good. KPHO-TV's programs originating in Phoenix, Arizona, are now being enjoyed as far west as Blythe, California; as far north as Page, Arizona; as far south as Nogales, Arizona; and as far east as Silver City, New Mexico. And 90 per cent or more of the reports show far superior picture quality.

Learn how an RCA modernization program can increase your station's sales while providing reduced maintenance and increased reliability. Your RCA Broadcast Representative will be glad to give you additional information about new transmitters and antennas that can bring your station up to date. There's a complete RCA line to choose from. Get the facts before you buy. RCA Broadcast and Television Equipment, Dept. WC-22, Building 15-5, Camden, N. J.

*Television station modernization
starts at the Transmitter Plant*



The Most Trusted Name in Television

RADIO CORPORATION OF AMERICA

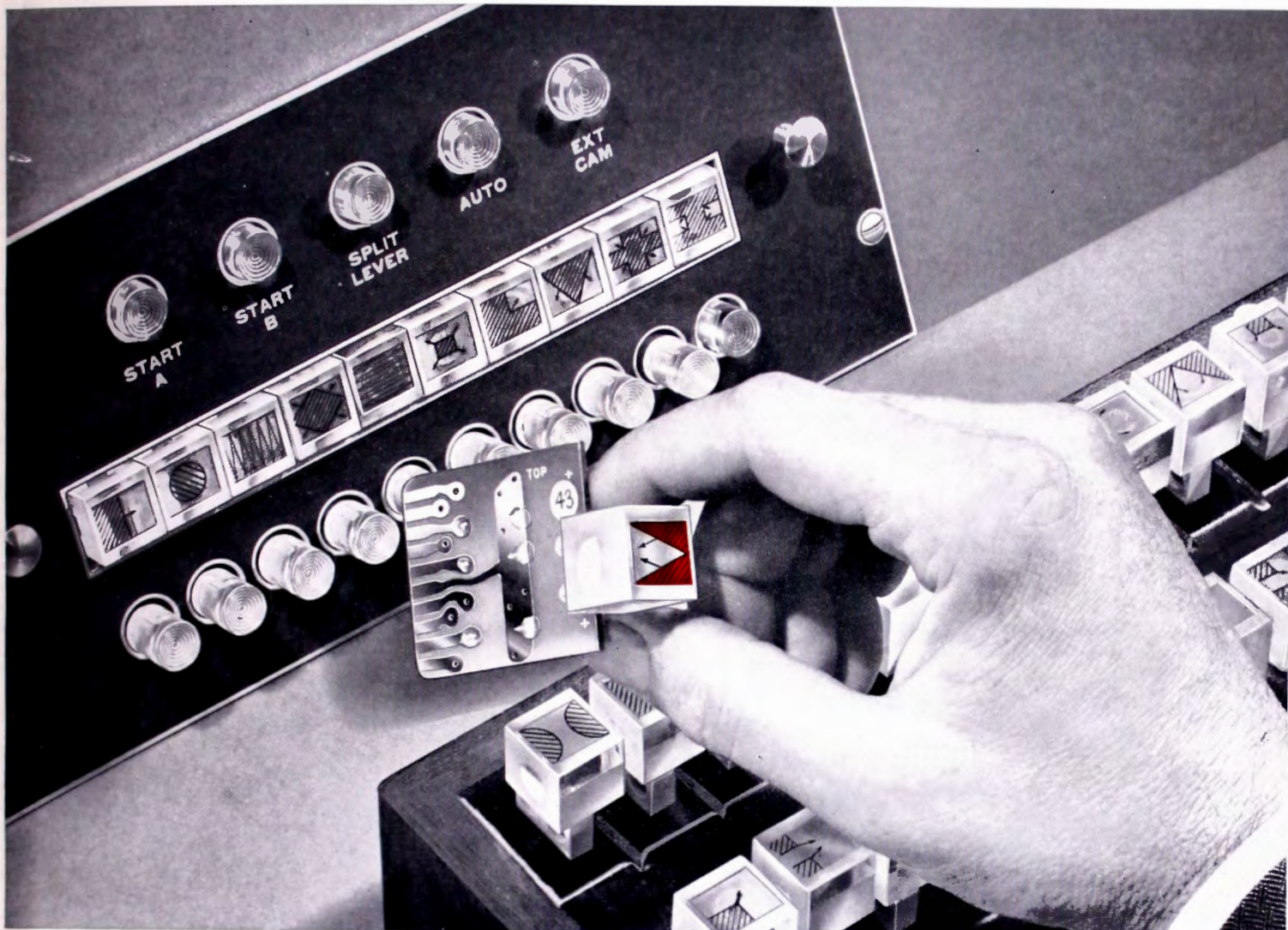

Now... pick an effect
from more than 150 possibilities!



Here's the ultimate in convenience for selection and presentation of program effects—the all new RCA Special Effects System. Key circuitry for each effect is contained in plug-in modules. Any ten effects may be pre-selected—simply plug ten modules into the control panel. Each module has illuminated symbol showing the effect it will produce. Slide an effect out—slide another in—it's just that easy. You get just the right effect to add that extra **SELL** to your programs and commercials.

SIMPLIFIED CONTROL—Push-buttons put effects selection at your fingertips. Push the buttons below the illuminated symbol and you are ready to go "on-air." Wipes and transitions are controlled by a standard fader lever for simple foolproof operation.

UNLIMITED VARIETY—The complete complement of 154 special effects includes wipes, split-screens, picture insets, block, wedge, circular and multiple frequency patterns. In addition, the system will accept a keying signal from any camera source to produce a limitless variety of effects—inset letters, drawings, trademarks; self-keyed video insets, and traveling mattes.

THE BEST EFFECTS WITH LESS EFFORT—Mix color and black-and-white. Enjoy exceptionally clean transitions . . . the most exciting effects ever conceived! And get them with the least amount of effort possible.

See your RCA Broadcast Representative or write to RCA, Broadcast and TV Equipment, Dept. W-264, Bldg. 15-5, Camden, N.J.



The Most Trusted Name in Television
 RADIO CORPORATION OF AMERICA

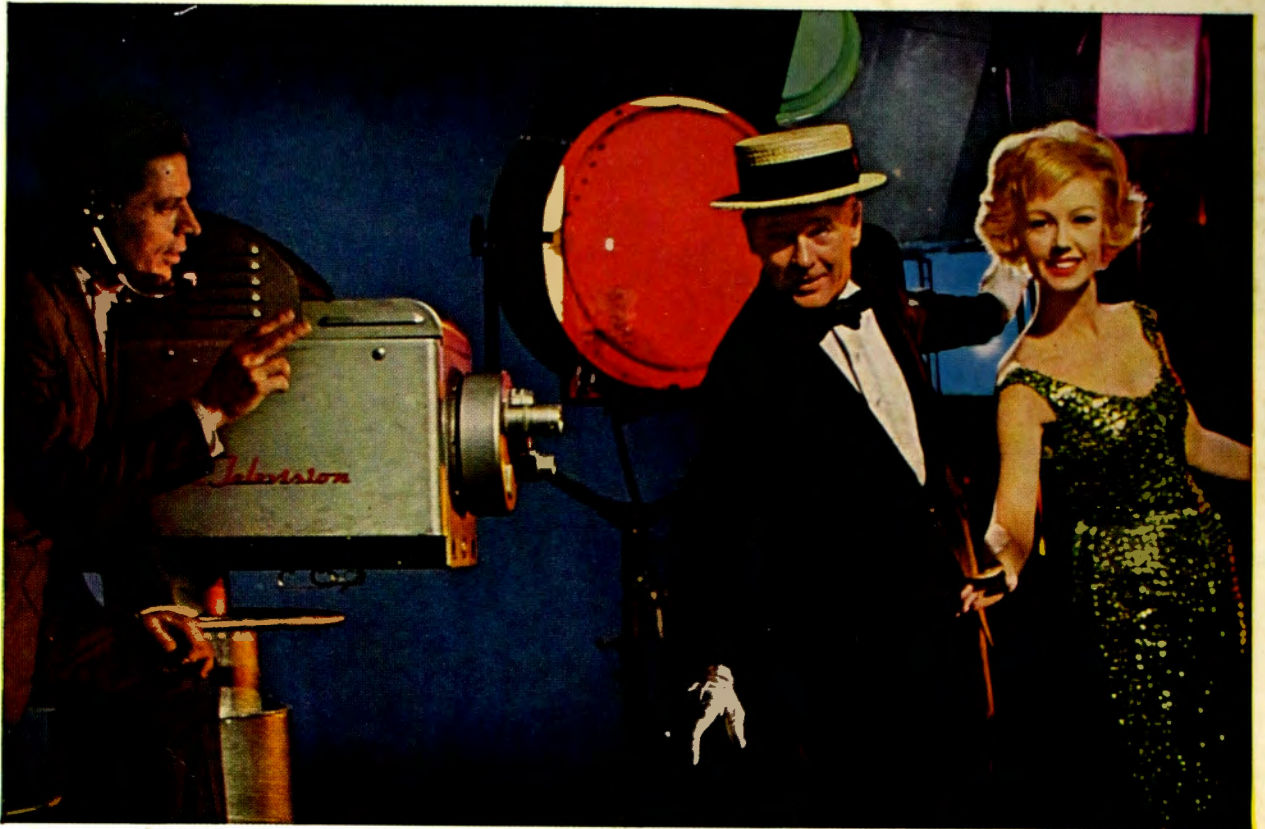

The most exciting new profit ingredient
in local broadcasting is

COLOR TV!

Today, 104 TV stations, network and independent, are equipped for local color. Most of them are programming in color on a regular daily basis.

Other stations, in large and small markets, are tooling up—33 plan to acquire live equipment, 44 plan to acquire film equipment in the near future. These station operators know that they must invest in color *now* if they want to enjoy improved profits in the '60's.

Look what local color can mean to you:

- Color provides an exciting *promotable plus*.
- Color builds station prestige . . . strengthens station image in minds of viewers and advertisers.
- Color doubles program ratings in color homes.

- Color commercials have greater impact—3½ times recall over black & white.
- Color attracts new local advertisers. Department stores, automotive dealers and others need and want color.
- Color wins praise from newspaper TV critics.

If you want to know more about profits in color, call or wire William Boss, Director, Color TV Coordination, RCA, 30 Rockefeller Plaza, N.Y.C. Columbus 5-5900.



The Most Trusted Name in Television