

OCT. 4th

1930

RADIO

REG. U.S. PAT. OFF.

WORLD

15c  
Per Copy

The First and Only National Radio Weekly

445th Consecutive Issue—NINTH YEAR

**Automatic**  
**Volume Control**  
**without**  
**an Extra Tube**

RADIO WORLD, Published by Hennessy Radio Publications Corporation; Roland Burke Hennessy, editor; Herman Bernard, managing editor and business manager, all of 145 West 45th Street, New York, N. Y.

# Accurate Tuning Condensers and Accessories

## EQUALIZER

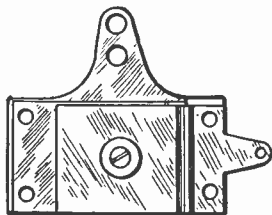

CAT. EQ-100 AT 35c

The most precise and rugged equalizing condenser made, with 20 mmfd. minimum and 100 mmfd. maximum, for equalizing the capacity where gang condensers are used that are not provided with built-in trimmers. Turning the screw alters the position of the moving plate, hence the capacity. Cross-section reveals special threaded brass pushing into which screw turns, hence you can not strip the thread. Useful in all circuits where trimming capacity of 100 mmfd. or less is specified. Maximum capacity stamped on

## SINGLE .00035

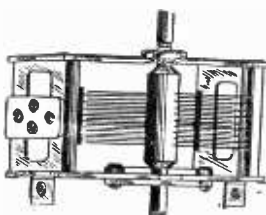

CAT. KH-3 AT 85c

A single .00035 mfd. condenser with nonremovable shaft, having shaft extension front and back, hence useful for gauging with drum dial or any other dial. Shaft is 1/4 inch diameter, and its length may be extended 3/4 inch by use of Cat. X8-4. Brackets built in enable direct sub-panel mounting, or may be piled off easily. Front panel mounting is practical by removing two small screws and replacing with two 3/64 screws 1/4 inch long. Condenser made by Scovill Mfg Co.

## THREE-GANG SCOVILL .0005 MFD.

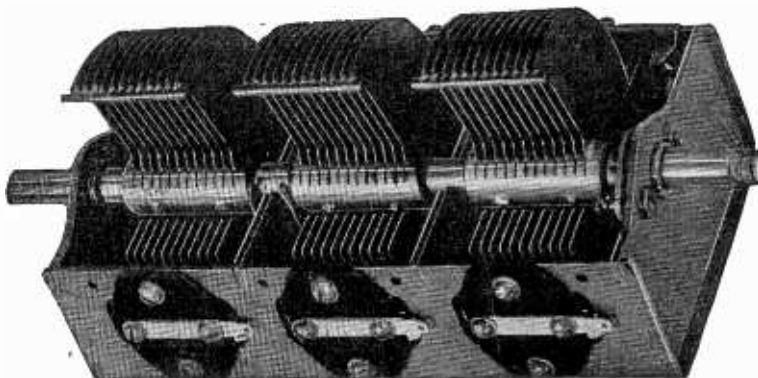

One of the finest strongest and best gang condensers ever made is this three-gang unit, each section of full .0005 mfd. capacity, with a modified straight frequency line characteristic. The net weight of this condenser is 3 1/4 lbs. Cat. SC-3G-5 at \$4.80.

HERE is a three-gang condenser of most superior design and workmanship, with an accuracy of at least 99 1/2 per cent at any setting — rugged beyond anything you've ever seen. Solid brass plates perfectly aligned and protected to the fullest extent against any displacement except the rotation for tuning. It has both side and bottom mounting facilities. Shaft is 1/4 inch diameter and extends at front and back, so two of these three-gangs may be used with a single drum dial for single tuning control. For use of this condenser with any dial of 1/4 inch diameter bore, use Cat. X8-8, one for each three-gang. Tension adjusters shown at right, either side of shaft.

### SALIENT FEATURES OF THE CONDENSER

- (1)—Three equal sections of .0005 mfd. capacity each.
- (2)—Modified straight line frequency shape of plates, so-called midline.
- (3)—Sturdy steel frame with rigid steel shields between adjacent sections. These shields minimize electric coupling between sections.
- (4)—The frame and the rotor are electrically connected at the two bearings and again with two sturdy springs, thus insuring positive, low resistance contact at all times.
- (5)—Both the rotor and the stator plates are accurately spaced and the rotor plates are accurately centered between stator plates.
- (6)—Two spring stoppers prevent jarring when the plates are brought into full mesh.
- (7)—The rotor turns as desired, the tension being adjustable by set-screw at end.
- (8)—The shaft is of steel and is 1/4 inch in diameter.
- (9)—Each set of stator plates is mounted with two screws to the frame. Thus the stator plates cannot turn side-wise with respect to the rotor plates. This insures permanence of capacity and prevents any possible short circuit.
- (10)—Each rotor section is provided with two soldering lugs so that connection can be made to either side.
- (11)—The thick brass plates and the generous proportions of the frame insure low resistance.
- (12)—Provision made for independent attachment of a trimmer to each section.
- (13)—The steel frame is sprayed to match the brass plates.
- (14)—The condenser, made by America's largest condenser manufacturer, is one of the best and sturdiest ever made, assuredly a precise instrument.

## RIGID AND FLEXIBLE LINKS



CAT. RL-3 AT 12c

The rigid link, Cat. RL-3, has two set-screws, one to engage each shaft, and is particularly serviceable where a grounded metal chassis is used, as the returns then need no insulation.



CAT. FL-4 AT 30c

Flexible insulated coupler for uniting coil or condenser shafts of 1/4 inch diameter. Provides option of insulated circuits.

For coupling two 1/4 inch diameter shafts, either coil shaft and condenser shaft, or two condenser shafts, a coupling link is used. This may be of the rigid type, all metal, where the linked units are not to be insulated. For condensers with 1/4 inch diameter shaft, to accommodate to dials that take 1/4 inch shaft, order Cat. X8-8 at 15c.

## EXTENSION SHAFTS, TWO SIZES



CAT. X8-4 AT 10c

Here is a handy aid to salvaging condensers and coils that have 1/4 inch diameter shafts not long enough for your purpose. Fits on 1/4 inch shaft and provides 3/8 inch extension, still at 1/4 inch diameter. Hence both the extension shaft and the bore or opening are 1/4 inch diameter. Order Cat. X8-4.

## .00035 TWO-GANG

A two-gang condenser, like the single type, KH-3, but consisting of two sections on one frame, is Cat. KHD-3, also made by Scovill. The same mounting facilities are provided. There is a shield between the respective sections. The tuning characteristic is modified straight frequency line. Order Cat. KHD-3 at \$1.70.

## DRUM DIAL

CAT DD-0-100 @ \$1.50

A suitable drum dial of direct drive type is obtainable for 1/4 inch shafts or 3/8 inch shafts, and with 0-100 scales. An eucytechon is furnished with each dial.



## FOUR-GANG .00035 MFD. WITH TRIMMERS BUILT IN

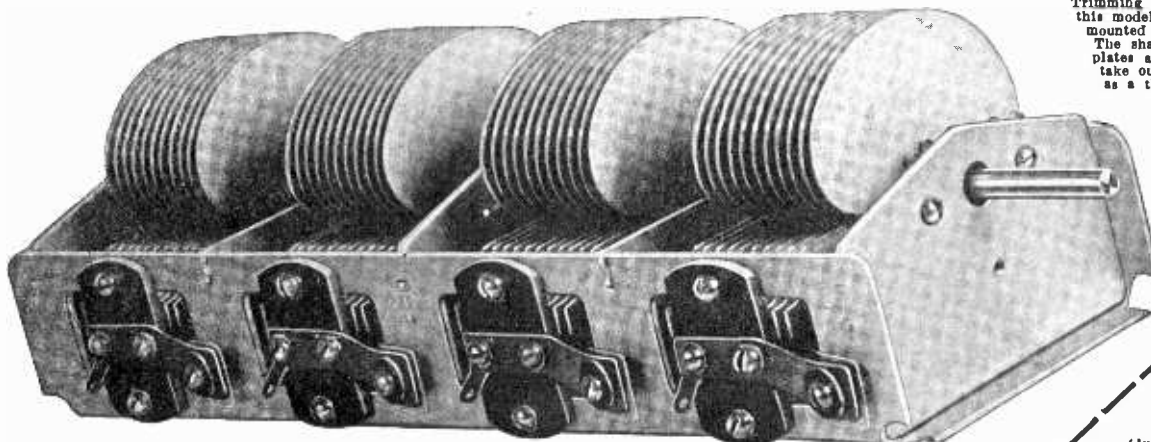

Trimming condensers are built into this model. The condenser may be mounted on bottom or on side. The shaft is removable, also the plates are removable, so you can take out one section and operate as a three-gang.

Four-gang .00035 mfd. with trimmers built in. Shaft and rotor blades removable. Steel frame and shaft aluminum plates. Adjustable tension at rear. Overall length, 11 inches. Weight, 3 1/2 lbs. Cat. SPL-4G-3 \$3.85.

## SHORT WAVES

Tuning condensers for short waves especially suitable for mixer circuits and short-wave adapters. These condensers are .00015 mfd. (150 microfarads) in capacity. They are suitable for use with any plug-in coil. Order Cat. SW-8-150 @ \$1.50. To provide regeneration from plate to grid return, for circuits calling for this, use .00025 mfd. Order Cat. SW-8-250 @ \$1.50.

A four-gang condenser of good, sturdy construction and reliable performance fits into the most popular tuning requirement of the day. It serves its purpose well with the most popular screen grid designs which call for four tuned stages, including the detector input. Ordinarily a good condenser of this type costs, at the best discount you can contrive to get, about twice as much as is charged for the one illustrated and even then the trimming condensers are not included. The question then arises, has quality been sacrificed to meet a price? As a reply, read the twenty-six points of advantage. The first consideration was to build quality into the condenser. The accuracy is 99 1/2 %.

QUARANTY RADIO GOODS CO., 143 West 45th St., N. Y. City (Just East of Broadway.)

Enclosed find \$.....for which ship designated parts:

Street Address.....  
City..... State.....

the following merchandise as advertised:

- Cat. X8-4 @ 10c
- Cat. KH-3 @ 85c
- Cat. X8-8 @ 15c
- Cat. KHD-3 @ \$1.70
- Cat. RL-3 @ 12c
- Cat. DD-0-100 @ \$1.50
- Cat. EQ-100 @ 35c
- Cat. SC-3 G-5 @ \$4.80
- Cat. SPL-4 G-3 @ \$3.95
- Cat. FL-4 @ 30c
- Cat. SW-8-150
- Cat. SW-8-250

ALL PRICES ARE NET



(Continued from preceding page)

prevalent values is accomplished by using higher values of resistors for biasing. For instance, with the 224 tubes in the intermediate channel of the Superheterodyne tuner diagrammed in Fig. 1, it is customary to use 300 ohms for biasing, affording 1.5 volts negative bias. However, here 700 ohms are shown instead, so that the bias is around 3.5 volts negative.

Small values of negative bias modulate downward. An increase in the intensity of the carriers, tuning from one station to another, or resonance as against off-resonance, results in a decrease in plate current. The needle kicks down.

In audio tests we are familiar with the advice: "If the needle kicks down, increase the bias; if it kicks up, decrease the bias." In audio circuits we are dealing with the signal intensity changes, and the object is to make the milliammeter needle stand still, so far as possible. But with automatic volume control we are dealing with the carrier intensity, and this amplitude is what is to govern the performance. The signal modulation itself must have no effect on the control system, otherwise loud notes would be reduced in volume, soft notes raised, and the tendency would be to have reproduction of all audio at the same volume for each note or word. That is not wanted at all.

#### Make Your Own Tests

When the bias is increased, the direction of needle deflection is changed. The modulation is positive, or upward. So, without accepting any particular value of resistance, you can make the test yourself. Using a single station as your guide, tune it in. If at resonance the needle shows a lower reading, raise the bias until at resonance the needle shows a higher reading. This can be done with a milliammeter in each individual plate circuit at a time, or a set tester plugged into one socket at a time.

In this connection it is helpful to change over to negative bias detection or power detection, if you now use leak-condenser detection. The reason is that leak-condenser detection modulates downward, and the other type upward, and you want to maintain the positive type of modulation all the way through. So, in the Superheterodyne tuner, even the modulator, or so-called "first detector," is of the negative bias type. A resistance value of from 1,500 to 5,000 ohms will provide modulation in this circuit. However, for the real detector, the last tube in the chain, the biasing resistor should be 20,000 ohms, for a coil in the plate circuit, or 50,000 ohms for a resistor plate load.

The reason why a measure of automatic volume control attends the performance of the circuit is that the increased amplitude of the carrier increases the bias, which increases the plate resistance, and reduces the volume. So, too, the modulator and the detector undergo increase in plate current, increase in bias, and reduction from what the volume would be otherwise. The action is instantaneous. The effect is gained, despite increased intensity increasing the plate current, which would indicate decrease in plate resistance. It is the tendency to increase in current that causes increase in bias, and consequent decrease in current from what it would be were the bias lower initially.

#### Oscillator Circuit Independent

In the oscillator circuit the usual value of 300 ohms, for 1.5 volts negative bias, may be used, since the carrier amplitude has no effect on the oscillator, which is an independent circuit.

The intermediate frequency amplifier consists of the three tubes to the left of the final detector. The same general types of coils used for broadcast reception may be used here, provided the primaries have a high inductance, as they have in coils intended for use with screen grid tubes. In the present circuit, however, the coils are used in a turned-about fashion, since the plate circuits are tuned, while the erstwhile primary is used as the pickup coil in the succeeding grid circuit.

What the intermediate frequency shall be may be determined by the experimenter himself. By using .00035 mfd. as the fixed capacity, and an equalizing condenser of .0001 mfd. (100 mmfd.) and coils designed for .00035 mfd. tuned radio frequency circuits, an intermediate frequency of 500 kc may be established, or some other frequency close to that. It is not important that the frequency be just 500 kc. It may be 490 or 510 with just as good results.

The frequencies in the broadcast band must be avoided, for reasons of interference and failure of adequate tuning throughout the broadcast spectrum, but there is no objection to choosing a frequency higher than the highest in the broadcast band. Since 1,500 kc is the highest frequency (200 meters lowest wavelength), the intermediate frequency may be 2,000 kc (150 meters wavelength), or somewhere between. Probably a somewhat lower frequency is easier of attainment with the coils at hand, so assume an intermediate frequency of 1,800 kc. Again there is no particular need of a certain frequency being chosen, nor even that you know exactly what the frequency is.

#### Use of Higher Frequency

To use the higher intermediate frequency, around 1,800 kc, simply omit the .00035 mfd. fixed condenser, and rely on the equalizers to resonate the circuits.

The modulator tuner is a standard antenna coil for the capacity of tuning condenser used, which in this instance was .0005 mfd. straight frequency line. If the modulator and oscillator tuning is to be accomplished with single control, then

straight frequency line condensers are not only desirable but imperative.

The oscillator coil may be just like the modulator coil, to start with, an inductance for .0005 mfd. It is preferable to use the higher frequency setting of the oscillator, of the two available, since volume is greater.

Working only the modulator, with earphones in its plate circuit, tune in a local station. Of course the tuning will be deucedly broad, but you will be able to determine, at least, the approximate position of maximum response. Note the setting of the condenser. Since a two-gang condenser is assumed or two separate condensers united by virtue of connection to a drum dial, the oscillator condenser's displacement is exactly the same as that of the determining condenser.

Now the only work remaining to make the circuits affect the intermediate channel is to remove turns from the secondary of the oscillator until the station comes in loudest. For fear of overstepping the mark, when one begins to hear the station, and then finds volume going up as turns come off, retain the wire intact, even though it is removed. Then if volume goes down again, you can restore the excess turns removed.

#### Good Coupling Method

If the 1,800 kc intermediate frequency is used, or any frequency thereabouts, a trimming condenser of about 50 mmfd. should be connected across the modulator's tuned circuit, and mounted on the front panel, since the frequency difference is great (in one instance, 1,800 minus 550, or 1,250 kc).

The coupling between the modulator and the oscillator is effected by means of a capacity-resistor series circuit from grid to grid. Values of .0001 mfd. and 1 meg., .00025 mfd. and 1 meg. and the like may be used. The smaller the capacity, and the larger the resistance, the looser the coupling. It is well to have the coupling loose. Also, this method of coupling, used in a Western Electric laboratory Superheterodyne seven years ago or so, retains the independence of the tuned circuits, whereas some other methods of coupling under certain conditions tend to make the two tuned circuits pull together, and act as one, resonating to a single frequency, under which circumstances there would be no reception.

#### Explaining the Unexplained

The butterfly switch, the volume control and the six circles at the extremes of the inductances in the mixing circuit have not been explained, so here goes.

The switch is simply a device that looks something like the pictorial representation. There are really four leaf-like blades, and each blade contacts with a tap on the switch, so that when three condensers are connected to three respective taps, and the switch is turned to engage first one tap, then two taps, then three taps, the capacities are connected in parallel and add up. That is an economical way of getting the desired total high capacity by using the sum of the smaller capacities, instead of having to provide a single large final capacity, in addition to smaller ones.

The same system of switching is used for the volume control. This consists of cutting in capacities in parallel so as to sidetrack part of the signal, thus reducing volume. The maximum capacity cut in, the sum of the respective capacities, is .0022 mfd. This is large enough to reduce the volume by about three-quarters. If it is desired to reduce the volume still farther, all that need be done is to use a larger capacity in the position occupied by the .0015 mfd. condenser.

#### Leaps-and-Bounds Method

This method of volume control is not gradual but works by leaps and bounds. There are three different steps of volume reduction. That makes a total of four volume levels, including full volume. When the switch is off, that is, the fourth wing of the butterfly is resting on the blank tap, full volume prevails.

There is a slight detuning effect when this volume control is used. This offers no disadvantages, since detuning in itself is a good way to reduce volume, and although this detuning is slight it works in the right direction.

The six rings at terminal positions of the coil in the grid circuit of the modulator, and the coils in the grid and plate circuits of the oscillator, represent places suggested for bringing out connections to plug-in receptacles, so that short-wave coils may be inserted in circuit. Hence, a single-winding coil in one instance, and a double-winding coil in the other, would be used.

Not only is the avenue open for the use of plug-in short-wave coils, whereby parallel connection of inductances would prevail, but it is also possible, due to the use of .0005 mfd. straight frequency line tuning condensers, to arrange six coils, three on each side of a tuning condenser, and by a switch cut in first one pair of short-wave coils, then the other pair, and thus cover from 15 to 140 meters and from 190 to 560 meters, merely by turning the switch.

This idea is being worked on, and if it proves quite satisfactory in all particulars, more data about it will be printed, including constructional details.

The choice of the intermediate frequency has been discussed, but it should be pointed out that if ship interference results on 500 kc (600 meters), turn down the trimmers, and work on 450 kc or thereabouts.

# Coils for Short Waves

By Edward Foster

THE winding of coils by the experimenter for short-wave reception sometimes presents a problem, or several problems. Different inductances are to be used, since different frequency bands are to be covered, yet one wants to be certain that there is adequate overlap, otherwise an important part of the frequency spectrum may be skipped.

The circuit shown in Fig. 1 is a standard one. It is offered in battery-operated form, since 201A tubes may be used, or even 199s, either with only 90 volts of B battery, and some dry cells to heat the filaments. The circuit may be built and left thus, not only acting as a short-wave receiver itself, but also as a suitable piece of coil testing and guiding equipment.

### Making the First Coil

A good start may be made by taking whatever diameter you intend to use, assumptively around 3 inches, and putting on two or three turns for the tuned secondary of the smallest coil. The primary that goes to antenna and ground need cause no concern. It may be from two turns to six turns in either instance. With six turns the signal strength will be greater. Don't worry about the stepdown ratio. While the ratio is downward, the sensitivity is upward, due to closer coupling.

Now you will find a secondary for the detector coil, of the same number of turns as the other secondary had. The plate winding in inductive relationship to the grid coil, has one turn more than the secondary. The primary may have three turns. If the detector will not oscillate, reverse the connections to the tickler coil, so that the lead that went to plate goes to the stator of the condenser C3 instead. C3 may be .00025 mfd. while C1 and C2 may be whatever you have handy, say .00014 mfd., .00015 mfd., .00025 mfd., .00035 mfd. or .0005 mfd., but of course both condensers C1 and C2 must be alike. It is also necessary that each circuit be separately tuned, not gauged, for the coil construction assistance. Besides, the grid returns are different.

### Making the Next Largest Coils

When you get the circuit working properly on the smallest coils, as described, await your opportunity to tune in a station, whether it be code or program, that requires engagement of nearly all the condenser capacity, say, a dial setting of 95 to 98 on the higher reading dial, if there is any disparity.

You now have a frequency equal to the highest frequency that the next largest coil is to tune to, therefore wind enough secondary turns so that with the smallest antenna coil in circuit, as formerly, the new detector coil will afford resonance when the dial setting is from 3 to 5. If the condenser changes capacity hardly at all in this region, use 7 or 9 as your dial reading guide. The tickler for this coil may have one-half as many turns as the secondary, and the primary five to seven turns.

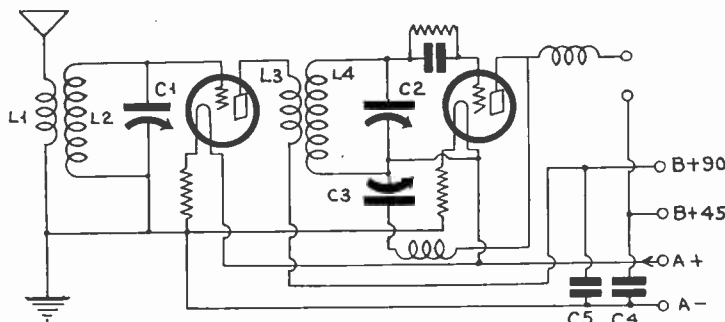

FIG. 1

DIAGRAM OF A CIRCUIT TO AID IN PROPER CONSTRUCTION OF SHORT-WAVE COILS TO BE SURE OF FREQUENCY OVERLAP

Now you know that the second largest coil brings in a signal at a very low dial setting, nearly at minimum capacity of the condenser, whereas the smallest coil brings in the same station at nearly the maximum capacity. With two different coils, therefore, but also different dial settings, you bring in the same station. So wind an antenna coil of the same ratio as used in the first instance, but with the secondary turns of the same number as the turns on the second largest detector coil.

### Covering the Broadcast Band

Repeat the process for the third coil. If you desire to get into the broadcast band, repeat the process for a fourth coil. If you are using a very small capacity, .00014 mfd. for instance, you will need five or six coils for each tuned circuit to cover the wave band, a total of ten or twelve coils. If you use .0005 mfd. straight frequency line condensers, you can cover the band, 15 to 550 meters, with three coils for each tuned circuit, a total of six coils.

Constants not previously given are: grid leak, 2 to 5 meg.; grid condenser, .00025 mfd. with clips; radio frequency choke, 10 to 25 millihenries; filament resistors, 4 ohms each for 201A tubes if battery voltage is 6 volts; 30 ohms each for 199s, with 4.5 volt source, or 50 ohms each for 199s with 6-volt source; C4 and C5, 1 mfd. each.

## Right or Wrong?

### QUESTIONS

- (1)—The higher the mutual conductance of a tube the better that tube is as a vacuum tube voltmeter whether it is used to measure AC or DC voltages.
- (2)—The amplitude of the sound track on a film of the variable amplitude type varies inversely as the frequency of the sound recorded when sounds of different frequencies but equal intensities are compared.
- (3)—The mutual conductance of a tube does not vary with the grid bias. For example, it is the same when it is measured at 5 and 6 volts as it is when it is measured at zero and 1 volt.
- (4)—The pressure of a phonograph needle on a record is of the order of a few ounces per square inch.
- (5)—An electromotive force is the same as a difference of potential or a voltage drop in a circuit.
- (6)—The only difference between a galvanometer and a current or voltage meter is that the galvanometer is more sensitive than either of the other two types of instruments.
- (7)—If a power transformer has been designed to work on 25 cycles it can be used also on higher commercial frequencies.
- (8)—There is no need of shielding radio frequency stages when the tubes are of the screen grid type because the capacity between the plate and the control grid is so low that no appreciable feedback can take place.

### ANSWERS

- (1)—Right. The value of a tube as a vacuum tube voltmeter, whether it be used as a direct reading instrument or a balance indicator, on AC or DC, is determined by the amount of plate current change for a given change in the grid voltage, and the greater this ratio between the plate current and grid voltage

changes, the more sensitive is the meter. This ratio is nothing but the mutual conductance of the tube.

(2)—Wrong. For equal intensities, the amplitude of the sound track remains constant for all frequencies.

(3)—Wrong. It decreases as the bias voltage increases and if the bias is high enough the mutual conductance is zero, for there is no plate current and hence no change in the current. When the mutual conductance is measured as in (1) the average value over the voltage change is obtained. To get the mutual conductance at a point the voltage should be changed by a very small amount in either direction of the voltage at the point in question, and then the plate current change should be divided by the voltage change.

(4)—Wrong. It is of the order of 13 tons to the square inch. The high pressure is due to the concentration of the weight of the pick-up unit on a very small surface.

(5)—Wrong. The electromotive force is numerically equal to the total voltage drop in the circuit and both are measured in volts. An electromotive force drives a current through a circuit, but a potential difference is the product of a current and an impedance.

(6)—Wrong. While it is true that a galvanometer is generally more sensitive, the greater sensitivity is the distinguishing feature. A galvanometer is not calibrated in either amperes or volts.

(7)—Right. It will work more efficiently on the higher frequencies. The main reason for designing a transformer for a high frequency is that it is more economical to do so if that transformer is not to be used on a lower frequency.

(8)—Wrong. Most of the coupling that causes oscillation is magnetic and capacitive coupling through the air. The coupling through the tube is a small part. There is a greater need for shielding the stages of a radio frequency amplifier from one another.





# Big Improvement

Bernard

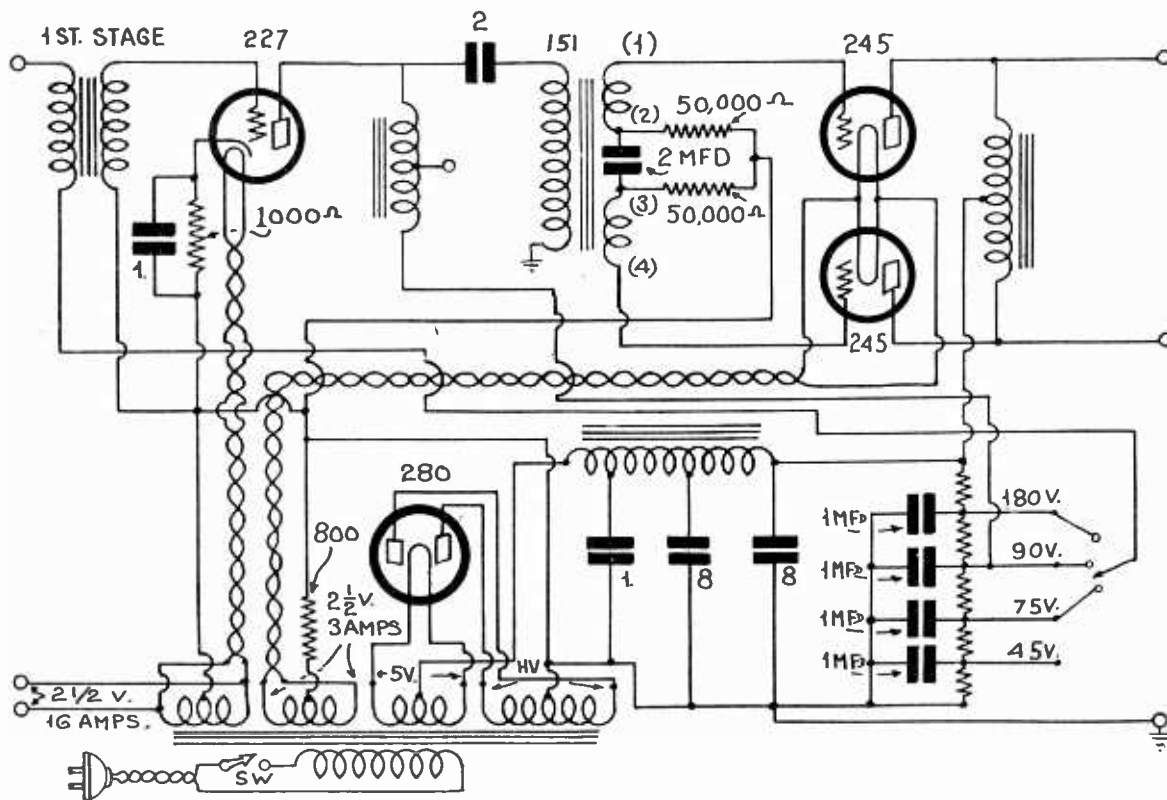

FIG. 2

FILTERING THE 227 OUTPUT, SO-CALLED PARALLEL PLATE FEED, KEEPS THE DIRECT CURRENT OUT OF THE PRIMARY OF THE PUSH-PULL INPUT TRANSFORMER, WITH CONSIDERABLE ACOUSTICAL IMPROVEMENT.

fare much better by including the improvement in any design you build.

Next we come to the secondary of the push-pull input transformer. It consists of two separate windings, one exactly like the other. The low potential ends adjoin on the terminal strip of the transformer, being brought out to lugs (2) and (3).

The distributed capacity is kept lower by the separate windings, also facility is afforded for a capacity-resistor filter. A 2 mfd. condenser is connected between (2) and (3), while from these two points separate 50,000-ohm resistors go to ground. This method has a stabilizing effect on the operation of the amplifier, which has been proved many times in actual practice and tests, although the theory of including the condensed is not altogether clear. Nevertheless, the scheme works out as stated and should be followed.

In the push-pull stage it is advisable to have "matched tubes." Under the same operating and voltage conditions the two tubes should draw the same plate current. Since a common resistor of 800 ohms biases both push-pull tubes (and needs no bypass condenser), alternate readings taken with a milliammeter in the individual plate circuits, or plugging-in of a set tester to obtain these readings, will afford a determination of matching. It is therefore true that the matching results only in respect to the direct current. As to the signal current, the matching depends on the push-pull transformer and on the output choke, so these must be of good design and quality.

The output choke is center-tapped. The extreme terminals go to the plates of the 245 tubes, the center tap to B plus maximum. Then a dynamic speaker may be connected to the output binding posts and no direct current, but only signal current, will flow through the primary of the output transformer that is built into the dynamic speaker. Also, impedance matching will be taken care of satisfactorily, since a high impedance is working into a lower one. The choke coil may have a total inductance of 30 henries, 15 henries each side of center, and it is satisfactory if the direct current resistance of the total winding does not exceed 400 ohms.

### Voltages

The positive B voltages are brought out to binding posts. So are grounded B minus, the detector input to the first audio trans-

### LIST OF PARTS

(For Fig. 2)

- One Amer-tran de luxe first stage audio transformer.
- One Amer-tran 151 push-pull input transformer.
- One 1,000-ohm wire-wound biasing resistor.
- One 800-ohm wire-wound biasing resistor.
- Two Lynch 50,000-ohm metalized resistors (0.05 meg.).
- Two 2 mfd. condensers, 200 volt DC or higher rating.
- Two 800 center-tapped choke coils, 30 henries, Cat. CT-CH. (Center is ignored for plate circuit of the 227).
- Five 1 mfd. condensers, 200 volts DC or higher rating.
- One Polo 245 filter choke, Cat. 245-CH.
- One 245 filter choke, Cat. 245-CH.
- One 1 mfd. Flechtheim condenser, type 245 (for B supply).
- Two 8 mfd. electrolytic condensers with mounting brackets.
- One Multi-tap voltage divider.
- One AC cable with plug.
- One AC switch (normally this is on the tuner).
- One UY (five-prong) and three UX (four-prong) sockets.
- One chassis (8x14 inches is large enough).
- Eight binding posts and a speaker output assembly.
- One 227, one 280 and two 245 tubes.

former's primary, and the 2 1/2-volt 16 ampere AC winding of the power transformer. The maximum B voltage is not brought out to a binding post, as it is not used save on the plates of the push-pull pair.

### Detector Bias Constants

What detector voltage should be applied will depend on the type of detector. For leak-condenser detector, 45 volts would suffice, but as this form of detection is not recommended, either 75, 90 or 180 volts may be applied to the detector. The usual value of biasing resistor for the detector, a 227, under these conditions would be 20,000 ohms (0.02 meg.). Across this biasing resistor a capacity of at least 1 mfd. should be connected.

# What About Radiostat?

By A. J. Endson

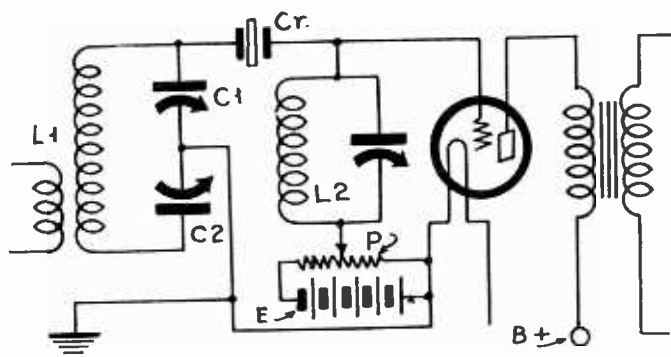

FIG. 1  
A SIMPLIFIED CIRCUIT OF THE STENODE RADIOSTAT SHOWING THE POSITION OF THE QUARTZ CRYSTAL JUST AHEAD OF THE FINAL DETECTOR IN THE RECEIVER.

THE Stenode Radiostat, recently developed in England, is a Superheterodyne type receiver employing a quartz crystal in the intermediate amplifier to obtain a very high degree of selectivity. It was developed by Dr. Joseph Robinson and its purpose is to eliminate interference of the heterodyne type. As a special transmission method, with accompanying receiver, it is also hoped that it will enable the use of many more channels in the spectrum now devoted to broadcasting. For example, it is hoped that one channel may be placed every 1,000 cycles, or closer together. At present there is one channel for every 10,000 cycles in America and one for every 9,000 cycles in Europe.

The basis of the system is the extremely high selectivity of a quartz crystal, a selectivity so great that the transmission band is only 50 cycles wide. A Superheterodyne type receiver is necessary with the system because a quartz crystal can be adjusted to only one frequency, so that it is necessary to change the frequency of the signal to fit the natural frequency of the crystal rather than to change the natural frequency of the tuned circuit or circuits to fit the signal, as is done in tuned radio frequency receivers.

## Sideband Suppression

The first views of this system several months ago raised a world-wide scientific controversy regarding the existence of sidebands. One group contends that no satisfactory broadcast reception can be conducted with extremely sharp circuits while another group maintains that it is not only feasible but that it has been done.

A curious course of reasoning is followed by those who maintain that broadcasting can be conducted with extremely sharp circuits, such as is represented by the quartz crystal. There are two distinct views of regarding a modulated wave. One is that it is a wave of constant frequency but of varying amplitude, the variation in amplitude occurring at a rate depending on the frequency of the modulating tone. The other is that the modulated wave is composed of three components of three different frequencies and invariable amplitude, that is, invariable as long as the depth of modulation is constant. These frequencies are the carrier and the two side frequencies. These side frequencies are equal to the sum of and difference between the carrier and the modulating frequencies.

The variable amplitude view is the natural view of the modulated wave; the carrier and the side frequency view is a mathematical equivalent of the other. Engineers use either, depending on which is the more convenient in any particular investigation. It is but a moment's work in mathematical juggling to prove that the two viewpoints are equally correct and nobody who understands the problem ever denies it. Even those who maintain that the side frequency theory is untenable admit the equivalence of the two, forgetting or ignoring the inconsistency of their position.

## Reduction of Modulation

Those who believe in side frequencies use them to prove that a sharply tuned circuit will suppress the side frequencies remote from the carrier and in that manner reduce the degree of modulation. Those who deny the tenability of the side frequency theory say that a sharply tuned circuit reduces the degree of modulation because such a circuit will not permit the amplitude to vary as rapidly as it should, especially when the amplitude variations occur at a very rapid rate. Both reach the same conclusion, as they necessarily must if they follow logical reasoning.

Those who sponsor the Stenode Radiostat say that the side frequency theory cannot be used to explain why good broadcast reception can be obtained with a tuned circuit as sharp as that

of a quartz crystal because the crystal cuts out completely the side frequencies differing by more than 50 cycles from the frequency of the carrier. So they turn to the variable amplitude theory, and, after having admitted the equivalence of the two viewpoints, say that that is quite adequate to explain the reception.

They say that the sharply tuned circuit reduces the degree of modulation, a fact which they have to admit because of experimental observations. But, they contend, the modulation is not completely suppressed. There is some variation in the amplitude of the carrier wave after it has gone through the crystal. If they did not admit this they would not have any signal left. There is enough variation in the amplitude, even at the highest rates of variation, to operate a detector circuit. But that detector circuit must be treated specially. They admit that there is a great deal of frequency distortion, the high audio notes being relatively suppressed much more than the low. This distortion is compensated for by treating the audio frequency amplifier so that it has a complementary characteristic.

## Stepping to the Moon

Now if the two viewpoints are identical, or even equivalent, how is it possible to explain reception by one and not by the other? How can a mere change of view change the facts in the case?

To realize the inconsistency of the position let us take an example. We cannot go to the moon because the distance is too great. But suppose the distance were only one step. Then anybody could step to the moon any time. That being the case, there is nothing simpler than to go to the moon. Let us say that the distance to the moon is one step, that is, let us define a step as a distance of 300,000 miles. Now we have an easy means of getting to the moon—we just take one step in that direction and we are there. Is it not funny that nobody thought of that before?

Those who admit the equivalence of the two ways of looking at a modulated wave must stick to their admission to the end. If the side frequency viewpoint does not lead to an explanation of reception through a sharply tuned circuit, the variable amplitude viewpoint cannot do so either. If the variable amplitude viewpoint can be used to explain it, so can the other. A change of viewpoint cannot change the properties of the modulated wave.

The proponents of the Stenode Radiostat say that the side frequencies are completely suppressed by the sharply tuned circuit. They are not. They also say that the sharply tuned circuit does not completely tune out the modulation. In that they are right. But if there is some modulation left, the wave that gets through the tuned circuit can be broken up into the three components. The amplitudes of the two side frequencies will not be so great as they were before, and that is the only difference. If the two viewpoints are true before the wave has passed through the filter, they are also true afterward. The tuned circuit has nothing to do with the viewpoints. A changed viewpoint will not change the nature of a problem.

## Claims for the Stenode Radiostat

The claims for the Stenode Radiostat are that the circuit is exceedingly selective, that it suppresses heterodyne whistles caused by stations operating on frequencies close to the desired frequency and that the quality of the received signals is satisfactory.

One cannot deny that the system is capable of a high order of selectivity. The quartz crystal insures sharpness of resonance. That it suppresses heterodyne whistles cannot be accepted without reservations. If the circuit suppresses everything differing by more than 50 cycles, then every heterodyne greater than 50 cycles will be cut out. But if the circuit does, it also cuts out all signal frequencies higher than 50 cycles. If there is a little modulation left after the sharp tuner higher than 50 cycles, there is also some heterodyning left, and that is built up with the modulation in the audio frequency compensator. That the quality may be satisfactory cannot be denied, because some persons are satisfied very easily.

It is claimed that the oscillator in the Stenode Radiostat is extremely critical. It is in every Superheterodyne of great selectivity, and it must be extraordinarily critical when there is a quartz crystal in the circuit through which the signal must pass.

It has been said that the circuit is subject to frequency variation at the transmitter, especially that due to modulation. Most transmitters "wobulate" a little in frequency and this "wobulation" is often serious on very deep modulation. Naturally, a very selective receiver would detect such frequency changes. But it is asserted that the signal would go out when "wobulation" set in and would stay out completely for several seconds, or even minutes. The frequency change due to modulation does not account for this at all. It might go out for a fraction of a cycle of modulation but it would not go out completely on all modulation frequencies and on all modulation depths. It would only account for distortion on the low tones.



# The 227 Tube Analyzed

By J. E. Anderson

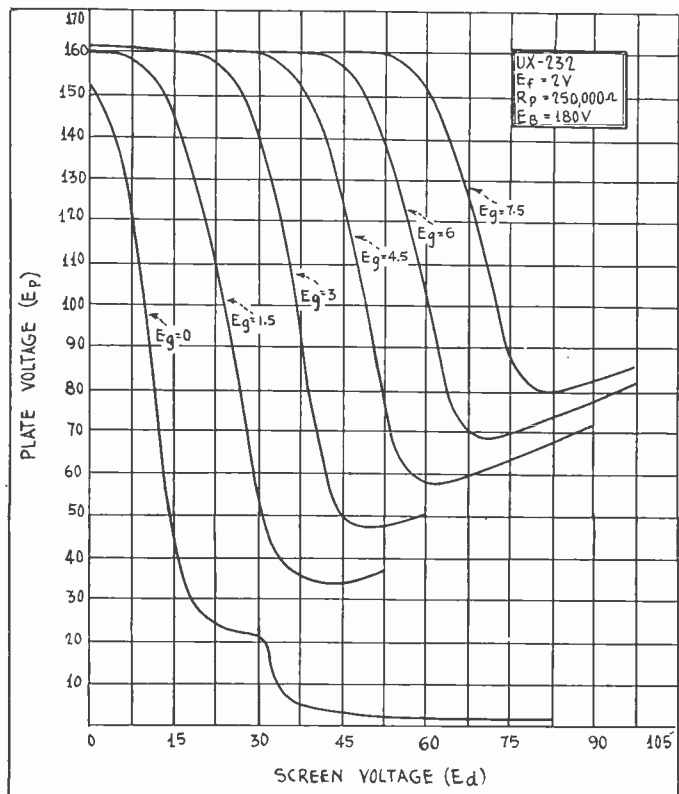

FIG. 65

SCREEN VOLTAGE, PLATE OUTPUT VOLTAGE CURVES FOR THE 232 SCREEN GRID TUBE FOR DIFFERENT VALUES OF GRID BIAS, TAKEN WITH 250,000 OHMS AND 180 VOLTS IN THE PLATE CIRCUIT.

[This is the ninth instalment of "Modern Radio Tubes." The first instalment appeared August 9th issue, in which the smaller battery type tubes were discussed. Subsequent instalments have dealt with the screen grid tubes, high mu tubes, the new 2-volt battery tubes, and with the 5-volt battery tubes. Last week information was given on the 224 screen grid tube. Next week data will be given on the 226 amplifier tube.—EDITOR.]

An interesting and instructive set of curves on the 232 screen grid tube is one which gives the relation between the effective plate voltage for different grid bias voltages as it varies with the applied screen voltage.

One such curve was given in Fig. 64 and a set of them is given in Fig. 65. All these curves were taken with a plate load resistance of 250,000 ohms and a plate battery voltage of 180 volts. The applied control grid bias is given on each curve.

The interesting region on each curve is the upper bend where the curvature is greatest. It gives the control grid bias and the screen voltage which makes the tube most effective as a Super-heterodyne modulator when the signal voltage is impressed on the control grid and the local oscillation is impressed on the screen grid, assuming that the circuit has been adjusted as indicated by the data on the graph.

According to these curves, when the control grid bias is zero, there is no positive screen voltage which is satisfactory. When the control grid voltage is 1.5 volts, however, there will be good modulation when the screen voltage is 7.5 volts. When the control grid bias is 7.5 volts, good modulating efficiency will be obtained when the screen voltage lies between 52.5 and 60 volts. Note that all the curves approach an effective plate voltage of approximately 160 volts, or 20 volts less than the applied plate battery voltage.

### Region of Instability

On each curve in Fig. 65 there is a region of instability, where the effective plate voltage may have either of two widely different values. The first curve shows the characteristic when the voltage continued to fall, and the last curve, that for  $E_g=7.5$ , shows the course of the curve when the voltage increased with increasing screen voltage. On the first curve a sudden drop occurs at 30 volts on the screen and from then on the voltage decreases slowly, approaching a value of 2.4 volts. Every time this curve was taken the same result was obtained so that this curve represents a relatively stable condition. The second curve represents a stable condition up to about 37.5 volts on the screen. Beyond this point it would either drop suddenly to a low value

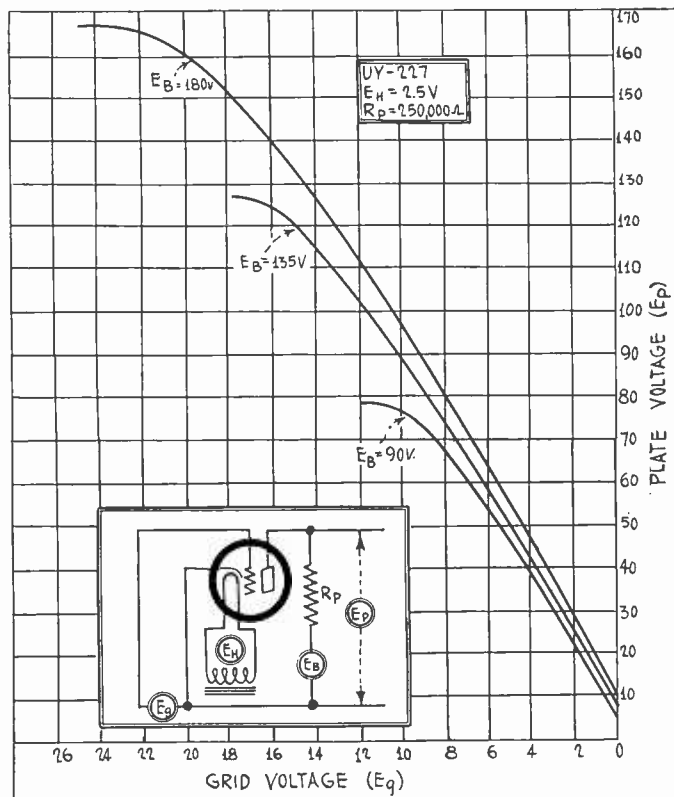

FIG. 75

GRID VOLTAGE, PLATE OUTPUT VOLTAGE CURVES FOR THE 227 TUBE FOR THREE DIFFERENT PLATE BATTERY VOLTAGES AND 250,000 OHMS IN THE PLATE CIRCUIT.

and approach a voltage of about 2.5 volts, or it would turn upward as indicated in the drawing. All the other curves showed this instability but the stability increased as the grid voltage increased. For example, in taking the two curves for  $E_g=6$  and  $E_g=7.5$  volts no measurement showed a very low value. Undoubtedly, if the measurements had been carried to higher screen voltages, the instability would have showed up for these also, or the trend in the curves would have turned downward. The two curves for  $E_g=1.5$  and  $E_g=3$  were not continued beyond 52.5 and 60 volts because of the instability.

The region of instability is of no practical interest because the circuit would be adjusted so that the operating point would fall on the left of the lower bend in the curve.

No matter what mutual characteristics are taken on a screen grid tube, this peculiarity always appears, and it imposes a limitation on the adjustments of the circuit. Take, for example, the curves in Fig. 70. At the top of each curve, with the exception of that for a screen voltage of 6 volts, there is a sudden jump in the curve, and the operating grid bias must be high enough to put the operating point to the left of that jump. The limiting points have been indicated by circles on this graph.

### 227

THE 227 has a heater and cathode structure like the 224 screen grid tube. That is, it is of the indirectly heated type and it may be used on either DC or AC. The heater terminal voltage should be 2.5 volts, when the heater current will be 1.75 amperes.

This tube may be used either as a detector or as an amplifier and it may be loaded either with a transformer or a resistance. For amplification it may be used either in radio or audio frequency circuits. For detection it may be used with either grid bias or grid leak and condenser, and when bias is used it may be either moderate for small signal detection or higher for power detection.

When detection is accomplished by means of grid leak and condenser, the grid return should be made directly to the cathode and the condenser should have a capacity of about  
(Continued on next page)

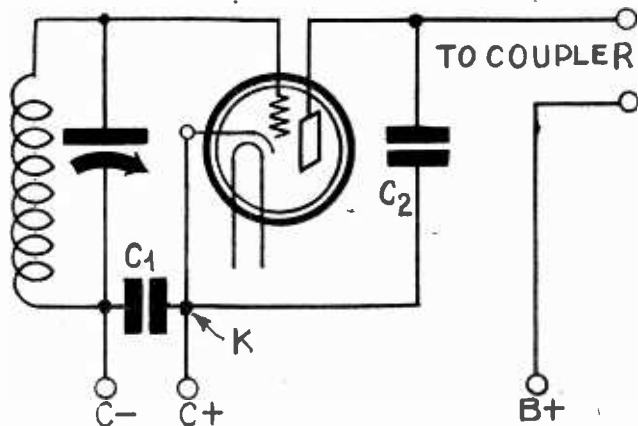

FIG. 76

THE CIRCUIT OF A GRID BIAS DETECTOR USING THE 227 TUBE. THE BIAS MAY BE SUPPLIED EITHER BY A BATTERY OR A VOLTAGE DROP IN A RESISTANCE.

(Continued from preceding page)

.00025 mfd. and the grid leak should have a resistance of from one to five megohms.

When grid bias detection is used, the grid return should be made to a point of negative potential the value of which depends directly on the voltage in the plate circuit. The bias for best detection is given in the following table:

**GRID DETECTION BIAS FOR THE 227**

Plate voltage	Grid bias	Remarks
45	4.5	weak signal detection
67.5	7.5	weak signal detection
90	10.5	weak signal detection
112.5	13.5	medium signal
135	16.5	power detection
157.5	19.5	power detection
180	22.5	power detection

The values in this table are correct when the load on the detector is a resistance of 250,000 ohms. When a low resistance transformer or audio choke coil follows the tube, the grid bias may be a little higher, but not more than one or two volts.

When the tube is used as amplifier with resistance coupling a suitable load resistance is 250,000 ohms, although lower values may be used if desired. The curves in Fig. 75 show the performance of the 227 tube when working into a 250,000 ohm resistance, for three different plate battery voltages as indicated. From these curves it is possible to get the amplification on any grid bias as well as to get the optimum bias for detection and amplification. Indeed, the values in the grid bias table above was obtained from them, interpolation having been used to get the bias values for voltages for which no curves are given.

Let us examine the curves to see what the performance of the tube is a voltage amplifier.

Suppose we use 180 volts in the plate circuit. Then we may, without incurring excessive distortion, permit the plate voltage to rise to 160 volts, where the grid voltage is 20 volts. We may also permit the grid bias to go to zero, where the output voltage is 11 volts. Thus a grid voltage change of 20 volts produces a change of 149 volts in the output voltage. Therefore the amplification is 7.45 times. The grid bias would be adjusted to 10 volts.

**Reducing the Distortion**

There is considerable distortion with this adjustment, for the amplification of one peak of the signal wave is 8.5 and that of the other is only 6.4 times. If we wish to reduce the distortion we may do so by reducing the grid bias. Let us assume that the tube is to feed a 245 power tube, which requires a signal amplitude of 50 volts. The double amplitude must therefore be 100 volts. At zero bias the plate voltage is 11 volts and at 111 volts on the plate the grid bias is 12 volts. Hence we may bias the tube by only 6 volts. The two signal peaks of each wave are now amplified 8.75 and 7.92. This not only represents a considerable improvement in the quality but an appreciable increase in the amplification. If the grid bias is reduced, the amplification will increase slightly and the distortion will decrease, but the output voltage will not be enough to load up a 245 power tube.

If the plate battery voltage is 135 volts, the amplification will be about the same as when the battery voltage is 180 volts, provided low bias values are used. This is evident from the fact that the two curves run parallel. If we must get maximum output from the tube with 135 volts in the plate circuit, we may allow the plate voltage to rise to 15 volts, which would require a bias of 7.5 volts. The mean amplitude of the output wave would be 56.4 volts, which is sufficient to load up a 245 power tube. However, the distortion is much greater than it should be and therefore it would be better to limit the output voltage to 96 volts, where the bias is 10 volts. This would permit a mean output amplitude of 44.4 volts, which is ample to load up a 171A

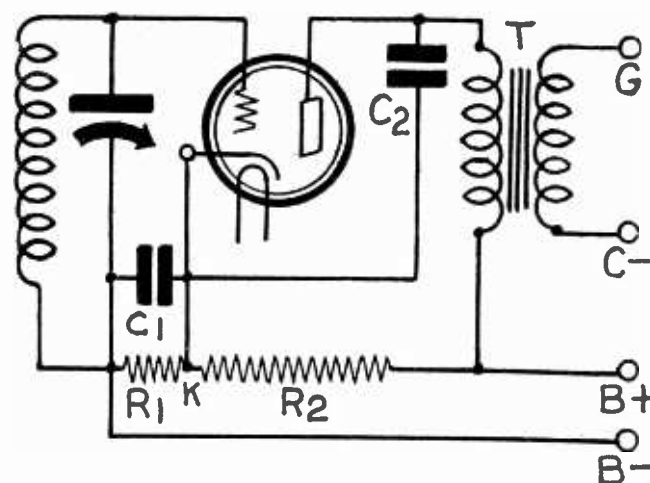

FIG. 77

THE CIRCUIT OF A GRID BIAS DETECTOR USING THE 227 TUBE IN WHICH THE BIAS IS TAKEN FROM THE B SUPPLY. BY CHOOSING SUITABLE VALUES OF R1 AND R2 THE PROPER DIVISION OF THE TOTAL VOLTAGE BETWEEN THE GRID AND THE PLATE MAY BE EFFECTED.

power tube. The mean amplification of the two sides of the wave is 8.88 times. The grid bias would be 5 volts.

**Low Plate Voltage Inadvisable**

When the plate battery voltage is 90 volts, the output voltage might be allowed to rise to 68 volts, where the grid voltage is 8 volts. This would require a grid bias of 4 volts. The voltage amplification would be nearly 8.2 times, and the output would be more than enough to load up a 120 or 231 power tube.

If the best quality is to be obtained from a resistance coupled amplifier having several 227s in tandem it is clear from the curves in Fig. 75 that a high plate battery voltage should be used and that the bias should be no higher than that demanded by the signal level. Thus it is better to use 180 volts in the plate circuit than any lower voltage, and the grid bias on any particular tube should be only slightly higher than the amplitude of the signal voltage impressed on the tube.

Suppose that the power tube is a 245, which requires a bias of 50 volts. We may, as we found above, use a bias on the 227 of 6 volts. We also found that the amplification was approximately eight. Hence we need an input to the second 227 from the power tube of 6/8 of a volt, and we may bias the tube by one volt. This arrangement will give as little distortion as is possible under the circumstances and at the same time the two 227s will give an amplification of about 70 times. If the detector is adjusted so that the output voltage is 0.75 of a volt, we will need only two 227 amplifier tubes between the detector and the power tube.

The schematic diagram in Fig. 75 shows the arrangement used in taking the curves and the meaning of the plate voltage  $E_p$ .

**CHARACTERISTICS OF 227**

Filament voltage, maximum.....	2.5
Filament current, amperes.....	1.75
Amplification factor.....	9.0
Plate voltage maximum.....	180
Plate resistance, ohms.....	9,000
Mutual conductance, micromhos.....	1,000
Base, standard UY, or five-prong.	

The recommended plate voltage when the tube is used as detector with grid leak and condenser is 45 volts.

The circuit diagram in Fig. 76 shows a grid bias detector using the 227 tube when a battery or other external source of voltage is employed, while the circuit in Fig. 77 shows an arrangement by which a suitable grid bias is obtained from the B supply. In either of these circuits C1 may have a value of 0.1 mfd. and C2 a value not greater than 0.0005 mfd.

The resistances R1 and R2 in Fig. 77 depend on the bias desired and on the value of the plate voltage applied, that is, the total voltage across R1 and R2. When the tube is adjusted for detection the normal plate current is so small that it may be neglected in comparison with the current that flows through R1 and R2, or the values of these resistors may be chosen so that this holds. Let us assume that the total voltage is 202.5 volts, which is to be divided so that the plate gets 180 and the grid 22.5 volts. Then the drop in R1 is to be 22.5 volts and that in R2, 180 volts. We might arbitrarily assign a value of 10 milliamperes to the current flowing through the two resistors. This gives us 2,250 ohms for R1 and 18,000 ohms for R2.

In case it is necessary to conserve the current, we might assign 5 milliamperes, which gives us resistance values just twice as high. Perhaps the best way of applying this scheme is to make R1 and R2 a single potentiometer of about 30,000 ohms, con-

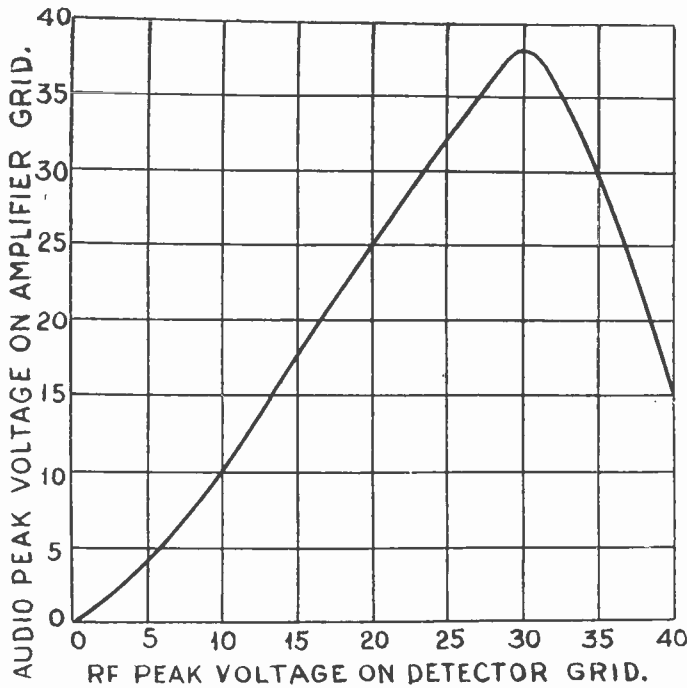

FIG. 78

A CURVE SHOWING THE PERFORMANCE OF THE 227 TUBE AS A POWER DETECTOR. THE OUTPUT VOLTAGE TAKES ACCOUNT OF THE STEP-UP IN THE AUDIO TRANSFORMER FOLLOWING THE TUBE.

necting the slider to the cathode. When this is done the best detecting efficiency can be found by simply moving the slider until the output is greatest.

The performance of the 227 as a power detector is illustrated in Fig. 78. The tube is working into an audio transformer and the curve includes the step-up of the transformer. The plate voltage is 180 volts and the grid bias is 25 volts. The curve shows that the detection is practically linear up to an input on the detector grid of 30 volts, peak value. When the input amplitude is 30 volts the peak voltage on the first audio tube is about 36 volts. As the input voltage is increased beyond 30 volts, the curve falls rapidly, due to the fact that the grid of the detector takes current. Clearly, it is not permissible to impress a voltage higher than 30 volts if the selectivity of the circuit is to be preserved. Since the output of the detector under the conditions represented in Fig. 78 is not sufficient to load up a 245 power tube, it is necessary to interpose an amplifier tube between the detector and the power tube. The extra amplification thus obtained will reduce the required amplification in the tubes preceding the detector. If we assume that the amplification in the extra audio stage is 7.5 times, which it will be if resistance coupling is used between the 227 and the power tube, we need an input of only 6.7 volts to the 227. Fig. 78 shows that this will be obtained if the signal amplitude impressed on the 227 detector is about 7.5 volts.

Plate Current Curves

In Fig. 79 we have a family of plate voltage, plate current curves for the 227 tube, covering grid bias voltages up to 32 volts. One load line for 18,000 ohms and a plate battery voltage of 180 volts is drawn across the curves. This line is drawn for convenience in drawing other load lines, parallel to it, for the computation of the output power. Since the 227 is not a power tube the computation is not carried out. Neither are load lines for high resistances drawn because Fig. 75 shows more clearly the performance of the tube in resistance coupled circuits. The curves in Fig. 79 can be used for estimating the plate current when the effective plate voltage and the grid bias are known, or for estimating the grid bias when the effective plate voltage and the current are known, or for estimating the effective plate voltage when the grid bias and the plate current are known. The curves also permit the determination of the amplification factor of the tube. For example, at 4 milliamperes and 13.5 grid volts the plate voltage is 160 volts and at 4 milliamperes and 18 grid volts the plate voltage is 200 volts. Thus a change in the grid bias of 4.5 volts causes a change of 40 volts in the plate voltage, at constant current. Hence the amplification factor is 40/4.5, or 8.9. The rated amplification factor is 9.

Controlling Volume in 224

The screen voltages usually recommended for a 224 do not always give the best results. Some means of adjusting the voltage is therefore desirable. A simple way is to return the screen lead to the slider of a potentiometer of about 30,000 ohms which is connected across 75 volts. By this means it is possible to vary the applied screen voltage between zero and 75 volts and thus find experimentally the voltage which gives best operation. Incidentally, this arrangement is also the best volume control that has been found for circuits incorporating the 224 tube.

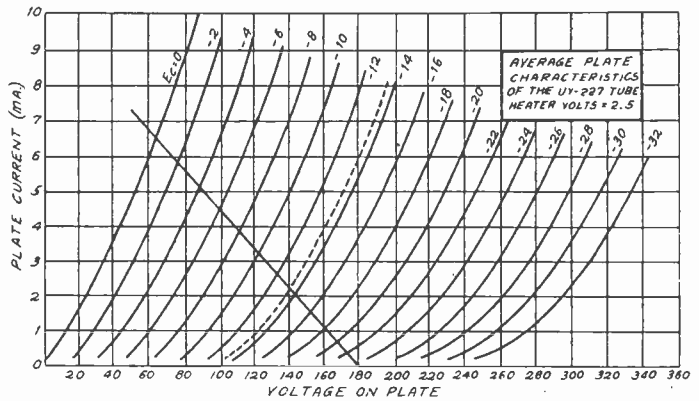

FIG. 79

A FAMILY OF PLATE VOLTAGE, PLATE CURRENT CURVES FOR THE 227 TUBE, TOGETHER WITH A LOAD LINE FOR 18,000 OHMS, TWICE THE VALUE OF THE INTERNAL RESISTANCE OF THE TUBE.

It is important never to attempt to get the required screen voltage by connecting a high resistance in series with either screen lead or with the common screen return lead. This will not give a definite screen voltage for it will vary with the signal as well as with the value of the heater current. Moreover, if a common resistance is used there will be coupling among the tubes and this will either upset the stability of the circuit or else reduce the amplification. Even when the potentiometer arrangement as suggested above is used, it is necessary to use individual radio frequency choke coils in each plate and screen return lead, and to by-pass each with a condenser as shown in the sample circuit. Besides this, it is necessary to use a large condenser from the slider of the potentiometer to ground. This condenser is not shown in the circuit because there is only one screen lead involved and the potentiometer is omitted.

The 20-ohm potentiometer across the heater is used as a means of eliminating hum. The slider is connected directly to the cathode of the 227 detector tube and to the negative end of the bias resistor for the 224. If a potentiometer of this value is not available, a center-tapped resistance of approximately the same value can be used in place of it, or else a center-tap of the 2.5-volt heater winding. The adjustable potentiometer is the best arrangement although it is not as convenient as either of the other methods.

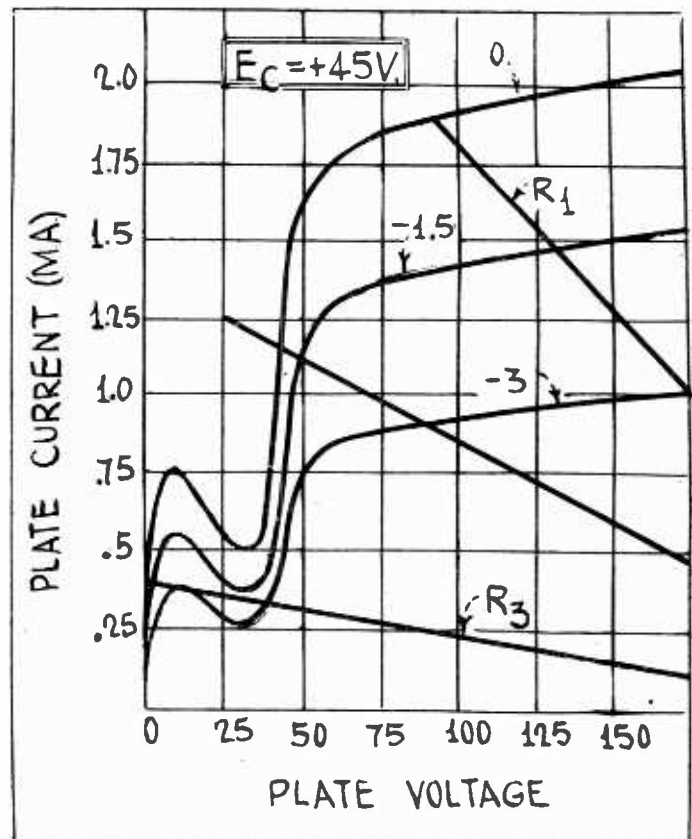

FIG. 79A

A FAMILY OF THREE PLATE VOLTAGE, PLATE CURRENT CURVES FOR THE 222 SCREEN GRID TUBE FOR 45 VOLTS IN THE SCREEN CIRCUIT. THREE LOAD LINES ARE ACROSS THE CURVES FOR THREE DIFFERENT RESISTANCE.

# How to Get Better Res

By John C

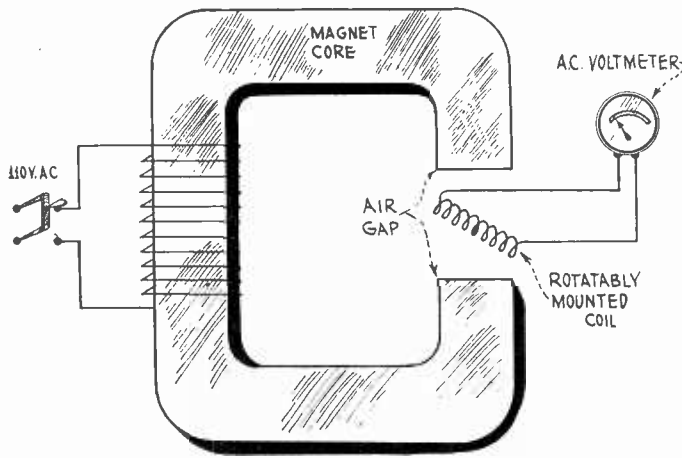

FIG. 1

A CIRCUIT ARRANGEMENT AND APPARATUS WHEREBY DIRECT INDUCTION EFFECTS MAY BE STUDIED. THE RELATION BETWEEN  $\phi$  AND THE INDUCING FLUX, DETERMINES THE INDUCED VOLTAGE.

THE antenna as a form of signal pick-up circuit is one that will be popular for many years to come, because when real reception results are wanted, especially those from distant places, this form of signal voltage generator, insofar as the receiving set is concerned, is the best.

Loop-antenna operated sets are either very sensitive signal detectors or can be made so, but even these work much better on extremely weak or distant reception when the loop is properly coupled, (as for instance like the coil arrangement called the loose coupler,) to an antenna. The reason for this is that when a loop-operated set is made sensitive enough to respond to a very weak signal, it is perhaps a hundred times more sensitive to more relatively local disturbances, and this condition, added to the effect of the non-proportional magnification of so-called set noises, or tube noises, often results in warring reception.

Therefore the antenna properly used provides the best means of increasing the signal strength over and above the noise level.

### Loop-Antennas Should be Kept Clean.

The effect of surface dust is always comparable to a theoretical case set up when you make the surface of an insulated wire carrying a high frequency current weakly conducting, that is, when you do this the wire tends first of all to be surrounded with a conducting layer, which if the layer does not touch the "insulated" conductor underneath, forms a source of capacity leakage.

But if on the other hand the surface layer becomes sufficiently moisture-laden, the chances of the conductor being weakly grounded are not remote by any means.

### The Outdoor Antenna

The most favorable reception season is advancing now and all who have outdoor antennas will do well to see that they are in good order.

Radio frequency currents tend to travel toward and along the exterior surface of a conductor. If this is true, what size or diameter should the live conductor of an outdoor conductor have? The answer is that it should be as large as the supporting strength of the masts or other points of suspension will permit. This might lead some of the readers to picture a copper wire of say 1/4 inch outside diameter, which if it were used as an antenna of say 125 feet long would mean that the sag with 100 pounds tension would be very noticeable indeed. In order that the sag should not be any greater than that customarily observed with eight-gauge aerials the tension would have to approach 1,000 pounds. But desirable as this size of copper conductor would be from the view point of low surface resistivity, the weight would be too great, so there must be a compromise.

A number of manufacturers put out "antenna kits" at a variety of prices, but these are usually "skinny antennas". When these are new the surface resistivity is lower than is the case when the more expensive kits are used, and at the end of six months

or a year in the open the span has increased surface resistance to such a degree that reception is not as good as it used to be. The customary replacement of one or more tubes follows. This does not always clear up the trouble.

### Mapping Service Area.

Those who correct reception faults do the best they can in cases where reception is weak but they are hopelessly beaten if weak reception is in any way due to antenna pick-up deficiency that is not traceable to any readily observed electrical or mechanical defect. All this is directly due to the fact that there is no standard of signal input measuring device.

What is needed is an instrument that will read in direct units the standard (or sub-multiple standard) micro volts per meter, the present accepted way of defining signal strength.

The local service area of broadcasting stations that serve the community in or near where you live is plotted more or less regularly by those whose business it is to know what this area is. The basis of arriving at the determination of this area is the establishment of a series of points radially distributed about the location of the transmitting antenna, where the carrier-wave is of uniform intensity. These points are noted on a regular geographical map and are linked by an imaginary line, which when the map is complete forms an irregular circle. Several of these irregular circles form a "complete" map, and the individual ones are the connected points where the signal voltage is the same, and therefore they are called equipotential lines, or field lines.

When the final results of a series of field strength measurements carried out over an average radius of say 100 miles yields the information that certain areas of reception are being slighted, i. e., the signal voltage is too low to operate receivers satisfactorily, it becomes necessary to effect certain changes in the transmitting antenna. With these corrections made the largest number of local listeners wants are satisfied, provided another dead spot has not been created by the aforesaid adjustment.

### Improvement Sought

More than one experimenter would like to know how to improve on his present receiving antenna system, particularly if some desired stations do not come in with sufficient volume.

The type of receiving antenna that is most commonly used is a length of 7-strand twisted conductor with individual wires Nos. 22 to 24 B. & S. gauge hard drawn copper.

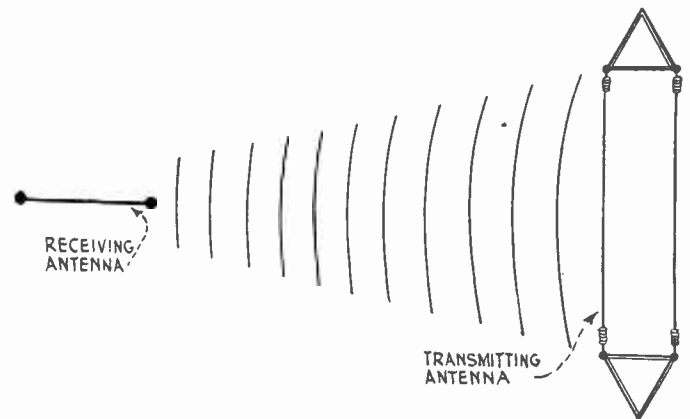

FIG. 2

A TYPE OF ANTENNA WHICH TO STUDY THE EFFECT OF DISPOSITION IN THE FIELD OF A GIVEN TRANSMITTER.

Stranded wire has been used for this class of antenna because it is more elastic than a solid conductor and also because it possessed more actual surface area than a solid wire of equivalent AC carrying capacity, and by the line of reasoning previously referred to also was more desirable for high frequency use than the solid conductor.

But experience has shown that the conventional antennas have a handicap that is not fully realized, and it is that after oxidation\* of the individual strands has taken place the strands have had some comparatively high series resistance (dc as well as high frequency AC) "inserted" in between them with the result that the desirably low cross-sectional area resistance is increased.

It has been previously pointed out that RF currents tend to

# Flux from An Antenna

Williams

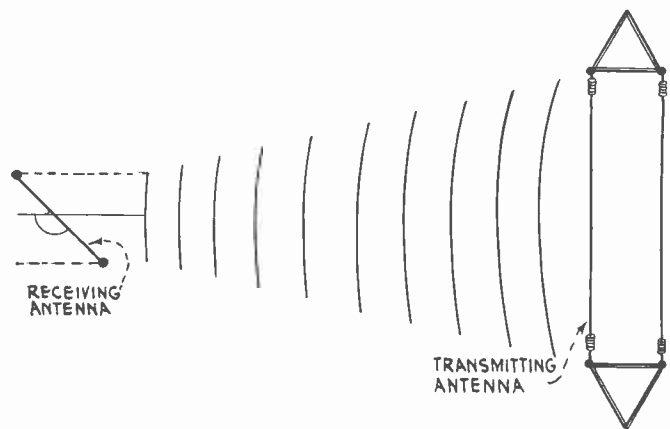

FIG. 3  
HOW THE EFFECT OF CHANGED INCIDENT FLUX IS OBSERVED.

flow toward the surface of a conductor, but this does not presuppose that they do not penetrate to any depth at all. On the other hand, some depth of penetration is undoubtedly achieved, which makes it desirable to consider cross-sectional resistance. It may be added that "surface" current flow of those high frequency alternations encountered in radio transmission and reception tends to be more manifest as the frequency increases, but the relative changes over the broadcast band need not cause the experimenter any special concern.

### No. 6 to No. 9 Solid Wire Antenna

The important feature of this present discussion is the compromise. Since all copper conductors are subject to oxidation, as previously pointed out, and there is a relatively serious effect of this coating in the case of stranded conductor, it has been found by trial extending over a long period that the best antenna conductor for average use that is not unduly expensive and is cheapest to maintain in satisfactory working condition is solid copper or phosphor bronze wire that is equivalent to between No. 6 to No. 9 B. & S. gauge. This wire may be readily cleaned with fine sand paper regularly and thus the surface resistance may be kept at the lowest value.

The next important step before considering the points of suspension of the antenna is where to put insulators, and perhaps also decide what they shall be made of. The primary function of antenna insulators is to act as virtual points of suspension and conductor terminals. They are supposed to determine the horizontal and vertical length of the antenna wire span.

Insulation as an absolute concept is invalid, because there is no real dividing line between conductors and insulators. A conductor is merely a path of low electrical resistance whereas if the path of current flow acquires very high resistance it becomes progressively a poor insulator then as the resistance reaches enormous values the path becomes a good insulator.

But in the main insulators are known as such because they present very high resistance to relatively low potential differences.

### Potentials Analyzed

The opposite ends of a perfectly horizontal span of wire are at the same potential at all times, when there is no branch circuit connected to the span at any point, but since a lead in wire is necessary if we are to make effective use of the antenna span the above condition is modified.

Also, it is modified when dust-bearing moisture is precipitated on the wire and in a more or less continuous coat over the insulators and other supporting media which if of metal, may be grounded.

But most good insulators have a smooth hard and non-porous surface that does not harbor dry dust or wet dust to any special degree, so that successive rains and winds effectively clean the

\*Oxidation is the name given to the chemical process whereby atmospheric oxygen combines with a substance. The product formed is called an "oxide." Thus copper wire that is exposed to pure atmosphere plus the effect of heat from the sun acquires a coating of copper oxide in a comparatively brief time. Of course physical contact with the oxygen is prerequisite to the formation of the coating.

insulator off before a conducting layer can form. This is true of good insulators, and we will not discuss poor ones.

The placement of insulators on the horizontal span is influenced mostly by the prevailing emfs generated in the wire when a radio wave passes across it. If the span forms a letter T with the lead-in wire in the vertical part of the letter, the emf developed at the two opposite ends of the horizontal span is the same.

But if the span forms an inverted L the voltage at the point where the lead in wire is attached is lower or higher than at the free end, depending on whether the elevation at the lead-in connection is lower or higher.

The best insulator is the moulded glass type with a ribbed barrel body. It is good practice to use at least three of these in series at either end of the T span.

### Study of Substitute Antenna

Fig. 1 shows an antenna test in a form that few would recognize, as the usual elements are missing, but that need cause no concern, because we are going to study some principles that affect reception by means of an AC voltmeter, of suitable range, and a coil of a suitable number of turns, so coupled that the coil's position in the field operates the voltmeter satisfactorily.

There is an operative flux furnished by an energized soft iron core that is uniformly distributed in the air gap in which the coil is placed. The energizing source is 110 volts AC, fed to the winding shown, which draws around 5 amperes. The AC flux cuts across the coil, inducing an emf in it that bears some relation to the angle the coil axis makes with the magnet core axis, and the voltmeter indicates the resultant induced volts at all times. But the condition under which induced voltage appears in the coil is that the maximum value appears when the coil axis is at right angles to the core axis. It will be apparent then that the generated voltage could be stated in terms of units of an angle, such as, so many volts per degree, relative of course to the incident flux direction.

Thus by noting the value of the generated voltage at successive angular positions of the rotatably mounted coil, we can correlate the above with standards of angular displacement, with which information a permanent curve can be drawn, for comparisons required later on. The cross-sectional area of the con-

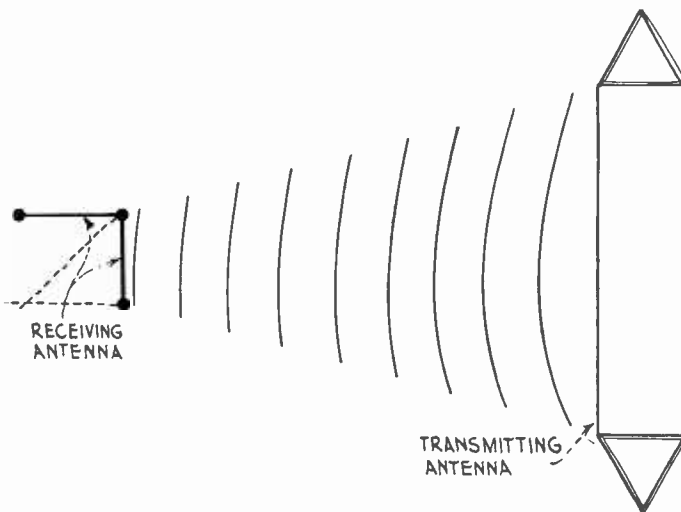

FIG. 4  
A TYPE OF ANTENNA THAT IS NOT EFFICIENT.

ductor of the movable coil would seem to have an influence on the deflection of the voltmeter, but this is not true in this case, as our instrument is a high-grade one, and its current requirements are a small fraction of the total available output current of the coil, and the load here is so slight that the percentage of error is negligible.

### A Practical Consideration

The rotatably mounted coil represents an analagous antenna, insofar as direct pickup is concerned under the conditions represented, and the AC voltmeter is the receiver. Also you have to accept the given conditions of flux emanation, which are only for demonstration purposes.

(Continued on next page)



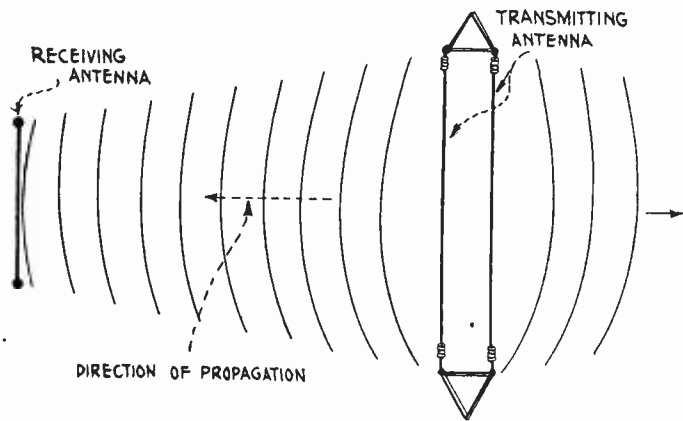

FIG. 5  
THE STRAIGHT-WIRE ANTENNA.

(Continued from preceding page)

In Fig. 2 we have a case that does not look especially promising to start with because of the relative position of the transmitting antenna and the receiving one, but as we are studying simple cases the first steps must be taken. It is assumed that there are no other sources of radiation affecting the receiving system, so that the only observable effects will be those that come from the transmitter shown.

According to what we have learned from Fig. 1, direct radiation in this case should result in no observable signal voltage at the receiving antenna, a conclusion that is entirely within reason if signal generation is accepted as being due to a condition where the radiated flux axis must always be at right angles to the conductor axis, but we are to find out whether this is strictly true.

All conductors have some size, and because of this, some observed facts relative to Fig. 2 are not as readily shown in the case where the apparatus of Fig. 1 is used, although we will not have to resort to the use of a detector more sensitive than, say, a three-circuit tuner.

Here the radiations are seen to advance directly across the conductor, and parallel to its axis. Relative to Fig. 2, some questions have been asked about the pickup qualities of certain "shaped" antenna conductors, the principal questions having to do with leakage and induction effects, due either to the manner in which the particular antenna wire is suspended, or the resultant effect of close proximity of the wire to the house, etc. Specific cases demand specific answers so the only way to handle this class of quizzers is to answer various letters personally, a much more satisfactory arrangement.

Most of the questioners are interested in knowing what antenna arrangement would provide the most signal, a very logical inquiry, since most of us are interested in getting all the signal we can, but the disposition of the antenna wire has been so consistently ignored in the inquiries that Fig. 2 was deemed a good starting point. In all the following, to simplify matters, the assumption of a uniform radio frequency output from the transmitting antenna is made. Let us see what we can learn from the next picture, in which a different state of things is apparent.

#### Antenna Voltage and Incident Flux

Since it has been pointed out that the disposition of the antenna conductor in the field of the radiated AC flux is important, it does not require any stretch of the imagination to extend this idea to some desired frequency, no matter where you happen to live. But in many instances it would be highly impractical to concentrate on one frequency alone so it becomes necessary to compromise, a point that seems difficult for some experimenters to realize.

Substantially the same rule holds for radio reception as the case of Fig. 1, and the idea is carried over to Fig. 3, where we see the receiving antenna located at an angle to the inducing flux, which, let us pretend, corresponds to an actual case. What voltage will be developed in this antenna relative to what would be developed if the wire were stretched parallel to the advancing flux or wave front? Obviously one-half, because the wire is exactly halfway between its zero coupling and maximum coupling positions.

The two dotted lines are now of interest, and we will proceed to use them, but only one at a time. This antenna is located on top of a flat wooden roof, the supports and building are of wood also, and there is no leakage of any kind. The object of adding one of the dotted-line conductors is to add to the pickup, so let's see whether we gain anything. The procedure is to shift one input meter lead, so that one end of one of the dotted line extensions is included in the circuit. If an increase of signal voltage is noted, then safe assumption is that the span was not parallel to the wave front in the first place. If no additional signal input is detected it can only be surmised that the orientation was correct in the first instance as it would be impossible to register a decrease, with the present arrangement. The

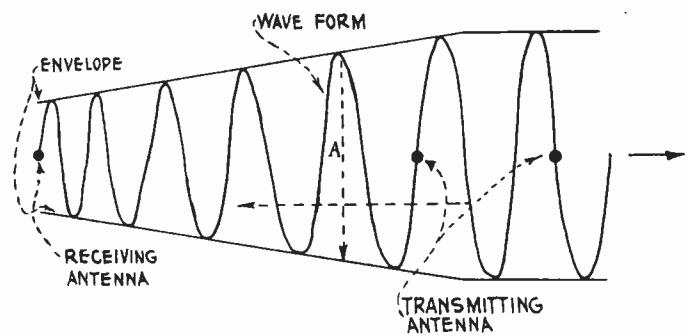

FIG. 6  
A HORIZONTAL COMPARISON-VIEW OF THE TRANSMITTING AND RECEIVING ANTENNAS.

addition of the other dotted-line wire would merely repeat what has been already shown, with the added proviso that if the dotted lines were extended the final results might not be any different.

Fig. 4 is another variation of flagrant disregard for the laws of induction, an example of which can be seen any time atop apartment houses.

#### DX Reception

DX reception, wherever one is located, usually occurs from no more than two distinct cardinal points, that is, the regular reception of DX so that it is understandable during the time that regular local broadcasting is in progress is certainly limited, and therefore it would seem in the light of the above to be a good plan to try to find out what these best DX reception directions are and erect individual antennas, say at least two, and have things so arranged that it is easy to switch from one to the other, and by this means it will be found that results as compared to the original system will be pleasingly different.

A moment's consideration of Fig. 4 should show this, but in case it does not, read slowly from here on.

While it is true that the advancing flux wave develops an emf in the antenna, it is also true that if the antenna is connected to a load circuit that is in turn connected to ground, a current will flow, depending principally on the impedance of the load circuit.

In this case let it be supposed that some such load is in the circuit here. How will its presence affect the observed reactions? The case here has been modified by the local re-radiation of one of the solid arms of our system, by the presence of a magnetic field that was manifested only when the load was applied, and this AC field acting at right angles to the one of the other arm has the effect of partly neutralizing it, and indeed if the field was of maximum intensity the resultant current would be reduced exactly one-half.

So the horizontal right angle antenna is actually poorer than a straight wire system of length equal to that of one of the arms, where the conditions are as previously noted.

One of the difficulties of analyzing antenna behavior is the fact that not one in a hundred antennas is so erected that all the variables affecting its performance can be readily observed. For instance in the case where a signal is more readily picked up when an iron roof is in the proximity of the antenna system, it is likely that some of the signal is picked up from the roof directly by induction, although the only positive proof of this would be to remove the metal sheet and re-observe the results.

#### Raising the Antenna

Again a case somewhat the opposite might be found to be the effect. In other words, suppose it was found necessary to raise the antenna vertically, say ten feet from the roof in order to increase the signal voltage a certain desired amount. It would then have been found that the initial trouble was excessive capacity loss, so it is seen that the individual conditions have to be measured every time to give satisfactory answers to individual problems.

In general, when erecting an antenna system over an iron or other metal roof, always aim to use tall supports so that the effective height of the antenna will insure a minimum of troublesome leakage effects.

One correspondent was anxious to know whether it would be correct to lead his "lead-in" wire along the shingled roof on insulators, then down over the eaves, and side of the house to the lead-in tubing. The best answer here is, always use the shortest lead-in route that will insure the best insulation, and in any case keep the lead-in wire at least two feet way from wooden exterior walls, to avoid surface leakage in wet weather, and as for metallic surfaces a good plan is to make three feet the minimum separation.

A brief consideration of Fig. 5 may help to decide the answer to the question of antenna length, because here we have no special problem in sight, at least not yet.

As a practical consideration to start with, it is reasonably safe to state that the length of antenna conductor is not more than half of the story, since the height above the earth, or ground, has to be considered as well as the set itself.

(Continued next week)

# September "Proceedings"

By Brunsten Brunn

**P.** A. DE MARS, G. W. Kenrick and G. W. Pickard report in the September "Proceedings" of the Institute of Radio Engineers, the results of field intensity measurements on low-frequency transmission (17.8 kc) from the R. C. A. station WCI, located at Tuckerton, N. J., as received at Newton Centre and at Medford, Mass. Observations were made by antennas and variously oriented loops and the results are compared with theoretical deductions. The average of received signals in the absence of magnetic disturbances is lowest during the night, and strong sunrise and sunset peaks are found. An inversion of the signal strength is noted during magnetic storms and at which times the night field strength is greater than the day field. The observations were continuous and were taken with automatic recorders.

The mathematical theory of loop reception is given.

### Certain Factors Affecting the Gain of Directive Antennas

This paper is contributed by G. C. Southworth, Department of Development and Research, American Telephone and Telegraph Company, New York, and is an analysis of the performance of antenna arrays as influenced by certain variables within the control of the designing engineer. The paper begins with a simple analysis of the interfering effects produced by two sources of waves of the same amplitude. It is shown that two antennas separated in space by  $\frac{1}{4}$  wavelength and in phase by  $\frac{1}{4}$  period give sensibly more radiation in one direction than in the opposite. This array has been called a unidirectional couplet. A number of such couplets may be placed in linear array to give an extremely useful directive system. A large number of diagrams are shown for such arrays as affected by the number of couplets and their spacing. The gains are calculated and compared with experimental data, showing a fair agreement between theory and observation.

Directional diagrams for arrays of coaxial antennas indicate that somewhat less gain may be expected from such antennas than when the couplets are spaced laterally, and that combinations of the two types of arrays give marked directional properties both when considered in the horizontal and vertical planes of reference.

Mathematical equations for calculating the directional diagrams of the linear arrays is appended, and special cases of these equations apply to the diagrams given in the text. The paper closes with an extended bibliography on arrays for those who wish to go into the subject more thoroughly.

### Radio Electric Clock System

H. C. Roters and H. L. Paulding, Stevens Institute of Technology, Hoboken, N. J., describe a clock system which employs radio time signals from a government station to correct automatically an electric clock system. Since interference is the usual limitation of a system of this kind, special emphasis has been given to a pulse amplifier by means of which pulses of a periodic character are amplified with an extremely high selectivity against interference. The mathematical theory of the pulse amplifier is developed in detail and response curves for the several stages are given.

The pulse amplifier has been designed so that the maximum amplification occurs at one cycle per second and so that the gain falls very rapidly as the frequency deviates from this value. At one cycle the gain is about 44 decibels, which is equal to approximately 25,000 times. At about 15 and 1-15 cycles the gain is zero. Thus there is very little chance that any interference will get through the amplifier. The special amplification characteristic has been obtained by using relatively low coupling resistances shunted with large condensers, and large isolating condensers in series with high grid leaks. Thus in each of two stages the coupling resistance is 50,000 ohms shunted by 4 mfd. and the isolating condenser is 0.25 mfd. in series with a grid leak of 2 megohms. Between the first and the second tubes the coupling resistance is 2 megohms and the shunting condensed is 0.5 mfd. The isolating condenser and the grid leak are the same as in the other two couplers. Across the load is another 4 mfd. condenser.

### A New Frequency-Stabilized Oscillator System

Ross Gunn, Naval Research Laboratory, Washington, D. C., describes a new vacuum tube self-oscillating system having extraordinary frequency stability comparing favorably with systems employing quartz crystals and magnetostrictive materials. The stability depends on the reërrant circulation of oscillations through tuned filter or coupling units, which attenuate all but one frequency. The unattenuated frequency is amplified each time it circulates. The effect is the same as the attenuation and transmission of a filter having an infinite number of sharply tuned sections. Frequency shifts due to vibration, variation in plate potential, filament current and keying are found to be

of the order of one thousandths of one per cent. The circuit was developed primarily for a frequency-stabilized generator for aircraft use, and it has been found satisfactory for this purpose. It should also be found useful in other applications where a constant frequency is demanded. One of the advantages of the circuit is its extreme flexibility, and seems to preclude its use as a primary frequency standard.

Many variations of the fundamental circuit are given but all depend on the reërrant circulation of current of the selected frequency. Another name for selective reërrant circulation might be selective regeneration. The main principles of the circuit are selective feedback, loose selective coupling between the tubes in the amplifier, and plenty of amplification to make up for the feeble feedback and the loose coupling.

### Interpolation Methods for Use With Harmonic Frequency Standards

J. K. Clapp, General Radio Company, Cambridge, Mass., describes methods of measuring frequencies by interpolation between known harmonics of standard frequencies or known harmonics of such frequencies. The subject is discussed under the following classifications:

I.—Direct beating methods, wherein the beat between known and unknown frequencies is utilized directly to operate frequency indicating or measuring devices.

II.—Direct interpolation methods in which the fundamental frequency of an interpolation oscillator is adjusted to zero beat in turn with the unknown and the adjacent known harmonic frequencies.

III.—Harmonic interpolation methods which are an extension of the principles of (II) permitting an interpolation oscillator of limited fundamental frequency range to be employed in the measurement of frequencies lying both above and below this range.

IV.—The principle of (III) points to a means for covering a wide range of unknown frequencies through the use of a low-frequency narrow-range oscillator fitted with harmonic producing circuits. A greatly open-out interpolation scale may be obtained.

### Precise and Rapid Measurement of Frequencies

N. P. Case, Department of Engineering Research, University of Michigan, Ann Arbor, Mich., outlines a precise and rapid method of measuring frequencies from five to two hundred cycles per second, which is also an extremely simple method. It depends on the fact that a condenser charged to a given voltage  $f$  times a second and then discharged through a resistance, the mean voltage across the resistance is proportional to  $f$ . This voltage is balanced against the voltage drop in a slide-wire potentiometer. The slide wire is first calibrated against a known frequency and subsequently other frequencies can be directly from the setting of the potentiometer on the wire when the circuit is balanced for the unknown frequency. The accuracy of the method is better than 0.1 cycle per second.

### A Note on the Mathematical Theory of the Multi-Electrode Tube

Those who revel in mathematical theory will find much pleasure in reading this paper by Peter Caporale, RCA-Victor, Camden, N. J., and they may find some practical information about multi-electrode tubes. As an exercise in mathematical analysis the paper is splendid; as a practical study of the properties of vacuum tubes it leaves much unexplained, although the symbolism contains expressions of the properties.

## Radio World Advertising Rates

	1 Inset.	4 consec. Inset., (each) 10%	13 consec. Inset. 12½%	26 consec. Inset. 15%	52 consec. Inset. 20%
1 page .....	\$150.00	\$135.00	\$131.25	\$127.50	\$120.00
½ page .....	75.00	67.50	65.62	63.75	60.00
¼ page .....	50.00	45.00	43.75	42.50	40.00
1/8 page .....	37.50	33.75	32.81	31.87	30.00
1/16 page .....	25.00	22.50	21.87	21.25	20.00
1 inch .....	18.75	16.87	16.41	15.94	15.00
1 inch .....	5.00	4.50	4.37	4.25	4.00

Classified advertisements, 7 cents a word; minimum, 10 words; must be paid in advance.

### Advertising Department

Radio World, 145 West 45th Street, New York, N. Y.

# Simple Mathematics

By Manning Manwaring

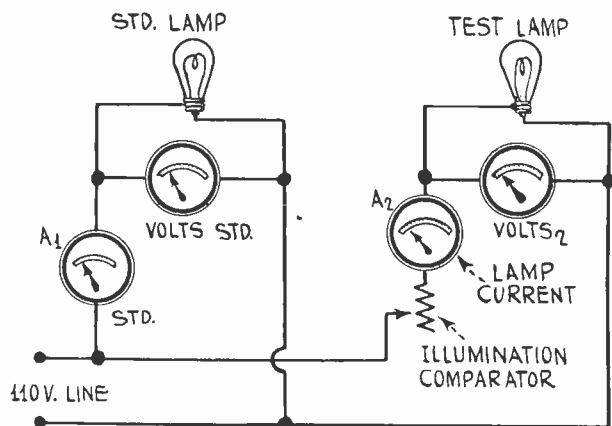

FIG. 4  
HOW TWO LAMPS ARE COMPARED, I. E., A SIMPLE PHOTOMETER MEASURING CIRCUIT.

[This article is a continuation of a discussion which appeared in the September 27th issue of RADIO WORLD, in which resistor networks, battery charging, and elementary lamp measuring devices utilizing forms of resistance measuring circuits as a basis of making test comparisons were described. The following article takes up the principle of the photometer and other measurement topics.—EDITOR.]

THE standards by which electrical apparatus is measured has to conform to a degree with that of the standard device chosen to represent the major characteristics of its particular kind. Thus when two lamps are compared, the choice may be on the basis of comparative current drawn or of the degree of illumination obtained, and it is safe to say that the likelihood of them being similar is remote. Usually one or the other is used and more often it is the wattage that is checked against the illumination in terms of filament input wattage to the lamp which is a "standard" one and whereby the relation between the lamp's light output and the light "input" of the measured source are compared.

These devices are employed by those whose business it is to measure lighting conditions in industrial plants, and especially where a quick and reasonably accurate survey of illumination requirements is required.

## A Photometer Circuit

Fig. 4 is really the basis of the device previously outlined, but being essentially a laboratory measuring instrument rather than a device to measure external illumination as the "foot-candle meter" is its description, or rather the points of interest about it in so far as we are concerned are confined to the difference between the circuits which can be observed readily by inspection.

The essential circuit arrangement is a network containing a "standard" lamp, and this lamp's filament has an ammeter in series with it, while a voltmeter is shunted across the filament. The lamp is previously calibrated in terms of foot-candles per unit power input expressed in watts at various voltages other than "standard" voltages, that is, for conditions other than standard, a table is supplied for the standard lamp whereby a constant check on its illumination is available at all times. The supplied table also indicates the maximum allowable input permissible without ruining the constants of the lamp.

The other circuit is essentially similar to the standard one except that no table is necessary and a controlling resistance called a "comparator" is used to adjust the lamp under measurement to any desired condition of illumination.

The uses of the photometer circuit are principally those of determining the illumination efficiency of lamps and their relative power consumption.

The meters of the two circuits are identical in deflection characteristics, and where only one set of them is available the use of two double throw, double pole switches makes it possible to employ one set of meters in both circuits.

There are many instances in the art of measurement where electrical circuits are employed for the measurement of quantities of non-electrical in origin and not all of them depend on a change in resistance as the basis of comparison from which values are derived.

## A Measurement of Mechanical Work

The case in Fig. 5 is one where a  $\frac{1}{4}$  horsepower motor is equipped with a flywheel load, this type of load being the best kind for the conditions under consideration. Ohms law will be

used here in somewhat the same fashion as it was previously, except that this circuit contains no steady "internal" emf that characterized the network of Fig. 2, where this emf was furnished by a battery.

Measurements of mechanical work that is done by or on rotating bodies must be in some way able to give an indication of the ratio of the mechanical equivalent of the supplied energy to that of the mechanical work done by the rotating body.

Here as in other cases, the measurement of the desired quantity in question involves to a certain degree knowing something about the special properties of the particular device. The most important part of this circuit scheme is the armature of the motor, and the specific property of the armature that influences the result of measurements is called armature reaction, and it will be necessary to go into an explanation of this effect very briefly.

The field coils that provide the magnetic flux in which the armature conductors rotate are seen and are also observed to be wound in opposite directions, thus providing the requisite correct polarity when a magnetizing current flows through the coils. The armature conductors are, of course, properly arranged and connected to a commutator against which the brushes B and B1 make contact with a degree of pressure that does not seriously interfere with the free rotation of the armature.

When the armature and field coils are connected as shown to the storage battery and the switch is closed, the armature rotates because its conductor fluxes react strongly with the fluxes in the polar air gap set up by the field coils, and since the armature is free to move the strong flux reactions overcome its bearings friction and it rotates.

The circuit network as portrayed includes a line voltmeter shunted around the battery and two ammeters  $A_2$  and  $A_1$ .  $A_2$  is in series with field coils and the armature, while  $A_1$  is in series with the field coils only. At this point a heavy flywheel is mounted so that the motor will turn it, and there is no extra bearing friction added to the motor armature by this addition. The necessary assumption is that the motor is of reasonable size, and therefore a  $\frac{1}{4}$  horsepower motor was selected.

Since a horsepower is 746 watts, the motor is a 186.5 watt design theoretically, but let us call it for convenience a 186-watt motor, and since watts are the product of volts and amperes, let us assume that the line voltage is 23.25 volts, and that the line current, motor running freely under the stated load, is 8 amperes. Under these conditions the motor is requiring its rated input of 186 watts, and the armature is taking just enough current (or power) to supply the frictional and windage losses of the system, as indicated by the result of the reading of  $A_2$  ammeter minus the reading of  $A_1$  ammeter.

With everything running normally, let us apply some uniform friction to the outer edge of the flywheel and observe the behavior of the ammeters  $A_2$  and  $A_1$ . We will see that the deflection of  $A_2$  will gradually increase as the applied external friction force increases and finally, if the armature is clamped so that it cannot move (a difficult feat, perhaps), the deflection of  $A_2$  will be very great.

Throughout all this series of events the deflection of  $A_1$  has remained constant, proving that the load variation had no influence on the power consumption of the field coils, and that their resistance remained constant in obedience to Ohm's law.

But how about the armature? It did not appear to obey Ohm's law particularly well as friction was applied to the flywheel and inspection has probably shown the reader by now that it did not obey Ohm's law until it became stationary, or at least it did not appear to obey it. Let us see whether it did or not. If it had been possible, we could have connected a center zero voltmeter to the motor terminals and run the motor by external power in order to find out whether it acted any differently as a generator than as a motor.

We would have found that the voltmeter did deflect differently, in fact, that its deflection in the latter case would have been opposite to that of the case when the device was used as a motor. But when the armature was running as a motor the conductors that compose it were rotating in precisely the same way as they were when it was a motor, so the obvious conclusion is that when the motor armature rotated, its conductors developed an emf that tended to oppose the emf applied to the motor.

The equation that expresses this condition is

$$EA - EM = RE$$

in which  $EA$  = Applied line voltage.

$EM$  = Back emf of motor,

$I$  = Indication of  $A_2$  ammeter, and

$RE$  = Effective resistance when armature is freely rotating under load.

It is clear that when the armature is clamped the result is a  
(Continued on next page)

# Bottles of Nothing

HOW bottles full of nothing act to pick up radio broadcast programs was explained in a talk from WGY, recently, by ELLIS L. MANNING, physicist of the General Electric Company research laboratory. Speaking on "What Price Emptiness," Mr. Manning said:

"I've never heard of anyone going to the store and asking the merchant for a dollar's worth of empty space, and yet a great many people spend a great many dollars each year buying empty space.

"Whenever you buy certain kinds of incandescent lamps, you are purchasing a little bit of emptiness wrapped up in a glass container. X-rays enable medical doctors to study and repair human anatomy, and x-rays are helping other kinds of doctors to study the anatomy of the atom—and, described in its simplest terms, an x-ray tube is simply two pieces of metal placed inside a glass bottle full of emptiness.

Vacuum bottles, on picnics, keep your coffee hot and your orange juice cold, and vacuum tubes make it possible to send voices—music—for thousands of miles through empty space. Other vacuum tubes provide us with electric eyes better in some respects than human eyes. All in all, you buy millions of dollars' worth of vacuum devices each year—and yet the price paid for such useful kinds of emptiness is surprisingly low when you think of the cost of learning how to make the kind of emptiness required—and then, how to make containers full of nothing do the jobs they do.

"Radio—either sending of programs or the reception of music and speech—is not at all the profound mystery it used to be. Certainly, radio is intimately connected with these containers of empty space called vacuum tubes. Without them, radio as we know it to-day would be impossible.

## Unfamiliar Names

"Most people have felt the wonder, the awe-inspiring mystery of the devices that permit ready and instant communication over the entire surface of the world. Many people, at some time or another, are curious about the how and why of radio. But usually our daily work claims so much of our attention that this business of radio is accepted, like a lot of other puzzling things, as a matter of course.

"Another reason for the general lack of understanding of radio—for real misunderstanding sometimes—lies in the unfamiliar names so constantly used by those who talk or write about the sending or receiving of programs. Who would know that a grid is simply an abbreviation for a well-known and familiar word gridiron, and that it means a small piece of metal, placed inside an exhausted bulb to do the same sort of job for electric, or electron-currents, that the faucet in the kitchen sink does for the flow of water through the pipe, that is, let a little bit flow when only a little is wanted, and a lot flow when much is needed? Who would suspect from the name, that an electrodynamic speaker means simply a new and infinitely better way of making something move—move more powerfully and more accurately. Names don't explain things, so why should names like kilocycles, Superheterodyne, radio frequency or screen grid mean anything definite to the great majority of persons?

"Actually, all these things do mean something, and in reality

the meaning isn't nearly so difficult or puzzling as the names seem to indicate. The job I've set out to do is simply that of taking apart some of these mysterious words to see what they're made of and then putting them back together again in such a way that they do make sense. Naturally, such a job can't be done in a few minutes—but perhaps we can make a start to-night.

"Everyone knows that broadcast programs are not sent out from the station as sound. Just step out on the back porch and try talking, or even yelling—sending sound—over to Australia or down to the Antarctic! So what the station sends isn't sound.

"You wouldn't really expect it to be, any more than you'd expect the telegraph company to send a slip of yellow paper from place to place along some wires. All the radio broadcast station does is to change the original sound—the music or the voice—into electric currents and then somehow use these electric currents to bump, jar, make splashes in the space around the station. The air hasn't a thing to do with it—broadcasting would go along just the same if all the air were removed from our Earth—although the people who listen to the programs might feel the loss of the atmosphere rather keenly.

## Station Creates Bumps in Space

"So, all a transmitting station does is make a lot of bumps in space. Now, the space behaves very much like jelly—if you bump or jar it in one spot, the disturbance travels—spreads out—and in less than a twinkling of an eye that jar has traveled all around the world.

"Vacuum tubes, of course, make it possible for broadcasting stations to produce the right kind of bumps in space. Incidentally, sending stations are not the only things that make bumps in space. When a spark like lightning jumps from cloud to earth or back again, the bumps produced in space are likely to reach your radio set and cause you to say unkind things about static, whatever that is.

"Now let's look at the other side of the picture for just a moment. These splashes in space—these so-called ether waves—reach your home possessing very little energy. So a receiving set, essentially, is just a gadget that will pick up these minute space disturbances and in some way make the tiny energy coming to the set from far away places control other energy, supplied by batteries or by the house current in your home.

"You see, the energy received from any broadcasting station is much too small to make a loudspeaker operate—you, yourself, must supply that energy but the incoming radio waves must be made to control your local supply. Again vacuum tubes are essential for this. Let's try to paint this picture over again.

"Imagine a nice expensive vase resting peacefully on the piano. Along the street comes a truck, or on the nearby track a train or trolley rushes by. All at once the vase begins to sing; that is, it vibrates. Not all trains or all trucks makes it vibrate—just certain ones. Whenever the bumps—vibrations—caused by the train or truck exactly suit the temperament of that piece of china, off it goes on a song and dance.

"Now the business of building a receiving set, boiled down, consists in providing a series of vases—or one vase with a lot of artistic temperament—that will sing or vibrate whenever

# Mathematics for Experimenters

(Continued from preceding page)

low resistance network where the armature and field from the two branches, and then these considered separately are merely two cases where  $R = E/I$  holds for the two branches and  $A_2$  indicates the total load as before. The efficiency of the motor as a "doer" of work depends upon the maximum mechanical force the motor can develop without getting excessively warm.

Reverting once again to Fig. 4 is not out of order, when it is recalled that one of the most important features of electric illumination tests is that the supply voltage shall be constant, and in some cases it is extremely important that the current shall be uniform also, especially in the case of low voltage lamps where the current flow is a considerably larger fraction of the supply voltage than is the case in illustration. The temperature of the control resistor should not be over 30° Centigrade.

This steady state of current flow is usually attained by the use of storage batteries supplementing the generator or merely the batteries alone where no generator is available.

The standard of illumination are compared by the use of two semi-transparent screens, each placed so as to be readily viewed in a dark box, while the two screens are equidistant from the two light sources and the comparator of the right hand circuit is adjusted until the illumination of the two screens is observed to be similar. It is customary to view the screens with one eye so as to eliminate the influence of any optical defect of the person making the test.

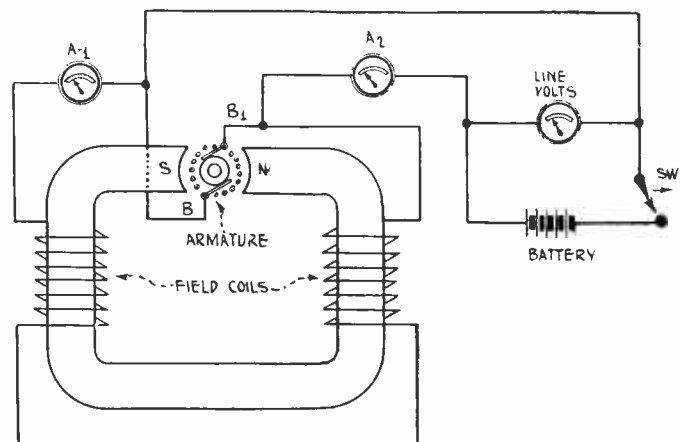

FIG. 5

A CASE WHERE TWO CIRCUITS REACT TO PRODUCE MECHANICAL WORK. INITIALLY THERE IS NO INTERNAL EMF BUT WORK IS DONE WHEN IT APPEARS.

**A Question and Answer Department conducted by Radio World's Technical Staff. Only Questions sent in by University Club Members are answered. The reply is mailed to the member. Join now!**

# RADIO UNIVERSITY

Annual subscriptions are accepted at \$6 for 52 numbers, with the privilege of obtaining answers to radio questions for the period of the subscription, but not if any other premium is obtained with the subscription.

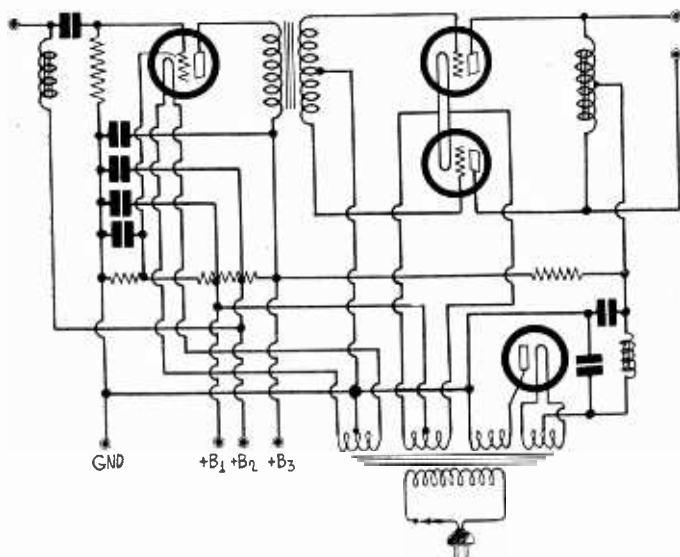

FIG. 852

**THE CIRCUIT OF A TWO STAGE AMPLIFIER WITH A 227 IN THE FIRST STAGE AND TWO 245S IN THE OUTPUT STAGE. THE CIRCUIT ALSO CONTAINS A HALF WAVE RECTIFIER AND A FILTER**

### A Push-Pull Amplifier

**I** HAVE materials for a stage of push-pull utilizing 245 tubes and a stage of single-sided amplification for 227 together with a half wave rectifier. Will you kindly publish a diagram showing how the parts should be connected?—P. A. S.

Fig. 852 seems to meet your requirements. The input is by means of choke, condenser and leak but if you have a transformer it is a simple matter to make substitution. Also, the output is by means of center tapped choke. If you have an output transformer you can use the primary in place of the mid-tapped choke, or you can connect the speaker to the secondary. The B terminals provided are for the radio amplifier and, of course, if you have a separate voltage supply for this they are not necessary. Place the voltage tap for the first tube so that there is about 180 volts between ground and the tap.

\* \* \*

### Why Transformer Gets Hot

**I** HAVE a filament transformer which I use to operate a number of heater type tubes and two 245 power tubes. After I have operated a few hours the transformer gets quite hot. Why does it, and do you suppose that there is something wrong with it?—C. W. C.

Presumably you are overloading the transformer. It has been designed to deliver a certain amount of current, and if you draw more than that there will be overheating. Transformers are designed so that they normally get quite hot, but they should not get so hot that the wax melts. Sometimes even when the transformer is loaded within its rating it gets a little too hot, and this is usually because it is not ventilated enough. See to it that there is a draught past the transformer. This may be insured by drilling holes under and over it. The heat from the transformer will then cause the draught.

\* \* \*

### Engraving Pre-Grooved Records

**H**OW is sound recorded on records which have been pre-grooved? It seems to me that in order to cut the sound into the groove an enormous sound power will be required, much greater than if the record were not pre-grooved. How is this difficulty overcome, if there is a difficulty?—W. H. W.

There is a real difficulty, all right, and it is solved by using a special engraving tool or needle. This tool rounded at the point, or it is relatively blunt, so that it does not go all the way to the bottom of the groove. The sound is cut into the top of the groove only and therefore not a great deal of sound power is needed to operate the cutting tool. In playing the record a similar blunt needle is necessary.

\* \* \*

### Measuring Large Capacities

**I**S there a simple way of measuring the capacity of a large condenser such as those used in B supply units? If so, please explain the method.—E. N. T.

The capacity of a large condenser can be measured in the same way as a resistance by an application of Ohm's law, but to do it it is necessary to have a source of AC voltage of known value and to have a current meter that measures alternating current. For the known voltage that of the lighting circuit may be used, which may be assumed to be 115 volts, unless a meter is available for measuring it accurately. The condenser to be measured is connected in series with the line and also in series with the AC meter. The ratio of the known voltage and the amperage indicated by the meter gives the reactance of the condenser at the frequency of the line voltage. The reciprocal of this ratio is proportional to the capacity and the factor of the proportionality is  $6.2832F$ , where  $F$  is the frequency of the line voltage. Hence the rule is: Divide the indicated current in amperes by the voltage of the line and divide this quotient by  $6.2832F$ , and the result is the capacity of the condenser in farads. Multiply by one million to get microfarads.

Let us take an example. Suppose the voltage of the line is 115 volts, effective value, the indicated current is 175 milliamperes, also effective value, the frequency of the line voltage 60 cycles per second. Therefore  $6.2832F$  equals 377. Dividing 0.175 amperes by 115 volts we get .00152 ohms, and dividing this number by 377 we get 0.000,004,004 farad. Multiplying by one million we get 4.04 microfarads.

\* \* \*

### Principle of the Ohmmeter

**O**N what principle does the direct reading ohmmeter operate? I understand how Ohm's law works but it is not clear to me how it is applied in the direct reading instrument.—C. E. T.

It works on the principle that the current through a resistor is inversely proportional to the resistance if the voltage in the circuit and remains constant. In every ohmmeter a battery of fixed voltage is used and the scale of the ammeter is calibrated on that basis. There is also a fixed resistance in series with the meter which is used solely for protection of the meter. This resistance is such that when the terminals for the unknown resistance are shorted the meter reads full scale. That point is therefore marked zero resistance. As higher resistances are put in series the meter reading is reduced. It is possible to calibrate the meter without the use of standard resistances provided that the current scale is visible at the same time as the resistance scale. Suppose we use a battery of 1.5 volts and we employ a milliammeter having a full scale reading of 1.5 milliamperes. We must put a resistance of 1,000 ohms in series permanently as a protection for the meter. Now if we add 1,000 ohms the current reading will be 0.75 milliamperes, so that point is marked 1,000 ohms. If we put 2,000 ohms in series, not counting the first 1,000 ohms, we get a current reading of 0.5 milliamperes and therefore we mark this 2,000 ohms. In the same manner we locate points for any other resistances we choose. For the calibration we don't need any resistance at all, except the 1,000 protector resistance, because we can assume that we have any resistance whatever and then calculate the current and mark the point suitably in terms of resistance. In calculating the resistance we always add the 1,000 ohm permanent resistance but we do not take it into account in calibrating the scale.

\* \* \*

### Output Voltage of 232

**I**S it possible to get enough output voltage from a 232 screen grid tube to load up a 245 power tube without serious distortion? If so, what are the conditions that should be imposed on the screen grid tube?—K. Y.

It is quite possible to get enough output from the 232 to load up a 245 power tube without a great deal of distortion. The conditions that should be imposed on the tube is set forth in the curves in Fig. 62, page 8, Sept. 27th issue. The screen voltage should be 22.5 volts, the plate battery voltage 202.5 volts or more, the load resistance 250,000 ohms, and the grid bias 1.25 volts negative. The signal input amplitude to the screen grid tube may be 0.75 volts.

\* \* \*

### Scanning Line Standards

**H**OW many scanning lines per frame are used as standard in most of the experimental laboratories? What is the chance that the standard now used will be adopted finally?—A. B. H.

Most transmitting stations in this country now use 48 lines per frame, and this is the standard adopted temporarily by the Radio Manufacturers Association. However, there are still some that use 24 lines, 30 lines, 50 lines, and 60 lines. One might say that there is no standard number. There is little likelihood that 48 lines will be adopted ultimately as the standard because it is not capable of fine enough definition of the picture. Possibly 60, 72, or even 100 will be used.



**Ohm's Law Again**

I WANT to tap a voltage divider so that I get voltages of 45, 67.5, 90, 135, and 180 volts. The total voltage across the voltage divider is 300 volts. Will you kindly tell me where to put the taps so as to get the desired voltages? That is, tell me the values of the resistances between adjacent taps.—R. G. H.

The problem is indeterminate because you have not specified the currents which will flow in the various resistance sections, nor have you given any information on which to form an estimate of the current. The placement of the taps is essentially an application of Ohm's law, and to apply that law it is necessary to know two of the three quantities involved.

\* \* \*

**Results with Short-Wave Converter**

I BUILT one of the short-wave converters which you described a short time ago, and I have been using it with a superheterodyne. I am not getting satisfactory results. What do you think is the reason?—L. A. J.

You did not say which converter you built nor with which superheterodyne you tried to operate it. It is possible that there is not enough radio frequency amplification in the superheterodyne. That is the usual reason why converters of the superheterodyne type do not work well with broadcast superheterodynes. In such cases it may be better to skip the radio frequency amplifier and the oscillator in the superheterodyne and couple the converter to the intermediate frequency amplifier. This will work if the intermediate frequency in the superheterodyne is of the order of 100 kc or higher.

\* \* \*

**Effect of Silver Plating**

WHAT is the advantage of using silver plated wire for tuning inductances? Does it make the selectivity of the coils greater or is silver used for decorative purposes?—T. C. F.

High frequency currents are concentrated near the surface of the wire and therefore if the surface layer of the wire is the best possible conductor, the selectivity of the coil will be high, that is, the resistance will be low. Of course, the thickness of the surface layer of the silver is very small so that the gain in selectivity is not great. The coil made of silver plated wire looks much better than other bare wire and it does not corrode like other wire. Hence the advantage is not only lower resistance but better appearance and permanence.

\* \* \*

**Effectiveness of Grid Suppressors**

HOW is it possible to suppress oscillation in an amplifier by putting a high resistance in the grid lead when no signal current flows in the grid circuit? If there is no current flowing through the suppressor there is no voltage drop in it and hence it cannot do any good. We either have to abandon the theory that no current flows in the grid circuit or else find some other explanation for the effectiveness of grid suppressors. Or so it seems to me, at least.—A. B. L.

That's right. We have to abandon the theory that no current flows in the grid circuit at radio frequency. There is a small current flowing because of the effective input capacity of the tube. This capacity may be 5 mmfd. or more and this is sufficient to account for the current that flows through the suppressor. At very high frequencies the current through 5 mmfd. may be quite high, and at broadcast frequencies it may also be considerable, especially at the higher frequencies in this band.

\* \* \*

**Band Coverage Facts**

WHAT are the conditions for the coverage of the broadcast band with a tuning condenser? Some broadcast receivers tune from below 550 kc to well above 1,500 kc while other receivers fail to cover the band by a wide margin. What determines when a condenser does or does not cover the band?—E. S. S.

The determining factor is the ratio of the change in capacity of which the condenser is capable to the minimum capacity in the tuned circuit when the condenser is set at minimum. This ratio must be 6.44 or greater. Thus if the capacity of the tuning condenser can be changed by .0005 mfd., the capacity in the circuit when the condenser is set at zero should be 77.6 mmfd., or less if the band is to be covered. If the capacity of the tuning condenser can be changed by only .00035 mfd. the minimum capacity cannot be larger than 54.4 mmfd. It is very difficult to design a circuit so that the minimum capacity is as low as that, especially if the coils are shielded, and it is for that reason that with .00035 mfd. tuning condensers the broadcast band can seldom be covered.

\* \* \*

**Curves for the 240 Tube**

If you have a characteristic curve of the 240 tube showing its performance in a resistance coupled circuit, please publish it. Or if you have published it recently, please refer to the issue in which it appeared.—V. A. V.

One of the curves in Fig. 853 is for the 240 tubes. As stated on the graph, the curve is for a plate battery voltage of 149 volts and a load resistance of 420,000 ohms, the measured value of a resistor rated at 500,000 ohms. The curvature at the top of the curve for the 240 tube is due to the fact that AC was used on the filament and that the grid drew current when the grid voltage with respect to the mid-point of the filament was less than 3.5 volts. The grid bias for amplification should be 5.5 volts since that point falls at the point of symmetry of the curve.

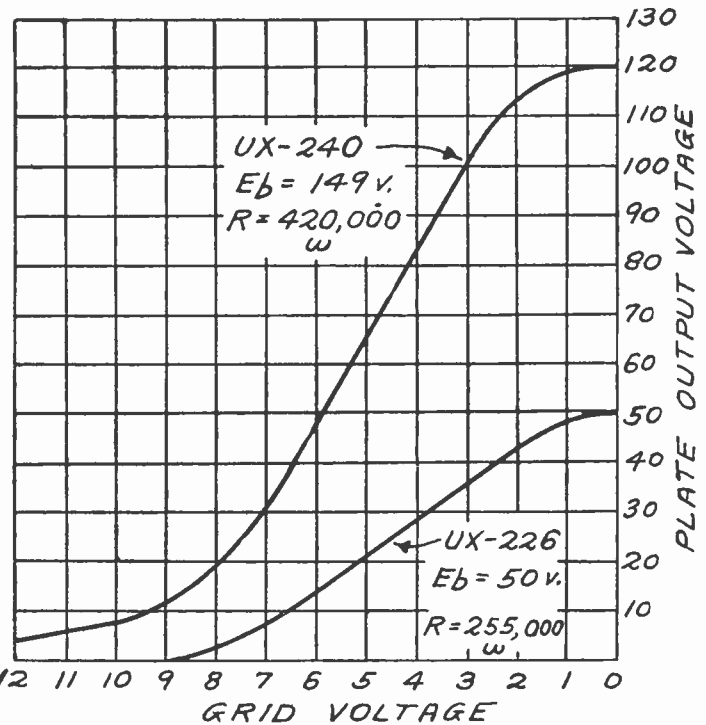

FIG. 853

THE UPPER CURVES IN THE GRAPH IS THE PERFORMANCE CHARACTERISTIC OF THE 240 HIGH MU TUBE WHEN WORKING INTO A HIGH RESISTANCE WITH AC ON THE FILAMENT. WITH DC ON THE FILAMENT THE CURVE WILL GO HIGHER UP AT LOW BIAS VALUES

**Single Control Superheterodyne**

WHAT is the condition for successfully building a single dial superheterodyne in which there is at least one sharp radio frequency tuner in addition to the oscillator tuner?—J. C. B.

The condition is that the RF circuit and the oscillator condensers tunes to frequencies differing by the intermediate frequency at all points of the dial. This may be accomplished by using straight line frequency condensers or using specially cut plates on one of them. It is not a simple matter to accomplish it and the better way is to provide a trimmer for one of the tuned circuits.

Join

Radio World's

**UNIVERSITY CLUB**

And Get Free Question and Answer Service for the Coming 52 Weeks. This Service for University Subscribers Only

Subscribe for RADIO WORLD for one year (52 numbers). Use the coupon below. Your name will be entered on our subscription and University Club lists by special number. When sending questions, put this number on the outside of the forwarding envelope (not the enclosed return envelope) and also put it at the head of your queries. If already a subscriber, send \$6 for renewal from close of present subscription and your name will be entered in Radio University.

**NO OTHER PREMIUM GIVEN WITH THIS OFFER**

[In sending in your queries to the University Department please paragraph and number them. Write on one side of sheet only. Always give your University Club Number.]

RADIO WORLD, 145 West 45th Street, New York City. Enclosed find \$6.00 for RADIO WORLD for one year (52 nos.) and also enter my name on the list of members of RADIO WORLD'S UNIVERSITY CLUB, which gives me free answers to radio queries for 52 ensuing weeks, and send me my number indicating membership.

Name .....

Street .....

City and State .....

# NOVELTIES WIN ATTENTION AT NEW YORK FAIR

The novelties and standbys of 1930-31 radio were exhibited at the Seventh Annual Radio World's Fair at Madison Square Garden, New York City. The fair lasted a week, simultaneously with national radio week and the celebration of the first decade of broadcasting.

The following were among the novelties of the manufactured receivers:

- (1)—Home sounding recording.
- (2)—Tone control.
- (3)—Automatic volume control.
- (4)—Automatic clock tuning.
- (5)—Compact receivers, suitable for mantleshelves.
- (6)—An A battery that thrives on the oxygen of the air, and has a useful life of 1,000 hours.

## Details of Home Recording

Home sound recording was described as a new parlor amusement, in that the possessors of the equipment can make phonograph records of the playing, talking and singing of friends and relatives, and even indulge their own vanity.

The same device permits the recording of broadcast programs. The record can be played about sixteen times before it becomes worn beyond the advisability of further use.

For recording of the sounds made in the home a microphone is used for pickup, and the voltage produced is put through the audio amplifier of the receiver. At the output of the amplifier is connected the engraving head, which is a sort of inverted phonograph pickup. The needle of the head makes indentations on a blank record consistent with the audio fluctuations emitted by the output tube or tubes, as this blank is moved by a regular turntable.

There are two types of blank records. One system uses grooved records, as some track is necessary to keep the needle in concentric motion. The other system has a gear attached to the turntable, and thus the recording head is caused to travel at the same speed of rotation as the turntable, and to move concentrically to cover the surface.

The records are 6 inches and 10 inches. The 6-inch record will play for about 1 minute and 15 seconds and the 10-inch record about 2 minutes and 25 seconds.

## Tone Control Popular

Tone control consists of turning a knob or a switch so that certain audio frequency regions of tonal response will be accentuated. Thus, if one is listening to a speech, the fullest response in the high audio frequency region will be sought, so that the sibilants will be crisp and speech will be most intelligible. This is done by turning the control to "treble" or "brilliant." In the same way, music may be accentuated, to bring out the violins or the piccolos. Also, the middle register may be accentuated, or the bass. A minimum of three positions is offered, while a fourth position, representing cutting the tone control out of circuit, is present in some receivers.

The purpose of the tone control is to enable the operator to have the reproduction sound as he desires. Thus his taste is suited and he gets better enjoyment out of his radio. In many instances defects in hearing are atoned for, since persons who have a dull response to

## Vatican Takes Over Marconi's Broadcaster

Vatican City.

The high-power broadcasting plant erected here by the Marconi Company has been formally taken over by the Pope. This plant, which was constructed under the personal supervision of Senatore Guglielmo Marconi himself, is now one of the most powerful radio transmitting stations in Europe. In accepting the plant His Eminence bestowed high praise on Mr. Marconi, who was the first to utilize radio waves for practical communication. The plant was officially consigned to the care of Father Gianfranceschi, the chaplain-scientist of the Nobile Arctic expedition in 1928.

bass can build up the bass in compensatory manner.

## Automatic Volume Control

Automatic volume control started to become popular with some of last season's receivers, but this year the inclusion of such controls is almost the rule in the better grade sets. The general method used is to couple an extra tube to the detector, because the radio frequency voltage is highest here, and to have this extra tube so biased that increases in carrier intensities increase the plate current flow in the tube. Hence any biasing resistor through which this current flows provides increased bias with increased carrier intensity, hence decreases the volume as the original amplitude increases. This resistor may be the common bias for RF tubes. Thus is a leveling effect produced.

Some receivers have automatic volume control without an extra tube. One way of doing this is to operate radio frequency amplifiers on a higher negative bias than commonly prevails. This, with power detection, produces in all radio and detecting circuits the same general effect of increased bias with increased carrier amplitude.

## Time Clock Tuning

Automatic clock tuning is beginning to show itself. This consists of a time switch and motor, whereby it is possible to set the time switch in advance, to tune in different stations at different hours. Thus, if one arrives home from work with the evening newspaper and makes his selection of stations for given periods of the evening, or even for a full twenty-four hours, the clock mechanism and time switch will actuate a motor, and cause the desired stations to be tuned in at the proper time, and the set to be turned off and on again as registered.

## Compact Receivers

Mantle receivers are being made by nearly all set manufacturers. These are compact AC sets, usually with two stages of screen grid radio frequency amplification, detector, and two single-sided audio stages. The design of the cabinet is generally Gothic, and follows the cabinet designs of last year's separate dynamic speaker housings. Into the compact sets the speaker is built, too, so that a fairly good receiver is housed in a small cabinet that will fit almost anywhere. A feature of these compact sets is low price, the list being around \$50 in many instances. This price includes everything except tubes.

The A battery that "breathes" is the product of the National Carbon Company. One point stressed in favor of this battery is that it serves as well even those tubes that are critical as to filament voltage, such as the 230 general purpose tube, the 231 power tube and 232 screen grid tube. These are the new 2-volt battery tubes of low power consumption.

The screen grid tube is used in nearly

all the receivers, including those manufactured by companies that did not go in for screen grid receivers last season. Some manufacturers, besides Radio Corporation of America and associates, are out with Superheterodyne receivers, now that the licensees are permitted to use this circuit, and screen grid tubes are used in the Superheterodynes, too.

Another interesting point was the appearance of automobile sets. While manufacturers have not gone into this field with much enthusiasm, some of them have taken quite the other view, hence a few have made preparations as if expecting a large volume of business from this direction.

## Anxious About Business Situation

The business situation was discussed by nearly all the manufacturers. The depressed condition of business is making itself felt on radio as well as on other lines of merchandise, and while sales in encouraging quantity had not begun yet, it was expected that weather conditions and a general hold-back of revelations until the fair was held, had much to do with the reluctance of the public to buy in quantities. It was expected that within a few weeks business would pick up at a greater momentum than during the corresponding period last year, so that the total turnover for 1930 should exceed that for 1929.

Parts manufacturers, as during the last few years, were not very substantially represented at the show. One exception was the Hammarlund Manufacturing Company, which had a new line to exhibit, and drew admiring attention because of its improved Hi-Q 31, a model of excellence in cutsum set building.

National Company, of Malden, Mass., drew considerable crowds, because of its new short-wave receiver and equipment and its remarkable AC screen grid tuner, the MB-30, designed by James Millen and Prof. Glenn H. Browning. Also, National Company showed its new short-wave tuning condenser and coils, its Velvetone push-pull power amplifier and special laboratory testing and measuring equipment of extreme precision.

## National's Thrill Box

The short-wave receiver, known as the Thrill Box, was displayed in AC and battery-operated forms. The AC model consists of a receiver separate from the B supply, and operates without hum. The reception of countless foreign stations, from many points of the United States, was the subject of verifications posted about the booth. National Company also showed its Kinematic remote control device.

Electrad, Inc., exhibited its complete line of resistors and other equipment. The resistors included voltage dividers, grid suppressors, biasing resistors and Tonatrol volume controls.

Besides, parts manufacturers that cater exclusively to set manufacturers and to makers of commercial equipment exhibited their new and continuing models of apparatus.

## Crystal Room Attracts Many

The Crystal Room was in full blast during the show. This consisted of a glass-enclosed studio. The National Broadcasting Company and the Columbia Broadcasting System used the Crystal Room as their own studio for many hours, as a feature that drew large crowds, some of whose members never before had seen a broadcast actually take place. Other stations contributed to the exhibition of talent.

One of the two treats to some members of the crowd was to see how talkies are made. In connection with this a publicity stunt was worked by a talkie producing company whereby tests were made of vocal qualities of show visitors, with the promise that winners would get at least a temporary job in Hollywood.

# 50 K W PLEAS MEET REBUFF OF BOARD AID

Washington.

Pleas by broadcasting stations for increase of power to 50,000 watts, made at hearings that are being held regularly by the Federal Radio Commission, met with objections from the chief engineer of the Commission, Dr. C. B. Jolliffe, that the Board should not deviate from its general order limiting the number of cleared channels to twenty for 50,000-watt operation. There are ninety-six channels in the broadcasting spectrum, ninety held by Dr. Jolliffe feared the blanketing effect of too many high-powered stations, and advised the Commission to go slowly in granting authority to use the maximum power. Questioned by a representative of a petitioning station, Dr. Jolliffe said that the Commission had not been able to make a study of its own of the effect of use of 50,000 watts because it had't the man-power.

WOR, Newark, N. J., operated by a subsidiary of a department store; WJZ, a New York station with transmitter in Bound Brook, N. J., and WHAM, the Stromberg-Carlson station, Rochester, N. Y., were heard.

## A Knotty Problem

WOR and WJZ, as applicants, presented an especially difficult problem to the Commission, as both stations are in the first zone, and there is only one channel, under the general order, that could newly get 50,000 watts. Now WJZ uses 30,000 watts, but asserts it could give better results to a larger area if granted the requested increase.

WJZ is an outlet of the National Broadcasting Company, and this fact was cited as an additional reason why this station should be given preference, although it was pointed out there was no dispute with any other applicant.

Some facts about the estimated service areas were adduced. C. W. Horn, general engineer of the National Broadcasting Company, testified that with its present 30,000 watts WJZ's steady day-and-night service area was 27½ miles radius, and estimated that the additional 20,000 watts would increase this to a 32-mile radius. The present dependable area is inhabited, he added, by 6,500,000 persons, whereas the 32-mile radius would bring the well-served population up 50 per cent.

WWJ, Detroit, Mich., operated by the Evening News Association, in seeking 50,000 watts set forth that its service area is spotty, because to the north and northeast the signals are attenuated, due to tall buildings.

## Lost \$544,219

To the south, southwest and west satisfactory reception is obtained for 18 or 20 miles, said Walter R. Hoffman, chief engineer of the station, but that 3,800,000 persons in Michigan can not be served adequately with the present power. If the 50,000-watt petition is granted the transmitter would be moved outside the city limits, the increased power, it is believed, resulting in bringing the poor reception in the slighted part of Detroit up to a satisfactory standard.

The station reported an operating loss of \$544,219 for the ten years ending August 1st, 1930, and stated its loss last year was \$69,000.

# \$10,000,000 for 1931 NBC Programs

It will cost approximately \$10,000,000 to provide talent for the sponsored and sustaining programs which will be broadcast over the National Broadcasting Company networks during the year of 1931, M. A. Aylesworth, president of the NBC, has estimated.

This is not the major cost in bringing NBC programs to the national radio audience. The cost of operation, exclusive of the fees paid to entertainers, will reach twenty million dollars, it was declared.

"We plan to make the year 1931 the most interesting and progressive in radio broadcasting," said Mr. Aylesworth. "Owners of radio sets can be assured of front seats at a continuous three-hundred-and-sixty-five-day-and-night performance of the world's finest entertainers, together with high-lights of public events, sports and public affairs, with impressive programs in religious, educational and agricultural broadcasting.

"In other words, the year 1931 will bring to the people of the United States greater public service through radio broadcasting."

# W A B C Has Site for 50 K W Use

Washington.

WABC, New York City, outlet of the Columbia Broadcasting System, which station has had a construction permit for a 50,000-watt station for many months, but has been unable to make any headway, due to protests every time it tried to pick out a site, at last has prevailed upon the Board of Public Utility Commissioners of New Jersey to let it have a trial as a 50,000-watt station in Wayne Township, Passaic County, N. J.

The Columbia System has sent a request to the Federal Radio Commission, stating that the site is now open to it, and asking approval. In this communication the Columbia System set forth:

"We wish to point out that within a radius of one-half mile of the proposed site there are only twelve homes, of which five have receiving sets; one-mile radius, 142 homes, seventy-three receiving sets; one and one-half miles, 417 homes, 210 receiving sets. These figures were determined by actual count in a house-to-house survey.

"Also attached to our application is a statement showing a computation of field strength in millivolts per meter of a fifty-kilowatt transmitter at Wayne, N. J. These computations were made after the degree of attenuation had been determined by the Bell Telephone Laboratories. It is the consensus of the engineering fraternity that the greatest field strength value shown in this compilation, namely 1,210 millivolts per meter for the first mile radius, is not an excessive signal strength from the standpoint of good reception for the whole service area, including an estimated audience of at least 9,000,000 persons."

At present WABC, with transmitter at Crossbay Boulevard, Queens County, N. Y., operates on 5,000 watts.

## NEW CORPORATIONS

Supertone Products Corp.; radio; attorney, S. Widder, 217 Havemeyer street, Brooklyn, N. Y.  
 Alben Radio Corp.; attorney, M. Friedburg, 18 East 41st street, Bronx, N. Y.  
 Talking Picture Appliance Service, Inc., Wilmington, Del.; Colonial Charter Co.

# R F IS PROVING AID TO HEALING BY HEAT FOCUS

Washington.

High radio frequencies are now being employed in experimental medicine in the creation of artificial fevers with a view of developing their possible curative properties, reports Dr. C. B. Jolliffe, chief engineer of the Federal Radio Commission.

The subject is being studied in private laboratories with considerable success, he stated. It has been found possible, he continued, to heat the internal organs of experimental animals without affecting the external tissues and the skin, and thus to obtain the diathermic benefits of the impulses.

The possible hazard to the human constitution from exposure to high frequencies is being investigated at the Naval Research Laboratory, at Bellevue, D. C., according to Capt. William H. Bell, chief of preventive medicine of the Navy. So far no ill effects have been detected, he said.

Experiments will be continued by the Navy to learn the therapeutic value of ultra-high frequencies, said Dr. Bell, but it is devoting its attention to the preventive side at present. Frequencies as high as 60,000 kilocycles have been used to induce artificial fevers, according to Dr. Bell.

According to reports to the Federal Radio Commission, some spectacular demonstrations of the properties of the ultra-high frequencies have been made.

Thus tomatoes have been cooked inside the can without heating the can itself other than by conduction from the heated contents, and eggs have been boiled inside a glass jar without directly heating the glass container.

It is possible by means of special apparatus to concentrate the effect of the electrical waves to a given spot.

## Lodge's London Talk Heard on Chain Here

Sir Oliver Lodge, famous English physicist and spiritualist, in a talk in London, which was rebroadcast in America over the Columbia Broadcasting System, cited recent trends in science as evidence of the existence of the spirit apart from the body.

"I believe," said Sir Oliver, "that existence is continuous and that death is not a break in its continuity, but a mere sloughing off of the material body. We go to a spiritual body, a body which we have, though it makes no appeal to a large percentage of us. We shall continue in the spiritual body when the material body has been left behind."

In radio Sir Oliver is known as the inventor of tuning. Those who read the early works on radio will discover that he used "syntony" for selecting one frequency to the exclusion of others. Syntonized circuits are tuned circuits.

## SECRECY IS SOUGHT

The Hague

The Dutch Postal officials are now testing an invention between The Hague and the Dutch East Indies by which it is hoped that secrecy in transatlantic radio-telephone talks may be obtained. At present any amateur with a suitable set can listen in to the conversations.



# KEY TUBES

Quality First

Despite the severely low prices the Key tubes are firsts of the very first quality. The tubes are manufactured under licenses granted by the RCA and its affiliated companies. All prices are net.

The KEY RADIO TUBE CO.  
145 West 45th St., New York City

Enclosed please find \$..... for which ship at once as marked below:

- |  |   |
|--|---|
| <input type="checkbox"/> 224 AC S. Grid.....\$1.43 | <input type="checkbox"/> 245AC Power tube \$1.10  |
| <input type="checkbox"/> 226 AC Ampl. .... .68     | <input type="checkbox"/> 227 AC det-amp... .85    |
| <input type="checkbox"/> 228 Batt. S. G..... 1.88  | <input type="checkbox"/> 201A Patt. .... .53      |
| <input type="checkbox"/> 112A Power ..... .78      | <input type="checkbox"/> 171A Power ..... .78     |
| <input type="checkbox"/> 280 AC Rectif. .... 1.00  | <input type="checkbox"/> 281 AC Rectif. .... 1.95 |
| <input type="checkbox"/> 199UX or UV..... .78      | <input type="checkbox"/> 250 AC Power..... 2.95   |

Name .....  
Address .....

City ..... State.....  
 Put cross if C. O. D. shipment is desired.

**5-DAY MONEY-BACK GUARANTEE**

**Orders - Inquiries**

60 pages  
Send for  
**FREE COPY**

Can be  
Secured  
by  
**MAIL**

**POLK'S REFERENCE BOOK  
and Mailing List Catalog**

Writes counts and prices on over 8,000 different lines of business. No matter what your business, in this book you will find the number of your prospective customers listed. Valuable information is also given as to how you can use the mails to secure orders and inquiries for your products or services.

Write for Your FREE Copy  
**R. L. POLK & CO., Detroit Mich.**  
Largest City Directory Publishers in the World  
Mailing List Compilers—Business Statistics  
Producers of Direct Mail Advertisers

## LOWEST PRICES on FINEST PARTS!

- |   |        |
|---|--------|
| <input type="checkbox"/> Edison 30-henry choke.....           | \$ .85 |
| <input type="checkbox"/> Edison 60-henry choke.....           | 1.65   |
| <input type="checkbox"/> Voltage dividers, all kinds.....     | .95    |
| <input type="checkbox"/> Victor 1 to 3 audio transformer..... | 1.05   |
| <input type="checkbox"/> Edison 1 to 3 audio transformer..... | .95    |

Everything in Radio at Bargain Prices!

Send for Bulletin!

**JACOB KAHN**

Suite 613A, 145 West 45th Street, New York, N. Y.

## Songwriters Service Co.

6719 Hollywood Boulevard, Dept. R. W.  
Hollywood, California

Talking Pictures offer new opportunities. Your songs personally submitted to Picture Studios, revised for publication by Hit Writers. Words, Music, Arranging, everything pertaining to songs.



## Your Choice of NINE Meters!

To do your radio work properly you need meters. Here is your opportunity to get them at no extra cost. See the list of nine meters below. Heretofore we have offered the choice of any one of these meters free with an 8-weeks subscription for RADIO WORLD, at \$1, the regular price for such subscription. Now we extend this offer. For the first time you are permitted to obtain any one or more or all of these meters free, by sending in \$1 for 8-weeks' subscription, entitling you to one meter; \$2 for 16 weeks, entitling you to two meters; \$3 for 26 weeks, entitling you to three meters; \$4 for 35 weeks, entitling you to four meters; \$5 for 44 weeks, entitling you to 5 meters; \$6 for 52 weeks, entitling you to six meters. Return this offer with remittance, and check off desired meters in squares below.

RADIO WORLD, 145 West 45th Street, New York, N. Y. (Just East of Broadway)

Enclosed please find \$..... for..... weeks subscription for RADIO WORLD and please send as free premium the meters checked off below.

I am a subscriber. Extend my subscription. (Check off if true.)

- |   |         |
|---|---------|
| <input type="checkbox"/> 0-6 Voltmeter D.C. ....        | No. 326 |
| <input type="checkbox"/> 0-50 Voltmeter D.C. ....       | No. 327 |
| <input type="checkbox"/> 6-Volt Charge Tester D.C. .... | No. 328 |
| <input type="checkbox"/> 0-10 Amperes D.C. ....         | No. 338 |
| <input type="checkbox"/> 0-25 Milliampers D.C. ....     | No. 325 |
| <input type="checkbox"/> 0-50 Milliampers D.C. ....     | No. 350 |
| <input type="checkbox"/> 0-100 Milliampers D.C. ....    | No. 390 |
| <input type="checkbox"/> 0-300 Milliampers D.C. ....    | No. 399 |
| <input type="checkbox"/> 0-400 Milliampers D.C. ....    | No. 394 |

NAME .....

ADDRESS .....

CITY..... STATE.....

## RADIO WORLD and "RADIO NEWS"

BOTH FOR ONE YEAR @ **\$7.00**

You can obtain the two leading radio technical magazines that cater to experimenters, service men and students, the first and only national radio weekly and the leading monthly, for one year each, at a saving of \$1.50. The regular mail subscription rate for Radio World for one year, a new and fascinating copy each week for 52 weeks, is \$6.00. Send in \$1.00 extra, get "Radio News" also for a year—a new issue each month for twelve months. Total, 64 issues for \$7.00

If renewing Radio World subscription, put cross in square at beginning of this sentence.

If renewing Radio News subscription, put cross in square at beginning of this sentence.

RADIO WORLD, 145 West 45th Street, New York, N. Y.

**HAMMARLUND DOUBLE DRUM DIAL**—Each section individually tunable. List price \$6—our price, \$3. Guaranty Radio Goods Co., 143 W. 45th St., New York.

**HOTEL LUDY**

SOUTH CAROLINA AVE. AT THE BOARDWALK  
**ATLANTIC CITY'S**

NEWEST CENTRALLY LOCATED  
FIREPROOF HOTEL

**\$6.00**  
DAILY AND UP  
AMERICAN PLAN

WIRE PHONE OR WRITE **R.B. LUDY M.D.**

## SOLDERING IRON FREE!



Works on 110-120 volts, AC or DC; power, 50 watts. A serviceable iron, with copper tip, 5 ft. cable and male plug. Send \$1.50 for 13 weeks' subscription for Radio World and get these free! Please state if you are renewing existing subscription.

**RADIO WORLD**

145 West 45th St. N. Y. City

## SUBSCRIBERS!

Look at the Expiration Date on Your Wrapper

Please look at the subscription date stamped on your last wrapper, and if that date indicates that your subscription is about to expire, please send remittance to cover your renewal.

In this way you will get your copies without interruption and keep your file complete.

SUBSCRIPTION DEPARTMENT

**RADIO WORLD**

145 WEST 45TH ST., N. Y. CITY

"RADIO TROUBLE SHOOTING," E. R. Haan. 328 pages, 300 illustrations, \$3. Guaranty Radio Goods Co., 143 W. 45th St., New York.

# Quick Action Classified Ads

Radio World's Speedy Medium for Enterprise and Sales

7 cents a word—\$1.00 minimum—Cash with Order

### MODEL AEROPLANES

"CITY OF CHICAGO" WORLD'S DURATION PLANE—30" Plan 20c. Model Aviator, Dept. RW, 601 Washington, Chicago.

**BARGAINS** in first-class, highest grade merchandise. B-B-I. phonograph pick-up, theatre type, suitable for home with vol. control, \$6.57; phono-link pick-up with vol. control and adapter, \$3.50; steel cabinet for HB Compact, \$3.00; four-gang .00035 mfd. with trimmers built in, \$1.95; .00025 mfd. Dubilier grid condenser with clips 18c. P. Cohen, Room 1214, at 143 West 45th Street, N. Y. City.

**SONG WRITERS**—Poems, Melodies. Opportunity. Tommie Malie, RW4215 North Ave., Chicago.

**TUBE "SECONDS"**—Good service from tubes that are called "seconds"—but they are good "seconds" not bad "thirds." Try UV199 @ 75c; 250 @ \$1.00. Direct Radio Co., 1562 Broadway, New York.

**POWER UNIT CONSTRUCTION**—The book that enables you to wind your transformers, chokes, and figure correct size resistors for the voltage control, and other valuable information. Price .50. Shipped C. O. D. Ralph B. Davis & Co., Prestonsburg, Ky.

**FREE! SMALLEST POSTAGE STAMP IN THE WORLD** with each packet of 100 foreign stamps for 8c. Chaplin Stamp Co., 2509 W. North Ave., Baltimore, Md.

"A B C OF TELEVISION" by Yates—A comprehensive book on the subject that is attracting attention of radioists and scientists all over the world. \$3.00, postpaid. Radio World, 145 West 45th St., N. Y. City.

**HORN UNIT, \$2.25**—This is the Fidelity Unit and has stood the test of time. Guaranty Radio Goods Co., 143 W. 45th St., New York.

# NEW POLO

POWER EQUIPMENT  
in Polished Aluminum Shield Cases

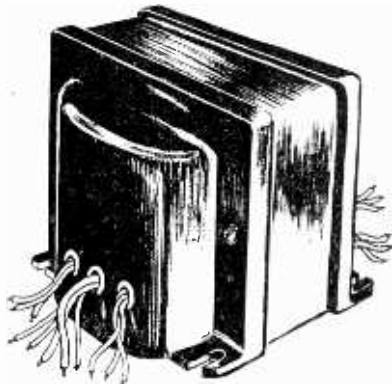

## 245 POWER TRANSFORMER

The 245 power transformer is for use with a 280 rectifier tube, to deliver 300 volts DC at 100 milliamperes, slightly higher voltage at lower drain, from a 110-volt AC line, 50-60 cycles. The primary is tapped at 82½ volts in case a voltage regulator (Clarostat or Amperite) is used. The black primary lead is common. If no voltage regulator is used the other primary lead is the green one, so tape the end of the red. If regulator is used, tape the end of the green and use the red with the black. The secondary voltages are all center tapped: 672 volts AC for 280 plates, 2½ v. 3 amps. for 245 output single or push-pull; 3 v. 2 amps. for 280 filament; 2½ volts 16 amps. for up to eight 224 or 227 tubes. Center taps are red and all leads are identified on name plate. The core is larger than formerly and won't saturate at 100 ma. Laminations hidden except at bottom. Eight-inch leads emerge from the sides, but if preferred may be taken off through the bottom of the transformer by pushing them through the rubber grommets. Shipping weight, 12 lbs. Overall size, 5" from left to right as illustrated; 4¼" from bulging bell end to other bell end; 4¼" high.

Order Cat. 245-PT (12 lbs.) @ ..... \$ 9.50  
For 40 cycles order Cat. 245-PT-40  
(14 lbs.) @ ..... 10.50  
For 25 cycles order Cat. 245-PT-25  
(16 lbs.) @ ..... 12.00

## 250 POWER TRANSFORMER

The 250 power transformer supplies voltages for two 281 rectifiers, to power 250 output, single or push-pull. The secondaries all center-tapped, are 1,200 volts AC for 281 plates; 7½ v. 3 amps. for two 281s; 7½ v. 3 amps. for one or two 250s; and 2½ volts, 16 amps. for up to eight 224s and 227s. 5" x 5½" x 4¼"; shipping weight, 16 lbs.

Order Cat. 250-PT (16 lbs.) @ ..... \$12.50  
For 40 cycles, order Cat. 250-PT-40  
(18 lbs.) @ ..... 13.50  
For 25 cycles, order Cat. 250-PT-25  
(20 lbs.) @ ..... 15.00

## 245 CHOKE COIL

100 ma choke coil for B filtration in 215 push-pull or single 245 circuits, 200 ohms DC resistance, inductance 30 henrys, a continuous winding tapped in two places, giving three sections and four overloads, and permitting a "choke input" to filter.



By this method rectifier tube life and filter condenser life are lengthened yet filtration is splendid. The black lead goes to the rectifier filament center, the red, green and yellow leads are next in order. Capacities suggested: black, none; red, 1 mfd.; green, 8 mfd.; yellow, 8 mfd. in shielded polished aluminum case. Shipping weight, 4 lbs. Order Cat. 245-CII @ \$4.00.

[We can supply the high voltage condensers as follows: 1 mfd., paper dielectric, @ \$1.50 each; 8 mfd. electrolytic @ \$1.50 each.]

## 250 CHOKE COIL

A larger choke is used for the 250 type B supply, consisting of a continuous winding tapped. Inductance, 40 henrys, DC resistance 150 ohms. Shipping weight, 5 lbs. Order Cat. 250-CII @ \$5.00.

## CENTER-TAPPED CHOKE

30 henrys, 150 ohms DC resistance, 100 ma rating, with two black leads emerging, and red center tap. For use in 245 or 250 push-pull output where a dynamic speaker that has its own output transformer is used. The impedances are thus satisfactorily matched. Connect the black leads to the plates of the push-pull tubes and the red to positive B. The tipped cords of the speaker (or primary of the output transformer built into the speaker) go to the plates also. Connection must not be made direct from plates to voice coil. This choke may also be used instead for filtration of B supplies, either as a single choke, by ignoring but taping the red lead, or as a double by using all three leads. Either black lead would go to rectifier. Shipping weight, 4 lbs. Order Cat. CT-CH @ \$3.50.

**SPECIAL FILAMENT TRANSFORMER**  
A special filament transformer, 110 v., 50-60 cycles, with two secondaries, one of 2½ v. 3 amp. for 245s, single or push-pull, other 2½ v. 12 amperes for up to six 224, 227, etc., both secondaries center-tapped. Shielded case, 6 ft. AC cable, with plug. Shipping weight, 4 lbs. Order Cat. SP-FLT (4 lbs.) @ \$4.25  
For 40 cycles, Cat. SP-FLT-40 (7½ lbs.) @ 5.00  
For 25 cycles, Cat. SP-LT-25 (6½ lbs.) @ 6.00

**POLO ENGINEERING LABORATORIES**  
143 West 45th Street, New York, N. Y.

# AMER-TRAN'S NEW POWER AMPLIFIERS



The American Transformer Company, makers of superb power amplifiers and components, has a new and marvelous line of push-pull power amplifiers, known as the "Series 80."

The six-tube power amplifier illustrated above is a three-stage system, with 227 first and second audio, and 250 push-pull output. Two 281 rectifiers are used, full wave. The first stage is transformer coupled, the second impedance coupled and the third transformer coupled. It is not intended this, or any other "Series 80" power amplifier, supply any voltage to any other device, e.g., a tuner. The five binding posts are two each for input and output and one for ground.

The input or primary of the first transformer has an impedance of 500 ohms, for general use, including microphone input. Input impedance of 2,000 or 4,000 ohms can be furnished instead, on request. The final output has an impedance of 15 ohms, for dynamic speaker voice coils, but 500-ohm impedance for line transformers and 4,000-ohm impedance for magnetic speakers can be furnished instead, on request.

The three-stage 250 push-pull power amplifier is Cat. PA-86 and lists for \$195, wired, less tubes. Net price, \$114.66.

The three-stage product, with 245 push-pull output, has the same general appearance, audio circuit and impedance factors at input and output, but five tubes instead of six, due to the use of a 280 rectifier. This is Cat. PA-84, list price, \$160, wired, less tubes; net price, \$94.08.

The five-tube two-stage amplifier with 250 push-pull output, is Cat. PA-85, list price, \$180, wired, less tubes; net price, \$105.84.

The four-tube two-stage 245 PP output is Cat. PA-83, list price, \$145, wired, less tubes; net price, \$85.26.

These power amplifiers are highly suitable for theatres, auditoriums, clubs, public address and home use. They are licensed by RCA and associates.

Two types of power transformers by Amer-tran for those who want to build their own power amplifiers are Cat. PB-250 for 250 output, single or push-pull; and Cat. PB-245 for 245 output, single or push-pull.



Cat. PB-250 furnishes power for two 281s and for two 250s. Two B supply chokes are built in. No filament voltage for tuner is supplied. Cat. PB-250 lists @ \$35; net, \$20.58.

Cat. PB-245 furnishes power for a 280 and two 215s, besides 2½ volts AC for heaters of five tubes. Two B chokes are built in. List price, \$32.50; net, \$19.11.

## Amer-Tran AF Transformers

First stage, de luxe, primary, in detector circuit, has 200 henrys inductance at 1 ma; turns ratio, 1-to-3. Cat. DL-1, list price, \$8.00; net, \$4.70. Second stage, turns ratio, 1-to-4; Cat. DL-2. List price, \$8.00; net, \$4.70.

Push-pull input transformer; turns ratio, 1-to-2½; single primary; two separate windings for secondary; Cat. 151, list price \$12; net, \$7.05.

## NATIONAL VELVETONE POWER AMPLIFIER

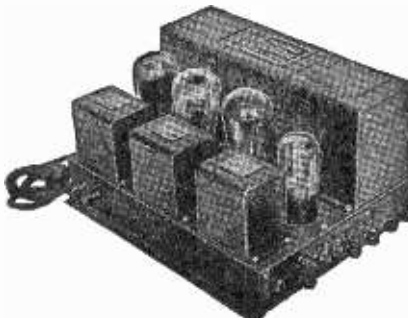

A 215 push-pull power amplifier especially suitable for powering AC tuners is the new model Velvetone. Uses one 280, one 227 and two 245. Furnishes 2½ volts AC for up to five other tubes, also plate voltages for tuner. Two stages of transformer coupling with output transformer. Cat. PPPA, list price, wired, \$97.50, less tubes; net, \$57.33. [Velvetone is licensed by RCA and associates.]

**Guaranty Radio Goods Co.**  
143 West 45th St., N. Y. City

Enclosed please find \$..... for which ship at once:

- Cat. PA-86 @ \$114.66
- Cat. PA-84 @ 94.08
- Cat. PA-83 @ 85.26
- Cat. PB-250 @ 20.58
- Cat. PB-245 @ 19.11
- Cat. DL-1 @ 4.70
- Cat. DL-2 @ 4.70
- Cat. 151 @ 7.05
- Cat. PPPA @ 57.33

Name .....

Address .....

City ..... State .....

USE

1 and 2 Watts  
Cartridge Type

Pig tail Type  
½ 1 and 2 Watts

Precision Wire Wound

**LYNCH METALLIZED**

**RESISTORS**

for your replacement work. They are accurate, dependable and guaranteed.

**Jobbers — Dealers Service Men**

Send for new descriptive catalog "W" showing new sizes and new low prices.

**LYNCH MFG. CO., Inc., 1775 Broadway, N. Y. C.**

# Set of SOCKET WRENCHES FREE



FOR turning nuts down or up there is nothing as efficient and handy as a socket wrench. Here is a set of three wrenches for hexagonal nuts, enabling use with 5/32, 6/32, 8/32 and 10/32 nuts. Fit the nut into the proper socket and turn down or up. The three different size sockets, one size on each wrench, enables use of three different outside diameters of nuts, but at least ten different sizes of threads. Send \$1.00 for eight weeks subscription for RADIO WORLD and get this set of three wrenches FREE!

**RADIO WORLD, 145 W. 45th St., New York, N.Y.**  
Enclosed \$1.00 for 8 weeks. Send wrenches.

Name .....

Address .....

City..... State.....

Cross here if extending existing subscription.

# Subscribers! Important!

Note subscription expiration date on wrapper containing your copy of RADIO WORLD. If nearing expiration date, please send in renewal so that you will not miss any copies. Subscription Dept., RADIO WORLD, 145 W. 45th St., New York City.

**BUILT to be LEADERS**

**LOFTIN-WHITE**  
Direct-Coupled  
**AMPLIFIER KITS**

ELECTRAD—Loftin-White Kits have always been outstanding for quality performance and ease of assembly. 3 types for all usual purposes, with 45 output; 50 output and 50 push-pull output. Write dept. R.W.-104 for details.

**175 Varick St., New York, N.Y.**  
**ELECTRAD**  
INC.

"MATHEMATICS OF RADIO."—A great help to everybody interested in radio. \$2 postpaid. Radio World, 145 W. 45th St., N. Y. City.



# High-Gain Shielded Coils

**A** SHIELDED radio frequency transformer for use as antenna coupler or as interstage coupler, for screen grid circuits. The coil is wound on a 1 1/4-inch diameter bakelite form with No. 28 enamel wire, primary on the outside, separated from the secondary by an insulating wrapper 42/10,000-inch thick. This moisture-proof insulation is so shaped that it completely insulates the primary from the secondary, preventing short-circuit. The coil form is mounted on a wooden base, which base has the removable shield bottom fastened to it. The drawn aluminum shield fits snugly over the wooden base, and coils remain always erect and amply spaced from the shield wall in all directions. The shielded coils are suitable for baseboard or metal chassis mounting. The four leads emerge through an insulated hole in the shield bottom.

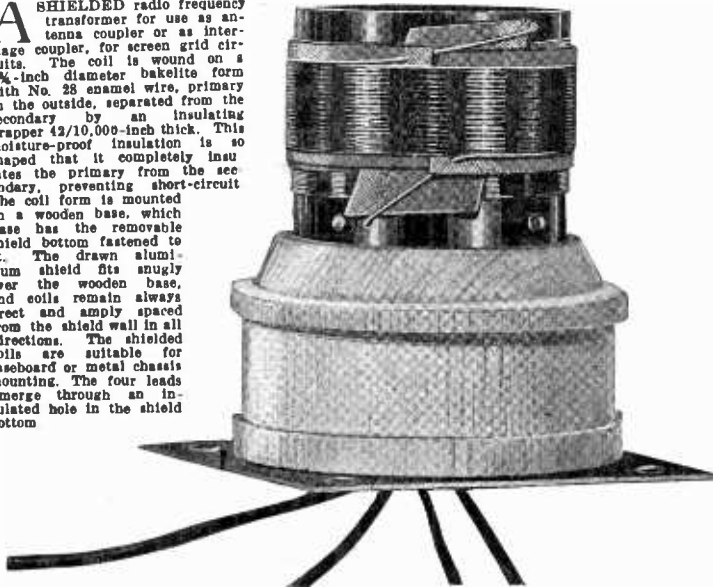

The coil comes already mounted on a shellacked wooden base, which is fastened at the factory to the shield bottom. Series A coil is illustrated.



The external appearance of the shield, with four 6/32 machine screws and nuts, which are supplied with each coil assembly.

## Precisely Matched for Gang Tuning

**O** NE primary lead-out wire from the coil, for antenna or plate connection, has a braided tinned alloy covering over the insulation. This alloy braid shields the lead against stray pick-up when the braid alone is soldered to a ground connection. The outleads are 6 inches long and are color identified. The wire terminals of the windings themselves, and the outleads, are soldered to copper rivets. Each coil comes completely assembled inside the shield, which is 2 3/4 inches square at bottom (size of shield bottom) and 3 1/2 inches high. High impedance primaries of 40 turns are used. Secondaries have 80 turns for .00035 mfd. and 70 turns for .0005 mfd.

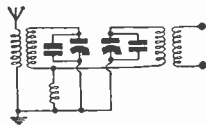

BP-6 is the coil at bottom.

**E**XTREME accuracy in winding and spacing is essential for coils used in gang tuning. These coils are specially suited for gang condensers, because the inductances of all are identical for the stated size condenser. The coils are matched by a radio frequency oscillator. The color scheme is as follows: shielded wire outlead is for antenna or plate; red is for ground or B plus. (These options are due to use of the same coil for antenna coupling or interstage coupling.) Blue is for grid and yellow is for grid return. For .00035 mfd. the Cat. No. is A-40-80-S. For .0005 mfd. the Cat. No. is A-40-70-S. Where a band pass filter circuit is used the small coupling coil to unite circuits is Cat. BP-6. The connection is illustrated herewith.

## Coils for Six-Circuit Tuner

Series C coils for use with six tuned circuits, as in Herman Bernard's six-circuit tuner, are wound the same as type A shielded coils, but the shields are a little larger (3 1/16-inch diameter, 3 1/4 inches high), and there are no shield bottoms, as a metal chassis must be used with such highly sensitive circuits. Fasten the brackets to the shield and then, from underneath the chassis, fasten the other arm of the two brackets to the chassis. Order Cat. C-6-CT-5 for .0005 mfd. and Cat. C-6-CT-5 for .00035 mfd. Five needed for Bernard's circuit. If band pass filter coupling coil is desired order Cat. BP-6 extra.

## Junior Model Inductances

The Series B coils have the same inductance and the same shields as the series A coils, but the primary, instead of being wound over the secondary, with special insulation between, is wound adjoining the secondary, on the form, with 1/4-inch separation, resulting in looser coupling. No wooden base is provided, as the bakelite coil form is longer, and is fastened to the shield bottom piece by means of two brackets. No outleads. Wire terminals are not soldered. Order Cat. B-SH-3 for .00035 mfd and Cat. B-SH-5 for .0005 mfd.

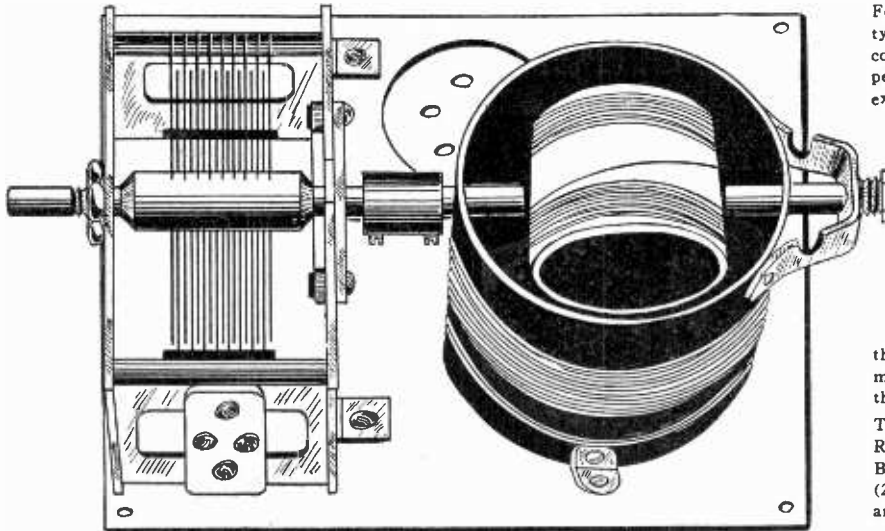

For a stage of screen grid RF, either for battery type tube, 222, or AC, 224, followed by a grid-leak-condenser detector, no shielding is needed, and higher per-stage amplification is attainable and useful. This extra-high per-stage gain, not practical where more than one RF stage is used, is easily obtained by using dynamic tuners. Two assemblies are needed. These are furnished with condensers erected on a socketed aluminum base. Each coil has its tuned winding divided into a fixed and a moving segment. The moving coil, actuated by the condenser shaft itself, acts as a variometer, which bucks the fixed winding at the low wavelengths and aids it at the high wavelengths, thus being self-neutralizing and maintaining an even degree of extra-high amplification throughout the broadcast scale.

Two assemblies are needed. For AC operation (224 RF and 224 or 227 detector), use Cat. BT-L-AC and BT-R-AC. For battery or A eliminator operation (222 RF and any tube as detector), use Cat. BT-L-DC and BT-R-DC.

Screen Grid Coil Co., 143 West 45th Street, New York (Just East of Broadway):

- Enclosed please find \$..... (Canadian must be express or P. O. Money Order), for which send me prepaid the following:
- A-40-80-S, each ..... \$2.25
  - Matched set of A-40-80-S, \$1 matching 10.00
  - A-40-70-S, each ..... 2.25
  - Matched set of four A-40-70-S ..... 10.00
  - BT-L-AC and BT-R-AC assembled, with condenser, link socket and base, per pair ..... 6.00
  - BT-L-DC and BT-R-DC assembled, with condenser, link, socket, base, per pair ..... 6.00
  - C-6-CT-5, .0005 mfd. shielded coil for six-circuit tuner ..... each \$2.25
  - C-6-CT-5, .00035 mfd. shielded coil for six-circuit tuner ..... each \$2.25
  - BP-6 ..... .25
  - EQ-100, equalizer of 20-100 mfd. capacity, made by Hammarlund ..... .35
  - B-SH-3, each ..... \$1.00
  - Matched set of four B-SH-3 ..... 4.00
  - B-SH-5, each ..... 1.00
  - Matched set of four B-SH-5 ..... 4.00
- (Note: All coils come with shields, except BP-6 and BT-L.)

NAME..... ADDRESS.....  
 CITY..... STATE.....  
 If ordering C.O.D. put cross here. Post office fee will be added to prices quoted.

BT-L for the antenna stage and BT-R for the detector input. BT-L consists of a small primary, with suitable secondary for the .00035 mfd. condenser supplied. BT-R has two effective coils: the tuned combination winding in the RF plate circuit, the inside fixed winding in the detector grid circuit. The moving coils must be "matched." This is done as follows: Turn the condensers until plates are fully enmeshed, and have the moving coils parallel with the fixed winding. Tune in the highest wavelength station receivable—above 450 meters surely. Now turn the moving coils half way round and retune to bring in the station. The setting that represents the use of lesser capacity of the condenser to bring in that station is the correct one. If gang tuning is used, put a 20-100 mmfd. equalizing condenser across the secondary in the antenna circuit and adjust the equalizer for a low wavelength (300 meters or less).