

# 38 STATIONS IN RACE FOR 50,000 WATTS

AUG. 2d  
1930

# RADIO

U.S. PAT. OFF.

# WORLD

The First and Only National Radio Weekly

436th Consecutive Issue—NINTH YEAR

15 Cents  
Per Copy

## THE MOORE "SUPER-DX"

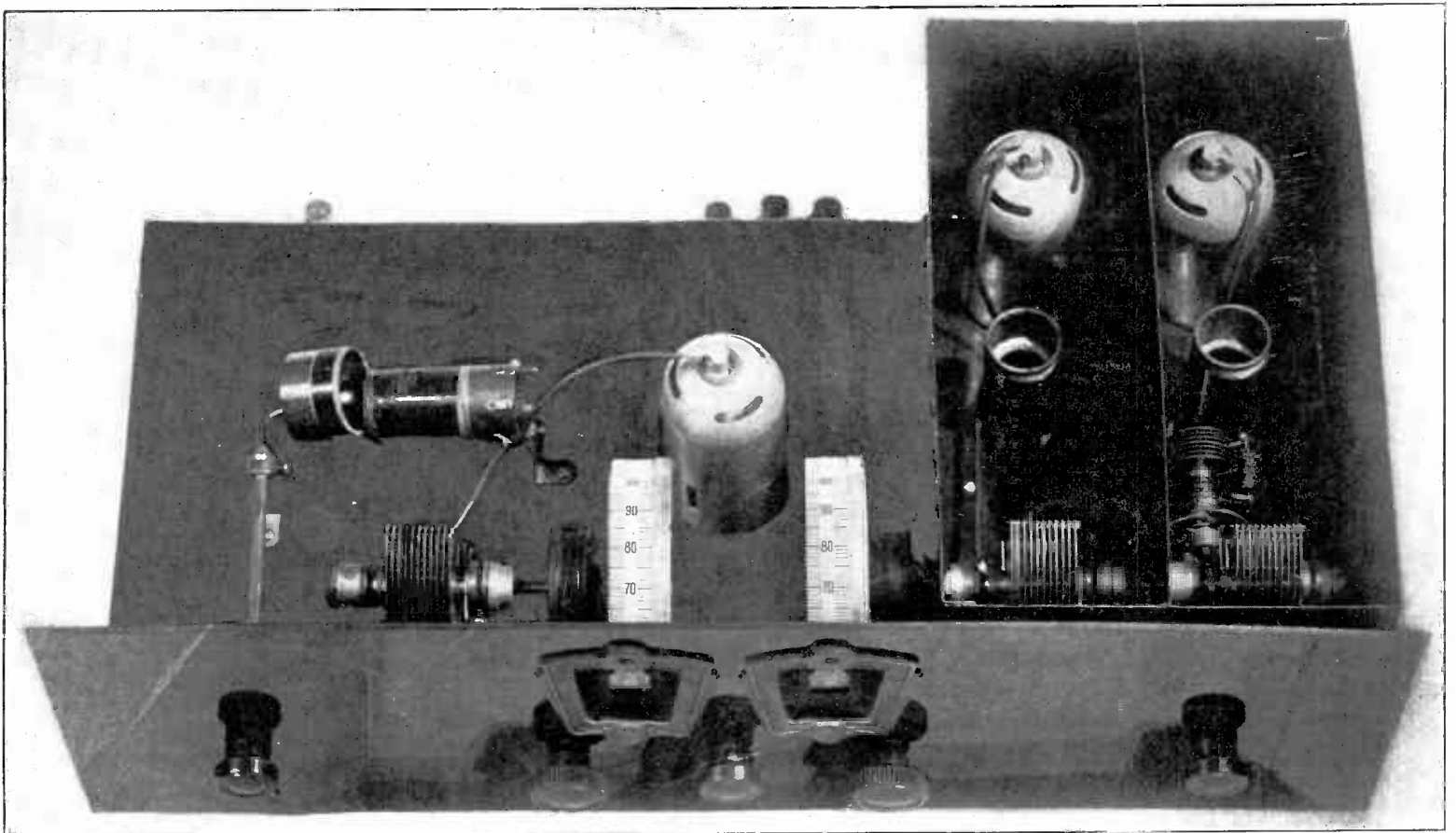

Extraordinary sensitivity marks this three-tube screen grid AC tuner, plus selectivity that makes it easy to get great DX. See article on pages 10 and 11.

TELEVISION  
STATIONS  
ON AIR

NEW BATTERY  
AND AC  
SW CONVERTERS

IS A LONG  
AERIAL GOOD,  
AFTER ALL?

### Balkite Push-Pull Receiver



The Balkite A-5 Neurodyne, one of the most sensitive commercial receivers ever developed; 8 tubes, including 280 rectifier. Wholly AC operated, 105-120 v. 50-60 cycles; in a table model cabinet, genuine walnut, made by Berkey & Gay.

Three stages of tuned RF neutralized, so there's no squealing; easy tuning; operation on short piece of wire indoors perfectly satisfactory; no repeat tuning points; no hum; phonograph pickup jack built in; excellent tone quality; good selectivity. Two posts are accessible for connecting the field coil of a DC dynamic speaker.

The parts of which this receiver is made are all ace-high and the wiring is done with extreme expertness, by Gillilan. The power supply is exceptionally fine, the set being worked at 50% less than the rated capacity of the power transformer and chokes, assuring long life. There is no hum, as filtration is remarkably good.

The illuminated drum dial, at center, reads 0-100 at left, and at right has a blank space in which to write call letters. The little knob at left is the volume control, and the one at right is the AC switch. Each RF stage is filtered and bypassed individually, and the RF coils, tuning condenser and power transformer are separately and totally shielded. The lead from antenna binding post to antenna winding of the first coil is of shielded wire that is grounded. Also, the receiver as a whole is totally shielded, with metal chassis and metal under-cover, so there is no stray pickup. Cat. BAL-AS, list price \$135; net price.....

**\$44.00**

### Silver-Plated Coils



Wound with non-insulated wire plated with genuine silver, on grooved forms, these coils afford high efficiency because of the low resistance that silver has to radio frequencies. The grooves in the moulded bakelite forms insure accurate space winding, thus reducing the distributed capacity, and keep the number of turns and separation constant. Hence the secondary reactances are identical and ideal for gang tuning.

The radio frequency transformer may be perpendicularly or horizontally mounted, and has braced holes for that purpose. It has a center-tapped primary, so that it may be used as antenna coil with half or all the primary in circuit, or as interstage coupler, with all the primary on a screen grid plate circuit, or half the primary for any other type tubes, including pentodes. The three-circuit tuner has a center-tapped primary, also. This tuner is of the single hole panel mount, but may be mounted on a chassis, if preferred, by using the braced holes. Pair consists of RF transformer and three-circuit tuner, both for .0005 mfd. only. Order Cat. G-RF-3CT. \$2.48 list price \$5.00; net price.....

### Shielded Lead-in Wire

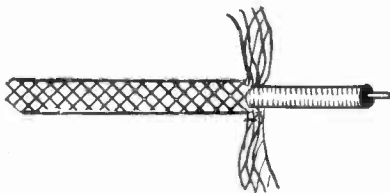

No 18 solid wire, surrounded by a solid rubber insulation covering, and above that a covering of braided copper mesh wire, which braid is to be grounded, to prevent stray pick-up. This wire is exceptionally good for antenna lead-in, to avoid pick-up of man-made static, such as from electrical machines. Also used to advantage in the wiring of receivers, as from antenna post of set to antenna improves for plate leads, or any leads, if long. This method of wiring a set improves selectivity and reduces hum. This wire is now appearing on the general market for the first time although long used in the best grade of commercial receivers. Order Cat. SH-LW. List price 9c per ft.; net price per foot **5c**

### New Multi-Tap Voltage Divider

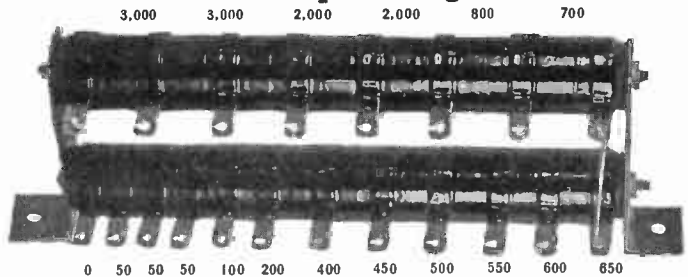

The resistance values between the twenty taps of the new Multi-Tap Voltage Divider are given above. The total is 17,100 ohms and affords nineteen different voltages.

The Multi-Tap Voltage Divider is useful in all circuits, including push-pull and single-sided ones, in which the current rating of 100 milliamperes is not seriously exceeded and the maximum voltage is not more than 400 volts. Higher voltages may be used at lesser drain.

The expertness of design and construction will be appreciated by those whose knowledge teaches them to appreciate parts finely made.

When the Multi-Tap Voltage Divider is placed across the filtered output of a B supply which serves a receiver, the voltages are in proportion to the current flowing through the various resistances. By making connection of grid returns to ground, the lower voltages may be used for negative bias by connecting filament center, or, in 227 and 224 tubes, cathode to a higher voltage.

If push-pull is used, the current in the biasing section is almost doubled, so the midpoint of the power tubes' filament winding would go to a lug about half way down on the lower bank.

Order Cat. MTVD, list price \$6.50, net price.....

**\$3.90**

### R-245 Set and Tube Tester

With the R-245 Tube and Set Tester you plug the cable into a vacated socket of a receiver, putting the removed tube in the tester, and using the receiver's power for making these tests: Plate current, on 0-20 or 0-100 ma. scale, changed by throwing a built-in switch; 0-60, 0-300 v. DC, changed by moving one of the tipped cables to another jack; filament or heater voltage (AC or DC), up to 10 volts, or any other AC voltage source, measured independently, up to 140 volts, including AC line voltage. Also screen grid voltage and screen grid current may be read by following connections specified in the new 8-page instruction sheet.

Each meter may be used independently. The two test leads, one red, the other black, with tip jack terminals, enable quick connections to meters for independent use.

With this outfit you can shoot trouble in receivers and test circuits using the following tubes: 201A, 200A, UX199, UX120, 210, 171, 171A, 112, 112A, 245, 224, 222, 226, 227, and pentodes.

When the R-245 is plugged into the vacated socket of a set and the removed tube is placed in the proper socket of the Tester, the receiver's power supplies all the voltages and currents. You see the vital tests made right before your eyes, all three meters registering immediately, all three reading at the same time.

Here are some of the questions answered by the Tester when plugged into the receiver:

What is the filament or heater voltage (no matter if DC or AC)? What is the plate voltage at the plate itself? What is the plate current drawn by the tube? Is the tube in good condition or does it require replacement? What is the grid bias voltage? What is the cathode voltage? What is the screen grid voltage? Besides, when meters are used independently, you can answer these questions: What is the screen grid current? What is the line voltage (no matter if AC or DC)? Is the circuit continuous or is it open? What is the total plate current drawn in the receiver? What are the respective B voltages at the B batteries or voltage divider?

Order Cat. R-245. List price, \$20; net price..... **\$11.40**

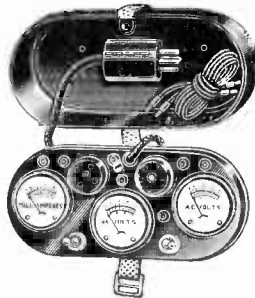

### Fixed Condensers

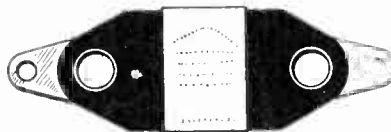

Dubilier Micon fixed condensers, type 642, are available at following capacities and prices:

.0001 mfd. ....	10c	.006	20c
.00025 mfd. ....	10c	.00025 with clips.	20c
.0003 mfd. ....	10c	All are guaranteed	
.00035 mfd. ....	15c	electrically perfect and	
.001	17c	money back if not	
.0015	17c	satisfied within five	
.002	18c	days.	

Order Cat. MICON .0001 etc. at prices stated.

### High-Voltage Meters

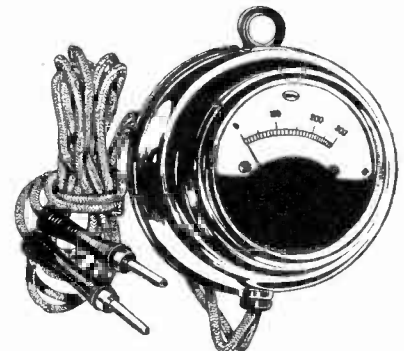

0-300 v., 200 ohms per volt. Cat. F-300 @ \$2.59  
 0-500 v., 235 o.p.v. Cat. F-500 @ ..... 3.75  
 0-600 v., AC and DC (same meter reads both); 100 ohms p.v. Order Cat. M-600 @ 4.95

### Double Drum Dial

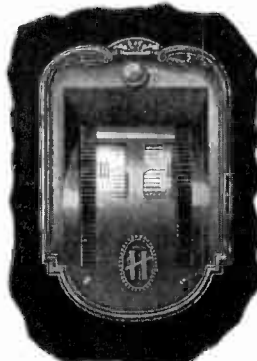

Hammarlund double drum dial, each section individually tunable. Order Cat. H-DDD. List price \$8.00; net **\$3.00** price .....

### Shielded RF Choke

Excellent in detector plate circuit or in B-plus RF leads of radio frequency tubes to purify signals.

An efficient radio frequency choke in a shielded case. Inductance, 50 millihenries. Useful for all RF chokes.

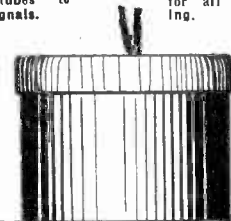

In some instances one outlead is connected to case, so use this lead for B-plus or for ground, otherwise ground the case additionally. Order Cat. SH-RFC. List price, \$1.00; **50c** net price .....

Guaranty Radio Goods Co., 143 West 45th St., New York, N. Y. (Just East of Broadway)

Enclosed please find \$..... (Canadian must be express or post office money order, for which please ship.)

<input type="checkbox"/> BAL-AS @ \$44.00	<input type="checkbox"/> Ft. of SH-LW @ .....5c p. f.	<input type="checkbox"/> M-600 @ ..... \$4.95
<input type="checkbox"/> MTVD @ ... 3.90	<input type="checkbox"/> H-DDD @ ... \$3.00	<input type="checkbox"/> F-300 @ ..... \$2.59
<input type="checkbox"/> G-RF-3CT @ 2.48	<input type="checkbox"/> SH-RFC @ ... 50c	<input type="checkbox"/> F-500 @ ..... 3.75
<input type="checkbox"/> R-245 @ ..... 11.40	<input type="checkbox"/> MICON @ ..... \$3.00	<input type="checkbox"/> MICON @ ..... \$4.95

If C.O.D. shipment is desired put cross here.

Your Name .....

Address .....

City..... State.....





Vol. XVII. No. 20 Whole No. 436  
 August 2d, 1930  
 15c per Copy, \$6.00 per Year  
 [Entered as second-class matter, March, 1922, at the Post Office at New York, N. Y., under act of March, 1879.]

**NINTH YEAR**  
 Latest Circuits and News  
 Technical Accuracy Second to None

A Weekly Paper published by Hennessy Radio Publications Corporation, from Publication Office, 145 West 45th Street, New York, N. Y.  
 (Just East of Broadway)  
 Telephone, BRyant 0558 and 0559

RADIO WORLD, owned and published by Hennessy Radio Publications Corporation, 145 West 45th Street, New York, N. Y. Roland Burke Hennessy, president and treasurer, 145 West 45th Street, New York, N. Y.; M. B. Hennessy, vice-president, 145 West 45th Street, New York, N. Y.; Herman Bernard, secretary, 145 West 45th Street, New York, N. Y.; Roland Burke Hennessy, editor; Herman Bernard, business manager and managing editor; J. E. Anderson, technical editor

# Television Technique

By Arthur Braddock

TELEVISION signals are designated by so many lines and so many frames. A frame is a complete picture as would be obtained with a camera. When television is transmitted on a 15-frame basis the meaning is that 15 pictures are transmitted every second, or that the scanning process is completed in one fifteenth of a second. A line is one stroke of the scanning device across the picture and is a portion of the frame. When pictures are transmitted on a 48-line basis, the frame is broken up into 48 strips and the entire picture is covered in 48 strokes of the scanning beam.

The process of scanning is much the same as reading the page of a book over and over again. The page represents the frame, the lines of type the lines of the frame. The progression of scanning is also the same as the progression of reading, from left to right in the lines and from top to bottom in the frame. But the speed is quite different. If the scanning is done on the basis of 48 lines and 15 frames, it takes 1/720 of a second to "read" the line and one-fifteenth of a second to "read" the frame.

## When Action Is Shown

If the picture transmitted is changing from instant to instant, such as is the case when the scene contains action, the process is not exactly like that of reading a page over and over again, but rather like reading successive pages in the book, all placed in the same position, changing instantaneously as soon as one is completed. The process of scanning is so rapid that there is no appreciable change in the scene during the scanning of one frame, or at least it should be so rapid.

Fine detail is obtained by using many lines per frame. Thus a 24-line picture will contain little detail. Forty-eight lines per frame give considerably more detail, and sixty give still more. So far a greater number of lines per frame has not been used in television.

A large number of lines per frame is only one condition for much detail, the mechanical condition. There is also an electrical condition which depends on the quality of the amplifiers used in the system, both transmitting and receiving. This condition is that the amplifiers should be able to "follow" all frequencies from below the audible limit up to about 50,000 cycles per second.

## The Finest Detail

The number of frames transmitted per second is one of the factors that determine the amount of flicker in the reproduced image. The more frames per second the less the flicker. Another factor entering into the flicker is the intensity of the illumination at the receiver. The greater the illumination, the greater the flicker for a given number of frames per second. This, of course, is a phenomenon associated with the "persistence of vision" and is physiologic or psychologic.

The regular television signals having the finest detail and the least flicker transmitted at this time are the transmissions by RCA, which have 60 lines and 20 frames. With a good amplifier and the proper scanner at the receiver fine pictures should be obtained from these signals. Most of the signals transmitted at this time by others are on a 48 line and 15 frame basis, a system now considered standard.

A slightly different system of scanning, designed to reduce flicker, is one used by W9XAP and W9XAO, Chicago. The scanning disc in this system has three spirals instead of one, and the holes in the discs are so arranged that the entire frame is covered three times for each revolution instead of once. However, this does not mean that the frame is scanned three times as rapidly, for each spiral covers only one-third of the total frame area. Yet as far as flicker is concerned it should have

approximately the same effect as if the rate of scanning were increased by a factor of three, according to the claims of the sponsors of this system. This system, as used by the stations named, has 45 lines and 15 frames.

## Reception Requirements

In order to receive the signals on any system it is necessary to have a scanning disc, or equivalent device, which corresponds with the transmitting scanner. For example, if the system operates on the basis of 60 lines and 20 frames, the receiving scanner must have provision for 60 lines and it must rotate so that 20 frames are covered every second. A receiver designed to receive 48 line, 15 frame pictures will not receive 60 line, 20 frame signals.

Neither could a receiver designed for 48 lines, 15 frames, and one spiral be used to receive signals from a station operating on the basis of 48 lines, 15 frames, and three spirals. The image would not be reassembled in the proper order and only confusion would result.

Very simple and inexpensive television receivers may now be obtained for receiving the standard signals, especially those working on the basis of 48 lines and 15 frames per second.

## Colored Television Pictures

Some work is being done on television pictures in natural color, especially by the Bell Laboratories. The principle of three-color television is about the same as that of three-color halftone pictures. Three primary colors are being used, and one channel is needed for each color, just as three plates and three impressions are needed for three-color halftone pictures.

When television in natural color is to be sent, three scanning devices are used. There are also color filters interposed between the source of light and the scanner. One filter passes nothing but blue light, another nothing but yellow, and a third nothing but red. For each color there is a special photo-electric cell, or group of such cells. The cell associated with the red is most sensitive to red, that associated with the yellow is most sensitive to that color, and that associated with the blue is most receptive to that color. These color selective cells are not absolutely necessary, but they aid in the color filtering and in increasing the efficiency of the system.

The red-sensitive cell, through the red-transmitting filter, sees nothing but the red portions of the object being transmitted. Each of the other two color-sensitive cells, through its particular color filter, sees nothing but those portions of the object having the appropriate color.

If one of these systems alone were transmitted and received, the received picture would be of a single color, corresponding to that of the color filter used. But if all three are transmitted and received simultaneously, the reconstructed picture will not only have the three primary colors but it will have all the other color values and shades.

## TELEVISION BROADCAST STATIONS

Call	Owner	Meters	k.c.	Schedule	Lines	Frames
W3XK	—Jenkins, Washington, D. C.	103	2,910		48	15
W2XCR	—Jenkins, Jersey City, N. J.	147	2,040	8-10 p.m.	48	15
K2XAV	—Baird, Boston, Mass.	107.1	2,800	3-5, 8-10 p.m.	48	15
W2XBS	—RCA, New York, N. Y.	137.4	2,180	2-5, 7-11 p.m.	48	15
W9XR	—Great Lakes Broadcasting Co., Chicago	142.8	2,100	7-11 p.m.	60	20
		105.2	2,850	3-4, 7-10 p.m.	24	15
W2XR	—Radio Pictures, N. Y. City	137	3,190	3-6, 7-10 p.m.	48	15
W9XAP (WMAQ)	—Chicago	107.1	2,800		45	3 spiral
W9XAO (WTRO)	—Chicago				45	3 spiral





# a Short-Wave Converter

Bernard

the receiver itself is highly sensitive. This requires that the volume control of the receiver be at "full volume" position.

### Coil Data

The built-in intermediate stage may be shielded, if desired, although this is not absolutely imperative. If shielding is used it is a good plan to select a coil intended originally for .0005 mfd. tuning, and to remove four turns.

If you desire to wind your own coil for this intermediate coupling, you may do so by putting 10 turns of No. 28 enamel wire on a tubing  $1\frac{3}{4}$  inches in diameter, for the primary, in the plate circuit; leave  $\frac{1}{4}$  inch space and wind 66 turns of the same kind of wire for the secondary, for the grid circuit.

The plug-in coils for short waves may be kept down to a total of five or even four coils. While coils with air-core, with 97 per cent. air dielectric, were used in the laboratory model, these can not be made by the reader, as the forms are not available, and machinery is required to reproduce them. But if the two major tuning condensers are straight frequency line types of .0005 mfd. maximum capacity, then on a 3 inch diameter, bakelite tubing wind two coils alike: three turns for the primary and three turns as the secondary. For the other pair, use eight turns as the primary and seventeen turns as the secondary. For the secondaries use No. 18 wire. For the primaries use that or any other kind of wire you have handy.

### Watch Oscillator Plate Winding

The plate winding may be an adjustable coil, about 10 turns on a separate 3 inch diameter, made independently and so arranged that you can push it nearer to or farther from the secondary, from a minimum separation of  $\frac{1}{2}$  inch to a right-angle position. Adjustment once made need not be altered often.

Another method would be to put the plate oscillator winding on the same form, in which case the number of plate turns would be five for the small coil and eleven for the large coil.

In any event the connections to the oscillator plate coil and to the oscillator grid coil must be made so that with windings in the same direction, B plus and ground, for respective windings, adjoin. If oscillation fails, you have not got this direction right, so reverse either the plate winding connections or the grid wind-

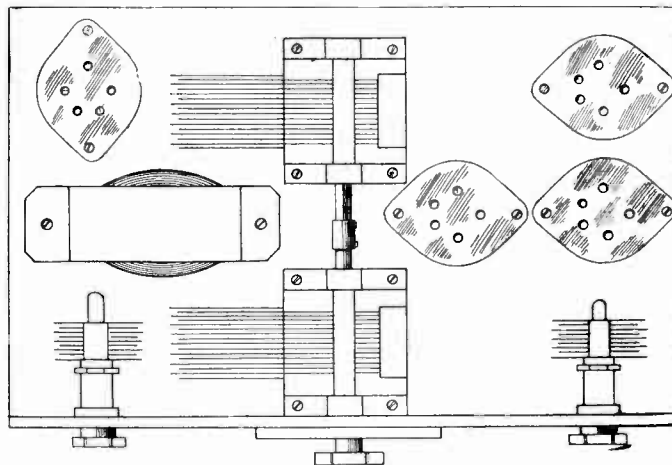

FIG. 2

LAYOUT OF PARTS FOR ASSEMBLING THE CONVERTER WITH INTERMEDIATE STAGE BUILT IN. SOME OF THE PARTS ARE NOT SHOWN. NOT ALL THE PARTS ARE PLACED ATOP THE SUBPANEL.

ing connections, and thus change the phase. This is true even if you use a movable coil.

The method of coupling the oscillator to the low side of the modulator permits a five-connection coil, instead of a six-connector.

These coil data are serviceable but are not absolutely inviolable as to primary windings and oscillator plate windings. Hence commercial coils with windings a little different need not be held under suspicion.

### Single Control Practical

A sketch showing how the principal parts may be arranged to build this converter is shown as Fig. 2. Some of the parts are not in view, as not all are above the subpanel. It was found handier to "lift" the subpanel so that it would meet the bottom of the tuning condensers, hence the condensers could be mounted directly on the subpanel.

Single control becomes feasible because of the inclusion of a trimming condenser which is also on the front panel. This may be of the same capacity value as that of the other midget condenser.

### Directions for Connecting

The method of working the converter is as follows:

1. Disconnect antenna lead from the broadcast receiver and connect it instead to the antenna binding post of the converter.
2. Disconnect ground lead from the broadcast receiver and connect it instead to the ground binding post of the converter, but run a wire lead from the ground post of one to the ground post of the other.
3. Connect the B plus binding post of the converter to B plus, 50 to 100 volts on your receiver. Usually the voltages nearer 100 give better assurance of oscillation.
4. Connect the output of the converter, which is represented by an unmarked post on the converter, to the vacated antenna post of the receiver.  
Insert the cable plug of the converter in an AC 110-volt service outlet.
6. Turn the switch of your receiver to "on" position and tune in.

The foregoing discussion pertains to an AC short-wave converter. Such a converter will work with any type receiver, battery or otherwise, including receivers that are themselves Superheterodynes.

However, some persons have no electric service in the home, or have direct current. Adaption of the Fig. 1 circuit may be made so that 201A tubes are used throughout, or even 199 tubes. A battery connections and filament resistors, besides biasing voltages of about 3 volts, would be necessary. The modulator would have its grid return made, however, to A plus (coil only), while the tuning condenser's rotor remains at A minus.

For current economy the pilot lights may be omitted for battery operation of a converter.

## Control's Place

and sensitivity of the receiver are unaffected. It is well to leave these things as nearly steady as possible, and to apply the attenuation to unsteady or AC values.

### Case of Automatic Volume Control

The application of automatic volume control to receivers is another factor. In general, this application denies the recommendation previously stated. No method has yet been presented for affecting the alternating current values, for instance the voltage drop between antenna and ground, or the coupling to the aerial. All automatic volume controls have been predicated on the bias-alteration circuit, which means affecting DC voltages. Particularly, the voltage is either the negative grid voltage, the positive plate voltage or the positive screen grid voltage. All these are bias voltages.

However, the automatic volume control, while it does change the amplification properties of the receiver, does so in respect to the carrier intensity, and is almost a "bookkeeping machine." You set it to establish a certain value of volume and not to exceed that volume, and you can feel certain that the stated volume will not be exceeded. The automatic volume control keeps tabs for you.

### Points on Shielding

Nevertheless, a manual volume control is desirable, even where an automatic one is present. How else are you to predetermine the volume? A tube doesn't know your preferences. Therefore, as a manual volume control is advisable, it is doubly advisable that it be in the antenna circuit somewhere, to govern the amount of pickup, for already there is a DC-voltage alterer in the circuit, and one such alterer is plenty.

The leads to the volume control may have shielded wire, with shield grounded, if the receiver is very sensitive. But any very sensitive receiver ought to have a bottom piece for the subpanel. That is, shield plenty and you may then dispense with the shielded wire if you desire.

# A Battery SW Adapter

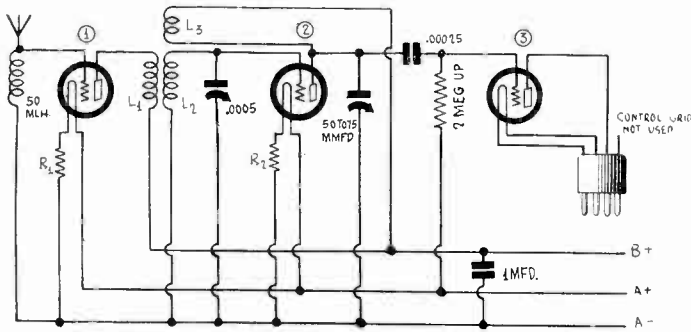

FIG. 1

A PLUG-IN TYPE ADAPTER UTILIZING THREE BATTERY TUBES. APERIODIC COUPLING IS USED BETWEEN THE ANTENNA AND THE FIRST TUBE, WHILE TUNED COUPLING AND REGENERATION ARE USED IN THE INPUT OF THE SECOND TUBE.

THE design of an AC short-wave adapter, for plugging into a radio frequency socket for voltages, and into the detector socket of a receiver for picking up the audio, was shown last week, issue of July 26th. The same fundamental circuit is shown this week, as Fig. 1, for battery-operated receivers.

It is not possible to pick up the voltages by plugging into the radio frequency part of the receiver, because of the filament resistor being an unknown quantity. There may be a separate resistor in each tube circuit, or one resistor for all tubes, or two or three tubes on one resistor and the rest independent. As there is no knowing about this, one can not plug in to pick up an unknown voltage. The solution therefore is to build the resistors into the battery-type adapter, and to plug into the detector for input only. A plus and A minus are run to the battery, or to the receiver's switch and the other side of the battery.

The adapter is really a short-wave receiver, all save the audio, and the method is simply to rely on the audio of the receiver. This is not a converter, which is to be combined with a broadcast receiver to constitute a short-wave Superheterodyne.

## Small Coils Used

The size of the cabinet to house this circuit is the same as for the AC model. It is 7x7x3 inches, inside dimensions. The dial and sockets are on top, one of the sockets being of the UY type for the plug-in coils, which are of the finger-handle type, wound on tube-base size forms. The regeneration condenser is mounted on the front elevation of the cabinet, and not on the top panel. The circuit is worked with the dial on top, not on the front, as is common with receivers.

The reason for presenting an adapter is that it will give good results, whereas the previous adapters, consisting of one-tube affairs, only the detector tube from the receiver being placed in the adapter tube socket, did not prove generally satisfactory. More sensitivity was needed. The stage of untuned radio frequency amplification provides that in part, while the tuned stage of regenerated RF aids this gain much more materially, so that a healthy kick results at the detector input.

## Interstage Coupling Explained

There is a novelty in the coupling to the detector. The winding that is used for feedback or regeneration is used also as the plate load for input to the succeeding stage. In other words, L3 to a fixed tickler, while the 50 mmfd. condenser is the re-

## LIST OF PARTS

- L1, L2, L3—Two plug-in coils to cover from about 15 meters to about 136 meters, with .0005 mfd. straight frequency line condenser.  
 R1, R2—Two 4 ohm resistors for 201A tubes.  
 One straight frequency line .0005 mfd. Hammarlund condenser.  
 One radio frequency choke, 50 millihenries.  
 One four-prong cable connector plug, with color-identified leads.  
 One 50 or 75 mmfd. maximum capacity midget condenser.  
 One 2 meg. leak, or higher resistance, with mounting.  
 One .00025 mfd. fixed condenser, mica dielectric.  
 One 1 mfd. bypass condenser.  
 Three four-spring (UX) sockets.  
 One 7x7 inch panel, with three UX sockets for tubes and one UY socket for coil.  
 One cabinet.  
 One antenna binding post.  
 One dial.

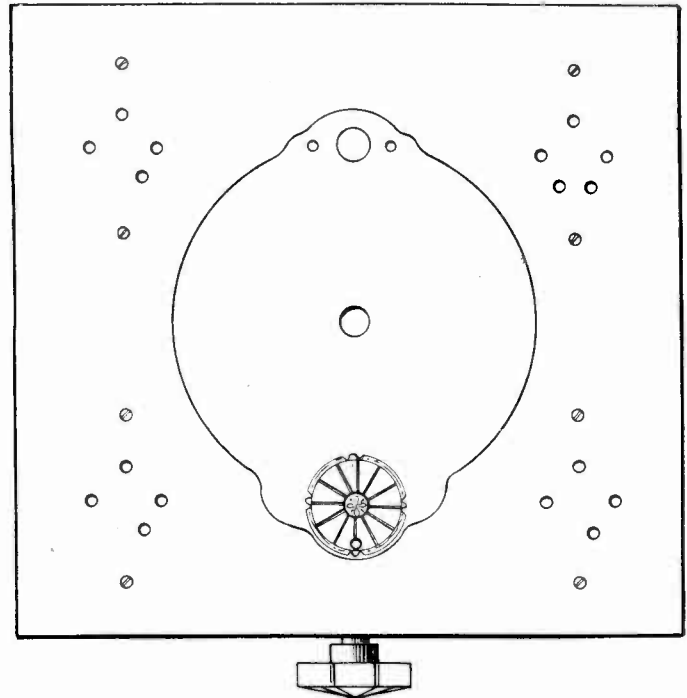

FIG. 2

THE PANEL LAYOUT OF THE ADAPTER SHOWN IN FIG. 1. THE TUNING CONTROL IS AT THE BOTTOM OF THE CENTRAL DIAL AND THE REGENERATION CONTROL IS ON THE SIDE IN FRONT. THE VERNIER DIAL MAKES TUNING EASY EVEN FOR THE SMALLER VALUES OF CAPACITY.

generation control. But L3 also is the load on the plate circuit for developing a voltage drop which is impressed on the series circuit consisting of the .00025 mfd. fixed condenser and the 2 meg. leak.

When the voltage is increasing in the grid circuit of the regenerated tube, the voltage in L3 is increasing, and for that reason L3 may be used for the double purpose—feedback in one stage and input to the next. To accomplish this, however, the isolating condenser, .00025 mfd. must be connected to the plate of the regenerated tube, and not to the other terminal of the plate coil (B plus).

The only tuning condenser used is .0005 mfd., but it should be of straight frequency line characteristic. The coils may be wound on old tube bases, with No. 24 single silk covered wire.

## Coil Data

There are two coils, No. 1 consists of five-turns primary, for L1, 1/8 inch separation, a twelve-turn secondary, for L2, 1/8 inch separation, and a seven-turn tickler for L3. All windings are in the same direction. The secondary and tickler are to be connected oppositely, that is, so that when wiring is done in the adapter, A minus and B plus terminals of secondary and tickler adjoin. The other coil is wound in the same manner, only the number of turns are: primary, L1, 20 turns; secondary, L2, 70 turns; tickler, L3, 26 turns. The wave range will be from 136 meters to 15 meters.

A five-prong tube base is needed for each of the two coils. Also one five prong socket in the adapter is needed to receive this base.

Using the designations of the base as if it were a tube, the coil connections should be:

prong of tube base	coil connection
cathode	plate of tube No. 1
heater on cathode side	B plus
plate	grid of tube No. 2
heater on plate side	A minus
grid	plate of tube No. 2

The B plus connection for the tickler coil is made to the same point as the B plus connection for the primary, i. e., to heater on the cathode side.

## Values of Resistors

The values of R1 and R2 will depend on the tubes used and on the voltage source. For 201A tubes the values are 4 ohms each, if the source is six volts. For 199 tubes the values are 50 ohms each if the source is six volts, but if the source is four and a half volts then the values are 20 ohms each.



# New Tubes in a Converter

By William J. Woods

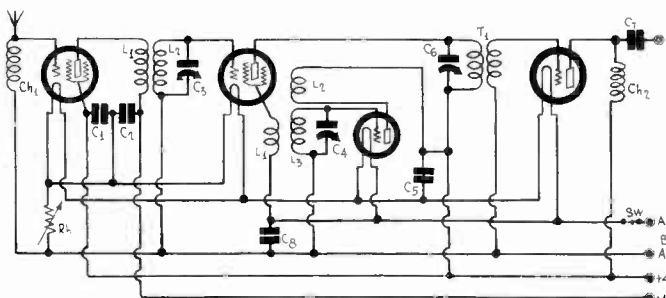

FIG. 1

THIS SHORT-WAVE CONVERTER HAS ONE UNTUNED RADIO FREQUENCY AMPLIFIER AND ONE TUNED INTERMEDIATE AMPLIFIER IN ADDITION TO THE USUAL OSCILLATOR AND MODULATOR. IT UTILIZES THE NEW LOW VOLTAGE TUBES.

THE new 2-volt tubes are particularly well suited to short-wave converters because they are small and permit compact assembly. They are also economical as to filament and plate currents and therefore may be maintained in operations with dry cell batteries at small cost. Moreover, their electric characteristics are such as to yield practically the same results, tube for tube, as circuits built with larger tubes.

It has been found that short-wave converters, that is, adapters utilizing an oscillator for converting the high frequency into a lower frequency lying in the tuning range of the broadcast receiver, invariably give results, and in most instances highly satisfactory results. But in all cases of frequency conversion there is a certain signal loss which must be made up by additional amplification, either in the high frequency level or in the intermediate level. Many have constructed converters and connected them ahead of broadcast receivers which had very little radio frequency amplification, and they have found that reception is not satisfactory on short waves. They should not have expected any results at all. Nobody would build a Superheterodyne receiver without an intermediate frequency amplifier, but that is just what they do when they put a short-wave converter ahead of a broadcast receiver that has no radio frequency amplification.

### Additional Amplification

In order to compensate for the loss incident to frequency conversion and to provide for any lack of amplification in the broadcast receiver, it is advisable to use a stage of untuned high frequency amplification ahead of the modulator tube and a stage of tuned intermediate frequency amplification after the modulator. These two stages of amplification make the converter applicable to many more broadcast receivers than it would be if the amplification were omitted, and they will make the sensitivity of the short-wave receiver vastly greater in all cases.

In Fig. 1 we have a circuit diagram of the four-tube short-wave converter in which the first screen grid stage is untuned and the output stage is tuned. The reason for not tuning the input to the first stage is that it is next to impossible to tune a short-wave receiver having two or more radio frequency tuners, as well as to keep it from oscillating where it should not oscillate. One radio frequency tuner and the oscillator tuner are enough to give satisfactory selectivity.

The modulator is coupled to the intermediate frequency tube by means of transformer T1, the primary of which is tuned with C6. The output coupler of this tube must be such that it will fit the majority of broadcast receivers by connecting the output lead to the antenna post on the set. Feeding the plate of the tube through the Ch2 and stopping by means of condenser C7 make it safe to connect to any receiver regardless of how the input circuit is arranged. It is understood that the ground on the broadcast receiver is to be connected to A minus of the battery serving the converter. That is, the ground lead is left on the broadcast receiver just where it is and a wire is run from the ground post to A minus on the converter.

### Design of Chokes

If the range of the tuner is to be from 1,500 to 20,000 kc the choke coil Ch1 must be designed so that it remains an effective choke at the upper frequency limit. Many radio frequency chokes assume the characteristics of a condenser as the frequency increases. To insure against this the choke should have the lowest possible distributed capacity and at the same time a rather low inductance. But if the inductance is made low, the

coupler is not effective at the lower frequency end of the tuning range. A method of getting satisfactory choking at all frequencies is to connect two or more coils in series, and some commercial choke coils are so made. That is, they are wound in grooves separated by an eighth of an inch or so. The method of winding gives a high inductance and a very small capacity.

If a slot-wound choke is not available the same effect can be secured by connecting a large coil, say one of 50 millihenries, in series with a small choke, say of one-half millihenry. The larger choke is commercial and the smaller can be made by winding 500 turns of No. 36 enameled wire on a form 1/2 inch in diameter.

In place of a choke coil a 100,000 ohm resistor may be used for Ch1 if desired. The resistor is equally effective throughout the range of the tuner.

The second choke Ch2 may be a regular commercial coil having an inductance of about 50 millihenries.

### The Intermediate Tuner

The intermediate tuner T1C6 should be adjusted to a frequency of 1,500 kc or a little high, or to the highest frequency to which the broadcast receiver with which it is to be used will tune. A radio frequency transformer designed for broadcast reception and screen grid tubes can be used directly. Such coils have fairly large primaries and can be tuned to 1,500 kc with a 100 mmfd. midget in most instances. If the winding is not quite large enough for this, a fixed condenser of 100 mmfd. can be used in addition, or any other value that may be needed.

There are five fixed condensers in the circuit, namely C1, C2, C5, C7 and C8, each of which should have a value of .01 mfd. or more.

The two tuning condensers C3 and C4 depend on the type of coils used. There are coils available wound for 140 mmfd. condensers, and when these coils are used a set of three coils is needed to cover the band from 15 to 200 meters. Two coil sets can be used if the tuning condensers have capacities of .0005 mfd. The following design is based on the supposition that the capacity of each tuning condenser is .0005 mfd. and that the intermediate frequency is 1,500 kc.

The oscillator winding L3 should be such that when C4 is set at maximum, that is, .0005 mfd., the circuit should tune to 3,000 kc. That requires an inductance of 5.64 microhenries. If the coil is wound with No. 24 double silk wire on a tube base, one and eleven-sixteenth inch in diameter, there should be seven turns. A few more than this should be put on to take care of the possibility of a lower intermediate frequency than 1,500 kc and the possibility that the tuning condenser capacity is less than .0005 mfd. It is always possible to remove turns if many broadcast stations should come in, that is, if the oscillator tunes lower than 3,000 kc.

It is suggested that the tickler L2 be wound with an equal number of turns so as to insure oscillation at all settings. The pick-up winding L1 is not critical but should contain from three to 5 turns of the same as or finer wire than that used on the oscillator winding L3.

### Covers Wide Range

It will be found that this oscillator coil will cover practically the entire band from 15 to 200 meters. However, it is desirable to have another coil with which to tune in the higher frequencies.  
(Continued on next page)

### LIST OF PARTS

- Ch1, Ch2—Two radio frequency choke coils.
- L1L2—A set of two tuned radio frequency transformers as described.
- L1L2L3—A set of two oscillator coils as described.
- T1—One radio frequency transformer designed for broadcast tuning.
- C1, C2, C5, C7, C8—Five .01 mfd. condensers.
- C3, C4—Two .0005 mfd. straight frequency line tuning condensers.
- C6—One 100 mmfd. trimmer condenser, or more capacity as required.
- Rh—One six-ohm rheostat.
- Sw—One filament switch.
- Five UX sockets (four for tubes and one for RF transformer).
- One UY socket for oscillator coil (one terminal of L1 may be a flexible lead to be connected to screen of modulator).
- Two 232 screen grid tubes.
- Two 230 general purpose tubes.
- Six binding posts.
- Two vernier dials for tuning C3 and C4.

# New Tubes in Battery-

By J. E.

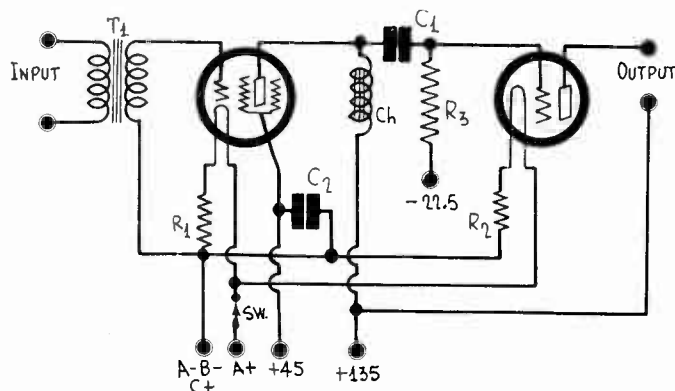

FIG. 1

A TWO-TUBE AMPLIFIER INCORPORATING ONE 232 SCREEN GRID TUBE AND ONE 231 POWER TUBE AND DESIGNED FOR HIGH GAIN.

A SMALL, high-gain audio frequency amplifier capable of putting out a moderate undistorted volume comes in handy for many purposes in the laboratory for testing out tuners, pick-up units, microphones, short-wave receivers, and portable sets. Such a device should be compact and inexpensive to operate, and it should be constructed so that it can be moved easily from place to place.

The new two-volt tubes are particularly suitable for this purpose. If the first tube in this amplifier be a screen grid tube, the 232, and the second a 231, the new power tube, only two stages are required, for the possible gain in the screen grid tube, if suitably coupled, is sufficient. The circuit diagram of such an amplifier is shown in Fig. 1. At first we have an audio frequency transformer T1, which should have a ratio of one to 3.5. The coupling between the screen grid tube should either be resistance or impedance. In the figure the impedance type is shown because this gives a higher gain and practically as good quality as resistance coupling.

### The Impedance Coupler

The choke coil Ch in the impedance coupler should have as high inductance as possible, and the simplest way of getting it is to use the secondary of an audio frequency transformer. In order not to cut the low frequency amplification it is essential that the stopping condenser C1 be not smaller than .01 mfd. If this is used it is better to use one of mica dielectric rather than one using special paper. However, a good paper condenser will work all right and it has the advantage that it takes less room. The grid leak R3 should not be smaller than one megohm, and larger values should be tried, for the larger the value the better the amplification on the low notes. The limit of the value of the leak is determined largely by leakage through the insulation of the grid of the power tube, which means the insulation of the condenser C1 and that of the tube socket.

The new tubes take a filament voltage of 2 volts, which may be obtained from a single storage cell or from two No. 6 dry cells connected in series. The storage battery gives approximately the correct voltage and no filament ballast is used. However, such a battery is not easily available for nearly all storage

### LIST OF PARTS

(For two-tube circuit)

- T1—One audio frequency transformer, ratio one to 3.5
- Ch—One high inductance choke coil (secondary of an audio transformer)
- R1—One 15 ohm filament ballast resistor.
- R2—One 7.5 ohm filament ballast.
- R3—One megohm grid leak, or higher, with mounting.
- C1—One 0.01 mfd. stopping condenser, preferably with mica dielectric
- C2—One 2 mfd. by-pass condenser or larger
- Sw—One filament switch
- Two UX sockets
- One grid connector
- One 232 screen grid tube
- One 231 power tube
- Two No. 6 dry cells
- Three 45 volt dry cell blocks
- One 22.5 volt grid battery
- Eight binding posts

batteries now are made with three cells in series. It is not good practice to cut in and use only one cell of such a battery. The better plan is to use two dry cells in series.

The current needed for the filament is only .190 ampere, which is so small that the dry cells will last a long while. The normal rated voltage of such cells in series is 3 volts, one more than is needed by the tubes. Hence it is necessary to use ballast resistors. R1 is in the negative leg of the screen grid tube filament and since the drop in it is one volt the bias on this tube will be the same. The value of R1 should be 17 ohms but it is all right to use 15 ohms.

The ballast R2 in the negative leg of the power tube should be 7.7 ohms, but 7.5 volts will be all right. This may be obtained by connecting two 15-ohm resistors in parallel.

### Better Arrangement

Perhaps a better arrangement is to use a rheostat in the negative lead of the filament battery, returning the grid of the first tube to A minus. If this is done both R1 and R2 may be omitted. The value of this rheostat should be such that the voltage across the filaments can be made exactly 2 volts when the cells are new. Since the current through this rheostat will be .190 ampere, the resistance necessary to drop one volt is 5.26 ohms. Either a six or 10 ohm rheostat will therefore be suitable.

When a rheostat is used it is advisable to instal a voltmeter in the circuit and connecting it across the filaments so that the rheostat may be set at all times so that the filament voltage is 2 volts. The rheostat could then have a filament switch built in to take the place of Sw.

Only one by-pass condenser is shown in the drawing, the one across the supply to the screen grid, or C2. This should have a capacity of 2 mfd. or more.

The screen of this tube takes a voltage of 45 volts and the plate a voltage of 135 volts. The plate of the output tube also takes 135 volts. Thus the B supply is taken care of by three 45 volt dry cell batteries.

The bias on the power tube should be 22.5 volts, which should be supplied by a dry cell battery especially designed for grid bias.

The maximum undistorted power output of the 231 is 170 milliwatts. This assumes that the peak signal voltage put into the tube is 22.5 volts. Since the 232 tube under the conditions of operation will easily give a gain of 60, the signal voltage on the screen grid tube control element will not be more than about  $\frac{1}{3}$  volt. The bias provided by the resistor R1, or the rheostat, is so much greater than this that there will be no danger of overloading the screen grid tube before the power tube is pressed to the limit.

Now if the ratio of the transformer is one to 3.5 the voltage across the primary of the transformer will never exceed about

## Converter Using

(Continued from preceding page)

quencies. This coil might contain three turns for each of L2 and L3 and two turns for L1.

The radio frequency tuner requires a different design, for this coil is to tune to 1,500 instead of 3,000 kc. If it be wound with No. 24 double silk wire on a tube base it should have 20 turns. That is for L2 on the radio frequency coil, the one which is tuned with C3. The primary of this coil should have half as many turns as the secondary and should be wound on the same form with about  $\frac{1}{8}$  inch separation.

The smaller coil in the radio frequency set should have 5 turns for L2 and 3 turns for L1, both wound on the same form.

It should not be expected that the dials will track when these coils are used, because there are too many variables which cannot be predicted. Moreover, only a fair degree of tracking can be achieved if the coil turns are adjusted experimentally. The reason for this is that one is a straight radio frequency amplifier and the other an oscillator and the two cover different ranges for the same signals.

### The Filament Circuit

The filaments of the tubes in Fig. 1 are connected in series-parallel. The filaments of the first two tubes are connected in parallel, as are those of the second two tubes, but the two parallel circuits are connected in series. There is also a rheostat Rh connected in this series, which is used for the purpose of taking up the excess voltage applied and also to provide a bias for the grids.



# Operated AF Circuits

Anderson

1/10. Therefore the amplifier will work to the limit of the power tube with almost any kind of detector, that is, grid leak, grid bias, or power detection. It will also get sufficient voltage from most pickup units, except condenser type microphones.

## A Push-Pull Circuit

If more output volume and better quality are desired, the same circuit can be assembled in push-pull, as shown in Fig. 2. This is really an excellent little amplifier and inexpensive to operate. It will cost a little more than twice as much as the single circuit in Fig. 1, and the extra cost is due to the use of one more audio transformer.

The push-pull circuit shows a rheostat  $R_h$  in the negative leg of the filament circuit, as was suggested for the single-sided circuit in Fig. 1. Since the current in this rheostat will be .38 ampere and the drop in it is about one volt, the resistance should be about 3 ohms. But since the smallest standard rheostat is 6 ohms, this should be used.

The position of the filament voltmeter is shown at  $V$ . It is recommended that this be used and that the scale be marked in red at two volts. The rheostat should then be adjusted so that the needle points to the red line at all times. The rheostat should be made so that the maximum resistance is in the circuit as soon as the switch is turned on. Most rheostats are so constructed, and moreover they are usually open at one end so that no special filament switch is needed.

In the push-pull amplifier by-passing is not imperative but it is still desirable and therefore  $C_o$  is connected from the two screens to the negative of the filaments. It should have a capacity of at least 2 mfd.

Each of the stopping condensers  $C_1$  and  $C_2$  should have the same value as  $C_1$  in Fig. 1, namely, .01 mfd. Each of  $R_1$  and  $R_2$  should also have the same value as  $R_3$  in Fig. 1. It is important that  $R_1$  and  $R_2$  be equal in value because the input voltages to the two tubes will not be equal unless they are. The two chokes  $Ch_1$  and  $Ch_2$  should also be equal, and as in the case of the circuit in Fig. 1, they may be the secondaries of two audio transformers.

A push-pull input transformer  $T_1$  is essential and an output transformer  $T_2$  is desirable. There are other methods of coupling a push-pull amplifier to a loudspeaker but the push-pull output transformer is the simplest and provides the most effective power transfer.

All the voltages applied to the push-pull circuit are the same as the corresponding voltages on the single sided circuit. However, it is desirable to use heavier B batteries on the push-pull circuit, for the plate current drain will be about twice as great as it is in the two-tube circuit. It is more economical to use larger batteries.

Also, it is well to double up on the filament supply, that is, to use four No. 6 dry cells in series parallel, for the current,

## the New Tube

Since two of the tubes are 232 screen grid tubes and the other two are 230 general purpose tubes, and each takes a filament current of .06 ampere and a filament voltage of 2 volts, the total current drawn from the A battery will be .120 ampere and the total voltage required is 4 volts. This voltage can be obtained by connecting three No. 6 dry cells in series and adjusting  $R_h$  so that it drops one-half volt. Since the drop is to be one-half volt and the current is .120 ampere, the resistance of the rheostat must be at least 4.16 ohms. A six-ohm rheostat is therefore sufficient, provided that not more than three dry cells are used in series.

The current drain is so small that it is not necessary to connect dry cells in parallel.

### 1½-VOLT NEGATIVE BIAS

The first two tubes get a control grid bias of one-half volt, which is sufficient both for amplification and modulation with the plate voltages specified. The grids of the oscillator and the output tube get a bias of 2.5 volts, which falls within the limits of good operation.

The screen of the modulator is returned to positive A, which makes the effective screen voltage 4 volts. The voltage on the screen of the first tube is 45 volts, which is also the plate voltage on the modulator, the oscillator and the output tube. A potential of 135 volts is applied to the plate of the screen grid amplifier. Thus the filament battery should consist of three No. 6 dry cells and the plate battery of three 45 volt dry cell B battery blocks.

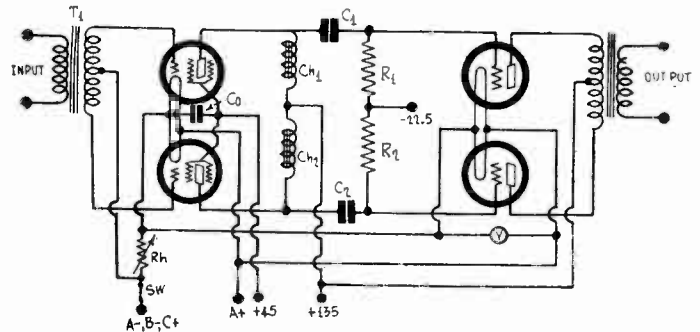

FIG. 2  
THIS FOUR-TUBE AMPLIFIER IS ESSENTIALLY THE SAME AS THAT IN FIG. 1 EXCEPT THAT IT IS PUSH-PULL IN BOTH STAGES.

.38 ampere, is more than should be taken continuously from one cell.

The maximum undistorted power output should be just twice that of the single sided circuit, namely 240 milliamperes, but actually it may be much greater, because the grids may be driven several volts positive before series distortion sets in. Moreover, the bias may be increased considerably over the 22.5 volts, so that the output may be as much as four times as great without appreciable distortion.

The increased output may be obtained from the power tubes without any appreciable distortion in the first stage for the input to that stage may be increased by a factor of almost three without driving the grids negative. The maximum output obtainable from the push-pull circuit is of the same order of magnitude as that from a 171A tube, which is enough for the average home. Indeed, it is more than enough.

### A Conservative Estimate

It was stated that the amplification of the screen grid tube in Fig. 1 was 60 times. This is really a conservative estimate, for the amplification factor of the tube is 400 and the load impedance at 400 cycles, assuming an inductance of 500 henries, is 1.257 megohms. Since the plate resistance of the tube is 800,000 ohms the theoretical gain is 370 times.

A circuit like the push-pull amplifier is especially suitable for the amplification of phonograph music in camp. The amplifier can be built so that it is easily carried around, and if a good pick-up unit and a good loudspeaker are used, the music is greatly superior to that which would be obtained by playing a portable phonograph in the mechanical way. Moreover, much greater volume can be obtained the electrical way, even with this little amplifier.

The amplifier is also suitable for use with a radio frequency tuner and detector of the type now sold in kit form and ready wired. Again, it is suitable for the amplification of the audio output of a short-wave receiver originally designed for head-phone reception.

Obviously, the two-tube amplifier can also be used for these purposes, although the output volume will be considerably less. But when only a moderate volume is desired, and when compactness and portability are important, then the two-tube amplifier fills the requirements satisfactorily. Many automobile receivers designed for loudspeaker operation do not have any greater output capability than this little amplifier.

When a phonograph pick-up is used with either of these amplifiers, it is simply connected in series with the primary of the input transformer.

### LIST OF PARTS

(For push-pull amplifier)

- T1—One push-pull input transformer.
- T2—One push-pull output transformer.
- Ch1, Ch2—Two high inductance choke coils (secondaries of audio transformers).
- Co—One 2 mfd. by-pass condenser.
- C1, C2—Two .01 mfd. mica dielectric condensers.
- R1, R2—Two equal grid leads, 1 megohm or higher, with mountings.
- RH—One six ohm rheostat with switch built in.
- Four UX sockets.
- Two grid connectors.
- Nine binding posts.
- Two RCA 231 power tubes.
- Two RCA 232 screen grid tubes.
- Four No. 6 dry cells connected in series parallel.
- Three 45 volt dry cell batteries connected in series.
- One 22.5 volt grid battery.
- One low reading voltmeter (0-3, or larger scale).

# The Moore Super

By E. Bunting

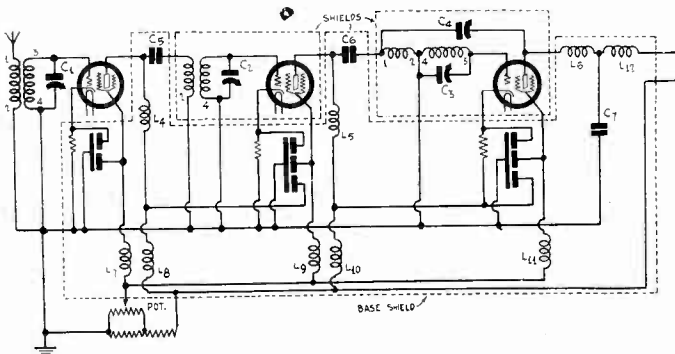

FIG. 1

THE DIAGRAM OF THE TUNER. THREE 224 TUBES ARE USED. THE ANTENNA STAGE IS INDEPENDENTLY TUNED. THE TWO REMAINING CIRCUITS ARE TUNED BY A TWO-GANG CONDENSER.

HOW many broadcast listeners living close to WEAQ, New York, have heard programs from WMAQ, Chicago, free from interference from the local station, when both were on the air? Not many, for WEAQ is a high power station and its frequency differs only by 10 kc from that of the Chicago station. It takes an exceptional receiver to separate the two stations so that those living near either can receive the other free from interference.

There is a real inducement to those living in the metropolitan district to receive signals from WMAQ, for that station transmits exclusive programs of unique merit. One example is the comedy team composed of Doctors Pratt, Sherman and Rudolph in their Musical Potpourri of Humor, Hokum and Harmony, broadcast from the studios of the Chicago "Daily News" station, a regular feature which never fails to entertain those who are lucky enough to receive it. Few, indeed, who live close to a powerful station operated on a frequency only 10 kc from the frequency of WMAQ are so lucky, for most receivers are not selective enough.

### Simple Receivers Designed

The engineering of modern factory-built receivers has today reached a stage which practically assures the buyer of any well-known receiver of the maximum sensitivity and quality which can be obtained through the use of apparatus now available, combined with a simplicity of control which renders totally unnecessary any skill in tuning. In securing this simplicity, however, designers have rendered impossible the adjustment of receivers to that last edge of sensitivity which reaches out long distances under adverse conditions, and with it the razor-edge selectivity that cuts through powerful locals to bring in stations a thousand miles away with as good quality as the locals produce.

Three years ago an engineer who foresaw that sales pressure would force this development forsook the design of commercial receivers and started work in a little shop in New York, with the purpose of having always the simplest receiver which would

bring in far-off broadcasters while the locals still operated with full power. His first year saw the Everyman 4 perfected for the "New York Sun Radio Section." The following year the Moore-Daniels, with one additional radio frequency tube, represented the marked improvement made necessary by the Federal Radio Commission's first reallocation of stations and this year the Moore Super DX has brought the full advantage of screen-grid amplification that made its predecessors famous among the nation's radio builders.

With this set, reception of any of the Chicago stations in New York, or vice versa, is no feat at all, and later in the evening the reception of stations from coast to coast has been accomplished with regularity, although location has something to do with this.

During one evening recently the writer heard more than fifty stations in his laboratory in New York during the two hours and a half prior to midnight, and one side of the room is covered with verifications, many received from distant stations. Letters from users of the receivers are very enthusiastic.

To the casual glance there is a Spartan simplicity to the tuner which gives no promise of such remarkable results. Three screen grid tubes, each with its coil and condenser, a few chokes and by-pass condensers, and nothing else. Two of the stages are shielded. The wiring runs from point to point so that the course of each lead can be followed without difficulty. In its simplicity, the set is reminiscent of those of several years ago. At first glance, too, the front panel is reminiscent of those same sets, for it shows two dials and three knobs, but a closer inspection shows two of the knobs to be adjustments for use in bringing in very weak signals only.

### Technical Description

A short technical description of this receiver, which has a sensitivity approaching one and one-half microvolts per meter over almost the entire band, may not be amiss at this point.

The antenna is coupled to the input circuit of the first tube through a modernized adaptation of the once popular variocoupler, which allows a variation in coupling coefficient from .016% to 8.7% at the will of the operator, a range which exceeds at both ends the entire run of fixed transformers used on standard sets.

This variation, of course, has a pronounced effect on the magnitude of reflected antenna capacity as applied to the secondary tuning capacity, and necessitates the use of a second tuning dial in order to keep the circuits at perfect resonance.

The balance of the RF amplifier consists of two stages of amplification using screen-grid tubes. Complete shielding is utilized throughout and is supplemented by individual filters in each of the power leads of each tube, reducing feed-back to the lowest value possible and permitting the gain per stage to be increased enormously. Biasing voltages are chosen throughout with careful reference to maximum amplification against low input conductance, so that the selectivity of each stage is kept very high. Stabilization of oscillatory effect due to the inter-elemental capacity of the tubes (which is appreciable even in screen-grid tubes) is accomplished by the use of "Chrono-phase" output circuit. This was developed some two years ago by Bert E. Smith. By combination of a high shunt impedance with the proper values of resistance and coupling capacity to the tuned circuit effect a slight phase displacement between input and output circuits is established, while retaining the necessary high impedance for high amplification.

### Betts' Circuit Utilized

The input to the detector circuit utilizes a modification of the well known Betts' circuit. A Hartley oscillator circuit with a very small capacity controlled from the front of the panel permits the introduction of a very small amount of controlled feedback which is confined to this circuit alone, and due to the design of the inductor, can be permanently adjusted at a constant value over the entire band, and need not be readjusted except for very weak signals. The screen of the detector tube, like the screens of the amplifiers, is connected to the variable arm of a potentiometer, giving exact control of the amplification of all tubes simultaneously. This is used as a volume control and is the only knob which, except for the tuning controls, is used for operating the set.

Thus, the circuit is seen to be entirely free from tricks of any kind. It represents simply the application of sound, well known engineering principles throughout, with properly designed and co-ordinated parts. And seemingly, it fulfills all the requirements for an all-round tuner. It can be used for local and thousand-mile reception with the simplest controls. Using

### LIST OF PARTS

- L1, L2, L3—Three Moore Super DX coils
- L4, L5, L6, L8, L9, L10, L11, L12—Eight RF choke coils
- L7—One Moore special choke
- C1, C2, C3—Three Hammarlund .0005 mfd. condensers.
- C4—One .00005 mfd. variable condenser
- C5, C6, C7—Three .002 mfd. condensers.
- Two 400 ohm grid bias resistors
- One 25,000 ohm bias resistor (grid leak type)
- Eight 0.1 mfd. by-pass condensers
- Three Hammarlund insulator couplers
- Three Hammarlund tube shields
- Two Hammarlund Drum dials with dial lights
- One Moore Super DX chassis, complete with shields (except tube shields)
- One 50,000-ohm or 30,000-ohm potentiometer
- Two UY sockets, baseboard mounting type
- One UY socket, sub-panel mounting type



# DX AC Tuner

Moore

power detection, it has sufficient output to operate any good amplifier. It has selectivity equalled by few, if any, others. Its power detection, it has sufficient output to operate any good extremely simple to build, inexpensive, and most important to all, it is absolutely stable when built—the user need anticipate no weary hours of “removing the squeals,” “balancing,” or otherwise adjusting. As soon as the last wire is in place he can sit right down and begin to “go out and get ‘em” with unbelievable quality if he is using a good amplifier and reproducer.

## Construction of Set

Take the steel chassis and place it on the table or bench with the two large holes for the tube sockets at the rear and to the right. When turning it over, in following these directions, keep them away from you.

Mount the sockets first, with the grid posts towards the front of the chassis. Then mount the filter condensers and coils, putting lugs under both tops and bottoms of each screw as used, and cleaning away the paint under them so that a good contact with the chassis will be had. Mount the tuning condensers with the maximum plate projection to the front.

Start the wiring with the filament leads, beginning at the first RF tube and progressing to the detector. Twist the leads tightly between tubes. It is a good plan to keep these wires of equal length as nearly as possible, which can be done if the wire connected to the right terminal of the first socket is connected to the right terminal of the next, and so on. This also aids in trouble shooting later. Finally, connect the terminals of the second RF tube to the 2.3 volt binding posts.

Now turn the chassis right side up. Connect the stator of the left hand variable condenser to the near terminal of the first coil, and leave about four inches of wire to be attached to a cap for the grid connection of the first tube. Attach far lower terminal to coil bracket. Connect each of the other condenser stators to the left hand rear terminal of its coil, and also to a grid cap. Mount the regeneration condenser and make sure the rotor is not grounded to chassis, connecting the rotor to the right hand rear terminal of the detector input coil. Then attach a piece of wire about six inches long to the stator of the regeneration condenser and pass it through the hole in the base directly below the lug. Attach about a foot of wire to each of the three terminals of the volume control and pass them through the hole in the center front of the chassis.

## Wiring Below Chassis

Now turn over the chassis, as all the rest of the wiring is on the bottom. Connect the lug on the bottom of the right hand condenser post to the one on the coil mounting bracket, and also to the common section of the first filter condenser block. Any other lugs attached directly to the chassis should also be picked up by this wire, which in turn should also connect all the common terminals of the filter blocks, and also the common terminals of the other two coils, the negative binding post, the ground binding post, and one side of each biasing resistor. No harm will be done by connecting this to several additional places on the chassis. It should also be attached to lugs placed under the screw holding the shield to the chassis. Note particularly that it is connected to the receptacle for each of the tube shields.

Now wire in the two RF plate leads, pulling each through a braid shield, and grounding the shield. The exact placement of the choke coil is not important, provided their centers are kept approximately two inches apart. Mount the plate coupling condensers directly on the plate terminals of the RF sockets, and then connect the other ends to the right hand rear coil terminals, through the shielded leads.

Each of the RF cathodes is connected to ground through a 400 ohm biasing resistor, and the detector cathode through a 25,000-ohm biasing resistor. Each resistor is shunted by a filter section. Each screen grid is connected through a choke to the arm of the volume control potentiometer. The screen grid terminals are also connected to individual filter sections.

## Connecting Dial Lights

The plate of the detector tube is connected to the lead coming through from the stator of the regeneration condenser, and also to two chokes in series. The center point of these two chokes (L6 and L12) is attached to C7, the other end of which is grounded. The remaining terminal of L12 goes to the “Output” binding post.

The balance of the wiring may now be put in, including the dial light wires, which are not shown but are simply shunted across the filament terminals of the nearest socket and are twisted tightly together all the way. The antenna coupling coil

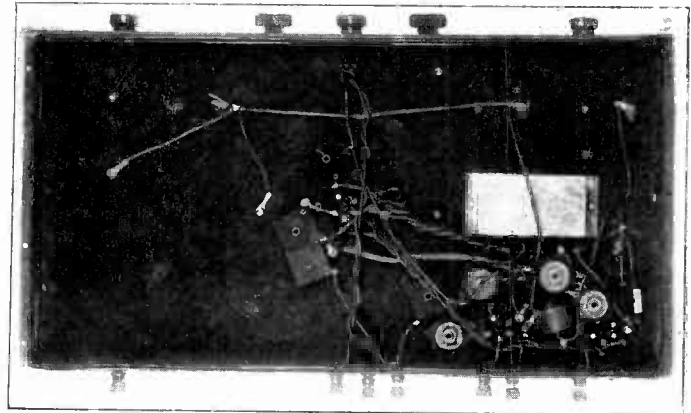

FIG. 2

LOOKING UNDERNEATH ARE SEEN A NEAT ARRANGEMENT OF INCIDENTAL PARTS AND A CLOSELY VARIED JOB.

should be connected to the antenna binding post and to the chassis.

Check over all wiring carefully, against both the pictorial and schematic circuit diagrams. When you are sure this is right, all the way through, attach your panel and mount the escutcheon plates of the dials. Place an insulating coupler on the shaft of the regeneration condenser and a rod through the panel and between the stator plates and the frame of the tuning condenser.

Put the antenna coil rod through the bushing mounted in the front panel, with the spring and collar on the shaft. Attach the knob, then push the spring into a compressed position with the sleeve and tighten the set screw. This should then remain in whatever position it is placed. Now mount the antenna primary coil on the rod. (It should already have been connected by the flexible lead as described above.)

Now attach the dials on the shafts of the condensers. With the plates all the way out, turn dial so that zero shows in the escutcheon. Fasten the dial to the shaft with one fastening bolt on the drum also tightened, then turn enough to fasten the other bolt. Repeat with the other dial. Turn to “100” with plates all the way in, and fasten the condenser rotors, but only with one screw on the detector input condenser, for this should be adjusted after set is on the air. Now mount and fasten the shield in place.

## The Job Is Done

Now put all the tools away except the screwdrivers. Clean up the mess you've made generally and make things neat all around. If you've done a good job, you won't need the pliers or the solder or the hammer or anything else any more for this job.

Connect the set to an amplifier with an input impedance of as nearly two hundred thousand ohms as is obtainable. The “low” side of the input should be connected to 180 volts positive. Connect the antenna, ground, heater and plate voltage leads. Turn on the power, and if no smoke arises, put in some tubes and wait until the cathodes are hot.

Turn the volume control up and wiggle the dials a bit. You should get music. If you don't, check it all over again, and fix whatever you had wrong. If you do, turn to a high wave station (WMCA, WIHO, KSD or KMTR, for instance), preferably one that requires little regeneration, and loosen the detector input condenser. Adjust this a little with a wood or bakelite stick until the signal is loudest, and then fasten it tightly. Be very careful with this adjustment, for your set's ability to get the other coast depends on the accuracy of this setting. Then put the top on the shield as far as possible while retaining access to the condenser and readjust to the greatest possible accuracy.

Now put it in the cabinet, drag it into the living room and tell your wife that you won't be to bed tonight. Get the battle over right away, for it'll save endless interruptions later on, and what do you care if she leaves you, now that you've got a good radio set. Then settle down to log a station on every channel. If there aren't too many heterodynes, you'll be able to paper your walls with verifications in a week or so, and you'll have enough envelopes left over to materially cut next winter's coal bill, so put off buying the oil burner for a while.

**AFFIRMATIVE**

*By Madison Carter*

**I**N the days of the "one-lunger," as the single-cylinder automobile was called, if you missed only occasionally on one cylinder you stopped. Nowadays your spark plug in one cylinder may go bad, and you get no ignition in that compartment, yet you can get home all right, because you have three or five or seven cylinders more in good order and operation. It might be said, therefore, that any one cylinder is not of such vital importance today as it was in the bad old days.

How operators used to nurse that single cylinder! They coddled it more than if it were their own child. A man with a four-cylinder car to-day, if he had to expend as much time and money on each cylinder as were spent on the cylinder of the darker days, would find little time left for business or leisure.

One simply had to devote his life to the upkeep of that cylinder or get nowhere, automotively.

**The Radio Set of Yesteryear**

In radio a parallel exists in the receiver. Take the one-tube radio circuit, popular as the three-circuit tuner, to which two stages of audio were hooked up if one desired to work a speaker. Certainly to obtain good results a high, long, outdoor aerial was necessary. If one used a crystal receiver the argument in favor of a long, high, well-insulated aerial was even stronger. This was the situation in the early days of radio broadcast reception. The radio frequency part of the receiver, which alone is concerned, was a "one-lunger," also, and the same care and attention had to be devoted to the receiver as to the automobile. So if a man had both car and set, his time was never his own, for he was a slave to the set when he was not a slave to the car.

Presently a stage of tuned radio frequency amplification was added ahead of the regenerative detector. Tuned radio frequency in the form of the Neutrodyne, came along, with three tuned stages, but no regeneration. Then came four tuned circuits in a Neutrodyne. Meanwhile the Superheterodyne was gaining in popularity. Along came the improved tubes, no neutralization necessary, and now five tuned circuits, with a tube for each one, are gaining popularity, as are six tuned circuits, where band pass filtration is used. Considering alone the receiver up to and including the detector, five tubes are the rule, where in the beginning one tube was orthodox.

**Unchanged Aerial Advice**

Despite this changed situation, we hear the same advice about aerials now as we did then: they should be long and high, say, 100 feet long, including lead-in, and as high up as possible, with stand-off insulators and lead-in insulators and low-loss wire with special insulation to keep dust and soot off the wire itself. Nothing less than No. 14 wire for the lead-in, and stranded wire, six strands equal to No. 18, as the minimum!

On the one hand, an outdoor aerial, if used, should be a good one. On the other hand, is the same aerial that is good for an old-fashioned set, good for the most modern and highly sensitive receiver? There is room for doubt. And I am among the doubters.

One point lost sight of quite frequently is the practical selectivity demand placed on the receiver. When a set is highly sensitive this demand is equivalently high. The object of having a receiver is to bring in broadcast programs well, separate stations adequately, and reach out when the spirit moves, without having to wait until all hours of the night, when all the locals are off the air.

**An Idea of Practical Selectivity**

Expressed in general terms, the longer and the higher your aerial, the worse will be your receiver from the viewpoint of practical selectivity. One may define practical selectivity as the ability of the receiver, under all operating conditions as they exist, to separate all receivable stations without interference which selectivity could eliminate, and confine strong locals to a minimum dial spread. This condition would exist were one able to tune in a strong local, then tune it out and tune in a weak distant station only 10 kc removed from the strong local.

Now we have receivers with a sensitivity of a fraction of a microvolt per meter. Speaking generally, that would mean that in New York City locals could be tuned in at adequate volume, and some distance as well, with no other aerial than a piece of wire from the antenna binding post to the floor, about three feet. The separation of stations is easy and complete.

When a long, high outdoor aerial is substituted, while the same actual selectivity exists, as this depends solely on the re-

# Resolved, T Aerial Is

ceiver, the practical selectivity is much lower. The strong locals take up more room on the dial. Tuning in a weak distant station 10 kc. removed from a powerful local passes beyond the point of realized expectation. It is simply a case of the intensity of the input having been raised. And the strong locals, with modern receivers, are too strong, when the input intensity is raised too high.

Therefore it can be realized that a receiver has a definite selectivity for any given frequency, or may have about the same selectivity for all broadcast frequencies, and the selectivity is independent of intensity of input. Yet that selectivity is a concrete factor only in connection with a stated input.

# Six Tones

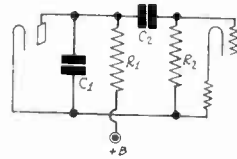

FIG. 1

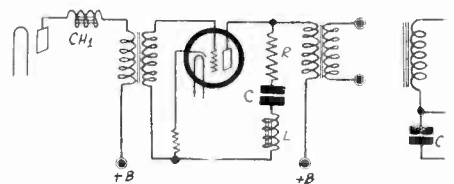

FIG. 2

FOUR TYPES OF

**I**N a previous issue, July 12th, we discussed various methods of controlling the tone of a radio receiver; that is, controlling the relative intensities of the high and the low frequencies in the output of the loudspeaker. We showed the effects of connecting condensers and chokes in series with the line as well as across the line. We also showed how strong peaks at certain frequencies could be removed.

The method of controlling the tone by means of two speakers, one adjusted to respond strongly to the high frequencies and the other adjusted to respond to the low, is illustrated in Fig. 5 herewith. The low-tone speaker may be a large-diaphragm dynamic which favors the low tones. The current fed this speaker may further contribute to the low tones by filtering out the high tones by means of series chokes and shunt condensers. The high-tone speaker may be a magnetic, inductor, or a small-cone dynamic. The current fed to this speaker may first be filtered by series condensers and shunt chokes to remove the low frequencies.

After having provided two speakers such that one favors the low tones strongly and the other the high tones, it is simply a matter of arranging a voltage divider by means of which the output of the power tube can be diverted to one speaker or the other in various proportions. The potentiometer P illustrates how this can be done.

The use of two different amplifiers with a single speaker was also mentioned, and Fig. 6 herewith shows the arrangement. Of course this arrangement is rather expensive and does the

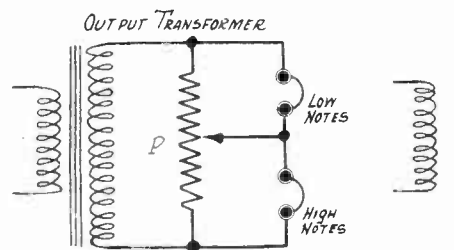

FIG. 5  
IF TWO SPEAKERS, ONE EFFECTIVE ON THE HIGH NOTES AND THE OTHER ON THE LOW NOTES, ARE AVAILABLE, THIS TYPE OF TONE CONTROL MAY BE USED.



# What a Long a Mistake

Assume an input of 50 microvolts per meter, this being the antenna field strength for a given station. The selectivity curve runs sharp. Now assume 1,000 microvolts. The shape of the curve is the same, since the receiver's selectivity has not changed, but the curve is lifted, and its upper sides do not fall within the desired 10 kc, but skirt beyond it. So with the new intensity of input we cannot get practical 10 kc. separation. Such separation has no meaning, except when a stated input is given, no more than is there any meaning to the statement that a certain package requires two postage stamps, unless you give the denomination of the stamps.  
So the better the aerial is, the worse it is likely to be! We

have not added tube after tube without accomplishing something. We have not added tuned circuit after tuned circuit without accomplishing something. We are confronted with extraordinary demands on the score of selectivity, and we must meet them. This we do by using multiple tuned circuits, with tubes between them, and build up the sensitivity and the selectivity by the same process. The result is, when we succeed, we do not need anything like the aerials of the days of yore. We get out of the receiver the value that was built into it only when we limit the size of our aerial to the requirements of location and of performance.

The city dweller is afflicted mostly with selectivity troubles that modern receivers overcome, but the way to overcome them is to use a modest-sized aerial, say, a wire run under the carpet, perhaps the length of the carpet. The volume from the speaker, under these conditions, is far greater than it ever was in the days of the three-tube regenerator (detector and two audio) with its 100-foot aerial.

### Effect of Long Aerial

Use of a long aerial is equivalent to the result obtained from amplification without tuning, an RF increase without discrimination. The object of introducing many tuned stages is not to be able to use a very long aerial and still have enough practical selectivity, but to enable use of a short aerial, with assurance of plenty of volume nevertheless, so that the degree of practical selectivity required will be attained actually.

Location enters into the situation because in rural districts the field strength of stations received is so much lower that the difference can be made up by using a long aerial.

However, the development of selectivity has not been for the benefit of the rural listener. For him the great advantage desired was increased sensitivity. Since the two considerations were developed by the same process and in the same manner, it simply happened that the rural listener fell in for greatly increased selectivity which he did not need, to obtain the increased sensitivity which he greatly desired.

### Difference in Location

So he can go back to where he was, in practical selectivity, as far as he needs or desires, by using a large, long aerial, and can outdo the usual prescription of 100 feet by 100 per cent., if he likes.

But an aerial should not be any longer than is necessary to work the receiver in the desired manner. If the requirements are met with a short aerial, then a short aerial it should be. If the aerial is indoors, so much the better. It may go around the moulding, or under the carpet, or may be mostly in the attic. That doesn't matter. It is the amount of pickup that matters. That should not be any greater than the circumstances require.

It is better to enjoy the resultant increase in practical selectivity even if this increase is not particularly needed, for the long aerial, like the untuned stages of amplification, brings in a greater percentage of noise with signal.

What is true of an aerial is true of a ground. Any ground lead is an assistant aerial. Many receivers, particularly of the AC type, work just as well without an external ground as with one. If use of external ground reduces hum, use the ground. But always remember that the shielded receiver and its steel-core transformers, are actually at ground potential, even if an external ground is not used, and thus the chassis and the rest of the assembly intended for grounding also are grounded.

# 2 Controls

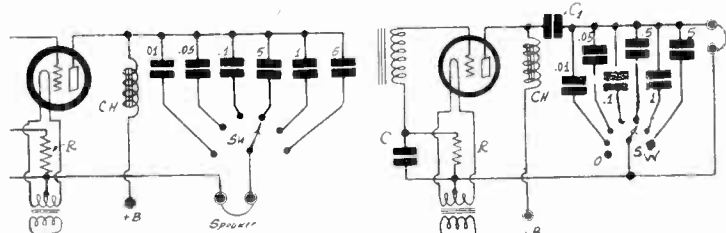

FIG. 3  
TONE CONTROLS.

FIG. 4

work no better than some of the other methods discussed. Moreover, as was suggested in the preceding article, it is necessary to take precautions against feeding the speaker with current from the two amplifiers out of phase.

The thing to remember in arranging tone control is that a series condenser and a shunt inductance cut the low frequency and a shunt condenser and a series inductance cuts the high frequencies. The smaller the series condenser and the smaller the shunt inductance the more the low notes are cut, and the larger the shunt condenser and the series choke the more the high notes are cut.

In dealing with grid leaks and stopping condensers it should be kept in mind that the grid leak resistance is the useful load and that the stopping condenser is in series with this load. For a given value of grid leak resistance, the low notes will be amplified the more the larger the stopping condenser. Also, for a given value of stopping condenser the low notes will be amplified the more the higher the grid leak resistance.

In a resistance coupled amplifier, if the high notes are to be suppressed, shunt condensers across either the grid leaks or the plate coupling resistors are most effective. A given value condenser across the grid leak resistance will be more effective than the same condenser across the plate coupling resistor because the grid leak resistance has a higher value than the plate resistor. Across either relatively small condensers will produce a large suppressing effect on the high notes because the resistors are large.

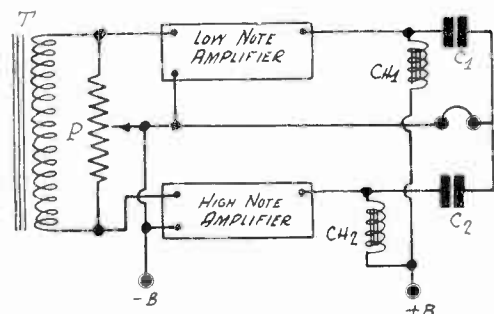

FIG. 6  
A TONE CONTROL EFFECT MAY ALSO BE OBTAINED BY USING TWO DIFFERENT AMPLIFIERS AND ONE SPEAKER AS SUGGESTED IN THIS FIGURE.

## NEGATIVE

By Ronald Baker

It is an advantage to have a long aerial today as in the days of the crystal set and the one-tube blooper. That advantage consists in having a good, big, fat signal delivered to your set, instead of a bad, little, skinny signal. There is no difference in cost worth mentioning. But everyone knows there is a difference in quantitative result.

There are radio chumps. They see things from queer angles. Of course, use a long aerial if you're a real radioist. You want distance—coast to coast—and you can't do it without a long aerial. No, sir, not that enormous distance!

All you need to do as a safeguard is to use a variable series condenser in the aerial circuit, or a potentiometer or other device, to reduce the input as desired. Then you have a very long, medium, short or scant aerial, as circumstances require!

A Question and Answer Department conducted by Radio World's Technical Staff. Only Questions sent in by University Club Members are answered. The reply is mailed to the member. Join now!

# RADIO UNIVERSITY

Annual subscriptions are accepted at \$6 for 52 numbers, with the privilege of obtaining answers to radio questions for the period of the subscription, but not if any other premium is obtained with the subscription.

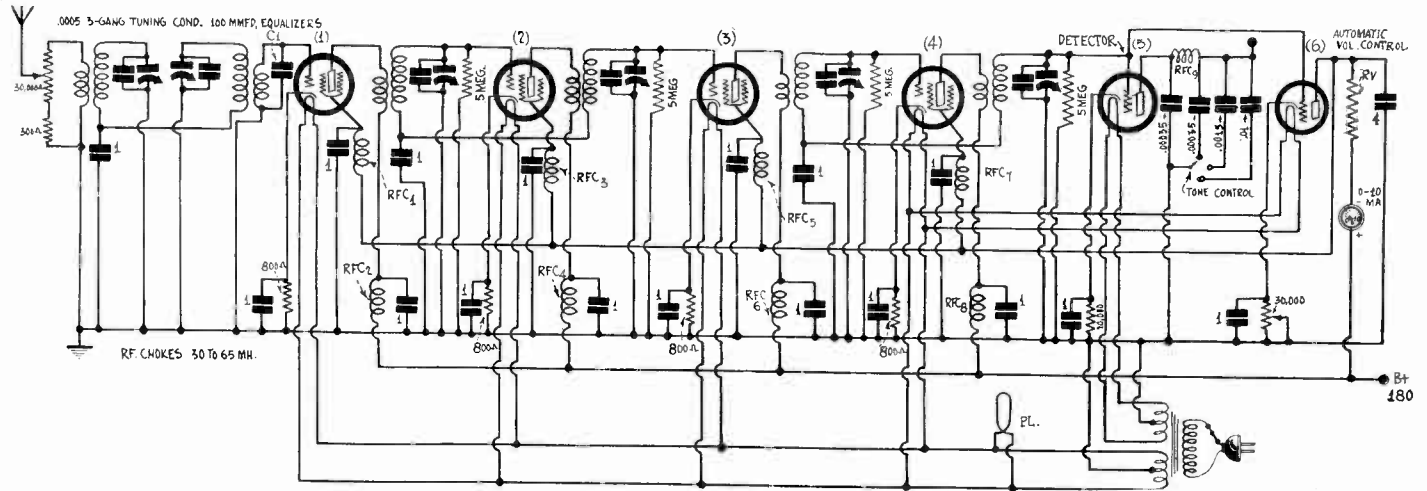

FIG. 836

THE CIRCUIT DIAGRAM OF A SIX-CIRCUIT TUNER AND RADIO FREQUENCY AMPLIFIER IN WHICH AN AUTOMATIC VOLUME CONTROL AND A TONE CONTROL HAVE BEEN INCORPORATED

### Six-circuit Tuner

PLEASE PUBLISH a circuit of a radio frequency tuner and amplifier in which an automatic volume control has been incorporated. If you can also include a tone control I shall appreciate that.—L.A.Y.

Fig. 836 shows such a circuit. It is the six-circuit tuner which is now in process of development.

### Best Type of Shielding

I HAVE NOTED that you have described many types of shields for tuning coils and radio frequency stages. In some cases you have had intact shields, in others shield cans with large and small holes in the tops, in still others you have had slots, and frequently you have recommended box shields including entire stages. From your experiments which type do you regard as the best?—B.M.J.

There is no one type of shielding that can be said to be best in all instances. What is best in any case must be determined from general principles and a little experimentation. First of all, a perfect shield is a compartment made of a good conductor, such as copper, brass, or aluminum, made so that it does not permit electric or magnetic flux from getting out of it, if the source of the flux is inside, or getting into it if the source of the flux is outside. That means that metal must be thick as well as a good conductor and that there should be no holes or slots in it. But a perfect shield is not necessarily the best in practice. Indeed, it may kill off the sensitivity of the receiver. A shield is a shield by virtue of currents induced in the metal. But these currents represent losses of energy, or losses of selectivity and sensitivity. These losses are greater the closer the metal is to the coil shielded, and therefore if a good shield is not to introduce excessive losses it must be large compared with the coil dimensions. If space limitations prevent the use of large shields the coils must also be reduced in size or slots or holes must be cut so as to reduce the losses. Unfortunately, these openings reduce the shielding effect. However, it is possible to arrange the shielding so that a good compromise is struck between good shielding and the losses, leaving the amplifier both stable and sensitive.

### Television Signal Amplification

PLEASE EXPLAIN why resistance coupled amplifiers are always recommended for the amplification of television signals? I can't see why audio transformer coupling cannot be used just as well because when one listens to television signals the noise falls distinctly in the range where most transformers are effective.—E.A.B.

It is true that when one listens to a television signal the sound appears to be confined to the part of the spectrum where most transformers are effective, but there is more to that signal than can be heard. In the first place there is a low frequency hum corresponding to the frequency with which the frames are repeated. This is usually 15 per second. Therefore the amplifier must be able to handle frequencies below this with full amplification. Then it contains a frequency equal to the repetition of the scanning lines, which may be 15x48, or 720 per second. This

is the characteristic frequency heard, but it is not the most important frequency. The important frequencies arise from the variation in the signal due to changes in brightness intensity along a scanning line, and these frequencies may have any value from the 15 cycles per second previously mentioned to extremely high, super-audible frequencies. There is no transformer made which will cover such a wide range, and particularly, there is no transformer which will handle frequencies as high as 50,000 cycles per second, if it at the same time handles low audio frequencies. Even some resistance coupled amplifiers will not amplify much above 10,000 cycles, and very few that go up to 50,000. Since resistance coupling comes nearest to giving the amplification desired, it is recommended.

### Potentiometer Volume Control

WHEN THE volume in a screen grid tube receiver is controlled with a potentiometer by means of which the screen voltage is adjusted, is not an unnecessary drain put on the B supply? It seems to me that volume controls not using this scheme could be used to better advantage.—M.P.A.

There is no doubt that the best volume control is one which works so that the amplification is not altered and so that no extra drain is put on the voltage supply. Theoretically, the best volume control is a potentiometer in the antenna-ground circuit by means of which the signal input voltage may be varied. Practically, this does not always work out satisfactorily because it lacks range. It is desirable to have another control to supplement the input control, and the best supplementary control that has been found for screen grid tubes of the AC type is one that controls the screen voltage. The extra current drain is so small that it need not be considered.

### Set Booms on Loud Volume

AS LONG as I operate my receiver with moderate volume all is well, but when I attempt to turn it up so as to make the set audible all over the house, a loud howl sets in. I can't figure out what causes it. There is nothing wrong with the circuit, for I have checked it over and I have others check it. Moreover, it seems to me, if there were something wrong with the hook-up the howl would be present all the time. Please suggest the cause and the remedy.—N.C.E.

It is not at all certain that the set will behave right on low volume and misbehave when the volume control if there is a defect in the wiring. For example, if the grid circuit of one of the audio tubes is open, or if the grid leak resistance is too high, the set might behave this way. However, since you have checked the circuit over we have to look elsewhere for the trouble. There are two possible causes, regeneration through the B supply and regeneration through the air or through the receiver structure. If the trouble is due to regeneration through the B supply, more by-pass condensers across the voltage taps on the voltage divider, especially across the section supplying the detector, should cure the trouble. This, however, should not be tried until the other possibility has been investigated. It is very likely that the trouble is due to feed-back through the air or through the mechanical supports between the tubes



and the loudspeaker. Does the trouble stop when you hold the speaker in the hand? If so, the trouble is most likely mechanical coupling between the speaker and the tubes. If it does not stop, the trouble may be due to air coupling. If so, it should stop when the speaker is taken out of the room or, sometimes, when the leads to the speaker are reversed. Touch the tubes with your hand and note whether or not the trouble stops. If it does, it is evidence for acoustic or air coupling being the cause. Possibly the detector tube or the first audio amplifier tube is microphonic. Try a new tube.

**Controlling Screen Grid Voltage**

I HAVE noted that the volume control in screen grid receivers in which the screen voltage is varied is very critical. Most of the range of the control is useless. It occurred to me that instead of varying the screen voltage on all the tubes, a less critical control could be obtained by controlling the voltage on only one or two tubes. What do you think of the idea?—G.E.D.

It is a good idea, indeed. You might wire the potentiometer so that it controls the screen voltage on the first and the second screen grid tubes. If avoidable, it is better not to control the screen voltage on the first tube, because if this voltage is lowered very much detection might occur, and this would cause modulation.

**Vibration of Condenser Plates**

IS IT POSSIBLE that the loudspeaker could set the plates of the variable condensers into vibration and thus cause a modulation and a feed-back? It seems to me that the condenser plates would have a natural period of vibration and that a sound from the speaker easily could set the condenser plates vibrating at this frequency. If this is true there is a good chance of getting oscillation at an audio frequency.—T.O.M.

It is quite possible, especially when the loudspeaker is close to the condensers and when the condensers are not protected from the sound coming from the speaker. There is also a possibility that the condenser plates may be set in vibration by mechanical coupling between the speaker and the condenser. Receiver manufacturers have found this to be true and they have been forced to remedy the situation. Many of them have mounted the condensers on rubber to kill off the mechanical coupling and inclosed them in boxes to exclude sound.

**Obtaining Screen Voltage**

WOULD YOU recommend the use of a high resistance in the screen circuit and connecting this to the same potential as the plate return in order to get the correct screen voltage?—R.S.T.

This is not a good way of obtaining screen voltage because of the uncertainty of the voltage drop in the resistance. However, there are circuits in which this arrangement must be used for practical reasons. For example, if a system of plug-in is used for picking up voltages it is often necessary to resort to this method because there are not enough prongs or springs in the receptacle to go around for all the leads.

**Primary or Secondary Tuning**

IN AN intermediate amplifier is it better to tune the primary or the secondary? What are the relative advantages of both?—C.N.G.

It makes practically no difference which winding is tuned, especially when screen grid tubes are involved. When the tuning adjustment is to remain fixed one has no advantage over the other. There is one exception. The tuned circuit following the modulator should preferably be tuned in the primary because the condenser then acts as a by-pass for the radio frequency currents.

**Magnetron Tubes**

IF ELECTRONS are affected by both electric and magnetic fields would it not be possible to control the electron stream from the cathode to the plate by means of a varying magnetic field just as well as by a varying electric potential?—M.P.S.

It has been done and tubes so constructed as to utilize a magnetic field are called Magnetrons. They have some very remarkable properties but they are not suitable for amplification in radio sets.

**Natural Period of a Coil**

I HAVE SEEN references to the natural period of a coil. Does this mean that a coil has a natural period of vibration even when there is no capacity present?—T.E.R.

There can be no natural period of a coil alone, that is, without any capacity. But every coil has a certain distributed capacity. The natural period of a coil is the period determined by the inductance of the coil and the distributed capacity. For frequencies above the natural frequency of resonance a coil acts as a condenser.

**More Winding Data**

HOW MANY turns of No. 28 double silk covered wire are required to tune in 500 kc with a .0005 mfd. condenser, using a form of 1.75 inches in diameter? Would such a coil be satisfactory for the intermediate frequency tuner in a Superheterodyne?—T.E.S.

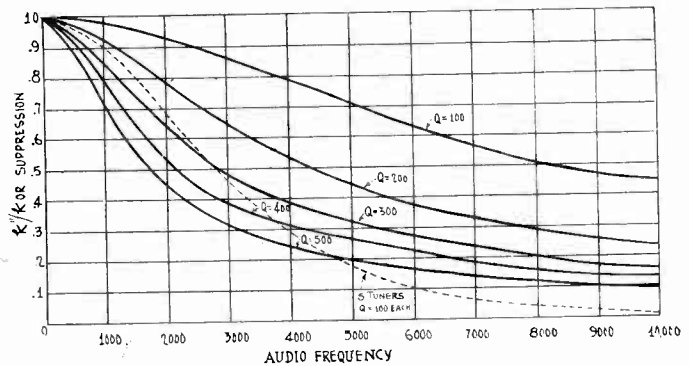

FIG. 837

QUALITY CURVES SHOWING THE SUPPRESSION OF THE HIGH NOTES FOR DIFFERENT DEGREES OF SELECTIVITY.

Wind 73 turns, 60 turns to the inch approximately. This will make a coil which will tune to 500 kc when just .0005 mfd. is across it. The distributed capacity will lower the frequency a little so that if this capacity is 25 mmfd. about 70 turns will be sufficient. It will make a good winding for an intermediate frequency tuner. If the transformer of which this winding is the secondary is to follow a screen grid tube, use about 35 turns for the primary and wind this on the same form without any separation between the adjacent ends of the two windings.

**Quality Curves**

IT IS WELL known that a sharp tuner suppresses the high audio frequencies, but how great is this suppression in tuners ordinarily met in practice? Is the suppression so great that it affects the quality appreciably, or is it merely detectable with sensitive instruments?—W.E.

Whether or not the suppression is great enough to be appreciable depends on the circuit, on the speaker, and on the listener. Perhaps it depends most on the listener. Some are very keen in determining the weakness of the high notes, while others never miss them even if they are entirely absent. The curves in Fig. 837 show the suppression at various frequencies for various degrees of selectivity. In these curves Q stands for the selectivity and is the ratio of the coil reactance to the coil resistance. It might be said that the suppression at 10,000 cycles for Q equals 100 is negligible for it is only 55 per cent. When Q is 500 the suppression is quite high and would certainly be appreciable.

Join

Radio World's

UNIVERSITY CLUB

And Get Free Question and Answer Service for the Coming 52 Weeks. This Service for University Subscribers Only

Subscribe for RADIO WORLD for one year (52 numbers). Use the coupon below. Your name will be entered on our subscription and University Club lists by special number. When sending questions, put this number on the outside of the forwarding envelope (not the enclosed return envelope) and also put it at the head of your queries. If already a subscriber, send \$6 for renewal from close of present subscription and your name will be entered in Radio University.

NO OTHER PREMIUM GIVEN WITH THIS OFFER

[In sending in your queries to the University Department please paragraph and number them. Write on one side of sheet only. Always give your University Club Number.]

RADIO WORLD, 145 West 45th Street, New York City. Enclosed find \$6.00 for RADIO WORLD for one year (52 nos.) and also enter my name on the list of members of RADIO WORLD'S UNIVERSITY CLUB, which gives me free answers to radio queries for 52 ensuing weeks, and send me my number indicating membership.

Name .....

Street .....

City and State .....

## 5 NEW BIDDERS MAKE 38 TOTAL IN 50 KW RACE

Washington.

Two new applications for a construction permit to use 50,000 watts brings up to thirty-eight the total number of stations either licensed, possessing construction permits, or having filed applications for the maximum power. There are fifty-one stations assigned to the forty cleared channels, due to time division in some instances, and since the Federal Radio Commission has decided to limit the number of clear channels to twenty there may be more time-sharing.

The present rush for 50,000 watts is the most striking example of intense interest in super-power in the history of radio broadcasting. The large number of applications is due to the fact that 50,000-watt equipment has proven dependable, and is now readily obtainable, while the results in enlarged service area and better signal strength and quality have been proved.

### Five New Applications

The two stations newly to request 50,000 watts are WBT, Charlotte, N. C., recently acquired by the Columbia Broadcasting System; WMC, Memphis, Tenn.; KFRC, San Francisco; KHJ, Los Angeles (same owner for last two), and KVOO, Tulsa, Okla. WBT enjoys full time on 1,080 kc, and is sending out no chain features except Columbia's, a recently adopted policy, as it also had National Broadcasting Company features formerly. The frequency of KVOO is 1,140 kc, which it shares with WAPI, Birmingham, Ala., which also has a request in for 50,000 watts.

Nine stations are now on the air with 50,000 watts. They are: WGY, Schenectady, N. Y.; WEAJ, Bellmore, N. Y.; KDKA, Pittsburgh; WENR, Chicago; WLW, Cincinnati; WBAP, Fort Worth, Tex.; WTIC, Hartford, Conn.; WTAM, Cleveland, and WFAA, Dallas, Tex. The same transmitter is used by the two Texas stations. WFAA and WBAP, WENR, Chicago, shares its channel with WLS, Chicago. WBAP and WFAA also share time. WTAM shares time with WBAL, Baltimore.

### Six Hold Permits Prior to License

Six stations hold construction permits permitting them to install apparatus of 50,000 watts output, upon completion of which within the prescribed provisions, licenses automatically are forthcoming. These stations are WLS, Chicago (shares WENR, Chicago); WOAL, San Antonio, Tex.; KNX, Los Angeles; KMOX, St. Louis; WABC, New York City, and KFI, Los Angeles.

The 23 stations having applications for construction permits pending are: WHAM, Rochester, N. Y.; WOWO, Fort Wayne, Ind.; WSM, Nashville, Tenn.; WSB, Atlanta; WRVA, Richmond; WAPI, Birmingham; WCFL, Chicago WHO-WOC, Des Moines and Davenport, Iowa; KWKH, Shreveport, La.; WWJ, Detroit; KTNT, Muscatine, Iowa; WFBM, Indianapolis; KGO, Oakland, Calif.; WMAQ, Chicago; WHAS, Louisville, Ky.; WCAU, Philadelphia; KVOO, Tulsa, Okla.; WBT, Charlotte, N. C.; KYW, Chicago, and WBZ, Springfield, Mass.; WMC, Memphis; KFRC, San Francisco, and KHJ, Los Angeles.

The maximum permanent power assigned is 25,000 watts, the extra 25,000 being assigned experimentally.

## Most Seek 50-fold Increase in Power

Washington.

In the race for 50,000 watts the applications show that, as a rule, 1,000-watt stations are seeking 50,000 watts.

WMC, Memphis, Tenn., in its application asks not only the power increase, but also a change in frequency. It is now operating on 780 kc (385 meters) and desires to use instead 650 kc (462 meters).

KFRC, San Francisco, asks permission to move its transmitter to a location to be approved by the Federal Radio Commission. This is a similar case to that of WABC, New York City, which was given a construction permit to use 50,000 watts, provided a suitable new location was found. However, WABC has been having difficulty finding the "suitable location" and meanwhile must continue to be limited to 5,000 watts.

## DEALERS LEAD IN BIG CITIES

Washington.

Radio sales per dealer are greater in the large cities of the United States than in the smaller cities, according to the results of a study of radio retailing during 1929 by the electrical equipment division of the Department of Commerce.

In cities having a population of 3,000,000 or over the average business per radio dealer was \$54,416, in cities with a population from 400,000 to 500,000 the average was \$53,844 per dealer, in cities having a population between 100,000 and 150,000 the average was \$30,807, while in cities having a population between 25,000 and 35,000 the average was \$18,792. The average sales in communities having a population less than 10,000 was less than one-tenth the average in cities having 3,000,000 or over.

Dealers in communities of under 10,000 represented 64.6 per cent. of the 10,533 reports received, but they accounted for only 26 per cent. of the total year's business reported of \$140,771,378.

### LITERATURE WANTED

Ted. Bradford, International Projector Corp'n, 90 Gold St., New York, N. Y.  
Ralph Holbrook, 706 E. Airline, Gastonia, N. C.  
Joseph Vietri, 2004 Davidson Ave., Bronx, N. Y.  
Gonzalo Moral, Frontera, Tabasco, Mexico.  
Roy L. Lamb, care W. H. B. Q., Dermon Bldg., Memphis, Tenn.  
G. Nogle, 548 Rouse St., Houston, Tex.  
C. M. Laudenberger, 511 Parsons St., Easton, Penna.  
J. Bender, 2530 Ocean Ave., Brooklyn, N. Y.  
M. C. Veltman (R. E.), U. S. Navy, care 2nd Brigade, U. S. M. C., Managua, Nicaragua.  
C. A., care P. M., New York City.  
Radio Service Laboratory, 220 Westchester Ave., Mount Vernon, N. Y.  
J. W. Bailey, P. O. Box 11, Fredericksburg, Va.  
Roscoe F. Adams, Osterville, Mass.  
M. Markowitz, 56 Featherbed Lane, New York City.

### NEW INCORPORATIONS

Better Radio Merchants Bureau, radio advertising, Atty., B. A. Mayer, 70 West 40th St., New York, N. Y.  
U. S. Broadcasting and Television Corp., New York, N. Y., operate radio stations. Atty., Martin Hutchinson, Wilmington, Del.

### A THOUGHT FOR THE WEEK

**UNCLE SAM** has widened his anti-bootlegging activities and is after the illicit sending of messages to rum-laden craft. Where, oh, where is the dramatist who will write a rip-snorting melodrama around the wireless bootleggers who are making use of radio to beat the w.k. Eighteenth Amendment? And how about "Booze Barons of the Air" as a title?

## PARTS MAKERS TO BE LICENSED FOR FIRST TIME

Following up its declared intention of releasing the Superheterodyne circuit to set manufacturers, now confined to tuned radio frequency receivers, the patent pool is negotiating for the licensing of parts manufacturers. Heretofore the pool, through the patent division of Radio Corporation of America, has refused to license any parts manufacturers. However, the reduction in the number of parts manufacturers has left only about a dozen of any consequence, with three such manufacturers doing more than half of the parts manufacturing for sale to custom set builders, experimenters and home constructors.

The basis of the licensing of the parts manufacturers would be the same as that newly established for the set manufacturers, which is 7½ per cent. royalty on the billing, with no minimum. The \$100,000 annual minimum formerly required is to be omitted from the contracts, partly due to unworkability. At present only three set manufacturers are up to date on their royalty payments, and those who are behind often owe from \$50,000 to \$100,000.

### License Affects Kits

The licensing of parts manufacturers concerns the sale of kits. These consist of parts grouped in one box and constituting an entity for the construction of some particular circuit, where information is furnished as how to build the circuit. Usually this information consists of a blueprint. However, the parts manufacturer's license would include authority to sell wired models.

The sale of individual parts, such as an audio transformer, radio frequency tuning coil or bypass condenser, independent of unit assembly, is not considered as requiring a license.

The large parts manufacturers who cater to custom set builders, home experimenters and the like are anxious to obtain a license. Some of them are well rated financially. However, the question of rating is an important one, and in the absence of a rating regarded by the pool as adequate a deposit of \$25,000 as guarantee of payment of royalties may be demanded.

The Superheterodyne situation has aroused much interest among manufacturers. Heretofore only RCA, Graybar and General Electric had Superheterodyne receivers, these being the same sets, simply with different labels, but it is desired to put this circuit, regarded as most superior, in even wider use, and besides some features of patents concerning tuned radio frequency will expire shortly.

### Short-Wave Converters to be Made

Two set manufacturers already have models of Superheterodynes, while parts manufacturers now negotiating for licenses are also working on Superheterodyne, anticipating the receipt of licenses.

Another new activity by set manufacturers is the making of short-wave converters, to be advertised as devices for making a short-wave Superheterodyne out of your broadcast receiver. Reports in the trade were that Stromberg-Carlson and Silver-Marshall would be among the first to come out with such a converter.

The release of the Superheterodyne patent to the licensees also would permit them to make a short-wave Superheterodyne receiver,



# ETHER POLICE STATION OPENS IN SEPTEMBER

The monitoring station of the Department of Commerce, at Grand Island, Nebr., will be put in operation in September. This receiving station and checking plant will be able to tune in any station anywhere on earth and will be the most sensitive station in the world, more than 200 times as sensitive as the average up-to-date radio receiver for home use.

The principal object of the station is to check up the frequencies of the licensed stations in the United States, including all broadcasting stations. Each one of the 600 broadcasting stations will be tested once a day for wobbling, and if off the assigned frequency more than the allotted margin of 500 cycles will be subject to discipline.

A system of warnings is to be worked out by the Federal Radio Commission, so that ample opportunity will be given to any offending station to correct the fault. This correction may be made by the installation of a quartz crystal control for adherence to frequency, or by some other method, one of which, now being developed, is the use of a screen grid tube because of the constancy of the plate current regardless of the frequency of oscillation.

## Station in Center of United States

The monitoring station will be approximately in the geographical center of the United States. It is now almost completed. It was built from designs of the Navy Department, under the supervision of the radio division of the Department of Commerce. It will have transmitting equipment, also, and be able to carry on communication with any station of the United States anywhere on earth, including ships at sea and stations on territorial possessions.

Because of the police duty the station will perform it has been referred to as "Uncle Sam's radio traffic cop." It will check up on the actual frequency of transmission of all types of service, including broadcasting, television, short waves, photoradio, point-to-point, portable, transcontinental, transoceanic, aircraft and experimental.

## Proposed Plan of Notification.

The proposed plan of notification is, first, the determination of the off-frequency transmission; second, the notification of the Navy Yard station, at Washington, D. C., of the fact; third, the delivery of the message by the Navy Department to the Federal Radio Commission.

Any notification to stations would be made by the Commission, which has authority to punish offenders.

There are about 20,000 United States Government stations throughout the world, and the monitoring station will be able to keep in touch with all of them.

There are three types of sets in the station. Two cover the range from 100,000 cycles to 20,000,000 cycles, and one the range from 10,000 cycles to 100,000 cycles. The superintendent in charge of the station is Benjamin Wolfe.

## ANY LUCK?

Doctor was using the stethoscope on his young son while the boy's sister, six, looked on quietly.

Finally the little girl asked:

"Daddy, did you tune in any new stations?"

## Motor Generator Auto Set Next

Next in line is an automobile receiver, using a motor generator. It is reported that Radio Corporation of America soon will announce such a unit assembly.

No details were obtainable. It was regarded as unlikely that the generator would be worked from the flywheel because of the unsteadiness of its speed, and the fact that no reception would be possible when the motor wasn't running. Therefore, experts said, it must be a motor generator that works from the storage battery. This would change the six volts DC to a high AC voltage, which then would be rectified to obtain high plate voltage. The storage battery would be used also to heat the filaments or heaters.

## EDUCATIONAL STATIONS QUIT

Washington.

Educational broadcasting stations may all disappear in the United States unless educators formulate a future program of action in respect to the allocation of certain channels for educational station broadcasts, the specialist in education by radio, Federal Office of Education, Armstrong Perry, stated.

During the past six months 14 of the 77 educational broadcasting stations ceased operation, Mr. Perry said. Such stations are operated by schools and colleges.

Lack of financing and want of technique in radio broadcasting, he explained, account for the disappearance of these stations.

Educators desire to have Congress, when it acts on new proposals affecting radio, set aside a reasonable number of wave lengths for the educational field, Mr. Perry explained. But before Congress devises new radio legislation it will be necessary for the educators to work out more definitely their opinions and plans in respect to the nature of their broadcasts, he added.

Argument raised against the proposed reservation of channels for the educational stations has been based upon the criticism that educational programs, Mr. Perry pointed out, are made by persons without any mastery of radio technique. It has been said, he continued, that on account of this lack of technique, programs are produced not suited to a large audience, and will continue to be so produced.

Mr. Perry stated that the colleges and universities which maintain broadcasting stations have answered by pointing out that they are not in competition with commercial stations and advertisers. Their audiences are concerned with a particular kind of program, one which is educational in character and not intended for amusement, he told "The United States Daily."

However, there is no antagonism between the commercial station and the educational station, Mr. Perry said. This fact was clearly evident at the recent Institute of Education by Radio, he added. Mr. Perry said it is apparent that nobody opposes the educational station.

The disappearance of the educational station is caused largely by a lack of financing, he explained. Unless the States, the universities, and the colleges finance their stations more liberally than heretofore this type of station will cease altogether, he said.

## MORE PATENTS NOW INCLUDED IN SET LICENSE

The Radio Corporation of America has announced that in the future its receiver licensees may avail themselves of the right to use patents covering the electrical entertainment field previously not included in the licenses. The licensees may use the Superheterodyne circuit, the super-regenerative circuit, patents on television receivers, and on home talkies. It is believed that the more liberal policy will stimulate research and development of new apparatus for electrical entertainment in the home and give the licensees an opportunity to share in the progress that they may do so under proper license. Heretofore no manufacturer has been licensed to use the Superheterodyne principle, and the patents relating to this circuit were closely held by the Radio Corporation expected within the next few years.

It is expected that many of the licensees will put out Superheterodynes now.

The RCA, Westinghouse, Graybar and General Electric Company already have announced that they will introduce a new Superheterodyne in which the tubes will include four screen grid tubes. This circuit is said to be many times more sensitive than the former Superheterodyne models, as well as much more selective. A tone control will be a feature in these receivers, which are now being manufactured at the RCA plant at Camden, N. J.

## Licensees Are Apprised

The licensees of the Radio Corporation were apprised of the new policy in a letter offering the new licenses. No mention was made of royalties, but it is understood that there will be no increase in the rate of 7½ per cent. Thirty-two licensed manufacturers have been offered the new extended licenses, including the Grigsby-Grunow Company of Chicago, which recently filed a suit against the Radio Corporation in the Federal Court at Kansas City, charging that a patent pool existed in violation of the Sherman Act.

"The new licenses will permit those who hold manufacturers' receiver licenses granted by the Radio Corporation of America to utilize the super-heterodyne principle in radio-telephone broadcast receiver circuits with respect to which the Radio Corporation of America has patent rights," said O. S. Schairer, vice-president in charge of patents.

"In addition, the enlarged licenses will include rights for radio-broadcast television receivers and apparatus for reproducing pictures and talking pictures for use in homes.

## Want to Stimulate Television

"Although of the opinion that television apparatus has not yet been developed to the stage where it is practical for general use in homes, we have decided to extend our licenses at this time to include such apparatus because of its relation to radio-telephone broadcast receivers and in order to stimulate the further development of the art.

"We are also ready to share with our licensees our patent rights pertaining to talking pictures for the home as well as the Superheterodyne, super-regeneration and other types of radio-telephone broadcast receivers.

"By extending to radio manufacturers the results of extensive research and development work, we believe that a healthy stimulus will be given to the further development of the radio art."

# RADIO WORLD

The First and Only National Radio Weekly  
Ninth Year

Owned and published by Hennessy Radio Publications Corporation, 145 West 45th Street, New York, N. Y. Roland Burke Hennessy, president and treasurer, 145 West 45th Street, New York, N. Y.; M. B. Hennessy, vice-president, 145 West 45th Street, New York, N. Y.; Herman Bernard, secretary, 145 West 45th Street, New York, N. Y. Roland Burke Hennessy, editor; Herman Bernard, business manager and managing editor; J. E. Anderson, technical editor.

## Following the Crowd

WE in radio often are compelled to follow like sheep, not due to lack of initiative, inventiveness or ingenuity, but to commercial requirements. Take the two outstanding considerations of the coming season: tone control and automatic volume control. Who will dare to venture forth with a considerable receiver that lacks either?

Now, the reasons for including a tone control or an automatic volume control were as great last season and the season before as they are now. The methods and processes were known to the art. But now the time has come; for psychological reasons, for including them.

The tone control enables the listener to alter the tone response from what it would be were the control absent. He has the advantage of making the reproduction consistent with his liking and preference. The advantage is that the listener gets what he wants.

The sales effect of such an opportunity can not be mitigated by any argument that true, faithful tone requires no compensation or control. It may be a fact that the listener does not want the reproduction to be an exact duplicate of the original. Suppose his ear happens to be much more sensitive to high audio frequencies. Why should he not have the opportunity of relatively increasing the strength of the low and middle notes? After all, what is a radio for, if not to render the most possible pleasure in listening to it?

Automatic volume control is in effect a biasing device. When the signal strength increases, plate current flow increases, hence the voltage drop in an introduced resistor increases. Thus, if this resistor is used for grid biasing, then the grids are made more negative, the greater the carrier intensity at the antenna input. This increased bias increases the plate resistance and lowers the volume, to that, in general, stations of considerably dissimilar carrier intensity at the point of reception tend to assume the same volume in reproduction. What the standard of volume shall be is determined by the listener. A manual volume control is used for this.

Very weak stations remain very weak, despite the automatic control, which is effective in cutting down the excessive intensity of strong stations, these usually being all locals, without diminishing the volume of weak stations. Hence one may tune from local to local, despite differences in the strength of their signals, and no deafening roar assails the ears. It is not true, however, that the automatic volume control equalizes the volume of all stations, since it neither diminishes nor increases the volume of the very weak ones, and always works only in the direction of decrease.

As for tone control, one can not possess one without being fully conscious of it, for indeed it requires manual operation. Since the automatic volume control need not be touched, this may exist in a re-

ceiver without the possessor even suspecting the fact. True, the fatiguing blast of over-powerful locals is absent, but it is not missed. If the blast were there it might be the subject of quick complaint. The fact it is absent may cause the total absence of any thought on the subject, just as we are unconscious of the shoes on our feet, until the shoes pinch.

It is interesting to observe controversies raging concerning tone control and automatic volume control. Tone, if right, needn't be changed, is one argument.

Automatic volume control is attacked by some on the ground that volume is rendered monotonous. They say that when the orchestra plays a crashing chord all you hear is the same steady volume that accompanied the violin solo, hence relatively the brasses are made to play an obbligato to the piccolo! But the, unsteady effect of the modulation upon the plate current remains intact in a correct automatic volume control. It is the strength of the carrier that is leveled, not the changes in intensity of the modulation.

One trap into which anybody may fall if he does not give the matter due consideration is that when a resistor and a condenser are used the time constant may be such that the automatic volume control eliminates the low notes. This is averted by proper proportion of resistance and capacity value. As the resistance value is dictated by the circuit, the solution usually lies in using a large enough condenser. The time constant of the circuit should be .1 second or higher for modern circuits that amplify fairly well down to 24 cycles.

Whatever the considerations, both assets are now being pressed hard for their technical and commercial advantages, and when several manufacturers start driving home a point the rest of the manufacturers are likely to be compelled to follow, if not like sheep, at least like good business men.

## Vacation Radio

WHAT it means to be without radio reception is being appreciated more this Summer than at any previous time, because the habit of listening never was at greater height than during this year, and the deprivation becomes all the more acute.

Summer, with its vacations and its exodus of entire households to watering places and mountains for the season, means at least temporary lack of radio reception for many. The family receiver may be a prized console, and the determination is not to carry it to the mountain, lake, stream or shore, or even if it is to be removed, it shows up late, like a distinguished politician at a banquet. One can't tote the console as one does a suitcase. The railroad porters simply couldn't stand the strain.

If denied the use of the family receiver, abstinence from listening-in will not be protracted. A special receiver for the recreation season, which may be a portable set, will be obtained. It will be purchased, if must be: borrowed, if possible.

## Prices Are Reduced on Four AC Tubes

Reduced list prices were announced by the licensed tube manufacturers as follows:

Tube	Former List	New List	Reduction
224	\$4.00	\$3.30	\$ .70
227	2.50	2.20	.30
245	3.50	2.00	1.50
280	3.00	1.90	1.10

### PILOT LICENSED

A license has been obtained from the patent pool by Pilot, following the suit against Pilot by the DeForest Company for infringement of the regeneration patent.

# Forum

## Short Waves Due for Spasm

THE articles recently published in your magazine about short-wave reception and circuits are timely and interesting, because the importance of short waves is gaining ground. Indeed, we are about to enter a spasm of almost fanatic enthusiasm for short-wave reception.

It is true that you have been featuring short-wave converters that, with the broadcast receiver they are to be used with, constitute a Superheterodyne, and that some attention has been paid to adapters which plug into the detector socket, but it seems you have been a little stingy on short-wave receiver circuits. However, nearly everybody has a broadcast receiver, among your readers, anyway, so maybe you're right in plugging the converter idea. I know that several set manufacturers will come out with converters, so maybe you spurred them on.

Any discussion of short waves must include television. Now we fans who have short-wave converters or receivers hear a lot of intermittent buzzing sounds that we know are television signals.

Some more information should be published about television. It is a fact that pictures of a sort can be picked up. They are not perfect, they are not large, they are not projected but must be observed peephole fashion, yet they are television, and you should encourage experimental work in the television field. Tell your readers just what they can build to receive television.

As soon as television transmitters standardize on the speed of the disc and the number of holes per frame you will be able to tell your readers how to build apparatus that will tune in half a dozen or more television stations from almost any point in the United States.

And don't forget that Central and South America can get our short waves and that in Central America particularly the interest focuses on short waves only, as the broadcast waves are static-laden all the time. Cultivate interest among residents of England and France, as well as Germany, and you will help the radio export business of the United States, tariff or no tariff.

EDWARD FRAUGHT,  
Minneapolis, Minn.

\* \* \*

## Gloom on Auto Sets

SO far as I am concerned automobile receivers are more or less of a flop. I have watched radio grow for years, but it has never yet produced a really excellent portable receiver, with the possible exception of a Superheterodyne portable I bought in France, where it was made. This pins no flower in Uncle Sam's buttonhole. And the auto set is in the same class as a portable, indeed is a portable, and results are commensurate.

I know very well that portable receivers do work and that car receivers do work, but my point is that they do not work well enough. Designers seem to get the idea that first-rate radio is intended only for the home. But as soon as any one comes along with a first-class auto radio he will get a great volume of business.

My opinion is that the auto set is not for the home constructor or for the parts business generally, but that the automobile manufacturers will build sets into their cars, and we will buy the car with set installed. That's where the market will be, so let's not kid ourselves.

IRVING WENIG,  
Radio Dealer, Chicago, Ill.



# Right or Wrong?

## QUESTIONS

(1)—Short-wave converters for battery operated tubes are not practical because the filament supply cannot be obtained from the receiver and it is unpractical to provide a separate A battery for the converter.

(2)—Regeneration in high frequency receivers are of little advantage in strengthening the signals because it is difficult to handle the control so that the circuit will be stable.

(3)—If the three-element vacuum tube had not been invented broadcasting as we know it today, and long-distance telephony, would not have been possible because both are based on the amplifying property of the tube.

(4)—If a tube is to be used successfully as a power tube it must have a large filament so that it can sustain a heavy filament emission for a long time.

(5)—Residual gases in the glass envelope of a three-element tube makes the tube glow with a blue light when high voltages are applied to the plate.

(6)—If an automobile receiver is to be used while the car is in motion it is desirable that an automatic volume control be incorporated in the circuit.

(7)—The grid of a vacuum tube must be between the plate and the filament if it is to be at all effective.

(8)—The alternating current in a circuit composed of an inductance coil and a condenser in series is always lagging the voltage inducing the current.

(9)—Every stage in an amplifier reverses the phase of the signal current, for example, the currents in two adjacent plate circuits are always flowing in opposite directions.

(10)—The higher the carrier frequency compared with the highest audio frequency that is to be impressed on it, the better will the high note reproduction be. For this reason frequencies of the order of 300,000 kilocycles are suitable for voice and music transmission.

(11) No current flows in the screen circuit of a screen grid tube and therefore it is impossible to connect the screen through a high resistance to the plate return and get the proper screen voltage.

(12) The current that flows through the grid bias resistor in the cathode lead of a screen grid tube is the sum of the plate and screen currents, and this sum is always less than the plate current alone because the plate and screen currents are in opposite phase.

(13) If the antenna circuit is tuned and coupled closely to the tuned secondary, the selectivity of the circuit is much lower than if either circuit alone were tuned.

(14) Television in natural color is based on the same principle as the printing of pictures in natural color.

## ANSWERS

(1)—Wrong. They are just as practical as converters for AC. Sometimes it is not quite so convenient to provide a filament supply because extra batteries are awkward and picking up the supply from the receiver usually entails making changes in the circuit. However, there is no reason why the converter tube filaments cannot be connected directly across the filament battery.

(2)—Wrong. Regeneration can be used to good advantage in any short-wave receiver, and it is not especially hard to control it. However, when the receiver is of the Superheterodyne type care must be exercised to prevent oscillation in the regenerative tube because if this oscillates as well as the oscillator no satisfactory signals can be obtained, if any.

(3)—Right. Without amplification we could not have oscillators, and without oscillators we could not have any satisfactory transmitters. Without amplification we could not conduct long distance transmission of voice for it would be practically impossible to transmit enough energy to carry. Repeaters along the line are necessary, and these repeaters are only vacuum tube amplifiers.

(4)—Right. Most loudspeakers demand a low impedance device from which to get its power. It also requires a great deal of power, relatively speaking. This can only be obtained with a moderate plate voltage and a heavy plate current. Hence the filament of the power tube must be so proportioned that it can emit a large number of electrons for a long time.

(5)—Right. The more gas that is left in the tube the more it glows and the lower the voltage at which it glows. The intensity of the glow, of course, depends on the current that flows through the tube by gaseous conduction.

(6)—Right. This is a practical necessity because the signal strength of stations vary widely with the position of the car. Not only does it vary over large distances but it may vary widely from block to block. Without the automatic control the output would vary so much and so frequently that no one could compensate for the variation with a manual control.

(7)—Wrong. In the first tube constructed by De Forest the grid was outside the tube. He found that by putting it inside it was much more effective in controlling the plate current. And

when he placed it between the filament and the plate he found it was still more effective.

(8)—Wrong. Whether the current is lagging or leading the voltage depends on which reactance predominates. If the inductive reactance predominates the current is lagging and if the capacitive reactance predominates the current is leading the voltage. If the two reactances are equal the current is in phase with the voltage and the circuit is resonant with the frequency of the voltage.

(9)—Wrong. Every tube reverses the phase, but every stage does not necessarily do so. If the transformer is connected so that it reverses the phase, the stage composed of one transformer and one tube does not reverse the phase. In a direct coupled amplifier the phase is always reversed by every stage.

(10)—Right. It is well known that the reproduction on 1,500 kc is better than on 550 kc and that this is because the ratio of the carrier frequency to the highest audio frequency is higher. When the carrier is as great as 300,000 kc the ratio is obviously still higher, in fact, it is 200 times higher. This means that on a 300,000 carrier a modulation frequency as high as 2,000,000 cycles would come through as well as one of 10,000 cycles on the 1,500 kc carrier. It would seem that television could be carried on well at 300,000 kc.

(11) Wrong. Current does flow but it is not constant, for it depends on the value of the plate current. As a rule it is not greater than one-third the value of the plate current. If a high resistance is put in the screen lead and the return is made to the same point as the return of the plate, the screen voltage will be right if the resistance value is so chosen that the excess voltage is dropped in the resistance. Suppose the plate voltage is 135 and the screen voltage is 45 volts. The excess would be 90 volts. If the screen current normally is 0.5 milliamperes, as in the case of the 232 tube, the resistance should be 180,000 ohms. If this resistance is not by-passed with a large condenser the tube will not function as a screen grid tube because the screen voltage will not remain steady.

(12) First part is right; second part is wrong. The current that flows in the cathode lead is the total current emitted by the cathode, and this is the sum of the screen and plate currents. If there is any current in the control grid circuit, that too is added. The screen and plate currents are not in opposite phase, but their changes due to control grid voltage changes are in opposite phase. It is for that reason that the sum of the screen and plate currents is substantially constant with respect to signal variations.

(13) Right. Under such conditions there is a high resistance reflected into the tuned secondary, and this may be so high that there is no selectivity at all. This may be demonstrated very easily.

(14) Right. Natural color pictures, so-called, are made by superposing three pictures printed in the three fundamental colors, red, yellow and blue, or certain shades of these colors. The completed picture appears to contain all the colors that were contained in the original. Color television is done the same way. Three pictures are sent, one for the red, one for the yellow and a third for the blue. Each is reproduced and all are combined on the viewing screen to form a picture apparently having all the shades of color.

## HOW TO DETERMINE BIAS

IF THERE is a simple way to determine the proper bias that I should be given an amplifier tube will you kindly give it? Also, if there is a simple way of determining the grid bias resistor I should also like to have that.—W. H. J.

The simplest way is to get a table of tube characteristics and refer to that table whenever the information is needed. Such tables are published frequently in books and magazines. They give plate voltages and the grid bias values that should be used for these plate voltages and they also give the corresponding plate currents. When the plate current and the required grid bias are known the grid bias resistor for each tube is determined by dividing the grid bias by the plate current, expressing the bias in volts and the plate current in amperes. For example, if the required bias is 13.5 volts and the plate current is 6 milliamperes, the grid bias resistor is  $13.5/0.006$  ohms, that is, 2,250 ohms.

\* \* \*

## REGENERATION CAUSES CRACKLES

THERE IS a great deal of crackling noise in my screen receiver as soon as I advance the sensitivity control. What is the cause of this? My volume control is in the screen circuits of the amplifier tubes and the crackling begins when the screen voltage is about 50 volts.—I. C.

This trouble is quite common in receivers of this type and the crackling is due to regeneration in the amplifier, or to actual oscillation at some frequency. It occurs more frequently at the high frequency end of the tuning control since the circuit is more regenerative at that end. There is nothing that can be done about it except to keep the screen voltage below that which will cause annoying crackling.

# High-Gain Shielded Coils

**A** SHIELDED radio frequency transformer for use as antenna coupler or as interstage coupler for screen grid circuits. The coil is wound on a 1 1/4-inch diameter bakelite form with No. 28 enamel wire, primary on the outside, separated from the secondary by an insulating wrapper 42/10,000-inch thick. This moisture-proof insulation is so shaped that it completely insulates the primary from the secondary, preventing short-circuit. The coil form is mounted on a wooden base, which has the removable shield bottom fastened to it. The drawn aluminum shield fits snugly over the wooden base, and coils remain always erect and amply spaced from the shield wall in all directions. The shielded coils are suitable for baseboard or metal chassis mounting. The four leads emerge through an insulated hole in the shield bottom.

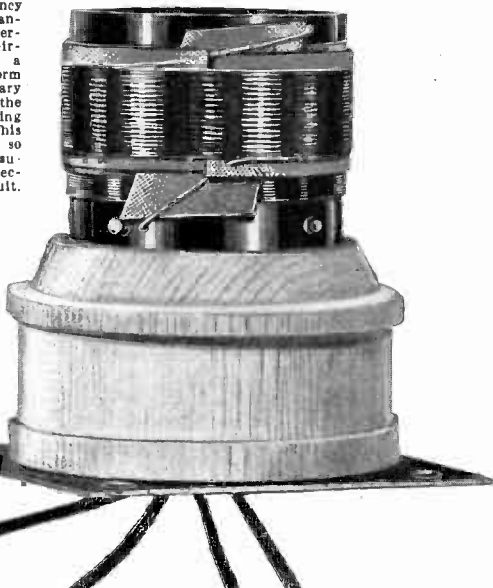

The coil comes already mounted on a shellacked wooden base, which is fastened at the factory to the shield bottom. Series A coil is illustrated.



The external appearance of the shield, with four 6/32 machine screws and nuts, which are supplied with each coil assembly.

## Precisely Matched for Gang Tuning

**O** NE primary lead-out wire from the coil, for antenna or plate connection, has a braided tinned alloy covering over the insulation. This alloy braid shields the lead against stray pick-up when the braid alone is soldered to a ground connection. The outleads are 6 inches long and are color identified. The wire terminals are soldered to copper rivets. Each coil comes completely assembled inside the shield, which is 2 3/4 inches square at bottom (size of shield bottom) and 3 3/4 inches high. High impedance primaries of 40 turns are used. Secondaries have 80 turns for .00035 mfd. and 70 turns for .0005 mfd.

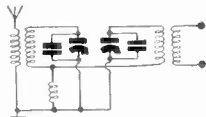

BP-6 is the coil at bottom.

**E** XTREME accuracy in winding and spacing is essential for coils used in gang tuning. These coils are specially suited for gang condensers, because the inductances of all are identical for the stated size condenser. The coils are matched by a radio frequency oscillator. The color scheme is as follows: shielded wire outlead is for antenna coupling or interstage coupling.) Blue is for grid and yellow is for grid return. For .00035 mfd. the Cat. No. is A-40-80-S. For .0005 mfd. the Cat. No. is A-40-70-S. Where a band pass filter circuit is used the small coupling coil to unite circuits is Cat. BP-6. The connection is illustrated herewith.

## Coils for Six-Circuit Tuner

Series C coils for use with six tuned circuits, as in Herman Bernard's six-circuit tuner, are wound the same as type A shielded coils, but the shields are a little larger (3 1/16-inch diameter, 3 3/4 inches high), and there are no shield bottoms, as a metal chassis must be used with such highly sensitive circuits. Fasten the brackets to the shield and then, from underneath the chassis, fasten the other arm of the two brackets to the chassis. Order Cat. C-6-CT-5 for .0005 mfd. and Cat. C-6-CT-5 for .00035 mfd. Five needed for Bernard's circuit. If band pass filter coupling coil is desired order Cat. BP-6 extra.

## Junior Model Inductances

The Series B coils have the same inductance and the same shields as the series A coils, but the primary, instead of being wound over the secondary, with special insulation between, is wound adjoining the secondary, on the form, with 1/4-inch separation, resulting in looser coupling. No wooden base is provided, as the bakelite coil form is longer, and is fastened to the shield bottom piece by means of two brackets. No outleads. Wire terminals are not soldered. Order Cat. B-SH-3 for .00035 mfd. and Cat. B-SH-5 for .0005 mfd.

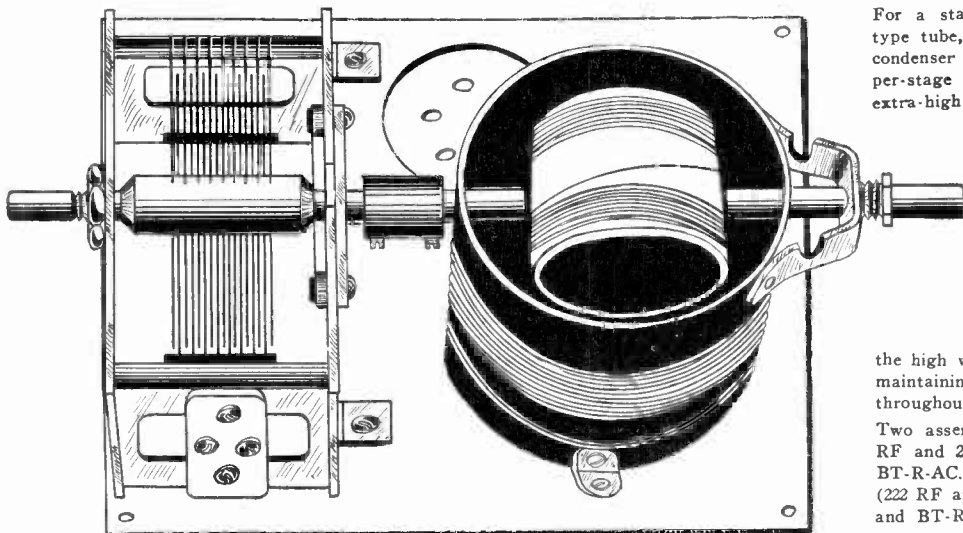

For a stage of screen grid RF, either for battery type tube, 222, or AC, 224, followed by a grid-leak-condenser detector, no shielding is needed, and higher per-stage amplification is attainable and useful. This extra-high per-stage gain, not practical where more than one RF stage is used, is easily obtained by using dynamic tuners. Two assemblies are needed. These are furnished with condensers erected on a socketed aluminum base. Each coil has its tuned winding divided into a fixed and a moving segment. The moving coil, actuated by the condenser shaft itself, acts as a variometer, which bucks the fixed winding at the low wavelengths and aids it at the high wavelengths, thus being self-neutralizing and maintaining an even degree of extra-high amplification throughout the broadcast scale.

Two assemblies are needed. For AC operation (224 RF and 224 or 227 detector), use Cat. BT-L-AC and BT-R-AC. For battery or A eliminator operation (222 RF and any tube as detector), use Cat. BT-L-DC and BT-R-DC.

Screen Grid Coil Co., 143 West 45th Street, New York (Just East of Broadway):

- Enclosed please find \$..... (Canadian must be express or P. O. Money Order), for which send me prepaid the following:
- A-40-80-S, each ..... \$2.25
  - Matched set of four A-40-80-S ..... 10.00
  - A-40-70-S, each ..... 2.25
  - Matched set of four A-40-70-S ..... 10.00
  - BT-L-AC and BT-R-AC, assembled, with condenser, link, socket and base, per pair ..... 6.00
  - BT-L-DC and BT-R-DC, assembled, with condenser, link, socket, base, per pair ..... 6.00
  - C-6-CT-5, .0005 mfd. shielded coil for six-circuit tuner ..... each \$2.25
  - C-6-CT-3, .00035 mfd. shielded coil for six-circuit tuner ..... each \$2.25
  - BP-6 ..... .25
  - EQ-100, equalizer of 20-100 mfd. capacity, made by Hammarlund ..... .35
  - B-SH-3, each ..... \$1.00
  - Matched set of four B-SH-3 ..... 4.00
  - B-SH-5, each ..... 1.00
  - Matched set of four B-SH-5 ..... 4.00

(Note: All coils come with shields, except BP-6 and BT-L.)

NAME..... ADDRESS.....

CITY..... STATE.....

If ordering C.O.D. put cross here. Post office fee will be added to prices quoted.

BT-L for the antenna stage and BT-R for the detector input. BT-L consists of a small primary, with suitable secondary for the .00035 mfd. condenser supplied. BT-B has two effective coils: the tuned combination winding in the RF plate circuit, the inside fixed winding in the detector grid circuit. The moving coils must be "matched." This is done as follows: Turn the condensers until plates are fully enmeshed, and have the moving coils parallel with the fixed winding. Tune in the highest wavelength station receivable—above 450 meters surely. Now turn the moving coils half way round and retune to bring in the station. The setting that represents the use of lesser capacity of the condenser to bring in that station is the correct one. If gang tuning is used, put a 20-100 mmfd. equalizing condenser across the secondary in the antenna circuit and adjust the equalizer for a low wavelength (300 meters or less).



### Trouble-Finding Dial FREE!

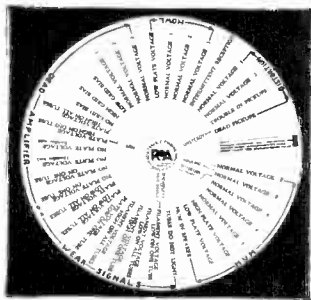

Here is an 8" diameter dial that you slide around to shoot trouble in an audio circuit or B supply or power amplifier. Trouble is divided into five groups: distortion, howl, dead amplifier, weak signals and hum. By sliding the dial to one of fifty different positions the cause of the trouble is read in the slotted opening. Invented by John F. Rider. Send 50 cents for four weeks subscription for Radio World and get a Trouble-Finding Dial free with instructions on back. If extending an existing subscription please so state.

### RADIO WORLD

145 West 45th Street, New York, N. Y.

### Official Parts for Popular Circuits

□ Universal Short-Wave Converter, using three 227 tubes; six de luxe precision short-wave air dielectric coils, condensers, chokes, 7"x14" panel, cabinet, etc. Cat. UN-SWC @.....\$24.73

GUARANTY RADIO GOODS CO.  
143 West 45th Street  
New York City

### MB-30 Price Hi-Q 30 Price Write or wire!

Guaranty Radio Goods Co.  
143 West 45th St.,  
New York City

### Subscribers! Important!

Note subscription expiration date on wrapper containing your copy of RADIO WORLD. If nearing expiration date, please send in renewal so that you will not miss any copies. Subscription Dept., RADIO WORLD, 145 W. 45th St., New York City.

### RECENT NUMBERS

for the current year are procurable at the rate of 15c a copy, or 7 copies for \$1.00. RADIO WORLD, 145 West 45th St., N. Y. City.

### FILL OUT AND MAIL NOW

SUBSCRIPTION BLANK

### RADIO WORLD

RADIO WORLD

145 West 45th Street, New York City

Please send me RADIO WORLD for.....months, for which

### SUBSCRIPTION RATES:

Single Copy.....\$ .15  
Three Months..... 1.50  
Six Months..... 3.00  
One Year, 52 Issues..... 6.00

Add \$1.00 a Year for Foreign Postage; 50c for Canadian Postage.

□ If this is a renewal, put cross in square at left.

please find enclosed



### KEY TUBES

Quality First

The following constitute the thirteen most popular tubes used in radio today. Despite the severely low prices the Key tubes are firsts of the very first quality. The tubes are manufactured under licenses granted by the RCA and its affiliated companies.

All prices are net and represent extreme discount already deducted.

GUARANTY RADIO GOODS CO.,  
143 West 45th St., N. Y. City. (Just East of Broadway)

Enclosed please find \$..... for which ship at once tubes marked below:

- 224 AC screen grid .....\$1.43
- 245 AC power tube .....\$1.10
- 226 AC amplifier ..... .85
- 227 AC det.-amp. ....\$1.88
- 222 battery 5G ..... .78
- 112A power tube ..... .78
- 171A power tube ..... .53
- 201A battery tube .....\$1.60
- 240 hi mu tube .....\$4.95
- 250 power tube .....\$3.25
- 210 power tube .....\$1.00
- 280 AC rectifier .....\$2.95
- 281 AC rectifier

Name .....

Address .....

City..... State.....

Put cross here if C. O. D. shipment is desired. Canadian remittance must be by postal or express money order.

### SOLDERING IRON FREE!



Works on 110-120 volts, AC or DC; power, 50 watts. A serviceable iron, with copper tip, 5 ft. cable and male plug. Send \$1.50 for 13 weeks' subscription for Radio World and get these free! Please state if you are renewing existing subscription.

### RADIO WORLD

145 West 45th St. N. Y. City

DOUBLE RANGE POTENTIOMETER; made by Centralab, designed for volume control. In dust-proof bakelite case. Price, \$1.05. Guaranty Radio Goods Co., 143 W. 45th St., New York.

FIDELITY HORN UNIT—Stands up to 450 volts without filtering. Can be used in the portable without horn attached. Price, \$2.25. Guaranty Radio Goods Co., 143 W. 45th St., New York.

ERLA-DYNAMIC CHASSIS, WEST-INGHOUSE RECTIFIER. Sensitive and efficient dynamic speaker chassis. List price, \$25; our net price, \$12.50. Guaranty Radio Goods Co., 143 W. 45th St., New York.

### BOOKS FREE!



### "AUDIO POWER AMPLIFIERS"

by J. E. Anderson and Herman Bernard, begins with an elementary exposition of the historical development and circuit constitution of audio amplifiers and sources of powering them and proceeds to an exposition of circuit laws, including Ohm's laws and Kirchhoff's laws. The determination of resistance values to produce required voltages is carefully expounded. All types of power amplifiers are used as examples: AC, DC, battery operated and composite. But the book treats of AC power amplifiers most generously, due to the superior importance of such power amplifiers commercially. Full technical data on tubes, 193 pages. (APAM)

### "FOOTHOLD ON RADIO"

In English that any one can understand, the technical side of radio is presented by Anderson and Bernard. It is intended for the sheer novice. The treatment is non-mathematical. The origin of the broadcast wave, its radiation, reception, amplification and rectification are set forth in clear language. Published June, 1930; 59 pages. (FOR)

### "THE SUPERHETERODYNE"

This is a volume by Anderson and Bernard, published July, 1930, dealing with the principles and practice of the Superheterodyne method of receiving. It explains the function of the oscillator, the modulator, the pre-modulator selector, and the intermediate frequency amplifier. It explains the cause of repeat points and gives methods for avoiding them or minimizing their effect. It expounds the relative advantages and disadvantages of high and low intermediate frequencies, and shows the effect of selectivity on the quality. Constructional circuits included, 112 pages. (ABSH)

### 115 LATEST COMMERCIAL SET DIAGRAMS

Compiled by John F. Rider. Contains, each on separate 9 x 12" sheet, schematics of Audiolabs 30B and 330; Balkite F; Crosley 41A, 42 A.C., 609, 600 A.C., 20, 21, 22, 1S, 30S, 33S, 804 A.C., 40S, 41S, 42S, 82S, 60S, 61S, 62S; Sonora 7P, A30, A32, B31, A30, A40, A44; Kennedy 80, 10, 20; Stewart-Warner 900 A.C., 950 battery, 950 A.C., 150 D.C., Model B; Radiola 44, 47, 66; Majestic 90, 97, power unit, 9173 power unit; Stromberg-Carlson 641, 642, 846; Edison R1, R2, C2 (50 and 25 cycles), R5 and C4, C1; American Boser 54 D.C.; Victor R32 and RE45; Grebe SK4 A.C. (early model), SK4 A.C. (late model), SK4 D.C., 428; Traveler A.C. power pack; Eria 224 A.C. screen grid; Silver-Marshall 30B, 30C, 30D, 30E; Eveready 1, 2 and 3; Series 30, Series 40, Series 50; Scientific 40, 9173 power unit; All American Mohawk 96 (60 cycle), 90 (25 cycle), 90 (60 cycle), 70, 73 and 75; Gulbranson Model C (early model), Model C (late model); Bremer-Tully 7-70 and 7-71, 81, 82; Earl 21, 22, 31, 32, 41, 42; Philco 65, 76, 87, 95 screen grid; Peerless Electrostatic series, screen grid; Fada 20, 20Z, 25 battery, 25, 25Z, 25, 25Z, M250, M250Z, Electric units, 35, 35Z, 75, 75Z; Brunswick 5 NC8 Radio Chassis Schematic, NC8 Audio Chassis Schematic, NC8 and 3 NC8 Audio Chassis Schematic, 5 NC8 cabinet wiring, 3 NC8 Radio Chassis Schematic, 3 NC8 cabinet wiring, S14, S21, S31, S81, S82 screen grid Radio Chassis Schematic, S14, S21, S31, S81, S82 screen grid Radio Chassis Actual, S14, S21, S31, S81, S82 Audio Chassis Schematic (25 cycle), S14, S21, S31, S81, S82 Audio Chassis Actual (60 cycle), S14, S21, S31, S81, S82 Audio Chassis Actual (60 cycle), S31, Audio Chassis Schematic (60 cycle) S31, Audio Chassis Actual (60 cycle), 3 KR8 cabinet wiring, 3 KR8 Radio Chassis, 3 KR8 Audio Chassis Schematic, 3 KR8 Audio Chassis Actual, 5 NO Radio Chassis Schematic, 5 NO Socket Power Schematic, 5 NO Socket Power Actual, 3 KRO and 3 KR6 Radio Chassis, 3 KRO and 3KR6 Socket Power, 5KR, 5KRO, 2KRO, 5KR6 Socket Power, 5KR, 5KRO, 2KRO, 5KR6 Radio Chassis; Amrad Del-Canto series; Spartan 89, 89A, 49, ensemble, 931, 301 D.C., 931 A.C., 110 A.C., 301 A.C. (SUPP. NO. 1)

### OTHER BOOKS

- "Radio Receiving Tubes," by Moyer & Wostrel. (MWT)
- "Practical Radio Construction and Repairing," by Moyer & Wostrel (new edition). (MWPRC)
- "Principles of Radio Communication," by Prof. Morecroft. (M-PRIN)
- "Elements of Radio Communication," by Prof. Morecroft. (M-ELEM)
- "Radio Manual," by G. E. Sterling, U. S. Geol. (MAN)
- "A B C of Television," by R. F. Yates. (TEL)
- "Drake's Encyclopedia," new edition. (DRA)
- "Experimental Radio," by Prof. Ramsay. (REX)
- "Fundamentals of Radio," by Prof. Ramsay. (RFM)
- "Principles of Radio," by Keith Henney. (PRK)
- "Trouble Shooter's Manual," J. F. Rider. (TSM)
- "Mathematics of Radio," by J. F. Rider. (MOR)
- "Testing Units," by Rider. (TTU)

Radio World, 145 West 45th Street, New York, N. Y.

Enclosed \$..... for subscription for RADIO WORLD for specified period. Send free (postpaid) the one premium book designated by my cross in square.

□ FOR \$2.00 for 16 weeks (16 issues) □ TTU

□ ABSH \$3.00 for 6 months (26 issues) □ Supp. No. 1

\$4.00 for 34 weeks (34 issues)

□ MOR □ MWPRC

\$5.00 for 42 weeks (42 issues)

□ MWT □ MVRP

\$6.00 for 1 year (52 issues)

□ APAM □ TSM □ M-ELEM

□ TEL □ REX □ PRK

□ RFM \$7.00 for 60 weeks (60 issues)

□ MAN \$10.00 for 86 weeks (86 issues)

□ DRA \$12 for 2 years (104 issues) □ M-PRIN

Name .....

Address .....

City..... State.....

□ If extending existing subscription put cross here.

# MOORE SUPER DX

Verified Reception  
Cuba & West Coast  
Coils - Kits - Parts - Sets

Set (3) Blue Prints

## \$1.50

### MOORE RADIO CO.

74 Cortlandt St., N. Y. C., Suite 302

RADIO WORLD'S BOOK SERVICE has been found of great value not only by radio fans, constructors, etc., but also by radio and other technical schools throughout the country. See the radio books advertisement in this issue.

"RADIO TROUBLE SHOOTING," E. R. Haan. 328 pages, 300 illustrations, \$3. Guaranty Radio Goods Co., 143 W. 45th St., New York.

## "Seconds" But Serviceable Tubes Nevertheless at Prices That Seem Incredible

A tube factory that maintains the highest possible standards for a large laboratory customer has tubes for sale that fall just a trifle below the most exacting specifications, but which are excellent tubes nevertheless. They are called "seconds" and they are "seconds," but they are not "thirds." You can get 500 hours excellent use out of them. Note the prices. Remit with order. Generous replacement policy.

112A	50c	227	50c
UV or UX-199	50c	245	50c
201A	45c	171A	50c
224	65c	280	50c
226	50c	281	60c

DIRECT RADIO CO.  
Room 504, at  
1562 Broadway, N. Y. City.  
(Between 46th and 47th Sts.)

## RADIO WORLD and "RADIO NEWS"

### BOTH FOR ONE YEAR @ \$7.00

You can obtain the two leading radio technical magazines that cater to experimenters, service men and students, the first and only national radio weekly and the leading monthly, for one year each, at a saving of \$1.50. The regular mail subscription rate for Radio World for one year, a new and fascinating copy each week for 52 weeks, is \$8.00. Send in \$1.00 extra, get "Radio News" also for a year—a new issue each month for twelve months. Total, 64 issues for \$7.00.

If renewing Radio World subscription, put cross in square at beginning of this sentence.  
 If renewing Radio News subscription, put cross in square at beginning of this sentence.

RADIO WORLD, 145 West 45th Street, New York, N. Y.

NEW DRAKE'S ENCYCLOPEDIA  
1,680 Alphabetical Headings from A-battery to Zero Beat; 1,025 Illustrations, 920 Pages, 240 Combinations for Receiver Layouts. Price, \$6.00. Radio World, 145 W. 45th St., N. Y. C

## RADIO AND OTHER TECHNICAL BOOKS At a Glance

"Audio Power Amplifiers," by Anderson and Bernard	\$3.50
"Drake's Radio Cyclopedea," by Manly	6.00
"The Electric Word," by Shubert	2.50
"Elements of Radio Communication," by Morecroft	3.00
"Experimental Radio," by Ramsey	2.75
"Foothold on Radio," by Anderson and Bernard	1.00
"Fundamentals of Radio," by Ramsey	3.50
"Mathematics of Radio," by Rider	2.00
"Practical Radio," by Moyer & Wostrel	2.50
"Practical Radio Construction and Repairing," by Moyer & Wostrel	2.50
"Principles of Radio," by Henney	3.50
"Principles of Radio Communication," by Morecroft	7.50
"Radio Blueprint Library"—AC Hook-ups	.35
"The Radio Manual," by Sterling	6.00
"Radio Receiving Tubes," by Moyer & Wostrel	2.50
"Radio Telegraphy & Telephony," by Duncan	7.50
"Radio Trouble Shooting," by Haan	3.00
"The Superheterodyne," by Anderson & Bernard	1.50
"The Thermionic Vacuum Tube," by Van der Bijl	5.00
"Treatise on Testing Units," by Rider	1.00
"Trouble Shooter's Manual," by Rider	3.50
"115 Latest Commercial Set Diagrams," by Rider	2.50

### TELEVISION

"A B C of Television," by Yates..... 3.00

### AVIATION

"A B C of Aviation," by Maj. Page	1.00
"Aerial Navigation and Meteorology," by Capt. Yancy	4.00
"Everybody's Aviation Guide," by Maj. Page	4.00
"Ford Model 'A' Car," Its Construction, Operation and Repair—by Maj. Page	2.00
"Modern Aircraft," by Maj. Page	5.00
"Modern Aviation Engines," by Maj. Page	9.00

## RADIO WORLD

145 West 45th Street  
New York, N. Y.

(Just East of Broadway)

## Set of SOCKET WRENCHES FREE!

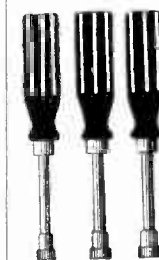

FOR turning nuts down or up there is nothing as efficient and handy as a socket wrench. Here is a set of three wrenches for hexagonal nuts, enabling use with 5/32, 6/32, 8/32 and 10/32 nuts. Fit the nut into the proper socket and turn down or up. The three different size sockets, one size on each wrench, enables use of three different outside diameters of nuts, but at least ten different sizes of threads. Send 50 cents for four weeks subscription for RADIO WORLD and get this set of three wrenches FREE!

RADIO WORLD, 145 W. 45th St., New York, N.Y.  
50 cents enclosed for 4 weeks' subscription for RADIO WORLD. Send socket wrenches free!

Name .....  
Address .....  
City ..... State .....

Cross here if extending existing subscription.

# Two for the price of One

Get a FREE one-year subscription for any ONE of these magazines:

- CITIZENS RADIO CALL BOOK AND SCIENTIFIC DIGEST (quarterly, four issues).
- RADIO (monthly, 12 issues; exclusively trade magazine).
- RADIO ENGINEERING (monthly, 12 issues; technical and trade magazine).
- RADIO INDEX (monthly, 12 issues) Stations, programs, etc.
- SCIENCE & INVENTION (monthly, 12 issues; scientific magazine, with some radio technical articles).
- AMERICAN BOY—YOUTH'S COMPANION (monthly, 12 issues; popular magazine).
- BOYS' LIFE (monthly, 12 issues; popular magazine).

Select any one of these magazines and get it FREE for an entire year by sending in a year's subscription for RADIO WORLD at the regular price, \$6.00. Cash in now on this opportunity to get RADIO WORLD WEEKLY, 52 weeks, at the standard price for such subscription, plus a full year's subscription for any ONE of the other enumerated magazines FREE! Put a cross in the square next to the magazine of your choice, in the above list, fill out the coupon below, and mail \$6 check, money order or stamps to RADIO WORLD, 145 West 45th Street, New York, N. Y. (Just East of Broadway).

Your Name .....

Your Street Address .....

City ..... State .....

- If renewing an existing or expiring subscription for RADIO WORLD, please put a cross in square at beginning of this sentence.
- If renewing an existing or expiring subscription for other magazine, please put a cross in square at the beginning of this sentence.

RADIO WORLD, 145 West 45th Street, New York, N. Y. (Just East of Broadway)

### DOUBLE

### VALUE!

# Quick Action Classified Ads

## Radio World's Speedy Medium for Enterprise and Sales

10 cents a word — 10 words minimum — Cash with Order

COLOSSAL BARGAIN—A 4-tube AC 105-120 Volt, 50-60 cycle, custom made receiver, in table model cabinet, with Mayolian B eliminator, A battery, Westinghouse trickle charger, C bias batteries, Relay switch, 5 tubes (includes Raytheon rectifier). One dial finger tuning, 171 output. Operates dynamic. Humless, sturdy performer. Can be heard by appointment. Will install free in residence if in or around New York City. A. Bashein, 1116-56 Street, Brooklyn, N. Y.

### SONGWRITERS

Address Tommie Malie, RW4215 North Ave., Chicago.

"CITY OF CHICAGO" WORLD'S DURATION PLANE—30" Plan 10c. Model Aviator, Dept. RW, 605 Washington, Chicago.

BARGAINS in first-class, highest grade merchandise. B-B-L phonograph pick-up, theatre type, suitable for home, with vol. control, \$6.57; phono-link pick-up with vol. control and adapter, \$3.50; steel cabinet for HB Compact, \$3.00; four-gang .00035 mfd. with trimmers built in, \$1.95; .00025 mfd. Dubilier grid condenser with clips, 18c. P. Cohen, Room 1214, at 143 West 45th Street, N. Y. City.



# Accurate Tuning Condensers and Accessories

## EQUALIZER

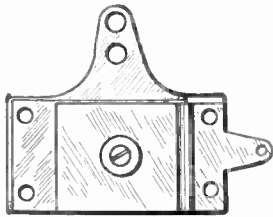

CAT. EQ-100 AT 35c

The most precise and rugged equalizing condenser made, with 20 mmfd. minimum and 100 mmfd. maximum, for equalizing the capacity where gang condensers are used that are not provided with built-in trimmers. Turning the screw alters the position of the moving plate, hence the capacity. Cross-section reveals special threaded brass bushing into which screw turns, hence you can not strip the thread. Useful in all circuits where trimming capacity of 100 mmfd. or less is specified. Maximum capacity stamped on

## SINGLE .00035

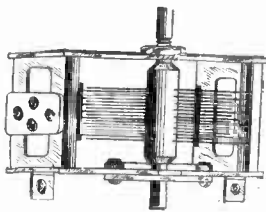

CAT. KH-3 AT 85c

A single .00035 mfd. condenser with nonremovable shaft, having shaft extension front and back, hence useful for ganging with drum dial or any other dial. Shaft is 1/4 inch diameter, and its length may be extended 1/2 inch by use of Cat. XS-4. Brackets built in enable direct sub-panel mounting, or may be piled off easily. Front panel mounting is practical by removing two small screws and replacing with two 3/32 screws 1/4 inch long. Condenser made by Scovill Mfg. Co.

## THREE-GANG SCOVILL .0005 MFD.

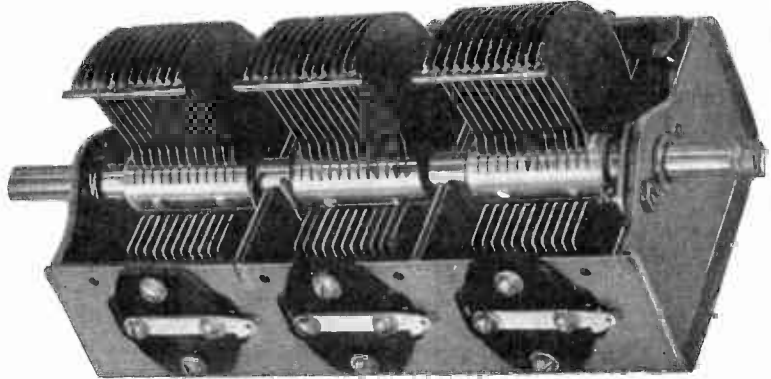

One of the finest, strongest and best gang condensers ever made is this three-gang unit, each section of full .0005 mfd. capacity, with a modified straight frequency line characteristic. The net weight of this condenser is 3 1/2 lbs. Cat. SC-3G-5 at \$4.80.

HERE is a three-gang condenser of most superior design and workmanship, with an accuracy of at least 99 1/2 per cent. at any setting — rugged beyond anything you've ever seen. Solid brass plates perfectly aligned and protected to the fullest extent against any displacement except the rotation for tuning. It has both side and bottom mounting facilities. Shaft is 3/8 inch diameter and extends at front and back, so two of these three-gangs may be used with a single drum dial for single tuning control. For use of this condenser with any dial of 1/4 inch diameter bore, use Cat. XS-8, one for each three-gang. Tension adjusters shown at right, either side of shaft.

### SALIENT FEATURES OF THE CONDENSER

- (1)—Three equal sections of .0005 mfd. capacity each.
- (2)—Modified straight line frequency shape of plates, so-called midline.
- (3)—Sturdy steel frame with rigid steel shields between adjacent sections. These shields minimize electric coupling between sections.
- (4)—The frame and the rotor are electrically connected at the two bearings and again with two sturdy springs, thus insuring positive, low resistance contact at all times.
- (5)—Both the rotor and the stator plates are accurately spaced and the rotor plates are accurately centered between stator plates.
- (6)—Two spring stoppers prevent jarring when the plates are brought into full mesh.
- (7)—The rotor turns as desired, the tension being adjustable by set-screw at end.
- (8)—The shaft is of steel and is 3/8 inch in diameter.
- (9)—Each set of stator plates is mounted with two screws at each side of insulators, which in turn are mounted with two screws to the frame. Thus the stator plates cannot turn sidewise with respect to the rotor plates. This insures permanence of capacity and prevents any possible short circuit.
- (10)—Each stator section is provided with two soldering lugs so that connection can be made to either side.
- (11)—The thick brass plates and the generous proportions of the frame insure low resistance.
- (12)—Provision made for independent attachment of a trimmer to each section.
- (13)—The steel frame is sprayed to match the brass plates.
- (14)—The condenser, made by America's largest condenser manufacturer, is one of the best and sturdiest ever made, assuredly a precise instrument.

## RIGID AND FLEXIBLE LINKS

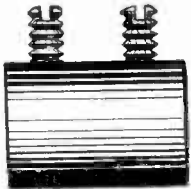

CAT. RL-3 AT 12c

The rigid link, Cat. RL-3, has two set-screws, one to engage each shaft, and is particularly serviceable where a grounded metal chassis is used, as the returns then need no insulation.

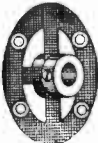

CAT. FL-4 AT 30c

Flexible insulated coupler for uniting coil or condenser shafts of 1/4 inch diameter. Provides option of insulated circuits

For coupling two 1/4 inch diameter shafts, either coil shaft and condenser shaft, or two condenser shafts, a coupling link is used. This may be of the rigid type, all metal, where the linked units are not to be insulated.

## EXTENSION SHAFTS, TWO SIZES



CAT. XS-4 AT 10c

Here is a handy aid to salvaging condensers and coils that have 1/4 inch diameter shafts not long enough for your purpose. Fits on 1/4 inch shaft and provides 1/2 inch extension, still at 1/4 inch diameter. Hence both the extension shaft and the bore or opening are 1/4 inch diameter. Order Cat. XS-4.

For condensers with 3/8 inch diameter shaft, to accommodate to dials that take 1/4 inch shaft, order Cat. XS-8 at 15c.

## .00035 TWO-GANG

A two-gang condenser, like the single type, KHS-3, but consisting of two sections on one frame, is Cat. KHD-3, also made by Scovill. The same mounting facilities are provided. There is a shield between the respective sections. The tuning characteristic is modified straight frequency line. Order Cat. KHD-3 at \$1.70.

## DRUM DIAL

CAT DD-0-100 @ \$1.50

A suitable drum dial or direct drive type is obtainable for 1/4 inch shafts or 3/8 inch shafts, and with 0-100 scales. An escutcheon is furnished with each dial

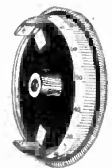

## FOUR-GANG .00035 MFD. WITH TRIMMERS BUILT IN

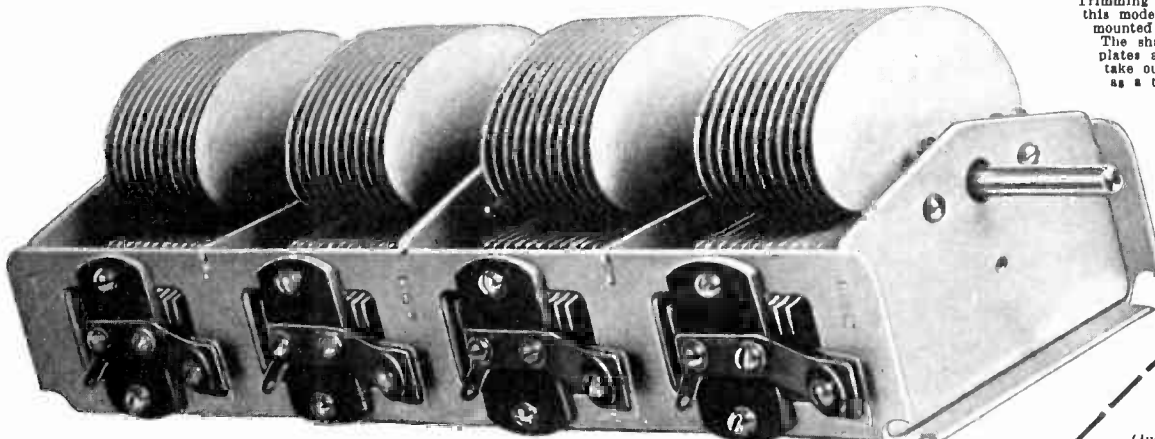

Trimming condensers are built into this model. The condenser may be mounted on bottom or on side. The shaft is removable, also the plates are removable, so you can take out one section and operate as a three-gang.

Four-gang .00035 mfd. with trimmers built in. Shaft and rotor blades removable. Steel frame and shaft aluminum plates. Adjustable tension at rear. Overall length, 11 inches. Weight, 3 1/2 lbs. Cat. SPL-4G-3 \$3.95.

## SHORT WAVES

Tuning condensers for short waves, especially suitable for mixer circuits and short-wave adapters. These condensers are .00015 mfd. (150 micro-microfarads) in capacity. They are suitable for use with any plug-in coils. Order Cat. SW-S-150 @ \$1.50. To provide regeneration from plate to grid return, for circuits calling for this, use .00025 mfd. Order Cat. SW-S-250 @ \$1.50.

A four-gang condenser of good, sturdy construction and reliable performance fits into the most popular tuning requirement of the day. It serves its purpose well with the most popular screen grid designs, which call for four tuned stages, including the detector input. Ordinarily a good condenser of this type costs, at the best discount you can contrive to get, about twice as much as is charged for the one illustrated and even then the trimming condensers are not included. The question then arises, has quality been sacrificed to meet a price? As a reply, read the twenty-six points of advantage. The first consideration was to build quality into the condenser. The accuracy is 99 1/2%.

GUARANTY  
RADIO GOODS CO.,  
143 West 45th St.,  
N. Y. C. City  
(Just East of Broadway.)

Enclosed find \$.....for  
which ship designated parts:

Street Address.....  
City..... State.....

the following merchandise as advertised:

- Cat. XS-4 @ 10c
- Cat. KH-3 @ 85c
- Cat. XS-8 @ 15c
- Cat. KHD-3 @ \$1.70
- Cat. RL-3 @ 12c
- Cat. DD-0-100 @ \$1.50
- Cat. EQ-100 @ 35c
- Cat. SC-3 G-5 @ \$4.80
- Cat. SPL-4 G-3 @ \$3.95
- Cat. FL-4 @ 30c
- Cat. SW-S-150
- Cat. SW-S-250

ALL PRICES ARE NET



# New Polo Power Transformers and Chokes

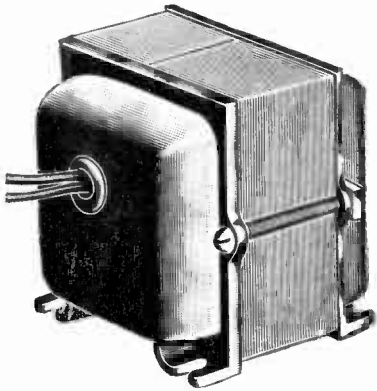

Shielded single choke, 200 ohms D.C. resistance, non-saturable at 100 milliamperes, with two black outleads, each 8 inches long. For filtration of B supplies. Inductance, 30 henrys. Cat. SH-S-CH, price.....\$5.00

The shielded single choke will pass 100 ma. One will suffice if the current is 100 ma. or less, for filtration of B supplies, provided the capacity at the filter output is 8 mfd. or more. Use two such shielded chokes if less than 8 mfd. is used at the filter output. Also, the shielded single choke may be used as in the power tube circuit for an output filter. In this connection use at least 2 mfd. for the capacity section of the filtered speaker output. Order Cat. SH-S-CH @.....\$5.00

The shielded double choke may be used for filtration where the B current is 60 ma. or less, with relatively small filter capacities, no less than 4 mfd. at the output, however. This choke consists of one winding, center-tapped. Its use is especially recommended for 171, 171A, 245 or 210 push-pull output. Connect the black leads (extremes of windings) to plates of the push-pull tubes, red center tap to B plus, and the speaker may be connected directly to plates without any direct current, but only signal current, flowing through the speaker. This system is applicable only to push-pull. Order Cat. SH-D-CH @.....\$5.00

In the same type of case, a 20-volt secondary filament transformer, for 110 volts, 50-133 cycle, may be obtained for use in conjunction with dry rectifiers, such as Kuprox, Westinghouse, Benwood-Linze and Elkton, in dynamic speakers or A battery eliminators. Not made for 25 or 40 cycles. Order Cat. SH-F-20 @.....\$2.50

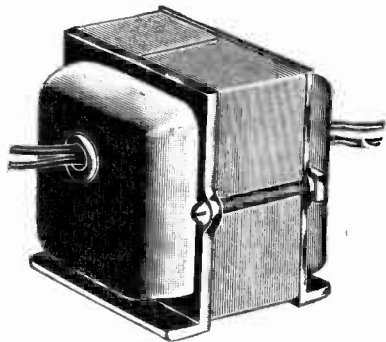

Twenty-volt filament transformer, 110 v. 50-133 cycle input, for use in conjunction with dry rectifiers. It will pass 2.25 amperes.

In a different type case, square, of cadmium plated steel with four mounting screws built in, size 4 1/4 inches wide by 8 3/4 inches high by 4 inches front to back, a 50-60 cycle filament transformer is obtainable with the same windings as the 245 power transformer, except that the high voltage secondary is omitted. Order Cat. 245-FIL @.....\$4.50

For 40 cycles order Cat. 245-FIL-40 @.....7.00  
For 25 cycles order Cat. 245-FIL-25 @.....8.50

[Any of the above three in the same case as the 245 power transformer, @ \$1.00 extra. Add PTC after the Cat. number.]

A single choke, unshielded, 65 ma rating, 30 henrys inductance, for B filtration or single output filter of speaker, is our Cat. US-S-CH @.....\$1.25

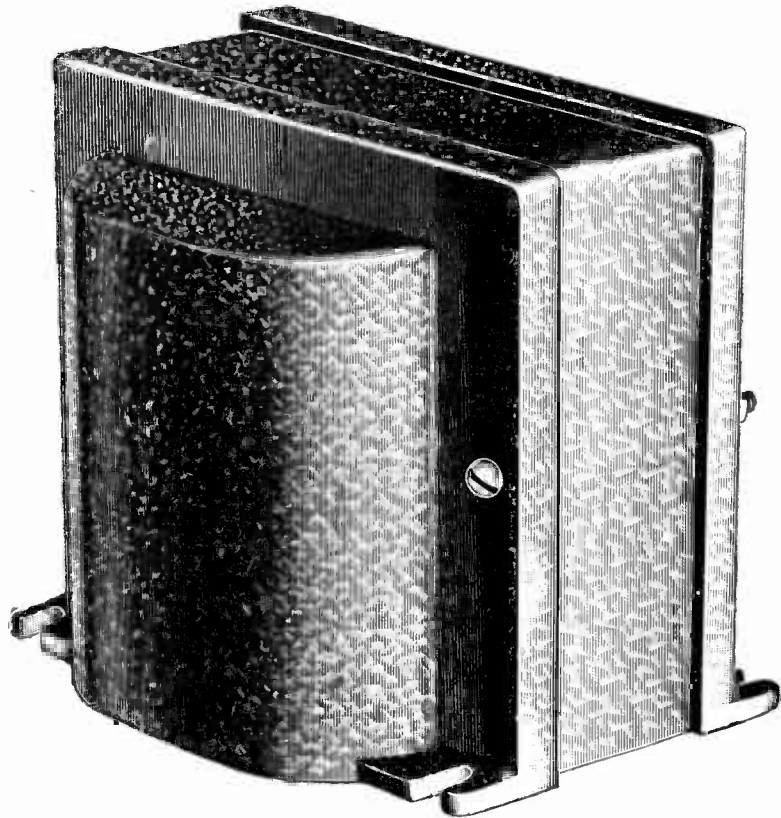

245 Power Transformer for use with 280 rectifier, to deliver 300 volts D.C. at 100 milliamperes, slightly higher voltage at lower drain, and supply filament voltages. Cat. 245-PT price.....\$8.50

The Polo 245 power transformer is expertly designed and constructed, wire, silicon grade A steel core and air gap large enough to stand the full rated load. The primary is for 110v. A.C., 50-60 cycles, tapped for 82.5 volts in case a voltage regulator, such as a Clarostat or Ampertite, is used. The black primary lead is common. If no voltage regulator is used, connect black lead to one side of the A.C. line, green lead to the other side of the line, and ignore red lead, except to tape the end. For use with a voltage regulator (82.5-volt primary) use red lead and ignore the green except to tape the end. The secondaries are: high voltage for 280 plates, with red center tap to ground; 2.5 volts, 3 amperes, red center tap to C plus, for 245 output, single or push-pull; 5 volts, 2 amperes, red center tap, as positive B lead, for filament of 280 tube; 2.5 volts, 16 amperes, red center tap to ground, for 224, 227 and pentode tubes, up to nine heater type tubes. Hence there are five windings.

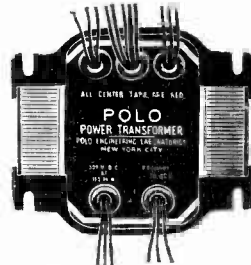

Bottom view of the 245 power transformer. All leads are plainly marked on the nameplate, including the top row.

A special filament transformer, 110 v., 50-60 cycles, with two secondaries, one of 2.5 v. 3 amp. for 245s, single or push-pull, other 2.5 v. 12 amperes for 224, 227, etc., both secondaries center-tapped. Shielded case, 6 ft. AC cable, with plug. Order Cat. F-2.5-D @.....\$3.75

The conservative rating of the Polo 245 power transformer insures superb results even at maximum rated draw, working up to twelve tubes, including rectifier, without saturation or overheating due to any other cause. This ability to stand the gaff requires adequate size wire, core and air gap, all of which are carefully provided. At less than maximum draw the voltages will be slightly greater, including the filament voltages, hence the 16 ampere winding will give 2.25 volts at maximum draw, which is an entirely satisfactory operating voltage, increasing to 2.5 volts maximum as fewer than a total of nine RF, detector and preliminary audio tubes are used.

The avoidance of excessive heat aids in the efficient operation of the transformer and in the maintenance of good regulation, for excessive heat increases the resistance of the windings.

The transformer is equipped with four slotted mounting feet and a nameplate with all leads identified. It is one of the very finest instruments on the radio market.

## Highest Capacity of Filament Secondary

SPECIAL pains were taken in the design and manufacture of the Polo 245 power transformer to meet the needs of experimenters. For instance, excellent regulation was provided, to effect minimum change of voltage with given change in current used. Also, the 2.5 volt winding for RF, detector and preliminary audio tubes, was specially designed for high current, to stand 16 amperes, the highest capacity of any 245 power transformer on the market. Hence you have the option of using nine heater type tubes. The shielded case is crinkle brown finished steel, and the assembly is perfectly tight, preventing mechanical vibration.

The power transformer weighs 11 1/4 lbs., is 7 inches high, 4 1/4 inches wide, and 4 1/4" front to back, overall.

Elevating washers may be used at the mounting feet to clear the outleads, or holes may be drilled in a chassis to pass these leads, and the transformer mounted flush.

## Advice in Use of Chokes and Condensers in Filter

With the 245 power transformer either one or two single chokes should be used, or a shielded double choke, depending on the current drain and the capacity of filter condenser used. Where the capacity at the output is 8 mfd. or more for a drain of 65 to 100 ma., a single choke will suffice (Cat. SH-S-CH), but where smaller output capacity than 8 mfd. is used on such drain, two such chokes should be used in series. Next to the rectifier, in either instance, use a 1 or 2 mfd., 550 A.C. working voltage rating condenser (D.C. rating, 1,000 volts). You may use your choice of capacity at the midsection.

If the drain is to be 85 milliamperes or less, the double choke, Cat. SH-D-CH, may be used for filtration, instead of two single shielded chokes.

The Polo 245 power transformer may be obtained for 25 cycles or 40 cycles on special order, as these are not stocked regularly, and remittance must accompany order. The same guaranty attaches to them as to all other Polo apparatus—money back if not satisfied after trial of five days. In these the primary and secondary voltages and taps are the same, only the case is deeper (front to back) because of larger core and wire for lower frequency.

For 40 cycles order Cat. 245-PT-40 @.....\$9.50  
For 25 cycles order Cat. 245-PT-25 @.....\$12.50

[Note: The filter for 40 cycles should consist of two shielded single chokes, Cat. SH-S-CH, with 2 mfd. next to the rectifier and 4 mfd. minimum at the joint of the two chokes, and at the end of the filter. For 25 cycles the same holds true, except that the output capacity at end of chokes should be 8 mfd. minimum.]

We Make Special Transformers to Order

Polo Engineering Laboratories, 143 West 45th St., New York, N. Y.

- |   |  |
|---|--|
| Enclosed please find \$.....                    | for which ship at once:                          |
| <input type="checkbox"/> Cat. 245-PT @...\$8.50 | <input type="checkbox"/> Cat. 245-FIL @...\$4.50 |
| <input type="checkbox"/> Cat. 245-PT-40 @ 9.50  | <input type="checkbox"/> Cat. 245-FIL-40 @ 7.00  |
| <input type="checkbox"/> Cat. 245-PT-25 @ 12.00 | <input type="checkbox"/> Cat. 245-FIL-25 @ 8.50  |
| <input type="checkbox"/> Cat. SH-S-CH @ 5.00    | <input type="checkbox"/> Cat. SH-F-20 @ 2.50     |
| <input type="checkbox"/> Cat. SH-D-CH @ 6.00    | <input type="checkbox"/> Cat. UN-S-CH @ 1.25     |
| <input type="checkbox"/> F-2.5-D @.....         | <input type="checkbox"/> @.....\$3.75            |

Note: Canadian remittance must be by post office or express money order.

If C.O.D. shipment is desired, put cross here. No C.O.D. on 25 and 40 cycle apparatus. For these full remittance must accompany order. The 25 and 40 cycle apparatus bears the 50-60-cycle label, but you will get actually what you order.

Name.....  
Address.....  
City..... State.....