

JUNE 21st

1930

RADIO

15 Cents

PER COPY

REG. U.S. PAT. OFF.

WORLD

The First and Only National Radio Weekly

430th Consecutive Issue—NINTH YEAR

Sensitivity of $\frac{1}{4}$ Microvolt Per Meter

Battery Set for Use on Remote Farms

A Novice's Troubles and Their Solution

An Approach to Understanding Inductance

Debate on the Value of Tone Control

Furore Over Fake SOS During Reed's Speech

Heat Radiation at Radio Frequencies with New Tube

Two High-Powered Stations are Synchronized

State Tax on Receivers Proves Unpopular

First Quarter of 1930 Far Ahead of 1929

New Polo Power Transformers and Chokes

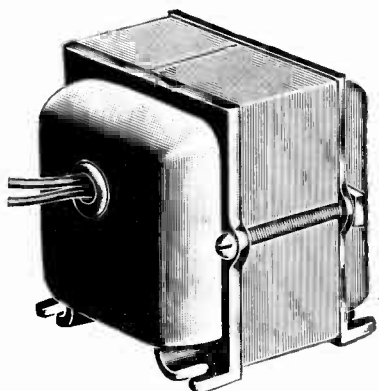

Shielded single choke. 200 ohms D.C. resistance, non-saturable at 100 milliamperes, with two black outleads, each 6 inches long. For filtration of B supplies. Inductance, 30 henrys. Cat. SH-S-CH, price.....\$5.00

The shielded single choke will pass 100 ma. One will suffice if the current is 100 ma. or less, for filtration of B supplies, provided the capacity at the filter output is 8 mfd. or more. Use two such shielded chokes if less than 8 mfd. is used at the filter output. Also, the shielded single choke may be used as in the power tube circuit for an output filter. In this connection use at least 2 mfd. for the capacity section of the filtered speaker output. Order Cat. SH-S-CH @.....\$5.00

The shielded double choke may be used for filtration where the B current is 60 ma. or less, with relatively small filter capacities, no less than 4 mfd. at the output, however. This choke consists of one winding, center-tapped. Its use is especially recommended for 171, 171A, 245 or 210 push-pull output. Connect the black leads (extremes of windings) to plates of the push-pull tubes, red center tap to B plus, and the speaker may be connected directly to plates without any direct current, but only signal current, flowing through the speaker. This system is applicable only to push-pull. Order Cat. SH-D-CH @.....\$6.00

In the same type of case a 20-volt secondary filament transformer, for 110 volts, 50-133 cycle, may be obtained for use in conjunction with dry rectifiers, such as Kuprox, Westinghouse, Benwood-Linze and Elkon, in dynamic speakers or A battery eliminators. Not made for 25 or 40 cycles. Order Cat. SH-F-20 @.....\$2.50



245 Power Transformer for use with 280 rectifier, to deliver 300 volts D.C. at 100 milliamperes, slightly higher voltage at lower drain, and supply filament voltages. Cat. 245-PT price.....\$8.50

The Polo 245 power transformer is expertly designed and constructed, wire, silicon grade A steel core and air gap large enough to stand the full rated load. The primary is for 110v A.C., 50-60 cycles, tapped for 82.5 volts in case a voltage regulator, such as a Clarostat or Amperite, is used. The black primary lead is common. If no voltage regulator is used, connect black lead to one side of the A.C. line, green lead to the other side of the line, and ignore red lead, except to tape the end. For use with a voltage regulator (82.5-volt primary) use red lead and ignore the green except to tape the end. The secondaries are: high voltage for 280 plates, with red center tap to ground; 2.5 volts, 3 amperes, red center tap to C plus, for 245 output, single or push-pull; 5 volts, 2 amperes, red center tap, as positive B lead, for filament of 280 tube; 2.5 volts, 16 amperes, red center tap to ground, for 224, 227 and pentode tubes, up to nine heater tube types. Hence there are five windings.

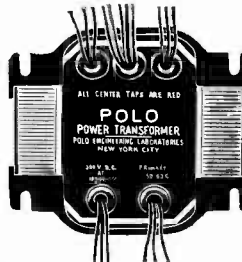

Bottom view of the 245 power transformer. All leads are plainly marked on the nameplate, including the top row.

A special filament transformer, 110 v., 50-60 cycles, with two secondaries, one of 2.5 v. 3 amp. for 245s, single or push-pull, other 2.5 v. 12 amperes for 224, 227, etc., both secondaries center-tapped. Shielded case, 6 ft. AC cable with plug. Order Cat. F-2.5-D @.....\$3.75

The conservative rating of the Polo 245 power transformer insures superb results even at maximum rated draw, working up to twelve tubes, including rectifier, without saturation, or overheating due to any other cause. This ability to stand the gaff requires adequate size wire, core and air gap, all of which are carefully provided. At less than maximum draw the voltages will be slightly greater, including the filament voltages, hence the 16 ampere winding will give 2.25 volts at maximum draw, which is an entirely satisfactory operating voltage, increasing to 2.5 volts maximum as fewer than a total of nine RF, detector and preliminary audio tubes are used. The avoidance of excessive heat aids in the efficient operation of the transformer and in the maintenance of good regulation, for excessive heat increases the resistance of the windings.

The transformer is equipped with four slotted mounting feet and a nameplate with all leads identified. It is one of the very finest instruments on the radio market.

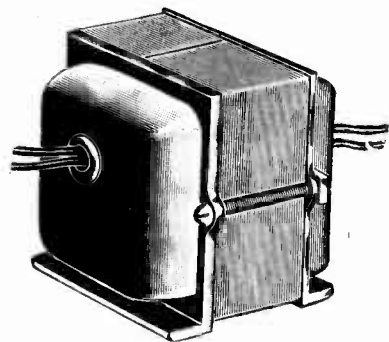

Twenty-volt filament transformer, 110 v. 50-133 cycle input, for use in conjunction with dry rectifiers. It will pass 2.25 amperes.

In a different type case, square, of cadmium plated steel with four mounting screws built in, size 4 1/4 inches wide by 8 3/4 inches high by 4 inches front to back, a 50-60 cycle filament transformer is obtainable with the same windings as the 245 power transformer, except that the high voltage secondary is omitted. Order Cat. 245-FIL @.....\$4.50
 For 40 cycles order Cat. 245-FIL-40 @.....7.00
 For 25 cycles order Cat. 245-FIL-25 @.....8.50
 [Any of the above three in the same case as the 245 power transformer, @ \$1.00 extra. Add PTC after the Cat. number.]

A single choke, unshielded, 65 ma rating, 30 henrys inductance, for B filtration or single output filter of speaker, is our Cat. US-S-CH @.....\$1.25

Highest Capacity of Filament Secondary

SPECIAL pains were taken in the design and manufacture of the Polo 245 power transformer to meet the needs of experimenters. For instance, excellent regulation was provided, to effect minimum change of voltage with given change in current used. Also, the 2.5 volt winding for RF, detector and preliminary audio tubes, was specially designed for high current, to stand 16 amperes, the highest capacity of any 245 power transformer on the market. Hence you have the option of using nine heater type tubes. The shielded case is crinkle brown finished steel, and the assembly is perfectly tight, preventing mechanical vibration.

The power transformer weighs 11 1/2 lbs., is 7 inches high, 4 1/2 inches wide, and 4 1/4" front to back, overall. Elevating washers may be used at the mounting feet to clear the outleads, or holes may be drilled in a chassis to pass these leads, and the transformer mounted flush.

Advice in Use of Chokes and Condensers in Filter

With the 245 power transformer either one or two single chokes should be used, or a shielded double choke, depending on the current drain and the capacity of filter condenser used. Where the capacity at the output is 8 mfd. or more for a drain of 65 to 100 ma., a single choke will suffice (Cat. SH-S-CH), but where smaller output capacity than 8 mfd. is used on such drain, two such chokes should be used in series. Next to the rectifier, in either instance, use a 1 or 2 mfd., 350 A.C. working voltage rating condenser (D.C. rating, 1,000 volts). You may use your choice of capacity at the midsection.

If the drain is to be 65 milliamperes or less, the double choke, Cat. SH-D-CH, may be used for filtration, instead of two single shielded chokes.

The Polo 245 power transformer may be obtained for 25 cycles or 40 cycles on special order, as these are not stocked regularly, and remittance must accompany order. The same guaranty attaches to them as to all other Polo apparatus—money back if not satisfied after trial of five days. In these the primary and secondary voltages and taps are the same, only the case is deeper (front to back) because of larger core and wire for lower frequency.
 For 40 cycles order Cat. 245-PT-40.....@ \$9.50
 For 25 cycles order Cat. 245-PT-25.....@ \$12.50
 [Note: The filter for 40 cycles should consist of two shielded single chokes, Cat. SH-S-CH, with 2 mfd. next to the rectifier and 4 mfd. minimum at the joint of the two chokes and at the end of the filter. For 25 cycles the same holds true, except that the output capacity at end of chokes should be 8 mfd. minimum.]

We Make Special Transformers to Order

Polo Engineering Laboratories, 143 West 45th St., New York, N. Y.

- Enclosed please find \$..... for which ship at once:
- | | |
|---|--|
| <input type="checkbox"/> Cat. 245-PT @...\$8.50 | <input type="checkbox"/> Cat. 245-FIL @...\$4.50 |
| <input type="checkbox"/> Cat. 245-PT-40 @ 9.50 | <input type="checkbox"/> Cat. 245-FIL-40 @ 7.00 |
| <input type="checkbox"/> Cat. 245-PT-25 @ 12.00 | <input type="checkbox"/> Cat. 245-FIL-25 @ 8.50 |
| <input type="checkbox"/> Cat. SH-S-CH @ 5.00 | <input type="checkbox"/> Cat. SH-F-20 @ 2.50 |
| <input type="checkbox"/> Cat. SH-D-CH @ 6.00 | <input type="checkbox"/> Cat. UN-S-CH @ 1.25 |
| <input type="checkbox"/> F-2.5-D @..... | <input type="checkbox"/>@ 3.75 |

Note: Canadian remittance must be by post office or express money order.

If C.O.D. shipment is desired, put cross here. No C.O.D. on 25 and 40 cycle apparatus. For these full remittance must accompany order. The 25 and 40 cycle apparatus bears the 50-60-cycle label, but you will get actually what you order.

Name.....
 Address.....
 City..... State.....

Accurate Tuning Condensers and Accessories

EQUALIZER

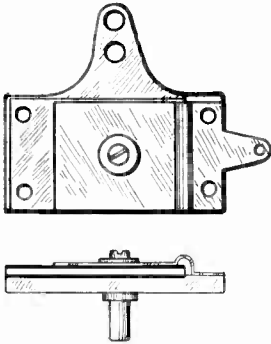

CAT. EQ-100 AT 35c

The most precise and rugged squaring condenser made with 20 mmfd. minimum and 100 mmfd. maximum, for equalizing the capacity where gang condensers are used that are not provided with built-in trimmers. Turning the screw alters the position of the moving plate, hence the capacity. Cross-section reveals special threaded brass bushing into which screw turns, hence you can not strip the thread. Useful in all circuits where trimming capacity of 100 mmfd. or less is specified. Maximum capacity stamped on

SINGLE .00035

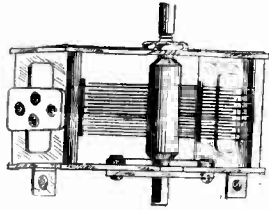

CAT. KH-3 AT 85c

A single .00035 mfd. condenser with nonremovable shaft, having shaft extension front and back, hence useful for ganging with drum dial or any other dial. Shaft is 1/4 inch diameter, and its length may be extended 1/4 inch by use of Cat. XS-4. Brackets built in enable direct sub-panel mounting, or may be slipped off easily. Front panel mounting is practical by removing two small screws and replacing with two 3/34 screws 1/2 inch long. Condenser made by Scovill Mfg. Co.

THREE-GANG SCOVILL .0005 MFD.

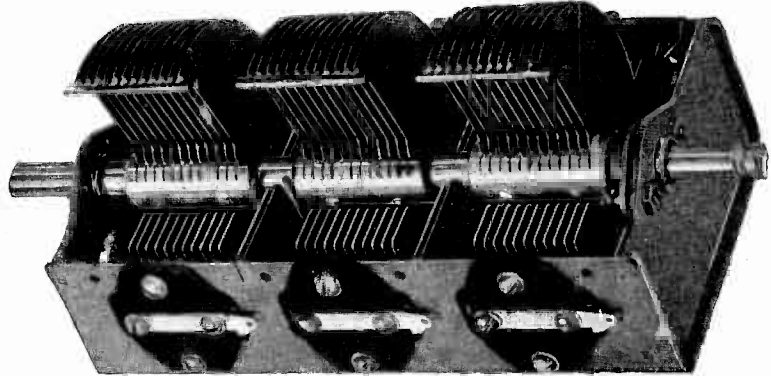

One of the finest, strongest and best gang condensers ever made is this three-gang unit, each section of full .0005 mfd. capacity, with a modified straight frequency line characteristic. The net weight of this condenser is 3 1/4 lbs. Cat. SC-3G-5 at \$4.80.

HERE is a three-gang condenser of most superior design and workmanship, with an accuracy of at least 99 1/2 per cent. at any setting — rugged beyond anything you've ever seen. Solid brass plates perfectly aligned and protected to the fullest extent against any displacement except the rotation for tuning. It has both side and bottom mounting facilities. Shaft is 1/4 inch diameter and extends at front and back, so two of these three-gangs may be used with a single drum dial for single tuning control. For use of this condenser with any dial of 1/4 inch diameter bore, use Cat. XS-8, one for each three-gang. Tension adjusters shown at right, either side of shaft.

SALIENT FEATURES OF THE CONDENSER

- (1)—Three equal sections of .0005 mfd. capacity each.
- (2)—Modified straight line frequency shape of plates, so-called midline.
- (3)—Sturdy steel frame with rigid steel shields between adjacent sections. These shields minimize electric coupling between sections.
- (4)—The frame and the rotor are electrically connected at the two bearings and again with two sturdy springs, thus insuring positive, low resistance contact at all times.
- (5)—Both the rotor and the stator plates are accurately spaced and the rotor plates are accurately centered between stator plates.
- (6)—Two spring stoppers prevent jarring when the plates are brought into full mesh.
- (7)—The rotor turns as desired, the tension being adjustable by set-screw at end.
- (8)—The shaft is of steel and is 1/4 inch in diameter.
- (9)—Each set of stator plates is mounted with two screws at each side of insulators, which in turn are mounted with two screws to the frame. Thus the stator plates cannot turn sideways with respect to the rotor plates. This insures permanence of capacity and prevents any possible short circuit.
- (10)—Each stator section is provided with two soldering lugs so that connection can be made to either side.
- (11)—The thick brass plates and the generous proportions of the frame insure low resistance.
- (12)—Provision made for independent attachment of a trimmer to each section.
- (13)—The steel frame is sprayed to match the brass plates.
- (14)—The condenser, made by America's largest condenser manufacturer, is one of the best and sturdiest ever made, assuredly a precise instrument.

RIGID AND FLEXIBLE LINKS

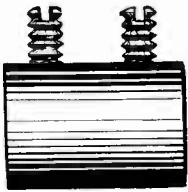

CAT. RL-3 AT 12c

The rigid link, Cat. RL-3, has two set-screws, one to engage each shaft, and is particularly serviceable where a grounded metal chassis is used, as the returns then need no insulation.

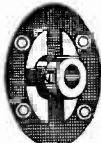

CAT. FL-4 at 30c

Flexible insulated coupler for wiring coil or condenser shafts of 1/4 inch diameter. Provides option of insulated circuits.

EXTENSION SHAFTS, TWO SIZES



CAT. XS-4 AT 10c

Here is a handy aid to salvaging condensers and coils that have 1/4 inch diameter shafts not long enough for your purpose. Fits on 1/4 inch shaft and provides 1/4 inch extension, still at 1/4 inch diameter. Hence both the extension shaft and the bore or opening are 1/4 inch diameter. Order Cat. XS-4.

For condensers with 1/4 inch diameter shaft, to accommodate to dials that take 1/4 inch shaft, order Cat. XS-8 at 15c.

.00035 TWO-GANG

A two-gang condenser, like the single type, KHS-3, but consisting of two sections on one frame, is Cat. KHD-3, also made by Scovill. The same mounting facilities are provided. There is a shield between the respective sections. The tuning characteristic is modified straight frequency line. Order Cat. KHD-3 at \$1.70.

DRUM DIAL

CAT DD-0-100 @ \$1.50

A suitable drum dial of direct drive type is obtainable for 1/4 inch shafts or 3/8 inch shafts, and with 0-100 scales. An escutcheon, is furnished with each dial.



FOUR-GANG .00035 MFD. WITH TRIMMERS BUILT IN

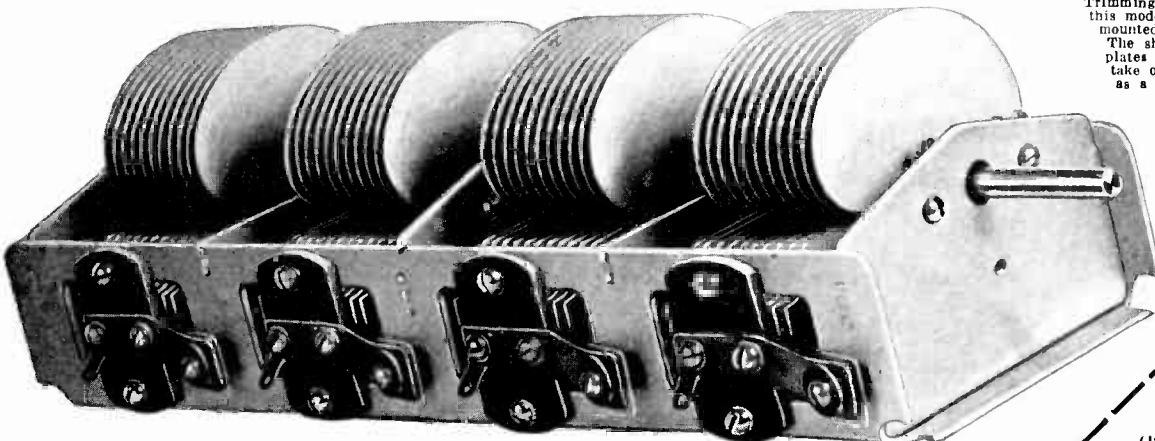

Trimming condensers are built into this model. The condenser may be mounted on bottom or on side. The shaft is removable, also the plates are removable, so you can take out one section and operate as a three-gang.

Four-gang .00035 mfd. with trimmers built in. Shaft and rotor blades removable. Steel frame and shaft aluminum plates. Adjustable tension at rear. Overall length, 11 inches. Weight, 3 1/2 lbs. Cat. SPL-4G-3 @ \$3.95.

SHORT WAVES

Tuning condensers for short waves, especially suitable for mixer circuits and short-wave adapters. These condensers are .00015 mfd. (150 micro-microfarads) in capacity. They are suitable for use with any plug-in coils. Order Cat. SW-S-150 @ \$1.50. To provide regeneration from plate to grid return, for circuits calling for this, use .00025 mfd. Order Cat. SW-S-250 @ \$1.50.

A four-gang condenser of good, sturdy construction and reliable performance fits into the most popular tuning requirement of the day. It serves its purpose well with the most popular screen grid designs, which call for four tuned stages, including the detector input. Ordinarily a good condenser of this type costs, at the best discount you can contrive to get, about twice as much as is charged for the one illustrated and even then the trimming condensers are not included. The question then arises, has quality been sacrificed to meet a price? As a reply, read the twenty-six points of advantage. The first consideration was to build quality into the condenser. The accuracy is 99 1/2 %.

GUARANTY
RADIO GOODS CO.,
143 West 45th St.,
N. Y. City
(Just East of Broadway.)

Enclosed find \$.....for
which ship designated parts:

Street Address.....
City..... State.....

the following merchandise as advertised:

- Cat. XS-4 @ 10c
- Cat. KH-3 @ 85c
- Cat. XS-8 @ 15c
- Cat. KHD-3 @ \$1.70
- Cat. RL-3 @ 12c
- Cat. DD-0-100 @ \$1.50
- Cat. EQ-100 @ 35c
- Cat. SC-3 G-5 @ \$4.80
- Cat. SPL-4 G-3 @ \$3.95
- Cat. FL-4 @ 30c
- Cat. SW-S-150
- Cat. SW-S-250

ALL PRICES ARE NET

Balkite Push-Pull Receiver

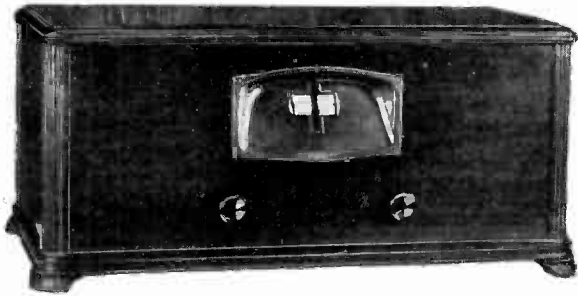

The Balkite A-5 Neutrodyne, one of the most sensitive commercial receivers ever developed; 8 tubes, including 250 rectifier. Wholly AC operated, 105-120 v. 50-60 cycles; in a table model cabinet, genuine walnut, made by Berkey & Gay.

Three stages of tuned RF, neutralized, so there's no squealing; easy tuning; operation on short piece of wire indoors perfectly satisfactory; no repeat tuning points; no hum; phonograph pickup jack built in; excellent tone quality; good selectivity. Two posts are accessible for connecting the field coil of a DC dynamic speaker.

The parts of which this receiver is made are all ace-high and the wiring is done with extreme expertness, by Gilfillan. The power supply is exceptionally fine, the set being worked at 50% less than the rated capacity of the power transformer and chokes, assuring long life. There is no hum, as filtration is remarkably good.

The illuminated drum dial, at center, reads 0-180 at left, and at right has a blank space in which to write call letters. The little knob at left is the volume control, and the one at right is the AC switch. Each RF stage is filtered and bypassed individually, and the RF coils, tuning condenser and power transformer are separately and totally shielded. The lead from antenna binding post to antenna winding of the first coil is shielded wire that is grounded.

Also, the receiver as a whole is totally shielded, with metal chassis and metal under-cover, so there is no stray pickup. Cat. BAL-A5, list price \$135; net price.....

\$44.00

Silver-Plated Coils



Wound with non-insulated wire plated with genuine silver, on grooved forms, these coils afford high efficiency because of the low resistance that silver has to radio frequencies. The grooves in the moulded bakelite forms insure accurate space winding, thus reducing the distributed capacity, and keep the number of turns and separation constant. Hence the secondary reactances are identical and ideal for gang tuning.

The radio frequency transformer may be perpendicularly or horizontally mounted, and has braced holes for that purpose. It has a center-tapped primary, so that it may be used as antenna coil with half or all the primary in circuit, or as interstage coupler, with all the primary on a screen grid plate circuit, or half the primary for any other type tubes, including pentodes. The three-circuit tuner has a center-tapped primary, also. This tuner is of the single hole panel mount, but may be mounted on a chassis, if preferred, by using the braced holes. Pair consists of RF transformer and three-circuit tuner, both for .0005 mfd. only. Order Cat., G-RF-3CT. \$2.48 list price \$5.00; net price.....

Shielded Lead-in Wire

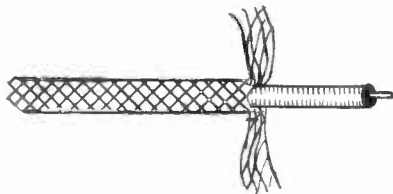

No 18 solid wire, surrounded by a solid rubber insulation covering, and above that a covering of braided copper mesh wire which braid is to be grounded, to prevent stray pick-up. This wire is exceptionally good for antenna lead-in, to avoid pick-up of man-made static, such as from electrical machines. Also used to advantage in the wiring of receivers, as from antenna post of set to antenna coil, or for plate leads, or any leads, if long. This method of wiring a set improves selectivity and reduces hum. This wire is now appearing on the general market for the first time although long used in the best grade of commercial receivers. Order Cat. SH-LW. List price 9c per ft.; net price per foot **5c**

New Multi-Tap Voltage Divider

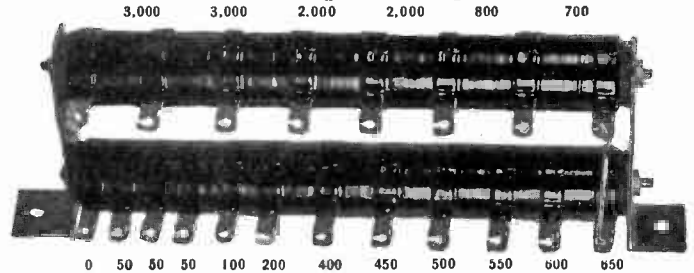

The resistance values between the twenty taps of the new Multi-Tap Voltage Divider are given above. The total is 17,100 ohms and affords nineteen different voltages.

The Multi-Tap Voltage Divider is useful in all circuits, including push-pull and single-sided ones, in which the current rating of 100 milliamperes is not seriously exceeded and the maximum voltage is not more than 400 volts. Higher voltages may be used at lesser drain.

The expertness of design and construction will be appreciated by those whose knowledge teaches them to appreciate parts finely made.

When the Multi-Tap Voltage Divider is placed across the filtered output of a B supply which serves a receiver, the voltages are in proportion to the current flowing through the various resistances. By making connection of grid returns to ground, the lower voltages may be used for negative bias by connecting filament center, or, in 227 and 224 tubes, cathode to a higher voltage.

If push-pull is used, the current in the biasing section is almost doubled, so the midtap of the power tubes' filament winding would go to a lug about half way down on the lower bank.

Order Cat., MTTVD, list price \$6.50, net price.....

\$3.90

R-245 Set and Tube Tester

With the R-245 Tube and Set Tester you plug the cable into a vacated socket of a receiver, putting the removed tube in the tester, and using the receiver's power for making these tests: Plate current, on 0-20 or 0-100 ma. scale, changed by throwing a built-in switch; 0-60, 0-300 v. DC, changed by moving one of the tipped cables to another jack; filament or heater voltage (AC or DC), up to 10 volts, or any other AC voltage source, measured independently, up to 140 volts, including AC line voltage. Also screen grid voltage and screen grid current may be read by following connections specified in the new 8-page instruction sheet.

Each meter may be used independently. The two test leads, one red, the other black, with tip jack terminals, enable quick connection to meters for independent use.

With this outfit you can shoot trouble in receivers and test circuits using the following tubes: 201A, 201A, UX119, UX120, 210, 171, 171A, 112, 112A, 245, 224, 222, 226, 227, and pentodes.

When the R-245 is plugged into the vacated socket of a set and the removed tube is placed in the proper socket of the Tester, the receiver's power supplies all the voltages and currents. You see the vital tests made right before your eyes, all three meters registering immediately, all three reading at the same time.

Here are some of the questions answered by the Tester when plugged into the receiver:

What is the filament or heater voltage (no matter if DC or AC)? What is the plate voltage at the plate itself? What is the plate current drawn by the tube? Is the tube in good condition or does it require replacement? What is the grid bias voltage? What is the cathode voltage? What is the screen grid voltage? Besides, when meters are used independently, you can answer these questions: What is the screen grid current? What is the line voltage (no matter if AC or DC)? Is the circuit continuous or is it open? What is the total plate current drawn in the receiver? What are the respective B voltages at the B batteries or voltage divider?

Order Cat. R-245. List price, \$20; net price..... **\$11.40**

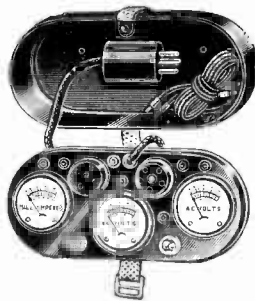

Fixed Condensers

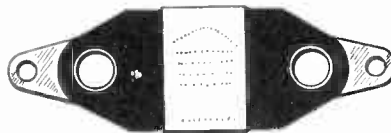

Dubilier Micon fixed condensers, type 642, are available at following capacities and prices:

.0001 mfd.	10c	.006	20c
.00025 mfd.	10c	.00025 with clips.	20c
.0003 mfd.	10c	All are guaranteed	
.00035 mfd.	15c	electrically perfect and	
.001	17c	money back if not	
.0015	17c	satisfied within five	
.002	18c	days.	

Order Cat. MICON .0001 etc. at prices stated.

High-Voltage Meters

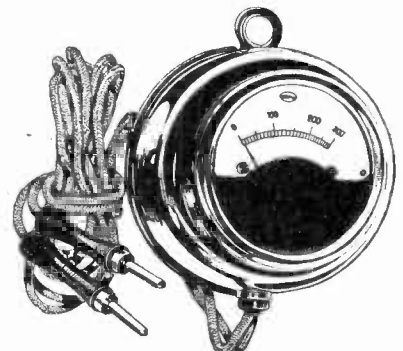

0-300 v., 200 ohms per volt. Cat. F-300 @ \$2.59
 0-500 v., 250 o.p.v. Cat. F-500 @ 3.73
 0-600 v., AC and DC (same meter reads both); 100 ohms p.v. Order Cat. M-600 @ 4.95

Double Drum Dial

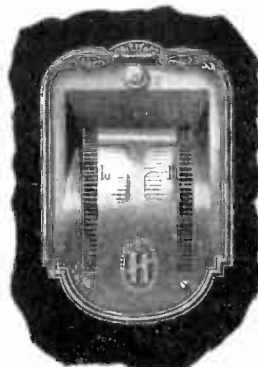

Hammarlund double drum dial, each section individually tunable. Order Cat. H-DDD. List price \$8.00; net price **\$3.00**

Shielded RF Choke

Excellent in detector plate circuit or in B-plus or DC leads of radio frequency tubes to purify signals.

An efficient radio frequency choke in a shielded case. Inductance, 50 millihenries. Useful for all RF chocking.

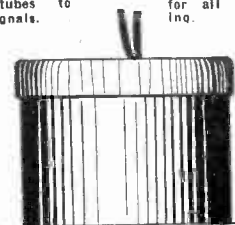

In some instances one outlead is connected to case, so use this lead for B-plus or for ground, otherwise ground the case additionally. Order Cat. SH-RFC. List price, \$1.00; net price **50c**

Guaranty Radio Goods Co., 143 West 45th St., New York, N. Y. (Just East of Broadway)

Enclosed please find \$..... (Canadian must be express or post office money order, for which please ship:

<input type="checkbox"/> BAL-AS @ \$44.00	<input type="checkbox"/> Ft. of SH-LW	<input type="checkbox"/> M-600 @ \$4.95
<input type="checkbox"/> MTTVD @ 3.90	<input type="checkbox"/> @ 5c p. f.	<input type="checkbox"/> F-300 @ \$2.59
<input type="checkbox"/> G-RF-3CT @ 2.48	<input type="checkbox"/> H-DDD @ \$3.00	<input type="checkbox"/> F-500 @ 3.73
<input type="checkbox"/> R-245 @ 11.40	<input type="checkbox"/> SH-RFC @ 50c	<input type="checkbox"/> MICON @ @
<input type="checkbox"/> If C.O.D. shipment is desired put cross here.		<input type="checkbox"/> MICON @ @

Your Name
 Address
 City State.....

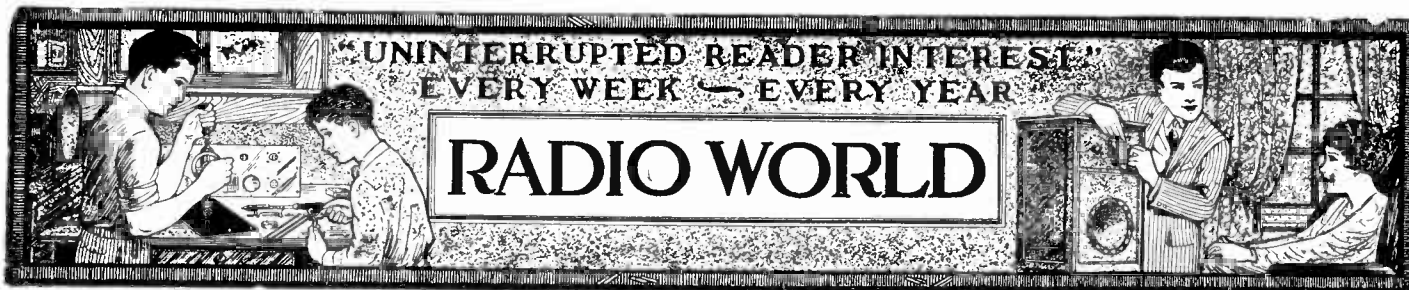

Vol. XVII. No. 14 Whole No. 430
 June 21st, 1930
 15c per Copy, \$6.00 per Year
 [Entered as second-class matter, March 1922 at the Post Office at New York, N. Y., under act of March, 1879.]

Latest Circuits and News
 Technical Accuracy Second to None
NINTH YEAR

A Weekly Paper published by Hennessy Radio Publications Corporation, from Publication Office, 145 West 45th Street, New York, N. Y.
 (Just East of Broadway)
 Telephone, BRyant 0558 and 0559

RADIO WORLD, owned and published by Hennessy Radio Publications Corporation, 145 West 45th Street, New York, N. Y. Roland Burke Hennessy, president and treasurer, 145 West 45th Street, New York, N. Y.; M. B. Hennessy, vice-president, 145 West 45th Street, New York, N. Y.; Herman Bernard, secretary, 145 West 45th Street, New York, N. Y.; Roland Burke Hennessy, editor; Herman Bernard, business manager and managing editor; J. E. Anderson, technical editor.

$\frac{1}{4}$ Microvolt Per Meter

By J. E. Anderson

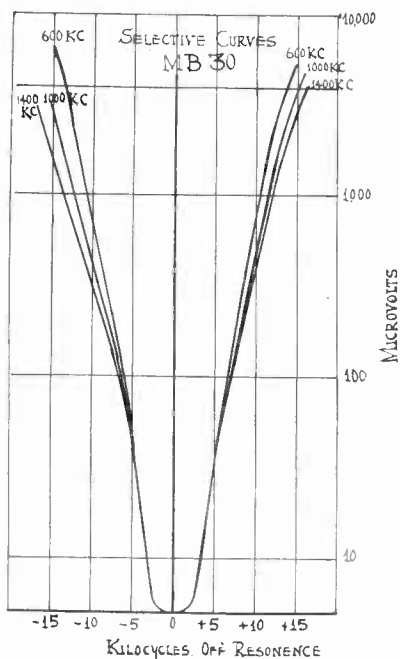

FIG. 1

THREE SELECTIVITY CURVES OF THE MB-30 TUNER IN WHICH BAND PASS FILTERS ARE USED TO IMPROVE SELECTIVITY WITHOUT CUTTING SIDE BANDS SERIOUSLY.

IT IS of interest to note what research engineers are doing to improve receivers, how they are attacking the various problems that must be solved to produce a really good receiver, and what success they are enjoying.

The curves reproduced here show graphically the results of research work having for its object getting a high degree of selectivity without at the same time impairing the audio quality. As everybody knows by this time, when the selectivity of a circuit is made exceedingly high by means of ordinary tuned circuits the sideband suppression becomes so great that only the low notes are brought out strongly and that the high audio frequencies are suppressed. To show the relative suppression of the highs as compared with the lows it is customary to give the overall selectivity curve of the tuner. While this curve does not tell all the discrimination that may occur in a circuit it tells all the discrimination that is due to selectivity.

It has long been known that band pass filters may be used, in theory at least, to improve the characteristics of a receiver in respect to sideband suppression, and this without sacrificing the selectivity as among broadcast channels. Research engineers are working more along this line than they have done heretofore and the curves here shown are splendid examples of what they have achieved.

Meaning of Curves

It has been customary to plot selectivity curves so that they show directly the transmission against frequency off resonance, but of late it has become almost standard practice to plot them so that they show the suppression against frequency off resonance. In one case the peak of the curve is upward, in the other it is downward. The curves reproduced herewith employ

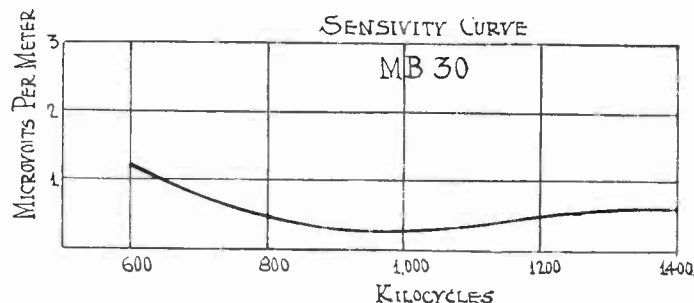

FIG. 2

THE SENSITIVITY CURVE OF THE MB-30 RECEIVER BETWEEN 600 KC AND 1,400 KC, SHOWING HIGH AND ALMOST UNIFORM SENSITIVITY THROUGHOUT THE BROADCAST RANGE.

the second method, that is, suppression against frequency off resonance. It makes no difference which way the curves are plotted, for with suitable interpretation they show exactly the same thing.

When the selectivity is high and a considerable range is to be shown, it is convenient to plot the suppression on a logarithmic scale rather than on an arithmetic scale, and this method has been employed in plotting the curves shown here. When comparing curves plotted on the logarithmic scale with curves plotted on the arithmetic scale it is well to remember that the logarithmic plot will give the impression that the selectivity is less, that is, the curves will be farther out from the frequency axis. This is because the logarithmic plot goes relatively farther out.

Band Pass Filter Curves

The curves in Fig. 1 are of a tuner comprising two band pass filters, each containing two tuned circuits, in addition to standard tuners. The suppression at the frequency of resonance is zero, not because there is no resistance in the circuit but because the suppression is arbitrarily taken as zero there. As the frequency impressed on the tuner deviates in either direction from the frequency of resonance the suppression increases, first very slowly, then more rapidly, until at 15 kc off resonance it is very great.

The band pass effect is noted both near the frequency of resonance at frequencies remote. Near the frequency of resonance the curve is broader than it would be for a series of ordinary tuned circuits, that is, the suppression for frequencies off resonance by only a few kilocycles is less than it would be for ordinary tuned circuits. At frequencies more than 10 kc off resonance, on the other hand, the suppression is greater than it would be for ordinary tuned circuits.

Fig. 2 shows the sensitivity of the receiver in question. It will be noticed that there is very little variation in the sensitivity with frequency. It is greatest just above the geometrical mean frequency of the broadcast band, which falls at 910 kc. The maximum falls between 950 and 1,000 kc. At this point it is better than .25 microvolt per meter. At 1,400 kc it is .6 microvolt per meter and at 600 it is 1.1 microvolts per meter. Throughout the band the sensitivity is much greater than that usually found in receivers. It should be remembered that the lower the microvolts per meter the greater the sensitivity because the curve gives the field intensity that will give a standard signal output, which is a fixed quantity.

[More data next week on the new MB-30]

A Set for 'Neglected

By Jeremiah

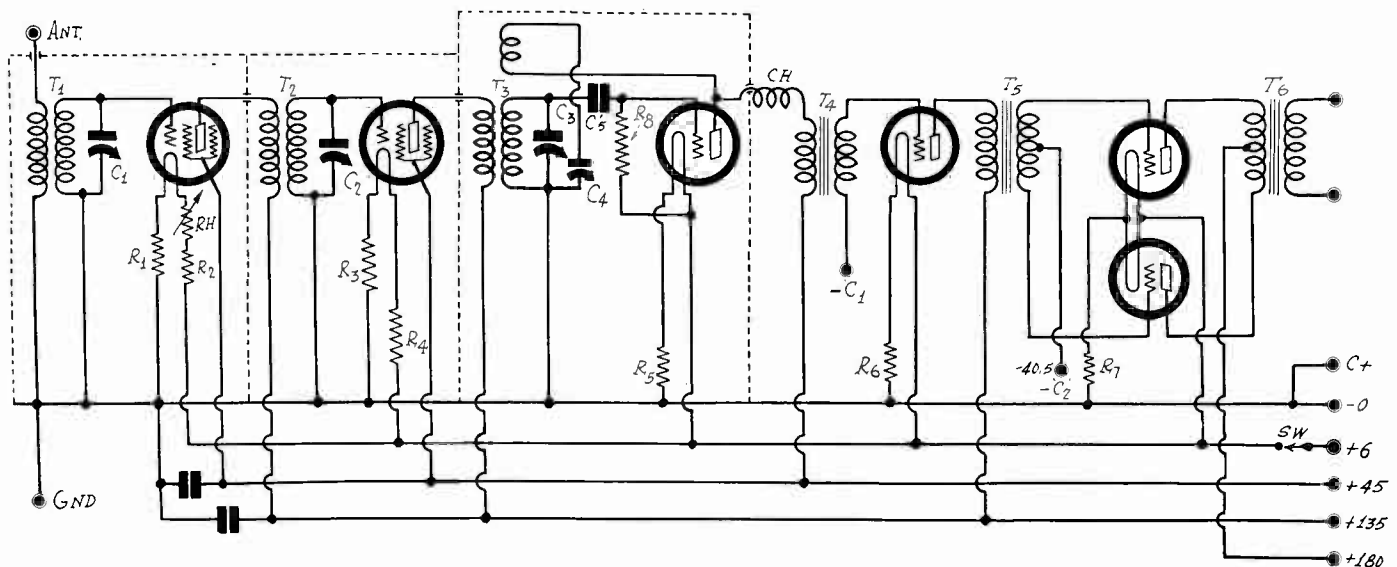

FIG. 1

THE DIAGRAM OF A SENSITIVE AND SELECTIVE SIX-TUBE BATTERY OPERATED RECEIVER SUITABLE FOR USE IN ELECTRICALLY ISOLATED DISTRICTS.

DWELLERS in the country where electric power is not available and those who for various reasons prefer battery operated receivers complain that they are being neglected. Nearly all the circuits and receivers published are for alternating current, and this has been true ever since the alternating current tubes came out on the market.

Nearly all modern AC sets are very sensitive, much more so usually than is necessary for the places where they are used. Battery sets, on the other hand, are not so sensitive, for most of them were worked out when sensitivity was not understood as it is today. But those who live in places where batteries must be used need greater sensitivity than those who live in electrified districts, for, as a rule, they live far away from broadcast stations. There is, therefore, no wonder that electrically isolated radio enthusiasts complain that they are being neglected.

A Circuit to Work On

Here is one battery-operated circuit for the neglected radio enthusiasts to work on. This is sensitive because it employs two screen grid radio frequency stages, a regenerative detector, and two stages of transformer coupled amplification. It has plenty of output volume because the last stage is push-pull, utilizing two 171A tubes.

But is this set sufficiently selective? Well, it has three tuned circuits, in one of which the resistance is reduced by regeneration. There is no reason at all why such a receiver should not be selective enough. Indeed, it may be made almost as selective as desired by the simple method of using more regeneration. Receivers using one radio frequency amplifier and one regenerative detector used to be selective enough for all practical purposes, and this set is more selective than that. Hence there should be no lack of selectivity. The only time that a receiver of this kind would not be selective enough would be when it is used within a mile or two of the antenna of a powerful broadcast station, and when the receiver antenna was excessively high. People interested in battery operated receivers usually do not live in the shadow of high power stations.

Of course, there are many ways in which the selectivity may be destroyed. Poor radio frequency transformers might be used, excessively close coupling between the antenna and the first tuned circuit, or between the windings of the interstage coils, might be employed. Then, again, the shielding might be placed so that each tuned circuit is partly short-circuited by metal around it. Again, the tuning condensers might be put in a gang without any precautions about lining them up properly.

Lining-up Misunderstood

At this point it is well to call attention to the fact there is a common misunderstanding of what is meant by lining up the condensers. It is thought by many that this means simply to adjust the stator and rotor plates so that each plate is centered between its two adjacent plates. This is only a part of the lining-up process, and it is a minor part. The condensers

LIST OF PARTS

- T1, T2, T3—Three radio frequency transformers as described
- T4—One audio frequency transformer
- T5—One push-pull input audio frequency transformer
- T6—One push-pull output audio frequency transformer
- Ch—One 50 millihenry radio frequency choke coil
- C1, C2, C3—Three .0005 mfd. tuning condensers or one three-section gang
- C4—One .00025 mfd. variable condenser
- C5, C7—Two 1 mfd. by-pass condensers
- R1, R2, R3, R4—Four 10-ohm filament resistors.
- R5, R6—Two 4-ohm filament resistors
- R7—One 2-ohm filament resistor
- R8—One 2 megohm grid leak with pig-tails or with mounting
- Sw—One filament switch (this may be built into Rh)
- Ten binding posts
- One pair of speaker tip jacks
- Two grid connectors for screen grid tubes
- Six UX sockets
- One front panel 7x18 inches
- One baseboard 7x17 inches
- Three shields for coils or for stages
- Three dials for the three tuning condensers or one for the gang
- One knob for the regeneration control condenser

may be lined up properly without making this adjustment at all, although it is well to make it if the condensers are made so that it can be done easily. If they are not so made chances are that the centering is as good as it can be made at the factory, and that is more accurate than it can be done at home.

What is meant by lining up of condensers is that the capacities are made equal. Since the condensers are made by the same tools out of the same material the variation between the sections of a gang is usually negligible. Hence it is usually necessary to consider the distributed capacities only, and they can be equalized by a trimmer condenser across each section of the gang, or across the coil connected across that section.

Another important factor is that the tuning coils be equal. It will avail nothing to make the capacities equal if the inductances of the coils are not also equal. There are many factors that contribute to the effective inductance of a coil, and one of these is the presence of metal near or around the coil. As a rule, metal near the coil reduces the inductance, and the reduction is greater the closer the metal is to the coil, and the more metal there is. For example, the plates of the tuning condensers will affect the inductance, so will a metal cabinet, a metal sub-panel and a shield around a coil. Even a loop of wire in the heater circuit, if at all coupled to the coil, will affect the inductance.

This change in the inductance would not seriously affect the

Folk' on a Farm

Strang

selectivity of a gang-controlled receiver were it not for the fact that all the coils are not affected in the same manner or in the same degree, and also for the fact that the effect varies with frequency. To avoid these complications the coils should not only be made alike in the first place, but they should be placed so their surroundings are equal. That is, each coil should be placed so that it is exposed to as much metal as the others. The simplest way to do this, though not necessarily the best way, is to put the coils inside shield cans, making the cans the same size and centering the coils. If the cans are large enough no detrimental effects result.

Shielding Boxes

In the figure a different type of shielding is suggested, namely, that of shield boxes. When this method is employed much more room, as a rule, can be given to the coils. The tube and socket can be put in a corner and the condenser can be put on one side. The average distance from the coil to the metal parts can be more than doubled. This method, however, is not suitable when the condenser comes in a gang, for the sections are so close together that there would be scarcely any more room for the coil than if it were put inside a tight fitting can.

If we assume that the shielding is not overdone by surrounding the coils in too small cans, that the inductances and the capacities have been equalized, and that the coupling is not too close, the circuit shown in Fig. 1 is capable of both high selectivity and high sensitivity.

The secondary windings of the radio frequency transformers T1, T2 and T3 are all the same, so if we give the winding data for one they are given for all. Likewise, the primaries of T2 and T3 are the same since both these transformers follow screen grid tubes.

Let us assume that the form is 1.75 inch bakelite tubing and that we use No. 28 enameled wire. The tuning condensers are .0005 mfd. Then to cover the broadcast band the secondaries should have 62 turns of the specified wire. When shield cans are put over the coils, more turns have to be put on, and the more the smaller the diameter of the shields.

The primaries of T2 and T3 should have 40 turns when working from screen grid tubes of the 222 type. These turns may be wound with the same size wire as the secondaries and on the same form, using a separation of one-quarter or three-eighths of an inch between the windings.

The Antenna Winding

While the primary of T1 may be the same as primaries of the other radio frequency transformers, somewhat better results will be obtained if a smaller winding with heavier wire is used, say 15 turns of No. 24 wire. This winding should be coupled loosely to the secondary for high selectivity. For example, it should be separated from one-quarter to half an inch from the nearest point of the secondary. However, it should be remembered that a larger number of turns, or closer coupling, will increase the sensitivity of the circuit. There is no best combination since what constitutes "best" is a matter of personal preference. A little experimentation on the part of the fan will soon determine which combination of turns suits him best. The proper value also depends to a considerable degree on the antenna constants, and these are never the same for two receivers.

We have one more winding, the tickler on T3. If the tubing on which T3 is is long enough the tickler winding can be put on the same form at the end of the secondary opposite to the primary. Twenty-five turns will suffice.

The regeneration is controlled by a variable condenser C4, which should have a maximum capacity of .00025 or .00035 mfd. It makes no difference which, but it should be provided with a knob or dial with which the capacity of the condenser can be changed by small amounts smoothly and evenly.

Condenser and leak method of detection is used because it is more sensitive than the bias method and therefore more suitable for the service which this receiver is expected to give. The grid condenser C5 has the usual value of .00025 mfd. The grid leak, which should have a value of 2 megohms, is connected from the grid to the positive side of the filament circuit in order to permit grounding of C3 or ganging all the tuning condensers.

The Audio Amplifier

The 50 millihenry choke Ch in the plate circuit should not be omitted, for if it is the circuit may not oscillate, since the distributed capacity of the primary of T4 may shunt signal current at radio frequency around the tickler.

The quality of the output depends almost entirely on the quality of the audio transformers selected for the circuit. There are many good ones available. T4 is an ordinary transformer, T5 is a push-pull input transformer and T6 a push-pull output transformer.

If the two output tubes are 171As the total undistorted power output of the circuit is well in excess of 2 watts, provided that the grid bias is 40.5 volts and the plate voltage is 180 volts. This output is more than ample for any home, and is a good reserve for the low note passages in music.

The filament circuit should be specially treated to get the proper grid bias voltages on the screen grid tubes without the use of bias batteries for these tubes. In the negative leg of the first filament we have a ten ohm resistor R1, which normally maintains the grid at 1.32 volts. In the positive leg we have another 10 ohm resistor, R2. The total resistance of 20 ohms is split in this manner to get the proper bias on the tube and at the same time permit the grounding of the tuned circuit ahead of the tube. A 30-ohm rheostat Rh is put in the positive leg of this filament circuit as a volume control.

The filament circuit of the second screen grid tube is treated exactly the same as that of the first except that the rheostat is omitted. Thus R3 and R4 are 10-ohm resistances.

R5 and R6 are 4-ohm resistances or equivalent ballast units and R7 is a 2-ohm resistance, or two 4-ohm resistances in parallel.

Bias on Audio Tubes

A battery is required to supply the bias for the grids of the audio tubes and three binding posts have been provided for it, a common post for the positive and two for the negative. On the "C1" 12 volts should be applied and on "C2" 40.5 volts. Seven additional binding posts are provided for the antenna, the ground, common minus, A plus, 45 volts plus, 135 volts plus and 180 volts plus.

Since there are two 171A tubes in the circuit, each drawing a normal plate current of 20 milliamperes, and since the other tubes draw about 15 milliamperes, the total current from the B battery will be 55 milliamperes. This is a considerable drain on the battery. Therefore, in order to insure a reasonable life of the batteries, heavy duty batteries should be used with the set. This is especially important when the set is used in places where replacements are not easy to get.

The set can, of course, be operated from a battery eliminator when alternating current is available, but if this type of power is available chances are that some other type of receiver would be selected. This particular one is for electrically isolated districts.

Photo-Electric Cells Match Colors Finely

A colorscope, designed to match colors much more closely than can the human eye, was demonstrated recently before members of the New York Electrical Society by their incoming president, Dr. H. H. Sheldon, professor of physics of Washington Square College, New York University, New York City.

The machine is the invention of Dr. Sheldon, who with his assistant, Dr. W. A. Schneider, associate professor of physics at the same school, developed the instrument.

The colorscope is used to match cloth, dyes, writing paper, wall paper and other

commercial products where identical color matching is essential, and it was learned that the apparatus was developed at the suggestion of a large textile manufacturer and that its use enables the factory to run after useful daylight ceases.

The standard usually accepted for commercial color comparisons is the "dyer's shade," explained Dr. Sheldon, and with the new device color variations of less than one-sixth of this standard can be detected.

The principle of the colorscope is based on the use of two photo-electric cells, arranged to form a balanced circuit un-

der a normal light source. If one of the cells receives more light than another the needle of a galvanometer deflects to the side giving the greater amount of reflected light and this deflection is in terms of the "dyer's shade."

An important innovation is the manner in which weave and sheen effects, which to the normal eye result in improper color matching, are taken care of. It is done by rotation, which blends the surface color of the fabric into a solid true fabric color.

Dr. Sheldon hopes to have the colorscope so developed that it will be possible to match colors at a distance.

All-Waver Operation

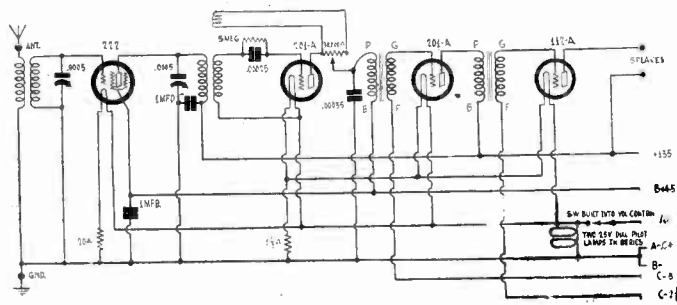

FIG. 1
DIAGRAM OF THE FOUR-TUBE ALL-WAVE BATTERY OPERATED RECEIVER

EXPERIMENTS with the All-Waver demonstrates that such a receiver is practical for local reception of broadcast stations and for the reception of short waves both from local and distant stations. Not only can modulated waves be brought in but also interrupted continuous waves. These are brought in by virtue of the fact that the detector circuit can be brought into oscillation and adjusted so that a heterodyne beat is produced.

Certain precautions are necessary to get signals on all coils and on all settings of the condensers. If there is considerable coupling between the two tuning coils a howl may develop which interferes with the reception of signals. A shield made of a sheet of aluminum placed midway between the coils will help to remove the coupling, provided that the shield is grounded.

While a grid leak of 5 megohms is suggested in the circuit diagram and in the list of parts, lower values should be tried for not in all cases does the 5 megohm leak give the best results. Since the grid condenser is provided with clips, it is a simple matter to insert different values.

Tubes Differ

If different tubes are available they should be tried, because the results obtained depend in a great measure on the efficiency of the tubes. This is particularly true of the screen grid amplifier and the detector.

The circuit was operated both by batteries and a B battery eliminator. It was found that the batteries introduced considerable coupling between the stages. This was due to the fact that the batteries used had seen considerable service and therefore had a high internal resistance. The coupling was reduced by connecting additional by-pass condensers across the voltage taps.

The indicated voltage on the screen grid and the plate of the detector is 45 volts. It was found, however, that when this voltage was raised to 67.5 volts the signals were appreciably greater. When the circuit was operated with a B battery eliminator it was not necessary to add any by-pass condensers because those normally in the B supply were sufficient. As far as sensitivity is concerned there was no difference between the two supplies.

The receiver was built into steel cabinet as illustrated on the front cover of June 14th issue. As will be seen from that photograph, the two tuning condensers with their dials were mounted directly on the front side of the cabinet. In the middle of the front panel is the regeneration control knob, which also is the filament switch.

Removable Top and Back

The cabinet is so constructed that the top and back can be removed. This is very convenient in wiring the set. Moreover, the bottom is open except for the sub-panel. After the parts have been mounted on the sub-panel it may be attached to the cabinet and the wiring done. Most of the wiring is done from underneath and whatever wiring is necessary in the interior is easily done with the top and back removed.

The tuning coils are placed directly behind the condensers on the sub-panel. Special mountings or coil receptacles are built into the sub-panel. The wiring may therefore be done before the coils are inserted. The tube sockets, all of the UX type, are mounted in a row at the rear of the sub-panel.

The two audio transformers are mounted in the middle of the sub-panel half way between the two tuning coils, one transformer being back of the other. These transformers form a shield between the coils and in some instances it may not be necessary to use any other shielding.

Terminal Arrangement

When additional shielding is used it should not be in the form of cans around the coils themselves. A sheet of metal, connected to ground, is enough, provided that it is not too small. It should be considerably larger than the largest dimension of the coils to be effective.

Two binding posts, one for the antenna and one for the

LIST OF PARTS

- Two sets of precision, de luxe coils, three coils to a set, total, six coils to cover 15 to 560 meters.
- One plate coil with mounting bushings.
- Two Hammarlund .0005 mfd. straight frequency condensers.
- One 20-ohm filament resistor. One $1\frac{1}{2}$ -ohm filament resistor.
- One $14\frac{1}{2} \times 9\frac{1}{2}$ inch bakelite subpanel, with four UX (four-prong) sockets and one built in UY (five-prong) socket; two coil receptacles, also built in.
- One 5-lead battery cable, 36 inches long, with five-prong plug.
- One steel cabinet with crinkle brown finish, $7 \times 15\frac{1}{2} \times 10\frac{1}{2}$.
- One steel bottom shield for cabinet.
- One 1-to-3 audio transformer. One 1-to-5 audio transformer.
- Two insulating washers, for volume control.
- Four subpanel brackets.
- One antenna-ground post unit. One speaker post unit.
- One .0025 mfd. grid condenser with clips.
- One Lynch 5 meg. metallized grid leak.
- Two National type VB-D variable ratio dials, maximum reduction 20-to-1, with two 2.5 volt pilot lights and brackets.
- Two Polymet 1 mfd. bypass condensers, single lug type (case goes to ground).
- One 30,000 ohm Clarostat potentiometer, with switch.
- Four spacers for tuning condensers.

ground, are mounted at the left rear edge of the sub-panel, directly behind the screen grid tube. Two other posts for the loudspeaker are mounted in a similar position at the right, directly behind the power tube. The order of the tubes is different in the set from that in the circuit diagram. The screen grid tube is at the extreme left, then comes the first audio frequency amplifier. This is followed by the detector and finally the power tube.

This order of tubes is used in order to get the radio frequency tubes as near as practicable to the coils in their grid circuits. It not only shortens the radio frequency leads, but also the audio frequency leads.

For the battery terminals a cable is provided. There are six leads in this cable and five of them terminate in a plug that fits into a UY type socket mounted at the extreme right on the sub-panel. Two leads in this cable are for A plus and A minus, two for the 135 volt supply and the 45 volt supply. The fifth is for the minus 3 volt bias. The lead not connected to the socket or to the plug is for the $7\frac{1}{2}$ volt bias for the power tube.

A color scheme in the cable leads permits easy identification of the terminals so that it is not necessary to trace them out every time they are to be connected. It is advisable to write the color combinations opposite each terminal on the circuit diagram or else to tag each lead appropriately.

Two Dial Lights

The diagram shows two dial lights connected in series. One of these is used for each vernier dial. They are connected in series because they are 2.5 volt lamps and the voltage source is six volts. Thus each lamp is operated at a temperature slightly higher than the rated value. The series connection simplifies the wiring of this part of the circuit. Since the lamps are near the condensers and the rotors of the condensers are connected to A minus, one terminal of one lamp is simply connected to the nearest available grounded part of the condenser or other ground. The other terminal is then connected by a wiring running straight along the panel to one terminal of the other lamp. The remaining terminal of the second lamp is then connected to the positive side of the nearest tube filament.

In the Public Eye

JOHN W. VAN ALLEN, noted lawyer: "There is no law now existing making the granting of licenses under patents obligatory upon the patent holder as such holder has the exclusive right under present laws as the owner of the patent to manufacture and sell the instruments of the invention covered by the patent."

* * *

CAPT. WILLIAM SPARKS, president, Sparks-Withington Co., Inc.: "The greatest inventions of modern life are illumination, transportation, communication and wireless telephony, or, as commonly known, the radio. And the greatest of these is the most modern invention—the radio. And to no one has this meant so much as to the shut-ins, confined to their homes or in hospitals through illness, accident or operation. It was my duty a few days ago to stand beside the operating table and see a most necessary but decidedly ugly operation; and it was my pleasure a few hours later to have a radio installed at the side of this patient and watch the calming influence of sweet music as it aided in alleviating the suffering of my friend."

A Novice's Troubles

By Lester Chadwick

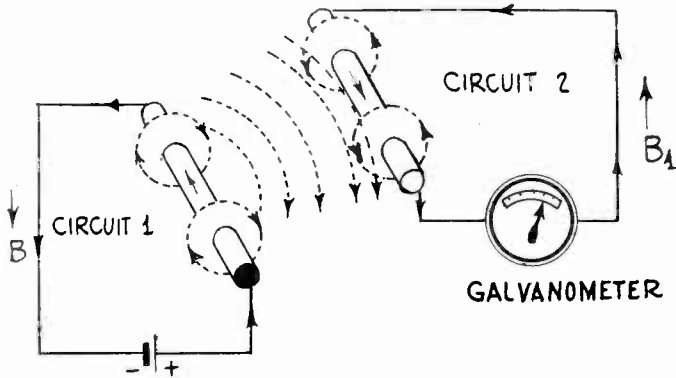

FIG. 1.

WHATEVER OCCURS IN CIRCUIT NO. 1 WILL APPEAR IN SIMILAR FORM IF NOT IN MAGNITUDE IN CIRCUIT

[Trouble-shooting articles are featured regularly. Last week AC receivers were given preliminary attention. The following installment carries his to be forward.—EDITOR.]

THE checking of a voltage divider continuity may not be absolutely essential but it certainly may avoid a lot of "grief" later on.

Most voltage dividers are wound with resistance wire in the form of a single-layer solenoid or coil. In such form they have an external magnetic field, with an area of possible troublesome coupling depending upon several factors.

The first factor of importance is the degree of filtration available with the parts on hand. If the power transformer has been properly located with due regard to the effect of its external field, and the filter chokes likewise properly located in this field, it will be realized that the position of the set wiring relative to the voltage divider or the location of the voltage divider relative to other inductance coils in the set is of some importance also.

Schematic Is Not Mechanical Layout

Some home constructors often fail to realize the inherent defects of the schematic diagram at this point. The schematic diagram of a set looks no more like the set itself than a schematic diagram of an armature looks like its counterpart in a motor. A voltage divider should be respected as such and not be placed in near inductive relationship to other component parts of the set, no matter what the schematic drawing shows! A voltage divider is primarily an agency of voltage and is to be kept to itself as much as possible.

Therefore locate the B eliminator parts as far away from the more sensitive portions of your set as you can.

Now I assume that some one will want to ask whether voltage dividers can be made up in the non-inductive way. The answer is yes, but it's too expensive to make them up like this on account of the resistance value you have to use within a given space and the problems of mechanical strength and heat dissipation. But I do not wish to infer that the solution of the problem is impossible.

The subject of by pass condenser placement in the sensitive screen-grid set that a fan builds now comes in for its share of attention.

Again the schematic diagram shows one thing and means another, in general.

Effectuating By-Pass Condensers

The location of a by-pass condenser in a sketch often results in its actual placement in a physically equivalent place by constructors, and some interesting observations have been made of home-constructed sets sent to servicemen for inspection and repair.

Constructors should realize that if a certain condenser is going to act as a by-pass that it should be made to do this, and be located as close to the high potential of by-passing as possible.

Radio frequency coil leads that are to be by-passed should be so treated as soon as they emerge from the shields that cover them, or at least within a few inches of emergence, and also the coil leads that run to the condenser in question should be straight.

This above statement applies mainly to plate lead returns, control-grid returns and cathods returns. The general practice is to run all of the above leads which are to be at the same potential to a convenient common junction.

The various connecting leads that run underneath the sub-

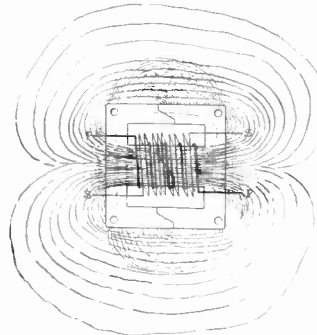

FIG. 2. EXTERNAL FIELD PATTERN OF E TYPE TRANSFORMER LAMINATION

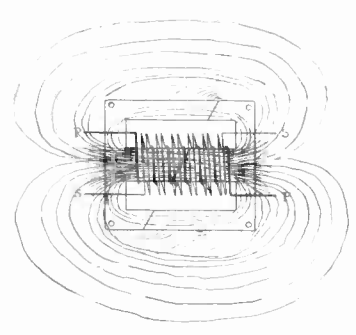

FIG. 3. EXTERNAL FIELD PATTERN OF F TYPE TRANSFORMER LAMINATION

panel of a set sometimes constitute short aerials and their action may lead the constructor to believe that the set is broad. Complete and appropriate by-passing often will remove trouble of this kind. Yet the first thing the constructor thinks of is coils. If the set is broad sure it's the coils. Well, don't be so sure.

Do set constructors realize their own responsibility in this case?

Three Considerations

The assembly considerations of a radio receiver can be divided into three general parts, each of which is as important as the other, in the following order:

- The most feasible electrical arrangement.
- The mechanical layout.
- Best all-around appearance.

Home constructors seem to have a tendency to want to dodge all three of these really important pre-requisites and then claim to be good set builders—I say that it is not done, and hence the source of contributory "grief" in the case of the poorly working set.

Fig. 1 shows circuit, elementary in form, that is used in electrical primers to show the relationship between the direction of flow of inducing and induced currents in two electrical circuits associated inductively but not otherwise connected.

A mere glance shows that the increasing current in Circuit No. 1 produces a deflection of the instrument included in Circuit No. 2. I imagine a radio tube in place of the galvanometer and also imagine a live voltage divider in place of the heavy conductor of Circuit No. 1. Here you have exactly the condition that applies to AC set wiring jobs.

Outlets for Shield

A lot has been written about shielding effects, but little attention has been paid to the evil of grounding some coil leads with in the shield and bringing others out.

This is bad because it creates an unbalance of capacitive relationship to ground that makes it difficult to obtain a degree of similar resonant adjustment when you try to line up your set.

I have stripped radio frequency coils from twenty receivers to date, that disgruntled customers said wouldn't work and found that they had failed to remove the enamel insulation from the ends of the coil lead wires. I'll bet a dollar they never tested the completed job for continuity.

One man said his set would not work and I requested its delivery complete with tubes, and found a 280 rectifier that was shorted, plate to filament, due to mechanical shock. I straightened that trouble out in five seconds.

Another fruitful source of shorts is the fraying of stranded conductor wire. The best way to avoid this difficulty is to twist the leads of stranded conductor and tin them well before soldering the wire to its intended terminal.

Amateur's Handbook

The Radio Amateur's Handbook, by A. Frederick Collins, edited by Geo. C. Baxter Rowe. Sixth edition, revised. 394 pages, 16 illustrations, and 100 figures. 4 1/4 x 7 3/4. (2.00.)

This standard book on radio appeared among the first, and and has been continuously reprinted and revised. New chapters include, among others, the Hammarlund Hi-Q 30 broadcast receiver; 245 Push-Pull Radio and Phonograph Amplifier; Further Developments in Vacuum Tubes; A Low-Power Telegraph Transmitter; A Combination 10-Watt Telegraph and Telephone Transmitter; The Construction and Use of Wave-meters; Radiovision—the Amateur's Next Job; and Radio in Other Fields.

Approach to

By John C.

NEEDLE DEFLECTS → THIS WAY IN ALL CASES

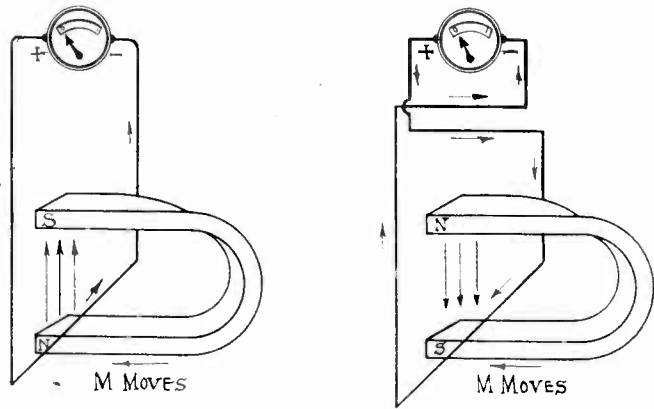

FIG. 1.

THE THREE CONDITIONS NECESSARY TO GENERATE AN ELECTRIC CURRENT

FIG. 2.

HOW CONDUCTORS AND FLUX DIRECTION MAY BE ALTERED WITHOUT AFFECTING FINAL RESULT

[This is another in the series of articles on experiments for novices. The experimental work is intended to lay the foundation for electrical principles as employed in radio.—EDITOR.]

WHEN you hold a straight wire over a compass needle that is pointing north and south and obtain a deflection when a current of electricity flows through the wire, you virtually stand at a typical crossroad of electro-magnetic experimental research. From here you ventured along one branch a short distance.

The relation between the direction of flow of an electric current, and the observed resultant magnetic fields directive action as revealed by the compass needle's behavior, is surely food for thought, because if a current of electricity in flowing through a wire is capable of setting up a field of magnetic influence, it is only reasonable to assume that there is a possibility of an electric current being set up in a wire when a magnetic field moves across it.

Fig. 1 shows the essential electrical and magnetic conditions necessary to produce the effect above spoken of.

Motion May Be Either Way

If you study Fig. 1 it will be apparent that the downward direction of the permanent magnet's flux while acting in the right way to set up a current in the fixed conductors need not after all be acting "downward." It could be acting upward. The only difference is that the direction of flow of the current set up in the fixed conductors would be reversed.

But even so the essential arrangement hasn't been changed any, because it is most necessary that the imaginary flux axis be made to move toward the fixed conductors' axes, in such way that the two axes are always mutually at right angles.

It is not always practical or desirable to move a source of magnetic flux to or away from a fixed conductor, hence other means must be devised to make commercial application of this phenomenon practical from an economic view point.

But before proceeding suppose you try this simple experiment. You will require a permanent magnet, a piece of insulated copper wire and a milliammeter of good sensitivity, i.e., low range, say 0 to 1 milliamper. Merely connect the two ends of the wire (after removing sufficient insulation) and to the + and - posts of the milliammeter, and make the magnet flux cut across the conductor as per Fig. 2.

Can Determine Current's Direction

From this it will be seen that if due regard is paid to the respective motions of conductors and inducing field there need be no difficulty in determining the direction of flow of an induced current.

Therefore if we know that an induced current flows along a wire away from us the magnet that produced that current was moving toward the wire and the North pole was uppermost.

Many electrical devices operate by virtue of this fact, even radio tubes.

Let us suppose that we wish to increase the observed effect of Figs. 1 and 2, particularly Fig. 2. We have three courses

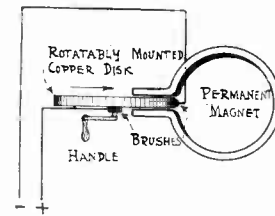

FIG. 3.

FARADAY'S DISC DYNAMO, DEVICE THE NOVICE CAN CONSTRUCT EASILY AT LOW COST

open. One is to increase the actual number of lines of magnetic force, the other is to increase the speed of motion toward the induced conductor, and the third is to increase the amount of induced conductor that is "swept" over by the inducing flux. Thus we have all the means presented by which we may magnify the observed phenomena.

In practice large generators and motors have values of inducing flux which when translated into generally understood units aggregate in the case of large station generators many hundreds of kilowatts. But the basic operating principle is none other than that set forth in Fig. 2.

Some one will ask: "Can electric currents be produced in copper wires only?"

The answer is, "No." The early experimenters found that electric currents could be produced in circular or square or in fact any shape of metal disk, copper or otherwise, provided the disk was rotated between the poles of a strong magnet. Michael Faraday discovered this fact and was able to produce measurable currents. The device was named the Faraday disc dynamo.

Construction of Disc Dynamo

The action of this device is one that the novice can easily study. The construction of such a device for demonstration purposes is simple.

Fig. 3 shows the construction. The rotatably mounted disc may be copper, aluminum, zinc or brass, and the magnet should be a good one. The air-gap in which the disc is mounted should be only very slightly wider than the thickness of the disc. The drawing shows collector brushes H and H'. The device will not generate an appreciable current unless the brushes are located at the positions shown.

In operation, this device is somewhat similar to a case where the armature conductors are composed of coils of one straight turn each, the current being generated in that portion of the disk that passes between the magnet poles only.

This device will also operate as a motor (at a very small fraction of a horsepower output), provided a sufficiently large current be passed through it. The principle set forth in Fig. 2 applies here also.

Now, if we retrace our steps once again to the mythical crossroad we in the light of past experience we may travel along the pathway leading to the simple explanation of induction.

Inductance Present Despite Shape

We know that a wire whether straight or coiled, or whatever its shape or path may be, will manifest an external magnetic field when it is carrying an electric current. If we arrange a parallel circuit we will find that when the circuit conditions are correct a current will exist in the parallel conductor B.

Fig. 4 shows the new conditions that we are to study. The circuit at the left consists of a straight wire, a battery, resistance (heavy-duty construction) and necessary connecting wires. The circuit at the right is straight wire also (but for purely explanatory purposes I have divided it into two parts). There is a galvanometer, or current indicating device, which in this instance is none other than our 0-1 milliammeter, and it serves its designated purpose in these cases very well.

What the Circuit Shows

The conditions, then, as depicted, show a circuit combination by means of which we are to examine the effects produced by a neighboring circuit.

A magnetic field is capable of producing changes, or observable changes at any rate, only when the current that originally produces it is varying in value, thus imparting a degree of motion to the magnetic field either to the left or right relative to the adjacent conductor. This motion depends upon whether

Resolved, That Tone Controls Are Necessary

AFFIRMATIVE

By C. J. M. Beals

TONE controls are featured in the receivers for the 1930-1931 season. The object of these controls is to allow the radio listeners to choose their own tone quality. If they want bass in abundance, they can have it by turning a knob. If they want treble aplenty, they can have that, too, by turning the same knob. And if they want a well balanced reproduction they can have that by setting the same knob at the proper point.

Many people object to a tone control of this kind. They say that most people don't know the difference between bass and treble when it concerns a radio receiver, and they never know the difference between realistic reproduction and production characterized by over emphasis on certain tone regions. Engineers, on the other hand, can build receivers so that the reproduction is as near natural as it is possible to make it, and this they can do whether or not they themselves can tell the good from the bad by ear test, for they do it by impartial instruments.

This may be all true, but any radio listener knows what he likes and what he does not like. If he likes nothing but the saxophone in a jazz selection who has the right to tell him that he can't have it alone to the exclusion of the other instruments on the ground that the reproduction is not natural. And if some one else likes nothing but the piccolo, why should he not be permitted to listen to that alone, even if the complete musical composition calls for the tuba as well?

Plain Speaking

It is well known that when the high notes are present in prominence and the low notes are suppressed to some extent, the speaking voice is much more easily understood than when the reproduction is all bass and no treble. Many people would rather listen to speech than to music. Why should they be forced to guess at half of what is being said just because a little more bass would make the signals a little more natural? People don't have radio sets just because the reproduction is ments on the ground that the reproduction is not natural? And nobody yet enjoyed listening to a story, whether in monolog or dialog form, if he cannot understand the speakers. Many radio receivers, realistic though they may be dubbed, are so boomy and bassy that speech is well nigh unintelligible.

And such boom and bass would have to be tolerated if it were not for the tone control that is now incorporated in many of the latest receivers.

Just as a speech is more easily understood when the bass is not too strong and the high notes are not imaginary, so music of a certain type, particularly orchestral and organ music, is more enjoyable when the high tones are suppressed so as to minimize extraneous noise. If those who prefer the more enjoyable type of music in preference to the more nearly realistic, is there any reason why they should not have what they like to hear? There is none, for when there is a tone control in each set any one can have the particular tone he wants without in any way interfering with the music the other fellow gets. Each one can turn his own tone control knob until he gets what he wants to hear, and it is nobody's business whether he uses good taste or not.

Consideration for Neighbors

The opponents of tone controls might raise the objection that the neighbors would probably be annoyed by the tone of the set emanating from adjoining apartments. Perhaps they would not appreciate the particular kind of quality that was "toned out" of the receiver. They would not like it anyway, so what difference does a little selection in tone make. Anyway, a neighbor is never considered when it comes to keeping boisterous radio sets going at all hours of the day and night, so why should he be brought into an argument on tone control. Let the neighbor create his own racket to the best of his enjoyment. He does, so why worry about him.

One point in favor of tone controls is that the quality from different stations is different. This difference may be due entirely to the fact that a receiver responds differently to different carrier frequencies. For example, the high notes may be much stronger relatively on a high carrier frequency than the same tones are on a low carrier frequency. Again, the difference may be due to differences in the transmitting equipment, and these differences may be due to anything from the transmitting studio to the transmitting antenna. Some stations may be exceptionally boomy while other stations may be quite deficient on the low notes.

Now with a tone control on the receiver all these differences can be compensated for to suit the listener. If the signals are rich in bass and the listener does not like the proportion of bass and treble he can change it by turning a knob. If the signals are rich in the higher notes and deficient in bass and the listener likes his bass, he can accentuate it by a twist of his tone control dial.

Tone Change With Distance

When the receiver is so sensitive that it will bring in distant stations regularly with satisfactory volume, it is usually also very selective. The sensitivity accentuates volume, it is usually also very selective. The selectivity accentuates the low notes and signals from distant stations are likely to be strong in bass. Indeed, the signals are usually so boomy in such cases that nobody likes them. A tone control on the receiver enables the listener to cut out some of the boominess and make the signals pleasant to listen to.

Still another case in which a tone control is desirable is in a regeneration circuit where feed back is relied on to make the set sensitive and selective. In all such circuits the bass is brought out very strongly when distant stations are nursed in. A tone control in the audio amplifier or in the speaker can be used to suppress the low tones and give the high frequencies a chance to become effective. A regenerative circuit will build up the high frequencies, too, but not so much as the low, that is, those lying very close to the carrier. So if the tone control is used to cut down a bit on the low tones there will be an overall gain due to the regeneration and there will not be the preponderance of bass.

While it is rarely necessary to use the tone control to cut out extraneous high frequency noises brought in with the signals from distant stations, due to the fact that the high selectivity cuts down on the noise, the tone control is there if it ever should become necessary. Static noises, for example, are mostly carried on high frequencies, and at times it is possible to render the signals intelligible by reducing some of the noise, even if this results in greater boominess of the signals. In this connection it is well to remember that it is possible to receive understandable speech by means of the zero beat method. When this method is used regeneration is carried to farthest possible point.

Use of Tone Control Optional

If there are certain disadvantages associated with a tone control it should be remembered that its use is not compulsory. Its use is entirely optional. Since it can be set so that the high frequencies or the low frequencies are emphasized it can also be set so that neither the highs nor the lows are emphasized. That is, it may be set so that the reception is normal. Therefore the presence of a tone control in a set is really not disadvantageous. But if it is in the set it is ready for use one way or the other when conditions arise that makes it advantageous. It gives the listener an opportunity to choose what he likes.

KDKA Transmits to Bartlett Party

At 11 p. m., Eastern Daylight Time, each Saturday night, KDKA, Pittsburgh, Pa., sends out messages to the captain and crew of the schooner Morrisey. The regular broadcast wave is used, 309 meters, as well as two short waves, 25 and 48 meters, as this combination is expected to reach the ship under any and all conditions.

The Morrisey is under command of Capt. Bob Bartlett and is on its way to Northeast Greenland for exploration purposes. Those desiring to send messages to the captain or his men must be relatives or friends of those addressed. The communications should be sent to Capt. George Wendt, Canadian Westinghouse Co., Ltd., Montreal, P. Q., Canada. No charge is made for any part of the work.

The ship's call letters are VOQH. Edward Manley is the ship's radio operator. There are a set and loudspeakers aboard, so all will hear the messages simultaneously.

ASKS FOR CHIEF OF BROADCASTS

Washington. No radical alteration of the present alignment of broadcasting stations is intended, said Chairman Charles McK. Saltzman of the Federal Radio Commission, favoring the appointment of a director of broadcasting. His statement follows:

"We are not on the verge of adopting rules that would upset the present allocation of wavelengths. There will be no upheaval.

"As a remedy for the evils of the zone system whereby the country is divided into five radio territories, I suggest the appointment of a director of broadcasting. His duty would be to receive all applications pertaining to broadcasting stations and, with the engineering staff, study the national problems and submit recommendations to the commission, which would act as a jury and render decisions. From the standpoint of the individual listener it is difficult to solve."

NEGATIVE

By Roger M. Morehouse

TONE controls are to be featured in the sets of 1931. What possible advantages could be derived from such devices in a radio receiver? Are they a confession on the part of radio manufacturers that they cannot tell what quality is realistic, or are they merely a different kind of appeal to the radio listeners? So many different appeals have been resorted to by the manufacturers in the past that it is now difficult to find one that will make the radio listeners think they have obsolete receivers. This year tone controls were hit upon as the big selling point. Any receiver during 1931 that does not have a tone control is out of date. Possibly a few will take this suggestion seriously.

In the past various vogues have come and gone. For a while, one season, high notes were in style. If the receiver could not bring out the hissing consonants so that every type of signal from the boom of the tuba to the high squeak of a little girl sounded like escaping steam.

Another season low notes were in vogue. Every receiving set had to boom if its quality were to be really realistic. It mattered not a particle whether anything above middle C came through or not. And many a radio listener proudly bade you listen to "those low notes." "Did you ever hear such realistic quality before?" The fact that one always failed to understand the announcer because of the total absence of consonants in his speech did not lower the valuation of "that realistic quality."

Then there was a season when furniture was the criterion for a good radio receiver. We heard "solid mahogany," "burled walnut," "quartered oak," but very little about quality of tone. When a prospective buyer inquired about the quality of the receiver he was reminded of the high polish on the cabinet, when he inquired about the selectivity he was told that the cabinet was made out of specially selected wood, when he inquired about the sensitivity his attention was called to the harmoniousness of the cabinet with this or that style of furniture.

The furniture era is still with us, but it is no longer the "big selling point."

We have had automatic volume controls, remote controls, power detections, screen grid tubes and a host of other appeals, each one being indispensable to realistic reproduction. There have been so many devices introduced to recreate the original signals that now there remains nothing but letting the listener select his own. That ought to be the last word, but it will not. Some excuse must be found next season for rendering the receivers of this season obsolete in the eyes of the gullible.

There ought not to be any valid excuse for introducing tone controls, since engineers can tell when the reproduction is realistic. They can tell it even if they themselves have no conception of the difference between good and bad. They have

Gets 10,000 Miles, Using 15 Grounds

Newport, R. I. Twelve grounds were used by W. R. Pierce, Jr., of Saunterstown, about twelve miles from here, to get stations all over the world on a simple broadcast receiver, but he has added three more grounds and stopped. More than fifteen grounds don't help him any, but the extra three did make an improvement, he reports.

He does not like to talk about the type of receiver used, as that, he says, confuses the issue. His own receiver, used elsewhere, works in average manner. But he does stress the fact that the extra grounds, properly placed, do the trick. He has gotten speaker volume on broadcast waves (not short waves) from stations 10,000 miles away.

Pierce is the lad who aroused the interest of the Department of Education in his great DX record. The Department of Interior sent a representative to interview him.

instruments with which they can measure the realism, or the approach to realism, and these instruments are impartial.

Realism Approached

The engineers can not only tell when the quality is good or bad, but they have now the means of approaching true realism as closely as they wish. The degree of approach is largely a matter of cost. A cheap receiver cannot approach realism as closely as an expensive receiver. A tone control attached to any receiver will not compensate for any defects. If compensation is necessary that should be made in the factory by the introduction of a suitable device.

No listener can tell when the quality is realistic as well as impartial instruments. So-called experts cannot tell much better than those who have no special training, and that applies to musicians. The only good that a tone control can do is to furnish the radio listener with a plaything with which he can note the effect on the tone by turning a knob. It may give him a chance to exercise his ego, give him an opportunity to demonstrate to his family and friends that he can set the tone control so that really fine quality results. If other listeners to that receiver don't like the combination of tones, it is just because they don't appreciate what is good, that is all.

One serious objection to the tone controls is that they are likely to cause bad listening habits. Suppose, for example, that the manipulator does not like the quality from a certain station when the control is in "neutral," and that he prefers to have more bass. Momentarily he may like the lower tone, yet realize that it is not natural. He listens to it for a while and in a short time it sounds quite natural. He may then decide to have more bass, so he turns the control a little more. Soon he will regard the new quality as natural. This he may continue until the tone has been made as boomy as the tone control permits. The tone now may be all bass, yet he likes it and thinks it natural.

Others who by necessity or out of courtesy are forced to listen to that receiver may not like it at all. Indeed, chances are that they would probably prefer to shut the receiver off. But they continue to suffer while the person with the distorted tone sense exercises his ego.

The vicious habit may go in the other direction also. The manipulator of the tone control knob may decide that clearer enunciation is the true goal to realism. So he turns the control to get rid of the bass and brings out the higher frequencies. He continues this course until the control is as far toward the higher frequency as possible, and then, he thinks, he has the highest attainable realism.

Tin Horn Music

Again, those around him who must listen to the set suffer. They know well that what comes out of the radio receiver differs in no respect from the tin horn music that used to emanate from the old type phonographs. It will be recalled that even these sounded natural until radio receivers came out and "showed them up." It was not until radio receivers came into general use that phonographs were improved to the point where they were comparable in quality to radio receivers. Improvements in radio receivers came as a matter of necessity. Competition led to the betterment of the quality of both radio and phonograph. Shall we spoil the results by putting in a tone control into every receiver so that anybody can select just as bad quality as is possible by the limitations of the tone control?

The argument that it is nobody's business just how bad quality a man selects for himself holds so long as only that man is affected. But how many radio receivers are operated for a single person. Very few, indeed. Perhaps the average number of listeners to each set is four. Only one out of these will determine the tone. The other four will suffer the results, and suffer they are certain to do, for it is not likely that four persons will enjoy the same kind of distortion.

Of course two out of the four will be children, some very small. They don't count, for they would not know the difference. What dad selects for them is good enough. But if they heard good stuff even when they are very small they would grow up with an appreciation for the good. And many of them have already grown up to the point where they are more able than dad to tell what is good and what is not. If they are old enough they will have no need for a tone control, and they may have a great deal to say about where it should be set if the receiver is provided with one. The tone control is a potential source of family dissension in such cases.

Perhaps we need not worry about the tone controls. The general trend in receiver design is simplification. A tone control just adds one more useless appendage, adding to the cost of the receiver without making any compensation. It will therefore go the way of all other frills. In a few years people will look at the odd receivers of 1931 as we do today at the receivers of 1922. Just think, back in 1931 they thought tone controls necessary!

A Question and Answer Department conducted by Radio World's Technical Staff. Only Questions sent in by University Club Members are answered. Those not answered in these columns are answered by mail.

RADIO UNIVERSITY

Annual subscriptions are accepted at \$6 for 52 numbers, with the privilege of obtaining answers to radio questions for the period of the subscription, but not if any other premium is obtained with the subscription.

I HAVE a short-wave receiver which is supposed to be sensitive enough to bring in foreign stations, but so far I have only received a few American stations. I have come to the conclusion that I am not tuning it correctly. Can you suggest methods for bringing in the foreign and distant American stations?—T. A. B.

The first thing you should do is to get a list of foreign and American stations, a list that not only gives the location and name of every station but also the wave on which each is operating and the time it is operating. You can get such a list free by enclosing with your request to Guaranty Radio Goods Co., 143 West 45th Street, N. Y. City, a personally addressed, stamped envelope. Naturally, it is useless to tune for a foreign station when that station is not operating. You must remember the difference in time. Having obtained this information, tune in some of the stronger American stations and then look in the list for foreign stations operating on a wave very close to the American stations. Explore the dials very carefully on either side of the American station. But don't go to this trouble unless you have ascertained that the station you want is on the air at the time. Advance the regeneration control, if you have such a control, until the circuit oscillates. This will enable you to hear the heterodyne of the distant station even if you cannot bring in the signals clearly.

WILL you kindly explain why it is that every station comes in at more than one point on the oscillator dial of a Superheterodyne? I have observed that some stations come in at as many as four points, but usually not at more than two points. Is there any simple explanation?—J. J. O'B.

It is relatively simple to explain why every station comes at two different points. When the oscillator is set so that its frequency differs by an amount equal to the intermediate frequency from the signal frequency, the signal comes through. Obviously, the oscillator can be set so that its frequency is either less or greater than the signal frequency by the required amount. Hence we have two normal points at which the signal should come in. When the signal comes in at more than two points we have to look to the harmonics. When there is considerable amplification ahead of the oscillator and also considerable distortion in the tubes ahead the second harmonic of the signal frequency will be strong. This harmonic is just like any other signal and it can be received by setting the oscillator at either of the two points as described above for the fundamental. This accounts for four points. Another possibility is that the harmonic of the oscillator beats with the fundamental of the signal. Again we have two points at which the signal may come in. Thus we have accounted for six points. We could go on in this way and show that the signal may come in at very many points, since there is no limit to the number of harmonics, either of the signal frequency or of the oscillator frequency. Fortunately the higher harmonics are very weak so that we cannot hear the signal at all of them. Moreover, the oscillator dial does not cover a wave band wide enough to bring in the signal at all the theoretically possible points.

CAN YOU EXPLAIN a simple method of studying induced currents by means of permanent magnets and electromagnets?—A. I.

You need a galvanometer or a sensitive milliammeter. A DC instrument is best because this not only shows the magnitude of the effect but also the direction, whereas an AC instrument shows the magnitude only. Get a coil of wire. It need not be more than a few turns, but the more turns the greater the effect. Connect this coil in series with the meter. Thrust one pole of the magnet into the coil quickly. The needle jumps in one direction and comes back to rest. Jerk the magnet out quickly. The needle jumps in the opposite direction, and then comes back to rest. The same with an electromagnet or simply with a second coil carrying current. If you do not have a suitable meter, such as a 0-1 milliammeter, use a small compass. You can get it for a dime.

HOW IS IT that the current in an antenna is said to be alternating when the antenna is grounded? How can any current flow in the antenna when the antenna is open at the far end?—H. E. F.

The first question may be answered with an analogy. Let us consider the case of tides in a narrow bay at the mouth of a river. Let the river represent the antenna and the ocean the ground. How is it that the water near a point of the mouth of the river can flow in either direction, that is, why does the water flow alternately? Water can flow both from the ocean and toward it under the influence of the tides. Or we might make the analogy still closer. Suppose we dip a long vertical

pipe into the ocean and put in a pump somewhere in the pipe. As the piston moves up and down the flow of the water at the point where the pipe enters the water flows alternately out of and into the ocean. The signal wave striking the antenna is the pump, the wire the pipe, and the ground the ocean. To answer the second question we have to resort to another analogy, so as to take into account the "compressibility" of the electric charge. Let us substitute an ocean of air, retaining the pipe and the pump, but closing the upper end of the pipe. For every downward stroke of the pump air will be forced out at the free end and for every upward stroke air will be forced into the pipe. At the open end the air current will be alternating, yet there will be no flow through the closed end of the pipe. The antenna has electric capacity just as the pipe has air capacity, and both the electric charge and the air are compressible.

IF THE earth has a magnetic field and a coil of wire is spun around rapidly, should there not be induced an alternating current in the coil? If this be true, how would you suggest measuring the current?—W. J. C.

It is certainly true. The earth inductor compass used in aviation is based on this fact. Likewise the strength of the earth's magnetic field is measured by the current induced in a coil that spins in the field, or by the quantity of electricity that is generated while the coil turns quickly through an angle of 180 degrees. To measure the steady alternating current generated when a coil spins in the earth's field, connect a sensitive AC instrument in series with the coil and set the coil rotating. You need no commutator but you do need slip rings unless you want to spin the meter too, which is not feasible.

PLEASE GIVE an easy and simple way of matching tubes. I am not getting the results from my Superheterodyne that I think I should and I believe that it is because my tubes are not matched.—E. W. J.

There is neither a simple nor an easy way of matching tubes because tubes have many characteristics. But if you are not getting the results you expect from your super it is not likely that unmatched tubes are at fault. A tube may be dead or nearly exhausted and thus cause insensitivity, but slight differences among tubes are of little importance. Check over the tubes with a tube tester or measure the mutual conductance to learn the condition of them.

WHAT IS THE trouble with my receiver when I am unable to tune to a higher wave length than 400 meters? My coils are supposed to have been wound for the size condensers I use, namely, .0005 mid.—W. W. K.

When the tuners will not cover the proper band of wavelengths the first thing to do is to look to the coils and condensers. The condensers may have a certain rating but there is little assurance that the actual capacity is equal to the rated capacity. Then, again, the coils may not be large enough even though they are supposed to have been wound for a given size condenser, but there is no assurance that they actually have been. There are many chances of error. When a given tuner will not tune to a higher wavelength than 400 meters the trouble is either that the condensers are too small or that the coils are too small, or it may be that both are too small. In cases of this kind it is easier to rewind the coils than to substitute new condensers. It is a very simple matter to add more turns to any coil until it will tune up to 550 meters, or to whatever wavelength is desired.

There is another reason why a tuner may not cover the band, and that is too much shielding around the coils. Shielding reduces the effective inductance. If this difficulty is suspected remove the shielding and note whether or not the circuit tunes to a higher wavelength. If it does, the shielding causes a reduction in the effective inductance of the coil.

IS THERE ANY METHOD of removing the distortion that is introduced by one tube, that is, the distortion due to the curvature of the grid voltage, plate current characteristic? I know that part of this distortion is eliminated by the push-pull arrangement of tubes, but I have heard that this is only the distortion arising in the two tubes in push-pull. What I am looking for is a method that will remove the distortion arising in a single tube.—L. W. J.

It is usually said that there is no method except using push-pull in all stages. However, in view of the fact that each tube reverses the phase of the signal, the distortion introduced by one tube is partly removed by the opposite phased distortion in the next stage. This partial correction of the distortion always occurs in directly coupled circuits, such as resistance and impedance. It is also true in transformer coupled circuits

Inductance

Williams

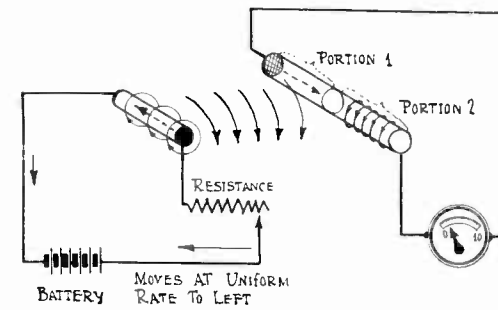

FIG. 4. CIRCUIT ARRANGEMENTS NECESSARY TO STUDY PARALLEL EFFECTS

the current in conductor C is increasing or decreasing.

But for the time being consider the effects produced in conductor E and meter M when the current flow in C is increasing at a uniform rate, this being effected when the movable contact of resistor R is moved to the left.

The arm is now moved to the left at a uniform rate and simultaneously we observe meter M. The needle is seen to deflect to a steady value and upon the conclusion of the travel of the movable contact of resistor R, the deflection of meter M is zero.

This shows that the right hand circuit obeys all the laws that govern operating conditions for circuits of this kind. It likewise obtains that if we now start out with the movable contact

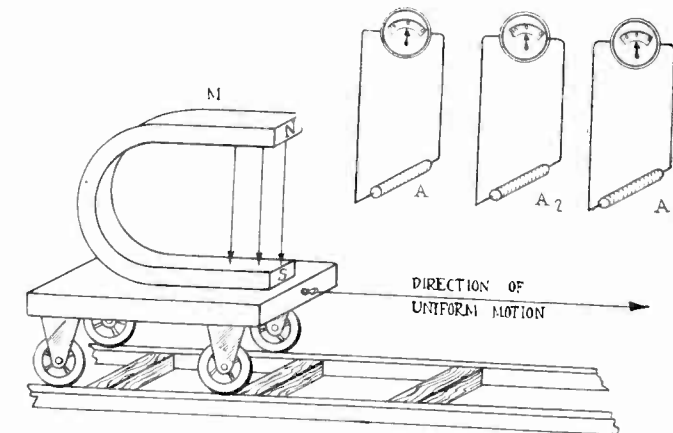

THE MAGNET M HAS TWO POLES, NORTH (N) AND SOUTH (S). THE CURRENT FLOWS IN ONE UNIFORM DIRECTION IN A LOAD CIRCUIT AS IN FIG. 1 OR 2

of resistor R at the extreme left (having previously reversed the connections to the milliammeter) and move the contact R to the right we will again obtain a deflection of meter M. Thus our system works both ways, provided proper precautions are taken.

We have therefore shown that magnetic fields act radially from or toward the conductor from whence they originate.

U. S. Firm Gets Greek Monopoly

Washington. A concession for the erection, equipment and operation of all radio broadcasting stations in Greece for a period of 20 years has just been granted to an American organization with principal offices in Philadelphia, according to advices reaching the electrical equipment division, Department of Commerce.

According to the information reaching the Department of Commerce, this station will be one of the most modern in Europe and the Near East. It will be operated on 25,000 watts power and engineers expect that the programs will regularly reach every principal city of Greece and under favorable conditions will be heard throughout Europe.

The expense of operating the broadcasting system will be defrayed by an annual subscription tax levied on receiving sets which will vary according to whether the set be operated in a private dwelling, a store, or place of amusement.

It is planned to operate the station with an entire American personnel for a period of two years, after which time it is believed that the station can be turned over to a native personnel under the supervision of American executives of the operating organization.

According to available records in the Department of Commerce, this is the first time that an American organization has been granted a concession to install and operate the entire radio broadcasting system of a foreign nation.

TALKIES TURN TO RADIO

The Fox Film Corporation has applied for a license to use radio transmission and reception in connection with directing the making of talkies.

STOVE REDUCES VOLUME

In summer resorts where AC is used the regulation is usually so poor that lighting an electric stove of 550 to 660 watts reduces the volume of the receiver 25 per cent.

Wave Checked By Beat Note

By R. C. HITCHCOCK
Research Department, Westinghouse Co.

When two mandolin strings are only slightly out of tune alternate loud and soft tones, sometimes called "waxing and waning" tones, are heard. These alternate loud and soft sensations are called beats, and are due to the difference in the frequencies of the two strings. If one is tuned to the A above middle C it vibrates 435 times a second. If the second string is slightly sharp, and vibrates, say, 437 times a second, the waxing and waning occurs at the difference frequency, 437 minus 435, or twice a second, a beat frequency of two per second.

Audible beats are used to good advantage in measuring two radio frequencies which are close together. To measure KDKA at its assigned 980 kc., a radio frequency oscillator of 982 kc. gives an audible beat of 2 kc., approximately the pitch of the third B above middle C. By measuring the whistle or beat between KDKA and three standard oscillators compared with the standards of the United States Bureau of Standards, KDKA's frequency can be accurately determined.

Measurements of KDKA's frequency over three years show an average daily deviation of only plus or minus 51 parts in a million. The Federal Radio Commission limit is plus or minus 500 cycles at a million, so that the KDKA variation is ten times better than the requirement.

NEW DRAKE'S ENCYCLOPEDIA
1,680 Alphabetical Headings from A-battery to Zero Beat; 1,025 Illustrations. 920 Pages, 240 Combinations for Receiver Layouts. Price, \$6.00. Radio World, 145 W. 45th St., N. Y. C.

"MATHEMATICS OF RADIO."—A great help to everybody interested in radio. \$2 postpaid. Radio World, 145 W. 45th St., N. Y. City.

Auto Radio Ban Is Easing Up

Hartford, Conn. Commissioner Robbins B. Stoeckel of the State motor vehicle department has announced that regulation instead of prohibition of radio receivers in automobiles will be the policy of the department.

Reception of programs during stops for the night or while parking for meals was cited by the commissioner as a use against which there need be no legislation, while listening to a radio when driving in congested districts was held to be a proper matter for regulation.

Boston, Mass. The Commissioner of Highways of the State of Massachusetts has postponed indefinitely the proposal to prohibit the use of radio receivers in automobiles operated on the public highway.

He first announced his intention to withhold licenses to all automobiles in which radio receivers had been installed. Later it was found that only 5 per cent. of the automobiles had radios and that therefore there was very little danger even if radios in automobiles increased the danger of operating cars, which was denied in testimony before him.

It is now believed by many that the proposal has been sidetracked indefinitely.

FORUM

Your magazine, though small, is interesting. I like to read the technical articles but do miss the news if you omit it, which you should never do. It is gratifying to see you print more and more news. No other national publication so promptly can supply the news of radio to its readers in authentic and well-edited form, so I beseech you to keep up the good work.

When you get around to it, publish the full constructional data on the Six Circuit Tuner, the description of which you interrupted because of delay in obtaining the subpanel. Also come back with that smoking stand. ARTHUR BRANDON.

provided that the leads of the transformers are connected so that the transformer does not reverse the phase. If the transformer is coupled so as to reverse the phase, as is done in most instances, the distortion is cumulative. The thing to do is to use push-pull in every stage of the audio amplifier, or to precede the push-pull output stage by two single-sided amplifiers phased so that the distortion in one is partly bucked out by that in the following. In this the detector should be regarded as the first audio tube. Thus the amplifier would consist of a detector, one single-sided amplifier, and one stage of push-pull. Possibly better results will be obtained by using a weak signal detector and two stages of push-pull. A weak signal detector is simply one, either grid leak, grid resistance or grid bias in which the impressed signal is very small. That is the usual type of detector.

* * *

IF A TRANSFORMER has been wound for 60 cycles and 110 volts, can it also be used on 25 cycles and 110 volts? If not, why not?—J. J. F.

A transformer wound for 60 cycles cannot be used for 25 cycles with safety, first because the primary current will be too high and is likely to cause dangerous heating, and second, because the secondary voltage will not be as high as it should be. The heating effect is the greater of these two disadvantages. The 25-cycle transformer requires more turns on the primary and a heavier core. A transformer wound for a lower frequency can be used on a higher frequency and will make a better transformer on the higher frequency than one that has been wound for the higher frequency in the beginning. Practical considerations of design enter into the choice of core and winding.

* * *

WILL YOU KINDLY recommend a book containing the principles of radio and the methods of calculating inductances of coils and capacities of condensers?—A. F. A.

One of the best books, perhaps, is Circular 74 of the Bureau of Standards. You can get it by sending 60c to the Superintendent of Documents, Government Printing Office, Washington, D. C.

* * *

IS IT NECESSARY to use a microphone when rebroadcasting the signals from another radio station or when broadcasting phonograph music? If so, please name the best microphone for the purpose?—S. G. C.

It is not necessary to use a microphone either when rebroadcasting the signals of another station or when broadcasting phonograph music. But it is necessary to have a transmitting license and also to have the permission from the originating station. To rebroadcast signals from any station without permission is against the law and violation of this law has lead several into serious difficulties with the Federal Government. If you have complied with all the legal requirements for rebroadcasting you can simply couple the output transformer of your radio receiver to the modulator tube in your transmitter and adjust the output to the proper level. Likewise you can broadcast phonograph music by connecting the pick-up to the modulator tube.

Right or Wrong?

QUESTIONS

(1)—Tuned radio frequency amplifiers cannot be used for short waves because it is impossible to stabilize the circuit.

(2)—The impedance of a circuit depends on the frequency only, regardless of the shape of the wave. That is to say, it is the same for a sinusoidal wave of frequency as it is for a square-pulse wave of the same frequency.

(3)—Are plate circuit and mutual characteristics of the newly announced tubes, 230, 231 and 232, entirely different from the corresponding characteristics of the older tubes?

ANSWERS

(1)—Wrong. While it is more difficult to stabilize tuned radio frequency amplifiers at short waves than at broadcast waves it is not at all impossible. It is only a few years ago that it was said that it was impossible to stabilize broadcast receivers. Now this is everyday practice and so will it be in the near future for short-wave receivers. Indeed, even now there are such receivers ready to be marketed, and it will not be long before they will be announced.

(2)—Wrong. The impedance depends on the wave shape, for if the wave shape is not purely sinusoidal there are other frequencies present and they have an effect on the impedance. A wave of square pulses is made up of the fundamental frequency with its harmonics. The impedance of the circuit is different for every harmonic frequency, for an inductive circuit being greater the higher the order of the harmonic. It is for this reason that a square-topped wave, after passing through a coil, is no longer square topped. The higher harmonics have been suppressed more than the fundamental, or more than the harmonics of lower order.

(3)—Wrong. The characteristics of the new tubes are very nearly the same as those of the battery-operated type designed for the same type of service. The main differences between the tubes are the filament voltage and current, both small.

A Noise Trouble Chart

By James A. Dowie

National Radio Institute

Among the chief causes of radio interference may be classified:

- (A) Interfering noises picked up by aerial system.
- (B) Interfering noises picked up from power or telephone circuits from outside.
- (C) Interfering noise picked up from electrical apparatus within the building where receiving set is installed.
- (D) Interfering noise within set due to defective apparatus.

Recognizing the Kind of Interference

The best test to determine whether interference comes in from outside of the building is to disconnect the aerial and ground from the receiving set when the noise is noticed. If the noise disappears, then it is undoubtedly caused by something outside the set.

The following table will enable you to distinguish the various noises heard and approximately the devices which may be causing them.

A	Cause
Sounds Heard	
Musical long and short dots and dashes varying in pitch.	Radio Code Transmitter.
Steady Whistle.	Heterodyne between two transmitting stations operating on nearly the same frequency or wave-length.
Violent Squeals varying in pitch.	Oscillating receiver being operated nearby or continuous wave (CW) transmitting stations.
Loud Crackling Noise.	(1)—Line interference due to aerial system too close to or parallel with power lines. (2)—Static (Discharge of lightning during a storm).
B	
Clicking Noises (regular and rapid).	Electrical devices using a vibrator such as battery chargers, stock tickers, ignition systems.
Crackling Noises (irregular).	Arc lamps, telephone and telegraph lines, street cars, electric railroads, sign flashers and electrical units using heating coils.
Crackling Noises (regular).	Moving picture equipment and regular electric sign flashers.
C	
Crackling Sounds (more or less steady).	Loose connection in house lighting system, such as switches, fuses, lamp sockets, wall plugs, etc.
Buzzing Noise (regular).	Motors, vacuum cleaners, electric sewing machines, oil burners, electric ranges and washing machines.
Buzzing Noise (irregular).	Vibrating buzzers, door bells, telephone bells, etc.
D	
Howling Noise.	Too high plate voltage. Oscillating tube in set. Wrong size grid leak. Microphonic tube. Magnetic induction between transformers.
Scratchy Noise.	Defective or loose grid leak. Defective tube. Defective condenser.
Rattling Noise.	Defective loudspeaker unit. Bent diaphragm. Overloaded tubes.
Knocking Noise (motor-boating).	Open circuit. Defective C battery or bias resistance. Grid suppressor of wrong value. Circuit oscillating at audio frequency.
Scraping Noise.	Condenser shafts not true.
Humming Noise.	Defective power unit, resistor choke coil, condenser, hum control or power tube. Low emission tubes. Shorted or open filament balancing resistor. Defective rectifier.

The foregoing classification, of course, is quite general, because many noises of entirely different characteristics may be emitted from the same kind of device.

HEATING ROOMS BY RF AN IDEA OF DR. WHITNEY

Schenectady, N. Y.

Ever since the first time man produced heat to keep himself comfortable the method of operation has been to heat the medium in which he lived, to enjoy participation in this relatively wide dissemination of heat. The efficiency factor always has been low, considering the effect of the heat on the individuals concerned, as compared with the general distribution of the heat.

Also, it took as much energy to provide the heat for one person as for any number of persons who could be crowded into the heated area.

Now, however, the possibility of radiating heat from a vacuum tube, worked at high frequencies of oscillation, and directing that heat to the individuals to be benefited, keeping them warm although the temperature of the room remains unchanged, is about to be investigated. The tube, called the fever tube because it was designed primarily to eradicate fevers from the human body by directive heating from the bulb to kill germs, is a product of the General Electric Company laboratories.

Unlike Present Plants

Dr. W. R. Whitney, director of the company's research laboratories, developed the fever tube, and is the one now to suggest the possibility of its application to economical heating, so that homes, factories, offices and the like may have individualized heating plants installed, consisting of high-frequency generation from the tube, which transmits the heat to the intended and selected objectives. The idea is being studied, preparatory to possible experimenting, as the theoretical soundness is admitted by experts.

Such a radio tube heating plant would be far from anything we think of to-day in connection with heating. In electric heating, which is not used so much commercially, because of expense, a coil of wire (resistance wire) has a voltage impressed on it that causes current to flow through the wire, the current being so high that the temperature of the wire is raised considerably, and heating of the air is effected. That is the simplest form we experience to-day, and may be represented by the familiar electric heater that consists of the coil of resistance wire on an insulated base, a polished copper reflector of conical shape, and a guard over the front of the reflector, to prevent burning accidents.

On the other hand, gas heaters come in the category once removed from electric heaters, and in about the same class as oil heaters, considering size and apparatus required.

Would Heat All Persons

Hot air, steam heat and hot water heaters represent the most elaborate installations, as they require a furnace, special plumbing and radiators. But the tube, if it works out as hoped, will enable dispensation with the coal furnace, plumbing and radiators, and would render susceptible to heating all persons who entered the room, so that no more would the thermometer on the wall be of any value as an index of comfort.

The average adult man, assumed to be 165 pounds, has a volume of 2.65 cubic

Sick Dog Cured by "Fever Tube"

Schenectady, N. Y.

The first patient to have enough confidence in a tube that is intended to kill germs in the body by directive heat application from a tube, called a fever tube, is a hound dog, selected, as dogs are never selected in domestic life, because of extreme inferiority.

Indeed, the dog may be said to have had an inferiority complex, for he was keenly conscious that he had lost his hair. He probably did not know that this blight was due to a supposedly incurable skin disease, nor did he know the name of the disease, nor does your correspondent know the name of the disease, thus showing again the common ground between beast and man.

Not only was the dog diseased and hairless but also undernourished. He hobbled along, tail under his haunches, as if perpetually suffering the mental reaction of a whipping.

But that dog, called "the radio pup," is no more the disreputable looking creature he was, for he had been steadily taking the cure, by receiving the directed heat of the fever lamp, a by-product of radio tube research of the General Electric Company. In the company's laboratories and one-dog kennel he is having a high time. His hair is fully restored, his appetite is good, and, as dogs go, he is a real success. For a consideration—an extra marrow bone or some liver—he might be induced to sign a testimonial of the effectiveness of the fever lamp, and thus give an incentive to its acceptance by the medical profession, which is interested in the tube's capabilities.

feet, yet it often happens that to provide heat for him a room containing thousands of cubic feet of air has to be heated. Assume that electricity is used, at a rate of 1,000 watts, to heat a room of 2,650 cubic feet, for one man. The efficiency is .001, a terrible showing.

Avoids Stuffy Room

Another point in favor of the tube method of heating would be the possibility of providing proper ventilation.

Now when a room is heated it is likely to get stuffy, and if the usual method of ventilation by opening the windows is resorted to, the room gets cold, or an enormous waste of energy has to be suffered to produce enough heat to sustain comfortable temperature with ventilation. The tube system permits wide open windows all the while.

Construction of Tube

The tube's application to arctic exploration is something else to think about. So is the radiation of cold, to make perspiring summer victims cool.

The fever tube has two plates, like a double-wave rectifier, but the plates are of composition materials. In conjunction with the tube a circuit is set up, tuned to a high frequency, around 5 meters, with the current of oscillation focused within the plates.

WLS LOSES TIME APPEAL

Washington.

WLS, Chicago, lost its appeal to upset the Federal Radio Commission's assignment of three-fourteenths of the time on 870 kc to WENR, Chicago. This amount of time on that frequency had been taken away from WLS.

BOOTLEG WAVE SIGNALS CAUSE ARREST OF PAIR

Two men were arrested by Department of Commerce investigators in Brooklyn, N. Y., recently, for operating a transmitter without a license, the arrest having resulted from a Coast Guard radio operator, aboard a cutter that tracks down bootleggers, hearing undecipherable signals.

The Coast Guard operator reported to the chief radioman, who got the help of E. H. Lee, assistant radio supervisor, and Forest F. Redburn, assistant radio inspector, the last two being under the Department of Commerce.

At first it was not known just where the signals were coming from, but the suspicious facts concerning them were that they were on a frequency not accounted for in the authorized list of stations, and the code was ciphered. However, some of the passages, in dots and dashes that did not make immediate sense, were copied, and an expert is trying to decipher them.

Investigation Lasts Four Weeks

The Department of Commerce men got their automobile loop receiver and signal intensity meter ready for action, and did considerable listening, as can be imagined from the fact they were four weeks finding just whence the signals emanated. It is believed the transmitter had been moved about, thus making location difficult.

The loop receiver operates on the familiar principle of delivering utmost signal intensity when the loop is pointing in the direction of the incoming wave, in aiding phase. Almost as great signal intensity is developed when the reception results from the loop being turned at an angle of 180 degrees, but in an opposing phase, but the sensitivity meter, or intensity measuring device precluded any error in that direction.

So the two men drew a map, with lines on it, showing the direction of the signal origin, taken from various points, some of them fifteen miles apart, and noted where the lines converged.

House Located, Pair Arrested

In that way they got the general drift of their destination, and by using the field intensity measuring equipment more finely, they were able to judge that the signals were coming from what seemed to be a vacant house. Either some one was operating a transmitter in that house or the house was haunted. As is always the case, the haunted theory evaporated.

This house was located on Troy avenue. The two investigators entered it. They say a man was operating a transmitter. He was arrested. A few moments later another man entered, as if ready for a night's work, but instead he, too, was arrested. Those seized said they were James L. Pelkey, of Laurelton, N. Y., and Harry C. Willis, of the Borough of Manhattan. The apparatus was seized.

The defendants were held in \$7,500 bail each for a hearing, when brought before a United States Commissioner.

VACUUM AIDS EFFICIENCY

The vacuum is in radio tubes because the electrons enjoy greater freedom of motion in vacuum, hence the tube is more efficient.

NEW INVENTION SYNCHRONIZES POWERFUL PAIR

Washington.

For the first time in history a frequency control so accurate as to be useful for synchronization has been devised. This device, made by Bell Telephone Laboratories, was put in successful operation recently. The new invention consists of a method of construction and maintenance of matched crystal control so that two stations, operating on the same frequency at the same time, within a relatively short geographical distance of each other, send out different programs but cause no interference with each other, except trivially at about half way between.

The successful demonstration of this device renews the hope that it will be of general commercial practicability to work two or more stations on the same channel at the same time, even though they use fairly high power, and are close together geographically.

By such accomplishment the present condition of congestion of the channel facilities, due to operation of only one high-powered station at a time on a given frequency, could be completely remedied, and present stations that suffer from and cause interference, such as heterodyne whistles and fading, would be able to render unobjectionable service to listeners.

Worked Out at WHO and WOC

For a few months WHO, des Moines, and WOC, Davenport, both in Iowa, and both operated by the Central Broadcasting company, made midnight tests of the new synchronization system, and were well satisfied. A petition thereupon was made to the Federal Radio Commission for authority to operate permanently on the synchronized basis, especially as both stations were assigned to the same frequency, 1,000 kc., and permitted the same power, 5,000 watts. They had to share time on this channel, and the main object of synchronization was to enable both to have unlimited time.

The Commission sent its chief engineer, Dr. C. B. Jolliffe, to the scene, and he was so favorably impressed with the demonstration that he recommended to the Commission the immediate authorization of synchronization, which recommendation the Commission speedily approved. So the two stations are now on the same wave at the same time, with two different programs, and negligible interference, that being confined to the midpoint of the 190-mile distance between them.

It is the first time that even preliminary success has been attained in such an experiment, without the use of land wires for frequency control.

Whistle Eliminated

Through the use of crystals, matched to a greater degree of accuracy than had been prevalent heretofore in crystal control, constituting almost absolute identity, and by a means of balancing one of the two waves additionally if the waves themselves should differ by even a cycle or two, success has been achieved. Even a difference of a few cycles would create considerable interference throughout the penetration range of both stations, in the form of an annoying whistle.

Nevertheless, two different programs are on the same wave at once now, without the whistle that many engineers be-

Jolliffe Finds

Test Significant

By DR. C. B. JOLLIFFE

Chief Engineer, Federal Radio Commission

The system of synchronization used by WHO and WOC is capable of remarkable stability. I think that the experiment is very significant.

It must be realized, however, that highly specialized equipment is being used. It can't be done with just any kind of equipment. The apparatus is ahead of the radio art at the present time.

To accomplish this synchronization stations must have this precise equipment.

lied could not be eradicated except by the adjunctive use of land wires. One way a land wire is used under the previous practice is to carry an audio frequency, a harmonic of which is used by the two stations to be synchronized, to attain the desired radio frequency.

The Iowa radio situation has been unsettled since WHO and WOC had to share time, they being the two largest stations in the State, hence it was argued the territory was not adequately served with consistency.

Sought Leave to Consolidate

The stations themselves felt that since time division was forced on them there was no need of operating two stations, since one with unlimited time would be more economical and render about as good service. However, the application for leave to consolidate, now before the Commission, is believed to be superseded by the grant of authority to synchronize, as what the stations want most is unlimited time for both stations, which successful synchronization makes practical in a manner consistent with the national distribution of channels.

To check up, and effectuate double insurance of identity of frequency between the two stations, a monitor has been set up at Marengo, half way between the two stations. The broadcasts of both stations are received at Marengo and sent at audio frequencies by land wire to Davenport only. No control signal is sent over this wire, but simply telephony for check-up, so that any off-frequency effects noticed at the critical midway point can be heard by the operator of the control board at Davenport, so he can readjust for identity. The controls at Des Moines are fixed.

Other Examples Not Identical

There have been other examples of synchronization, most of them by land wires. The experiment of WBZ, at Springfield, Mass., and WBZA, at Boston, to enable Westinghouse to have its programs clearly heard in Boston, was successful, using land wires, but was abandoned as too expensive. The two stations were consolidated and given greater power, 15,000 watts, to penetrate the so-called dead spots.

The experiment of WGY, Schenectady, N. Y., and KGO, Oakland, Calif., both General Electric stations, 2,800 miles apart, is in general successful, two crystals, ground at the same place and under the same conditions to assure accuracy, being used. Although both use 790 kc. at the same time for part of their hours on the air, the distance between the two stations is so great that the results can not be said to be applicable to stations only a few hundred miles apart, nor is the double check system used.

Some engineers maintained that synchronization at distances greater than a few hundred miles could be effected, but General Electric disproved this.

SET TAX PAID SLOWLY SHOWS UNPOPULARITY

Columbia, S. C.

That taxes on radio sets are not popular is indicated by the fact that South Carolina, the first State in the Union to impose a tax on receivers, experienced difficulty in making collections.

When the last day had arrived for payment of the taxes it was found that only one-third of the set owners had fulfilled the requirement of the law, yet listening went on just the same.

Time Is Extended

A conference of State executives was called quickly, and it was decided to extend the time limit for ten days. This extension was granted, and tax collectors were instructed to start a vigorous campaign to get everybody to pay up on time. Although \$50,000 was expected to be received, only \$12,000 was collected up to the time the extension was put in effect.

The Tax Commission thought that the public would take more kindly to the tax. Politicians had so arranged the tax that the proceeds would go toward the State Park Tuberculosis Sanitarium.

Sentimental Appeal Fails

However, the supposedly sentimental appeal did not prove effective, so time extension and a course of coaxing and threatening was decided on as necessary.

The tax is graduated according to the value of the set, and the rates are as follows: 50 cents for sets costing less than \$50, \$1 for sets between \$50 and \$200, \$2 for sets between \$200 and \$500, and \$2.50 for sets costing more than \$500.

The tax is bringing an average of approximately \$1 per set, the Tax Commission stated.

RMA to Attack Constitutionality

The Radio Manufacturers Association will challenge the constitutionality of a tax imposed by the South Carolina legislature on owners of receiving sets. That reception of radio as well as transmission is interstate commerce and therefore beyond the jurisdiction of the States will be contended by the RMA in opposing this and similar taxes on owners of sets.

RCA Omits Quarterly Report to Exchange

The financial report of the Radio Corporation of America for the first quarter of 1930 was not filed with the New York Stock Exchange. By special permission from the Exchange the filing, required by the rules, was dispensed with, on the ground that no report that would show the true situation could be filed, on account of the recent recapitalization and unification plan adopted by the stockholders. Under this plan RCA acquired manufacturing facilities from General Electric and Westinghouse for RCA stock.

The reorganization is under attack in the suit recently brought by the Federal Government in which monopoly and conspiracy were alleged, and alleged violations of the Sherman law cited.

RADIO WORLD

The First and Only National Radio Weekly
Ninth Year

Owned and published by Hennessy Radio Publications Corporation, 145 West 45th Street, New York, N. Y. Roland Burke Hennessy, president and treasurer, 145 West 45th Street, New York, N. Y.; M. B. Hennessy, vice-president, 145 West 45th Street, New York, N. Y.; Herman Bernard, secretary, 145 West 45th Street, New York, N. Y.
Roland Burke Hennessy, editor; Herman Bernard, business manager and managing editor; J. E. Anderson, technical editor.

Sense Without Censorship

ON the advice of counsel the Federal Radio Commission has been maintaining it has no power of censorship over radio programs. Hence it has been slow to act where programs of doubtful propriety have been broadcast. But it is ready now to act to stop programs of undoubted impropriety, and has rescinded the license of KVEP, Portland, Ore., over which station, six nights a week, every week, the self-styled Oregon Wildcat, Robert Duncan, denounced all and sundry, including citizens held in impeccable esteem.

The owner of the station, William D. Schaeffer, in his own defense, said he had sold the time on the air to Duncan, and that he did not feel authorized to exercise any censorship, since he had no more such authority than has the Commission, which admits it has none. Nevertheless, on the ground of abuse of license, the revocation was ordered, and the civic organizations, Better Business Bureau and complaining and maligned individuals of Portland felt better. This good feeling increased when Duncan was arrested on a Federal warrant, for using indecent language on the air, since broadcasting comes under the interstate category.

What constitutes censorship is a matter of definition, and in the strict legal sense the Commission may have no censorship powers. It can not prohibit the broadcasting of a program that in the opinion of its members may have an unwholesome effect on public thought or morals. But it can revoke the license of a station which permits the transmission of programs that constitute an abuse of the license granted to the station. The offense must be clear and vicious, whereas mere censorship permits the dictation of deletions without regard to whether they are advisable in the opinion of any one except the censors. Also, the Commission acts against the station, whereas a censor conceivably might act also against the sponsor of a distasteful program or even the artists appearing in it.

Speaking of the revocation of the KVEP license, Commissioner Robinson said: "It may as well be proclaimed that this Commission knows its province and duty in instances like this, and that it may be relied on to fulfill them in the public interest."

About the last condition that radio stations and listeners alike would want would be censorship, except possibly that at least the listeners would prefer censorship to the continuation of some of the so-called programs that are heard all too often. Stations that are used almost exclusively for the denunciation of a particular religion, stations that sanction the broadcasts of offers of a marriage broker to render "strictly confidential" services for a fee in obtaining desirable mates, "no fee unless successful"; and stations that permit fortune-tellers, rajah this or that, to divine the future, and utter poor-

ly concealed remarks about dollar bills insecurely pinned to questions sent in, deserve some attention from the Commission, if only a check-up on the steadiness of adherence to assigned wavelength or operation well within the maximum power allotted under the station license.

But maybe such stations would protest they are not making the common mistake of confusing liberty with license. Why, haven't they actually got the license hanging on the wall?

Lonesome

A CONSIDERABLE part of one's life had to be lived alone in the days before radio. Indeed, the farther back we go in history the more we find the human race subjected to the misery of being alone too much. To-day the cry may be that one can scarcely have a quiet moment to himself. In this interdependent age a man hardly can call his soul his own. It is better that way. The very influence that transformed the local markets of Washington's day to the world markets of to-day heightened the social aspect of man's life, and so he is less alone than ever.

Nevertheless inclination has not been defied. Man desires less and less to be alone, and sociability is growing. He tries very hard to be contacted with fellow human beings. From very infancy this desire for companionship is obvious. We did not have the opportunity of observing the babies of Caesar's day, but we assume they cried less just because left alone than do the babies of to-day, because sociability has become an inherited characteristic. Even parents must be sociable with their offspring.

Man had an opportunity to be lonesome enough even a decade ago, but soon thereafter radio came along, and in a few years grew to such great strength and purpose that the voices of announcers and artists, and even the individualities of musicians and full orchestras, became more familiar to him than the voices and eccentricities of relatives of the second order, such as cousins.

So, if one's family has gone a-visiting for a holiday, and there is nobody in the house with the man of the house, he is not lonesome, for he is not alone. So, also, the bride of this warm June does not feel the hours drag unduly until the new light of her life returns from work, for she is not lonesome. She, too, has her host of radio intimates, none of whom she has ever seen, but all of whom she knows so much better than nearly everybody whom she has ever seen. It used to take some self-sustaining mental qualities to avoid the synonymy of aloneness and lonesomeness. One might be alone and sing over it, not being lonesome, but will had to be ascendant, rampant. Now one may be alone, and if unable to sing over it, can have some one, over the radio, sing to him.

Not only is the sheep herder, on the plain with not more than one human being for a hundred miles around, now acoustically in the midst of things, and the lighthouse keeper no more a gloomy contrast to the twinkle in the light he tends, and other folk fired with radiated companionship, but the trouble seems to be that it is hard to get some of them to take their minds off radio, especially during an important broadcast, to attend to their workaday duties. And that difficulty of enticing any one away from his radio listening is the right sort of condition.

It is infinitely better to be deeply interested in something rather than to be bored by everything.

A person listening intently to the radio is all-alive. A lonesome person is melancholy, and half-dead. And we're for life and plenty of it.

THEY SAY

CHARLES McK. SALTZMAN, chairman, Federal Radio Commission: "On a hot afternoon with a room full of applicants waiting for interviews, with a basket full of correspondence yet unread, the telephone announcing that another law suit has been filed in the District Court of Appeals, the average Radio Commissioner heartily wishes that the International Conference had forgotten to make this broadcasting allocation and fervently prays that the next International Conference which meets at Madrid in 1932, will either confine the use of radio to such trivial purposes as safety of life at sea, aviation and communication, or else give the whole spectrum over to broadcasting."

* * *

MORRIS METCALF, president, Radio Manufacturers Association: "Automobile radio is one of the novel features this year. While it is not exactly new for the reason that several individuals have worked with it for a number of years, it is only within the last year that steps have been taken to make its use general. Since that time several manufacturers and laboratories have entered the field in earnest and the adaptation of the radio to the automobile is rapidly becoming popularized. The best sales argument so far as automobile radio is concerned is demonstration. Adverse propaganda during the last few months has instilled into the minds of many persons the fear that a radio in the car will cause carelessness in driving and be distracting to the driver. It is only necessary for the prospect to take one ride in a car so equipped and he at once sees the fallacy of his opinions."

Diction Medal

Won by Bach

Alwyn E. W. Bach, one of the announcers of the National Broadcasting Company, won the gold medal of the American Academy of Arts and Letters for good diction over the radio. Last year the award was made to Milton Cross, also an announcer of the N. B. C.

Hamlin Garland, for the Academy, said the medal is not awarded for the best announcer, but for good diction, since the committee can hear only a few of the thousands of regular announcers throughout the country. The winner has the highest markings in articulation, pronunciation, freedom from both local accent and strident tones, and for exhibition of taste and scholarship. Mere popularity did not interest the committee.

"There may be some announcers superior to him," said Hamlin, of Bach, "but our committee is not concerned with hypothetical cases."

State to Use Air in Safety Drive

Trenton, N. J. The Commissioner of Motor Vehicles, R. B. Stoeckel, announced that radio broadcasts will be undertaken by the department, to promote safety on the highway. It was the department's endeavor to instil in listeners the necessity for driving carefully and walking carefully, to reduce the number of accidents.

Specific things that drivers and pedestrians can do will be stated in the talks. Also, it is said a few words may be included regarding the back seat drivers, as sometimes they are responsible for accidents.

FIRST QUARTER IS \$12,500,000 AHEAD OF 1929

Washington.

A survey of retail radio business during the first quarter of the year indicates that sales during the whole of 1930 should approximate \$645,000,000, according to a joint estimate of the Department of Commerce and the National Electric Manufacturers Association, made public June 3 by the electrical division of the Department. The partial returns thus would indicate an increase of 9.3 per cent over 1929.

The estimate is derived from the regular quarterly questionnaires sent to radio equipment distributors and takes into account seasonal variations which have been noted in official surveys of the last three years, it was explained orally by the division.

Expect \$144,500,000 Year

The average return per reporting dealer applied to the total number of known dealers queried would indicate that total sales for the first quarter of 1930 were approximately \$144,500,000 as compared with \$132,000,000 for the same quarter of 1929, according to the division.

Previous surveys of the division have shown that retail business during the first quarter comprises 22½ per cent of the year's sales. A checkup of the surveys of 1929, 1928 and 1927 reveals that this percentage varies only slightly. The averages for the second, third and fourth quarters are 15 per cent, 22½ per cent and 40 per cent respectively, it was stated.

The basis for the estimates of the year's business was furnished by returns from 7,153 dealers or approximately one-sixth of the known dealers who were sent questionnaires.

16.6% of Dealers Replied

The percentage of replies varies from year to year and only about 40 per cent of those who reply are repeaters in the subsequent surveys, indicating that eventually most of the dealers are reached, it was pointed out by "The United States Daily."

The average business of the retailers reporting for the 1930 first quarter was \$3,350 as compared with an average of \$3,368 in the first quarter of 1929. The lower individual average in the face of a higher total for the 1930 quarter is due to the smaller percentage of returns received this year. The replies this year constituted 16.6 per cent of the dealers queried while last year 19.4 per cent of the dealers reported, the division explained the lower proportion being due to the fact that the number of dealers has considerably increased.

Unequal Sales Distribution

During 1929, according to the surveys of the division, approximately 88 per cent of the total retail sales were accounted for by 36 per cent of the dealers. About 38 per cent of the business was done by dealers handling radio exclusively, 12½ per cent by music stores, 11 per cent by furniture stores and 7½ per cent by automotive dealers.

35% OF FARMERS HAVE SETS

Richmond, Va.

The Commissioner of Agriculture has reported that thirty-five per cent. of the farmers in this State have radio sets.

Pests Electrocuted in Orchard Trees

Washington

Insects that infest apple and pear trees and greenhouses are being killed by electricity radiated at radio frequencies, 100,000 volts being fed into antennas spread above the trees, the consequent current being carried to ground through the trees. This completion of the circuit works fatal havoc with the pests.

Growers in the States of Idaho and Washington report to the Department of Agriculture that the experiments have been highly successful, without injury to the plants and trees.

RMA TO ENTER COPYRIGHT WAR

Reports on radio litigation in which the public and radio industry are interested were received by the Radio Manufacturers Association's Board of Directors at a meeting.

The RMA decided to protect the interests of the radio public and industry in two cases pending in the courts which test the rights of authors and composers to exact license royalties.

The case of a restaurant in Los Angeles and a hotel in Kansas City, sued for using their radio sets without paying royalties to the authors and composers of music, are involved. The broadcasters also are interested in the litigation.

In the Los Angeles case the broadcast station had a license from the authors and composers but the restaurant did not, and the court decided that the restaurant did not need a license. In the Kansas City case, neither the broadcasting station nor the hotel had a license from the authors and composers. The broadcaster put in no defense and lost, but the hotel won, and the case is before the United States Supreme Court on the composers' appeal.

That license rights of authors and composers should stop at the broadcast station and not extend to the use of receiving sets in public places such as hotels, restaurants, garages, or in dealer demonstrations, is the position taken by the RMA and those opposing the license claims of the authors and composers.

1929 Was Bad Year for the Manufacturers

The radio industry has reached its lowest ebb and future progress must be upward, according to a statement by Morris Metcalf, first Vice President of the Radio Manufacturers Association.

"1929 was a bad year for most of us," Mr. Metcalf said. "Let us hope that it was the worst that we shall see. We could not stand another like it. It is inconceivable that an industry with the fascinating appeal, remarkable growth and proved vitality of radio, will not forge ahead. The coming season must be better, because it cannot well be worse, and already there are many signs of improvement."

"Given reasonably satisfactory general business conditions, the radio season of 1930-31 should be one of the most profitable and satisfying in the short history of the industry. Perhaps we have learned a lesson. After remorse comes reform, reaction and reward."

SOUND TRACK CALLED VITAL TO TELEVISION

Washington.

Television alone is not of sufficient interest or importance to constitute a means of home entertainment, but sound must be transmitted as well, so that radio talkies can be enjoyed, says the Short-wave and Television Laboratory, Inc., of Boston, in filing an appeal with the Court of Appeals of the District of Columbia, from a decision of the Federal Radio Commission denying a "sound license" to the applicant.

The broadcast channel requested by the corporation was 1370 kc, 250 watts daytime power and 100 watts nighttime power, for purely local service, to share time with WLEY, Lexington, Mass., which uses only half time.

Operates WIXAV

The petition for reversal of the Commission's decision, and issuance by the court of an order to the Commission to grant the request, set forth the following:

"Appellant is regularly engaged in rendering a high type of radiovisual programs from its station, WIXAV, to a growing audience of 'lookers in.' These programs have developed a wide and intense interest, but appellant is handicapped by the lack of aural accompaniment which is necessary to give vitality and interest to the programs, to make full use of available program material (such as sound film, orchestras, dramatic works, etc.) to properly develop interest in television among broadcast listeners and for other purposes indicated in record.

"The necessary aerial channels are available only in the broadcast band (550-1500 kilocycles); in Boston such a channel is available to appellant only by means of the facility now requested.

Could Listen Alone

"The use of the requested facility in providing a sound channel for radiovisual programs would be so conducted by appellant that it would not lessen the interest of the programs when received by ear alone by the ordinary broadcast listeners. Granting the application would not result in interference with nearby receiving sets."

TELEVISION THEATRE OPENS

Jersey City, N. J.

The first radio television theatre was opened at Lincoln Park in this city under the auspices of the Jenkins Company and the Jersey City Chamber of Commerce when Mayor Frank Hague, Earl Carroll, Lee De Forest, Casey Jones and others broadcast their voices and features. About fifty radiovisual receiving sets had been set up in radio shops and other places throughout the city. The television part was sent over W2XCR and W2XCD and the sound over WRNY and WHOM.

GM TO SELL DEALER DIRECT

General Motors Radio Corporation, owned in part by RCA, has eliminated the jobber, except in a few sparsely settled sections, and will sell sets direct to dealers. The GM line is to be exclusively handled by franchised dealers, in return for which they get territorial freedom from competition. A separate service organization has been set up, as a factory responsibility.

BOARD PROBES SOS THAT CUTS ATTACK ON RCA

Washington.

The Federal Radio Commission has begun an investigation of the charge that a false SOS signal was sent out recently, causing broadcasting stations on the Eastern seaboard to be ordered shut down, and that the SOS was reported while former Senator James A. Reed, of Missouri, at a Democratic rally at Sedalia, Mo., was beginning that part of his speech attacking the radio trust.

Senator Reed's speech was being carried by a network of sixty-five stations of the Columbia Broadcasting System. The word to resume broadcasting did not come until twenty-six minutes had elapsed, by which time the former Senator had finished his speech. Meanwhile WABC and other Eastern stations of the Columbia system had been off the air.

Under the radio act the maximum penalty for sending a false SOS is \$5,000 fine or five years' imprisonment or both.

An operator of the Radiomarine Corporation of America, a subsidiary of the Radio Corporation of America, at Tuckerton, N. J., heard a faint SOS call on 600 meters, but could not get the call letters. He notified the United States Naval Communications service by telephone.

Senate Discusses SOS

Senator Dill, of the State of Washington, brought up the subject in the Senate. He said:

"I want to be frank and say that I do not believe any one of the officials of the Radio Corporation did it. But I think somebody did it.

"I think it was done for the purpose of stopping the speech. But the reaction will do far more harm to the radio trust than the speech of Senator Reed, forceful and effective as it was.

"It is almost impossible to believe that anyone would be so contemptible as to do this for the purpose of stopping a speech. Personally I absolve the officials of the Radio Corporation from it. But I have a strong suspicion that somebody operating a transmitter, hoping to help the cause of the Radio Corporation by keeping the listeners in the metropolitan area of New York from hearing it, did do this thing.

Suspects Local Origin

"I may say that, so far as we can learn, no other listening station heard the SOS call. The Navy communication service has been undertaking to learn of anyone else. The powerful station at Arlington did not hear it; the Coast Guard stations did not hear it—all of which would indicate that it was done by some local person."

Senator Dill added that President Aylesworth, of the National Broadcasting Company, had telephoned him saying that the SOS had put the company, which is owned in part by RCA, in a false light, and that he was considering offering Reed the opportunity to give his speech in full over the NBC. Senator Dill suggested the offer be made to Reed himself.

Reed Non-Committal

Sedalia, Mo.

Former Senator Reed said he was unaware he had been cut off by any of the stations until he had finished his speech. He said he didn't even know whether the SOS was bona-fide or whether it was inspired by any animus toward him.

Cites Need for Music Education

There is a need for musical education, so that radio listeners will be able to appreciate better the highest grade music now being furnished by numerous stations and sponsors of programs, said Mark P. Campbell, president of the Music Trades Chamber of Commerce.

"To be a good listener one must have some education in music," he said.

He pointed out that radio hurt the sale of sheet music and of pianos, but since it has stimulated interest in music to such a great extent, the sheet music and piano trades are learning to capitalize the situation, and radio bids fair to promote greatly the sales in both classes.

ASKS HOOVER TO KEEP JUDGE

Washington.

Judge Hugh M. Morris, who offered his resignation to President Hoover as Judge of the United States District Court, District of Delaware, soon after the Federal Government filed its suit in Delaware against the radio trust, should be asked to remain at least until the suit is decided, said Senator Dill, of the State of Washington. Senator Dill wrote to President Hoover asking the President to request the Judge to remain on the bench long enough for the purpose.

"Judge Morris is the best qualified judge on the Federal bench to pass on this case," said Senator Dill. "Because so many corporations engaged in the radio business are incorporated in Delaware he has decided a long list of patent cases as well as cases involving the anti-trust laws.

"I understand Judge Morris's reason for his resignation is his desire to improve his financial status. I recognize the merit of that."

Senator Norris, of Nebraska, recalled that Kenesaw Mountain Landis was a Federal Judge in Chicago, "making it rather unpleasant for Mr. Insull, who managed all the public utilities in Chicago"—when he was offered \$50,000 a year to be "umpire in the baseball world," when the legality of certain added securities of the Insull Corporation was coming up for consideration.

Senator Norris said:

"So these great corporations and special interests have a peculiar way of getting valuable men out of the Federal service by kicking them upstairs.

"I think it is comparable to the case of Mr. Culherson, who was a member of the Tariff Commission whom the special interests were unable to control or handle. They kicked him upstairs by having him appointed Ambassador to a foreign country."

National Radio Week Set for Sept. 22-27

The date of National Radio Week has been set to coincide with the week of the Radio World's Fair in New York City, September 22nd to 27th. It will be celebrated throughout the radio industry by manufacturers, dealers, jobbers and broadcasting stations with special programs and special sales promotion campaigns.

FRIENDLINESS IN TRUST SUIT IS RIDICULED

By JAMES C. DILL

U. S. Senator, State of Washington

I want to review briefly the history of the dissolution suit brought by the Federal Government against the radio trust.

The radio trust was formed as the result of some meetings held in 1919.

For a long time they said they were organized at the request of the Government. We found upon investigation that the only basis for that claim was that Government officials had asked General Electric Co. not to sell the Alexander alternator to England.

Then the Radio Corporation said that Mr. Daugherty, former Attorney General, had given his blessing to these contracts. I have always been doubtful as to the value of any blessing he might have given to any contract, in view of his record as Attorney General. Yet they claim that this justified anything they wanted to do.

Dubious on Young's Statement

Then the Federal Trade Commission made an investigation and after a long time declared they had no jurisdiction. The whole subject then went to the Attorney General's office.

The assistants in the Department of Justice worked on it for some two years. Mr. Donovan was especially active. Then Mr. Sargent, who was Attorney General, pigeonholed the report.

When Mr. Mitchell became Attorney General he asked Mr. O'Brien to make an investigation and report on the matter, and he reported that suit ought to be brought. The suit has been brought and has been filed in the courts of Delaware.

As soon as it was filed Owen D. Young, chairman of the General Electric Co., and also an officer in the Radio Corporation, said he was delighted that the suit was brought, that it was a splendid test suit and they wanted to know about it. I do not know why he made that statement.

Ridicules "Friendly" Test

I think it is not only misleading, but I think it should be resented by the Department of Justice, because it indicates that the suit was brought by agreement, that the suit is a milk-and-water affair, when in reality it is an aggressive militant proposal to dissolve and destroy this radio octopus representing, as it does, some \$6,000,000,000, an octopus that reaches out into every field of radio activity and its connections.

The talk about it being a friendly suit is simply ridiculous. I refuse to believe that the Department of Justice has any other purpose than that of pressing it and prosecuting it with all the vigor at its command.

RCA Sues Arcturus on Patents on Tubes

A suit directed against Arcturus, on the ground of patent infringement in the making of tubes, was begun by the Radio Corporation of America and associates, in New York City.

The Dale Company, a distributor of Arcturus tubes, was named as defendant, to avoid complications due to interstate legal action. Arcturus operates in New Jersey.

WILDCAT UNDER ARREST STRUCK BY ONE VICTIM

Portland, Ore.

Robert Gordon Duncan, the self-styled Oregon Wildcat, was arrested here on a Federal warrant charging him with using obscene and indecent language in broadcasts from KVEP, 1,500 kc, which had its license revoked by the Federal Radio Commission in Washington recently for tolerating these broadcasts nightly for several months.

When the Wildcat was entering the United States Marshal's office Edgard E. Piper, one of the individuals he had denounced most violently in the broadcasts, was waiting for him. The Wildcat saw him and stopped.

Piper took advantage of the scant distance between the Wildcat and the Deputy Marshal who was "escorting" Duncan to the Marshal's office, and with a leap landed a crushing right to the Wildcat's jaw, causing the Wildcat's knees to sag. Another Deputy Marshal intervened and one of Piper's ensuing blows, intended for the Wildcat, landed on the peacemaker's nose.

Piper Also Arrested

Thereafter the Wildcat had company, in the person of his physical attacker, for a charge of assaulting a prisoner in Federal custody was lodged against Piper. A few hours later both men were released on bail.

Duncan had been conducting a campaign of abuse since the primaries a few months ago, in which he was defeated for the Congressional nomination. He attacked the successful candidate long after the campaign was over, and also uttered invective against other individuals as well as against chain stores, banks and newspapers. Portland civic associations and the Better Business Bureau joined in a request to the Federal Radio Commission to cancel KVEP's license.

The decision was handed down by the Commission a few days before the station's license was to expire, and took the form of a refusal to issue a renewal.

Appeal From Ouster Fails

Washington.

The appeal taken by the owner of KVEP from the ruling of the Federal Radio Commission refusing to renew the station license because six nights a week, every week, Robert Duncan was permitted to make vituperative speeches in an ugly and indecent manner, met with failure.

This is believed to end the case of the virtual license revocation, since appeal to the United States Supreme Court could be on constitutional grounds only. The decisions of the Court of Appeals on administrative matters are final.

New Incorporations

Electrofarad Corp., Wilmington, Del., Corporation Trust Co.

Home Service Radio Corp., Newark. Atty., Frank G. Masini, Newark, N. J.

De Luxe Specialty Co., Camden, N. J., radios. Atty., Raymond L. Siris, Camden.

Atlas Surplus Corp., radio business. Attys., Lippman, Kleban & Bernstein, 280 Madison Ave., New York, N. Y.

General Radio and Equipment Co., Philadelphia, Pa. Corporation Guarantee and Trust Co.

Shubert Radio Co., Atlantic City, N. J., radio supplies. Attys., Thompson & Hanstein, Atlantic City, N. J.

Radio Surplus Corp., radios. Atty., M. M. Lewis, 299 Broadway, New York, N. Y.

Elevation Solves Work on 5.55 Meters

Washington.

Frequencies from 35,000 kc (8.57 meters) to 54,000 kc (5.55 meters) are excellent for short-range communication, such as is needed in Hawaii, says the Mutual Telephone Company of Hawaii, which requested the Federal Radio Commission to grant it licenses on ultra-high frequencies ever received by the Commissions for the commercial use of these frequencies ever received by the Commission. At present communication is by land wire telegraph.

Sixteen applications for use of frequencies in this region were filed by the company. The extremity in the transoceanic band under the international agreement is 23,000 kc (13.043 meters), so any nation may use the frequencies requested by the telephone company.

The Commission was informed that on 35,000 to 54,000 kc both the transmitter and receiver must be located at an altitude which will overcome the absorption of the earth. In other words, it was explained, that the radio signals must be transmitted from a beam antenna on a straight line, in the same manner as light, without dependency upon a ground wave which follows the earth. Any appreciable "mass" between the two points would tend to block off the signal, just as a ray of light would be cut off.

GRID ROTATES IN NEW TUBE

A rotating grid or control element, which provides the vacuum tube with the additional factor of time, has been introduced. The control element in the new tube is rotated by means of electrons striking the vanes of the rotor. The source of the electrons is the 27-type cathode. The rotating element, in the form of a cylinder with slits and angular vanes, surrounds the cathode, and in turn is surrounded by the plate. According to A. B. DuMont, chief engineer of the DeForest Co., it has been found that the speed can be varied by changing the grid voltage and increasing the cathode temperature.

From tests it appears that by redesigning the electron motor tube it can be made into a synchronous electron motor, designed to run at various speeds. The general scheme of such an application is to separate the plate into sections, and arrange the vanes so as to correspond to the sections of the plate.

Hence if an alternating current is supplied between filament and plate, the rotor will be held in synchronism when the speed is such that each vane moves one section in one cycle. It is also possible to drive the rotor by a synchronous motor similar to that employed in electric clocks. By dividing the vanes and providing separate plates for the top and bottom vanes, an alternating current can be generated, or one frequency changed to another.

Various commutating and switching actions can be accomplished without sparking and variable contact resistance. The shape of the AC wave can be controlled. The electron motor can be applied to drive a small clock or meter mechanism, all of which may be placed in the bulb. In television it is possible to place all the mechanism inside a small glass bulb.

PASSENGERS ENJOY LINER'S PICTURE NEWS

Facsimiles of printed matter, including photographs of persons figuring in the news, stock market reports and newspaper cartoon strips, are being furnished to the United States liner America, from the American side, each day the ship is on the ocean. This service is additional to the regular ship's newspaper, printed daily aboard the vessel.

A receiving set that picks up, amplifies and records these radio-transmitted facsimiles, is installed in the smoking room of the liner. The device combines the latest inventions of the General Electric Co., Radio Corporation of America and the Westinghouse Company. The system is a farther advance of the one used recently to transmit the front-page of a newspaper from Oakland, Calif., to Schemectady, N. Y.

Uses Special Filter Circuit

RCA in an announcement said:

"To overcome the difficulties of vibration the apparatus has been mounted on sponge rubber, and special filter circuits were arranged to eliminate interference caused by the ship's motors or by extraneous radio signals. On a previous trip of the America an observer received photoradio signals, transmitted from New Brunswick, N. J., during the duration of the 10-day voyage.

"Maj. Richard H. Ranger, engineer in charge of photoradio activities for the RCA, believes it is entirely practical to maintain a regular facsimile service to ships over distances up to 3,500 miles. Maj. Ranger explained that the facsimile transmission to the America is of an experimental nature.

Passengers May Watch

"The photoradio receiver has been placed in the smoking room so that passengers may watch the actual reception of pictures, news bulletins, etc. After passing through the machine the photoradio material will be posted on the ship's bulletin board."

Material sent to the America included Robert L. Ripley's cartoon, "Believe It or Not," Percy Crosby's "Skippy," daily weather maps of the United States, and important news items.

Literature Wanted

Portable Sound Equipment Co., 2034 Sunset Blvd., Los Angeles, Calif.

James F. Blaney, 129 B Street, So. Boston, Mass.

J. Robertson, Jr., 4034 Ind. Ave., Chicago, Ill.

Ray Overstreet, Hotel Plant, Plant City, Fla.

G. M. Hevener, Y. M. C. A., Coatesville, Pa.

J. O. Clement, 196 Dallas Place, Spartanburg, S. C.

R. C. Jones, 6316 Dorchester Ave., Chicago, Ill.

Benton Letson, Columbia, Ala.

George Schlink, 670 57th Ave., West Allis, Wis.

D. L. Parsonhouse, 133 Lagrave Ave., Grand Rapids, Mich.

R. R. Freeman, P. O. Box 536, Phoenix, Ariz.

Ralph W. Ellingen, 1005 Monroe St., Mendota, Ill.

Albert Loser, 613 Center St., No. Bergen, N. J.

LYNCH

Precision Wire Wound Resistor



Especially adaptable for milliammeter and voltmeter multipliers. $\frac{1}{2}$ to 1% tolerance. Designed for uses where accurate, non-inductive, high value, low distributed capacity resistors are required. Molded, permanent contacts. Rating of one watt.

Send for new descriptive catalog on above Resistance as well as new pigtail Resistances designed especially for use in popular circuits.

LYNCH MFG. CO., INC.
1775 Broadway New York

RADIO AND OTHER TECHNICAL BOOKS At a Glance

"Audio Power Amplifiers," by Anderson and Bernard	\$3.50
"Drake's Radio Encyclopedia," by Manly	6.00
"The Electric Word," by Shubert	2.50
"Elements of Radio Communication," by Morecroft	3.00
"Experimental Radio," by Ramsey	2.75
"Foothold on Radio," by Anderson and Bernard	1.00
"Fundamentals of Radio," by Ramsey	3.50
"Mathematics of Radio," by Rider	2.00
"Practical Radio," by Moyer & Wostrel	2.50
"Practical Radio Construction and Repairing," by Moyer & Wostrel	2.50
"Principles of Radio," by Henney	3.50
"Principles of Radio Communication," by Morecroft	7.50
"Radio Blueprint Library"—AC Hook-ups35
"The Radio Manual," by Sterling	6.00
"Radio Receiving Tubes," by Moyer & Wostrel	2.50
"Radio Telegraphy & Telephony," by Duncan	7.50
"Radio Trouble Shooting," by Haan	3.00
"The Superheterodyne," by Anderson & Bernard	1.50
"The Thermionic Vacuum Tube," by Van der Bijl	5.00
"Treatise on Testing Units," by Rider	1.00
"Trouble Shooter's Manual," by Rider	3.50

TELEVISION

"A B C of Television," by Yates..... 3.00

AVIATION

"A B C of Aviation," by Maj. Page.....	1.00
"Aerial Navigation and Meteorology," by Capt. Yancy	4.00
"Everybody's Aviation Guide," by Maj. Page	4.00
"Ford Model 'A' Car," Its Construction, Operation and Repair—by Maj. Page.....	2.00
"Modern Aircraft," by Maj. Page.....	5.00
"Modern Aviation Engines," by Maj. Page..	9.00

RADIO WORLD

145 West 45th Street
New York, N. Y.
(Just East of Broadway)

SOCKET WRENCH SET FREE

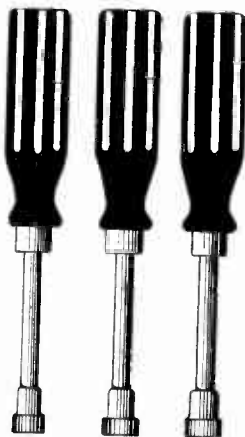

FOR turning down nuts there is nothing as efficient and handy as a socket wrench. Here is a set of three wrenches for hexagonal nuts, enabling use with 5/32, 6/32, 8/32 and 10/32 nuts. Fit the nut into the proper socket and turn down. The three different size sockets, one size on each wrench, enables use of three different outside diameters of nuts, but at least four different sizes of threads. Send 50 cents for four weeks subscription for RADIO WORLD and get this set of three wrenches free!

RADIO WORLD,

145 West 45th Street, New York, N. Y.

Enclosed please find 50 cents for four weeks subscription for RADIO WORLD. Send set of three socket wrenches free!

Name

Address

City State

Cross here if renewing.

NEW NATIONAL THRILL BOX

Cat. ACSW5, National complete parts for 5-tube AC Short Wave Thrill Box; list price, \$79.50, net price.....\$45.35

Cat. DCSW5, National complete parts for 5-tube battery operated short-wave Thrill Box; list price, \$75; net price.....\$42.75

Wired by Jackson Laboratories, \$5.70 extra. Add letter "W" to catalogue symbols.

AC model uses two UY224, three UY227, with provision for ventode in RF stage if preferred. Cat. ACSW5 does not include power supply. Use National A and B power unit, 2.5 v. AC, 150 plate volts. Cat. 5880-AB; list, \$34.50; net \$19.66. One 280 tube required. Order 280 Key tube @.....\$1.13 net

Guaranty Radio Goods Co.
143 West 45th Street
New York, N. Y.
(Just East of Broadway)

Official Parts for Popular Circuits

Universal Short-Wave Converter, using three 227 tubes; six de luxe precision short-wave air dielectric coils, condensers, chokes, 7"x14" panel, cabinet, etc. Cat. UN-SWC @.....\$24.75

GUARANTY RADIO GOODS CO.
143 West 45th Street
New York City

FIDELITY HORN UNIT—Stands up to 450 volts without filtering. Can be used in the portable without horn attached. Price, \$2.25. Guaranty Radio Goods Co., 143 W. 45th St., New York.

DOUBLE RANGE POTENTIOMETER; made by Centralab, designed for volume control. In dust-proof bakelite case. Price, \$1.05. Guaranty Radio Goods Co., 143 W. 45th St., New York.

RADIOMEN: TRY FURMHOLD liquid soldering flux for cleanest joints you ever saw. Noncorrosive. Solder sticks instantly. No coaxing. Big bottle \$1. Sample, 50c. Guaranteed. Furmhold Co., 109-24 208th St., Bellaire, N. Y.

FILL OUT AND MAIL NOW

SUBSCRIPTION BLANK

RADIO WORLD

RADIO WORLD

145 West 45th Street, New York City

Please send me RADIO WORLD for months, for which

SUBSCRIPTION RATES:

Single Copy.....	.15
Three Months.....	1.50
Six Months.....	3.00
One Year, 52 Issues.....	6.00
Add \$1.00 a Year for Foreign Postage; 50c for Canadian Postage.	

please find enclosed

If this is a renewal, put cross in square at left.

Quick Action Classified Ads

Radio World's Speedy Medium for Enterprise and Sales

10 cents a word — 10 words minimum — Cash with Order

FOR SALE—Ultradyn and Hi-Q30. F. L. Hanson. Ilion, N. Y.

HANDY 4 FT. FLEXIBLE TEST-CORDS WITH UNIVERSAL CLIPS—42c—POSTPAID. THREE FOR \$1.00.

TELE-DYNE ELECTRICAL LABORATORY,
2935 WALNUT STREET, CHICAGO.

A REVELATION! Acid-free soldering paste 20c can. Liquid flux 30c bottle. Guaranteed. Furmhold Co. 109-24 - 208th Street, Bellaire, N. Y.

CUSTOM-BUILT SETS: Loftin-White Amplifier \$30. MB29 \$55. S-M 712 Tuner \$55. All makes. Complete list free. J. T. Boyer, Jr., 853 Piedmont Ave., Winston-Salem, N. C.

START A BUSINESS of your own. Unlimited possibilities. Write for particulars. **STOWELL PRODUCTS,** Beach City, Ohio.

RADIO TUBES—All types \$1.00 prepaid. Miller, 628 North Eighth, Allentown, Pa.

BARGAINS in first-class, highest grade merchandise. B-B-L phonograph pick-up, theatre type, suitable for home, with vol. control, \$6.57; phono-link pick-up with vol. control and adapter, \$3.50; steel cabinet for HB Compact, \$3.00; four-gang .00035 mfd. with trimmers built in, \$1.95; .00025 mfd. Dubilier grid condenser with clips, 18c. P. Cohen, Room 1214, at 143 West 45th Street, N. Y. City.

THE ELECTRIC WORD, by Paul Schubert.

A narrative of the rise of radio from the discovery of Hertzian waves and the first practical use of them by Marconi, in 1900, to its present-day position of eminence. This book will be of great interest, not only to the great army of persons concerned in one way or another with radio work, but also to the layman whose immediate interest in radio is confined to his own set, and who will be fascinated by this story of an interplay of science, business, politics, and diplomacy that is without parallel in history. Price \$2.50.

RADIO WORLD, 145 W. 45th St., New York City

RADIO WORLD and "RADIO NEWS"

BOTH FOR ONE YEAR @ \$7.00

You can obtain the two leading radio technical magazines that cater to experimenters, service men and students, the first and only national radio weekly and the leading monthly, for one year each, at a saving of \$1.50. The regular mail subscription rate for Radio World for an year, a new and fascinating copy each week for 53 weeks is \$6.00. Send in \$1.00 extra, get "Radio News" also for a year—a new issue each month for twelve months. Total, 64 issues for \$7.00.

☐ If renewing Radio World subscription, put cross in square.
RADIO WORLD, 145 West 45th Street, New York, N. Y.



Your Choice of NINE Meters!

To do your radio work properly you need meters. Here is your opportunity to get them at no extra cost. See the list of nine meters below. Heretofore we have offered the choice of any one of these meters free with an 8-weeks subscription for RADIO WORLD, at \$1, the regular price for such subscription. Now we extend this offer. For the first time you are permitted to obtain any one or more or all of these meters free, by sending in \$1 for 8-week's subscription, entitling you to one meter; \$2 for 16 weeks, entitling you to two meters; \$3 for 26 weeks, entitling you to three meters; \$4 for 35 weeks, entitling you to four meters; \$5 for 44 weeks, entitling you to 5 meters; \$6 for 52 weeks, entitling you to six meters. Return this offer with remittance, and check off desired meters in squares below.

RADIO WORLD, 145 West 45th Street, New York, N. Y. (Just East of Broadway)

Enclosed please find \$..... for..... weeks subscription for RADIO WORLD and please send as free premium the meters checked off below.

- I am a subscriber. Extend my subscription. (Check off if true.)
- 0-6 Voltmeter D.C. No. 326
- 0-50 Voltmeter D.C. No. 337
- 6-Volt Charge Tester D.C. No. 23
- 0-18 Amperes D.C. No. 338
- 0-25 Milliamperes D.C. No. 325
- 0-50 Milliamperes D.C. No. 350
- 0-100 Milliamperes D.C. No. 390
- 0-300 Milliamperes D.C. No. 399
- 0-400 Milliamperes D.C. No. 394

NAME
 ADDRESS
 CITY STATE

Two for the price of One

Get a FREE one-year subscription for any ONE of these magazines:

- CITIZENS RADIO CALL BOOK AND SCIENTIFIC DIGEST (quarterly, four issues).
- RADIO (monthly, 12 issues; exclusively trade magazine).
- RADIO ENGINEERING (monthly, 12 issues; technical and trade magazine).
- RADIO INDEX (monthly, 12 issues) Stations, programs, etc.
- SCIENCE & INVENTION (monthly, 12 issues; scientific magazine, with some radio technical articles).
- AMERICAN BOY—YOUTH'S COMPANION (monthly, 12 issues; popular magazine).
- BOYS' LIFE (monthly, 12 issues; popular magazine).

Select any one of these magazines and get it FREE for an entire year by sending in a year's subscription for RADIO WORLD at the regular price, \$6.00. Cash in now on this opportunity to get RADIO WORLD WEEKLY, 52 weeks, at the standard price for such subscription, plus a full year's subscription for any ONE of the other enumerated magazines FREE! Put a cross in the square next to the magazine of your choice, in the above list, fill out the coupon below, and mail \$6 check, money order or stamps to RADIO WORLD, 145 West 45th Street, New York, N. Y. (Just East of Broadway).

Your Name
 Your Street Address
 City State.....

- If renewing an existing or expiring subscription for RADIO WORLD, please put a cross in square at beginning of this sentence.
- If renewing an existing or expiring subscription for other magazine, please put a cross in square at the beginning of this sentence.

RADIO WORLD, 145 West 45th Street, New York, N. Y. (Just East of Broadway)

Horn Unit \$2.25



Fidelity Unit, Cat. FDU, price \$2.25

The Fidelity unit is pre-eminent for horn-type speakers such as exponential horns. The faintest word from a "whispering tenor" or the tumultuous shout of the crowd or highest crescendo of the band is brought out clearly, distinctly. Stands up to 450 volts without altering. Works right out of your set's power tube, or tubes, requiring no extra voltage source. Standard size nozzle and thread. Works great from AC set, battery set or any other set, push-pull.

or otherwise. The casing is full nickel finish, highest polish.

This unit can be used in a portable without any horn attached and will give loud reproduction. Order Cat. FDU, with 30-inch tipped cord; weight, 2 1/4 lbs.; size, 2 3/4-inch diameter, 2 1/2-inch height. (This is the large size). Price..... \$2.25

GUARANTY RADIO GOODS CO.
 143 West 45th Street, New York City

"Seconds"

But Serviceable Tubes Nevertheless at Prices That Seem Incredible

A tube factory that maintains the highest possible standards for a large laboratory customer has tubes for sale that fall just a trifle below the most exacting specifications, but which are excellent tubes nevertheless. They are called "seconds" and they are "seconds," but they are not "thirds." You can get 500 hours excellent use out of them. Note the prices. Remit with order. Generous replacement policy.

112A	50c	227	50c
UV or UX-199	50c	245	50c
201A	45c	250	75c
210	60c	171A	50c
224	65c	280	50c
226	50c	281	60c

DIRECT RADIO CO.
 Room 504, at
 1562 Broadway, N. Y. City.

HAMARLUND DOUBLE DRUM DIAL—Each section individually tunable. List price \$6—our price, \$3. Guaranty Radio Goods Co., 143 W. 45th St., New York.

Subscribers! Important!

Note subscription expiration date on wrapper containing your copy of RADIO WORLD. If nearing expiration date, please send in renewal so that you will not miss any copies. Subscription Dept., RADIO WORLD, 145 W. 45th St., New York City.

"RADIO TROUBLE SHOOTING," E. R. Haan. 328 pages, 300 illustrations, \$3. Guaranty Radio Goods Co., 143 W. 45th St., New York.

KEY TUBES Quality First



The following constitute the thirteen most popular tubes used in radio today. Despite the severely low prices the Key tubes are first of the very first quality. The tubes are manufactured under licenses granted by the RCA and its affiliated companies.

All prices are net and represent extreme discount already deducted.

GUARANTY RADIO GOODS CO.
 143 West 45th St., N. Y. City. (Just East of Broadway)

Enclosed please find \$..... for which ship at once tubes marked below:

- 224 AC screen grid \$1.43
- 245 AC power tube \$1.28
- 226 AC amplifier68
- 227 AC det.-amp.90
- 222 battery SG \$1.88
- 112A power tube78
- 171A power tube78
- 201A battery tube53
- 240 hi mu tube \$1.60
- 250 power tube \$4.95
- 210 power tube \$3.25
- 280 AC rectifier \$1.13
- 281 AC rectifier \$2.95

Name
 Address
 City State

☐ Put cross here if C. O. D. shipment is desired. Canadian remittance must be by postal or express money order.

Parts for All-Wave Set

[Order what individual parts you desire. You don't have to order all.]

- Two sets of precision, de luxe coils, wound on ribs, 93 per cent. air dielectric, three coils to a set; one detector plate coil with mounting bushings total, seven coils to cover 15 to 560 meters (Cat. AW-CK) @..... \$12.00
- Two Hamarlund .0005 mfd. straight frequency line condensers (Cat. II-SF-5 @ \$3.30.... 6.60
- One 20-ohm filament resistor (Cat. FIL-20) @ .20
- One 1 1/3 ohm filament resistor (Cat. FIL-13) @ .20
- One 1 1/2 x 3/4 inch bakelite subpanel, with Four UX and one UY sockets built in, also two coil receptacles built in (Cat. AW-SUB @ 3.50
- One 5-lead battery cable with 5-prong plug attached (Cat. 5-L-CP) @ 1.50
- One steel cabinet with crinkle brown finish 7 1/2 x 10 1/2 (Cat. AW-CAB) @ 4.50
- One bottom shield for cabinet (Cat. SH-BOT) @ 1.50
- One 1-to-3 audio transformer (Cat. GB-1-3) @ 1.50
- One 1-to-5 audio transformer (Cat. GB-1-5) @ 1.50
- Two insulating washers for volume control (Cat. IN-W) @ .05 1.0
- Four subpanel brackets (Cat. BRA) @ .05 2.0
- One antenna-ground binding post unit (Cat. A-G-RPU) @35
- One speaker binding post unit (Cat. SP-RPU) @35
- One .00025 mfd. grid condenser with elips (MICON-00025-CL) @ 1.18
- One Lynch 5 meg. metallized grid leak (Cat. LYN-5) @ 3.30
- Two National type VB-D variable ratio dials; maximum reduction to 20-to-1, with 2.5 volt pilot lights and illumination brackets (Cat. VB-D-PB) @ \$1.80..... 3.60
- Two Polymet 1 mfd. bypass condensers, single lug type, (case goes to ground), (Cat. POLY-1) @ 30c @ 1.00
- One 30,000 ohm Clarostat wire-wound potentiometer with switch attached (Cat. CLA-30,000-S) @ 1.50
- Four Spacers for condensers @ .025..... 1.0
- All parts (Cat. AP-AVR) \$40.78

PORTABLE

as described on page 10 of June 7th issue, \$35.00 assembled.

Guaranty Radio Goods Co.
 145 W. 45th St., N. Y. C., Just E. of B'way

Hi-Q 30

GET OUR PRICE ON AC OR BATTERY MODEL

Write or wire!

Guaranty Radio Goods Co.

143 West 45th St.,
 New York City

