

JUNE 14th

1930

RADIO

REG. U.S. PAT. OFF.

WORLD

The First and Only National Radio Weekly

429th Consecutive Issue—NINTH YEAR

15 Cents

PER COPY

ALL-WAVE 4-TUBE BATTERY SET

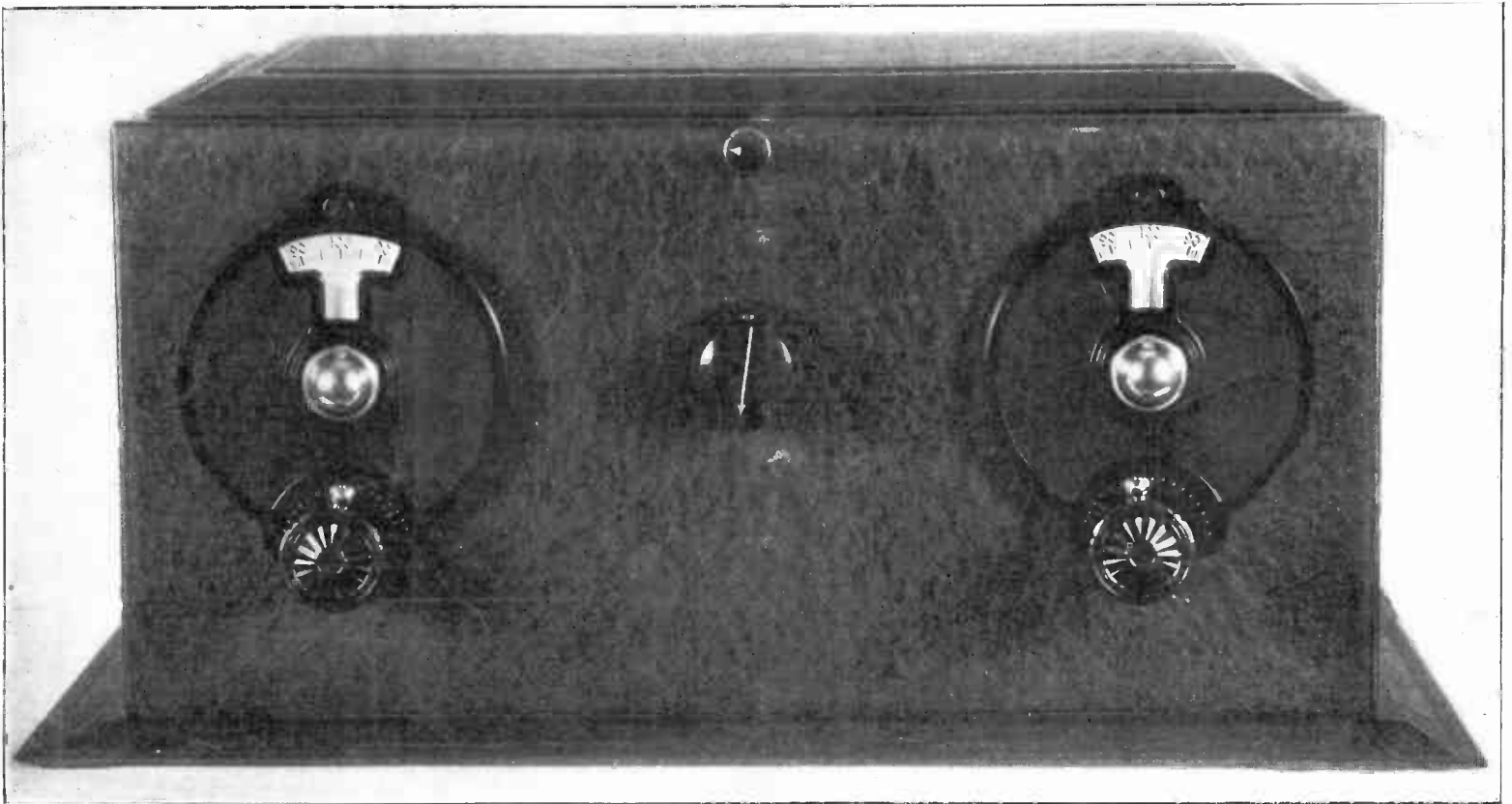

Front view of 15-560 meter receiver. See page 8 for diagram and coil construction data.

**How to Get
Foreign
Stations**

**TRF is O.K.
for Short Waves;
Circuits Given**

**The Pinnacle
of Receiver Pep;
How to Attain It**

**Magnetic
Experiments
for Novices**

RADIO WORLD, Published by Hennessy Radio Publications Corporation. Roland Burke Hennessy, editor; Herman Bernard, managing editor and business manager, all of 145 West 45th Street, New York, N. Y.

New Polo Power Transformers and Chokes

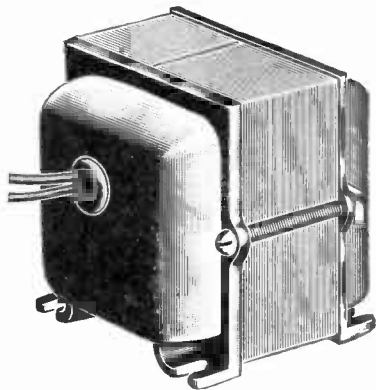

Shielded single choke. 200 ohms D.C. resistance, non-saturable at 100 milliamperes, with two black outleads, each 6 inches long. For filtration of B supplies. Inductance, 30 henrys. Cat. SH-S-CH, price.....\$5.00

The shielded single choke will pass 100 ma. One will suffice if the current is 100 ma. or less, for filtration of B supplies, provided the capacity at the filter output is 8 mfd. or more. Use two such shielded chokes if less than 8 mfd. is used at the filter output. Also, the shielded single choke may be used as in the power tube circuit for an output filter. In this connection use at least 2 mfd. for the capacity section of the filtered speaker output. Order Cat. SH-S-CH @.....\$5.00

The shielded double choke may be used for filtration where the B current is 60 ma. or less, with relatively small filter capacities, no less than 4 mfd. at the output, however. This choke consists of one winding, center-tapped. Its use is especially recommended for 171, 171A, 245 or 210 push-pull output. Connect the black leads (extremes of windings) to plates of the push-pull tubes, red center tap to B plus, and the speaker may be connected directly to plates without any direct current, but only signal current, flowing through the speaker. This system is applicable only to push-pull. Order Cat. SH-D-CH @.....\$6.00

In the same type of case a 20-volt secondary filament transformer, for 110 volts, 50-133 cycle, may be obtained for use in conjunction with dry rectifiers, such as Kuprox, Westinghouse, Benwood-Linze and Elkon, in dynamic speakers or A battery eliminators. Not made for 25 or 40 cycles. Order Cat. SH-F-20 @.....\$2.50

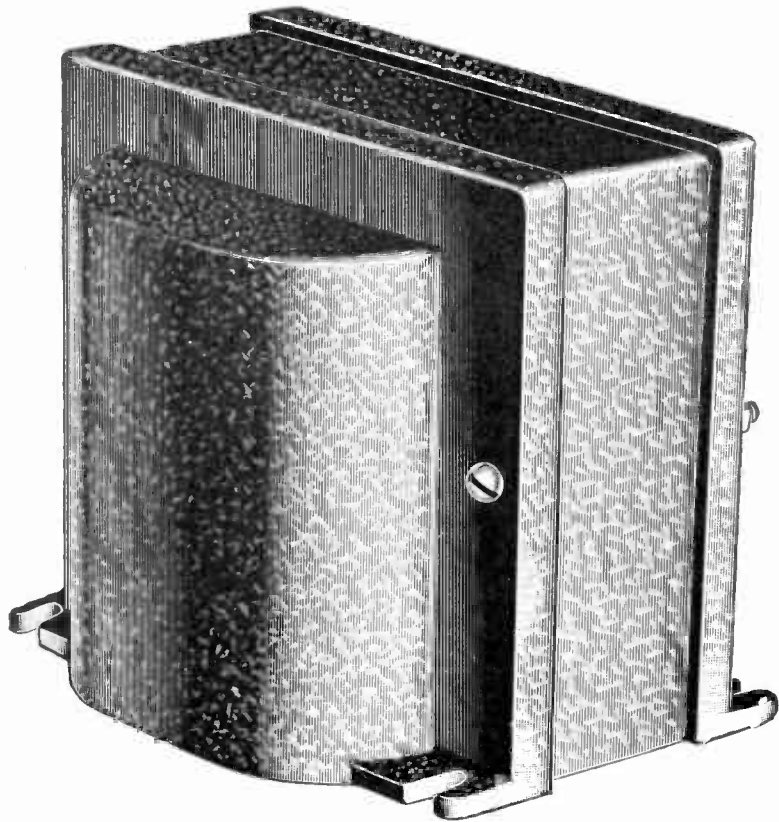

245 Power Transformer for use with 280 rectifier, to deliver 300 volts D.C. at 100 milliamperes, slightly higher voltage at lower drain, and supply filament voltages. Cat. 245-PT price.....\$8.50

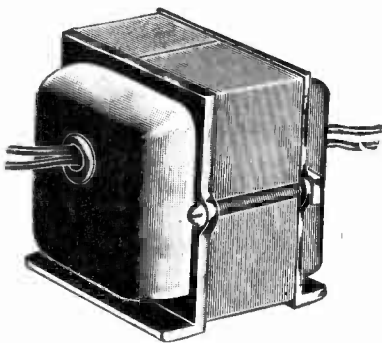

Twenty-volt filament transformer, 110 v. 50-133 cycle input, for use in conjunction with dry rectifiers. It will pass 2.25 amperes.

In a different type case, square, of cadmium plated steel with four mounting screws built in, size 4 1/2 inches wide by 8 1/2 inches high by 4 inches front to back, a 50-60 cycle filament transformer is obtainable with the same windings as the 245 power transformer, except that the high voltage secondary is omitted. Order Cat. 245-FIL @.....\$4.50
 For 40 cycles order Cat. 245-FIL-40 @.....7.00
 For 25 cycles order Cat. 245-FIL-25 @.....8.50
 [Any of the above three in the same case as the 245 power transformer, @ \$1.00 extra. Add PTC after the Cat. number.]
 A single choke, unshielded, 85 ma rating, 30 henrys inductance, for B filtration or single output filter of speaker, is our Cat. US-S-CH @.....\$1.25

The Polo 245 power transformer is expertly designed and constructed, wire, silicon grade A steel core and air gap large enough to stand the full rated load. The primary is for 110v A.C., 50-60 cycles, tapped for 82.5 volts in case a voltage regulator, such as a Clarostat or Amperite, is used. The black primary lead is common. If no voltage regulator is used, connect black lead to one side of the A.C. line, green lead to the other side of the line, and ignore red lead, except to tape the end. For use with a voltage regulator (82.5-volt primary) use red lead and ignore the green except to tape the end. The secondaries are: high voltage for 280 plates, with red center tap to ground; 2.5 volts, 3 amperes, red center tap to C plus, for 245 output, single or pushpull; 5 volts, 2 amperes, red center tap, as positive B lead, for filament of 280 tube; 2.5 volts, 18 amperes, red center tap to ground, for 224, 227 and pentode tubes, up to nine heater type tubes. Hence there are five windings.

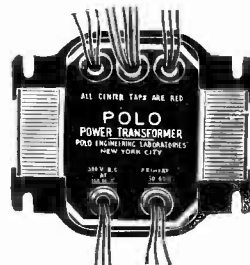

Bottom view of the 245 power transformer. All leads are plainly marked on the nameplate, including the top row.

A special filament transformer, 110 v. 50-60 cycles, with two secondaries, one of 2.5 v. 3 amp. for 245s, single or push-pull, other 2.5 v. 12 amperes for 224, 227, etc., both secondaries center-tapped. Shielded case, 6 ft. A.C. cable, with plug. Order Cat. F-2.5-D @.....\$3.75

The conservative rating of the Polo 245 power transformer insures superb results even at maximum rated draw, working up to twelve tubes, including rectifier, without saturation, or overheating due to any other cause. This ability to stand the gauntlet requires adequate size wire, core and air gap, all of which are carefully provided. At less than maximum draw the voltages will be slightly greater, including the filament voltages, hence the 18 ampere winding will give 2.25 volts at maximum draw, which is an entirely satisfactory operating voltage, increasing to 2.5 volts maximum as fewer than a total of nine RF, detector and preliminary audio tubes are used.

The avoidance of excessive heat aids in the efficient operation of the transformer and in the maintenance of good regulation, for excessive heat increases the resistance of the windings. The transformer is equipped with four slotted mounting feet and a nameplate with all leads identified. It is one of the very finest instruments on the radio market.

Highest Capacity of Filament Secondary

SPECIAL pains were taken in the design and manufacture of the Polo 245 power transformer to meet the needs of experimenters. For instance, excellent regulation was provided, to effect minimum change of voltage with given change in current used. Also, the 2.5 volt winding for RF, detector and preliminary audio tubes, was specially designed for high current, to stand 18 amperes, the highest capacity of any 245 power transformer on the market. Hence you have the option of using nine heater type tubes. The shielded case is crinkle brown finished steel, and the assembly is perfectly tight, preventing mechanical vibration. The power transformer weighs 1 1/2 lbs., is 7 inches high, 4 1/2 inches wide, and 4 1/2 inches front to back, overall.

Elevating washers may be used at the mounting feet to clear the outleads, or holes may be drilled in a chassis to pass these leads, and the transformer mounted flush.

Advice in Use of Chokes and Condensers in Filter

With the 245 power transformer either one or two single chokes should be used, or a shielded double choke, depending on the current drain and the capacity of filter condenser used. Where the capacity at the output is 8 mfd. or more for a drain of 65 to 100 ma., a single choke will suffice (Cat. SH-S-CH), but where smaller output capacity than 8 mfd. is used on such drain, two such chokes should be used in series. Next to the rectifier, in either instance, use a 1 or 2 mfd., 550 A.C. working voltage rating condenser (D.C. rating, 1,000 volts). You may use your choice of capacity at the mid-section.

If the drain is to be 65 milliamperes or less, the double choke, Cat. SH-D-CH, may be used for filtration instead of two single shielded chokes. The Polo 245 power transformer may be obtained for 25 cycles or 40 cycles on special order, as these are not stocked regularly, and remittance must accompany order. The same guaranty attaches to them as to all other Polo apparatus—money back if not satisfied after trial of five days. In these the primary and secondary voltages and taps are the same, only the case is deeper (front to back) because of larger core and wire for lower frequency.

For 40 cycles order Cat. 245-PT-40.....@ \$9.50
 For 25 cycles order Cat. 245-PT-25.....@ \$12.50
 [Note: The filter for 40 cycles should consist of two shielded single chokes, Cat. SH-S-CH with 2 mfd. next to the rectifier and 4 mfd. minimum at the joint of the two chokes and at the end of the filter. For 25 cycles the same holds true, except that the output capacity at end of chokes should be 8 mfd. minimum.]

We Make Special Transformers to Order

Polo Engineering Laboratories, 143 West 45th St., New York, N. Y.

- | | |
|---|--|
| Enclosed please find \$..... | for which ship at once: |
| <input type="checkbox"/> Cat. 245-PT @...\$8.50 | <input type="checkbox"/> Cat. 245-FIL @...\$4.50 |
| <input type="checkbox"/> Cat. 245-PT-40 @ 9.50 | <input type="checkbox"/> Cat. 245-FIL-40 @ 7.00 |
| <input type="checkbox"/> Cat. 245-PT-25 @ 12.00 | <input type="checkbox"/> Cat. 245-FIL-25 @ 8.50 |
| <input type="checkbox"/> Cat. SH-S-CH @ 5.00 | <input type="checkbox"/> Cat. SH-F-20 @ 2.50 |
| <input type="checkbox"/> Cat. SH-D-CH @ 6.00 | <input type="checkbox"/> Cat. UN-S-CH @ 1.25 |
| <input type="checkbox"/> F-2.5-D @..... | <input type="checkbox"/> 3.75 |

Note: Canadian remittance must be by post office or express money order.

If C.O.D. shipment is desired, put cross here. No C.O.D. on 25 and 40 cycle apparatus. For these full remittance must accompany order. The 25 and 40 cycle apparatus bears the 50-60-cycle label, but you will get exactly what you order.

Name.....
 Address.....
 City..... State.....



Vol. XVII. No. 13 Whole No. 429
 June 14th, 1930
 15c per Copy, \$6.00 per Year
 [Entered as second-class matter, March
 1922 at the Post Office at New York,
 N. Y., under act of March, 1879.]

Latest Circuits and News
 Technical Accuracy Second to None
NINTH YEAR

A Weekly Paper published by Hennessy
 Radio Publications Corporation, from
 Publication Office, 145 West 45th Street,
 New York, N. Y.
 (Just East of Broadway)
 Telephone, BR Y ant 0558 and 0559

RADIO WORLD, owned and published by Hennessy Radio Publications Corporation, 145 West 45th Street, New York, N. Y. Roland Burke Hennessy, president and treasurer, 145 West 45th Street, New York, N. Y.; M. B. Hennessy, vice-president, 145 West 45th Street, New York, N. Y.; Herman Bernard, secretary, 145 West 45th Street, New York, N. Y.; Roland Burke Hennessy, editor; Herman Bernard, business manager and managing editor; J. E. Anderson, technical editor.

Parallel Rectifiers

By Edison Farrell

It is well recognized that if one thing can do the work of two similar things it is better to use only one. But this does not always hold good. For example, we might build a B battery eliminator with one rectifier tube or we might build the same circuit with two such rectifier tubes. At first thought it might seem that it would be a waste of equipment to use two if one would serve just as well. The first thought, indeed, would also be the last thought were there not other factors entering into the problem. For example, there is the life of the tube to consider. If one tube is made to do the work that tube might last six months. Two tubes one after the other would then last a year. But two tubes used simultaneously for the same service might last three years. Obviously there is a great advantage in making the tubes last three years rather than one year and still get the same service out of them.

There is a homely analogy in the case of a team of horses. One horse might do a certain work for six months before it would become exhausted. Two similar horses, working one after the other, would then do the work for one year. But if the two horses are worked simultaneously the team might last for three years doing the same work. Each horse would do half the work all the time and that half would not be hard enough to cause exhaustion for several years.

While rectifier tubes do not have the same recuperative powers that horses have, the analogy is nevertheless correct for they do have a certain type of recuperative power and they do have a certain life in terms of service. Much more damage is done to a tube when it is constantly overworked than when it is worked well within its limits.

Putting Tube in Parallel

So if we have a certain work for rectifier tubes to do it is far better to team a pair of them up and divide the work between them. They will go on for a much longer time to do their work satisfactorily than if they were made to do the whole work one after the other until both were exhausted.

One of the causes of rapid exhaustion is too much heat. If one tube is made to do all of the work the filament temperature has to be much higher and the plate current will be twice as great and therefore the heating effect of the plate current will be four times as great. It is this squaring effect of the heating that makes the life span short.

Now if we put two similar tubes in parallel it is possible to work the tubes at a filament voltage 2 volts less than if only one tube were used. That is a reduction of 40 per cent. in the voltage and also in the current. The reduction in the heating will be in the ratio of 25 to 9, which is almost 3 to 1. Of course, the tubes operate by virtue of the filament heating and if the 3 to 1 reduction in the temperature reduced the efficiency of the tubes to the point where they would not render the proper service the arrangement would defeat itself. But this is not the case. The temperature is still high enough to make the tubes work when they are in a team.

Reserve Power

Even when the filament temperature is not reduced below the normal for a single tube there is a decided advantage in teaming up a couple of tubes, but in this case the advantage is mainly in the plate circuit. For a certain service a certain current flows. This current heats the plates and deteriorates the tubes. If the current is divided between the two tubes the heating is reduced in the ratio of 4 to 1. This certainly is not negligible.

Now suppose there is a sudden increase in the demand on the tubes for any reason whatsoever. One tube might not be able to supply it, or if it is, the demand may be much greater

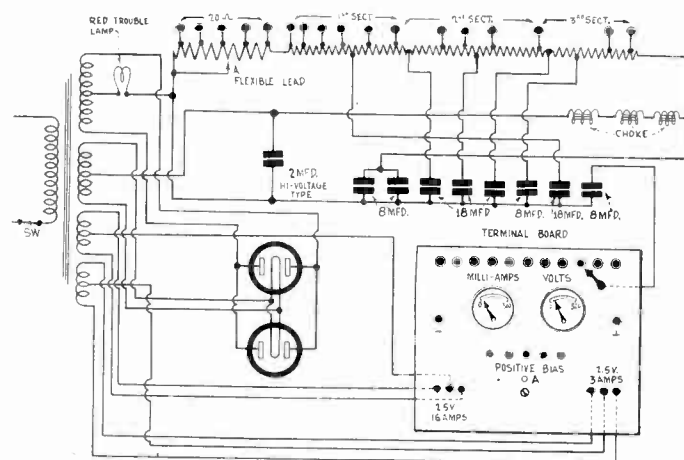

FIG. 1

THE CIRCUIT DIAGRAM OF A B SUPPLY AND A SUPPLY CIRCUIT IN WHICH TWO 280 TYPE RECTIFIER TUBES ARE USED IN PARALLEL TO LENGTHEN THE COMBINED LIFE OF THE TWO TUBES.

than should be expected of the tube. Two tubes, on the other hand, would be ample to supply the extra demand, not only for a moment but for a considerable period of time. Here, again, we might draw on the horse analogy. One horse might not be able to pull a wagon out of a bad hole, but two of them could do it easily without any undue strain on either. If the horse is willing to pull he could easily exhaust himself in a few minutes of pulling without any results. A tube is always willing and it too can exhaust itself in a very short time of overload. Undoubtedly most radio fans have seen a rectifier tube show its willingness by a moment's brilliance, after which it is dead. That happens quite often, but it would not happen so often if there were two tubes to take up the load that is suddenly put on them.

There are conditions, of course, which would make both tubes blow up just about as quickly as one in the same position. But we are not counting on accidents as the normal order of events. When two tubes are put into a circuit where one tube could serve, there are many safeguards against accidents. For example, we have the resistance in the power transformer windings. The current drawn through the circuit must encounter this resistance, and the greater the current the greater the voltage drop. Thus the resistance in the transformers will protect two tubes much better than it will protect a single tube.

We have also the resistance in the filter chokes, which works in exactly the same manner. The higher the current the greater the voltage drop, and this limits the current. In other words, the regulation of the circuit is practically the same whether one or two tube be used, and the regulation prevents excessive current when that current is divided between two tubes.

In Fig. 1 we have the circuit of a B supply in which two 280 tubes are used in parallel for the purpose of lengthening their combined life by safeguarding the two tubes and dividing the load between them. This circuit not only illustrates the manner of using two tubes in parallel, but it also illustrates a very good B supply. It has ample choking in the three choke coils and plenty of by-passing in the nine condensers of a total of 88 microfarads.

The Human Side of Noise

By Brunsten Brunn

MANY owners of super-sensitive radio receivers are disappointed with the performance of the sets because of the amount of noise they pick up.

They find that their receivers are capable to pick up regularly stations 1,000 miles away and frequently stations as far as 2,000 miles away. But they also find that the sets not only bring in the programs from the distant stations but also all kinds of electric noises originating for miles around their receivers.

Naturally these disappointed fans want to know the cure of the noise evil. What should be done?

Engineers have looked into this problem thoroughly and they have a pretty good line on the noise problem.

On the question of reducing the amount of noise they do not offer much encouragement.

One famed engineer versed in mathematics has proved that there is practically no hope of improving the signal-to-noise ratio, the criterion which determines the usefulness of a sensitive receiver. Experimental engineers have corroborated the mathematical conclusions, and their assertions seems to give less hope than ever, since we have, as a rule, greater confidence in experiment than in mathematical deduction.

The mathematical and the experimental engineers agree that there is little hope of clearing up the noise intermingled with signals from distant stations.

Sources of Noise

The sources of noise are legion and it is a wonder that any clear signals can be received from either local or distant stations. Every household electrical appliance from a lamp to a cooking stove is a potential or actual source of noise.

Some of these are continuous, others intermittent. The continuous sources of noise cause the greater interference since they give no respite. The intermittent sources of noise also may become continuous when there are many intermittent sources in one locality. This statement no one living in a crowded apartment-house section of the city will deny. The noise from turning on of electric lamps alone in the gloaming is sufficient to spoil most programs. Continuous sources of noise are those that continue all the time between starting and stopping. Thermostats, motors of all kinds having brushes, X-ray machines, vibrators, electric bells, sign flashers and the like are continuous sources, for as long as they are on they give out a steady interference.

Most of these sources of noise are man-made and cannot be called static or atmospheric. Since they are man-made they can also be cured, provided that they are attacked at their origin. But the remedy is expensive and it seems that nobody bothers.

Why, for example, should one housewife stop cleaning her house with a vacuum cleaner just because somebody else wants to listen to a radio program?

Why should she have the motor in the cleaner fixed as long as it runs without trouble to her?

Why should an X-ray specialist stop plying his trade just because somebody happens to be in no need of X-raying? There may be a time when the law will say that only electrically silent vacuum cleaners, X-ray machines, door bells and the like shall operate. That may stop the operation of nearly all electrical machines and appliances, for it is a job of first magnitude to silence all the electrical devices.

Nature's Noise

It may be that a law prohibiting such devices would be unenforceable, even if the law officers tried enforcement, for at this time at least nobody is really in favor of it. While everybody is in favor of having the noise stopped, nobody wants to stop the noise he himself makes. Nobody could get away with bootleg noisemakers in case a general law were passed, for every noise maker shouts loudly that it exists and where it exists.

While man-made noise predominates in the average radio receiver on an average day, there is plenty of natural noise which is entirely uncontrollable, and it may be that stopping the man-made noise would not be worth while in view of the situation.

What would it avail, for example, if all the man-made noise were stopped only to have 49 per cent. of the total noise remaining in the form of natural noise? It really makes no difference whether all the noise is present or only part of it on certain days, for just a small part of it is sufficient to force the listener to turn his set off.

It is the super-sensitive radio receiver that brings in most of the noise? Why should this be so? Because if the set is sensitive enough to pick-up the signals from a station located 3,000 miles away it is also sensitive enough to pick up a larger proportion of the man-made and natural noises originating in an area having a 3,000 miles radius, or 28,000,000 square miles. In

area having a 3,000 mile radius, or 28,000,000 square miles. In that area there must always be many atmospheric discharges every few seconds and countless examples of man-made noises.

It is not enough to say that only those atmospheric discharges occurring in the area of 3,000 mile radius about the receiver will be picked up. Chances are that, as far as static crashes are concerned, the radius will be increased to 12,000 miles, and the area that of the surface of the entire earth. If short-wave signals travel around the earth a time or two, why not the static crashes which are much stronger than the short-wave intensity? And at least a portion of the crashes will be within the range of waves that travel long distances.

Local Reception Clear

Reception of local stations is usually clear except on certain days when thunderstorms are in the vicinity. And this clearness holds as well for the super-sensitive receivers as for the relatively insensitive sets, or at least it holds nearly as well.

The reason why the signals from the local stations are clear is that the signals are strong as compared with the noise strength. That is, the ratio of the signal to the noise is high.

The only practical method of combating noise that has yet been discovered is to increase the strength of the signal until it drowns out the noise.

This method of combating the noise, whether natural or man-made, has been advanced by radio engineers since the beginning of broadcasting. It was for this reason that the power of broadcasting stations was increased from 500 watts to 50,000 watts, the limit now set by the Federal Radio Commission. If the engineers and certain members of the Federal Radio Commission who understand the problem could have their way the limit would not be 50,000 watts. Possibly it would be a million watts. If such powers were used by a few stations in well-selected geographical positions the problem of noise would be solved in all but a few out-of-the-way places.

Since the signal strength of a station varies approximately inversely as the distance, if the strength of a station were increased ten-fold, the service radius of that station would be increased in the same proportion, and the service area would be increased hundred-fold. For equal distribution of listeners in that area the reliable service, in terms of listeners, would also be increased hundred-fold, and that by increasing the power of the station only ten-fold. That, obviously, would be economy both in power and in channel space.

Reduction of Noise

The noise remains constant in so far as the power of the transmitter is concerned. But the signal at any given point in the service area of the station would be increased in proportion to the increase in power of the station. Hence super-sensitive receiver would not be necessary, and there would be little complaint of noises in the signals. At least one of these super-power transmitting stations could be received in any part of the country with a crystal or a one-tube set. Two or three stations could be received everywhere with a three-tube set, and with much less noise.

We said above that local stations could be received with almost as little noise with a very sensitive receiver as with a modest receiver. They could be received with exactly as little noise were it not for the fact that receiving tubes introduce noises. Not a little of the noise that is heard in multi-tube receivers is introduced by the tubes themselves, and therefore the larger the number of tubes in a set the more noisy that set will be. This is quite apart from the noise that the multi-tube set, when adjusted to high sensitivity, brings in from the outside. Is there any wonder that the super-sensitive set mingles a great deal of noise with the signals from the distance stations?

Quieter tubes must be developed to reduce tube noises. Engineers are working on this problem, a problem which may find a solution in research.

But there is still another source of noise which shows up when there is a high degree of amplification, and that is the irregular conductivity of the wires with which the receiver is put together. It was thought formerly that electric current flowed along at a steady rate in a conductor when a steady voltage was applied across the conductor. This is not known to be erroneous. The current flow is quite irregular, and the irregularities when magnified millions of times, as they would be in a super-sensitive receiver, make themselves heard in the loud-speaker. This irregularity in the conductivity is now under investigation in large laboratories, and it may be that means will be found for silencing the new noise. Then, again, it may be that it will always be with us like the poor.

SW Reference Tuning

[The National Company has just brought out its 1930 double screen grid short-wave 5-tube Thrill Box, in battery-operated and AC forms. In connection with the operation of these many interesting pointers are given for short-wave reception. Hence "Operating Notes," by James Millen, in collaboration with Robert S. Kruse, from the company's short-wave pamphlet, part of which is reprinted from "Radio News," are published herewith. A copy of the full pamphlet, with list of short-wave broadcasting stations of the world, may be obtained by sending a request to Technical Editor, RADIO WORLD, 145 West 45th Street, New York, N. Y., and enclosing a personally addressed, stamped envelope.—EDITOR.]

ALTHOUGH the reception of foreign short-wave broadcasting stations is no longer an unusual experience for thousands of radio fans, there are still many owners of short-wave receivers who have never heard anything outside of the United States or Canada. Their disappointing failures can be explained usually by either or both of two reasons: they do not exercise enough patience in tuning their sets, or they do not know when and where to listen.

From his contacts with several thousand purchasers of a popular short-wave receiver kit, the writer would say that non-technical people have been somewhat oversold on the idea that foreign reception is merely a matter of flipping a switch. It isn't at all. Troublesome hand-capacity effects have been pretty well eliminated, but you still have to hang a bit tensely over the dials and wait for signals to fade in to an understandable level.

Must Master Tuning Art

The advent of short-wave broadcasting (as distinctly distinguished from "ham" radio telegraphy) has revived the fine art of dial twisting, and unless the set owner masters it he will never know the thrill of hearing VK2ME in Sydney, or RA97 in Siberia, or that German jawbreaker at Koenigswusterhausen.

The most important dial or knob is the one that controls the regenerative action of the detector.

This is true for all types and makes of short-wave receivers, as they all use a regenerative detector, with and without tuned or untuned r. f. amplification and with one, two or three stages of variously coupled AF amplification.

Simply keep the detector in a continual state of oscillation by rocking the regeneration dial back and forth as you turn the tuning dial a fraction of a degree at a time. When you encounter a carrier wave you will hear a tell-tale whistle.

Tuning by Zero Beat

If the signal is fairly strong, you can back down the regeneration until the whistle disappears; if the signal is rather weak, it is best to "zero-beat" it. This is the process of keeping the circuit in oscillation, but tuning it so that the frequency of the local oscillations is exactly the same as that of the incoming carrier wave. Under this condition no whistle is generated, there being no heterodyne action, and the voice or music can be distinguished.

The signals will sound rather "mushy" if they are zero-beated, but at least they will be recognizable. Sometimes, after a station is brought in by the zero-beat method, its strength may increase so much that the detector can be thrown out of oscillation; the signals will then clear up considerably.

Unless a very short antenna is used, the tuned RF stage is rather broad. The trimmer condenser serves to compensate for various lengths of antenna that may be used, and need be set but once, when the receiver is first put in operation. As it affects the operation of the detector stage, it should be adjusted and then forgotten, in order that the stations may be logged accurately.

Method of Alignment

The aligning procedure is simple: the detector is put just over the edge of oscillation and the trimmer condenser turned until a point is found where oscillation ceases. Of course, the detector may still be made to oscillate by simply advancing the regeneration control. This method of alignment is much more accurate than the usual custom of tuning in a station for maximum volume.

Having a good receiver in good operating condition is only half the battle. You have to know when to listen, and at what points on the dials. The accompanying list of stations, with their hours of operation in Eastern Standard time, should be of great assistance to you in this respect.

The Difference in Time

One thing many people cannot seem to get into their heads is that time is different in different places in the world. Many short-wave set owners finish their suppers at 7:00 or 7:30 in the evening and then sit down to their receivers with the innocent expectations that there will be short-wave stations to hear all evening. This is not always so. Seven o'clock New York time is midnight in London, and G5SW, the famous British Broad-

casting Company's short-waver, is just signing off for the night.

The writer has read hundreds of letters from people who complain of their inability to bring in London for their bridge guests—at nine o'clock. This is an age of scientific achievement, but even a dozen short-wave sets won't bring in a station that isn't transmitting.

Right now the best times to hear foreign stations are early in the morning and about the middle of the afternoon.

Between 4 and about 8 a. m. the stations in Australia, Siam, Siberia, the Dutch East Indies and Holland are quite active, and they deliver astoundingly strong signals. VK2ME, in Sydney, is testing pretty regularly with Schenectady and with the British Post Office stations in England, and comes through with fair reliability. He is not on every morning, but if you don't get him one day you probably will the next.

Dutch Stations Praised

Those Dutch stations are by far the best ones. PLE and PLF, in Java, working with PHI, PCO and PCK in Holland, operate powerful transmitters, and if you tune way down low on your smallest coil, you can get them loud enough to wake up the family next door.

If you have always confined your listening hours to the early evening, you won't know your set in the early morning. The air is comparatively clear and quiet and the very low-wave stations skip in without much coaxing.

During the afternoon the German stations get busy, and come through just a little under WGY. In England G5SW starts at 2 p. m., E. S. T., and is an old stand-by.

Skip Distance Effects

As you know, skip distance effects vary with wavelength, time of day, and the condition of the atmosphere. Therefore, divide your listening schedule something like this: 14 to about 20 meters, best from daybreak to about 2:00 p. m., and then fades out as darkness approaches; it is useless to listen below 20 meters after dark. 20 to 35 meters Europeans from 1:00 p. m. to about ten in the evening (if they happen to be putting on late programs). 35 to 75 meters, best between twilight and day-break.

You can locate many of the foreigners by spotting some of the American stations. For instance, you can get W2XAF (WGY) pretty easily on 31.48 meters; crawl just under him and look for PCJ, NRH, and the German station at Koenigswusterhausen.

Little NRH, in Costa Rica, is about two degrees below these. You can spot this group of stations because they are about ten degrees below a very powerful code station on about 33 meters. This is XDA, in Mexico City, which also occasionally uses voice. When it does it sounds just about as WJZ does to a receiver located in Bound Brook.

Crowded on 48 and 49 Meters

There is a whole mess of stations around 48 and 49 meters. Generally the American stations fill up the ether pretty well in this band, but if your set is selective you can cut between them and pick out some interesting stations in Central and South America. First locate W3XAU (Philadelphia), and tune just above him for that station, HRB, in Honduras. Log KDKA (W8XK) on its new 49 meter wave, and just below him find HKT, in Bogota, Colombia. After tuning in the powerful American telephone transmitter WND, on 44.4 meters, hang on close and listen carefully for VRY, in Georgetown, British Guiana. The operating hours of these South Americans are given in the list. It is quite easy to identify them, as they obligingly announce in English as well as in Spanish.

Short-wave reception conditions have the habit of changing quickly and without apparent provocation. If you don't hear a single foreign station for a week don't feel discouraged; the next week you may hear a dozen at a time.

ACTION OF AN AUTOMATIC VOLUME CONTROL

DOES an automatic volume control keep the volume level exactly constant or is there some variation?—J. B. K.

There is always some variation in the volume or the automatic feature would not work. It is the variation that makes it work. We have the same proposition in so-called automatic rheostats. When the voltage rises the current rises also. But the rise in the current causes an increase in the resistance which prevents the current from rising as high as it would have done had the automatic feature not been present. Likewise, when the signal voltage increases the automatic volume control causes an increase in the grid bias, which in turn reduces the amplification. But the net volume is greater than it was before the signal began to increase. However, it is smaller than it would have been had the automatic feature not been present. What the automatic volume control does is to reduce the signal fluctuations to a point where they are not

Why TRF is O. K.

By J. E.

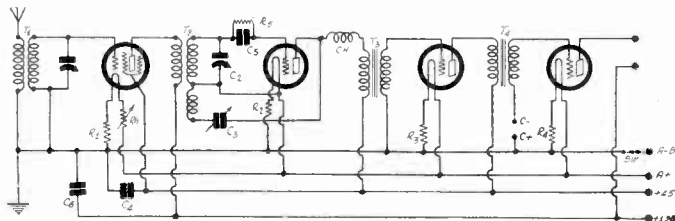

FIG. 1

THE CIRCUIT DIAGRAM OF A FOUR-TUBE SHORT-WAVE RECEIVER UTILIZING ONE 222 AND TWO GENERAL PURPOSE TUBES AND ONE 112A.

IF tuned radio frequency amplification is a desirable thing for broadcast reception, why is it not also a good thing for short-wave reception? Are there any reasons why it should not be used for short-wave reception? Also, if regeneration is a good thing for broadcast reception, is it not also a good thing for short-wave reception?

Radio fans have been treated to all kinds of adapters and converters for receiving short waves with their broadcast receiver. Is this because complete short-wave receivers are unworkable, or is it because most fans would not pay a few more dollars to have a complete short-wave receiver as long as they can get some results with adapters and converters?

TRF Just as Good for Short Waves

Radio frequency amplification is just as good for short-wave reception as for broadcast reception. There are only two technical reasons why it has not been used. One is that the selectivity is so great that looking for a short-wave station used to be as difficult as opening a combination lock without having the combination. The other is that it is difficult to prevent oscillation in the circuit.

But both difficulties have been solved. It is not necessary to make the set unmanageably selective, yet it is not necessary to sacrifice the selectivity. It is only necessary to get rid of the unmanageability. It used to be difficult to keep the circuit from oscillating, but that is no longer true. So now there are really no technical reasons why tuned radio frequency amplification should not be used for receiving short-wave stations.

Complete Receivers Workable

Of course, complete short-wave receivers are workable, even those of the tuned radio frequency type. More of them are in successful use than adapter type hook-ups. This does not include the converter type, for most of these are successful. Many fans who build short-wave adapters or converters undoubtedly would build complete short-wave receivers if they had the opportunity. The opportunity is not a matter of availability of the price at all but rather the availability of the parts and the circuit diagram.

Regeneration in the circuit is not only desirable but almost a necessity. It is the thing that makes the circuit exceedingly sensitive when sensitivity is needed; selective, when selectivity is needed; easy to tune, which is always necessary, and that which makes it possible to tune in interrupted continuous waves as well as spark and modulated waves.

We have in Fig. 1 the circuit diagram of a four-tube regenera-

five receiver, which might be a short-wave broadcast, or all-wave receiver, depending on the choice of tuning coils. It will be noted that the circuit is like the circuits of many broadcast receivers. Whatever virtues the circuit has as a broadcast receiver it has as a short-wave receiver also.

The tubes incorporated in the circuit are of the direct current type because with DC on the filaments much quieter operation is obtained on the short waves and also because we have a greater choice of tubes. For example, we may build the circuit with 201A, 222, and 112A tubes, or we may build it with 99s, 222s, and 120s, or we may use the new tubes just announced, the 230, 231 and 232. There is really an advantage in building the circuit with small tubes since a large power output is not necessary and the saving of battery consumption is a consideration that should not be overlooked.

Amounts of Power Needed

Let us see what the filament power is for this circuit when built with the three different classes of tubes. When we use one 222 and three 201As or 112As the total filament power is 5.3 watts, counting that used up in the ballast resistors. When we use one 222, two 99s and one 120 tube the total filament power is only 1.728 watts, counting the loss in the ballast resistors adjusted to a voltage source of 4.5 volts. When we use the new tubes, one 232 screen grid tube, two 230 general purpose

Peculiarities of AC

Those who contemplate operating their newly-constructed short-wave receiving equipment, whether a straight receiver or a Superheterodyne converter type, will do well to check over the condition of their A voltage and B voltage sources.

The writer has been engaged in making experiments with short-wave receiving circuits of both the above general types and has found that reception of short waves via either system is sadly impaired if B voltage filtration is poor and likewise if the source of A voltage has a low ripple.

Signals Not Always Strong

If you have had previous experience along these lines you need not read on, but to those who haven't, I have a brief word.

When you use a converter type of short-wave pick-up you have added a stage of tuned radio frequency plus an oscillator, a very good combination.

Now, if the short-wave signal intensity is good and you get good loudspeaker response, why I suppose that all's well, but it often happens the short-wave signal is not so strong, or it seems to waver. Here the effect of background noise is much more apparent than it was before, and the cause of it must be traced and removed, or at least the effect must be subdued.

It may have been thought by many that some of the noises associated with converter operation were a necessary accompaniment of short-wave reception, but this is not necessarily true, although some may show up from which the regular broadcast set seems to be immune.

Inspect the Set First

In case you want to find out where some of the continuous background noise comes from, try looking for it around the

LIST OF PARTS

For Fig. 1

- T1—One set of four-terminal plug-in coils as described.
- T2—One set of five-terminal plug-in coils as described.
- T3, T4—Two audio frequency transformers.
- Ch—One 50 millihenry choke coil.
- C1C2—Two Hammarlund .0005 mfd. straight frequency line condensers.
- C3—One Hammarlund .00025 mfd. condenser.
- C4, C6—Two 1 mfd. by-pass condensers.
- C5—One .00025 mfd. grid condenser with resistor clips.
- R1—One 20 ohm ballast resistor.
- R2, R3, R4—Four 4 ohm ballast resistors.
- R5—One 2 megohm grid leak.
- Rh—One 30-ohm rheostat.
- Sw—One filament switch.
- Five UX sockets.
- One UY socket.
- Ten binding posts.
- Two vernier dials.

Requirements for

IHAVE been looking into the possibilities of a car receiver but am unable to decide what tubes to use, how many of them, and what type of circuit to put them in. Will you kindly point out the advantages and disadvantages of the different kinds of tubes and tell what type of circuit you think is suitable?—B. O. B.

The first requirement of the tubes used in a car receiver is ruggedness. The AC tubes like the 227 and 224 are perhaps the most suitable from this point of view. Unfortunately, these tubes take a good deal of current from the car battery. While tubes of the 226 type have not been recommended for this service they should be suitable also, for they have sturdy filaments and low filament voltage. As many as four of these tubes can be connected in series across a 6-volt storage battery. But these tubes are subject to ready oscillation if neutralization is not employed. The new tubes, 230, 231 and 232, just announced, should prove satisfactory, since three of them can be connected in series. The power tube in this series takes a different cur-

for Short Waves

Anderson

tubes and one 231 power tube, the total filament power required is only one watt, when the voltage source is 3 volts, that is, two dry cells in series, or better, four dry cells in series parallel. When we use a 2 volt source, such as a single storage cell, the power is only 2/3 of a watt.

We must confess, however, that when the new tubes are used in a circuit like this a few modifications are necessary. These will be taken up after we have discussed the circuit as it should be for the older tubes. The changes concern the three voltages, A, B, and C and the arrangement of the filament circuit.

T1 is an input transformer which should be of the plug-in type if short waves are to be tuned in. An old tube base of the UX type, or a special form of this type, should be used for winding the coil. If the tuning condenser C1 has a maximum capacity of .0005 mfd., the secondary of the larger of the plug-in coils should have 24 turns of No. 24 DCC wire on the tube base. The primary of this transformer can have three or more turns but not more than ten. If the desired number of turns cannot be put on the form, as sometimes happens, use one size finer wire or use double silk instead of double cotton.

Range of Coils

This coil will reach to 1,500 kc with the tuning condenser specified, but it is impossible to say how far it will go in the other direction. However, if another coil be made with 5 turns for the secondary and one or two turns for primary, the entire

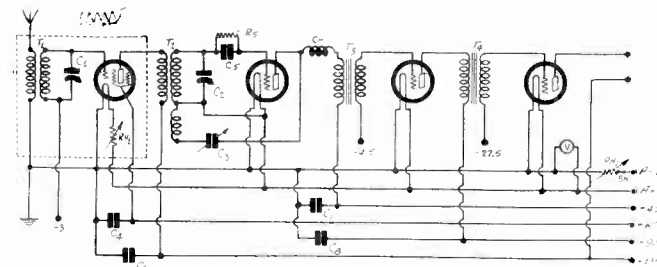

FIG. 2

THE CIRCUIT DIAGRAM OF THE SAME SHORT-WAVE RECEIVER ADAPTED TO THE NEW LOW VOLTAGE TUBES.

short-wave band will be covered. It is well to wind the smaller coil with heavier wire, such as number 18 double cotton or silk, although it is not necessary to use heavier wire.

The three-circuit tuning coil T2 is wound on an old UY base. This has to be removed from an old tube because there are yet no forms of this type made for plug-in coils. In winding the secondary of this coil start with the G prong for the grid connection, bring the wire through a small hole in the side of the form near the top and directly over the grid prong. Wind on 24 turns of No. 24 DCC wire, tap and bring the tap lead to the K prong on the form. Continue the winding until five more turns have been put on and then terminate at the P prong on the form.

Treat this coil sparingly with collodion so that the turns will be held firmly in place. On top of this winding, near the bottom, wind the primary, using the finest double cotton covered wire available. Ten turns will be enough. Bring the terminals of this winding to the two heater prongs on the base.

The smaller three circuit tuner is wound in a similar way on the same type of base. The secondary may have five turns, the tickler two turns, and the primary three turns. If No. 24 DCC wire is used for this coil there will be ample room without winding the primary on top of the other windings.

Control of Regeneration

The regeneration is controlled by means of a variable condenser C3, which is the most common method employed in short-wave sets. Since this condenser is "live" on both sides it is subject to body capacity when the circuit is adjusted to critical regeneration or to oscillation, unless precautions be taken against it. The condenser should be set back so that it may be coupled to the knob with an insulating rod. There should also be a grounded shield between the condenser and the knob. The capacity of this condenser should be .00025 mfd.

The 50 millihenry choke Ch is put between the plate and the primary of T3 to force the signal currents through the tickler.

The volume is largely controlled by means of the tickler condenser C3, but an additional volume control is provided in the 30 ohm rheostat Rh in the positive lead to the screen grid tube filament. While this is not needed often it is well to have it available.

When the tubes used are 222, 201A or 112A, the ballast resistors should have the following values: R1, 20 ohms; R2, R3, R4, each 4 ohms. The bias on all the tubes is provided for except that for the output tube. Two binding posts are provided for this, to which a 13.5 volt battery should be connected. The two by-pass condensers C4 and C6 should be 1 mfd. each, or larger.

Circuit for New Tubes

When the new tubes are used in the receiver the circuit should be arranged as in Fig. 2. The volume control rheostat Rh1 is retained as in circuit Fig. 1 but a common rheostat Rh2 of six ohm resistance is put in the common lead. This rheostat should have a built-in switch Sw. A low-range voltmeter V should be permanently connected across the filament circuit so that the proper voltage of 2 volts may be maintained at all times. The voltage source should be three volts, supplied by four dry cells connected in series-parallel. A "C" battery should be provided so that three volts can be applied to the first tube, 4.5 volts to the third, and 22.5 volts to the last. The proper plate voltages and the screen voltage are given. There are two additional by-pass condensers, C7 and C8, each of which should be one mfd. or more.

The other constants are the same as in Fig. 1.

The first stage in Fig. 2 is shown to be included in a grounded metal shield. This is desirable although it is not always necessary. It is also desirable to use a shield in the same manner in Fig. 1.

for Short Waves

set first. A low-pitched smooth ripple, unnoticeable when regular broadcasting is being received, may originate with the A power pack.

You may have overloaded the pack by the addition of two tubes or you may have to increase the choke inductance value in this pack.

Also, the present filter condenser capacity may be insufficient for the new operating conditions or it may be simply defective. This capacity is generally composed of a unilateral condenser—or several units of such condenser capacity enclosed in a single can.

Or, if this field of investigation does not prove fruitful, some additional by passing of the B voltage source may be required.

The values of by pass condensers for this purpose may be in units of 1 mfd. each, at least.

Good Tubes Important

I should also include at this point the advisability of selecting good tubes, or at least checking upon the tubes you now have.

Not so long ago a person sent a short-wave converter and its tubes to the writer for inspection, claiming that it wouldn't work. A brief checkup with a tube tester, made while the converter was being operated, showed one tube was short-circuited from grid to filament.

Poor electrical contact of any vital set or converter part produces its share of background noise, too, due to high contact resistance and so look for trouble in your own equipment first. Don't forget to solder joints.

A poor ground connection is a fruitful source of noise, especially with a converter, and high contact resistance at this point must be avoided.

An Auto Receiver

rent from the other and therefore it cannot be connected in series with the other tubes. Since there is likely to be a great deal vibration in the car it is necessary to mount the tubes, or the complete receiver, so that the vibrations will not be transmitted to the tubes. See last week's issue, June 7th, for a full discussion of the three new tubes. The sensitivity requirements of a car receiver vary widely and for that reason a receiver will not give satisfactory service on a car unless there is an automatic volume control. But a control of this type adds at least one tube to the circuit. A receiver having three tuned stages controlled by one dial, two screen grid tubes, one general purpose detector with grid leak and grid condenser type of detection, one general purpose audio amplifier tube, one power amplifier or general purpose output tube, and two audio frequency transformers should make a suitable receiver for a car. Another tube might be added for automatic volume control.

The tuning condensers should be provided with brakes so they will not jar out of tune.

Coils for All-Waver

By Herman Bernard

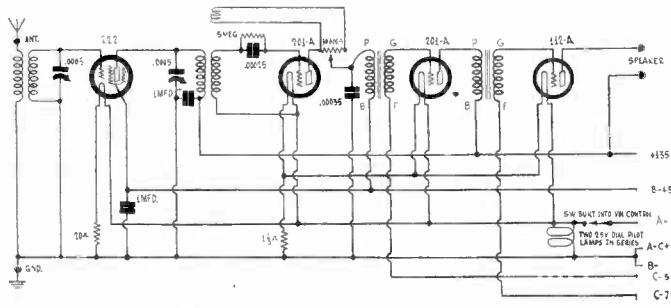

CIRCUIT DIAGRAM OF THE ALL-WAVE UNIVERSAL BATTERY MODEL RECEIVER.

[This is the second instalment of the article on the construction of the Universal All-Wave Receiver, operating on one 222 tube, two 201As and one 112A. Hence the receiver may be operated from a storage battery and 135 volts of B battery, or from storage A battery and B eliminator, or A eliminator and B batteries or A and B eliminators. In subsequent articles the construction of an AC-operated all-wave receiver will be described.—EDITOR.]

EVERYBODY interested in radio reception is interested in broadcast waves, or short waves, or both. At some time or other a decision usually is made to build a broadcast receiver. The temptation always is to make some provision for reception of short waves, as well, even if the main consideration are broadcast waves.

One such provision might be the use of a suitable short-wave converter, which uses an existing broadcast receiver exactly as it is, and besides three more tubes in the short-wave converter. A picture diagram of such a converter was published last week, issue of June 7th. But such a provision most likely applies with greatest pertinence to the utilization of an existing broadcast receiver, whereas the present discussion concerns the construction anew of a receiver, and one that makes provision for both short waves and broadcast waves.

One of the points that must arise is the tuning of the broadcast wavelengths without using two coils to cover 200 to 545 meters, or, using one coil, without having to use an additional condenser for tuning. Therefore a .0005 mfd. straight frequency line condenser fills the need nicely, as there are just that condenser and just one coil for each tuned circuit in the broadcast band. As there are two tuned circuits, the total number of coils used is twice what there would be for one tuned circuit, or six, instead of three. Besides, there is a regeneration winding additional, making seven coils, or the regeneration winding may be on the detector coil form.

Coil Winding Data

The data on winding the coils will be predicated on the assumption that bakelite or hard rubber tubing is used, even though the commercial coils recommended are wound on ribbed forms, to afford 93 per cent. air dielectric. It is not practical to duplicate the commercial coils, as the ribbed forms are made by machinery, and, unfortunately, are not independently available. Nevertheless, the same wave band coverage will be assured, even though the radio frequency losses will not be so low when the standard bakelite or hard rubber forms are used.

Get two pieces of bakelite, $2\frac{5}{8} \times \frac{1}{2}$ inch, and on a central longitudinal line of each drill four $6/32$ machine screw holes (No. 29 drill), separated from one another as follows: First hole, $3/16$ inch from the end; next hole, $1/2$ inch from its predecessor; third hole, also $1/2$ inch way; fourth hole, $1\frac{1}{4}$ inches away from its predecessor. Both pieces of bakelite are drilled exactly alike, and will serve as the coil base. Into each of the four holes will be placed a prong, such as is used on the base of a tube or on phone or speaker cords.

Now get six round bakelite forms, $2\frac{3}{4}$ inches in diameter and $2\frac{5}{8}$ inches axial length, and drill two holes along the axial length $2\frac{3}{4}$ inches apart, to correspond to the extreme holes on the bakelite mounting strips already drilled. Considering hardware, there will be a clearance of about $1/4$ inch between tops of two pair of prongs, for winding the primary of 5 turns of No. 24 single silk covered wire. Use space between second and third prongs. Put on this winding before the prongs are attached to the strip or the strip to the circular bakelite form.

Ample Overlapping of Tuning

Between the prongs, $1\frac{1}{4}$ inches apart, or about 1 inch apart, considering the hardware at top, wind on the form three turns of No. 18 enamel wire, spacing the turns about the thickness

LIST OF PARTS

Two sets of precision, de luxe coils, wound on ribs, 93 per cent air dielectric, three coils to a set, total, six coils to cover 15 to 560 meters (or build your own coils, as described).

One plate coil with mounting bushings.

Two Hammarlund .0005 mfd. straight frequency line condensers.

One 20-ohm filament resistor. One $1\frac{1}{3}$ -ohm filament resistor.

One $14\frac{1}{4} \times 9\frac{1}{2}$ inch bakelite subpanel, with four UX (four-prong) sockets and one built in UY (five-prong) socket; two coil receptacles, also built in.

One 5-lead battery cable, 36 inches long, with five-prong plug.

One steel cabinet with crinkle brown finish, $7 \times 15\frac{1}{2} \times 10\frac{1}{2}$.

One steel bottom shield for cabinet.

One 1-to-3 audio transformer. One 1-to-5 audio transformer.

Two insulating washers, for volume control.

Four subpanel brackets.

One antenna-ground post unit. One speaker post unit.

One .00025 mfd. grid condenser with clips.

One Lynch 5 meg. metallized grid leak.

Two National type VB-D variable ratio dials, maximum reduction 20-to-1, with two 2.5 volt pilot lights and illumination brackets.

Two Polymet 1 mfd. bypass condensers, single lug type (case goes to ground).

One 30,000 ohm Clarostat wire-wound potentiometer, with switch attached.

Four spacers for tuning condensers.

of the wire. As there will be considerable overlapping of wave-lengths, two turns may be used instead of three. Space winding is important.

Anchor the beginnings and ends of windings through two small parallel holes you drill in the circular form. Then attach the circular form to the mounting strip, by passing the hardware through the coinciding holes, and tightening down. It is preferable to put lugs at top of the strip and bakelite spacers between strip and circular form. Solder the terminals of the coils as follows: One secondary terminal to one extreme prong, the other secondary terminal to the other extreme prong, primary to the two inside prongs. Make up two units like this, each representing Coil No. 1.

The same procedure is followed in making and winding Coil No. 2, except, of course, the number of turns is different. Put on four primary turns of the same kind of wire as used for the previous primary, and put on 17 turns, space-wound as previously, for the secondary, using No. 18 enamel wire here. Two such coils are needed.

The two types of coils previously outlined will cover the short-wave band, 15 to 200 meters, so the only tuned type required additionally is to enable tuning in the broadcast band.

The Broadcast Coil

Coil No. 3, therefore, will consist of 14 turns primary, separation of about $1/4$ inch, and then a secondary of 52 turns, for .0005 mfd. tuning, both primary and secondary wound with the same kind of wire, namely, No. 24 silk covered. Please note that No. 18 wire is **not** used on the secondary of Coil No. 3, nor is space-winding used.

The plate winding, if it is to be an adjustable coil in the detector circuit, consists of 10 turns of No. 18 enamel wire on $2\frac{3}{4}$ inches diameter, 1 inch axial length. Put on the winding at one extreme end, to allow room for a right-angle pivot bracket. Use two pieces of bakelite tubing about $1\frac{1}{4}$ inch high, to pass $10-32$ machine screws (about $3/8$ inch outside diameter), as support for the pivot and hence support for the coil form itself.

The direction of winding is not important, except in the case of the seventh or plate coil. But the easiest solution is not to regard the direction of winding even here, but to connect the coil in circuit, and, if oscillation fails, reverse the connections of terminals of the plate coil.

In mounting the tuning condensers, use $1/8$ inch thickness of spacers to keep the condensers' rotors off the pilot lamp brackets.

Regeneration Coil on Detector Form

It is practical to obtain regeneration with a detector plate winding on the same form as the primary and secondary. If that method is used, wind one turn for Coil No. 1, six turns for Coil No. 2, and 18 turns for Coil No. 3, as the plate winding, in the same direction as the other windings, using No. 24 silk wire. Connect leads to this winding appositely to the secondary connection.

A Goal: Pinnacle of Pep

By Lester Chadwick

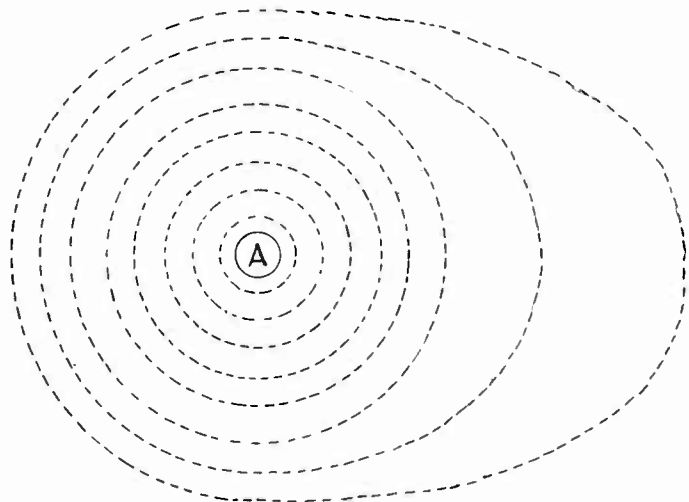

FIG. 1

A CONNECTED-LINE DIAGRAM OF PARTS OF A RADIATED ELECTRIC FIELD AT THE SAME POTENTIAL AROUND A CIRCULAR RADIATOR A.

A TOO literal interpretation of wiring schematics often leads the constructor into byways from which extrication is often tedious, it is well to point out some pitfalls.

Let us consider the energy collector, the antenna.

When you stretch a horizontal wire from your house to the barn or a conveniently high tree or pole, you doubtless think its all over but the incidental connections. Well, it's not quite so. An aerial wire is exactly similar to a wire in an alternating magnetic field and its disposition in that field invariably has a pronounced effect on the obtainable results, from the point of reception, and therefore, it deserves attention.

Antenna's Effectiveness

The effectiveness of a horizontal antenna depends directly on its height vertically upward from the earth's surface, and if the earth at the given point under consideration is covered with houses the "earth's surface" then becomes the roofs of the surrounding neighborhood. If you live along a river which runs through a valley your aerial is bound to be shielded to a certain extent and in this case tall supports are an absolute necessity. Also (this is somewhat theoretical) if the nature of the terrain between your location and the transmitter is such that absorption effects predominate (those being due to furious or semi-ferrous deposits or an arid soil condition) then you must elevate your antenna to a point where the radiation field from the transmitter is stronger.

The horizontal length of an aerial largely determines the amount of current that flows, but the height above the earth necessary to obtain good reception depends upon the absorption radius of the transmitter radially distant from you. Thus if all the radiated energy available from a given station at a height of 10 feet from the earth was dissipated completely in 100 miles, then you would have to elevate your aerial to sufficient additional height to intercept the balance of the radiated energy that is dissipated out at a greater radial distance. The wave front due to a horizontal wire radiator (the transmitting antenna) is really only a convenient fiction, a theoretical condition whose effect when explained practically can be made to fit in with other observed phenomena of reception, and thus account for the effects commonly interpreted by us listeners.

The "wave-front" idea can be more readily visualized if I state that it is a series of imaginary connected points along which the radiated magnetic lines (due to the current flow in the antenna) are equally distributed. This state of affairs leads directly to the conception of a connected series of points that are at the same potential or merely equi-potential planes. See Fig. 1.

Now, the point that I wish to explain is that these "wave fronts" of equi-potential radiated energy leave the transmitting antenna supposedly as continuous and connected undulating variations and spread outward radially from the horizontal axis of the transmitting antenna as uniformly increasing hemispherical forms. According to this idea, no matter where you are located signals should come in.

Limited by Absorption Effects

But such certainty is far from the fact, and we find that absorption effects occur which greatly limit the reception range

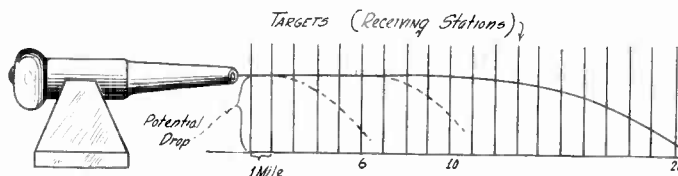

FIG. 2

A MECHANICAL ANALOGY BETWEEN TRANSMISSION RANGE AND FALL OF POTENTIAL.

of our set, and so we try to find a reason—and turn to mechanics for a moment for help.

Let us suppose that we have a gun of such proportions and mounting that we can fire a projectile to any desired distance parallel to the earth's surface **before** it hits the earth.

Fig. 2 shows the arrangement, and the series of targets (receiving stations) in line are easily punctured. The height of the projectile line of flight corresponds to the time—rate of our radio transmitted waves absorption by the earth.

The gun is loaded with enough powder to send the projectile 6 miles, and there is a row of targets extending for 20 miles, and each target is one mile from the other. We fire. Path No. 1 shows the rate of fall of the projectile with distance. Then we load the gun again with a 10 mile charge, and fire again. We obtain a second rate of fall-distance curve, and lastly we fire a 20½ mile charge and the result is that the last target is hit.

So it is with radio reception. Absorption effects easily can interfere with the operation of your set, by producing refraction or bending of the portion of the wave-front in whose parallel-to-the-earth line your antenna lies. This refraction causes your inability to hear the desired station. The only remedy (and it is effective) is to elevate your horizontal aerial until you reach a point where the station is heard. This all assumes that you operate your set at its maximum volume.

Having discussed antennas generally the subject of adequate insulation is next in line. Most antenna kits contain a 70 foot-length of stranded copper wire, a length of rubber covered lead-in wire and an insulated fabric-covered lead-in insulator, and two small porcelain strain insulators. Now the two insulators and the strip are in most cases the cause of much reception grief, especially that lead-in insulator strip.

In wet weather it is a good conductor to ground and at other times—not as good an insulator as it should be—and therefore I use and recommend a 14 or 20 inch length of thick walled gauge glass tubing. Drill a neat hole through the house and inserting the tubing through it, and allowing the tubing to project outward and downward at least 6 inches.

Double Discharge Arrester

Buy a good lightning arrester, one which consists of two discharge points mounted in a glass envelope. Avoid the sealed-in-with wax type whether its battery wax or tar compound—these wax sealed types are good for a while but weathering effects soon spoil their insulating qualities.

Also, antenna lead-in wires should be as direct as possible and undesirable capacity to ground should be avoided—especially the kind produced when the lead-in wire reaches the set via the far cellar window case, then being wrapped around the furnace pipes until it reaches the chimney smoke pipe, then along the cellar beams parallel to the water pipes that go to the kitchen, then up to the set. This concealed plan may suit the aesthetic taste but it is bad for DX reception especially, and very poor generally.

The lightning arrester's function is not generally understood, and I would like to make it plain that this device does not prevent lightning from striking the antenna.

Its purpose is gradually and continually to dissipate the electrical charges that accumulate on the antenna, diverting them to ground, and thus prevent the building up of a dangerous potential.

The writer has witnessed the results of the aftermath of lightning striking a radio receiver. In this case it was a Radiola 20 and one coil was reduced to ruin. The rest of the set was all right.

Case of AC Sets

Passing to the set, we now enter upon the meaty portion of this discussion—as in the case of the antenna lead-in, the antenna lead wire that extends from the antenna-post to the antenna coupling coil should take a brief and direct route. This lead wire should be well insulated, preferably rubber covered, as it is, in most cases. Rubber covered wire with shielded

(Continued on next page)

A knitting needle may be magnetized in such way that it has several poles in addition to its normal north and south ones. Indisputable confirmation is furnished by dipping a needle of this kind into fine iron filings. The filings will cling to the needle in various places, plainly indicating the presence of several poles.

There are two kinds of magnetization, transverse and longitudinal, and if special means of flux distribution is provided it is possible to duplicate this feat.

Magnetic

By John C.

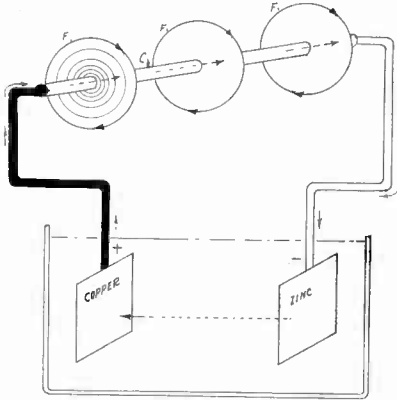

FIG. 1
SIMPLE CELL USED TO SHOW RELATIONSHIP BETWEEN CURRENT FLOW AND EFFECT ON COMPASS NEEDLE.

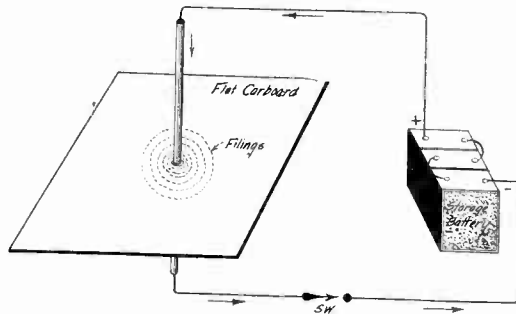

FIG. 2
HOW MAGNETIC FIELD INCIDENTAL TO CURRENT FLOW IN A WIRE IS FORMED AROUND A CONDUCTOR.

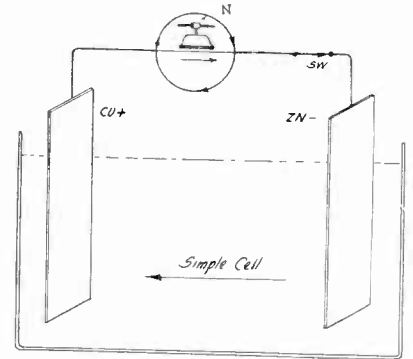

FIG. 3
CIRCUIT INCLUDING SIMPLE CELL SHOWS RELATION BETWEEN CURRENT FLOW AND MAGNETIC LINES.

[The following article is the 2nd of a series of experiments for novices and involves the exposition of some fundamental ideas told in story book fashion. The first article appeared in the May 31st issue.—EDITOR.]

THE last article dealt with the mysterious force that causes a lamp to light. Incidentally some attention was given to gradual fall of potential.

When a wet cell's external circuit is completed, a current flows because the zinc plate is at a higher position in the electrochemical series of metals than is copper, and, continues to flow as long as the external circuit remains closed and also as long as the zinc plate can combine with the solution.

Now, when an electric current flows along a wire, or other solid conductor, nothing happens chemically because the individual conducting parts of the wire are so closely packed together, and there are so many parts, that there is no special resistance offered to the current. At least under the conditions the ratio of the cross-section of the wire to the current flowing through it is large, and the wire does not heat up. This wire does not have to contend with forces that promote disintegration.

Effect of Electrolyte

But when a quantity of pure distilled water is poured into a clean transparent jar and the two dissimilar plates again are inserted into the jar and the external circuit is completed, nothing occurs. An ammeter needle stays at zero, and the lamp does not light either. Also, nothing appears to be happening within the jar either, nevertheless the zinc is above the copper chemically. The closeness of aggregation of the constituent parts of a solid conductor and their contact with one another is the reason why current can flow along a wire.

But in a liquid, such as water, which is normally an insulator, something has to be done to make the water conducting, if we wish to take advantage of the natural difference in electrochemical energy level between copper and zinc. So we provide the water in the jar with ions, or moveable electrical charges, and if we supply enough of them the zinc plate begins to accumulate a lot of small bubbles, and the copper plate starts to give off a still larger quantity. These bubbles are hydrogen and oxygen and as time goes on they are given off in increasing quantities.

Now, why does all this happen?

It has been known long that an increase of temperature always accelerates any chemical action and likewise the complementary effect that heat is generated when a chemical reaction begins having the effect of further facilitating chemical union of dissimilar substances.

The Faster, The Faster

Hence it can be said of most chemical unions "the faster it goes the faster it goes," and in the case of the simple cell, as heat develops the decomposition of the cells, electrolyte (or solution) proceeds faster until the current output of the cell is limited by the resistance of the external wire circuit joining the cells. Then finally as more and more zinc combines with the hydrochloric acid electrolyte the temperature rises, further accelerating the rate of combination of the zinc and solution.

until the reaction suddenly slows down and finally stops. The supplies for making this experiment are not costly and there are many combination of water and acids, and salts of metals that will form electric cells.

Trouble Shooting

(Continued from page 9)

mesh exterior, the mesh grounded is excellent. The ground lead should be similarly treated and in the case of a very sensitive circuit the lead should be quite short, and if this is impossible then it should be by-passed to ground by means of a 1 mfd. condenser.

In the AC receiver, heater circuit leads should be well twisted and should not be allowed to wander in all directions, because undesirable coupling effects that tend to produce hum and subsequent distortion due to this form of pick up by neighboring circuits, and also inter-receiver amplification of AC hum is very unpleasant to listen to.

Some AC receivers that are constructed at home have separate power transformers arranged in an assembly unit that is separate from the regular chassis. By this arrangement it is possible to avoid some of the afore-mentioned hum pick-up troubles that are due to inter-circuit coupling but of course good filtration is paramount.

The constructor should upon receipt and assembly of parts look at and test the B eliminator portion of the set first, setting up the power transformer and exciting it, then clipping ear phones on the terminals of one of the chokes intended for use, and placing this together with the transformer on the chassis, (if they are assembled this way) in their respective intended positions and then listen for the hum pick up by the choke. If it is audible in the phones the position of the choke must be altered until the hum is inaudible in the phones. Or if two chokes are used, the two chokes must be connected in opposing

Right or

QUESTIONS

- (1)—Can an all-wave receiver be constructed successfully with a set of plug-in coils for the various frequency ranges?
- (2)—Is it very difficult to build a frequency changer for converting a broadcast receiver into a short-wave receiver because if the oscillator is not coupled properly no results will be obtained?

ANSWERS

- (1)—Right. Such a receiver was described by Herman Bernard in the June 7th issue of RADIO WORLD and is continued in the

Experiments

Williams

In the early days our experimenters had to rely on batteries almost exclusively as a source of electrical energy and as a result many forms of battery-cells were developed, some for high current density at rapid discharge rates and others for long shelf life at low discharge rate, or intermittent use.

There are today two main types of cell: the primary (or non-rechargeable) cell and the secondary (or rechargeable) cell. Of the long list of the primary type there are in use today only three principal types, the Edison La Lande, the copper sulphate and the ammonium chloride manganese-dioxide paste type (standard dry cell).

Of these three the copper sulphate cell has by far the longest shelf and active life and also is of the greatest historical interest, having been in use as a power source on telegraph circuits many years before the present nation-wide powered telephone and telegraph circuits were common.

The writer well remembers that automobiles of two decades ago carried a set of dry cells about in order to facilitate starting the engine. You switched to the magneto afterward, and if the magneto got wet you ran your car on dry cells, and arrived home safely—if they lasted.

More Practical Use

The secondary cell, however, is much more practical and now replaces the primary cell in many installations, notably in railway signal work, and in automobiles, too. As mostly everyone knows, this type of cell provides a source of steady current and is used in the electrical laboratories, where once the primary cell was used.

Primary cells include all types that are ready for discharge when the cell elements are combined chemically, whereas secondary cells include all those which when assembled require that

in AC Sets

series insofar as the effect of the power transformers external field is concerned. This location of chokes by ear phone listening test is the most practical and effective method of properly arranging these parts and if this detail is given painstaking attention the effect on the final results will be found to be worth while.

The next step is to check the voltage-divider for circuit continuity and this may be easily done by connecting it in series with a high resistance voltmeter and a few dry cells or other suitable source of potential.

If the divider is ok, then wiggle the connection taps and if the voltmeter reading remains stationary you may safely assume that the divider is ok. Don't forget to make the ground test also, between the divider tube and ground.

Non-inductively wound or otherwise suitably made fixed condensers are used as "buffer condensers" or are connected directly across the rectifier tubes "raw" output, these should be tested by connecting them (the individual sections, if these are used) in series with a lamp (first) and a source of voltage sufficient to light the lamp if the condenser is shorted. Upon completing the circuit the lamps will light momentarily—this is charging current only. Under this condition a low range milliammeter may be substituted for the lamp and if the reading obtained is zero—the condenser may be assumed ok, a steady deflection on the other hand would show that the condenser leaked and if the applied voltage be increased, under these conditions) the milliammeter reading will increase also. A megohm-voltmeter enables one to make quick and accurate measurements of insulation-resistance.

Wrong?

present issue. The thing that determines the frequency to which a given circuit tunes is the product of the inductance and the capacity. If by means of plug-in coils the inductance can be changed, any wave band may be covered. The plug-in system is preferable to the older method utilizing taps on the coils.

(2)—Wrong: It is very easy, indeed, for about the only condition that need be satisfied is that the oscillator function. Even if there is no intentional coupling between the oscillator and the modulator there may be enough stray coupling to make the converter work. Of course, it works better when the proper amount of coupling between the two has been effected.

Suspend a knitting needle so that its point projects near the pole of a magnet, and in doing so is maintained slightly higher than when at its normal position of rest. A bunsen burner is lit and the flame is adjusted until its tip gently heats the end of the needle nearest to the magnet. The hot needle swings away because it has momentarily lost its attractive force, and on leaving the proximity of the flame cools off.

the chemical state of both electrodes be changed before the device is operative. This chemical change is provided by means of a so-called "charging" potential supplied by an external source, as a dynamo.

This history of the development of electrical devices is colorful, and intimately connected with our national progress.

The experiment of interest to the novice, now that something is known of dry and wet cells, is that of investigating some of the relationships and effects when a steady current flows along a conductor.

Most persons learn that the earth has what is called a magnetic field and that there are "poles," two of them,—North and South. The earth's magnetic flux is supposed to converge at these two places. Let us do a few simple experiments to find out how this magnetic field operates.

When an electric current flows along a wire there immediately occurs a condition known as a "magnetic field" this "field" completely surrounds the wire and is uniform at all points in a given radius from the center of the wire.

Current Flow as in Fig. 1

Let us look at Fig. 1. Here we have a simple cell connected so that when SW is closed a current will flow through the horizontal external wire, and if a compass is placed atop this wire so that the wire lies at right angles to the horizontal axis of the compass needle, and SW is closed, the needle will jerk around and point in a direction that will depend on the position of the observer.

If the observer is standing facing the South pole end of the needle when the needle was pointing north, then the needle will swing to the left, thus indicating that the direction of the wire's magnetic field is at right angles to the earth's field and is acting from left to right, as the arrow C shows, actually the needle assumes a final position of rest, that is,—the resultant of the two magnetic forces acting on it. If the current through the wire be increased we will find that the needle will align itself more closely to the wire's magnetic flux. Or, if you prefer, try the experiment of Fig. 2, in which a compass needle is placed on a cork that floats in a shallow pan-full of water. The needle will orientate (if it is a magnet) North and South and if you arrange a conductor above the needle parallel to the needle's axis the needle will be deflected as in the former case.

Relationship Between Current and Field

Now, these experiments show that there is a relation between the direction of flow of an electric current and the directive effect of the magnetic field accompanying this current flow. Fig. 2 shows this relationship in its most readily visualized form.

Let us suppose a man is driving a right-handed (clockwise) screw into a piece of wood. Well, the direction of motion of the screw into the wood is down, while the hand rotates to the right. If you as an observer will imagine yourself looking at conductor C end (or at the heavily shaded end) the flux lines are seen acting to the right while the current flows away from you.

Later on we will look at a circuit similar to Fig. 2 in which a radio tube is substituted for the simple cell, and will show a gaseous rectified tube similar to the Raytheon, and how it works.

Now, magnetic phenomena, though normally invisible, can be rendered visible with the assistance of fine iron filings, of which the experimenter can easily secure sufficient supply at a hardware store.

To find out what the magnetic field of a wire conductor similar to Fig. 2 looks like, arrange the conductor to pass vertically through a sheet of smooth white cardboard. Then sprinkle a light layer of filings on the cardboard around the wire and then pass a heavy current through the wire. The filings will arrange themselves in closely packed circles around the axis of the vertical wire similar to Fig. 3.

Easy to Perform

The above experiments may be performed by the novice and they are most interesting and help one to master the fundamental facts that underly all electrical science, and the expense involved is very small.

When I was considerably younger I used to annex all the good preserving jars I could find to make Leyden jars, and I also made my own spark coil, and what a coil!

Any reader who cares to have the constructional details of this coil may obtain them by writing me, enclosing a personally addressed stamped envelope. The coil data will be mailed to you, *but remember* you have to make it all yourself. Address me: John C. Williams, c/o RADIO WORLD, 145 West 45th Street, New York City.

Resolved, That Power By Ra

AFFIRMATIVE

By Sidney J. Slack

PROPHETS arise frequently and predict that the time will arrive when sufficient power will be radiated by electric waves to run our trains, ships, automobiles, and flying machines, to drive our factories, and to light and heat our homes.

Just as often as these prophets speak, scientists come forward with the cry "false prophet." Scientists are always shouting "false prophet," yet they themselves are often those who prove the shout is false and that the prophets are true by accomplishing the things which they have said are impossible.

Scientists are now in the state of doubting that television will ever become a practical accomplishment, yet they are busy bringing about practical television. Some of those at work on television may not call themselves scientists, but may prefer to call themselves engineers or practical inventors. Whatever they call themselves, they are using scientific facts and principles in their work if they are making any headway at all. Acknowledged scientists may not recognize these experimenters as scientists and may call them simple tinkerers, but just the same if these tinkers are making any headway in television, as many of them are, they are using science.

Some recognized scientists are working with television along scientific lines, and they are getting results. Yet even they doubt.

Status of Power by Radio

The status of power by radio is in about the same position as television. Scientists doubt and scoff. Prophets predict. Tinkerers are trying to bring it about, and among the tinkerers are scientists, engineers and practical inventors. If we are to judge by the history of other "impossible" accomplishments, the possibility of power by radio does not seem at all hopeless.

Take radio, for example. Who would have thought thirty years ago that it would be possible to send messages from one continent to another with a tiny radio transmitter? Who would have thought ten years ago that it would be possible to entertain a nation with a transmitter radiating a total power no greater than that of a medium size automobile? Even the prophets of those days would have shouted "impossible." Yet today this accomplishment is taken for granted. Its mystery has disappeared even to those who still have no conception of how the thing is done. If this can be done with radio entertainment, why cannot it also be done with power?

Again, let us take the distribution of power by wire. Who would have thought fifty years ago that the water power of Niagara Falls could be converted into electricity and sent hundreds of miles on tiny copper wires to light homes, drive household appliances, operate factories, trains and trolley cars? Not the most prescient prophet would have had the foresight to see it. Yet now the entire country is interconnected with power distributing wires, some running from this waterfall, some to that.

Wires Guide Power

It may be asserted that this is widely different from power by radio, but is it really? Scientists now tell us that the electric current does not flow through the wires from the power plant to the points hundreds of miles away where it is used, but that electric effect is really around the wires, in the space. The wires merely act as guides for the electric current.

If electric power can be guided by wires why can it not be guided in some other manner and by some other means? We now have beam radio communication by means of which signals can be sent half way around the earth with an extremely small amount of power. What is there to prevent sending more power in a beam? There is nothing if there is a necessity for doing it.

The power that is used for operating millions of radio receivers throughout the world is exactly the same kind of power as that required to operate electrical machinery and appliances. The fact that broadcast rather than guided power is radiated does not alter the fact. The only difference is in the amount of power. It takes just a little to operate a million radio receivers. It takes considerably more to operate an electric lamp, a toaster, an automobile, a train, or a ship. Hence to make power by radio practical it is only necessary to increase the transmitted power.

Electric lamps have been operated from the power radiated from broadcast stations. If a lamp can so be operated why should not a motor be operated by simply increasing the transmitted power in proportion? If one motor can be operated a thousand motors can be operated the same way, or any number of motors.

It is interesting to know that the first to suggest the possibility of transmitting power without wires was Nikola Tesla, the well-known electrical engineer who is responsible for the development of some of the best known and most practical electrical machines. If he thinks power by radio is practical, it must be more than an idle dream of a fanatic. He knows the possibilities and limitations of electricity as well as any one.

So many seemingly impossible things have been accomplished by scientists in the past that it is nothing short of folly to say now that anything is impossible in the future. So many seemingly impractical things have been accomplished by engineers, that it is irrational to say that other things which now are not practical cannot become practical in the future. All that we can say is that a thing is impossible or impractical today. In the future the thing may be an everyday commonplace. So it is with power by radio. Here at least one of the difficulties has been overcome, for it is no longer impossible to transmit power by radio; it is being done every day in every section of the world. However, it is still unpractical, but it is not reasonable to hold that it will be so tomorrow. One must, indeed, have little faith in the continued future engineers and scientists to entertain such an idea.

RADIO UN

Short Waves on a Super

I HAVE a Superheterodyne and a short-wave adapter designed for plugging into the second detector of the Super. Will you kindly show how the adapter may be connected so that I can use the high amplification in the intermediate amplifier?—V. A. D.

There is no way in which this may be done with the adapter. It is necessary to build a frequency changer for changing the signal frequency to the frequency of the intermediate amplifier. Such frequency changers have been published in *RADIO WORLD* for several weeks, and are called converters. The essential part is the oscillator in the converter. It is also possible to accomplish the same thing by changing the oscillator and radio frequency tuning coils in the Superheterodyne so that they will cover the short-wave band. But the simplest way is to add an oscillator to the adapter already at hand. See the converter picture diagram on page 5 of the June 7th issue.

Which is the Better Receiver?

WHICH IS the better receiver, a Superheterodyne or a screen grid receiver?—E. A. M.

That question is difficult to answer, for the Superheterodyne may be a screen grid receiver, and neither receiver may be any good, or either may be very good. One is tempted to ask, which is better, thoroughbred or a Percheron? A Superheterodyne is one type of receiver and a screen grid receiver is usually a TRF receiver. Either receiver may be made as good as desired. Then the question does not say in what respect the receiver is to be better.

The Definition of Mho

WHAT IS the meaning of a mho? This term is used frequently in radio literature but it is never explained.—R. K. F.

The mho is the unit of conductance, just as the ohm is the unit of resistance, the ampere the unit of current and the volt the unit of electrical pressure. Since conductance is the reciprocal of resistance the name for the unit of conductance is the ohm written backwards. Let M represent the conductance of a circuit, then if the voltage is E and the current is I , we have $I=ME$. We also have $E=RI$, where R is the resistance of the circuit. Comparing these equations, which are really definitions, we see that $M=1/R$, the more usual definition of conductance.

Every electrical impedance has a corresponding reciprocal, which tells how easy it is for a current to flow through a circuit, just as the impedance tells how difficult it is for the current to flow. The reciprocal of impedance is admittance, the reciprocal of reactance is susceptance, and the reciprocal of resistance, as we have already said, is conductance. Impedance, reactance and resistance are all measured in ohms; admittance, susceptance and conductance are measured in mhos. The susceptance of a condenser is directly proportional to the capacity whereas a condenser's reactance is inversely proportional to the capacity. The susceptance of a coil is inversely proportional to the inductance whereas its reactance is directly proportional. In radio, conductance is seldom used except to express the amplifying power of a tube when both the amplification constant

Radio Will Become Practical

NEGATIVE

By Henry Burr

POWER by radio is an ever-recurrent suggestion. It comes mostly from those who are still working with perpetual motion machines, those who think that something may be obtained for nothing. Of course, power by radio is a fact, for every broadcast station, every radio transmitter sends out power.

But these stations do not send out enough power to operate a single radio receiver, let alone a lamp or a motor. You may object to this statement and say that as many as ten million radio receivers may be tuned to one station at the same time and all will get enough power to operate the receivers. Such an objection is based purely on misconception. The transmitting station does not operate any receiver.

Let us do a little figuring to point out the fallacy that a

DIVERSITY

and the internal plate resistance are taken into account. The expression is "mutual conductance," which is equal to u/r , where u is the amplification constant and r the plate resistance. This is a conductance because the resistance is in the denominator and is therefore a reciprocal. It is mutual because the amplification factor takes account of the relative effect of a voltage in the grid circuit and in the plate circuit. When the mutual conductance is expressed in mhos its product with the grid voltage gives the plate current in amperes. Thus if the mutual conductance is .002 mhos and the grid voltage changes by one volt, the plate current changes by .002 ampere. The mutual conductance is usually given in micromhos in order to make it expressible in convenient whole numbers.

* * *

Hum Eradication

IHAD A receiver which gave me fine results, but it was battery operated and I wanted an AC set. You kindly furnished me with a diagram which I used in rebuilding the set. Now this set works, but there must be something wrong because there is a slight hum in the output. If you can suggest a remedy for the hum you will do me a great favor.—T. C. B.

You are lucky that you have only a slight hum. Looking for the causes of hum is often a laborious and unprofitable undertaking. There are so many causes of hum that it is next to impossible to locate them all. Sometimes it is only a question of moving a transformer from one position to another, and at other times it is only necessary to move a lead. If the set hums only when a carrier wave is tuned in it is best to increase the filtering in the B supply, for most of the hum then comes from the residual ripple. Additional capacity in the filter and possibly another choke coil are necessary. It is particularly important to improve the filtering of the B supply to the detector.

* * *

Rule for Determining Bias Resistor

IS THERE any rule by which the grid bias resistor for a tube is determined so as to give the proper grid bias? If so, will you kindly give it? Which is better, a grid bias resistor or a battery for maintaining the grid properly negative?—J. A. E.

There is a simple rule but to apply it you have to know what bias is necessary and what the plate current in the tube will be when this bias is applied to the tube. These tube data will be found in "Audio Power Amplifiers" by Anderson and Bernard. The plate current and the grid bias are taken from tables of characteristics of the tube in question. Take the 245 tube, for example. When the plate voltage on this tube is 250 volts the plate current is 32 milliamperes and the grid bias should be 50 volts. The value of the grid bias resistor is that which when 32 milliamperes flow through it the drop will be 50 volts. By Ohm's law we have $R = 50/.032$, or 1,560 ohms. That is the rule. There is no essential difference between the results of grid bias batteries and bias resistors. Resistors require no attention after they have once been installed and properly bypassed. Batteries have to be kept in good condition and should be replaced at least once a year. Grid batteries are often neglected and for that reason cause much distortion which is usually attributed to other causes.

broadcast station operates the receivers. An average radio receiver requires 50 watts. The strongest broadcast station in this country sends out 50,000 watts. Then if all the power transmitted could be utilized by the receiving sets, only 1,000 receivers could be tuned in to that powerful station. But ten million receivers may be tuned in and all will receive the programs. Since the power transmitted is only enough for a thousand average receivers, each of the ten million sets would only get .0001 part of the required power. That is, there are only 5 milliwatts for each receiver.

Gets Only Small Fraction

It is not to be supposed that each receiver actually gets this amount of power. Probably 99.99 per cent. of all the energy transmitted goes to waste. Hence each receiver gets an extremely small amount of power. It is not the power from the broadcast station that is used to operate the receiver, but the power that is supplied locally to the receiver. The power from the station is used only for "setting off" the local power. It serves a purpose similar to the spark in a gas engine. No one would contend that it is the spark that drives the car, especially not after having bought gasoline for a while.

That power may be transmitted by radio nobody denies, for it is being done every day. What is being denied is that it can be done practically for the propulsion of ships, trains, airplanes, automobiles, and for the lighting and heating of homes and for doing the different kinds of work now done by electricity transmitted by wires.

There is one thing against the practicability and this is a powerful factor. It is simply this, there is not enough energy available to do it. We might conceivably build a broadcasting station large enough to drive all the automobiles in the country, but to do so we would have to assemble all the electric power plants now existing and build many more, utilizing all the coal, all the oil, all the wood, all the water falls, and all other sources of power into one gigantic power plant to drive the broadcast station. And the energy would have to be used up at such a rapid rate that all the resources would not last more than a few minutes. After that grand explosion what would there be? Nothing left to turn the wheels.

Suppose it were possible to transmit power by radio for the operation of all devices requiring energy. Who would pay for it? Would it be necessary to attach a radiometer of some kind on every machine for measuring the energy taken from the air and charge according to the number of watt-hours used? It now costs about 2 cents a mile to supply gasoline to a car. Suppose the efficiency of the car were decreased in the ratio of 10,000 to 1, and it would be decreased much more if the energy were broadcast. How much then would it cost to operate a car? About 10,000 times as much, or \$200 per mile. That would be the cost if the car were kept running all the time. But the total energy used would be the same if the car were not run at all, for the transmitter would send out energy whether used or not. As long as one car, or one light, was operated it would be necessary to keep the plant going full blast. When electric power is distributed by wire the plant output is proportioned according to the load, and this is one reason why power can be transmitted with reasonable efficiency over wires.

There is only one broadcast station sending out radiant power as far as we are concerned, and that is the sun. It shines all the time whether we use the power or not. Nobody has to pay for it, so the wastage does not matter. Of course, a large part of the sunshine that falls on the earth is used even though it is not used immediately. The power now stored in the gasoline was sunshine billions of years ago. So was the power that is stored in coal. The power derived from water falls was sunshine last season. The power stored in wood and other combustible vegetation was sunshine last year, or last decade, or maybe last century.

Would the power dispersed by our gigantic radio station and not used immediately also be stored in other forms? Hardly, for the universe is not geared to broadcast waves. It is geared to light waves. While we have been told that plants grow better under the influence of radio waves, that hens lay more and better eggs when subjected to such waves, and that cows give more and sweeter milk when intercepting broadcast waves, we have also been told that the moon is made of green cheese.

Why Radio Power Is Impractical

Power by radio is impractical because there is not enough energy available on earth to keep the wheels moving for more than an instant, because the efficiency of such a method of power distribution is almost nil, because there would be no way of proportioning the output of a station to the needs of the moment, because there is no way of equitably distributing the cost, because the whole thing is just a fantastic dream entertained seriously only by perpetual motion cranks.

BIG COMPANIES AT SHOW, BUT OMIT EXHIBITS

Atlantic City, N. J.

The Sixth Annual Convention and Trade Show of the Radio Manufacturers Association opened in this city and held for one week in the Civic Auditorium, where over 200 radio manufacturers exhibited their latest products. Several thousand radio men representing these exhibitors took pains to prepare the greatest trade show the industry has ever held, and over 30,000 radio dealers, jobbers, salesmen, service men and radio editors from every section of the country were present to look over the latest radio products to be offered to the public in the Fall.

Welcomed by Committee

The visiting tradesmen were welcomed by a reception committee of prominent Radio Manufacturers Association members, headed by Morris Metcalf, of Springfield, Mass., first vice-president of the RMA. H. B. Richmond, Cambridge, Mass., president of the RMA, reported that an unprecedented public interest was evidenced in the trade show this year.

"The public is evidently anxious to know and see the latest developments in radio receivers," said Mr. Richmond.

The radio industry was represented practically 100 per cent. in this year's show, the first to be held in the East, all previous shows having been held in Chicago. The old and established set manufacturers are showing new and improved receivers while many new and important companies have made their debut this year.

Ninety Fewer Exhibitors

About 200 manufacturers of sets and equipment had space at the show, which was held so that the wares might be exhibited to the trade prior to the public view at the Radio World's Fair in New York in September.

However, there were 90 more exhibitors last year, as financial troubles sank quite a few manufacturers.

Quite a few of the large space takers, like RCA, Victor, General Electric, Westinghouse and Atwater Kent, were not exhibitors in the strict sense, as they did not exhibit any apparatus. One reason given unofficially was the desire to avoid any sales impediment to present models, and another was caution against copyists, as new features shown in June could be incorporated by competitors in time for the September market, but revelation in September would be too late for such piracy to be effected this season.

Business Situation Brighter

Screen grid sets predominated. No pentode set was shown.

Those who did exhibit showed that the trend is toward better tone or rather the suiting of tone to the buyer's taste. Refinements were evidenced, but no startling changes at all.

Business conditions are improving, was the consensus of exhibitors, and 1930-31 should be a good radio season.

A THOUGHT FOR THE WEEK

LOST—The eighteenth letter of the alphabet! If found, return to the broadcasters at the New York stations who insist on telling their hearers that they are listening to station this, that and the other—New York, or New York, or almost anything but New York.

KHJ Writ Stops Channel Sharing

Washington.

A temporary injunction prohibiting the Federal Radio Commission from disturbing in any manner the assignment of KHJ, of Los Angeles, Calif., was issued by Justice Hitz, of the Supreme Court of the District of Columbia.

The temporary injunction was issued on application of attorneys for the Los Angeles station. The bill of complaint alleged that the Commission had authorized KGA, at Spokane, Wash., to operate on the 900-kilocycle channel, used by KHJ. It was contended that the Los Angeles station would be "irreparably injured" by the operation of KGA on that channel, on the grounds that interference would be caused, and that the service now being rendered "to a large listening public in and around Los Angeles will be destroyed."

TUBE'S SILVER LINING VEXES

The metallic coating which presents the appearance of silver on the inside of the glass bulb of most vacuum tubes has always attracted the attention of the radio listener.

Some radio dealers report that customers will frequently examine a tube carefully before buying and refuse to accept a tube which, in their opinion, has too much or too little "silver" on the inside of the glass, probably thinking that this indicates the worth of the tube.

Service men also find that their clients, too, are often quite concerned about the condition of the "silver" in their tubes. In this connection it is frequently suggested by the owner of a set that a particular tube is probably the cause of the trouble because the coating inside the glass seems to be greater or less than when the tube was new.

An official of E. T. Cunningham, Inc., explained that the density of the silver-like coating in vacuum tubes has nothing whatsoever to do with the performance of the device. This coating is not silver but magnesium, and its presence is necessary to insure a high vacuum.

Before the air has been exhausted from the tube in the factory the glass is perfectly clear. After pumps have removed as much air as possible the stem is sealed and the tube is placed in a radio-frequency furnace.

This machine, as its name indicates, produces heat which causes a small quantity of magnesium placed inside the tube to explode and be deposited on the inside wall of the glass. This process consumes all undesired gas which had not been removed by the pumps.

Grimes Gets Post As RCA Engineer

David Grimes, radio engineer and writer, has joined the License Division of the Radio Corporation of America. Mr. Grimes has been appointed engineer in charge of the circuit and apparatus section of the recently organized Patent License Division laboratory.

The laboratory was organized for co-operating with the manufacturing companies licensed under RCA patents.

TRANSMITTER POWER LIMITS PUT IN EFFECT

Washington.

Stations hereafter constructed will not be permitted to install equipment enabling them to use greater power than their license authorizes them to use, the Federal Radio Commission announced.

Heretofore there was no limit as to the capacity of the transmitter, but only to the amount of power actually to be used. However, some stations that had excess capabilities were tempted to step up their power beyond authorized limits, while others, because of the capacity of the plant, were tempted to petition the Commission for authority to increase their power up to the workable limit of the plant. Stations allotted low power will be permitted to build to a small excess over the allotment.

Standard Power Rating

Also, the Commission decided on a standard method of rating the maximum power of a station as the installed vacuum tube capacity of the oscillator or radio frequency power amplifier which supplies power to the antenna.

Radio supervisors and inspectors of the Department of Commerce, who police the ether, have complained about difficulty in determining the actual output of stations because of the absence of a standard method of measurement, said V. F. Graves, acting chief engineer of the Commission. With the issuance of the order, however, all transmitters must be equipped with indicating instruments of accepted accuracy which will give the values of the antenna current. Consequently, in a properly equipped station, inspectors will be enabled to ascertain the power of stations with a glance at these instruments.

Must Use Standard Tubes

To prevent the "overloading" of transmitters, or the "stepping up" of licensed power through the use of over-sized tubes, the order places a specific prohibition against the use of other than standard tubes for transmitters of particular rated output. "No licensee shall increase the number of vacuum tubes or change to vacuum tubes of higher rating in the oscillator or radio frequency power amplifier which supplies power to the antenna, or change the system of modulation without the authority of the Commission therefor," it reads.

Not Retroactive

Mr. Graves explained the order is not retroactive, but that the provisions dealing with power output of transmitters shall become effective as new equipment is installed.

RCA-Victor Moves Test Plant to Camden

The experimental station of RCA-Victor Company, Inc., formerly at Yonkers, N. Y., just above the New York City line, has been moved to Camden, N. J., where the rest of the plan of this RCA subsidiary is located. Receivers are tested at the station.

An application has been made to the Federal Radio Commission to use 250 watts, instead of 150 watts, on the eight short-wave experimental channels used.

OUSTS STATION FOR 'WILDCAT'S' NIGHTLY ABUSE

Washington.

By unanimous vote the Federal Radio Commission, for the first time in its history, revoked the license of a station for permitting the broadcasting of improper programs.

KVEP, Portland, Ore., 15 watts, 1,500 kc, was the station, punished for the broadcast of "obscene, indecent and profane language."

Although using only 15 watts, the station covered the entire metropolitan area of Portland, about 60 square miles, encompassing one-third the population of Oregon, said W. E. Richardson, attorney for the station, in opposition to the petition for revocation.

The offensive broadcasts were the offshoot of a political campaign. Representative Franklin F. Korrell, of Portland (Rep), defeated Robert Duncan in the recent primaries. During the campaign both candidates used the station, but representative Korrell complained to the Commission that although the campaign was over, he was still being subjected to attacks by Duncan from the station, and that also in the guise of opposing chain stores Duncan was villifying and maligning citizens of Portland of unimpeachable integrity.

Better Business Bureau Acts

Private citizens, as well as business and civic organizations, including the Better Business Bureau, joined in the petition for revocation of the license. The Bureau was represented at the hearing by John C. Kendall.

Every night, from 8 to 10 p.m., Duncan, who calls himself "the Oregon wildcat," would hold forth at the station, pouring out his comments and denunciations.

For the station Richardson, said that as the station's facilities had been used by one candidate, they were at the disposal of opposing candidates, by the very rule of political equality adopted by the Commission. The lawyer also cited KVEP as necessary to the population of Portland, because of its coverage.

William D. Schaeffer, owner of the station, said he had sold time to Duncan and that he had no authority under the law to censor Duncan's programs, any more than the Commission itself has any censorship authority.

The revocation took the form of a refusal to renew the license, which expired the day after the decision was rendered.

No "Semblance of Contradiction"

Commissioner Ira E. Robinson, who presided at the hearing, said:

"In all my two years and a half experience as a member of this Commission I have not observed a case of such violation of license as that proved before me, without the semblance of contradiction, while hearing the case of KVEP. Heretofore I have not had occasion to believe that any licensee would allow over his station such misuse of his license by profanity, obscenity and vilification of particular individuals.

"It clearly appeared from the record that the station has been devoted in the greater sense to mere personal vindictive use. None of this has been informative, enlightening or entertaining to the public. All this has been under the cloak of opposition to chain stores.

"A station may be used for opposition to chain stores in the right way. Either side of that issue may present its views.

Warner Brothers Seek World Voice

Washington.

The Warner Bros. Broadcasting Corporation, a subsidiary of Warner Bros. Pictures Corporation of Hollywood, has filed with the Federal Radio Commission an application for authority to erect an experimental radio broadcasting station for international rebroadcasting. The object is to attempt to obtain a world-wide audience for programs featuring Warner movie stars and talkies, by relaying broadcast wave programs.

The request is for a station using 6,030 kc, at 750 watts.

AIR ALIGNMENT CALLED OK NOW

Washington.

The listener interest in the activities of the Federal Radio Commission is evidenced by the volume of fan mail the Commission receives whenever a problem affecting broadcasting generally is before that agency, Commissioner Harold A. Lafont stated orally.

In the past few years there has been a "surprising drop" in the amount of letters from listeners, the Commissioner declared. He based this condition on the theory that radio reception conditions apparently are good in most every area.

"I have found it is unusual for the public to go to the trouble of writing when conditions are satisfactory," he said. "But once they become bad, and radio reception is impaired, the volume of mail received by the Commission shows it."

Recently word has gone out, said the Commissioner, that modification of the present broadcast set-up, with particular reference to high power and cleared channels, is being considered. He said he has noticed an increase in his correspondence with the abnormal mail largely having to do with his current broadcast problem.

"My advocacy of high power and cleared channels as a means of giving the maximum number of people good radio service attracts considerable comment from listeners supporting this view," he said. "I am firmly of the opinion that the only manner in which the rural or remote listener can be served is by placing stations of high power on exclusive channels, where they will not be disturbed by interference which inevitably occurs when stations of considerable power are placed on the same channel without adequate geographical separation between them."

He pointed out, says "The United States Daily," that the Commission now is considering various plans, including one of the curtailment of the number of cleared channels, and a reduction in the present maximum power of 50,000 watts.

"There are arguments on both sides," he declared, adding that he is irrevocably reconciled to the view that the only manner in which the country can best be served is with high power and cleared channels.

But mere vilification of persons is no argument on that line, nor is profanity and unrefined talk not usually hearable in polite company. Free speech is guaranteed. But license to insult one's enemies as well as the decency of American authority has no protection under this law.

"It may as well be proclaimed that this Commission knows its province and duty in instances like this, and that it may be relied on to fulfill it in the public interest."

CHICAGO 'BIG 5' HAS \$1,880,000 TALENT BUDGET

Chicago.

Again Chicago challenges New York for the title of "Radio Capital of the World."

Further evidence is the bi-city controversy has been developed through the medium of a survey just completed by WENR, Chicago.

According to this analysis, five stations in Chicago, known as "the Big Five," have a yearly broadcasting talent bill of \$1,880,000. The information was submitted to WENR by Judith Waller, director of WMAQ; Homer Hogan, director of KYW; Ralph Atlass, director of WBBM; Henry Sellinger, director of WGN, and Morgan Eastman, manager of WENR.

According to the figures obtained, the average cost per station is between \$6,500 and \$7,500 a week. The figures arrived at include expense of talent that is borne by the stations, plus that which is paid for by advertisers.

Increased Attention by Chains

The second important point in the survey reveals that the national chains have accorded Chicago an increasing amount of attention during the past ten months. As a result, the Columbia Broadcasting system is now presenting from Chicago sixteen hours a week of programs, whereas a year ago it was giving only one hour. The National Broadcasting Company has twenty-four hours a week of programs that originate in Chicago, while a year ago they had only two or three hours per week.

During the past twelve months, the new studios of WMAQ in the Daily News building, and WENR, in the Chicago Civic Opera building, have been completed and are now occupied by these stations.

Use or Plan 100% Modulation

KYW has just announced its removal to the extensive studios in the Straus building formerly occupied by WENR. WBBM has been forced to enlarge its studios in the Wrigley building, and a number of major improvements have been made in the WGN studios in the Drake Hotel.

KYW, WENR and WBBM have also included extensive additions to the mechanical equipment in their transmitting stations. All five stations either have installed 100% modulation or have contracted for such installations.

Radio Relied on for Air Transport Safety

Washington.

Specific problems in aeronautics that call for active research directed at the application of radio are listed in a report of the liaison committee on aeronautic radio research to Clarence M. Young, Assistant Secretary of Commerce for Aeronautics, made public by the Department of Commerce.

Recent experience has demonstrated "that we must look to radio to overcome a number of obstacles standing in the way of the highest degree of safety and reliability in air transportation," the committee says.

WHO AND WOC DESIRE TO BE SYNCHRONIZED

Washington.

The Federal Radio Commission has received the first application for authority to synchronize two high-power stations on the same broadcast channel on a regular service basis, operating without control wires.

The application was filed by the Central Broadcasting Company, operating WHO, Des Moines, Iowa, and WOC, Davenport, Iowa. The application requested authority to operate WOC and WHO on 1,000 kc during unlimited hours in synchronization.

This application recalls other attempts at synchronization of two stations. The first was WBZ, Springfield, Mass., and WBZA, Boston, Mass., operated by the Westinghouse Electric and Manufacturing Company. These two stations were operated for a number of years on the same channel, being synchronized by a wire line connecting them. A synchronizing wave at audio frequency was sent from WBZ to WBZA, from which the transmitted wave at WBZA was derived.

Finally Gave It Up

For a long time this experiment was pointed out as a success, but recently the Westinghouse Company filed an application with the Federal Radio Commission for permission to replace the two stations with a single, high-power station to cover the service area of the two smaller stations. The reason given for the proposed change was that there was much interference between the stations, especially in certain locations between them. Interference patterns, theoretically expected but scoffed at by many, proved to be the practical stumbling block on which the experiment fell.

Another noteworthy synchronization experiment is that between WGY, Schenectady, N. Y., and KGO, Oakland, Calif., both operated by the General Electric Co., which has been in progress ever since the 1928 reallocation worked out by the Federal Radio Commission.

WGY—KGO Working Well

The great geographical separation between these stations and the increased percentage modulation have made the interference between these stations relatively unimportant.

There is an interference area in the Middle West which lies outside the service range of either station. These stations are not synchronized by wire connection as were WBZ and WBZA.

Doctor on Air Asks for Patients, is Charge

Washington.

Temporary extension of the license of KFKB, Milford, Kans., charged with having permitted the broadcasting of programs of Dr. John R. Brinkley alleged to be inimical to the public health, was ordered by the Federal Radio Commission.

The license of the station, which expired on May 31st, was extended to June 20th, pending determination of the case. Charges that Dr. Brinkley used "profane, obscene and indecent" language over the station, and solicited medical practice by means of radio, were lodged against the station by the American Medical Association.

34 Applications For New Stations

Washington.

Short Wave and Television Laboratory, Inc., of Boston, Mass., was refused a permit to construct a broadcasting station using 250 watts day time and 100 watts night, on 1,370 kc.

WCSC, Charleston, S. C., owned by F. Jordan and Lewis Burk, was recently granted permission to operate, having previously held a construction permit only.

A special permit to operate on 3,256 kc. using 100 watts, for a period of 30 days, beginning May 20, has been granted to Warner Brothers Pictures Corporation, by the Commission, for experimental purposes.

Approximately 34 applications for constructional permits for new stations have been received recently and easily twice that number of stations are either installing new equipment or want to.

Consolidation of two Wisconsin broadcasting stations, and their operation as a single station are proposed in an application filed with the Commission on May 14, by the University of Wisconsin. The stations involved are WLBL, at Stevens Point, now operated by the Wisconsin Department of Markets, and WHA, at Madison, now operated by the University.

The Milwaukee "Journal" has requested permission to construct a television station operating in the continental short-wave band, and proposes to use 2,800 kc. This newspaper now operates WTMJ.

DEFOREST VIEW ON TELEVISION

In a recent speech over WCCO Minneapolis, Minn., Dr. Lee DeForest, inventor of the vacuum tube, in speaking of its use in television, said:

"In the future we will receive television pictures over the electric light or telephone wires, though for the next few years television will be by radio.

"This marvelous new development, which has at last been realized, is made possible by means of the vacuum tube. Even now, if one resides within 50 miles of a good television station, he can receive nightly very good pictures by radio.

"Today television is about where radio was in 1922. But its progress will be rapid from now on, just as was that of the radio industry after that date. However, television presents many peculiar problems, exceedingly intricate and difficult of solution. Although radiovision is a reality today and will be in thousands of homes by next Christmas, yet the television of our dreams is a long way off, and when this comes into our homes it will be by way of wires and not by radio."

Hoover Asks Funds for Police Radio Plant

Washington.

A broadcasting station is planned for the Metropolitan Police Force of the District of Columbia, according to an estimate of appropriations for the District sent to the House of Representatives by President Hoover.

The total amount asked for in the estimate was \$46,472.75, of which, according to an accompanying letter from the Bureau of the Budget, \$18,500 would be used in the establishment of a police broadcasting station.

CHAUFFEURS AS BUILDERS RANK WITH DOCTORS

The interest in radio set building at home is still very high, according to a recently completed compilation of replies to a questionnaire sent out by the Hammarlund Manufacturing Company. The engineering advancements, making radio more and more intriguing, are a great contributing factor toward this sustained interest, the survey indicated.

"Three general classes were found to exist," said Lewis Winner, under whose guidance the survey was conducted, "those who like to tinker, those who like to construct for some permanence, because of the superiority of custom-built receivers, and those who are engaged in building of radio sets as a profession.

Women, 18 to 30, Are Experimenters

"In the tinker class, between the ages of 20 and 35 there is a sharp cut-off in interest. Boys and men from 12 to 20 and men from 35 up are the most interested in tinkering. Those between the ages of 12 and 16 and 55 and 70 are the most enthusiastic experimenters.

"In direct contrast, there are quite a number of women between the ages of 18 and 30, who are experimenters, some being engaged in it for fun, and others professionally. About 50% fall into each class.

"The middle-aged man is the builder of his own custom-built set, which has held true for at least two years.

"In the professional class, the ages vary, there being a slight predominance between the ages of 29 and 40.

Doctors and Chauffeurs Active

Doctors, both medical and dental, and chauffeurs, constitute 75% of the users of parts for the various foregoing purposes, it was also found.

"Specifically, among those questioned, 75% of the instructors and professors of preparatory schools and colleges throughout the country indicated their preference for the custom set to the manufactured type. The custom-built set, according to these educators, is not only more selective and sensitive, but a flawless reproducer, because of the greater pains taken with its construction as well as the use of higher grade components. Fully 95% of these instructors and professors do their own building, it was noted."

Government of India Assumes Radio Control

Washington.

WITH the acquisition of all the assets of the Indian Broadcasting Company, amounting to approximately \$108,000, the government of India in effect assumes full control over broadcasting in the country, according to a report received in the Department of Commerce from Assistant Trade Commissioner Wilson C. Flake at Calcutta.

The stations will be operated by the government under the name of the Indian State Broadcasting Service and will form a part of the posts and telegraph department. The government will appoint an advisory committee consisting of two technical men and two business men each from Bombay and Calcutta which will function under the chairmanship of the member for industries and labor.

ONE PROGRAM FROM 3 LANDS TO SPAN SEAS

Berlin.

When the World Power Conference is held here and the National Electric Light Association convention is held in San Francisco, Calif., four cities in three countries will be connected by radio for an interchange of addresses.

Thomas A. Edison will speak from Llewellyn Park, N. J., and Guglielmo Marconi will speak from London. Oskar von Miller, president of the World Power Conference, and Karl Koetegen, chairman of the conference, will speak from Berlin, while Mathew Sloane, president of the National Electric Light Association, and Owen D. Young will speak from San Francisco. Lord Derby, retiring president of the World Power Conference, also will address the listeners.

Addresses will begin at noon in San Francisco (Pacific standard time) and at 9 p.m. in Berlin on June 18th. At this time the delegates to the World Power Conference will be gathered at a banquet in the Sport Palast, marking the climax of the activities of the conferences.

The speeches will be broadcast both in Germany and in the United States over Nationwide hook-ups. The projected broadcast has aroused keen interest on the part of German radio enthusiasts throughout the Reich, and they regard it as the most complicated international arrangement yet attempted.

Literature Wanted

Nordahl Onstad, Ada, Minn.
William Frederick Chamberlain, 12 Voorhees St., Newark, N. J.
Benjamin Melch, 35 Crouen St., Brooklyn, N. Y.
Floyd Ruby, 604 W. Summit Ave., Shenendoah, Iowa.
Charles Harrison, Box 102, Farmville, Va.
James Howell, 315 Pike St., Covington, Ky.
Vernon Snyder, Sorrento, Maine.
C. P. Lush, 209 East Main St., Stoughton, Wis.
George Musil, 421 Wyoming Ave., Audubon, N. J.
E. A. Potect, 3741 Michigan Ave., St. Louis, Md.
G. R. Youngren, 148 W. 23rd St., New York City.
E. C. Waidler, 325 E. Broadway, Toledo, Ohio.
Henry Pasierb, 370 Montaup, Fall River, Mass.
James L. Mitchell, 1026 Rosedale Road, N.E., Atlanta, Ga.
O. E. Story, 1154 W. Van Buren St., Chicago, Ill.
W. E. Gray, 1305 W. College, Independence, Mo.
H. Ivan. Radio Contractor, 957 E. 149th St., Cleveland, Ohio.
M. J. Anderson, Whitelaw, Wis.
George W. Kolter, 2302 Valentine Ave., New York City.
Wm. Reidy, 510 Almond St., Syracuse, N. Y.
Kenneth Macolin, 310 W. 121st St., New York City.
Charles Brunner, 1394 Bushwick Ave., Brooklyn, N. Y.
Ted Sheehan, Hodder St., East Brighton, 3.6, Victoria, Australia.
Fred Chadwick, 150 Pleasant St., Southbridge, Mass.
F. L. Lemm, 1932 Jefferson St., Muskegon, Mich.
Mallory Lamont, Raeford, N. C.
Clyde Payne, 823 W. Jourdan, Newton, Ills.

New Incorporations

Finegold Radio and Electric Service Co.—Atty. H. Rosenblatt, 5 Beekman St., New York, N. Y.
Kalter Radio—Atty. O. Fensterheim, 51 Chambers St., New York, N. Y.
Wilmington Radio Laboratories, Inc., Wilmington, Del.—Atty. C. W. Hazel, Wilmington, Del.
Onondaga Radio Broadcasting Corp.—Atty. Franchot, James & Warren, Buffalo, N. Y.
Hart Radio Stores—Atty. S. Soulnick, 110 West 40th St., New York, N. Y.
Bison Radio Company—Atty. N. S. Silverberg, Buffalo, N. Y.
Monmouth Broadcasting Co., Red Bank, N. J.—Atty. Applegate, Stevens, Foster & Reussille, Red Bank, N. J.
Gemco Radio Stores—Atty. S. Harrington and Davidson, Buffalo, N. Y.

Electro-Magnet Saves Auto Tires

Little Rock, Ark.

The familiar electro-magnetism as present in radio circuits and horseshoe magnets has been put to use as a saver of automobile tires.

Gravel highways in Arkansas are to be made "puncture proof," according to the chairman of the State Highway Commission, Dwight H. Blackwood, in announcing that the commission's equipment engineer, J. A. Francis, has assembled an electro-magnetic machine which picks up nails, bits of wire and other articles likely to menace automobile tires.

The machine, which is mounted on a truck, covers an 18-foot driving surface in a round trip, and can be operated from 6 to 10 miles an hour, Mr. Blackwood said.

During a recent experiment trip over 38 miles, he said, the machine picked up 1,020 pounds of nails and other metal articles.

LINER RECEIVES PICTURES FAST

There has been installed on The United States Liner America a new system of fac-simile reception, an invention of Capt. H. R. Ranger of RCA. This system eliminates dots and dashes and is much quicker.

The America is the first ship to be equipped with the new system. This system of transmission will speed up communication because the entire picture, or news article, is printed on a strip about 40 inches wide, being flashed at once.

News sent to ships in this manner will constitute an ocean newspaper that may also include advertising matter.

For the present the America will only carry a fac-simile receiver. Transmitter installations on this and other ships may be made later.

The pictures and printed matter are to be transmitted from the RCA stations at New Brunswick, N. J., and Rocky Point, N. Y., by short waves.

Bernie Cummins Weds

Bernie Cummins, leader of the New Yorker Hotel Orchestra, which broadcasts regularly through National Broadcasting Company networks, and Miss Katherine Mahoney, of 150 Riverside Drive, were married recently in the Lady Chapel of St. Patrick's Cathedral, New York City. 11 o'clock Thursday morning. They met in Florida four years ago while he was leading an orchestra at a hotel.

92 ELEMENTS LISTED

"The 92 Elements" is the title of a circular issued by P. C. Kullman & Co., 110 Nassau Street, New York City, listing the chemical elements by atomic number, giving the name, symbol, atomic weight, melting point and year of discovery. "All things in this world," says an announcement, "are composed of one or more of these elements or their compounds or the derivative(s) thereof." A copy will be sent to those mentioning RADIO WORLD.

SHORT SERVICE COURSE

A five-day short course for radio service men will be conducted by the General Extension Division and College of Electrical Engineering of the University of Florida at Gainesville from July 7th to 12th inclusive.

SOIL RETAINING MOISTURE BEST FOR A STATION

Washington.

Placing a radio station and planting corn or cotton, have one point in common, according to the Department of Agriculture, which issued the following:

The right kind of soil is important to the corn or cotton crop, and the right kind of soil is important to the most effective operation of the radio station.

New Use for Soil Survey

This fact came out when a representative of a large concern manufacturing radio transmitting apparatus visited the United States Department of Agriculture and asked to examine soil-survey reports and maps as a guide to the placement of radio stations in the Middle West and Southwest. This use of the soil-survey records was new to the soil specialists of the Department.

The radio expert explained that engineers have found that radio transmission is better over soils which are retentive of moisture than over drier soils.

Less Absorption by Moist Soil

They believe this is because the drier soils absorb the radio waves to a greater degree than do the moist soils. He said that the soil maps and the detailed descriptions have already proved useful in locating stations.

South Carolina Gets Set Tax Under Way

Blanks on which all radio in the State of South Carolina are to be reported by the owners to the State tax commission have been sent to several thousand radio owners, according to an oral statement by R. A. Little, director of the license division of the tax commission. Names of the set owners were obtained by field agents through the cooperation of radio dealers, Mr. Little explained.

The tax, says "The United States Daily," is graduated according to the value of the set and the rates are as follows: 50 cents for sets costing less than \$50; \$1 for sets between \$50 and \$200; \$2 for sets between \$200 and \$500, and \$2.50 for sets costing more than \$500. The proceeds of the tax go to the State tuberculosis sanatorium at State Park near Columbia, the law provides.

\$75,000 Is Offered For Earl Co. Assets

Newark, N. J.

Harry G. Hendricks and Oscar A. Kalmer, receivers for the Earl Radio Corporation, have applied to Vice-Chancellor Alonzo Church for permission to sell the assets of the company to a bidder who had offered \$59,250. The bidder was S. & R. Radio Corporation, of New York, N. Y.

Merritt Lane, counsel for a group of stockholders, opposed the application, saying that he was ready to make an informal offer of \$65,000. Counsel for other stockholders informed the Vice-Chancellor that they were prepared to make offers as high as \$75,000. The Vice-Chancellor ordered the receivers to advertise for bids.

"Seconds"

But Serviceable Tubes Nevertheless at Prices That Seem Incredible

A tube factory that maintains the highest possible standards for a large laboratory customer has tubes for sale that fall just a trifle below the most exacting specifications, but which are excellent tubes nevertheless. They are called "seconds" and they are "seconds," but they are not "thirds." You can get 500 hours excellent use out of them. Note the prices. Remit with order. Generous replacement policy.

112A	50c	227	50c
UV or UX-199	50c	245	50c
201A	45c	250	75c
210	60c	171A	50c
224	65c	280	50c
226	50c	281	60c

DIRECT RADIO CO.
Room 504, at
1562 Broadway, N. Y. City.

RECENT NUMBERS

for the current year are procurable at the rate of 15c a copy, or 7 copies for \$1.00. RADIO WORLD, 145 West 45th St., N. Y. City.

Horn Unit \$2.25



Fidelity Unit, Cat., FDU, price \$2.25

The Fidelity unit is pre-eminent for horn-type speakers such as exponential horns. The faintest word from a "whispering tenor" or the tumultuous shout of the crowd or highest crescendo of the band is brought out clearly, distinctly. Stands up to 450 volts without filtering.

Works right out of your set's power tube, or tubes, requiring no extra voltage source. Standard size nozzle and thread. Works great from AC set, battery set or any other set, push-pull or otherwise. The casing is full nickel finish, highest polish.

This unit can be used in a portable without any horn attached and will give loud reproduction. Order Cat. FDU, with 50-inch tipped cord; weight, 2 1/2 lbs.; size, 2 1/2-inch diameter, 2 1/2-inch height. (This is the large size). Price, \$2.25

GUARANTY RADIO GOODS CO.
143 West 45th Street, New York City

RADIO WORLD'S BOOK SERVICE has been found of great value not only by radio fans, constructors, etc., but also by radio and other technical schools throughout the country. See the radio books advertisement in this issue.

Equip Yourself Now With Necessary Meters!

To do your radio work properly you need meters. Here is your opportunity to get them at no extra cost. See the list of nine meters at left. Heretofore we have offered the choice of any one of these meters free with an 8-week subscription for RADIO WORLD, at \$1, the regular price for such subscription. Now we extend this offer. For the first time you are permitted to obtain any one or more of all of these meters free, by sending in \$1 for 8-week's subscription, entitling you to one meter; \$2 for 16 weeks, entitling you to two meters; \$3 for 24 weeks, entitling you to three meters; \$4 for 32 weeks, entitling you to four meters; \$5 for 40 weeks, entitling you to 5 meters; \$6 for 48 weeks, entitling you to six meters. Return this offer with remittance, and check off desired meters in squares at left.

RADIO WORLD will help you in your radio work, so you will be able to use the meters most valuably. Keep abreast of all the new circuits, intimate details on perfecting existing sets, and get inside track on sensitivity, distance, reception, tonal quality, and news of radio, technical and non-technical. Enjoy the writings of Dr. Lee De Forest, McMurdo Silver, J. E. Anderson, Herman Bernard and a host of other radio engineers who contribute their knowledge to you through the medium of RADIO WORLD, the first and only illustrated national radio weekly. You can find no magazine that better caters to your needs than RADIO WORLD. Short waves? RADIO WORLD will tell you all about them. Extremely sensitive broadcast receivers? Their construction and operation are fully discussed with confident regularity. Power supplies --push-pull or otherwise? AC receivers? Screen grid tubes? Large receivers that give a super-abundance of performance--small, economical receivers that give performance out of all comparison to their size? Are you interested in these? Then you're interested in RADIO WORLD.

Present mail subscribers may renew their subscription under this remarkably generous offer. Put a cross in square.

RADIO WORLD

145 W. 45th St., N. Y. City--Published Weekly.
All Newsstands, 15c per copy--\$3, six months--\$8 a year



Your Choice of These Nine Meters FREE!

<input type="checkbox"/> 0-5 Voltmeter D.C.	No. 329
<input type="checkbox"/> 0-50 Voltmeter D.C.	No. 327
<input type="checkbox"/> 0-Volt Charge Tester D.C.	No. 23
<input type="checkbox"/> 0-10 Amperes D.C.	No. 328
<input type="checkbox"/> 0-25 Milliamperes D.C.	No. 325
<input type="checkbox"/> 0-50 Milliamperes D.C.	No. 326
<input type="checkbox"/> 0-100 Milliamperes D.C.	No. 328
<input type="checkbox"/> 0-300 Milliamperes D.C.	No. 328
<input type="checkbox"/> 0-400 Milliamperes D.C.	No. 324

Two for the price of One

Get a FREE one-year subscription for any ONE of these magazines:

- CITIZENS RADIO CALL BOOK AND SCIENTIFIC DIGEST (quarterly, four issues).
- RADIO (monthly, 12 issues; exclusively trade magazine).
- RADIO ENGINEERING (monthly, 12 issues; technical and trade magazine).
- RADIO INDEX (monthly, 12 issues) Stations, programs, etc.
- SCIENCE & INVENTION (monthly, 12 issues; scientific magazine, with some radio technical articles).
- AMERICAN BOY--YOUTH'S COMPANION (monthly, 12 issues; popular magazine).
- BOYS' LIFE (monthly, 12 issues; popular magazine).

Select any one of these magazines and get it FREE for an entire year by sending in a year's subscription for RADIO WORLD at the regular price, \$6.00. Cash in now on this opportunity to get RADIO WORLD WEEKLY, 52 weeks, at the standard price for such subscription, plus a full year's subscription for any ONE of the other enumerated magazines FREE! Put a cross in the square next to the magazine of your choice, in the above list, fill out the coupon below, and mail \$6 check, money order or stamps to RADIO WORLD, 145 West 45th Street, New York, N. Y. (Just East of Broadway).

Your Name

Your Street Address

City State.....

DOUBLE

VALUE!

- If renewing an existing or expiring subscription for RADIO WORLD, please put a cross in square at beginning of this sentence.
- If renewing an existing or expiring subscription for other magazine, please put a cross in square at the beginning of this sentence.

RADIO WORLD, 145 West 45th Street, New York, N. Y. (Just East of Broadway)

Parts for All-Wave Set

[Order what individual parts you desire. You don't have to order all.]

- Two sets of precision, de luxe coils, wound on ribs, 93 per cent. air dielectric, three coils to a set; one detector plate coil with mounting bushings total, seven coils to cover 15 to 360 meters (Cat. AW-CK) @..... \$12.00
- Two Hammarlund .0005 mfd. straight frequency line condensers (Cat. H-SF-5 @ \$3.30) @..... 6.60
- One 20-ohm filament resistor (Cat. FIL-20) @..... .20
- One 1 1/3 ohm filament resistor (Cat. FIL-13) @..... .20
- One 14 1/2 x 9 1/2 inch bakelite subpanel, with Four UX and one UY sockets built in, also two coil receptacles built in (Cat. AW-SUB @..... 3.50
- One 5-lead battery cable with 5-prong plug attached (Cat. 5-L-CP) @..... 1.50
- One steel cabinet with wrinkle brown finish 7x15 1/2 x 10 1/2 (Cat. AW-CAB) @..... 4.50
- One bottom shield for cabinet (Cat. SH-BOT) @..... 1.50
- One 1-to-3 audio transformer (Cat. GB-1-3) @..... 1.50
- One 1-to-5 audio transformer (Cat. GB-1-5) @..... 1.50
- Two insulating washers for volume control (Cat. IN-W) @ .05..... .10
- Four subpanel brackets (Cat. BRA) @ .05..... .20
- One antenna-ground blinding post unit (Cat. A-G-BPU) @..... .35
- One speaker binding post unit (Cat. SP-BPU) @..... .35
- One .0025 mfd. grid condenser with clips (MICOX-.0025 CL) @..... .18
- One Lynch 5 meg. metallized grid leak (Cat. LYN-5) @..... .30
- Two National type VB-D variable ratio dials, maximum reduction to 20-to-1, with 2.5 volt pilot lights and illumination brackets (Cat. VB-D-PB) @ \$1.80..... 3.60
- Two Polymet 1 mfd. bypass condensers, single lug type, (case goes to ground), (Cat. POLY-1) @ 50c..... 1.00
- One 30,000 ohm Clarostat wire-wound potentiometer with switch attached (Cat. CLA-30,000-S) @..... 1.50
- Four Spacers for condensers @ .025..... 10
- All parts (Cat. AP-AWB)..... \$10.78

PORTABLE

as described on page 10 of June 7th issue, \$35.00 assembled.

Guaranty Radio Goods Co.
145 W. 45th St., N. Y. C., Just E. of B'way

Official Parts for Popular Circuits

- 1,500 to 200,000 ohmmeter, 0-10, 0-200, 0-1,000 voltmeter, at 1,000 ohms per volt; includes 0-1 ma. resistors, knob, calibrated panel, switches, cabinet, etc., as described by Herman Bernard. Cat. OM-VM @..... \$13.70
- Universal Short-Wave Converter, using three 227 tubes; six de luxe precision short-wave air dielectric coils, condensers, chokes, 7"x14" panel, etc. Cat. UN-SWC @..... \$22.37

GUARANTY RADIO GOODS CO.
143 West 45th Street
New York City

NEW NATIONAL THRILL BOX

Cat. ACSW5: National complete parts for 5-tube AC Short Wave Thrill Box; list price, \$79.50; net price..... \$45.35

Cat. DCSW5: National complete parts for 5-tube battery operated short-wave Thrill Box; list price, \$75; net price..... \$42.75

Wired by Jackson Laboratories, \$5.70 extra. Add letter "W" to catalogue symbols.

AC model uses two UY224, three UY227, with provision for ventode in RF stage if preferred. Cat. ACSW5 does not include power supply. Use National A and B power unit, 2.5 v. AC, 150 plate volts, Cat. 5880-AB; list, \$34.50; net \$19.66. One 280 tube required. Order 280. Key tube @..... \$1.13 net

Guaranty Radio Goods Co.

143 West 45th Street
New York, N. Y.
(Just East of Broadway)

RADIO WORLD'S QUICK-ACTION CLASSIFIED ADS

10 CENTS A WORD
10 WORDS MINIMUM
CASH WITH ORDER

Erla Dynamic Chassis, Westinghouse Rectifier

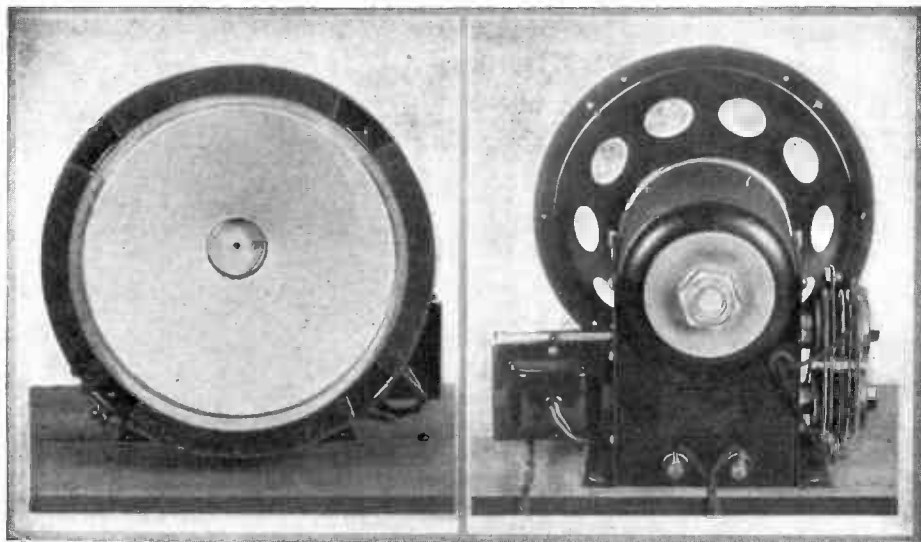

One of the most sensitive and most faithful dynamic speaker chassis, the Erla, has a 9-inch outside diameter cone, with built-in Westinghouse Rectox dry metallic rectifier, output transformer and mounting board. Equipped with 10-ft. A.C. cable and plug, to go into house socket, 110 v. 50-60 cycle, and two 10-ft. tipped leads for connection to set. Will stand up to output of 250 tubes in push-pull, but will work well on any set, battery-operated or A.C. Order Cat. ER-D-AC. List price \$25.00; net price \$12.50.
Besides the AC Erla we also have the DC type, for use on 90-125 volts. It may be connected direct to 110 v. DC house line or to 90 v. of B supply. Order Cat. ER-D-DC, list price \$20, net price \$10.00.
6v. DC model, to be energized by your 6-volt storage battery. Order Cat. ER-6-v. @ 9.25

\$12.50

Ansonia Speaker



Ansonia magnetic speaker, in genuine walnut cabinet. A loudspeaker that gives you real performance, that stands up to a 171 or 171A tube without requiring an output filter, and that works splendidly from output filters in sets using tube 171A in push-pull. And the magnetic unit in this Ansonia Speaker is of the very best Ansonia type. The cabinet is a beauty, indeed. Order Cat. AN-G. List price \$35, net price \$4.89

Velvetone Power Amplifier

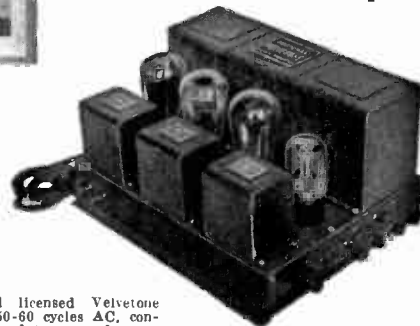

The National Company's wired and licensed Velvetone push-pull power amplifier, for 110 v. 50-60 cycles AC, consisting of B supply for 280 rectifier, and two transformer-coupled audio stages, the first 227, the second 245s in push-pull, with output transformer built in. Supplies all B voltages for an AC or any other tuner, also 2.5 v. heater voltage for 227 and screen grid RF, detector and preliminary audio tubes, and is especially suitable for the MB-29 tuner. Order Cat. PPA. List price \$97.50; net price \$56.52
MB 29 AC screen grid tuner parts, assembled complete in chassis. Uses four 224 and one 227 detector. Equipped with new tuning condensers, built-in trimmers, volume control and AC front panel switch (not illustrated). Order Cat. MB-29-K, list price \$69.50; net price \$39.61

\$56.52
\$39.61

MB-29 Screen Grid Tuner

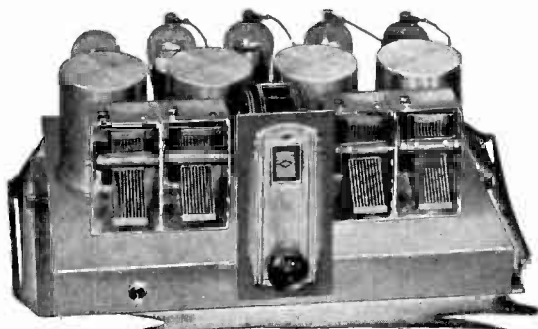

Mike Lighter



Cigar-cigarette stand, with imitation microphone pedestal, into which is built a lighter. Press button at top and light up. 10-ft AC cable and plug. Works on AC or DC, 110 v. Order Cat. MIK-L-S, list price \$2.75; net price \$1.49

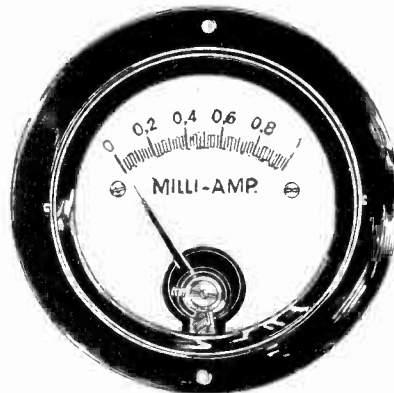

O-1 milliammeter, 99% accurate; panel mount type; internal resistance, 88 ohms; used as voltmeter, with 1,000 series ohms for each volt to be read, has resistance of 1,000 ohms per volt. Order Cat. F-O-1, list price \$12; net price \$5.95

220-v Kodol "B" Supply



Spring Action Nipper



Handiest radio tool. Cuts even 8/32 machine screws. All wire, of course. Order Cat. NIP, list price \$2.75; net price \$1.49

Turntable Motor



Synchronous motor, for phonograph records. 80 revolutions per minute. Works on 60-cycle 110 v. AC. Smooth-running and lasts a lifetime. Fine for console installation. Turntable free with each synchronous motor order. Order Cat. SY-M, list price \$20, net price \$10.00

"Radio Trouble Shooting" By E. R. Haan

The outstanding exposition of the solution of radio troubles. Just the thing for service men and experimenters. 328 pages. 6x9 inches. 300 illustrations. Order Cat. HA-TS @ \$3.00

Write for circular on Haan's book.

Reference Book

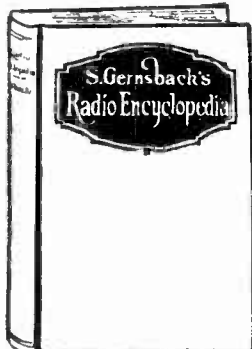

Biggest bargain price of this famous encyclopedia, containing definitions of 1930 different terms. Classifies alphabetically and defines the terms used in radio. Pages 9x12 inches. 540 illustrations. Cross-indexed. Order Cat. GER-EN, list price \$2.50, net price \$1.49

Kuprox B eliminator, Model 316, 220 volts DC, utilizing 280 tube, for 110 v. AC, 50-60 cycles, to deliver positive voltages of 45, 90, 135 and 180 and negative voltage of 40 for biasing 171 or 171A, also delivers 4 volts negative for other receiver tubes. One knob on the terminal panel controls the actual voltage on the 45-volt tap and another knob controls the voltage on the 180-volt tap. The terminal panel contains in addition to the two knobs seven binding posts for B minus, which is connected to the case, for the four positive and the two negative voltages. It is provided with a standard plug and an 80-inch connecting cord. The overall dimensions are: width 5 1/4 inches; length, 13 inches; height, 8 1/4 inches. Order Cat. KO-B, list price \$35, net price \$13.16
280 TUBE FREE WITH EACH KO-B

Guaranty Radio Goods Co., 143 W. 45th Street, New York, N. Y. (Just east of Broadway)

Enclosed please find \$..... for which send me the following:
 Cat. ER-D-AC @ \$12.50
 Cat. ER-D-DC @ \$10.00
 Cat. AN-G @ \$4.89
 Cat. PPA @ \$56.52
 Cat. MB-29-K @ \$39.61
 Cat. MIK-L-S @ \$1.49
 ER-6-V @ \$9.25
 Cat. NIP, \$1.49
 Cat. GER-EN, \$1.49
 Cat. SY-M, \$10.00
 Cat. HA-T-S, \$3.00
 Cat. F-O-1, \$5.95
 Cat. KO-B, \$13.16

Canadian remittance must be by express or P. O. Money Order. If ordering C. O. D. put cross here.

Name
 Address
 City..... State.....

Headquarters for Outstanding Books—FREE!

"AUDIO POWER AMPLIFIERS"—Anderson and Bernard

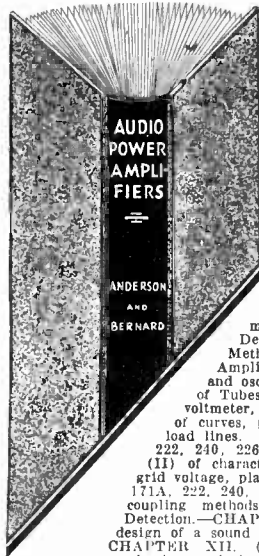

"Audio Power Amplifiers" is the first and only book on this important subject. The authors are:

J. E. Anderson, M.A., former instructor in physics, University of Wisconsin, former Western Electric engineer, and for the last three years technical editor of "Radio World."

Herman Bernard, LL.B., managing editor of "Radio World."

The book begins with an elementary exposition of the historical development and circuit constitution of audio amplifiers and sources of powering them. From this simple start it quickly proceeds to a well-considered exposition of circuit laws, including Ohm's laws and Kirchhoff's laws. The determination of resistance values to produce required voltages is carefully expounded. All types of power amplifiers are used as examples: AC, DC, battery operated and composite. But the book treats of AC power amplifiers most generously, due to the superior importance of such power amplifiers commercially.

CHAPTER I. (page 1) General Principles, analyzes the four types of power amplifiers, AC, DC, battery-operated and composite, illustrates them in functional blocks and schematic diagrams.—CHAPTER II. (page 20) Circuit Laws, expounds and applies Ohm's laws and those known as Kirchhoff's laws.—CHAPTER III. (page 35) Principles of Rectification, expounds the vacuum tube, both filament and gaseous types, electrolytic and contact rectifiers, full-wave and half-wave rectification, current flow and voltage derivation. Regulation curves for the 280 tube are given.—CHAPTER IV. (page 62) Practical Voltage Adjustments, gives the experimental use of the theoretical knowledge previously imparted. Determination of resistance values is carefully revealed.—CHAPTER V. (page 72) Methods of Obtaining Grid Bias.—CHAPTER VI. (page 90) Principles of Push-Pull Amplifier.—CHAPTER VII. (page 98) Oscillation in Audio Amplifiers, motorboating and oscillation at higher audio frequencies.—CHAPTER VIII. (page 118) Characteristics of Tubes, tells how to run curves on tubes, how to build and how to use a vacuum tube voltmeter, discusses hum in tubes with AC on the filament or heaters and presents families of curves, plate voltage-plate current, for 240, 220, 201A, 112A, 271A, 227 and 245, with load lines. Also, plate voltage-plate current characteristics of 220, 201A, 201A, 112A, 171A, 222, 240, 226, 227, 224, 245, 250, full data on everything. There is a composite table (II) of characteristics of Rectifier and Voltage Regulator Tubes, and individual tables, giving grid voltage, plate current characteristics over full useful voltage ranges for the 220, 201A, 112A, 171A, 222, 240, 227, 245 and 224.—CHAPTER IX. (page 151) Reproduction of Recordings, states coupling methods and shows circuits for best connections.—CHAPTER X. (page 161) Power Detection.—CHAPTER XI. (page 121) Practical Power Amplifier, give AC circuits and shows the design of a sound reproduction system for theatres. A page is devoted to power amplifier symbols.—CHAPTER XII. (page 183) Measurements and Testing, discloses methods of qualitative and quantitative analysis of power amplifier performance. Order Cat. APAM.

"Radio Manual"—Sterling



The new edition of "The Radio Manual" answers questions about the principles, methods, or apparatus of radio transmitting and receiving. A complete course in radio operation in a single volume.

20 big chapters cover: Elementary Electricity and Magnetism; Motors and Generators; Storage Batteries and Charging Circuits; The Vacuum Tube; Circuits Employed in Vacuum Tube Transmitters; Modulating Systems and 100% Modulation; Wave-meters; Piezo-Electric Oscillators; Wave Traps; Marine Vacuum Tube Transmitters; Radio Broadcasting Equipment; Arc Transmitters; Spark Transmitters; Commercial Radio Receivers; Marconi Auto-Alarm; Radio Beacons and Direction Finders; Aircraft Radio Equipment; Practical Television and Radiomovies; Eliminating Radio Interference; Radio Laws and Regulations; Handling and Abstracting Traffic.

The author, G. E. Sterling, is Radio Inspector and Examining Officer, Radio Division, U. S. Dept. of Commerce. Edited by Robert S. Kruse. Nearly 900 pages, 269 illustrations; flexible fabric cover. Order Cat. MAN.

"FOOTHOLD ON RADIO"

In simple English that any one can understand, the technical side of radio is presented by Anderson and Bernard in their book, "Foothold on Radio." Any one who can read English can understand this book. It is intended for the sheer novice. The treatment is non-mathematical. The origin of the broadcast wave, its radiation, reception, amplification and rectification are set forth in clear language. Side bands are explained simply. The types of receiving circuits are illustrated, described and contrasted. A chapter is devoted to loudspeakers, explaining the different kinds and the principles of their operation. Performance is compared. Audio coupling is fully explained, also the action of the vacuum tube, with a special analysis of plate current and its behavior. Those who have been thirsting for a book that reveals the marvels of the radio science will appreciate this little volume. Paper cover 60 pages, fully illustrated. Published May, 1930. Order Cat. FOR.

"Principles"—Morecroft

The outstanding book by Prof. John H. Morecroft is "Principles of Radio Communication," of which the new second edition is now ready. Prof. Morecroft, of the Electrical Engineering Department of Columbia University and past president of the Institute of Radio Engineers, is a noted authority. Set builders, experimenters, distributors, dealers, salesmen and teachers, students and operators, all find Morecroft their standby, and now the new second edition awaits you. 1,091 pages and 831 illustrations in this cloth-bound volume. Order Cat. M-PRIN.

"THE SUPERHETERODYNE"

This is a new volume by Anderson and Bernard dealing with the principles and practice of the Superhetrodyne method of receiving. It explains the function of the oscillator, the modulator, the pre-modulator selector, and the intermediate frequency amplifier. It explains the cause of repeat points and gives methods for avoiding them or minimizing their effect. It expounds the relative advantages and disadvantages of high and low intermediate frequencies, and shows the effect of selectivity on the quality.

It illustrates various forms of oscillator and tells of the advantages of each. Different types of modulators and pick-up systems are explained and their advantages stated. Different methods of coupling in the intermediate frequency amplifier are shown.

Image interference is discussed in detail and methods given by which it may be reduced. A special method of ganging the oscillator to the radio frequency condensers is explained, a method which allows either the high or the low oscillator setting to be selected by means of a variometer in the oscillator circuit. One section is given over to coil design for the radio frequency tuners, the oscillator, and the intermediate frequency filter.

Audio amplifiers suitable for superheterodynes are also described. These include transformer, resistance, and push-pull amplifiers for AC and DC. While the book is primarily intended to expound the principles of the Superheterodyne, the practical phase has not been neglected. Detailed descriptions of AC and DC superheterodynes, designed in conformity with best practice and sound applications of the principles, have been included in the book. These descriptions are well illustrated. Order Cat. ABSH.

"Elements"—Morecroft

A good book for beginners is Prof. Morecroft's "Elements of Radio Communication," to inform you authoritatively on the technical phases of radio in plain language, provided you have some foundation knowledge of radio. The book is a complete course on the elements of radio, containing much material never before published. It has 226 pages, 170 illustrations and a complete index. Cloth bound. Order Cat. M-ELEM.

115 LATEST COMMERCIAL SET DIAGRAMS—Rider

Schematic diagrams of 115 latest commercial receivers, including screen grid, collated by John F. Rider, into Supplement No. 1, each diagram on a separate sheet 8 1/2 x 11 inches. Needed by every service man. "Trouble Shooter's Manual," by Rider, contains 200 diagrams, but the present 115 are additional and up to date. No duplication. Audiolia 90B and 730; Bakelite F; Crosley 41A, 42 A.C., 609, 600 A.C., 20, 21, 22, 318, 308, 338, 304 A.C., 408, 418, 428, 828, 909, 918, 928; Sonora 71, A30, A32, B31, A36, A40, A44; Kennedy 80, 16, 20; Stewart-Warner 900 A.C., 950 battery, 950 A.C., Model B; Radiola 44, Model B; Radiola 45, Model B; Radiola 90, 906 power unit, 903 power unit; Stromberg-Carlson 641, 642, 846; Edson H1, R2, C2 (50 and 25 cycle); R5 and C4; American Beach 54 D.C.; Victor R32 and RE45; Grebe SK4 A.C. (early model), SK4 A.C. (late model), SK4 D.C. 428; Traveler A.C. power pack; Eria 224 A.C. screen grid; Silver-Marshall 30B, 30C, 30D, 30E; Eveready 1, 2 and 3, Series 30, Series 40, Series 50; Steinite 40, 50 and 102, 50 power unit; All American Mohawk 96 (60 cycle), 90 (25 cycle), 90 (60 cycle), 70, 73 and 75; Gulbranson Model C (early model), Model C (late model); Bremer-Tully 7-70 and 7-71, 81, 82; Earl 21, 22, 31, 41, 42; Philco 65, 78, 87, 95 screen grid; Peerless Electrostatic series, screen grid; Fada 20, 20Z, 22 battery, 25, 25Z, 25Z; M50, 25ZU. Electric units, 35, 35Z, 75, 77; Brunswick 5 N8 Radio Chassis Schematic, N8 Audio Chassis Schematic, NCS and 3 NCS; NCS Radio Chassis Schematic, 3 NCS cabinet wiring, S14, S21, S31, S81, S82 screen grid Radio Chassis Schematic, S14, S21, S31, S81, S82 screen grid Radio Chassis Actual, S14, S21, S31, S82 Audio Chassis Schematic (25 cycle), S14, S21, S31, S81, S82 Audio Chassis Schematic (60 cycle), S14, S21, S31, S81, S82 Audio Chassis Actual (25 cycle), S14, S21, S31, S81, S82 Audio Chassis Actual (60 cycle), S31, Audio Chassis Schematic (60 cycle) S31, Audio Chassis Actual (60 cycle), 3 KR8 cabinet wiring, 3 KR8 Radio Chassis, 3 KR8 Audio Chassis Schematic, 3 KR8 Audio Chassis Actual, 5 NO Radio Chassis Schematic, 5 NO Socket Power Schematic, 3 KR8 Audio Chassis, 3 KR8 Audio Chassis, 3 KRO and 3 KR6 Socket Power, 5KR, 5KRO, 2KRO, 5KR6 Radio Chassis; Amrad Bel-Canto series; Spartan 89, 89A, 49, ensemble, 931, 301 D.C., 931 A.C., 110 A.C., 301 A.C. Order Cat. SUPP. No. 1.

"Trouble Shooter's Manual"

The first comprehensive volume devoted exclusively to the topic uppermost in every service man's mind is "Trouble Shooter's Manual," by John F. Rider. It is not only a treatise for service men, telling them how to overcome their most serious problems, and fully diagramming the solutions, but it is a course in how to become a service man. It gives all the details of servicing as they have never been given before. Finding the right mode of attack, applying the remedy promptly and obtaining the actual factory-drawn diagrams of receivers always have been a big load on the service man's chest. But no more.

This book is worth hundreds of dollars to any one who shoots trouble in receivers—whether they be factory-made, custom-built or home-made receivers.

MORE THAN 100 WIRING DIAGRAMS OF RECEIVERS MADE BY MORE THAN FORTY DIFFERENT SET MANUFACTURERS ARE PUBLISHED IN THIS BOOK, INCLUDING OLD MODELS AND LATEST MODELS: RCA, ATWATER KENT, CROSLLEY, MAJESTIC, ZENITH, STROMBERG, CARLSON, KOLSTER, FEDERAL, FADA, ETC. 240 pages, size 8 1/2 x 11"; 200 illustrations. Imitation leather cover. Order Cat. TSM.

"Mathematics of Radio"

"Mathematics of Radio," by Rider, 128 pages, 8 1/2 x 11", 119 illustrations, bridges the gap between the novice and the college professor. It gives a theoretical background so necessary for a proper understanding of radio and audio circuits and their servicing. Formulas for capacity, inductance, impedance, resistance, etc., are explained. Flexible cover. Order Cat. MOR.

"Treatise on Testing Units"

"Treatise on Testing Units for Service Men," by Rider, is a 43-page, illustrated book on testing units and circuits. Tells what equipment a service man should have and how to use it most effectively and quickly. Order Cat. TTU.

Radio World, 145 West 45th Street, New York, N. Y. (Just East of Broadway—Phone BRYant 0558.)

Enclosed please find \$..... for which please enter my subscription for RADIO WORLD for specified period and send free (postpaid) the one premium book designated by my cross in square.

FOR \$2.00 for 16 weeks (16 issues) TTU

ABSH \$3.00 for 6 months (26 issues) Supp. No. 1

\$4.00 for 34 weeks (34 issues) MOR MWPRC

\$5.00 for 42 weeks (42 issues) MWT MWPR

\$6.00 for 1 year (52 issues) APAM TSM M-ELEM

TEL REX PRK

RFM \$7.00 for 60 weeks (60 issues)

MAN \$10.00 for 86 weeks (86 issues)

DRA \$12 for 2 years (104 issues) M-PRIN

Name

Address

City

State

If extending existing subscription put cross here.

OTHER BOOKS

"ABC of Television," by Raymond Francis Yates, tells the whole story and gives data on construction of a television receiver. 214 pages, 100 illustrations. Cloth bound. Order Cat. TEL.

"Drake's Encyclopedia," new edition, 2 1/2" thick, weighs 3 1/2 lbs., 920 pages, 1,025 illustrations. Order Cat. DRA.

"Experimental Radio," by R. R. Ramsey, Ph.D., Prof. Physics, Indiana University. 255 pages, 168 illustrations. Cloth cover. Order Cat. REX.

"Fundamentals of Radio," by Ramsey, 371 pages, 462 illustrations. Order Cat. RFM.

"Principles of Radio," by Keth Henney, M.A., former director, laboratory, Radio Broadcast. 477 pages, 305 illustrations. Order Cat. PRK.

"Radio Telegraphy and Telephony," by Rudolph L. Duncan and Charles F. Drew, of Radio Institute of America. Order Cat. RTT.

High-Gain Shielded Coils

A SHIELDED radio frequency transformer for use as antenna coupler or as interstage coupler, for screen grid circuits. The coil is wound on a 1 3/4-inch diameter bakelite form with No. 28 enamel wire, primary on the outside, separated from the secondary by an insulating wrapper 42/10,000-inch thick. This moisture-proof insulation is so shaped that it completely insulates the primary from the secondary, preventing short-circuit. The coil form is mounted on a wooden base, which base has the removable shield bottom fastened to it. The drawn aluminum shield fits snugly over the wooden base, and coils remain always erect and amply spaced from the shield wall in all directions. The shielded coils are suitable for baseboard or metal chassis mounting. The four leads emerge through an insulated hole in the shield bottom.

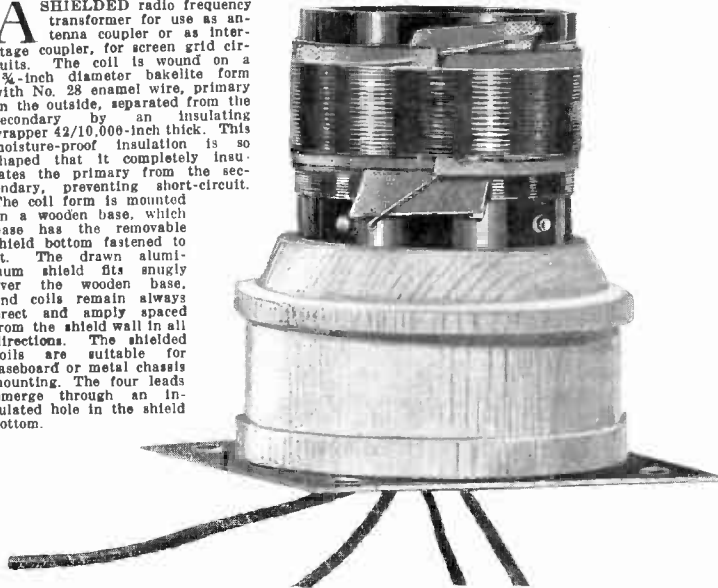

The coil comes already mounted on a shellacked wooden base, which is fastened at the factory to the shield bottom. Series A coil is illustrated.



The external appearance of the shield, with four 6/32 machine screws and nuts, which are supplied with each coil assembly.

Precisely Matched for Gang Tuning

O NE primary lead-out wire from the coil, for antenna or plate connection, has a braided tinned alloy covering over the insulation. This alloy braid shields the lead against stray pick-up when the braid alone is soldered to a ground connection. The outleads are 6 inches long and are color identified. The wire terminals of the windings themselves, and the outleads, are soldered to copper rivets. Each coil comes completely assembled inside the shield, which is 2 3/4 inches square at bottom (size of shield bottom) and 3 3/4 inches high. High impedance primaries of 40 turns are used. Secondaries have 80 turns for .00035 mfd. and 70 turns for .0005 mfd.

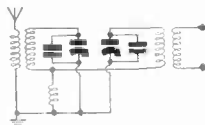

BP-6 is the coil at bottom.

E XTREME accuracy in winding and spacing is essential for coils used in gang tuning. These coils are specially suited for gang condensers, because the inductances of all are identical for the stated size condenser. The coils are matched by a radio frequency oscillator. The color scheme is as follows: shielded wire outlead is for antenna or plate; red is for ground or B plus. (These options are due to use of the same coil for antenna coupling or interstage coupling.) Blue is for grid and yellow is for grid return. For .00035 mfd. the Cat. No. is A-10-80-S. For .0005 mfd. the Cat. No. is A-10-70-S. Where a band pass filter circuit is used the small coupling coil to unite circuits is Cat. BP-6. The connection is illustrated herewith.

Junior Model Inductances

The Series B coils have the same inductance and the same shields as the series A coils, but the primary, instead of being wound over the secondary, with special insulation between, is wound adjoining the secondary, on the form, with 1/4-inch separation, resulting in looser coupling. No wooden base is provided, as the bakelite coil form is longer, and is fastened to the shield bottom piece by means of two brackets. No outleads. Wire terminals are not soldered. Order Cat. B-SH-3 for .00035 mfd., and Cat. B-SH-5 for .0005 mfd.

Coils for Six-Circuit Tuner

Series C coils for use with six tuned circuits, as in Herman Bernard's six-circuit tuner, are wound the same as type A shielded coils, but the shields are a little larger (3 1/16-inch diameter, 3 3/4 inches high), and there are no shield bottoms, as a metal chassis must be used with such highly sensitive circuits. Fasten the brackets to the shield and then, from underneath the chassis, fasten the other arm of the two brackets to the chassis. Order Cat. C-6-CT-5 for .0005 mfd. and Cat. C-6-CT-3 for .00035 mfd. Five needed for Bernard's circuit. If band pass filter coupling coil is desired order Cat. BP-6 extra.

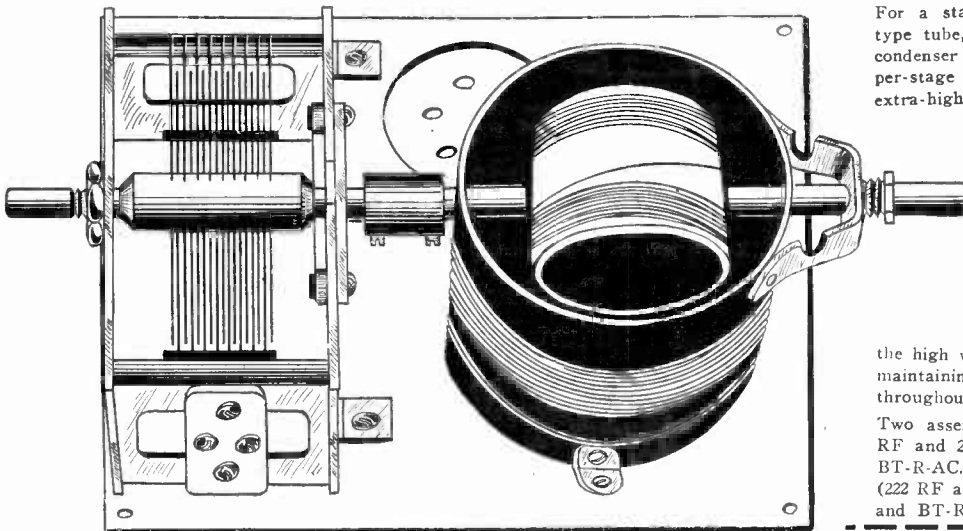

For a stage of screen grid RF, either for battery type tube, 222, or AC, 224, followed by a grid-leak-condenser detector, no shielding is needed, and higher per-stage amplification is attainable and useful. This extra-high per-stage gain, not practical where more than one RF stage is used, is easily obtained by using dynamic tuners. Two assemblies are needed. These are furnished with condensers erected on a socketed aluminum base. Each coil has its tuned winding divided into a fixed and a moving segment. The moving coil, actuated by the condenser shaft itself, acts as a variometer, which bucks the fixed winding at the low wavelengths and aids it at the high wavelengths, thus being self-neutralizing and maintaining an even degree of extra-high amplification throughout the broadcast scale.

Two assemblies are needed. For AC operation (224 RF and 224 or 227 detector), use Cat. BT-L-AC and BT-R-AC. For battery or A eliminator operation (222 RF and any tube as detector), use Cat. BT-L-DC and BT-R-DC.

Screen Grid Coil Co., 143 West 45th Street, New York (Just East of Broadway):

- Enclosed please find \$..... (Canadian must be express or P. O. Money Order), for which send me prepaid the following:
- A-10-80-S, each \$2.25
 - Matched set of four A-10-80-S 10.00
 - A-10-70-S, each 2.25
 - Matched set of four A-10-70-S 10.00
 - BT-L-AC and BT-R-AC, assembled, with condenser, link, socket and base, per pair 4.00
 - BT-L-DC and BT-R-DC, assembled, with condenser, link, socket, base, per pair 6.00
 - C-6-CT-5, .0005 mfd. shielded coil for six-circuit tuner each \$2.25
 - C-6-CT-3, .00035 mfd. shielded coil for six-circuit tuner each \$2.25
 - BP-625
 - EQ-100, equalizer of 20-100 mfd. capacity, made by Hammarlund 35
- (Note: All coils come with shields, except BP-6 and BT-L.)

BT-L for the antenna stage and BT-R for the detector input. BT-L consists of a small primary, with suitable secondary for the .00035 mfd. condenser supplied. BT-R has two effective coils: the tuned combination winding in the RF plate circuit, the inside fixed winding in the detector grid circuit. The moving coils must be "matched." This is done as follows: Turn the condensers until plates are fully enmeshed, and have the moving coils parallel with the fixed winding. Tune in the highest wavelength station receivable—above 450 meters surely. Now turn the moving coils half way round and return to bring in the station. The setting that represents the use of lesser capacity of the condenser to bring in that station is the correct one. If gang tuning is used, put a 20-100 mmfd. equalizing condenser across the secondary in the antenna circuit and adjust the equalizer for a low wavelength (300 meters or less).

NAME..... ADDRESS.....
 CITY..... STATE.....
 If ordering C.O.D. put cross here. Post office fee will be added to prices quoted.

Balkite Push-Pull Receiver



The Balkite A-5 Neutrodyne, one of the most sensitive commercial receivers ever developed; 8 tubes, including 280 rectifier. Wholly AC operated, 105-120 v. 50-60 cycles; in a table model cabinet, genuine walnut, made by Berkey & Gay.

Three stages of tuned RF, neutralized, so there's no squealing; easy tuning; operation on short piece of wire indoors perfectly satisfactory; no repeat tuning points; no hum; phonograph pickup jack built in; excellent tone quality; good selectivity. Two posts are accessible for connecting the field coil of a DC dynamic speaker.

The parts of which this receiver is made are all ace-high and the wiring is done with extreme expertness, by Ghillean. The power supply is exceptionally fine, the set being worked at 50% less than the rated capacity of the power transformer and chokes, assuring long life. There is no hum, as filtration is remarkably good.

The illuminated drum dial, at center, reads 0-100 at left, and at right has a blank space in which to write call letters. The little knob at left is the volume control, and the one at right is the AC switch. Each RF stage is filtered and bypassed individually, and the AC switch, each RF denser and power transformer are separately and totally shielded. The lead from antenna binding post to antenna winding of the first coil is of shielded wire that is grounded. Also, the receiver as a whole is totally shielded, with metal chassis and metal under-cover, so there is no stray pickup. Cat. BAL-A5, list price \$135; net price.....

\$44.00

Silver-Plated Coils



Wound with non-insulated wire plated with genuine silver, on grooved forms, these coils afford high efficiency because of the low resistance that silver has to radio frequencies. The grooves in the moulded bakelite forms insure accurate space winding, thus reducing the distributed capacity, and keep the number of turns and separation constant. Hence the secondary reactances are identical and ideal for gang tuning.

The radio frequency transformer may be perpendicularly or horizontally mounted, and has braced holes for that purpose. It has a center-tapped primary, so that it may be used as antenna coil with half or all the primary in circuit, or as interstage coupler, with all the primary on a screen grid plate circuit, or half the primary for any other type tubes, including pentodes. The three-circuit tuner has a center-tapped primary, also. This tuner is of the single hole panel mount, but may be mounted on a chassis, if preferred, by using the braced holes. Pair consists of RF transformer and three-circuit tuner, both for .0005 mfd. only. Order Cat. G-RF-3CT. list price \$5.00; net price.....

\$2.48

Shielded Lead-in Wire

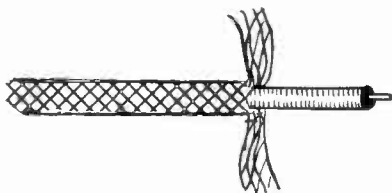

No 18 solid wire, surrounded by a solid rubber insulation covering, and above that a covering of braided copper mesh wire, which braid is to be grounded, to prevent stray pick-up. This wire is exceptionally good for antenna lead-in, to avoid pick-up of man-made static, such as from electrical machines. Also used to advantage in the wiring of receivers, as from antenna post of set to antenna coil, or for plate leads, or any leads, if long. This method of wiring a set improves selectivity and reduces hum. This wire is now appearing on the general market for the first time although long used in the best grade of commercial receivers. Order Cat. SH-LW. List price 9c per ft.; net price per foot

5c

New Multi-Tap Voltage Divider

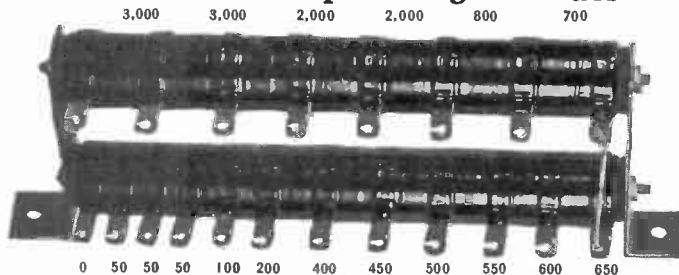

The resistance values between the twenty taps of the new Multi-Tap Voltage Divider are given above. The total is 17,100 ohms and affords nineteen different voltages.

The Multi-Tap Voltage Divider is useful in all circuits, including push-pull and single-sided ones, in which the current rating of 100 milliamperes is not seriously exceeded and the maximum voltage is not more than 400 volts. Higher voltages may be used at lesser drain.

The expertness of design and construction will be appreciated by those whose knowledge teaches them to appreciate parts finely made.

When the Multi-Tap Voltage Divider is placed across the filtered output of a B supply which serves a receiver, the voltages are in proportion to the current flowing through the various resistances. By making connection of grid returns to ground, the lower voltages may be used for negative bias by connecting filament center, or, in 227 and 224 tubes, cathode to a higher voltage.

If push-pull is used, the current in the biasing section is almost doubled, so the midtap of the power tubes' filament winding would go to a lug about half way down on the lower bank.

Order Cat. MTVD, list price \$6.50, net price.....

\$3.90

R-245 Set and Tube Tester

With the R-245 Tube and Set Tester you plug the cable into a vacated socket of a receiver, putting the removed tube in the tester, and using the receiver's power for making these tests: Plate current, on 0-20 or 0-100 ma. scale, changed by throwing a built-in switch; 0-60, 0-300 v. DC, changed by moving one of the tipped cables to another jack; filament or heater voltage (AC or DC), up to 10 volts, or any other AC voltage source, measured independently, up to 140 volts, including AC line voltage. Also screen grid voltage and screen grid current may be read by following connections specified in the new 8-page instruction sheet.

Each meter may be used independently. The two test leads, one red, the other black, with tip jack terminals, enable quick connection to meters for independent use.

With this outfit you can shoot trouble in receivers and test circuits using the following tubes: 201A, 200A, UX199, UX120, 210, 171, 171A, 112, 112A, 245, 224, 222, 226, 227, and pentodes.

When the R-245 is plugged into the vacated socket of a set and the removed tube is placed in the proper socket of the Tester, the receiver's power supplies all the voltages and currents. You see the vital tests made right before your eyes, all three meters registering immediately, all three reading at the same time.

Here are some of the questions answered by the Tester when plugged into the receiver:

What is the filament or heater voltage (no matter if DC or AC)? What is the plate voltage at the plate itself? What is the plate current drawn by the tube? Is the tube in good condition or does it require replacement? What is the grid bias voltage? What is the cathode voltage? What is the screen grid voltage? Besides, when meters are used independently, you can answer these questions: What is the screen grid current? What is the line voltage (no matter if AC or DC)? Is the circuit continuous or is it open? What is the total plate current drawn in the receiver? What are the respective B voltages at the B batteries or voltage divider?

Order Cat. R-245. List price, \$20; net price.....

\$11.40

Fixed Condensers



Dubilier Micon fixed condensers, type 642, are available at following capacities and prices:

.0001 mfd.	10c	.006	20c
.00025 mfd.	10c	.00025 with clips. 20c	
.0003 mfd.	10c	All are guaranteed electrically perfect and money back if not satisfied within five days.	
.00035 mfd.	15c		
.001	17c		
.0015	17c		
.002	18c		

Order Cat. MICON .0001 etc. at prices stated.

High-Voltage Meters

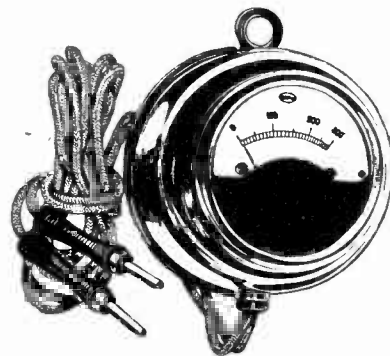

0-300 v., 200 ohms per volt. Cat. F-300 @ \$2.59
 0-500 v., 233 a.p.v. Cat. F-500 @ 3.73
 0-600 v., AC and DC (same meter reads both); 100 ohms p.v. Order Cat. M-600 @ 4.95

Double Drum Dial

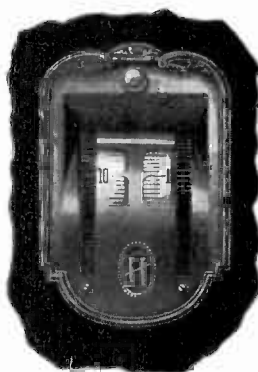

Hammarlund double drum dial, each section individually tunable. Order Cat. H-DDD. List price \$8.00; net price.....

Shielded RF Choke

Excellent in detector plate circuit or in B-plus RF leads of radio frequency tubes to purify signals.

An efficient radio frequency choke in a shielded case. Inductance, 50 millihenries. Useful for all RF chocking.

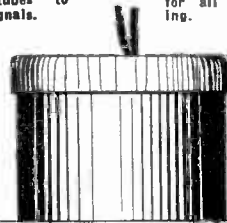

In some instances one outlead is connected to case, so use this lead for B-plus or for ground, otherwise ground the case additionally. Order Cat. SH-RFC. List price, \$1.00; net price.....

Guaranty Radio Goods Co., 143 West 45th St., New York, N. Y. (Just East of Broadway)

Enclosed please find \$..... (Canadian must be express or post office money order, for which please ship:

- BAL-AS @ \$44.00
- Ft. of SH-LW @.....5c p. 1.
- M-600 @..... \$4.95
- MTVD @ 3.90
- H-DDD @ \$3.00
- F-300 @ \$2.59
- G-RF-3CT @ 2.48
- SH-RFC @ 50c
- F-500 @ 3.73
- R-245 @ 11.40
- MICON @.....
- MICON @.....
- If C.O.D. shipment is desired put cross here.

Your Name

Address

City..... State.....

RADIO AND OTHER TECHNICAL BOOKS

At a Glance

"Audio Power Amplifiers," by Anderson and Bernard	\$3.50
"Drake's Radio Encyclopedia," by Manly	6.00
"The Electric Word," by Schubert	2.50
"Elements of Radio Communication," by Morecroft	3.00
"Experimental Radio," by Ramsey	2.75
"Foothold on Radio," by Anderson and Bernard	1.00
"Fundamentals of Radio," by Ramsey	3.50
"Mathematics of Radio," by Rider	2.00
"Practical Radio," by Moyer & Wostrel	2.50
"Practical Radio Construction and Repairing," by Moyer & Wostrel	2.50
"Principles of Radio," by Henney	3.50
"Principles of Radio Communication," by Morecroft	7.50
"Radio Blueprint Library"—AC Hook-ups	.35
"The Radio Manual," by Sterling	6.00
"Radio Receiving Tubes," by Moyer & Wostrel	2.50
"Radio Telegraphy & Telephony," by Duncan	7.50
"Radio Trouble Shooting," by Haan	3.00
"The Superheterodyne," by Anderson & Bernard	1.50
"The Thermionic Vacuum Tube," by Van der Bijl	5.00
"Treatise on Testing Units," by Rider	1.00
"Trouble Shooter's Manual," by Rider	3.50

TELEVISION

"A B C of Television," by Yates	3.00
---------------------------------	------

AVIATION

"A B C of Aviation," by Maj. Page	1.00
"Aerial Navigation and Meteorology," by Capt. Yancy	4.00
"Everybody's Aviation Guide," by Maj. Page	4.00
"Ford Model 'A' Car," Its Construction, Operation and Repair—by Maj. Page	2.00
"Modern Aircraft," by Maj. Page	5.00
"Modern Aviation Engines," by Maj. Page	9.00

RADIO WORLD

145 West 45th Street
New York, N. Y.
(Just East of Broadway)

Hi-Q 30

GET OUR PRICE ON
AC OR BATTERY MODEL

Write or wire!

Guaranty Radio Goods Co.

143 West 45th St.,
New York City

NEW DRAKE'S ENCYCLOPEDIA
1,680 Alphabetical Headings from A-
battery to Zero Beat; 1,025 Illustrations,
920 Pages, 240 Combinations for Receiver
Layouts. Price, \$6.00. Radio World, 145
W. 45th St., N. Y. C

SOCKET WRENCH SET FREE

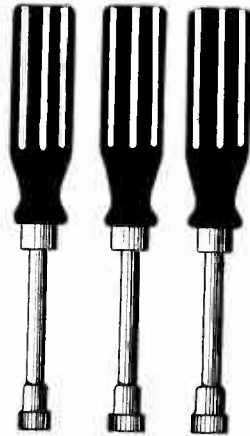

FOR turning down nuts there is nothing as efficient and handy as a socket wrench. Here is a set of three wrenches for hexagonal nuts, enabling use with 5/32, 6/32, 8/32 and 10/32 nuts. Fit the nut into the proper socket and turn down. The three different size sockets, one size on each wrench, enables use of three different outside diameters of nuts, but at least four different sizes of threads. Send 50 cents for four weeks subscription for RADIO WORLD and get this set of three wrenches free!

RADIO WORLD,

145 West 45th Street, New York, N. Y.

Enclosed please find 50 cents for four weeks subscription for RADIO WORLD. Send set of three socket wrenches free!

Name

Address

City State

Cross here if renewing.

SUBSCRIBE NOW!

RADIO WORLD, 145 West 45th St., New York City. Enclosed please find my remittance for subscription for RADIO WORLD, one copy each week for specified period:

- \$6 for one year, 52 issues.
- \$3 for six months, 26 issues.
- \$1.50 for three months, 13 issues.
- This is a renewal of an existing mail subscription (Check off if true).

Your name

Address

City

Highest Grade Key Tubes at Defiant Prices!

Screen Grid Tubes

224	at	\$1.43
222	at	1.88

Power Tubes

250	at	4.95
210	at	3.25
245	at	1.28
112A	at	.78
171A	at	.78

Other Tubes

227	at	.90
226	at	.68
280	at	1.13
281	at	2.95
201A	at	.53
240	at	1.60

The above constitute the nine most popular tubes used in radio today. Despite the severely low prices the Key tubes are firsts of the very first quality. Besides, there is a generous replacement guaranty! The above tubes are manufactured under licenses granted by the RCA and its affiliated companies.

All prices are net and represent extreme discount already deducted.

GUARANTY RADIO GOODS CO., 143 West 45th St., N. Y. City. (Just East of Broadway).

Enclosed please find \$..... for which ship at once tubes marked below:

<input type="checkbox"/> 224 AC screen grid\$1.43
<input type="checkbox"/> 245 AC power tube\$1.28
<input type="checkbox"/> 228 AC amplifier68
<input type="checkbox"/> 227 AC det. amp.90
<input type="checkbox"/> 280 AC rectifier90
<input type="checkbox"/> 222 battery screen grid\$1.13
<input type="checkbox"/> 112A power tube\$1.88
<input type="checkbox"/> 171A power tube78
<input type="checkbox"/> 201A battery tube53
<input type="checkbox"/> 240 hi mu tube\$1.60
<input type="checkbox"/> 250 power tube4.95
<input type="checkbox"/> 210 power tube3.25

Name

Address

City State

Put cross here if C. O. D. shipment is desired.
Canadian remittances must be by postal or express money order.

Quick Action Classified Ads

Radio World's Speedy Medium for Enterprise and Sales

10 cents a word — 10 words minimum — Cash with Order

EDUCATIONAL

BOOKKEEPING OR ACCOUNTING LEARNED IN 60 hours. New method. Easy. Thorough. Personal instruction. Reasonable tuition. Diploma. Accounting Institute, Duluth, Minn.

HANDY 4 FT. FLEXIBLE TEST-CORDS WITH UNIVERSAL CLIPS—42¢—POSTPAID. THREE FOR \$1.00.

TELE-DYNE ELECTRICAL LABORATORY,
2935 WALNUT STREET, CHICAGO.

A REVELATION! Acid-free soldering paste 20c can. Liquid flux 30c bottle. Guaranteed. Furnhold Co. 109-24 - 208th Street, Bellaire. N. Y.

START A BUSINESS of your own. Unlimited possibilities. Write for particulars. **STOWELL PRODUCTS,** Beach City, Ohio.

RADIO TUBES—All types \$1.00 prepaid. Miller, 628 North Eighth, Allentown, Pa.

BARGAINS in first-class, highest grade merchandise. B.B.L. phonograph pick-up, theatre type, suitable for home, with vol. control, \$6.57; phono-link pick-up with vol. control and adapter, \$3.50; steel cabinet for HB Compact, \$3.00; four-gang .00035 mfd. with trimmers built in, \$1.95; .00025 mfd. Dubilier grid condenser with clips, 18c. P. Cohen, Room 1214, at 143 West 45th Street. N. Y. City.

THE ELECTRIC WORD, by Paul Schubert.

A narrative of the rise of radio from the discovery of Hertzian waves and the first practical use of them by Marconi, in 1900, to its present-day position of eminence. This book will be of great interest, not only to the great army of persons concerned in one way or another with radio work, but also to the layman whose immediate interest in radio is confined to his own set, and who will be fascinated by this story of an interplay of science, business, politics, and diplomacy that is without parallel in history. Price \$2.50.

RADIO WORLD, 145 W. 45th St., New York City

Accurate Tuning Condensers and Accessories

EQUALIZER

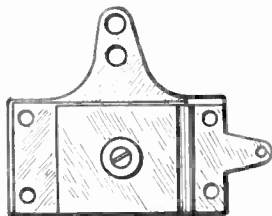

CAT. EQ-100 AT 35c

The most precise and rugged equalizing condenser made, with 20 mmfd. minimum and 100 mmfd. maximum, for equalizing the capacity where gang condensers are used that are not provided with built-in trimmers. Turning the screw alters the position of the moving plate, hence the capacity. Cross-section reveals special threaded brass bushing into which screw turns, hence you can not strip the thread. Useful in all circuits where trimming capacity of 100 mmfd. or less is specified. Maximum capacity stamped on

SINGLE .00035

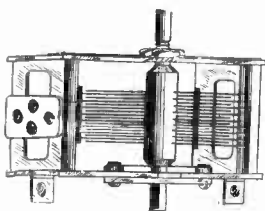

CAT. KH-3 AT 85c

A single .00035 mfd. condenser with nonremovable shaft, having shaft extension front and back, hence useful for ganging with drum dial or any other dial. Shaft is 1/4 inch diameter, and its length may be extended 3/8 inch by use of Cat. XS-4. Brackets built in enable direct sub-panel mounting, or may be plied off easily. Front panel mounting is practical by removing two small screws and replacing with two 3/32 screws 3/4 inch long. Condenser made by Scovill Mfg. Co.

Turning the screw alters the position of the moving plate, hence the capacity. Cross-section reveals special threaded brass bushing into which screw turns, hence you can not strip the thread. Useful in all circuits where trimming capacity of 100 mmfd. or less is specified. Maximum capacity stamped on

THREE-GANG SCOVILL .0005 MFD.

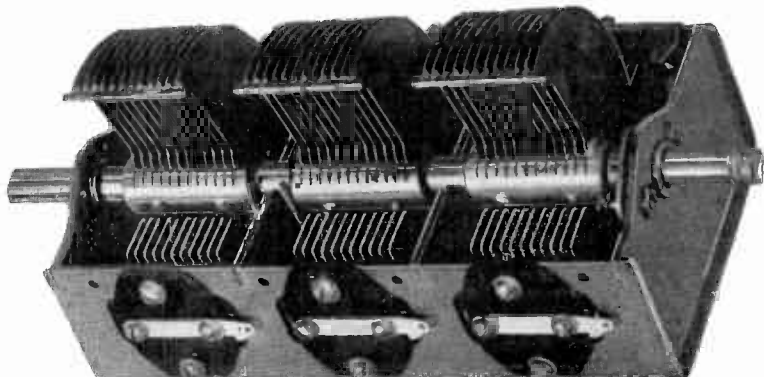

One of the finest, strongest and best gang condensers ever made is this three-gang unit, each section of full .0005 mfd. capacity, with a modified straight frequency line characteristic. The net weight of this condenser is 3 3/4 lbs. Cat. SC-3G-5 at \$4.80.

HERE is a three-gang condenser of most superior design and workmanship, with an accuracy of at least 99% per cent. at any setting — rugged beyond anything you've ever seen. Solid brass plates perfectly aligned and protected to the fullest extent against any displacement except the rotation for tuning. It has both side and bottom mounting facilities. Shaft is 3/8 inch diameter and extends at front and back, so two of these three-gangs may be used with a single drum dial for single tuning control. For use of this condenser with any dial of 1/4" diameter bore, use Cat. XS-8, one for each three-gang. Tension adjusters shown at right, other side of shaft.

SALIENT FEATURES OF THE CONDENSER

- (1)—Three equal sections of .0005 mfd. capacity each.
- (2)—Modified straight line frequency shape of plates, so-called midline.
- (3)—Sturdy steel frame with rigid steel shields between adjacent sections. These shields minimize electric coupling between sections.
- (4)—The frame and the rotor are electrically connected at the two bearings and again with two sturdy springs, thus insuring positive, low resistance contact at all times.
- (5)—Both the rotor and the stator plates are accurately spaced and the rotor plates are accurately centered between stator plates.
- (6)—Two spring stoppers prevent jarring when the plates are brought into full mesh.
- (7)—The rotor turns as desired, the tension being adjustable by set-screw at end.
- (8)—The shaft is of steel and is 3/8 inch in diameter.
- (9)—Each set of stator plates is mounted with two screws at each side of insulators, which in turn are mounted with two screws to the frame. Thus the stator plates cannot turn alongside with respect to the rotor plates. This insures permanence of capacity and prevents any possible short circuit.
- (10)—Each stator section is provided with two soldering lugs so that connection can be made to either side.
- (11)—The thick brass plates and the generous proportions of the frame insure low resistance.
- (12)—Provision made for independent attachment of a trimmer to each section.
- (13)—The steel frame is sprayed to match the brass plates.
- (14)—The condenser, made by America's largest condenser manufacturer, is one of the best and sturdiest ever made, assuredly a precise instrument.

RIGID AND FLEXIBLE LINKS

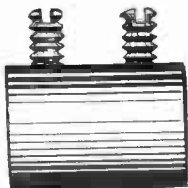

CAT. RL-3 AT 12c

The rigid link, Cat. RL-3, has two set-screws, one to engage each shaft, and is particularly serviceable where a grounded metal chassis is used, as the returns then need no insulation.

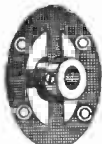

CAT. FL-4 at 30c

Flexible insulated coupler for uniting coil or condenser shafts of 1/4 inch diameter. Provides option of insulated circuits.

EXTENSION SHAFTS, TWO SIZES

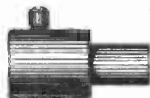

CAT. XS-4 AT 10c

Here is a handy aid to salvaging condensers and coils that have 1/4" diameter shafts not long enough for your purpose. Fits on 1/4" shaft and provides 3/8" extension, still at 1/4". Hence both the extension shaft and the bore or opening are 1/4" diameter. Order Cat. XS-4.

For condensers with 3/8" diameter shaft, to accommodate to dials that take 1/4" shaft, order Cat. XS-8 at 15c.

.00035 TWO-GANG

A two-gang condenser, like the single type, KHS-3, but consisting of two sections on one frame, is Cat. KHD-3, also made by Scovill. The same mounting facilities are provided. There is a shield between the respective sections. The tuning characteristic is modified straight frequency line. Order Cat. KHD-3 at \$1.70.

DRUM DIAL

CAT DD-0-100 @ \$1.50

A suitable drum dial of direct drive type is obtainable for 1/4" shafts or 3/8" shafts, and with 0-100 scales. An escutcheon is furnished with each dial.



FOUR-GANG .00035 MFD. WITH TRIMMERS BUILT IN

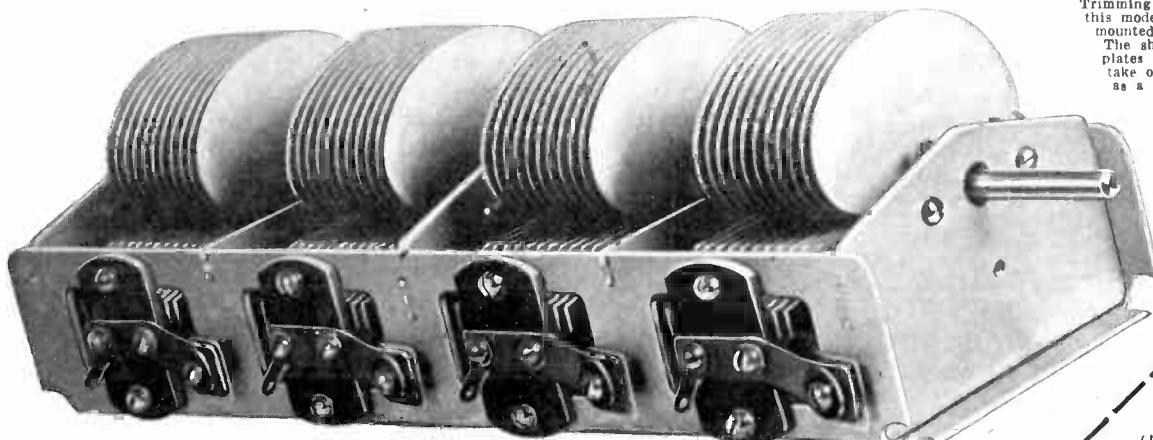

Four-gang .00035 mfd. with trimmers built in. Shaft and rotor blades removable. Steel frame and shaft aluminum plates. Adjustable tension at rear. Overall length, 11 inches. Weight, 3 1/2 lbs. Cat. SPL-4G-3 @ \$3.95.

SHORT WAVES

Tuning condensers for short waves, especially suitable for mixer circuits and short-wave adapters. These condensers are .00015 mfd. (150 microfarads) in capacity. They are suitable for use with any plug-in coils. Order Cat. SW-S-150 @ \$1.50. To provide regeneration from plate to grid return, for circuits calling for this, use .00025 mfd. Order Cat. SW-S-250 @ \$1.50.

A four-gang condenser of good, sturdy construction and reliable performance fits into the most popular tuning requirement of the day. It serves its purpose well with the most popular screen grid designs, which call for four tuned stages, including the detector input. Ordinarily a good condenser of this type costs, at the best discount you can contrive to get, about twice as much as is charged for the one illustrated and even then the trimming condensers are not included. The question then arises, has quality been sacrificed to meet a price? As a reply, read the twenty-six points of advantage. The first consideration was to build quality into the condenser. The accuracy is 99 1/2 %.

Trimming condensers are built into this model. The condenser may be mounted on bottom or on side. The shaft is removable, also the plates are removable, so you can take out one section and operate as a three-gang.

GUARANTY RADIO GOODS CO.,
143 West 45th St.,
N. Y. C. City
(Just East of Broadway.)

Enclosed find \$.....for which ship designated parts:

Street Address.....
City..... State.....

the following merchandise as advertised:

- Cat. XS-4 @ 10c
- Cat. KH-3 @ 85c
- Cat. XS-8 @ 15c
- Cat. KHD-3 @ \$1.70
- Cat. RL-3 @ 12c
- Cat. DD-0-100 @ \$1.50
- Cat. EQ-100 @ 35c
- Cat. SC-3 G-5 @ \$4.80
- Cat. SPL-4 G-3 @ \$3.95
- Cat. FL-4 @ 30c
- Cat. SW-S-150
- Cat. SW-S-250

ALL PRICES ARE NET