

**FEB. 15**

1930

**15c**

Per Copy

**RADIO**

REG. U.S. PAT. OFF.

**WORLD**

*412th Consecutive Issue—EIGHTH YEAR*

**NR4 ANALYZED**

**STABILITY OF  
NON-REACTIVE AF**

**SCREEN GRID TUBES  
COMPARED WITH OTHERS**

**OVERALL TESTS  
FOR CIRCUITS**

**New**  
**Detector System**  
**for**  
**Non-Reactive**  
**Audio**

RADIO WORLD, published by Hennessy Radio Publications Corporation. Roland Burke Hennessy, editor;  
Herman Bernard, managing editor and business manager, all of 145 West 45th Street, New York, N. Y.

# High Impedance Audio Transformers

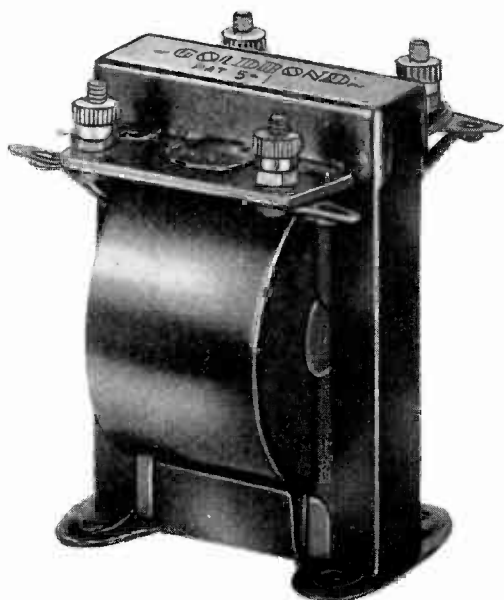

A single stretch of copper wire without soldered connections of in-between joints is used on each winding of both transformers. The "Gold Bond" model is illustrated.

Order Cat. GB-1-3 for 1-to-3 ratio **\$1.50 each**  
 Order Cat. GB-1-5 for 1-to-5 ratio

Audio frequency coupling transformers with high impedance primaries and secondaries are made in two models and two ratios of each model. At left is the "Gold Bond" shielded type, at right the "Universal" unshielded type for subpanel mounting, overall height 2 1/4". The ratios are 1-to-3 and 1-to-5, primary to secondary.

The shielded "Gold Bond" model has 4,000 turns on the primary, so the 1-to-3 model has 12,000 secondary turns and the 1-to-5 model 20,000 secondary turns. Extreme compactness and neatness prevail.

The "Universal" model for subpanel mounting has 3,200 primary turns.

Laminations in both are of best silicon steel in a strong steel frame. The coils in both are vacuum impregnated and therefore moisture-proof.

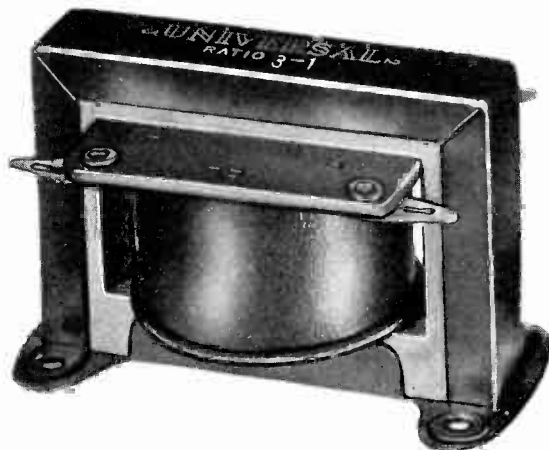

Excellent reproduction of tonal values as supplied by the detector or first audio tube is assured by use of either of the transformers. The "Universal" model illustrated above, is excellent for replacement purposes. Even on this model high plate voltages may be used, with consequent high plate currents, due to the relatively large diameter of wire used.

Order Cat. UVS-1-3 for 1-to-3 ratio **\$1.13 each**  
 Order Cat. UVS-1-5 for 1-to-5 ratio

**GUARANTY RADIO GOODS Co., 143 West 45th Street, New York City**

**FIVE-DAY MONEY-BACK GUARANTY!—C. O. D. ORDERS ACCEPTED.**

## 1/4" Extension Shaft



Here is a handy aid to salvaging condensers and coils that have 1/4" diameter shafts not long enough for your purpose. Fits on 1/4" shaft and provides 3/4" extension, still at 1/4" price 10c net.  
**RADIO WORLD**  
 145 W. 45 St., N. Y. City

## Aristocrat Floor Speaker

With Molded Wood Horn of 8 ft. tone travel (exponential type) with baffle and horn motor built in. **\$12.00**  
 Extraordinary bargains.

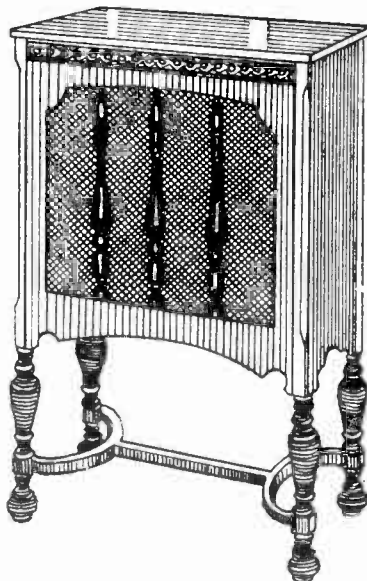

The speaker cabinet is walnut finish, 33" high, 24 1/2" wide, 17 1/2" deep, with carved legs. Golden cloth grille covers front opening. Built inside is No. 595 molded wood horn with baffle and No. 203 driving motor unit that stands 250 volts without filtration. Horn and motor removable. Table alone is worth price asked.  
 Shipped C.O.D. if desired.

**Acoustical Engineering Associates**  
 143 WEST 45th STREET NEW YORK CITY

**PLEASE GIVE US TWO WEEKS** for changing your address, showing new renewal expiration date, etc. Subscription orders are arriving in such large numbers that it takes two weeks to effectuate the change. **RADIO WORLD**, 145 West 45th St., N. Y. City.

## USE LYNCH RESISTORS

for new Loftin-White Set and Amplifier, automobile radio sets, and new 245 resistance-coupled amplifier. Write for catalog and 40-page booklet.  
**LYNCH MFG. CO., Inc., 1775 B'way, N. Y.**

## RADIO AND OTHER TECHNICAL BOOKS At a Glance

- RADIO**
- "Audio Power Amplifiers," by Anderson and Bernard ..... \$3.50
  - "Elements of Radio Communication," by Morecroft ..... 3.00
  - "Foothold on Radio, A," by Anderson and Bernard ..... 1.00
  - "Mathematics of Radio," by Rider ..... 2.00
  - "Practical Radio," by Moyer & Wostrel ..... 2.50
  - "Practical Radio Construction and Repairing," by Moyer & Wostrel ..... 2.00
  - "Principles of Radio Communication," by Morecroft ..... 7.50
  - "Radio Blueprint Library"—AC Hook-ups ..... .35
  - "Radio Cyclopedic," by Drake ..... 6.00
  - "Radio Receiving Tubes," by Moyer & Wostrel ..... 2.50
  - "Superheterodyne Construction and Operation," by Lacault ..... .25
  - "Thermionic Vacuum Tube, The," by Van der Bijl ..... 5.00
  - "Trouble Shooter's Manual," by Rider ..... 3.50
- TELEVISION**
- "A B C of Television," by Yates ..... 3.00
- AVIATION**
- "A B C of Aviation," by Maj. Page ..... 1.00
  - "Aerial Navigation and Meteorology," by Capt. Yancy ..... 4.00
  - "Everybody's Aviation Guide," by Maj. Page ..... 4.00
  - "Ford Model 'A' Car," Its Construction, Operation and Repair—by Maj. Page ..... 2.00
  - "Modern Aircraft," by Maj. Page ..... 5.00
  - "Modern Aviation Engines," by Maj. Page ..... 9.00

**RADIO WORLD**  
 145 West 45th Street  
 New York, N. Y.  
 (Just East of Broadway)

## CONE ASSEMBLY WITH DOUBLE MAGNET UNIT

**\$4.95**



An excellent magnetic type speaker for installation in any cabinet. The unit is a double-magnet Paratone, with two magnet coils, for utmost sensitivity. Each horseshoe magnet is 3/4" thick. The magnet coils are forever protected against dust and other foreign, injurious substances, by special bakelite housings. The pin is reverse drive. The cone frame is metal. The 9" cone is specially treated buckram.

All assembled, with long cord, ready to play, Shipping weight 6 lbs **\$4.95**  
 (Cat. CAS) Net

The unit alone (cord included) It will operate any type sounding surface, including paper, cloth, wood, etc. Shipping weight 4 lbs **\$2.95**  
 Net

**Guaranty Radio Goods Co.**  
 145 West 45th St., New York City

**Highest Grade  
Key Tubes at  
Defiant  
Prices!**

**Screen Grid Tubes**

**224 at \$1.43**

**222 at 1.88**

**Power Tubes**

**245 at 1.28**

**112A at .78**

**171A at .78**

**Other Tubes**

**227 at .90**

**226 at .68**

**280 at 1.13**

**201A at .53**

The above constitute the nine most popular tubes used in radio today. Despite the severely low prices the Key tubes are firsts of the very first quality. Besides, there is a five-day money-back guaranty! The above tubes are manufactured under licenses granted by the RCA and its affiliated companies.

All prices are net and represent extreme discount already deducted.

**228 HIGH-GAIN DETECTOR**

Increase the sensitivity of modern AC-operated circuits by substituting the new 228 AC high mu tube (large amplification), for the 227 tube otherwise used as detector in up-to-date circuits. The result is immediately obvious in the greatly increased volume. Then the weak, distant stations come in stronger and tone quality is improved. Simply substitute the 228 for the 227 in the detector socket only. No wiring change of any kind is required. Price, \$1.88.

GUARANTY RADIO GOODS CO., 143 West 45th St., N. Y. City. (Just East of Broadway).

Enclosed please find \$..... for which ship at once tubes marked below:

- 228 AC high mu. ....\$1.88
- 224 AC screen grid .....\$1.43
- 245 AC power tube .....\$1.28
- 228 AC amplifier ..... .68
- 227 AC det.-amp. .... .90
- 280 AC rectifier .....\$1.13
- 222 battery screen grid .....\$1.88
- 112A power tube ..... .78
- 171A power tube ..... .78
- 201A battery tube ..... .53
- Matched pair of 245s for push-pull (for both) .....\$2.56
- Matched pair 171As for AC push-pull (for both) .....\$1.80
- Matched pair of 112As for push-pull (for both) .....\$1.80

Name .....

Address .....

City ..... State .....

Put cross here if C. O. D. shipment is desired.  
Canadian remittance must be by postal or express money order.

**5-Day money-back guaranty**

**Attention...  
Radio Service Men**



is compiling an international list of names of qualified service men throughout the United States and Canada, as well as in foreign countries.

This list, which RADIO-CRAFT is trying to make the most complete one in the world, will be a connecting link between the radio manufacturer and the radio service man.

RADIO-CRAFT is continuously being solicited by radio manufacturers for the names of competent service men; and it is for this purpose only that this list is being compiled. There is no charge for this service to either radio service men or radio manufacturers.

We are asking every reader of this magazine who is a professional service man to fill out the blank printed below or (if he prefers not to cut the page of this magazine) to put the same information on his letterhead or that of his firm, and send it in to RADIO-CRAFT. The data thus obtained will be arranged in systematic form and will constitute an official list of radio service men, throughout the United States and foreign countries, available to radio manufacturers. This list makes possible increased cooperation for the benefit of the industry and all concerned in the betterment of the radio trade.

NATIONAL LIST OF SERVICE MEN,  
c/o RADIO-CRAFT, 98 Park Place, New York, N. Y.

Please enter the undersigned in the files of your National List of Radio Service Men. My qualifications are as set forth below:

Name (please print) ..... (City) ..... (State) .....

Address .....  
Firm Name and Address ..... (If in business for self, please so state)

Age ..... Years' Experience in Radio Construction? .....

Years in Professional Servicing? ..... (What Makes?) .....

Have You Agency for Commercial Sets? ..... (What Makes?) .....

What Tubes Do You Recommend? ..... (What Specialties?) .....

Custom Builder .....  
Study Courses Taken in Radio Work from Following Institutions .....

Specialized in Servicing Following Makes .....

What Testing Equipment Do You Own? .....

What Other Trades or Professions? .....

Educational and Other Qualifications? .....

Comments ..... (Signed) .....

(R.W. 215)

**SEPARATE TESTER COMBINATION**

Consists of two-meter assembly in neat black metal case, with an external high resistance meter. The two meters in the case read (a) 0-20, 0-100 milliamperes; (b) 0-10 volts, AC or DC, same meter reads both. The external high resistance meter reads 0-600 volts, AC or DC (same meter reads both). Thus you can test any plate current up to 100 ma., any filament voltage, AC or DC, up to 10 V., and any plate voltage, or line voltage or other AC or DC voltage, up to 600 volts. Five-prong plug, screen grid cable, and 4-prong adapter included. Order Cat. ST-COMB @.....\$11.00  
2-meter assembly, cable plugs, Cat. 215 @ \$7.00  
0-600 AC-DC meter alone, Cat. M600 @ \$4.95

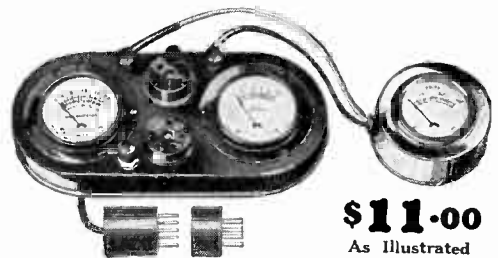

**\$11.00**  
As Illustrated

Guaranty Radio Goods Co., 143 West 45th St., N. Y. City

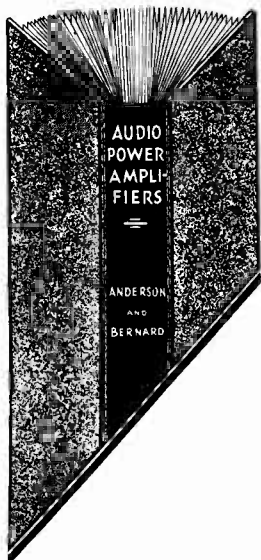

"Audio Power Amplifiers," 193 pages, 147 illustrations; Maroon Cloth Bound Cover, Lettering in gold. Price, \$3.50.

# "AUDIO POWER AMPLIFIERS"

By J. E. ANDERSON and HERMAN BERNARD

*The First and Only Book on This Important Subject—Just Out*

**I**N radio receivers, separate audio amplifiers, talking movies, public address systems and the like, the power amplifier stands out as of predominating importance, therefore a full and authentic knowledge of these systems is imperative to every technician. "Audio Power Amplifiers" is the book that presents this subject thoroughly. The authors are

J. E. Anderson, M.A., former instructor in physics, University of Wisconsin, former Western Electric engineer, and for the last three years technical editor of "Radio World."  
Herman Bernard, LL.B., managing editor of "Radio World."

They have gathered together the far-flung branches of their chosen subject, treated them judiciously and authoritatively, and produced a volume that will clear up the mysteries that have perplexed many.

What are the essentials to the reproduction of true tone values? What tubes? How should voltages be adjusted? These are only four out of 1,400 questions raised and solved in "Audio Power Amplifiers." The book begins with an elementary exposition of the historical development and circuit constitution of audio amplifiers and sources of powering them. From this simple start it quickly proceeds to a well considered exposition of circuit laws, including Ohm's laws and Kirchhoff's laws. The determination of resistance values to produce required voltages is carefully expounded. All types of power amplifiers are used as examples: AC, DC, battery operated and composite. But the book treats of AC power amplifiers most generously, due to the superior importance of such power amplifiers commercially.

Rectification theory and practice in all the applied branches, grid bias methods and effects, push-pull principles, power detection, reproduction of recordings and methods of measurements and testing are set forth. And besides there is a chapter on the subject of motorboating, with which one of the authors is probably better familiar than any other textbook author. Then, too, there is a chapter on tubes, with essential curves and a full list of tables of tube data. Every tube that will be used in an audio amplifier—therefore virtually all tubes—is clearly diagnosed, classified and tabulated! These data on tubes should be at every radio engineer's hand.

"Audio Power Amplifiers" is a book for those who know something about radio. It is not for novices—not by a mile. But the engineers of manufacturers of radio receivers, power amplifiers, sound installations in theatres, public address systems and phonograph pickups will welcome this book. Engineers—even chief engineers—of the Bell Telephone Laboratories, Radio Corporation of America, Westinghouse Electric & Mfg. Co., Western Electric, Photophone, Vitaphone and the like needn't be afraid they won't learn something from this little book.

## Table of Contents

	Page
Chapter I	
General Principles .....	1
Chapter II	
Circuit Laws..	20
Chapter III	
Principles of Rectification	35
Chapter IV	
Practical Voltage Adjustments ..	62
Chapter V	
Methods of Obtaining Grid Bias..	72
Chapter VI	
Principles of Push - Pull Amplifier ..	90
Chapter VII	
Oscillation in Audio Amplifiers .....	98
Chapter VIII	
Characteristics of Tubes .....	118
Chapter IX	
Reproduction of Recordings .....	151
Chapter X	
Power Detection .....	161
Chapter XI	
Practical Power Amplification .....	171
Chapter XII	
Measurements and Testing ...	183

The book consists of 193 pages in type the size used in printing these words, known as 8 point, and therefore a great deal of text is contained in these 193 pages, and the book is small enough to be carried conveniently in the side pocket of a sack coat. It was purposely printed that way because busy engineers and other experimenters will want to consult this precious volume while riding in conveyances, as well as when in the laboratory, and compactness was therefore desirable.

The edition is strictly limited to 1,000, and the publishers recognize that the field of distribution is necessarily small, hence the price is \$3.50. Those to whom such a volume is of any value would not be without it at any price.

The device of presenting no more information or greater number of illustrations, but of using larger type, and thicker and often cheaper paper, to present a bulkier appearance, was purposely avoided. The paper is finest super stock and the size of the page is 5 x 8".

## Detailed Exposition of Chapter Contents

**Chapter I. General Principles**, analyzes the four types of power amplifiers, AC, DC, battery-operated and composite, illustrates them in functional blocks and schematic diagrams, and treats each branch in clear textual exposition. Audio coupling media are illustrated and discussed as to form and performance: transformer, resistance-resistance, impedance-impedance, impedance-resistance, resistance-autotransformer, autotransformer-resistance and non-reactive. Push-pull forms are illustrated, also speaker coupling devices. Simple audio amplifiers are illustrated and analyzed. Methods of connection for best results are stressed.

**Chapter II. Circuit Laws**, expounds and applies Ohm's laws and their special form known as Kirchhoff's laws. Direction of current flow in tube circuits is revealed in connection with the application of these laws to several circuits, including a DC 110-volt A, B and C supply, and series and parallel filaments in general. Special diagrams are published for Ohm's and Kirchhoff's laws.

**Chapter III. Principles of Rectification**, expounds the vacuum tube, both filament and gaseous types, electrolytic and contact rectifiers, and explains why and how they work. Full-wave and half-wave rectification are treated, with current flow and voltage derivation analysis. Regulation curves for the 280 tube are given. Voltage division, filtration and stabilization are fully illustrated and dissected.

**Chapter IV. Practical Voltage Adjustments**, gives the experimental use of the theoretical knowledge previously imparted. Determination of resistance values is carefully revealed.

**Chapter V. Methods of Obtaining Grid Bias**, enumerates shows and compares them.

**Chapter VI. Principles of Push-Pull Amplifier**, defines the push-pull relationship, with keys to the attainment of desired electrical symmetry.

**Chapter VII. Oscillation in Audio Amplifiers**, deals with motorboating and oscillation at higher audio frequencies, explaining why it is present, stating remedies and giving expressions for predetermination of regions of instability. The trouble is definitely assigned to the feedback through common impedance of load reactors and B supply, and in some special instances to the load's relationship to the C bias derivation as well. The feedback is shown as negative or positive and the results stated.

**Chapter VIII. Characteristics of Tubes**, tells how to run curves on tubes, how to build and use a vacuum tube voltmeter, discusses hum in tubes with AC on the filament or heater, and presents families of curves, plate voltage-plate current, for the 240, 220, 201A, 112A, 171A, 227 and 245, with load lines. Also, plate-screen current characteristics of the 224, at five different control grid biases, at plate voltages 0-250. Then Table I gives the Average Characteristics of Amplifier and Detector Tubes 220, 200A, 201A, 112A, 171A, 222, 240, 226, 227, 224, 245, 210 and 250, stating use, filament voltage, current, and resistance, Det. B volts, Amplifier B volts, grid bias for amplification and detector, plate current, plate AC resistance, mutual conductance, mu, maximum undistorted power output, physical size. There is a composite table (II) of characteristics of Rectifier and Voltage Regulator Tubes, and individual tables, giving grid voltage, plate current characteristics over full useful voltage ranges for the 220, 201A, 112A, 171A, 222, 240, 227, 245 and 224.

**Chapter IX. Reproduction of Recordings**, states coupling methods and shows circuits for best connections.

**Chapter X. Power Detection**, explains what it is, when it should be used, and how to use it. A rectifying detector, designed by one of the authors, is expounded also.

**Chapter XI. Practical Power Amplifier**, gives AC circuits and shows the design of a sound reproduction system for theatres. A page is devoted to power amplifier symbols.

**Chapter XII. Measurements and Testing**, discloses methods of qualitative and quantitative analysis of power amplifier performance. A scale illustrates the audio frequencies in comparison with the ranges of voice and musical instruments. A beat note oscillator is described. Thirteen causes of hum, with remedies, are stated, also the estimation of power required for output and preliminary tubes.

You may safely order "Audio Power Amplifiers," either enclosing your remittance or ordering the book mailed C.O.D. Examine it for five days. If you are not completely satisfied with it for any reason, or for no reason, send it back in five days with a letter asking for a refund. A check refunding the purchase price will be sent to you immediately. We can not send the book on approval, without payment before receipt, so please do not ask us to do so.

## What Is Not As Well As What Is

**S**OMETIMES it is more important to expose a fallacy than merely to state the fact. A crop of technical weeds has grown into the garden of audio amplification, and the authors have gone to the pains of exposing these.

The book "Audio Power Amplifiers" is free from traditional errors, except in citing them as fallacious conclusions. Each attack on a fallacy is abundantly supported by proof of the REAL facts.

As an example, take the theory that motorboating is due to grid blocking. The authors say: "Many explanations for this oscillatory condition (motorboating) have been made, some of which are wholly untenable. One of these is that the oscillation is due to blocking of the grids of the amplifiers. . . . If blocking of the grid were the cause of the phenomenon, the wave form of the oscillation would be very irregular, but an oscillograph shows that it is very nearly of a sinusoidal form."

Then follows an exposition of motorboating, and oscillation at other frequencies, with expressions for predetermining the instability or stability of audio circuits.

### Send in This Coupon Now!

Hennassy Radio Publications Corporation,  
145 West 45th Street, New York, N. Y.  
(Just East of Broadway).

- Please send at once postpaid ..... copies of "Audio Power Amplifiers," by J. E. Anderson and Herman Bernard, for which please find enclosed \$3.50 per copy.
- Please send ..... copies C.O.D. I will pay \$3.50 plus Post Office charges.

Name .....

Address .....

City ..... State .....

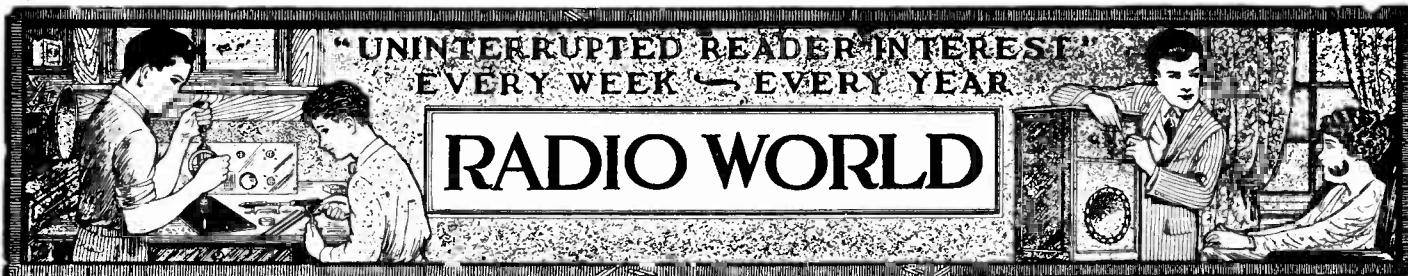

Vol. XVI, No. 22 Whole No. 412  
 February 15th, 1930  
 15c per Copy, \$6.00 per Year  
 [Entered as second-class matter, March, 1922, at the Post Office at New York, N. Y., under act of March, 1879.]

Latest Circuits and News  
 Technical Accuracy Second to None  
**EIGHTH YEAR**

A Weekly Paper published by Hennessy Radio Publications Corporation, from Publication Office, 145 West 45th Street, New York, N. Y. (Just East of Broadway) Telephone, BRyant 0558 and 0559

RADIO WORLD, owned and published by Hennessy Radio Publications Corporation, 145 West 45th Street, New York, N. Y. Roland Burke Hennessy, president and treasurer, 145 West 45th Street, New York, N. Y.; M. B. Hennessy, vice-president, 145 West 45th Street, New York, N. Y.; Herman Bernard, secretary, 145 West 45th Street, New York, N. Y. Roland Burke Hennessy, editor; Herman Bernard, business manager and managing editor; J. E. Anderson, technical editor.

# Carrier Intensity Detector

## New System Utilizes Instability in Non-Reactive Audio

By Herman Bernard

Managing Editor

THE NR4, first published in the February 1st issue, is shown this week in a slightly changed form. Instead of the detector biasing resistor, R2, of 20,000 ohms, being connected directly to negative, it is connected to the second tap on the voltage divider. The screen grid voltage on the detector tube is lifted a little, so that the connection is made to the fifth tap. Otherwise the diagram is the same.

The object of suggesting the change is that, although the volume is a little less, the selectivity is considerably increased, and the circuit works without any "thickness" of tuning. Such "thickness" is due to attenuation of power tube plate current.

While only a little plate current is necessary in this circuit for the power tube, the diagram as shown this week produces a flow of 22 milliamperes and permits an effective plate voltage of 250 on the power tube, at maximum signal input. The applied voltage on this plate is some 12 volts more, the difference being due to the voltage drop in the 500 ohms DC resistance of the speaker winding.

### INSTABILITY ANALYSIS

No output filter is needed under either method of connection, the one on next page or the one republished from the February 1st issue. None is needed, as the current is only 22 milliamperes on the loudest signal and rises to 30 milliamperes at 190 volts at no signal.

The comparative instability should be judged preferably on the basis of current at no signal and current at loudest receivable signal. This is 30 as compared with 22 milliamperes, or about 33 1/3 per cent. The weakest station will create a situation about equal to a no-signal condition.

This instability aspect has worried some inquirers, but there is nothing to worry about. It is merely a reciprocal current-voltage condition that does not adversely affect the practical operation of the circuit at radio or audio frequencies. In fact, it helps to depress large differences in volume.

The audio channel is non-reactive, which means that it is free from the phase displacement of current and voltage caused by condensers and coils, hence free from frequency distortion. This is relative non-reactance, since bypass and filter condensers are used in the B supply and adjuncts. But no isolating condenser is used in the audio circuit, and no coil. The reactive effect on the audio coupling form by the presence of the bypass and filter condensers is small. Their effect on the filtration of the B supply is relatively large.

### NEW DETECTOR FORM ANNOUNCED

At the expense of volume the circuit shown can be made as selective as desired. It is possible to achieve the utmost in faithful selectivity, by close arrangement of detector screen grid and negative bias voltages, in a manner to cause the carrier intensity to govern the operating point. The screen voltage is then only slightly less than the plate voltage. This results in an entirely new form of detection, which makes detection impossible except at resonance. Hence there is no incidental detection and no possibility of detection of interfering signals, as the intensity of the carrier would have to reach a predetermined level, and nothing except the intended frequency could produce that level. At the present writing the system is not recommended for general use, but is suggested for experi-

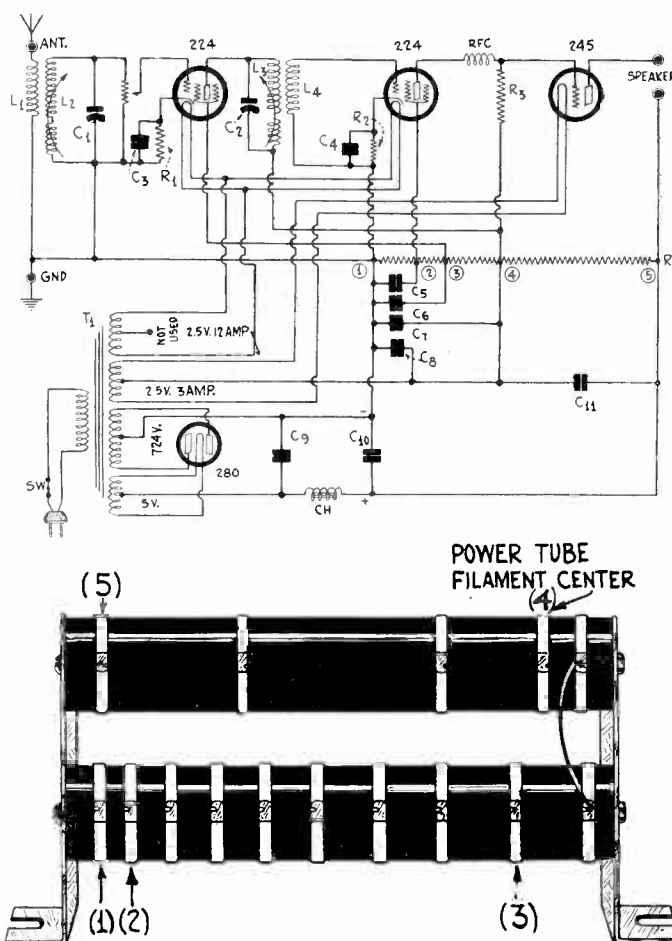

FIG. 1

THE NR4, WITH DETECTOR BIASING RESISTOR RETURNED TO NEGATIVE OF THE VOLTAGE DIVIDER, AS SHOWN IN FEBRUARY 1ST ISSUE. THE TWO ILLUSTRATIONS SHOULD BE READ TOGETHER

ments. How to try it with this circuit in modified form I describe elsewhere in this issue.

Now, since the non-reactive audio channel is made highly unstable as to power tube plate voltage and plate current, an example chosen for first mention because these values are susceptible of easy measurement, it follows that the effective detector plate voltage is unstable. By taking the detector bias off the voltage divider entirely—the NR4 now takes it partly off the divider—the carrier intensity will make the consequent current changes through the biasing section used for the

# Performance of NR4, w

## Voltages and Currents Given, Also

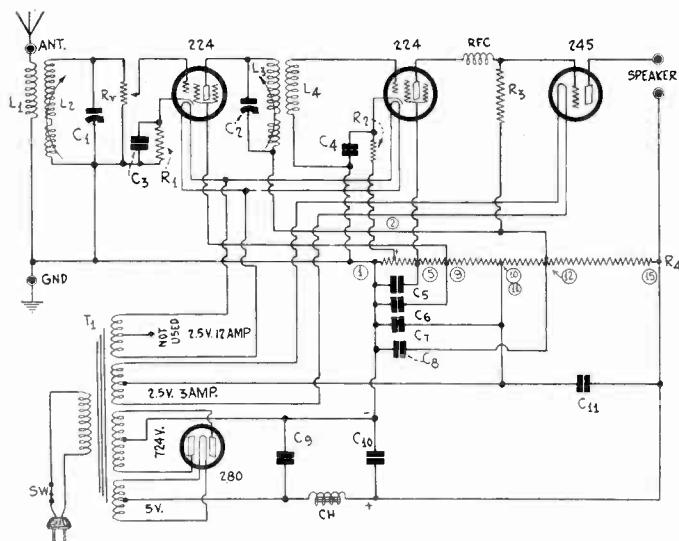

FIG. 2

THE NR4. USING THE SAME PARTS AS PREVIOUSLY, BUT WITH DETECTOR BIASING RESISTOR R2 RETURNED TO A POSITIVE POINT ON THE VOLTAGE DIVIDER, WITH SCREEN VOLTAGE RAISED A LITTLE.

detector effective in changing the bias. Hence a point is selected that requires a certain value of carrier intensity to make the detector plate current high enough to enable operation at the critical point of bias for detection. Since negative grid-bias detection is used, the higher the signal intensity or carrier strength, the higher the current flowing through the plate-load resistor, the greater the drop in this resistor, the higher the negative bias on the power tube, as this bias is the drop in the resistor, the smaller the plate current in the power tube, and the smaller the current through the section of the voltage divider used for detector biasing.

### LIMITED SENSITIVITY

The shortcoming of this system of detection, aside from its instability, is the fact that with a simple tuner only about half a dozen stations can be tuned in, even in New York City, since a certain magnitude of carrier is required to bring about detection and anything less than this magnitude will avoid reception of the station by causing the tube not to detect but to amplify, or be "dead" so that no plate current changes are produced. This is just the opposite to an automatic volume control feature, since only loud stations are received at all. Use of more radio frequency amplification, preferably with an RF automatic volume control, would enable enough amplitude to enlarge greatly the number of stations receivable.

As was stated, detection will be confined solely to resonance. Hence one tuned circuit would be enough. The radio frequency amplification could be untuned, as selectivity is not adversely affected by absence of tuning antecedent stages. In

### LIST OF PARTS

- L1L2, C1—Bernard antenna tuner assembly, including link, coil, condenser. Cat. BT-L-AC.
- L3L4, C2—Bernard interstage tuner assembly, including link, coil, condenser. Cat. BT-R-AC.
- Rv—Volume control, 0-500,000 ohm Electrad Tonatrol potentiometer.
- R1—800 ohm Electrad resistance strip.
- R2—20,000 ohm resistor leak with mounting (0.02 meg.).
- R3—0.5 meg. Lynch resistor leak with mounting.
- R4—Multi-Tap Voltage Divider.
- C3—.01 mfd. condenser.
- C4, C5, C6, C7, C8, C11—Six 1 mfd. 200 volts. DC.
- C9, C10—Two 1 mfd. 1,000 volt DC.
- RFC—Shielded RF choke, 50 millihenrys.
- T1—Polo filament-plate supply. Cat. PFPS.
- Ch—Polo single choke. Cat. PSC.
- Ant., Gnd., Sp(—), Sp(+)—Four binding posts.
- SW—One pendant AC switch with 12 ft. AC cable.
- Drilled metal subpanel with sockets affixed (9½ x 15").
- Subpanel and front panel insulators.
- Two dials.

## Voltage and Current

### Values in the NR 4

THE VOLTAGE and current measurements obtained on the NR4 when hooked up according to the diagram, Fig. 2, as published at left, with 110 volt AC input, were as follows:

#### RF Tube, 224

Heater voltage, 2.5 volts AC.  
 Negative bias, 4 volts.  
 Screen grid voltage, 100 volts.  
 Screen grid current, 1 milliampere.  
 Applied plate voltage, 190 volts.  
 Effective plate voltage, 190 volts.  
 Plate current, 4 milliamperes.

#### Detector, 224

Heater voltage, 2.5 volts AC.  
 Negative bias, 5 volts.  
 Screen grid voltage, 24 volts.  
 Screen grid current, 83 microamperes.  
 Applied plate voltage, 180 volts.  
 Effective plate voltage, 119 volts.  
 Plate current, 27 microamperes.

#### Power Tube, 245

Filament voltage, 2.5 volts AC.  
 Applied plate voltage, 262 volts.  
 Effective plate voltage on loudest stations (depends on drop in speaker winding), 250 volts.  
 Negative bias, 56 volts.  
 Plate current, on loudest station, 22 milliamperes.

#### Voltage Divider

Total voltage (across extremes), 400 volts.

fact, an enormously long aerial could be used. I tried 350 feet, at an elevation of 182 feet from ground, with a good ground as well, and found it impossible to pick up any interference, using only one tuned circuit. Selectivity was independent of aerial length. In fact, the tuned circuit was connected directly to aerial and ground, a condition that usually makes separation of stations impossible, and yet the nine stations obtainable under those conditions came in without any cross-talk.

### QUALITY OF SELECTION

The circuit could be resonant at only one frequency at a time, hence could detect only one carrier at a time. The usual considerations of inadequate exclusion by one tuned circuit do not apply, nor is it possible to cut side bands by using one tuned circuit. Sideband cutting arises from cascaded tuned circuits and from regeneration, but neither was used. The phenomenon of the carrier intensity alone being made to determine detection made it absolutely necessary to achieve resonance to be able to hear anything, and the moment you were off resonance you were out of the detecting region and heard nothing whatsoever. Hence you can not possibly pick up more than one station at a time.

The so-called incredible selectivity of a single tuned circuit feeding the detector of a non-reactive audio channel arises from the relatively high negative bias used for detection, obtainable in any way, since that increases the input impedance, but a simple tuned circuit feeding the detector—radio frequency amplification omitted—under best conditions brings in eight stations in New York City with good separation if the stations themselves have good channel separation. This is loudspeaker operation. Yet the performance can be repeated under the same detector biasing conditions with two transformer audio steps connected in the usual manner.

But when the detector is worked at its most critical bias condition, obtainable by accurate apportionment of screen, plate, and control grid voltages, the selectivity may well be such as to occasion incredulity. But the instability is of a high order.

### FEATURES OF FIG. 2

The apportionment of voltages is such, in Fig. 2, as to make the circuit somewhat of the automatic volume control type, while the selectivity increase over the circuit, as previously shown, is on account of some carrier intensity detection. A compromise was struck, which left the automatic volume con-

# ith Non-Reactive Audio

## Method of Achieving Good Selectivity

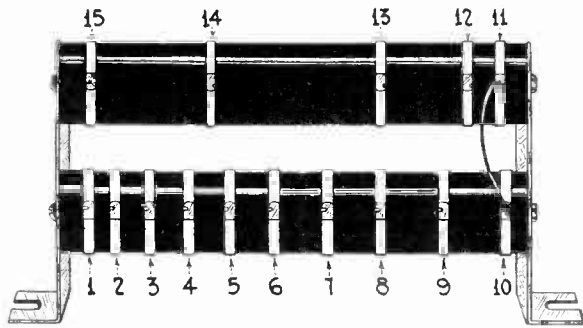

FIG. 3  
VOLTAGE DIVIDER CONNECTIONS CORRESPONDING  
TO THOSE IN FIG. 2

control feature predominating. The circuit was gaited to a medium loud station, so stronger ones came in no louder, weaker ones coming in louder than in other systems, due to the reduced 245 plate resistance as the detector bias receded.

The automatic volume control is due to the use of part of the voltage divider, if only 50 ohms, through which 44 milliamperes flow at resonance with a station of selected original intensity. The 44 milliamperes represent the total drain, including all screens and plates of all three tubes, and voltage divider bleeder. The bleeder current alone is 24 milliamperes. The modulated current is preponderating through the voltage divider, on weak signals, when the 44 milliamperes rise to 55 milliamperes, so the automatic volume control is most effective where needed most, as a sort of booster. The best of such controls are only partly effective.

### BIAS IS 5 VOLTS NEGATIVE

The reason for the existence of the automatic volume control when part of the voltage divider is used for biasing the detector was fully explained in last week's issue, February 8th.

In the NR4, as diagrammed now, the bias is 5 volts negative when the total current through the biasing section is 44 milliamperes, the detector screen-grid voltage 24 volts, the applied detector plate voltage 180 volts.

The detector plate current is too small to be measured on usual meters, but the total of the detector plate and screen currents through the 20,000-ohm resistor and the 50-ohm section of the voltage divider was .00014 milliampere. Through 20,000 ohms, therefore, the drop was 2.8 volts. The 44 milliamperes through the 50-ohm section produced a drop of 2.2 volts, hence the negative bias on the detector was the sum of the two, or 5 volts.

The bias on the power tube is the drop in the plate load resistor, not measurable except with a vacuum tube voltmeter, for that alone draws no current from the measured circuit, and all other devices would draw more current than what flowed through the plate resistor. A voltmeter of 20,000 ohms resistance per volt would be only 50 per cent accurate.

### 245 AS VACUUM TUBE VOLTMETER

The bias is obtained by measuring the resistance of the plate resistor. It is rated at 0.5 meg., and was actually so close as to justify the use of the 500,000 ohms for computation. With 250 volts on the plate of the 245 power tube, and with 22 milliamperes of plate current, from calibration of the 245 it was known that the negative bias was 56 volts. This, indeed, is using the 245 itself as a vacuum tube voltmeter, whereby we know the drop in the plate resistor of 500,000 ohms to have 56 volts. By Ohm's law, which is never wrong, we can now determine the current through the plate resistor. The current is the voltage divided by the resistance, or 56 volts divided by 500,000 ohms, equals .0001102 ampere, or about 110 microamperes.

As for other aspects of the circuit: The Bernard tuners are used, and these have a moving coil in series with a fixed winding, the total comprising the tuned winding. In the antenna stage the primary is a small winding in the antenna-ground circuit, while the secondary is tuned and has the dynamic coil in it.

### INTERSTAGE COIL DIFFERENT

The interstage coil is of different construction, with three forms instead of two. The outside form consists of the fixed part of the tuned winding. The dynamic coil, the remainder of the tuned winding, is on the moving form. In this instance the combination constitutes the primary, not the secondary, as the plate circuit is tuned, which is the best method of obtaining high amplification from the screen grid tube. The third form, inside, contains a large winding used as pickup coil to the

## How to Adopt NR 4

### to the New Detector

THE CARRIER intensity detection system depends on the most unstable condition of the non-reactive circuit, whereby even so small a difference as the voltage drop across the plate load resistor due to the carrier current puts the detector at a detecting point.

To try this method in modified form on the NR4, connect cathode of detector to the second lug (2) on the voltage detector, and detector screen grid to the third lug (3). Remove R2.

The selectivity condition that absolutely blots out the strongest station if either dial is turned just a trifle does not prevail, as the detection does not depend exclusively on the carrier intensity. To make this condition prevail would require voltage adjustments not obtainable directly from the present voltage divider. However, the potentiometer could be placed from the third lug to the fourth, with screen grid lead to the midtap, and the arm moved until the desired condition prevails.

When working thus the circuit will tune out the strongest local in less than one division of any dial, even if you use only one tuned circuit. Hence it is so selective a station that otherwise comes in "all over the dial," actually will be "hard to find" when tuning the carrier intensity detector.

It is interesting to experiment with this detector. It need not be used permanently with the NR4.

detector, so that step-up ratio is established. By use of the Bernard tuners full coverage of the wavelength band is assured, besides high gain is established at the low frequencies (high wavelengths).

The moving coils are physically connected to the condenser shafts and may be pushed around to any relative position with the fingers. Turn the condensers so that the plates are entirely enmeshed. Then see that both dynamic coils are parallel with the fixed winding.

It is necessary that the variometer effect be obtained in the right direction, so that the dynamic coils aid the fixed segments when the condenser plates are totally enmeshed, and oppose at the other extreme.

### BALANCING DIAL SETTINGS

You may find that you get widely diverse dial settings, and other complications, but all are easily remedied when you bear in mind that the dynamic coils can be in only one correct position at full capacity of the condenser, and that correct position alone brings in the very highest wavelength stations. When either moving coil is wrongly placed, 526 meters is as high as you can tune with that circuit, otherwise 550 meters is the highest. You can reach down to the lowest wavelength, no matter if the dynamic coils are rightly or wrongly positioned, but when wrongly, 200 meters comes in far too high up on the dial. So straighten this out.

But still the circuits will not tune in step. To accomplish this it is necessary to add fixed capacity across the first tuning condenser. An equalizing condenser of 80 mmfd. will just about do it, but sometimes not, so add an extra 80 mmfd. condenser. Use one equalizer at full capacity and adjust the other so that at some low wavelengths, around 300 meters, the dials read together. Remember both equalizers are across the same tuning condenser.

As for tone quality, you will find it as good as you have ever heard, probably better.

### CURE FOR ANY SQUEALS

Regarding hum, there is some hum, not objectionable when the program is heard, and a compliment to the circuit for its fine low-note reproduction.

The circuit may squeal at the very low wavelengths, but the volume control should take care of this. If not, use a 3,000 ohm grid suppressor from control grid of the RF tube to the

## Special Non-Reaction Service

If you have any questions to ask about non-reactive circuits, address Non-Reactive Editor, RADIO WORLD, 145 West 45th Street, N. Y. City. You will get some reaction. Tabulate questions so answers can be written next to them.

# Conversion of AC Compact

Same Tuner Used, Audio Change Easily Made

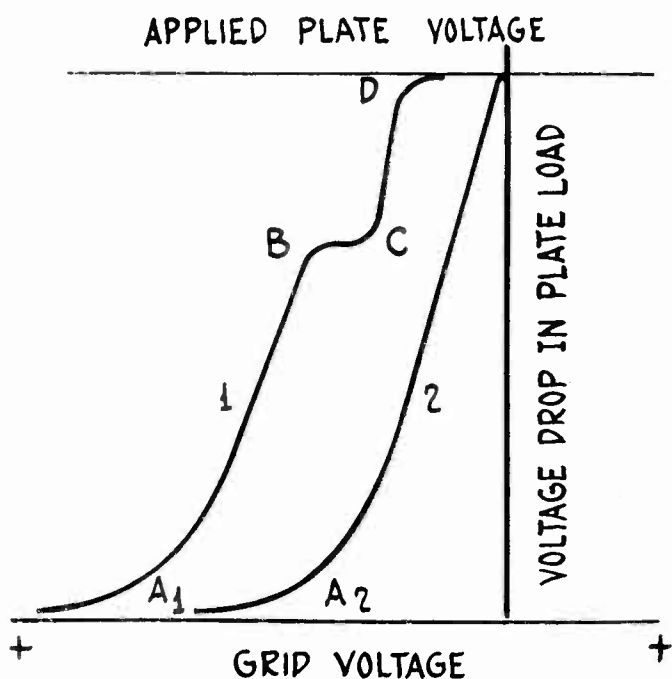

FIG. 4

CURVES SHOWING THE RELATION BETWEEN THE GRID BIAS AND THE PLATE CURRENT, OR THE VOLTAGE DROP IN THE PLATE LOAD RESISTANCE, OF A SCREEN GRID TUBE FOR TWO DIFFERENT SCREEN VOLTAGES. THE POINTS OF GREATEST DETECTING EFFICIENCY ARE A1 AND A2.

stator of the tuning condenser, the coil being connected to the stator, not to the grid itself.

In New York City the circuit tunes in all locals, some 28 stations, about 20 on the air at the same time, without interference. It did not get much distance, but this may be because I operated the circuit only with knobs, not dials. Not including the rectifier, this is a three tube circuit, and as such it is the best three tube circuit so far developed.

The volume on local stations is all-sufficient for speaker operation, and the volume control is necessary on some stations.

## How to Convert Compact to the New NR4 Circuit

The NR4 uses parts closely resembling those in the AC model of the HB Compact. It is recommended that the Compact be changed over to the NR4. The Mershon would be connected with 18 mfd. as C10, 18 mfd. as C8, 8 mfd. as C4, and 8 mfd. as C5. The two chokes in the Polo block would be left united, without capacity at the midsection, to constitute the single choke Ch by series connection. C9, 1 mfd., 1,000 volts, R2, 20,000 ohms, RFC, 50 millihenrys, R3, 0.5 meg., R1, 800 ohms, C3, .01 mfd., would be required. The present potentiometer could be used for Rv. C6 and C11 at 1 mfd., 200 volts, would be required, too. The original voltage divider affords adequate taps.

## Two Curves Exemplify Carrier Intensity Detector

A peculiar effect may be brought about when using non-reactive amplifiers in which the first tube is a grid bias detector of the screen grid type. The operating grid bias is obtained from a drop in a resistor, and this drop depends on the plate current flowing through the resistor. The plate current in turn depends on the intensity of the signal that is impressed on the grid of the detector. For a certain signal intensity there may not be any detection at all but as the intensity increases detection begins.

### REFERENCE TO CURVES

An explanation of the phenomenon can be made simply by referring to curves giving the relation between the grid voltage and the plate circuit. In Fig. 4 are two such curves, for two different screen voltages and the same applied plate voltage. The ordinates (vertical) in these curves are actually the drops in the plate load resistance, but are equivalent to plate current since the plate load resistance is constant.

Suppose the starting grid bias of the detector tube is adjusted so that the plate current is zero. This would mean that the starting operating point would be to the left of the bends A1 and A2 in the curves. For the sake of definiteness let us confine our attention to curve No. 1, which is for the higher screen voltage. The starting grid bias would then be considerably greater than that which gives the plate current indicated at A1. The starting operating point is to the left of the point where the curve touches the horizontal axis.

### BEST DETECTING POINT

Best detection occurs when the bias is such that the operating point is where the curvature or bend is greatest, that is, in the vicinity of A1. While the signal voltage is weak the positive swing of the voltage wave does not enter that region of the curve where plate current is shown but remains all the time where the current is zero. But as the signal voltage increases the positive loops of the voltage wave will encroach on the curved portion of curve No. 1.

As soon as any plate current at all flows this current will change that grid bias on the power tube, making it more negative. The plate current in the power tube decreases, and since this current flows through the grid bias resistor for the detector, the grid bias decreases. That is to say, the actual operating point on the detector grid bias, plate current curve moves to the right, and it moves into the region of the curve where the detection efficiency is higher.

### SCREEN VOLTAGE CHANGES SIMILARLY

The screen voltage also changes in the same direction as the bias so that the curve as a whole moves toward the right. This makes the point of highest detection efficiency recede from the grid bias and makes the change less abrupt. However, the operating point moves faster as a result of the grid bias change, and as the signal voltage increases the operating point overtakes the point of highest detecting efficiency.

There is an important and practical effect of this operation. It takes a strong signal to be detected at all, and that signal is detected very efficiently. Signals off resonances will not be detected. The result is that the circuit is highly selective. The selectivity is enhanced by the fact that the operating point is sufficiently negative to preclude the flow of any grid current.

## Pointers Are Given On Aerial Location

The following pointers on aerials are made by E. T. Cunningham, Inc.:

It is advised that location of the set within the room and the route of the aerial lead-in should not be determined until the exact position of all other electrical wiring in the room and close by is located. Cable lead-ins of high voltage, supplying electrical power for neighboring households, should be especially determined in apartment houses, it is declared.

After such electrical wiring is traced, the aerial lead-in should be so placed that it is farthest away from them.

Similarly, the aerial itself should be placed as far away from power wires on the roof as possible. Metal roofs and other

metallic objects also are sources of disturbance, and good height for the aerial is recommended when roofs are made of tin, copper, or metal alloys of any kind.

Short aerials often prove more satisfactory, for both local and distant reception, than long aerials, it is stated by a Cunningham engineer.

This is frequently true with screen grid receivers, whose high amplification ability compensates for the reduction in the aerial length. Greater selectivity and less interference is achieved by shortening the aerial, thus adding to the set's ability to "tune in" distant stations, as well as increasing the enjoyment of the listener to the actual program.



# New Loftin-White Kit

Electrad's Assembly Provides Strong Output from 245

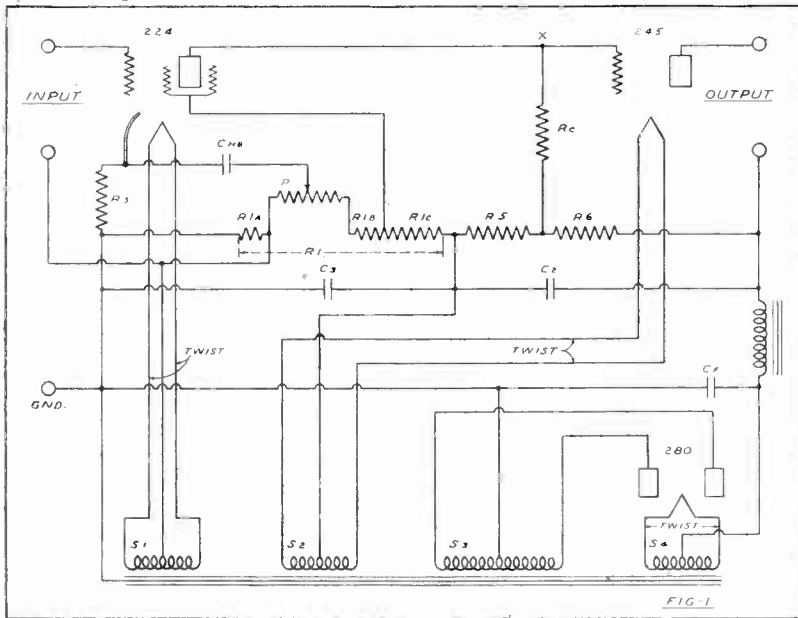

FIG. 1

THE DIAGRAM OF THE ELECTRAD LOFTIN-WHITE AMPLIFIER WHICH IS OBTAINABLE IN KIT FORM. THE POWER UNITS CONTAIN TWO 25 VOLT WINDINGS AND ONE FIVE VOLT WINDING. THEY ALSO CONTAIN A HIGH VOLTAGE, CENTER-TAPPED WINDING FOR THE FULL WAVE RECTIFIER. THE VARIOUS RESISTANCES HAVE BEEN SPECIALLY MADE FOR THIS CIRCUIT.

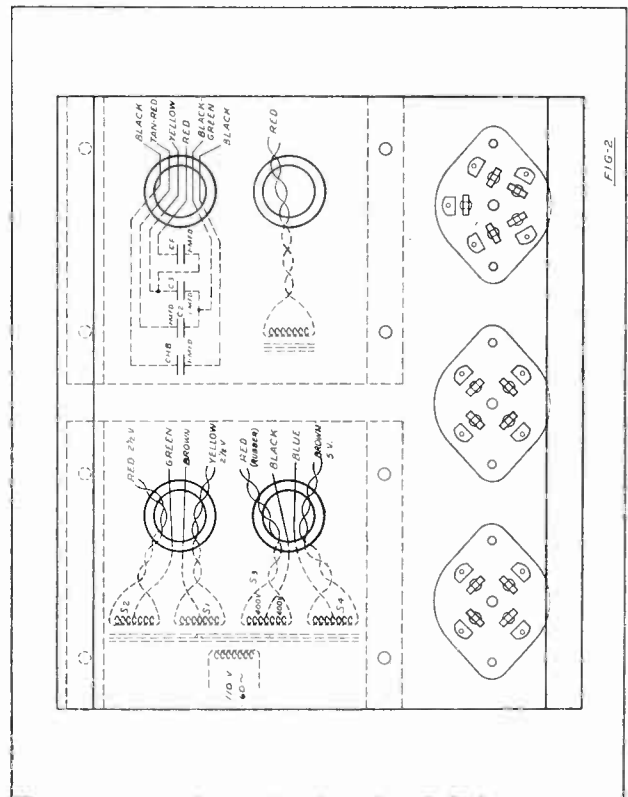

FIG. 2

THE PLAN OF THE ELECTRAD LOFTIN-WHITE AMPLIFIER SHOWING THE POSITIONS OF THE POWER BLOCK, THE CONDENSER BLOCK AND THE THREE SOCKETS

A CHARACTERISTIC of the Loftin-White amplifier which makes this circuit so attractive to radio fans is its simplicity. The Electrad amplifier built according to the findings of Loftin and White is no exception to the rule of simplicity, as can be seen from the pictures and drawings herewith. All the by-pass condensers required in the circuit are contained in a single block, likewise all the filament and power windings are contained in another block.

On the front there are four binding posts, two for input and two for output. At the back there is one binding post for the ground connection and a knob controlling the hum-bucking adjustment.

It is really surprising that such a simple and inexpensive circuit should give such splendid results, and many fans not con-

vinced theoretically that there is anything superior about it change their mind when they have heard its performance. No one is skeptical after a demonstration.

The illustrated device was built up from the official Loftin-White kit put out by Electrad, Inc., of 175 Varick Street, New York City, of which Arthur Moss is the head. The amplifier may be used after a tuner or after a phonograph pickup.

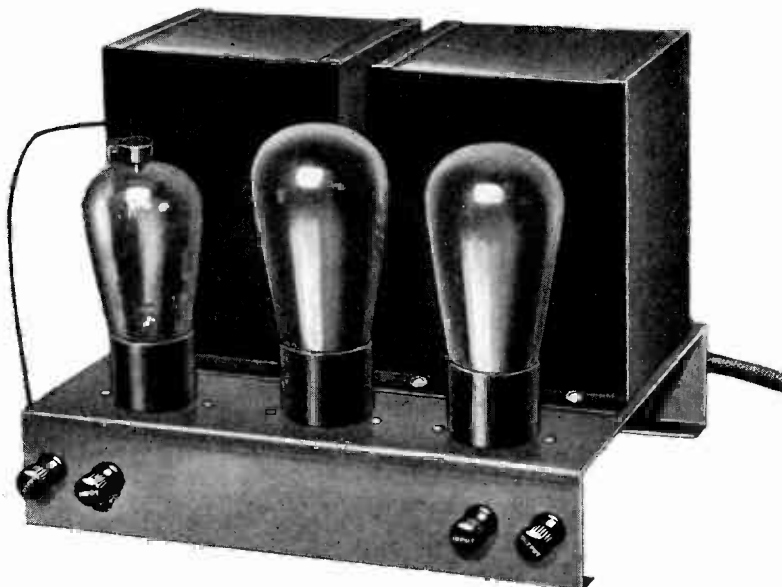

FIG. 3

FRONT VIEW OF THE ASSEMBLED ELECTRAD LOFTIN-WHITE AMPLIFIER WITH THE THREE TUBES IN POSITION.

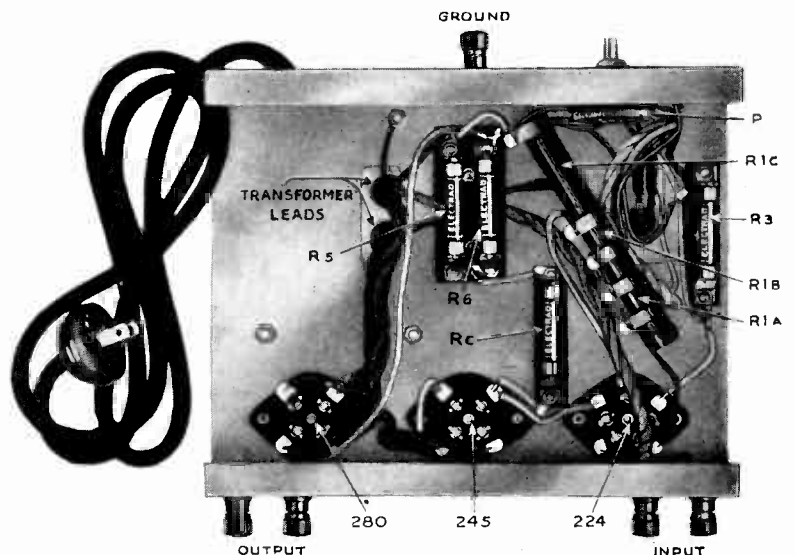

FIG. 4

A VIEW OF THE UNDER SIDE OF THE SUB-PANEL OF THE ELECTRAD LOFTIN-WHITE AMPLIFIER WHICH SHOWS THE POSITIONS OF THE VARIOUS RESISTANCES AND POTENTIOMETERS. THE DESIGNATIONS CORRESPOND WITH THOSE IN FIG. 1

# Stability and Instability

## Slight Wiring Changes Produce Large Diff

By J. E.

Technical

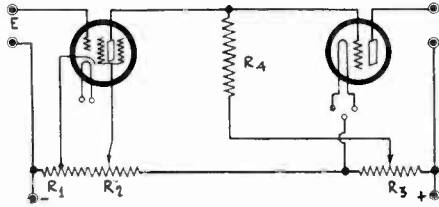

FIG. 1

THIS NON-REACTIVE AMPLIFIER IS RELATIVELY UNSTABLE BECAUSE THE BIAS RESISTOR IS PLACED SO THAT THE FEED BACK FROM THE POWER TUBE IS IN PHASE.

THAT non-reactive amplifiers behave differently than other types of circuit is one of the first things that experimenters discover. They notice, for example, that the plate current in the power tube undergoes wide and seemingly erratic changes when the adjustments of the voltages on the tube or tubes ahead are changed by small amounts. Or it may be that the plate current in the power tube will drop to almost zero and remain at this value for large changes in the voltages on the other tube.

These fluctuations, or lack of fluctuations, in the power tube plate current are not erratic at all. They are normal and should be expected. The adjustment of the tube or tubes ahead of the power tube should be made so that the changes in the plate current of power tube occur in the right way when changes are made in the grid bias of the tube ahead.

If the plate current in the power tube does not change at all for relatively large changes in the grid bias of the tube ahead there can be no amplification and obviously the adjustment is wrong. The condition that no change in the plate current of the power tube occurs for large changes in the grid bias of the first tube occurs usually when the screen voltage on the first tube is too large, and may not take place at all when the screen voltage is low.

### STABILITY OF NON-REACTIVE CIRCUITS

The behavior of the power tube plate current is indicative of the behavior of the plate current in the first tube. Usually the plate current in the first tube is so small that it cannot be measured with instruments ordinarily used for measuring plate current. Indeed, they may be so small that they cannot even be detected with these instruments. They can only be detected by their effects on the plate current in the power tube.

The adjustments of the voltages on the first tube have a great deal to do with the stability of the amplifier, or the lack of stability, as the case may be. For that reason it is worth while to examine a circuit critically with a view of finding its state of stability.

Consider first the circuit in Fig. 1. This consists of two tubes, an AC screen grid tube and a 245 power tube. The total voltage available is connected across the three resistances R1, R2 and R3 in series. The signal voltage impressed on this circuit is assumed to be E, applied where indicated.

What is the state of stability in this circuit? Suppose there is an increase in the bias on the first tube. This increase may be due to a suitable change in E or to an increased drop in the resistance R1. What is the effect of this change in the grid voltage of the first tube, and particularly what is the effect on the drop in the resistance R1? Does the assumed increase in the bias increase the drop in R1 still further or does it decrease it? If the assumed change results in an increase in the drop in R1 the circuit is unstable and if it results in a decrease the circuit is stable.

### THE CUMULATIVE EFFECT

We have assumed that the grid voltage on the first tube becomes more negative, that is, that the bias is increased. This increase in the bias results in a decrease in the plate current through R4, which in turn results in a decrease in the voltage drop in the resistance, and hence a decrease in the bias on the second tube. This decrease in the bias of the power tube results in an increase in the plate current of that tube. The increased current flows through R1 and R2 but not through R3. Indeed, the current through R3 decreases if the voltage regulation of

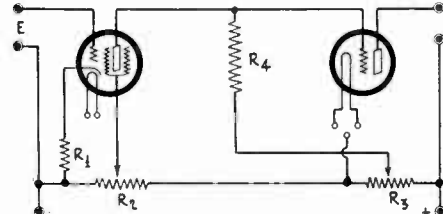

FIG. 2

THE GRID BIAS RESISTOR IN THIS CIRCUIT IS PLACED SO THAT THE CIRCUIT IS RELATIVELY STABLE. FEED BACK FROM THE POWER TUBE DOES NOT OCCUR.

the voltage supply is not perfect. But the change in the current through R3 will be small and can be neglected. Not so the increase in the current through R1 and R2. This increase is of the first magnitude and may in fact be many times greater than the current that flows steadily through this resistance.

Since the current through R1 increases as a result of our assumed change in the bias of the first tube, the voltage drop in R1 also increases. Hence the circuit is unstable. That is to say, the change we introduced at first results in a still greater change in the voltage in the same direction. Had we started with a decrease in the bias of the first tube we would have reached the same conclusion, that is, that the resulting change in R1 is in the same direction as the change introduced.

This reflected change really amounts to regeneration, and the circuit amplifies more than it would have done had not R1 been connected so as to result in a cumulative change. Whether or not the instability is great enough to start oscillation depends entirely on the amplification. If the circuit is such as to create oscillation, the circuit is unstable in fact, but if it is such as only to increase the amplification, the circuit is only potentially unstable.

### COUNTERACTING EFFECT OF SCREEN VOLTAGE

In the above reasoning we neglected the effect of the change in the screen voltage. Since this voltage increases with the increase in the current through R2, or decreases in phase with it, as the case might be, we have to consider its effect. The increase in the screen voltage tends to increase the plate current in the first tube when the bias tends to decrease. Hence the change in the screen grid voltage tends to stabilize the circuit. The effect of the grid voltage, however, is greater than the effect of the screen voltage, or else there would be no amplification in the circuit.

There is also a change in the plate voltage applied to the first tube, and this change also is such as to reduce the instability. The voltage is increased when plate current in the first tube is decreased. While there are two opposing factors tending to stabilize the circuit, the effect of the grid bias changes is much the greater, thus leaving the circuit unstable, actually or potentially.

### CONNECTION FOR STABILITY

Now let us consider the circuit in Fig. 2. This is the same as that in Fig. 1 with the exception that R1 is connected so that only the screen and plate currents of the first tube flow through it. This change in the circuit, simple though it may be, has a great effect on its performance.

Let us assume, as before, that there is an increase in the bias on the grid of the first tube. The increase in the bias causes a decrease in the plate current through R4, which in turn causes an increase in the plate current of the power tubes. There is a negligible change, a decrease, in the voltage drop in R3, and there is a large increase in the drop in R2 due to the fact that the increased plate current from the power tube flows through it.

The first effect of the increase in the voltage drop in R2 is to increase the screen grid voltage on the tube. This tends to increase the plate voltage in the tube and hence to counteract the effect in the change in the grid bias. It, therefore, appears that this circuit is stable. However, we have to investigate the effect of any changes that might occur in the drop in R1.

In a screen grid tube the sum of the screen and the plate currents is very nearly constant, for as one goes up the other

# Non-Reactive Circuits

## ference in Results, Including Regeneration

Anderson

Editor

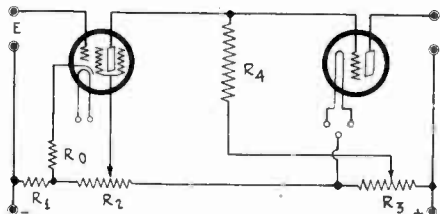

FIG. 3

BY SUITABLY CHOOSING THE GRID BIAS RESISTORS  $R_0$  AND  $R_1$  THIS CIRCUIT CAN BE MADE NEUTRAL IN SO FAR AS FEED BACK IS CONCERNED.

down when the grid voltage on the tube changes. However, if the tube is adjusted for amplification, the plate current exceeds the screen grid current and any changes in the plate current will be larger than the corresponding changes in the screen circuit. Since both the plate and the screen currents flow through  $R_1$ , the change in the voltage drop in  $R_1$  will be due to the change in the plate current. As the plate current decreases, the change in the drop in  $R_1$  will be a decrease, or in the direction opposite to the grid voltage change that produced it. This is degeneration and again we conclude that the circuit is stable. Indeed, this circuit may be so stable that it will not amplify well.

### COMPROMISE POSSIBLE

We thus conclude that the circuits in Fig. 1 and Fig. 2 are totally different although they look almost identical.

In a good amplifier we want neither regeneration nor degeneration. Or if we want regeneration we only want a little of it so that the circuit will not break into oscillation. Is it possible to arrange the circuit so that we can enjoy this happy compromise?

The fact that one of the circuits is stable and the other unstable suggests a simple arrangement which will effect the compromise. If we combine the two as we have done in Fig. 3, resistance  $R_0$  will make the circuit stable and resistance  $R_1$  will make it unstable. The two together will make it neutral, or feebly regenerative or degenerative, according to the relative values of  $R_1$  and  $R_0$ .

It is not a simple matter to calculate the relative values of these two resistors which will result in the neutralizing adjustment, because we do not know what the current changes in the two will be for a given change in the grid voltage. The best that can be done is to give the result in general terms. Suppose  $i_0$  is the change in the signal current through  $R_0$  and  $i_1$  the change in the signal current through  $R_1$  due to a given change in the grid voltage  $E$ . Then in order that there should be no net change in the feedback, either positive or negative,  $R_0 i_0$  should be equal to  $R_1 i_1$ . But this equation is of little help since we do not know the values of the current changes. Experimentally the adjustment could be made exactly on a given circuit, but it would not be simple. The experiment would be based on the scheme used in determining the amplification factor of a tube.

### APPROXIMATE SOLUTION

But by making certain reasonable assumptions we might arrive at a solution which gives the order of magnitudes of the two resistances. Let us first assume that the changes in the current are proportional to the steady plate currents, which may or may not be justified. Next let us assume that through  $R_1$  only the plate current of the power tube flows and through  $R_0$  only the plate current of the first tube. This assumption is not far from the truth in view of the relative values of the currents.

The plate current in the first tube will be about 50 microamperes and that in the power tube about 32 milliamperes. If we put these two currents in the formula we arrive at the conclusion that  $R_0$  should be 6,400 times greater than  $R_1$ .

But how large should either be? This we can settle by using the required bias on the first tube, which should be 1.5 volts, half of which is dropped in  $R_1$  and the other half in  $R_0$ . At this point we have to use a different current through  $R_1$ , for we can no longer assume that the plate current of the power tube alone flows through it. For bias purposes the current through  $R_1$  will be the 32 milliamperes of the power tube plus the current through  $R_3$ . We may adjust the current so that the total is 42 milliamperes. Hence we have .75 volts

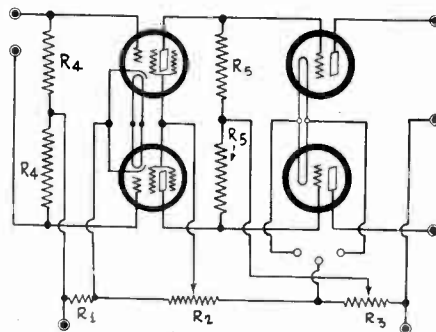

FIG. 4

THIS IS THE PUSH-PULL VERSION OF THE CIRCUIT IN FIG. 1. IF IT IS NOT SYMMETRICAL IT IS UNSTABLE TO SIGNAL VOLTAGES. IT IS ALWAYS UNSTABLE TO DC VOLTAGE CHANGES IN THE SUPPLY.

divided by 42 milliamperes from which to determine  $R_1$ . We get nearly 18 ohms. Multiplying this by 6,400 we obtain 115,200 for  $R_0$ . Thus the order of magnitudes of the two resistors is 20 for  $R_1$  and 100,000 for  $R_0$ . Exact adjustment in any case can be effected by making  $R_0$  fixed and  $R_1$  variable.

### EFFECT OF BY-PASSING

A by-pass condenser across any resistance such as  $R_1$  or  $R_0$  will tend to reduce the feed back, whether it causes regeneration or degeneration. For that reason a condenser should always be used. But if a condenser across  $R_1$  in Fig. 1 is to be effective at the low and middle audio frequencies it must have a very high capacity. Indeed, it would have to be unreasonably high if it is to prevent feed back at the lowest audio frequencies. The reason for this is that the resistance is small.

A resistance across  $R_1$  in Fig. 2, or across  $R_0$  in Fig. 3, would not have to be so large because the resistance is higher. It would be very easy to nullify the effect of the balance established between  $R_0$  and  $R_1$  in Fig. 3 by connecting condensers of improper values. If condensers are used their impedances should be proportional to the resistors, or their capacities should be inversely proportional to them. For example, if the condenser across  $R_1$  is 8 mfd. that across  $R_0$  should be only .0016 mfd. If this proportion is not maintained the advantage gained by balancing would be lost and it would be better to use  $R_1$  alone and then connect an electrolytic condenser across it.

### STABILITY OF PUSH-PULL CIRCUITS

What has been said of the single-sided amplifiers in Figs. 1 and 2 applies with almost equal force to push-pull amplifiers of the same types. If the push-pull amplifiers could be made exactly symmetrical this statement would not be true because there could then be no feed back one way or the other. But no amplifier can be made exactly symmetrical, due to differences in tubes and resistors. Any such amplifier is to some extent single-sided, that is, stronger on one side than on the other.

(Continued on next page)

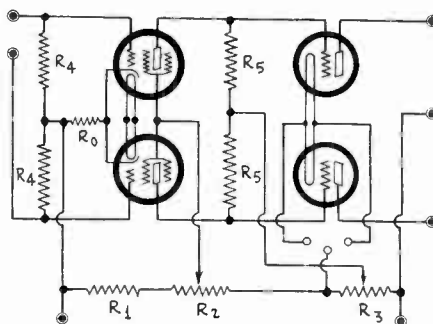

FIG. 5

THIS IS THE PUSH-PULL VERSION OF THE CIRCUIT IN FIG. 2. IT IS RELATIVELY STABLE BOTH AS TO SIGNAL AND SUPPLY VOLTAGES.

# Results with Screen Grid T

## Gang Tuning One Reason for Same Number of SG

By Edward

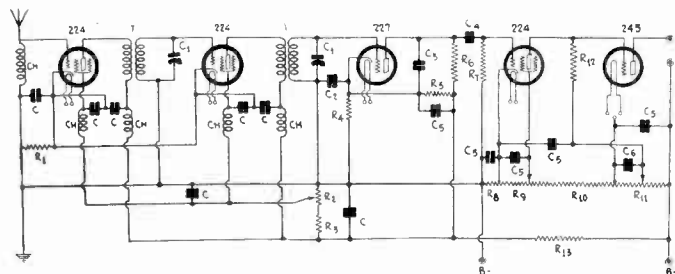

FIG. 1

THIS RECEIVER COMBINES ORDINARY RESISTANCE COUPLING WITH NON-REACTIVE COUPLING TO GAIN MANY ADVANTAGES.

IF screen grid tubes are so much superior to three-element tubes, why is it necessary to use more of them in modern receivers than are used in circuits using three-element tubes exclusively? This question has been asked many times and in many quarters, and it does seem a reasonable question to ask.

The answer to this question is that it is not necessary to use more screen grid tubes than three-element tubes if we are satisfied with the same sensitivity, or if we are content with double tuning controls.

We have seen many receivers incorporating four and more screen grid tubes which did not do as well, either in sensitivity or selectivity, as circuits incorporating three-element tubes throughout. But comparisons of this kind are misleading as they are fair neither to the screen grid nor the three-element tube receivers. To make a fair comparison it is necessary to take all the conditions into consideration and to weigh their relative importance.

### GANG TUNING DIFFICULT

When many tuned circuits are controlled by a single knob there is often a great loss in selectivity, and as a result of this, also a great loss in sensitivity. More tuned circuits and more amplifier tubes are necessary to overcome the effects of lack of tracking of the tuned circuits. But single control is a great convenience and most persons prefer single tuning control.

The DX records made in the early days of broadcasting with receivers using one or two radio frequency tubes, including the detector, were largely the result of well-controlled regeneration, but extremely accurate tuning also was responsible. If a receiver has two tuners now, both controlled by the same knob, and if there is no regeneration, it is quite likely that the set will not break records.

If the two tuned circuits in the receiver are accurately tuned, and if there are no great losses in the tuning coils, a receiver incorporating two screen grid tubes ahead of the detector will be sensitive enough for all average use. Much, however, will depend on the coils used and how they are used. They must not be shielded too well, because if they are the eddy current losses will be excessive.

### PRECAUTIONS AGAINST LOSSES

If we put the coils inside small shields, as must be done for space reasons when many tuned circuits and many screen grid tubes are used, there will be so much loss in the shields that selectivity and sensitivity are heavily taxed. If, however, we allow much room between the shielding and the coils both will be good. When only two tuning coils are used, as in the circuit in Fig. 1, it is possible to mount the coils, without resort to shielding, so there is no inductive coupling between them. To do so we place them electrically at right angles, or so that the field of one coil cuts that of the other at right angles. The simplest way of doing this is to make their axes perpendicular to each other and place them so that the centers of the two coils lie on the same horizontal line. It is possible to place three coils so that they are mutually perpendicular but no more.

When the coils have been placed so that there is no mutual inductance between any two there is no need at all for shielding so far as the magnetic fields go. But there would still have to be some shielding against electric coupling. This shielding would not have to surround the coils, but only separate the parts of one stage from the parts of another. A sheet of aluminum or other good conductor of electricity is all that would be required, provided that this sheet is connected to ground.

In placing the sheet shield it should be remembered that it

### LIST OF PARTS

- Ch—Five 50 millihenry choke coils.
  - T—Two radio frequency transformers such as Screen Grid Coil Co. SGS5.
  - C—Seven .1 mfd. by-pass condensers.
  - C1—Two .0005 mfd. tuning condensers.
  - C2—One 2 mfd. condenser, low voltage rating.
  - C3—One .00025 mfd. condenser.
  - C4—One .01 mfd. mica type condenser.
  - C5—Five 2 mfd. or larger by-pass condenser, 400 volt rating.
  - C6—One 4 mfd. by-pass condenser, or larger.
  - R1—One 150 ohm resistor, 10 milliampere capacity or more.
  - R2—One Electrad 5,000 ohm potentiometer.
  - R3—One 7,000 ohm fixed resistor.
  - R4—One Electrad 2,000 ohm resistor.
  - R5—One Electrad 25,000 ohm resistor.
  - R6—One Lynch .1 megohm metallized resistor with mounting.
  - R7—One Lynch one megohm resistor with mounting.
  - R8—One 25 ohm resistor, 60 milliampere capacity.
  - R9R10—One 2,000 ohm potentiometer, 60 milliampere capacity.
  - R11—One 25,000 ohm potentiometer.
  - R12—One Lynch .5 megohm resistor with mounting.
  - R13—One 15,000 ohm resistor.
  - Four five prong sockets.
  - One four prong socket.
  - A power supply giving at least 400 volts and 60 milliamperes and at least two 2.5 volt windings.
- [The current which any of these resistors will carry will be less than 10 milliamperes, except those otherwise listed.]

must intercept any electric line of force running from any part of one stage to any part of another stage, considering only those parts which are at a high potential. Since the lines of force may be curved, it is best to make the shield larger than the geometrical dimensions would call for.

### USE OF LARGE COILS

As there are only two tuned circuits in the receiver illustrated in Fig. 1, we are not limited to the use of very small coils.

## Stability of Non-

(Continued from

Inssofar as it is unsymmetrical it may be either stable or unstable.

Let us consider for a moment the circuit in Fig. 4, which is the push-pull version of that in Fig. 1. Suppose there is a disturbance in the voltage drop in R1 in Fig. 4 tending to increase the voltage drop. The plate currents of both screen grid tubes will be decreased and those in both power tubes will be increased. Hence the current through R1, and consequently the drop, will be increased. This circuit is therefore unstable even when perfectly symmetrical, but only to disturbances in the bias resistor, or DC voltage supply.

Suppose there is a change in the current through both resistances marked R4. This change will make the grid of one input tube more negative and that of the other less negative by the same amount. The two plate currents will change correspondingly. So will the plate currents in the power tubes. One will admit more current and the other less by the same amount. There will be no change in the drop in R1. Hence the circuit is stable insofar as the signal voltage is concerned. There will be cumulative changes due to disturbances in the plate supply, but these are proportional and are not likely to upset the adjustment of the amplifier.

### UNBALANCED INTENSIFIED

If, however, the two sides of the amplifier are not equal as to amplification and if the tubes are not equal as to mutual conductances, the inequalities will be intensified and cause a greater unbalance of the circuit. We conclude that this amplifier is not the best, just as we concluded in connection with the circuit in Fig. 1.

Let us see how the circuit in Fig. 5 behaves to changes in supply and signal voltages. It will be noted that this is the push-pull version of the circuit in Fig. 2.

# ubes Compared with Others

## Valves with No Greater Sensitivity or Selectivity

Foote Harrison

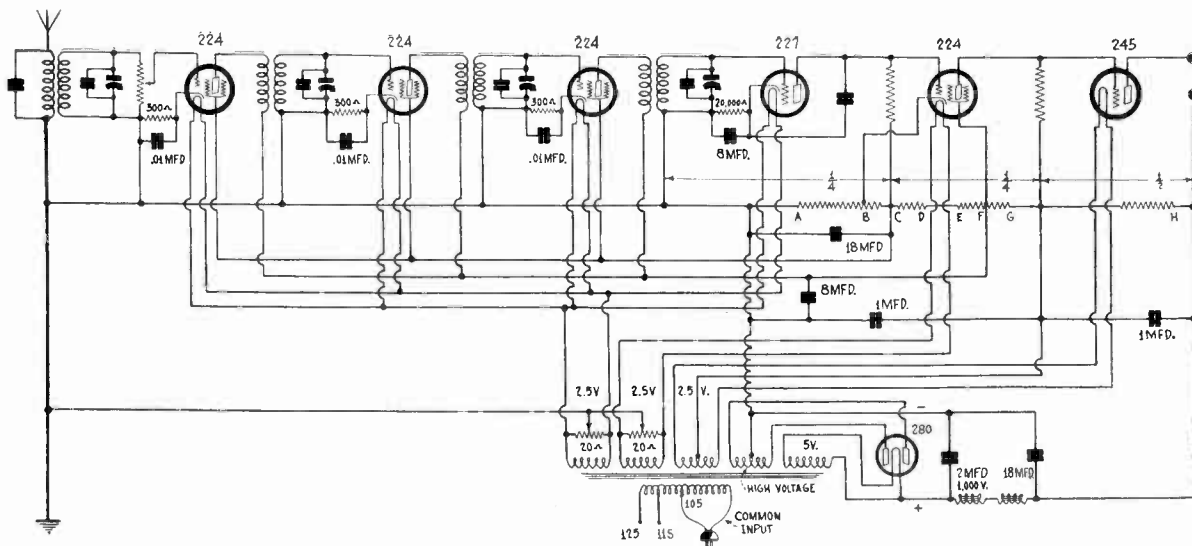

A SPLENDID VOLUME CONTROL IS PROVIDED IN THIS RECEIVER IN THE FORM OF A HALF MEGOHM POTENTIOMETER IN THE GRID CIRCUIT OF THE FIRST TUBE. THOROUGH FILTERING IS PROVIDED FOR THE NON-REACTIVE AUDIO AMPLIFIER.

Diameters as large as three inches can well be used, although somewhat smaller coils will work out all right.

When building a receiver of this simple type it is strongly recommended that the condensers be tuned separately. If they must be put on one control there should be a good sized trimmer, available from the panel, across one of them. Whether this trimmer should be put across the first or the second C1 depends on the inductances of the coils and the distributed capacity in the two tuned circuits. It will only take a few minutes to determine where it should be in any particular case.

### ADJUSTMENT OF CIRCUITS

It cannot be emphasized too strongly that common control of two or more tuned circuits is not consistent with selectivity and sensitivity unless every tuned circuit has been adjusted so that it is exactly alike every other. The adjustment is usually

a difficult task as it requires not only an adjustment of the distributed capacity in each circuit but also of the inductance of each coil.

It may be worth while to give a few practical suggestions on the adjustment of tuned circuits. Suppose there is a trimmer condenser across each tuning condenser and further suppose that the main condensers are connected to the same shaft. Let a short-wave station, near the 200-meter limit, be tuned in. Adjust the trimmers until the station selected comes in loudest. Note the settings of the trimmer condensers. Now go to the other end of the dial and in the same manner tune in a long-wave station. The trimmer condensers will now undoubtedly have different adjustments.

Note particularly which tuned circuit required the greater change in the trimmer condenser. For example, the second tuned circuit in a receiver like that in Fig. 1 may require that the trimmer condenser be fully meshed at 550 kc., while the first requires only that it be half meshed. This may mean that the inductance in the second tuned circuit is too small and that a turn or two should be added. Or it may mean that the first coil is too large and that a turn or two should be removed from that. Whether it means the one or the other must be determined from the position on the dial that the high wave station comes in. If it comes in well below 100 on the dial turns should be removed from the first. If it is very close to the 100 mark it is safest to add a turn or two to the second.

If the trimmer condensers should show the reverse situation, the above directions should also be reversed.

### THE AUDIO SYSTEM

The audio system in the circuit above is a bit unusual. Between the detector and the first audio amplifier the coupler is the ordinary resistance with stopping condenser. That between the first audio tube and the power is that popularized by Loftin and White.

There are several reasons for the choice of this type of coupling. The first is that the required voltage is not so high as it would be if non-reactive coupling were used throughout. The second is that the circuit is more easily adjusted. The third, quality is not impaired. Fourth, amplification at zero frequency is eliminated except after the stopping condenser. Fifth, the change in the plate current in the detector due to changes in signal level does not upset the adjustment of the voltages in the non-reactive portion of the amplifier. Sixth, the audio amplification is greatly increased. Seventh, the detecting efficiency is not impaired, but rather enhanced. Eighth, less radio frequency amplification is needed to obtain a given output than when only one audio tube is used.

A possible disadvantage is that under certain conditions the circuit may motorboat. The reason for this is that the detector and the power tube have a common impedance in the B supply. The feedback through this impedance is such as to increase the signal. This effect, however, is minimized by the parallel connection of the plates, or by the use of separate voltage dividers. Since R13 must be a rather high resistance, very little feedback can occur and the danger of motorboating is not great. If it should occur it can be stopped by a condenser of large value. This condenser should be placed either across R5 or across both R5 and R4, and it should preferably be an electrolytic.

# Reactive Audio

(page 11)

If the drop in  $R_o$  increases for any reason there will be no feed back from the power tubes because the plate currents from those tubes do not flow through the resistance. But the plate currents as well as the screen currents of the first two tubes will flow through it, and the net current will flow in such direction as to decrease the change. The circuit is stable as far as changes in the drop in  $R_o$  are concerned.

Now suppose a signal voltage is impressed on the two R4 resistances. Let the voltage impressed on the upper tube be slightly larger than that impressed on the lower. Each signal will feed back and reduce the input on that tube, but since the signal impressed on the upper tube is the larger this will be decreased the more. Moreover, since this is greater it will determine the feedback direction for both tubes, and therefore the signal input to the lower tube will be augmented while that of the upper will be decreased. Hence the inequality will be decreased. Here is another point in which the circuit in Fig. 5 is superior to that in Fig. 4.

Since the feed back in the circuit of Fig. 4 is opposite to that in Fig. 5, it follows that any difference in the input voltages on the two tubes in Fig. 4 will be intensified.

### NOT ALL ADVANTAGE

But the circuit in Fig. 5 does not have all the advantages and that in Fig. 4 all the disadvantages. When  $R_o$  in Fig. 5 is large enough to give the proper bias, the reverse feed back will be so large that the amplification is reduced greatly. This reduction, however, need not be appreciable except at the lowest audio frequencies, because a by-pass condenser of usual values will be effective in preventing any feed back at the more essential audio notes. A little reverse feedback at the sub-audible notes is advantageous in that it prevents disturbances in the voltage adjustments.

# Overall Measurements

## Two Oscillators and Vacuum Tube Volt

By Captain Peter

Contributing

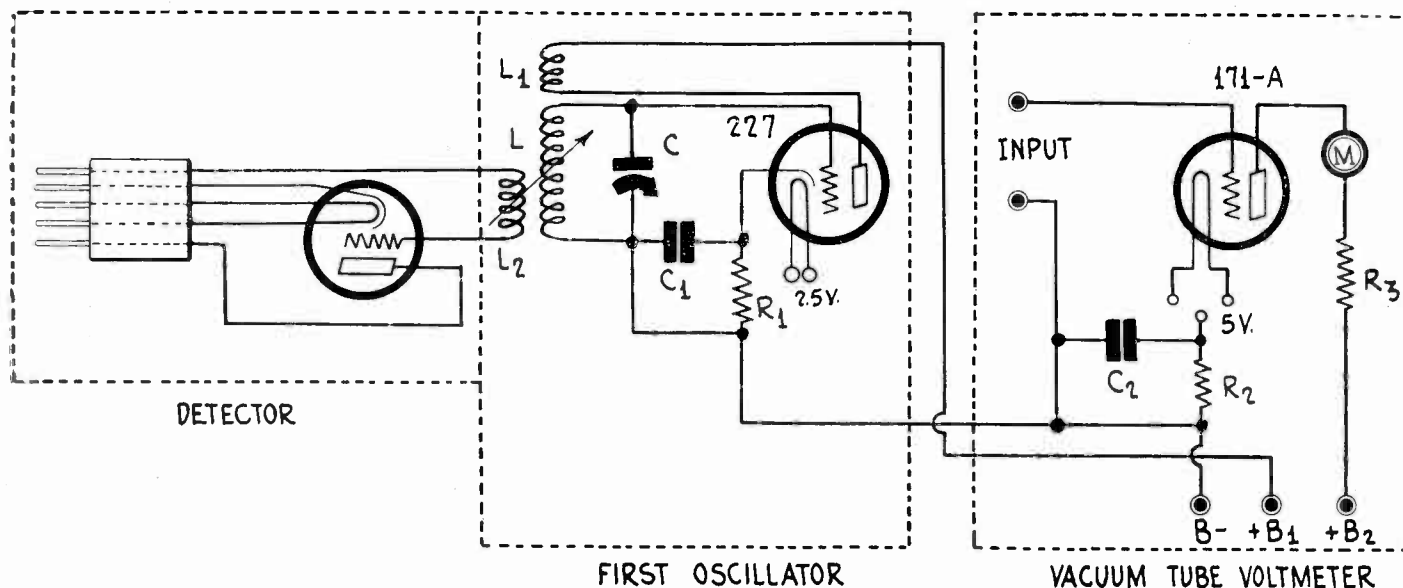

A SUGGESTED ARRANGEMENT FOR MEASURING THE OVERALL AMPLIFICATION, THE SELECTIVITY, AND THE AUDIO FREQUENCY CHARACTERISTIC OF RADIO RECEIVERS.

VARIOUS methods for measuring the overall amplification of a radio receiver have been described but nearly all are complex and not readily applicable in places where only a limited equipment is available.

The method which is about to be described seems to be simple enough to fall within the scope of all experimentally inclined fans and is capable not only of measuring the overall amplification of receivers but also of measuring the selectivity and the quality of the audio amplifier. As far as is known to the writer the method has never been described before, although in the January issue of the Proceedings of the Institute of Radio Engineers Suits describes a method of measuring harmonic contents of alternating current and voltage waves by a method which is based on a similar idea.

The principle of the method is as follows:

A radio frequency voltage of constant, though not necessarily known, intensity is introduced into the grid circuit of the detector tube in the receiver to be tested. The frequency of this voltage is adjusted until it beats at a suitable audio frequency with an unmodulated radio frequency introduced into the receiver in the usual manner. This signal voltage may be derived from a local broadcast station during moments the carrier is not modulated or it may be introduced by a separate local oscillator. It is preferable to use two local oscillators, one coupled to the input of the receiver and the other to the detector grid.

The beat frequency generated in the detector is impressed on the audio amplifier without any special connections, and the amplified beat voltage is measured at the output by means of a vacuum tube voltmeter.

### PROPORTIONAL TO SIGNAL

The intensity of the beat note produced is proportional to the local oscillation introduced at the detector and also to the signal voltage as it arrives to the detector from the radio frequency amplifier. This proportionality assumes that the detector operates on the square law of detection, an assumption which is usually justified.

If the voltage introduced by the local oscillator directly into the detector is kept constant in magnitude, the beat note produced will be proportional to the signal voltage from the amplifier. Now if the signal impressed on the input of the radio frequency amplifier is also constant the beat note will be proportional to the amplification at radio frequency. If the signal is derived from a local station the intensity will be constant, since fading effects will not be appreciable, and also since the frequency will not vary enough to detune the amplifier to an appreciable extent. The trouble with using a local station as a source is that it does not remain unmodulated for long periods, and there may not be sufficient time to take a reading. If a local oscillator is used for supplying the signal the intensity can be maintained reasonably constant for long periods.

The amplification in the audio circuit is involved because the beat note is amplified before it is impressed on the vacuum tube voltmeter. Hence the device not only measures the radio frequency amplification but also the audio frequency amplification, and the detecting efficiency as well.

### MEASURING THE SELECTIVITY

The selectivity of the circuit can be measured by detuning the receiver by known amounts and measuring the audio frequency output at each setting. In order to accomplish this with fair accuracy it is necessary that the tuning dial of the receiver be calibrated. It may be that this calibration is not accurate enough for measurement purposes or that it can not be calibrated accurately enough. In that case another method would have to be used. When the tuning of the radio amplifier is changed for this purpose it is essential that this change does not in any way change the frequency of either of the two radio voltages involved.

In case it is not practical to detune the radio amplifier the same effect can be achieved by leaving the tuner where a given signal comes in loudest and then change the frequencies of both radio voltages impressed on the detector. This can be accomplished easily if the two oscillators used are calibrated in kilocycles. The two frequencies should be changed so that the audio frequency beat remains constant, since a change in the audio frequency might lead to spurious results due to differences in the amplification at different audio frequencies. It is relatively simple to pick out an audio frequency of say 1,000 cycles and adjust to that every time. As a guide a tuning fork or a Helmholtz resonator may be used, or even a given note on a piano. The 400 cycle note is often used as standard of reference.

### MEASURING AUDIO AMPLIFICATION

The measurement of the amplification at audio frequencies, and hence the quality, is suggested in the preceding paragraph. When this is to be done the radio frequency impressed on the radio frequency amplifier is left unchanged and only that introduced directly on the grid of the detector is changed by known amounts. Here again the method calls for a calibrated oscillator, calibrated in kilocycles or fractions thereof at low frequencies.

When the frequency of the second oscillator is changed the amplification in the audio amplifier will change because the audio frequency is changed. The output at any audio frequency can be measured with the vacuum tube voltmeter. Since the intensities of the two radio frequencies are constant and since the tuning of the receiver is not changed, any changes in the readings of the voltmeter must be due to changes in the amplification in the audio circuit.

The vacuum tube voltmeter may be connected at one of several different points, depending how much of the audio system it is desired to include in the test. For example, it may be con-

# NEW CONDENSER MIKE AT WBAL NON-POLARIZED

Baltimore, Md. WBAL is using a new type of condenser microphone designed by Gerald W. Cooke, chief engineer. This microphone has been in experimental use at this station for about a year. Duplicates have been constructed in the WBAL shops and are used almost exclusively at this station. Moist or humid weather has no effect on the efficiency or operation of these microphones, says WBAL.

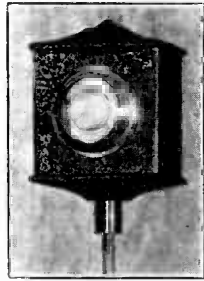

Under Mr. Cooke's direction, special circuits have been installed in WBAL's studios to permit the operation of two condenser microphones in each studio and also one in the announcer's booth. The microphones themselves are very different from the usual type of condenser microphone and are like no others being used today.

### Use Push-Pull

They employ the push-pull principle of operation in that the vibrating diaphragm of the microphone is provided with two fixed plates forming the condenser of the instrument, one of the plates being perforated in a special manner to permit the passage of the sound wave energy to the diaphragm and cause the diaphragm to vibrate in accordance with the sound.

No polarizing voltages are used with this instrument and no audio amplifiers are used. The usual polarizing and amplifying system is replaced with a simple radio frequency system giving complete freedom from distortion, according to WABC, and thus insuring that the electrical output of the microphone is exactly in accordance with the vibration of the diaphragm.

### Silent Background

The use of these microphones results in a silent background for the reproduced music, especially valuable for broadcasting in large auditoriums where high amplification is necessary properly to reproduce the sound.

"WABL's listeners may have noticed the high quality of organ pick-ups from the Peabody Conservatory of Music in Baltimore during the recitals on Thursday evenings and also during the Evening Reveries programs on Sunday nights," says an announcement by the station. "Prior to the use of these microphones the reproduction of these programs was always somewhat marred, but it is felt that the quality obtained with this new type of condenser instrument has permitted the broadcasting of the deep bass tones as well as the flute-like tones of the small pipes of the great organ with a faithfulness and reality that leaves little to be desired."

Cooke has been chief engineer of WABL ever since the station was planned, early in the Summer of 1925. He is a John Hopkins School of Engineering graduate.

## Filling Graf With Tube Gas Long Job

Dirigibles, such as the Graf Zeppelin, cannot fly without gas, and radio tubes cannot work with gas. As much care is devoted to getting the gas out of a tube as to keeping it in the Zeppelin. The vacuum in the modern radio tube is well high perfect, according to Walter Krahl, chief engineer of the Arcturus Radio Tube Company, of Newark, N. J.

"Assuming that the residual gas in a good radio tube were all hydrogen," says Mr. Krahl, "it would require 167,000,000,000,000 tubes to supply enough gas to fill the gas bags on the Graf Zeppelin. A few years ago, before we perfected our evacuating systems, only half this number of tubes would have been required."

"An idea of how many tubes are represented by the number 167,000,000,000,000," concludes Mr. Krahl, "will be more tangibly appreciated when it is mentioned that this represents the world's production for about three million years! Each year we leave about one cubic foot of gas divided among all the tubes made on earth."

## TRADE EXHIBIT GOES TO EAST

Plans are maturing for the annual radio industry events, the convention and trade show of the Radio Manufacturers Association at Atlantic City, week of June 2. More than 30,000 persons connected with or interested in radio manufacturing and radio merchandising attended this event last year.

This is the first time that the show and convention, the largest industrial gathering in the United States, has been held in the East. For three years the events have been held in Chicago.

There will be national gatherings of affiliated radio industry organizations, the National Federation of Radio Associations, the Radio Wholesalers Association, the organizations of radio dealers and jobbers, and other radio organizations.

The show, convention and banquet will be held in the new mammoth civic auditorium on the boardwalk.

The very latest in modern radio will be exhibited. The latest in receiving sets, tubes, loudspeakers, parts, cabinets, accessories, etc., will be displayed by about 300 of the leading radio manufacturers, all members of the RMA, but only for the trade. The radio exhibition will not be open to the public.

## Two Stations Ask For Increased Power

Washington.

WLBW, operated by the Radio Wire program Corporation of America, formerly the Petroleum Telephone Co., of Oil City, Pa., 500 watts night, 1,000 watts day, asked an increase to 1,000 watts day and night on the 1,260-kilocycle channel.

Change in wave length and increase in power from 100 to 500 watts was sought by KMJ, of Fresno, Calif., operated by the Fresno "Bee." The station now operates on 580 kilocycles and desires a change to 1,210 kilocycles.

## Stock He Got at \$1,500 Grew to \$3,071,897

Another Kolster executive who made a big profit on stock transactions was Maurice C. Rypinski, who was general sales manager, a position he accepted with C. Brandes, Inc., in 1922, which corporation was bought out by the Kolster Radio Corporation. Mr. Rypinski is now radio department manager of the Westinghouse Electric and Manufacturing Company.

He testified before John A. Bernhard, special master in chancery, at a hearing in Newark, N. J., in an investigation of whether any one had "rigged the market" for Kolster stock, as charged by Albert Schwartz, a lawyer of Paterson, N. J., himself a holder of 400 shares of Kolster stock. Mr. Rypinski denied, as had Henry W. Stone, president, and Rudolph Spreckels, chairman of the board, participation in any part of or the short sale of any Kolster stock.

Mr. Stone had testified to making a profit of \$698,000 on Kolster stock, and Mr. Spreckels, the sugar magnate, had made large sales, too, by his own testimony, which did not reveal the profit.

For \$1,500 Rypinski bought 30 per cent. of the Brandes stock in 1922, an opportunity offered to him if he would accept the sales management. The money was a "nominal" amount for the stock, he declared.

He remained in the position during and after ownership changes, including the Federal Brandes regime, and in 1929 disposed of his last holdings, in Kolster, by open market sale, whereupon he was able to figure his profit from \$1,500 as \$3,070,397, but—

There was the Federal income tax!

And the net profit, tax deducted, was only \$934,326.

Frederic Dietrich, vice-president of Kolster and also a director thereof, made \$2,021,219 net profit on \$1,200 invested in 1912, he himself testified. His gross profit was \$6,248,265, he said. The 1912 purchase brought him control of the Brandes corporation. It was from Mr. Dietrich that Mr. Rypinski got 30% of Mr. Dietrich's holdings for the nominal \$1,500. Mr. Dietrich, who never participated as an executive of Kolster, despite his title, held only preferred stock. Like Mr. Spreckels, he is a heavy creditor of the Kolster Corporation, which is in the hands of three co-receivers, and has indorsed heavy notes. He puts the amount owed him on Kolster notes at \$700,000 and the amount of Kolster paper he endorsed at \$1,200,000.

## New NBC Artists Service Signs Up Noted Talent

Creation of a new NBC Artists Service and the signing of a number of the foremost stars of the concert and operatic world were announced by M. H. Aylesworth, president of the National Broadcasting Company.

Schuman-Heink, Werrenrath, Lauri-Volpi, Walter Damrosch, Josef Lhevinne, Mischa Levitzki, Paul Kochanski and Hallie Stiles are under contract and will make personal appearances throughout America next season under the auspices of the new organization.

The NBC Artists Service enlarges the scope of the concert activities begun by the National Broadcasting Company about a year ago under the direction of George Engles. The Service will absorb all present concert and managerial activities of the National Broadcasting and Concert Bureau, which name will be discontinued.

The NBC also is sponsoring the expansion of the Civic Concert Service, now in Chicago, to include the entire country.

The function of this organization is to build up permanent audiences throughout the country by means of membership subscriptions extending over a period of five years. At present 1157 cities are operating on this plan, each with annual memberships ranging from 1,000 to 3,800. The same system will now be made available throughout the eastern states as well as the west, according to Engles. New York headquarters has been established at the National Broadcasting Company Building.

Engles explained that the new NBC Artists Service will continue to represent more than 200 artists now under contract to the National Broadcasting and Concert Bureau, whose activities in radio, talking pictures, vaudeville and concert have become an important factor in the entertainment field.

## Two Foreign Programs Heard Over Chains in One Afternoon

Two European broadcasts were relayed throughout the United States by the National Broadcasting Company recently.

The first was a special program from Holland, where Dutch program experts offered special musical features for American listeners. The second was another topical review from the scene of the London Naval Arms Conference, continuing NBC's weekly service for American audiences on this event.

As an additional feature of the Holland program, the music was prefaced by a short talk by William Hard, who was heard as NBC's official observer at the naval parley during the opening days. Hard was now in Eindhoven, Holland, en route for other parts of Europe before returning to the United States.

The Dutch program was heard in this country through all combined networks of the NBC, at 1 P. M., Eastern Standard Time. By special arrangement, WOR also was linked with WEF and WJZ in the New York area.

England was heard at 4:20 P. M., S. S. T. The voice was that of Vernon Bartlett, official commentator of the British Broadcasting Corporation. WJZ and WOR in New York headed the NBC network for this feature.

## Screen Grid Tubes Widen Day Range

"Daytime reception has been materially benefited by newest type receivers using screen grid tubes," reports Alfred H. Grebe, who has been in touch with stations throughout the country.

Judith C. Waller, director of WMAQ, Chicago, declares that the daytime range of that station has been very widely extended and that reception is reported as far away as New Orleans, Texas, Oklahoma, the Dakotas, and in Saskatchewan.

The highly sensitive receivers thus made it possible for hundreds of thousands of persons living a considerable distance from broadcast stations to receive programs during daylight hours. In agricultural sections, the information received in these programs, as well as the entertainment, is much desired, and enthusiastic letters have been forwarded to the stations as a result.

C. W. Horn, Chief Engineer of the National Broadcasting Company, says that the screen grid tubes have enabled the manufacturers to design more selective receivers. He terms this feature of selectivity a paramount factor in achieving the superior results in reception which are now so common.

## TUBE MARKET CONCENTRATING

Competitive lines in the radio tube field are being drawn now for the sharpest contest in the history of the industry, said Paul P. Huffard, newly elected president of National Carbon Company.

"The industry finds itself in the same condition that confronted the automotive industry in its early years," he said. "From a position in which a good portion of the annual production came from a number of scattered manufacturers, the automotive industry has evolved to a stage where the bulk of production comes from a very few concerns. This is exactly the stage at which, in our opinion, the radio tube industry will have arrived by the end of 1930. The handwriting is definitely on the wall and should not be disregarded."

"National Carbon Company, through its Eveready Raytheon Tube division, is definitely in the tube business to stay. With 40,000,000 radio listeners estimated today in the United States, the tube market offers one of the greatest replacement markets available to industry. It is destined to grow from year to year."

"As a result of our withdrawal from the glutted radio receiving set field, our company has fortunately taken itself out of a competitive position with all set makers."

"National Carbon Company, in addition to extensive manufacturing resources, enjoys the advantage of possessing the largest force of salesmen contacting the tube distributors of America. This sales force consists of more than 200 men, operating nationally. In our Eveready Raytheon tube division this year we are confirming our own confidence in the future of the tube business itself by supporting our dealers with the largest advertising appropriation being devoted to any single product of National Carbon Company, Inc."

Most tube makers are finding the going tough indeed just now.

## TERMS EXPIRE FOR ALL FIVE ON THE BOARD

An amendment to the radio law makes the terms of the present Radio Commissioners expire on February 23rd. President Hoover has not disclosed what changes, if any, he will make, but there is a general impression that reappointments will be the order of the day. Of the Commissioners.

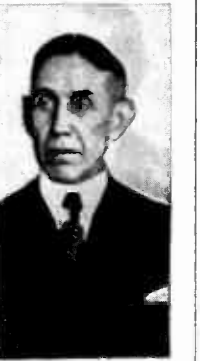

Ira E. Robinson

Chas. McK. Saltzman



W. D. L. Starbuck

two are appointees of President Hoover. They are Maj.-Gen. Charles McK. Saltzman, Middle Western States, and W. D. L. Starbuck, for New York and New England.

The other Commissioners are Ira E. Robinson, Southwest chairman; Harold A. Lafount, Western States, and Eugene O. Sykes, Southern States.

It is regarded as certain that four of the Commissioners, excepting Mr. Robinson, will be reappointed, but many believe Mr. Robinson will not only be continued as a Commissioner but also as chairman. Contrary reports circulated earlier cited the possibility of Mr. Robinson being passed over entirely, some one else appointed to the Commission, and Maj.-Gen. Saltzman, former Signal Corps chief, made chairman.



Eugene O. Sykes

Harold A. Lafount

# of Receiver Performance

## meter Test Selectivity, Gain and Quality

V. O'Rourke

Editor

nected across the input to the power tube or across the loudspeaker. If the effects of the loudspeaker are not desired a suitable non-reactive resistance can be connected in place of the speaker and the voltmeter connected across this resistance.

It may be desired to study the effects of baffle boards of different sizes or of a single baffle board at different frequencies. Again, it may be desired to study the effects of open windows and various sound-absorbing surfaces in the room. Suitable conditions can be arranged in any case very simply. The vacuum tube voltmeter in these cases should be connected across the speaker.

### ARRANGEMENT OF TESTER

Fig. 1 herewith shows the essentials of the circuit. The tube to the left is the detector tube in the receiver to be tested. It is transferred to the test circuit and connections are made with a suitable cable. It will be noted that the detector tube and the rest of the tester are entirely independent except for the coupling between the coils L and L2. This independence is maintained in order that the test circuit should have as little influence on the receiver as possible. The same tube is plugged into the receiver detector socket and the only reason for transferring it is to introduce the coil L2 in the grid circuit.

Now this coil will have a slight detuning effect on the last tuned circuit. This should be compensated for when the change-over is made.

Loose coupling between the oscillator LC and the detector is essential because if the coupling is close the effect of the oscillator on the tuning characteristic may be so great that compensation for it may not be possible, and also because if the coupling is not loose it may be impossible to secure very low audio frequency beat notes.

### EFFECT OF TRANSFERRING TUBE

It will be noted that when the detector tube shown in the figure is plugged into the detector socket in the set the grid lead picks up the last tuned circuit, only introducing the coils L2 in the lead between the tuned circuit and the grid. The cathode lead picks up the corresponding lead without any change at all, except in the length of the leads. Likewise the heater circuit is picked up. The plate lead is also picked up without change other than a lengthening of the leads.

The second oscillator, that shown in Fig. 1, is of the ordinary type used in Super-heterodynes and its tuning range should be the same as that of the tuned circuits in the receiver. Thus the inductance of L should be 160 microhenries when the condenser C has a capacity of .0005 mfd. L1 is the usual tickler coil, which may or may not be of the rotatable type. The pickup coil L2 should be small and it should be mounted so that it can be rotated with respect to coil L. Half a dozen turns on a one inch diameter will suffice.

Condenser C should be provided with a dial having a real vernier or with a very large dial with many divisions. The dial should also be mounted directly on the shaft of the condenser so that there can be no backlash or lost motion to upset the calibration.

The calibration can be accomplished accurately by comparing the oscillations generated with the frequencies of broadcast stations. With a very small antenna, coupled extremely loosely, it is possible to pick up the squeal of nearly every broadcast station in the country, even if the work is done at one extreme of the country. It may be difficult to identify all stations and thus to locate the frequency on the dial, but this work can be disposed of by plotting a curve of frequency against dial settings. A few stations will be recognized easily, and they will be well distributed over the dial. Weaker squeals of remote stations can be located by reference to the other and louder squeals.

The first oscillator, not shown, which is to replace the broadcast station, should be just like that shown and it should be calibrated in the same way. After one of them has been calibrated against broadcast stations the other oscillator can be calibrated against the first.

### THE VACUUM TUBE VOLTMETER

There are many kinds of vacuum tube voltmeter which will measure AC voltages. Many have been described in RADIO WORLD. The circuit of a simple meter of this type is shown in Fig. 1, using a 171A tube. This tube is especially suitable because it has a low amplification factor and a high emission. The low amplification factor makes it possible to cover a wide range of voltages and the high emission insures constancy of the calibration.

While the circuit shows that the same plate battery is used for both the oscillator and the voltmeter it is best to use inde-

pendent batteries. However if very large by-pass condensers are connected across the plate return leads one battery will serve both tubes without any trouble. Only one by-pass condenser, C2, is shown, and this is connected across the grid bias resistance of the voltmeter tube. Two microfarads will be large enough for this condenser. The grid bias resistance should be so large that the tube will operate as a grid bias detector. It is preferable to use a battery for bias. This battery should be connected between the same point as the resistor and in place of it.

The input terminals of the vacuum tube voltmeter should be connected across the points the voltage between which it is desired to measure, for example, across the loudspeaker terminals. The meter M in the plate circuit of the tube should be a sensitive milliammeter, say an instrument of 0-1 milliampere sensitivity, or better a microammeter. The value of the resistance R3 depends on the particular tube used, on the bias selected, on the sensitivity of the meter and on the plate voltage applied to the 171A tube.

### LIMITING VOLTAGES

If a high plate voltage is used the range of the voltmeter will be greater and then the resistance R3 should have a high value.

It is not essential that the vacuum tube voltmeter have as wide a range as the voltages that may be encountered in ordinary reception because the voltage of the beat note may be adjusted to almost any desired level either by adjusting the radio frequency voltage impressed on the receiver or by adjusting the radio frequency voltage introduced directly into the grid circuit of the detector, that is, by adjusting the coupling between coils L and L2.

It might be stated that the audio voltages encountered in a radio receiver across the loudspeaker may be as high as 150 volts. There is no reason why voltages higher than 5 volts should be used while testing the circuit for amplification and selectivity. The only reason for using high voltages would be to test the effects of overloading, a use to which the circuit is not adaptable. Hence the vacuum tube voltmeter need only have a moderate range, which can be obtained by using a plate voltage of the usual values for the tube and a grid voltage about twice or three times the usual values.

For the details of construction and calibration of the vacuum tube voltmeter the reader is referred to articles specially treating this subject.

### CONSTRUCTION OF OSCILLATORS

Those who wish to try the method of measuring the overall amplification should start by constructing two equal oscillator circuits, one entirely independent of the other and both shielded. The tuning condenser in each should be a .0005 mfd. The tuning coils should be wound for the condensers used and may be those in Super-heterodyne receivers to generate the local frequency. An important feature is the variable coupling between the oscillator inductance and the pick-up coil. Many Super-heterodyne oscillator coils are constructed so that the pickup coupling can be adjusted from zero to a maximum depending on the geometry of the assembly. There is no need for a higher plate voltage on either tube than 45 volts.

## Fixed and Ballast

### Controls Compared

A line ballast, according to Charles Golenpaul, of the Clarostat Manufacturing Company of Brooklyn, N. Y., is an automatic line voltage compensator which, as a ballast, throws more or less resistance in series with the power transformer of the all-electric radio set, to allow for the increased or lowered line voltage.

When the line voltage is exceedingly low, such as below 100, the radio set can still function at full efficiency, since the design of the power transformer allows for operation on a voltage as low as 85, while the ballast makes up the difference between that and the line at all times.

"The fixed resistor type, usually in the form of a plug or similar attachment, on the other hand, is simply a fixed resistance value designed to cut down the line voltage," he added. "It introduces the same resistance into the circuit at all times. When the line voltage is high, the resistor serves to safeguard the tubes, filter condensers and other components; but when the line voltage is low, there is no means of increasing it by reducing the 25-ohm resistance."



# RMA ALL WET ON PENTODES, IS CECO REPLY

The official statement of the Radio Manufacturers Association, stating there was nothing new in the pentode announced by Ceco Manufacturing Co., of Providence, R. I., and that no improvement in performance can be obtained with pentodes that can not be had with present tubes, brought a blasting retort from Ernest Kauer, president of Ceco. Mr. Kauer characterized the RMA statement as "ill-advised propaganda," and said that failure even to consult Ceco, an RMA member, showed that "some one was bent on putting something over quickly."

## What the Elements Are

The tube, he said, is not the same as the European one with which the RMA statement compared it.

The pentode is a five-element tube, differing from the screen grid tube because of a second screen. The elements are cathode, plate, control grid, screen grid around the plate and screen grid between cathode and control grid. Contact to the fifth element is made to a binding post on the side of the base. Otherwise the tube looks like a 224.

So far only an AC model is announced, and it is intended for radio frequency amplification.

## Paragraph Cited

In his reply Mr. Kauer refers to the "introductory paragraph" of the RMA report. This paragraph read:

"To advise the radio public and industry correctly and authoritatively regarding the 'new' pentode radio tube, the Radio Manufacturers Association, comprises all important manufacturers, today issued a statement regarding the pentode. It was declared neither new nor revolutionary. No improvement in performance can be obtained with pentodes that cannot be had with present tubes, the official statement declared, and it is unlikely that pentodes will replace present tubes this year."

## Reply to RMA

Mr. Kauer's statement, released by his company's publicity representatives, was as follows, in full:

"From Fred Baer & Associates, 366 Madison Avenue, New York City.

## "KAUER ANSWERS "RMA CRITICISM "OF AC PENTODE

"The 'news release' issued last week by the Radio Manufacturers Association in connection with the AC pentode tube caused Ernest Kauer, president of Ceco Manufacturing Co., Providence, R. I., to make the following comment:

"I consider that news release an ill-advised piece of propaganda. It can have no good effect on the radio industry. Its introductory paragraph is not supported by the facts brought to its support. The body of the statement, when analyzed, really supports the claims of Ceco's engineers.

"Whoever in the RMA caused this statement to be issued made no effort to secure our pentode tubes for testing. They have gone on the assumption that the European pentode and our pentode

# College Girls Swim to Music

Saratoga Springs, N. Y.

Skidmore College has adopted "musical swimming." Miss Margaret Bridgman, dean, thinks the idea of examination week as a time of terror and worry is out of date. With midyear examinations approaching, she called on the departments of psychology and physical education to devise ways of saving Skidmore girls from headaches and "nerves." A substitute for midnight oil, wet towels and pots of coffee was sought. It was found in a combination of music and physical exercise. Every day the organ played soft music in the chapel, a series of piano recitals was arranged, and the students encouraged to skate on the college rink. But most of all, every girl is urged to calm her nerves and sustain her strength by "musical swimming."

A loudspeaker was installed directly above the swimming pool. Market reports and solemn speeches are tuned out, but every variety of music tuned in. Loudspeakers have been used on many beaches, but the music scarcely reached the waters. In the Skidmore pool the students practice "musical swimming" by stroking rhythmically with the music. They find the livelier tunes great fun, while music in the waltz tempo is found by the psychology instructors watching the experiment to be particularly soothing to tired nerves.

# LINE VOLTAGE SURVEY STARTS

A nation-wide survey is being made by the Allied Engineering Institute, at the instance of a group of radio manufacturers. The purpose is to obtain authentic data on voltage conditions in every town and city of the United States, so that radio set manufacturers will be able to furnish receivers adaptable to the voltage conditions of each particular locality.

Those who have experienced imperfect radio reception such as under-volume, fading, sudden blasts of volume, tube burn-outs and distortion, are asked to write to the Allied Engineering Institute, Suite 429, 30 Church Street, New York City, telling of the conditions of radio reception in their vicinity. Those who have AC meters can be of assistance if they will send in a record of the line voltage readings at several different times of the day. For example, in most cities the voltage is higher during the day than in the evening

are identical, whereas they are different types of tubes.

## Cites Foolish Haste

"To deny that Ceco's development is an advance in the radio art is as futile as was the attempt of automobile manufacturers who tried to delay the use of four wheel brakes or balloon tires.

"Little if any thought was given to that news release before it was issued. The fact that Ceco, as the pioneer in the development of the AC pentode tube for its practical application here, and as a member of the RMA, was not consulted, shows that someone in the organization was bent on putting something over quickly. As I see it, all they achieved was a foolish haste. They did nothing constructive, unless the distribution of misinformation can be called constructive.

"Tests in laboratories other than our own show that the AC pentode as developed by Ceco will do all that we claim for it."

# LICENSES RING WITH BANS ON VESTED RIGHTS

Washington.

What will be done about WMAK, Buffalo, N. Y., now on 900 kc, which frequency is tentatively intended for a new station, owned by the Buffalo "Evening News" will not be clear at least until the impending reallocation. Forty major changes are to be made in the broadcasting structure, and WMAK may find itself in another channel on limited time.

It is intended that the "News" station shall have full time. The construction permit says so, but that is not inevitably controlling.

## WMAK Gets Temporary Aid

Meanwhile, by a recent Commission order, WMAK got a 90-day license for 900 kc on part time as did WFBL, Syracuse, N. Y. WMAK was charged by the "News" with being owned by a corporation that had a monopoly of Buffalo stations. Each license contains this clause:

"This license is only temporary, and is not to be taken as a finding of public convenience, interest or necessity. It is issued merely ad interim until such time as the Buffalo Evening News is entitled to license on a construction permit heretofore issued to it if that be within the terms of this temporary license. Nor is this license to be taken as any reversal of the judgment of the Commission whereby the frequency of 900 kilocycles has been assigned for license to the Buffalo Evening News on the aforesaid construction permit."

## Claim Always Lost

Clauses such as these are intended to make it plain to stations that nothing even approaching a "vested right" goes with a license. In several court contests with the Board, stations have claimed a "vested right." WGY, Schenectady, N. Y., was first with this claim, put forth by Charles Evans Hughes, then WGY's counsel. Mr. Hughes likened long occupancy of a particular frequency as equivalent to a trade mark.

No "vested right" claim by a station has been sustained by a court.

# Manufacturers Aid Aero-Radio Study

The Radio Manufacturers Association, comprising virtually all radio makers, is cooperating with the Federal Government in the application of radio to aeronautics. Dr. Lewis M. Hull, of Boonton, New Jersey, who has done considerable aero-radio development, has been appointed by H. B. Richmond, president of the Radio Manufacturers Association, on the Aeronautical Radio Research Committee just formed by the Department of Commerce. Harry H. Blee, of the Department's Aeronautical Branch is chairman.

Other members include Dr. J. H. Delinger, of the Bureau of Standards; Herbert Hoover, Jr., of the Aeronautical Chamber of Commerce, Army, Navy and other experts. The committee will study radio problems in aeronautics and compile information to assist in developing the important application of radio to aeronautics.

# WORLD SIGNALS FOSTER STUDY OF TIME GAP

Will the development of international broadcasting put stations on a twenty-four-hour-a-day basis of service?

Principal events throughout the world already are being relayed, thanks to the efficiency of short waves, high power, and improved transmitting and receiving apparatus. What happens in one country may be tuned in by listeners in another, even at the far ends of the earth.

It is the time factor that intervenes. That was dramatically conveyed to millions in the United States and Canada by the address of King George opening the London Naval Conference. To New Yorkers that meant listening in at 6 a. m., in California at 3 a. m.

## The Song Paralleled

And when it's Wednesday in the U. S. A. it's Thursday in New Zealand. Time changes with each 15 degrees of longitude and the world is divided into 24 zones for the purpose of recording time.

This becomes a vital consideration in international broadcasting, the era of which is now beginning.

That is why all those interested in broadcast reception are recalling their study of this time division in their grammar school days, never figuring that they would have very much interest in the way it operates. Now traveling and radio bring the topic into the limelight. We remember that the meridian of longitude which runs through the little town of Greenwich, England, is the starting point, so that international time is expressed in terms of Greenwich Mean Time (G. M. T.) Traveling 180 degrees away, east to west, a day is actually lost at the International Date Line; a day is gained in the opposite direction.

## Told in Book

In order that we might hear reports of the Naval Conference at customary hours, speakers appear before the microphone in the early morning, or after midnight, in London. This is convenient from the viewpoint of the invisible audience in the North American Continent, but such a process could hardly apply except on occasions of exceptional importance and certainly not in the relaying of an actual news event as it occurs.

If Australian programs are to be carried to the United States, they would be best heard in the East from 4 to 6 a. m. At these periods the experimental programs from 2ME, Sydney, for example, have been picked up by WGY in Schenectady.

These points are brought out by Eric Palmer, Jr., in his new book entitled, "Riding the Air Waves," published by Horace Liveright, Inc., dealing with the adventures of the youthful owner of Amateur Station W2ATZ and covering the latest phases of short wave relays.

The author is the son of Eric Palmer, formerly publicity representative of Freed-Eiseman and of the Radio World's Fair, and more recently an executive of a Western radio chain.

## GILBERT NOW WITH PILOT

Charles Gilbert has become affiliated with the Pilot Radio & Tube Corporation, of Brooklyn, N. Y., as vice-president in charge of merchandising. He was a close business associate of Dr. Lee DeForest. More recently he was with Kolster.

# More Stations Seek Short-Wave Permit

A few broadcasting stations, such as KDKA, WGY and WABC, have maintained simultaneous short wave transmitters, but the list is about to grow considerably. Activity in this direction followed the repeated successes of the National Broadcasting Company in sending relayed European programs into American homes.

WOR, Newark, N. J., which is to be owned as of record by the Bamberger department store in Newark, N. J., is erecting a short-wave transmitter.

The Voice of Brooklyn, Inc., has applied for a construction permit on 2,800 kc., 500 watts. Other applications are pending.

Stations want their programs heard all over the world now.

# SIGNALS FROM OVERSEA GAIN

The first network rebroadcast of a program originating across the Atlantic took place a year ago. The National Broadcasting Company, with less than three hours notice, successfully picked up and rebroadcast a symphony concert from London through a network of thirty associated stations.

In July, 1929, Thanksgiving Services for the recovery of King George of England, held in Westminster Abbey, London, were rebroadcast through the NBC network. The same morning a program originating in Sydney, Australia, was picked up and went on the American network.

Later came the broadcast description of the Schneider cup races.

In October American listeners heard a program from Holland and just before Christmas there came a program from German studios. Christmas Day shattered all previous records for programs from Holland, Germany and England went on the air in rapid succession.

New Year's Eve brought more programs from abroad. Then, when the Naval Parley opened in London the morning of January 21st, radio outdid itself. The voice of King George opening the parley and the addresses of the delegation chief from the United States, England, France, Italy and Japan were heard. Secretary of State Stimson, who had never addressed an American network audience as a cabinet member, was heard from London.

## New Corporations

Stitz Radio Studio—Atty. H. A. Kulowski, Buffalo, N. Y.  
Bamberger Broadcasting Service, Inc.—Atty. Pitney, Hardin & Skinner, Newark, N. J.  
Brandywine Radio Shop, Inc.—Atty. Edward T. Varley, Wilmington, Del.  
Radio Mart—Atty. D. B. Williams, 521 Fifth Ave., New York, N. Y.  
Catrons radio—Atty. M. Annis, 1560 Broadway, New York, N. Y.  
Winthrop Radio Co.—Atty. S. M. Rivelson, 38 Park Row, New York, N. Y.  
Locust Radio Co.—Atty. G. Voigt, Jamaica, Queens, New York.  
Griffiths, Inc.—Bernardsville—Atty. W. Eddy Heath, Somerville, N. J.  
Vaco Radio Corp.—Atty. O. L. Landman, 26 Court St., Brooklyn, N. Y.  
more. Md.  
Leroy Flippen, 912 W. 13th St., Oklahoma City, Okla.  
F. W. C. Baines, Box 1058, Saskatoon, Sask., Can.  
B. A. Dwojakowski, 991 Canfield, E., Detroit, Mich.  
Sol. Weber, 836 Mt. Prospect Ave., Newark, N. J.  
R. T. Stubbs, Box 86, Rosebud, Tex.  
Charles F. Kirkland, 4432 W. 10th Ave., Gary, Ind.

# MAXIM PLEADS WITH SENATORS FOR AMATEURS

Washington.

Hiram Percy Maxim, president of the American Radio Relay League, consisting of 17,000 amateurs, appearing before the Senate Committee on Interstate Commerce, asked that in working out the Couzens bill for a communication commission, asked that the amateurs be "protected, encouraged and adequately provided for," a condition that, he added, does not exist today.

He urged that the new avenues of communication which doubtlessly will be opened by their research be not entirely taken away from them for the use of commerce and industry, but that they be allowed sufficient room in which to maintain their own experimental networks, always available to the Nation in emergency, and serving as a training school for radio operators.

## Cites 1912 Legal Safeguard

In 1912, Mr. Maxim pointed out, Congress specifically provided that there should be amateurs and it allocated to them waves below 200 meters (1,500 kilocycles).

"They were considered the 'useless waves' at that time," he explained, "but there was room enough and the amateurs set about seeing what could be done with them. It was an historic occasion in the art of radio communication, for it marked the birth of shortwave radio."

"This legislative act," he declared, "was one of the wisest steps a Congress ever took, and I submit that if it is wisdom to judge of the future by the past, then we here today may safely assert that it will further the art of communication during the 18 years to come just as much as it furthered the art of radio communication during the 18 years that have passed, if the Senate Committee on Interstate Commerce, in working out the details of Senate bill for a Federal commission on communications see to it that our radio amateurs are protected, encouraged and adequately provided for."

For the 1,500-kilocycle limit of the days after the World War, amateurs have made possible regular commercial operations on frequencies up to 23,000 kilocycles, and are now experimenting with excellent results beyond that limit and in the "ultra-high" frequencies, Mr. Maxim said.

## Crowded Beyond Endurance

Finally, he said, at the International Radio Conference of 1927, and despite the efforts of American delegates, the American amateur "was all but sacrificed."

He continued: "All that was left of the territory the amateur had so brilliantly chiseled out of the solid were extremely narrow bands around 160, 80, 40 and 20 meters. Here we find him today, more than 17,000 in number, crowded beyond all conception and almost beyond endurance, suffering from what he feels is injustice and ingratitude and in constant danger of losing even the little that he still retains."

Declaring that both the Federal Radio Commission and the Department of Commerce have recognized the position of the amateurs, Mr. Maxim said, according to "The United States Daily," his organization would be "very well satisfied if the Government communications commissions of the future deal with us as fairly as have the existing agencies."

# NBC TAKES IN \$15,000,000 AT NO PROFIT

The National Broadcasting Company became, in fact, an international broadcasting organization, increased its network facilities more than twenty per cent and nearly doubled its personnel in 1929, according to the annual report to the Advisory Council made by M. H. Aylesworth, president of the NBC.

Those present at the annual meeting of the Advisory Council held in the National Broadcasting Company Building, 711 Fifth Avenue, New York, included Charles Evans Hughes, Elihu Root, Owen D. Young, John W. Davis, William Green, Paul D. Cravath, Gen. James G. Harbord, Walter Damrosch, Mrs. John D. Sherman, Francis D. Farrell, Morgan J. O'Brien and Dr. Chas. S. MacFarland.

"In 1929 our gross income was approximately \$15,000,000, all of which was devoted to service to the radio audience," said Mr. Aylesworth. "There was no profit. One hundred and ninety-nine clients used NBC facilities during the year 1929 as compared with ninety-six during 1928."

## Democracy Realized

"Nothing comparable to network broadcasting as a means to the realization of our democratic ideals in national cultural development has ever before existed," Mr. Aylesworth said. "Our population has already reached a figure that would have been almost certain to have brought disintegration a hundred years ago," he added in pointing out the service radio has rendered in developing a mass-consciousness of a common national ideal. Radio broadcasting already is bringing about revolutionary changes in marketing methods, the report continued. It gives the farmer all of the information available to the buyer of his products and for the first time in history places him on an equal footing with the buyer, Mr. Aylesworth pointed out. An hour at noon six days a week is devoted by the NBC in supplying this information to farmers and producers.

## Suggests a Contest

A national oratorical contest to train young speakers in the technique of microphone oratory was suggested in the report.

Relief of the "traffic jam" on the air is hoped for through development of synchronized broadcasting which means the employment of a single wavelength by a number of stations broadcasting the same program at the same time, the report said. NBC engineers have been conducting experiments in this work for the past year.

The NBC now is definitely engaged in international broadcasting, Mr. Aylesworth stated.

That present radio facilities, had they been available in 1914, probably would have averted the World War, was pointed out in the report which sees the microphone replacing cannon in the settlement of international disputes.

## A THOUGHT FOR THE WEEK

**L**OVE! Love! It's an awful thing!  
Proof? List to the crooners sing  
Syncopated wails that ring  
Through the microphone and bring  
Heartaches, earaches—ting-a-ling!  
(See—our brains have taken wing!)  
Gee! But love is an awful thing!

## Summary of 1929 Report on NBC

Broadcasting has been called "the fastest growing industry." Here is what happened to the National Broadcasting Company during 1929 according to the annual report of M. H. Aylesworth, president of the company, submitted to the Advisory Council of the organization.

Fourteen stations were added to the national network, including one Canadian station. The network now includes 73 stations.

Gross revenue of the NBC in 1929 totalled more than \$15,000,000. There were no profits.

Fifty-four hundred miles of wire were added to the NBC System, bringing the total to 32,500 miles of wire lines.

More than one million letters from listeners were received in the year.

The personnel of the NBC was increased from 558 to 917 in 1929.

Sixty hours of programs a week were added to the regular schedule of broadcasts from the key stations of the network.

The President of the United States spoke thirteen times through a national network. There were twenty-seven addresses by cabinet members, twenty-eight senators were heard and twelve members of the lower house made addresses.

Virtually the entire population of the United States can be entertained or informed by one program in the same hour.

## NEGRO STATION IS REQUESTED

Washington.

"A voice for the Negro" was asked by William J. Thompkins, who appeared before the Federal Radio Commission on an application by the Kansas City "American" for a 250-watt license to broadcast on 1,120 kilocycle. The Negro newspaper, of which Thompkins is managing editor, asserts there are no stations licensed to any Negro or Negro organization.

Thompkins told the Commission: "We hope to stimulate interracial interests, offering America's only distinctive music—the Negro folklore, exemplifying the spiritual life of the Negro in sermons, and demonstrating the Negro's conception of patriotism and Americanism."

One of the reasons for the station, said the witness, is for the uplifting and educating of the Negro, and to give people "the Negro viewpoint."

The application filed by the newspaper was for unlimited time. Representatives of WISN, Milwaukee, Wis., and KTRA, Houston, Tex., asked leave to object to the assignment.

## "Old Man Donaldson," War Veteran, Dead

"Old Man Donaldson" is dead. Colonel C. T. Davis, pioneer radio writer and author, died at his home, 100 East 55th Street, New York City, after prolonged ill health. Although he had been partly disabled by his illness, Colonel Davis continued to be active until a few days before the end. His last work was in adapting several short stories for presentation in Collier's Radio Hour.

Colonel Davis, an Englishman by birth, did not take up drama as a profession until after the war. He was a captain at the front in the World War.

## MIKE IS MADE WITH AMAZING PRECISION FEAT

An amazing example of precision in manufacturing is illustrated in the new type microphone manufactured by the Western Electric Company for sound picture apparatus and radio broadcasting.

The condenser type microphone was developed to provide the most sensitive and faithful method of picking up all kinds of sound ranging from the highest soprano notes to the low boom of a bass drum, and to reproduce them with utmost fidelity.

Each transmitter must pass 46 mechanical and electrical inspections before being accepted as a finished product. The insulation, for example, must show a resistance of at least 80,000,000,000 ohms, the natural frequency of the diaphragm is required to be between 5,000 and 5,050 cycles a second and the back plate of the condenser must be within .00008 inches of a true plane.

## Assembled Under Microscope

The test which determines the last factor is made by utilizing certain laws of physics regarding the interference of light waves. It is almost impossible for the layman to understand such a degree of accuracy.

The assembly and inspection of the microphone are done in an air conditioned room which is supplied with air at a constant temperature of 70 degrees Fahrenheit and a constant humidity of less than 40 per cent. Between operations all piece parts are kept in jars in which a supply of calcium chloride absorbs all moisture. The intricate assembly operations are carried out in dust-proof boxes under a low power binocular microscope which magnifies the object being assembled to 16 times its actual size.

## Frequency Tested

In the first assembly operation a duralumin diaphragm only a thousandth of an inch thick is mounted in a shell with a ring which can be adjusted to stretch the diaphragm. An oscillograph is used to determine that the diaphragm has been stretched so that its natural frequency is between 5,000 and 5,050 cycles per second.

The diaphragm and the backplate, which as already mentioned, is lapped to within .00008 inches of a true plane, are then thoroughly cleaned under a microscope. A duralumin spacer of from .001 to .0012 inches, placed between the backplate and the diaphragm, insures the proper capacity of the condenser. This assembly is then sealed with hot wax. The condenser is sealed off from the outside air by means of a thin membrane, the air is exhausted and the space is filled with nitrogen. This prevents any change in atmospheric pressure from affecting the capacity of the condenser.

## Set Manufacturers Buy 87% of Resistors

From International Resistance Company

There are very few radio parts, other than basic materials such as wire, metal, bakelite, etc., that are produced nowadays by radio manufacturers. Probably the three items which are produced in the greatest quantity by radio manufacturers are volume controls, resistors and fixed condensers, and a statistical survey showed that 87 per cent of the resistors used by radio manufacturers are purchased and that it is impossible for the radio set manufacturer himself to produce his own resistors at a cost approaching that which he may purchase them for.

# BAR TO DISCUSS NEED TO AMEND LEGISLATION

Washington

The American Bar Association, through its committee on communications, will discuss four aspects of radio legislation at its meeting February 20th, called by Louis G. Caldwell, committee chairman. Mr. Caldwell was general counsel of the Federal Radio Commission. He listed the topics as follows:

- "1. Need for amendments to radio act of 1927.
- "2. The Couzens bill to establish a commission on communications (S. 6).
- "3. Miscellaneous bills concerning radio and other forms of electrical communication now pending or proposed in Congress.
- "4. Problems of State and municipal regulation of radio and other forms of electrical communication."

## Members of Congress Invited

The invitations sent out by Mr. Caldwell contained the following:

"Members of Congress (and particularly members of the Senate Committee on Interstate Commerce and the House Committee on Merchant Marine and Fisheries), members of the Federal Radio Commission and lawyers of its legal division, members of the American Section of the International Committee on Wireless Telegraphy, representatives of the various branches of the radio industry and, generally, all lawyers interested in the law of electrical communications are cordially invited to attend, to participate in the discussion, and to submit recommendations."

## Robinson To Open Session

The meeting will be opened by Chairman Ira E. Robinson, of the Federal Radio Commission, who will welcome the committee members and discuss some of the legal aspects of radio.

## AC Sets Outsell Others by 30-to-1

Washington.

AC sets outsell battery-operated sets in New York City 30-to-1, according to reports obtained for the third quarter of 1929 from more than fifty dealers by the Electric Division of the Department of Commerce. The figures were 4,054 and 135. The combined price was \$925,995, or an average of \$221 per set.

In the entire country during the same period showed that more than 6,000 dealers sold a total of about 8,000 battery-operated sets and 133,000 electric sets, the total sales of both being \$21,662,874.

## LITERATURE WANTED

- R. C. Smith, 2413 Clark Ave., Parsons, KKans.  
Oliver F. Klein, 783 39th St., Milwaukee, Wis.  
W. M. Horn, Leon, Iowa.  
A. R. Wapple, 807 College St., Georgetown, Texas.  
Delmar Lesswing, 403 Herman St., Buffalo, N. Y.  
J. C. Black, Box 410, Temple, Tex.  
C. A. Turner, 1002 N. Washington, Enid, Okla.  
Sheldon Drennan, Asheville Sch., Asheville, N. C.  
E. L. Selander, 370 E. 7th St., Winona, Minn.  
L. L. Proctor, 13454 Anglin, Detroit, Mich.  
Peter J. Lang, Victoria, Kans.  
Cadillac Radio, 427 E. 75th St., N. Y. City.  
Jerome E. Hacker, 6602 Barton Ave., Hollywood, Calif.  
P. Glauw, 7144 Theodore St., Phila., Pa.  
Anton Bisk, Ladysmith, Wis.  
Joseph E. Callahan, 1301 Holbrook St., Balti-

## Solution Proposed for Iowa Dispute

Washington

Adjustment of the Iowa broadcasting problem by establishment of a new company which would own and operate the two large stations of that State, WHO at Des Moines, and WOC at Davenport, is proposed in an application filed with the Federal Radio Commission by the Central Broadcasting Co., of Des Moines, the new corporation.

The two stations would be synchronized by wire to give a continuous program to listeners in the territory, Dr. Frank W. Elliott, of Davenport, who is vice-president in charge of operation of the company, told the Commission.

Since the reallocation of November 11th, 1928, the two stations have been forced to divide time on the 1,000-kilocycle channel, says "The United States Daily."

Dr. Elliott said an application shortly will be filed for authority to erect a station using the maximum power of 50,000 watts. Then, he said, the plan is to reduce one of the stations to a regional status and maintain the 50,000 watt transmitter as a national station. These developments, however, he explained, are subject to Commission approval.

The new company is capitalized at \$500,000. The Bankers Life Company, of Des Moines, which heretofore has operated WHO, has sold its interests to the new company. The Palmer School of Chiropractic, which has operated the Davenport station, it was stated, will sell out to the new corporation in exchange for its stock. The new corporation is entirely devoted to broadcasting, and has other plans for expansion, Dr. Elliott informed members of the Commission.

## SQUIER WANTS PHONED MUSIC

Washington.

Testifying before the Senate Committee in charge of the Couzens' bill for the creation of a Federal Communications Commission, General George O. Squier, retired, expressed the opinion that the Bell system should be required to utilize its extensive wire system for broadcasting entertainment by the wire radio system to telephone subscribers at a nominal monthly rate, thus permitting the use of every telephone line for 16 hours a day instead of the present average of 18 minutes per day.

This method of entertainment distribution would eliminate advertising as well as all kinds of interference to which space radio is subject, according to Gen. Squier. He also pointed out that at the present time the space radio facilities are already saturated.

General Squier claims that by means of the monophone, one of his many inventions in carrier telephony or wire radio, the entertainment could be broadcast to every home without any interference with the ordinary conversational use of the telephone. The programs would be broadcast over the wire system by means of high frequency currents which are far above the audible limit and above those frequencies used in telephony.

The monophone attached to the telephone receiver would convert the modulated high frequency current into audible signals in the same manner that the radio receiver converts the modulated radio waves. He also pointed out that an entire city could be served satisfactorily with a few watts of power and it would no longer be necessary to use enormous power such as is now required for space broadcasting in order to overcome natural and man-made electrical disturbances.

# HIGHER QUALITY CITED TO MAKE 1930 BEST YEAR

Officials of twenty-seven broadcasting stations, located in representative sections of the country, are unanimous in agreeing that 1930 will bring a substantial increase in radio's popularity, giving interesting and varied reasons as the basis for their opinions, in answer to a questionnaire forwarded by George K. Throckmorton, executive vice-president and general manager of E. T. Cunningham, Inc., radio tube company.

"What phases," asked Mr. Throckmorton, "will be the most important in effecting radio's expansion during the coming year?"

The majority of these officials are agreed that three factors—namely, the betterment of receiving and broadcasting facilities and the higher standard of programs—are the foundation upon which radio is to build a still greater public following.

## Attracts High Class Talent

At the same time, many other reasons are cited as additional effecting factors by officials of individual stations. For instance, as reported from WOR, of Newark, N. J., radio's popularity will increase in 1930 because "resistance of high class talent to radio has broken down."

From WOW, Omaha, comes the comment that "irresistible programs and news features" are winning new fans, and an official of WWNC, Asheville, N. C., adds the salient point that "the plug-into-light-socket receiver has answered the demand for a set that requires little, if any, attention." WLBW, Oil City, Pa., includes "more interest" to the "more sets—better programs—better reception" list.

## Good Taste Better

An official of WMAQ, Chicago, amplifies his statement by declaring that "increasing understanding on the part of program sponsors as to good taste in announcements, constant competition and the natural development of the means for better programs are bringing, in turn, greater popularity."

An interesting point is stressed by an official of WDSU, New Orleans, La., on his observation that "radio has not reached saturation point of interest."

From WNAX, Yankton, S. D., comes a specific estimate that radio's popularity will increase by twenty-five per cent during the coming year. The assertion that "more brains are going into broadcasting" is a supplementary bit of advice from an official of KFBB, Great Falls, Mont.

## Necessity, Not a Luxury

The fact that radio may be classified as a "necessity" and not a "luxury" is emphasized in the answers from several stations. KOMO, Seattle, Wash., pictures radio as "taking its place with the automobile as a family necessity," while an official of KFRC, San Francisco, uses another illustration in saying that the radio set "is regarded almost as necessary in the American home as the kitchen stove."

## 4,500,000 Receivers in Use Held Obsolete

According to statistics just compiled, out of the 11,500,000 radio receivers in this country approximately 4,500,000 are of obsolete design. If radio manufacturers are correct in their opinion, however, millions of these obsolete receivers will be replaced by the new sets this year.

# RADIO ACT VOID, HIGHEST COURT TOLD BY WNYC

Washington.

Having been denied exclusive assignment to 570 kc, 526 meters, by the Federal Radio Commission, and having lost its appeal to the Circuit Court of Appeals, WNYC, owned and run by the City of New York, has attempted to get the Supreme Court to review the lower court's finding, and finally reverse it. The municipality makes the assertion that the radio act, in at least two respects, is unconstitutional and that Congress has no power to regulate broadcasting.

WNYC is sharing the wave with WMCA, and the two stations have been at loggerheads for a couple of years. Occasionally the strife resulted in both stations, both in New York City, being on the air at the same time. WNYC, prior to the reallocation of November 11th, 1928, occupied the channel exclusively.

Arthur J. W. Hilly, corporation counsel of the city, and a boyhood friend of Mayor James J. Walker, argues in the brief that the radio act of 1927 in so far as it terminated all existing broadcasting licenses or rights without notice and a hearing and without compensation "violates the Fifth Amendment of the Federal Constitution and is invalid and void."

## Arbitrariness Alleged

It is contended further in the brief that section 89 of the radio act in so far as it provides that allocations shall be charged to the State, district or territory wherein the studio of the station is located and not where the transmitter is located is "unreasonable, invalid and void."

Other points raised in the summary of argument follow:

"The reallocation orders of the Radio Commission which deprive petitioner of the unlimited use of its established frequency were made without giving petitioner notice and an opportunity to be heard and are therefore in violation of the Fifth Amendment of the Federal Constitution.

"The procedure adopted and followed by the Radio Commission which resulted in the denial of petitioner's application for a modification of the reallocation ordered was arbitrary, unreasonable and violative of law.

## Calls Action Unlawful

"The reallocation orders of the Radio Commission in so far as they compel the petitioner to surrender half of its broadcasting time are an unlawful hindrance of and interference with the exercise of petitioner's governmental and municipal functions. In no event could the exercise of such functions be 'interstate commerce.'

"The findings of the Radio Commission which resulted in the denial of petitioner's application for modifications of the reallocation orders were not based upon evidence adduced at any hearing and the determination of the Commission upon such findings were violative of the Fifth Amendment of the Federal Constitution."

Arguing that Congress "has no power under the commerce clause of the Federal Constitution to regulate broadcasting," the petitioners pointed out that the interstate commerce act, and the radio act of 1912, specified that Congress should control transmission of "commercial messages or intelligence by wireless," and that there is nothing in the acts to regulate broadcasting.

"Both of these acts by express words and unmistakable intent were directed to

## Police Radio for Three More Cities

Washington.

Amateurs must not disclose the messages they overhear. Against regulations. Always has been. But now more so than ever, because police departments are sending voice-modulated short waves from headquarters to patrol motors equipped with special tuners.

Detroit has radio crime detection. Chicago is putting in a system. Now three more cities are in the same class, even licensed:

Cincinnati, Ohio, WKDU, 1,712 kc, 500 watts.

Youngstown, Ohio, (no call yet) 2,416 kc, 500 watts.

Pasadena, Calif., KGJX, 1,712, 2,416, 2,462 kc, 250 watts.

the control of the transmission of commercial messages or intelligence by wireless between shore and ship stations, or of signals between ships on the high seas for the protection of life and property. This is plainly evidenced by the provisions of the act of 1910 quoted above as well as by the provisions of the act of 1912.

"The latter act specially refers to 'commercial intercourse.' There is nothing in either of the acts to indicate an intent on the part of Congress (and this is made further apparent by the above quotation from the report of the committee which considered the act of 1912) to regulate broadcasting nor that broadcasting was even contemplated at that time."

## Commerce or no Commerce?

It is argued also that broadcasting is not "commerce." The brief points out that in the only case arising under the radio act in which this question was raised at length, the United States v. American Bond and Mortgage Company, the court held that broadcasting was interstate commerce.

Discussing the commerce clause, the petition states that in decisions construing the powers of Congress under it, "there runs the basic idea of tangibility, if not of the thing transported, certainly of the means by which it is transported. In the case of the railroad there is the train running from one State into another or the track over which the train runs; in the case of the telephone and telegraph there is the wire and the pole or conduit which conducts the wire.

## Not Common Carriers

"In radio broadcasting, however, there is no physical tangible connection between the sending and receiving station, but more important than this there is the intent, or purpose to establish communication between one or more particular individuals; there is nothing transported from the sender to the receiver that the sender was under any duty or obligation to send or that the receiver had any right to receive.

"There is nothing over which Congress could exercise control under the commerce clause. The generating or transmitting machine itself being stationary and local, is certainly not subject to Federal control. The same may be said of the receiving apparatus. It, too, is local, complete in itself and disconnected from any physical conducting medium.

## Second Case in Highest Court

"The fact that broadcasting stations are not 'common carriers' and could not be made such even under the doctrine of the pipe line cases would seem to be conclusive on the point now argued."

This is the second case involving the radio act to come before the United States Supreme Court. The first was the successful suit of WGY, Schenectady, N. Y., to retain full time on 970 kc.

# WMCA FIGHTS WGBS "BERTH" ON NEW WAVE

Washington.

As an outgrowth of the unsuccessful attempts of WMCA and WNYC in New York City to obtain full-time assignments, WMCA, which shares 570 kc (526 meters) with WNYC, protested to the Federal Radio Commission against the recent assignment to WGBS, also of New York City, to 600 kc (500 meters), full time. The 600 kc frequency had not been used in New York City. WMCA asserts that everyone was told and believed there were too many full-time broadcasting stations with studios in the metropolitan area, operating with high power in a congested district.

## WGBS Wave Temporary

WGBS formerly had its studio in the Gimbel Bros. department store, but was sold to the General Broadcasting System, of which Dailey Paskman, former manager of WGBS in the Gimbel store, was head. Now the studio is in the Hotel Lincoln while the transmitter is about eight miles away, in Astoria, across the East River.

WNYC is owned and operated by the City of New York, and has a separate fight on the Commission, in a Supreme Court motion aimed to gain an exclusive wave.

Orestes H. Caldwell, formerly a member of the Federal Radio Commission, in a recent speech said that political considerations were actuating the assignment of frequencies and power. It was inferred he had reference in particular to the assignment of an exclusive wave to WGBS.

At the Commission it was pointed out that the WGBS assignment was only temporary, and was being made the basis of a study of conditions in the New York area.

## New Set-Up Soon

As a reallocation is impending, involving forty major changes, some of these are expected to involve stations with studios in New York City. Some such stations have transmitters in New Jersey.

The Radio Corporation of America has asked the commission to assign certain experimental licenses to the R. C. A. Victor Company, Inc., including Station W2XW in New York City, W2XN in the Bronx, W2XCI at New York City and W2XAJ at Yonkers.

# Slump Called "Over"

Cambridge, Mass.

The recent depression in the radio industry appears to have passed and January radio sales showed marked improvement, according to H. B. Richmond, of this city, president of the Radio Manufacturers Association, comprising all important radio manufacturers.

"The radio industry apparently has turned a corner and is now on the up-grade," said Mr. Richmond. "Sales of all radio products in January showed a marked improvement over December and November. From parts and accessory manufacturers, as well as receiving set manufacturers, come general reports of decided improvement in their January business.

"Broadcasting is also at its peak, domestic as well as the new regular international broadcast. The heavyweight pugilistic contest, scheduled in February, is another large sales stimulus in prospect."

# TREATMENT OF WCFL BY BOARD AMAZES LABOR

Washington.

Edward N. Nockels, secretary of the Chicago Federation of Labor, and manager of WCFL, Chicago, who appeared on behalf of the American Federation of Labor, told the Senate committee considering the Couzens bill he supported the views of Hope Thompson, counsel for the Federation, respecting broadcasting, as expressed before the committee. He advocated a communications commission, as proposed in the Couzens bill, declaring that the past few years have demonstrated that the Federal Radio Commission has dealt with the radio problem inefficiently.

Mr. Nockels declared that organized labor had not been treated justly by the Radio Commission in allocation of broadcasting facilities. Its single station, WCFL, he said, operates daylight hours only, with 1,500 watts power, whereas he said that the "radio trust own and operate some 11 stations with an aggregate of about 230,000 watts of power, and are granted the exclusive use of 6 or 7 out of the 90 available channels in the United States."

## Too Much Entertainment

By means of chain hookups, moreover, he declared, "the stations owned by the radio trust tie into their control some 100 or more of the leading radio broadcasting stations in the United States—practically all of these which have more than a local service range."

He said that Congress should require that radio be used for something more than entertainment and amusement. "However entertaining and amusing the average program may be," he declared, "it is certainly not in the public interest that this new means of communication should be monopolized for entertainment, amusement and advertising."

## Stresses Education

Some of the facilities, he suggested, should be apportioned among stations under restrictions requiring that a substantial part of the time be devoted to education.

About 60 broadcasting stations are operated by manufacturers and dealers in radio supplies, while some 25 or 30 great metropolitan newspapers have been granted licenses for other stations, he said. Some 350 licenses have been issued, according to "The United States Daily," to various private business concerns, entirely local in character, while 40 churches, about 70 educational institutions, and 30 local chambers of commerce hold broadcasting licenses.

An "astounding and well-nigh unbelievable fact," he said, "is that organized labor, with 4,000,000 members and comprising with their families almost a fifth of the entire population of the country, has asked the Radio Commission for just one channel of the 90 available, together with ample power and adequate time of operation, and have been denied it."

## YANOCHOWSKI HEADS KELLOGG

The Kellogg Switchboard & Supply Company, radio manufacturers of Chicago, announced the election of G. A. Yanochowski as president, succeeding W. L. Jacoby, who died recently. Mr. Yanochowski has been associated with the Kellogg Company for the past fifteen years.

# Forum

## Wants Technical Stuff Positively

I SEE in the February 1st edition that Joseph Henkin, Sioux Falls, S. D., requests that you cut out the technical stuff, stating that "the time is past when the public is interested in how to build a set."

Well Joe is sidetracked. He should come to Chicago where on Saturdays and often on other days home builders and set builders are lined up two and three deep, clamoring for clerks to take their money for parts. Joe may be an announcer of a broadcasting station, but he admits his ignorance of conditions when he states the ready-built sets are better than anything that can be built by an amateur. The ready-built sets often look better, but the ones that get the results are nine times out of ten, built by amateurs. He should listen to the DX program over WMAQ every Friday night where the records of the amateurs conclusively demonstrate who make the best set—the best furniture.

Keep up your magazine along the present lines. I buy all the leading radio magazines, but when they cut out the stuff that interests the amateur they cut me out.

A. J. L. WALKUP,  
Chicago, Ill.

\* \* \*

## No, Not to Henkin

IN reply to Joseph Henkin's letter in the February 1st issue, I have this to say:

NO! NO!

Dear operator, You'd better have a little experimenter's blood inoculated into you, a little of the radio amateur's principle, respect for the enlightenment of the public in quality in radio and for the encouragement and education of the boy just beginning in radio. There is nothing wrong with RADIO WORLD and I hope it has more dope for the set builder.

For the sake of the boys who now depend on magazines to develop their ideas, they are more valuable to the country at large than the listener, and must be encouraged to continue.

Self-trained men all boost the beginner. I'm one and I feel thankful that some magazines are interested in beginners. I don't know where your idea originated, but I hope that you will change your mind. I'm telling you indirectly why RADIO WORLD should publish dope for the set builder and beginner! And in closing I wish you would have read the Commandments and Don'ts! for operators and experimenters in different issues of the QST. I know you'll feel differently. RADIO WORLD has plenty of news of events and markets, monopolies, Senate bills, etc.—The experimenter and listener are both served.

FRANCIS WALCZAK,  
Elwood City, Pa.

\* \* \*

## Sets That Do Things

YOUR Forum contained a letter written by Mr. Henkin advising you to discontinue technical articles. I disagree with him, as your magazine is about the only one that is left on the market from which technical and experimental data can be obtained, and I do not believe there are any of us who have real radio sets who have not used several of your articles to our benefit.

On my particular home-made set, KMOX is on 30; WPG on 29½; KSOO on 29; KFSG on 28½; KSL on 28; and I am of the opinion that if Mr. Henkin

# AUDITIONS FOR ALL, NEW PLAN TRIED BY WLW

Cincinnati, O.

Personal invitations to visit the Crosley broadcasting studios for auditions that will determine their suitability for radio appearance on WLW and WSAI have been sent to musicians and entertainers in Cincinnati and environs.

Others will be invited as their names are brought to the attention of station officials, Ford Billings, director of broadcasting, said.

"To a great percentage of those entertainers and musicians who have never made any attempts to get into broadcasting, the business probably seems a closed field, open only to those who got in when the art was 'young' or to those who know someone with a 'pull' at the stations," he continued.

## Constant Need of Variety

"Radio entertainment as we see it is by no means a closed corporation. Constant need of variety demands an unending procession of new talent that will bring new types of amusement, new interpretations, and other novelties for the radio audience."

Ideas for programs are as vitally needed as are entertainers, musicians and actors, Billings said, expressing a willingness to consult with any writer or producer who has a thoroughly organized idea for a group of programs or even for a single production.

"There is just as much chance for the 'free lance' radio writer as for the 'free lance' in the magazine or newspaper field," he said. "While we employ a large staff of continuity writers to prepare our programs, we also purchase some of our best continuities from writers who never come near the studios but who know exactly the sort of material we can use."

## Wants Workable Ideas

"Here again, our chief demand is only that the idea be presented to us in a workable plan and not merely as a nebulous suggestion. The writer who listens to radio programs from all over the country with the idea of building new programs from an original angle should be no more of a rarity than the writer who studies magazines on a newsstand with the idea of discovering new markets for his stories or articles."

Billings pointed out that the tremendous increase of sponsored programs is originating a new demand for extraordinary features not duplicated on other programs.

## PALMER JOINS TOBE STAFF

George E. Palmer, general sales manager of the Dubilier Condenser Corporation, resigned to go with Tobe Deutschmann as vice-president in charge of the condenser division.

would put out an announcement for listeners to reply to that very few factory sets a few hundred miles away from his station will receive KSOO when KMOX and KSL are both going, and if they do, how can they expect to receive KSFG or WPG? It has always been up to the home constructor and experimenter to solve these things as I have not yet seen any factory-built sets that will do what is required.

A. G. NUTTING,  
Livingston, Mont.

# A Substantial Four-Gang Condenser

for

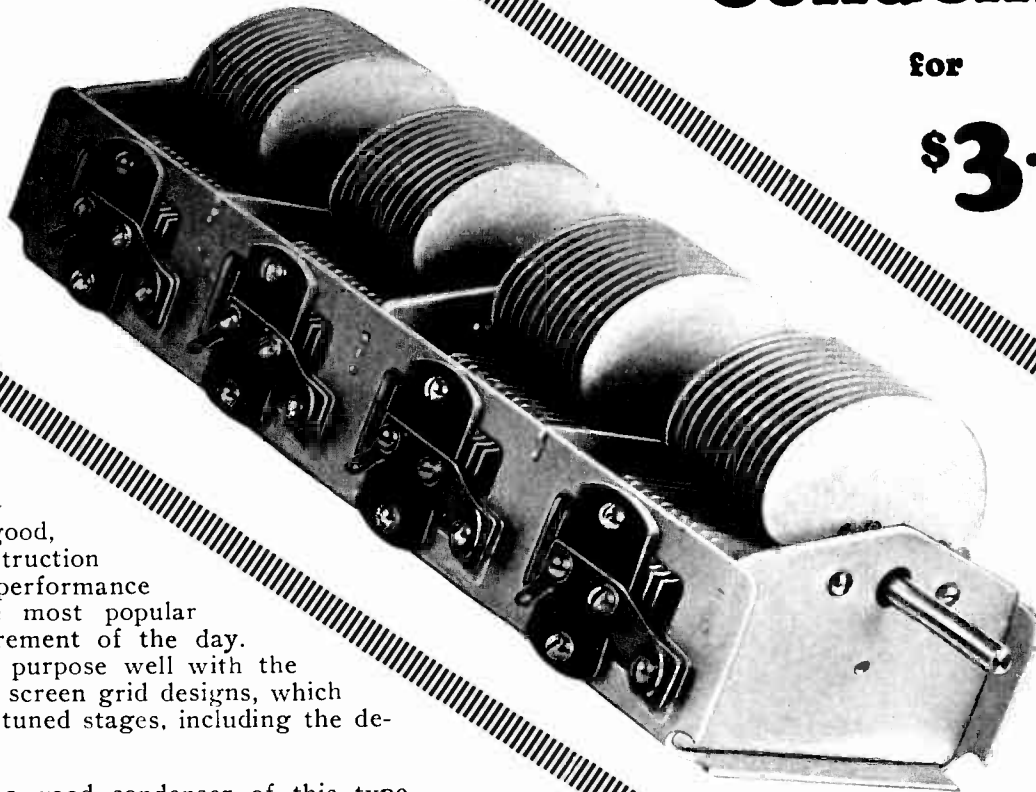
**\$3.95**

**A** FOUR-GANG CONDENSER of good, sturdy construction and reliable performance fits into the most popular tuning requirement of the day. It serves its purpose well with the most popular screen grid designs, which call for four tuned stages, including the detector input.

Ordinarily a good condenser of this type costs, at the best discount you can contrive to get, about twice as much as is charged for the one illustrated **and even then the trimming condensers are not included.** The question then arises, has quality been sacrificed to meet a price? As a reply, read the twenty-six points of advantage. The first consideration was to build quality into the condenser.

The reason for the low price is that the condenser was manufactured in very large quantities and is sold to the consumer with only one handling between factory and him, at a price only 10% above the cost of production.

All claims are backed up by our guaranty—**MONEY BACK IF IN FIVE DAYS AFTER RECEIPT OF CONDENSER YOU ARE NOT COMPLETELY SATISFIED.**

The Capacity is .00035 mfd. for each section. We haven't this condenser in any other capacity. The price is net to all, no matter what quantity. Order one shipped C. O. D.

**5-DAY  
MONEY-BACK  
GUARANTY**

GUARANTY RADIO GOODS CO.  
143 West 43rd St., New York, N. Y.  
(Just East of Broadway)

Please ship me within one day of receipt of this order one four-gang tuning condenser capacity of each section .00035 mfd. with trimmers built in, as advertised, at \$3.95. Please send C. O. D.

Name .....

Address .....

City .....

State .....

## 26 Points of Advantage!

*THE desirability and dependability of this condenser are attested by the following roster of features:*

- (1)—Rigid steel frame.
- (2)—Accurate mechanical alignment.
- (3)—Single steel shaft.
- (4)—Shaft supported at both ends and at the center.
- (5)—Accurate spacing of rotor and stator plates.
- (6)—Plates made of aluminum of uniform thickness.
- (7)—Stator plates shielded from each other and from external conductors.
- (8)—Each section provided with a built-in adjustable trimmer condenser.
- (9)—Steel spring bearings.
- (10)—Adjustable tension on bearings.
- (11)—Shaft and rotor plates removable.
- (12)—Low minimum capacity in each section.
- (13)—Low loss insulation between stator and rotor plates.
- (14)—Common rotor connection to steel frame.
- (15)—Each rotor attached to common shaft with two set screws.
- (16)—Exact equality of all condenser sections at all settings.
- (17)—Side and bottom mounting provisions.
- (18)—Straight line wavelength shape of plates.
- (19)—Brass soldering lug for each condenser stator section.
- (20)—Capacity increases with counter clockwise rotation of shaft.
- (21)—Capacity of each section, .00035 mfd.
- (22)—Plates cannot short.
- (23)—Easy turning shaft.
- (24)—Will last a lifetime.
- (25)—Eleven rotor and eleven stator plates in each section.
- (26)—Weight (condenser alone), 3½ lbs.

# NEW J-245-X TROUBLE-SHOOTING JIFFY TESTER

*Illumination Continuity and Polarity Tester FREE with Each Outfit!*

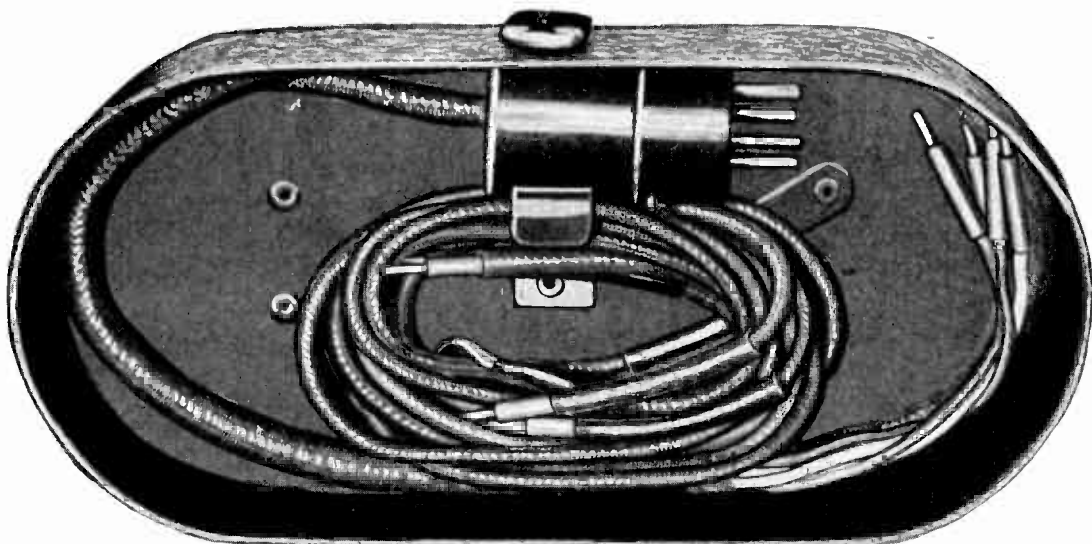

Your Price  
**\$15.82**  
Complete

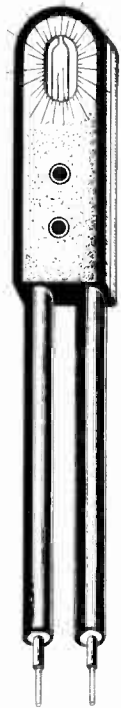
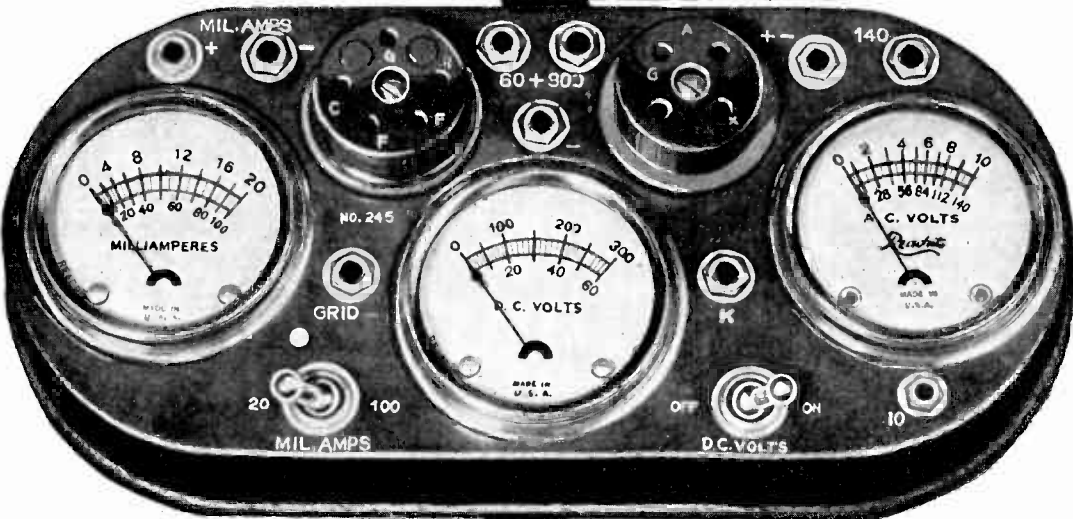

Illumination Tester. Vest Pocket Size. Shows Shorts and Opens Visually, also polarity of DC line. A Neon lamp is built in.

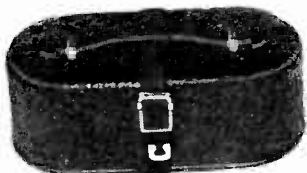

The three-meter assembly. In the crackle-brown finish carrying case, with slip-on cover in place. The handle is genuine leather. The buckled strap holds the cover on.

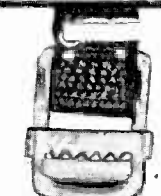
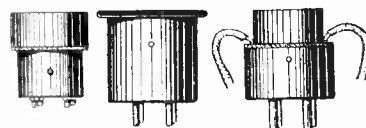

Illustration above is 2/3 scale.



J-111 Multiplier, upper left, with tip; below it, J-106 Multiplier with tip; plugs, left to right, J-19, conforms UV socket to UX plug; J-20, conforms UX tester socket to UV199 tube; J-24, to test Kellogg and old style Arcturus tubes.



## Makes All Necessary Tests in a Jiffy and Simplifies Service Work!

WHEN servicing a radio set, power amplifier, speech amplifier or sound reproduction or recording equipment, the circuits and voltages are almost inaccessible, unless a plug-in tester is used.

The Jiffy 245-X plugs in and does everything you want done. It consists of:

- (1)—The encased three-meter assembly, with 4-prong (UX) and 5-prong (UY) sockets built in; changeover switch built in, from 0-20 to 0-100 ma.; ten vari-colored jacks, five of them to receive the vari-colored tipped ends of the plug cable; grid push-button, that when pushed in connects grid direct to the cathode for 224 and 227 tubes, to note change in plate current, and thus shorts the signal input.
- (2)—4-prong adapter for 5-prong plug of cable.
- (3)—Screen grid cable for testing screen grid tubes.
- (4)—Pair of Test Leads for individual use of meters.
- (5)—J-106 Multiplier, to make 0-300 DC read 0-600.
- (6)—J-111 Multiplier, to make 0-140 AC read 0-560.
- (7)—Two jack tips to facilitate connection of multipliers to jacks in tester.
- (8), (9), (10)—Three adapters so UV199 and Kellogg tubes may be tested.
- (11)—Illumination Tester.

The illumination tester will disclose continuities and opens and also the polarity of DC house mains. It is as handy as a pencil and fits in your vest pocket. It works on voltages from 100 to 400. There are two electrodes in a Neon lamp in the top of the instrument. On AC both electrodes light. On DC only one lights, and that one is negative of the line, the light being on the same side as the lead. Hence the illuminator shows whether tested source is AC or DC, and if DC, which side is negative.

Even the output of the speaker cord will show a light. Also, the device will test which fuses are blown in fused house lines, AC or DC. Besides it tests ignition of spark plugs of automobiles, boats and airplanes, also faulty or weak spark plugs.

Just flash on the illumination tester momentarily. It will last about 4,000 flashes.

THE new Jiffy Tester, J-245-X, is a complete servicing outfit. It consists of a three-meter assembly in a metal case, with slip-on cover and a cable plug. There are ten adapters. It is vital to have the complete outfit so you can meet any emergency.

With this outfit you plug the cable into a vacated socket of a receiver, putting the removed tube in the tester, and using the receiver's power for making these tests: plate current, up to 100 milliamperes; plate voltage up to 300 volts; filament or heater voltage (AC or DC), up to 10 volts.

Each meter may be used independently. One of the adapters—a pair of test leads, one red, the other black, with tip jack terminals—serves this purpose. Multiplier J-106 extends the range of the DC voltmeter to 600 volts, but this reading must be obtained independently, as must readings on the 0-60 scale of the DC voltmeter. Independent reading of the AC voltmeter for line of voltage is necessary; also to use 0-140 scale while Multiplier J-111 extends the AC scale to 560 volts for reading power transformer secondaries.

The other adapters permit the testing of special receiver tubes, so that tests may be made, in all, of 22 different tubes: 201A, 200A, UX199, UV199, 120, 240, 171, 171A, 112, 112A, 245, 224, 222, 228, 280, 281, 227, 226, 210, 250, Kellogg tubes and old style Arcturus tubes.

GUARANTY RADIO GOODS CO.  
143 West 45th Street, Just East of Broadway,  
N. Y. City.

Please send me on 5-day money-back guaranty your J-245-X Jiffy Tester, complete, with all 10 adapters, and with illuminated Tester FREE with each order. Also send instruction sheet, tube data sheet and rectifier tube testing information.

Enclosed please find \$15.82 remittance. Ship at your expense. [Canadian must be P.O. or Express M.O.]

Please ship C. O. D. @ \$15.82 plus cartage and P.O. fee.

NAME .....

ADDRESS .....

CITY ..... STATE .....

5-DAY MONEY-BACK GUARANTY



**O-1 MA, \$5.95**

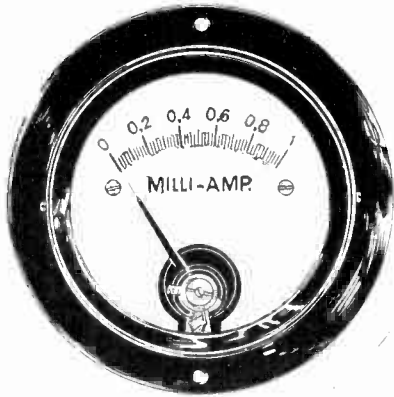

Here is a 0-1 milliammeter, accurate to plus or minus 1% clearly legible to two-one hundredths of a milliampere at any reading (20 microamperes). This expertly made precision instrument is offered at the lowest price so far for a 0-1 ma. Order Cat. FO-1 at \$5.95. C. O. D. orders accepted.

**Guaranty Radio Goods Co.**  
143 West 45th Street,  
New York City

**AERIAL TUNER**

Improves Your Reception

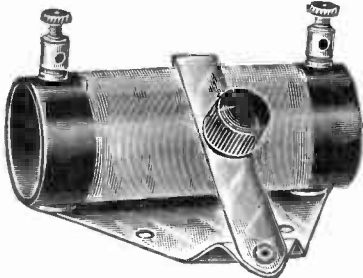

Remove aerial lead from set. Connect aerial instead to one of the binding posts of the Aerial Tuner. Connect the other binding post of the Aerial Tuner to antenna post of your set. Then move the lever of the Aerial Tuner until any weak station comes in loudest. The lever need not be moved for every different frequency tuned in. The Aerial Tuner acts as an antenna loading coil and puts the antenna's frequency at any frequency in the broadcast band that you desire to build up. Price, 85c.

**GUARANTY RADIO GOODS CO.**  
143 West 45th Street  
New York City  
(Just East of Broadway)

BRILLIANT, NEW  
**NATIONAL**  
MODERNISTIC PROJECTION DIAL  
WITH RAINBOW FEATURE

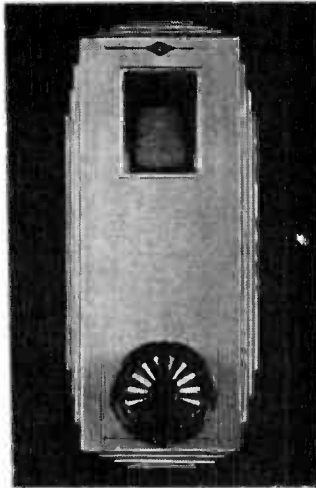

Modernize the appearance of your receiver by installing the brilliant new National dial, with color wheel built in, so that as you turn the dial knob one color after another floods the screen on which the dial numbers are read. On this screen the numbers are projected, so that you get the same dial reading from any position of the eye. This is just what DX hunters want—laboratory precision of dial reading.  
The escutcheon is of modernistic design. The Verner Vernier mechanism drives the drum superbly.  
Order today. Remit with order and we pay cartage. Shipments day following receipt of order.

- GUARANTY RADIO GOODS CO.**  
143 W. 45th St., N. Y. City (Just E. of B'way)  
Enclosed please find \$3.13 for which please send me dial marked below:
- Cat. HC6, National modernistic drum dial, with color wheel built in, pilot bracket, 6-volt pilot lamp for storage battery or A eliminator sets; hardware; instructions ..... \$3.13
  - Cat. HC2½, same as above, but with 2½-volt AC pilot lamp ..... 3.13
  - Order C.O.D. and I pay cartage.

NAME .....

ADDRESS .....

CITY ..... STATE .....

**Hi-Q 30**  
**Wholesale**  
**Prices!**

Write or wire!

**Guaranty Radio Goods Co.**  
143 West 45th St.,  
New York City

**NATIONAL**

**Velvet B Eliminator \$16.13**  
120 Volts (250 Tube Free)



Latest Model National Velvet-B, Type 8580, in handsome crackle finish black metal casing, for use with sets up to and including six tubes. Input 105-120 volts AC, 50 to 60 cycles. Output, 180 volts maximum at 35 milliamperes. Three variable output intermediate voltages. (Det., RF, AF). Eliminator has excellent filter system to eliminate hum, including 30 henry choke and 18 mfd. Mershon condenser. No motorboating!  
(Eliminator Licensed under patents of the Radio Corporation of America and associated companies.)

**Guaranty Radio Goods Co.**  
143 W. 45TH STREET  
(Just East of Broadway)  
NEW YORK CITY

**RADIO WORLD**  
and "RADIO NEWS"

BOTH FOR  
ONE YEAR @ **\$7.00**

You can obtain the two leading radio technical magazines that cater to experimenters, service men and students, the first and only national radio weekly and the leading monthly, for one year each, at a saving of \$1.50. The regular mail subscription rate for Radio World for one year, a new and fascinating copy each week for 52 weeks, is \$6.00. Send in \$1.00 extra, get "Radio News" also for a year—a new issue each month for twelve months. Total, 64 issues for \$7.00.  
 If renewing Radio World subscription, put cross square.  
**RADIO WORLD, 145 West 45th Street, New York, N. Y.**



**GUARANTY RADIO GOODS CO.**  
143 West 45th Street, New York, N. Y.

**Quick Action Classified Ads**

**Radio World's Speedy Medium for Enterprise and Sales**  
10 cents a word — 10 words minimum — Cash with Order

**ARISTOCRAT FLOOR SPEAKER**—With Molded Wood Horn and Horn Motor built in. Great value. \$14.00. Acoustical Engineering Associates, 143 W. 45th St., N. Y. C.

**POLO 245 POWER SUPPLY.** Read all about it on another page of this issue. Polo Engineering Laboratories, 57 Dey St., N. Y. City.

**"EVERYBODY'S AVIATION GUIDE."** By Maj. Page. \$2 postpaid. Also "Modern Aircraft" by same author. \$5. postpaid. Radio World, 145 W. 45th St., N. Y. City.

**BE SURE TO READ** the advertisement on another page of this issue about the HB Compact Guaranty Radio Goods Co., 143 W. 45th St. N. Y. City.

**"MATHEMATICS OF RADIO."**—A great help to everybody interested in radio. \$2 postpaid. Radio World, 145 W. 45th St., N. Y. City.

**DISTON ELIMINATORS** \$6.95. Edison Batteries \$1.95. Audio Transformers 95c. Western Electric Amplifier \$14.00. Get our big bargain list sets and parts. Quality Radio Shop, Richmond, Indiana.

**BERNARD** Tuning Equipments. Star, 111 W. 28th St., Indianapolis, Ind.

**TWO FOR ONE.** Radio World for 52 weeks and Radio News twelve months at the combination rate of \$7. Radio World, 145 W. 45th St., N. Y.

**WORLD'S BEST AVIATION BOOKS:** "A B C of Aviation," \$1.00; "Modern Aviation Engines," \$9.00 postpaid. Both by Maj. Page. "Aerial Navigation and Meteorology," By Capt. Yancey. \$4.00 postpaid. Radio World, 145 W. 45th St., N. Y. City.

**RADIO PARTS**—Western set builders compare our prices with eastern houses. MAIL ORDER RADIO, Box 1110, Portland, Ore.

**PATENTS**

PATENTS pending sold to Mrs. You pay for results only. W. Nestle. 852 Belmont, Chicago.

**OUTDOOR WORK**—Get outdoor government job; \$1680 year. Patrol forests; protect game. Write for details. Bradley Inst., All, Denver, Colo.

**"A B C OF AVIATION."** By Maj. Page. \$1.00 postpaid. Radio World, 145 W. 45th St., N. Y. City.

**"AUDIO POWER AMPLIFIERS,"** by J. E. Anderson and Herman Bernard, the first and only book on the subject. \$3.50. Hennessy Radio Publications Corporation, 145 West 45th St., N. Y. City.

# Highest Grade Speakers at Lowest Prices!

**T - E - M - P - L - E      F - A - R - R - A - N - D**



Temple AC Dynamic Model 10, in a beautiful cabinet. The speaker chassis is one of the finest made. There are an output transformer and dry rectifier built in. The cabinet has decorated walnut front and back, with carved grille ornament. An AC switch is accessible underneath cabinet. Rear is removable for adjustment of resistor knob to match the impedance of your receiver's output tube. Connect plugged AC cable to 110 volts AC, 50 to 60 cycles, and connect tipped cords to speaker post of receiver. This remarkable speaker Cat. TEM-10 at only.....

**\$15.34**

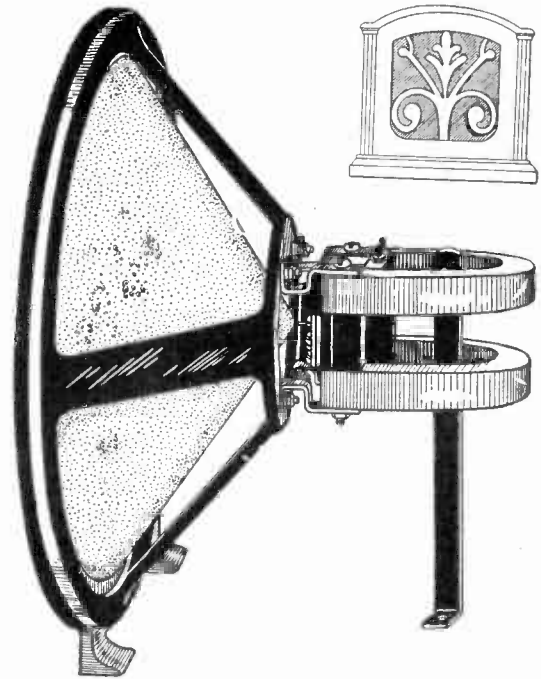

Farrand Inductor Chassis, consisting of the unit, cone, spider, bracket, assembled, but not in a cabinet.

Model 6-G, 10" extreme diameter of cone front rim ..... **\$8.00**  
 Model 10-G, 12" extreme diameter of cone front rim ..... **\$10.00**

Model 10-G-PP for connection to push-pull, requiring no output device, because unit is constructed as a center tapped output impedance. Center tap is yellow and goes to B+. Tipped cords go direct to plates. Outside diameter 12"..... **\$11.00**

Brookfield cabinet, No. 10 or No. 6 for those speakers, ..... **\$6.50**

## R - O - L - A

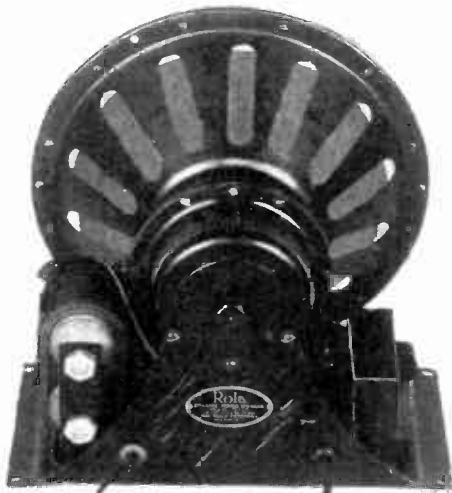

Rear view of the Rola chassis

Rola Model D-10 dynamic chassis, less cabinet, for 110 volts 50-60 cycles AC. Dry rectifier and output transformer built in. The fine workmanship of this chassis is shown in the illustrations of the front and rear views. Extreme diameter of rim 9 inches but baffles with cutouts down to 7 inches may be used.

This is the biggest dynamic chassis bargain we have ever offered and enables you at low price to obtain one of the best chasses made. Tone is most excellent.

Order Cat. No. RO-10 at .....

**\$11.34**



Front view of the Rola chassis. Holes are provided for attachment to your own baffle. The rim is protected by a lining of felt. The voice coil (center) is firmly mounted.

The Temple, Rola and Farrand speakers are highly recommended by us for true tone and high volume. They are extremely sensitive as well. The chasses (Farrand and Rola) will work without a baffle, but it is preferable to provide one. The Temple requires no extra baffle, as the cabinet is itself a baffle box.

All three speakers are sold in factory-sealed cartons. Immediate delivery.

Model 10-G-PP Farrand may be used in push-pull without any output device. Connect yellow lead to B+, tipped leads to power tube plates. May be used on single output by ignoring yellow lead.

Acoustical Engineering Associates  
 143 West 45th Street, New York City. (Just East of Broadway)  
 Gentlemen: Enclosed please find  money order  check  
 for \$ ..... for which please send me at once  
 One Model 6-G Farrand Inductor ..... \$8.00  
 One Model 10-G Farrand Inductor ..... 10.00  
 One Model 10-G-PP Farrand Inductor ..... 11.00  
 One Model 10 Brookfield cabinet ..... 6.50  
 One Model 8 Brookfield cabinet ..... 6.50  
 One TEM-10 Temple Dynamic in cabinet ..... 15.34  
 One RO-10 Rola dynamic chassis ..... 11.34  
 For C. O. D. shipment put cross here

Name .....  
 Address .....  
 City ..... State .....  
 [Prepaid orders shipped same day as received. Canadian remittance must be by postal or express money order.]

# High Gain at Low Cost HB44 - - - \$45.59

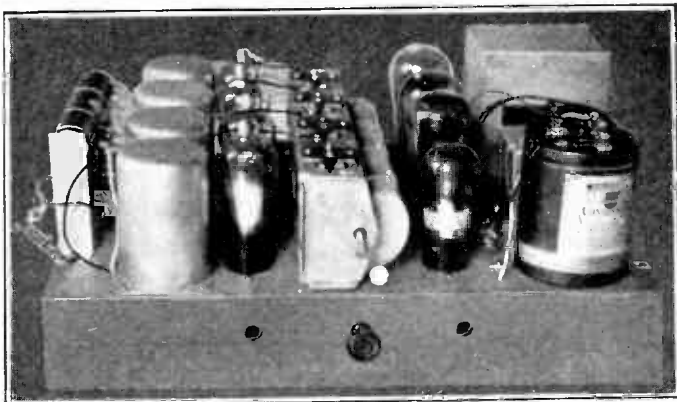

The HB44, assembled, presents in compact form, on a 17½ x 11½" steel chassis, a completely AC operated shielded receiver, using four 224 screen grid tubes, one 227, two 245s in push-pull, and a 280 rectifier, eight tubes all told. Here is the circuit that will bring 'em in from all over the country—and at a price you can afford—\$45.59. This price includes EVERYTHING except speaker, cabinet and tubes.

## It's the Real Thing!

- (a) Three stages of tuned R.F., using 224 screen grid tubes.
- (b) Tuned input to 224 power detector.
- (c) Audio, consisting of first stage resistance coupled, second stage 245s in push-pull
- (d) Four totally shielded R.F. coils.
- (e) A chassis all drilled for necessary parts.
- (f) A four gang condenser, guaranteed accurate, with equalizing condensers built in
- (g) 61 mfd. of filter and bypass capacity.
- (h) Thirteen different fixed voltages available from the output.
- (i) Single dial control.

### LIST OF PARTS FOR THE HB44

<input type="checkbox"/> SL1, SL2, SL3, SL4—Four stage individually shielded coil cascade for .00035 mfd. (Four Cat. SH-3 of Screen Grid Coil Co.).....	\$ 3.80
<input type="checkbox"/> C1, C2, C3, C4—One four gang .00035 mfd. condenser with equalizers E1, E2, E3, E4 built in.....	3.95
<input type="checkbox"/> C5—One .01 mfd. mica condenser.....	.35
<input type="checkbox"/> C6, C7, C13, C14—Four 1 mfd. 200 volt DC bypass condensers....	2.00
<input type="checkbox"/> C8—One 1 mfd. 550 volt AC filter condenser.....	.85
<input type="checkbox"/> C9, C10, C11, C12—One Mershon, consisting of four condensers, two of 8 mfd. and two of 18 mfd. with bracket (Cat. Q-2-8, 2-18-B).	5.15
<input type="checkbox"/> R1—One Electrad 25,000 ohm potentiometer with knob and two insulators.....	1.60
<input type="checkbox"/> R2—One 50,000 ohm Lynch metallized resistor (.05 meg.), with mounting.....	.45
<input type="checkbox"/> R3—One Lynch 5.0 meg. metallized grid leak, with mounting.....	.40
<input type="checkbox"/> R4—One 5,000 ohm resistor with mounting.....	.50
<input type="checkbox"/> VD—One Multi-Tap Voltage Divider, 13,850 ohms, 14 taps.....	3.95
<input type="checkbox"/> T1—One push-pull input transformer.....	2.50
<input type="checkbox"/> OPC—One center-tapped output choke.....	2.50
<input type="checkbox"/> T2—One Polo filament-plate supply (Cat. PFPS).....	7.50
<input type="checkbox"/> Ch—One double filter choke coil, 30 henrys each section, 100 ma.....	3.71
<input type="checkbox"/> SW—One pendant AC switch with 12 ft. cable.....	.80
<input type="checkbox"/> PL—One 2.5 volt pilot lamp and bracket.....	.70
<input type="checkbox"/> Speaker (+), (-), Ant., Gnd.—Four binding posts with insulators.....	.40
<input type="checkbox"/> One Clarostat Humdinger, 30 ohms.....	.50
<input type="checkbox"/> One subpanel 17½" x 11½", with five UY and three UX sockets.....	3.00
<input type="checkbox"/> One vernier dial.....	.50
<input type="checkbox"/> Four National grid clips.....	.24
<input type="checkbox"/> Hardware.....	.24
<input type="checkbox"/> All parts (less cabinet, tubes and speaker).....	\$45.59
<input type="checkbox"/> Tubes: four 224, one 227, two 245, one 280.....	9.51

GUARANTY RADIO GOODS CO.,  
143 West 45th Street, New York, N. Y.  
(Just East of Broadway.)

- Please ship all parts for HB44 @.....\$45.59
- Eight tubes for HB44.....9.51
- Please ship C.O.D.
- Enclosed find \$..... remittance.  
(Canadian must be P. O. or Express M. O.)

NAME.....

ADDRESS.....

CITY..... STATE.....

FIVE DAY MONEY-BACK GUARANTY

# 0-60,0-300 HIGH RESISTANCE DC VOLTMETER

With three 28" tipped leads built in

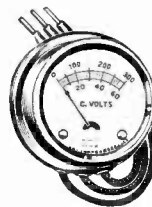

J-246 Voltmeter, for measuring all direct current voltages, including B eliminators. 0-60, 0-300 (double range).

A portable type, high resistance meter, 2 ¼" outside diameter, for close reading of direct current voltages up to 60 volts, and for reading DC voltages up to 300 volts. Three vari-colored 28" insulated leads, with jack tips, are built in. Black is minus, yellow is 0 volts maximum and red is 300 volts maximum. These voltages are marked at the meter outlets. Cat. J-246. Net price, \$2.28.

Multiplier, with jack terminals, to increase range 0-300 range to 0-600. Cat. J-106JT (with jack terminals), net price, \$1.18.

GUARANTY RADIO GOODS CO.  
143 West 45th St., N. Y. City

# MICROPHONE LIGHTERS

for cigars or cigarettes, with button switch at top. Press the switch and light up!



Model A lighter, microphone design, with 5-ft. AC cable and plug. Works on 110 volts, AC any frequency and on direct current. Price \$1.00



Model B lighter, microphone design, on tray, with 5-ft AC cable and plug. Works on 110 volt AC, any frequency, and on direct current. Exactly the same lighter as the other, only tray is added. Price.....\$1.50

This lighter is instantaneous. Hold button down only long enough to light a cigar or cigarette. The two models are furnished in attractive sprayed finish. Both are very compact! For instance, the tray is only 4½" in diameter. Use these lighters in your home and for holiday gifts.

he heater element is renewable. Price 35 cents.

- RADIO WORLD, 145 West 45th St., N. Y. City
- Please send me Model A Microphone Lighter at \$1.00
  - Please send me Model B at \$1.50.
  - Enclosed is remittance [Canadian must be P.O. or express money order.]
  - Ship C. O. D.

Name.....

Address.....

City..... State.....

MORECROFT wrote a great book when he turned out "Principles of Radio Communication." Second edition now ready. Price \$7.50. Radio World, 145 W. 45th St., N. Y. City.

"AERIAL NAVIGATION and METEOROLOGY." By Capt. Yancey. \$4.00 postpaid. Radio World, 145 W. 45th St., N. Y. City.

# RADIO WORLD BOOK SERVICE

AS the first and only national radio weekly, now in its eighth year, RADIO WORLD publishes the most timely, up-to-date news of radio circuits and events in the set-building and broadcasting fields. Technical accuracy second to none. Get a copy at your news-stand today, 15c. RADIO WORLD advises impartially on all radio topics, including what text books to buy, and helps you to read the books properly. Every book advertised on this page is essential to your radio library.

## Five New Volumes Offer Short-Cut to Knowledge!

### MORECROFT

#### "Elements of Radio Communication"

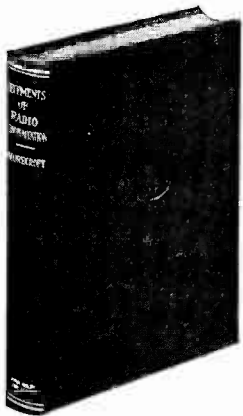

The latest book by Prof. John H. Morecroft, of the Engineering Department of Columbia University, and past president of the Institute of Radio Engineers, is his "Elements of Radio Communication," a book for the novice to enjoy. We regard this as the best elementary book to inform you authoritatively on the technical phases of radio in plain language, without requirement of mathematical knowledge. The book is a complete course on the elements of radio, containing much material never before published. It has 226 pages, 170 illustrations and a complete index. Just out, it is the book of the year in radio. Cloth bound. Order Cat. ME @ \$3.00

By the same author: "Principles of Radio Communication," second (new) edition. This book is for advanced students. It is the standard of excellence in its field. It

covers much the same ground as the later book, only much more fully and more technically. Contains 1,001 pages, 831 illustrations. Cloth bound. Order Cat. MP @ \$7.50

### MOYER and WOSTREL

#### "Radio Receiving Tubes"

The need for an elementary book on radio tubes that answers all the important questions has been filled by James A. Moyer, Director of University Extension, Massachusetts Department of Education, and John F. Wostrel, Instructor in Radio Engineering, Division of University Extension, Massachusetts Department of Education.

This new book is a complete discussion of tube principles, functions and uses, thoroughly up-to-date. In this book the essential principles underlying the operation of vacuum tubes are explained in a non-technical manner as is consistent with accuracy. The book covers the construction, action, reactivation, testing and use of vacuum tubes as well as specifications for vacuum tubes and applications for distant control of industrial processes and precision measurements. 297 pages, cloth bound. Order Cat. MWVT @ \$2.50

By the same authors: "Practical Radio," including the testing of radio receiving sets. 378 pages, 223 illustrations. Cloth bound. Order Cat. MWPR @ \$2.50

"Practical Radio Construction and Repairing," 319 pages, a companion volume. Order Cat. MWPRC @ \$2.00  
 [NOTE: The standard book on tubes for advanced students is "The Thermionic Vacuum Tube," by Hendrik Van der Bijl. Order Cat. VDB @ \$5.00]

### ANDERSON and BERNARD

#### "Power Amplifiers"

Here is the first book to be published on the subject of "Power Amplifiers." Now printing, it is certain to fill a void in radio literature. The whole subject is fully covered in a masterful theoretical discussion of audio amplifiers and power supplies, supplemented by constructional chapters, with complete wiring diagrams and specification of parts. Learn while you build! J. E. Anderson, M. A., technical editor of RADIO WORLD, and Herman Bernard, LL. B., managing editor of RADIO WORLD, both of the Institute of Radio Engineers, have explained fully the phenomena of power amplifiers. Learn all about motorboating and its cures, push-pull theory and practice, grid bias methods and effects, vacuum tubes in audio circuits, AC and battery type AF amplifiers, phase relationships, common impedance, filter systems, by-pass condenser effects, necessities for tone quality, values of coupling constants, and a host of other topics associated with power amplification, including speech amplifiers and "talkie" installations.

More than 200 pages and more than 100 illustrations are devoted to an analysis of this outstanding radio subject. "Power Amplifiers" is authoritative, original and comprehensive. It is free from the traditional errors that have crept into this subject. The theoretical part of the book can be understood by most novices, while the constructional part, that capitalizes the previously imparted knowledge, is thoroughly understandable by anybody. There is virtually no mathematics in the book. Cloth bound. Order Cat. PAM @ \$3.50

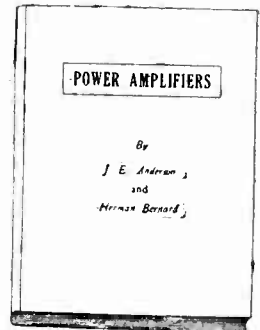

### RIDER

#### "Service Man's Manual"

Two new books by John F. Rider, R. E. Member, Institute of Radio Engineers, constitute the series grouped by him under the heading "Service Man's Manual." Part I is "Mathematics of Radio," Part II is "Trouble Shooter's Manual."

The value of one of these books is more than doubled by the possession of the other.

"The Mathematics of Radio," 128 pages, 8 1/2 x 11", 119 illustrations, bridges the gap between the novice and the college professor. It gives a theoretical background so necessary for a proper understanding of radio and audio circuits and their servicing. Flexible cover. Order Cat. MOR @ \$2.00

The first comprehensive volume devoted exclusively to the topic uppermost in every service man's mind is "Trouble Shooter's Manual," just published. It is not only a treatise for service men, telling them how to overcome their most serious problems, and fully diagramming the solutions, but it is a course in how to become a service man. It gives all the details of servicing as they have never been given before. Finding the right mode of attack, applying the remedy promptly and obtaining the actual factory-drawn diagrams of receivers always have been a big load on the service man's chest. But no more. Rider, expert on trouble shooting, has produced the outstanding volume on servicing, and has taken the load off the service man's chest!

This book is worth hundreds of dollars to any one who shoots trouble in receivers—whether they be factory-made, custom-built or home-made receivers. The home experimenter, the radio engineer, the custom set-builder, the teacher, the student—all will find this new book immensely informative and absolutely authoritative.

MORE THAN 100 WIRING DIAGRAMS OF RECEIVERS MADE BY MORE THAN FORTY DIFFERENT SET MANUFACTURERS ARE PUBLISHED IN THIS BOOK, INCLUDING OLD MODELS AND LATEST MODELS! RCA, ATWATER KENT, CROSLEY, MAJESTIC, ZENITH, STROMBERG CARLSON, KOLSTER, FEDERAL, FADA, Etc. 240 pages, size 8 1/2 x 11", 200 illustrations. Imitation leather cover. Order Cat. TSM @ \$3.50

## FREE! Read Radio World Every Week



- 0-6 Voltmeter D.C. Cat. 326
- 0-50 Voltmeter D.C. Cat. 327
- 6-Volt Charge Tester D.C. Cat. 23
- 0-10 Amperes D.C. Cat. 328
- 0-25 Milliamperes D.C. Cat. 325
- 0-50 Milliamperes D.C. Cat. 350
- 0-100 Milliamperes D.C. Cat. 390
- 0-300 Milliamperes D.C. Cat. 399
- 0-400 Milliamperes D.C. Cat. 394

RADIO WORLD will help you in your radio work, so you will be able to use meters most valuably. Keep abreast of new circuits, intimate details on perfecting existing sets, get inside track on sensitivity, distance reception, tonal quality, and news of radio, technical and non-technical. Enjoy the writings of McMurdo Silver, J. E. Anderson, Herman Bernard, John F. Rider and a host of other radio engineers in RADIO WORLD. You can find no magazine that better caters to your needs than RADIO WORLD. Short waves? RADIO WORLD will tell you all about them. Extremely sensitive broadcast receivers? Their construction and operation are fully discussed with confident regularity. Power supplies—push-pull or otherwise? AC receivers? Screen grid tubes? Large receivers that give a super-abundance of performance—small, economical receivers that give performance out of all comparison to their size? Are you interested in these? Then you're interested in RADIO WORLD.

See the list of nine meters at left. Obtain one or more of these meters free, by sending in \$1 for 8-weeks' subscription, entitling you to one meter; \$2 for 16 weeks, entitling you to two meters; \$3 for 26 weeks, entitling you to three meters; \$4 for 35 weeks, entitling you to four meters; \$5 for 44 weeks, entitling you to 5 meters; \$6 for 52 weeks, entitling you to six meters.

Present RADIO WORLD mail subscribers may renew their subscription under this remarkably generous offer. Put a cross in square. □

### RADIO WORLD

145 W. 45th St., N. Y. City—Published Weekly.  
 All Newsstands, 15c per copy—\$3. six months—\$6 a year

Gentlemen: Enclosed find \$..... for which please send items checked on coupon. (R-10)

<input type="checkbox"/> CAT. ME @ \$3.00	<input type="checkbox"/> CAT. 326	Name .....
<input type="checkbox"/> CAT. MP @ \$7.50	<input type="checkbox"/> CAT. 327	
<input type="checkbox"/> CAT. PAM @ \$3.50	<input type="checkbox"/> CAT. 23	
<input type="checkbox"/> CAT. MWVT @ \$2.50	<input type="checkbox"/> CAT. 328	Address .....
<input type="checkbox"/> CAT. MWPR @ \$2.50	<input type="checkbox"/> CAT. 325	
<input type="checkbox"/> CAT. MWPRC @ \$2.00	<input type="checkbox"/> CAT. 350	
<input type="checkbox"/> CAT. MOR @ \$2.00	<input type="checkbox"/> CAT. 390	
<input type="checkbox"/> CAT. TSM @ \$3.50	<input type="checkbox"/> CAT. 399	
<input type="checkbox"/> CAT. VDB @ \$5.00	<input type="checkbox"/> CAT. 394	City..... State.....

# Efficient Coils for Standard Circuits at Lowest Prices

## ANTENNA COUPLER

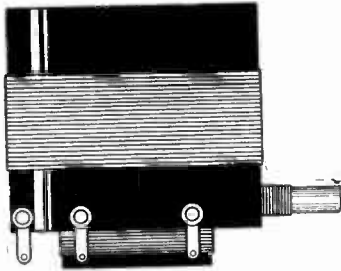

Cat. No. VA5—\$0.85  
FOR .0005 MFD. CONDENSER  
Moving primary and fixed secondary, for antenna coupling. Serves as volume control.  
Cat. No. VA3 for .00035 mfd. ....\$0.98

## BERNARD TUNERS

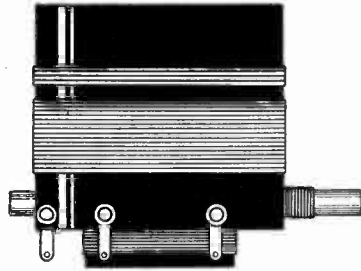

Cat. No. BT5A—\$1.35  
FOR .0005 MFD. CONDENSERS

Bernard Tuner BT5A for .0005 mfd. for antenna coupling, the primary being fixed and the secondary tuned. This coil is used as input to the first screen grid radio frequency tube. Secondary has moving coil.  
Cat. No. BT5A for .00035 mfd. ..\$1.35  
Bernard Tuner BT5B for .0005 mfd. for working out of a screen grid tube, tuned primary, untuned secondary. Primary has moving coil.  
Cat. No. BT5B for .00035 mfd. ..\$1.35

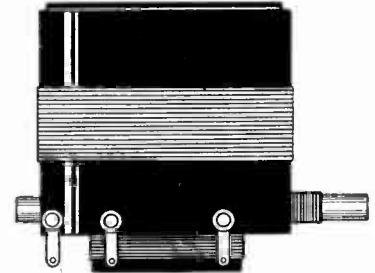

Cat. No. BT5B—\$1.35  
FOR .0005 MFD. CONDENSER

## SG TRANSFORMER

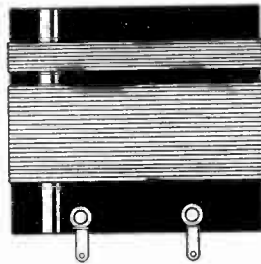

Cat. No. SGS5—\$0.60  
FOR .0005 MFD. CONDENSER  
Interstage radio frequency transformer, to work out of a screen grid tube, primary untuned.  
Cat. No. SGS3 for .00035 mfd. ....\$0.65

## DIAMOND PAIR

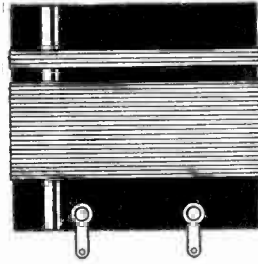

Cat. No. RF5—\$0.80  
FOR .0005 MFD. CONDENSER

Cat. No. RF5—\$0.80  
FOR .0005 MFD. CONDENSER

Antenna coil for any standard circuit, and one of the two coils constituting the Diamond Pair.  
Cat. No. RF3 for .00035. \$0.65

Cat. No. SGT5—\$0.85  
FOR .0005 MFD. CONDENSER

Interstage 3-circuit coil for any hookup where an untuned primary is in the plate circuit of a screen grid tube.  
SGT3 for .00035 mfd. ....\$0.90

Order the Diamond Pair, Cat. DP5 for .0005 mfd. at .....\$1.45  
Order the Diamond Pair, Cat. DP3 for .00035 mfd. at .....\$1.55

[Note: These same coils are for AC or battery circuit.]

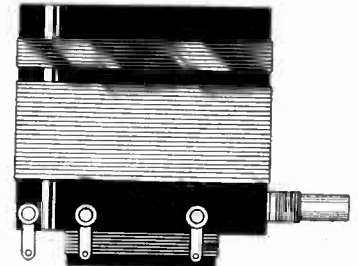

Cat. No. SGT5—\$0.85  
FOR .0005 MFD. CONDENSER

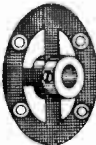

FL4 \$0.30  
Flexible insulated coupler for uniting coil or condenser shafts  
Order Cat. FL4 at .....\$0.30  
Equalizing condenser, 80 mmfd., for connection across any tuning condenser where ganging is resorted to, or for equalizing independently tuned circuits to make dials track.  
Order Cat. EQ80 at .....\$0.35

## STANDARD TUNER

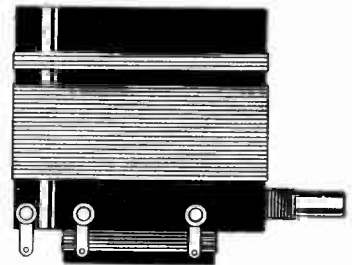

Screen Grid Coil Company,  
143 West 45th Street,  
New York, N. Y. (Just East of Broadway.)

Enclosed please find \$..... for which please send at once the following parts:

- Cat. No. .... at \$ .....
  - Cat. No. .... at \$ .....
  - Cat. No. .... at \$ .....
- Please ship C. O. D.

Name .....

Address .....

City ..... State ..... at .....

**LOOK AT YOUR WRAPPER**  
You will see by the date thereon when your subscription for Radio World expires. If the subscription is about to run out, please send us renewal so that you will not miss any copies. Subscription Department, RADIO WORLD, 145 West 45th St., N. Y. City.

TELEVISION and all about it in "A B C of Television," by Raymond Francis Yates. \$3 postpaid. Radio World, 145 W. 45th St., N. Y. City.

**ARISTOCRAT FLOOR SPEAKER**  
With Molded Wood Horn and Horn Motor built in. Good value. \$12.00.  
Acoustical Engineering Associates, 143 W. 45th St., N. Y. C.

**MICROPHONE LIGHTERS**  
For cigars or cigarettes, with button switch at top. Press switch, and lighter acts instantaneously. \$1.00. Model B lighter on tray, \$1.50. Radio World, 145 W. 45th St., N. Y. C.

**FULL EXPOSITION OF HB COMPACT, BATTERY MODEL**  
Complete details on the theory and construction of the HB Compact were published in a four-part article in Radio World, written by Herman Bernard, designer of the circuit and inventor of the Bernard Dynamic Tuners used in the circuit. Full details on how to wind your own coils, full-sized pictorial diagram of the wiring. Order the August 24th, 31st, September 7th and 14th issues, 60c—  
RADIO WORLD, 145 West 45th Street, New York, N. Y.

## FILL OUT AND MAIL NOW

SUBSCRIPTION BLANK

# RADIO WORLD

RADIO WORLD

145 West 45th Street, New York City

Please send me RADIO WORLD for ..... months, for which

**SUBSCRIPTION RATES:**  
Single Copy.....\$ .15  
Three Months..... 1.50  
Six Months..... 3.00  
One Year, 52 Issues..... 6.00  
Add \$1.00 a Year for Foreign Postage; 50c for Canadian Postage.

please find enclosed

# SUBSCRIBERS!

Look at the Expiration Date on Your Wrapper

Please look at the subscription date stamped on your last wrapper, and if that date indicates that your subscription is about to expire, please send remittance to cover your renewal.

In this way you will get your copies without interruption and keep your file complete.

SUBSCRIPTION DEPARTMENT  
**RADIO WORLD**  
145 WEST 45TH ST., N. Y. CITY

# Non-Reactive Audio with Tuner!

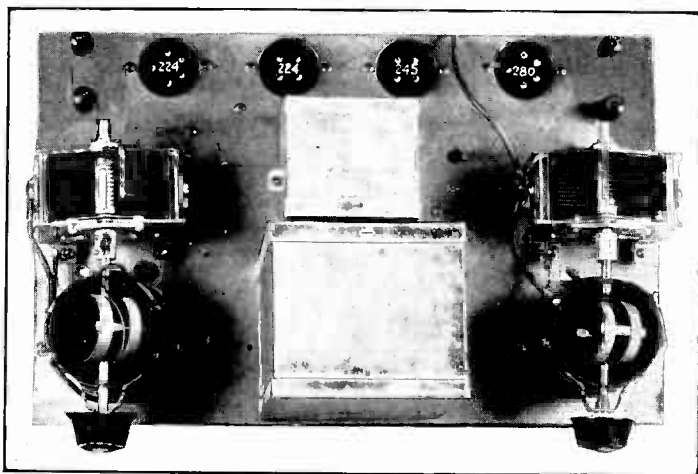

Layout of the NR-4, using a steel chassis, 15" wide x 9 1/2" deep. The volume control (not shown) is at center. For installation dials replace the illustrated knobs.

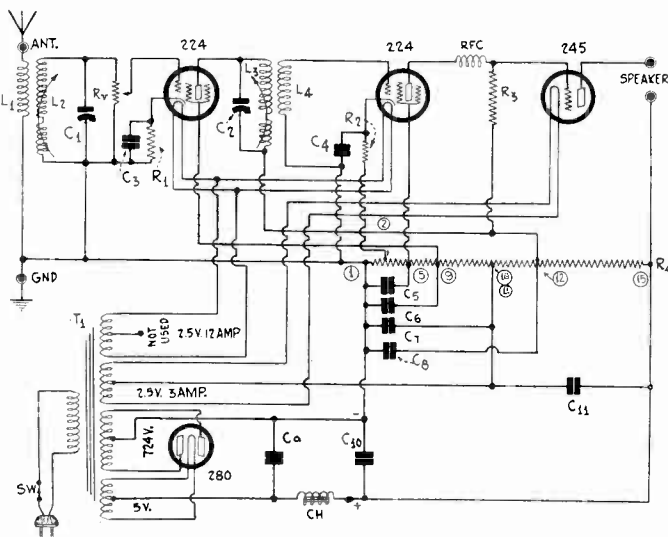

The NR-4 circuit diagram, with numbers designating voltage divider taps, corresponding to illustration below.

## Multi-Tap Voltage Divider

For non-reactive audio circuits, instead of using variable resistors you may more conveniently use a voltage divider with numerous taps. Used as in the NR-4 it will not get hot—barely tepid after 10 hours continuous operation—because it will stand 125 milliamperes! The conservative rating, actual use, is 50 watts.

Two rugged, expertly engineered wire-wound, enamelled resistors, mounted in series, one atop the other, with fourteen useful lugs, providing all necessary choice of voltages without the uncertainty of adjustable variable resistance.

The Multi-Tap Voltage Divider has a total resistance value of 13,850 ohms, in the following steps: 3,000, 4,500, 2,000, 800, 700, 600, 550, 500, 400, 200, 100 and 50 ohms. With the zero voltage lug (at lower left) the total number of useful lugs is fourteen. The resistance stated are those between respective lugs and are to be added together to constitute 13,850 ohms total.

Extreme care has been exercised in the manufacture of the Multi-Tap Voltage Divider. It is mounted on brackets insulated from the resistance wire.

The Multi-Tap Voltage Divider is useful in all circuits, including push-pull and single-sided ones, where the current rating of 125 milliamperes is not seriously exceeded and the maximum voltage is not more than 400 volts. If good ventilation is provided, this rating may be exceeded 15 per cent.

The expertness of design and construction will be recognized by those whose knowledge teaches them to appreciate parts finely made.

When the Multi-Tap Voltage Divider is placed across the filtered output of a B supply which serves a receiver, the voltages are in proportion to the current flowing through the various resistances. Sample voltages are 300, 180, 120, 75, 50, 40, 35, 30, 25, 18, 10, 8 and 3. By making suitable connection of grid returns the lower voltages may be used for negative bias or even for positive voltage on the plates.

Order Cat. MTVD at \$3.95.

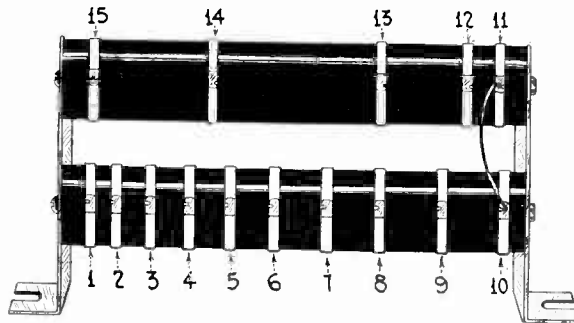

Multi-Tap Voltage Divider, showing where to connect the leads for plate and screen voltages in connection with circuit diagram above.

## NR-4

The Remarkable Non-Reactive Circuit designed by Herman Bernard, using the newly popular audio channel for AC operation. Speaker operation on four tubes, including rectifier.

- L1, L2, C1—One Bernard antenna coil, .00035 mfd. condenser, link, Cat. BT-L-AC..... \$3.00
  - L3, L4, C2—One Bernard interstage tuner, with .00035 mfd. condenser, link, Cat. BT-R-AC ..... 3.00
  - C3—One .01 mfd. condenser..... .35
  - C4, C5, C6, C7, C8, C9, C12—Seven 1 mfd. condensers, low voltage..... 3.50
  - C9, C10—Two 1 mfd. filter condensers, 550 v. A.C. r.m.s 1,000 volts D.C..... 2.00
  - Rv (vol. control)—One Electrad Tonatrol pot. (500,000 ohms) ..... 1.50
  - R1—One Electrad 800 ohm biasing resistor strip ..... .20
  - R2—One .02 meg. (20,000 ohms) resistor with mounting ..... .55
  - R3—One Lynch 0.5 meg. metallized resistor with mounting ..... .50
  - R4—One Multi-Tap Voltage Divider, with brackets, Cat. MTVD ..... 3.95
  - T1—One Polo filament-plate supply, (50-60 cycle), Cat. PFPS ..... 7.50
  - Ch—One single Polo B filter choke, Cat. PSC 2.50
  - RFC—One shielded radio frequency choke, 50 millihenries ..... .50
  - SW—One pendant AC switch with 12 foot cable ..... 1.12
  - Ant., Gnd., Speaker—Four binding posts.... .40
  - One steel chassis 15" wide by 9 1/2" deep, with sockets affixed ..... 3.50
  - Two dials, 100 to 0 ..... 1.00
  - Insulators (four for subpanel, three for front panel) ..... .22
- \$35.29
- Tubes: Two 224, one 245, one 280..... \$5.27

## Construction Advice.

In building the NR-4, insulate the right-hand condenser from the chassis, as it tunes the SG plate circuit, and ground the chassis, also connecting ground and negative of the B supply. Then, to have both condensers equally elevated, insulate the left-hand one, but connect its frame to sub-panel by a lead soldered to a lug fastened to sub-panel.



Polo 245 Filament Plate Supply (less chokes) has four windings, all save primary center-tapped (red), is 4 1/2" wide, 5" high, 4" front to back. Weight, 9 lbs. Filament windings, 2.5 v. at 12 amps., 2.5 v. at 3 amps. (for 245 filaments), 5 v. at 2 amp. for 280 rectifier, and 724 v. @ 80 m.a. center-tapped. Order Cat. PFPS @ \$7.50. [For 25 cycles order Cat. PFPS-25 @ \$12.00.] [For 40 cycles order Cat. PFPS-40 @ \$10.00.]

## Headquarters

We are headquarters for information and advice on non-reactive audio amplifiers and tuners therefor. Write us your questions, or telephone BARclay 8659. Telegraphed inquiries answered same day as received. All orders promptly filled. Five-day money-back guaranty on everything. Square deal is our motto.

## Please Use This Coupon

Jaynox Laboratories,  
57 Dey Street, N. Y. City.  
Walter J. McCord, Chief Engineer.

Please ship at once C. O. D. tested parts for NR-4 as advertised. I am attaching a list of these parts desired.

All parts are desired, as indicated by cross in square at left of this sentence.

Name .....

Address .....

City ..... State .....

5-DAY MONEY-BACK GUARANTY

The Most Fascinating  
Radio Book of  
the year!

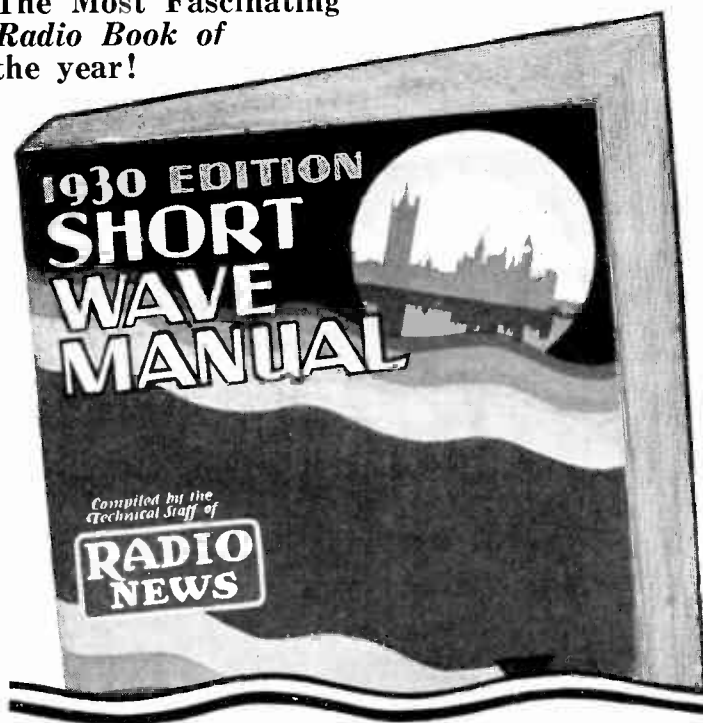

# FREE with the NEW RADIO NEWS

**T**HE thrill of the Short Waves! It's like the invention of radio all over again. If you've ever decoded messages straight from South Africa or Australia—if you've ever known the kick of getting Europe or Little America direct—if you've ever had S.W. chats with friends hundreds of miles away, then you know what we mean.

The Short Waves are opening up a tremendous new field of amazing possibilities. An entirely new world of experimenting, of thrills, of new experiences with these miraculous S.W.'s lies ahead.

Because you and thousands of other radio men want to keep posted on all the latest wrinkles on Short Waves, the Technical Staff of RADIO NEWS has especially prepared a complete new SHORT WAVE MANUAL—so up-to-the-minute that, even as this is being written, complete proofs have not yet come from the printer.

Crowded with chapters especially written by that foremost Short Wave authority, Lieut. W. H. Wenstrom, this volume represents the last word in authentic Short Wave data. You will be fascinated with such chapters as:

- Breaking into Amateur Transmitting
- S-W Transmitter for the Average Home and Purse
- A Portable S-W Transmitter and Multiwave Receiver
- For Real Thrills Get Down in the Amateur Wave Bands
- Ready for a Short-Wave Chat
- Getting the Most from Your S-W Transmitter
- Some Experiments on Ultra-High Frequencies
- Short-Wave Stations of the World

It is one thing to pound the key of a short-wave transmitter and hope to high heaven that your signals are "getting out." It is another thing to under-

stand intelligently the conditions under which it is accomplished and how to get the most out of your Short Wave work. Here's the Manual that gives you the complete and latest dope—just the book you want!

## Why It's Yours FREE!

RADIO NEWS has many thousands more readers than any other radio magazine. But we feel there are still a few of you radio men who have been so close to your work that you don't realize what you are missing.

That's why, although we will sell thousands of these SHORT WAVE MANUALS for a substantial price, for a limited time you can have a copy entirely FREE as an inducement to try RADIO NEWS.

Here's the magazine that tells you all about the newest receivers, all about the latest discoveries in servicing and handling radio parts and sets—and then goes beyond all that to give you the vital radio news of the whole world in a terse, business-like way that demands reading by every man whose interest lies in radio.

If the Federal Radio Commission makes a new ruling—if an Austrian inventor designs an improved tube—if a new discovery in television occurs in Greece or even Patagonia, you'll find it all explained in RADIO NEWS.

That is why we say *with emphasis*—if it's radio news, it's in RADIO NEWS. Here's the magazine for the man who wants to see with modern vision the future trends and developments of radio's rapid progress.

### Mail Coupon Before It's Too Late

The NEW RADIO NEWS, Dept. 215-RW,  
MACKINNON-FLY PUBLICATIONS, Inc.,  
381 Fourth Avenue, New York, N. Y.

Gentlemen: Send me, ENTIRELY FREE, postpaid, the new 1930 SHORT WAVE MANUAL, and enter my subscription for the next Eleven Big Issues of the NEW RADIO NEWS at only \$2 which I enclose (regular newsstand price \$2.75). I understand you will cheerfully refund my \$2 and I may keep the S.W. MANUAL if I am not perfectly satisfied after reading the first issue.

Name.....

Address.....

City & State.....

Are you a Serviceman ? Engineer ? Dealer ? Experimenter ?

Present subscription will be extended from expiration.

### Send for Your FREE S-W Book NOW!

To introduce the NEW RADIO NEWS to you, we will send you the next Eleven Big Numbers, almost a full year subscription, for only \$2—and will ship you the new 1930 SHORT WAVE MANUAL, postpaid, ENTIRELY FREE! You save 75¢ on the newsstand price of RADIO NEWS and get this invaluable S.W. volume without cost! Risk nothing. Mail coupon TODAY-