

# LOFTIN-WHITE CIRCUITS!

# RADIO

REG. U.S. PAT. OFF.

# WORLD

408th Consecutive Issue—EIGHTH YEAR

JAN. 18th

1930

15¢

HB44 Trouble-Shooting

The Art of Soldering

Piezo Oscillators

Cures for Crackles

## Secrets of Successful Gang Tuning

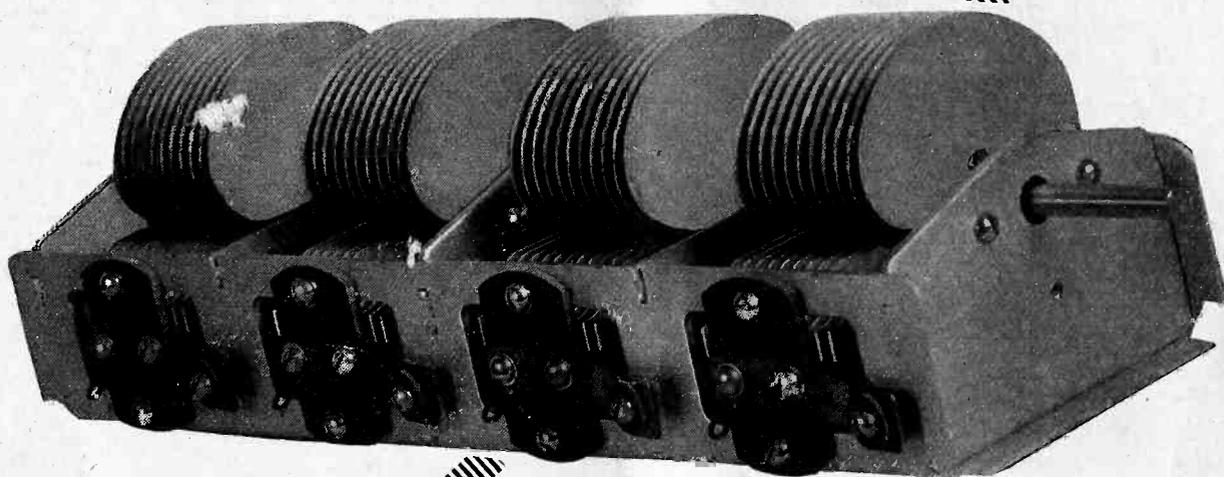

Invention Enables 100  
Cycle Broadcast Band, In-  
stead of 10,000 Cycles

Units of Measurement  
and How to Use Them

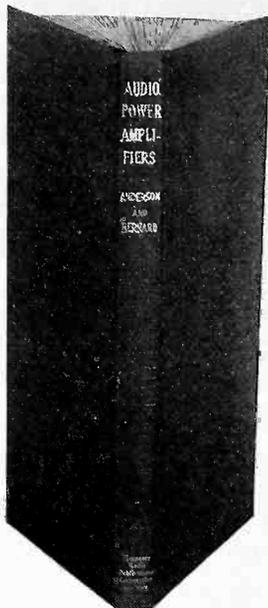

"Audio Power Amplifiers," 193 pages, 147 illustrations; Maroon Cloth Bound Cover, Lettering in gold. Price, \$3.50.

# "AUDIO POWER AMPLIFIERS"

By J. E. ANDERSON and HERMAN BERNARD

*The First and Only Book on This Important Subject—Just Out*

**I**N radio receivers, separate audio amplifiers, talking movies, public address systems and the like, the power amplifier stands out as of predominating importance, therefore a full and authentic knowledge of these systems is imperative to every technician. "Audio Power Amplifiers" is the book that presents this subject thoroughly. The authors are

J. E. Anderson, M.A., former instructor in physics, University of Wisconsin, former Western Electric engineer, and for the last three years technical editor of "Radio World."

Herman Bernard, LL.B., managing editor of "Radio World."

They have gathered together the far-flung branches of their chosen subject, treated them judiciously and authoritatively, and produced a volume that will clear up the mysteries that have perplexed many.

What are the essentials to the reproduction of true tone values? What coupling media should be used? What tubes? How should voltages be adjusted? These are only four out of 1,400 questions raised and solved in "Audio Power Amplifiers."

The book begins with an elementary exposition of the historical development and circuit constitution of audio amplifiers and sources of powering them. From this simple start it quickly proceeds to a well-considered exposition of circuit laws, including Ohm's laws and Kirchhoff's laws. The determination of resistance values to produce required voltages is carefully expounded. All types of power amplifiers are used as examples: AC, DC, battery operated and composite. But the book treats of AC power amplifiers most generously, due to the superior importance of such power amplifiers commercially.

Rectification theory and practice in all the applied branches, grid bias methods and effects, push-pull principles, power detection, reproduction of recordings and methods of measurements and testing are set forth. And besides there is a chapter on the subject of motorboating, with which one of the authors is probably better familiar than any other textbook author. Then, too, there is a chapter on tubes, with essential curves and a full list of tables of tube data. Every tube that will be used in an audio amplifier—therefore virtually all tubes—is clearly diagnosed, classified and tabulated! These data on tubes should be at every radio engineer's hand.

"Audio Power Amplifiers" is a book for those who know something about radio. It is not for novices—not by a mile. But the engineers of manufacturers of radio receivers, power amplifiers, sound installations in theatres, public address systems and phonograph pickups will welcome this book. Engineers—even chief engineers—of the Bell Telephone Laboratories, Radio Corporation of America, Westinghouse Electric & Mfg. Co., Western Electric, Photophone, Vitaphone and the like needn't be afraid they won't learn something from this little book.

## Table of Contents

	Page
Chapter I	
General Principles .....	1
Chapter II	
Circuit Laws..	20
Chapter III	
Principles of Rectification .....	35
Chapter IV	
Practical Voltage Adjustments ..	62
Chapter V	
Methods of Obtaining Grid Bias..	72
Chapter VI	
Principles of Push - Pull Amplifier ..	90
Chapter VII	
Oscillation in Audio Amplifiers .....	98
Chapter VIII	
Characteristics of Tubes .....	118
Chapter IX	
Reproduction of Recordings .....	151
Chapter X	
Power Detection .....	161
Chapter XI	
Practical Power Amplification .....	121
Chapter XII	
Measurements and Testing ...	183

The book consists of 193 pages in type the size used in printing these words, known as 8 point, and therefore a great deal of text is contained in these 193 pages, and the book is small enough to be carried conveniently in the side pocket of a sack coat. It was purposely printed that way because busy engineers and other experimenters will want to consult this precious volume while riding in conveyances, as well as when in the laboratory, and compactness was therefore desirable.

The edition is strictly limited to 1,000, and the publishers recognize that the field of distribution is necessarily small, hence the price is \$3.50. Those to whom such a volume is of any value would not be without it at any price.

The device of presenting no more information or greater number of illustrations, but of using larger type, and thicker and often cheaper paper, to present a bulkier appearance, was purposely avoided. The paper is finest super stock and the size of the page is 5 x 8".

## Detailed Exposition of Chapter Contents

**Chapter I. General Principles**, analyzes the four types of power amplifiers, AC, DC, battery-operated and composite, illustrates them in functional blocks and schematic diagrams, and treats each branch in clear textual exposition. Audio coupling media are illustrated and discussed as to form and performance: transformer, resistance-resistance, impedance-impedance, impedance-resistance, resistance-autotransformer, autotransformer-resistance and non-reactive. Push-pull forms are illustrated, also speaker coupling devices. Simple audio amplifiers are illustrated and analyzed. Methods of connection for best results are stressed.

**Chapter II. Circuit Laws**, expounds and applies Ohm's laws and their special form known as Kirchhoff's laws. Direction of current flow in tube circuits is revealed in connection with the application of these laws to several circuits, including a DC 110-volt A, B and C supply, and series and parallel filaments in general. Special diagrams are published for Ohm's and Kirchhoff's laws.

**Chapter III. Principles of Rectification**, expounds the vacuum tube, both filament and gaseous types, electrolytic and contact rectifiers, and explains why and how they work. Full-wave and half-wave rectification are treated, with current flow and voltage derivation analysis. Regulation curves for the 280 tube are given. Voltage division, filtration and stabilization are fully illustrated and dissected.

**Chapter IV. Practical Voltage Adjustments**, gives the experimental use of the theoretical knowledge previously imparted. Determination of resistance values is carefully revealed.

**Chapter V. Methods of Obtaining Grid Bias**, enumerates, shows and compares them.

**Chapter VI. Principles of Push-Pull Amplifier**, defines the push-pull relationship, with keys to the attainment of desired electrical symmetry.

**Chapter VII. Oscillation in Audio Amplifiers**, deals with motorboating and oscillation at higher audio frequencies, explaining why it is present, stating remedies and giving expressions for predetermination of regions of instability. The trouble is definitely assigned to the feedback through common impedance of load reactors and B supply, and in some special instances to the load's relationship to the C bias derivation as well. The feedback is shown as negative or positive and the results stated.

**Chapter VIII. Characteristics of Tubes**, tells how to run curves on tubes, how to build and use a vacuum tube voltmeter, discusses hum in tubes with AC on the filament or heater, and presents families of curves, plate voltage—plate current, for the 240, 220, 201A, 112A, 171A, 227 and 245, with load lines. Also, plate-screen current characteristics of the 224, at five different control grid biases, at plate voltages 0-250. Then Table I gives the Average Characteristics of Amplifier and Detector Tubes 220, 200A, 201A, 112A, 171A, 222, 240, 226, 227, 224, 245, 210 and 250, stating use, filament voltage, current, and resistance, Det. B volts, Amplifier B volts, grid bias for amplification and detector, plate current, plate AC resistance, mutual conductance, mu, maximum undistorted power output, physical size. There is a composite table (II) of characteristics of Rectifier and Voltage Regulator Tubes, and individual tables, giving grid voltage, plate current characteristics over full useful voltage ranges for the 220, 201A, 112A, 171A, 222, 240, 227, 245 and 224.

**Chapter IX. Reproduction of Recordings**, states coupling methods and shows circuits for best connections.

**Chapter X. Power Detection**, explains what it is, when it should be used, and how to use it. A rectifying detector, designed by one of the authors, is expounded also.

**Chapter XI. Practical Power Amplifier**, gives AC circuits and shows the design of a sound reproduction system for theatres. A page is devoted to power amplifier symbols.

**Chapter XII. Measurements and Testing**, discloses methods of qualitative and quantitative analysis of power amplifier performance. A scale illustrates the audio note oscillator is described. Thirteen causes of hum, with remedies, are stated, also the estimation of power required for output and preliminary tubes.

You may safely order "Audio Power Amplifiers," either enclosing your remittance or ordering the book mailed C.O.D. Examine it for five days. If you are not completely satisfied with it for any reason, or for no reason, send it back in five days with a letter asking for a refund. A check refunding the purchase price will be sent to you immediately. We can not send the book on approval, without payment before receipt, so please do not ask us to do so.

## What Is Not As Well As What Is

**S**OMETIMES it is more important to expose a fallacy than merely to state the fact. A crop of technical weeds has grown into the garden of audio amplification, and the authors have gone to the pains of exposing these.

The book "Audio Power Amplifiers" is free from traditional errors, except in citing them as fallacious conclusions. Each attack on a fallacy is abundantly supported by proof of the REAL facts.

As an example, take the theory that motorboating is due to grid blocking. The authors say: "Many explanations for this oscillatory condition (motorboating) have been made, some of which are wholly untenable. One of these is that the oscillation is due to blocking of the grids of the amplifiers."

If blocking of the grid were the cause of the phenomenon, the wave form of the oscillation would be very irregular, but an oscillograph shows that it is very nearly of a sinusoidal form.

Then follows an exposition of motorboating, and oscillation at other frequencies, with expressions for predetermining the instability or stability of audio circuits.

## Send in This Coupon Now!

Hennesy Radio Publications Corporation,  
145 West 45th Street, New York, N. Y.  
(Just East of Broadway).

Please send at once postpaid ..... copies of "Audio Power Amplifiers," by J. E. Anderson and Herman Bernard, for which please find enclosed \$3.50 per copy.

Please send ..... copies C.O.D. I will pay \$3.50 plus Post Office charges.

Name .....

Address .....

City..... State.....

# RADIO AND OTHER TECHNICAL BOOKS At a Glance

## RADIO

- "Audio Power Amplifiers," by Anderson and Bernard .....\$3.50
- "Elements of Radio Communication," by Morecroft ..... 3.00
- "Foothold on Radio, A," by Anderson and Bernard ..... 1.00
- "Mathematics of Radio," by Rider ..... 2.00
- "Practical Radio," by Moyer & Wostrel ..... 2.50
- "Practical Radio Construction and Repairing," by Moyer & Wostrel ..... 2.00
- "Principles of Radio Communication," by Morecroft ..... 7.50
- "Radio Blueprint Library"—AC Hook-ups ..... .35
- "Radio Cyclopaedia," by Drake ..... 6.00
- "Radio Receiving Tubes," by Moyer & Wostrel ..... 2.50
- "Superheterodyne Construction and Operation," by Lacault ..... .25
- "Thermionic Vacuum Tube, The," by Van der Bijl ..... 5.00
- "Trouble Shooter's Manual," by Rider ..... 3.50

## TELEVISION

- "A B C of Television," by Yates ..... 3.00

## AVIATION

- "A B C of Aviation," by Maj. Page ..... 1.00
- "Aerial Navigation and Meteorology," by Capt. Yancy ..... 4.00
- "Everybody's Aviation Guide," by Maj. Page ..... 4.00
- "Ford Model 'A' Car," Its Construction, Operation and Repair—by Maj. Page ..... 2.00
- "Modern Aircraft," by Maj. Page ..... 5.00
- "Modern Aviation Engines," by Maj. Page ..... 9.00

# RADIO WORLD

145 West 45th Street  
New York, N. Y.  
(Just East of Broadway)

## NEW Morecroft

"Elements of Radio Communication," by Prof. John H. Morecroft, of the Engineering Department of Columbia University, is the latest book on radio by this outstanding authority.

This book is entirely new and contains matter which never before has been published. It is written in plain language so that every radio novice can understand it, yet it is a complete course in the elements of radio.

It contains 266 pages, 170 illustrations and a complete index. Price \$3.00.

**RADIO WORLD**  
145 West 45th St., New York, N. Y.

TELEVISION and all about it in "A B C of Television," by Raymond Francis Yates. \$3 post-paid. Radio World, 145 W. 45th St., N. Y. City.

## 4-GANG CONDENSER

With Trimmers  
Built in ..... **\$3.95**

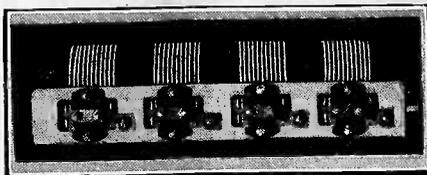

Capacity of each of the four sections is .00035 mfd. Overall length 11". Accurate capacity and precise alignment. Used in HB33 and HB44.

**GUARANTY RADIO GOODS CO.**  
143 West 45th Street New York  
[Just East of Broadway]

## New DRAKE'S ENCYCLOPEDIA

A reference work that has subjects classified in alphabetical order.

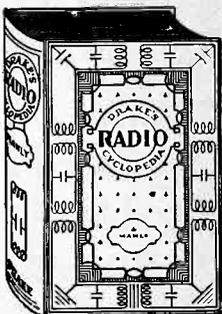

Each rule, fact, method, plan, layout and diagram is instantly picked out and separated from everything else by placing all subjects in alphabetical order with cross references for every imaginable name under which the information might be classed.

This alphabetical arrangement lets the experienced worker refer directly to the one thing in which he is interested at the moment without hunting through non-essentials. The needs of the beginner are cared for.

The important articles deal primarily with receivers and reception. They do not stop with the electrical end, but go also into the mechanics of construction.

Every new thing in radio is covered in detail.

BOOK IS 2 1/2" THICK.  
WEIGHS 3 1/4 LBS., 1,025 ILLUSTRATIONS.

1,680 Alphabetical Headings from A-battery to Zero Beat  
1,025 Illustrations, Diagrams, Layouts and Graphs  
920 Pages, Each 6 by 9 inches  
240 Combinations for Receiver Layouts

### OF THE PRINCIPAL ARTICLES

159 Concern service men, 129 help the set builder, 162 help the experimenter, 155 interest the student, 75 assist in sales work, 73 interest set owners.

**PRICE, \$6.00**

Remit with order and we pay cartage. Canadian remittance must be by postal or express money order Order C. O. D. and you pay cartage.

**RADIO WORLD, 145 W. 45th St., N. Y. City**

# MICROPHONE LIGHTERS

for cigars or cigarettes, with button switch at top. Press the switch and light up!

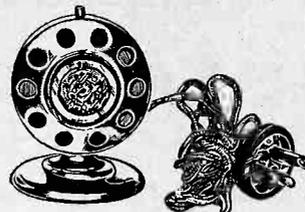

Model A lighter, microphone design, with 5-ft. AC cable and plug. Works on 110 volts, AC any frequency and on direct current. Price \$1.00

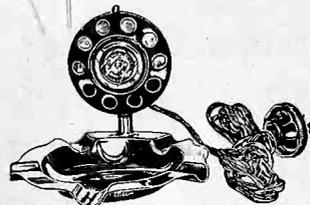

Model B lighter, microphone design, on tray, with 5-ft AC cable and plug. Works on 110 volt AC, any frequency, and on direct current. Exactly the same lighter as the other, only tray is added. Price.....\$1.50

This lighter is instantaneous. Hold button down only long enough to light a cigar or cigarette. The two models are furnished in attractive sprayed finish. Both are very compact! For instance, the tray is only 4 1/2" in diameter. Use these lighters in your home and for holiday gifts.

The heater element is renewable.

- RADIO WORLD, 145 West 45th St., N. Y. City**
- Please send me Model A Microphone Lighter at \$1.00.
  - Please send me Model B at \$1.50.
  - Enclosed is remittance [Canadian must be P.O. or express money order.]
  - Ship C. O. D.

Name .....  
Address .....  
City ..... State .....

# NATIONAL SCREEN GRID TUNER

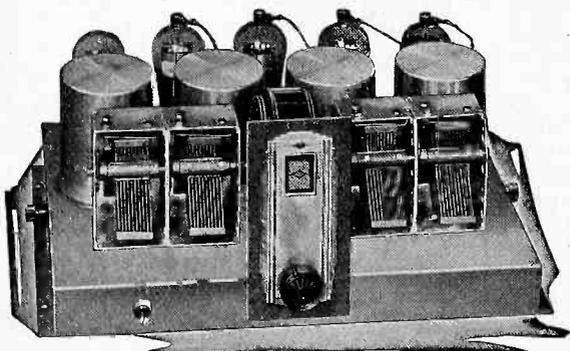

The most sensitive tuned radio frequency tuner so far developed, the MB-29 is long on distant reception, and penetrates seemingly unsurmountable barriers to reception. On the MB-29 the stations come in no matter where you are. The MB-29, designed by James Millen and Prof. Glen H. Browning, is the choice of the most discriminating. It is designed only for AC operation, uses four stages of screen grid BF and a power detector (227). Use 135 to 180 volts on the detector. Testimonials from radio's hardest-boiled experts prove this is the circuit of circuits. Buy the parts and find fullest radio delight. You will be sure nobody else has a tuner as good as yours, unless he too has an MB-29. Complete component parts for National Screen Grid Tuner MB-29, mounted on frosted aluminum chassis, including rainbow modernistic drum dial HC. Order catalog No. MB-29-K, list price, less tubes, \$69.50. Your price .....

**WRITE FOR WHOLESALE PRICES**

# MB-29

## Push-Pull Amplifier

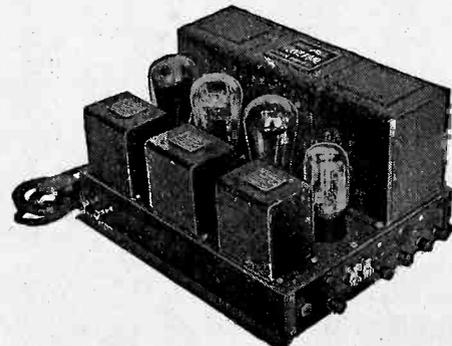

View of National Velvetone Push-Pull Power Amplifier, an expertly made A, B and C supply and audio amplifier, producing marvelous tone quality.

The National Velvetone Push-Pull Power Amplifier (shown at right) consists of an AC-operated filament-plate supply, with two stage transformer audio amplifier and output transformer built in. Made only for 110-V., 50-60 cycles. Sold only in completely wired form, licensed under RCA patents.

The new Power Amplifier has been developed and built to get the very most out of the MB-29. It is a combination power supply and audio amplifier, using a 280 tube for a rectifier, one stage of transformer audio with a 227 tube and a stage of push pull amplification with two 245s. It furnishes all power for itself and for the MB-29, as well as the audio channel. Order catalog PPPA, list price, completely wired and equipped with phonograph jack, (less tubes) \$97.50. Your price.

**WRITE FOR WHOLESALE PRICES**

## GUARANTY RADIO GOODS CO.

143 WEST 45TH STREET NEW YORK CITY

Highest Grade  
Key Tubes at  
**Defiant  
Prices!**

Screen Grid Tubes  
224 at \$1.43  
222 at 1.88

Power Tubes  
245 at 1.28  
112A at .78  
171A at .78

Other Tubes  
227 at .90  
226 at .68  
280 at 1.13  
201A at .53

The above constitute the nine most popular tubes used in radio today. Despite the severely low prices the Key tubes are firsts of the very first quality. Besides, there is a five-day money-back guaranty! The above tubes are manufactured under licenses granted by the RCA and its affiliated companies.

All prices are net and represent extreme discount already deducted.

**228 HIGH-GAIN DETECTOR**

Increase the sensitivity of modern AC-operated circuits by substituting the new 228 AC high mu tube (large amplification), for the 227 tube otherwise used as detector in up-to-date circuits. The result is immediately obvious in the greatly increased volume. Then the weak, distant stations come in stronger and tone quality is improved. Simply substitute the 228 for the 227 in the detector socket only. No wiring change of any kind is required. Price, \$1.88.

GUARANTY RADIO GOODS CO., 143 West 45th St., N. Y. City. (Just East of Broadway).

Enclosed please find \$..... for which ship at once tubes marked below:

- 228 AC high mu.....\$1.88
- 224 AC screen grid.....\$1.43
- 245 AC power tube.....\$1.28
- 226 AC amplifier......68
- 227 AC det.-amp......90
- 280 AC rectifier.....\$1.13
- 222 battery screen grid.....\$1.88
- 112A power tube......78
- 171A power tube......78
- 201A battery tube......53
- Matched pair of 245s for push-pull (for both).....\$2.56
- Matched pair 171As for AC push-pull (for both).....\$1.80
- Matched pair of 112As for push-pull (for both).....\$1.80

Name .....

Address .....

City ..... State .....

Put cross here if C. O. D. shipment is desired.  
Canadian remittance must be by postal or express money order.

**5-Day money-back guaranty**

**SECURITY DEALER**

Wants Attractive Stock Issue

Send full particulars  
**W. E. A. WHEELER  
& COMPANY**

90 Wall Street  
NEW YORK CITY

**LYNCH**

**TUBADAPTA**  
For Better TONE

List Price, \$2.50  
Improves reception and prolongs life of expensive power tubes. Used in last audio stage. Write for descriptive circular and complete catalogue Lynch Guaranteed Radio Products. LYNCH MFG. CO., Inc., 1775 B'way, N. Y.

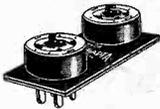

**CLAROSTAT**

LINE BALLAST No. 2179 approved for HAMMARLUND "HIQ-30"; ideal for automatic line voltage regulator. Also used in Silver broadcast receivers and is standard equipment in many leading receivers.

WRITE for data or ask your dealer about it.

CLAROSTAT MFG. CO.,  
291 North 6th Street Brooklyn, N. Y.

**NEWEST BOOK  
ON VACUUM TUBES**

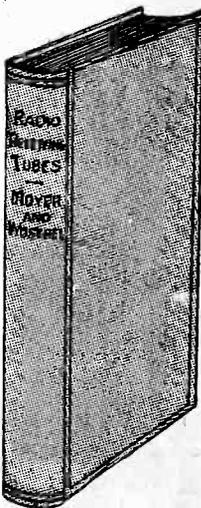

"RADIO RECEIVING TUBES," by James A. Moyer and John F. Wostrel, first edition just off the press. No radio service man, experimenter or student of radio should be without this authoritative book on the principles and applications of vacuum tubes. It answers all your questions relating to receiving, amplifying and rectifying tubes. It is a complete discussion of tube principles, functions and uses, thoroughly up-to-date.

In this book the essential principles underlying the operation of vacuum tubes are explained in a non-technical manner as is consistent with accuracy. The book covers the construction, action, reactivation, testing and use of vacuum tubes as well as specifications for vacuum tubes and applications for distant control of industrial processes and precision measurements.

Price \$2.50

**RADIO WORLD**

145 West 45th Street, New York City  
(Just East of Broadway)

**LOOK AT YOUR WRAPPER**

You will see by the date thereon when your subscription for Radio World expires. If the subscription is about to run out, please send us renewal so that you will not miss any copies. Subscription Department, RADIO WORLD, 145 West 45th St., N. Y. City.

**Orders - Inquiries**



**POLK'S REFERENCE BOOK  
and Mailing List Catalog**

Gives counts and prices on over 8,000 different lines of business. No matter what your business, in this book you will find the number of your prospective customers listed. Valuable information is also given as to how you can use the mails to secure orders and inquiries for your products or services.

Write for Your FREE Copy  
**R. L. POLK & CO., Detroit, Mich.**  
Largest City Directory Publishers in the World  
Mailing List Compilers—Business Statistics  
Producers of Direct Mail Advertising



**Fourteen Circuits**

Each Shown in Colored Picture Diagram, Colored Schematic Diagram and Front Panel Layout

Get This FREE Book!

Complete AC electric receivers, with B eliminators included, also AC receivers without B eliminators, also battery operated models, all easy-to-build circuits, using your own parts.

RADIO WORLD, 145 W. 45th St., N. Y. City.  
(Just East of Broadway)

Gentlemen: Enclosed please find \$1.00 for which please send me Radio World each week for eight weeks (regular price, \$1.20) and besides send me a FREE copy of the 1929 edition of The Radio Blueprint Library of AC and Battery Hookups.

Name .....

Address .....

City..... State.....

Note: Present mail subscribers may take advantage of this offer by putting a cross in this square.  Your subscription will be extended eight weeks.

[Canadian remittance must be by postal or express money order, due to high discount rate on cashing Canadian checks in New York.]

**PUBLISHERS CAN SUPPLY ALL 1929  
COPIES OF RADIO WORLD**

Excepting issues of Jan. 5, Feb. 23, and May 11

If you have missed any copies of Radio World for the year 1929 and want to complete your file, let us know what issues you are short and we will mail what we can at 15c a copy, or any seven issues for \$1.00, mailed postpaid.

Circulation Dept., Radio World, 145 W. 45th St., N. Y. City.



Your Choice of These Nine Meters FREE!

- 0-5 Voltmeter D.C. No. 329
0-50 Voltmeter D.C. No. 337
0-Volt Charge Tester D.C. No. 23
0-10 Amperes D.C. No. 338
0-25 Milliamperes D.C. No. 325
0-50 Milliamperes D.C. No. 336
0-100 Milliamperes D.C. No. 339
0-500 Milliamperes D.C. No. 338
0-400 Milliamperes D.C. No. 394

Equip Yourself Now With Necessary Meters!

To do your radio work properly you need meters. Here is your opportunity to get them at no extra cost. See the list of nine meters at left. Heretofore we have offered the choice of any one of these meters free with an 8-week subscription for RADIO WORLD, at \$1. the regular price for such subscription. Now we extend this offer. For the first time you are permitted to obtain any one or more or all of these meters free, by sending in \$1 for 8-week's subscription, entitling you to one meter; \$2 for 16 weeks, entitling you to two meters; \$3 for 24 weeks, entitling you to three meters; \$4 for 32 weeks, entitling you to four meters; \$5 for 40 weeks, entitling you to 5 meters; \$6 for 48 weeks, entitling you to six meters. Return this offer with remittance, and check off desired meters in squares at left.

RADIO WORLD will help you in your radio work, so you will be able to use the meters most valuably. Keep abreast of all the new circuits; intimate details on perfecting existing sets, and get inside track on sensitivity, distance reception, tonal quality, and news of radio, technical and non-technical. Enjoy the writings of Dr. Lee De Forest, McMurdo Silver, J. E. Anderson, Herman Bernard and a host of other radio engineers who contribute their knowledge to you through the medium of RADIO WORLD, the first and only illustrated national radio weekly. You can find no magazine that better caters to your needs than RADIO WORLD. Short waves? RADIO WORLD will tell you all about them. Extremely sensitive broadcast receivers? Their construction and operation are fully discussed with excellent regularity. Power supplies—push-pull or otherwise? AC receivers? Screen grid tubes? Large receivers that give a super-abundance of performance—small, economical receivers that give performance out of all comparison to their size? Are you interested in these? Then you're interested in RADIO WORLD.

Present mail subscribers may renew their subscription under this remarkably generous offer. Put a cross in square. [ ]

RADIO WORLD

145 W. 45th St., N. Y. City—Published Weekly. All Newsstands. 15c per copy—\$3. six months—\$6 a year.

Component Parts for 245 Push-Pull Power Amplifier

(as described and specified by Herman Bernard) Check off which parts you desire. All parts sold separately.

- [ ] C1—One .00025 mfd. mica condenser..... .21
[ ] C2—One .01 mfd. mica fixed condenser..... .35
[ ] C3—One Flechthelm 1 mfd. filter condenser, 1,000 volts DC continuous working voltage rating, 550 volts AC (root mean square) continuous voltage rating..... 1.76
[ ] C4, C5, C6, C7—Four Mershon condensers in one copper casing, two of 8 mfd. and two of 18 mfd. with low bracket. Cat. Q2-8 2-18B..... 5.15
[ ] C8, C9, C10, C11, C12, C13, C14, 15, C16—Nine 1 mfd. bypass condensers, 200 volts DC continuous working voltage rating..... 4.50
[ ] T1—One Polo Filament-Plate Supply transformer: 110 volt 50-60 cycle primary, 724 volt secondary center-tapped, 5 volt 2 amp. secondary center-tapped; 2.5 volt 3 ampere secondary center-tapped, and 2.5 volt 12 ampere secondary center-tapped. Cat. PFPS..... 7.50
[ ] FC, PFOC—Two center-tapped chokes for high current one used as filter choke, other as push-pull output choke..... 7.42
[ ] PPIT—One push-pull input transformer..... 3.41
[ ] SW—One AC pendant through-switch, with 12-ft. AC cable and male plug..... 1.10
[ ] F—One 2 ampere fuse, with holder..... .50
[ ] CO—One convenience outlet (for dynamic speaker AC cable)..... .50
[ ] PJ, PJS—Phonograph Jack with automatic switch and plug..... 1.42
[ ] R1—One resistor, 0.1 meg..... .30
[ ] R2—One grid leak, 5.0 meg..... .30
[ ] R3—One multi-tap voltage divider, 50 watt rating; fourteen taps affording thirteen different voltages; 13,850 ohms..... 3.85
[ ] Two resistor mountings.....
[ ] Roll of heavy insulated hookup wire for power work.....
[ ] Fifteen binding posts..... 1.50
[ ] One 15x9 1/2" cadmium plated steel subpanel, with self-bracketing flanges, one five-prong and three four-prong sockets built in; sockets marked to identify tubes that go in them; subpanel drilled and insulated where necessary; flat insulating washers; hardware..... 4.00
[ ] All parts..... \$43.57
Ferranti AF5CC push-pull input instead of above input transformer..... 9.60

[Note: For 40 cycles 110v. order Polo P40 FPS at \$10; for 25 cycles 110v. order Polo P25 FPS at \$11.]

Guaranty Radio Goods Co.

143 West 45th Street Just East of Broadway NEW YORK CITY

Blueprint of the New One-Dial Push-Pull Battery Model SG DIAMOND

Full-sized picture diagram of the wiring, with list of parts. This 5-tube receiver is really superlative. It gives you screen grid radio frequency amplification and push-pull output, most economically.

Send \$1.00 today for this blueprint or order it shipped C. O. D.

RADIO WORLD

145 West 45th Street Just East of Broadway New York City

One Tube? Two Tubes? Three Tubes? Four Tubes?

Circuits for Schoolboys—Easy to Build, Very, Very Inexpensive!

- A One Tube Receiver, parts costing \$4.28!
A Two Tube Audio Amplifier, parts costing \$5.23!
A Three Tube Speaker—Operating Circuit, parts costing \$11.10!
A Four Tube Speaker—Operating Circuit, parts costing \$12.72!
The construction of these circuits, with a pictorial diagram as one of the illustrations, was described by Jack Tully, himself a schoolboy, in RADIO WORLD. See list below.
[ ] Sept. 21st and 28th issues, One-Tube DX Set, by Jack Tully; two-part article.
[ ] Oct. 5th, Three-Tube Single Dial Speaker Set, by Jack Tully.
[ ] Oct. 12th, Two Stage Transformer, Coupled Audio Amplifier, by Jack Tully.
[ ] Oct. 19th, Four-Tube DX Speaker Set, by Jack Tully. 15 cents a copy. Order at once while these copies are available.
RADIO WORLD, 145 W. 45th St., New York

LACAULT'S BOOK

GIVES YOU A FINE UNDERSTANDING OF the SUPER-HETERODYNE

R. E. LACAULT, E.E., I.R.E., who died recently, was one of the outstanding authorities on the Super-Heterodyne. He wrote a book, "Super-Heterodyne Construction and Operation," that explains in a non-technical manner the phenomena associated with a Super-Heterodyne. More, it gives a clear outline of the way such a receiver functions, and naturally gives the clues to solving virtually all the troubles that may arise in a Super.

So thoroughly did Lacault do his work that he covered associated topics, thus making his book a sidelight on radio in general, including advice on trouble-shooting.

Therefore the service man, the home experimenter, the custom set builder and the student will welcome this book.

It consists of 103 pages and includes 68 illustrations. It is bound in maroon buckram.

There are three valuable tables in the book, also. One classifies harmonics into groups, e.g. sound, radio, short waves, heat, light, chemical rays, X-rays and "unknown." Another is a trouble-shooting chart, classifying "trouble experienced" and "causes" and referring to the text for specific solutions. The third is a table for converting broadcast frequencies to wavelengths (accurate to .1 of a meter) or for converting the wavelength into frequency.

THE book begins with a comparison of alternating and direct current and proceeds to a discussion of the relation of wavelength to frequency. Then tuning is explained. Condensers, coils, induction, vacuum tube operation and testing, earphones and speakers, rectification, oscillation, grid condenser action, modulation, grid bias detection, regeneration, beat notes, frequency changing, audio amplification, batteries, serials, loops, wiring, sockets, and shielding are only some of the other important topics covered.

Besides, there is an entire chapter on the construction of a Super-Heterodyne receiver, with list of parts, front, top and rear views of set, front panel layout, shield dimensional drawings, schematic diagram of wiring and picture diagrams of the top and bottom views of the subpanel.

You Can Get This Book At Once!

You will want this book not only for present reading but also for future reference. It is authoritative and highly informative. Send for it now! It's free with each order for an eight weeks' subscription for RADIO WORLD. Present subscribers may renew under this offer. Their subscriptions will be extended eight weeks. Please use coupon.

RADIO WORLD, 145 W. 45th St., N. Y. City (Just East of Broadway)

Gentlemen: Enclosed find \$1.00. Please enter my subscription for RADIO WORLD for eight weeks at \$1.00 and send me at once one copy of R. E. Lacault's "Super-Heterodyne Construction and Operation," FREE!

[ ] I am a subscriber at present. (Check off if true.)

Name .....

Address .....

City..... State.....

5-DAY MONEY-BACK GUARANTEE [ ] If C. O. D. desired, put cross here.

Component Parts

for ONE-DIAL

PUSH-PULL BATTERY DIAMOND

[Check off parts you want. Each part is sold separately.]

- [ ] L1L2—Antenna coil RF3 @..... \$ .65
[ ] L3L4L5—3-circuit SG coil SGT3 @..... .90
[ ] L6—Push-pull output transformer..... 2.50
[ ] T1—Push-pull input transformer..... 2.50
[ ] CT—80 mfd. equalizer..... .35
[ ] C1, C2—Two .00035 mfd. ext. shafts @ 98c..... 1.96
[ ] C3, C5—Two .01 mfd. mica condensers.... .70
[ ] R—One 6.5 ohm filament resistor..... .25
[ ] R1, Sw—One 75 ohm switched rheostat... .80
[ ] R2, C4—2 meg. Lynch leak, grid clip condenser..... .51
[ ] R3—One .25 meg..... .30
[ ] R4—One 5.0 meg..... .30
[ ] R5—One 1.3 ohm filament resistor..... .20
[ ] Ant., Gnd., Sp. (+) Sp. (-)—Four posts @ .10..... .40
[ ] One drilled front panel 7x18"..... 1.85
[ ] One socketed, self-bracketing metal subpanel, all holes drilled..... 3.50
[ ] One National new modernistic drum dial with color wheel, pilot bracket, 6v. lamp, hardware, knob..... 3.13
[ ] Two matched knobs for rheo. and tickler @ .18..... .36
[ ] Five vari-colored cable leads @ .07..... .35
[ ] Metal link and insulated shaft..... .22
[ ] One screen grid clip..... .06

[ ] All parts (including blueprint)..... \$21.89

GUARANTY RADIO GOODS CO., 143 W. 45th St., N.Y.C. (Just East of Broadway)

Enclosed please find \$..... for which please mail at once the parts for the Push-Pull Battery Model Diamond of the Air as checked off above.

[ ] If ordering C.O.D. put check mark here.

Name .....

Address .....

City..... State.....

TRIAL SUBSCRIPTION, 8 WEEKS, \$1.00. Send \$1 and we will send you Radio World for 8 weeks, postpaid. RADIO WORLD, 145 West 45th St., N. Y. City.

"MODERN AIRCRAFT," By Maj. Pagé, \$5. postpaid; and "Everybody's Aviation Guide," By Maj. Pagé, price \$2. postpaid. Latest and best up-to-date aviation books. Radio World, 145 W. 45th St., N. Y. City.

# NEW J-245-X TROUBLE-SHOOTING JIFFY TESTER

*Illumination Continuity and Polarity Tester FREE with Each Outfit!*

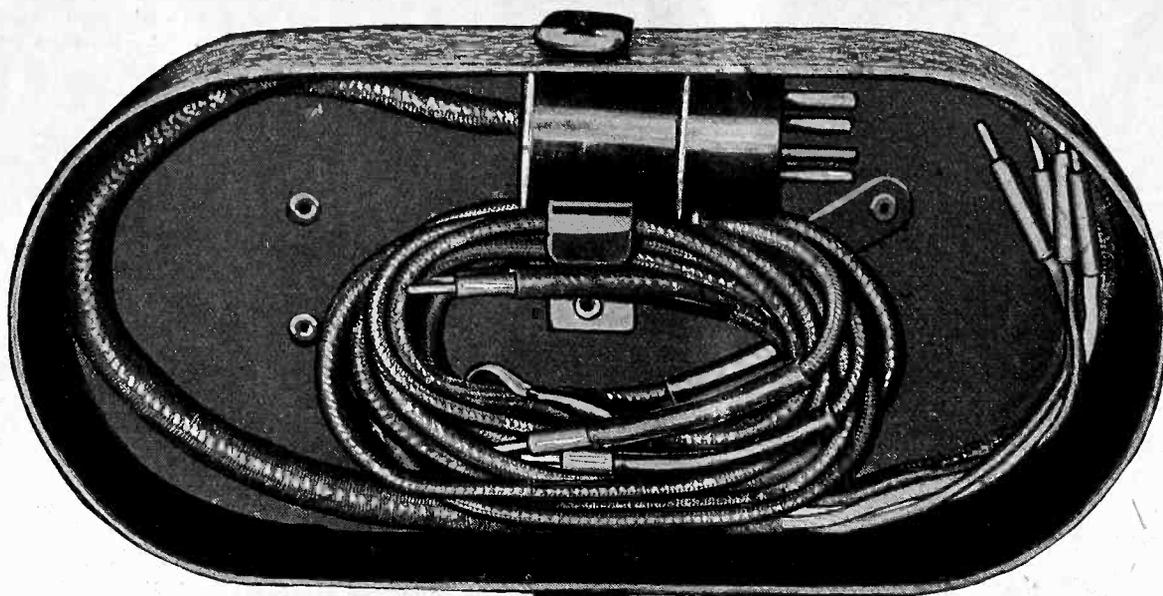

Your Price  
**\$15.82**

Complete

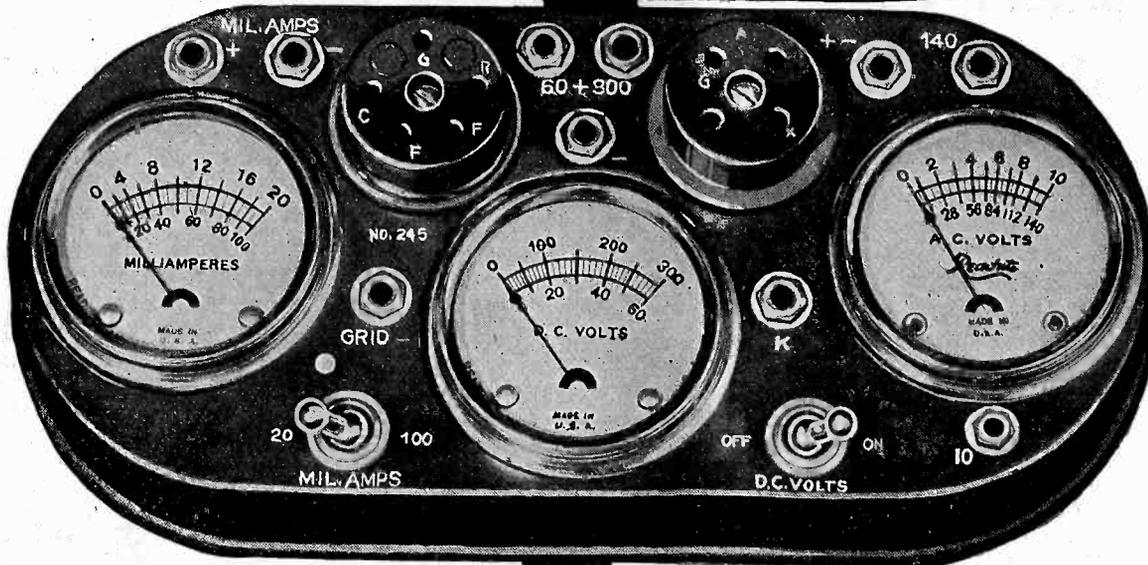

Illumination Tester, Vest Pocket Size, Shows Shorts and Opens Visually, also polarity of DC line. A Neon lamp is built in.

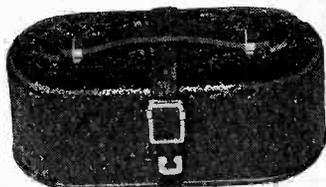

The three-meter assembly, in the crackle-brown finish carrying case, with slip-on cover and a cable plug. There are ten adapters. It is vital to have the complete outfit so you can meet any emergency.



Illustration above is 2/3 scale.

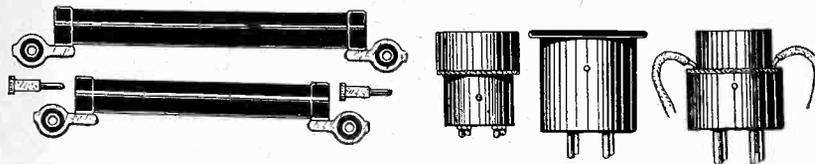

J-111 Multiplier, upper left, with tip; below it, J-106 Multiplier with tip; plugs, left to right, J-19, conforms UV socket to UX plug; J-20, conforms UX tester socket to UV199 tube; J-24, to test Kellogg and old style Arcturus tubes.

## Makes All Necessary Tests in a Jiffy and Simplifies Service Work!

**T**HE new Jiffy Tester, J-245-X, is a complete servicing outfit. It consists of a three-meter assembly in a metal case, with slip-on cover and a cable plug. There are ten adapters. It is vital to have the complete outfit so you can meet any emergency.

With this outfit you plug the cable into a vacated socket of a receiver, putting the removed tube in the tester, and using the receiver's power for making these tests: plate current, up to 100 milliamperes; plate voltage up to 300 volts; filament or heater voltage (AC or DC), up to 10 volts.

Each meter may be used independently. One of the adapters—a pair of test leads, one red, the other black, with tip jack terminals—serves this purpose. Multiplier J-106 extends the range of the DC voltmeter to 600 volts, but this reading must be obtained independently, as must readings on the 0-60 scale of the DC voltmeter. Independent reading of the AC voltmeter for line of voltage is necessary; also to use 0-140 scale while Multiplier J-111 extends the AC scale to 560 volts for reading power transformer secondaries.

The other adapters permit the testing of special receiver tubes, so that tests may be made, in all, of 22 different tubes: 201A, 200A, UX199, UV199, 120, 240, 171, 171A, 112, 112A, 245, 224, 222, 228, 280, 281, 227, 226, 210, 250, Kellogg tubes and old style Arcturus tubes.

**W**HEN servicing a radio set, power amplifier, speech amplifier or sound reproduction or recording equipment, the circuits and voltages are almost inaccessible, unless a plug-in tester is used.

The Jiffy 245-X plugs in and does everything you want done. It consists of:

- (1)—The encased three-meter assembly, with 4-prong (UX) and 5-prong (UY) sockets built in; changeover switch built in, from 0-20 to 0-100 ma.; ten vari-colored jacks, five of them to receive the vari-colored tipped ends of the plug cable; grid push-button, that when pushed in connects grid direct to the cathode for 224 and 227 tubes, to note change in plate current, and thus shorts the signal input.
- (2)—4-prong adapter for 5-prong plug of cable.
- (3)—Screen grid cable for testing screen grid tubes.
- (4)—Pair of Test Leads for individual use of meters.
- (5)—J-106 Multiplier, to make 0-300 DC read 0-600.
- (6)—J-111 Multiplier, to make 0-140 AC read 0-560.
- (7)—Two jack tips to facilitate connection of multipliers to jacks in tester.
- (8), (9), (10)—Three adapters so UV199 and Kellogg tubes may be tested.
- (11)—Illumination Tester.

The illumination tester will disclose continuities and opens and also the polarity of DC house mains. It is as handy as a pencil and fits in your vest pocket. It works on voltages from 100 to 400. There are two electrodes in a Neon lamp in the top of the instrument. On AC both electrodes light. On DC only one lights, and that one is negative of the line, the light being on the same side as the lead. Hence the illuminator shows whether tested source is AC or DC, and if DC, which side is negative.

Even the output of the speaker cord will show a light. Also, the device will test which fuses are blown in fused house lines, AC or DC. Besides it tests ignition of spark plugs of automobiles, boats and airplanes, also faulty or weak spark plugs.

Just flash on the illumination tester momentarily. It will last about 4,000 flashes.

**GUARANTY RADIO GOODS CO.**  
145 West 45th Street, Just East of Broadway,  
N. Y. City.

Please send me on 5-day money-back guaranty your J-245-X Jiffy Tester, complete, with all 10 adapters, and with illuminated Tester FREE with each order. Also send instruction sheet, tube data sheet and rectifier tube testing information.

Enclosed please find \$15.82 remittance. Ship at your expense. [Canadian must be P.O. or Express M.O.]

Please ship C. O. D. @ \$15.82 plus cartage and P.O. fee.

NAME .....

ADDRESS .....

CITY ..... STATE .....

**5-DAY MONEY-BACK GUARANTY**

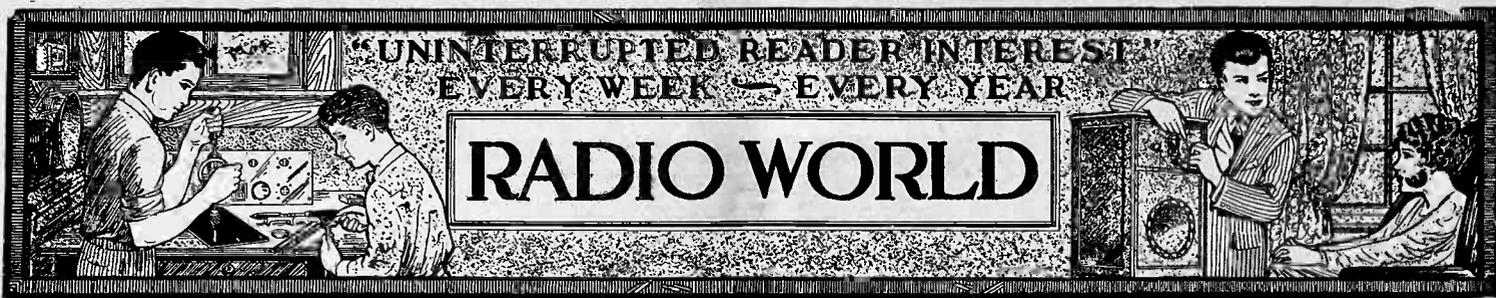

Vol. XVI, No. 18 Whole No. 408  
 January 18th, 1930  
 15c per Copy, \$6.00 per Year  
 [Entered as second-class matter, March, 1922, at the Post Office at New York, N. Y., under act of March, 1879.]

Technical Accuracy Second to None  
 Latest Circuits and News  
**EIGHTH YEAR**

A Weekly Paper published by Hennessy Radio Publications Corporation, from  
 Radio Publications Corporation, from  
 Publication Office, 145 West 45th Street,  
 New York, N. Y.  
 (Just East of Broadway)  
 Telephone, BRyant 0558 and 0559

RADIO WORLD, owned and published by Hennessy Radio Publications Corporation, 145 West 45th Street, New York, N. Y. Roland Burke Hennessy, president and treasurer, 145 West 45th Street, New York, N. Y.; M. B. Hennessy, vice-president, 145 West 45th Street, New York, N. Y.; Herman Bernard, secretary, 145 West 45th Street, New York, N. Y. Roland Burke Hennessy, editor; Herman Bernard, business manager and managing editor; J. E. Anderson, technical editor.

# Loftin-White Circuits

## Non-Reactive Audio Amplifiers Improved

By *J. E. Anderson*

Technical Editor

EVERY once in a while there is much interest in non-reactive amplifiers, that is, amplifiers in which the tubes are coupled with non-reactive resistors and without the use of any stopping condensers or choke coils. The interest aroused from time to time has never been lasting, as far as the fans are concerned, because these amplifiers are relatively unstable and difficult to get into operating condition.

Just now, however, there is keen interest in a non-reactive amplifier sponsored by Loftin and White and popularized by well-known writers on radio.

Because of the expressed interest of many of our readers in this system we herewith describe two of the circuits proposed.

Those among our readers who remember the series of articles in RADIO WORLD in the Fall of 1928 will realize there is now nothing essentially new in these circuits, since the principles involved were fully discussed more than a year ago. Special reference is made to articles in the September 15th, September 29th and October 6th, 1928, issues of RADIO WORLD, where the principles involved were discussed in conjunction with push-pull amplification.

### WHERE CREDIT IS DUE

At that time credit was given for the ideas presented in these circuits to G. H. Paris, of Duluth, Minn., and to an English writer named Johnston.

Lack of novelty at this time in no way detracts from the credit that is due to Loftin and White for having devised and constructed simple and stable amplifiers on this principle.

There is one feature of the Loftin-White application which deserves special mention, and that is the hum-bucking arrangement by which they balance out hum from the amplifier and thereby make it possible to use a plate current supply that is exceedingly simple and inexpensive. It is so simple that one might say that the filtering is only nominal, yet complete. This is an achievement of no small magnitude and may be the thing needed to transform this theoretically excellent circuit into one which is equally excellent practically.

There are many advantages of this system of amplification which tempt one to be exceedingly patient with its shortcomings. These are unexcelled quality, simplicity of circuit, and low cost of operation and assembly. The main disadvantage has been instability. We are assured that Loftin and White have overcome this difficulty.

### DETAILS OF THE CIRCUIT

Fig. 1 herewith shows the schematic of the two-tube Loftin-White amplifier together with its plate voltage supply. The first tube is a 224 screen grid tube and the second a 245 power tube. These two tubes give adequate amplification and volume, the amplification, of course, being mainly contributed by the screen grid tube.

A discussion of this circuit is mainly a discussion of the manner in which the proper voltages are obtained on the various elements on the two tubes, both AC and DC voltages.

The input voltage on the circuit is obtained from a portion of the signal voltage drop across the potentiometer P1. The portion of the total drop impressed on the tube depends on the setting of the slider, and the voltage may be varied from zero to the full drop across P1. The input signal voltage to the

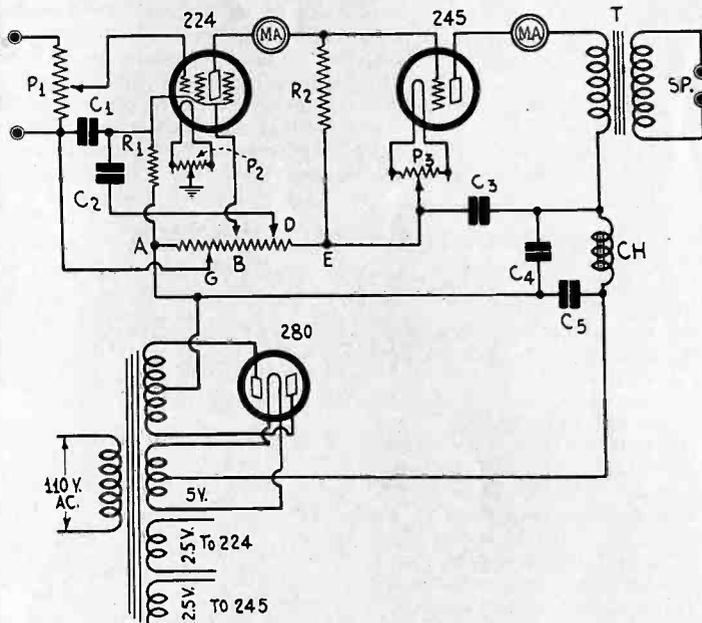

FIG. 1  
 THE TWO-TUBE, LOFTIN-WHITE NON-REACTIVE AMPLIFIER IN WHICH NO STOPPING CONDENSER IS USED BETWEEN THE PLATE OF THE FIRST AND THE GRID OF THE SECOND TUBE

second tube is the signal voltage drop in the coupling resistor R2.

The recommended value of this coupling resistor is 1.0 meg. The steady voltage drop in this resistor is the bias on the succeeding tube, as the resistor is connected between the grid and the center of the filament of the power tube. This bias should be 50 volts for a 245, and therefore the steady current through R2 should be 50 microamperes. The screen grid tube voltages should be adjusted until this current flows in the plate circuit, and is read on the 0-1 milliammeter, or microammeter, connected in the plate lead of the first tube.

### PLATE VOLTAGE ON SCREEN GRID TUBE

The plate voltage on the screen grid tube is the voltage drop in the resistance between points A and E, less the steady drop in R1. The drop in R1 can be neglected in comparison with the drop in the resistance between A and E so we need only consider the main drop. The current through the resistance AE is practically equal to the plate current of the power tube. The currents diverted by the plate and screen of the first tube can be neglected in comparison with the 32 milliamperes required by the power tube.

The recommended values for the two main sections of the resistor between A and E are A to B, 600 ohms and B to E, 2,900 ohms. Thus the total resistance is 3,500 ohms, and through

# Reverse Brake on Hum

## Out-of-Phase Equal Voltage Used in New Way

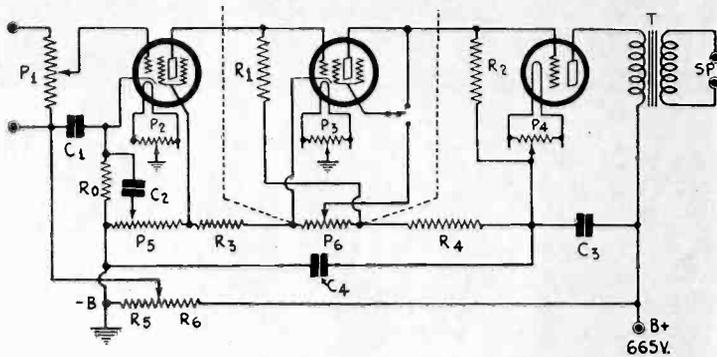

FIG. 2

THE THREE-TUBE, LOFTIN-WHITE NON-REACTIVE AMPLIFIER. A SWITCH IS PROVIDED FOR CONVERTING THE MIDDLE TUBE FROM A SCREEN GRID TUBE TO A THREE-ELEMENT TUBE, IN EFFECT, FOR ALTERING THE VOLUME. THIS FIRST TUBE IN THIS CIRCUIT IS ALSO SUPPOSED TO WORK AS A DETECTOR.

this 32 milliamperes flow. Therefore the drop is 112 volts. This is a rather low voltage to apply to a screen grid tube when one megohm is used in its plate circuit, but this is all right provided the screen voltage is lower than the usual rated value.

$R_1$  is 100,000 ohms. Through this resistance both the plate and the screen currents flow, and the plate current alone would establish a steady drop of 5 volts. If the screen current is of the same order of magnitude as the plate current the total drop in  $R_1$  would be 10 volts. This would be too high bias for a screen grid tube, and therefore the grid return is connected to a point on the resistance AE which is at a suitably higher voltage so that the grid bias has the proper value for amplification. This adjustment is brought about experimentally by moving the point G.

### GETTING THE SCREEN VOLTAGE

The screen voltage on the tube is also adjusted by trial by sliding the return lead over the resistance, that is, by moving the point B. The resistance value given above, namely, 600 ohms, gives a voltage of 18 volts on the screen, which was the correct adjustment in one instance. This low screen voltage is consistent with the low plate voltage and the high resistance load on the tube.

The first section of the resistance between A and E, next to A, is a 200 ohm potentiometer, and the grid return of the first tube is connected to the slider of this potentiometer. That is to say, G is the slider. Next comes a 400 ohm fixed resistance, which ends at B. Next is a 400 ohm potentiometer with the slider at D. Then follows a 2,500 ohm resistor terminating at D. This really provides only a variation for the grid bias since the slider D is used for another purpose to be discussed later. In other words, although B appears as a slider for the screen grid voltage the screen is really returned to a fixed point. If the screen voltage is to be adjusted independently it will be necessary to provide another potentiometer, still keeping the total resistance between A and E at 3,500 ohms. But the values given above are those recommended by the sponsors of the circuit after much experimenting.

### HUM-BUCKING DEVICE

A condenser  $C_2$ , of 0.1 mfd., is connected between the cathode of the screen grid tube and a point D on the voltage divider. The object of this condenser is to introduce a hum component into the grid circuit of the tube in opposite phase to the hum introduced by the ripple in the supply current. The amount of hum thus introduced is varied by slider point D. A point can be found where the hum introduced in one direction is just equal to that introduced in the other, when no hum appears in the signal. This is a noteworthy contribution by Loftin and White.

It is recommended that separate filament transformers be used for the two tubes, or at least separate windings on the same transformer. It will be noted that on each one is a potentiometer the mid-point of which is connected to ground in the case of the first tube and to N in the case of the second. A potentiometer is superior to a center tap on the transformer winding because you can get a closer centering. Since the voltages involved are low it is not necessary to use potentiometers higher than 10 ohms.

It will be observed that the by-pass condensers used in the B supply are only 1.0 mfd. each, and only four of them are used. One of these,  $C_1$ , by-passes the grid bias supply of the first tube and another,  $C_3$ , by-passes the plate supply of the second tube.

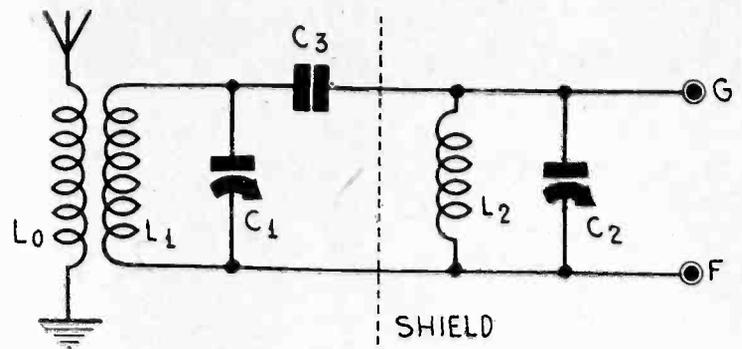

FIG. 3

A SUGGESTED TUNER TO BE USED AHEAD OF THE CIRCUIT IN FIG. 2 TO COMPLETE THE RECEIVER. EXCEPTIONAL SELECTIVITY IS CLAIMED FOR THE COMBINATION, AS WELL AS HIGH SENSITIVITY.

The remaining two condensers,  $C_4$  and  $C_5$ , are the regular by-pass condensers in the B supply. A single choke Ch is used in the filter, and this should not have a direct current resistance higher than 500 ohms because of the heavy current and the need of high voltage.

### HIGH VOLTAGE NEEDED

The total voltage needed for this type of circuit is equal to the sum of the plate voltages of the two tubes. Thus if the power tube is to get 250 volts and the screen grid tube 112 volts, the total voltage should be 362 volts. There are many plate voltage supply units which will give this voltage, since the current drawn is only 32 milliamperes.

There is a milliammeter in the plate lead of the power tube as well as one in the plate lead of the screen grid tube. The second meter indicates the plate current of the last tube and hence also the current flowing through the resistance AE. It is important that the current be about 32 milliamperes if the resistance values recommended are to give the correct voltages on the plate and the screen of the first tube. However, small variations in the current do not matter so much because there will be corresponding variations in the voltages, and if the balance should be upset it is a simple matter to readjust with the potentiometers.

### THE THREE TUBE CIRCUIT

A three-tube circuit working on the same principle is shown in Fig. 2. The first two tubes are of the screen grid type and the last is a 250 power tube. The arrangement in this circuit is slightly different, but the principle is the same.

The total voltage required for this circuit is 650 volts. The first screen grid tube gets a voltage of about 15 volts, the second about 75 volts and the power tube the remaining available voltage. The voltage on the screen of the first tube is about 2.5 volts and that on the second about 15 volts.

The coupling resistors are 1.0 meg., as in the two-tube circuit. The second coupling resistor is connected from the grid to the cathode, or mid-point of the filament circuit, and therefore the drop in this resistor is the bias on the power tube. The other coupling resistor is connected from the grid of the middle tube to a point on the voltage divider which insures that the bias on the second tube has the proper value.

It will be noted that the return is made to a point which is positive with respect to the cathode. This means that the steady drop in the first coupling resistor is greater than the bias required.

### RESISTOR VALUES RECOMMENDED

The recommended values of the various voltage divider resistors are as follows:  $R_0$ , 100,000 ohms;  $P_5$ , 320 ohms;  $R_3$ , 180 ohms;  $P_6$ , 500 ohms;  $R_4$ , 2,500 ohms;  $R_5$ , 400 ohms, and  $R_6$ , 60,000 ohms. These are for the particular combination of tubes and voltages given in Fig. 2 and in no other.

The condensers in Fig 2 have the same values as those in Fig. 1.  $C_1$ ,  $C_3$ , and  $C_4$  are 1.0 mfd. condensers and  $C_2$  is a 0.1 mfd. condenser. It will be noted that condensers  $C_3$  and  $C_4$  are across high voltages. For this reason they should be of a high voltage rating, say 1,000 volts.

The hum-bucking condenser is connected differently in the three-tube circuit. Note that in Fig. 1 the condenser is returned to a point on the positive side of the screen return to the voltage divider, whereas in Fig. 2 it is connected to a point on the negative side. The differences are due mainly to the distribution of the voltages.

(Continued next week)

# Soldering As An Art

## Cleanliness the First Essential of Success in Wiring a Circuit

By Capt. Peter V. O'Rourke

Contributing Editor

**M**AKING neatly soldered joints while building radio receivers is an art that must be acquired. Many fans have been told that they should use a hot iron, and indeed that is one of the necessary conditions. But fans have also found that using a hot "iron" it has required so much time to complete a joint, to make the solder flow and take hold, that during the process insulators such as hard rubber, wax, wire covering, and others have melted or burned. There was no lack of heat in the "iron," but there was actually too much of it. A neat soldered joint must be made quickly when there is any danger of burning insulation and damaging certain parts by the heat that flows from the "iron."

What is the reason the solder will not flux when the iron is hot enough not only to melt the solder but to make the joints to be soldered so hot that when the solder comes in contact with them it melts? There are several reasons, but all may possibly be summed up by saying lack of preparation of the joint, or possibly by saying lack of cleanliness of the joint.

### IRON MUST BE PREPARED

One of the essential conditions for good soldering is that the "iron" be properly prepared. It must not only be hot but it must be clean and well tinned. When starting out on a job of soldering the "iron" should first be filed down so that the copper is everywhere exposed. There must be no dirt on the tip of the "iron" nor any pits due to corrosion. After the filing the copper should be covered with a layer of solder. If the filed surfaces are clean and the "iron" hot enough it is only necessary to apply rosin core solder to the surfaces and spread it out. If they are not so clean it may be necessary to employ a more effective flux than rosin, such as soldering paste or even acid. If acid core solder is used it is essential that every speck of acid be removed from every part of the "iron" after the tinning process, for if ever so little is left on, it will attack the copper and make deep pits in the surfaces, requiring much filing before the "iron" again can be restored to good working condition.

After a good layer of tin has been applied to the copper it is in good condition for soldering. But it must be kept in that condition. If the "iron" overheats, the tin, or solder, will be burned off, and a layer of oxide of tin will replace the metal. While this oxide is on the copper good soldering cannot be effected. Possibly that is responsible more than anything else for bad soldered joints and burned insulation. Then there is the dirt that gathers on the copper during operation, such as burned rosin. This must be removed occasionally, and the best way to remove it is to wipe the copper with a dry cloth. This also removes any oxide which may have formed. Whenever the copper has been wiped, a little clean solder should be applied. It is easier to keep the copper in a good working condition by occasional wiping and retinning than to restore it after all the solder has been burned off.

### AVOIDING OVERHEAT

Overheating of the copper does not occur while the "iron" is actually in use, but during moments of idleness, when heat is supplied to it by the electric current and no heat is taken away by the work. One way of preventing overheating is to turn off the current the moment the "iron" is put aside for the pliers or the diagonals. But if that is done it is cold by the time it is needed again, and a delay will result while the "iron" is heating up again.

Another method of preventing the "iron" from getting too hot while not in use, yet permitting it to keep sufficiently hot for good soldering, is illustrated in the accompanying sketch. A rheostat of suitable resistance is connected in series with the heating circuit and its resistance adjusted so that the current that flows is just sufficient to supply the heat losses of radiation. If the current is adjusted so that the copper remains at a good soldering temperature while not in use, it will not be hot enough for soldering, especially if the copper comes in contact frequently with extensive metals or heavy copper leads. Hence a switch is provided whereby the rheostat can be short out of the circuit, allowing the full current to flow while the "iron" is in use.

In the sketch this switch is indicated under the rheostat and is manually operated. It is possible to arrange the switch so that when the "iron" is laid aside the switch automatically opens and so that when it is picked up again the switch closes. The weight of the "iron" being used to open and close the switch. Any ingenious set builder can devise such an automatic switch. If he does a good deal of soldering he will find that this device will save a great deal of time and at the same time will result in better soldering and a longer life of the iron.

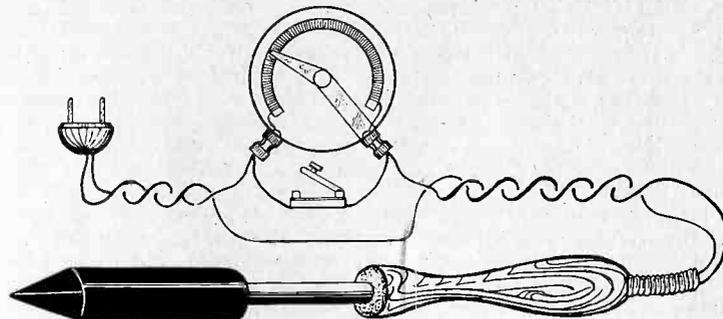

TO PREVENT A SOLDERING COPPER FROM GETTING TOO HOT DURING MOMENTS IT IS NOT ACTUALLY IN USE A RESISTANCE CAN BE PUT IN SERIES WITH THE HEATER TO LIMIT THE CURRENT TO A VALUE SUCH THAT WILL JUST KEEP THE COPPER AT A SOLDERING HEAT.

### PREPARING THE WORK

Just as the "iron" must be clean, so must the work be clean before a good soldered joint can be made. If the conductors to be soldered together are tinned there is no difficulty at all. It is only necessary to apply the "iron" until the conductors are hot, and then apply the solder until it fluxes.

If the conductors are bare copper or brass greater care must be exercised to make the solder flux and stick to the metals. It is advisable to tin the conductors first, individually, and then solder them together. However, if the surfaces are thoroughly cleaned so that the metals are bright, and if a good flux is used, such as rosin or paste, there will be no difficulty, provided the "iron" is hot, clean, and tinned.

There are certain types of wire which are difficult to solder because it is difficult to get the surfaces clean. One example is Litz, in which the strands are fine and enameled. The enamel must first be scraped off before the solder will stick, and the removal is not easy. If, however, the bared strands are dipped into alcohol and ignited, the strands will come clean and bright. Another wire which must be cleaned carefully is that which has a layer of rubber over it. Very often this wire is also stranded, which makes cleaning more difficult because of the fineness of the strands. One way of cleaning the strands is to spread them out on a flat surface and rubbing them with fine sand paper.

### SOLDERING NICKEL AND IRON

Sometimes it becomes necessary to solder iron or nickel, or alloys containing these metals. Solder will stick to iron without much trouble provided the surface is well cleaned, but to make solder stick to nickel is more difficult. But even with this metal the secret is thorough cleaning of the surfaces. However, where nickel, or nickel plate iron, forms one of two conductors that are to be joined, it is usually best to join them mechanically with screws or rivets. Fortunately, it is not often that it is necessary to join nickel conductors. It is more frequent that it is necessary to join aluminum conductors. This cannot be done with ordinary soldering methods and the simplest way is to make pressure junctions.

Where contact is made by pressure and screws it is safest to put a lock washer under the nut so that no matter what happens the nut will not work loose.

### CONDENSER TURNS WITHOUT TUNING

I have a receiver with which I cannot get down to the 200 meter limit. In fact I cannot get below 220 meters. I turn the condensers but they do not seem to have any effect. It seems to me that as long as it is possible to turn the tuning condensers there should be a decrease in the wavelength to which the circuit tunes. If you can explain the behavior of the condensers I shall appreciate it very much.—I. W.

It is possible that as the condenser rotors are turned they move toward conductors which are connected to the stator plates in some way. The capacity of the condenser proper decreases but the capacity between the rotor plates and the conductor connected to the stator increases. If these two effects just balance each other there would be no change in the tuning. There have been cases in which the capacity actually increased as the condenser plates were opened. You can bring in the short wave stations by removing a turn or two of wire from the tuned coil, and it may be that you can do this without at the same time throwing the high wave stations off the dial.

# Secret of Gang Tuning

## Equality of Inductance and Capacity Is Essential

By Edward Fitch Burroughs

**N**EARLY all modern radio receivers employ ganged condensers for tuning, all condensers being coupled to a single control knob. Any receiver that does not incorporate this form of tuning stands little chance of being accepted by the fans. For that reason even those fans who like to build their own receivers to satisfy their whims as to quality and sensitivity demand gang-controlled tuning units.

These fans frequently buy ganged condensers and put them into receivers, and they find to their disappointment that not as good results are obtained as with receivers having fewer radio frequency amplifiers in which all the tuned circuits are independently controlled. They wonder why, and quite often believe that they have picked on the wrong circuit or that they have obtained defective parts. Those who have given the subject of gang-control a thorough study wonder why they get as good results as they do. Gang tuning of several tuned circuits is the acme of simplicity when it comes to operation but it is one of the most complex of subjects when it comes to making it work electrically. And the complexity mounts much more rapidly than the number of tuned circuits on the same control.

### REQUIREMENTS OF CONDENSERS

The first essential of success with gang-controlled receivers is that all the condenser sections in the gang have the same rate of capacity change at all settings, that is, over the entire tuning range of the circuit. All the condensers do not have to have the same maximum capacity, for any differences in this respect can be compensated in the inductances. But it is better that all the sections be equal for if they are there is a better chance that all the sections will have the same rate of capacity change at every setting.

There are many reasons why the rate of change of the capacities of the sections of a gang condenser may be different. One of them, and the most difficult to control in the manufacture of condensers, is the variation in the thickness of the plates. If all the plates are cut out of one sheet of metal there will be little variation from this effect, but it is obviously impossible to make condensers in this necessarily practical way and in quantity production. Even if they are cut out of the same sheet there will be some variation because the sheet may be thicker at one side than at the other.

Another cause of variation is differences in the shape of the condenser plates. Such differences will be small, to be sure, since all are cut with the same tool, but small differences are of importance in gang-controlled condensers. As an example of differences in shape one might mention those due to wear on the tools. One plate may have been cut after the tool has been in use for some time, another may have been cut when the tool was new. That plate which was cut with an old tool may not be cut so cleanly and may have a rougher edge and even burrs. Small though the burrs may be they will have a considerable effect on the capacity.

### VARIATION DUE TO SPACING

Another source of variation is differences in spacing of the plates. The spacers may have different thicknesses for the same reason that the plates may have different thicknesses. These will inevitably have an effect on the rate of change of capacity.

It is true that in a well constructed gang condenser all these variations are minute and may be negligible if other sources of differences are eliminated. Suppose every section in a gang condenser has a capacity at every setting which is equal to that of any other section, within tolerable limits. Is there any certainty that these condensers will be the same when connected into a circuit? There is a certainty, to be sure, but in the adverse direction. There is every chance that the condensers will not be the same when mounted and connected. Hence the circuits will not tune right. The receiver will not be selective and its sensitivity will be comparatively low.

What can be done to prevent this change? One thing that can be done is to mount all the sections in similar position with respect to other conductors as far as this is possible. If the condenser is surrounded by shielding, all the sections should have the same space relation to this shielding. Likewise, every section should be placed similarly with respect to coils and tubes.

If all the sections cannot be placed similarly, the same condition should be brought about artificially by means of trimming condensers. But not all differences can be compensated for by trimming condensers, although a great deal can be done in this respect with them.

The condenser is not always to blame for differences that may exist in a circuit. That they are is merely jumping at conclusions because the condensers show up the differences. Suppose, for example, that by the aid of trimmers the condensers are all brought into step at 550 kc. Then the condenser gang is turned to 1,500 kc and the balance is all upset, requiring an entirely different adjustment of the trimming condensers. Are the condensers to blame? Perhaps partly, but most of the trouble is due to the inequalities of the tuning inductances. One coil may not have had enough inductance, thereby making it necessary to use more of the trimming condenser capacity. Another coil may not have had enough inductance, thereby making it necessary to adjust the trimming condenser to have very little capacity. The thing to do in this case is to attack the coils and make them equal.

And how can that be done? The first suggestion usually is to add or remove turns. But there is more to the effective inductance than turns. The shielding also affects the inductance, as does any conductor which may be in the field of the coil. The windings not tuned affect the inductance if the coupling is appreciable. The fact that the surroundings of a coil affects the inductance indicates the necessity of putting all the coils in similar settings as well as the condensers. Not only is the inductance of a coil changed by the presence of other conductors in the field by the distributed capacity is changed. However, this change in the distributed capacity is constant as long as the coil is fixed in position, and therefore the distributed capacity adds to the zero setting capacity of the condenser and can be compensated for by the trimming condensers.

### DUAL TRIMMING

It may be that the correct amount of inductance cannot be obtained in any case by adjusting the number of turns. It may be necessary, for example, to employ a fractional turn. This is rarely necessary when the coil is wound on a small form and contains many turns.

In view of the fact that in order to make the tuned circuits equal at every setting over the scale it is necessary not only to make the capacity rate of change the same but also the inductances, it would seem best to use both an inductive and a capacitive trimmer. The use of capacity trimming is universal but the use of inductive trimming is very rare. Yet one is as important as the other. The only reason a capacity trimmer is used exclusively is that it is easier to provide a small adjustable condenser than a small variometer. If both were used in a circuit it would be possible to adjust inductance and the capacity so that if the adjustment were made at any setting it would be equally good at every other setting. Then there would be no lack of either sensitivity or selectivity.

In selecting a gang condenser the safest thing to do is to pick one that has been made by a manufacturer that makes all the condensers for the better grade of receivers. These condensers are made to rigid specifications out of stock that has been selected for uniformity. Equality of capacity change of all the sections is thus assured. The exact value of the maximum capacity of each condenser is not of much importance because the coil to go with it can always be selected to match. However, it is important that the capacity be not too small, for if it is the broadcast band cannot be covered. The minimum should be not less than .00035 mfd.

## Smallest Number of Lines for Use in Television

**W**HAT IS THE smallest number of lines that can be used in a satisfactory system of television? I have heard of systems using as few as 20 and as many as 60 lines per frame. Is there any number of lines which gives better results than any other?—V. O. K.

There is no limit one way or the other, nor is there any one number which gives the best results. Fine pictures have been obtained by Baird on 30 lines per frame. Bell Laboratories have shown good pictures with 50 lines, and RCA have demonstrated good pictures on 60 lines. The more lines that are used the finer will be the definition of the image, and conversely, the fewer lines, the poorer the definition. As the number of lines increases the difficulty of transmission increases rapidly and requires a wider frequency band. In the Baird system 30 lines are used because in Great Britain and in Germany the signal must stay within a 10 kilocycle band.

# Piezo Oscillators

## How They Control or Establish Carrier Frequency

Washington.

**T**HE Bureau of Standards, Department of Commerce, described the testing of oscillators used at stations, in the following text:

Piezo oscillators are the most satisfactory frequency standards yet devised for use in radio broadcasting stations.

A piezo oscillator may be used either to check or to control the frequency of a radio station.

Most of the piezo oscillators tested by the Bureau of Standards are used to check the frequency of a station, because there is considerable difficulty in submitting a complete piezo oscillator intended to control the station frequency. A description of the apparatus and methods used at the Bureau in testing piezo oscillators will be given in the Bureau of Standards Journal of Research for January.

A piezo oscillator is a generator of radio-frequency current, the frequency of which is determined primarily by the dimensions of the quartz plate used.

If another radio-frequency generator is operated at approximately the same frequency, a beat note will be produced, the frequency of which can be measured with considerable precision. The measurement of the frequency of a piezo oscillator can therefore be made with high precision although the device may not maintain its frequency as accurately as may be desired.

The complete piezo oscillator must be submitted for test. Preliminary tests are first made to determine that the quartz plate operates readily and does not have one or more extra frequencies near the desired frequency. The piezo oscillator is then kept in a constant temperature room for at least two days during which the frequency is measured.

The method of measurement may be briefly stated as follows:

All measurements on piezo oscillators for broadcasting stations are made by reference to a 200-kc. temperature-controlled piezo oscillator.

In accomplishing this result, harmonics of a 10-kilocycle generator accurately adjusted in terms of the standard, are used in the setting of another radio-frequency generator to the frequency assigned to the station submitting the piezo oscillator for test. Special indicating circuits are employed to make the required settings of the apparatus. After these settings are made, a beat note usually is heard in the telephone receivers connected to the test piezo oscillator.

The frequency of the beat note is matched by comparison with a similar note produced by a calibrated audio-frequency generator. The frequency of the audio generator represents the correction to be applied to the piezo oscillator under test. At the same time that this measurement is made, a check measurement is made on the radio-frequency generator using a frequency meter. The radio-frequency generator is next readjusted to zero beat with the test piezo oscillator and another reading taken with the frequency meter.

The difference between the two readings of the frequency meter should give the same frequency as the audio generator. Under certain conditions one of the radio-frequency generators is set 400 cycles off of the required harmonic by matching the beat note with the note produced by a tuning fork.

While the method and apparatus were developed chiefly for piezo oscillator testing, they have also proved to be useful in frequency meter calibration and station frequency measurement. The system has the following advantages: Great accuracy, high precision, usefulness of a given frequency standard over a wide range, large number of calibration points available, flexibility of system and ready operation.

## Right or Wrong?

(1)—Synchronization in television can be achieved simply by sending a synchronizing impulse in the picture signal once every scanning line.

(2)—Satisfactory television images cannot be obtained with as few as 30 scanning lines per image and a speed as slow as 12.5 repetitions per second.

(3)—The trouble with television transmission at this time is that it is necessary to use a light so intense that it is uncomfortable to those who are being televised.

(4)—One of the best methods of obtaining correct grid bias for power detection is to connect a 25,000 ohm potentiometer from B plus to B minus, with the grid return of the detector to B minus and the cathode of this tube to the slider of the potentiometer. To vary the bias it is then only necessary to move the slider until best detection results.

(5)—Ganging of condensers in a superheterodyne can be done successfully by selecting the proper value of oscillator inductance and by using a small trimmer condenser across the main oscillator condenser.

(6)—Ganging of the condensers in a superheterodyne is also possible by using an inductive trimmer in the oscillator circuit.

(7)—When a 30-ohm rheostat is put in the filament circuit of two 222 tubes the current through the filaments is so small that the circuit is virtually inoperable. It is assumed that there is a ballast in addition to the rheostat and that this ballast is just right for normal filament voltage.

### ANSWERS

(1)—Right. Automatic synchronism can be achieved in this way by a very simple and ingenious arrangement devised by Baird and is used in the latest of the Baird television systems.

(2)—Wrong. In the latest Baird system the number of scanning lines per frame is 30 and the speed of repetition is 12.5 per second, and the resulting images are exceptionally good. This is due in part to the accuracy of the scanning and in part to the close synchronism and the steadiness of the reproduced images.

(3)—Wrong. The intensity of the light now used is so weak that it is not at all uncomfortable. Looking into the source of the light it appears no stronger than a moderately bright incandescent electric lamp. Of course, the brightness of the scanning spot is many times greater than the apparent brightness of the source. The weak light used is possible because of the development of more sensitive photo-electric cells.

(4)—Right. The advantages of using a resistor from the B plus terminal to the cathode has been expounded many times, and this is just one way of applying the method. Moreover, it is the simplest way of using it in a detector.

(5)—Right. It can be done easily provided that only the higher frequency of the oscillator is used for beating with the signal. The oscillator coil is made smaller than the other coils and a small variable condenser is used to take up the differences that necessarily exist.

(6)—Right. When an inductive trimmer is used both the higher and the lower oscillator settings can be utilized provided that the oscillator inductance is made equal to the inductances of the other tuned circuits.

(7)—Wrong. If a 30-ohm rheostat is used in addition to the regular ballast it can be set at zero so as to operate the tubes under normal conditions. If all the resistance of the rheostat is used the amplification will be practically nil, but that is just what the rheostat is for, that is, to control the volume.

## Winding of Coils for .000375 mfd.

**I** HAVE CONDENSERS of .000375 mfd. capacity and bakelite tubing 1.75 inches in diameter on which I wish to wind coils to fit the condensers and the broadcast band. How many turns should I put on and what size and type of wire are most suitable?—M. N. P.

The distributed capacity in each circuit will probably amount to 25 micromicrofarads so that the total capacity will be .0004 mfd. when the variable condensers are fully meshed. A suitable wire for the small diameter coil is No. 28 enamel copper. This will require 69 turns for the tuned winding. Since there may be some variation in the distributed capacity it is safest to put on a few more turns and then remove one at a time until the coil and the condenser cover the broadcast band satisfactorily. If there is a shield around the coil the distributed capacity will be considerably higher than if the coil is in the open. Hence

more turns would have to be removed when there is a shield around the coil.

The 69 turn winding is the one across which the condenser is connected, whether that is the primary or the secondary. For the other winding of the transformer the number of turns depends on the position and the kind of tube with which it is to work. If the transformer is to follow a screen grid tube and the secondary is tuned, the primary may consist of 30 or 40 turns of wire on a form which fits snugly into the main winding form. If the secondary is the untuned winding it may contain as many turns as the tuned winding, or more turns, also put on a form that fits inside the tuned winding. The untuned winding may be of fine wire. If the transformer is to follow a three-element tube the primary should be untuned and it may contain 15 to 20 turns on the same form as secondary.

# Units of Measurement

## Resistance, Capacity, Inductance, Current, Voltage, Frequency

By J. E. Anderson and Herman Bernard

**R**ESISTANCE is measured in ohms, capacity in farads, current in amperes, and voltage in volts. Wide ranges of these values are used in radio receivers, hence multiple and decimal quantities are employed to express values.

Resistance in ohms is common, as, for instance, a rheostat of 20 ohms, or a voltage divider of 25,000 ohms. Values of less than one ohm are seldom used in radio. But values in hundreds of thousands or even millions of ohms are frequent, for instance, a grid leak of 2,000,000 ohms. A million ohms are a megohm, so 2,000,000 ohms would be written as 2 meg.

A farad is a large quantity of capacity, and one millionth of a farad, called a microfarad, is a common denomination. For bypassing and filtration capacities are almost always used in units of microfarads. So the condenser next to a rectifier tube may be one microfarad, written 1 mfd. Smaller values than 1 mfd. are expressed decimally. Thus one-tenth of one microfarad would be written as .1 mfd., sometimes with a cipher preceding the decimal point, to avert typographical error, e. g., 0.1 mfd. For the same reason 2 meg. may be written 2.0 meg.

Small values of microfarads are used for tuning condensers. A common value is five ten-thousandths of a microfarad, written .0005 mfd., and spoken as triple-oh-five mfd.

### "MICRO MIKES"

A micro-microfarad (mmfd.) is one one millionth of a microfarad, hence a millionth millionth a farad. A capacity of .0005 mfd. therefore might be stated as 500 mmfd. Compensating, equalizing or trimming condensers are of such low capacity that it is usual to define the capacity in micro-microfarads. Also, the minimum capacity of a tuning condenser, representing the capacity when the rotor plates are totally unmeshed from the rotor plates, is, expressed in micro-microfarads (colloquially called "micro-mikes"). A frequent value of this minimum is 50 mmfd. (also expressible as .00005 mfd.). Therefore the so-called "zero capacity is a misnomer, as the minimum is always in excess of zero.

If the rotor plates of a tuning condenser are semi-circular and the stator plates are likewise, the variation in capacity is proportional to the number of degrees of rotation, called the angle of displacement. When dial settings of 0 to 100 are calibrated against capacity the "curve" is a straight line, and the variation is therefore called straight capacity line. This type of tuning condenser is not used in modern receivers, but was the type predominating in early receivers. However, capacity measurement devices often use the straight capacity line type of condenser.

### MODIFIED TUNING CONDENSERS

Three types of variable condensers have specially cut plates, so that when the condenser is connected across a coil a given type of preferred tuning results: straight wavelength, straight frequency or midline, which strikes a medium between straight wavelength and straight frequency lines.

The reason for special shaping of plates is to spread out the stations as to dial readings, particularly at lower capacity settings. The straight capacity type of condenser causes low wavelength stations to be crowded into a short stretch of the dial, with an awkwardly large spreadout at high wavelengths. Straight wavelength line condensers make the dial readings proportionate to the wavelength. Straight frequency line condensers cause the dial readings to be proportionate to the frequency.

While the straight capacity type condenser makes tuning in of low wavelength stations inconvenient, hence is not desirable, the selection of a remedial condenser is a matter of personal preference. The straight wavelength, straight frequency and midline condensers all offer good solutions in different ways. All three remedial types uncrowd the lower end of the dial at the expense of the upper end.

The wavelength and the frequency types have the advantage of enabling an approximate calibration of a quantity production dial in meters or kilocycles, respectively, instead of requiring resort to arbitrary numbers from 0 to 100 or 100 to 0. Hence dials calibrated from 1,500 to 550 kilocycles, or 200 to 545 meters, become practical. If you know a station's wavelength or frequency, and the station is within reception range, you can tune in the station by turning the dial to the stated wavelength or frequency.

### INDUCTANCE

The henry is the unit of inductance. Only at audio frequencies, or for B supply filtration, is this large unit used. A common audio choke coil is one of 30 henrys. In tuning coils at radio frequencies the measurement is given in millionths of a

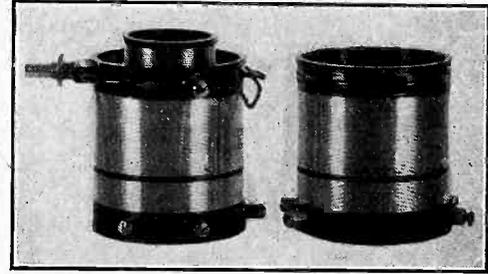

THE INDUCTANCE OF TUNING COILS IS MEASURED IN MICROHENRIES. THE INDUCTANCE DEPENDS ON THE SIZE OF THE TUBING, THE SIZE AND INSULATION OF THE WIRE AND, PRINCIPALLY, THE NUMBER OF TURNS OF WIRE.

henry, called microhenries. Hence a coil for .0005 mfd. tuning, consisting of 55 turns of No. 21 wire on a 2½-in. diameter tubing, would have an inductance of about 170 microhenries (170 mh.). Radio frequency choke coils have an inductance measured in thousandths of a henry, called millihenries. A standard value is 85 millihenries (85 mh.).

### CURRENT

An ampere is a high amount of current in radio receiver circuits. Only the filament or heater will require as much as an ampere. Plate current will be in milliamperes, which are thousandths of an ampere, except that a detector tube may draw less than one milliampere (1 ma.) plate current if the plate load is a resistor or if negative bias detection is used with any type load. One one-thousandth of a milliampere, or millionth of an ampere, is a microampere. Hence 20 milliamperes would be written .02 ampere, while two-tenths of a milliampere would be written .0002 ampere or 200 mca. (200 microamperes).

The current values are expressed in these ways for alternating and direct current.

### VOLTS

Multiples of volts are used in radio receivers. Seldom is less than a volt used. The low voltages are present on filaments or heaters, or for biasing purposes, the high voltages for the plates of tubes. Power tubes, however, particularly those of high undistorted power output, require high negative bias. For instance, the 250 tube, the largest power tube found in radio receivers and power amplifiers for home use, at 450 volts on the plate requires 84 volts negative bias. This 84 volt negative bias voltage may be higher than the voltage on the plates of radio frequency amplifier tubes in the same receiver.

### FREQUENCY

Frequency is measured in cycles. A thousand cycles are a kilocycle (kc), and a million cycles, a megacycle (mgc.). Wavelength is distance, measured in meters. A meter is about 39.37 inches. A thousand meters are a kilometer (kilo.).

Since the speed of a radio wave is 186,000 miles a second, equalling 300,000,000 meters, if we know the wavelength we can compute the frequency, or if we know the frequency we can compute the wavelength.

Suppose a man is firing a pistol, two bullets each second. Assume he shoots several bullets. We know the frequency is 2. Suppose the speed or velocity of the bullet is 100 feet a second. We now have the frequency of discharge and the velocity. If two bullets are fired each second, and the speed of the bullets is 100 feet a second, the distance between successive bullets is the velocity per second divided by the number of bullets per second, that is, 100 divided by 2, or 50 feet.

In radio the determination of the distance between crests of successive waves (wavelength) is by the same formula: wavelength equals the velocity divided by the frequency. Wavelength is symbolized  $\lambda$  (the Greek letter lambda), so the formula is written:

$$\lambda = V/f$$

where  $\lambda$  is the wavelength,  $V$  the velocity and  $f$  the frequency. Suppose the speed of the bullet, its velocity, were not known, but that the distance between bullets (50 feet) and the frequency of discharge (2) were known. What would the velocity be? It would be the number of discharges per second multiplied by the distance between bullets, or the velocity equals  $2 \times 50$  or 100 feet per second. So

$$V = f\lambda$$

# Channels Multiplied

## Stenode Radiostat Said to Permit Super-Selectivity

By Neal Fitzalan

A NEW system of radio reception whereby a broadcast channel can be reduced to a width of only 100 cycles per second is said to have been invented in London by Dr. James Robinson, former chief of wireless research to His Majesty's Royal Air Force. The new system has been named "Stenode Radiostat," the first part of which is derived from the Greek and meaning "narrow path."

In reading the description of the system one is reminded of the old super-regenerative receiver invented by Major Edwin H. Armstrong several years ago and which stirred up considerable interest in the early days of broadcasting.

It will be recalled that in theory the super-regenerative receiver worked on the principle of continuous stopping of oscillation in a detector circuit adjusted so that if left alone would oscillate vigorously. The regeneration made the circuit extremely receptive to weak radio signals due to the great reduction in the resistance in the tuned circuit. It is well known that when a circuit oscillates clear signals cannot be received. For this reason a device was introduced into the circuit which stopped the oscillation some 10,000 times every second, or at a rate which corresponded to a super-audible frequency. The regeneration in the circuit started the oscillations as many times a second. The result, in theory at least, was that full advantage was taken of the enormous sensitivity which super-regeneration afforded without at the same time suffering from continuous oscillation.

### PRINCIPLE OF STENODE RADIOSTAT

The principle of the Stenode Radiostat is somewhat similar. But before we attempt to explain it let us discuss briefly the requirements of clear broadcast reception.

The width of a channel for broadcast purposes is 10,000 cycles. It should be at least 20,000 cycles wide for the very best quality. But the limited space in the broadcast spectrum and the great demand for channels impose the 10,000 cycle condition. Good quality then calls for wider space and the demand for channel room demands a narrower space for each channel. Any device which will permit the use of a very narrow channel without any sacrifice in the quality will therefore be a welcome addition to radio.

Much has been said of sideband cutting, meaning the suppression of the higher audio frequencies contained in a modulated wave as a result of too high selectivity. It is quite possible to obtain such high selectivity that only the bass notes would be reproduced. Indeed, many Superheterodynes and some regenerative receivers have been constructed in which the selectivity was much too great for good quality. If we were to limit the space occupied by each broadcast station to 100 cycles an enormously selective receiver would be required to separate the signal of one station from the signals of other stations. And after the separation had been effected only tones of less than 100 cycles could be heard. That is, if we use the established method of reception.

### PROLONGED RESPONSE

A resonant circuit has the property of continuing its vibration for a considerable period after the exciting force has ceased to exist. The same is true of every resonant system. For example, a bell is struck once and it keeps ringing for a considerable period, and the more resonant it is the longer it will keep on ringing. The same applies to a piano string, a pendulum, a bar of steel, a tuning fork, a piece of quartz.

Difficulties arise at times when highly resonant systems are excited so rapidly that the vibration caused by one excitation has not time to die down before the system is again excited. Take a bell, for example. It is struck once and it keeps ringing. If it is struck again before the ringing has died down the ringing due to the second excitation will mingle with the ringing due to the first. There will be interference between the two, although they are of the same frequency, and the resulting noise will be a continuous din. To avoid this large resonant bells are struck at considerable times apart, or else the vibrations are intentionally killed before the bell is struck again. This is done in a piano by the damper, which is used to avoid a confusion of sounds. Doing this is more important when there are several resonant systems of different pitch to be excited at intervals.

### TUNED CIRCUIT A RESONANT SYSTEM

The disagreeable effects due to prolonged ringing of the resonant systems are very evident in carrillon playing. Here the prolongation of the vibrations are in part due to the resonance of the room in which the carrillon is and in part to the resonance of the mechanical vibrators. So-called poor acoustics

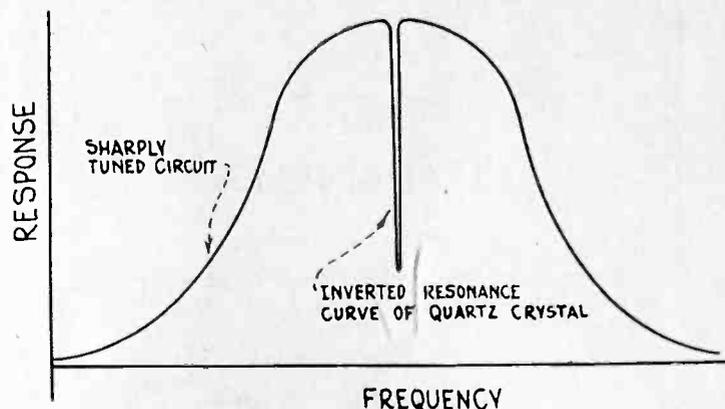

QUALITATIVE COMPARISON BETWEEN THE SELECTIVITY OF A SHARPLY TUNED ELECTRICAL CIRCUIT AND THAT OF A QUARTZ CRYSTAL. THE RESONANCE CURVE OF THE CRYSTAL IS SUPERIMPOSED ON THAT OF THE ELECTRICAL CIRCUIT AND IS THAT OBTAINED WHEN THE CRYSTAL ABSORBS ENERGY FROM THE ELECTRICAL CIRCUIT.

of auditoriums is also due to the prolongation of the vibrations by resonance, in this instance the resonance in the room.

A tuned circuit in a radio receiver is one form of resonant system. If this system is "struck" by an incoming wave it keeps on vibrating for some time, and the less resistance in the circuit, that is, the less damping, the longer it will vibrate. This continued vibration is the cause of the boominess of many selective receivers. It vibrates by resonance only at the frequency to which it is tuned, or to frequencies very close to this frequency. It is tuned to the carrier frequency but not to any of the side frequencies. It is, however, nearly tuned to the side frequencies representing the low audio notes, and only roughly tuned to those side frequencies which represent high audio notes. Hence the low notes are prolonged and intensified more than the high.

A high resonant system does not respond as quickly as a non-resonant system, although the final response of the resonant system is enormously greater than the final response of the non-resonant system. This has a direct bearing on the speed of signalling with systems involving resonant circuits. With a non-resonant system the possible speed is practically unlimited, but it requires a very great force to conduct the signalling. With a highly resonant system the possible speed is slow, but it does not require much force to conduct the communication. It is necessary to wait for the response to build up and down before another impulse can be transmitted. In a non-resonant system it is not necessary to wait at all.

Voice communication requires a fairly high speed of signalling, say 5,000 impulses per second. Broadcast communication involving true realism of speech and music requires a still higher speed, say 10,000 or 20,000 impulses per second. Television of good quality requires a still higher speed, say 50,000 to 100,000 impulses per second. For this reason non-resonant circuits, as far as possible, are used for television. Of course, it is not practical to dispense with all resonance in the receiver.

### SUPER-SELECTIVE SYSTEMS

There are many systems which are extremely selective. Perhaps the most resonant system yet discovered is the quartz crystal used as frequency control in most modern transmitters. In getting an idea how resonant a good quartz crystal is, a comparison is useful. Suppose we take the best possible tuned circuit and plot its resonance curve, spreading out the frequency scale so that the top of it is sensibly flat over a considerable region. Then if we superimpose the resonance curve of a quartz crystal on this it will look like a straight vertical line, with scarcely any separation between its two branches. A steel bar is another highly resonant system but it does not compare favorably with a quartz crystal.

The idea back of the invention of Dr. Robinson is the use of extremely resonant circuits, intentionally producing the prolongation of the response which we discussed in conjunction with the bells, and then introduce a periodic stopping of the vibration, that is, to introduce a device which does electrically just what the hand does in stopping the bell from continuing ringing, or what the damper does in the piano. The details of this device are not available at this time, pending patent applications throughout the world.

# Heat Causes Crackles

## Condensers Break Down Due to Poor Ventilation

By Herbert E. Hayden

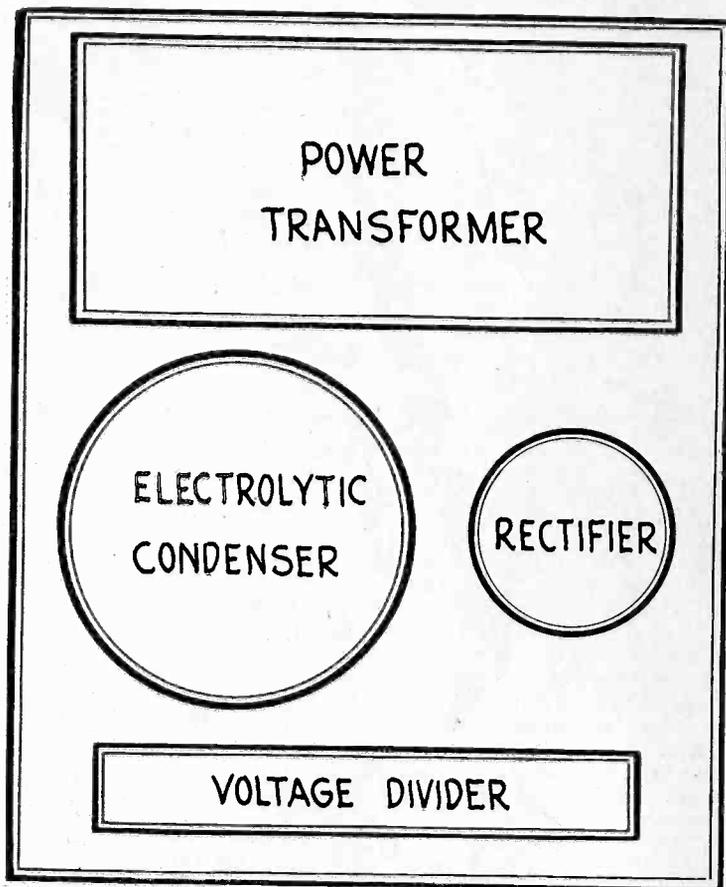

A POOR ARRANGEMENT OF THE PARTS IN A B SUPPLY UNIT. THE ELECTROLYTIC CONDENSER IS HEMMED IN BY THE POWER TRANSFORMER, RECTIFIER TUBE, AND THE VOLTAGE DIVIDER. IT IS SURE TO OVERHEAT.

QUITE often owners of home-built receivers, and at times those of factory make, find that a severe crackle develops in the output after the receiver has been in operation for half an hour or so. What is the cause of this trouble?

Undoubtedly there are many causes which could account for the crackling, but there is one that is to blame more than any other, and that is excessive heat. The heat in the receiver gets so intense that the wax in by-pass condensers and transformers softens or even melts and so that the electrolyte in electrolytic condensers boils.

When the receiver is first turned on the parts are all cool and the operation is as it should be. The output sound is pure and free from any crackling. But as the receiver functions the parts heat up and the crackling develops. Usually the trouble is in the B voltage supply where most of the heat is developed.

### PREVENTING CRACKLES

In order to prevent the occurrence of crackling it is essential that the circuit be built so that any part that contains insulators which may melt is far away from the heat-generating parts, or so that there is ample ventilation.

Perhaps the greatest source of heat in the receiver is the power transformer. Frequently it gets so hot that it is impossible to put a hand on it and leave it there for more than a second. Such heat is great enough to melt many waxes used as insulators in condensers. Hence condensers should be kept away from the power transformer.

Another prolific source of heat is the rectifier tube. This is always so hot that it will burn the hand that touches it. However, this does not mean that more heat is generated in the tube than in the transformer. It means that it does not radiate the heat so well because it has less radiating surface, and usually poorer radiating surface, too. The heat generated in the filament of the 280 rectifier tube is equivalent to that of a 10-watt electric light, since the filament requires this power. There is additional heat generated on the plates of the rectifier tube, which may be as high as 5 watts. Thus the total would be about 15 watts. This is small in comparison with the power required by the average light in a house, but it is large when one considers that all the heat generated is often kept in a confined space.

Considerable heat is also generated by the amplifier tubes in

the receiver, both on the filaments and on the plates. That this is true can be verified by touching any one of the tubes in the receiver. The power tube, particularly, is much too hot to touch.

The total power required by a modern receiver is probably in the neighborhood of 75 watts. Many sets are so rated. Now a 75-watt light in the house generates a good deal of heat. It is not noticed because it is usually far away from any observer and is well ventilated. Hence it does no harm. But when the same amount of heat is generated inside a small radio cabinet with inadequate ventilation it is enough to do a considerable damage to the more fusible substances such as rubber, sealing wax, insulating wax and varnish.

In a half hour a 75-watt light, or a radio receiver of equivalent rating, will generate 32,400 calories, which is sufficient heat to raise the temperature of a third of a quart of water from 32 to 112 degrees Fahrenheit, that is, to raise the temperature from freezing to boiling. It is also sufficient to melt, or at least to soften, a considerable amount of wax used in by-pass condensers, and that is just what it does in many radio receivers.

Suppose a wax-filled or an electrolytic condenser is placed in actual contact with the case of the power transformer or in very close proximity with the rectifier tube in the power supply. Much of the heat generated in the transformer or in the tube will then be transferred to the condenser. If it is a wax-filled condenser the wax will soften and the insulation will not be as good as when it is solid. The filtering will be imperfect. Likewise if the condenser is of the electrolytic type the electrolyte will become hot and the performance of the condenser will be less satisfactory.

One thing that frequently occurs is that the electrolyte expands and exudes through the crack between the copper can and the insulator on top. The electrolyte forced out will dry and leave the salt on the top. This is the cause of the accumulation of white substance on top of these condensers. Fans whose condensers have formed such accumulations of salt have assumed that the condensers were defective, whereas the fact is that the layout of the power supply instead has been defective, or the ventilation of the device has been inadequate.

### HEAT IN VOLTAGE DIVIDER

Another source of heat in the B supply is the voltage divider. There have been cases in which this device has become so hot as to char woodwork. It is a wonder that fires have not been started in this manner. This condition was recognized a long time ago and it was rectified. Voltage dividers were made larger so that there was a greater radiating surface from which the heat could escape, and at the same time the resistance strip was mounted so that the heat could escape by convection, that is to say, by a draught of air. The chimney effect was brought into play. Moreover, asbestos was placed between any material which would be damaged by excess heat and the voltage divider.

It is not enough, however, to treat the voltage divider alone in this manner. Every part in which considerable amounts of heat are produced should be treated in the same manner. But putting asbestos protectors in strategic positions in no way eliminates the heat. It still remains in the cabinet unless it is carried away by radiation from the external surfaces of the cabinet or by convection through holes cut in the cabinet for that purpose. The amount of heat that can be carried away by radiation from the external surfaces is negligible in the case of wood cabinets, for the heat must first get to these surfaces by conduction through the wood, and wood is a very poor heat conductor. In metal cabinets a little more heat is carried away in that manner because heat travels easily in metal, just as electricity does. The radiation is further enhanced if the external surfaces of the metal are painted black.

Most of the heat that is produced inside the cabinet must necessarily be carried away by ventilation. Hence the cabinet should be provided with air vents both at the bottom and at the top, the bottom holes for cold air to enter and the top holes for hot air to escape. If this is not done the condensers inside will get overheated whether or not they are protected locally by asbestos or other stuff.

And if the condensers get overheated the receiver will crackle half an hour or so after it has been turned on.

When a condenser is called on to carry a heavy alternating current, such as a strong signal current, there will be internal heating which will have the same effect as if the heat comes from the outside of the condenser. There are two condensers which often break down from this effect, and they are the condenser in series with the loudspeaker and the large condenser across the voltage divider. This is another reason why the receiver should be well ventilated to prevent condenser breakdown and crackles.

# HB 44 Efficiency Data

## Trouble-Shooting in Screen Grid Receiver Is Explained

**S**ELECTIVITY and sensitivity are like a see-saw. When one goes up, for a given number of similarly tuned circuits, the other goes down. Therefore, the HB44 was so designed that the selectivity was abundant.

The sensitivity is most marked below 400 meters, and it is in this range that most of the distant stations come in, plenty of them, with clear-cut separation among them.

On the higher wavelengths there is less sensitivity but more selectivity, because the amplification is less the higher the wavelength, a condition known as the rising characteristic of tuned radio frequency, since the higher the frequency the higher the amplification.

At higher wavelengths selectivity is higher, another natural characteristic, unless altered by regenerative effects on lower wavelengths, an intrusion, by the way, which often works in a most favorable direction.

### MAY DOUBLE ANTENNA TURNS

Since there is selectivity to spare, any who desire to build up the volume on the higher wavelengths may do so by winding more turns on the primary of the antenna coupler. The number of turns is not critical at all. Even if there are around 40 turns now on the 1 $\frac{3}{4}$ -inch diameter tubing used, you may safely double the number of turns.

This will bring in the highest wavelength stations with suitable volume in those locations where this special treatment is necessary, due to weak field strength of some high wavelength stations.

For instance, in many parts of New York City and its suburbs, WEAJ comes in very weakly, also WNYC and WMCA, but the location difficulty may be circumvented this way.

### USE PICTURE DIAGRAM FOR WIRING

The design as published in picture form on the following two pages should be followed, but for reading the circuit in conjunction with text, the schematic diagram is preferable, because better subject to glance reading. It takes time to follow the connections of a picture diagram, while a schematic reveals itself at sight. Yet in building any receiver, of course the picture diagram is the thing. It shows you where each part is and where each lead is connected.

It will be found that the negative bias applied to the radio frequency amplifying tubes 1, 2 and 3, is rather critical, so the Clarostat Humdinger should be adjusted for maximum volume, even though the moving arm has to be placed at one extreme end. At worst, you can not fail to use at least 12 ohms of resistance, as the device is built that way, and at the current flowing in the section of the voltage divider of which the adjustable resistor is a part, the resultant minimum bias is about 1 volt. This would be enough, although the rated voltage is 1.5 volts. The object is to attain the best sensitivity level, let the bias be what it may, since it is confined to authentic limits by the constants of the parts.

### HIGHER SCREEN GRID VOLTAGE

There need be no hesitancy in using a higher voltage on the screen grids than that shown. The potentiometer's side that goes to plus 50 volts, equal to the midtap of the power tubes' filament winding, may be connected to the next highest lug. But do not move the bias for the power tubes to this lug. If any experiments are to be made with biasing, moving the filament center connection on the voltage divider down, rather than up, one lug.

The voltages obtained should come near to the rating. As for the filaments, there will be no trouble here, since all filaments, save the 280 filament, take 2.5 volts and the power transformer windings have ample current capacity. The 280 filament voltage is 5 volts, and should be tested with all tubes out of the receiver, even the 280 out of its socket, and a plug-in tester put into the 280 socket. The only reading you will get this on most testers is the filament voltage, but having determined this to be 5, you need investigate this point no further.

The screen grid, plate and bias voltages may be measured, using a high resistance voltmeter. The total voltage across the divider will be around 300 volts, but if it is even 10 per cent more or less, it is not important.

### BIAS COMPUTED

The drop between the power tube filament winding's center tap and ground should be around 50 volts. If you get a reading much different from this, measure the plate current of one of the power tubes under existing voltage conditions. Since

this tube is a 245, the total voltage across the divider being 300, the bias voltage will be 50 if the plate current is 32 milliamperes in the single power tube tested. The other power tube, since this is push-pull, must be in circuit while this test is being made, and so must every other tube in the receiver.

The reason for a wrong reading of bias voltage likely would be too low a resistance voltmeter, so the computed bias on the basis of known overall B voltage, and plate current in one power tube, is an ample substitute for use of a poor meter. But if you have a high-class meter use it, since you will get an accurate reading, and it will jibe with the computed value, unless there is something the matter with the tube.

### HUM ERADICATION

A small amount of hum has to be tolerated, because the circuit amplifies the low notes well, and hum is in the low-note region. But when the program is being received the hum becomes inaudible by comparison. Nobody would notice it while anything was being played, sung or spoken. Even when the carrier alone is on for a moment or so, while an announcer or a program halts, the hum isn't more than feeble, because the filtration is particularly good.

So if you are troubled with excessive hum, first look to the filter condenser, the one next to the rectifier, and be sure that it is not of large capacity. In this circuit 1 mfd. was recommended and this should be used.

Test the power tubes under equal conditions, that is, work both, measure the plate current of one, then, turning off the set, interchange tubes in the push-pull sockets, so that the other tube is now in the same socket used previously for testing. The plate current should be approximately the same, and the deviation should not exceed 1.5 milliamperes. Unbalance of this sort is provocative of hum, so use two 245 tubes that draw the same plate current under the same operating conditions, even though the difference may be due only to one tube having a little better emission than the other.

Sometimes a .00025 mfd. condenser connected across a half-section of the secondary of the push-pull input transformer will reduce hum. Try one section, then the other. The one on which the trick works is the one on which the condenser should be left.

### OPEN GRIDS

The most frequent cause of hum in home-constructed receivers, it is sad to relate, is not anything wrong with a diagram or the parts used, but with the wiring, whereby a grid circuit is left open.

Either in the radio, detector or audio circuits, if there is an open grid there is an open season for humming. It is hum of the worst type, in that it is always objectionable, and further it starts loud and gets louder and louder, then less, or starts low and gets louder and louder and then recedes again, behaving thus all the while the circuit is operated. Close up the grid circuits properly and your hum will disappear if due to this cause.

### RESONANT HUM

Resonant hum is often due to detection in radio frequency amplifiers, remedied by lowering the bias on these tubes, as may be done with the Humdinger, or by introducing an extra audio frequency filter in the B plus lead going to the plates of the RF tubes. A 30 henry choke intercepts this lead, for RF only, and a 1 mfd. or higher condenser is connected from the end of the plate coils of the receiver to ground. Resonant hum is the type that appears only when you tune in a station.

## How Can Voltage Leak Over Insulator's Surface?

**I** READ IN a book on radio about leakage of voltage over the surface of an insulator. Could you tell me what that means? I understand how current can leak through an insulator, but how voltage can leak is beyond my comprehension.—A. A. J.

It is also beyond our comprehension. The one who made the statement probably did not have a clear conception of voltage or he would have confined himself to current leakage. If a condenser is charged to a certain potential difference between the plates, that is to say, to a certain voltage, and if that condenser leaks, a small current will flow from one plate to the other through the insulation, and this flow will continue as long as there is a voltage difference. At any time the current leakage is proportional to the voltage difference. As the current flows the voltage difference decreases, and perhaps it is because of this fact that the idea of voltage leakage is entertained by some.





A Question and Answer Department conducted by Radio World's Technical Staff. Only Questions sent in by University Club Members are answered. Those not answered in these columns are answered by mail.

# RADIO UNIVERSITY

Annual subscriptions are accepted at \$6 for 12 numbers, with the privilege of obtaining answers to radio questions for the period of the subscription, but not if any other premium is obtained with the subscription.

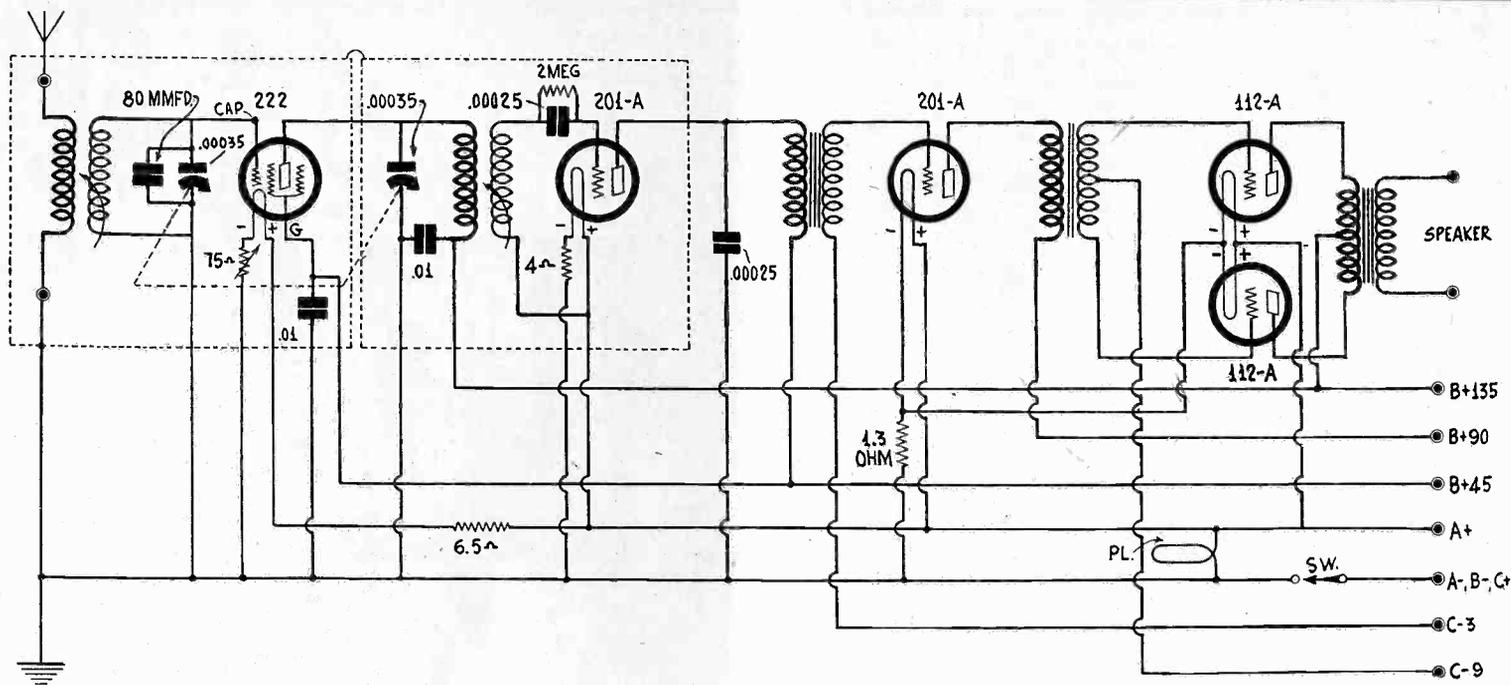

FIG. 822  
A SCREEN GRID TUBE FOR HIGH SENSITIVITY AND PUSH-PULL FOR A HIGH UNDISTORTED OUTPUT ARE INCORPORATED IN THIS BATTERY-OPERATED RECEIVER.

### DC PUSH-PULL RECEIVER

**K**INDLY PUBLISH a diagram of a four-stage, push-pull receiver with one screen grid tube and two 112A tubes in the push-pull. The set is to be operated with storage battery and a B supply unit.—J. B. K.

You will find such a receiver in Fig. 822 above. All the components are specified except the tuning coils. They are the Bernard dynamic tuning coils for the condensers specified. Of course, the circuit can also be built with ordinary tuning coils provided that they fit the condensers used. Note that the primary of the interstage coil is tuned.

### SET HAS LOST ITS SENSITIVITY

**S**OME TIME ago I built the Diamond of the Air, one stage of resistance coupling and one stage of transformer. At first this set worked very well and gave good quality. Recently it has failed to work at all. When I first turn on the power there is a peep and then the set dies entirely. I have tested all the tubes, measured the voltages, and tried different values of grid leak without results. What do you think is the matter with the set?—K. W. J.

It sounds like a case of defective leakage in one of the grid circuits. It may be in any stage but most likely in one of the audio, possibly the one that is preceded by a resistance coupler. The trouble may be due to insufficient leakage through the grid leak or to too much leakage from the plates to the grid. One of the grid circuits may actually be open. To test this condition measure the plate currents in all the tubes. You may find that while the peep is heard the plate current is normal in all the tubes and that when the set is dead the plate current in one of the tubes is either zero or very much too high. This condition is often met in resistance coupled amplifiers.

### ENERGY LOSS IN SHIELDS

**I**S IT NOT A fact that the shields used in modern receivers reduce the sensitivity and the selectivity? If it is a fact, why are shields used?—A. W. S.

Yes, it is a fact. The reduction in the sensitivity and the selectivity is greater the smaller the shields are with respect to the size of the coils inside them. They are used despite this reduction because the receiver would not work without them. The feed back from one stage to preceding stages would be so great that the circuit would oscillate uncontrollably, and when it does it is of no use in receiving signals. So the shields introduce losses which result in overall gain. Of course, if the shields are too small the losses may be greater than the gain,

in which case it would be better to remove one stage so that more room can be given to the remaining stages, especially more to the coils in the shields. It is because the relative sizes of the coils and the shields count that small coils are used in shields of given size. Better overall results are obtained with coils of small size than with coils of large size, although by themselves the larger coils are superior to the smaller.

### RECEIVER HUMS ON SUNDAYS

**O**N HOLIDAYS, Sundays, and late at night my radio set hums with such intensity as to ruin a program that is received with ordinary volume. At other times while there is a hum present it is not too objectionable. This type of hum has been received on several other sets I have built. On an all battery set I could eliminate it by pulling the service switch on the house current. This is obviously impossible on a AC set. All sets have been regenerative, and it seems to make no difference whether the audio is transformer, impedance, or resistance coupled. Apparently the hum occurs only when the load is lessened on the city current. What is the cause and is there any remedy for this condition?—H. A. G.

Undoubtedly this trouble is due to oscillation or excessive regeneration. The hum from the line is picked up by the receiver and is intermodulated with the radio frequency current in the receiver, and then amplified together with the desired signal. This happens in nearly all regenerative receivers or in receivers in which there are parasitic oscillations. The remedy is to prevent regeneration. The reason it hums more when the load on the line is partially cut off is that the voltage rises to a point where oscillation begins.

### USING BATTERY FOR FIELD CURRENT

**I**HAVE a dynamic speaker operated with AC and a built-in rectifier. Is it possible to connect a 90 volt battery across the field winding in place of the rectifier?—A. C. Q.

Dynamic speakers operated with AC usually have fields of low resistance because the rectifier used supplies power at low voltage and heavy current. If you were to connect a 90 volt battery across the low resistance field winding the current would be very high and both the battery and the field winding would be ruined in a few minutes. Probably the speaker would start to burn. However, if the rectifier used with the speaker is of the high voltage type, whether it is a tube or a dry rectifier, the field winding would be of high resistance and it would be safe enough to connect a 90 volt battery across it. But the battery would not last very long.

**RECEIVER WEAK ON STRONG STATIONS**

**I**N MY LOCALITY the long wave broadcast stations are much stronger than the short wave stations, yet with my receiver I can get the weak stations much better than the strong. What is the cause of this peculiarity of my set?—  
J. E. W.

That is not a peculiarity of your set at all. It is a property of all radio receivers unless special design has been done to equalize the sensitivity. Radio frequency transformers are much more effective at the short wave stations. If you want to bring up the sensitivity of the receiver at the long wave stations you can do so by adding turns to the primaries of the RF transformers, if they are untuned, or to the secondaries, if they are untuned. The greater the number of turns the greater will be the sensitivity at all frequencies, until the number is so high that the distributed capacity of the untuned winding reduces the response at the high frequencies. The coil form will be full long before this happens. The number of turns can also be increased on the antenna coil so as to increase the pick-up. If this results in too great sensitivity on the high waves it is a simple matter to put a small condenser in series with the antenna. This condenser may be as small as .0001 mfd.

**INTERESTED IN SUPERHETERODYNES**

**I** AM INTERESTED in superheterodynes and should like to know how it is possible to determine where the repeat points can be expected on the dial. I realize that in every superheterodyne such repeats are present and that they cannot easily be avoided. What relation is there between the intermediate frequency and the points on the dial where the repeats appear?—P. W. A.

The repeats come in on the oscillator dial at points representing a frequency separation equal to twice the intermediate frequency. For example, suppose that the intermediate frequency is 50 kc and a station operating on 600 kc is tuned in. This will come at a point on the dial representing 550 kc and again at a point representing 650 kc. The difference between these two points is 100 kc, which is twice the intermediate frequency. It will be noted that one of those points falls on the end of the tuning range of the receiver, assuming that it just covers the broadcast band. Any station operating on a frequency lower than 600 kc can only be received at one setting since all the others would be outside the tuning range.

If the intermediate frequency is 50 kc as assumed above it is clear that a station operating on 700 kc will come in at 650 kc as well as the station operating on 600 kc. There would be image interference between these two stations if they should happen to be within reception range of the receiver. Any other two stations operating 100 kc apart would be subject to image interference, except those operating on frequencies below 600 kc.

The higher the intermediate frequency of the superheterodyne the wider is the region in which there is no interference of broadcasting stations. For example, if the intermediate frequency is 200 kc the repeat points come in 400 kc apart and there cannot be any image interference below 750 kc. Thus there would be 20 channels which would be free from image interference. When the intermediate frequency is only 50 kc there are only five channels which are free.

**RECEIVES WITHOUT AERIAL**

**W**HAT IS THE USE of having an aerial on a receiver when I can get all the stations I want without any aerial at all and no ground? The only thing that an aerial seems to do to my set is to make it less selective.—F. R. C.

There is no use at all in your case of having either an aerial or a ground. You are fortunate in having such a good receiver. There are not many sets that can be operated satisfactorily without either an antenna or ground, or both. As a matter of fact you are not really operating your set without antenna and ground because some of the wiring of the set acts as an antenna and some other part acts as ground or counterpoise.

**SIZE OF BAFFLE BOARD**

**W**HAT IS THE VERY BEST size of baffle board to use with a push-pull radio receiver and a dynamic type loud-speaker? Upon what does the size depend, that is, what factors enters into the determination of the size?—W. H. D.

The very best size in any case is a baffle board of infinite extent. Naturally, this is not the most practical size since it is not possible to realize it. The next best thing to an infinite plane baffle board is a large wall with the speaker placed in the middle. When it comes down to baffle boards of reasonable and practical dimensions there is no definite rule to go by in selecting the size. There is one quite definite rule and that is that the side of a square baffle board, or the diameter of a circular baffle, should be at least equal to one quarter of the wavelength of the lowest tone it is desired to receive with full intensity. But even that is not very definite because there is no agreement as to what the lowest frequency should be. Some may put this at 30 cycles, and they would require a very large baffle board; others may put the lowest note at 60 cycles, and they would only need a baffle board one-half as large in linear dimensions as those who demand full volume on 30 cycles. For a 60 cycle lower limit the board should be 4 feet 7 inches square, or its

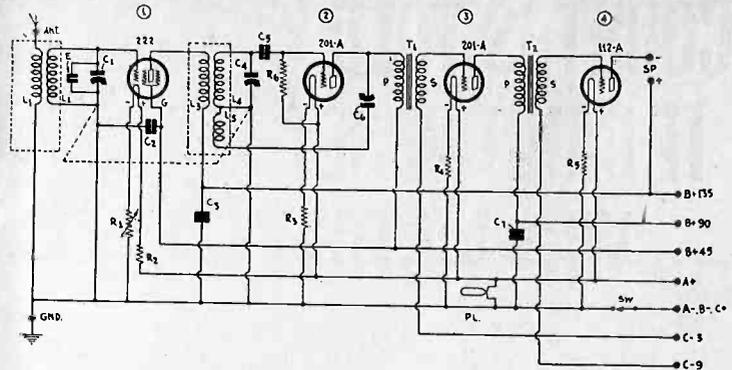

FIG. 823

THOSE WHO WANT A SIMPLE RECEIVER THAT COMBINES SENSITIVITY AND ECONOMY OF OPERATION WILL FIND THIS CIRCUIT SUITABLE FOR BUILDING.

diameter should be that. For a 30-cycle lower limit the corresponding dimension should be 9 feet 2 inches. These dimensions are based on the supposition that the velocity of sound in air is 1,100 feet per second, which is about right at ordinary room temperatures.

When the lower frequency limit is set at 60 cycles it does not mean that 30-cycle tones cannot be heard if they are impressed on the speaker. It means that they will be much weaker than if the larger baffle board were used.

**SIMPLE BATTERY RECEIVER**

**W**ILL YOU PLEASE publish a simple four-tube, battery-operated receiver using one screen grid tube as radio frequency amplifier. I prefer a regenerative circuit with transformer coupling. Please specify the tubes to be used.—  
K. W. J.

Fig. 823 is a good circuit which fits your description of what you want.

Join

Radio World's

**UNIVERSITY CLUB**

And Get Free Question and Answer Service for the Coming 52 Weeks. This Service for University Subscribers Only

Subscribe for RADIO WORLD for one year (\$2 numbers). Use the coupon below. Your name will be entered on our subscription and University Club lists by special number. When sending questions, put this number on the outside of the forwarding envelope (not the enclosed return envelope) and also put it at the head of your queries. If already a subscriber, send \$6 for renewal from close of present subscription and your name will be entered in Radio University.

**NO OTHER PREMIUM GIVEN WITH THIS OFFER**

[In sending in your queries to the University Department please paragraph and number them. Write on one side of sheet only. Always give your University Club Number.]

RADIO WORLD, 145 West 45th Street, New York City.

Enclosed find \$6.00 for RADIO WORLD for one year (52 nos.) and also enter my name on the list of members of RADIO WORLD'S UNIVERSITY CLUB, which gives me free answers to radio queries for 52 ensuing weeks, and send me my number indicating membership.

Name .....

Street .....

City and State.....

If renewing subscription, put cross here.

# COURT IS TOLD IT CAN'T UPSET WGY VICTORY

Washington.

The Supreme Court of the United States is powerless to upset the victory gained by WGY, Schenectady, N. Y., in the Court of Appeals of the District of Columbia, which victory granted full time to the station, although the Federal Radio Commission had allowed only part time under the November 11th, 1928, reallocation.

## New York's Contention

This contention was made in a brief filed by the People of the State of New York, through Hamilton Ward, Attorney General of that State.

The case is before the Supreme Court on a writ of review obtained by the Commission in an attempt to have the lower court's decision overturned. This remedy is known as certiorari.

The station is owned by the General Electric Company and operates on 790 kilocycles.

In the brief New York contends that although the United States Supreme Court has granted the petition for a writ of certiorari, that the Supreme Court has no jurisdiction to review the case, since the judgment of the court of appeals was an administrative judgment and not subject to review.

## Cites Deprivation

The contention also is set forth that the people of the State are parties in interest. In support of this contention it is argued that the Federal radio act conceives of a State as a party interested in radio licensing.

Supporting the contention that the limited license issued to WGY would not give the broadcasting service which public convenience, interest or necessity require, the brief argues that New York has the greatest system of hospitals in the country, most of which are located at or near Schenectady and depend on WGY for their radio programs.

## New Volume Control Announced by Electrad

A new high voltage volume control was announced by Electrad, Inc., of 175 Varick Street, New York City. It is the Model B Super Tonatrol, particularly adapted for use by manufacturers on account of its compact size and clever arrangement whereby, if desired, two completely isolated circuits may be controlled by one shaft. Single control units are also supplied.

Model B Super Tonatrol (illustrated) has the same general construction and operating characteristics as Model A announced six months ago. The contact is a pure silver multiple type which floats over the resistance element with smoothness and which grows smoother with use, owing to a microscopic deposit of silver from the contact on the resistance element. The specially developed resistance element itself is fused at high temperature to the surface of a vitreous enameled metal plate. The result is greater permanence and accuracy of resistance values and more rapid heat dissipation. Laboratory tests equivalent to more than ten years' average use failed to produce

## Vatican to Erect Message Station

Washington.

A radio station is to be erected by the Holy See in a part of the Vatican territory previously intended to be used as a Vatican airport, according to a report from Vice Consul Donald C. Wilcox, Rome, made public by the Department of Commerce.

Apparently the Vatican State has not abandoned the idea of having its own landing field, but at present it is considered more important to set up a wireless station for the prompt transmission and reception of official communications.

## FEAT IGNORED, INVENTOR DIES

Vienna, Austria.

Otto Nussbaumer, according to the Austrians, the inventor of wireless telephony as well as the first person to discover the detecting properties of crystals, died at Salzburg. He was 54 years old.

Twenty-five years ago he was doing research work in Graz University when he discovered a method of transmitting speech and music by electrical waves over short distances. While the received signals were quite audible they were not clear.

The system devised by Nussbaumer is quite unlike the system invented later and which now is basis of all broadcasting throughout the world. The university authorities decided that he had performed an interesting scientific trick of no practical value and experiments had to be suspended for lack of funds.

Nothing was known of Nussbaumer's pioneer work until the occasion of the Austrian broadcasting jubilee last year, when Professor Ettenreich of Graz told the story which the inventor himself had been too modest to publish.

During the years of broadcasting's growth Nussbaumer watched that growth with quiet delight, but he never even uttered a single word suggesting that he and his confidantes had let a precious invention slip through their fingers.

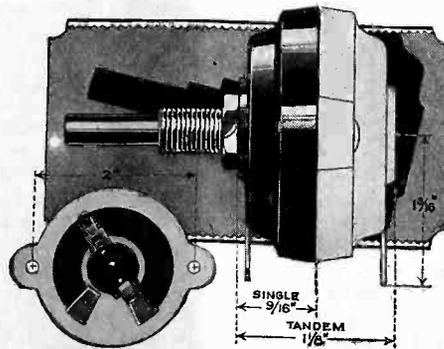

any material signs of wear or variation in resistance value and showed a practical immunity to changes in temperature and humidity.

An advantage offered by the dual or tandem type Super Tonatrol is that a tapered resistance can be used in the antenna circuit, while a uniform resistance, operated for the same shaft, can control the grid circuits.

# STOP PROFANITY ON AIR, DEMAND OF LAWMAKERS

Washington.

The use of profanity on the air is growing, and laws to prohibit it should be enacted, said Representative Lankford, (Dem.), of Douglas, Ga.

Steps against profanity over the radio were advocated by Senator Dill (Dem.), of Washington, in calling the attention of the Senate to a telegram sent by L. K. Watrous, of Minneapolis, Minn., to the Federal Radio Commission, containing allegations against KWKH, of Shreveport, La.

The telegram to the Commission, follows in full text:

"Henderson Shreveport station KWKH quotes you as saying you have no right to censure his talk or inclination to do so. Certain it is public decency and respect of society in general, as well as best interests of child welfare, should at least move you to stop his constant cursing over air. If you cannot at least protect the radio public and the welfare of child life in preventing his soiling the air with filthy, unnecessary words and expressions, you should step aside and let more active men protect the inspiring standards of American life and so perpetuate the high standards set by all other radio stations on the air. Do you intend to let this one exception prove definite Governmental weakness as quoted by Henderson last night?"

## Dill's Reply

In the Senate Senator Dill said:

"I have inquired of the members of the Radio Commission in order to learn whether or not the statement to the effect that the Radio Commission considers it has no power to stop the use of profanity and obscene language over the air is correct, and I am told that that is the attitude of the majority of the Commission.

"Public interest alone would be sufficient to justify the Radio Commission in putting a stop to the use on the air of terms and phrases of profanity, but the law specifically makes it a crime for anybody to use profanity over the air from a radio station."

## Quotes Law

Senator Dill then read from section 29 of the law of 1927 relative to radio, which states that "no person within the jurisdiction of the United States shall utter any obscene, indecent, or profane language by means of radio communication." He stated that a penal provision is attached to this law.

"The Radio Commission, if it feels it cannot take action by revoking or suspending a station's license, ought to call upon the district attorney of the community to enforce the penal provision of the law," Senator Dill said.

## Improving, Anyway!

PLEASE accept this note to mean that I really think RADIO WORLD is improving and has some helpful articles of late.

I appreciate your efforts.

Earl Walrod,  
Tulsa, Oklahoma.

# BILL CALLS FOR STATIONS' SALE TO GOVERNMENT

Washington.

Representative Lankford of Georgia introduced a bill for government ownership and control of all radio communications under a proposed Department of General Welfare. Concerning the bill he said:

"My bill is to create a department of general welfare with authority and funds to control all radio communications within the United States for the use of the three great branches of our Government and for the use and benefit of the public schools, churches, and all other legitimate assemblies, groups and organizations of American people.

"The department would also be authorized and required to prepare, secure and provide such movie films as may from time to time be needed and requested by the Departments of Government and the organizations just mentioned.

## Means Much to Schools

"The bill carries provision for the Federal Government paying 50 per cent of the cost of free school books for the children of the Nation.

"The bill would enable the Government by and through the radio and motion picture to do much more effectively and cheaply what is now attempted in hundreds of ways.

"There is nothing that would mean so much to the public schools and to all the people. The general welfare of everyone would be greatly promoted.

"Under the scheme of the bill, the Government would own and control all radio communications. Why not? What about the freedom of the air? Why not the radio, with all its miraculous possibilities, be owned and operated by all the people for all the people?

## Wonderful Possibilities

"In the movie field the department would only furnish whatever high class films might be required for the schools, churches, lodges, and various organizations of the country. Private enterprise could operate wherever there is demand for their activities.

"The Government would only attempt to furnish clean, high class, instructive, beneficial entertainment to the people.

"I feel that there are wonderful possibilities in the operation of a department of general welfare as here proposed."

## Universal is Sued By RCA on Patents

Buffalo, N. Y.

Suits charging infringement of patents used in radio communications apparatus have been filed in Buffalo, and Newark, N. J., by the Radio Corporation of America against the Universal Wireless Communication Co.

In the Buffalo case three bills of complaint were filed in the United States district court, alleging infringement of six patents relating to vacuum tubes, crystals, and their circuits. The New Jersey case is based upon the De Forest feed-back patents, and was filed with the United States District Court for the District of New Jersey.

District Judge William N. Runyon, of the New Jersey court, signed an order to show cause.

## DE FOREST ELECTED HEAD OF I. R. E.

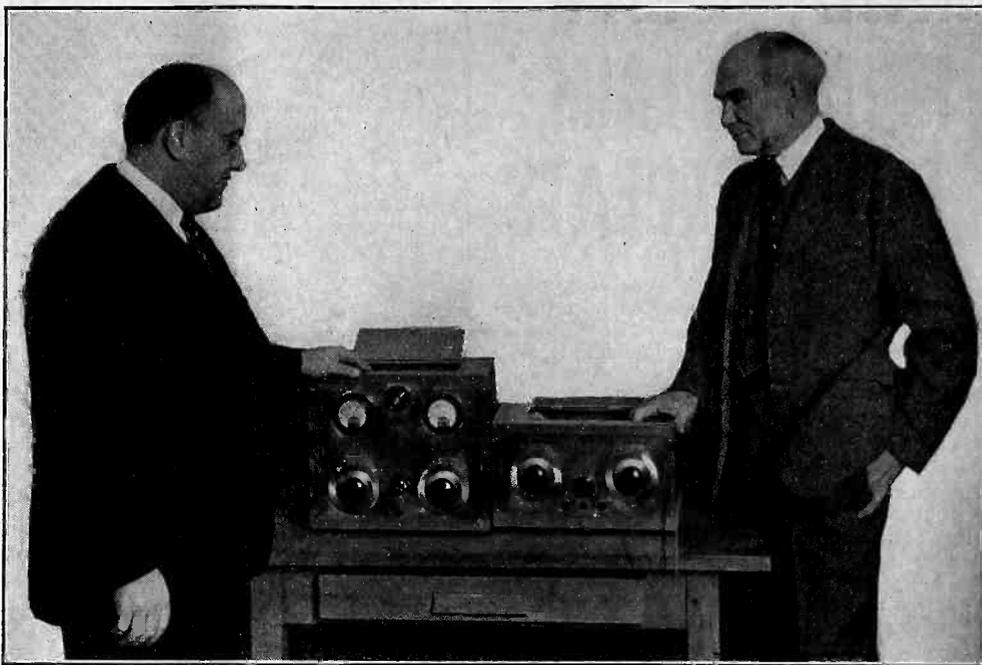

Wendell Buck

DR. LEE DE FOREST (RIGHT) AND LOUIS GERARD PACENT, PIONEERS IN THE RADIO FIELD. DR. DE FOREST WAS ELECTED RECENTLY AS PRESIDENT OF THE INSTITUTE OF RADIO ENGINEERS, WHILE MR. PACENT WAS NOMINATED AS PRESIDENT OF THE RADIO CLUB OF AMERICA. THEY ARE SEEN DISCUSSING A NEW DEVELOPMENT IN SHORT WAVE RECEIVERS. DR. DE FOREST AND MR. PACENT HAVE BEEN FRIENDS FOR TWENTY-THREE YEARS. DR. DE FOREST DEFEATED RAYMOND HEISING, OF THE BELL TELEPHONE LABORATORIES, FOR THE PRESIDENCY

## RADIO TALKIES ON AIR NIGHTLY BY 2 STATIONS

Every evening, from 7 to 9 P. M., Eastern Standard Time, the experimental transmitter W2XCD of the DeForest Radio Company at Passaic, N. J., is on the air with test programs. The frequency of this transmitter is 1604 kilocycles, or 187 meters, and the signals can be tuned in by many broadcast receivers.

### Increasing Power

The power of W2XCD is being steadily increased. The transmitter went on the air several weeks ago with 50 watts. At the beginning of the year, the power had been increased to 500 watts, and is to be further increased up to 5000 watts. A 100-kilowatt short-wave transmitter is now being constructed by the DeForest engineering staff, employing new water-cooled transmitting tubes, for long-distance broadcasting to overseas countries.

W2XCD is located on the second floor of the DeForest experimental laboratory building adjoining the radio tube plant at Passaic. The installation is entirely experimental and is intended mainly to test tubes under actual operating conditions, as well as to conduct certain studies in radio transmission. Many reports are being received from all parts of the United States and Canada regarding successful reception of the signals.

### Received Over Wide Range

Radio talkies or combined and synchronized sight and sound broadcast programs are available in the New York metropolitan area and over a considerable portion of the country. Every week-day

## The Passing of Jimmie

Readers of RADIO WORLD and members of the radio trade will be sorry to know that James H. Carroll, connected with this publication for several years, passed away at his home in Brooklyn on January 4th.

Jimmie Carroll endeared himself to the staff of RADIO WORLD and to his many other friends in radio, because of his loyalty and his smiling helpfulness whenever he could do a good turn for the other fellow. He was straightforwardness itself, possessed of a wonderful character. He was clean in all his relations of life.

His friends will miss his cheery greeting, his willingness at all times to do good deeds, and his warm, ever-present smile that helped to light up many a shadow of the day.

Jimmie Carroll loved radio, and radio loved Jimmie Carroll.

evening, at 8:15 and again at 9:00 P. M., Eastern Standard Time, W2XCD, Passaic, N. J., W2XCR, Jersey City, N. J. (Jenkins Television Corp.), are on the air with synchronized pictures and sound.

W2XCR operates on 2800 kilocycles, or 107 meters, and may be tuned in on a short-wave receiver for television purposes.

### Composition of Talkies

The Jenkins radio talkies consist of half-tone pictures, scanned in 48 lines at a speed of 15 pictures per second. The radiovision pick-up is by means of special film in the Jenkins studio at Jersey City, while the synchronized sound pick-up is by means of disk recordings mechanically coupled with the film pick-up. The sound signals are amplified and transmitted over direct wire to the DeForest transmitter at Passaic.

The first public demonstration of the Jenkins radio talkies will be given in Newark, N. J., within the next few weeks, say the promoters.

# WAVE PRIORITY INVALID CLAIM, COURT REPEATS

Washington.  
WENR, Chicago, was allotted half time on 870 kilocycles by the Court of Appeals of the District of Columbia, which required WLS, Chicago, to relinquish enough hours on this channel to make the readjustment possible. WLS had contended it used this channel first and was entitled to priority rights. The court overruled this argument, in line with its denial of priority rights in the WGY case, where the station won on other points.

The Federal Radio Commission had denied half time to WENR, operated by the Insull interests, but had given it two-sevenths time. WENR appealed to the court and the decision is the result.

The court affirmed the action of the Commission in denying WLS's application for full time on 870 kilocycles, and denying the application of WCBD, Zion City, Ill., which formerly operated on the frequency for restoration to the frequency on limited time.

### WLS Priority Cited

Commission counsel, arguing the case, had contended with WLS that WLS, because of its prior use of the 870 kilocycle channel and its unquestioned good service in the interest of farmer-listeners in the Middle West, was entitled to preference on the frequency. The court stated that, although it is true that WLS began broadcasting earlier than WENR, and that it was the first assigned to the channel, "these facts, however, are not controlling, for neither station has any fixed right in the frequency as against the reasonable regulatory power of the United States."

"We are of the opinion," said the court, "that the operating time upon this channel should be shared equally by WLS and WENR."

### Economic Considerations

"We base this opinion upon a consideration of the excellent service heretofore rendered to the public by WENR, and its capacity for increased service; also its large expenditures for meritorious programs for public instruction and entertainment, and the popularity of the station; also its ability by means of its 50,000 watt transmitter to cover a large area; and the assured financial responsibility behind it.

"It is manifest also that an allowance of only two-sevenths time for broadcasting is totally inadequate for the economical operation of such a station."

WLS, established in 1924 by Sears, Roebuck & Company, was taken over in November, 1928, by the Prairie Farmer, with 51 per cent of the station owned by the latter company and the remaining 49 per cent by Sears-Roebuck. It now operates with 5,000 watt power, but holds a construction permit for a 50,000 watt transmitter.

## Westinghouse Tests Plane Communication

Springfield, Mass.

The Westinghouse Electric and Manufacturing Company has made arrangements for the use of the Springfield Airport for conducting experiments in two-way radio communication between ground and airplanes.

## Literature Wanted

THE names and addresses of readers of RADIO WORLD who desire literature on parts and sets from radio manufacturers, jobbers, dealers and mail order houses are published in RADIO WORLD on request of the reader. The blank at bottom may be used, or a post card or letter will do instead.

RADIO WORLD,  
145 West 45th St., N. Y. City.  
I desire to receive radio literature.

Name .....

Address .....

City or town .....

State .....

- Adolph Hoppe, 31 Walfert Terrace, Rochester, N. Y.
- Elmer Ogle, 215 Avenue "E," Crowley, La.
- Nolan Uhls, 1712 Fairfax Ave., W. H., Cincinnati, Ohio.
- S. S. Rank, 310 First Ave., Johnsonburg, Pa.
- Elmer Wutzler, 1215 E. 6th St., Alton, Ill.
- William Brown, 495 St. Pauls Pl., Bronx, N. Y. City.
- Russell Coutant, Box 310, Western Ave., Marlboro, N. Y.
- B. DeMeis, 6515 11th Ave., Brooklyn, N. Y.
- Y. Pchek, 773 Forest Ave., Bronx, N. Y. City.
- B. L. Lehle, 514 Park Ave., Wilmette, Ill.
- A. E. Sparling, 507 N. 104th St., Seattle, Wash.
- Court Cisler, 10 Lockwood St., Geneva, Ohio.
- Efren Gil, Ave. 13 Poniente 509, Puebla, Pue., Mex.
- M. F. Michaels, 42 Canedy St., Fall River, Mass.
- Herbert S. Wyer, 55 Bond St., Hartford, Conn.
- Thos. S. Hughes, Fort Ogden, Fla.
- F. N. Watters, 5766 Vicente St., Oakland, Calif.
- Geo. L. Gardner, 24 Coomes Ave., Springfield, Mass.
- Tom Harrington, 3601 E. 10th St., Long Beach, Calif.
- Jos. V. Stracuzza, 431 Tenth St., New Kensington, Pa.
- Little Star Radio Shop, South Bend, Ind.
- E. J. Erickson, 504 S. Union St., Aurora, Ill.
- J. Lohman, 4 113th St., Troy, N. Y.
- J. R. McNicholas, 151 W. 14th St., N. Y. City.
- R. Wildman, 20 W. Atlantic Ave., Haddon Hgts., N. J.
- John Z. Pay, 2043 Robin St., Lakewood, Ohio.
- Bartlett Auto Supply, Bartlett, Cook Co., Ill.
- James Payne, Fries, Va.
- Ralph H. Bellinger, 2823 Scioto St., Cincinnati, Ohio.
- D. A. Mawell, Elec. Dept., Public Schools, Braddock, Pa.
- Arthur Langraf, 42 Market St., Brantford, Canada.
- P. V. Apple, 62 2nd St., Erlanger, No. Car.
- E. M. Atwood, W. U. Tel. Co., No. Platte, Neb.
- David Allan, 64 Epping St., Lowell, Mass.

# \$450,000,000 IN SETS SOLD IN YEAR 1929

Washington.

Despite temporary recession in the sale of radio receiving sets, caused largely by the stock market collapse in the latter months of 1929, the radio industry looks forward to 1930 as another record-breaking year, said Federal Radio Commissioner Harold A. Lafount. He was formerly a manufacturer of radio accessories. He said that the natural development in radio programs and improved methods of regulating broadcasting, made possible by experience, will contribute to the expected development. Although there admittedly was overproduction of receiving sets in 1929, he said, the industry does not expect this to be a burden.

### Absolence Reduced

Whereas in past years the industry has offered something radically new in radio receiving sets, which tended to render obsolete the sets of the preceding year, Mr. Lafount stated to "The United States Daily" that no sweeping changes are now being considered. Moreover, he said, there apparently are no radical changes contemplated that will disturb existing reception conditions.

On the whole, said Commissioner Lafount, the broadcasting situation should improve. Stations are offering better programs. Listeners generally are afforded improved reception through the station installation of modern equipment, automatically controlled, to keep them on their assigned frequencies, and thus eliminating to a great extent, at least, interference with other stations. There is much room for improvement in the broadcasting set-up, he stated, but the terrific congestion of stations on the limited number of channels is responsible for the condition.

### \$450,000,000 for Sets

"The industrial situation gradually will work itself out," said Commissioner Lafount, "with no unfavorable reaction upon the public. It is not unlikely that some manufacturers will retire and that there will be consolidations, but the readjustment period should not be drastic or revolutionary."

Preliminary statistics from the industry, said Mr. Lafount, indicate that, in spite of the disappointing fourth quarter, sales of receiving sets in 1929 established a new annual record. Preliminary figures, he said, are that sales of receivers amounted to more than 3,500,000 units for the year, as against some 2,500,000 for 1928. The gross revenue, in round figures, he said, was estimated at \$450,000,000, or about 40 per cent above the total for 1928.

## Use of Damped Waves Discouraged by Board

Washington.

To reduce to a minimum interference caused by transmitters employing damped waves, the Federal Radio Commission has just adopted a new general order specifying frequencies upon which such transmitters will be allowed to operate. The order states also that no license will be issued hereafter for the operation of any station using, or proposing to use, transmitters employing damped wave emissions.

# Forum

### Advices More News

I WISH to say a word in behalf of your good radio magazine. I believe it is the best magazine of the kind on the market. I believe though you are making a mistake in not printing more radio news, as you have lots of subscribers who know nothing and care nothing about technicalities, but are only interested in the news. So please let me suggest that you include more news and I feel sure the public at large will be better satisfied.

Arthur Day,  
Sergeant, Kentucky.

\* \* \*

### Sick!

I AM sick of reading schoolboy stuff and the same stuff about three and four-tube circuits reshaped. I can't see where it is doing me any good to be reading RADIO WORLD.

John Harris,  
Detroit, Mich.

LACAULT'S BOOK, "Superheterodyne Construction and Operation," and Radio World for 8 weeks for \$1. Radio World, 145 W. 45th St., N. Y. City.

# \$10,000,000 AIR UNIVERSITY PLAN BLOCKED

Washington.

A fact finding subcommittee of the Advisory Committee on Education by Radio recommended the establishment of a national air university, endowed privately at \$10,000,000. This was opposed by Secretary Wilbur of the Department of Interior. The Advisory Committee therefore is expected to kill the proposal of the fact-finding subcommittee. It failed to act on the proposal when it came up for consideration.

Dr. William John Cooper, United States Commissioner of Education, said that the recommendations made by the fact-finding committee were too far-reaching at the present experimental stage of radio as a factor in education. He pointed out, however, that in spite of the failure to act favorably upon the proposed university by radio and the reaching of any agreement with respect to the other recommendations, distinct progress has been made.

### Opposition by Wilbur

Secretary Wilbur, it was stated at the Department of the Interior, said the magnitude of the proposals require further experiments in the use of radio as a branch of education before so large an undertaking can be considered. For this reason a new subcommittee was appointed.

A statement issued by the Department of Interior said:

The advisory committee on education by radio has given its subcommittee instructions as to the principles upon which its recommendations are to be based. It wants to recommend, in the first place, that an agency be set up in the Federal Office of Education for the study of education by radio. It wants, in the second place, to provide for an advisory committee made up of individuals from educational institutions and agencies, from broadcasting organizations, and from the general public to work with this agency within the Government.

### More Research Asked

It wants to recommend that the funds for carrying on this work be provided by congressional appropriation. In defining the work that this is to be a part of the Office of Education, the advisory committee believes that it should study the development and encouragement of programs and make researches into the important problems in this field; that it should disseminate information; that it should stimulate local and national interest in radio education; that it should prepare plans for the integration of effort among broadcasting agencies; that it should suggest programs upon request; that it should scientifically evaluate programs and producers.

This action on the part of the advisory committee on education by radio came after it had given extended consideration to a recommendation made by its fact-finding subcommittee that a campaign be put on the purpose of which was to raise, outside of the Government, the sum of \$10,000,000 to endow a national radio university. The committee failed to act favorably upon that recommendation after having heard Secretary Wilbur who warned against too great haste in establishing final agencies in a field which was so experimental.

## Physicians Oppose Wynne on Quacks

Washington.

Letters supporting and opposing the request of Health Commissioner Shirley W. Wynne, of New York City, that steps be taken to prevent medical quacks from advertising over radio stations have been received by the Federal Radio Commission.

Some physicians and other medical workers oppose the movement of the New York official. In each case the Commission is responding that, under the radio law, it has no power of censorship, but that if there is any evidence of obscene or indecent language being used in such advertising programs, the Commission may consider it when the licenses of the stations broadcasting the programs are before it for renewal.

## MIXUP ON TWO WJSV STUDIOS

Washington.

A subpoena—the first subpoena ever issued by the Federal Radio Commission—for the attendance of a witness, and calling for production of documents or written data concerning a broadcasting station, was served on J. S. Vance, president of the Independent Publishing Company, operating WJSV, at Mount Vernon Hills, Va.

Mr. Vance was subpoenaed to appear at a hearing involving the application of WMBG at Richmond, Va., for a change in status from a local to a regional station. The subpoena was requested by Wilbur M. Havens, president of Havens & Martin, Inc., operating the Richmond station.

The application was made "to ascertain the main studio location of WJSV," said Mr. Havens. WJSV maintains a studio at Mount Vernon Hills and another in Washington, D. C. The radio act specifies that a station shall be considered in the radio zone in which its main studio is located.

The subpoena demands that Mr. Vance bring books, papers, and radio logs or schedules showing the number of hours broadcast daily from the studio of WJSV at Mount Vernon Hills, and from the studio in Washington.

WMBG now operates on the 1,210-kilocycle channel with 100 watts. It seeks assignment on the 1,240-kilocycle channel with 500 watts, and proposes to show that WJSV is a Washington station, and that consequently its assignment should not be charged against the Virginia quota.

WJSV operates on the 1,460 kilocycle full time, with KSTP, at St. Paul, Minn., both stations using 10,000 watts. The channel is known as a "heterodyne" channel.

### RADIO WORLD'S QUICK-ACTION CLASSIFIED ADS

10 CENTS A WORD  
10 WORDS MINIMUM  
CASH WITH ORDER

## 2ND SELECTION FOR WABC SITE ALSO OPPOSED

WABC, New York City, key station of the Columbia Broadcasting System, which was diverted from erecting a transmitter in New Jersey because of opposition to "an invader," and which then sought a site on Long Island, is meeting opposition in its new efforts, also.

George V. Harvey, president of Queens, one of the boroughs of New York City, discussed the project of WABC to erect a plant at or near the Raunt in that borough. He said:

"It is believed that this powerful equipment would blanket the dial of thousands of radio receiving sets in Brooklyn and Queens, and I oppose it. If New Jersey does not want it, certainly Queens does not. I will take the matter up with my building department immediately.

### Must Protect Listeners

"We are glad to have the present home of WABC in Queens. Its present power output is 5,000 watts and that is sufficient to overspread the Long Island and Greater New York area with a very strong signal.

"Some set owners tell me that even at the present power rating the waves are so strong that they overspread more space on the dial than one station should occupy. There are too many radio set owners in the thickly populated sections of Queens and Brooklyn to have a 50,000-watt station in their midst to spray the aeriels with powerful electric waves. The radio listeners must be protected and afforded good reception. In turn that helps the radio industry."

President Harvey's stand follows a protest registered by the radio dealers in Brooklyn and Queens.

\* \* \*

### Board Gets Complaints

Washington.

The proposal of the Columbia Broadcasting System to install the new high-powered transmitter of WABC on Long Island, close to its present site, is being opposed by civic and radio trade groups in the surrounding territory, it was declared at the Federal Radio Commission.

The new complaints, it was declared, are on the ground that a high powered transmitter will prevent reception of other stations by listeners residing in the area close to the station. Radio dealers contend that this will react unfavorably for sales of sets.

Columbia recently was given a construction permit to install a 50,000-watt station for WABC, which now uses 5,000 watts. After protracted hearings before the Commission, at which the New Jersey interests combated the construction permit, the system announced its plan to withdraw that construction permit, and subsequently filed the application for the New York location. The plan, as explained to the Commission, is to install the new transmitters in "steps" of 5,000 watts each, rather than the 50,000-watt outfit.

### A THOUGHT FOR THE WEEK

Radio gives us music, classic and popular; tragedy, comedy, grand opera, minstrelsy, recitation, oratory—and jazz! And to those of the under-twenty millions the greatest of these is jazz! But who wouldn't be under twenty, in spite of Atwater Kent.

# High Gain at Low Cost HB44 - - - \$45.59

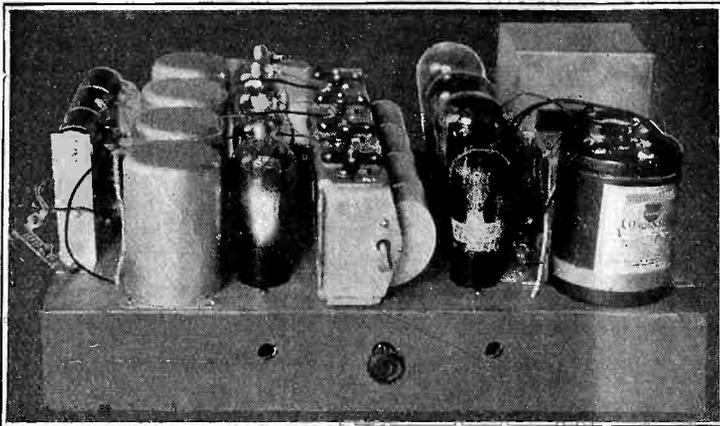

The HB44, assembled, presents in compact form, on a 17½ x 11½" steel chassis, a completely AC operated shielded receiver, using four 224 screen grid tubes, one 227, two 245s in push-pull, and a 280 rectifier, eight tubes all told. Here is the circuit that will bring 'em in from all over the country—and at a price you can afford—\$45.59. This price includes EVERYTHING except speaker, cabinet and tubes.

## It's the Real Thing!

- (a) Three stages of tuned R.F., using 224 screen grid tubes.
- (b) Tuned input to 224 power detector.
- (c) Audio, consisting of first stage resistance coupled, second stage 245s in push-pull.
- (d) Four totally shielded R.F. coils.
- (e) A chassis all drilled for necessary parts.
- (f) A four gang condenser, guaranteed accurate, with equalizing condensers built in.
- (g) 61 mfd. of filter and bypass capacity.
- (h) Thirteen different fixed voltages available from the output.
- (i) Single dial control.

### LIST OF PARTS FOR THE HB44

<input type="checkbox"/> SL1, SL2, SL3, SL4—Four stage individually shielded coil cascade for .00035 mfd. (Four Cat. SH-3 of Screen Grid Coil Co.).....	\$ 3.80
<input type="checkbox"/> C1, C2, C3, C4—One four gang .00035 mfd. condenser with equalizers E1, E2, E3, E4 built in.....	3.95
<input type="checkbox"/> C5—One .01 mfd. mica condenser.....	.35
<input type="checkbox"/> C6, C7, C13, C14—Four 1 mfd. 200 volt DC bypass condensers.....	2.00
<input type="checkbox"/> C8—One 1 mfd. 550 volt AC filter condenser.....	.85
<input type="checkbox"/> C9, C10, C11, C12—One Mershon, consisting of four condensers, two of 8 mfd. and two of 18 mfd. with bracket (Cat. Q-2-8, 2-18-B).	5.15
<input type="checkbox"/> R1—One Electrad 25,000 ohm potentiometer with knob and two insulators.....	1.60
<input type="checkbox"/> R2—One 50,000 ohm Lynch metallized resistor (.05 meg.), with mounting.....	.45
<input type="checkbox"/> R3—One Lynch 5.0 meg. metallized grid leak, with mounting.....	.40
<input type="checkbox"/> R4—One 5,000 ohm resistor with mounting.....	.50
<input type="checkbox"/> VD—One Multi-Tap Voltage Divider, 13,850 ohms, 14 taps.....	3.95
<input type="checkbox"/> T1—One push-pull input transformer.....	2.50
<input type="checkbox"/> OPC—One center-tapped output choke.....	2.50
<input type="checkbox"/> T2—One Polo filament-plate supply (Cat. PFPS).....	7.50
<input type="checkbox"/> Ch—One double filter choke coil, 30 henrys each section, 100 ma..	3.71
<input type="checkbox"/> SW—One pendant AC switch with 12 ft. cable.....	.80
<input type="checkbox"/> PL—One 2.5 volt pilot lamp and bracket.....	.70
<input type="checkbox"/> Speaker (+), (—), Ant., Gnd.—Four binding posts with insulators.	.40
<input type="checkbox"/> One Clarostat Humdinger, 30 ohms.....	.50
<input type="checkbox"/> One subpanel 17½" x 11½", with five UY and three UX sockets..	3.00
<input type="checkbox"/> One vernier dial.....	.50
<input type="checkbox"/> Four National grid clips.....	.24
<input type="checkbox"/> Hardware.....	.24
<input type="checkbox"/> All parts (less cabinet, tubes and speaker).....	\$45.59
<input type="checkbox"/> Tubes: four 224, one 227, two 245, one 280.....	9.51

GUARANTY RADIO GOODS CO.,  
143 West 45th Street, New York, N. Y.  
(Just East of Broadway.)

- Please ship all parts for HB44 @.....\$45.59
- Eight tubes for HB44..... 9.51
- Please ship C.O.D.
- Enclosed find \$..... remittance.  
(Canadian must be P. O. or Express M. O.)

NOTE: If only some (not all) parts are desired, check off on list at left and tear out and send in this entire page.

NAME.....

ADDRESS.....

CITY..... STATE.....

FIVE DAY MONEY-BACK GUARANTY

# TELEVISION FOR HOME CONSTRUCTORS

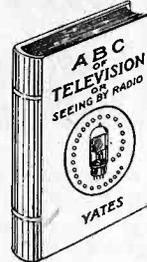

Full explanation of the theory and practice of television is contained in the new 210-page book (5¼ x 8½"), with 100 illustrations.

## ABC of Television

By Raymond Francis Yates,  
*Students and Experimenters alike will glory in the possession of this masterful volume. Popularly written, easily understood.*

### TABLE OF CONTENTS

**CHAPTER I—TELEVISION—THE NEW CONQUEST OF SPACE**  
How the Principles of Television were Invented in 1884 and what the Future Holds for this Promising New Child of Science—A Description, in Narrative Form, of the Television of the Future.

**CHAPTER II—TELEVISION SYSTEMS**  
Complete and Elementary Explanation of the Fundamental Principles of Television As They Are Applied Today in Both Transmitting and Receiving—Methods of Synchronization, Scanning and the Function of Photoelectric Cells.

**CHAPTER III—TELEGRAPHING PICTURES**  
An Outline of the Various Successful Methods Employed Today in the Transmission of Facsimiles and Photographs by Wire and Wireless Systems—Practical Description of Telephotographic Receivers for Home Use With Practical Instruction Concerning Their Operation.

**CHAPTER IV—PHOTOELECTRIC CELLS**  
How Photoelectric Cells Serve as "Light Microphones" in Modulating Radio Waves With Light Impulses—Elementary Outline of the Theory of Photoelectric Phenomena.

**CHAPTER V—AMPLIFYING PICTURES**  
Theory and Practice of the Amplification of Picture Signals Together With Data for the Construction of Television Amplifiers That Will Function With a Minimum of Picture Distortion.

**CHAPTER VI—THE AGILE NEON LAMP**  
Theory, Operation and Practical Application of Neon Tubes in Television Reception—How the Neon Tube Functions as a "Light Loud Speaker" in Television Reception.

**CHAPTER VII—SELENIUM CELLS**  
Theory of Selenium Cells Together With a Description of the Popular Types of Cells and Practical Data Concerning Their Construction by Home Experimenters.

**CHAPTER VIII—THE PROBLEM OF SCANNING**  
The Function of the Scanning Disc With Complete Instructions for the Design and Construction of Different Types of Scanning Devices Including Drums and Moving Belts.

**CHAPTER IX—SYNCHRONIZING TELEVISION**  
An A B C Outline of the Synchronizing Methods Now Employed by the Television Broadcasters of Today—Problems of Synchronizing Television Scanning Discs Treated in a Popular Way.

**CHAPTER X—TRANSMITTING TELEVISION AT HOME**  
How the Experimenter Can Construct and Operate Both a Television Transmitter and Receiver for Home Use—This Equipment Makes Possible the Transmission of the Outline of Simple Objects From One Room to Another.

**CHAPTER XI—HOW TO MAKE A TELEVISION RECEIVER**  
Practical Application of the Principles of Television in the Construction of a Television Receiver Involving a Special, Highly Efficient Short-Wave Receiver.

RADIO WORLD, 145 West 45th Street, New York City  
(Just East of Broadway)

Enclosed please find \$3.00 for which send at once at your expense one copy of "A B C of Television, or, Seeing by Radio," by Raymond Francis Yates, as advertised.

NAME.....

ADDRESS.....

CITY..... STATE.....

### FULL EXPOSITION OF HB COMPACT, BATTERY MODEL

Complete details on the theory and construction of the HB Compact were published in a four-part article in Radio World, written by Herman Bernard, designer of the circuit and inventor of the Bernard Dynamic Tuners used in the circuit. Full details on how to wind your own coils. Full-sized pictorial diagram of the wiring. Order the August 24th, 31st, September 7th and 14th issues, 60c—

RADIO WORLD, 145 West 45th Street, New York, N. Y.

MORECROFT wrote a great book when he turned out "Principles of Radio Communication." Second edition now ready. Price \$7.50. Radio World, 145 W. 45th St., N. Y. City.

"AERIAL NAVIGATION and METEOROLOGY," By Capt. Vancey. \$4.00 postpaid. Radio World, 145 W. 45th St., N. Y. City.

# THREE IMPORTANT BOOKS FOR SERVICE MEN!

- "Trouble Shooter's Manual"** *The most popular and fastest-selling book in radio today. Wiring diagrams of commercial receivers are contained in this outstanding book.*
  - "Mathematics of Radio"** *A sure route to a good grasp on radio technique. Radio theory outlined so that anybody can understand it.*
  - "Testing Units for Service Men"** *Circuits and Methods of Testing Equipment, particularly use of individual meters and of meters united in combination testers.*
- These Three Books by John F. Rider Constitute an Outstanding Asset to All Possessors!

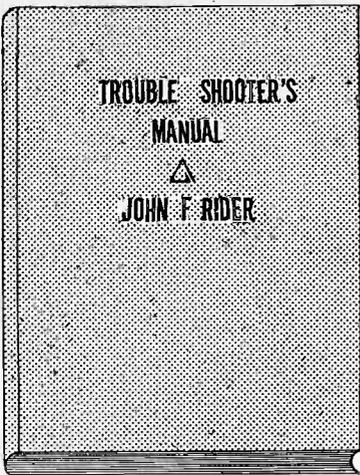

## "Trouble Shooter's Manual"

is the first comprehensive volume devoted exclusively to the topic. The 240 pages include 200 illustrations devoted to wiring diagrams of factory-made receivers, besides other illustrations. It is not only a treatise for service men, telling them how to overcome their most serious problems, and fully diagramming the solutions, but is a course in how to become a service man.

*This book is worth hundreds of dollars to any one who shoots trouble in receivers—whether they be factory-made, custom-built or home-made receivers.*

Besides 22 chapters covering thoroughly the field of trouble shooting, this volume contains the wiring diagrams of models, as obtained direct from the factory, a wealth of hitherto confidential wiring information released for the first time in the interest of producing better results from receivers. You will find these

diagrams alone well worth the price of the book. The wiring diagrams are of new and old models, of receivers and accessories and as to some of the set manufacturers. all the models they ever produced are shown in wiring diagrams! Here is the list of receivers, etc., diagrams of which are published in this important and valuable book:

## Wiring Diagrams of All These Receivers

- R. C. A.**  
69, 62, 20, 64, 30, 105, 51, 18, 32, 50, 25 A.C., 28 A.C., 41, Receptor S.P.U., 17, 18, 33.
- FEDERAL**  
Type E series filament, Type E series filament, Type D series filament, Model K, Model H.
- ATWATER-KENT**  
10B, 12, 20, 30, 35, 48, 32, 33, 40, 39, 36, 37, 40, 42, 52, 50, 44, 43, 41 power units for 37, 38, 44, 43, 41.
- CROSBLEY**  
XJ, Triflydn 3R3, 601, 401, 401A, 608, 704, B and C supply for 704, 704A, 704B, 705, 706.
- STEWART-WARNER**  
300, 305, 310, 315, 320, 325, 500, 520, 525, 700, 705, 710, 715, 720, 530, 535, 750, 801, 802, 806.
- GREBE**  
MU1, MU2, synchrophase 5, synchrophase AC6, synchrophase AC7, Deluxe 428.
- PHILCO**  
Philco-electric, 82, 86.
- KOLSTER**  
4-tube chassis used in 6 tube sets, tuning chassis for 7 tube sets, power amplifier, 7 tube power pack and amplifier, 6 tube power pack and amplifier, 6 tube power pack and amplifier, rectifier unit K-23.
- ZENITH**  
39, 39A, 392, 392A, 40A, 33PX, 35APX, 352X, 352APX, 37A, 35P, 35AP, 352P, 352AP, 34P, 342P, 33, 34, 35, 35A, 342, 352, 352A, 362, 31, 333, 353A, power supply ZE17, power supply ZE12.
- MAJESTIC**  
70, 70B, 180, power pack 7BP3, 7P6, 7P3 (old wiring) 8P3, 8P6, 7BP6.
- FRESHMAN**  
Masterpiece, equaphase, G, G-60-S power supply, L and LS, Q15, Q, K60-S power supply.
- STROMBERG-CARLSON**  
1A, 2B, 501, 502, 523, 524, 635, 638, 403AA power plant, 404 RA power plant.
- All-AMERICAN**  
6 tube electric, 8 tube 80, 83, 84, 85, 86, 88, 6 tube 60, 61, 62, 65, 66, u and 8 tube A.C. power pack.
- DAY FAN**  
OEM7, 4 tube, 5-5 tube 1925 model, Day Fan 8 A.C., power supply for 6 tube A.C., B power supply 5524 and 5525, motor generator and filter, 6 tube motor generator set, 6 tube 110 volt D.C. set, 6 tube 32 volt D.C. set.
- FADA**  
50/80A receivers, 460A, Fada 10, 11, 30, 31, 10Z, 11Z, 30Z, 31Z, 16, 17, 32, 16Z, 32Z, 18, 18, special, 192A-192S and 192BS units, R80A, 430A, and SF 50/80A receivers, 460A receiver and R60 unit, 7 A.C. receiver, 475 UA or CA, and SF45-75 UA or CA, 50, 70, 71, 72, C electric unit for special and 7 A.C. receivers. ABC 6 volt tube supply, 86V and 82W, E180Z power plant and E 420 power plant.
- FRED EISEMANN**  
NR5, FE1B, NR70, 470, NR57, 457, NR11, NR80 D.C.
- COLONIAL**  
26, 31 A.C., 31 D.C.
- WORKRITE**  
8 tube chassis, 6 tube chassis.
- AMRAD**  
70, 7100, 7191 power unit.
- SPARTON**  
A.C. 39.
- MISCELLANEOUS**  
DeForest F5, D10, D17. Super Zenith Magnavox dial, Thermodyne, Grimes 4DL inverse duplex, Garod neurodyne, Garod EA, Ware 7 tube, Ware type T, Federal 102 special, Federal 59, Kennedy 220, Operadio portable, Sleeper RX1, Amrad inductrol.

- ### HERE ARE THE 22 CHAPTER HEADINGS
- Service Procedure
  - Practical Application of Analysis
  - Vacuum Tubes
  - Operating Systems
  - Aerial Systems
  - "A" Battery Eliminators
  - Troubles in "A" Eliminators
  - Trouble Shooting in "A" Eliminators
  - "B" Battery Eliminators
  - Troubles in "B" Battery Eliminators
  - Trouble Shooting in "B" Battery Eliminators
  - Speakers and Types
  - Audio Amplifiers
  - Trouble Shooting in Audio Amplifiers
  - Troubles in Detector Systems
  - Radio Frequency Amplifiers
  - Trouble Shooting in RF Amplifiers
  - Series Filament Receivers
  - Testing, and Testing Devices
  - Troubles in DC Sets
  - Troubles in AC Sets

## "Testing Units for Service Men."

A 43-page, liberally illustrated book on testing units and circuits. Tells what equipment a service man should have and how to use it most effectively and quickly. Rapidity of operation is one of the points stressed throughout this valuable book, as a service man's time is his chief stock in trade.

### CONTENTS

- Tube Reactivator and Voltages
- Calibrated Vacuum Tube Bridge
- General Utility Tube Tester
- AC-DC Receiver Tester
- Eliminator Testers
- Signal Generator for Receiver Testing
- Oscillators
- Cathode Ray Oscillograph
- Indicating Systems
- Tube Voltmeters
- Measurement of Inductance, Impedance, Capacity, DC Resistance
- Multi-Range Meters
- Service Station Test Bench

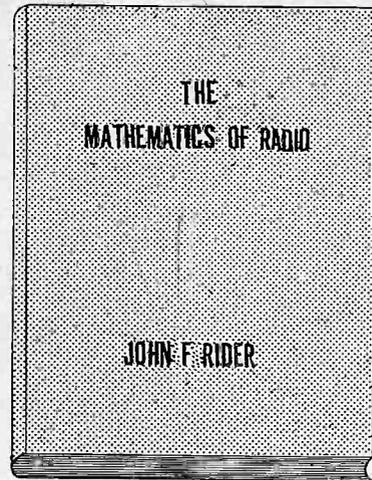
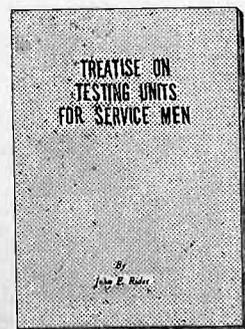

## "Mathematics of Radio"

### TABLE OF CONTENTS:

- OHM'S LAW.**
- RESISTANCES:** Basis for resistance variation, atomic structure, temperature coefficient, calculation of resistance variation, expression of ampere, volt and Ohm fractions, application of voltage drop, plate circuits, filament circuits, filament resistances, grid bias resistances.
- OC FILAMENT CIRCUITS:** Calculation of resistances.
- AC FILAMENT CIRCUITS:** Transformers, wattage rating, distribution of output voltages, voltage reducing resistances, line voltage reduction.
- CAPACITIES:** Calculation of capacity, dielectric constant, condensers in parallel, condensers in series, voltage of condensers in parallel, in series, utility of parallel condensers, series condensers.
- VOLTAGE DIVIDER SYSTEMS FOR B ELIMINATORS:** Calculation of voltage divider resistances, types of voltage dividers, selection of resistances, wattage rating of resistances.
- INDUCTANCES:** Air core and iron core, types of air core inductances, unit of inductances, calculation of inductance.
- INDUCTANCE REQUIRED IN RADIO CIRCUITS:** Relation of wavelength and product of inductance and capacity, short wave coils, coils for broadcast band, coupling and mutual inductance, calculation of mutual inductance and coupling.
- REACTANCE AND IMPEDANCE:** Capacity reactance, inductance reactance, impedance.
- RESONANT CIRCUITS:** Series resonance, parallel resonance, coupled circuits, bandpass filters for radio frequency circuits.
- IRON CORE CHOKERS AND TRANSFORMERS:** Design of chokes, core, airgap, inductance, reactance, impedance, transformers, half wave, full wave windings.
- VACUUM TUBES:** Two element filament type, electronic emission, limitations, classifications of filaments, structure, two element rectifying tubes, process of rectification, tungar bulb.
- THREE ELEMENT TUBES:** Structure of tube, detector, grid bias, grid leak and condenser, amplifiers, tube constants, voltage amplification, resistance coupling, reactance coupling, transformer coupling, variation of impedance of load with frequency, tuned plate circuit.
- POWER AMPLIFICATION:** Square law, effect of load, calculation of output power, undistorted output power, parallel tubes, push-pull systems, plate resistance.
- GRAPHS AND RESPONSE CURVES:** Types of paper, utility of curves, types of curves, significance of curves, voltage amplification, power amplification, power output, radio frequency amplification.
- MULTIPLE STAGE AMPLIFIERS:** Resistance coupling, reactance coupling, tuned double impedance amplification, underlying principles, transformer coupling, turns ratio, voltage ratio, types of cores, late current limitation, grid current limitation.
- ALTERNATING CURRENT TUBES:** Temperature variation hum, voltage variation hum, relation between grid and filament, filament circuit center tap, types of AC tubes.
- SCREEN GRID TUBE:** Structural design, application, amplification, associated tuned circuits, radio frequency amplification, audio frequency amplification.

RADIO WORLD, 145 West 45th St., New York, N. Y.  
(Just East of Broadway)

- Enclosed please find:
- \$3.50 for which please send me postpaid "Trouble Shooter's Manual" (Cat. TSM), by John F. Rider, 240 pages, 8 1/2 x 11", more than 200 illustrations, including wiring diagrams of commercial receivers as advertised; imitation leather cover, gold lettering.
  - \$2.00 for which please send me postpaid "Mathematics of Radio" (Cat. MOR), by John F. Rider, 128 pages, 8 1/2 x 11", 110 illustrations, flexible cover.
  - \$1.00 for which please send me postpaid "Treatise on Testing Units for Service Men" (Cat. TU), by John F. Rider, 43 pages, 8 1/4 x 9 1/4".
  - If ordering C.O.D., put cross in this square.

NAME.....

ADDRESS.....

CITY..... STATE.....

[Canadian remittances must be made by postal or express money order.]

**0-1 MA, \$5.95**

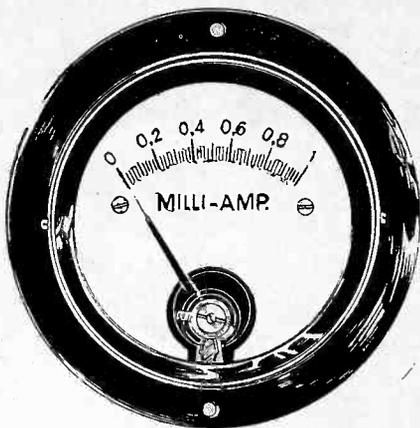

Here is a 0-1 milliammeter, accurate to plus or minus 1% clearly legible to two-one hundredths of a milliampere at any reading (20 microamperes). This expertly made precision instrument is offered at the lowest price so far for a 0-1 ma. Order Cat. FO-1 at \$5.95. C. O. D. orders accepted.

**Guaranty Radio Goods Co.**  
143 West 45th Street,  
New York City

**AERIAL TUNER**

Improves Your Reception

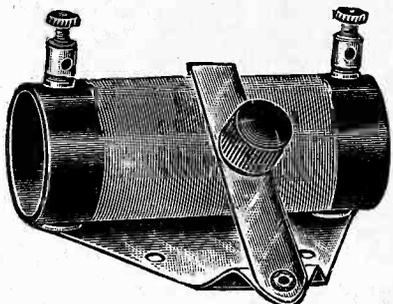

Remove aerial lead from set. Connect aerial instead to one of the binding posts of the Aerial Tuner. Connect the other binding post of the Aerial Tuner to antenna post of your set. Then move the lever of the Aerial Tuner until any weak station comes in loudest. The lever need not be moved for every different frequency tuned in. The Aerial Tuner acts as an antenna loading coil and puts the antenna's frequency at any frequency in the broadcast band that you desire to build up. Price, 85c.

**GUARANTY RADIO GOODS CO.**  
143 West 45th Street  
New York City  
(Just East of Broadway)

**BRILLIANT, NEW NATIONAL**  
**MODERNISTIC PROJECTION DIAL**  
**WITH RAINBOW FEATURE**

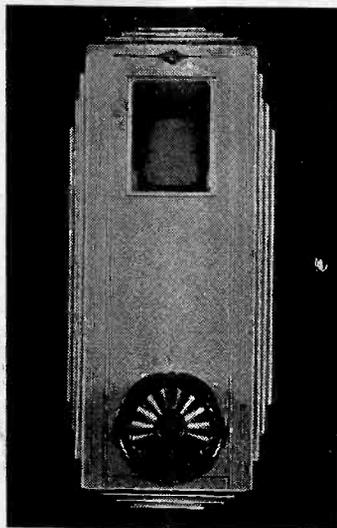

Modernize the appearance of your receiver by installing the brilliant new National dial, with color wheel built in, so that as you turn the dial knob one color after another floods the screen on which the dial numbers are read. On this screen the numbers are projected, so that you get the same dial reading from any position of the eye. This is just what DX hunters want—laboratory precision of dial reading.

The escutcheon is of modernistic design. The Velvet Vernier mechanism drives the drum superbly. Order today. Remit with order and we pay cartage. Shipments day following receipt of order.

**GUARANTY RADIO GOODS CO.,**  
143 W. 45th St., N. Y. City (Just E. of B'way)  
Enclosed please find \$3.13 for which please send me dial marked below:  
 Cat. HC8, National modernistic drum dial, with color wheel built in, pilot bracket, 6-volt pilot lamp for storage battery or A eliminator sets; hardware; instructions ..... \$3.13  
 Cat. HC2½, same as above, but with 2½-volt AC pilot lamp ..... 3.13  
 Order C.O.D. and I pay cartage.

NAME .....

ADDRESS .....

CITY ..... STATE .....

**Hi-Q 30**  
**Wholesale**  
**Prices!**

Write or wire!

**Guaranty Radio Goods Co.**  
143 West 45th St.,  
New York City

**NATIONAL**

**Velvet B Eliminator \$16.13**  
180 Volts (280 Tube Free)



Latest Model National Velvet-B, Type 8580, in handsome crackle finish black metal casing, for use with sets up to and including six tubes. Input 105-120 volts AC, 50 to 60 cycles. Output, 180 volts maximum at 35 milliamperes. Three variable output intermediate voltages. (Det., R.F., A.F.). Eliminator has excellent filter system to eliminate hum, including 30 henry choke and 18 mfd. Mershon condenser. No motorboating! (Eliminator Licensed under patents of the Radio Corporation of America and associated companies.)

**Guaranty Radio Goods Co.**  
143 W. 45TH STREET  
(Just East of Broadway)  
NEW YORK CITY

**New Junior Model**  
**POLO UNIT \$4**

The famous twin magnet principle for double sensitivity, large magnets for great flux, permanently adjusted armature, all are in the new junior model Polo Unit. Weight, 2¾ lbs. Stands 150 volts unfiltered. Stands up to 250 push-pull filtered. Works any output tube, power or otherwise. Supplied with 10-ft. cord. Order unit now. Five-day money-back guarantee. Shipped C. O. D. if desired.

**Acoustical Engineering Associates**  
143 West 45th Street  
New York City  
(Just East of Broadway)

**Blueprint FREE!**

Get a free blueprint of either circuit listed on the coupon below, by sending \$1.00 for eight weeks' subscription for RADIO WORLD, or send \$1.50 for 13 weeks' (quarter of a year) and get both blueprints free!  
**RADIO WORLD, 145 W. 45th St., N. Y. City**  
Enclosed please find:  
 \$1 for which send RADIO WORLD for 8 weeks and send free blueprint of the battery model 4-tube Screen Grid Diamond of the Air.  
 \$1 for which send RADIO WORLD for 8 weeks and send free blueprint of the 4-tube AC Screen Grid Diamond of the Air.  
 \$1.50 for which send RADIO WORLD for 13 weeks and send both blueprints free. (If renewing a subscription put cross here.)

NAME .....

ADDRESS .....

CITY..... STATE.....

**Quick Action Classified Ads**

**Radio World's Speedy Medium for Enterprise and Sales**  
10 cents a word — 10 words minimum — Cash with Order

**ARISTOCRAT FLOOR SPEAKER**—With Molded Wood Horn and Horn Motor built in. Great value. \$14.00. Acoustical Engineering Associates, 143 W. 45th St., N. Y. C.

**POLO 245 POWER SUPPLY.** Read all about it on another page of this issue. Polo Engineering Laboratories, 57 Dey St., N. Y. City.

**EDISON STORAGE BATTERIES**—100 volts \$6.50; ¼ Horsepower Alternating Motors \$7.00. Hoffmann Electrical Shops, 904 North Fifth, Philadelphia, Pa.

**BE SURE TO READ** the advertisement on another page of this issue about the HB Compact. Guaranty Radio Goods Co., 143 W. 45th St., N. Y. City.

**"MATHEMATICS OF RADIO"**—A great help to everybody interested in radio. \$2 postpaid. Radio World, 145 W. 45th St., N. Y. City.

**DISTON ELIMINATORS** \$6.95. Edison Batteries \$1.95. Audio Transformers 95c. Western Electric Amplifier \$14.00. Get our big bargain list sets and parts. Quality Radio Shop, Richmond, Indiana.

**USED RADIO PARTS.** Very low prices. Mack Gamble, Hannibal, Ohio.

**TWO FOR ONE.** Radio World for 52 weeks and Radio News twelve months at the combination rate of \$7. Radio World, 145 W. 45th St., N. Y.

**WORLD'S BEST AVIATION BOOKS:** "A B C of Aviation," \$1.00; "Modern Aviation Engines," \$9.00 postpaid. Both by Maj. Pagé. "Aerial Navigation and Meteorology," By Capt. Yancey. \$4.00 postpaid. Radio World, 145 W. 45th St., N. Y. City.

**OUTDOOR WORK**—Get Outdoor Govt. Jobs; \$1,860 year. Patrol forests; protect game. Write for details. Bradley Institute, All, Denver, Colo.

**"AUDIO POWER AMPLIFIERS,"** by J. E. Anderson and Herman Bernard, the first and only book on the subject. \$3.50. Hennessy Radio Publications Corporation, 145 West 45th St., N. Y. City.

**A. C. TUBES**—Manufactured by licensed R.C.A. manufacturer. UX250—.95 UX224—.85 UX245—.85 UX227—.80 UX280—.75 UX226—.65. Charles Blackmore, Windsor, Missouri.

**"EVERYBODY'S AVIATION GUIDE,"** By Maj. Pagé. \$2 postpaid. Also "Modern Aircraft" by same author. \$5. postpaid. Radio World, 145 W. 45th St., N. Y. City.

# RADIO WORLD BOOK SERVICE

As the first and only national radio weekly, now in its eighth year, RADIO WORLD publishes the most timely, up-to-date news of radio circuits and events in the set-building and broadcasting fields. Technical accuracy second to none. Get a copy at your news-stand today, 15c. RADIO WORLD advises impartially on all radio topics, including what text books to buy, and helps you to read the books properly. Every book advertised on this page is essential to your radio library.

## Five New Volumes Offer Short-Cut to Knowledge!

### MORECROFT

#### "Elements of Radio Communication"

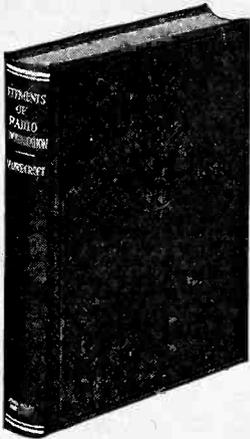

The latest book by Prof. John H. Morecroft, of the Engineering Department of Columbia University, and past president of the Institute of Radio Engineers, is his "Elements of Radio Communication," a book for the novice to enjoy. We regard this as the best elementary book to inform you authoritatively on the technical phases of radio in plain language, without requirement of mathematical knowledge. The book is a complete course on the elements of radio, containing much material never before published. It has 228 pages, 170 illustrations and a complete index. Just out, it is the book of the year in radio. Cloth bound. Order Cat. ME @ .....\$3.00

By the same author: "Principles of Radio Communication," second (new) edition. This book is for advanced students. It is the standard of excellence in its field. It covers much the same ground as the later book, only much more fully and more technically. Contains 1,001 pages, 831 illustrations. Cloth bound. Order Cat. MP @..... \$7.50

### MOYER and WOSTREL

#### "Radio Receiving Tubes"

The need for an elementary book on radio tubes that answers all the important questions has been filled by James A. Moyer, Director of University Extension, Massachusetts Department of Education, and John F. Wostrel, Instructor in Radio Engineering, Division of University Extension, Massachusetts Department of Education.

This new book is a complete discussion of tube principles, functions and uses, thoroughly up-to-date. In this book the essential principles underlying the operation of vacuum tubes are explained in as non-technical a manner as is consistent with accuracy. The book covers the construction, action, reactivation, testing and use of vacuum tubes as well as specifications for vacuum tubes and applications for distant control of industrial processes and precision measurements. 297 pages, cloth bound. Order Cat. MWT @.....\$2.50

By the same authors: "Practical Radio," including the testing of radio receiving sets, 378 pages, 223 illustrations. Cloth bound. Order Cat. MWPR @.....\$2.50  
"Practical Radio Construction and Repairing," 319 pages, a companion volume. Order Cat. MWPRC @.....\$2.00  
[NOTE: The standard book on tubes for advanced students is "The Thermionic Vacuum Tube," by Hendrik Van der Bijl. Order Cat. VDB @.....\$5.00]

### ANDERSON and BERNARD

#### "Power Amplifiers"

Here is the first book to be published on the subject of "Power Amplifiers." Now printing, it is certain to fill a void in radio literature. The whole subject is fully covered in a masterful theoretical discussion of audio amplifiers and power supplies, supplemented by constructional chapters, with complete wiring diagrams and specification of parts. Learn while you build! J. E. Anderson, M. A., technical editor of RADIO WORLD, and Herman Bernard, LL. B., managing editor of RADIO WORLD, both of the Institute of Radio Engineers, have explained fully the phenomena of power amplifiers. Learn all about motorboating and its cures, push-pull theory and practice, grid bias methods and effects, vacuum tubes in audio circuits, AC and battery type AF amplifiers, phase relationships, common impedance, filter systems, by-pass condenser effects, necessities for tone quality, values of coupling constants, and a host of other topics associated with power amplification, including speech amplifiers and "talkie" installations.

More than 200 pages and more than 100 illustrations are devoted to an analysis of this outstanding radio subject. "Power Amplifiers" is authoritative, original and comprehensive. It is free from the traditional errors that have crept into this subject. The theoretical part of the book can be understood by most novices, while the constructional part, that capitalizes the previously imparted knowledge, is thoroughly understandable by anybody. There is virtually no mathematics in the book. Cloth bound. Order Cat. PAM @.....\$3.50

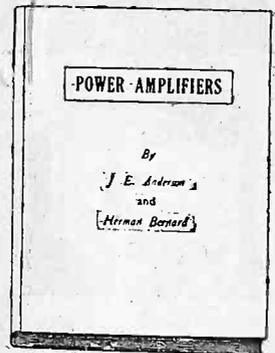

### RIDER

#### "Service Man's Manual"

Two new books by John F. Rider, R. E., Member, Institute of Radio Engineers, constitute the series grouped by him under the heading "Service Man's Manual." Part I is "Mathematics of Radio." Part II is "Trouble Shooter's Manual."

The value of one of these books is more than doubled by the possession of the other.

"The Mathematics of Radio," 128 pages, 8 1/2 x 11", 119 illustrations, bridges the gap between the novice and the college professor. It gives a theoretical background so necessary for a proper understanding of radio and audio circuits and their servicing. Flexible cover. Order Cat. MOR @.....\$2.00

The first comprehensive volume devoted exclusively to the topic uppermost in every service man's mind is "Trouble Shooter's Manual," just published. It is not only a treatise for service men, telling them how to overcome their most serious problems, and fully diagramming the solutions, but it is a course in how to become a service man. It gives all the details of servicing as they have never been given before. Finding the right mode of attack, applying the remedy promptly and obtaining the actual factory-drawn diagrams of receivers always have been a big load on the service man's chest. But no more. Rider, expert on trouble shooting, has produced the outstanding volume on servicing, and has taken the load off the service man's chest!

This book is worth hundreds of dollars to any one who shoots trouble in receivers—whether they be factory-made, custom-built or home-made receivers. The home experimenter, the radio engineer, the custom set-builder, the teacher, the student—all will find this new book immensely informative and absolutely authoritative.

MORE THAN 100 WIRING DIAGRAMS OF RECEIVERS MADE BY MORE THAN FORTY DIFFERENT SET MANUFACTURERS ARE PUBLISHED IN THIS BOOK, INCLUDING OLD MODELS AND LATEST MODELS! RCA, ATWATER KENT, CROSLEY, MAJESTIC, ZENITH, STROMBERG CARLSON, KOLSTER, FEDERAL, FADA, Etc. 240 pages, size 8 1/2 x 11"; 200 illustrations. Imitation leather cover. Order Cat. TSM @.....\$3.50

## FREE! Read Radio World Every Week

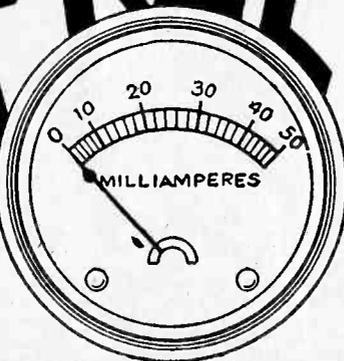

RADIO WORLD will help you in your radio work, so you will be able to use meters most valuably. Keep abreast of new circuits, intimate details on perfecting existing sets, get inside track on sensitivity, distance reception, tonal quality, and news of radio, technical and non-technical. Enjoy the writings of McMurdo Silver, J. E. Anderson, Herman Bernard, John F. Rider and a host of other radio engineers in RADIO WORLD. You can find no magazine that better caters to your needs than RADIO WORLD. Short waves? RADIO WORLD will tell you all about them. Extremely sensitive broadcast receivers? Their construction and operation are fully discussed with confident regularity. Power supplies—push-pull or otherwise? AC receivers? Screen grid tubes? Large receivers that give a super-abundance of performance—small, economical receivers that give performance out of all comparison to their size? Are you interested in these? Then you're interested in RADIO WORLD.

See the list of nine meters at left. Obtain one or more of these meters free, by sending in \$1 for 8-weeks' subscription, entitling you to one meter; \$2 for 16 weeks, entitling you to two meters; \$3 for 26 weeks, entitling you to three meters; \$4 for 35 weeks, entitling you to four meters; \$5 for 44 weeks, entitling you to 5 meters; \$6 for 52 weeks, entitling you to six meters.

Present RADIO WORLD mail subscribers may renew their subscription under this remarkably generous offer. Put a cross in square. □

### RADIO WORLD

Gentlemen: Enclosed find \$..... for which please send items checked on coupon. (R-10)

145 W. 45th St., N. Y. City—Published Weekly.  
All Newsstands, 15c per copy—\$3, six months—\$6 a year

- 0-6 Voltmeter D.C.....Cat. 326
- 0-50 Voltmeter D.C.....Cat. 337
- 6-Volt Charge Tester D.C.....Cat. 23
- 0-10 Amperes D.C.....Cat. 338
- 0-25 Milliamperes D.C.....Cat. 325
- 0-50 Milliamperes D.C.....Cat. 350
- 0-100 Milliamperes D.C.....Cat. 390
- 0-300 Milliamperes D.C.....Cat. 399
- 0-400 Milliamperes D.C.....Cat. 394

- CAT. ME @.....\$3.00
- CAT. MP @.....\$7.50
- CAT. PAM @.....\$3.50
- CAT. MWT @.....\$2.50
- CAT. MWPR @.....\$2.50
- CAT. MWPRC @.....\$2.00
- CAT. MOR @.....\$2.00
- CAT. TSM @.....\$3.50
- CAT. VDB @.....\$5.00
- CAT.....326 Name .....
- CAT.....327
- CAT.....23
- CAT.....338
- CAT.....325 Address .....
- CAT.....350
- CAT.....390
- CAT.....399
- CAT.....394 City..... State.....

TRIAL SUBSCRIPTION, 8 WEEKS, \$1.00. Send \$1 and we will send you Radio World for 8 weeks, postpaid. RADIO WORLD, 145 West 45th St., N. Y. City.

TWO FOR PRICE OF ONE!  
Radio World, 52 issues, and Radio News, 12 issues, in combination for special \$7 subscription price. Radio World, 145 W. 45th St., N. Y. City.

RECENT NUMBERS  
for the late last year are procurable at the rate of 15c a copy, or 7 copies for \$1.00. RADIO WORLD, 145 West 45th St., N. Y. City.

# Power Amplifier Equipment

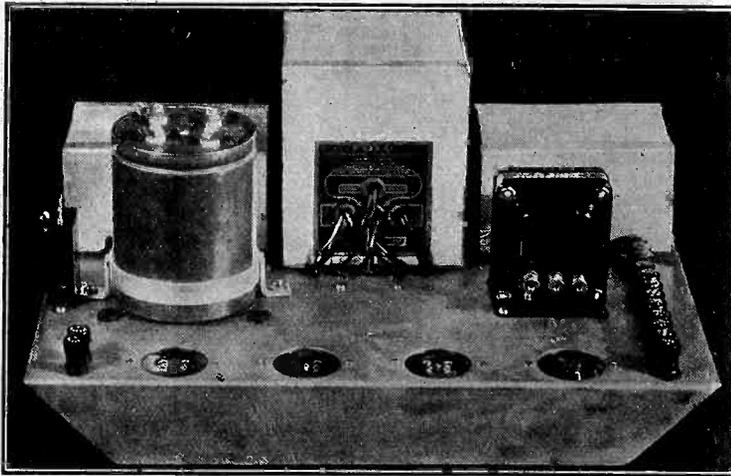

At left is illustrated a push-pull power amplifier, using a first stage of resistance coupled audio, 280 rectifier and two 245s in push-pull, as described in the November 2d issue of Radio World. Abounding volume and faithful tone reproduction are assured. The Polo Filament-Plate Supply, two Polo center-tapped audio chokes and a Multi-Tap Voltage Divider are used, with a Q 2-8, 2-18 Mershon condenser, an input push-pull audio transformer and auxiliary equipment. The total parts, including cadmium-plated steel sub-panel, come to \$43.57 net, the best power amplifier for that modest amount. Provision is made for phonograph pickup plug insertion. Thirteen output voltages are provided, including 300, 180, 75, 50 and an assortment of nine different voltages under 50 available for bias. All A, B and C voltages are provided for the power amplifier and for a tuner to be used with it employing 227, 224 or 228 tubes. Order Cat. PO-245-PA @ \$43.57 net,

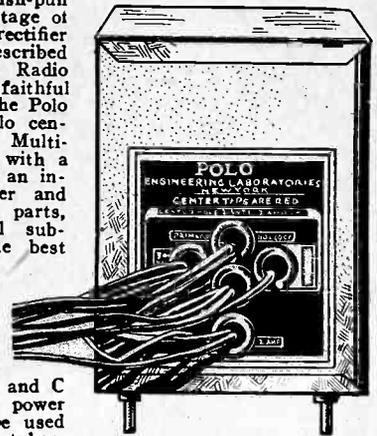

Polo 245 Filament Plate Supply (less chokes) has four windings, all save primary center-tapped (red), is 4 1/4" wide, 5" high, 4" front to back. Weight, 9 lbs. Filament windings, 2.5 v. at 12 amps., 2.5 v. at 3 amps. (for 245 filaments), 5 v. at 2 amps. for 280 rectifier, and 724 v. @ 80 m.a., center-tapped. Order Cat. FFPS @ \$7.50. [For 25 cycles order Cat. FFPS-25 @ \$12.00.] [For 40 cycles order Cat. FFPS-40 @ \$10.00.]

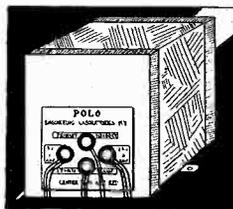

Polo Filament Transformer Only. four windings, consists of 50-60 cycles 110 v. winding, 2 1/2 v. at 12 amps., 2 1/2 v. at 3 amps., 5 v. at 2 amps. All windings, save primary, are center-tapped (red). Size, 4 1/4" high x 3 3/4" wide x 3" front to back. Weight, 6 lbs. Order Cat. PFT @ \$4.25. [For 25 cycles order PFT-25 @ \$7.00; for 40 cycles order PFT-40 @ \$6.25.]

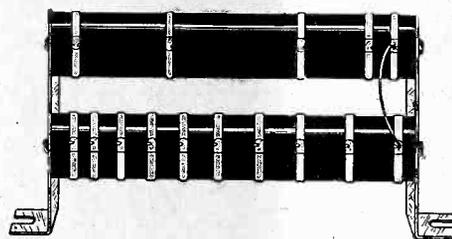

Two rugged, expertly engineered wire-wound, enamelled resistors, mounted in series, one atop the other, with fourteen useful lugs, providing all necessary choice of voltages without the uncertainty of adjustable variable resistance.

The Multi-Tap Voltage Divider has a total resistance value of 13,850 ohms, in the following steps: 3,000, 4,500, 2,000, 800, 700, 600, 550, 500, 450, 400, 200, 100 and 50 ohms. With the zero voltage lug (at lower left) the total number of useful lugs is fourteen. The resistance stated are those between respective lugs and are to be added together to constitute 13,850 ohms total.

A conservative rating of the Multi-Tap Voltage Divider is 50 watts, continuous use. The unit is serviceable in all installations where the total current drain does not exceed 125 milliamperes.

Extreme care has been exercised in the manufacture of the Multi-Tap Voltage Divider. It is mounted on brackets insulated from the resistance wire that afford horizontal mounting of the unit on baseboards and subpanels.

There long has been a need for obtaining any necessary intermediate voltage, including all biasing voltages, from a Multi-Tap Voltage Divider, but each lug has to be put on individually by hand, and soldered, so that manufacturing difficulties have left the market barren of such a device until now.

The Multi-Tap Voltage Divider is useful in all circuits, including push-pull and single-sided ones, where the current rating of 125 milliamperes is not seriously exceeded and the maximum voltage is not more than 400 volts. If good ventilation is provided, this rating may be exceeded 15 per cent.

The expertness of design and construction will be appreciated by those whose knowledge teaches them to appreciate parts finely made.

When the Multi-Tap Voltage Divider is placed across the filtered output of a B supply which serves a receiver, the voltages are in proportion to the current flowing through the various resistances. If a B supply feeds a receiver with two-stage audio amplifier, the last stage a single-sided 245, then the voltages would be 250 maximum for the power tube, 180, 135, 75, 50, 40, 35, 30, 25, 18, 10, 6 and 3. By making suitable connection of grid returns the lower voltages may be used for negative bias or even for positive voltage on the plates.

If push-pull is used, the current in the biasing section is almost doubled, so the midtap of the power tubes' filament winding would go to a lug about half way down. Order Cat. MTVD at \$3.95.

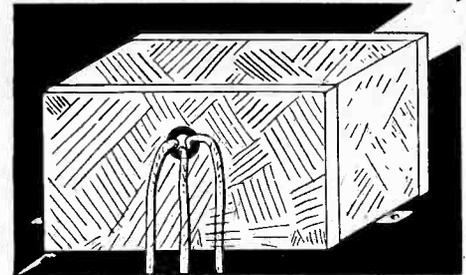

Center-tapped double choke, 125 m.a. rating, 30 henrys in each section. Used for filtering B supply or for a push-pull output impedance, where speaker cords go directly to plates of tubes. Center tap is red. Order Cat. PDC @ \$3.71.

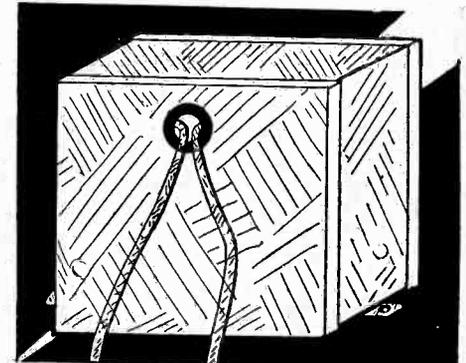

Single 30 henry 100 m.a. choke for filtered output (where condenser is used additionally) or for added filtration of a B supply. Order Cat. PSC @ \$2.50.

**By-pass Condensers**  
For by-passing B- leads to ground or C minus from 200 v. post or less, where current is less than 10 m.a., 1 mfd. paper dielectric condensers are useful. Order LV-1 @ \$0.50 ea.

**Filter Condensers**  
For high voltage filtration next to the rectifier, use 1 or 2 mfd. The 2 mfd. makes the output voltage a little higher.  
Order Cat. HV-1 (1,000 v. DC, 550 v. AC) @ \$1.76  
Order Cat. HV-2 (1,000 v. DC, 550 v. AC) @ \$3.52

**Filament-Plate-Choke Block**  
Same as Filament-Plate Supply, except that two 50 henry chokes are built in. Six windings: primary, 110 v., 50-60 cycles; 2.5 v. at 12 amps.; 2.5 v. at 3 amps.; 5 v. at 2 amps.; 724 v. at 80 m.a.; choke. All AC windings center-tapped (red), except primary. Connect either end of a choke to one end of other choke for midsection. Order Cat. P-245-FPCH @ \$10.00. [For 40 cycles order P-245-FPCH-40 @ \$13.50.] [For 25 cycles order P-245-FPCH-25 @ \$14.50.]

## ACOUSTICAL ENGINEERING ASSOCIATES.

143 West 45th St., N. Y. City.  
(Just East of Broadway.)

Please ship at once the following:

Quantity	Cat. No.	Product	Price
<input type="checkbox"/>	PO-245-PA	Power amp. parts, 50-60 c.	\$43.57
<input type="checkbox"/>	PO-245-PA-40	Same, 40 cycles	46.07
<input type="checkbox"/>	PO-245-PA-25	Same, 25 cycles	48.57
<input type="checkbox"/>	FFPS	Fil. plate supply, 50-60 c.	7.50
<input type="checkbox"/>	FFPS-40	Same, 40 cycles	10.00
<input type="checkbox"/>	FFPS-25	Same, 25 cycles	12.00
<input type="checkbox"/>	PFT	Fil. trans., 50-60 c.	4.25
<input type="checkbox"/>	PFT-40	Same, 40 cycles	6.25
<input type="checkbox"/>	PFT-25	Same, 25 cycles	7.00
<input type="checkbox"/>	P-245-FPCH	Power-filter block	10.00
<input type="checkbox"/>	P-245-FPCH-40	Same for 40 cycles	13.50
<input type="checkbox"/>	P-245-FPCH-25	Same for 25 cycles	14.50
<input type="checkbox"/>	PDC	Single choke	2.50
<input type="checkbox"/>	PSC	Multi-tap volt. div.	3.95
<input type="checkbox"/>	MTVD	Double c.-t. choke	3.71
<input type="checkbox"/>	Q2-8, 2-18B	Mershon with bracket	5.15
<input type="checkbox"/>	LV-1	200 v., 1 mfd. by-pass cond.	.50
<input type="checkbox"/>	HV-1	1,000 v., 1 mfd. filter cond.	1.76
<input type="checkbox"/>	HV-2	1,000 v., 2 mfd. filter cond.	3.52
<input type="checkbox"/>	SPO	Subpanel	3.50

Enclosed, please find check—money order—for the above. [Note: Canadian remittance must be by postal or express money order.]

Please ship C.O.D.

NAME.....

ADDRESS.....

CITY..... STATE.....

5-DAY MONEY-BACK GUARANTEE!

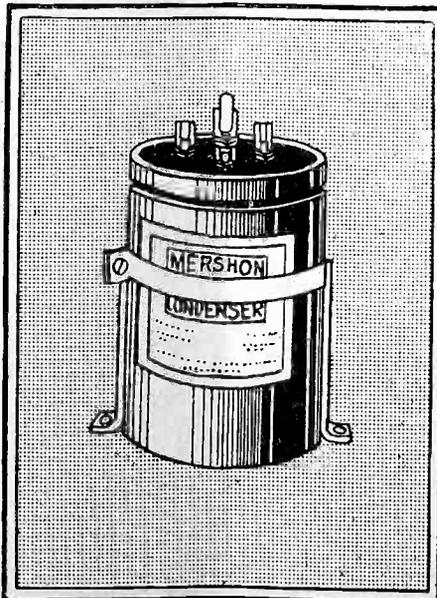

The Mershon electrolytic condenser, 415 volts DC, for filtering circuits of B supplies. Q 2-8, 2-18 has four capacities in one copper casing: two of 8 mfd. and two of 18 mfd. The copper case is negative. The smaller capacities are nearer the edge of the case. The vent cap should not be disturbed, and the electrolyte needs no refilling or replacement.

Mershon electrolytic condensers are instantly self-healing. Momentary voltages as high as 1,000 volts will cause no particular harm to the condenser unless the current is high enough to cause heating, or the high voltage is applied constantly over a long period.

High capacity is valuable especially for the last condenser of a filter section, and in by-passing, from intermediate B+ to ground or C+ to C-, for enabling a good audio amplifier to deliver true reproduction of low notes. Suitably large capacities also stop motor-boating.

Recent improvements in Mershons have reduced the leakage current to only 1.5 to 2 mils total per 10 mfd. at 300 volts, and less at lower voltages. This indicates a life of 20 years or more, barring heavy abuse.

In B supplies Mershons are always used "after" the rectifier tube or tubes, hence where the current is direct. They cannot be used on alternating current. Rated 415 v. DC.

The Mershon comes supplied with special mounting bracket. Order \$5.15 Q 2-8, 2-18 B @ .....

### Short Wave Circuit

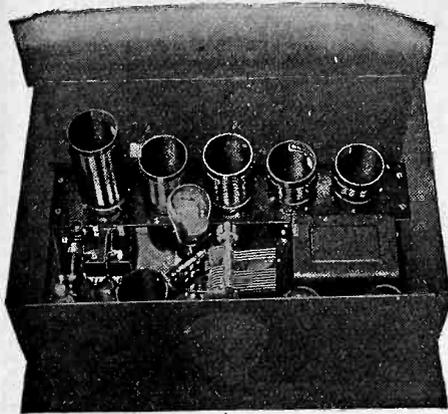

National Thrill Box, 4-tube short wave circuit, 15 to 535 meters, battery-operation of filaments; B supply, either batteries or eliminator.

Get a real kick out of listening to foreign stations on a real short-wave circuit, the National Thrill Box. Uses one 222 screen grid RF amplifier, one 200A detector, one 240 first audio and one 171A or 112A output. Single control. Buy the parts and build the circuit in two hours. Data sheet shows dial settings where foreign stations come in. Cat. SW4EF, all parts, including decorative brown steel cabinet, all six plug-in coils, list price \$51.90 (less tubes). Write for wholesale prices.

### Guaranty Radio Goods Co.

143 West 45th Street New York City

### Horn Unit \$2.25

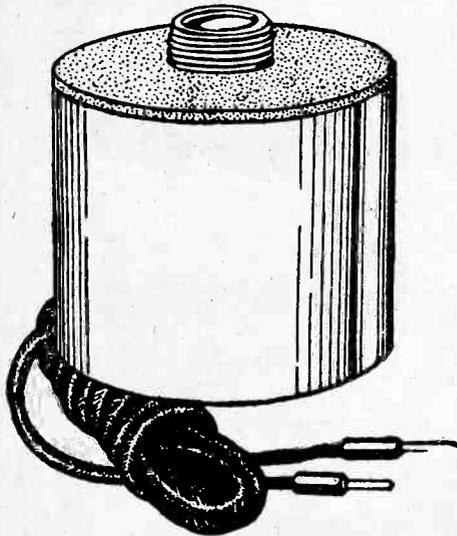

This unit is pre-eminent for horn-type speakers such as the exponential horns or other long tone travel horns. The faintest word from a "whispering tenor" or the tumultuous shout of the crowd or highest crescendo of the band is brought out clearly, distinctly. Stands up to 450 volts with out filtering. Works right out of your set's power tube, requiring no extra voltage source. Standard size nozzle and cap are die-cast aluminum, one piece, with milled platinum-like finish. The casing is full nickel, of highest possible polish. Works great from AC set, battery set or any other set, push-pull or otherwise.

#### For Portable Use

This unit can be used in a portable without any horn attached and will give loud reproduction. Order Cat. 225, with 4 1/2 ft. cord attached. (Shipping weight, 2 lbs.) \$2.25

#### Air-Column Horn

8-ft. tone travel molded wood horn (less unit No. 225) is obtainable already mounted in a baffle box. Outside overall dimensions of baffle box, 21 1/4" high, 18" wide, 15" front to back. Shipping weight, 27 lbs. Order Cat. 596 @ \$8.00

Acoustical Engineering Associates,  
145 W. 45th St., N. Y. City (Just E. of B'way).  
Please ship C. O. D.  
 Cat. No. 225 @ \$2.25  Cat. No. 596 @ \$8.00

Name .....

Address .....

City ..... State .....

FIVE-DAY MONEY-BACK GUARANTEE

# Tone That Thrills!

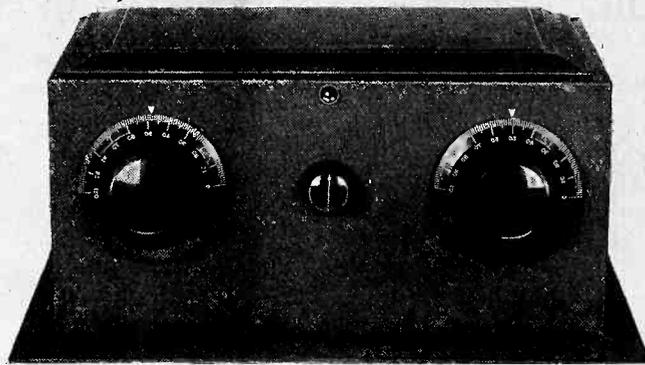

Front view of the HB Compact, battery model, the simple 4-tube receiver that works a speaker at high volume and produces tone that is of the very purest kind. Cabinet is only 15" wide, 9 1/2" front to back, 7" high.

Build the  
**HB Compact**  
(Battery model)

**\$18.55**

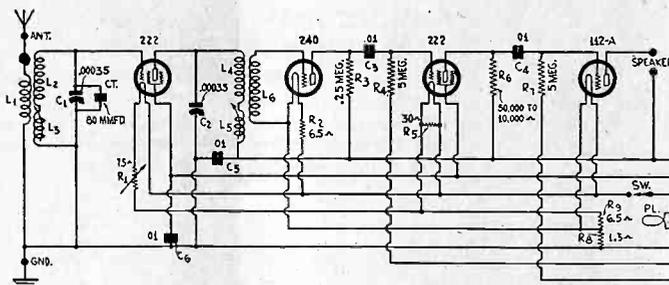

Follow this diagram of the HB Compact, battery model, when building this tone-marvelous receiver.

Everybody is delighted with the exquisite tone of the HB Compact, battery model. "Never heard anything like it," is the usual comment. The receiver uses a 222 screen grid tube for RF, 240 bias detector, 222 first audio and 112A power tube. Draws only .75 ampere filament, 18 milliamperes plate current. Very economical to run. B batteries last 6 months or more. Plentifully selective and sensitive. Build it now!

### LIST OF PARTS

[Check off what parts you want]

- L1L2L3—Antenna coil, BT3A ..... 1.35
- L4L5L6—interstage coil, BT3B ..... 1.35
- C1, C2—Two .00035 mfd., brackets ..... 2.00
- CT—Hammarlund 80 mmfd. .... .35
- C3, C4, C5, C6—Four .01 mfd. mica fixed ..... 1.40
- R1, SW—75 ohm switch rheostat ..... .80
- R2, R9—Two 6.5 ohm filament resistors ..... .50
- R3, R4, R6, R7—.25, 5.0, 0.05 and 5.0 meg. with 4 mounts ..... 1.65
- R5—30 ohm filament resistor ..... .45
- R8—1.3 ohm filament resistor ..... .20
- Ant., and, Sp. (+), Sp. (—) Four posts ..... .40
- PL—Pilot lamp 6v. and bracket ..... .70
- Drilled, socketed steel subpanel 9 1/2 x 14 1/2" ..... 2.00
- Crinkle brown steel cabinet, 7 x 9 1/2 x 15" ..... 3.50
- Two metal links ..... .20
- Seven leads for battery cable ..... .70
- Two Dials ..... 1.00
- All parts ..... \$18.55
- Tubes: two 222., one 240, one 112A ..... \$ 5.79

The HB Compact, battery model, designed by Herman Bernard, has tone quality second to none. All who appreciate music will revel in the delightful tone of this amazing circuit.

Send in your order for parts today to Guaranty Radio Goods Co., 143 West 45th Street, New York, N. Y., just E. of B'way. Use Coupon.

Name .....

Address .....

City ..... State .....

Guaranty Radio Goods Co., 143 West 45th St., New York.

# Two for the price of One

Get a FREE one-year subscription for any ONE of these magazines:

- CITIZENS RADIO CALL BOOK AND SCIENTIFIC DIGEST (quarterly, four issues).
- RADIO (monthly, 12 issues; exclusively trade magazine).
- RADIO ENGINEERING (monthly, 12 issues; technical and trade magazine).
- SCIENCE & INVENTION (monthly, 12 issues; scientific magazine, with some radio technical articles).
- AMERICAN BOY—YOUTH'S COMPANION (monthly, 12 issues; popular magazine).
- BOYS' LIFE (monthly, 12 issues; popular magazine).

Select any one of these magazines and get it FREE for an entire year by sending in a year's subscription for RADIO WORLD at the regular price, \$6.00. Cash in now on this opportunity to get RADIO WORLD WEEKLY, 52 weeks, at the standard price for such subscription, plus a full year's subscription for any ONE of the other enumerated magazines FREE! Put a cross in the square next to the magazine of your choice, in the above list, fill out the coupon below, and mail \$6 check, money order or stamps to RADIO WORLD, 145 West 45th Street, New York, N. Y. (Just East of Broadway).

Your Name .....

Your Street Address .....

City ..... State .....

If renewing an existing or expiring subscription for RADIO WORLD, please put a cross in square at beginning of this sentence.

RADIO WORLD, 145 West 45th Street, New York, N. Y. (Just East of Broadway)

A GREAT ADVERTISING MEDIUM  
That describes Radio World. Rates on application. Radio World, 145 W. 45th St., N. Y. City.

HIGH RESISTANCE PHONES \$1.65  
You can't beat them at the price. Send now. Guaranty Radio Goods Co., 143 W. 45th St., N. Y. C.

DOUBLE

VALUE!

# The Latest in Tuning Equipment

## SHIELDED COIL

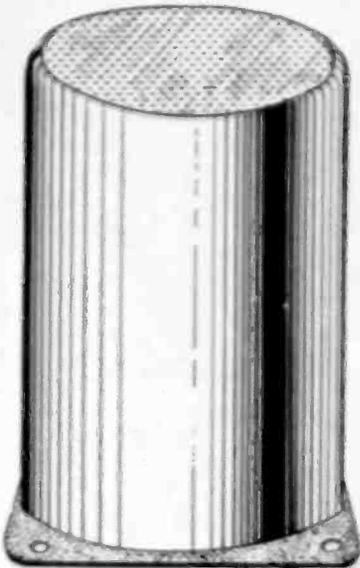

MF transformer in aluminum shield 2 1/2" across at bottom, 3 1/2" high. If metal enclosure is used no extra base is needed. Coils have brackets on. You must assemble in shield yourself and solder winding terminals to built-in leads. For all elements and covers, including screen grid tubes.

Cat. No. 822 for .0005 mfd. .... \$0.20  
 Cat. No. 823 for .0005 mfd. .... \$1.00  
 Cat. 824 (extra large) ..... \$0.10

## BERNARD TWO-TUBE TUNER ASSEMBLY

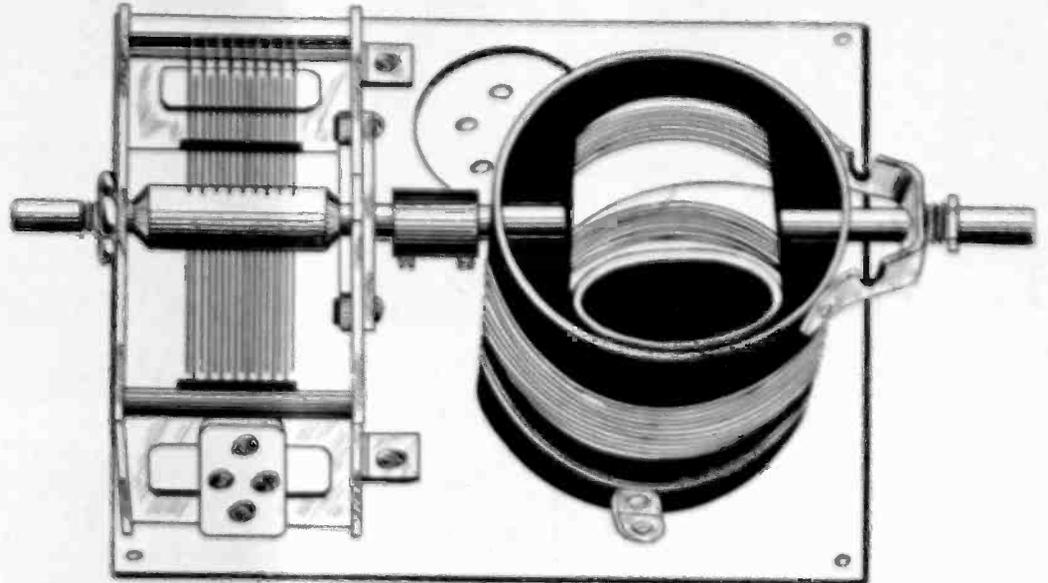

For building a tuner consisting of a stage of screen grid radio frequency amplification and a detector. AC or battery operated, use the Bernard two-tube tuner assembly. Suitable for single control with one 6-trm dial or separately tuned stages with two 6-trm dials. The assembly consists of antenna stage (BTL-AC or BTL-DC), tuning, Bernard Tuner BTLA, a .0005 mfd. condenser, socket, link and aluminum base. The detector input stage (BTL-AC or BTL-DC) consists of the same parts, but the coil has a tuned primary with untuned input to detector. Assemblies are mounted but are untested.

The condenser has shaft protruding at rear, so if two dials you need coil to give 60000 p.p.m. to adjust inductance and condenser at front panel for the color.

For AC operation, 221 MF and 222, 223 or 224 detector, order Cat. No. BTL-AC and BTL-DC at \$4.00 for both. For battery operation of elements, 221 MF and 222, 223, 224 or 224A detector, order Cat. No. BTL-DC and BTL-DC at \$4.00 for both.

[Note: For drum dial single control as 60000 p.p.m. variable condenser to detector. This is extra at \$0.20. Order Cat. 82-50.]

## ANTENNA COUPLER

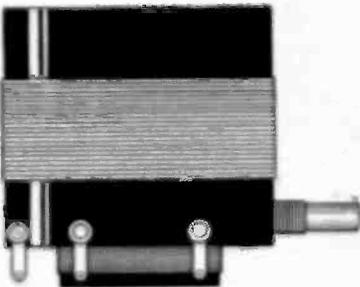

Cat. No. V43-00.05  
 FOR .0005 MFD. CONDENSER

Wiring primary and lead secondary, for antenna coupling. Suitable for vacuum control.

Cat. No. V43 for .0005 mfd. .... \$1.20

## BERNARD TUNERS

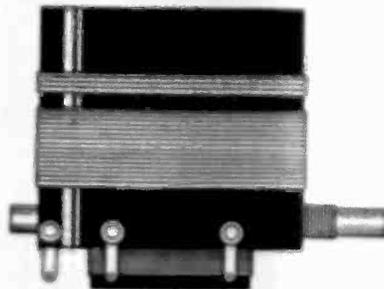

Cat. No. BTLA-01.15  
 FOR .0005 MFD. CONDENSERS

Bernard Tuner BTLA for .0005 mfd. for antenna coupling, the primary being fixed and the secondary tuned. This coil is used as input to the first screen grid radio frequency tube. Secondary has moving coil.

Cat. No. BTLA for .0005 mfd. .... \$1.25

Bernard Tuner BTLB for .0005 mfd. for working end of a screen grid tube, tuned primary, untested secondary. Primary has moving coil.

Cat. BTLB for .0005 mfd. .... \$1.25

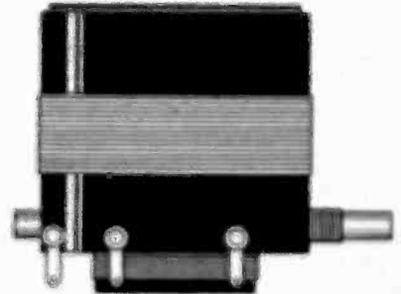

Cat. No. BTLB-01.15  
 FOR .0005 MFD. CONDENSERS

## SG TRANSFORMER

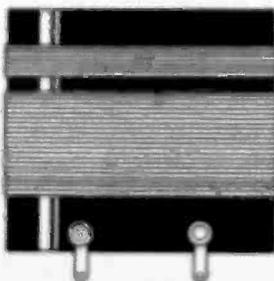

Cat. No. 8681-01.05  
 FOR .0005 MFD. CONDENSERS

Intermediate radio frequency transformer, to work out of a screen grid tube, primary untuned.

Cat. No. 8681 for .0005 mfd. .... \$1.00

## DIAMOND PAIR

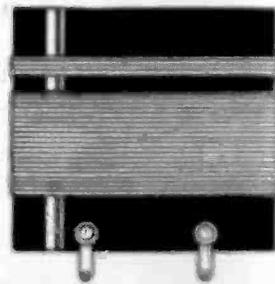

Cat. No. 873-01.05  
 FOR .0005 MFD. CONDENSERS

Cat. No. 873-01.05  
 FOR .0005 MFD. CONDENSERS

Antenna coil for 221 standard circuit, and one of the two coils constituting the Diamond Pair.

Cat. No. 873 for .0005 mfd. .... \$1.05

Cat. No. 8675-01.05  
 FOR .0005 MFD. CONDENSERS

Intermediate 1-circuit coil for 60000 p.p.m. where an untuned primary is in the plate circuit of a screen grid tube.

BTLB for .0005 mfd. .... \$1.25

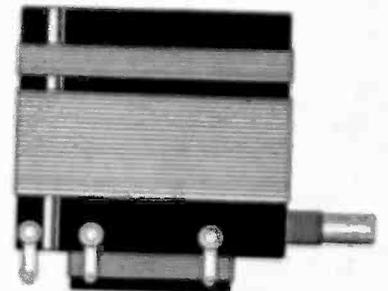

Cat. No. 8675-01.05  
 FOR .0005 MFD. CONDENSERS



FLA 8130  
 Flexible in-parallel capacitor for tuning coil or condenser shaft.

Order Cat. FLA at ..... \$1.20

Excluding condenser, 20 watts, for non-tuning access any tuning condenser where ranging is required, or for equalizing independently tuned circuits to make dial track.

Order Cat. FLA at ..... \$1.20

Order the Diamond Pair, Cat. DPA for .0005 mfd. at ..... \$1.25

Order the Diamond Pair, Cat. DPA for .0005 mfd. at ..... \$1.25

[Note: These come with one for AC or battery circuit.]

## STANDARD TUNER

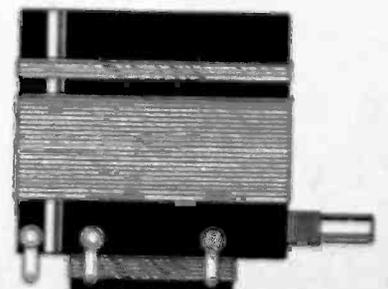

The standard three-circuit tuner is used with primary in the plate circuit of one MF tube, AC or battery type, excepting only screen grid tube.

For .0005 mfd. order TU at ..... \$1.25

For .0005 mfd. order Cat. TU at ..... \$1.25

All coils have 2 1/2" diameter, except the standard coil, which is wound on 1 1/2".

The coils are wound by machine on a bakelite form, and the tuned windings have automatic inductance for a given capacity condenser, 1 .0005 mfd. or .0005 mfd. Full coverage of the wave band is assured.

All coils with a moving coil have single hole panel mounting feature. All others have two mounting provision. The coils should be used with connection legs at bottom, to shorten leads.

Only the Bernard Tuners have a shaft extending from rear. This feature is necessary in dual physical coupling to tuning condenser shaft may be accomplished by the standard link.

Screen Grid Coil Company,  
 141 West 42nd Street,  
 New York, N. Y. (Just East of Broadway.)

Enclosed please find \$..... for which please send at once the following parts:

Cat. No. .... at \$.....  
 Cat. No. .... at \$.....  
 Cat. No. .... at \$.....

Please ship C. O. D.

Name: .....

Address: .....

City: ..... State: .....

### Parts for BERNARD TWO-TUBE TUNER

Using 222 and 201A for Battery Operation—  
Order what parts you desire.

- L1L2L3, C1, socket, link, base, .00035 mfd. tuning condenser—One Bernard tuner assembly for left-hand position when using a drum dial, socket for DC screen grid tube 222 (Cat. BT-L-DC)..... \$3.00
- L4L5L6, C2, socket, link, base, .00035 mfd. tuning condenser—One Bernard tuner assembly for right-hand position when using drum dial; socket for four-prong DC tube, 201A, 240, 112A, etc. (Cat. BT-R-DC)..... 3.00
- R1—One 75 ohm. rheostat..... .87
- R2—One 6.5 ohm. filament resistor..... .25
- R3—One 5 meg. grid leak..... .30
- R4—One 4 ohm. filament resistor..... .20
- C3, C4—Two .01 mfd. mica dielectric fixed condensers..... .70
- C5—One .00025 mfd. mica dielectric fixed condenser with clips..... .25
- C6—One .00025 mfd. mica dielectric fixed condensers..... .20
- SW—One A battery switch..... .40
- Ant., Gnd., A minus, A plus, B plus 45, B plus 135, and P, seven binding posts..... .70
- One National Velvet Vernier Modernistic dial, with rainbow feature and pilot light and bracket. 3.13
- One drilled front panel, 7x18", black bakelite. 1.80
- All parts..... \$17.60
- All parts for AC Tuner, including fil. trans..... \$22.10

Your Name .....

Your Address .....

- If C.O.D. is desired put cross here.
- If remittance enclosed put cross here. Canadian remittance must be express or P.O. money order.

GUARANTY RADIO GOODS CO.,  
143 West 45th Street, N. Y. City  
Just East of Broadway.

### CONE ASSEMBLY WITH DOUBLE MAGNET UNIT

\$4.95



An excellent magnetic type speaker for installation in any cabinet. The unit is a double-magnet Paratone, with two magnet coils, for utmost sensitivity. Each horseshoe magnet is 3/4" thick. The magnet coils are forever protected against dust and other foreign, injurious substances, by special bakelite housings. The pin is reverse drive. The cone frame is metal. The 8" cone is specially treated buckram.

All assembled, with long cord, ready to play. Shipping weight 6 lbs. \$4.95 (Cat. CAS) Net .....

The unit alone (cord included). It will operate any type sounding surface, including paper, cloth, wood, etc. Shipping weight 4 lbs. (Cat. UA). \$2.95 Net .....

Guaranty Radio Goods Co.  
145 West 45th St., New York City

## MORECROFT

New second edition of "Principles of Radio Communication," by Prof. John H. Morecroft, of the Electrical Engineering Department of Columbia University and past president of the Institute of Electrical Engineers. This is an outstanding and authoritative book on the subject.

This large book on radio principles and practice is something that you must not be without. Every set builder, every designer, every engineer, every service man, simply must have this book. Ready reference to all intricate problems makes this volume invaluable. Set builders, experimenters, distributors, dealers, salesmen and teachers, students and operators, all find Morecroft their standby, and now the new second edition awaits you. 1,001 pages and 83' illustrations in this cloth-bound volume.

Price ..... \$7.50

### RADIO WORLD

145 West 45th Street  
New York City

(Just East of Broadway)

### MICROPHONE LIGHTERS

For cigars or cigarettes, with button switch at top. Press switch, and lighter acts instantaneously. \$1.00. Model B lighter on tray, \$1.50. Radio World, 145 W. 45th St., N. Y. C.

### Aristocrat Floor Speaker

\$12.00

With Molded Wood Horn of 8 ft. tone travel (exponential type) with baffle and horn motor built in. Extraordinary bargains.

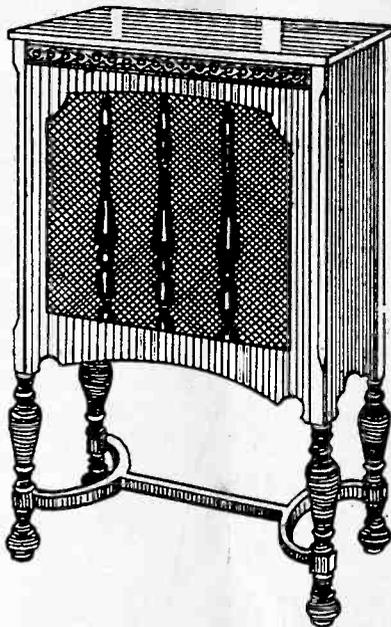

The speaker cabinet is walnut finish, 33" high, 24 1/2" wide, 17 1/2" deep, with carved legs. Golden cloth grille covers front opening. Built inside is No. 595 molded wood horn with baffle and No. 203 driving motor unit that stands 250 volts without filtration. Horn and motor removable. Table alone is worth price asked.

Shipped C.O.D. if desired.

Acoustical Engineering Associates  
143 WEST 45th STREET NEW YORK CITY

## 0-60,0-300

HIGH RESISTANCE

## DC VOLTMETER

With three 28" tipped leads built in

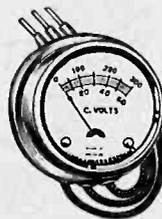

A portable type, high resistance meter, 2 1/2" outside diameter, for close reading of direct current voltages up to 60 volts, and for reading DC voltages up to 300 volts. Three vari-colored 28" insulated leads, with jack tips, are built in. Black is minus, yellow is 60 volts maximum and red is 300 volts maximum. These voltages are marked at the meter outlets. Cat. J-246. Net price, \$2.28.

J-246 Voltmeter, for measuring all direct current voltages, including B eliminators. 0-60, 0-300 (double range).

Multiplier, with jack terminals, to increase range 0-300 range to 0-600. Cat. J-108JT (with jack terminals), net price, \$1.18.

### GUARANTY RADIO GOODS CO.

143 West 45th St., N. Y. City

### RADIO WORLD and "RADIO NEWS"

BOTH FOR ONE YEAR @ \$7.00

You can obtain the two leading radio technical magazines that cater to experimenters, service men and students, the first and only national radio weekly and the leading monthly, for one year each, at a saving of \$1.50. The regular mail subscription rate for Radio World for one year, a new and fascinating copy each week for 52 weeks, is \$6.00. Send in \$1.00 extra, get "Radio News" also for a year—a new issue each month for twelve months. Total, 64 issues for \$7.00.

If renewing Radio World subscription, put cross square.  
RADIO WORLD, 145 West 45th Street, New York, N. Y.



GUARANTY RADIO GOODS CO.  
143 West 45th Street, New York, N. Y.

## SUBSCRIBERS!

Look at the Expiration Date on Your Wrapper

Please look at the subscription date stamped on your last wrapper, and if that date indicates that your subscription is about to expire, please send remittance to cover your renewal.

In this way you will get your copies without interruption and keep your file complete.

SUBSCRIPTION DEPARTMENT  
RADIO WORLD  
145 WEST 45TH ST., N. Y. CITY

## SEPARATE TESTER COMBINATION

Consists of two-meter assembly in neat black metal case, with an external high resistance meter. The two meters in the case read (a) 0-20, 0-100 milliamperes; (b) 0-10 volts, AC or DC, same meter reads both. The external high resistance meter reads 0-600 volts, AC or DC (same meter reads both). Thus you can test any plate current up to 100 ma., any filament voltage, AC or DC, up to 10 V., and any plate voltage, or line voltage or other AC or DC voltage, up to 600 volts. Five-prong plug, screen grid cable, and 4-prong adapter included. Order Cat. ST-COMB @ \$11.00 2-meter assembly, cable plugs, Cat. 215 @ \$7.00 0-600 AC-DC meter alone, Cat. M600 @ \$4.95

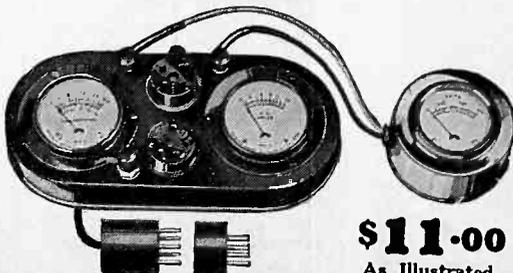

\$11.00  
As Illustrated

Guaranty Radio Goods Co., 143 West 45th St., N. Y. City

# Highest Grade Speakers at Lowest Prices!

## T - E - M - P - L - E      F - A - R - R - A - N - D

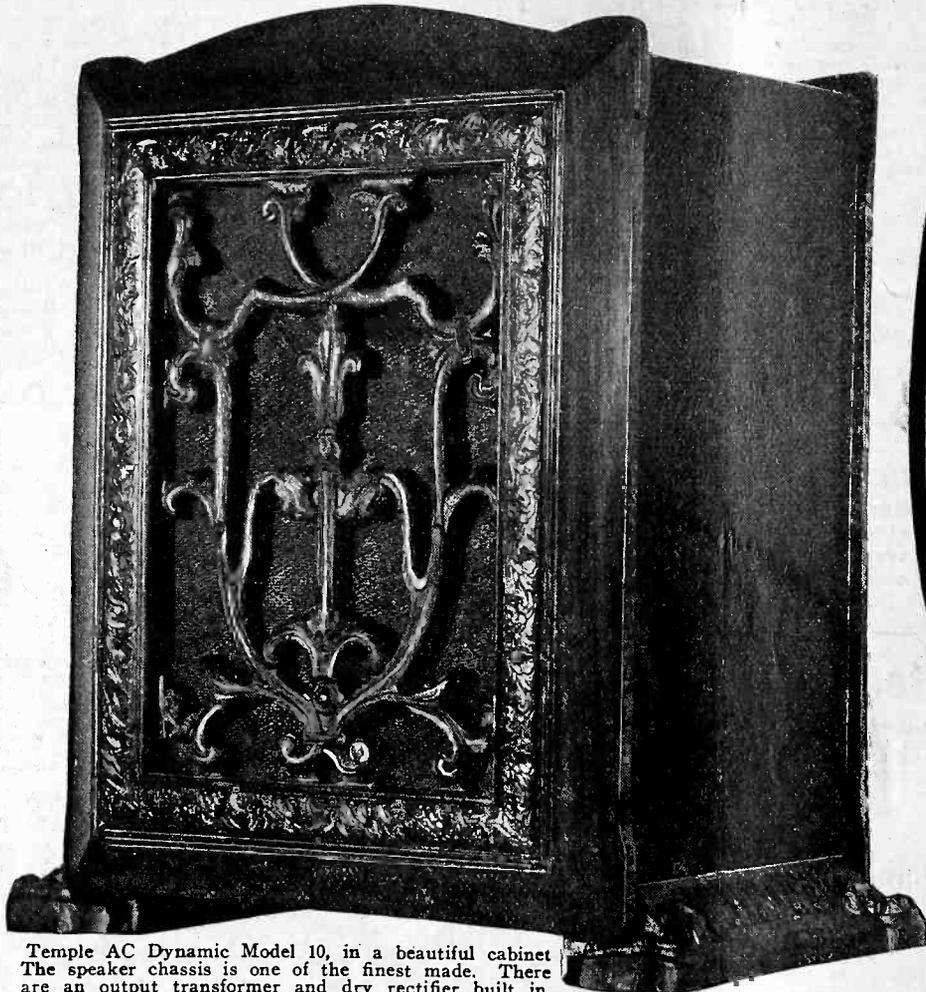

Temple AC Dynamic Model 10, in a beautiful cabinet. The speaker chassis is one of the finest made. There are an output transformer and dry rectifier built in. The cabinet has decorated walnut front and back, with carved grille ornament. An AC switch is accessible underneath cabinet. Rear is removable for adjustment of resistor knob to match the impedance of your receiver's output tube. Connect plugged AC cable to 110 volts AC, 50 to 60 cycles, and connect tipped cords to speaker post of receiver. This remarkable speaker Cat. TEM-10 at only.....

**\$15.34**

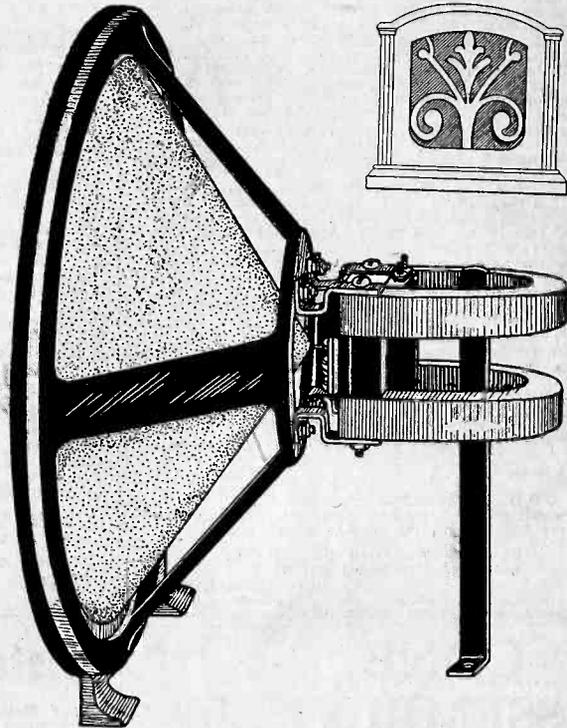

Farrand Inductor Chassis, consisting of the unit, cone, spider, bracket, assembled, but not in a cabinet.

Model 6-G, 10" extreme diameter of cone front rim ..... **\$8.00**

Model 10-G, 12" extreme diameter of cone front rim ..... **\$10.00**

Model 10-G-PP for connection to push-pull, requiring no output device, because unit is constructed as a center tapped output impedance. Center tap is yellow and goes to B+. Tipped cords go direct to plates. Outside diameter 12"..... **\$11.00**

Brookfield cabinet, No. 10 or No. 6 for those speakers, ..... **\$6.50**

## R - O - L - A

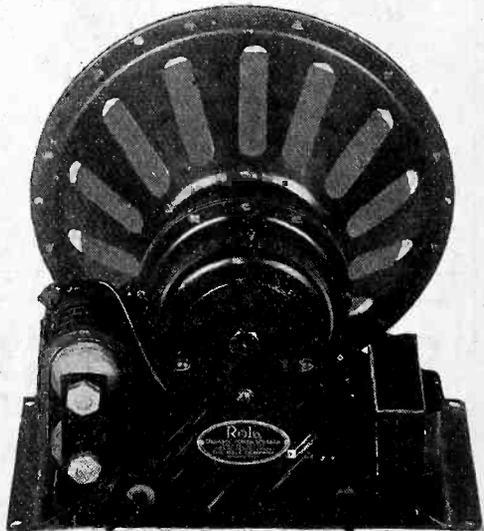

Rear view of the Rola chassis

Rola Model D-10 dynamic chassis, less cabinet, for 110 volts 50-60 cycles AC. Dry rectifier and output transformer built in. The fine workmanship of this chassis is shown in the illustrations of the front and rear views. Extreme diameter of rim 9 inches but baffles with cutouts down to 7 inches may be used.

This is the biggest dynamic chassis bargain we have ever offered and enables you at low price to obtain one of the best chassis made. Tone is most excellent.

Order Cat. No. RO-10 at .....

**\$11.34**

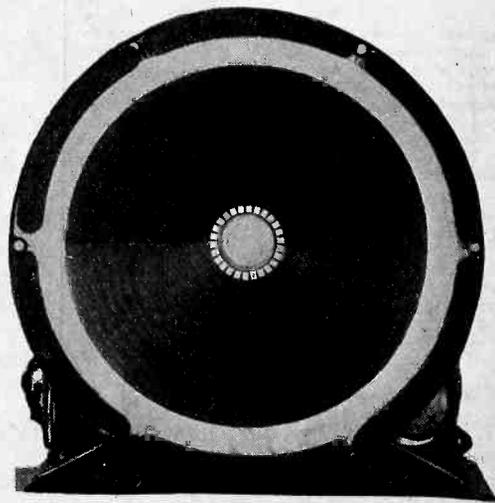

Front view of the Rola chassis. Holes are provided for attachment to your own baffle. The rim is protected by a lining of felt. The voice coil (center) is firmly mounted.

Acoustical Engineering Associates  
143 West 45th Street, New York City. (Just East of Broadway)

Gentlemen: Enclosed please find  money order  check for \$ ..... for which please send me at once

- One Model 6-G Farrand Inductor ..... \$8.00
- One Model 10-G Farrand Inductor ..... 10.00
- One Model 10-G-PP Farrand Inductor ..... 11.00
- One Model 10 Brookfield cabinet ..... 8.50
- One Model 6 Brookfield cabinet ..... 8.50
- One TEM-10 Temple Dynamic in cabinet ..... 15.34
- One RO-10 Rola dynamic chassis ..... 11.34

For C. O. D. shipment put cross here

Name .....

Address .....

City ..... State .....

[Prepaid orders shipped same day as received. Canadian remittance must be by postal or express money order.]

The Temple, Rola and Farrand speakers are highly recommended by us for true tone and high volume. They are extremely sensitive as well. The chassis (Farrand and Rola) will work without a baffle, but it is preferable to provide one. The Temple requires no extra baffle, as the cabinet is itself a baffle box.

All three speakers are sold in factory-sealed cartons. Immediate delivery.

Model 10-G-PP Farrand may be used in push-pull without any output device. Connect yellow lead to B+, tipped leads to power tube plates. May be used on single output by ignoring yellow lead.