

TWO TUBE AC SCREEN GRID TUNER

JAN. 4th, 1930

15 CENTS

RADIO

REG. U.S. PAT. OFF.

WORLD

406th Consecutive Issue—EIGHTH YEAR

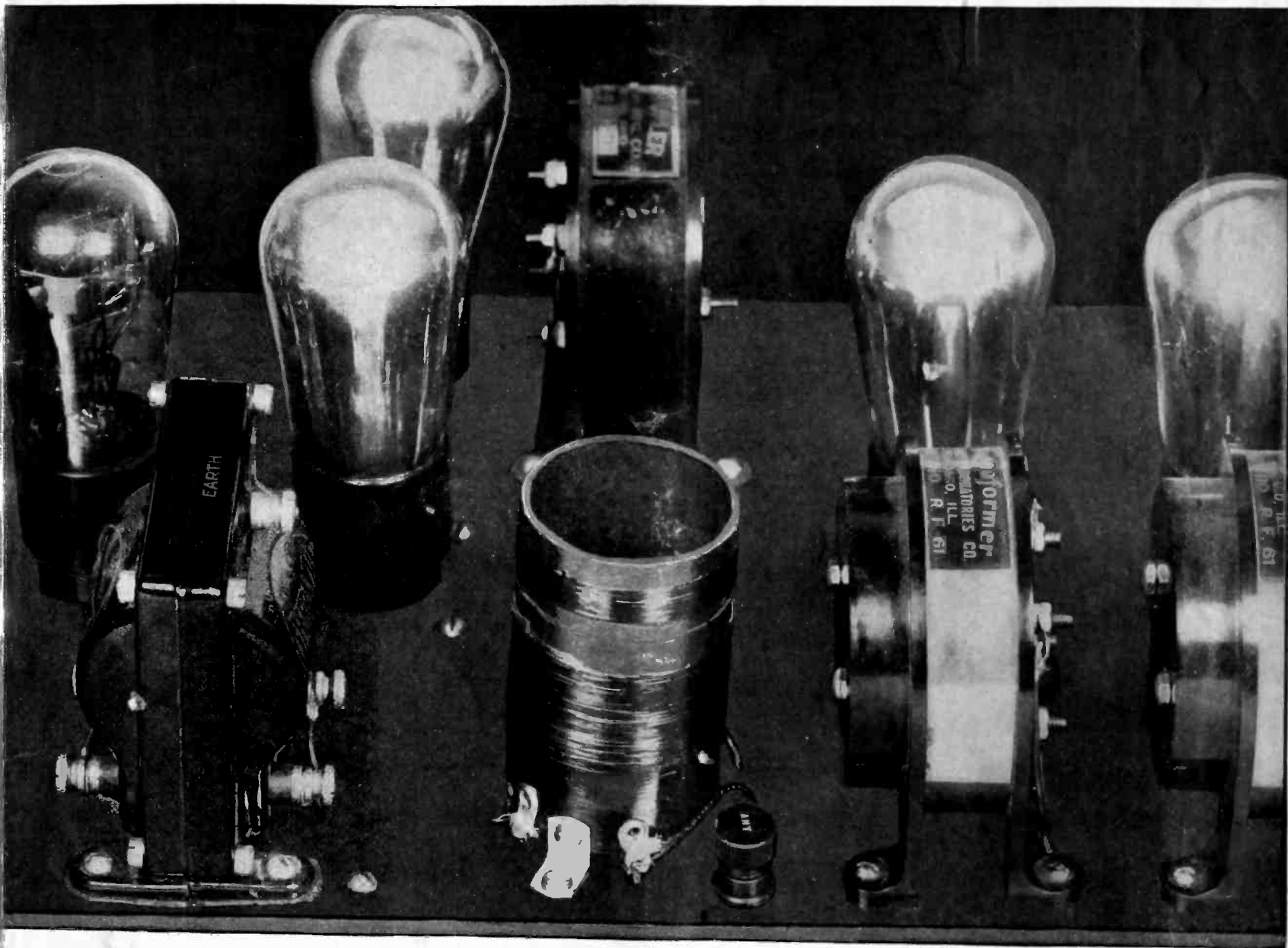

An antenna coil dispenses with the loop in the Magnaformer 9-8. Other changes are suggested in article on page 14.

WHAT ABOUT PUSH-PULL RESISTANCE AF?

HB55, AC Circuit for a 180 Volt B Eliminator

MICROVOLT PER METER—WHAT'S THAT?

RADIO WORLD, published by Hennessy Radio Publications Corporation. Roland Burke Hennessy, editor; Herman Bernard, managing editor and business manager, all of 145 West 45th Street, New York, N. Y.

Highest Grade Speakers at Lowest Prices!

T - E - M - P - L - E F - A - R - R - A - N - D



Temple AC Dynamic Model 10, in a beautiful cabinet. The speaker chassis is one of the finest made. There are an output transformer and dry rectifier built in. The cabinet has decorated walnut front and back, with carved grille ornament. An AC switch is accessible underneath cabinet. Rear is removable for adjustment of resistor knob to match the impedance of your receiver's output tube. Connect plugged AC cable to 110 volts AC, 50 to 60 cycles, and connect tipped cords to speaker post of receiver. This remarkable speaker Cat. TEM-10 at only.....

\$15.34

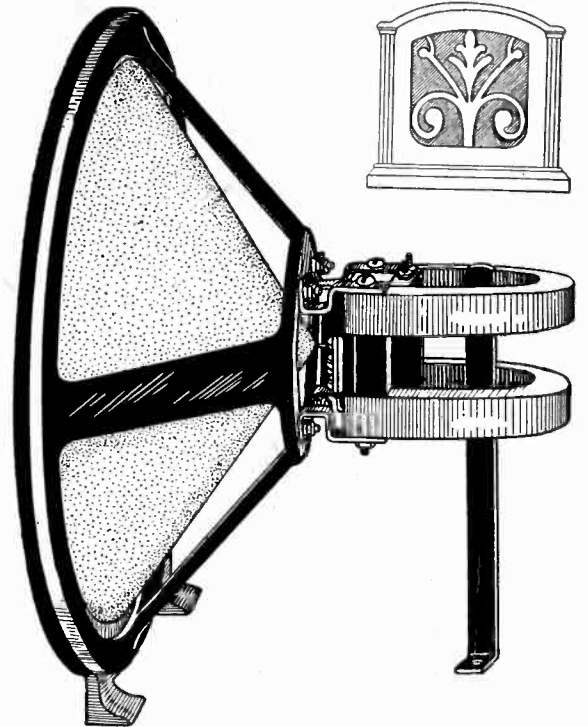

Farrand Inductor Chassis, consisting of the unit, cone, spider, bracket, assembled, but not in a cabinet.

Model 6-G, 10" extreme diameter of cone front rim **\$9.00**

Model 10-G, 12" extreme diameter of cone front rim **\$10.00**

Model 10-G-PP for connection to push-pull, requiring no output device, because unit is constructed as a center tapped output impedance. Center tap is yellow and goes to B+. Tipped cords go direct to plates. Outside diameter 12"..... **\$11.00**

Brookfield cabinet, No. 10 or No. 6 for those speakers, **\$6.50**

R - O - L - A

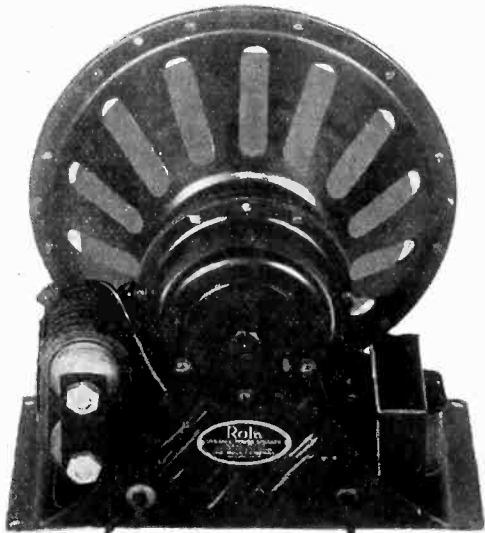

Rear view of the Rola chassis

Rola Model D-10 dynamic chassis, less cabinet, for 110 volts 50-60 cycles AC. Dry rectifier and output transformer built in. The fine workmanship of this chassis is shown in the illustrations of the front and rear views. Extreme diameter of rim 9 inches but baffles with cutouts down to 7 inches may be used.

This is the biggest dynamic chassis bargain we have ever offered and enables you at low price to obtain one of the best chasses made. Tone is most excellent.

Order Cat. No. RO-10 at

\$11.34

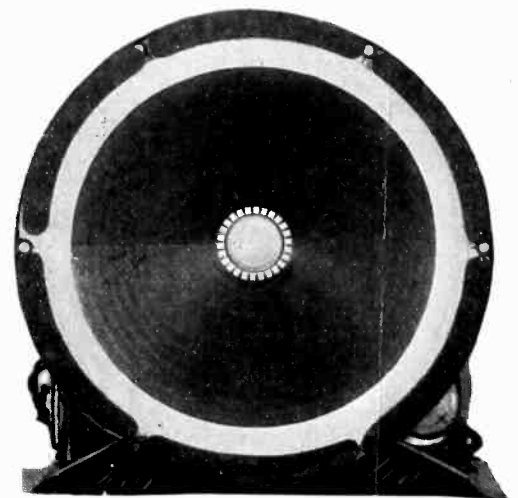

Front view of the Rola chassis. Holes are provided for attachment to your own baffle. The rim is protected by a lining of felt. The voice coil (center) is firmly mounted.

Acoustical Engineering Associates
143 West 45th Street, New York City. (Just East of Broadway)
Gentlemen: Enclosed please find money order check
for \$ for which please send me at once

<input type="checkbox"/> One Model 6-G Farrand Inductor	\$9.00
<input type="checkbox"/> One Model 10-G Farrand Inductor	10.00
<input type="checkbox"/> One Model 10-G-PP Farrand Inductor	11.00
<input type="checkbox"/> One Model 10 Brookfield cabinet	6.50
<input type="checkbox"/> One Model 6 Brookfield cabinet	6.50
<input type="checkbox"/> One TEM-10 Temple Dynamic in cabinet	15.34
<input type="checkbox"/> One RO-10 Rola dynamic chassis.....	11.34

For C. O. D. shipment put cross here

Name

Address

City State

[Prepaid orders shipped same day as received. Canadian remittance must be by postal or express money order.]

The Temple, Rola and Farrand speakers are highly recommended by us for true tone and high volume. They are extremely sensitive as well. The chasses (Farrand and Rola) will work without a baffle, but it is preferable to provide one. The Temple requires no extra baffle, as the cabinet is itself a baffle box.

All three speakers are sold in factory-sealed cartons. Immediate delivery.

Model 10-G-PP Farrand may be used in push-pull without any output device. Connect yellow lead to B+, tipped leads to power tube plates. May be used on single output by ignoring yellow lead.

High Gain at Low Cost

HB44 - - - \$45.59

HB33 - - - \$23.28

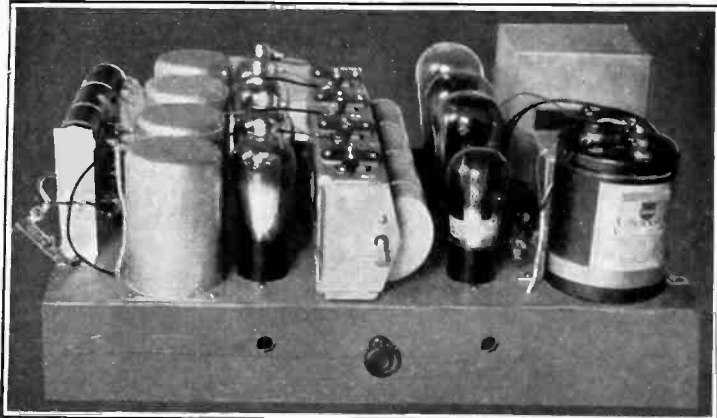

The HB44, assembled, presents in compact form, on a 17½ x 11½" steel chassis, a completely AC operated shielded receiver, using four 224 screen grid tubes, one 227, two 245s in push-pull, and a 280 rectifier, eight tubes all told. Here is the circuit that will bring 'em in from all over the country—and at a price you can afford—\$45.59. This price includes EVERYTHING except speaker, cabinet and tubes.

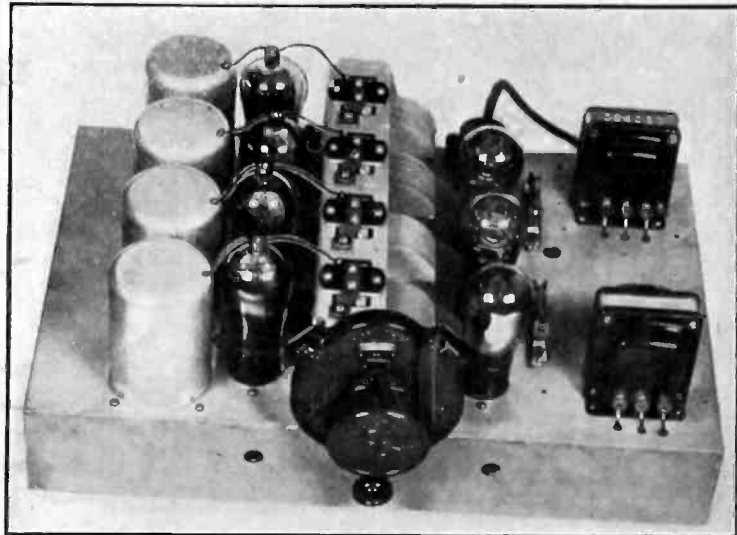

The HB33 is the shielded battery model, using seven tubes instead of eight, because there is no rectifier tube. Filament drain only 1.25 amperes, plate current drain 30 milliamperes.

Now Get All the DX You Want!

Every one at some time feels the urge to possess an ultra-sensitive receiver, one so sensitive that at night stations can be tuned in from all over the United States and Canada, and without objectionable interference.

A screen grid circuit, properly designed, using good parts that need not be expensive, will give you these results in full. The HB44, for AC operation, total parts costing only \$45.59, including power apparatus, has:

- (a) Three stages of tuned R.F., using 224 screen grid tubes.
- (b) Tuned input to 224 power detector.
- (c) Audio, consisting of first stage resistance coupled, second stage 245s in push-pull.
- (d) Four totally shielded R.F. coils.
- (e) A chassis all drilled for necessary parts.
- (f) A four gang condenser, guaranteed accurate, with equalizing condensers built in.
- (g) 61 mfd. of filter and bypass capacity.
- (h) Thirteen different fixed voltages available from the output.
- (i) Single dial control.

LIST OF PARTS FOR THE HB44

- SL1, SL2, SL3, SL4—Four stage individually shielded coil cascade for .00035 mfd. (Four Cat. SH-3 of Screen Grid Coil Co.)..... \$ 3.80
- C1, C2, C3, C4—One four gang .00035 mfd. condenser with equalizers E1, E2, E3, E4 built in..... 3.95
- C5—One .01 mfd. mica condenser..... .35
- C6, C7, C13, C14—Four 1 mfd. 200 volt DC bypass condensers..... 2.00
- C8—One 1 mfd. 550 volt AC filter condenser..... .85
- C9, C10, C11, C12—One Mershon, consisting of four condensers, two of 8 mfd. and two of 18 mfd. with bracket (Cat. Q-2-8, 2-18-B). 5.15
- R1—One Electrad 25,000 ohm potentiometer with knob and two insulators..... 1.60
- R2—One 50,000 ohm Lynch metallized resistor (.05 meg.), with mounting..... .45
- R3—One Lynch 5.0 meg. metallized grid leak, with mounting..... .40
- R4—One 5,000 ohm resistor with mounting..... .50
- VD—One Multi-Tap Voltage Divider, 13,850 ohms, 14 taps..... 3.95
- T1—One push-pull input transformer..... 2.50
- OPC—One center-tapped output choke..... 2.50
- T2—One Polo filament-plate supply (Cat. PFPS)..... 7.50
- Ch—One double filter choke coil, 30 henrys each section, 100 ma.. 3.71
- SW—One pendant AC switch with 12 ft. cable..... .80
- PL—One 2.5 volt pilot lamp and bracket..... .70
- Speaker (+), (-), Ant., Gnd.—Four binding posts with insulators. 40
- One Clarostat Humdinger, 30 ohms..... .50
- One subpanel 17½" x 11½", with five UY and three UX sockets.. 3.00
- One vernier dial..... .50
- Four National grid clips..... .24
- Hardware..... .24
- All parts (less cabinet, tubes and speaker)..... \$45.59
- Tubes: four 224, one 227, two 245, one 280..... 9.51
- Crinkle brown drilled steel cabinet, 19 x 12 x 8" outside..... 3.60

LIST OF PARTS FOR THE HB33

- SL1, SL2, SL3, SL4—Four stage individually shielded coil cascade for .00035 mfd. (Cat. SH-3 of Screen Grid Coil Co.)..... \$ 3.80
- C1, C2, C3, C4—Four gang .00035 mfd. condenser with equalizers E1, E2, E3, E4..... 3.95
- C5, C6—Two .01 mfd. mica fixed condenser..... .70
- C7, C8—Two 1.0 mfd. bypass condensers, 200 volt DC working voltage..... 1.00
- R1, Sw—30 ohm rheostat with switch, knob, 2 insulators..... .90
- R2, R3—Two 6.5 ohm fixed filament resistors..... .50
- R4—One .05 meg. Lynch metallized resistor..... .35
- R5—One 5.0 meg. Lynch metallized resistor..... .30
- R6—One 1 ohm fixed filament resistor..... .20
- T1—One push-pull input transformer..... 2.50
- T2—One push-pull output transformer..... 2.50
- PL—Pilot lamp and bracket..... .70
- Ant., Gnd., Speaker—Four binding posts..... .40
- One vernier full-vision dial..... .50
- One flanged subpanel, seven UX, one UY sockets..... 3.00
- Four grid clips..... .24
- One 5-lead connector cable..... 1.50
- Hardware..... .24
- All parts (less cabinet, tubes, speaker)..... \$23.28
- Tubes: four 222, three 112A..... 7.06
- Crinkle brown drilled steel cabinet, 19 x 12 x 8" outside..... 3.60

It's the Real Thing!

Do not make the mistake of assuming that simply because the prices of the parts of the HB44 and HB33 are low that performance is not of the very highest, as quantity production of parts results in a low price passed on to the consumer for his benefit. You can take it for granted that these circuits, designed by Herman Bernard, are all they are cracked up to be. The claims made are conservative, and not bombastic. It stands to reason that four tuned stages, working into screen grid tubes, must give superlative results, if the design is expert and the parts are good.

Take the HB44, for example, Parts used include those of Electrad, Inc., National Company, Amrad Corporation (Mershon Division), Clarostat Mfg. Co., Lynch Manufacturing Corp., Splittdorf, Polo Engineering Laboratories, and Martin Copeland. These are manufacturers with indeed high reputations.

The parts for the HB33 are on the same high plane of quality.

You are assured of most excellent tone quality when you build either of these receivers, as the audio coupling media are the same in both, and negative bias detection is used in both. Choose either one—it's the real thing, rest assured!

GUARANTY RADIO GOODS CO.
143 West 45th Street, New York, N. Y.
(Just East of Broadway.)

- Please ship all parts for HB44 @..... \$45.59
- Please ship all parts for HB33 @..... 23.28
- Cabinet for above (same one for either)..... 3.60
- Eight tubes for HB44..... 9.51
- Seven tubes for HB33..... 7.06
- Please ship C.O.D.
- Enclosed find \$..... remittance.
- (Canadian must be P. O. or Express M. O.)

NOTE: If only some (not all) parts are desired, check off on list at left and tear out and send in this entire page.

NAME.....
ADDRESS.....
CITY..... STATE.....
FIVE DAY MONEY-BACK GUARANTY

The Latest in Tuning Equipment

SHIELDED COIL

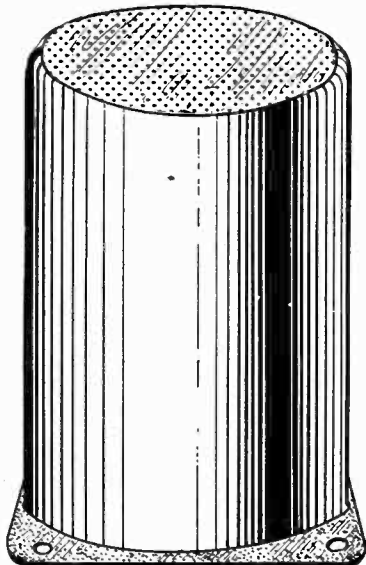

RF transformer in aluminum shield 2 3/4" square at bottom, 3 1/4" high. If metal sub-panel is used no extra base is needed. Coils have brackets on. You must assemble in shield yourself and solder winding terminals to built-in lugs. For all circuits and stages, including screen grid tubes.

Cat. No. SH3 for .00035 mfd.\$0.95
 Cat. No. SH5 for .0005 mfd.\$1.00
 Cat. SHB (extra base)\$0.10

BERNARD TWO-TUBE TUNER ASSEMBLY

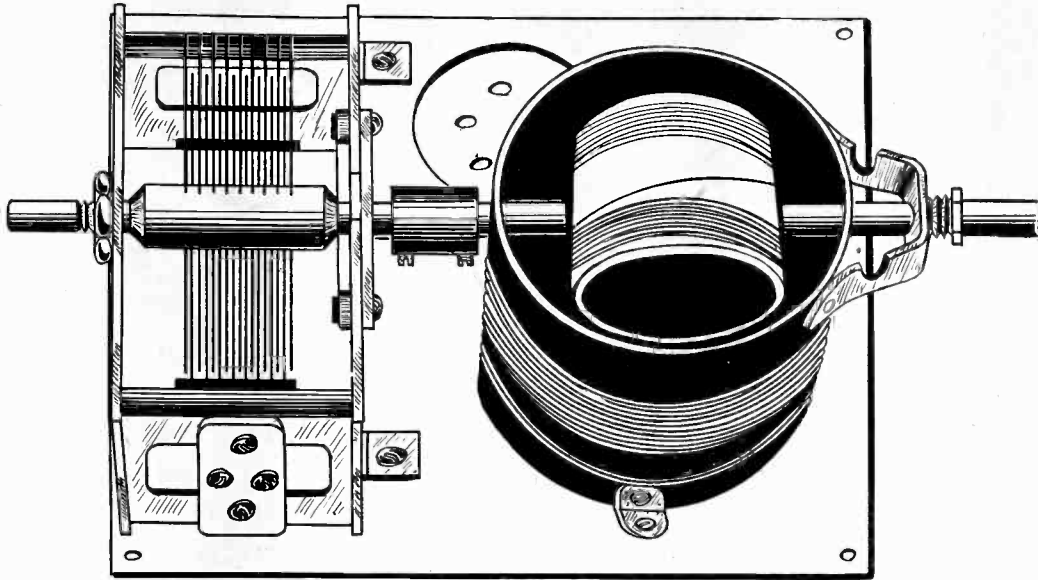

For building a tuner consisting of a stage of screen grid radio frequency amplification and a detector. AC or battery-operated, use the Bernard two-tube tuner assembly. Suitable for single control with one drum dial or separately tuned stages with two flat-type dials. The assembly consists of antenna stage (BTL-AC or BTL-DC), having Bernard Tuner BT3A, a .00035 mfd. condenser, socket, link and aluminum base. The detector input stage (BTR-AC or BTR-DC) consists of the same parts, but the coil has a tuned primary with untuned input to detector. Assemblies are unwired but are erected.

The condenser has shaft protruding at rear, so if two dials are used coil is put at front panel in either instance and condenser at front panel for the other.

For AC operation, 224 RF and 224, 227 or 228 detector, order Cat. No. BTL-AC and BTR-AC at \$6.00.
 For battery operation of filaments, 222 RF and 222, 240, 201A or 112A detector, order Cat. No. BTL-DC and BTR-DC at \$6.00.

[Note: for drum dial single control an 80 mmfd. equalizing condenser is necessary. This is extra at \$0.35. Order Cat. EQ-80.]

ANTENNA COUPLER

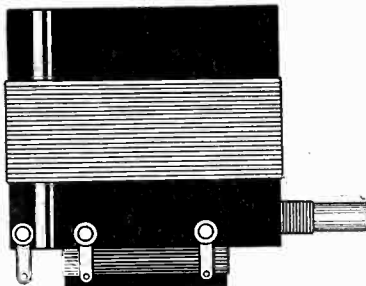

Cat. No. VA5—\$0.85
 FOR .0005 MFD. CONDENSER

Moving primary and fixed secondary, for antenna coupling. Serves as volume control
 Cat. No. VA3 for .00035 mfd.\$0.90

BERNARD TUNERS

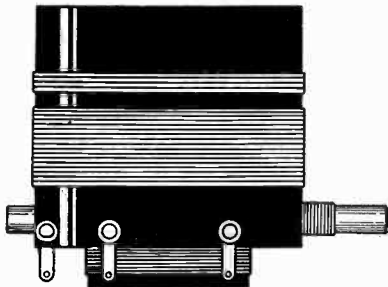

Cat. No. BT5A—\$1.35
 FOR .0005 MFD. CONDENSERS

Bernard Tuner BT5A for .0005 mfd. for antenna coupling, the primary being fixed and the secondary tuned. This coil is used as input to the first screen grid radio frequency tube. Secondary has moving coil.

Cat. No. BT3A for .00035 mfd. ..\$1.35

Bernard Tuner BT5B for .0005 mfd. for working out of a screen grid tube, tuned primary, untuned secondary. Primary has moving coil.

Cat. BT3B for .00035 mfd. ..\$1.35

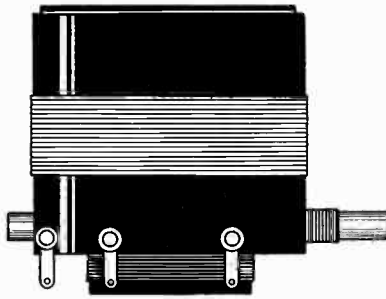

Cat. No. BT5B—\$1.35
 FOR .0005 MFD. CONDENSER

SG TRANSFORMER

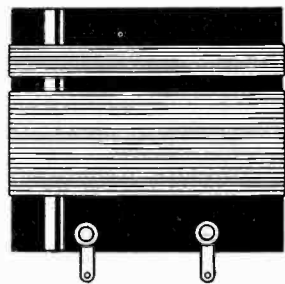

Cat. No. SGS5—\$0.60
 FOR .0005 MFD. CONDENSER

Interstage radio frequency transformer, to work out of a screen grid tube, primary untuned.

Cat. No. SGS3 for .00035 mfd.\$0.65

DIAMOND PAIR

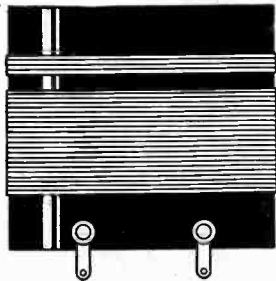

Cat. No. RF5—\$0.60
 FOR .0005 MFD. CONDENSER

Cat. No. RF5—\$0.60
 FOR .0005 MFD. CONDENSER

Antenna coil for any standard circuit, and one of the two coils constituting the Diamond Pair.

Cat. No. RF3 for .00035 mfd.\$0.65

Cat. No. SGT5—\$0.85
 FOR .0005 MFD. CONDENSER

Interstage 3-circuit coil for any hookup where an untuned primary is in the plate circuit of a screen grid tube.

SGT3 for .00035 mfd.\$0.90

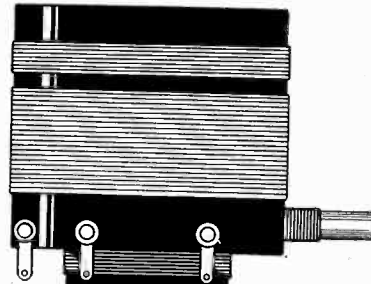

Cat. No. SGT5—\$0.85
 FOR .0005 MFD. CONDENSER



FL4 \$0.30
 Flexible insulated coupler for uniting coil or condenser shafts

Order Cat. FL4 at\$0.30

Equalizing condenser, 80 mmfd. for connection across any tuning condenser where ganging is resorted to, or for equalizing independently tuned circuits to make dials track.

Order Cat. EQ80 at\$0.35

Order the Diamond Pair, Cat. DP5 for .0005 mfd. at\$1.45

Order the Diamond Pair, Cat. DP3 for .00035 mfd. at\$1.55

[Note: These same coils are for AC or battery circuit.]

STANDARD TUNER

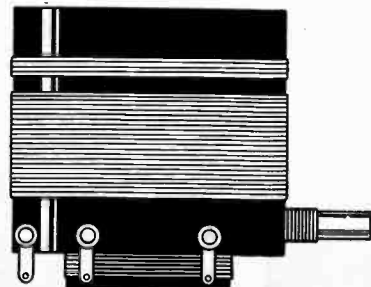

The standard three-circuit tuner is used with primary in the plate circuit of any RF tube, AC or battery type, excepting only screen grid tube. For .0005 mfd. order T5 at\$0.85

For .00035 order Cat. T3 at\$0.90

All coils have 2 1/2" diameter, except the shielded coil, which is wound on 1 3/4".

The coils are wound by machine on a bakelite form, and the tuned windings have identical inductance for a given capacity condenser, i. e., .0005 mfd. or .00035 mfd. Full coverage of the wave band is assured.

All coils with a moving coil have single hole panel mounting fixture. All others have base mounting provision. The coils should be used with connection lugs at bottom, to shorten leads.

Only the Bernard Tuners have a shaft extending from rear. This feature is necessary so that physical coupling to tuning condenser shaft may be accomplished by the insulated link.

Screen Grid Coil Company,
 143 West 45th Street,
 New York, N. Y. (Just East of Broadway.)

Enclosed please find \$..... for which please send at once the following parts:

Cat. No. at \$

Cat. No. at \$

Cat. No. at \$

Please ship C. O. D.

Name

Address

City State

Short Wave Circuit

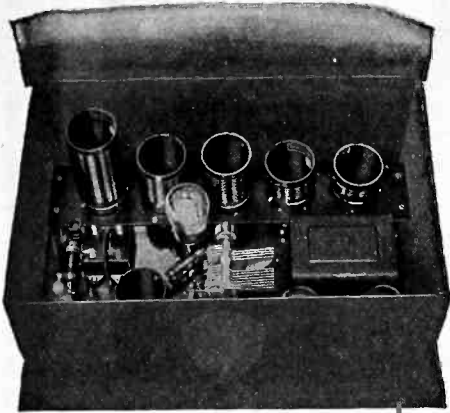

National Thrill Box, 4-tube short wave circuit, 15 to 535 meters, battery-operation of filaments; B supply, either batteries or eliminator.

Get a real kick out of listening to foreign stations on a real short-wave circuit, the National Thrill Box. Uses one 222 screen grid RF amplifier, one 200A detector, one 240 first audio and one 171A or 112A output. Single control. Buy the parts and build the circuit in two hours. Data sheet shows dial settings where foreign stations come in. Cat. SW4EF, all parts, including decorative brown steel cabinet, all six plug-in coils, list price \$51.90 (less tubes). Your price \$31.00.

Guaranty Radio Goods Co.

143 West 45th Street New York City

Horn Unit \$2.25

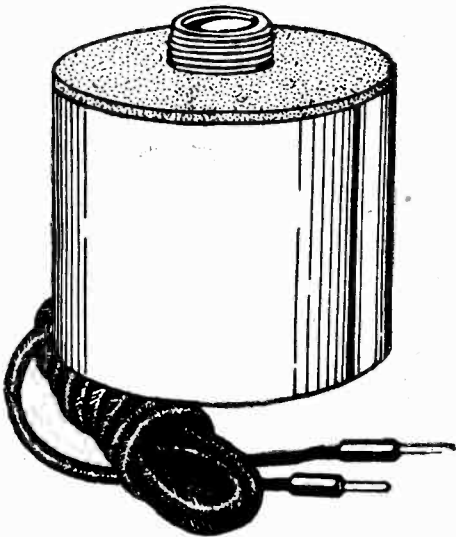

This unit is pre-eminent for horn-type speakers, such as the exponential horns or other long tone-travel horns. The faintest word from a "whispering tenor" or the tumultuous shout of the crowd or highest crescendo of the band is brought out clearly, distinctly. Stands up to 450 volts without filtering. Works right out of your set's power tube, requiring no extra voltage source. Standard size nozzle and cap are die-cast aluminum, one piece, with milled platinum-like finish. The casing is full nickel, of highest possible polish. Works great from AC set, battery set or any other set, push-pull or otherwise.

For Portable Use

This unit can be used in a portable without any horn attached and will give loud reproduction. Order Cat. 225, with 4 1/2 ft. cord attached (Shipping weight, 2 lbs.) \$2.25

Air-Column Horn

8-ft. tone travel molded wood horn (less unit No. 225) is obtainable already mounted in a baffle box. Outside overall dimensions of baffle box, 21 1/4" high, 18" wide, 15" front to back. Shipping weight, 27 lbs. Order Cat. 596 @ \$8.00.

Acoustical Engineering Associates,
145 W. 45th St., N. Y. City (Just E. of B'way).
Please ship C. O. D.
 Cat. No. 225 @ \$2.25 Cat. No. 596 @ \$8.00

Name

Address

City State

FIVE-DAY MONEY-BACK GUARANTEE

Tone That Thrills!

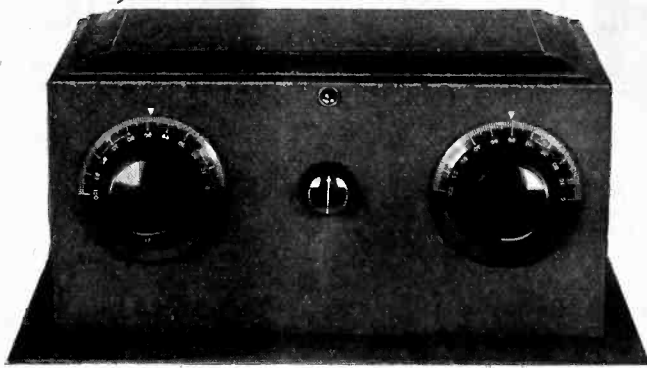

Build the
HB Compact
(Battery model)

\$18.55

Front view of the HB Compact, battery model, the simple 4-tube receiver that works a speaker at high volume and produces tone that is of the very purest kind. Cabinet is only 15" wide, 9 1/2" front to back, 7" high.

Everybody is delighted with the exquisite tone of the HB Compact, battery model. "Never heard anything like it," is the usual comment. The receiver uses a 222 screen grid tube for RF, 240 bias detector, 222 first audio and 112A power tube. Draws only .75 ampere filament, 18 milliamperes plate current. Very economical to run. B batteries last 6 months or more. Plentifully selective and sensitive. Build this re-

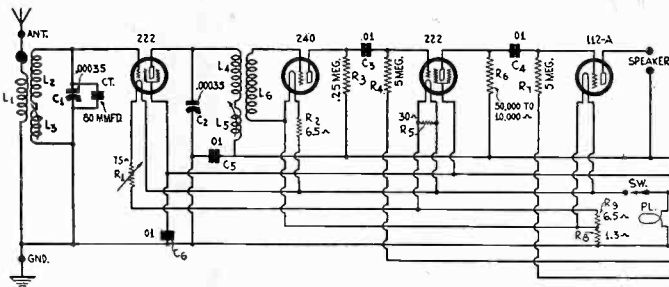

Follow this diagram of the HB Compact, battery model, when building this tone-marvelous receiver.

LIST OF PARTS

[Check off what parts you want]

- L1L2L3—Antenna coil, BT3A 1.35
- L4L5L6—Interstage coil, BT3B 1.35
- C1, C2—Two .00035 mfd. brackets 2.00
- CT—Hammarlund 80 mmfd.35
- C3, C4, C5, C6—Four .01 mfd. mica fixed 1.40
- R1, SW—75 ohm switch rheostat80
- R2, R9—Two 6.5 ohm filament resistors50
- R3, R4, R6, R7—0.25, 5.0, 0.05 and 5.0 meg. with 4 mounts 1.65
- R5—30 ohm filament resistor45
- R8—1.3 ohm filament resistor20
- Ant., gnd., Sp. (+), Sp. (—)—Four posts40
- PL—Pilot lamp 6v. and bracket70
- Drilled, socketed steel subpanel 9 1/2 x 14 1/4 2.00
- Crinkle brown steel cabinet, 7 x 9 1/2 x 15 3.50
- Two metal links20
- Seven leads for battery cable70
- Two Dials 1.00
- All parts \$18.55
- Tubes: two 222., one 240, one 112A 4.39

The HB Compact, battery model, designed by Herman Bernard, has tone quality second to none. All who appreciate music will revel in the delightful tone of this amazing circuit.

Send in your order for parts today to Guaranty Radio Goods Co., 143 West 45th Street, New York, N. Y., just E. of B'way. Use Coupon.

Name

Address

City State

Guaranty Radio Goods Co., 143 West 45th St., New York.

MORECROFT

New second edition of "Principles of Radio Communication," by Prof. John H. Morecroft, of the Electrical Engineering Department of Columbia University and past president of the Institute of Electrical Engineers. This is an outstanding and authoritative book on the subject.

This large book on radio principles and practice is something that you must not be without. Every set builder, every designer, every engineer, every service man, simply must have this book. Ready reference to all intricate problems makes this volume invaluable. Set builders, experimenters, distributors, dealers, salesmen and teachers, students and operators, all find Morecroft their standby, and now the new second edition awaits you. 1,001 pages and 83" illustrations in this cloth-bound volume.

Price **\$7.50**

RADIO WORLD

145 West 45th Street
New York City
(Just East of Broadway)

RADIO WORLD'S BOOK SERVICE has been found of great value not only by radio fans, constructors, etc., but also by radio and other technical schools throughout the country. See the radio books advertisements in this issue.



GUARANTY RADIO GOODS CO.
143 West 45th Street, New York, N. Y.

TWO FOR PRICE OF ONE!

Radio World, 52 issues, and Radio News, 12 issues, in combination for special \$7 subscription price. Radio World, 145 W. 45th St., N. Y. City.

A GREAT ADVERTISING MEDIUM That describes Radio World. Rates on application. Radio World, 145 W. 45th St., N. Y. City.



Vol. XVI, No. 16 Whole No. 406
 January 4th, 1930
 15c per Copy, \$6.00 per Year
 [Entered as second-class matter, March, 1922, at the Post Office at New York, N. Y., under act of March, 1879.]

Technical Accuracy Second to None
 Latest Circuits and News
EIGHTH YEAR

A Weekly Paper published by Hennessy Radio Publications Corporation, from Publication Office, 145 West 45th Street, New York, N. Y. (Just East of Broadway) Telephone, BRyant 0558 and 0559

RADIO WORLD, owned and published by Hennessy Radio Publications Corporation, 145 West 45th Street, New York, N. Y. Roland Burke Hennessy, president and treasurer, 145 West 45th Street, New York, N. Y.; M. B. Hennessy, vice-president, 145 West 45th Street, New York, N. Y.; Herman Bernard, secretary, 145 West 45th Street, New York, N. Y. Roland Burke Hennessy, editor; Herman Bernard, business manager and managing editor; J. E. Anderson, technical editor.

A Two Tube AC Tuner

Works Splendidly Into a Power Pack—Uses Bernard Tuners

By James H. Carroll

Contributing Editor

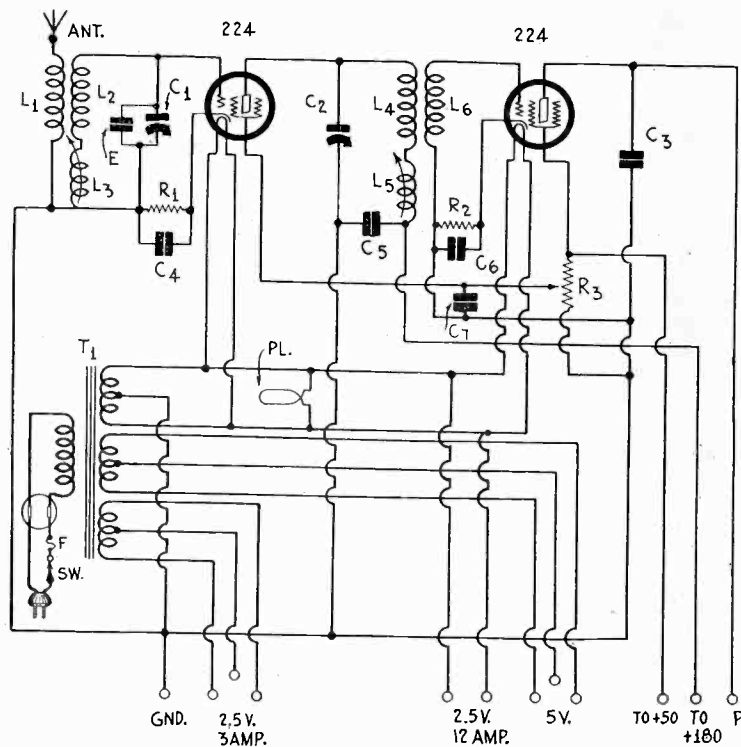

FIG. 1

DIAGRAM OF THE AC BERNARD TUNER, USING TWO SCREEN GRID TUBES, ONE FOR RADIO FREQUENCY AMPLIFICATION, THE OTHER FOR NEGATIVE BIAS DETECTION.

A TWO-TUBE A C tuner, fundamentally the same as the one for battery operation published last week, uses substantially the same parts, except that the sockets are of the five-prong UY type, and the filament transformer is added, besides resistors and by-pass condensers. This makes a dandy tuner to go with an AC power amplifier, and besides renders available 2.5 volts for operation of one or two 245 output tubes, or 5 volts for 112, 112A, 171 or 171A, singly or in matched pairs, and besides permits heating three other heater type tubes—224, 227 or 228—from the high current 2.5 volt winding. The B voltages must be supplied by the power amplifier.

The Bernard tuner assemblies, left and right types, are used, and in addition two extension shafts are employed. These provide a 1/4-inch shaft at one end and take a 1/4-inch shaft in the receptacle at the other end. The object of introducing these is to permit sufficient separation to enable the filament transformer to be moved close to the National modernistic color wheel drum dial.

A 7"x21" front panel is required, and this is obtainable all ready drilled. The tuner assemblies have aluminum bases, so no subpanel is necessary, the bases being elevated from the bottom of a table model cabinet to provide clearance for the socket lugs.

The Bernard tuners have a tuned inductance consisting of a fixed coil and a moving coil, an important object of this combination being to insure coverage of the complete band of broadcast

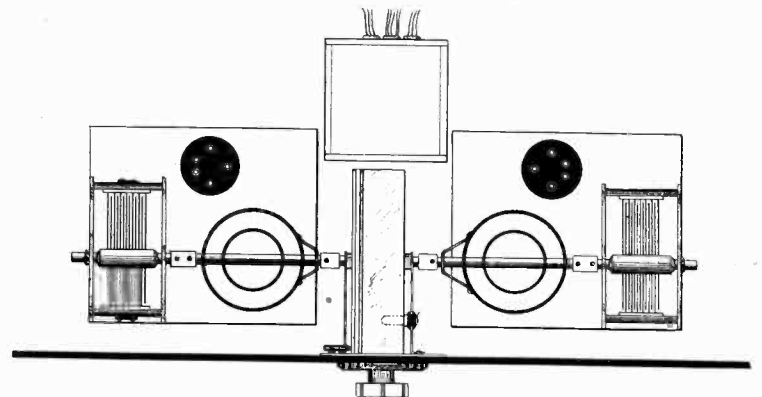

FIG. 2

THE TUNER ASSEMBLIES ARE PLACED TO LEFT AND RIGHT OF THE DRUM DIAL. THE FILAMENT TRANSFORMER IS PUT BEHIND THE DRUM.

wavelengths when resorting to the high-gain method of tuning the screen grid plate circuit. To obtain the fine results that this combination assures it is necessary to have the moving coils in proper position.

You may complete the wiring and then pay attention to the position of the moving coils. Turn the dial to read 100 and have both moving coils parallel with the fixed winding, using only your eye as your guide. They may not be electrically parallel, for one may be bucking the fixed winding and the other aiding it, but this you will correct.

Tune in a station. Tune in several other stations. Notice whether they come in with a snap and provide good selectivity. Then see that if the entire wave band is tuned in. If the low wavelength stations come in with too much capacity of the tuning condensers in use, you will not be able to tune in the highest wavelength station. You should tune in 200 meters at 15 or lower and 500 meters at about 80. If the readings are much higher than this, reverse both moving coils by turning both around half a circle. Be sure though that when the condenser plates are totally enmeshed that the moving coils are parallel with the fixed windings. Now tune in the entire wave band.

As an extra precaution, turn only one of the coils around half way now. Should selectivity and volume improve, note whether the entire band is tuned in. If so you are all set, if not reverse both moving coils.

By making these tests you will have both moving coils aid the fixed windings at the high wavelengths and buck them at the low wavelengths.

The P lead from the detector goes to the first audio coupling unit, in the power pack, which should be a .1 meg. resistor. If you are using a first stage of transformer coupled audio you may introduce the resistor between the P lead from the tuner and the P post of the first audio transformer primary, placing an .01 mfd. condenser from the P lead of tuner to G of the first audio socket. The screen grid detector tube works best with a high impedance load, and this is a good way to provide it if you have a first stage transformer. If your first stage is resistance coupled, be sure the plate resistor is .1 meg.

[More details next week.]

Good Regulation Needed

It Improves Quality and Avoids Motorboating

By Brunsten Brunn

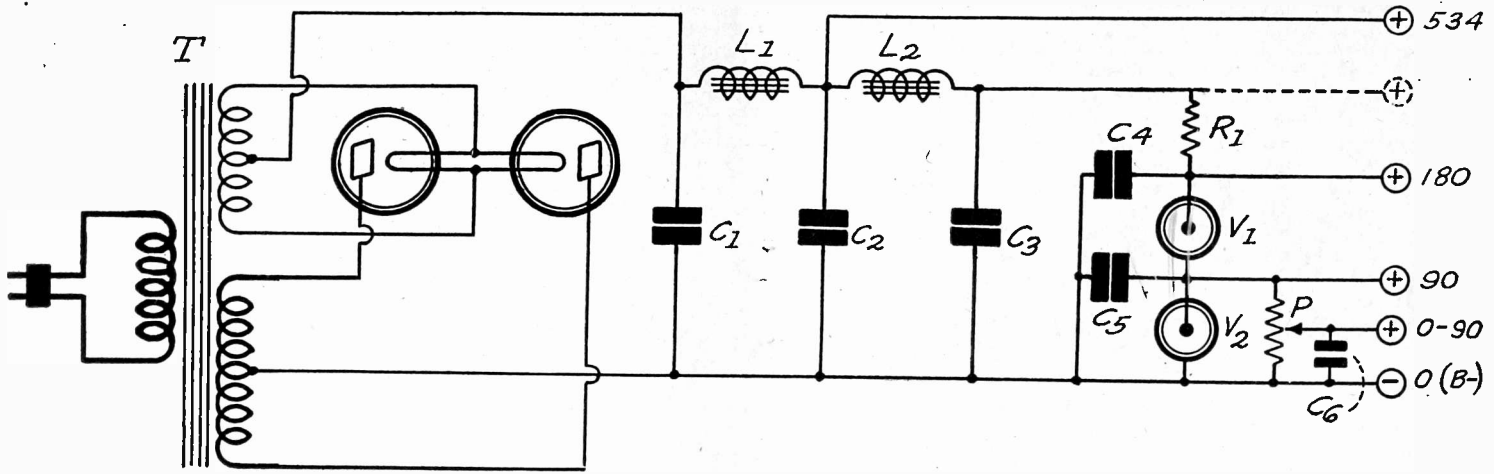

FIG. 1
POWER TUBE PLATE CURRENT IS MADE TO AVOID PASSING THROUGH L2.

THERE are many power amplifiers in which 250 type tubes are used in push-pull in the last stage. Such a circuit requires both high voltage and heavy current for operation. Moreover, it requires a steady plate voltage if good quality is to be obtained from it. This is particularly necessary when the same B supply is used to supply the plates of several other stages in the same amplifier. If the voltage is not kept steady the fluctuation indicates, as a rule, that the regulation is poor and that there is not sufficient by-pass capacity across the voltage taps on the filter and voltage divider.

To supply adequately such an amplifier it is necessary to use at least two 281 tubes in the rectifier. While the same current could be obtained with two or more 280 type rectifier tubes these do not withstand the high voltage and therefore they are not suitable for the high voltage supply. The 281 tubes have been designed especially for heavy duty service and they can be depended on.

VOLTAGE CONSTANCY

One method of improving the regulation, and hence the voltage constancy, is to connect the plate return of the two 250 power tubes so that the plate current from these flows only through one of the chokes in the filter. This choke may be especially designed to carry heavy current without appreciable voltage drop and without much saturation of the core. The inductance of this coil, L1 in Fig. 1, need not be more than 10 or 20 henries because in a well-balanced push-pull circuit there is practically no change in the demand of current on the rectifier tube. When one tube in the stage relinquishes its demand for current the other tube takes it up in exactly the same proportion. But there will be some change because the stage cannot be completely balanced.

A small change in the current draw in the power amplifier does not do any damage provided that this change is not reflected back into the plate and grid circuits of the other amplifiers in the circuit. If it is motorboating will result or at least frequency distortion due to the tendency for the circuit to motorboat.

In Fig. 1 the feedback from the last stage to any of the preceding stages is prevented first by C2 and second by the high inductance choke coil L2. Then again, if any fluctuation in the current should get through the high inductance choke these fluctuations will be reduced by condenser C3.

REGULATOR TUBES USED

The greatest stabilizing influence in this circuit are the voltage regulator tubes V1 and V2 connected across the two 90 volt sections of the voltage divider between zero and 180 volts. If the plate current varies within certain limits, which are sufficiently wide to allow for nearly all fluctuations that may occur, the voltage across the sections remains at 90 volts each, or 180 volts across the two tubes. Suppose then, for example, that these taps be connected to the plate circuits in a resistance coupled amplifier. This type of circuit requires constancy to a high degree if motorboating is not to occur. Any fluctuations in the voltage divider or in the plate circuits of the tubes will be taken up by the voltage regulator tubes so that in effect the supply is equivalent to a voltage source with perfect regulation, or one in which the regulation is as good as that of a storage B battery. Motorboating cannot occur. Neither can any appreciable distortion occur on account of feedback for the

feedback will be so small that even when amplified to a high degree the resulting change due to this feedback will be negligible.

The only reason voltage regulator tubes are not used in all B supplies is that the expense is not warranted in amplifiers intended for only a moderate power output. Then, also, the regulator tubes take current and when small rectifier tubes are used all the current that should be drawn from them is needed by the amplifier tubes in the circuit and by the voltage divider. When the amplifier is powerful, like one employing two 250 tubes, however, it is good economy to use the voltage regulator tubes.

INDIVIDUAL FILTERS

When a small B supply is used on a resistance coupled amplifier of high gain it is advisable to use individual filter resistances and condensers for each plate circuit. One method of doing this is illustrated in the Fig. 2. Here we have four terminals with a resistance between each and ground. There is also one condenser from each point to ground. Each one of these should be connected to a separate circuit in a resistance coupled amplifier or to radio frequency amplifiers. Of course, if the circuit contains fewer than four plate circuits that should be treated in the manner indicated it is not necessary to use all of them.

The resistances shown in this circuit are not coupling resistors at all. Their sole purpose is to prevent feedback. The coupling resistors are connected between the points shown and the plates of the tubes.

Many will no doubt ask what the values of the filter resistors should be to drop the voltage by a stated amount. The answer is based on the current that flows. It is of no use to specify the voltage drop desired without also specifying the current flowing, for if both are not given the value of the resistance cannot be given. However, in a resistance coupled amplifier in which the coupling resistors are 100,000 ohms or higher let the value of each of these resistors be 20,000 ohms and let the current be whatever it will. If there is too high a voltage drop in the resistors boost the applied voltage to make up for it.

It is of no value to use condensers across the resistors less than 2 mfd. if the circuits involved carry audio frequency current.

The voltage on the various tubes is raised or lowered by moving the potentiometer slider P up or down. When it is at point 6 the voltage is as high as the B supply can maintain.

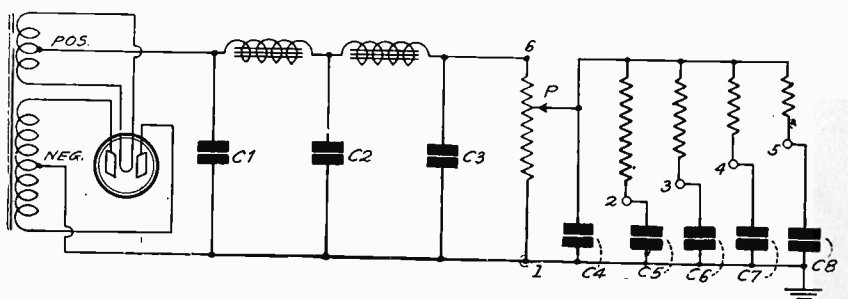

FIG. 2
INDIVIDUAL FILTERS TO STOP FEEDBACK

HB 55, to Work from AC

Two Stages of Shielded Screen Grid RF, Nega

By Herman
Managing

"I HAVE a B eliminator." So say many radioists. They want AC operation, but would like to omit the expense of a new B supply, as they deem their B eliminator all right. Also they want push-pull audio. They can have these advantages. Fig. 1 shows the circuit.

It is understood that the current drain will be greater than what they have been accustomed to take from the B eliminator, hence the filtration will not be adequate, unless extra capacity is provided. That capacity is easily obtained compactly, and in large doses, by use of the Mershon electrolytic condenser. C10, C11, C12 and C13 are the anodes of a Q 2-8, 2-18 Mershon, C12 and C13 are 18 mfd. each, in parallel at the output, where they reduce hum and improve quality, especially on low notes, and C10 and C11 being 8 mfd. each. The smaller capacities are nearer the edge of the case.

EXCELLENT TUNER SECTION

The push-pull output consists of two 171A tubes. The undistorted power output is ample for any home. It is a fact that even a single 112A gives a large enough undistorted power output for home use, overloading being preventable by adjustment of a volume control that governs the signal amplitude ahead of the detector. Such a control is used in this circuit, even though 171As are used as output, since the proper location of a volume control in any circuit is ahead of the detector.

By using two stages of screen grid radio frequency amplification and a screen grid detector, the sensitivity and selectivity are excellent. The audio amplification is high, due to the screen grid tube used as detector, the resistance-coupled first stage coupled thereto, and the transformer-coupled push-pull output.

The six tubes used are three 224, one 227 and two 171A. A filament transformer heats the heaters of the screen grid tubes and the first audio tube, as well as the filaments of the output pair.

Since the transformer has three secondary windings of the, two of 2.5 volts at high current, one of 2.5 volts at low current and the other at 5 volts low current, the first audio stage and pilot lamp may be heated from the low current 2.5 volt winding. The other 2.5 volt winding serves the first three tubes, and the 5 volt winding, rated at 2 amperes, heats the filaments properly of the output pair.

BYPASS CONDENSER VALUES

Each stage has an individual biasing resistor, bypassed by a condenser of a capacity sufficient for the purpose. In the radio frequency level the two biasing resistor bypass condensers may be .01 mfd., for the detector and first audio they should be 1 mfd., while for the power tube stage no less than 4 mfd. should be used. The capacity used in the power tubes' stage is 8 mfd., as previously stated.

It will be noted that all plates receive the same applied voltage. But the effective plate voltages are different. The voltage on the radio frequency amplifiers is highest, since the voltage dropped in the primary of the RF transformers is least, due to their small DC resistance.

The greatest drop takes place in the detector circuit plate resistor. The plate current will be about .2 milliamperes, or too low to give a reading on most milliammeters of a 0-20 or higher scale. This current at 180 volt total drop, shows that the total DC resistance of the load resistor, plate-to-cathode resistance and the biasing resistor R3 is 900,000 ohms. This gibes with the rated resistance values of 800,000 ohms for the plate-to-cathode circuit, and .1 meg. for the load resistor A4. The value of the biasing resistor is 5,000 ohms, negligible in comparison to the other values.

INTERESTING DETECTOR CIRCUIT

The detector circuit is highly interesting. The 224 tube is worked as a negative bias detector, with medium value of bias about 5 volts. The plate current flows through this biasing resistor, R3, but so does the screen grid current.

The screen grid current preponderates, indeed is about four times as great as the plate current. Also the screen current is about the same regardless of the plate voltage, hence regardless of changes in plate current that are introduced by the modulation.

It is particularly fortunate to have some steady and relatively high value of current, as this acts as a bleeder to the biasing resistor. Instead of being a bleeder current in the strict sense, serving no other purpose, it is here, of course, the necessary screen grid current, flowing from B plus to screen grid (G post of socket) and to ground.

So it serves a purpose.

The first is its necessary purpose in connection with voltaging the screen grid, the second is in permitting the use of a smaller value of biasing resistor than otherwise. Whatever the circuit

affords or permits, the biasing voltage, once selected, is a fixed quantity, and it may be provided in any of several ways. To produce the desired value, the higher the current through the biasing resistor, the lower the resistance value, in the familiar inverse ratio according to Ohm's law. So here we are able to use a lower resistor, hence present a lower impedance. This in turn makes a bypass condenser of any given value much more effective than if the same value were used across a higher resistance. Also, the lower impedance is an attribute in the quality performance of the detector, not to mention its sensitivity. This type of detector has good sensitivity and fine stability, a combination not too common, by the way.

SHIELDED COILS USED

To feed the detector two shielded stages of screen grid radio frequency amplifications are used. The third shielded coil is to couple the second RF stage to the detector. A three-gang condenser may be used, and trimmers adjusted at a low wavelength, then left thus.

In building the circuit, the condenser is placed facing the left, as the front panel is toward you, while behind the condenser are the three shielded coils and three sockets. A drum dial is used—the new National modernistic dial with color wheel—and to the right of this go the filament transformer and the Mershon. Behind these are the three remaining sockets and in the input and output audio transformers.

Illustrations of the layout are expected to be published next week, issue of January 11th.

A switch is shown in the primary lead of the filament transformer. This is a pendant switch. A dummy shaft and knob should be used for maintaining an even appearance of the front. The volume control is at a corresponding position at left. The front panel is only 7x21". And, by the way, the complete assembly (less the separate B eliminator) may be housed in a standard depth cabinet as only 8½" depth actually is required.

COIL DATA

Coils to fit into the prescribed round shields may be wound on 1¼" diameter, the tubing not more than 1¼" high. For .00035 mfd. the windings may be from 25 to 35 turns on all three primaries, and, after leaving ¼" space, 93 turns for all secondaries, using No. 29 enamelled wire throughout. The larger number of primary turns gives greater amplification at lesser selectivity, so if you want the most selectivity, use 25 turns.

At any event, use the same number of turns on all primaries. Otherwise the effective inductance of the secondaries as well

Right or

(1)—Tuning the primary of a radio frequency coupler following a screen grid tube results in a higher amplification than if the secondary is tuned.

(2)—The plate and the screen currents combined in a screen grid tube remain nearly constant as the signal voltage is varied.

(3)—Inductance of a coil depends on the number of turns only and does not depend on the length of the coil, the size of the wire, and the size of the form on which the wire is wound.

(4)—A screen grid tube is a good amplifier if the cap element is left open and the tube is used as a three-element tube.

(5)—The plate on a tube is at a higher steady potential than the battery end of the coupling resistor or transformer.

(6)—When one refers to the plate as the high potential end in respect to the signal voltage fluctuations one is talking nonsense.

(7)—The copper can on an electrolytic condenser is positive because it is connected to ground.

(8)—One of the reasons why trouble is experienced from motor-boating in good receivers is that the power equipment is too small, that is, that coils have too low inductance and too high resistance and that by-pass condensers have too low capacity.

(9)—The band width of a band-pass filter tuner remains the same from one end of the scale to the other. That is to say, it is independent of the frequency.

(10)—The closer the coupling between the two equal tuned circuits in a band-pass filter the wider the transmission band.

ANSWERS

(1)—Right. This is because the impedance of a tuned circuit at the resonant frequency is very high and that such an impedance forces the tube to work efficiently. The lower the resistance in the series tuned circuit the higher is the parallel resonant resistance, and the higher is the load on the tube.

With 180 Volt B Eliminator

ive Bias Detector and 171 A Push-Pull Output

Bernard
Editor

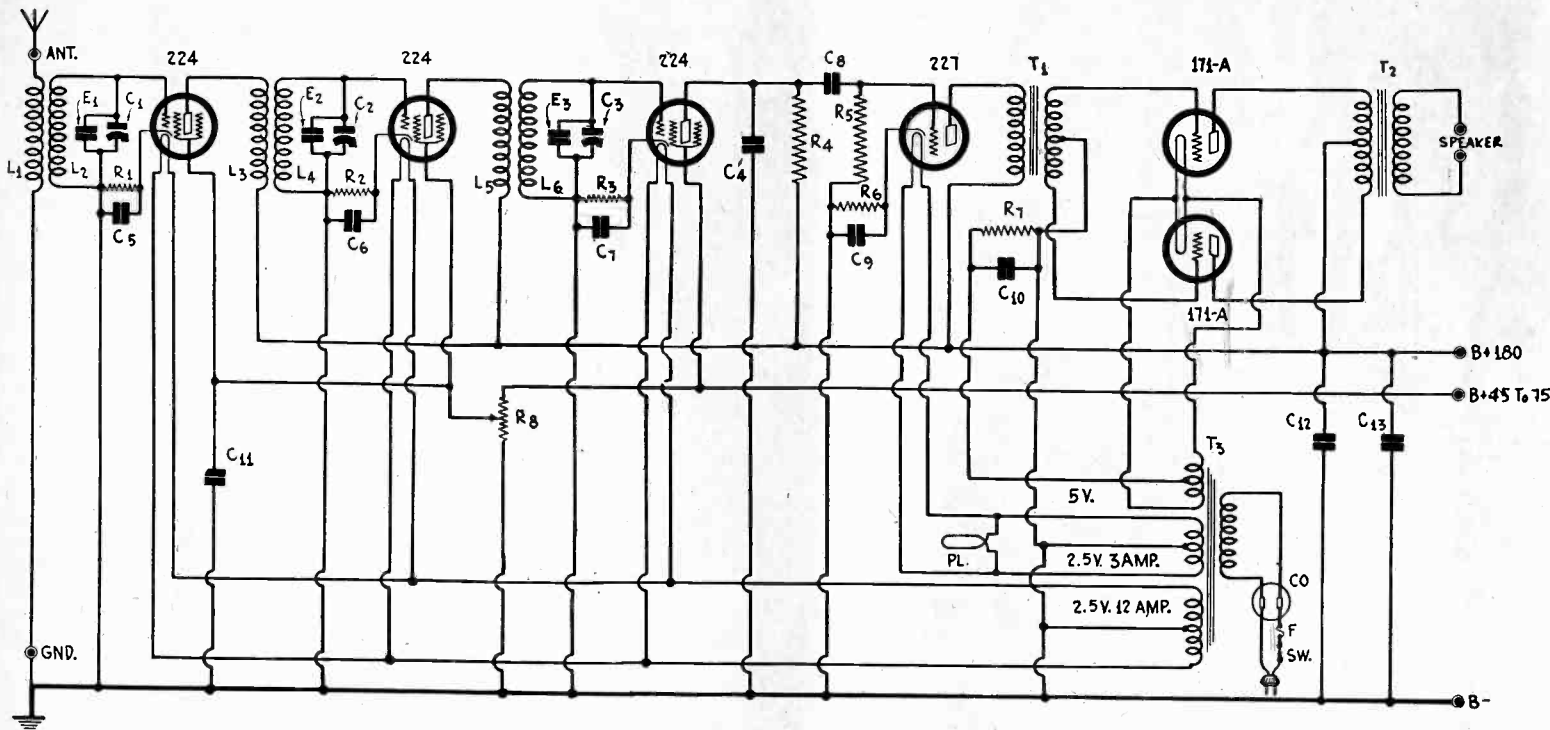

FIG. 1

AN ATTRACTIVE CIRCUIT FOR THOSE WHO HAVE A 180-VOLT B ELIMINATOR, AND DESIRE AN AC RECEIVER. PLUG THE B ELIMINATOR IN THE CONVENIENCE OUTLET CO.

as of the primaries will be staggered, and the tuned circuits at many settings will be slightly off resonance.

The effect of a larger number of primary turns, in respect to a fixed number of secondary turns, is to reduce the effective inductance of the secondary while of course increasing the effective inductance of the primaries. The decrease is due to the inductance loss through mutual coupling.

For .0005 mfd. the primaries may be as stated, the secondaries having 75 turns.

In connecting up to the B eliminator, note that the ground

lead of the receiver is B minus, hence B minus of the eliminator must be connected to ground, which may be done simply by running B minus up to the set. Incidentally, B minus goes to no other point. It is actually C minus, of different values, all through this circuit.

The telling points of this circuit, to sum up, are:

- (1) Screen grid radio frequency amplification, using shielded coils.
- (2) Negative grid biased 224 detector.
- (3) Push-pull output.
- (4) AC operation.
- (5) Good tone, sensitivity and selectivity.
- (6) Stability.
- (7) Compactness.

LIST OF PARTS

- L1L2, L3L4, L5L6—Three shielded radio frequency transformers .00035 mfd. (Three Cat. SH-3)
- C1, C2, C3—One three-gang .00035 mfd. tuning condenser
- E1, E2, E3—Three Hammarlund 80 mmfd. equalizing condensers
- C4—One .00025 mfd. fixed condenser
- C5, C6, C8—Three .01 mfd. condensers
- C7, C9—Two 1 mfd. bypass condensers
- C10, C11, C12, C13—Four Mershon condensers in one copper case, 8, 8, 18 and 18 mfd. respectively, with bracket (Cat. Q 2-8, 2-18 B).
- R1, R2—Two electrad grid resistor strips, 400 ohms each
- R3—One 5,000 ohm tubular resistor with mount
- R4—One 0.1 Lynch metallized resistor, with mount
- R5—One 5 meg. Lynch metallized grid leak, with mount
- R6—2,000 ohm Electrad wire-wound Resistor, type B
- R7—One 1,000 ohm Electrad wire wound resistor, type B
- R8—One Electrad 25,000 ohm Super tonatrol, potentiometer type, with knob
- Ant., Gnd., Speaker Minus, Speaker Plus—Four binding posts
- T1—One push-pull input transformer
- T2—One push-pull output transformer
- T3—One filament transformer (Polo Cat. PFT)
- PL—One National modernistic dial with 2.5 volt AC pilot lamp
- F—One 2 ampere fuse with fuse clips
- CO—One convenience outlet
- SW—One AC pendant switch, with AC cable and male and female plug.
- Three leads for B voltage cable
- One drilled front panel, 7"x21"
- One subpanel, with four UY sockets and two UX sockets
- One dummy shaft, knob and bushing

Wrong?

(2)—Right. The reason for this is that screen and the plate currents are nearly complementary. They always vary in opposite directions. Of course, there is some variation in the sum of the two.

(3)—Wrong. The inductance depends on the number of turns, the diameter of each turn, the size of the wire, and on the length of the coil. That is, the inductance depends on the relative positions of the turns.

(4)—Wrong. It does not amplify at all. The voltages must be adjusted to the proper values on all the elements or the tube will not work.

(5)—Wrong. The plate is at a lower potential than the battery side of the coupling device by the amount of drop in the coupler. If the coupler is resistance there is a very great difference of potential.

(6)—Wrong. While the answer in the preceding question would seem to indicate that the statement is true, the signal potential at the plate is actually higher in value than the signal potential at the battery end of the coupler. The battery end of the coupler is effectively grounded and so the signal potential there is zero.

(7)—Wrong. It is the negative which is grounded and the case of the condenser is the negative.

(8)—Right. The surest way of getting into this trouble is to use a cheap, inadequately by-passed B supply for a good receiver. The better the receiver the greater the trouble that is sure to follow. Likewise, the poorer the B supply the more trouble.

(9)—Wrong. The width of the pass band is directly proportional to the frequency when the coupling is inductive and it is inversely proportional when the coupling is capacitive. Hence, even with band-pass filters of the simple type, ten kilocycle selectivity throughout the scale of the tuner is not a reality.

(10)—Right. For low degrees of coupling the width of the band is practically proportional to the coupling.

What About Push-P

Some Fancy Schemes Prove Fallac

By Driblek

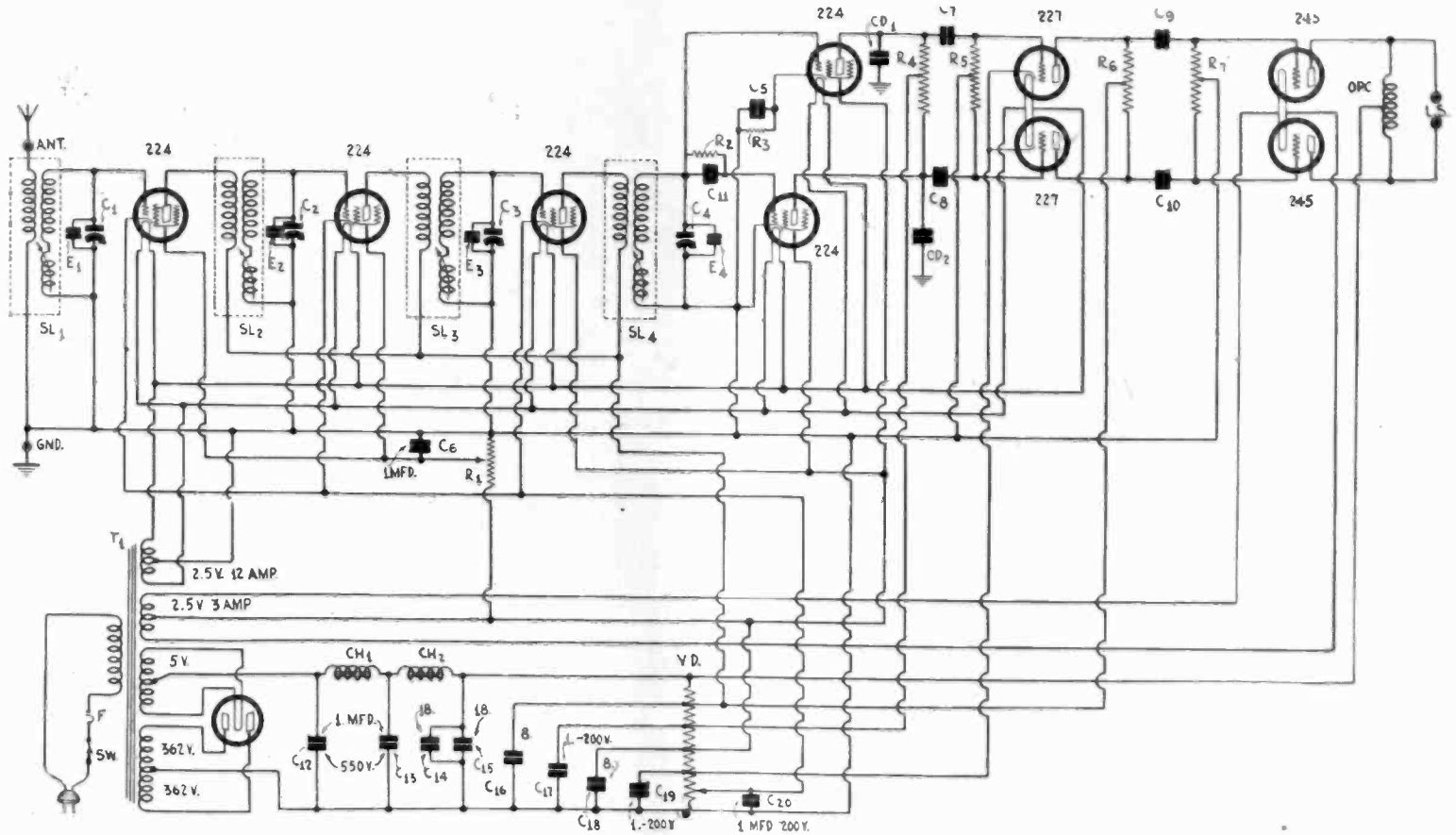

FIG. 1

IN THIS RECEIVING CIRCUIT A SUGGESTED NEW PUSH-PULL DETECTOR IS USED TO PERMIT THE USE OF RESISTANCE COUPLING BETWEEN THE DETECTOR AND THE PUSH-PULL AMPLIFIER. ONE DETECTOR TUBE OPERATES ON THE GRID BIAS PRINCIPLE AND THE OTHER ON THE GRID LEAK AND CONDENSER METHOD.

THE problem of coupling a detector tube to a push-pull amplifier by means of resistance is still unsolved. Various circuits purporting to solve the problem have been published in popular articles in radio magazines from time to time, but so far not one has been a complete and satisfactory solution, and some have not approached it.

The only suggestion offered which had any sound theoretic basis was published in RADIO WORLD, October 5th, 1929, and had previously been suggested in an English technical journal. That circuit made use of a phase inverter tube which took the output of the detector and reversed the phase by an angle of about 180 degrees before the voltage was impressed on one side of the resistance coupled push-pull amplifier. The other side of the push-pull amplifier was coupled directly to the detector in the usual way.

If the output of the phase inverter tube is adjusted so that its absolute value is equal to the direct output of the detector, the signal in the push-pull amplifier will be balanced as far as magnitude is concerned but not necessarily in respect to phase. The phase shift by the tube is not exactly 180 degrees for all frequencies. And, of course, if the phases in the two sides of the push-pull amplifier are not exactly 180 degrees apart much of the benefit of the push-pull action is lost.

ADJUSTING THE OUTPUT

Since the direct output of the detector in this circuit must be exactly equal in magnitude to the output of the phase inverter tube, it is clear that there must be no amplification whatsoever in the phase inverter tube. Neither should there be any distortion. The adjustment of the output to equality with that of the detector is a relatively simple matter, for it can be adjusted both by adjusting the input voltage to that tube and by adjusting the output coupling devices. But the adjustment must be effected so that there is no other phase shift than that introduced by the normal action of the tube. If there are condensers in the circuit, as there usually must be, there will be other phase shifts which will alter the phase relationship between the two sides of the push-pull amplifier from that of 180 degrees difference.

There are two ways in which phase shift is introduced. First,

there are shunt capacities in the circuit, mostly those between the elements of the tube. These introduce lags in the high frequencies which may be sufficient to alter the 180 degree relationship greatly. Hence the circuit will not function well at the high audio frequencies. Second, there will be series condensers, used for blocking purposes, which will introduce shifts of phase at the very low frequencies. The lower the frequencies the greater this shift. Therefore the amplifier will not function well at the very low frequencies. There will, however, be a considerable frequency range in the middle register in which the shifts of phase will be negligible, and in this most important region the operation of the amplifier will be satisfactory.

POSSIBILITY WITH NON-REACTIVE CIRCUIT

Amplifiers in which there are no stopping condensers have been devised which are quite satisfactory. If the principle of these can be applied to this phase inverter circuit it would be possible to achieve true 180 degree phase difference for all except the very high audio frequencies at which the effect of the inter-electrode capacities becomes appreciable. The gain in such circuit would be substantial and it is hoped that it will be worked out soon by some one.

Another circuit has been suggested for solving the problem, one based on the difference between the grid bias detector and the leak-condenser detector. This idea is illustrated in the accompanying diagram.

It is well known that a grid bias detector modulates upward, that is, the plate current increases as the radio frequency signal voltage increases. The audio frequency signal is therefore in phase with the modulation in the radio frequency signal.

It is equally well known that the leak-condenser detector modulates downward, that is, the plate current decreases as the radio frequency signal voltages increases. Therefore the audio frequency signal is in opposite phase with the modulation of the radio frequency signal voltage.

Now, then, if one side of the push-pull resistance coupled amplifier be preceded by one type of detector and the other side of the amplifier by the other type of detector, the signals in the two sides

ull Resistance Audio?

ious, But Real Solution is Awaited

Hokanda

of the amplifier will be 180 degrees out of phase. At least one necessary condition for coupling a push-pull amplifier by means of resistance to a detector is then satisfied.

MAKING SIGNALS EQUAL

It remains to insure that the signals applied to the two sides of the amplifier are equal in magnitude. Suppose the input voltage to the two detector tubes be the same, as they will be when connected as in the diagram herewith. The equality of the outputs of the detectors then depends on the detecting efficiency of the two detectors. It is well known that the leak-condenser detector is more sensitive than the other. Hence the outputs will not be the same unless something is done to compensate for the difference in detecting efficiency.

One way would be to reduce the input to the more sensitive detector until the magnitudes of the outputs of the two were equal, which might be done with a potentiometer to the slider of which the grid of the more sensitive detector is connected. By adjusting the position of the slider any desired signal voltage could be impressed on the more sensitive tube. The potentiometer is not shown in the figure, but it could well be R2 if this is connected from C11 to the cathode instead of to the grid of the upper. The grid of the lower detector tube would then be removed from its connection to C11 and connected to the slider. By moving the slider down toward the cathode any desired reduction in the signal input to the lower detector could be obtained.

Another method of equating the output voltages of the two detector tubes would be to manipulate the output coupling resistances. For example, the upper portion of R4 could be made larger than the lower section. This would put a higher load on the less sensitive detector than on the other and consequently the input voltage on the upper side of the amplifier would be increased relatively to that of the other side.

USING DIFFERENT TUBES

Still another method of equating the outputs of the two detectors would be to use different detector tubes, making the grid bias detector more sensitive than the other. For example, the grid bias detector tube could be one of a high amplification constant and the other a general purpose tube. In the figure both detectors are screen grid tubes, but if this method of equating the outputs were used, only the upper would be a screen grid tube. The use of a high mu tube, either of the screen grid type or the three-element tube type, the load impedance method could well be used in addition as an equalizer, since the high mu tube normally takes a higher load impedance.

If it is necessary to equalize the volumes in the two sides of the amplifier more than is possible in the detector it is still not too late at the input of the first audio stage. The resistance R5, for example, may be a high resistance potentiometer with a slider for the grid bias connection. If this is moved toward the lower tube the greater part of the drop in the potentiometer will be impressed on the upper 227 tubes.

During the process of adjustment it is necessary to have some means of determining when the outputs of the two sides of the amplifier are equal. Possibly the best way is to use a vacuum tube voltmeter for measuring the input to the power tubes, that is, for measuring the signal voltages across the two sections of R7. In the absence of such a meter a headset or other sound producer can be put into the common plate lead of the output tube. When the signal intensity in this lead is minimum the amplifier is most nearly balanced.

MORE PHASE SHIFTS

Now suppose that the two detector circuits and the coupler following them have been adjusted so that the magnitudes of the input voltages to the two sides of the amplifier are equal, what is the assurance that the circuit will be truly push-pull? There is every assurance that it will not be exactly push-pull, but only approximately so.

There is practically no phase shift in the grid bias detector, for only the small input capacity between the grid and the cathode enters. This also enters in approximately the same way in the other circuit, but not quite. Any difference, however, due to this cause would be very small and negligible for all essential audio frequencies. But we have a small grid condenser and a leak across it in the other detector. This will introduce differences and these differences will change the relative phases of the two signals so that the output voltages will not be exactly 180 degrees out of phase.

Part of the phase shift at the higher frequencies can be compensated for by manipulating the sizes of the by-pass condensers CD1 and CD2, but the adjustment must be made experimentally for there

is no other way of determining just what the proper values of the two condensers should be. While adjusting them one should listen to the highest audio notes present in the signal while the headset is coupled to the common plate lead in the power amplifier.

ANOTHER PUSH-PULL DETECTOR

There is another possibility for achieving push-pull detection in resistance coupling. Suppose one of the tubes is adjusted to detect on the lower bend of the grid voltage plate current curve. As the radio frequency signal increases the plate current increases, as was stated previously. Now let the other tube be adjusted to operate at the upper bend of the curve. As the radio frequency signal increases the plate current is decreased. Hence the two tubes will operate in opposite phase although the same signal is impressed on both simultaneously.

There are many objections to this scheme. One is that the detecting efficiency of the two tubes will not be the same, if the tubes are alike, because the curvatures at the upper and lower bends are not the same. Also, the tube operating at the upper bend will be positive part of every cycle and therefore it will draw grid current. This will place a load on the tuned circuit which will lower the selectivity. This fact, however, does not upset any phase relationship, except in so far as the inter-electrode capacities are changed by the changed operating conditions.

It is clear that many of the suggestions offered above are only applicable to tubes of the heater type except by the use of separate grid batteries.

RADIO FREQUENCY TUNER

The radio frequency amplifier in the diagram is shown in conjunction with the proposed push-pull detector to show the essential connections. This amplifier is exceptionally sensitive as well as selective so that a very strong signal is available for the detector and the audio amplifier.

Questions

- (1)—State the two types of current. Give an example of each.
- (2)—How does the input high frequency voltage get past the "barrier" of direct voltage in the plate circuit?
- (3)—Does the detector output consist of audio or radio frequencies or both?
- (4)—Does a tube function differently at audio than at radio frequencies?
- (5)—Is a magnetic field set up in a resistor across which a pulsating direct voltage exists?

Answers

- (1)—Alternating and direct. The carrier frequency of the broadcasting station is alternating current. The current in a flashlight fed by a dry cell is direct.
- (2)—The radio frequency input to a tube is an alternating voltage of which the tube produces an enlarged copy in the form of pulsating direct plate current. When this pulsating current, which is of the same frequency as the alternating current, is passed through a coil, the electro-magnetic action restores the alternating condition.
- (3)—Both. The radio frequency is usually detoured to ground, as only the audio frequency is desired.
- (4)—No. The principle of operation is the same.
- (5)—No.

Broadcast Sermon Brings \$25,000 Bequest

Her receiving set gave Mrs. Virginia J. Kent, widow, her first contact with the Church of the Nazarene while she was staying at a hotel at Long Beach, Cal. After hearing the Rev. L. A. Reed's broadcast sermon, she discussed spiritual matters with the pastor.

When she died recently in Chicago she left \$25,000 to the church at Long Beach.

Methods of Using Scr

Either Leak-Condenser, Low Negative

By Herbert

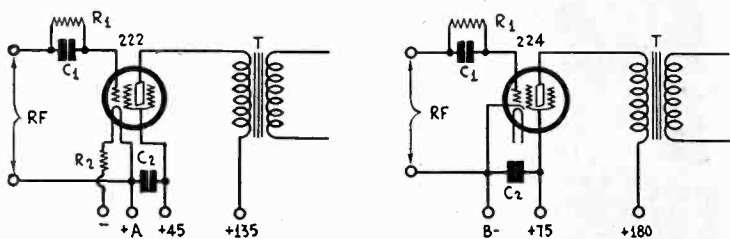

FIG. 1, FIG. 2

THESE TWO DIAGRAMS SHOW THE CONNECTIONS OF DC AND AC SCREEN GRID TUBES AS GRID LEAK, GRID CONDENSER DETECTORS.

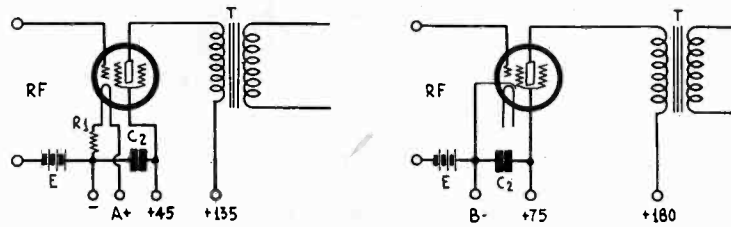

FIG. 5, FIG. 6

SCREEN GRID TUBES CAN ALSO BE USED AS GRID BIAS DETECTORS PROVIDED THE GRID BIAS CAN BE CHOSEN SUITABLY HIGH. THESE TWO CIRCUITS SHOW THE ESSENTIAL CONNECTIONS FOR THE DC AND AC TUBES.

MANY circuits for detection by means of screen grid tubes have been published, as the advantage of this tube as a detector are great. There are two different screen grid tubes, the battery type and the AC type, and each can be used in two ways, first as a screen grid tube and second as a space charge tube. Then again, either tube may be operated as a grid bias detector or as a leak-condenser detector. And again either may be used as a detector of weak signals or of strong signals. Therefore there is a large variety of circuit arrangements for obtaining detection by means of these tubes.

As a power, or strong signal detector, it is possible to get such a high output that it is not necessary to use a two-stage audio frequency amplifier in order to get a sufficient signal voltage to load up a power tube. With the weak signal arrangement, however, the output of the detector is not sufficient to load up the power tube without an extra audio amplifier, and one audio stage will not suffice.

same signal input the audio output from the AC detector should be considerably greater.

POWER DETECTION

A strong signal detector using a 222 screen grid tube and grid leak and condenser is shown in Fig. 3. In this case the grid return is made to the negative end of the filament, the ballast resistor being placed in the positive leg. The value of the grid leak in this instance is only .25 megohm and the grid condenser capacity is only .0001 mfd. Thus both the condenser and the leak have been reduced in value.

The use of the AC screen grid tube in the same manner is shown in Fig. 4. The values of the grid leak and grid condenser are the same as in Fig. 3, that is, .25 megohm and .0001 mfd. The grid return, however, is made to minus one volt

USUAL CONSTANTS

When the screen grid tube is used as a weak-signal, leak-condenser detector the usual grid circuit constants and connections are employed, because as far as the grid circuit is concerned it behaves exactly like a three-element tube. The advantage of the screen grid tube over the three-element tubes comes from the fact that the screen grid tube is a better audio frequency amplifier. Detection occurs in the grid circuit, and the audio frequency voltage fluctuations are amplified in the plate circuit just as if the tube were only used as an amplifier at audio frequency.

Referring to Fig. 1, which represents a 222 screen grid detector circuit, the value of R1 should be from 1 to 1.5 megohms and the condenser C1 should be .00025 mfd. for weak signals. The grid return, as shown, is made to the positive end of the filament. The indicated plate and screen grid voltages are of the usual values. The ballast R2, which should be 20 ohms for a filament voltage source of 6 volts, is connected in the negative leg, or it may be put in the positive provided that it be placed below the grid return. Condenser C2 operates mainly at audio frequency voltages and therefore it should not be smaller than about 2 mfd.

A weak signal detector for an AC screen grid tube is shown in Fig. 2. The grid leak R1 should be 1 meg., the grid condenser .00025 mfd., and the grid return should be made to the cathode. There is practically no difference, then, between the connections in the two cases, nor in the values of the circuit elements. The AC screen grid tube 224, is a considerably better audio amplifier than the DC tube and therefore for the

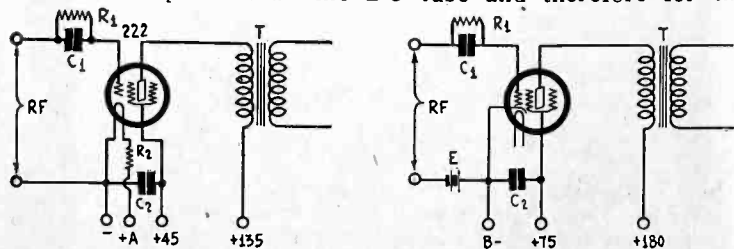

FIG. 3, FIG. 4

POWER DETECTION, OR STRONG SIGNAL DETECTION, CAN BE EFFECTED WITH SCREEN GRID TUBES IF THE GRID CONDENSER AND GRID LEAK BE CHOSEN SUITABLY, AND IF THE GRID RETURNS BE MADE AS SHOWN HERE.

Questions

WHICH TUBE SHOULD BE USED?

IN AN AMPLIFIER using battery tubes and transformer coupling what tube should be used ahead of the 171A push-pull amplifier?—P. W. C.

Either a 201A or a 112A. The 112A gives a little better results than the other because it has a lower plate resistance.

HOW DISCLESS TELEVISION WORKS

I READ recently about a television receiver in which no scanning disc was used. How does it work?—J. J. K.

There are several television systems which work without a scanning disc but perhaps you have in mind the cathode ray system. This works on the same principle as the Braun cathode ray oscillograph, exemplified by the Western Electric cathode ray oscillograph. This device is a modified form of vacuum tube. A narrow beam of electrons from a heated filament inside a large pear-shaped, evacuated tube is made to impinge on a phosphorescent screen. The intensity of this beam is modulated by the television signal. It only remains to distribute this beam over the phosphorescent screen so as to "paint" the picture. The distribution is done by voltages across electrodes between which the beam has to pass on its way from the filament to the screen. One set of electrodes causes the beam up and down across the screen and the other to move it back and forth. If the frequencies of the two voltages are adjusted properly, the beam will cover the entire screen in an orderly manner and will trace the picture. The light on the phosphorescent screen is feeble, which is a disadvantage of the system. The advantages are compactness and high speed without lag.

EFFECT OF LARGE ZERO CAPACITY

WHAT is the effect of a large zero setting capacity on the range of a radio frequency tuner? Does it narrow the band or does it widen it? For a given variable portion of the tuning condenser can the inductance in the circuit be reduced to make up for a large zero setting capacity?—Wm. H. J.

The tuning range of a tuner depends on the ratio of the variable portion of the condenser to the minimum capacity. The greater this ratio the wider the tuning range. Hence if the variable portion has a given value the range will be smaller the larger the minimum capacity. It is for this reason that .0005 mfd. tuning condensers are usually recommended in preference to .00035 mfd. condensers.

Screen Tube as Detector

Bias or Power Detector May Be Employed

E. Hayden

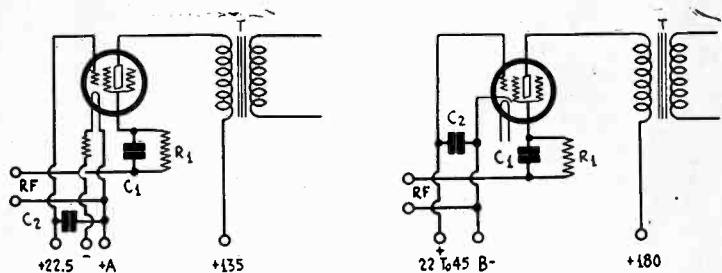

FIG. 7, FIG. 8

THE SCREEN GRID TUBES CAN ALSO BE USED AS SPACE CHARGE TUBES FOR DETECTION PURPOSES. THESE DIAGRAMS SHOW THE CONNECTIONS WHEN A GRID LEAK AND GRID CONDENSER ARE USED.

instead of to the cathode. Therefore a grid bias battery E is indicated, but this is merely to emphasize the need of a bias. There is no convenient battery of one volt. In an actual circuit the one volt bias would be obtained from a drop in a resistor.

Naturally, when power detection is used a much higher frequency signal voltage must be used to load up the detector to the overloading point. That is the principal difference between power and weak signal detection. Since the power detector is not so sensitive as the weak signal detector it becomes necessary to put another stage of amplification ahead of the detector. As to the total number of tubes in the receiver it makes no difference, because the weak signal detector requires an extra audio stage. The advantage of power detection comes from the fact that there is less distortion in a radio

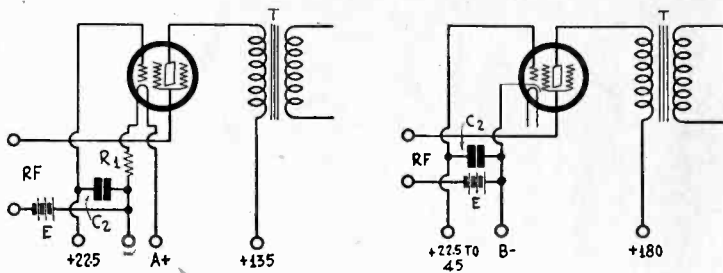

FIG. 9, FIG. 10

IF GRID BIAS DETECTION WITH THE SPACE CHARGE CONNECTION IS DESIRED, THESE TWO DIAGRAMS SHOW HOW THE TUBES SHOULD BE CONNECTED.

frequency amplifier and tuner than there is in an audio amplifier fier.

GRID BIAS DETECTION

Grid bias detection is more popular now than it has been previously. This is largely because more amplification is available in radio frequency amplifiers so that a high signal voltage may be impressed on the detector. When grid bias is used the grid condenser is omitted or else it is made as large as in audio frequency amplifiers. If a condenser is used a grid leak is used and this has about the same resistance as in audio frequency amplifiers.

The grid bias is much higher than in audio frequency amplifiers and depends on both the screen grid voltage and on the plate voltage. Usually the bias is adjusted until the plate current is less than one milliamper and often as low as one-tenth milliamper. The best bias for power detection is not necessarily the bias which gives greatest detecting efficiency.

In Fig. 5 is shown the circuit for a DC screen grid tube. In this the bias is supplied by the drop in R1 and by the voltage of the battery E. It is clear that the circuit is identical with that of an amplifier except that the bias is higher.

Fig. 6 shows the same circuit for an AC screen grid tube. This also is hooked up as an amplifier with the exception of the higher bias.

No by-pass condenser is shown in the plate circuit of any of the diagrams given above, but it is understood that it is used.

When a transformer is used for coupling the detector to the first amplifier there is usually sufficient distributed capacity in the primary to detour the radio frequency component in the plate current to make detection efficient, but when the tube is followed by a resistance coupler a condenser of not more than .0005 mfd. should be connected between the plate and the filament or the cathode. It is also understood that the high voltage leads are well by-passed.

SPACE CHARGE DETECTION

When the space charge connection is used the screen grid is used as control grid and the inner grid is connected to a positive voltage from 22.5 to 45 volts. Otherwise the circuits are the same as for screen grid uses of the tube. Figs. 7 and 8 show the DC and the AC screen grid tubes, respectively, connected in space charge fashion in grid leak and grid condenser detector circuits. The tube can be used in this fashion as a grid bias detector also, and if the grid bias is high enough it will stand a very high signal voltage.

Figs. 9 and 10 show the two tubes used as grid bias detectors with the space charge connection of the grids.

The space charge detector is very sensitive when used in this manner provided that the critical voltages are adjusted properly.

In every one of the preceding diagrams there is a condenser marked C2. Each works primarily at audio frequency and therefore should be large to be effective.

A point to bear in mind in connection with the 224 medium negative used as grid bias or high grid bias (power) detector, with individual biasing resistor, is that the screen and plate currents flow through the resistor. Hence the resistor may be 5,000 to 6,000 ohms or thereabouts, a relatively low value. The screen current is steady, so that the bias is relatively steady despite the variations in signal amplitude. This improves quality.

of Interest

USING MOTOR-GENERATOR

Is it practical to use a motor-generator for powering a radio receiver, that is, to supply both the filament and the plate voltages? If so, what is necessary to eliminate the hum which necessarily is present in the output of such a device?—L. L. D.

It is entirely practical and is used in some of the finest radio receiver installations. There is one advantage in using a motor-generator to supply the plate voltage, and that is the constancy of the voltage. If a rectifier tube is used to supply the plate voltages the tube gradually deteriorates and the output of the receiver gradually grows worse. If a motor-generator is used there are only line voltage fluctuations which will change the output, but these are minimized. Any sudden voltage fluctuations will not appear as noises in the receiver because the motor-generator acts as a stabilizer. To remove the ripple an ordinary filter circuit is used, that is, series chokes and shunt condensers. As a rule, not as much filtering is necessary because there is less ripple in the output from the motor-generator than from the rectifier. There may be some difficulty in eliminating ripple from the filament current since this current may be heavy. The easiest way to remove it is to use electrolytic condensers of several thousand microfarads. Just a little inductance is usually sufficient in this circuit.

MEANING OF MICROVOLT PER METER

WHAT is the significance of the expression microvolts per meter? My idea is that if a wire one meter long is mounted vertically in the field of a wave the voltage induced therein gives one microvolt per meter.—J. K. M.

If you erect a wire one meter long the voltage induced therein by the radio wave gives the field strength and if the voltage is measured in microvolts, the result is the number of microvolts per meter. But it will not give one microvolt unless the field strength is one microvolt per meter. If you put up an antenna 10 meters long, counting only the actual height, and you get a voltage of one microvolt, the field strength is only one-tenth microvolt per meter. Field strengths are usually measured with a loop rather than with an open antenna. The effective height of the loop is used. Using an open antenna there is no way of knowing just what its effective height is but the effective height of a loop can be determined quite accurately with a ruler or meter stick.

Magnaformer Modernized

Negative Bias Modulation and Detection Improve Operation

By Hood Workman

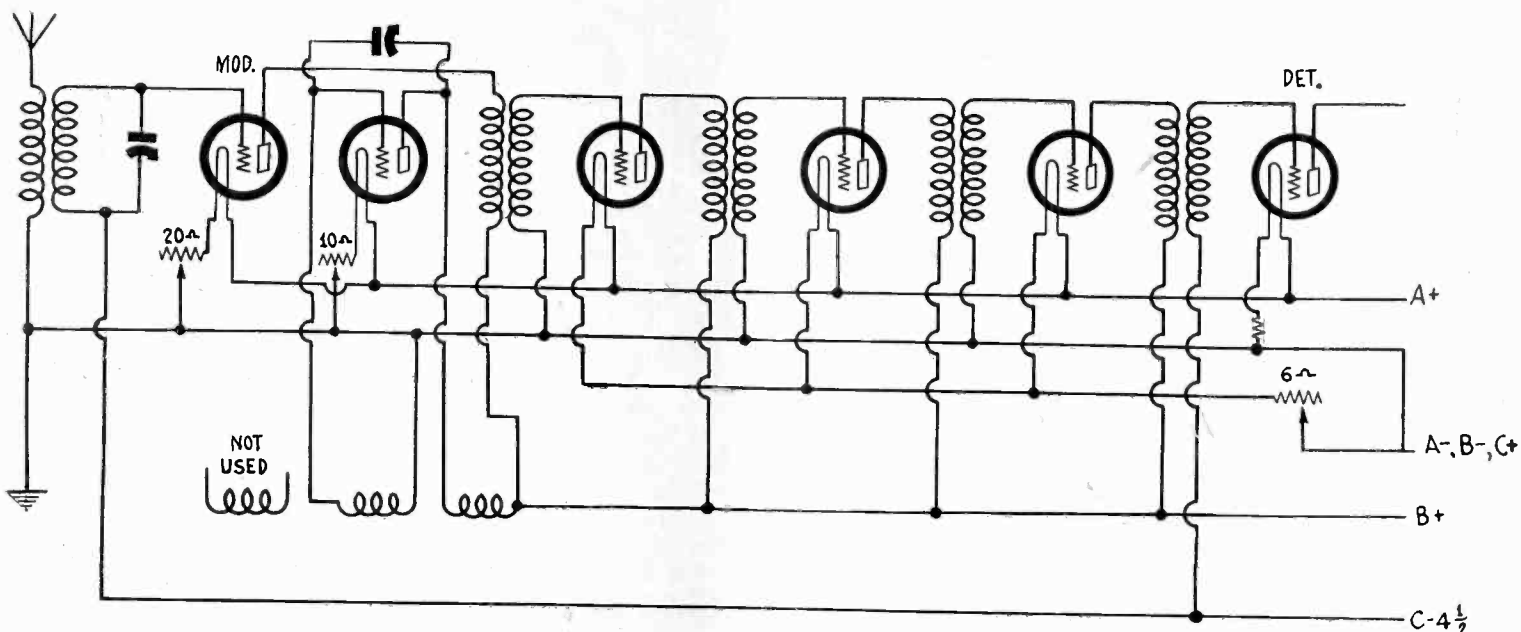

DIAGRAM OF THE TUNER CIRCUIT, INCLUDING INTERMEDIATE AMPLIFIER, OF A MAGNAFORMER 9-8, WHEN THAT RECEIVER IS SUBJECTED TO CERTAIN CHANGES FOR EASE OF OPERATION, IMPROVED STABILITY AND BETTER TONE QUALITY, WITHOUT ANY SACRIFICE OF SENSITIVITY.

THE Magnaformer 9-8 was one of the most popular receivers for kit construction in 1927 and a great number of these are in use. The circuit as originally presented required a loop for operation, but it is quite practical, and indeed advantageous, to use an antenna coupler. Also some other changes may be made to advantage, including the introduction of negatively biased grid circuits for the modulator and the detector.

The circuit has a switch which cuts in or out the fourth intermediate frequency stage. The coupler that feeds the detector should be removed, and likewise the socket whose plate circuit fed this coupler. Therefore the preceding coupler is made to feed into the detector.

At the place where the coupler was situated on the subpanel the new antenna coupler is placed. This may be any suitable coil, for instance, if a $2\frac{1}{2}$ " diameter tubing is handy, wind 14 turns, leave $\frac{1}{2}$ " space, and wind 55 turns, using No. 24 wire. For $1\frac{3}{4}$ " diameter the turns may be 20 primary, $\frac{1}{2}$ " space, 67 secondary. Use No. 28 enamel wire. The first winding is for the aerial-ground circuit, the other for the input to the first tube, the modulator. Antenna and ground posts may be established where the loop jacks were.

CHANGED GRID RETURNS

All grid returns of the tuner, exclusive of the oscillator, are to be changed. The modulator and the detector grid returns go to minus $4\frac{1}{2}$ volts of C battery. The intermediate stages are returned to negative A. Hence the potentiometer that was at left on the front panel is not used. Remove it, and in its place put a 20 ohm rheostat, which will be used as volume control.

The modulator and oscillator formerly were on one rheostat, but this is changed, so that this rheostat serves only the oscillator. A 6-ohm rheostat is used for giving the intermediate frequency tubes their best operating voltage. This is well under 5 volts for these tubes, even though they are 201A.

A 4 to 10 ohm fixed resistor is used to drop the A battery voltage for the detector. This resistor is shown in the negative leg, not designated by any constant, however, as it may be anything from 4 to 10 ohms.

The switch rheostat at right on the front panel is removed, and may be used in place of the 6 ohm rheostat shown in the diagram herewith. A toggle switch is placed in the vacated position, and a knob placed on the switch shaft to match the knob on the volume control rheostat at left.

In the position formerly occupied by the 9-8 switch, which would cut in and out the extra intermediate stage, a pilot bracket is put, with a 6 volt lamp. Connect this lamp across the oscillator filament.

Remove the connections to the pickup winding of the oscillator coil. Formerly the loop circuit was completed to A plus through this pickup winding, which coupled modulator and oscillator. We have dispensed with the grid leaks, and closed the clips of the two grid condensers, to short these condensers out of circuit, because we are using negative bias modulation and detection.

HOW TWO ARE COUPLED

We do not need the pickup winding of the oscillator, because the antenna coil is near enough to the oscillator, even when six inches away, or a little more, to provide adequate coupling between modulator and oscillator circuits. The coupling in any instance should be small, as the smaller it is the less the whistling when tuning in, and the better are the two circuits in independence of tuning.

The diagram does not show the audio channel, as this is not changed. The tubes, from left to right, as shown, are the modulator, oscillator, first, second and third intermediate frequency amplifiers, and detector. The three stages of intermediate are entirely sufficient, as is proved by the fact the tubes of these stages must be worked well under 5 volts.

Under the new system the intermediate frequency amplifier will not oscillate, as the rheostat controlling the tubes in this channel is turned until there is no oscillation. Hence there is no necessity for swinging these grids positive to stop oscillation, a method that works all right, but which is not the wisest.

The sensitivity will be greater this way, because an aerial is used and because the intermediate frequency amplifier is always somewhat negatively biased. The negative bias modulator and detector work excellently but the voltage must be $4\frac{1}{2}$ for about 45 volts on the plates, represented by B plus in the diagram.

In the receiver itself the tubes do not run in the order shown, since the oscillator is alone, near the front panel, but otherwise the schematic order is duplicated physically.

USE 240 AS MODULATOR

The modulator tube should be a high mu 240 instead of a 201a, as better sensitivity obtains. This holds true no matter which type of modulator hookup is used, even leak-condenser. The oscillator may be a 201A or a 112A, the 112A giving a steadier oscillation, with less whistling attending the tuning.

No filament voltage except that of the modulator for volume control need be touched after the settings are once made. Nor will the circuit be tricky in tuning. Repeat points will be diminished, due to lessened distortion. Tone quality will be improved, because the detector will not be overloaded, except on strongest locals, when the volume control can be adjusted to keep down the terrific volume to what a human ear can stand in a standard sized room.

LITTLE NEEDED FOR AERIAL

Only a small aerial is necessary. About 15 feet of wire under the carpet or around the moulding will give at least as great pick-up as was obtained with the loop. If desired, an outdoor aerial may be used, but should not exceed 50 feet in most locations. Many who don't want to use an orthodox aerial may connect ground lead to the antenna post and leave the ground post blank.

Watch Condenser Mounting

When Building the HB33 or HB44, High-Gain Circuit

THE HB33, a high gain screen grid receiver, using three stages of tuned screen grid radio frequency amplification, tuned screen grid detector, first stage of resistance-coupled audio working into a 112A, and second stage transformer coupled audio working into 112A in push-pull, should be constructed from the pictorial diagram of the wiring published last week. The diagram shows the view of the top of the steel chassis, on which there is virtually no wiring, and then the bottom view of the chassis is presented, turned "backward," as it were, the front becoming the rear, so as to preserve the same relative right and left directions. This greatly simplifies the reading of the diagram, as leads take the same course in the diagram as in your receiver.

The large schematic diagram was published the previous week, issue of December 21st, and constructional details were given, principally in regard to mechanical rather than wiring problems, as it was stated the pictorial diagram would be published. This diagram last week disposes of the wiring problems at once.

HOW TO MOUNT CONDENSER

On the score of the mechanical problems, the details previously published are sufficient, except that a few words more should be stated concerning the mounting of the four gang tuning condenser. This has a capacity of .00035 mfd. when used without any metal tight against it, but if the condenser is mounted right to the subpanel the capacity mounts to .00042 mfd. This is a steady .00012 mfd. capacity addition, so the minimum capacity is heightened too, and full coverage of the wave band would not be assured, unless the precautions set forth Dec. 21st are taken. These will be repeated now with additions.

The subpanel or chassis has a row of holes down the center, consisting of four large holes and eight small ones. The large ones were intended to avoid any possibility of the stator of any section contacting with the subpanel and thus grounding the grid, hence shortening the input to the particular stage tuned by that section. To prevent this grid insulating washers might be used additionally, where the condenser is mounted so as to "hug" the subpanel, without elevation, but it is suggested that the problem be solved in another way, as outlined last week, that consisting of elevating the condenser $\frac{1}{4}$ " from the subpanel.

Take two extruded fibre washers, each $\frac{1}{8}$ " high, and put them one atop the other, with their flat surfaces on the top of the subpanel and bottom of the condenser, respectively. Only eight such washers actually are needed, four being used at the two front holes for the condenser frame, and four at the rear. The holes are drilled in the subpanel, these being the small holes side by side near the front and near the rear, the large opening for clearance of the other stator being between the small holes.

ELEVATION OF $\frac{1}{4}$ " IS SOLUTION

Now, it will be obvious that if the condenser is elevated $\frac{1}{4}$ " that the stator screws concerning which some concern was expressed will be lifted $\frac{1}{4}$ ", also, and this brings them entirely out of any danger of touching the subpanel, and without resort to grid insulation.

Excellent rigidity is attained when this method of mounting the condenser is followed. The four other screws may be driven through the bottom of the subpanel to engage the frame of the condenser, without resort to bushings. Also this method dispenses with the necessity of removing at all the screws and incidental lock washers that go to the stators.

The object, of course, is to avoid the high capacity to ground existing if the condenser is mounted directly on the chassis without washers being used for elevation. It is a fact that elevation alone is the object sought, and not insulation, the fact the washers are insulated being accidental. They were available for the purpose and serve it well. Of course, the frame of the condenser has to be connected to the subpanel metallicly, but this is attained not only through the screws that pass through these eight extruded washers, but also by the screws in conjunction with which no washers are used.

One not having the condenser and chassis before him might suppose that there is something complicated about this, but in fact it is all very simple when you come to build the receiver and have the parts right before you.

The same instructions regarding the mounting of the condenser apply to the HB44, which is the AC counterpart of the battery-operated HB33. Details concerning the HB 44 were published last week, and it is expected that in two weeks the pictorial diagram of the AC model will be printed the same size as the pictorial model of the HB33 herewith.

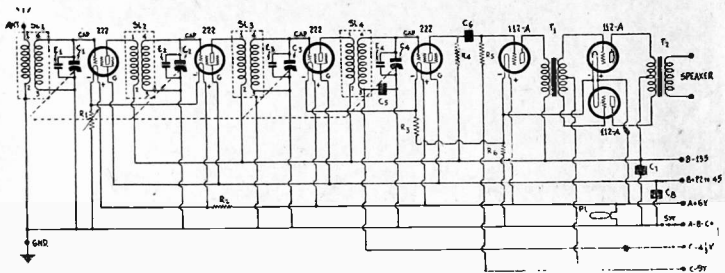

DIAGRAM OF THE HB33 CIRCUIT

DETAIL CONCERNING CABINET

As previously stated, the receiver may be operated outside the cabinet. But when you come to put it in the cabinet you will have to remove the blades of the condensers by loosening the set screws and pulling out the shaft. It is really the shaft you want to remove, but the blades must come out, too.

Notice that there is an adjusting screw, for tension, at rear of the condenser.

When the receiver is in the cabinet, replace the condenser blades and put the shaft back in place, also the round metal washer between the first section and the front of the frame. Now you should carefully center the assembly, so that by the eye test the moving blades will be exactly equi-distant from the stator blades between which they rotate.

If you tighten the tension adjustment screw at the rear of the condenser you push all the blades forward, toward the front, so that if you want more frictional resistance during the rotation incidental to tuning, and adjust for that purpose, realign the moving blades at center between stator blades. Otherwise you will not gain full value from the equalizing capacities built into the condenser.

So, in equalizing, it should not be necessary to drive the screw all the way down for any stage, but only part of the way, and if you find the opposite is required to achieve resonance, then the moving blades are not correctly centered in respect to the stator blades on either side of them, and correct this.

STATIONS FROM ALL OVER U. S.

Any lack of sensitivity or selectivity in the receiver may be ascribed to you misjudgment of the four gang condenser, so be certain that you get this right. It is easy enough, but unless you are forewarned you might make a mistake that would cause baffling lack of results, whereas you must know that from a well-designed receiver of this type, using four screen grid tubes in the tuner, you have a right to expect abnormal results, and if directions are carefully followed you certainly should be able to tune in quite easily stations from all over the country, including stations on high wavelengths that are not brought in, or not brought in well, on most receivers, since the sensitivity of the run of receivers falls off sharply at the higher wavelengths.

LIST OF PARTS

- SL1, SL2, SL3, SL4—Four stage individually shielded coil cascades for .00035 mfd. (Cat. SH-3 of Screen Grid Coil Co.).
- C1, C2, C3, C4—Four gang .00035 mfd. condenser with equalizers E1, E2, E3, E4.
- C5, C6—Two .01 mfd. mica fixed condenser.
- C7, C8—Two 1.0 mfd. bypass condensers 200 volt DC working voltage.
- R1, Sw—30-ohm rheostat with switch, knob, insulators.
- R2, R3—Two 6.0-ohm fixed filament resistors.
- R4—One .05 meg. Lynch metallized resistor.
- R5—One 5.0 meg. Lynch metallized resistor.
- R6—One 1-ohm fixed filament resistor.
- T1—One push-pull input transformer.
- T2—One push-pull output transformer.
- PL—Pilot lamp and bracelet.
- Ant., Gnd. Speaker—Four binding posts.
- One drilled steel cabinet, brown crinkle finish.
- One vernier full-vision dial.
- One flanged subpanel with seven UX sockets and one UY socket.
- Four grid clip.
- One 5-lead connector cable.

Microvolts per Meter—V

Field Strength Necessary to Produce a Given

By J. E.
Technician

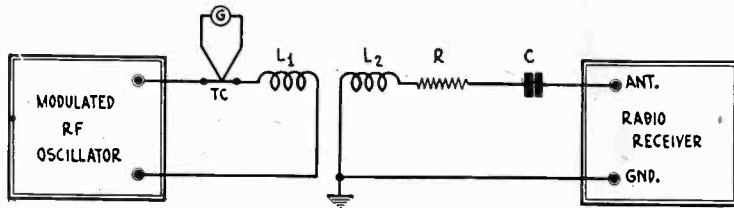

FIG. 1

AN ARRANGEMENT USED IN TESTING THE SENSITIVITY OF RADIO RECEIVERS. THE MODULATED OSCILLATOR IS COUPLED TO THE STANDARD ARTIFICIAL ANTENNA BY MEANS OF MUTUAL INDUCTANCE, WHICH MAY BE VARIED TO ADJUST THE INPUT.

THE loudness with which a given broadcast station is received at any place with a given set depends on the field strength of the signal at that place. The field strength of that station at that particular place may vary from time to time, and for that reason the loudness of the signal varies also.

What is the meaning of field in this case? Let us begin by explaining the meaning of a steady electric field. Suppose the earth is at zero potential, an assumption which can always be made if we wish to start measuring voltage, that is, potential, at the ground. Then suppose there is a conductor parallel with ground, such as a large sheet of metal, which is kept at a potential 1,000 volts positive. Let this plate be a distance of 100 feet above the ground. Then the difference of potential between the earth and the charged plate is 1,000 volts. The field strength is the potential difference per unit length. If we use the foot as the unit of length the field strength in this assumed case is 10 volts per foot. It has this value everywhere between the ground and the charged plate for there is supposed to be nothing in the space between the earth and the plate which changes the rate of fall of potential.

VARIABLE FIELD STRENGTH

Now it may be that the rate of fall of potential is not uniform between the earth and the plate. There may be, for example, other conductors in the space which are charged at different potentials. These would alter the rate of change of potential. But still at any point the field can be measured in terms of volts per foot. At one point the field strength may be zero, at another point it may be 5 volts per foot, at still another it may be 500 volts per foot. When the rate of change of the potential is not uniform the intensity at any point is determined by taking the potential difference between two points very close together and dividing this voltage by the distance in feet between the two points.

Since electrical units, including those in radio, have been built up on the metric system of measurement it is customary to use the meter as the unit of length in making field strength measurements, or in some instances, the centimeter, which is the scientific unit of length. Hence field strengths relating to insulators are usually expressed in volts per centimeter. But field strengths of radio waves are expressed in microvolts per meter, and sometimes in millivolts per meter. The reason for using the meter in this instance is that the voltages involved are so small that if the centimeter were used inconveniently small numbers would be required to express the strength.

RADIO FIELD STRENGTHS

Radio wave field strengths are measured in the same manner as steady field strengths, although the voltage varies rapidly as time goes on. The ground may be taken as zero potential all the time. Then as a wave passes the voltage at a point above the ground varies through a certain range, measured with respect to ground. Whether the voltage at that point is positive or negative does not matter. At any instant the voltage at the point may be 500 millivolts. At another instant it may be zero. If the 500 millivolt potential is the maximum during a cycle this value is twice the amplitude of the wave and the amplitude of course is 250 millivolts. The effective value is .707 times 250, or 146.75 millivolts.

This, however, is not the field strength of the wave unless it happens that the chosen point was unit distance above the ground. Suppose the point is ten meters above the ground.

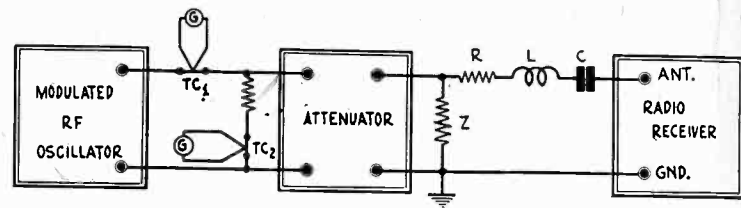

FIG. 2

IN THIS ARRANGEMENT FOR TESTING THE SENSITIVITY OF RECEIVERS AN ATTENUATOR IS USED FOR ADJUSTING THE INPUT TO THE STANDARD ANTENNA.

Then the field strength is approximately 15 millivolts per meter. If the point is only one meter above the ground then the field strength is 146.75 millivolts per meter, but if that is the case a point ten meters up would have an effective voltage of nearly 1.5 volts. The field strength is always the number of voltage units difference in potential per unit vertical distance. When the voltage varies like that of a radio wave the effective voltage counts and this is .707 times the amplitude of the wave.

NO WIRE NECESSARY

It is not necessary that a wire be erected between two points in order that a potential difference may exist. When the radio wave passes the voltage exists whether there is a wire or not. The only function of the wire is to permit making use of the voltage difference that does exist. The potential difference between the ends of the antenna, say the ground and the high point, becomes an electromotive force in the wire which causes a current to flow. This current is greatest near the ground so that if the primary of a radio frequency transformer be placed in the antenna near the ground the greatest signal intensity will be transferred to the receiver.

In measuring the field intensity at any point a loop is used for pick-up rather than a vertical wire. It is possible to calculate the voltage that will be induced in a loop of known dimensions by any given field strength so the problem of measuring field strength is reduced to measuring the dimensions of the loop and later measuring the voltage induced in the loop. What is known as the effective height of the loop is used in place of the height of the antenna, and the effective height of the loop depends on the number of turns on it and on the area of each turn, or if the areas of the different turns vary the area of the mean turn is used.

SENSITIVITY OF RECEIVERS

The sensitivity of receivers is usually expressed by the number of microvolts per meter required to put out a standard audio signal when the set has been adjusted to its greatest sensitivity. Thus the more sensitive a receiver is the smaller the number of microvolts per meter will be required to express it. A very sensitive receiver might have a sensitivity of one microvolt per meter and a less sensitive set 10 microvolts per meter.

Since there are many variable factors affecting the output of a receiver it is necessary to use a standard input, which must be provided by a local oscillator. The wave emitted by this oscillator should be free from harmonics and it should be modulated 30 per cent. There must be a means of measuring the output of this oscillator, which is usually a thermocouple and a sensitive microammeter.

The output of this oscillator must be coupled to the receiver under test through an artificial antenna having standard characteristics. The standard antenna has an inductance of 20 microhenries, capacity in series with the inductance of 200 mmfd., and a total series resistance of 25 ohms. These are the average characteristics of an antenna four meters high, and this height is taken as standard.

CIRCUITS FOR MEASURING SENSITIVITY

One arrangement for measuring the sensitivity of a receiver is shown in Fig. 1. At the left is the modulated radio frequency oscillator. The output is measured with the thermocouple TC and the microammeter or galvanometer G. The signal is

What on Earth Are They?

Response Gauges Sensitivity of a Receiver

Anderson

Editor

transferred to the artificial antenna circuit by means of mutual inductance between the coils L1 and L2. The field intensity is obtained by the formula $E=6.28fMI/h$, in which E is the field strength in microvolts per meter, f the frequency of the frequency of the current in kilocycles per second, M is the mutual inductance in microhenries between coils L1 and L2, I is the current through L1 in microamperes, and h is the height of the antenna, assumed to be the standard of 4 meters. The values of L2, R and C were given above for the standard artificial antenna. R is the total resistance and therefore includes that of the coil L2.

In the circuit in Fig. 1 the signal intensity impressed on the receiver can be varied either by varying the coupling between L1 and L2, that is, M or by varying the current through the primary coil.

Another arrangement for measuring the sensitivity is shown in Fig. 2. This differs from the arrangement in Fig. 1 mainly in the manner in which the signal is attenuated, or reduced to the lowest value which gives a standard output signal. The modulated oscillator is the same as in the preceding circuit and the output current is measured in the same way by means of the thermocouple TC1 and the galvanometer. The voltage across the input terminals of the attenuator is measured by a similar thermocouple TC2 and another galvanometer. The attenuator is usually of the resistor type. That is, it has certain series and shunt resistances which may be altered in number and value to reduce the voltage across Z to any desired proportion of the measured voltage across the corresponding input impedance.

FORMULA FOR INPUT SIGNAL

The values of L, C and R in this circuit are the same as the values of L2, C and R in Fig. 1, namely, 20 microhenries, 200 mmfd. and 25 ohms, respectively. However, R includes the resistance of Z as well as that of L. The formula for the field intensity in this instance is $E=KZI/h$, in which E is the field strength in microvolts per meter, K is the attenuation constant of the attenuator, Z the coupling impedance, I the current through the thermocouple TC1 measured in microamperes, and h is the height of the antenna (4 meters).

It will be noticed that the input voltage to the receiver is the drop in Z. If the attenuator is calibrated in volts, the formula takes the form $E=KV/h$, in which K is the attenuation factor and V is the voltage across the input impedance as measured by thermocouple TC2 and the second galvanometer. That is, the input voltage is the product of the input impedance and the current in the thermocouple TC2. Since K is the attenuation factor the voltage across Z is KV. The reason the voltage is not measured directly in Z is that this is so small that it cannot be measured accurately with any available thermocouples. Accurate attenuators can be constructed out of non-inductive resistances or they can be purchased already calibrated.

LOOP RECEIVERS

When the receiver is made for loop reception the measuring device takes a simple form, as shown in Fig. 3. The same modulated oscillator is used and the same current measuring device. The primary coil takes the form of a small loop L. This coil is placed so that its center line passes through the center line of the receiver loop in the manner indicated. The two coils may or may not be parallel, but if they are not, the angle between them must be measured as this enters into the calculation.

With this arrangement the field intensity can be calculated with the formula $E=18,850NA^2I\cos B/(A^2+X^2)^{3/2}$, in which E is the field intensity, N the number of turns on the coupling coil, A the radius of this coil in centimeters, I the current through the coil in microamperes, and X the distance in centimeters between L and the receiver loop, the center turn on each being taken. The value of the cos B term can be obtained from trigonometric tables once the angle B has been found. If the loops are parallel the cos B term is unity and need not be considered. The value of E is given in microvolts per meter.

ASSUMED VALUES

It will be realized that these devices, particularly those in Figs. 1 and 2, do not give the actual values of the field strength because of the assumed height of the antenna. But they do give convenient and standardized methods for comparing com-

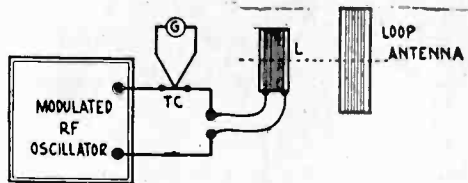

FIG. 3

WHEN THE RECEIVER TO BE TESTED HAS A LOOP THIS ARRANGEMENT IS USED IN TESTING THE SENSITIVITY OF THE RECEIVER.

mercial receivers. The loop method gives more definite indication of the field strength because there is no assumption of height.

It is clear that the circuit in Fig. 1 is the simpler of the two which are suitable for the ordinary receiver using an open antenna because the coil L1 is simpler and cheaper than the attenuator in Fig. 2. The only difficulty in Fig. 1 is to know what the mutual inductance is between the two coils. This, however, can be calculated without a great deal of labor when the two coils are regular and placed with their centers on the same line. It can also be measured with simple means.

One way of varying the coupling is to rotate the smaller coil inside the other, or even outside. The mutual inductance for any setting of the rotor can then be calculated from measured inductance values of the two coils separately and the inductance when they are in series. For example, if the measured inductances of the two coils are L1 and L2 and the measured inductance of the two in series aiding is L3, the mutual inductance between them is $(L3-(L1+L2))/2$. If a dial is attached to the rotor coil L3 can be measured at several different settings of the dial, and the mutual inductance determined at each setting. A curve can be plotted of mutual inductance versus dial settings and thus the mutual inductance at any setting can be determined from a few measurements. Note that it is only necessary that the scale cover more than ninety degrees because the mutual inductance varies from zero to maximum while the rotor turns through this angle. Negative values of mutual inductance are of no interest in this case.

The values of L1 and L2 can be calculated with simple formulas because coil forms for which simple formulas are available can be selected.

STANDARD SIGNAL

The standard signal is one modulated 30 per cent with an audio frequency of 400 cycles per second which is free from harmonic content. The standard output is .05 watt in a resistance equal to the plate resistance of the tube used as power tube. That is, the product of the signal current squared and the resistance is supposed to be .05 watt.

If the power tube is followed by an output transformer the resistance to be connected to the secondary is to be equal to the reflected resistance of the tube as seen from the secondary of the transformer. The tube is to be operated so that the second harmonic in the signal does not exceed 5 per cent. It is assumed that the tube is large enough to put out the standard signal before it becomes overloaded.

VOLUME CONTROLS IN SCREEN GRID RECEIVERS

IN nearly all up-to-date screen grid receivers using the 224 type tube, I have noticed that the volume is controlled by varying the screen grid voltage with a potentiometer. Is there not a better volume control that could be used? I have tried it and have not had much luck with it. It seems to me that when the screen grid voltage is changed the efficiency of the tubes changes greatly.—W. H. S.

This method of controlling the volume is now used almost exclusively because there is no other satisfactory way of controlling the receivers. Yes, the efficiency of the screen grid tubes change when the screen grid voltage is varied, and that is just exactly the reason for changing it. The volume could be changed by changing the heater current in the tubes, just as is done in receivers using DC screen grid tubes, but the volume does not respond quickly enough to make the scheme satisfactory. If changing the screen grid voltage were not the most satisfactory method of controlling the volume it would not be used by all those who have designed outstanding receivers.

A Question and Answer Department conducted by Radio World's Technical Staff. Only Questions sent in by University Club Members are answered. Those not answered in these columns are answered by mail.

RADIO UNIVERSITY

Annual subscriptions are accepted at \$6 for 52 numbers, with the privilege of obtaining answers to radio questions for the period of the subscription, but not if any other premium is obtained with the subscription.

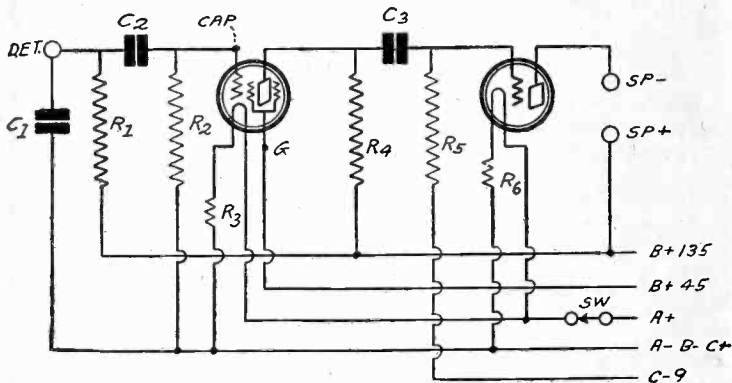

FIG. 817

A TWO-STAGE RESISTANCE COUPLING AMPLIFIER WHICH CAN BE USED WITH A RADIO RECEIVER FOR GETTING LOUDSPEAKER VOLUME, ALTHOUGH NO AUDIO TRANSFORMER IS USED IN THE CIRCUIT.

LOUDSPEAKER VOLUME WITHOUT TRANSFORMERS

I HAVE been told that loudspeaker operation is impossible without the use of audio frequency transformers for coupling the audio stages. Is that correct? If not, please show circuits which will give loudspeaker volume without transformers—D. J. D.

You have been misinformed. The best audio frequency amplifiers do not contain any audio transformers at all. Have you not heard of resistance coupled amplifiers? In Fig. 817 is a typical audio frequency, resistance coupled amplifier of two stages which, when connected to a moderately sensitive receiver, will give you enough volume to operate the average loudspeaker. There is no limit to the volume that you can get from a resistance coupled circuit if you use large enough output tube and employ sufficient amplification. Fig. 818 shows you a complete radio receiver in which not a single audio transformer is used, yet it will give sufficient volume to operate almost any loudspeaker. For battery operation that is about as good a receiver as you can get without going into a great deal of expense.

AUTOMATIC VOLUME CONTROL

IS AN automatic volume control in a receiver really practical? If you think it is, please publish a circuit diagram of one or tell me where I can find such a diagram. I mean the type of volume control which operates at radio frequency, not the type which controls the amplification by the signal strength in the audio frequency level.—J. K.

There is a circuit diagram of the RCA 64 in Trouble Shooter's Manual by John F. Rider. This receiver has an automatic volume control of the type you ask for.

GREAT IMPROVEMENT IN SET

I BUILT a screen grid receiver the way you described it, but it did not work out as well as it was supposed to do. It was very selective, but it would only bring in local stations. Substitution of general purpose tubes cleared up the trouble. With 201A tubes the circuit is wonderful. Why does not receiver work with screen grid tubes?—A. C. C.

Either the tubes were defective or you did not use them right. If the circuit worked by merely substituting 201A tubes the connections were surely wrong before because the screen grid tubes require a different hook-up. Then again your voltages may not have been right. In most instances of failure the voltages are at fault.

MULTIPLE CONNECTION OF SPEAKERS

I WISH to connect several speakers to my push-pull, 250 tube power amplifier. Should I connect them in series or in parallel or in some other combination? The speakers are of different make.—O. G. H.

It is not an easy matter to connect speakers of different constants to the same output circuit. If they are connected in parallel the low impedance speakers will partly short-circuit the high impedance speakers; if they are connected in series the high impedance speakers will take most of the output power. In either case the impedances are not right for best transfer of energy from the tubes to the speakers. If the speakers are in series the load impedance is likely to be too high, and if they are in parallel it is likely to be too low.

Now if the speakers are connected in series parallel the re-

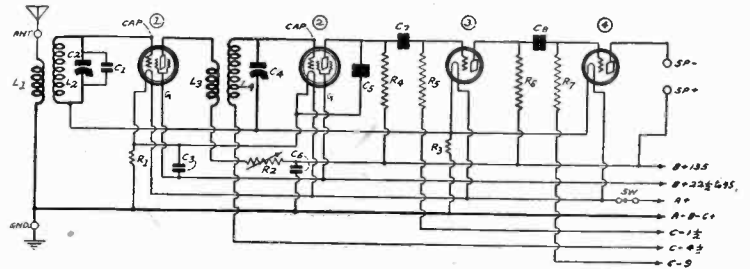

FIG. 818

A COMPLETE RADIO RECEIVER IN WHICH RESISTANCE COUPLING IS USED IN THE AUDIO AMPLIFIER. LOUDSPEAKER VOLUME WILL BE OBTAINED, ALTHOUGH NO TRANSFORMERS ARE USED.

sulting impedances is somewhat difficult to predict. If all the speakers are the same two in series and two in parallel will give the same impedance as a single speaker, and all will get the same amount of power. But if they are different one branch may have a much higher impedance than the other and the situation becomes about the same as if two speakers, one of low impedance and one of high, were connected in parallel. If two speakers are of a type which has one-half the impedance each than another speaker, the two low impedance speakers should be connected in series and then connected in parallel with the high impedance speaker. The total impedance of the three speakers will then be equal to that of one of the low impedance speakers. If the output impedance of the amplifier is such as to match this impedance all is well.

VACUUM TUBE VOLTMETER

WHAT type of indicating meter would you recommend for use with a vacuum tube voltmeter?—J. B. K.

That depends entirely upon what kind of vacuum tube voltmeter and for what purpose it is to be used. For measuring alternating voltages with accuracy, a sensitive microammeter is recommended, one having a sensitivity of at least 0-100 microamperes. Such a meter is desirable because the current required is so small that the tube used will last indefinitely without recalibration. For less accurate work a 0-1 milliammeter will do. If the instrument is not to be direct-reading it is possible to use any kind of indicating current meter. For different types of vacuum tube voltmeter look in back issues of Radio World where complete descriptions have been given of different types.

WINDING DATA ON SMALL COIL

PLEASE let me know how many turns of No. 28 enameled wire I should put on a 1.25 inch diameter to give an inductance which will cover the broadcast band with a .0005 mfd. tuning condenser.—F. D.

Use 84 turns and wind them without other spacing than that afforded by the insulation. The coil will be 1.135 inches long on the average. The thickness of the wire will vary a little.

BIAS RESISTOR FOR 245

I HAVE a voltage divider having a large number of taps and a total resistance of nearly 14,000 ohms. Would it be possible to use part of this resistance for grid bias resistor to serve a 245 power tube?—P. C. A.

If the taps are located at the right points it is possible. It is only necessary to connect B minus to a point 1,500 ohms from one end of the resistor and then connect the end of the 1,500 ohm section to the center tap of the filament for the 245 tube.

SCREENS USED AS BAFFLE

I HAVE in mind of building a receiver on a high panel and treat it somewhat like a highboy. The loudspeaker would be placed in the center. Then I plan to have swinging doors the length of the height of the panel, the width of each being equal to one-half of the width of the panel. In operation these doors will be swung open and placed so that they will act as a baffle board. The panel will be about five feet high and the total width with doors open will be about 36 inches. Would this arrangement work satisfactorily? In place of the swinging doors I was thinking that I might put screens on each side of the speaker. How would this arrangement work?—J. O. P.

SUPPLY CURRENT FOR DYNAMIC FIELD

WILL YOU kindly publish a circuit diagram of a current supply for a dynamic speaker requiring 90 volts for the field?
—E. R. H.

Fig. 819 is the circuit diagram of a simple B supply unit. This might be used, or part of it. Cut off everything to the right of C2 and connect the field winding across this condenser. This will work all right provided that the voltage is not too high. Of course, the voltage depends on the voltage across the secondary of the power transformer. If the voltage across each half is 110 volts you will have ample current and voltage for your dynamic field. It is difficult, though, to get a transformer of such low voltage, unless it is especially wound for the purpose. You might use the commercial transformer of lowest voltage which you can get and then limit the current in the field by a resistance in series with the field. To determine the value of resistance you need you must know the voltage at the out of the rectifier and the current required by the field. Suppose the voltage is across a resistance placed across C2 when a current of 40 milliamperes flow, and suppose further that the rated current of the speaker is 40 milliamperes and the voltage 90 volts. You must then put a resistance in series with the speaker to cut the voltage from 220 to 90 when a current of 40 milliamperes flow. That is, you must have a resistance equal to $130/.04$, or 3,250 ohms. Hence, in this case get a variable resistance of 5,000 ohms, capable of carrying more than 40 milliamperes, and connected in series with the field. Then adjust it until the current in the speaker is 40 milliamperes or until the voltage across the field is 90 volts.

Either arrangement should work very well. Undoubtedly, something very attractive could be worked up along this line, as well as something very effective acoustically. If you build such a cabinet there would be room not only for an elaborate radio receiver but also for a phonograph, with record compartments and all. Not only that, but you might find room in it for a home movie outfit. The upper part of the panel might be used for the screen.

USE OF ELECTROLYTIC CONDENSER

YOU are always recommending the use of a large condenser across the grid bias resistor in the power stage, and I have found that it is a good idea to do so. In fact I want to use an electrolytic condenser. Now I am wondering whether it would be possible to use a section of the electrolytic condenser used in the power pack. I realize that the copper can is negative and that this is common for all the sections. It seems to me that some arrangement would be possible which would allow this use of the condenser.—A. D.

The way most receivers are connected it is possible to use one of the sections of the electrolytic condenser without any special arrangement. Connect the can to B minus and one of the sections to the mid tap of the filament transformer serving the power tube. The center tap is positive with respect to B minus by the drop in the grid bias resistor. One of the high capacity sections cannot be used for any better purpose.

CONNECTION OF PHONOGRAPH

I NOTICE in the AC model HIQ-30, described in the December 21 issue of RADIO WORLD that the phonograph pick-up unit is connected between the grid of the detector and ground, and that there is no provision made for opening the radio input circuit. Does not this circuit short-circuit the phonograph input?—A. B. W.

As was clearly explained in the article to which you refer, the short-circuit is prevented by the high resistance grid leak and the high impedance of the grid condenser. There is only a slight short-circuiting effect at the highest audio frequencies, but this is desirable to equalize the high and the low frequencies and to eliminate some of the scratch noises.

COMPARISON OF OUTPUT

WHICH will give the more output, a single 245 tube or two 112As in push-pull?—M. N. W.

With maximum recommended plate voltages on the tubes one 112A gives a maximum undistorted output of 300 milliwatts and two in push-pull would give about 1,000 milliwatts. A single 245 will give a maximum undistorted output of 1,600 milliwatts. It will require a much greater amplification ahead of the 245 than ahead of the 112A to get this maximum undistorted output.

DOES CARRIER FREQUENCY VARY?

IS IT a fact that the carrier frequency of a broadcast station varies when the signal is modulated, and that the degree of variation is greater the greater the degree of modulation?—W. H. H.

That is more or less the case. However, it depends on the kind of broadcasting station that is in question. Where a piezo crystal is used to control the frequency there is practically no variation in the frequency. Likewise where a master oscillator is used there is practically no variation, provided that there is no reaction between the modulator and the oscillator. In the old type broadcaster where the oscillator and the modulator were coupled directly together in the Heising circuit there was considerable frequency variation accompanying modulation.

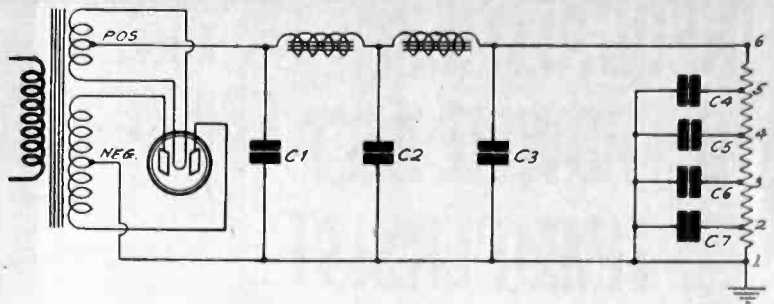

FIG. 819

A SIMPLE RECTIFIER AND FILTER CIRCUIT WHICH CAN BE USED FOR SUPPLYING THE FIELD OF A DYNAMIC SPEAKER. ONLY ONE CHOKE AND TWO CONDENSERS NEED BE USED, BUT A RESISTANCE SHOULD BE CONNECTED IN SERIES WITH THE FIELD TO LIMIT THE CURRENT.

EQUIPMENT FOR 25 CYCLE POWER

WHAT are the principal differences between power transformers intended for 60 cycle and 25 cycle work? If a transformer has been designed for 25 cycles can it be used on 60 cycles satisfactorily?—T. P. R.

The transformer made for 25-cycle work is usually built on a larger scale, and therefore it costs more than one made for 60-cycle work. The 25-cycle transformer has a larger core and more turns on the windings. If a transformer has been built for 25 cycles it can be used for 60-cycle work but one built for 60 cycles cannot be used for 25-cycle work.

MODULATION OF DIRECT CURRENT

COULD it be said correctly that the plate current in a vacuum tube is modulated by the radio or audio frequency current?—M. Q.

Yes, it may be looked on in this manner. Modulation is a variation in the amplitude of a radio frequency current, but it could also be regarded as a variation in the "amplitude" of a steady current.

Join

Radio World's

UNIVERSITY CLUB

And Get Free Question and Answer Service for the Coming 52 Weeks. This Service for University Subscribers Only

Subscribe for RADIO WORLD for one year (52 numbers). Use the coupon below. Your name will be entered on our subscription and University Club lists by special number. When sending questions, put this number on the outside of the forwarding envelope (not the enclosed return envelope) and also put it at the head of your queries. If already a subscriber, send \$6 for renewal from close of present subscription and your name will be entered in Radio University.

NO OTHER PREMIUM GIVEN WITH THIS OFFER

[In sending in your queries to the University Department please paragraph and number them. Write on one side of sheet only. Always give your University Club Number.]

RADIO WORLD, 145 West 45th Street, New York City. Enclosed find \$6.00 for RADIO WORLD for one year (52 nos.) and also enter my name on the list of members of RADIO WORLD'S UNIVERSITY CLUB, which gives me free answers to radio queries for 52 ensuing weeks, and send me my number indicating membership.

Name

Street

City and State

INEQUALITIES OF POWER AND TIME PERSIST

Washington.

The Senate has been informed by the Radio Commission that while the desired equality of power required by the Davis amendment to the radio law has been achieved as far as possible in the allocation of frequencies and time of station operation, there still exist inequalities in radio facilities.

"This was due," the Commission said, "first, to the fact that States have not availed themselves of the opportunity of obtaining their proportion of power, through lack of applications, and second, to the fact that some applications for power could not be approved. Had the necessary number of applications been received from stations located at suitable points or applications received for increases of power at existing stations at suitable points, this equality of power would have been accomplished."

N. Y. and N. J. Situations

The report stated that "in New York State, on March 28th, 1928, there were forty-eight stations operating day or night or both, while on November 27th, 1929, there were fifty-three, of which ten were national, twenty-eight regional and fifteen local stations. In New Jersey, in March, 1928, there were twenty-six stations, compared with fourteen in November, 1929, of which three were national, ten regional and one local.

"In March, 1928, New York State had thirty-four frequencies, which were reduced in November, 1929, to twenty-eight, of which ten were national, twelve regional and six local. In New Jersey, in March, 1928, there were eighteen frequencies, which were reduced in November, 1929, to seven, of which three were national, three regional and one local.

Wattage Comparison

"In March, 1928, New York State had 127,390 watts power, which was increased in November, 1929, to 162,765 watts, of which 145,000 watts were used on national frequencies, 16,750 on regional and 1,015 on local channels.

"New Jersey in March, 1928, had 54,175 watts, but this was reduced in November, 1929, to 14,850 watts, of which 10,000 watts were used on national frequencies, 4,750 on regional and 100 watts on local channels."

Webster and Segal Resign Legal Posts

Washington.

The resignation of Bethuel M. Webster, Jr., and Paul M. Segal, as general counsel and assistant general counsel, respectively, of the Federal Radio Commission, have become effective. They will enter private practice of law in Washington, Mr. Webster joining a prominent law firm while Mr. Segal will specialize individually in the practice of radio law.

Appointment of Thad. H. Brown, of Ohio, chief counsel of the Federal Power Commission, as general counsel of the Federal Radio Commission, to succeed Mr. Webster, was announced. He was president of the Cleveland Broadcasting Corporation, operating WJAY in Cleveland for seven months in 1927. He served in the World War.

Literature Wanted

THE names and addresses of readers of RADIO WORLD who desire literature on parts and sets from radio manufacturers, jobbers, dealers and mail order houses are published in RADIO WORLD on request of the reader. The blank at bottom may be used, or a post card or letter will do instead.

RADIO WORLD,
145 West 45th St., N. Y. (City).
I desire to receive radio literature.

Name

Address

City or town

State

Nathan Wagefeld, 56 E. 1st St., New York City.

George C. Anderson, 2251 Gravois Ave., St. Louis, Mo.

Warren Caton, 3017 E. 16th Ave., Denver, Colo.
Geo. A. Mercer, 124 So. 13th St., Minneapolis, Minn.

W. C. Engel, 615 Griffon, Danville, Ill.
Abraham Coblenz, 601 East 138th St., New York City.

V. Bottoms, 178 Bartlett Ave., Toronto 4, Canada.

Chas. W. Yeager, 1316 S. Date Ave., Alhambra, Calif.

R. F. Munn, 67 Hattie St., San Francisco, Calif.

Reid R. Davis, 607 W. 137th St., New York City.

Geo. Guest, 16 Parkdale Ave., Buffalo, N. Y.

Russell Coutant, Box 310 Western Ave., Mari-
boro, N. Y.

John E. Loftus, 142 Nott Terrace, Schenectady,
N. Y.

Joseph Masone, 290 West Main St., Stamford,
Conn.

Ralph Matan, 1321 H St., N. E., Washington,
D. C.

G. E. A. Innes, 2570 Triumph St., Vancouver,
B. C., Can.

David Steinmark, 3988 Amboy Rd., Great Kills,
S. I., N. Y.

C. W. Berglund, 323 W. DeWald, Fort Wayne,
Ind.

Vernon Estelle, 5712 Lafayette Ave., Chicago,
Ill.

Dr. M. C. Spencer, 2214 N. Ballou St., Chicago,
Ill.

SCHOOL OF AIR TO START SOON

A new plan of educational instruction by radio has been offered to Secretary of the Interior, Ray Lyman Wilbur, by the Columbia Broadcasting System of New York in conjunction with the Grigsby-Grunow Co., of Chicago, manufacturers of radio receivers. The tentative plan provides for a series of educational broadcasts to be presented for the school term beginning the first week in February.

The practical use of radio in the public schools of the country is a matter now under investigation by the Advisory Committee on Education by Radio, appointed by the Secretary of the Interior. The proposed experiment is a practical step in attempting to use the radio as a direct method of education.

This educational feature will be called "The American School of the Air" and will be broadcast one-half an hour, twice a week, Tuesday and Thursday afternoons, at 2.30 p.m., to junior high school pupils. Tuesdays will be devoted to the teaching and development of American history. Dramatic episodes relating to the economic, social and political life of the nation will go on the air. Thursday afternoons will be reserved for a more diversified program and will include American literature, political science, health and hygiene, American music and nature study. Leading educators all over the country have been called upon for suggestions. The expense of the programs will be borne by the Grigsby-Grunow Company and broadcast over the Columbia System.

MANY STATIONS SHOW A PROFIT, SENATE IS TOLD

Washington.

A report to the Senate by Paul M. Segal, assistant general counsel of the Radio Commission, shows that many broadcasting stations are coming out of "the red" and are at last making money, while others are self-supporting and most of them are breaking even. The report, based on a questionnaire, is to be used by the Senate on a method of assessing license fees upon users of the air to defray the administrative costs of radio. The following are extracts from the report:

"Only 340 of the approximately 610 stations thus far have answered that portion of the questionnaire relating to profits and losses over a given twelve-month period. An analysis of these returns, however, shows that eighty stations, ranging in power from 100 to 50,000 watts, lost more than \$10,000 over the previous year, as compared to fifty-three stations which showed profits of more than \$10,000.

54 Made, 36 Lost

"In the next monetary category, a favorable trade margin of between \$5,000 and \$10,000 was realized by fifty-four stations, as against thirty-six stations which lost to this extent. Thirty-five stations profited and twenty-three lost in the grade of \$2,500 to \$5,000, while \$2,500 profits were shown by twenty-six stations, while thirty-five stations lost up to that amount.

"In the matter of broadcasting time the report showed that of the total of 1,252,802 hours consumed by all stations, the total time sold, exclusive of chain programs, is 410,426 hours, or about 33 per cent. The total time used for station programs and the promotion of good will for the broadcaster's own business is placed at 51 per cent. The average figures for the individual stations, of course, amount to identically the same in percentages.

Upkeep Costs Differ

"Statistics on the annual average gross operating costs of stations disclose strange trends. For example, the average cost of superpowered 50,000 watt stations is placed at \$265,707.83, while stations using just half that power, spent an average of \$468,266.41. Similarly, the average expenditure of a 350 watt station was \$190,000, whereas a 250 watt station cost only \$26,702.17, and a 500 watt station \$27,907.52.

"Stations of 100 watts and under spent an average of \$9,118.46 a year; 200 watts, \$7,933.33; 750 watts, \$99,193.71; 1,000 watts, \$59,270.89; between 1,000 and 2,000 watts, \$53,900; 5,000 watts, \$115,268.58; 7,500 watts, \$200,000; 10,000 watts, \$117,676.45; 15,000 watts, \$173,052, and 20,000 watts, \$179,000."

Aerovox Asks \$500,000 for Dubilier 'Threats'

The use of mineral oil as a cooling agent in the manufacture of electrical condensers forms the basis of a suit the Aerovox Wireless Corporation brings against the Dubilier Condenser Corporation on the recent patent No. 1,736,764, granted to Aerovox.

Aerovox is filing a countersuit against the Dubilier in another action for \$500,000 damages, saying Dubilier intimidated Aerovox by alleging infringements of Dubilier patents.

HOOVER'S QUICK PEN SAVES LIFE OF COMMISSION

Washington.

President Hoover has signed the Dill-White bill, prolonging indefinitely the life of the Radio Commission as an administrative body.

But for this quick action by the President, the Commission would have become an appellate body on the first of this year, with regulatory authority devolving upon the Department of Commerce.

The bill also authorizes the Commission to appoint a chief engineer at \$10,000, two assistants at \$7,500 each, and such other engineering aids as it considers necessary.

Some radio leaders in Congress are said to regard the continuance of the present Radio Commission as a measure of expediency to bridge the gap until a communications agency with powers similar to those of the Interstate Commerce Commission can be established.

Several cases are now pending in the Court of Appeals of the District of Columbia in which broadcasters are attacking the authority of Congress to control radio facilities. The decisions of the court in these cases, when made, are expected to have important bearing on the provisions of any new radio measures.

Musicians Assured Radio Aids Them

Washington.

Peter W. Dykoma, Professor of Musical Education at Teachers College, Columbia University joins the distinguished ranks of those who see aid to musical education in radio and sound devices. The Professor asserts that the spread of radio, phonograph and "talkie" music should not be discouraged, despite the uncertainty it has created among musicians. He believes the increasing demand for music teachers will provide employment for many musicians now out of work. Among other statements, the Professor said:

"Even if it were possible to put a stop to the widespread use of 'canned music,' I seriously question whether it would be a wise move. It seems to me that it is immensely better for the great masses of people to have some music that is passably good than to have none at all. The music that we get from the phonograph, the radio, and the talking movies certainly is at least passably good, and it has improved marvelously in the last three or four years."

Depositions Ordered In Television Suit

Washington.

Justice Jennings Bailey in District of Columbia Supreme Court has issued an order that the Federal Radio Commission take depositions of twenty-two New Yorkers in the suit brought against Charles F. Jenkins, prominent television inventor, by Arthur D. Lord, a New York City broker suing Jenkins for \$612,500 claimed to be due him as commission in the sale of the Jenkins patents to the Jenkins Television Corporation.

WABC Gives Up Site in Jersey

Washington.

Sam Pickard, vice-president of the Columbia Broadcasting System, owners of the key station WABC, has announced that the company has withdrawn its application to the Radio Commission for authority to locate a 50,000-watt transmitter for WABC at Columbia Bridge, N. J. The application already had been granted by the Commission. This is in answer to the complaint of the State of New Jersey that "foreign" stations were "invading" the State.

"The transmitter will not be located in New Jersey," Mr. Pickard declared, "because our company does not want to arouse the ill-will of the people of the State. We want to give the best service we can and thought the New Jersey site would suit our purposes. If the people of the State do not want it located there, it will go elsewhere."

The transmitter of WABC is now located west of Cross Bay Boulevard in Queens County, New York City, and uses 5,000 watts power. Mr. Pickard denied a report that the 50,000-watt transmitter would be located at the same place and that the power will be increased gradually in steps of 5,000 watts each.

LIMIT ON CHAIN FINALLY KILLED

Washington.

At its final meeting of 1929 the Radio Commission rescinded its chain broadcasting order. This rule would have prohibited sending the same program by chain stations within 300 miles of each other. The order was issued last September, but its effective date postponed several times. The Commission gave the following reasons for rescinding the order:

"To assure the uninterrupted broadcasting of high-class chain programs for the benefit of the general public" and "to afford adequate time to the Commission to investigate and determine whether chain programs are being unnecessarily duplicated, and to enable the Commission to determine what progress has been made toward the successful operation of two or more stations on the same frequency in synchronism, either by wire connection or otherwise."

The commission also said that it wanted "opportunity to determine whether chain broadcasting may be successfully carried on in the future with more economic use of frequencies than now employed."

WORTH THINKING OVER

Enters that lusty youngster, Master 1930, and introduces himself to radio and all the other arts, sciences and activities of the times. Give him a hearty welcome. Be not afraid of him. Take his hand and go out adventuring with him and let the world see that radio, though ages old in principle, still has far to go in practice and that there are greater worlds to conquer and greater things to be done for the eternal glory of the craft.

A THOUGHT FOR THE WEEK

If Beethoven or Handel were of this age we might expect from either a radio-inspired composition that would go booming sonorously down the corridors of time. However, so far as America is concerned, we can always fall back on that good old "Rhapsody in Blue."

DAMROSCH WISE BUT STOKOWSKI "RADIO NOVICE"!

At last perfect symphonic transmission over the radio has been accomplished, according to Walter Damrosch, conductor. Mr. Damrosch expresses the following opinion after three years of intensive experimentation.

"We have had some of the greatest engineering minds of the country at work. They have accomplished wonders. In fact, I can say that hardly any technical difficulties remain. If under the new conditions the results of broadcasting a symphonic program are not satisfactory, the conductor himself is to blame.

"I understand Mr. Stokowski has not been completely satisfied with the results he has been getting over the air. He must not forget that while he is a distinguished veteran as a symphonic conductor, he is still a novice in the art of broadcasting. A knowledge of radio acoustics and the proper placement of the orchestra in relation to the microphone solves many of the seemingly mountainous difficulties that beset a conductor during his broadcasting novitiate.

Handicaps Eliminated

"Many of the old handicaps have been eliminated through the recent invention of the condenser microphone. It is no longer necessary to have several microphones placed in front of and above the orchestra. Instead we have one single microphone, so delicately constructed that it is able to transmit the softest pianissimos and withstand the loudest crescendoes.

"In former years radio engineers did not dare let the full force of a crescendo hit their instruments for fear they would be shattered. A conductor would work up to a grand climax—and then there would be no climax. When the man at the controls in the operating room saw one coming he would tone down the controls.

"The new condenser microphone makes this unnecessary. I can now conduct my orchestra just as I would at Carnegie Hall. Even the kettle-drums can be played exactly as the score indicates. The works of the masters can be heard just as they were intended by the composers.

Placement Solved

During the past three years I have experimented a great deal in the placement of the orchestra so that the tone color and properties of the different choirs be transmitted properly. At every rehearsal my assistant, Ernest La Prade, is in the operating room, noting every effect and suggesting changes when necessary. Sometimes, when a particularly delicate nuance is being worked upon, I myself go to the operating room and listen to the effect.

"We now know exactly where every instrument should be in relation to the microphone in order to produce the right effect. It has been like learning to move chessmen about, but we now know the secret of every move."

BLAN ISSUES A CHALLENGE

Blan, the Radio Man, 89 Cortlandt Street, New York City, challenges any other dealer in the country to match his stock of Hammarlund parts. This does not cover the Hammarlund-Roberts Hi-Q 30, but includes only the 1930 line of Hammarlund Mfg. Co.

1930 LIST OF STATIONS BY CALL LETTERS

With Location, Power, Frequency and Wavelength

[The transmitter location of each station is given, but where the studio is located in some other city or town, the studio location is given also, designated by the letter "S." Where two different powers are given, the larger is usually for daylight use only. "Kc" stands for frequency in kilocycles, "kw" for power in kilowatts, "M" for wavelength in meters.]

Station	Transmitter	Power	kc.	M.	Station	Transmitter	Power	kc.	M.
WEHS	Evanston, Ill.	100	1500	199.9	WJSV	Mt. Vernon Hills, Va.	10kw.	1460	205.4
WELK	Phila., Pa.	100	1370	218.8	WJW	Mansfield, Ohio (Formerly WLBY)	100	1210	247.8
WEMC	Berrien Springs, Mich.	1kw.	590	508.2	WJZ	Bound Brook, N. J. S—New York City, N. Y.	30kw.	760	394.5
WENR	WBCN—Chicago, Ill.	50kw.	870	344.6	WKAQ	San Juan, P. R.	500	890	336.9
WEVD	Forest Hills, N. Y. S—New York City	500	1300	230.6	WKAR	E. Lansing, Mich.	1kw.	1040	288.3
WEW	St. Louis, Mo.	1kw.	760	394.5	WKAV	Laconia, N. H.	100	1310	228.3
WFAA	Dallas, Texas	10kw.	800	374.5	WKBB	Joliet, Ill.	100	1310	228.3
WFAN	Philadelphia, Pa.	500	610	491.5	WKBC	Birmingham, Ala.	100	1310	228.3
WFBC	Knoxville, Tenn.	50	1200	249.9	WKBF	Indianapolis, Ind.	500	1400	214.2
WFBE	Cincinnati, O.	100	1200	249.9	WKBH	La Crosse, Wis.	1kw.	1380	217.3
WFBG	Attoona, Pa.	100	1310	228.3	WKBH	Chicago, Ill.	50	1500	199.9
WFBJ	Collegeville, Minn.	100	1370	218.8	WKBH	Youngstown, Ohio	500	570	526
WFBP	Syracuse, N. Y.	750	900	331.1	WKBQ	Jersey City, N. J.	250	1450	206.8
WFBM	Indianapolis, Ind.	1kw.	1230	243.8	WKBQ	Battle Creek, Mich.	50	1420	211.1
WFBR	Baltimore, Md.	250	1270	236.7	WKBQ	New York, N. Y.	250	1350	221.3
WFDF	Flint, Mich.	100	1310	228.3	WKBS	Galesburg, Ill.	100	1310	228.3
WFI	Philadelphia, Pa.	500	560	535.4	WKBV	Connersville, Ind.	100-150	1500	199.9
WFIW	Hopkinsville, Ky.	1kw.	940	319	WKBW	Amherst, N. Y. S—Buffalo, N. Y.	5kw.	1470	204
WFJC	Akron, Ohio	500	1450	206.8	WKBZ	Ludington, Mich.	50	1500	199.9
WFKD	Wissinoming, Pa. S—Philadelphia, Pa.	50	1310	228.3	WKEN	Grand Island, N. Y. S—Buffalo, N. Y.	1kw.	1040	288.3
WFLA	WSUN—Clearwater, Fla.	2½kw.	900	331.1	WKJC	Lancaster, Pa.	100	1200	249.9
WGAL	Lancaster, Pa.	15	1310	228.3	WKRC	Cincinnati, Ohio	500	550	545.1
WGBB	Freeport, N. Y.	100	1210	247.8	WKY	Oklahoma City, Okla.	1kw.	900	331.1
WGBC	Memphis, Tenn.	500	1430	209.7	WLAC	Nashville, Tenn.	5kw.	1490	201.2
WGBF	Evansville, Ind.	500	630	475.9	WLAP	Louisville, Ky.	30	1200	249.9
WGBI	Scranton, Pa.	250	880	340.7	WLB	WGMS—Minneapolis, Minn.	500	1250	239.9
WGBS	Astoria, L. I., N. Y. S—New York City	500	600	499.7	WLBC	Muncie, Ind.	50	1310	228.3
WGCM	Gulfport, Miss.	100	1210	247.8	WLBK	Kansas City, Kans.	100	1420	211.1
WGCP	Newark, N. J.	250	1250	239.9	WLBG	Ettrick, Va. S—Petersburg, Va.	250	2kw.	900
WGES	Chicago, Ill.	500	1360	220.4	WLBI	Stevens Pt., Wis.	1kw. & 500	1260	238
WGH	Newport News, Va.	100	1310	228.3	WLBX	L. I. City, N. Y.	100	1500	199.9
WGHP	Fraser, Mich. S—Detroit, Mich.	750	1240	241.8	WLBZ	Bangor, Maine	500	620	483.6
WGL	Fort Wayne, Ind.	100	1370	218.8	WCI	Ithaca, N. Y.	50	1210	247.8
WGMS	WLB—See WLB-WGMS				WLEX	Lexington, Mass.	500	1360	220.4
WGN	WLBB—Elgin, Ill.				WLEY	Lexington, Mass.	100-250	1420	211.1
WGR	Amherst, N. Y. S—Buffalo, N. Y.	25kw.	720	413	WLJ	WGN—See WGN-WLIB			
WGT	Atlanta, Ga.	250	890	336.9	WLK	Philadelphia, Pa.	500	560	535.4
WGTS	Schenectady, N. Y.	50kw.	790	372.5	WLOE	Chelsea, Mass. S—Boston, Mass.	100-250	1500	199.9
WHA	Madison, Wis.	750	940	319	WLS	Crete, Ill. S—Chicago, Ill.	5kw.	870	344.6
WHAD	Milwaukee, Wis.	250	1120	267.7	WLSI	WDWF—See WDWF—WLSI			
WHAM	Victor Twp., N. Y. S—Rochester, N. Y.	5kw.	1150	260.7	WLTH	Brooklyn, N. Y.	500	1400	214.2
WHAP	Carlstadt, N. J. S—New York City	1kw.	1300	230.6	WLW	Mason, Ohio			
WHAS	Jeffersonstown, Ky. S—Louisville, Ky.	10kw.	820	365.6	WMA	Cincinnati	50kw.	700	428.3
WHAZ	Troy, N. Y.	500	1300	230.6	WLWL	Kearny, N. J. S—New York City	5kw.	1100	272.6
WHB	Kansas City, Mo.	500	950	315.6	WMAK	Cazenovia, N. Y.	250	570	526
WHBC	Canton, Ohio	10	1200	249.9	WMAK	Martinsville, N. Y. S—Buffalo, N. Y.	750	900	331.1
WHBD	Mt. Orab, Ohio	100	1370	218.8	WMAL	Washington, D. C.	250-500	630	475.9
WHBJ	Hattiesburg, Miss.	100	1370	218.8	WMAN	Columbus, Ohio	50	1210	247.8
WHBF	Rock Island, Ill.	100	1210	247.8	WMAQ	Addison, Ill. S—Chicago	5kw.	670	447.5
WHBL	Sheboygan, Wis.	500	1410	212.6	WMAY	St. Louis, Mo.	100-250	1200	249.9
WHBQ	Memphis, Tenn.	100	1370	218.8	WMAZ	Macon, Ga.	250-500	890	336.9
WHBU	Anderson, Ind.	100	1210	247.8	WMBA	Newport, R. I.	100	1500	199.9
WHBY	West De Perre, Wis. S—Green Bay Wis.	100	1200	249.9	WMBC	Detroit, Mich.	100	1420	211.1
WHDF	Calumet, Mich.	100	1370	218.8	WMBD	Peoria Hts., Ill.	500w.-1kw.	1440	208.2
WHDH	Gloucester, Mass.	1kw.	830	361.2	WMBF	WIOD—See WIOD-WMBF			
WHDI	Minneapolis, Minn.	500	1180	254.1	WMBG	Richmond, Va.	100	1210	247.8
WHEC	WABO—Rochester, N. Y.	500	1440	208.2	WMBH	Joplin, Mo.	100-200	1420	211.1
WHFC	Cicero, Ill.	100	1500	199.9	WMBI	Addison, Ill. S—Chicago	5kw.	1080	277.6
WHIS	Bluefield, W. Va.	100	1420	211.1	WMBJ	Pittsburgh, Pa.	100	1500	199.9
WHK	Cleveland, Ohio	1kw.	1390	215.7	WMBO	Auburn, N. Y.	100	1370	218.8
WHN	New York, N. Y.	250	1010	296.9	WMBQ	Brooklyn, N. Y.	100	1500	199.9
WHO	Des Moines, Iowa	5kw.	1000	299.8	WMBR	Tampa, Fla.	100	1210	247.8
WHP	Lemoyne, Pa. S—Harrisburg, Pa.	500	1430	209.7	WMC	Memphis, Tenn.	500-1kw.	780	384.4
WIAS	Ottumwa, Iowa	100	1420	211.1	WMCA	Hoboken, N. J. S—New York City, N. Y.	500	570	526
WIBA	Madison, Wis.	100	1210	247.8	WMES	Boston, Mass.	50	1500	199.9
WIBG	Elkins Park, Pa.	50	930	322.4	WMMN	Fairport, W. Va.	250-500	890	336.9
WIBM	Jackson, Mich.	100	1370	218.8	WMP	Lapeer, Mich.	100	1500	199.9
WIBO	Desplaines, Ill. S—Chicago, Ill.	1&1½kw.	560	535.4	WMRJ	Jamaica, N. Y.	10	1420	211.1
WIBR	Stuebenville, Ohio	50	1420	211.1	WMSG	New York, N. Y.	250	1350	221.1
WIBS	Jersey City, N. J.	250	1450	206.8	WMT	Waterloo, Iowa	250	600	499.7
WIBU	Poynette, Wis.	100	1310	228.3	WNAC	WBIS—Quincy, Mass. S—Boston, Mass.	1kw.	1230	243.8
WIBW	(near) Topeka, Kan.	1kw.-500w.	580	516.9	WNAD	Norman, Okla.	500	1010	296.9
WIBX	Utica, N. Y.	100-300	1200	249.9	WNAT	Philadelphia, Pa.	100	1310	228.3
WICC	Easton, Conn. S—Bridgeport, Conn.	500	1190	252	WNAX	Yankton, S. Dak.	1kw.	570	526
WIL	St. Louis, Mo.	100-250	1200	249.9	WNBF	Binghamton, N. Y.	50	1500	199.9
WILL	Urbana, Ill.	250-500	890	336.9	WNBJ	New Bedford, Mass.	100	1310	228.3
WILM	Wilmington, Del.	100	1420	211.1	WNBJ	Knoxville, Tenn.	50	1310	228.3
WIOD	WMBF—Miami Beach, Fla.	1kw.	560	535.4	WNBO	Washington, Pa.	100	1200	249.9
WIP	Philadelphia, Pa.	500	610	491.5	WNBR	Memphis, Tenn.	500	1430	209.7
WISN	Milwaukee, Wis.	250	1120	267.7	WNBW	Carbondale, Pa.	10	1200	249.9
WJAC	Johnstown, Pa.	100	1310	228.3	WNBX	Springfield, Vt.	10	1200	249.9
WJAD	Waco, Texas	1kw.	1240	241.8	WNBZ	Saranac Lake, N. Y.	50	1290	232.4
WJAG	Norfolk, Nebr.	1kw.	1060	282.8	WNJ	Newark, N. J.	250	1450	206.8
WJAK	Marion, Ind.	50	1310	228.3	WNQX	Knoxville, Tenn.	1kw.	560	535.4
WJAR	Providence, R. I.	250-400	890	336.9	WNR	Greensboro, N. C.	250	1440	208.2
WJAS	North Fayette Twp. S—Pittsburgh, Pa.	1kw.	1290	232.4	WNYC	New York, N. Y.	500	570	526
WIAX	Jacksonville, Fla.	1kw.	1260	238	WOAI	San Antonio, Texas	50	1190	252
WJAY	Cleveland, Ohio	500	610	491.5	WOAN	Lawrenceburg, Tenn.	500	600	499.7
WJAZ	Mt. Prospect, Ill. S—Chicago, Ill.	5kw.	1480	202.6	WOAX	Trenton, N. J.	500	1280	234.2
WJBC	La Salle, Ill.	100	1200	249.9	WOBT	Union City, Tenn.	100-250	1310	228.3
WJBI	Red Bank, N. J.	100	1210	247.8	WOBV	(near) Charleston	250	580	516.9
WJBK	Ypsilanti, Mich.	50	1370	218.8	WOC	Davenport, Iowa	5kw.	1000	299.8
WJBL	Decatur, Ill.	100	1200	249.9	WODL	Jamestown, N. Y.	25	1210	247.8
WJBO	New Orleans, La.	100	1420	211.1	WODP	Paterson, N. J.	1kw.	1250	239.9
WJBT	WBBM—See WBBM-WJBT				WODX	Springhill, Ala. S—Mobile, Ala.	500	1410	212.6
WJBU	Lewisburg, Pa.	100	1210	247.8	WOI	Ames, Iowa	5kw.	560	535.4
WJBW	New Orleans, La.	30	1200	249.9	WOKO	Mt. Beacon, N. Y. S—Poughkeepsie, N. Y.	500	1440	208.2
WJBY	Gadsden, Ala.	50	1210	247.8	WOL	Washington, D. C.	100	1310	228.3
WJDX	Jackson, Miss.	500-1kw.	1270	236.1	WOMT	Manitowoc, Wis.	100	1210	247.8
WJJD	Mooseheart, Ill.	20kw.	1130	265.3	WOOD	Furnwood, Mich. S—Grand Rapids, Mich.	500	1270	236.1
WJKS	Gary, Ind.	500-1½kw.	1360	220.4	WOPI	Bristol, Tenn.	100	1500	199.9
WJLR	Sylvan Lake Village, Mich. S—Detroit, Mich.	5kw.	750	399.8	WOQ	Kansas City, Mo.	1kw.	610	491.5

(Continued on next page)

Station	Transmitter	Power	kc.	M.	Station	Transmitter	Power	kc.	M.	Station	Transmitter	Power	kc.	M.
WOR	Kearny, N. J.				KFFR	Portland, Ore.	100	1420	211.1	KMTR	Hollywood, Calif.	500	570	526
	S—Newark, N. J.	5kw.	710	422.3	KFIO	Spokane, Wash.	100	1230	243.8	KNX	Los Angeles, Calif.			
WORC	Auburn, Mass.				KFIZ	Fond du Lac, Wis.	100	1420	211.1		S—Hollywood, Calif.	5kw.	1050	285.5
	S—Worcester, Mass.	100	1200	249.9	KFJB	Marshalltown, Iowa	100	1200	249.9	KOA	Denver, Colo.	12½kw.	830	361.2
	(formerly WKBE)				KFJF	Oklahoma City, Okla.	5kw.	1470	204	KOAC	Corvallis, Ore.	1kw.	550	545.1
WORD	Batavia, Ill.				KFJI	Astoria, Ore.	100	1370	218.8	KOB	State College			
	S—Chicago, Ill.	5kw.	1480	202.6	KFJM	Grand Forks, N. D.	100	1370	218.8		New Mexico	10kw.	1180	254.1
WOS	Jefferson City, Mo.	500-1kw.	630	475.9	KFJR	Portland, Ore.	500	1300	230.6	KOCW	Chickasha, Okla.	250&500	1400	214.2
WOV	Secaucus, N. J.				KFJY	Fort Dodge, Iowa	100	1310	228.3	KOH	Reno, Nev.	100	1370	218.8
	S—New York City	1kw.	1130	265.3	KFJZ	Fort Worth, Texas	100	1370	218.8	KOIL	Council Bluffs, Iowa	1kw.	1260	238
WOW	Omaha, Neb.	1kw.	590	508.2	KFKA	Greeley, Colo.	500&1kw.	880	340.7	KOIN	Sylvan, Ore.			
WOWO	Ft. Wayne, Ind.	10kw.	1160	258.5	KFKB	Millford, Kans.	5kw.	1050	285.5		S—Portland, Ore.	1kw.	940	319
WPAP	WQAO—See WQAO-WPAP				KFKU	Lawrence, Kans.	1kw.	1220	245.8	KOL	Seattle, Wash.	1kw.	1270	326.1
WPAW	Pawtucket, R. I.	100	1210	247.8	KFKX	KYW—See KYW-KFKX				KOMO	Seattle, Wash.	1kw.	920	325.9
WPC	Chicago, Ill.	500	560	535.4	KFLV	Rockford, Ill.	500	1410	212.6	KOOS	Marshfield, Ore.	50	1370	218.8
WPCB	Hoboken, N. J.				KFLX	Galveston, Texas	100	1370	218.8	KORE	Eugene, Ore.	100	1420	211.1
	S—New York City	500	810	370.2	KFMM	Northfield, Minn.	1kw.	1250	239.9	KOY	Phoenix, Ariz.	500	1390	215.7
WPEN	Philadelphia, Pa.	100-250	1500	199.9	KFNF	Shenandoah, Iowa	500&1kw.	890	336.9	KPCB	Seattle, Wash.	50	1210	247.8
	(formerly WPSW)				KFOR	Lincoln, Nebr.	100&250	1210	247.8	KPJM	Prescott, Ariz.	100	1500	199.9
WPG	Atlantic City, N. J.	5kw.	1100	272.6	KFOX	Long Beach, Calif.	1kw.	1250	239.9	KPO	San Francisco, Calif.	5kw.	680	440.9
WPOE	Patchogue, N. Y.	30-100	1420	211.1	KFPI	Dublin, Texas	15	1310	228.3	KPOF	Denver, Colo.	500	880	340.7
WPOR	WTR—See WTR-WPOR				KFPM	Greenville, Texas	15	1310	228.3	KPPC	Pasadena, Calif.	50	1200	249.9
WPS	State College, Pa.	500	1230	243.8	KFPW	Siloam Springs, Ark.	50	1340	223.7	KPO	Seattle, Wash.	100	1210	247.8
WPTF	Raleigh, N. C.	1kw.	680	440.9	KFPY	Spokane, Wash.	1kw.&500	1340	223.7	KPRC	Sugarland, Texas			
WQAM	Miami, Fla.	1kw.	1240	241.8	KFOA	KMOX—See KMOX-KFOA					S—Houston, Texas	1kw.&2½kw.	920	325.9
WQAN	Scranton, Pa.	250	880	340.7	KFOJ	Anchorage, Alaska	100	1230	243.8	KPSN	Pasadena, Calif.	1kw.	950	315.6
WQAO	WPAP—Cliffside, N. J.				KFOU	Holy City, Calif.	100	1420	211.1	KPWF	Westminster, Calif.	5 to 10 kw.	1490	201.2
	S—New York City, N. Y.	250	1010	296.9	KFOV	Seattle, Wash.	100	1420	211.1	KQ	Pittsburgh, Pa.	500	1380	217.3
WQBC	Utica, Miss.	300	1360	220.4	KFQZ	Hollywood, Calif.				KQW	San Jose, Calif.	500	1010	296.9
WQZ	Weyron, W. Va.	60	1420	211.1		S—Los Angeles, Calif.	250	860	348.6	KRE	Berkeley, Calif.	100	1370	218.8
WRAF	LaPorte, Ind.	100	1200	249.9	KFRC	San Francisco, Calif.	1kw.	610	491.5	KREG	Pasadena, Calif.	100	1500	199.9
WRAK	Erie, Pa.	50	1370	218.8	KFRU	Columbia, Mo.	500	630	475.9	KREP	Phoenix, Ariz.	500	620	483.6
WRAW	Reading, Pa.	100	1310	228.3	KFS	San Diego, Calif.	500&1kw.	600	499.7		(formerly KFAD)			
WRAX	Philadelphia, Pa.	250	1020	293.9	KFSG	Los Angeles, Calif.	500	1120	267.7	KRGV	Harlingen, Texas	500	1260	238
WRBI	Tifton, Ga.	20	1310	228.3	KFUI	Juneau, Alaska	10	1310	228.3	KRLD	Dallas, Texas	10kw.	1040	288.3
WRBJ	Hattiesburg, Miss.	10	1500	199.9	KFUL	Galveston, Texas	500	1290	232.4	KRMD	Shreveport, La.	50	1310	228.3
WRBL	Columbus, Ga.	50	1200	249.9	KFUM	Colorado Springs, Colo.	1kw.	1270	236.1	KRSC	Seattle, Wash.	50	1120	267.7
WRBO	Greenville, Miss.	100	1210	247.8	KFUO	Clayton, Mo.	500&1kw.	550	545.1	KSAC	Manhattan, Kans.	500&1kw	580	516.9
WRBT	Wilmington, N. C.	100	1370	218.8	KFUP	Denver, Colo.	100	1310	228.3	KSAT	Birdsville, Texas			
WRBU	Gastonia, N. C.	100	1210	247.8	KFVD	Culver City, Calif.	250	710	422.3		S—Fort Worth, Texas	1kw.	1240	241.8
WRC	Washington, D. C.	500	950	315.6	KFVS	Cape Girardeau, Mo.	100	1210	247.8		(formerly KTAT)			
WREC	Whitehaven, Tenn.				KFWB	Hollywood, Calif.	1kw.	950	315.6	KSCJ	Sioux City, Iowa	1kw.	1330	225.4
	S—Memphis, Tenn.	500&1kw.	600	499.7	KFWF	St. Louis, Mo.	100	1200	249.9	KSD	St. Louis, Mo.	500	550	545.1
WREN	Lawrence, Kans.	1kw.	1220	245.8	KFWI	San Francisco, Calif.	500	930	322.4	KSEI	Pocatello, Idaho	250	900	331.1
WRHM	Fridley, Minn.				KFWW	Richmond, Calif.	500&1kw.	930	322.4	KSL	Salt Lake City, Utah	5kw.	1130	265.3
	S—Minneapolis, Minn.	1kw.	1250	239.9	KFXD	Jerome, Idaho	50	1420	211.1	KSMR	Santa Maria, Calif.	100	1200	249.9
WRJN	Racine, Wis.	100	1370	218.8	KFXE	Denver, Colo.	250	630	475.9	KSO	Clarinda, Iowa	500	1380	217.3
WRJ	Hamilton, Ohio	100	1310	228.3	KFXJ	Edgewater, Colo.	50	1310	228.3	KSOO	Sioux Falls, S. D.	2kw.	1110	270.1
WRNY	Coytesville, N. J.				KFXM	San Bernadino, Calif.	100	1200	249.9	KSTP	Westcott, Minn.			
	S—New York City, N. Y.	250	1010	296.9		(formerly KFWC)					S—St. Paul, Minn.	10kw.	1460	205.4
WRR	Dallas, Texas	500	1280	234.2	KFXR	Oklahoma City, Okla.	100	1310	228.3	KTAB	Oakland, Calif.	1kw.	560	535.4
WRUF	Gainesville, Fla.	5kw.	1470	204	KFFY	Flagstaff, Ariz.	100	1420	211.1	KTAP	San Antonio, Texas	100	1420	211.1
WRVA	Mechanicsville, Va.				KFYR	Abilene, Texas	100&250	1420	211.1	KTBI	Los Angeles, Calif.	750	1300	230.6
	S—Richmond, Va.	5kw.	1110	270.1	KGA	Bismarck, N. D.	500	550	545.1	KTBR	Portland, Ore.	500	1300	230.6
WSAI	Mason, Ohio				KGAR	Spokane, Wash.	5kw.	1470	204	KTBS	Shreveport, La.	1kw.	1450	206.8
	S—Cincinnati, Ohio	500	1330	225.4	KGB	Tucson, Ariz.	100	1370	218.8	KTBS	Hot Springs Nat'l Park, Ark.	10kw.	1040	288.3
WSAJ	Grove City, Pa.	100	1310	228.3	KGB	San Diego, Calif.	250	1360	220.4	KTM	Santa Monica, Calif.			
WSAN	Allentown, Pa.	250	1440	208.2	KGB	Ketchikan, Alaska	500	900	331.1		S—Los Angeles, Calif.	500	780	384.4
WSAR	Fall River, Mass.	250	1450	206.8	KGBX	St. Joseph, Mo.	100	1310	228.3	KTNT	Muscataine, Iowa	5kw.	1170	256.3
WSAZ	Huntington, W. Va.	250	580	516.9	KGBZ	York, Nebr.	500&1kw.	930	322.4	KTSA	San Antonio, Texas	1&2kw.	1290	232.4
WSB	Atlanta, Ga.	1kw.	740	405.2	KGCA	Decorah, Iowa	50	1270	236.1	KTSL	Cedar Grove, La.			
WSBC	Chicago, Ill.	100	1210	247.8	KGCI	San Antonio, Texas	100	1370	218.8		S—Shreveport, La.	100	1310	228.3
WSBT	South Bend, Ind.	500	1230	243.8	KGCR	Watertown, S. D.	100	1210	247.8	KTSM	El Paso, Texas	100	1310	228.3
WSDA	WSGH—See WSGH-WSDA				KGCU	Mandan, N. D.	100	1200	249.9	KTUE	Houston, Texas	5	1420	211.1
WSFA	Montgomery, Ala.	500	1410	212.6	KGCC	Dell Rapids, S. D.	50	1370	218.8	KTW	Seattle, Wash.	1kw.	1270	236.1
WSGH	WSDA—Brooklyn, N. Y.	500	1400	214.2	KGDE	Fergus Falls, Minn.	50	1200	249.9	KUJ	Longview, Wash.	10	1500	199.9
WSIX	Springfield, Tenn.	100	1210	247.8	KGDM	Stockton, Calif.	250	1100	272.6	KUOA	Fayetteville, Ark.	1kw.	1390	215.7
WSJS	Winston-Salem, N. C.	100	1310	228.3	KGDY	Oldham, S. D.	15	1200	249.9	KUSD	Vermillion, S. D.	500&750	890	336.9
	(formerly WJZ)				KGEF	Los Angeles, Calif.	1kw.	1300	230.6	KUT	Austin, Texas	500	1120	267.7
WSM	Nashville, Tenn.	5kw.	650	461.3	KGEG	Yuma, Colo.	50	1200	249.9	KVEP	Portland, Ore.	15	1500	199.9
WSMB	New Orleans, La.	500	1320	227.1	KGER	Long Beach, Calif.	250	1370	218.8		(formerly KWBS)			
WSMK	Dayton, Ohio	200	1380	217.3	KGEW	Fort Morgan, Colo.	100	1200	249.9	KVI	Des Moines, Wash.			
WSOA	Deerfield, Ill.				KGEZ	Kalispell, Mont.	100	1310	228.3		S—Tacoma, Wash.	1kw.	760	394.5
	S—Chicago, Ill.	5kw.	1480	202.6	KGFE	Alva, Okla.	100	1420	211.1	KVL	Seattle, Wash.	100	1370	218.8
WSPD	Toledo, Ohio	500&1kw.	1240	241.8	KGFG	Oklahoma City, Okla.	100	1370	218.8	KVOA	Tucson, Ariz.	500	1260	238
WSSH	Boston, Mass.	100&250	1420	211.1	KGFI	Corpus Christi, Texas	100	1500	199.9	KVOO	Tulsa, Okla.	5kw.	1140	263
WSUT	Iowa City, Iowa	500	600	499.7	KGFI	Los Angeles, Calif.	100	1420	211.1	KVOS	Bellingham, Wash.	100	1200	249.9
WSUN	WFLA—See WFLA-WSUN				KGFL	Hallock, Minn.	50	1200	249.9	KWCR	Cedar Rapids, Iowa	100	1310	228.3
WSPV	Buffalo, N. Y.	50	1370	218.8	KGFL	Raton, N. Mex.	50	1370	218.8	KWEA	Shreveport, La.	100	1210	247.8
WSYR	Syracuse, N. Y.	250	570	526	KGFW	Ravenna, Nebr.	50	1310	228.3	KWG	Stockton, Calif.	100	1200	249.9
WTAD	Quincy, Ill.	500	1440	208.2	KGFX	Pierre, S. D.	200	580	516.9	KWJJ	Portland, Ore.	500	1060	232.8
WTAG	Worcester, Mass.	250	580	516.9	KGGC	San Francisco, Calif.	50	1420	211.1	KWK	St. Louis, Mo.	1kw.	1350	221.1
WTAM	Brecksville Village, Ohio				KGGF	Picher, Okla.	500	1010	296.9	KWKC	Kansas City, Mo.	100	1370	218.8
	S—Cleveland, Ohio	50kw.	1070	280.2	KGGM	Albuquerque, N. Mex.	250&500	1230	243.8	KWKH	Kennonwood, La.	10kw.	85	

Import Your Own Goods

German Export Magazine published in English offers numerous bargains in latest articles, novelties and new inventions. Also opportunities for obtaining profitable distributing agencies. Sample copy 60 cents postpaid (none free or on memo). Two monthly copies \$1.00. Subscription price \$3.00 per year for 12 monthly copies with special privileges. Square Deal Supply Co., R-246 Fifth Ave., N. Y.



Fourteen Circuits

Each Shown in Colored Picture Diagram, Colored Schematic Diagram and Front Panel Layout

Get This FREE Book!

Complete AC electric receivers, with B eliminators included, also AC receivers without B eliminators, also battery operated models, all easy-to-huild circuits, using your own parts.

RADIO WORLD, 145 W. 45th St., N. Y. City. (Just East of Broadway)

Gentlemen: Enclosed please find \$1.00 for which please send me Radio World each week for eight weeks (regular price, \$1.20) and besides send me a FREE copy of the 1929 edition of The Radio Blueprint Library of AC and Battery Hookups.

Name
Address
City..... State.....

Note: Present mail subscribers may take advantage of this offer by putting a cross in this square. Your subscription will be extended eight weeks.

[Canadian remittance must be by postal or express money order, due to high discount rate on cashing Canadian checks in New York.]

Parts for the HB 55

[Two 224 AF, 224 power detector, 227 first AF, 171A push-pull output, all to work with 180. volt B eliminator.]

- L1L2, L3L4, L5L6—Three shielded radio frequency transformers for .00035 mfd. (Three Cat. SH-3) \$2.85
- C1, C2, C3—One three-gang .00035 mfd. tuning condenser 4.50
- E1, E2, E3—Three Hammarlund 80 mmfd. equalizing condensers 1.05
- C4—One .00025 mfd. fixed condenser25
- C5, C6, C8—Three .01 mfd. condensers 1.05
- C7, C9—Two 1 mfd. bypass condensers 1.00
- C10, C11, C12, C13—Four Mershon condensers in one copper case, 8, 8, 18 and 18 mfd. respectively, with bracket. (Cat. Q 2-8, 2-18 B) 5.15
- R1, R2—Two Electrad grid resistor strips, 400 ohms each40
- R3—One 5,000 ohm resistor with mount60
- R4—One 0.1 meg. Lynch metallized resistor, with mount50
- R5—One 5 meg. Lynch metallized grid leak with mount50
- R6—One 2,000 ohm Electrad wire-wound resistor, type B85
- R7—One 1,000 ohm Electrad wire wound resistor, type B85
- R8—One Electrad 25,000 ohm Super Tonatrol, potentiometer type, with knob 1.50
- Ant., Gnd., Speaker Minus, Speaker plus—Four binding posts40
- T1—One push-pull input transformer 2.50
- T2—One push-pull output transformer 2.50
- T3—One filament transformer (Polo Cat. PFT) 4.50
- PL—One National modernistic dial with 2.5 volt AC pilot lamp 3.13
- F—One 2 ampere fuse with fuse clips25
- CO—One convenience outlet10
- SW—One AC pendant switch, with AC cable and male and female plugs 1.25
- Three leads for B voltage cable15
- One drilled front panel, 7"x21" 1.65
- One subpanel, with four UY sockets and two UX sockets 3.00
- One dummy shaft, knob and bushing35

Order what parts you desire.

- All parts \$40.83
- Tubes. Three 224, one 227, two 171A 6.75

Name
Address
City..... State.....

GUARANTY RADIO GOODS CO.
143 West 45th Street
New York
[Just East of Broadway]

TELEVISION FOR HOME CONSTRUCTORS



Full explanation of the theory and practice of television is contained in the new 210-page book (5 1/2 x 8 3/4"), with 100 illustrations.

ABC of Television

By Raymond Francis Yates,
Students and Experimenters alike will glory in the possession of this masterful volume. Popularly written, easily understood.

TABLE OF CONTENTS

CHAPTER I—TELEVISION—THE NEW CONQUEST OF SPACE
How the Principles of Television were Invented in 1884 and what the Future Holds for this Promising New Child of Science—A Description, in Narrative Form, of the Television of the Future.

CHAPTER II—TELEVISION SYSTEMS
Complete and Elementary Explanation of the Fundamental Principles of Television As They Are Applied Today in Both Transmitting and Receiving—Methods of Synchronization, Scanning and the Function of Photoelectric Cells.

CHAPTER III—TELEGRAPHING PICTURES
An Outline of the Various Successful Methods Employed Today in the Transmission of Facsimiles and Photographs by Wire and Wireless Systems—Practical Description of Telephotographic Receivers for Home Use With Practical Instruction Concerning Their Operation.

CHAPTER IV—PHOTOELECTRIC CELLS
How Photoelectric Cells Serve as "Light Microphones" in Modulating Radio Waves With Light Impulses—Elementary Outline of the Theory of Photoelectric Phenomena.

CHAPTER V—AMPLIFYING PICTURES
Theory and Practice of the Amplification of Picture Signals Together With Data for the Construction of Television Amplifiers That Will Function With a Minimum of Picture Distortion.

CHAPTER VI—THE AGILE NEON LAMP
Theory, Operation and Practical Application of Neon Tubes in Television Reception—How the Neon Tube Functions as a "Light Loud Speaker" in Television Reception.

CHAPTER VII—SELENIUM CELLS
Theory of Selenium Cells Together With a Description of the Popular Types of Cells and Practical Data Concerning Their Construction by Home Experimenters.

CHAPTER VIII—THE PROBLEM OF SCANNING
The Function of the Scanning Disc With Complete Instructions for the Design and Construction of Different Types of Scanning Devices Including Drums and Moving Belts.

CHAPTER IX—SYNCHRONIZING TELEVISION
An A B C Outline of the Synchronizing Methods Now Employed by the Television Broadcasters of Today—Problems of Synchronizing Television Scanning Discs Treated in a Popular Way.

CHAPTER X—TRANSMITTING TELEVISION AT HOME
How the Experimenter Can Construct and Operate Both a Television Transmitter and Receiver for Home Use—This Equipment Makes Possible the Transmission of the Outline of Simple Objects From One Room to Another.

CHAPTER XI—HOW TO MAKE A TELEVISION RECEIVER
Practical Application of the Principles of Television in the Construction of a Television Receiver Involving a Special, Highly Efficient Short-Wave Receiver.

RADIO WORLD, 145 West 45th Street, New York City (Just East of Broadway)

Enclosed please find \$3.00 for which send at once at your expense one copy of "A B C of Television, or, Seeing by Radio," by Raymond Francis Yates, as advertised.

NAME
ADDRESS
CITY..... STATE.....

LOOK AT YOUR WRAPPER

You will see by the date thereon when your subscription for Radio World expires. If the subscription is about to run out, please send us renewal so that you will not miss any copies. Subscription Department, RADIO WORLD, 145 West 45th St., N. Y. City.

FULL EXPOSITION OF HB COMPACT, BATTERY MODEL

Complete details on the theory and construction of the HB Compact were published in a four-part article in Radio World, written by Herman Bernard, designer of the circuit and inventor of the Bernard Dynamic Tuners used in the circuit. Full details on how to wind your own coils, full-sized pictorial diagram of the wiring. Order the August 24th, 31st, September 7th and 14th issues, 60c—RADIO WORLD, 145 West 45th Street, New York, N. Y.

PUBLISHERS CAN SUPPLY MOST 1929 SUMMER COPIES OF RADIO WORLD

If you have missed any copies of Radio World for the summer of 1929 and want to complete your file, let us know what issues you are short and we will mail what we can at 15c a copy, or any seven issues for \$1.00, mailed postpaid.

Circulation Dept., Radio World, 145 W. 45th St., N. Y. City.

FILL OUT AND MAIL NOW

SUBSCRIPTION BLANK

RADIO WORLD

RADIO WORLD

145 West 45th Street, New York City

Please send me RADIO WORLD for months, for which

SUBSCRIPTION RATES:

- Single Copy \$.15
- Three Months 1.50
- Six Months 3.00
- One Year, 52 Issues 6.00
- Add \$1.00 a Year for Foreign Postage; 50c for Canadian Postage.

please find enclosed

.....
.....
.....

RADIO AND OTHER TECHNICAL BOOKS

At a Glance

RADIO

- "Audio Power Amplifiers," by Anderson and Bernard\$3.50
- "Elements of Radio Communication," by Morecroft 3.00
- "Foothold on Radio, A," by Anderson and Bernard 1.00
- "Mathematics of Radio," by Rider 2.00
- "Practical Radio," by Moyer & Wostrel 2.50
- "Practical Radio Construction and Repairing," by Moyer & Wostrel 2.00
- "Principles of Radio Communication," by Morecroft 7.50
- "Radio Blueprint Library"—AC Hook-ups35
- "Radio Cyclopaedia," by Drake 6.00
- "Radio Receiving Tubes," by Moyer & Wostrel 2.50
- "Superheterodyne Construction and Operation," by Lacault25
- "Thermionic Vacuum Tube, The," by Van der Bijl 5.00
- "Trouble Shooter's Manual," by Rider 3.50

TELEVISION

- "A B C of Television," by Yates 3.00

AVIATION

- "A B C of Aviation," by Maj. Page 1.00
- "Aerial Navigation and Meteorology," by Capt. Yancy 4.00
- "Everybody's Aviation Guide," by Maj. Page 4.00
- "Ford Model 'A' Car," Its Construction, Operation and Repair, by Maj. Page 2.00
- "Modern Aircraft," by Maj. Page 5.00
- "Modern Aviation Engines," by Maj. Page 9.00

RADIO WORLD

145 West 45th Street
New York, N. Y.
(Just East of Broadway)

NEW Morecroft

"Elements of Radio Communication," by Prof. John H. Morecroft, of the Engineering Department of Columbia University, is the latest book on radio by this outstanding authority.

This book is entirely new and contains matter which never before has been published. It is written in plain language so that every radio novice can understand it, yet it is a complete course in the elements of radio.

It contains 266 pages, 170 illustrations and a complete index. Price \$3.00.

RADIO WORLD
145 West 45th St., New York, N. Y.

RECENT NUMBERS

for the late last year are procurable at the rate of 15c a copy, or 8 copies for \$1.00. **RADIO WORLD**, 145 West 45th St., N. Y. City.

4-GANG CONDENSER

With Trimmers
Built in **\$3.95**

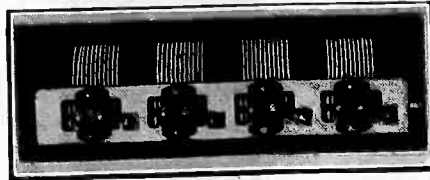

Capacity of each of the four sections is .00035 mfd. Overall length 11". Accurate capacity and precise alignment. Used in HB33 and HB44.

Guaranty Radio Goods Co.
143 West 45th Street,
New York City

New DRAKE'S ENCYCLOPEDIA

A reference work that has subjects classified in alphabetical order.

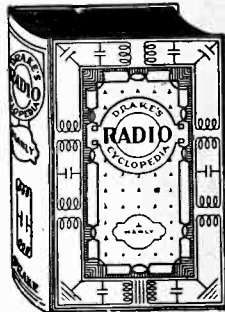

Each rule, fact, method, plan, layout and diagram is instantly picked out and separated from everything else by placing all subjects in alphabetical order with cross references for every imaginable name under which the information might be classed.

This alphabetical arrangement lets the experienced worker refer directly to the one thing in which he is interested at the moment without hunting through non-essentials. The needs of the beginner are cared for.

The important articles deal primarily with receivers and reception. They do not stop with the electrical end, but go also into the mechanics of construction.

BOOK IS 2 1/2" THICK, WEIGHS 3 1/2 LBS., 1,025 ILLUSTRATIONS.

Every new thing in radio is covered in detail.
1,680 Alphabetical Headings from A-battery to Zero Beat
1,025 Illustrations, Diagrams, Layouts and Graphs
920 Pages, Each 8 by 9 inches
240 Combinations for Receiver Layouts
OF THE PRINCIPAL ARTICLES

159 Concern service men, 129 help the set builder, 162 help the experimenter, 155 interest the student, 75 assist in sales work, 73 interest set owners.

PRICE, \$6.00

Remit with order and we pay cartage. Canadian remittance must be by postal or express money order. Order C. O. D. and you pay cartage.

RADIO WORLD, 145 W. 45th St., N. Y. City

MICROPHONE LIGHTERS

for cigars or cigarettes, with button switch at top. Press the switch and light up!

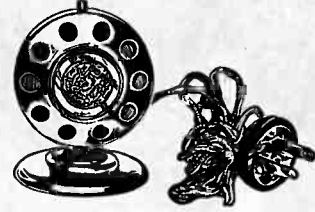

Model A lighter, microphone design, with 5-ft. AC cable and plug. Works on 110 volts, AC any frequency and on direct current. Price \$1.00

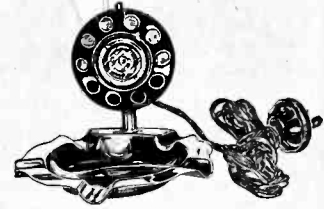

Model B lighter, microphone design, on tray, with 5-ft AC cable and plug. Works on 110 volt AC, any frequency, and on direct current. Exactly the same lighter as the other, only tray is added. Price.....\$1.50

This lighter is instantaneous. Hold button down only long enough to light a cigar or cigarette. The two models are furnished in attractive sprayed finish. Both are very compact! For instance, the tray is only 4 1/4" in diameter. Use these lighters in your home and for holiday gifts.

The heater element is renewable.

- RADIO WORLD, 145 West 45th St., N. Y. City**
- Please send me Model A Microphone Lighter at \$1.00.
 - Please send me Model B at \$1.50.
 - Enclosed is remittance [Canadian must be P.O. or express money order.]
 - Ship C. O. D.

Name:

Address:

City:..... State.....

NATIONAL SCREEN GRID TUNER

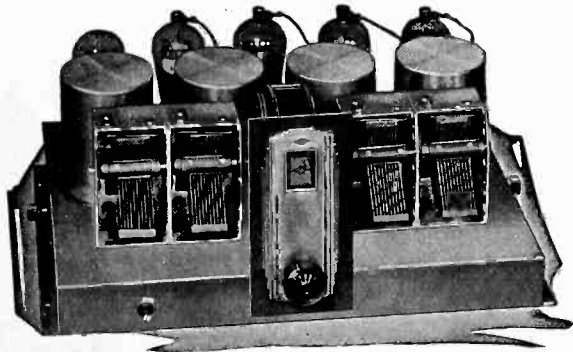

The most sensitive tuned radio frequency tuner so far developed, the MB-29 is long on distant reception, and penetrates seemingly unmountable barriers to reception. On the MB-29 the stations come in no matter where you are. The MB-29, designed by James Millen and Prof. Glen H. Browning, is the choice of the most discriminating. It is designed only for AC operation, uses four stages of screen grid RF and a power detector (227). Use 135 to 180 volts on the detector. Testimonials from radio's hardest-bolled experts prove this is the circuit of circuits. Buy the parts and find fullest radio delight. You will be sure nobody else has a tuner as good as yours, unless he too has an MB-29. Complete component parts for National Screen Grid Tuner MB-29, mounted on frosted aluminum chassis, including rainbow modernistic drum dial HC. Order catalog No. MB-29-K, list price, less tubes, \$69.50. **\$40.00**
Four price

MB-29

Push-Pull Amplifier

The National Velvetone Push-Pull Power Amplifier (shown at right) consists of an AC-operated filament-plate supply, with two stage transformer audio amplifier and output transformer built in. Made only for 110-V., 50-60 cycles. Sold only in completely wired form, licensed under RCA patents.

The new Power Amplifier has been developed and built to get the very most out of the MB-29. It is a combination power supply and audio amplifier, using a 280 tube for a rectifier, one stage of transformer audio with a 227 tube and a stage of push pull amplification with two 245s. It furnishes all power for itself and for the MB-29, as well as the audio channel. Order catalog PPPA, list price, completely wired and equipped with phonograph jack, (less tubes) **\$55.00**
\$97.50. Your price.

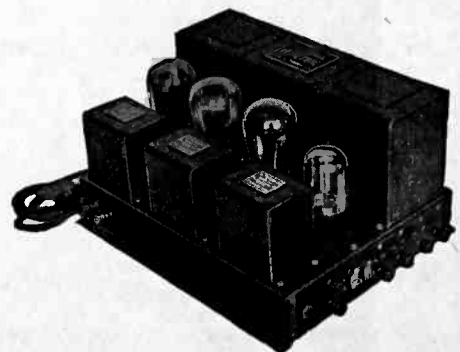

View of National Velvetone Push-Pull Power Amplifier, an expertly made A, B and C supply and audio amplifier, producing marvelous tone quality.

GUARANTY RADIO GOODS CO.

143 WEST 45TH STREET

NEW YORK CITY

O-1 MA, \$5.95

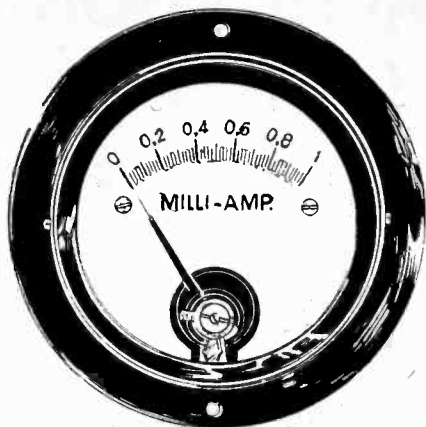

Here is a 0-1 milliammeter, accurate to plus or minus 1% clearly legible to two-one hundredths of a milliampere at any reading (20 microamperes). This expertly made precision instrument is offered at the lowest price so far for a 0-1 ma. Order Cat. FO-1 at \$5.95. C. O. D. orders accepted.

Guaranty Radio Goods Co.
143 West 45th Street,
New York City

AERIAL TUNER

Improves Your Reception

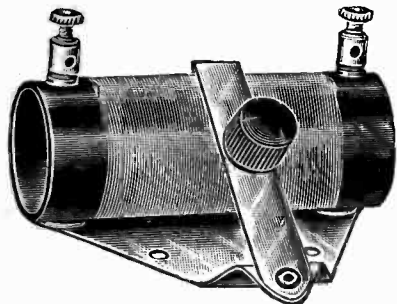

Remove aerial lead from set. Connect aerial instead to one of the binding posts of the Aerial Tuner. Connect the other binding post of the Aerial Tuner to antenna post of your set. Then move the lever of the Aerial Tuner until any weak station comes in loudest. The lever need not be moved for every different frequency tuned in. The Aerial Tuner acts as an antenna loading coil and puts the antenna's frequency at any frequency in the broadcast band that you desire to build up. Price, 85c.

GUARANTY RADIO GOODS CO.
143 West 45th Street
New York City
(Just East of Broadway)

BRILLIANT, NEW
NATIONAL
MODERNISTIC PROJECTION DIAL
WITH RAINBOW FEATURE

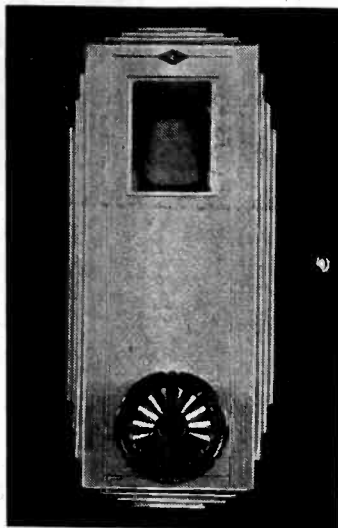

Modernize the appearance of your receiver by installing the brilliant new National dial, with color wheel built in, so that as you turn the dial knob one color after another floods the screen on which the dial numbers are read. On this screen the numbers are projected, so that you get the same dial reading from any position of the eye. This is just what DX hunters want—laboratory precision of dial reading.

The escutcheon is of modernistic design. The Velvet Vernier mechanism drives the drum superbly.

Order today. Remit with order and we pay cartage. Shipments day following receipt of order.

GUARANTY RADIO GOODS CO.,
143 W. 45th St., N. Y. City (Just E. of B'way)

Enclosed please find \$3.13 for which please send me dial marked below:

- Cat. HC6, National modernistic drum dial, with color wheel built in, pilot bracket, 6-volt pilot lamp for storage battery or A eliminator sets; hardware; instructions \$3.13
- Cat. HC2½, same as above, but with 2½-volt AC pilot lamp 3.13
- Order C.O.D. and I pay cartage.

NAME

ADDRESS

CITY STATE

RADIO WORLD'S BOOK SERVICE has been found of great value not only by radio fans, constructors, etc., but also by radio and other technical schools throughout the country. See the radio books advertisements in this issue.

LACAULT'S BOOK

"Super-Heterodyne Construction and Operation," giving the master's most masterful exposition of the theory, performance and construction of this fascinating type of circuit, is a necessity to every serious radio experimenter. More than 100 pages and more than 50 illustrations. Buckram cover. This book by B. E. Lacault, FREE if you send \$1.00 for an 8-weeks subscription to Radio World. Present subscribers may accept this offer. Subscription will be extended.

RADIO WORLD 145 W. 45th St., N. Y. City
Just East of B'way

NATIONAL

Velvet B Eliminator \$16.13
150 Volts (250 Tube Free)



Latest Model National Velvet-B, Type 8880, in handsome crackle finish black metal casing, for use with sets up to and including six tubes. Input 105-120 volts AC, 50 to 60 cycles. Output 180 volts maximum at 35 milliamperes. Three variable output intermediate voltages. (Det., RF, AF). Eliminator has excellent filter system to eliminate hum, including 30 heavy choke and 15 mfd. Mershon condenser. No motorboating! (Eliminator Licensed under patents of the Radio Corporation of America and associated companies.)

Guaranty Radio Goods Co.
143 W. 45TH STREET
(Just East of Broadway)
NEW YORK CITY

New Junior Model

POLO UNIT \$4

The famous twin magnet principle for double sensitivity, large magnets for great flux, permanently adjusted armature, all are in the new junior model Polo Unit. Weight, 2¾ lbs. Stands 150 volts unfiltered. Stands up to 250 push-pull filtered. Works any output tube, power or otherwise. Supplied with 10-ft. cord. Order unit now. Five-day money-back guarantee. Shipped C. O. D. if desired.

Acoustical Engineering Associates
143 West 45th Street
New York City
(Just East of Broadway)

SECURITY DEALER

Wants Attractive Stock Issue

Send full particulars

W. E. A. WHEELER & COMPANY

90 Wall Street
NEW YORK CITY

Quick Action Classified Ads

Radio World's Speedy Medium for Enterprise and Sales

10 cents a word — 10 words minimum — Cash with Order

ARISTOCRAT FLOOR SPEAKER—With Molded Wood Horn and Horn Motor built in. Great value. \$14.00. Acoustical Engineering Associates, 143 W. 45th St., N. Y. C.

POLO 245 POWER SUPPLY. Read all about it on another page of this issue. Polo Engineering Laboratories, 57 Dey St., N. Y. City.

EDISON STORAGE BATTERIES—100 volts \$6.50; ¼ Horsepower Alternating Motors \$7.00. Hoffmann Electrical Shops, 904 North Fifth, Philadelphia, Pa.

TELEVISION and all about it in "A B C of Television," by Raymond Francis Yates. \$3 postpaid. Radio World, 145 W. 45th St., N. Y. City.

"EVERYBODY'S AVIATION GUIDE." By Maj. Page. \$2 postpaid. Also "Modern Aircraft" by same author. \$5. postpaid. Radio World, 145 W. 45th St., N. Y. City.

EVERYTHING IN RADIO
At attractive Prices Sets or parts
Orders shipped exactly as ordered. Prompt service. Write for prices. Inquiries invited. Send your address.
ALL RADIO CO., 417 North Clark St., Chicago

TWO FOR ONE. Radio World for 52 weeks and Radio News twelve months at the combination rate of \$7. Radio World, 145 W. 45th St., N. Y.

WORLD'S BEST AVIATION BOOKS: "A B C of Aviation," \$1.00; "Modern Aviation Engines," \$9.00 postpaid. Both by Maj. Page. "Aerial Navigation and Meteorology," By Capt. Yancey. \$4.00 postpaid. Radio World, 145 W. 45th St., N. Y. City.

"AERIAL NAVIGATION and METEOROLOGY." By Capt. Yancey. \$4.00 postpaid. Radio World, 145 W. 45th St., N. Y. City.

"AUDIO POWER AMPLIFIERS," by J. E. Anderson and Herman Bernard, the first and only book on the subject. \$3.50. Hennessy Radio Publications Corporation, 145 West 45th St., N. Y. City.

A. C. TUBES—Manufactured by licensed R.C.A. manufacturer. UX250—.95 UX224—.85 UX245—.85 UX227—.80 UX280—.75 UX226—.65. Charles Blackmore, Windsor, Missouri.

"MATHEMATICS OF RADIO."—A great help to everybody interested in radio. \$2 postpaid. Radio World, 145 W. 45th St., N. Y. City.

BE SURE TO READ the advertisement on another page of this issue about the HB Compact. Guaranty Radio Goods Co., 143 W. 45th St., N. Y. City.

Highest Grade Key Tubes at Defiant Prices!

Screen Grid Tubes

224 at \$1.43

222 at 1.18

Power Tubes

245 at 1.28

112A at .78

171A at .78

Other Tubes

227 at .90

226 at .68

280 at 1.13

201A at .53

The above constitute the nine most popular tubes used in radio today. Despite the severely low prices the Key tubes are firsts of the very first quality. Besides, there is a five-day money-back guaranty! The above tubes are manufactured under licenses granted by the RCA and its affiliated companies.

All prices are net and represent extreme discount already deducted.

228 HIGH-GAIN DETECTOR

Increase the sensitivity of modern AC-operated circuits by substituting the new 228 AC high mu tube (large amplification); for the 227 tube otherwise used as detector in up-to-date circuits. The result is immediately obvious in the greatly increased volume. Then the weak, distant stations come in stronger and tone quality is improved. Simply substitute the 228 for the 227 in the detector socket only. No wiring change of any kind is required. Price, \$1.88.

GUARANTY RADIO GOODS CO., 143 West 45th St., N. Y. City. (Just East of Broadway).

Enclosed please find \$..... for which ship at once tubes marked below:

- 228 AC high mu. \$1.88
- 224 AC screen grid \$1.43
- 245 AC power tube \$1.28
- 226 AC amplifier68
- 227 AC det.-amp.90
- 280 AC rectifier \$1.13
- 222 battery screen grid \$1.18
- 112A power tube78
- 171A power tube78
- 201A battery tube53
- Matched pair of 245s for push-pull (for both) \$2.56
- Matched pair 171As for AC push-pull (for both) \$1.80
- Matched pair of 112As for push-pull (for both) \$1.80

Name

Address

City State

Put cross here if C. O. D. shipment is desired.

Canadian remittance must be by postal or express money order.

5-Day money-back guaranty

No. 9

\$21 NET

to Dealer



Tests Screen-Grid

Readrite

Set and
Tube Tester

The simplest of all testers to use. Not a switch or binding post to manipulate. The meters are all instantly interchangeable. Only one push button for grid condition. The three A.C. voltmeters are repulsion type 0-8, 0-15, 0-150. The three D.C. voltmeters have high resistance, 0-8, 0-50, 0-500. The three D. C. Milliammeters are 0-10, 0-50, 0-300. A.C. Voltmeters may be used as milliammeters for

testing rectifier tubes, thereby obtaining more accurate readings.

Case is light in weight, covered with grained leatherette, size 10 1/2" x 7 1/2" x 3 3/4". A most flexible tester, complete for present day testing and immediately adapting itself to future needs. Every service man should have the READRITE No. 9—A truly remarkable tester.—An investment usually paid for in the first few calls.

LIST PRICE NO. 9 — \$35.00 COMPLETE

Send for catalog of Readrite instruments, resistors, etc.*

Readrite Meter Works,

12 College Ave.

Bluffton, Ohio

ESTABLISHED 1904

No matter what your resistance problem may be—whether an unknown high resistance value for a critical receiving circuit or a heavy duty low resistance value for grid-biasing the largest audio power tube or even transmitting tube—

Remember **CLAROSTAT** for Every Purpose
there's a

Clarostat Mfg. Co., 291 N. 6th St., B'klyn, N. Y.

Aristocrat Floor Speaker

With Molded Wood Horn of 8 ft. tone travel (exponential type) with baffle and horn motor built in. Extraordinary bargain. **\$12.00**

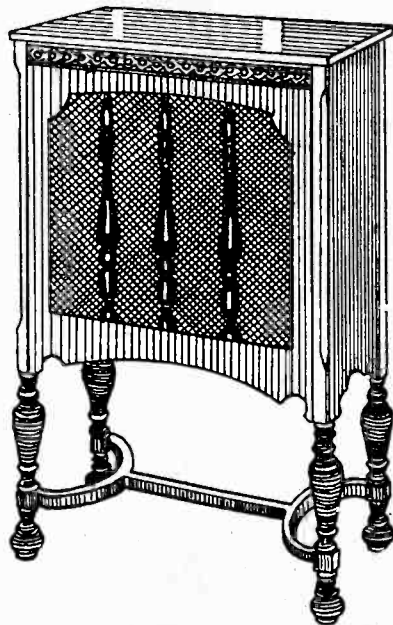

The speaker cabinet is walnut finish, 33" high, 24 1/2" wide, 17 1/2" deep, with carved legs. Golden cloth grille covers front opening. Built inside is No. 595 molded wood horn with baffle and No. 203 driving motor unit that stands 250 volts without filtration. Horn and motor removable. Table alone is worth price asked. Shipped C.O.D. if desired.

Acoustical Engineering Associates
143 WEST 45th STREET NEW YORK CITY

Your Jobber can supply. If ordered direct remittance (\$21 NET F. O. B. FACTORY) must accompany order.

A FOUR METER TESTER with five auxiliary meters. All have single scales. No confusion taking readings. The four meter readings show at a glance the plate voltage, filament voltage, grid bias voltage, plate milliamperes and grid change. These nine meters tell everything a radio service man should know in testing A.C. and D.C. sets. With it the latest designed sets and tubes are fully tested, including the plate, grid, cathode and filament of screen grid 224 A. C. tubes, 250 power tubes, and both plates of rectifier tubes. Other meters may be added.

LYNCH

TUBADAPTA
For Better TONE

List Price. \$.250

Improves reception and prolongs life of expensive power tubes. Used in last audio stage. Write for descriptive circular and complete catalogue Lynch Guaranteed Radio Products. LYNCH MFG. CO., Inc., 4775 B'way, N. Y.

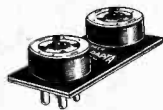

Orders - Inquiries

60 pages
Send for
FREE Copy
Can be Secured
by
MAIL

POLK'S REFERENCE BOOK and Mailing List Catalog

Gives counts and prices on over 8,000 different lines of business. No matter what your business, in this book you will find the number of your prospective customers listed. Valuable information showing how to use the mails to secure orders and inquiries for your products or services is given.

Write for **FREE** Copy
R. L. POLK & CO., Detroit, Mich.
Largest City Directory Publishers in the World. Branches in Principal Cities
Mailing List Compilers—Business Statisticians
Producers of Direct Mail Advertising

NEW DRAKE'S ENCYCLOPEDIA

1,680 Alphabetical Headings from A-battery to Zero Beat; 1,025 Illustrations, 920 Pages, 240 Combinations for Receiver Layouts. Price, \$6.00. Radio World, 124 W. 45th St., N. Y. C

MICROPHONE LIGHTERS—For cigars or cigarettes, with button switch at top. Press switch, and lighter acts instantaneously. \$1.00. Model B lighter on tray, \$1.50. Radio World, 145 W. 45th St., N. Y. C.

DOING THE BEST WE CAN

Radio World has been receiving so many subscriptions of late that the Subscription Department is somewhat behind in its work. Please give us time to enter your subscription. We will enter all subscriptions as fast as we possibly can.

PUBLISHERS OF RADIO WORLD.

O-1 MA, \$5.95

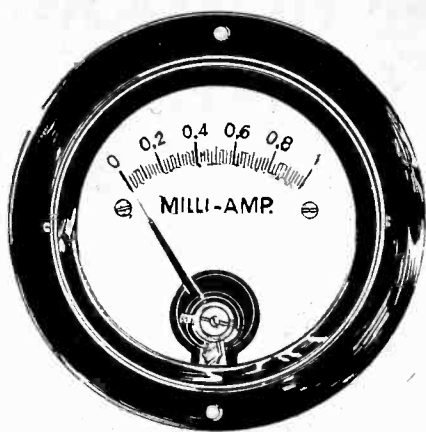

Here is a 0-1 milliammeter, accurate to plus or minus 1% clearly legible to two-one hundredths of a milliampere at any reading (20 microamperes). This expertly made precision instrument is offered at the lowest price so far for a 0-1 ma. Order Cat. FO-1 at \$5.95. C. O. D. orders accepted.

Guaranty Radio Goods Co.
143 West 45th Street,
New York City

AERIAL TUNER

Improves Your Reception

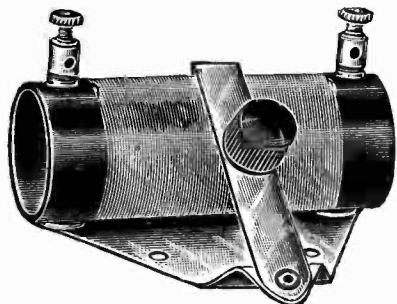

Remove aerial lead from set. Connect aerial instead to one of the binding posts of the Aerial Tuner. Connect the other binding post of the Aerial Tuner to antenna post of your set. Then move the lever of the Aerial Tuner until any weak station comes in loudest. The lever need not be moved for every different frequency tuned in. The Aerial Tuner acts as an antenna loading coil and puts the antenna's frequency at any frequency in the broadcast band that you desire to build up. Price, 85c.

GUARANTY RADIO GOODS CO.
143 West 45th Street
New York City
(Just East of Broadway)

BRILLIANT, NEW NATIONAL MODERNISTIC PROJECTION DIAL WITH RAINBOW FEATURE

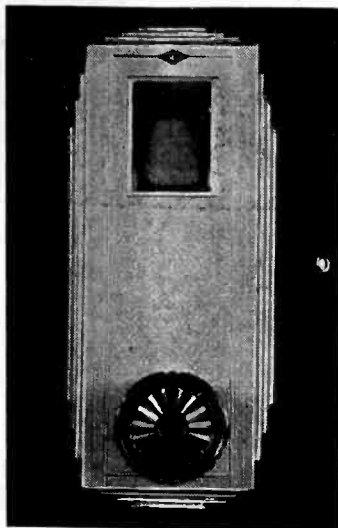

Modernize the appearance of your receiver by installing the brilliant new National dial, with color wheel built in, so that as you turn the dial knob one color after another floods the screen on which the dial numbers are read. On this screen the numbers are projected, so that you get the same dial reading from any position of the eye. This is just what DX hunters want—laboratory precision of dial reading.

The escutcheon is of modernistic design. The Velvet Vernier mechanism drives the drum superbly. Order today. Remit with order and we pay cartage. Shipments day following receipt of order.

GUARANTY RADIO GOODS CO.,
143 W. 45th St., N. Y. City (Just E. of B'way)
Enclosed please find \$3.13 for which please send me dial marked below:
 Cat. HC6, National modernistic drum dial, with color wheel built in, pilot bracket, 6-volt pilot lamp for storage battery or A eliminator sets; hardware; instructions \$3.13
 Cat. HC2½, same as above, but with 2½-volt AC pilot lamp 3.13
 Order C.O.D. and I pay cartage.

NAME
ADDRESS
CITY STATE

RADIO WORLD'S BOOK SERVICE has been found of great value not only by radio fans, constructors, etc., but also by radio and other technical schools throughout the country. See the radio books advertisements in this issue.

LACAULT'S BOOK

"Super-Heterodyne Construction and Operation," giving the master's most masterful exposition of the theory, performance and construction of this fascinating type of circuit, is a necessity to every serious radio experimenter. More than 100 pages and more than 50 illustrations. Buckram cover. This book by R. E. Lacault, FREE if you send \$1.00 for an 8-weeks subscription to Radio World. Present subscribers may accept this offer. Subscription will be extended.

RADIO WORLD 145 W. 45th St., N. Y. City
Just East of B'way

NATIONAL

Velvet B Eliminator \$16.13
150 Volts (250 Tube Free)



Latest Model National Velvet-B, Type 8880, in handsome crackle finish black metal casing, for use with sets up to and including six tubes. Input 105-120 volts AC, 50 to 60 cycles. Output 180 volts maximum at 35 milliamperes. Three variable output intermediate voltages. (Det., RF, AF). Eliminator has excellent filter system to eliminate hum, including 30 henry choke and 18 mfd Mershon condenser. No motorboating! (Eliminator Licensed under patents of the Radio Corporation of America and associated companies.)

Guaranty Radio Goods Co.
143 W. 45TH STREET
(Just East of Broadway)
NEW YORK CITY

New Junior Model POLO UNIT \$4

The famous twin magnet principle for double sensitivity, large magnets for great flux, permanently adjusted armature, all are in the new junior model Polo Unit. Weight, 2¾ lbs. Stands 150 volts unfiltered. Stands up to 250 push-pull filtered. Works any output tube, power or otherwise. Supplied with 10-ft. cord. Order unit now. Five-day money-back guarantee. Shipped C. O. D. if desired.

Acoustical Engineering Associates
143 West 45th Street
New York City
(Just East of Broadway)

SECURITY DEALER

Wants Attractive Stock Issue

Send full particulars

W. E. A. WHEELER & COMPANY

90 Wall Street
NEW YORK CITY

Quick Action Classified Ads

Radio World's Speedy Medium for Enterprise and Sales

10 cents a word — 10 words minimum — Cash with Order

ARISTOCRAT FLOOR SPEAKER—With Molded Wood Horn and Horn Motor built in. Great value. \$14.00. Acoustical Engineering Associates, 143 W. 45th St., N. Y. C.

POLO 245 POWER SUPPLY. Read all about it on another page of this issue. Polo Engineering Laboratories, 57 Dey St., N. Y. City.

EDISON STORAGE BATTERIES—100 volts \$6.50; ¼ Horsepower Alternating Motors \$7.00. Hoffmann Electrical Shops, 904 North Fifth, Philadelphia, Pa.

TELEVISION and all about it in "A B C of Television," by Raymond Francis Yates. \$3 postpaid. Radio World, 145 W. 45th St., N. Y. City.

"EVERYBODY'S AVIATION GUIDE." By Maj. Page. \$2 postpaid. Also "Modern Aircraft" by same author. \$5 postpaid. Radio World, 145 W. 45th St., N. Y. City.

EVERYTHING IN RADIO
At attractive Prices Sets or parts
Orders shipped exactly as ordered. Prompt service. Write for prices. Inquiries invited. Send your address.
ALL RADIO CO., 417 North Clark St., Chicago

TWO FOR ONE. Radio World for 52 weeks and Radio News twelve months at the combination rate of \$7. Radio World, 145 W. 45th St., N. Y.

WORLD'S BEST AVIATION BOOKS: "A B C of Aviation," \$1.00; "Modern Aviation Engines," \$9.00 postpaid. Both by Maj. Page. "Aerial Navigation and Meteorology," By Capt. Yancey. \$4.00 postpaid. Radio World, 145 W. 45th St., N. Y. City.

"AERIAL NAVIGATION and METEOROLOGY." By Capt. Yancey. \$4.00 postpaid. Radio World, 145 W. 45th St., N. Y. City.

"AUDIO POWER AMPLIFIERS," by J. E. Anderson and Herman Bernard, the first and only book on the subject. \$3.50. Hennessy Radio Publications Corporation, 145 West 45th St., N. Y. City.

A. C. TUBES—Manufactured by licensed R.C.A. manufacturer. UX250—.95 UX224—.85 UX245—.85 UX227—.80 UX280—.75 UX226—.65. Charles Blackmore, Windsor, Missouri.

"MATHEMATICS OF RADIO."—A great help to everybody interested in radio. \$2 postpaid. Radio World, 145 W. 45th St., N. Y. City.

BE SURE TO READ the advertisement on another page of this issue about the HB Compact. Guaranty Radio Goods Co., 143 W. 45th St., N. Y. City.

Highest Grade Key Tubes at Defiant Prices!

- Screen Grid Tubes
- 224 at \$1.43
222 at 1.18
- Power Tubes
- 245 at 1.28
112A at .78
171A at .78

- Other Tubes
- 227 at .90
226 at .68
280 at 1.13
201A at .53

The above constitute the nine most popular tubes used in radio today. Despite the severely low prices the Key tubes are firsts of the very first quality. Besides, there is a five-day money-back guaranty! The above tubes are manufactured under licenses granted by the RCA and its affiliated companies.

All prices are net and represent extreme discount already deducted.

228 HIGH-GAIN DETECTOR

Increase the sensitivity of modern AC-operated circuits by substituting the new 228 AC high mu tube (large amplification); for the 227 tube otherwise used as detector in up-to-date circuits. The result is immediately obvious in the greatly increased volume. Then the weak, distant stations come in stronger and tone quality is improved. Simply substitute the 228 for the 227 in the detector socket only. No wiring change of any kind is required. Price, \$1.88.

GUARANTY RADIO GOODS CO., 143 West 45th St., N. Y. City. (Just East of Broadway).

- Enclosed please find \$..... for which ship at once tubes marked below:
- 228 AC high mu. \$1.88
 - 224 AC screen grid \$1.43
 - 245 AC power tube \$1.28
 - 226 AC amplifier69
 - 227 AC det.-amp.90
 - 280 AC rectifier \$1.13
 - 222 battery screen grid \$1.18
 - 112A power tube78
 - 171A power tube78
 - 201A battery tube53
 - Matched pair of 245s for push-pull (for both) \$2.56
 - Matched pair 171As for AC push-pull (for both) \$1.80
 - Matched pair of 112As for push-pull (for both) \$1.80

Name

Address

City State

Put cross here if C. O. D. shipment is desired.
Canadian remittance must be by postal or express money order.

5-Day money-back guaranty

No. 9
\$21 NET
to Dealer



Tests Screen-Grid

Readrite

Set and
Tube Tester

The simplest of all testers to use. Not a switch or binding post to manipulate. The meters are all instantly interchangeable. Only one push button for grid condition. The three A.C. voltmeters are repulsion type 0-6, 0-15, 0-150. The three D.C. voltmeters have high resistance, 0-8, 0-50, 0-500. The three D. C. Milliammeters are 0-10, 0-50, 0-300. A.C. Voltmeters may be used as milliammeters for

testing rectifier tubes, thereby obtaining more accurate readings.

Case is light in weight, covered with grained leatherette, size 10 1/2" x 7 1/2" x 3 3/4". A most flexible tester, complete for present day testing and immediately adapting itself to future needs. Every service man should have the READRITE No. 9—A truly remarkable tester.—An investment usually paid for in the first few calls.

LIST PRICE NO. 9 — \$35.00 COMPLETE

Send for catalog of Readrite instruments, resistors, etc.*

Readrite Meter Works,

12 College Ave.

Bluffton, Ohio

ESTABLISHED 1904

No matter what your resistance problem may be—whether an unknown high resistance value for a critical receiving circuit or a heavy duty low resistance value for grid-biasing the largest audio power tube or even transmitting tube—

Remember—there's a **CLAROSTAT** for Every Purpose

Clarostat Mfg. Co., 291 N. 6th St., B'klyn, N. Y.

Aristocrat Floor Speaker

With Molded Wood Horn of 8 ft. tone travel (exponential type) with baffle and horn motor built in. Extraordinary bargain. **\$12.00**

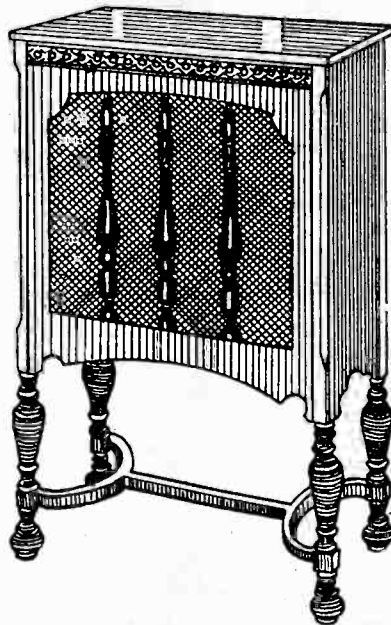

The speaker cabinet is walnut finish, 33" high, 24 1/2" wide, 17 1/2" deep, with carved legs. Golden cloth grille covers front opening. Built inside is No. 595 molded wood horn with baffle and No. 203 driving motor unit that stands 250 volts without filtration. Horn and motor removable. Table alone is worth price asked. Shipped C.O.D. if desired.

Acoustical Engineering Associates
143 WEST 45th STREET NEW YORK CITY

Your Jobber can supply. If ordered direct remittance (\$21 NET F. O. B. FACTORY) must accompany order.

A FOUR METER TESTER with five auxiliary meters. All have single scales. No confusion taking readings. The four meter readings show at a glance the plate voltage, filament voltage, grid bias voltage, plate milliamperes and grid change. These nine meters tell everything a radio service man should know in testing A.C. and D.C. sets. With it the latest designed sets and tubes are fully tested, including the plate, grid, cathode and filament of screen grid 224 A. C. tubes, 250 power tubes, and both plates of rectifier tubes. Other meters may be added.

LYNCH

TUBADAPTA
For Better TONE

List Price. \$.250

Improves reception and prolongs life of expensive power tubes. Used in last audio stage. Write for descriptive circular and complete catalogue Lynch Guaranteed Radio Products. LYNCH MFG. CO., Inc., 4775 Broadway, N. Y.



Orders - Inquiries

60 pages
Send for FREE COPY
Can be Secured by MAIL

POLK'S REFERENCE BOOK and Mailing List Catalog

Gives counts and prices on over 8,000 different lines of business. No matter what your business, in this book you will find the number of your prospective customers listed. Valuable information showing how to use the mails to secure orders and inquiries for your products or services is given.

Write for FREE Copy
R. L. POLK & CO., Detroit, Mich.
Largest City Directory Publishers in the World. Branches in Principal Cities
Mailing List Compilers—Business Statistics
Producers of Direct Mail Advertising

NEW DRAKE'S ENCYCLOPEDIA

1,680 Alphabetical Headings from A-battery to Zero Beat; 1,025 Illustrations, 920 Pages, 240 Combinations for Receiver Layouts. Price, \$6.00. Radio World, 124 W. 45th St., N. Y. C

MICROPHONE LIGHTERS—For cigars or cigarettes, with button switch at top. Press switch, and lighter acts instantaneously. \$1.00. Model B lighter on tray, \$1.50. Radio World, 145 W. 45th St., N. Y. C.

DOING THE BEST WE CAN

Radio World has been receiving so many subscriptions of late that the Subscription Department is somewhat behind in its work. Please give us time to enter your subscription. We will enter all subscriptions as fast as we possibly can.

PUBLISHERS OF RADIO WORLD.



Your Choice of These Nine Meters FREE!

- 0-5 Voltmeter D.C. No. 328
0-50 Voltmeter D.C. No. 327
0-Volt Charge Tester D.C. No. 23
0-10 Amperes D.C. No. 328
0-25 Milliamperes D.C. No. 325
0-50 Milliamperes D.C. No. 326
0-100 Milliamperes D.C. No. 329
0-300 Milliamperes D.C. No. 329
0-400 Milliamperes D.C. No. 324

Equip Yourself Now With Necessary Meters!

To do your radio work properly you need meters. Here is your opportunity to get them at no extra cost. See the list of nine meters at left. Heretofore we have offered the choice of any one of these meters free with an 8-weeks subscription for RADIO WORLD, at \$1, the regular price for each subscription. Now we extend this offer. For the first time you are permitted to obtain any one or more of all of these meters free, by sending in \$1 for 8-weeks subscription, entitling you to one meter; \$2 for 16 weeks, entitling you to two meters; \$3 for 26 weeks, entitling you to three meters; \$4 for 35 weeks, entitling you to four meters; \$5 for 44 weeks, entitling you to 5 meters; \$6 for 52 weeks, entitling you to six meters. Return this offer with remittance, and check off desired meters in squares at left.

RADIO WORLD will help you in your radio work, so you will be able to use the meters most valuably. Keep abreast of all the new circuits, intimate details on perfecting existing sets, and get inside track on sensitivity, distance reception, tonal quality, and news of radio, technical and non-technical. Enjoy the writings of Dr. Lee De Forest, McMurdo Silver, J. E. Anderson, Herman Bernard and a host of other radio engineers who contribute their knowledge to you through the medium of RADIO WORLD, the first and only illustrated national radio weekly. You can find no magazine that better caters to your needs than RADIO WORLD. Short waves? RADIO WORLD will tell you all about them. Extremely sensitive broadcast receivers? Their construction and operation are fully discussed with confident regularity. Power supplies - push-pull or otherwise? AC receivers? Screen grid tubes? Large receivers that give a super-abundance of performance - small, economical receivers that give performance out of all comparison to their size? Are you interested in these? Then you're interested in RADIO WORLD.

Present mail subscribers may renew their subscription under this remarkably generous offer. Put a cross in square. [

RADIO WORLD

145 W. 45th St., N. Y. City - Published Weekly. All Newsstands, 15c per copy - \$3, six months - \$6 a year

Component Parts for 245 Push-Pull Power Amplifier

(as described and specified by Herman Bernard) Check off which parts you desire. All parts sold separately.

- [] C1 - One .00025 mfd. mica condenser. .21
[] C2 - One .01 mfd. mica fixed condenser. .35
[] C3 - One Flechthelm 1 mfd. filter condenser, 1,000 volts DC continuous working voltage rating, 550 volts AC (root mean square) continuous voltage rating. 1.70
[] C4, C5, C6, C7 - Four Marshon condensers in one copper casing, two of 8 mfd. and two of 18 mfd. with low bracket, Cat. Q2-8, 2-18B. 5.15
[] C8, C9, C10, C11, C12, C13, C14, 15, C16 - Nine 1 mfd. bypass condensers, 200 volts DC continuous working voltage rating. 4.50
[] T1 - One Polo Filament-Plate Supply transformer: 110 volt 50-60 cycle primary, 724 volt secondary center-tapped, 5 volt 2 amp. secondary center-tapped; 2.5 volt 3 ampere secondary center-tapped, and 2.5 volt 12 ampere secondary center-tapped. Cat. FPS. 7.50
[] FC, PFC - Two center-tapped chokes for high current one used as filter choke, other as push-pull output choke. 7.42
[] PPIT - One push-pull input transformer. 3.41
[] SW - One AC pendant through-switch, with 12-ft. AC cable and male plug. 1.10
[] F - One 2 ampere fuse, with holder. .50
[] CO - One convenience outlet (for dynamic speaker AC cable). .50
[] PJ, PJS - Phonograph Jack with automatic switch and plug. 1.42
[] R1 - One resistor, 0.1 meg. .30
[] R2 - One grid leak, 5.0 meg. .30
[] R3 - One multi-tap voltage divider, 50 watt rating; fourteen taps affording thirteen different voltages; 13,850 ohms. 3.95
[] Two resistor mountings.
[] Roll of heavy insulated hookup wire for power work.
[] Fifteen binding posts. 1.50
[] One 15x9 1/2" cadmium plated steel subpanel, with self-bracketing flanges, one five-prong and three four-prong sockets built in; sockets marked to identify tubes that go in them; subpanel drilled and insulated where necessary; flat insulating washers; hardware. 4.00
[] All parts \$43.57
Ferranti AF60C push-pull input instead of above input transformer. 9.60

[Note: For 40 cycles 110v. order Polo P40 FPS at \$10; for 25 cycles 110v. order Polo P25 FPS at \$11.]

Guaranty Radio Goods Co.

143 West 45th Street Just East of Broadway NEW YORK CITY

LACAULT'S BOOK

GIVES YOU A FINE UNDERSTANDING OF the SUPER-HETERODYNE

R. E. LACAULT, E.E., I.R.E., who died recently, was one of the outstanding authorities on the Super-Heterodyne. He wrote a book, "Super-Heterodyne Construction and Operation," that explains in a non-technical manner the phenomena associated with a Super-Heterodyne. More, it gives a clear outline of the way such a receiver functions, and naturally gives the clues to solving virtually all the troubles that may arise in a Super.

So thoroughly did Lacault do his work that he covered associated topics, thus making his book a sidelight on radio in general, including advice on trouble-shooting.

Therefore the service man, the home experimenter, the custom set builder and the student will welcome this book.

It consists of 103 pages and includes 68 illustrations. It is bound in maroon buckram.

There are three valuable tables in the book, also. One classifies harmonics into groups, e.g., sound, radio, short waves, heat, light, chemical rays, X-rays and "unknowns." Another is a trouble-shooting chart, classifying "trouble experienced" and "causes" and referring to the text for specific solutions. The third is a table for converting broadcast frequencies to wavelengths (accurate to .1 of a meter) or for converting the wavelength into frequency.

THE book begins with a comparison of alternating and direct current and proceeds to a discussion of the relation of wavelength to frequency. Then tuning is explained.

Condensers, coils, induction, vacuum tube operation and testing, earphones and speakers, rectification, oscillation, grid condenser action, modulation, grid bias detection, regeneration, beat notes, frequency changing, audio simplification, batteries, aeriads, loops, wiring, sockets, and shielding are only some of the other important topics covered.

Besides, there is an entire chapter on the construction of a Super-Heterodyne receiver, with list of parts, front, top and rear views of set, front panel layout, shield dimensional drawings, schematic diagram of wiring and picture diagrams of the top and bottom views of the subpanel.

You Can Get This Book At Once!

You will want this book not only for present reading but also for future reference. It is authoritative and highly informative. Send for it now! It's free with each order for an eight weeks' subscription for RADIO WORLD. Present subscribers may renew under this offer. Their subscriptions will be extended eight weeks. Please use coupon.

RADIO WORLD, 145 W. 45th St., N. Y. City (Just East of Broadway)

Gentlemen: Enclosed find \$1.00. Please enter my subscription for RADIO WORLD for eight weeks at \$1.00 and send me at once one copy of R. E. Lacault's "Super-Heterodyne Construction and Operation," FREE!

[] I am a subscriber at present. (Check off if true.)

Name

Address

City..... State.....

5-DAY MONEY-BACK GUARANTEE [] If C. O. D. desired, put cross here.

Component Parts

for ONE-DIAL

PUSH-PULL BATTERY DIAMOND

[Check off parts you want. Each part is sold separately.]

- [] L1L2 - Antenna coil RF3 @ \$.65
[] L3L4L5 - 3-circuit SG coil SGT3 @90
[] L6 - Push-pull output transformer 2.50
[] T1 - Push-pull input transformer 2.50
[] CT - 80 mfd. equalizer35
[] C1, C2 - Two .00035 mfd. ext. shafts @ 98c 1.96
[] C3, C5 - Two .01 mfd. mica condensers70
[] R - One 6.5 ohm filament resistor25
[] R1, Sw - One 75 ohm switched rheostat80
[] R2, C4 - 2 meg. Lynch leak, grid clip condenser51
[] R3 - One .25 meg.30
[] R4 - One 5.0 meg.30
[] R5 - One 1.3 ohm filament resistor20
[] Ant., Gnd., Sp. (+) Sp. (-) - Four posts @ .1040
[] One drilled front panel 7x18" 1.85
[] One socketed, self-bracketing metal subpanel, all holes drilled. 3.50
[] One National new modernistic drum dial with color wheel, pilot bracket, 6v. lamp, hardware, knob 3.13
[] Two matched knobs for rheo. and tickler @ .1836
[] Five vari-colored cable leads @ .0735
[] Metal link and insulated shaft22
[] One screen grid clip06
[] All parts (including blueprint) \$21.89

GUARANTY RADIO GOODS CO., 143 W. 45th St., N.Y.C. (Just East of Broadway)

Enclosed please find \$..... for which please mail at once the parts for the Push-Pull Battery Model Diamond of the Air as checked off above.

[] If ordering C.O.D. put check mark here.

Name

Address

City..... State.....

TRIAL SUBSCRIPTION, 8 WEEKS, \$1.00. Send \$1 and we will send you Radio World for 8 weeks, postpaid. RADIO WORLD, 145 West 45th St., N. Y. City.

"AERIAL NAVIGATION and METEOROLOGY." By Capt. Yancey. \$4.00 postpaid. Radio World, 145 W. 45th St., N. Y. City.

Blueprint of the New One-Dial Push-Pull Battery Model SG DIAMOND

Full-sized picture diagram of the wiring, with list of parts. This 5-tube receiver is really superlative. It gives you screen grid radio frequency amplification and push-pull output, most economically.

Send \$1.00 today for this blueprint or order it shipped C. O. D.

RADIO WORLD

145 West 45th Street Just East of Broadway New York City

One Tube? Two Tubes? Three Tubes? Four Tubes?

Circuits for Schoolboys - Easy to Build, Very, Very Inexpensive!

- A One Tube Receiver, parts costing \$4.28!
A Two Tube Audio Amplifier, parts costing \$5.23!
A Three Tube Speaker - Operating Circuit, parts costing \$11.10!
A Four Tube Speaker - Operating Circuit, parts costing \$12.72!

The construction of these circuits, with a pictorial diagram as one of the illustrations, was described by Jack Tully, himself a schoolboy, in RADIO WORLD. See list below.

- [] Sept. 21st and 28th issues, One-Tube DX Set, by Jack Tully; two-part article.
[] Oct. 5th, Three-Tube Single Dial Speaker Set, by Jack Tully.
[] Oct. 12th, Two Stage Transformer, Coupled Audio Amplifier, by Jack Tully.
[] Oct. 19th, Four-Tube DX Speaker Set, by Jack Tully. 15 cents a copy. Order at once while these copies are available.

RADIO WORLD, 145 W. 45th St., New York

Parts for BERNARD TWO-TUBE TUNER

Using 222 and 201A for Battery Operation—Order what parts you desire.

- L1L2L3, C1, socket, link, base, .00035 mfd. tuning condenser—One Bernard tuner assembly for left-hand position when using a drum dial, socket for DC screen grid tube 222 (Cat. BT-L-DC).....\$6.00
- L4L5L6, C2, socket, link, base, .00035 mfd. tuning condenser—One Bernard tuner assembly for right-hand position when using drum dial; socket for four-prong DC tube, 201A, 240, 112A, etc. (Cat. BT-R-DC).....6.00
- R1—One .75 ohm. rheostat......25
- R2—One 6.5 ohm. filament resistor......25
- R3—One 5 meg. grid leak......30
- R4—One 4 ohm. filament resistor......20
- C3, C4—Two .01 mfd. mica dielectric fixed condensers......70
- C5—One .00025 mfd. mica dielectric fixed condenser with clips......25
- C6—One .00025 mfd. mica dielectric fixed condensers......20
- SW—One A battery switch......40
- Ant., Gnd., A minus, A plus, B plus 45, B plus 135 and B, seven binding posts......70
- One National Velvet Vernier Modernistic dial, with rainbow feature and pilot light and bracket, 3.13 One drilled front panel, 7x18", black bakelite. 1.80
- All parts.....\$20.60
- All parts for AC Tuner, including fil. trans.....\$25.10

Your Name

Your Address

- If C.O.D. is desired put cross here.
- If remittance enclosed put cross here. Canadian remittance must be express or P.O. money order.

GUARANTY RADIO GOODS CO.,
143 West 45th Street, N. Y. City
Just East of Broadway.

CONE ASSEMBLY WITH DOUBLE MAGNET UNIT

\$4.95



An excellent magnetic type speaker for installation in any cabinet. The unit is a double-magnet Faratone, with two magnet coils, for utmost sensitivity. Each horseshoe magnet is 3/4" thick. The magnet coils are forever protected against dust and other foreign, injurious substances, by special bakelite housings. The pin is reverse drive. The cone frame is metal. The 9" cone is specially treated buckram.

All assembled, with long cord, ready to play. Shipping weight 4 lbs. \$4.95 (Cat. CAS) Net

The unit alone (cord included). It will operate any type sounding surface, including paper, cloth, wood, etc. Shipping weight 4 lbs. (Cat. UA) \$2.95 Net

Guaranty Radio Goods Co.
145 West 45th St., New York City

Hi-Q 30 Wholesale Prices!

Write or wire!

Guaranty Radio Goods Co.
143 West 45th St.,
New York City

BROADWAY-HOLLYWOOD

World's most intriguing places. Where famous stage, screen, radio stars live their lives. Intimate stories of their stage and personal doings in

NEW YORK STAR National Illustrated Amusement Weekly
Edited by Roland Burke Hennessy. Clever writers cover comedy, tragedy, fascination of professional life. Portraits and unusual pictures of favorites. 10c copy, \$5 year (52 issues). SPECIAL: 13 issues \$1 and experts answer your questions. FREE. STAR, 1562 Broadway, New York.

NEWEST BOOK ON VACUUM TUBES

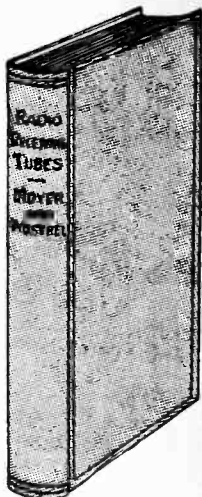

"RADIO RECEIVING TUBES," by James A. Moyer and John F. Wostrel, first edition just off the press. No radio service man, experimenter or student of radio should be without this authoritative book on the principles and applications of vacuum tubes. It answers all your questions relating to receiving, amplifying and rectifying tubes. It is a complete discussion of tube principles, functions and uses, thoroughly up-to-date.

In this book the essential principles underlying the operation of vacuum tubes are explained in a non-technical manner as is consistent with accuracy. The book covers the construction, action, reactivation, testing and use of vacuum tubes as well as specifications for vacuum tubes and applications for distant control of industrial processes and precision measurements.

Price \$2.50

RADIO WORLD
145 West 45th Street, New York City
(Just East of Broadway)

HIGH RESISTANCE PHONES \$1.65
You can't beat them at the price. Send now. Guaranty Radio Goods Co., 143 W. 45th St., N. Y. C.

ARISTOCRAT FLOOR SPEAKER
With Molded Wood Horn and Horn Motor built in. Good value. \$12.00. Acoustical Engineering Associates, 143 W. 45th St., N. Y. C.

READ OUR CLASSIFIED ADS
And use this department if you have anything to sell. 10c a word, \$1 minimum. Radio World, 145 W. 45th St., N. Y. City.

Multi-Tap Voltage Divider

TWO rugged, expertly engineered wire-wound, enamelled resistors, mounted in series, one atop the other, with fourteen useful lugs, providing all necessary choice of voltages without the uncertainty of adjustable variable resistance.

The Multi-Tap Voltage Divider has a total resistance value of 13,850 ohms, in the following steps: 3,000, 4,500, 2,000, 800, 700, 600, 550, 500, 450, 400, 200, 100 and 50 ohms. With the zero voltage lug the total number of useful lugs is fourteen. The resistances stated are those between respective lugs and are to be added together to constitute 13,850 ohms total.

A conservative rating of the Multi-Tap Voltage Divider is 50 watts, continuous use. The unit is serviceable in all installations where the total current drain does not exceed 125 milliamperes.

Extreme care has been exercised in the manufacture of the Multi-Tap Voltage Divider. It is mounted on brackets insulated from the resistance wire and that afford horizontal mounting of the unit on baseboards and subpanels.

There long has been a need for obtaining any necessary intermediate voltage, including all biasing voltages, from a Multi-Tap Voltage Divider, but each lug has to be put on individually by hand, and soldered, so that manufacturing difficulties have left the market barren of such a device until now.

The Multi-Tap Voltage Divider is useful in all circuits, including push-pull and single-sided ones, where the current rating of 125 milliamperes is not seriously exceeded and the maximum voltage is not more than 400 volts. If good ventilation is provided, this rating may be exceeded 15 per cent.

The expertness of design and construction will be appreciated by those whose knowledge teaches them to appreciate parts finely made.

When the Multi-Tap Voltage Divider is placed across the filtered output of a B supply which serves a receiver, the voltages are in proportion to the current flowing through the various resistances. If a B supply feeds a receiver with two-stage audio amplifier, the last stage a single-sided 245, then the voltages would be 250 maximum for the power tube, 180, 135, 75, 50, 40, 35, 30, 25, 16, 10, 6 and 3. By making suitable connection of grid returns the lower voltages may be used for negative bias or even for positive voltage on the plates.

If push-pull is used, the current in the biasing section is almost doubled, so the midtap of the power tubes' filament winding would go to a lug about half way down.

Order Cat. MTVD at \$3.95.

Polo Engineering Laboratories,
143 W. 45th St., N. Y. City.
Gentlemen: Enclosed please find \$3.95 for which please send at once one Multi-Tap Voltage Divider, 13,850 ohms, 14 taps, mounted on brackets, 50 watt rating; Cat. MTVD.

Name

Address

CityState

Blueprint FREE!

Get a free blueprint of either circuit listed on the coupon below, by sending \$1.00 for eight weeks' subscription for RADIO WORLD, or send \$1.50 for 13 weeks' (quarter of a year) and get both blueprints free!

RADIO WORLD, 145 W. 45th St., N. Y. City

- Enclosed please find:
- \$1 for which send RADIO WORLD for 8 weeks and send free blueprint of the battery model 4-tube Screen Grid Diamond of the Air.
- \$1 for which send RADIO WORLD for 8 weeks and send free blueprint of the 4-tube AC Screen Grid Diamond of the Air.
- \$1.50 for which send RADIO WORLD for 13 weeks and send both blueprints free. (If renewing a subscription put cross here)

NAME

ADDRESS

CITY..... STATE.....

MICROPHONE LIGHTERS

For cigars or cigarettes, with button switch at top. Press switch, and lighter acts instantaneously. \$1.00. Model B lighter on tray, \$1.50. Radio World, 145 W. 45th St., N. Y. C.

TRIAL SUBSCRIPTION

Send \$1 for trial subscription for 8 weeks, starting with current issue, or of any recent issue you desire. Radio World, 145 W. 45th St., N. Y. City.

SEPARATE TESTER COMBINATION

Consists of two-meter assembly in neat black metal case, with an external high resistance meter. The two meters in the case read (a) 0-20, 0-100 milliamperes; (b) 0-10 volts, AC or DC, same meter reads both. The external high resistance meter reads 0-600 volts, AC or DC (same meter reads both). Thus you can test any plate current up to 100 ma., any filament voltage, AC or DC, up to 10 V., and any plate voltage, or line voltage or other AC or DC voltage, up to 600 volts. Five-prong plug, screen grid cable, and 4-prong adapter included. Order Cat. ST-COMB @.....\$11.00 2-meter assembly, cable plugs, Cat. 215 @ \$7.06 0-600 AC-DC meter alone, Cat. M600 @ \$4.95

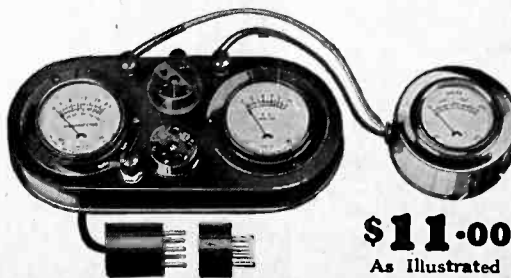

\$11.00
As illustrated

Guaranty Radio Goods Co., 143 West 45th St., N. Y. City

Power Amplifier Equipment

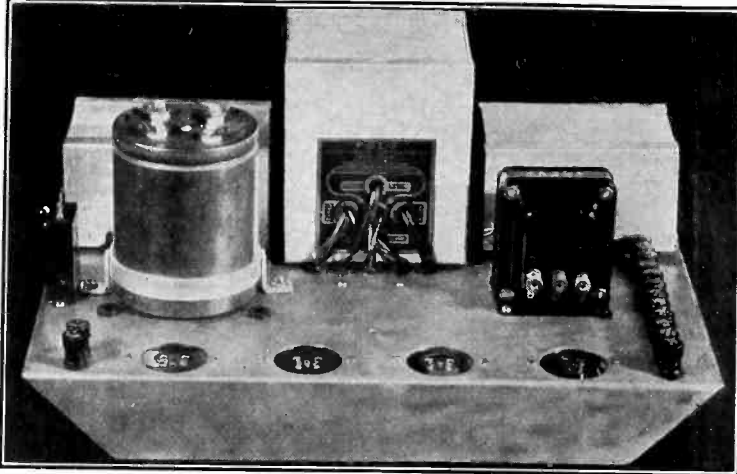

At left is illustrated a push-pull power amplifier, using a first stage of resistance coupled audio, 280 rectifier and two 245s in push-pull, as described in the November 2d issue of Radio World. Abounding volume and faithful tone reproduction are assured. The Polo Filament-Plate Supply, two Polo center-tapped audio chokes and a Multi-Tap Voltage Divider are used, with an input push-pull audio transformer and auxiliary equipment. The total parts, including cadmium-plated steel sub-panel, come to \$43.57 net, the best power amplifier for that modest amount. Provision is made for phonograph pickup plug insertion. Thirteen output voltages are provided, including 300, 180, 75, 50 and an assortment of nine different voltages under 50 available for bias. All A, B and C voltages are provided for the power amplifier and for a tuner to be used with it employing 227, 224 or 228 tubes. Order Cat. PO-245-PA @ \$43.57 net,

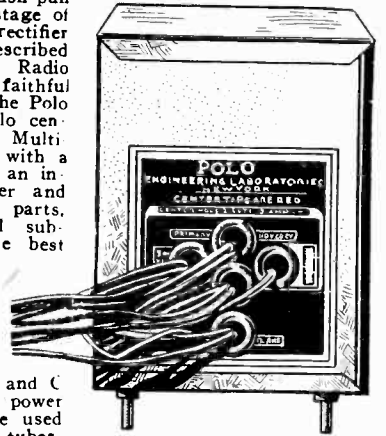

Polo 245 Filament Plate Supply (less chokes) has four windings, all save primary center-tapped (red), is 4 1/2" wide, 5" high, 4" front to back. Weight, 3 lbs. Filament windings, 2.5 v. at 12 amps., 2.5 v. at 3 amps. (for 245 filaments), 5 v. at 3 amps. for 280 rectifier, and 724 v. @ 80 m.a., center-tapped. Order Cat. PFPS @ \$7.50. [For 25 cycles order Cat. PFPS-25 @ \$12.00.] [For 40 cycles order Cat. PFPS-40 @ \$10.00.]

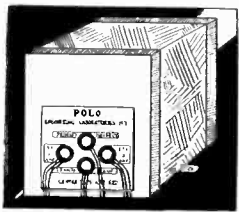

Polo Filament Transformer Only, four windings, consists of 50-60 cycles 110 v. winding, 2 1/2 v. at 12 amps., 2 1/2 v. at 3 amps., 5 v. at 2 amps. All windings, save primary, are center-tapped (red). Size, 4 1/2" high x 3 3/4" wide x 3" front to back. Weight, 6 lbs. Order Cat. PFT @ \$4.25. [For 25 cycles order PFT-25 @ \$7.00; for 40 cycles order PFT-40 @ \$6.25.]

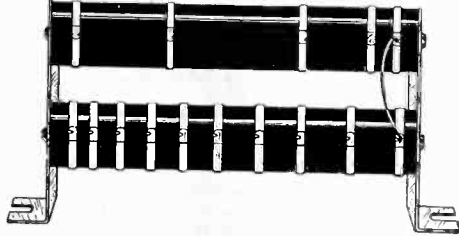

Two rugged, expertly engineered wire-wound, enamelled resistors, mounted in series, one atop the other, with fourteen useful lugs, providing all necessary choice of voltages without the uncertainty of adjustable variable resistance.

The Multi-Tap Voltage Divider has a total resistance value of 13,850 ohms, in the following steps: 3,000, 4,500, 2,000, 800, 700, 600, 550, 500, 450, 400, 200, 100 and 50 ohms. With the zero voltage lug (at lower left) the total number of useful lugs is fourteen. The resistance stated are those between respective lugs and are to be added together to constitute 13,850 ohms total.

A conservative rating of the Multi-Tap Voltage Divider is 50 watts, continuous use. The unit is serviceable in all installations where the total current drain does not exceed 125 milliamperes.

Extreme care has been exercised in the manufacture of the Multi-Tap Voltage Divider. It is mounted on brackets insulated from the resistance wire that afford horizontal mounting of the unit on baseboards and subpanels.

There long has been a need for obtaining any necessary intermediate voltage, including all biasing voltages, from a Multi-Tap Voltage Divider, but each lug has to be put on individually by hand, and soldered, so that manufacturing difficulties have left the market barren of such a device until now.

The Multi-Tap Voltage Divider is useful in all circuits, including push-pull and single-sided ones, where the current rating of 125 milliamperes is not seriously exceeded and the maximum voltage is not more than 400 volts. If good ventilation is provided, this rating may be exceeded 15 per cent.

The expertness of design and construction will be appreciated by those whose knowledge teaches them to appreciate parts finely made.

When the Multi-Tap Voltage Divider is placed across the filtered output of a B supply which serves a receiver, the voltages are in proportion to the current flowing through the various resistances. If a B supply feeds a receiver with two-stage audio amplifier, the last stage a single-sided 245, then the voltages would be 250 maximum for the power tube, 180, 135, 75, 50, 40, 35, 30, 25, 16, 10, 6 and 3. By making suitable connection of grid returns the lower voltages may be used for negative bias or even for positive voltage on the plates.

If push-pull is used, the current in the biasing section is almost doubled, so the midtap of the power tubes' filament winding would go to a lug about half way down. Order Cat. MTVD at \$3.95.

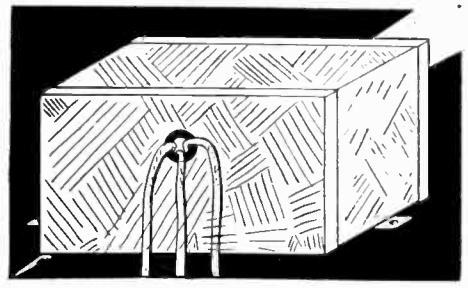

Center-tapped double choke, 125 m.a. rating, 80 henrys in each section. Used for filtering B supply or for a push-pull output impedance, where speaker cords go directly to plates of tubes. Center tap is red. Order Cat. PDC @ \$3.71.

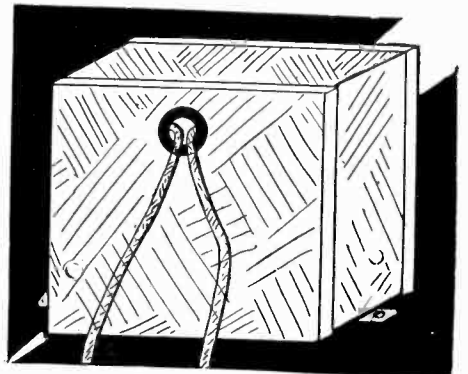

Single 30 henry 100 m.a. choke for filtered output (where condenser is used additionally) or for added filtration of a B supply. Order Cat. PSC @ \$2.50.

By-pass Condensers
For by-passing B+ leads to ground or C minus from 200 v. post or less, where current is less than 10 m.a., 1 mfd. paper dielectric condensers are useful. Order LV-1 @\$0.50 ea.

Filter Condensers
For high voltage filtration next to the rectifier, use 1 or 2 mfd. The 2 mfd. makes the output voltage a little higher.
Order Cat. HV-1 (1,000 v. DC, 550 v. AC)\$1.76
Order Cat. HV-2 (1,000 v. DC, 550 v. AC)\$3.52

Filament-Plate-Choke Block
Same as Filament-Plate Supply, except that two 50 henry chokes are built in. Six windings: primary, 110 v., 50-60 cycles; 2.5 v. at 12 amps.; 2.5 v. at 3 amps.; 5 v. at 2 amps.; 724 v. at 80 m.a.; choke All AC windings center-tapped (red), except primary. Connect either end of a choke to one end of other choke for midsection. Order Cat. P-245-FPCH @ \$10.00 [For 40 cycles order P-245-FPCH-40 @ \$13.50.] [For 25 cycles order P-245-FPCH-25 @ \$14.50.]

ACOUSTICAL ENGINEERING ASSOCIATES,
143 West 45th St., N. Y. City.
(Just East of Broadway.)

Please ship at once the following:

Quantity	Cat. No.	Product	Price
<input type="checkbox"/>	PO-245-PA	Power amp. parts, 50-60 c.	\$43.57
<input type="checkbox"/>	PO-245-PA-40	Same, 40 cycles	46.07
<input type="checkbox"/>	PO-245-PA-25	Same, 25 cycles	48.57
<input type="checkbox"/>	PFPS	Fil. plate supply, 50-60 c.	7.50
<input type="checkbox"/>	PFPS-40	Same, 40 cycles	10.00
<input type="checkbox"/>	PFPS-25	Same, 25 cycles	12.00
<input type="checkbox"/>	PFT	Fil. trans., 50-60 c.	4.25
<input type="checkbox"/>	PFT-40	Same, 40 cycles	6.25
<input type="checkbox"/>	PFT-25	Same, 25 cycles	7.00
<input type="checkbox"/>	P-245-FPCH	Power-filter block	10.00
<input type="checkbox"/>	P-245-FPCH-40	Same for 40 cycles	13.50
<input type="checkbox"/>	P-245-FPCH-25	Same for 25 cycles	14.50
<input type="checkbox"/>	PDC	Single choke	2.50
<input type="checkbox"/>	PSC	Multi-tap volt. div.	3.95
<input type="checkbox"/>	MTVD	Double c.-t. choke	3.71
<input type="checkbox"/>	Q-2-B, 2-18B	Mershon with bracket	5.15
<input type="checkbox"/>	LV-1	200 v., 1 mfd. by-pass cond.	.50
<input type="checkbox"/>	HV-1	1,000 v., 1 mfd. filter cond.	1.76
<input type="checkbox"/>	HV-2	1,000 v., 2 mfd. filter cond.	3.52
<input type="checkbox"/>	SPO	Subpanel	3.50

Enclosed please find check—money order—for the above. [Note: Canadian remittance must be by postal or express money order.]
 Please ship C.O.D.

NAME.....
ADDRESS.....
CITY..... STATE.....
5-DAY MONEY-BACK GUARANTEE!

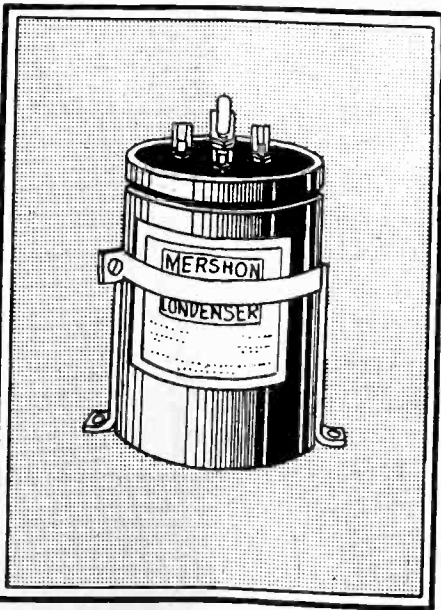

The Mershon electrolytic condenser, 415 volts DC, for filtering circuits of B supplies. Q 2-8, 2-18 has four capacities in one copper casing: two of 8 mfd. and two of 18 mfd. The copper case is negative. The smaller capacities are nearer the edge of the case. The vent cap should not be disturbed, and the electrolyte needs no refilling or replacement.

Mershon electrolytic condensers are instantly self-healing. Momentary voltages as high as 1,000 volts will cause no particular harm to the condenser unless the current is high enough to cause heating, or the high voltage is applied constantly over a long period.

High capacity is valuable especially for the last condenser of a filter section, and in by-passing, from intermediate B+ to ground or C+ to C-, for enabling a good audio amplifier to deliver true reproduction of low notes. Suitably large capacities also stop motor-boating.

Recent improvements in Mershons have reduced the leakage current to only 1.5 to 2 mils total per 10 mfd. at 300 volts, and less at lower voltages. This indicates a life of 20 years or more, barring heavy abuse.

In B supplies Mershons are always used "after" the rectifier tube or tubes, hence where the current is direct. They cannot be used on alternating current. Rated 415 v. DC.

The Mershon comes supplied with special mounting bracket. Order **\$5.15**
Q 2-8, 2-18 B @

THREE IMPORTANT BOOKS FOR SERVICE MEN!

"Trouble Shooter's Manual" *The most popular and fastest-selling book in radio today. Wiring diagrams of commercial receivers are contained in this outstanding book.*

"Mathematics of Radio" *A sure route to a good grasp on radio technique. Radio theory outlined so that anybody can understand it.*

"Testing Units for Service Men" *Circuits and Methods of Testing Equipment, particularly use of individual meters and of meters united in combination testers.*

These Three Books by John F. Rider Constitute an Outstanding Asset to All Possessors!

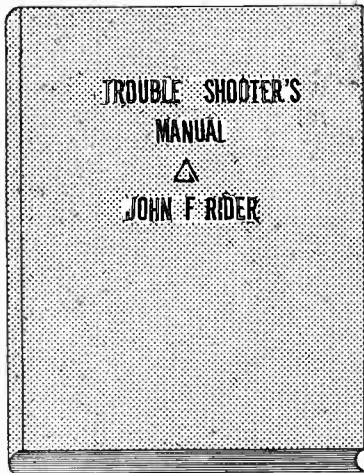

"Trouble Shooter's Manual"

is the first comprehensive volume devoted exclusively to the topic. The 240 pages include 200 illustrations devoted to wiring diagrams of factory-made receivers, besides other illustrations. It is not only a treatise for service men, telling them how to overcome their most serious problems, and fully diagramming the solutions, but is a course in how to become a service man.

This book is worth hundreds of dollars to any one who shoots trouble in receivers—whether they be factory-made, custom-built or home-made receivers.

Besides 22 chapters covering thoroughly the field of trouble shooting, this volume contains the wiring diagrams of models, as obtained directly from the factory, a wealth of hitherto confidential wiring information released for the first time in the interest of producing better results from receivers. You will find these

diagrams alone well worth the price of the book. The wiring diagrams are of new and old models, of receivers and accessories and as to some of the set manufacturers, all the models they ever produced are shown in wiring diagrams! Here is the list of receivers, etc., diagrams of which are published in this important and valuable book:

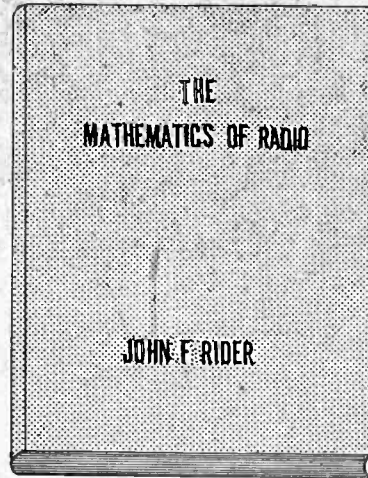

"Mathematics of Radio"

TABLE OF CONTENTS:

OHM'S LAW.
RESISTANCES: Basis for resistance variation, atomic structure, temperature coefficient, calculation of resistance variation, expression of ampere, volt and Ohm fractions, application of voltage drop, plate circuits, filament circuits, filament resistances, grid bias resistances.
DC FILAMENT CIRCUITS: Calculation of resistances.
AC FILAMENT CIRCUITS: Transformers, wattage rating, distribution of output voltages, voltage reducing resistances, line voltage reduction.
CAPACITIES: Calculation of capacity, dielectric constant condensers in parallel, condensers in series, voltage of condensers in parallel, in series, utility of parallel condensers, series condensers.
VOLTAGE DIVIDER SYSTEMS FOR B ELIMINATORS: Calculation of voltage divider resistances, types of voltage dividers, selection of resistances, wattage rating of resistances.
INDUCTANCES: Air core and iron core, types of air core inductances, unit of inductances, calculation of inductance.
INDUCTANCE REQUIRED IN RADIO CIRCUITS: Relation of wavelength and product of inductance and capacity, short wave coils, coils for broadcast band, coupling and mutual inductance, calculation of mutual inductance and coupling.
REACTANCE AND IMPEDANCE: Capacity reactance, inductance reactance, impedance.
RESONANT CIRCUITS: Series resonance, parallel resonance, coupled circuits, bandpass filters for radio frequency circuits.
IRON CORE CHOKERS AND TRANSFORMERS: Design of chokes, core, airgap, inductance, reactance, impedance, transformers, half wave, full wave windings.
VACUUM TUBES: Two element filament type, electronic emission, limitations, classifications of filaments, structure, two element rectifying tubes, process of rectification, tungar bulb.
THREE ELEMENT TUBES: Structure of tube, detector, grid bias, grid leak and condenser, amplifiers, tube constants, voltage amplification, resistance coupling, reactance coupling, transformer coupling, variation of impedance of load with frequency, tuned plate circuit.
POWER AMPLIFICATION: Square law, effect of load, calculation of output power, undistorted output power, parallel tubes, push-pull systems, plate resistance.
GRAPHS AND RESPONSE CURVES: Types of paper, utility of curves, types of curves, significance of curves, voltage amplification, power amplification, power output, radio frequency amplification.
MULTIPLE STAGE AMPLIFIERS: Resistance coupling, reactance coupling, tuned double impedance amplification, underlying principles, transformer coupling, turns ratio, voltage ratio, types of cores, late current limitation, grid current limitation.
ALTERNATING CURRENT TUBES: Temperature variation, voltage variation, relation between grid and filament, filament circuit center tap, types of AC tubes.
SCREEN GRID TUBE: Structural design, application, amplification, associated tuned circuits, radio frequency amplification, audio frequency amplification.

Wiring Diagrams of All These Receivers

- | | | |
|---|--|---|
| <p>R. C. A.
60, 62, 20, 64, 30, 105, 51, 18, 32, 50, 25 A.C., 28 A.C., 41, Receptor S.P.U., 17, 18, 33.</p> <p>FEDERAL
Type E series filament, Type E series filament, Type D series filament, Model K, Model H.</p> <p>ATWATER-KENT
10B, 12, 20, 30, 35, 48, 32, 33, 40, 38, 36, 37, 40, 42, 52, 50, 44, 43, 41 power units for 37, 38, 44, 43, 41.</p> <p>CROSLLEY
XJ, Trirdyn 3R3, 601, 401, 401A, 608, 704, B and C supply for 704, 704A, 704B, 705, 706.</p> <p>STEWART-WARNER
300, 305, 310, 315, 320, 325, 500, 520, 525, 700, 705, 710, 715, 720, 530, 535, 750, 801, 802, 806.</p> <p>GREBE
MU1, MU2, synchrophase 5, synchrophase AC8, synchrophase AC7, Deluxe 428.</p> <p>PHILCO
Philco-electric, 82, 86.</p> <p>KOLSTER
4-tube chassis used in 6 tube sets, tuning chassis for 7 tube sets, power amplifier, 7 tube power pack and amplifier, C tube power pack and amplifier, 6 tube power pack and amplifier, rectifier unit K-23.</p> | <p>ZENITH
39, 39A, 392, 392A, 40A, 35PX, 35APX, 352X, 352APX, 37A, 35P, 35AP, 352P, 352AP, 34P, 342P, 33, 34, 35, 35A, 342, 352, 352A, 362, 31, 333, 353A, power supply ZE17, power supply ZE12.</p> <p>MAJESTIC
70, 70B, 180, power pack 7BP3, 7P6, 7P3 (old wiring) 8P3, 8P6, 7BP6.</p> <p>FRESHMAN
Masterpiece, equaphase, G, G-60-S power supply, L and I.S, Q15, Q, K60-S power supply.</p> <p>STROMBERG-CARLSON
1A, 2B, 501, 502, 523, 524, 635, 638, 403AA power plant, 404 RA power plant.</p> <p>ALL-AMERICAN
6 tube electric, 8 tube 80, 83, 84, 85, 86, 88, 6 tube 80, 81, 82, 85, 86, u and 8 tube A.C. power pack.</p> <p>DAY FAN
OEM7, 4 tube, 5-5 tube 1925 model, Day Fan 8 A.C., power supply for 6 tube A.C., B power supply 5524 and 5525, motor generator and filter, 6 tube motor generator set, 6 tube 110 volt D.C. set, 6 tube 32 volt D.C. set.</p> | <p>FADA
50/80A receivers, 460A, Fada 10, 11, 30, 31, 10Z, 11Z, 30Z, 31Z, 16, 17, 32, 16Z, 32Z, 18, 18, special, 192A-192S and 192BS units, R30A, 430A, and SF 50/80A receivers, 460A receiver and R80 unit, 7 A.C. receiver, 475 UA or CA and SP45-75 UA or CA, 50, 70, 71, 72, G electric unit for special, and 7 A.C. receivers, ABC 6 volt tube supply, 86V and 82W, E180Z power plant and E 420 power plant.</p> <p>FREED EISEMANN
NR5, FE18, NR70, 470, NR57, 457, NR11, NR80 D.C.</p> <p>COLONIAL
26, 31 A.C., 31 D.C.</p> <p>WORKRITE
8 tube chassis, 6 tube chassis.</p> <p>AMRAD
70, 7100, 7191 power unit.</p> <p>SPARTON
A.C. 39.</p> <p>MISCCELLANEOUS
DeForest F5, D10, D17. Super Zenith Magnavox dial, Thermodyne, Grimes 4DL Inverse duplex, Garod neodyne, Garod EA, Ware 7 tube, Ware type T, Federal 102 special, Federal 59, Kennedy 220, Operadio portable, Sleeper RX1, Amrad Inductrol.</p> |
|---|--|---|

HERE ARE THE 22 CHAPTER HEADINGS

- | | |
|---|--|
| <p>Servive Procedure
 Practical Application of Analysis
 Vacuum Tubes
 Operating Systems
 Aerial Systems
 "A" Battery Eliminators
 Troubles in "A" Eliminators
 Trouble Shooting in "A" Eliminators
 "B" Battery Eliminators
 Troubles in "B" Battery Eliminators</p> | <p>Trouble Shooting in "B" Battery Eliminators
 Speakers and Types
 Audio Amplifiers
 Trouble Shooting in Audio Amplifiers
 Troubles in Detector Systems
 Radio Frequency Amplifiers
 Trouble Shooting in RF Amplifiers
 Series Filament Receivers
 Testing, and Testing Devices
 Troubles in DC Sets
 Troubles in AC Sets</p> |
|---|--|

"Testing Units for Service Men."

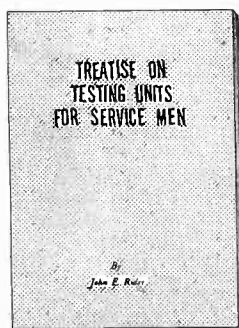

A 43-page, liberally illustrated book on testing units and circuits. Tells what equipment a service man should have and how to use it most effectively and quickly. Rapidity of operation is one of the points stressed throughout this valuable book, as a service man's time is his chief stock in trade.

CONTENTS

- Tube Reactivator and Voltages
- Calibrated Vacuum Tube Bridge
- General Utility Tube Tester
- AC-DC Receiver Tester
- Eliminator Testers
- Signal Generator for Receiver Testing
- Oscillators
- Cathode Ray Oscillograph
- Indicating Systems
- Tube Voltmeters
- Measurement of Inductance, Impedance, Capacity, DC Resistance
- Multi-Range Meters
- Service Station Test Bench

RADIO WORLD, 145 West 45th St., New York, N. Y.
 (Just East of Broadway)

Enclosed please find:

- \$3.50 for which please send me postpaid "Trouble Shooter's Manual" (Cat. TSM), by John F. Rider, 240 pages, 8 1/2 x 11", more than 200 illustrations, including wiring diagrams of commercial receivers as advertised; imitation leather cover, gold lettering.
- \$2.00 for which please send me postpaid "Mathematics of Radio" (Cat. MOR), by John F. Rider, 128 pages, 8 1/2 x 11", 119 illustrations, flexible cover.
- \$1.00 for which please send me postpaid "Treatise on Testing Units for Service Men" (Cat. TU), by John F. Rider, 43 pages, 6 1/4 x 9 1/4".
- If ordering C.O.D., put cross in this square.

NAME.....

ADDRESS.....

CITY..... STATE.....

[Canadian remittances must be made by postal or express money order.]

NEW J-245-X TROUBLE-SHOOTING JIFFY TESTER

Illumination Continuity and Polarity Tester FREE with Each Outfit!

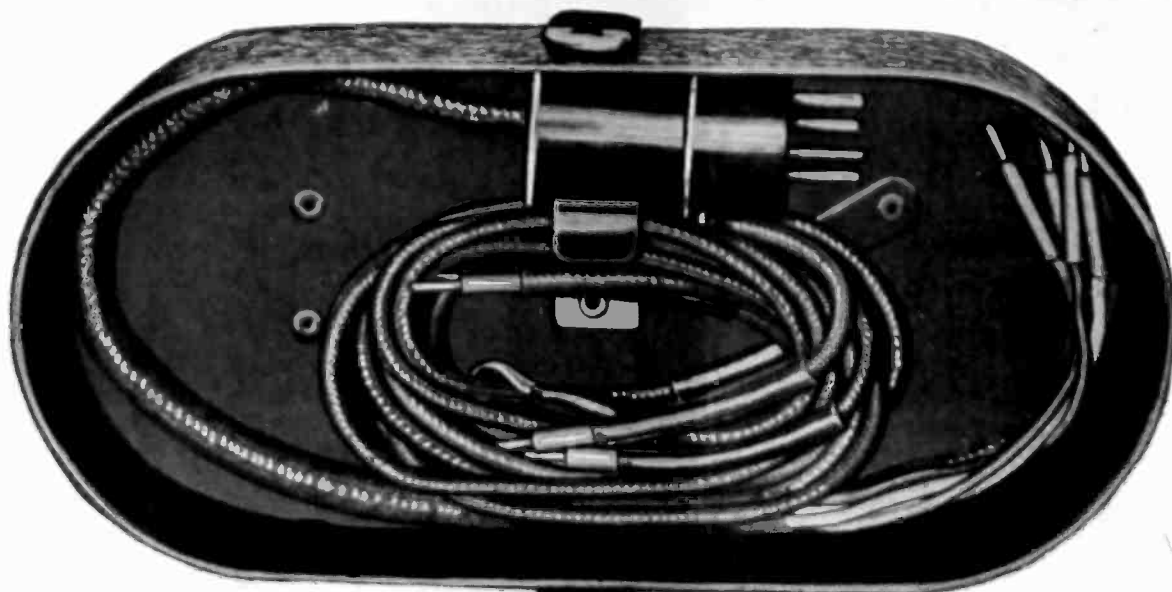

Your Price
\$15.82

Complete



Illumination Tester, Vest Pocket Size, Shows Shorts and Opens. Visually, also polarity of DC lines. A Neon lamp is built in.

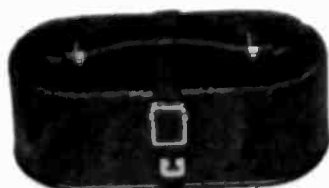

The three-meter assembly, in the crackle-brown finish carrying case, with slip-on cover and a cable plug. There are ten adapters. It is vital to have the complete outfit so you can meet any emergency.



Illustration above is 2/3 scale.

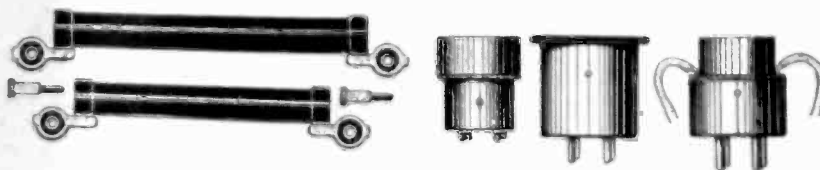

J-111 Multiplier, upper left, with tip; below it, J-106 Multiplier with tip; plus, left to right, J-19, conforms UV socket to UX plug; J-20, conforms UX tester socket to UV199 tube; J-24, to test Kellogg and old style Arcturus tubes.

Makes All Necessary Tests in a Jiffy and Simplifies Service Work!

THE new Jiffy Tester, J-245-X, is a complete servicing outfit. It consists of a three-meter assembly in a metal case, with slip-on cover and a cable plug. There are ten adapters. It is vital to have the complete outfit so you can meet any emergency.

With this outfit you plug the cable into a vacated socket of a receiver, putting the removed tube in the tester, and using the receiver's power for making these tests: plate current, up to 100 milliamperes; plate voltage up to 300 volts; filament or heater voltage (AC or DC), up to 10 volts.

Each meter may be used independently. One of the adapters—a pair of test leads, one red, the other black, with tip jack terminals—serves this purpose. Multiplier J-106 extends the range of the DC voltmeter to 600 volts, but this reading must be obtained independently, as must readings on the 0-60 scale of the DC voltmeter. Independent reading of the AC voltmeter for line of voltage is necessary; also to use 0-140 scale while Multiplier J-111 extends the AC scale to 560 volts for reading power transformer secondaries.

The other adapters permit the testing of special receiver tubes, so that tests may be made, in all, of 22 different tubes: 201A, 200A, UX199, UV199, 120, 240, 171, 171A, 112, 112A, 245, 224, 222, 228, 280, 281, 227, 226, 210, 250, Kellogg tubes and old style Arcturus tubes.

WHEN servicing a radio set, power amplifier, speech amplifier or sound reproduction or recording equipment, the circuits and voltages are almost inaccessible, unless a plug-in tester is used.

The Jiffy 245-X plugs in and does everything you want done. It consists of:

- (1)—The encased three-meter assembly, with 4-prong (UX) and 5-prong (UY) sockets built in; changeover switch built in, from 0-20 to 0-100 ma.; ten vari-colored jacks, five of them to receive the vari-colored tipped ends of the plug cable; grid push-button, that when pushed in connects grid direct to the cathode for 224 and 227 tubes, to note change in plate current, and thus shorts the signal input.
- (2)—4-prong adapter for 5-prong plug of cable.
- (3)—Screen grid cable for testing screen grid tubes.
- (4)—Pair of Test Leads for individual use of meters.
- (5)—J-106 Multiplier, to make 0-300 DC read 0-600.
- (6)—J-111 Multiplier, to make 0-140 AC read 0-560.
- (7)—Two jack tips to facilitate connection of multipliers to jacks in tester.
- (8), (9), (10)—Three adapters so UV199 and Kellogg tubes may be tested.
- (11)—Illumination Tester.

The illumination tester will disclose continuities and opens and also the polarity of DC house mains. It is as handy as a pencil and fits in your vest pocket. It works on voltages from 100 to 400. There are two electrodes in a Neon lamp in the top of the instrument. On AC both electrodes light. On DC only one lights, and that one is negative of the line, the light being on the same side as the lead. Hence the illuminator shows whether tested source is AC or DC, and if DC, which side is negative.

Even the output of the speaker cord will show a light. Also, the device will test which fuses are blown in fused house lines, AC or DC. Besides it tests ignition of spark plugs of automobiles, boats and airplanes, also faulty or weak spark plugs.

Just flash on the illumination tester momentarily. It will last about 4,000 flashes.

GUARANTY RADIO GOODS CO.
143 West 45th Street, Just East of Broadway,
N. Y. City.

- Please send me on 5-day money-back guaranty your J-245-X Jiffy Tester, complete, with all 10 adapters, and with illuminated Tester FREE with each order. Also send instruction sheet, tube data sheet and rectifier tube testing information.
- Enclosed please find \$15.82 remittance. Ship at your expense. [Canadian must be P.O. or Express M.O.]
- Please ship C. O. D. @ \$15.82 plus cartage and P.O. fee.

NAME
ADDRESS
CITY STATE

5-DAY MONEY-BACK GUARANTY