

SECRET OF HIGHER B SUPPLY VOLTAGES!

October 5th, 1929

15 Cents

RADIO

REG. U.S. PAT. OFF.

WORLD

The First and Only National Radio Weekly

393rd Consecutive Issue—EIGHTH YEAR

PUSH-PULL
RESISTANCE
AUDIO

TELEVISION'S
STATUS TO-DAY
EXPLAINED

THREE TUBE SG CIRCUIT: PARTS \$11.10

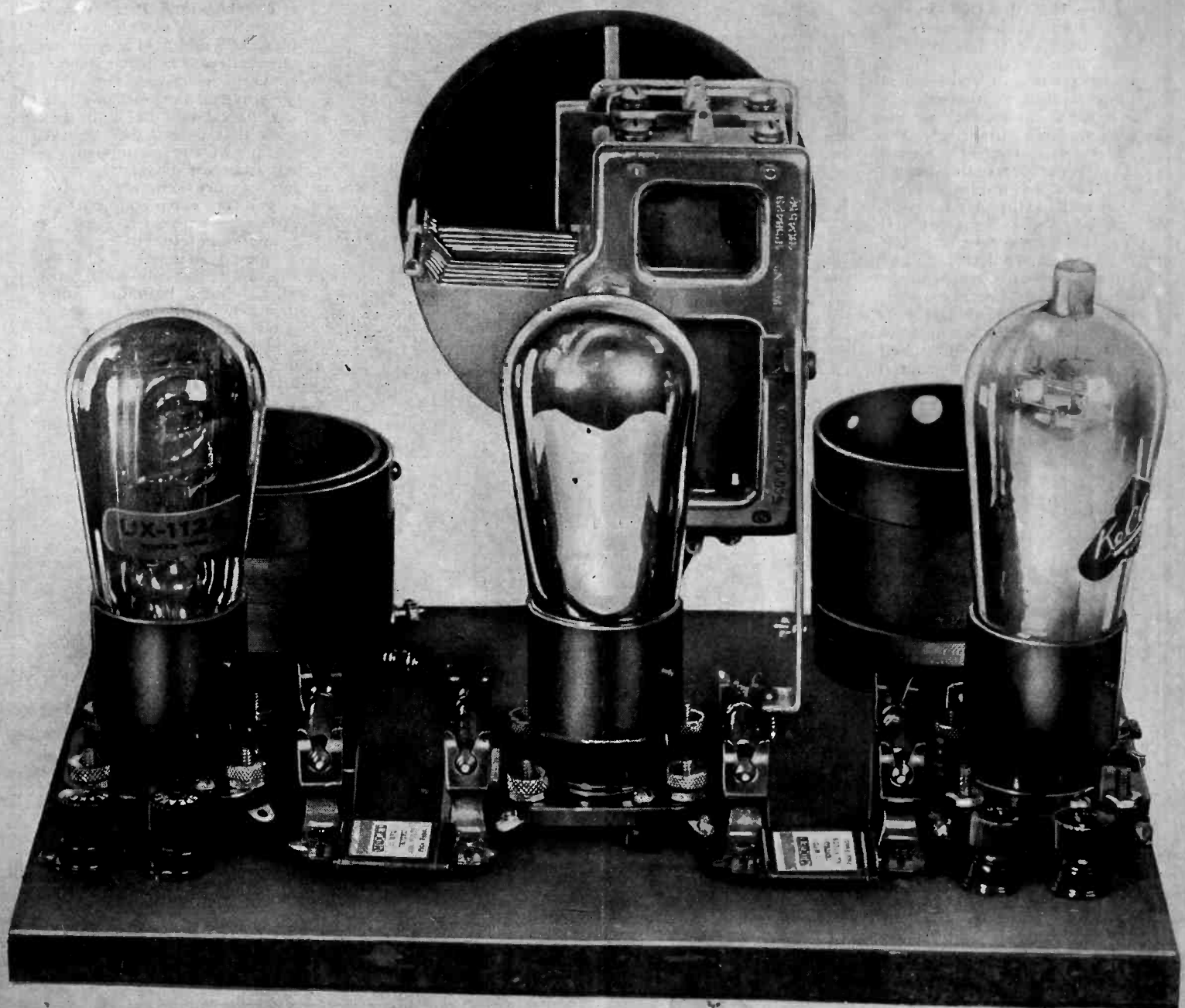

See pages 15, 16 and 17 for "blueprint" of and article on Schoolboy's Three Tube

A NEW IDEA IN COILS!

The Bernard Tuner Works Screen Grid Tubes Up to the Hilt!

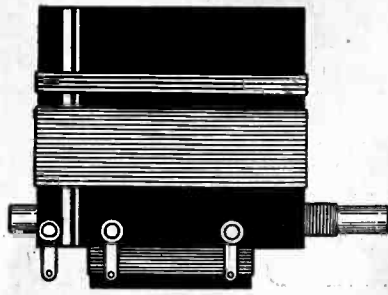

Cat. No. BT5A—\$2.50
FOR .0005 MFD. CONDENSERS
 Bernard Tuner for antenna coupling, the primary being fixed and the secondary tuned. This coil is used as input to the first screen grid radio frequency tube. The double-action tuning method invented by Herman Bernard is employed. Adjust an equalizing condenser across the tuning condenser so that exactly the same dial settings prevail through all circuits. This equalizer, 90 mmfd., once set, is left thus.
 Cat. No. BT3A for .00035 mfd.\$2.85

FOR the first time in radio a coil has been designed that permits working the screen grid tube up to the enormous amplification level that theory long promised but practice long denied.

The secret lies in tuning the plate circuit of the screen grid tube, and still covering the entire broadcast band. Herman Bernard, noted radio engineer, invented the solution—a tuned coil consisting of a fixed and a rotating winding in series, the moving coil turned by the same dial that turns the tuning condenser. An insulated link physically unites condenser shaft and moving coil. Thus when the condenser plates are entirely in mesh the moving coil is set for maximum inductance, that is, it aids the other part of the tuned winding. As the condenser is turned to lower capacity setting the moving coil aids less and less, until at the middle of the dial it acts as if fixed. From then on the moving coil bucks the fixed winding, greatly reducing the total effective inductance, and thus nullifying the effect of the high starting capacity.

The Bernard Tuner is a two-winding coil for interstage coupling, working out of a screen grid tube, 222 or 224, and into any type tube. The tuned primary has been coupled to it a still larger inductance, on separate inside form, for step-up, thus greatly increasing an already enormous amplification! This is Cat. No. BT5B for .0005 mfd., BT3B for .00035 mfd. Use BT5A or BT3A for antenna coupler, tuning the secondary, with an equalizing condenser across the antenna tuning condenser, so that the high minimum capacity of the tube's output will be duplicated at the input.

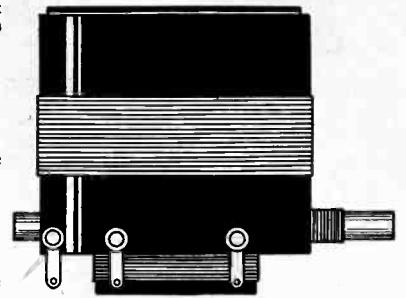

Cat. No. BT5B—\$2.50
FOR .0005 MFD. CONDENSERS
 Bernard Tuner for working out of a screen grid tube, consists of a rotary coil in series with a fixed coil, the two constituting a tuned primary, for tuning the combined rotary and fixed windings to exceed the broadcast band of wavelengths. The condenser shaft and rotary coil shaft are physically coupled so one motion turns both. Develops the highest possible amplification from the screen grid tube.
 Cat. BT3A for .00035 mfd.\$2.85

The Diamond Pair

Since 1925 the Diamond of the Air has been an outstanding circuit. It has undergone few changes. When power tubes and screen grid tubes appeared these were included. When AC operation became practical, the model was described for such use. Whether battery-operated or AC-operated, the Diamond of the Air is a dependable and satisfactory circuit. It uses a screen grid RF stage, tickled detector and two stages of transformer coupled audio. The same coils are used for both models, battery or AC. The secondaries are tuned. They are matched with fine precision, to permit ganged tuning.

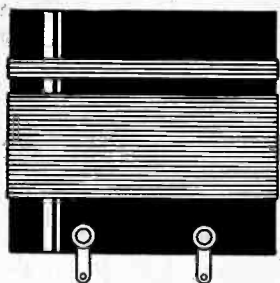

Cat. No. RF5—\$0.75
FOR .0005 MFD. CONDENSER
 Antenna coil for any standard circuit, and one of the two coils constituting the Diamond Pair. The secondary is carefully wound to match the inductance of the companion coil's secondary, so equality of tuning prevails.
 Cat. No. RF3 for .00035...\$0.80

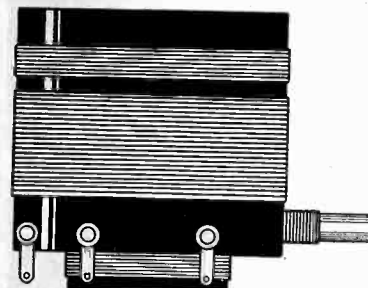

Cat. No. SGT5—\$1.25
FOR .0005 MFD. CONDENSER
 Interstage 3-circuit coil for any hook-up where an untuned primary is in the plate circuit of a screen grid tube. This primary has a large impedance (generous number of turns), so as to afford good amplification. Used in the Diamond of the Air.
 SGT3 for .00035 mfd.\$1.30

The Diamond Pair of coils for .0005 mfd. tuning are Cat. Nos. RF5 and SGT5. A circuit of excellent stability, extremely high selectivity and good sensitivity, the Diamond of the Air should be built with coils that permit full capitalization of the virtues of the circuit. Not only is the number of turns correct for this circuit on each coil, but the spacing between aperiodic primary and tuned secondary is exactly right. Note that the 3-circuit coil SGT5 (or SGT3) has a high impedance primary. This means good amplification from the screen grid tube, obtained in a manner that guarantees selectivity attainment.

ANTENNA COUPLER

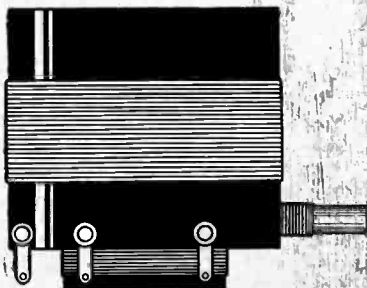

Cat. No. VA5—\$1.10
FOR .0005 MFD. CONDENSER
 Moving primary and fixed secondary, for antenna coupling, adjustable from a knob at the front panel, thus providing volume control.
 Cat. No. VA3 for .00035 mfd.\$1.15

SG TRANSFORMER

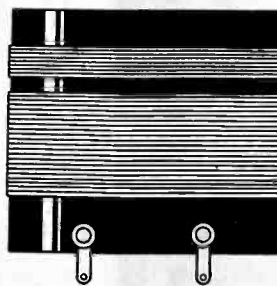

Cat. No. SG85—\$0.75
FOR .0005 MFD. CONDENSER
 Interstage radio frequency transformer, to work out of a screen grid tube, where the generous-sized primary is in the untuned plate circuit.
 Cat. No. SG83 for .00035 mfd.\$0.80

STANDARD TUNER

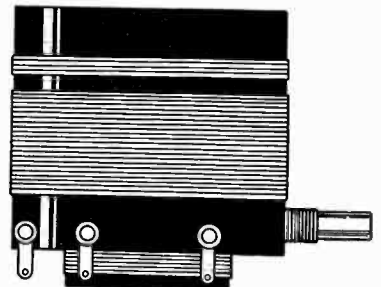

Cat. No. T5—\$1.25
FOR .0005 MFD. CONDENSER
 Standard three-circuit tuner, for antenna stage, or interstage coupling where primary is in the plate circuit of any tube except a screen grid. Provides abundant selectivity and gives smooth tickler action.
 Cat. T3 for .00035 mfd.\$1.30

SCREEN GRID COIL COMPANY, 143 West 45th St., New York, N. Y. Just East of Broadway

Enclosed please find \$..... for which please ship at once, parcel post prepaid, the following coils:

Quantity	Cat. No.	Price	Quantity	Cat. No.	Price	Quantity	Cat. No.	Price	Quantity	Cat. No.	Price
<input type="checkbox"/>	BT5A	\$2.50	<input type="checkbox"/>	RF5	\$0.75	<input type="checkbox"/>	VA5	\$1.10	<input type="checkbox"/>	SG85	\$0.75
<input type="checkbox"/>	BT5B	\$2.55	<input type="checkbox"/>	RF3	\$0.80	<input type="checkbox"/>	VA3	\$1.15	<input type="checkbox"/>	SG83	\$0.80
<input type="checkbox"/>	BT5B	\$2.60	<input type="checkbox"/>	SGT5	\$1.25	<input type="checkbox"/>	T5	\$1.25	<input type="checkbox"/>	FL1	\$0.35
<input type="checkbox"/>	BT3B	\$2.55	<input type="checkbox"/>	SGT3	\$1.30	<input type="checkbox"/>	T3	\$1.30	<input type="checkbox"/>	EQ80	\$0.35

NAME

ADDRESS

CITY..... STATE.....

5-DAY MONEY-BACK GUARANTEE!

Insulated Link

A flexible coupling device to unite two independent 1/4" shafts for single dial operation of a tuning condenser and a Bernard Tuner. If the condenser has shaft protruding from the rear, then the condenser may be panel-mounted and the coil shaft coupled by the link to either extension shaft of the condenser. If the condenser has no shaft protruding at rear, mount the Bernard Tuner on the front panel. It has shaft protruding at rear for coupling by the link to the condenser's front shaft. To make sure of insulated protection do not force the receptacles of the link together when mounting.



FL1..\$0.35

Data on Construction

The coils are wound by machine on a bakelite form 2 1/2" wide, and the tuned windings have identical inductance for a given capacity condenser, i. e., .0005 mfd. or .00035 mfd. Full coverage of the wave band is assured. The wire is silk insulated.

All coils with a moving coil have single hole panel mounting fixture. All others have base mounting provision. The coils should be used with connection lugs at bottom, to shorten leads.

Only the Bernard Tuners have a shaft extending from rear. This feature is necessary so that physical coupling to tuning condenser shaft may be accomplished by the insulated link.

(Note: Those desiring the 80 mmfd. equalizing condenser for use with the antenna model Bernard Tuner, BT5A or BT3A, should order EQ80 at \$0.35.)

SCREEN GRID COIL COMPANY
 143 West 45th Street, New York City

Rider Lifts a BIG Load Off the Service Man's Chest!

In New Book Noted Radio Engineer Devotes 240 Pages to Trouble Shooting in All Receivers and Gives the Wiring Diagrams of Factory-Made Sets in 200 Illustrations—You Can Carry This Book Around With You—No More Torture Tracing Out Circuits.

“Trouble Shooter’s Manual” By John F. Rider JUST OUT!

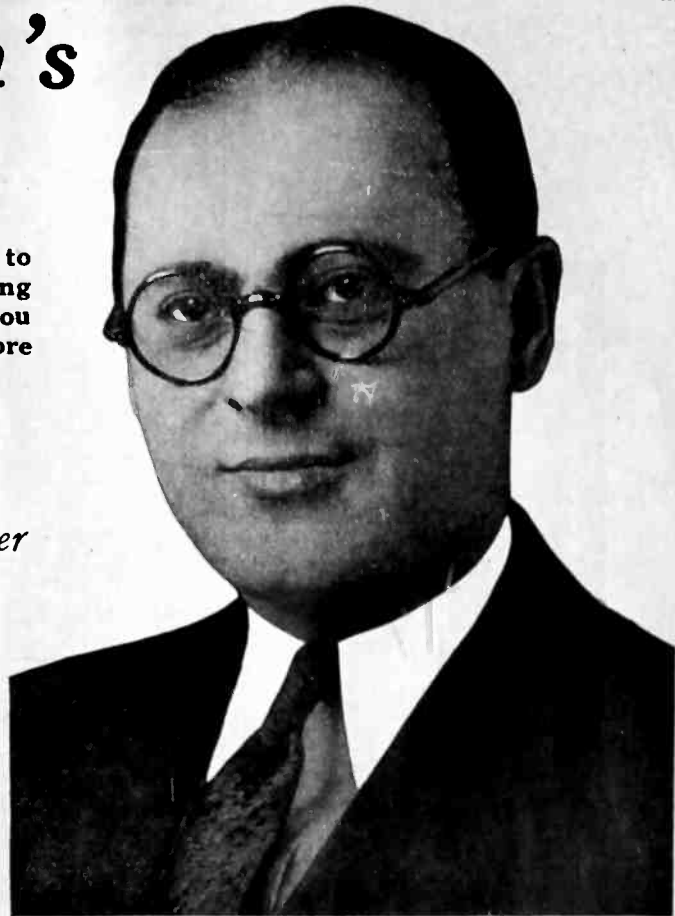

JOHN F. RIDER
Member, Institute of Radio Engineers

The first comprehensive volume devoted exclusively to the topic uppermost in every service man's mind is "Trouble Shooter's Manual," just published. It is not only a treatise for service men, telling them how to overcome their most serious problems, and fully diagramming the solutions, but it is a course in how to become a service man. It gives all the details of servicing as they have never been given before. Finding the right mode of attack, applying the remedy promptly and obtaining the actual factory-drawn diagrams of receivers always have been a load on the service man's chest. But no more. Rider, expert on trouble shooting, has produced the outstanding volume on servicing, and has taken the load off the service man's chest!

This book is worth hundreds of dollars to any one who shoots trouble in receivers—whether they be factory-made, custom-built or home-made receivers. The home experimenter, the radio engineer, the custom set-builder, the teacher, the student,—all will find this new book immensely informative and absolutely authoritative.

Wiring Diagrams of All These Receivers!

Besides 22 chapters covering thoroughly the field of trouble shooting, this volume contains the wiring diagrams of models, as obtained direct from the factory, a wealth of hitherto confidential wiring information released for the first time in the interest of producing better results from receivers. You will find these diagrams alone well

- R. C. A.** 60, 62, 20, 64, 30, 105, 51, 16, 32, 50, 25 A.C., 28 A.C., 41, Receptor S.P.U., 17, 18, 33.
- FEDERAL** Type F series filament, type E series filament, type D series filament, Model K, Model H.
- ATWATER-KENT** 10B, 12, 20, 30, 35, 48, 32, 33, 49, 38, 36, 37, 40, 42, 52, 50, 44, 43, 41, power units for 37, 38, 44, 43, 41.
- CROSLLEY** XJ, Trirdyn 3R3, 601, 401, 401A, 608, 704, B and C supply for 704, 704A, 704B, 705, 706.
- ZENITH** 39, 39A, 392, 392A, 40A, 35PX, 35APX, 352PX, 352APX, 37A, 35P, 35AP, 352P, 352AP, 34P, 342P, 33, 34, 35, 35A, 342, 352, 353A, 362, 31, 32, 333, 353A, power supply ZE17, power supply ZE12.
- MAJESTIC** 70, 70B, 180, power pack 7BP3, 7P6, 7P3 (old wiring) 8P3, 8P6, 7BP6.
- FRESHMAN** Masterpiece, equaphase, G, G-60-S power supply, L and LS, Q15, K, K-60-S power supply.
- FADA** 50/80A receivers, 460A Fada 10, 11, 30, 31, 10Z, 11Z, 30Z, 31Z, 16, 17, 32, 16Z, 32Z, 18, special, 192A-192S and 192BS units, R80A, 480A, and SF 60/80A receivers, 460A receiver and R60 unit, 7, A.C. receiver, 475 UA or CA and SF45-75 UA or CA, 50, 70, 71, 72, C electric unit for special and 7 A.C. receivers, ABC 6 volt tube supply, 88V and 82W, E180Z power plant and E 420 power plant.
- FREED-EISEMANN** NR5, FE19, NR70, 470, NR 57, 457, NR11, NR80 DC.

worth the price of the book. The wiring diagrams are of new and old models, of receivers and accessories, and as to some of the set manufacturers, all the models they ever produced are shown in wiring diagrams! Here is the list of receivers, etc., diagrams of which are published in this most important and valuable book:

- STEWART-WARNER** 300, 305, 310, 315, 320, 325, 600, 520, 525, 700, 703, 710, 715, 720, 530, 535, 750, 801, 802, 806.
- STROMBERG-CARLSON** 1A, 2B, 501, 502, 523, 524, 635, 636, 403AA power plant, 404 RA power plant.
- ALL-AMERICAN** 6 tube electric, 8 tube 80, 83, 84, 85, 86, 88, 9 tube 60, 61, 62, 65, 66, 6 and 3 tube A.C. power pack.
- PHILCO** Philco-electric, 82, 86.
- KOLSTER** 4-tube chassis used in 6 tube sets, tuning chassis for 7 tube sets, power amplifier, 7 tube power pack and amplifier, 6 tube power pack and amplifier, rectifier unit K23.
- COLONIAL** 28, 31 A.C., 31 D.C.
- WORKRITE** 4 tube chassis, 6 tube chassis.
- AMRAD** 70, 7100, 7191 power unit.
- SPARTON** A.C. 8v.
- MISCELLANEOUS** DeForest F5, D10, D17, Super Zenith Magnavox dial, Thermodyne, Grimes 4DL inverse duplex, Garod EA, neutrodyne, Garod EA, Ware 7 tube, Ware type T, Federal 103 special, Federal 59, Kennedy 220, Operadio portable, Sleeper RX1, Armad Industrol.

Some of the Questions Settled in Book:

Securing information from the receiver owner, list of questions, practical chart system of repairs, circuits and operating conditions. Repairs in the home, method of operation, spare tubes, the process of elimination, recognizing symptoms, examples of practical application, tracing distortion, tracing electrical disturbances; vacuum tube tests; neutralizing systems, filament circuits, grid circuits, methods of securing grid bias, plate circuits; long aerials; short aerials; selectivity, imperfect contact, directional qualities; grounds; "A" battery eliminator types, design, operating limitations, requirements for perfect operation, AC eliminators, DC eliminators; "A" eliminator hum, reasons, voltage, reasons, noise; full wave, half wave, B battery eliminators, filament rectifiers, gaseous rectifier, dry disc rectifier, wiring, parts used, design, voltage regulation, operating limitations, requirements for perfect operation, combination filament and plate voltage eliminators, AC and DC types; B battery eliminator output current and voltage, excessive hum, dead eliminator, poor design, reasons for defects, motorboating, punctured condensers, shorted chokes, voltage regulator tubes, function of filter system, C bias voltages, voltage divider systems, filter condensers, by-pass condensers, voltages in the system; determining voltages in B eliminators, AC, DC, voltage drop, effect of shorted filter system, defective rectifiers, defective transformer, defective chokes, defective by-pass condenser, design of filter system, defective voltage divider network, relation between hum and output voltage, isolation of troubles, external filters, noise filters; cone, dynamic exponential speakers, troubles, dead, weak output, distorted output, rattle, continuity testing, windings, magnets, frequency filters, testing, chokes, condensers, hum elimination; audio amplifier types, transformer, resistance, impedance, auto-transformer, combinations, requirements for perfect operation, operating limitations, tubes, forms of coupling, plate voltage, grid voltage, filament voltage, isolating condensers, voltage reducing resistances, noises, analysis of trouble, plate current, grid current.

“The Mathematics of Radio”

John F. Rider wrote two companion books grouped under the title "Service Man's Manual." The first was "Mathematics of Radio," the second "Trouble Shooter's Manual." The value of one of these books is more than doubled by the possession of the other. "The Mathematics of Radio," 128 pages, 8 1/2 x 11", 119 illustrations, bridges the gap between the novice and the college professor. It gives a theoretical background necessary for a proper understanding of radio and audio circuits and their servicing.

Here are the 22 chapter headings:

- SERVICE PROCEDURE
- PRACTICAL APPLICATION OF ANALYSIS
- VACUUM TUBES
- OPERATING SYSTEMS
- AERIAL SYSTEMS
- "A" BATTERY ELIMINATORS
- TROUBLES IN "A" ELIMINATORS
- TROUBLE SHOOTING IN "A" ELIMINATORS
- "B" BATTERY ELIMINATORS
- TROUBLES IN "B" BATTERY ELIMINATORS
- TROUBLE SHOOTING IN "B" BATTERY ELIMINATORS
- BATTERY ELIMINATORS
- SPEAKERS AND TYPES
- AUDIO AMPLIFIERS
- TROUBLE SHOOTING IN AUDIO AMPLIFIERS
- TROUBLES IN DETECTOR SYSTEMS
- RADIO FREQUENCY AMPLIFIERS
- TROUBLE SHOOTING IN RF AMPLIFIERS
- SERIES FILAMENT RECEIVERS
- TESTING, AND TESTING DEVICES
- TROUBLES IN DC SETS
- TROUBLES IN AC SETS

RADIO WORLD, 145 West 45th St., New York, N. Y. (Just East of Broadway)

Enclosed please find: \$3.50 for which please send me postpaid "Trouble Shooter's Manual," by John F. Rider, being Part II of "Service Man's Manual," 240 pages, 8 1/2 x 11", more than 200 illustrations, including wiring diagrams of commercial receivers as advertised; imitation leather cover, gold lettering.

\$2.00 for which please send me postpaid "Mathematics of Radio," by John F. Rider, 128 pages, 8 1/2 x 11", 119 illustrations, flexible cover, this being Part I of "Service Man's Manual."

NAME
ADDRESS
CITY STATE

FLECHTHEIM

1,000 v. DC
500 v. AC(rms)
Filter Condensers at
Professional Discounts



Filter Condenser, Actual Size

Result of Years of Experimenting

UNBELIEVABLY compact, light in weight, made of the highest grade materials, these condensers are the result of many years of patient and constant research. The marvelous achievement is exemplified and substantiated by independent tests.

Types HV can be used to replace all types of condensers having a continuous working voltage up to 1,000 volts DC and will give utmost satisfaction and dependability for a rectified AC voltage up to and including 550 volts rms. Hence, it is just the filter condenser you want for 171A, 245 or 210 power packs, single or push-pull.

Twelve Telling Points

- (1) Rated conservatively at voltages up to 1,000 volts DC (500 rms. AC.)
- (2) Tested and re-tested at 1,500 volts DC.
- (3) Breakdown voltage of 2,500 volts DC.
- (4) Breakdown voltage, foil to case, 5,000 volts AC.
- (5) Power factor (voltage loss) less than 1%.
- (6) Resistance over 600 megohms per mfd.
- (7) Negligible dielectric losses.
- (8) Capacity is non-inductive and is accurate to within 5% of rating.
- (9) Remarkably compact size; all capacities same height.
- (10) Great saving in weight.
- (11) Highly perfected terminal connectors and insulators.
- (12) Proved by fatigue tests to have longer life.

THREE-IN-ONE

Type HV244 is a high-grade capacity bank to operate at voltages up to and including 750 rms AC. Just the unit to use for a B supply for the 250 tubes, single or push-pull. Consists of a bank of condensers tapped 0-2-4-4 mfd. The 2 mfd. section is made to withstand the terrific punishment of voltage surges, and sudden transient line voltages.

ACOUSTICAL ENGINEERING ASSOCIATES

143 West 45th Street, New York, N. Y.

Please send at once the Flechtheim condensers specified below. Quantity desired is marked in square.

- Send C.O.D. (check off).
 Remittance enclosed. (check off).

Type	Capacity Mfd.	Size	List Price	Net Price
<input type="checkbox"/> HV 5	.05	2 x 1 1/2 x 3/4"	\$1.75	\$1.03
<input type="checkbox"/> HV 10	.10	2 x 1 1/2 x 3/4"	2.00	1.18
<input type="checkbox"/> HV 25	.25	2 x 1 1/2 x 3/4"	2.25	1.32
<input type="checkbox"/> HV 50	.50	2 x 1 1/2 x 3/4"	2.50	1.47
<input type="checkbox"/> HV 100	1	2 x 1 1/2 x 3/4"	3.00	1.76
<input type="checkbox"/> HV 200	2	2 x 1 1/2 x 1 1/4"	5.00	2.94
<input type="checkbox"/> HV 400	4	2 x 1 1/2 x 2 1/4"	9.00	5.20
<input type="checkbox"/> HV 244	0-2-4-4	3 3/8 x 4 x 2 3/4"	25.00	

Name
Address
City State

Component Parts for the SCHOOLBOY'S 3-Tube Circuit as described by Jack Tully

L1L2—One antenna coupler, RF3.....	\$.80
L3L4—One screen grid coupler, TP3.....	.95
C1C2—One double condenser, .00035 mfd. ea.....	1.50
C3—One Hammarlund 80 mfd. equalizer.....	.35
C4, C5—Two, .01 mfd. mica fixed cond. (both).....	.70
C6—One .0025 mfd. mica fixed condenser.....	.21
R1, R4, R7—Three 5.0 meg. grid leaks (all 3).....	1.05
R2, Sw—One 75-ohm rheostat with switch.....	.80
R3—One 1.0 meg. metallized resistor.....	.35
R5—One 6.5-ohm fixed filament resistor.....	.25
R6—One 0.25 meg. metallized resistor.....	.21
R8—One 1.3-ohm fixed filament resistor.....	.20
Ant. Grid. Sp. — Sp. — All 3 binding posts.....	.40
1, 2, 3—Three UX sockets (all 3).....	.90
One seven-lead battery cable.....	.50
Four resistor mountings (all four).....	.84
One dial.....	.33
Hardware as prescribed by Jack Tully.....	.46

Three Kelly tubes: one 222, 240, 112a..... \$11.10
\$5.70

All prices are strictly net and represent extreme discount already deducted.

Guaranty Radio Goods Co.
143 West 45th Street
New York City
(Just East of Broadway)

SCHOOLBOYS Can Build a Broadcast Receiver for Only \$4.28

Using Component Parts for the Schoolboy 1-Tube DX Circuit

as described by Jack Tully

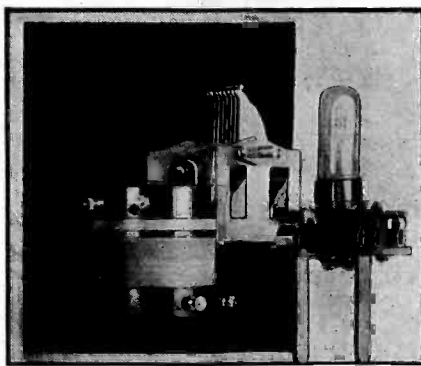

Side view of the Schoolboy's One-Tube Receiver

COMPONENT PARTS

[Check those you want.]

GUARANTY RADIO GOODS CO.
143 West 45th Street
New York, N. Y.

L1, L2, L3—3 circuit .00035 tuner knob.....	Price \$1.30
C1—Tuning condenser, .00035 mfd.....	.30
C2—Grid condenser, .00025 with clips.....	.21
C3—Fixed condenser, .0005 mfd.....	.19
R1—One 2-meg. leak.....	.30
R2—One 30-ohm rheostat, knob.....	.32
One 7 x 10" front panel.....	.59
One 3 x 6" subpanel.....	.42
One dial with pointer.....	.43
Six supporting brackets at .04.....	.24
	\$4.28

LACAULT'S BOOK

Super Heterodyne Construction and Operation, giving the master's most masterful exposition of the theory, performance and construction of this fascinating type of circuit. Is a necessity to every serious radio experimenter. More than 100 pages and more than 50 illustrations. Buckram cover. This book by R. E. Lacault, FREE if you send \$1.00 for an 8-weeks subscription for Radio World. Present subscribers may accept this offer. Subscription will be extended.

RADIO WORLD 145 W. 45th St., N. Y. City Just East of 8' way

PEERLESS 12" AC Super Dynamic Speaker in SONORA Highboy Cabinet

At Only **\$37.50**

LIST PRICE, \$155.00

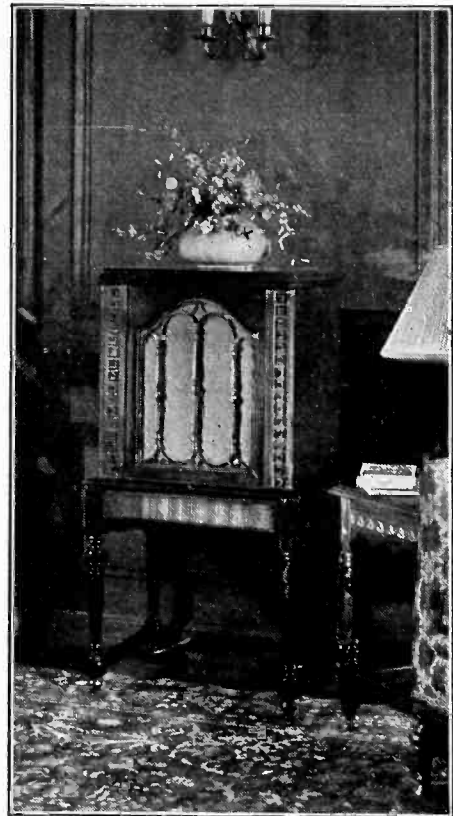

The famous Peerless AC dynamic speaker, with Kuprox rectifier and 1,500 mfd. hum-killing condenser built in, all housed in this 40" high Sonora cabinet of fascinating ply-walnut. The cabinet is all one piece—carved legs, marqueterie panel and grille pillars. Sliding back is made of cane. This imposing floor model speaker, exactly as illustrated, in original factory packing case, shipping weight 100 lbs. **\$37.50**

Amazing Buy!

Never in your life did you hear of such an amazing bargain—highest class, perfect, guaranteed merchandise at more than 75% off list price! Look at that beautiful highboy cabinet, its graceful legs, with archer's bow tiepiece; its rosetted side panels at front, its shapely grille pillars, all in two-tone effect, with high-polish surface of walnut. The speaker sets against a golden grille, with ample baffle board concealed.

Money-Back Guarantee!

Every precaution has been taken to produce the finest possible tone. The speaker is the genuine famous Peerless, operating directly from the 110-volt 50-60 cycle AC line. The cane back leaves the cabinet acoustically open to avoid box resonance. The entire outfit—speaker, rectifier, 1,500 mfd. condenser, AC cable, speaker cords and AC switch, all built up and wired—is sold only in this handsome cabinet.

Order yours TODAY on a 5-day money-back guarantee basis. No C.O.D. orders filled.

ACOUSTICAL ENGINEERING ASSOCIATES,

143 West 45th Street, New York, N. Y.

Gentlemen: Enclosed please find \$37.50 for which please ship by express at once one 12" diameter genuine Peerless AC dynamic speaker, with built-in Kuprox dry rectifier, 1,500 mfd. hum-killing condenser, AC cable, speaker cord, and AC switch built in, all contained in the Sonora ply-walnut highboy cabinet, with cane removable back; the cabinet consisting of one piece, ply-walnut, 40" high, 19" wide, 18" front to back; all in original factory carton. No C.O.D.

- Speaker alone \$23.50
 Cabinet alone \$15.00

Name
Address
City State

5-DAY MONEY-BACK GUARANTEE

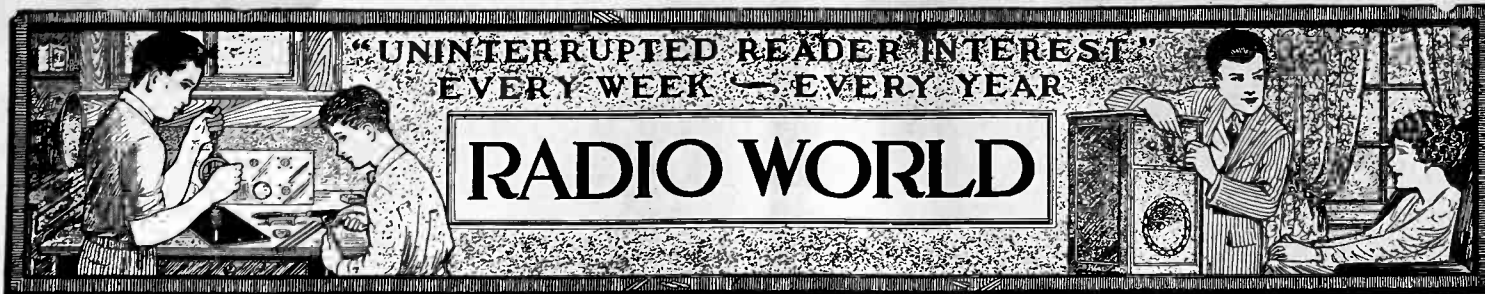

Vol. XVI. No. 3 Whole No. 393
 October 5th, 1929
 15c per Copy, \$6.00 per Year
 [Entered as second-class matter, March, 1922, at the Post Office at New York, N. Y., under act of March, 1879.]

Technical Accuracy Second to None
 Latest Circuits and News

EIGHTH YEAR

A Weekly Paper published by Hennessy
 Radio Publications Corporation, from
 Publication Office, 145 West 45th Street,
 New York, N. Y.
 (Just East of Broadway)
 Telephone, BRyant 0558 and 0559

B SUPPLY VOLTAGES

How They Are Affected by First Condenser

By Herbert E. Hayden

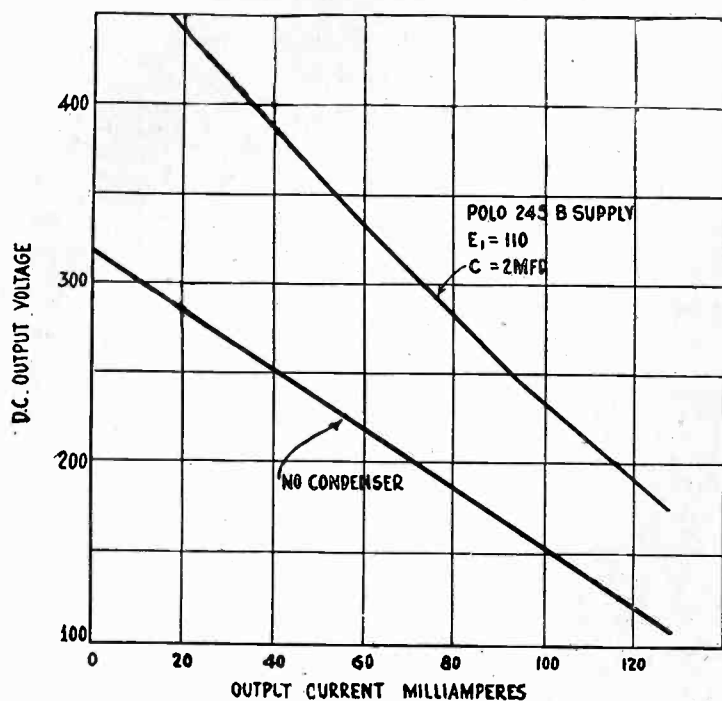

FIG. 1
 TWO REGULATION CURVES OF A POLO 245 POWER SUPPLY UNIT, THE UPPER CURVE WITH CONDENSER NEXT TO RECTIFIER, THE LOWER WITHOUT CONDENSER.

THE design of B supply units has become more or less standardized. Irrespective of the type of rectifier that is used, the filter begins with a shunt condenser of 1, 2 or 4 mfd. across the line. This is followed by a choke coil in series, usually in the positive side. Then follows another shunt condenser. A second series choke follows, and then a final shunt condenser of a capacity considerably larger than that previously used. In shunt with the final bypass condenser is the voltage divider, with its associated bypass condensers, and the load. There are many variations from this circuit, adapted to special requirements, but the circuit described above is regarded as standard.

For a long time it was considered necessary to use the first shunt condenser in order to obtain proper operation of the rectifier-filter. Recently, however, B supply units have been designed in which this condenser is omitted entirely. Several advantages are claimed for this arrangement. In the first place the tube is not subjected to such high stresses or strains, and its life is said to be lengthened. Secondly, the output of such a filter is more easily filtered. Thirdly, the voltage regulation is considerably better, and this fact is probably one of the chief advantages, at least in certain applications.

The arrangement has one principal disadvantage. The output voltage for a given output current is considerably lower, requiring a much higher effective AC input voltage on the rectifier tube.

The reason for the lower output voltage is clear. The power transformer works into a high inductance choke coil, through the rectifier tube. This choke causes a high voltage drop due to its high impedance. The presence of this choke in series with the line, without any storage condenser, also accounts for the more steady current drain from the tube.

Difference Illustrated

To illustrate the difference between the two circuits, two regulation curves have been taken on a Polo 245 power block, which are reproduced in Fig. 1. The lower curve was taken without any condenser, and the drop in the curves is due to resistances in the power transformer, in the 280 rectifier tube, and in the two choke coils built into the unit. The upper curve was taken under the same conditions with the exception that a 2 mfd. condenser was connected across the line next to the rectifier tube.

In both these cases the primary voltage was 110 volts, giving a total effective voltage of 724 volts across the secondary of the power transformer. The filament voltage on the rectifier tube was 5 volts.

On the lower curve the maximum DC voltage is only 325 volts, less than the effective AC voltage across each half of the secondary of the transformer. This maximum, of course, occurs when no current is drawn from the circuit. The regulation curve is very nearly straight over the range shown, and the voltage drop per milliamper change in the current drawn is 1.46 volts. This might be taken as a measure of the regulation. The smaller this drop per milliamper, the better is the regulation.

The upper curve has a steeper slope, and the slope varies from point to point. The unit was designed to work at 80 milliamperes and therefore we take the slope of the curve near this point. At 85 milliamperes the voltage is 270 volts and at 75 milliamperes it is 295 volts. The difference between the two voltages is 25 volts and the difference between the two currents is 10 milliamperes. Hence the drop per milliamper is 2.5 volts. If the slope be taken on the lower curve near the 80-milliamper point, it comes out 1.8 volt per milliamper. As the current drain increases, the difference between the slopes of the two curves becomes less.

Difference Unimportant

The difference between the slopes of the two curves in the normal operating range is not great enough to warrant the omission of the condenser, especially in view of the much greater voltage obtainable when the condenser is used.

If the bypass condenser is made larger than 2 mfd. the output voltage will be slightly higher than that indicated by the upper regulation curve. Thus 4 mfd. would make the voltage approximately 300 at 80 milliamperes. However, it is not recommended that a higher value than 2 mfd. be used, because of the high momentary drains on the rectifier tube which result when the first condenser has a high value.

While the curves have been carried to 128 milliamperes, the tube should never be operated at a current greater than about 110 milliamperes. Most receivers do not take more than 80 milliamperes, even when the output stage contains two 245 tubes. Hence this supply transformer, when operated with a single 280 tube, will provide ample power for most receivers.

(Continued on page 8)

WHAT ABOUT RES

Phase Shifts Present Problems, But

By J. E.

Technical

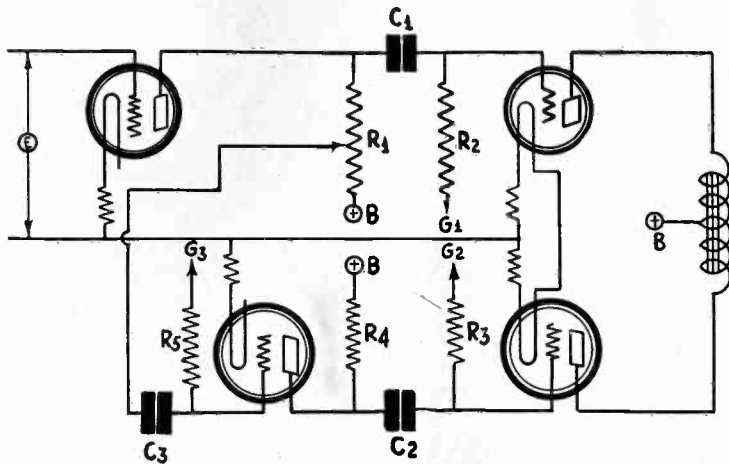

FIG. 1
A SCHEME FOR CONNECTING A SINGLE-SIDED AMPLIFIER TO A PUSH-PULL AMPLIFIER WITHOUT THE USE OF A PUSH-PULL INPUT TRANSFORMER.

PUSH-PULL amplification is admittedly superior to single-sided amplification. But push-pull requires the use of transformers, particularly an input transformer, and many people prefer to use resistance coupling, although there are available some excellent push-pull transformers.

For years experimenters have been trying to devise a scheme whereby the output of a detector could be impressed on a direct-coupled amplifier, especially a resistance-coupled circuit, in such a manner as to divide the signal equally between the two tubes in a push-pull circuit. Several circuits have been published purporting to be successful, but all have merely indicated lack of understanding on the part of the sponsors. In all instances one side of the push-pull amplifier was dead, that is, the grid-plate side of the circuit was grounded at the signal frequency as well as the filament side. In some instances the circuits were merely drawn in push-pull fashion whereas the two sides were actually in parallel.

To produce the push-pull effect it is not only necessary to divide the signal equally between the two sides of the push-pull amplifier, but it is also necessary that it be divided so that the signals applied to the two sides be in opposite phase, that is, so that when the signal decreases on one side it increases at the same rate on the other. The only way that these conditions have been met successfully in the past is by means of a transformer.

One Solution of Difficulty

There is one apparent solution to the difficulty, and that is by this use of an extra tube for reversing the phase of the signal before it is impressed on one side of the push-pull circuit. The first publication of this method appeared in "Experimental Wireless and Wireless Engineer" (London), Vol. 6, June, 1929, under the name of F. Aughtie. Others, however, had employed the same circuit for a number of years.

The theory of this method is shown in Figs. 1 and 2, which were given in Aughtie's article essentially in the same form. Considering first Fig. 1, the signal voltage e is impressed on the grid of the first tube. This voltage causes a corresponding current to flow through the load resistance R_1 and establishes a signal voltage in it. The entire drop across this resistor is impressed on the second tube through condenser C_1 and grid leak R_2 .

Part of the signal voltage in R_1 is also impressed on the grid of the first inverted tube through the condenser C_3 and R_5 . The signal impressed on this tube is amplified and its phase reversed by the tube so that the signal voltage drop in R_4 is in reverse phase compared with the voltage drop in R_1 . If the position of the tap on R_1 be chosen suitably, the magnitude of the signal voltage drop in R_4 will also be equal to the magnitude of the signal voltage drop in R_1 . If the signal voltage drops in R_1 and R_4 are equal in magnitude and opposite in phase, the input voltages to the two final tubes are also equal

and opposite in phase. Thus the signal has been broken up in such manner that the input voltages to the two power tubes are equal in magnitude and opposite in phase, which is exactly what a push-pull input transformer does.

The tube used for reversing the phase should preferably be one of low amplification factor. The lower the amplification factor on this tube the higher up on R_1 must the tap be placed.

Aughtie leaves the grid return connections open as indicated in the drawing to emphasize the fact that it may be necessary to adjust the bias voltages on the two tubes independently to obtain true push-pull action in the final stage. The two output tubes may not be identical. They seldom are in any kind of push-pull circuit, and if they are not alike the circuit will not be balanced. Any small unbalance does not do a great deal of harm, except that it tends to saturate the core of the output choke. If perfect balance is obtained it is possible to use a much smaller and less expensive choke with as good results.

Now if the grid voltages are adjusted independently it is possible to adjust the plate current in each tube so that they are exactly equal, at least over the essential frequency range. But it is not certain that when the DC components of the total plate current are matched the AC components will be balanced as well. If they are not, the circuit is not push-pull. However, the change in mutual conductance with bias over the usual operating range is small, so that balance of the two plate currents insures good AC balance as well. This is especially true if the two output tubes are of the same type and if they are selected with reference to equality of the operating characteristics.

Phase Shift Effects

Aughtie calls attention to the necessity of independence of the phase shift in the phase reverser tube with frequency. If the phase reversal is different from 180 degrees, the two voltages impressed on the two output tubes will not have the proper phase relationship. The voltages may differ by 160 degrees, for example, instead of 180 degrees. Or again, the difference may be 200 degrees. Under these conditions the advantage of push-pull is lost, at least partly. The more the phase difference deviates from the 180 degree relation, the greater is this effect.

This effect occurs, the author states, at the high audio frequencies and is due to the interelectrode capacities of the phase reverser tube. It is due to the same effect as that which causes high audio frequencies to be amplified less than the low audio frequencies in a resistance-coupled amplifier. This is another reason for using a phase reverser tube of low amplification constant, for the effect is greater the greater the amplification factor of the tube. It is also greater the greater the load resistance, in this case R_4 .

There is another phase distortion effect which the author of this paper does not mention, and it is this which caused other experimenters to reject the circuit. It will be noticed that the signal current which flows through R_2 , and which establishes the signal voltage which is impressed on the upper output tube, first must flow through C_1 . Again it will be observed that the signal current which ultimately reaches R_3 to produce the signal input on the inverted output tube must flow through C_3 and C_2 .

C_1 and R_2 will cause a certain shift in the phase of the signal, depending on the capacity of C_1 and the resistance of R_2 . Likewise C_3 and R_5 will produce a certain phase shift, and C_2 and R_3 still another. The phase shifts due to C_3R_5 and C_2R_3 are additive. Thus the signal voltages on the two output tubes generally will not be 180 degrees out of phase, but they will differ by some other angle. This phase distortion is greater, the lower the frequency. Hence there is unbalance both at the high and the low frequencies. Thus it appears that this arrangement is not a solution of the problem, after all. But certainly it is an approximate solution. Whether the resulting quality from such a circuit is better than the quality from a push-pull circuit involving transformers of the best available type is a question. A transformer introduces a phase shift at the high frequencies alone, and this can be compensated for by the use of a condenser.

Compensating Phase Shift

Since the relative phase shift between the two sides of the circuit in Fig. 1 depends on the values of the series condensers and the grid leaks, it appears that it can be minimized by proportioning the values so that the phase shift introduced by C_1

RESISTANCE PUSH-PULL?

One Makeshift Solution is Offered

Anderson

Editor

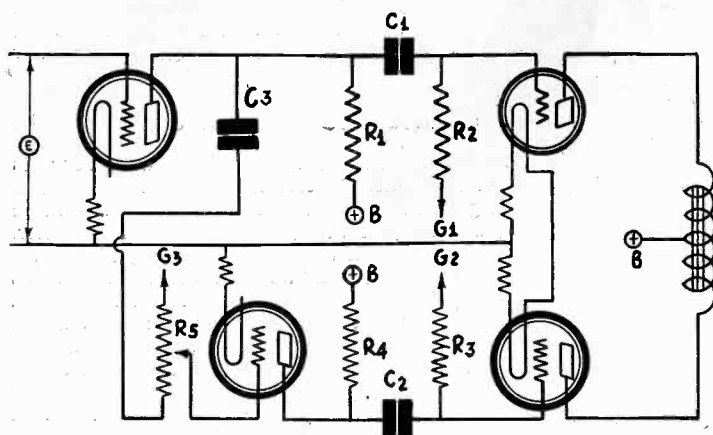

FIG. 2

A MODIFICATION OF THE CIRCUIT SHOWN IN FIG. 1 IN WHICH THE SIGNAL VOLTAGE FOR THE PHASE REVERSER TUBE IS TAKEN FROM THE GRID LEAK.

and R2 is equal to the shifts of the two other condensers and leaks. Except for the very lowest frequencies, the phase shifts by the leaks and the stopping condensers will be very small so that we can take the tangents equal to the phase shift angles. On this assumption we have $1/C1R2\omega = 1/C3R5\omega + 1/C2R3\omega$ as a condition that the signal voltages across R2 and R3 shall be in opposite phase.

Obviously, the frequency cancels out, since it is a factor in ω . Hence the phase shift will be the same in both sides for all frequencies as far as this effect is concerned, provided that we make the reciprocal of C1R2 equal to the sum of the reciprocals of C3R5 and C2R3. If then we make the three grid leaks equal, we have the condition that $1/C1 = 1/C3 + 1/C2$. We can further simplify the case by making C3 equal C2, whence we get the condition that C1 be half as large as either of the other two condensers. A customary value of C1 is .01 mfd. C2 and C3 should then be .02 mfd. condensers.

Since the phase shifts by the condensers and leaks are smaller the higher the grid leaks, the approximation is closer the higher the grid leak resistance. Each leak might have a value of 2 megohms, for example. However, with these values the approximation is not good below 100 cycles per second, and as the grid leaks cannot be increased without danger of blocking, it is advisable to make the condensers larger than .01 and .02 mfd.

Alternative Connection

The circuit in Fig. 2 is a slight modification of that in Fig. 1 and may be used alternatively. There is no difference in the operation, and the choice between them depends on which tapped resistor is available, the plate resistor R1 or the grid leak R5. It may be easier to find, or to assemble, a suitable plate resistor than a grid leak. If it is, the circuit in Fig. 1 should be assembled.

It is possible to estimate the location of the tap on resistor R1 in Fig. 1 when the phase reverser tube is given. Suppose we use a 201A tube and that R1 and R4 are 100,000 ohm units. Assume also that the voltage drop across R1 is E volts. That across R4 is to have the same value. The question is what proportion of E must be used in order that the voltage across R4 be equal to E. Assume that x is the fraction that must be used. Then the input voltage on the phase reverser tube is xE, neglecting the effect of the grid leak R5 and the stopping condenser C3. Let μ be the mu of the tube and r its internal resistance. The voltage across R4, therefore, will be, by the usual formula for voltage amplification in a resistance coupled amplifier, $\mu x E R4 / (r + R4)$. This should be equal to E. Since E cancels out, we have the relation $r + R4 = \mu x R4$, whence $x = (r + R4) / \mu R4$.

If R4 equals 100,000 ohms, r equals 20,000 ohms, and μ equals

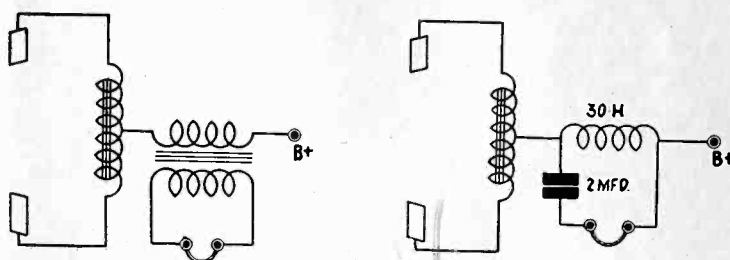

FIG. 3

TWO ARRANGEMENTS FOR CONNECTING A HEADSET IN THE COMMON B LEAD TO THE TWO OUTPUT TUBES FOR BALANCING.

8, we have x equals .15. Since the voltage drop in R4 is proportional to the resistance, there should be 15,000 ohms between the tap and the B battery connection.

The exact point to place the tap cannot be predetermined because the exact values are not known in any case. It must be found experimentally.

Adjustment of the Circuit

The adjustment of the circuit should begin with the output tubes. Place a milliammeter in the lead to one of the plates above the output choke and note the reading. Adjust the grid bias on this tube until the reading of the meter indicates the normal plate current for the plate voltage applied. Then put the meter in the corresponding plate lead of the other tube and adjust the bias on that tube until the same current reading is obtained. Since the tubes are supposed to be the same and since the plate voltages applied to the tubes are also the same, the grid bias voltage should be the same or nearly alike. If two milliammeters are used, the work can be facilitated by putting one in each plate circuit and then adjusting the grid voltages until the currents in the two tubes are the same.

Where Headset Goes

When this adjustment has been made, connect a headset or other sound detector in the common plate lead to the two output tubes. If the tubes take much current, it is not safe to connect the sound detector directly in the circuit, but it may be connected by means of a transformer or a choke and condenser in the usual manner. The diagrams in Fig. 3 show the two methods.

The position of the tap on R1 can now be adjusted until the sound in the headset is zero or minimum when any signal e is impressed on the grid of the first tube. When the sound is zero or minimum the inputs to the two output tubes are equal and hence the circuit is balanced. After this adjustment has been made the loudspeaker should be connected across the output choke from plate to plate of the power stage.

The same method of adjustment is applicable to Fig. 2, the tap be adjusted on the grid leak R5 instead of on the plate resistor R1. If R5 is a 2 megohm resistor, the tap should be placed approximately $2,000,000 \times .15$, or 300,000 ohms from the grid bias battery. This is derived from the fact that the voltage across R1 and R5 is the same, neglecting the effect of C3.

Additional Amplification

It is, of course, not necessary to stop with the two final tubes in Figs. 1 and 2. It is quite feasible to add another stage of push-pull amplification. This should be preferably a resistance-coupled stage, or the advantage of the new scheme would be lost. Instead of using the mid-tapped output choke, two equal resistors of about 100,000 ohms each would be used, connecting the B supply to the junction. Two equal stopping condensers would also be used and two grid equal grid leaks preceding the two new push-pull tubes. The mid-tapped choke would be placed in the plate circuits of these tubes just as it is placed in the circuits shown.

WHERE TELEVISION

Still Experimental, but Home Entertainment

By D. E.

Chairman, Television Committee

The ensuing article by D. E. Replogle, formerly of the engineering staff of Raytheon Manufacturing Company, now with the Eveready-Raytheon Company, tube merchandisers, is an intensely interesting and well-written exposition of the state of the television art. The author, himself an engineer, although sales have occupied most of his attention in recent years, states that television receivers will be separate from broadcast receivers, due to difference in radio frequency and audio frequency ranges. As for audio he says: "To receive television signals with any degree of satisfaction it is necessary to design very special and costly apparatus. Whereas broadcasting amplifiers with a frequency of 50 to 5,000 cycles have been adequate, it will be necessary to have amplifiers with a range of 20 to 50,000 cycles per second. . . . Thus makes obvious the fact that present radio receivers . . . would not be at all suitable for half-tone reception. . . . Television will require distinct and new receivers, and a so-called television attachment is meaningless and of no use."

We publish Mr. Replogle's article because of its interest. We disagree with his conclusion. It is true that commercial radio receivers are even now all too often tonal abominations, with splendid radio amplification and wretched audio. With these distorting machines no television reception is possible or thinkable. But if an audio amplifier that is faithfully effective from 20 to 50,000 is "necessary" for television reception, why is it not also advisable for broadcast sound reception? Such an amplifier is practical for television, but the author does not explain why it is not practical for a broadcast receiver. Inferentially Mr. Replogle is simply referring to a resistance-coupled audio amplifier. Also inferentially a sad commentary on the run of commercially-made receivers, present and even future, may be read between the lines.

Certainly an attachment is feasible. Certainly present-day commercial receivers will have to be scrapped on that account.

As we said, we do not agree with him, but we agree his article is well worth publishing.—EDITOR.

THAT television will require distinct and new receivers, separate from the broadcast receiving set, is now assured from the progress being made in laboratory and other television experiments. The question is often asked:

"Is the increased interest in television manifested among experimenters and broadcasters significant?"

For several months a television transmitter has been broadcasting on a regular schedule in New York City. A new station is soon to go on the air with increased power in Jersey City. From Pittsburgh experimental television signals can be received regularly.

Another station has been on the air on an abbreviated regular schedule from Washington, D. C. In New England one station has been on the air intermittently for the past year. In Chicago one station is now on the air regularly and another is building a

POWER detection is spreading rapidly among the radio fans, just as other new ideas in the past have spread. Now the fans want to know how they can change their old receivers that use grid leak and condenser into receivers using power detection.

"What changes are necessary?" is a question asked daily by every one who has heard of power detection.

It depends entirely on the receiver to be changed. In many instances the only practical change that can be made is to change the entire receiver. Why? Because power detection implies a very high radio frequency amplification and a comparatively low audio frequency amplification. The only object of power detection is to get rid of the audio amplifier, or as much of it as possible.

If there is not sufficient radio frequency amplification in the circuit, there is no object at all of changing to power detection. There will not be enough signal at the detector to put on an audio signal that can operate a loudspeaker without using as much audio amplification. Chances are that when power detection has been installed in such a receiver it will be necessary to add another stage of audio amplification. Such a change would not be a gain, but a decided loss.

But when there is plenty of radio frequency amplification, more than enough for the old type of detector, the situation is different. There may then be enough radio frequency voltage on the detector to operate it as a power detector and to dispense with one of the audio frequency amplifier tubes.

Power detection is really a relative thing. Properly it should mean an arrangement such that all audio amplification could be dispensed with and so that the loudspeaker could be put in the plate circuit of the detector tube. No such achievement has been made public, except for an experimental television Superheterodyne.

The other extreme of power detection is simply that which in the past has been called grid bias detection, which usually requires a full complement of audio frequency amplifier tubes. In between

very modern television studio and transmission apparatus with prospects of being on a regular schedule later. On the Pacific Coast several experimental stations have been operating on irregular schedules.

Flood of License Requests

The Federal Radio Commission has been flooded with requests for licenses to broadcast experimental television signals, and several such licenses have been granted recently, so that at least three more television broadcasting stations are being planned for this Winter. This looks like a very formidable array of transmitting stations.

However, it must be understood that none of these stations has yet put on the air signals intended to have an entertainment value. All transmitting to date is frankly experimental and, in cases where regular schedules are being maintained, is for solving the difficulties and problems that must arise from regular sustained transmission, such as the charting of reception zones in and about the broadcasting stations, as well as the degree of success that can be expected in picking up these signals at a distance.

Much data already have been obtained along these lines and much further data looking toward a more complete solution of the difficulties are expected to result from research work now in progress.

Dating probably last year from the successful demonstration of simultaneous sound and sight transmission at the New York Radio World's Fair, over wire, there has been a serious interest in television by a number of manufacturing and experimental concerns, and the very recent and wonderful demonstrations staged by the Bell Telephone laboratories in New York City in which excellent transmission of pictures in natural colors was attained, has added to this serious interest. Such results, of course, can be achieved only with transmitting and receiving equipment of enormous cost.

It should be and has been to some extent pointed out that these demonstrations at present are laboratory possibilities only, and while wonderful in the results accomplished still fall far short of the necessary commercial development before television can become a source of public entertainment.

At the meeting of the Television Standardization Committee of the Radio Manufacturers' Association, held in Washington last May, a most helpful discussion was provoked on some of the outstanding problems that must be solved before television can be considered as "commercially here."

CHANGE D

Substituted Power Type

By Captain Peter

the two extremes we have several choices, depending on how many audio frequency tubes we wish to use, or how many we must use to get a signal strong enough to operate the loudspeaker. We might need one audio tube, two audio tubes, or possibly three tubes. The last tube should always be a power tube, or a stage of push-pull of two such tubes.

When we use a grid condenser and a grid leak for detection the undistorted signal output voltage from the detector may be of the order of .05 volt. This obviously requires at least two tubes before the voltage is high enough to load up a power tube of the 250 type, which requires a voltage of about 84 volts. In fact the amplification must be 1,700. The output of a grid bias detector may be almost anything from zero up, depending on the value of the radio frequency signal voltage impressed on the detector tube, on the grid bias used on the tube, and on the plate voltage applied. It also depends on the tube that is used for detector.

STANDS TO-DAY

ment Draws Near, Says Engineer

Leplogle

Radio Manufacturers Association, Inc.

This meeting, as well as attempting to recommend standard practice that would simplify the reception of television signals, proved to be a meeting ground for the leading television engineers and experimenters in the industry to exchange ideas and experiences on problems which were of mutual interest. It was noted that in a very healthy way various groups of experimenters were attacking the problems in different ways with the result that our combined knowledge of the art was greatly furthered by free and frank exchanges of experiences.

It has been the writer's privilege to see several demonstrations of television. Some have been good and some have been passable and others have been impossible. In all systems there are unsolved a number of things essential to successful entrance of television as an entertainment in the home.

While the above is a true statement of facts, it is not a pessimistic outlook on the future of television, because never before has there been such an intense concentration of engineering talent on the subject. The very fact that the problems have been analyzed and definitely put in form is a real advance, and while it is impossible to predict how fast progress can be made in solving these problems one would be lacking in faith in modern engineering ability if he could not become enthusiastic over the ultimate success of this new art. The element of time is the only thing that cannot be definitely estimated.

It may be questioned whether the public would be interested in television. On this score the thousands of letters received from experimenters by companies known to be active in this field seem to be sure proof of very healthy experimental interest at least, and, if the early growth of radio is kept in mind, it will be remembered that it was just the same sort of experimental interest that preceded the tremendous popular demand for radio.

Film Projection First

One does not need to be a prophet or son of a prophet to predict the same sort of growth for television. In all probability, the immediate future will see decided activity among experimenters in setting up apparatus to receive these television signals which will constantly be increasing in interest, quantity and quality.

Analysis of the present trend in television indicates very clearly that the first means of obtaining subject matter will be through the use of the talking picture films. One of the chief reasons for this is that the subject-matter on films easily can be made of interest,

readily can be handled and permits simplicity in the transmitter. Then, too, sound can be taken directly from the track on the film so that sound and sight can be transmitted simultaneously.

Of course, separate channels on the air must be utilized for the sight and sound.

The next step will probably be the photographing of outdoor scenes, and by means of a quick developing film transmitter, almost immediate transmission of these scenes. Several methods of doing this give good promise of success.

Following this the next step seems to be the broadcasting of events as they occur directly through a suitably designed transmitter. This, however, seems to be much more distant than either of the other two methods of obtaining subject-matter. Paralleled with the progress outlined will be the broadcasting from television studios, where the sound and sight of the artists will be transmitted simultaneously.

To transmit and receive television signals with any degree of satisfaction it is necessary to design very special and costly apparatus. Whereas broadcasting amplifiers with a frequency range of 50 to 5,000 cycles have been adequate for sound transmission, it will be necessary to have amplifiers with a range of 20 to 50,000 cycles per second for sight transmission. This alone presents a real difficulty.

This makes obvious, however, the fact that present radio receivers, even if television broadcasting were permitted in the sound broadcast band, would not be adequate or at all suitable for half-tone reception.

Sees a Positive Trend

Then, too, for economic and technical reasons, it has been found best to place television broadcasting between the wavelengths of 100 and 150 meters to which none of the commercial receivers now on the market will tune.

Because of these major reasons and several others that occur to the engineer, a television receiver must be a very different receiver in electrical design from that now being used for sound broadcast. The one conclusion that can be drawn from this is that television will require distinct and new receivers for its reception and that a so-called television attachment is meaningless and of no use.

This is of general interest to the radio consuming public because it does not mean that your present radio receiver will become obsolete, but it does mean that you will have a complete television receiver with scanning mechanism and so forth, which will be distinct and separate, but will work in conjunction with your radio receiver, for dual reception of sight and sound. The very positive trend is for the television receiver, amplifier and scanning mechanism to be in one cabinet.

DETECTOR?

Demodulator Explained

W. O'Rourke

The only distinction between grid bias detection and power detection as was suggested above, is the signal level. Both are bias detection, provided we put the radio frequency signal into the tube by way of the grid.

Let us inquire about the magnitude of radio frequency voltage necessary in a typical case of power detection. Suppose the only audio tube is a 245 operated at maximum plate voltage. This tube can take a grid voltage up to 50 volts. If a 3-to-1 step-up transformer is used between the detector and the power tube, the signal voltage across the primary of the transformer must be about 17 volts. That is so high that it is necessary to use a fairly high voltage as well as a correspondingly high grid bias on the detector.

The calculation of the output voltage from a detector is not such a simple procedure as the calculation of the output of an amplifier, for it depends on several more factors. First it depends on the impedance of the primary of the transformer, then on the

internal impedance of the detector tube to the audio frequency detected. Again, it depends on the efficiency of the detector tube, which in itself is a complex quantity. Above all, the output depends on the degree of modulation of the signal voltage in its radio frequency phase.

While we cannot calculate the output voltage exactly, we can make a few assumptions which will give an indication of what is required. Suppose the rectified voltage is one-half of the radio frequency signal voltage and that the degree of modulation is 100 per cent. The output voltage will then be about $\frac{1}{4}$ of the radio frequency voltage. Since we needed an audio frequency voltage of 17 across the transformer, we shall need a radio frequency voltage of 68 volts. This is not to be taken as accurate, but as a mere rough approximation. All that the figure indicates is that we need a very husky radio frequency voltage.

Let us suppose that we need a radio frequency voltage of 50 volts. That means amplitude. The grid bias on the tube should be twice that amount. That is not very practical.

Now let us assume that the intensity of the signal to be received is one millivolt per meter. We have an antenna, let us say, which is 5 meters high. The voltage in the antenna circuit is then 5 millivolts. This must be stepped up to 50, the amplitude needed on the detector grid. The amplification must be 10,000 times. As circuits go now-a-days this is not a very great amplification. But when we consider those receivers which are to be "changed over" to power detection it is enormous. So when an old-time receiver is changed over to power detection, it is quite likely that local stations which have entertained the fan will become as weak as stations overseas which come in feebly on rare occasions only.

When considering changing over the first consideration should be to keep the same number of tubes in the circuit and then simply move the detector tube toward the power tube. However, moving the detector this way is not simple. It requires many other changes.

POWER AMPLIFIERS

Why the Actors Seem to Be Lisp

By J. E. Anderson

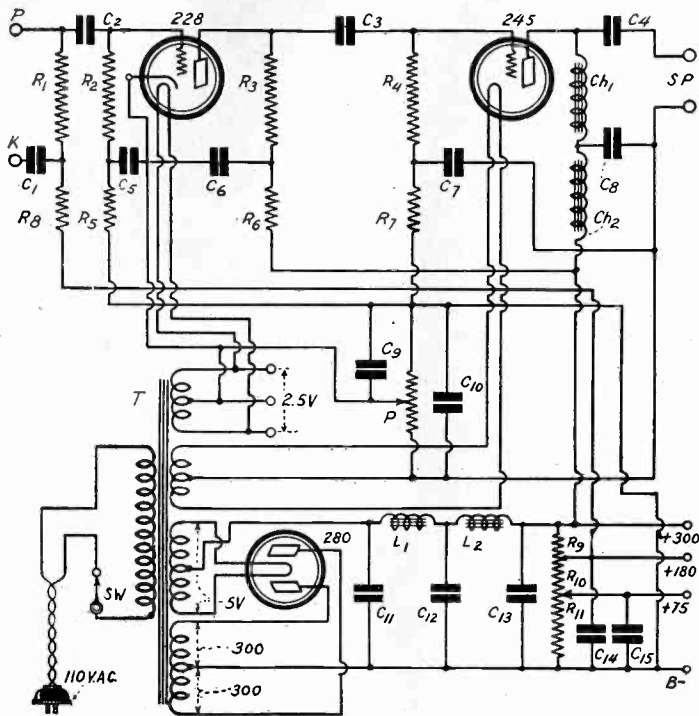

FIG. 100
TWO-STAGE RESISTANCE COUPLED AMPLIFIER WITH
B SUPPLY PROVIDED WITH FILTER CONDENSERS
AND RESISTORS TO PREVENT MOTORBOATING.

[This article is an instalment of "Power Amplifiers," a book being published serially and soon to appear in book form.—EDITOR.]

As is well known, resistance coupled amplifiers served by B-supply units are subject to motorboating or to amplitude distortion resulting from feed back through the impedance common to two or more plate circuits. This condition is very often met in such amplifiers having three-plate circuits on the common power supply. We have shown how the feed back may be minimized by means of condensers, resistors and choke coils. We now show (Fig. 100) a complete resistance coupled amplifier having three-plate circuits together with the power supply, in which the various means for eliminating feed back have been inserted to show their relation to the circuit.

The circuit is supposed to be preceded by a tube detector, which is served by the same B supply. If it is not, the amplifier contains only two plate circuits. However, even if the detector is not connected, or if it is not lighted, the circuit may motorboat. Indeed, it may oscillate more severely without the tube, because the plate resistance of that tube acts as a partial short circuit to R1.

In this amplifier R1 and R3 are coupling resistors, each of which should have a value of from 100,000 to 250,000 ohms. R2 and R4 are grid leaks, each of which should have a value of one megohm. R6 and R8 are filter resistors, the object of which is to prevent feed back when taken in conjunction with the condensers C1 and C6. Each of these condensers should not be smaller than 2 mfd. R5 and R7 are also filter resistors serving the same purpose in the grid circuits as R6 and R8 serve in the plate circuits. The condensers C5 and C7 by-pass these resistors. The values of these condensers should be the same as the plate circuit by-pass condensers. Resistors R6 and R8 should have a value of about 10,000 ohms and resistors R5 and R7 from 20,000 to 50,000 ohms.

Note particularly that the by-pass condensers C1, C5, C6, C7, and C8 connect to the cathode of the tubes with which they are associated. The cathode of the power tube, of course, is the mid-tap of the filament.

It is the signal current in the last tube which causes the greatest feed back if it is allowed to get into the plate voltage supply unit. For this reason the output circuit is specially

treated so that the least possible signal current from this tube gets into the B supply. First the signal passes to the speaker through condenser C4, which should have a capacity of 4 mfd. or greater. The speaker is returned to the mid-tap of the filament, that is, to the cathode. Since most of the signal current flows this way, the greater part of the total current is diverted from the B supply.

However, the current corresponding to the low notes has difficulty passing through condenser C4, even if this is as large as 4 mfd., and it passes more easily through the choke coil Ch1. In order to prevent as much as possible of the low-note signal current from passing through Ch1, and hence into the B supply, the inductance of this coil should not be less than 30 henries. The greater the inductance, the better, provided that its DC resistance is low.

Even if the filtering is such that only a small percentage of the signal current can go by way of Ch1, this small amount may be large compared with the signal currents in the plate circuits of the preceding two tubes, and hence it may cause considerable trouble. Of course, the filter condensers and resistors associated with these tubes prevent much of the feed back, but we have not yet done all that can be done to minimize it. Another coil Ch2 is inserted in the plate circuit of the power tube. This also should have a high inductance and a low DC resistance. The inductance must be high to insure the highest possible signal voltage drop and the DC resistance must be low to prevent any appreciable DC voltage drop. The effectiveness of Ch2, and of Ch1 also, for that matter, is greatly enhanced if a condenser C8 is connected from the junction of Ch1 and Ch2 to the cathode of the tube. There is no theoretical limit to the capacity of this condenser, and certainly it should not be smaller than 2 mfd.

We have not yet said anything about the grid bias for the two tubes shown in the circuit. That for the power tube is provided by the voltage drop in the potentiometer P, the total resistance of which should be 1560 ohms. Since the bias obtained results from a DC feed back, it is clear that P must be adequately by-passed if it is not to produce a signal feed-back as well. This feed-back would result in a lowering of the amplification of the low notes. If the value of C10, the by-pass condenser across P, is large enough, practically all signal feed back is prevented. Its capacity should not be less than 4 mfd. The effect of the reverse feed back in lowering the amplification can only be appreciated by arranging the circuit so that the by-pass and condenser can be inserted and removed quickly while the signal is rich in low notes. Every one performing this experiment is convinced that the price of a large condenser is well spent. Many who have done it have resorted to electrolytic condensers of a capacity as high as 50 mfd.

The bias for the high-mu tube, in this case a 228 heater, is

LIST OF PARTS

- R1, R3—Two Lynch metallized 250,000-ohm resistors with mountings.
- R2, R4—Two Lynch metallized 1-megohm resistors with mountings.
- R8, R6—Two Ferranti wire-wound 10,000-ohm resistors with mountings.
- R5, R7—Two Ferranti wire-wound 20,000-ohm resistors with mountings.
- P—One Electrad wire-wound 1,500-ohm fixed resistor and one 200-ohm rheostat.
- C1, C5, C6, C7, C8, C9—Six Flechtheim 2-mfd. by-pass condensers, 600-volt test.
- C2, C3—Two Aerovox .02-mfd. mica condensers.
- C4—One Flechtheim 4 mfd. (or larger) condenser, 800-volt test.
- C10—One Flechtheim 4 mfd. (or larger) condenser, low-voltage test.

This condenser may be an electrolytic of high capacity.
Ch1—One National output choke.
Ch2—One Ferranti B2 choke coil.
One 228 tube with one Y-type socket.
One 245 tube with one X-type socket.
Seven binding posts.

For list of parts for the B supply see list under Fig. 97.

IN TALKING MOVIES

ing and Orchestras Sound Artificial

ud Herman Bernard

FIG. 101.

A COMPLETE LAYOUT OF THE SOUND PRODUCING EQUIPMENT USED IN ONE SYSTEM OF TALKING MOVING PICTURES, INCLUDING SOUND PICK-UP DEVICES FOR SOUND-ON-FILM, SYNCHRONIZED PHONOGRAPH, AND NON-SYNCHRONOUS PHONOGRAPH. ALL THE PICK-UP DEVICES ARE IN DUPLICATE TO FACILITATE CHANGING AT THE END OF A FILM OR OF A RECORD. A FADER IS PROVIDED WHEREBY THE CHANGE-OVER CAN BE DONE QUICKLY OR IN SMALL IMPERCEPTIBLE STEPS. TWO OR MORE EXPONENTIAL HORN TYPE SPEAKERS ARE USED TO PROJECT THE SOUND IN THE THEATRE. THESE SPEAKERS CONVERT ABOUT 50 PER CENT OF THE ELECTRICAL ENERGY INTO SOUND.

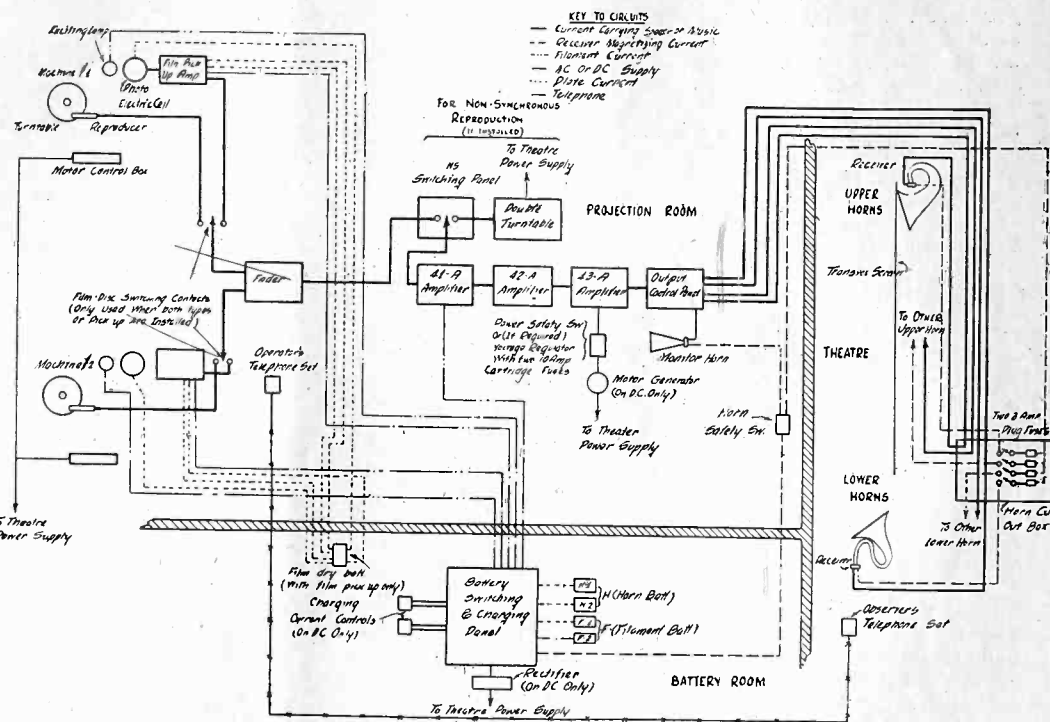

also obtained from the drop in P. Since the voltage on the plate of this tube is 300 volts, it requires a bias of approximately 4 volts. This is obtained by returning the cathode of the heater tube to a point 4 volts up from the negative end of P, returning the grid of the tube to the negative end. Condenser C9, of 2 mfd. or higher, is connected across the portion of the resistor used for bias for the heater tube.

Above the value of P was specified as 1,560 ohms. There is no commercial resistor or potentiometer of this value available. Hence we have to compromise. We can get a fixed resistor of 1,500 ohms, one which will carry 50 milliamperes or more. One side of this should be connected to the mid-tap of the 2.5-volt winding serving the power tube. We can also get a 200-ohm rheostat. This should be connected between the negative side of the B supply and the open end of the 1,500-ohm resistor. The cathode of the heater tube should then be connected to the junction of the rheostat and the fixed resistor. If the rheostat is set at 125 ohms, the bias will be approximately correct for both tubes.

An alternative is to make P a wire-wound resistor strip of 1,500 ohms on which there is a sliding contact for the cathode return.

The 2.5-volt winding used for the 228 can be used for a couple of heater tubes in the radio frequency amplifier and for that reason three binding posts have been provided.

The construction of the B supply is essentially the same as that of the B supplies shown with Figs. 97 and 98. All the parts are the same, with the possible exception of the distribution of the taps on the voltage divider. Suppose that the resistor also serves an AC screen grid tube and a heater type detector operating with grid condenser and leak. We can then assume that the current to the 180-volt tap is 5 milliamperes, one-half milliampere to the detector and the rest to the plate of the screen-grid tube. The screen, connected to the 75-volt tap, takes one milliampere. The current to the power tube and the 228 need not be considered as it flows through no part of the voltage divider. Let us allow a bleeder current of 25 milliamperes.

Then R11 should be 75/.025, or 3,000 ohms. R10 carries 26 milliamperes. Hence its values should be 105/.026, or 4,000 ohms. R9 carries 31 milliamperes and therefore its value should be 3,870 ohms. The total resistance of the voltage divider is therefore 10,870 ohms.

Since the bleeder current can be increased or decreased, the total resistance might be made 9,000 ohms, or it can be increased to 12,000 or 15,000 ohms. If, however, the values are changed the voltage taps should be set so that the proportions calculated above and maintained. Small deviations do not matter because

the tubes will function even if the voltages are not exactly as specified.

The power amplifiers used in talking movies do not differ in any essential respect from the power amplifiers used in radio receivers and public address systems. An amplifier used with a radio receiver gets its input from a detector tube, and an amplifier used in public address systems gets its voltage directly from a microphone. In some instances either of these amplifiers gets its input voltage from a pick-up unit on a phonograph record.

Many amplifiers used in conjunction with "talkies" also derive their input voltages from pick-up units and phonograph records. However, most of the "talkies" are of the type in which the sound is recorded on the film which carries the moving picture. In these systems the power amplifier receives its input voltage from a photoelectric cell.

These various input systems require different degrees of amplification of the signal voltage before it is of sufficient intensity to be impressed on the tube or tubes operating the sound producer. Then, again, there are theaters of many different dimensions, requiring different amounts of sound power. Thus the amplification required in any case also depends on the size of the theater.

In Fig. 101 is shown a sketch of the equipment used by the Western Electric sound projection system, which is provided with three different sound pick-ups. The first is the photoelectric pick-up from the sound track on the film; the second is the phonograph pick-up synchronized with the action on the film, and the third is a non-synchronized phonograph pick-up for incidental music. All three are in duplicate to facilitate change of records and films.

The photoelectric pick-up consists of an exciting lamp for the photoelectric cell, the photocell itself, and a film pick-up amplifier to compensate for the low signal output from the photoelectric cell. The synchronized phonograph pick-up consists of a special turntable, a reproducer, usually called the pick-up unit, and a motor control box. The non-synchronized phonograph pick-up consists simply of a double turntable.

The equipment is provided with a switching arrangement by means of which any one of the three pick-ups can be thrown on the common amplifier, and also for selecting either one of the two duplicates. A fader is provided in the line from the two synchronized sources of sound. This is a device which enables the operator to change over from one machine to the other either quickly or in small steps. By means of the fader the change-over can be made so slowly that the audience is unaware of the change from one machine to the other. (Cont. next week.)

THE HB

Instructions on Mounting and

By Herman

[The following is the third and final instalment of the article on the construction of the AC Model HB Compact, which consists of five tubes, including 280 rectifier. The other tubes are three 224 screen grid AC tubes and one 245 power tube. The entire receiver, including A, B and C power supply, is contained in an 8x15x10" steel cabinet, with decorative brown crackle finish. The metal subpanel on which all parts are placed, save the three that are panel-mounted, is 14 $\frac{1}{4}$ x9 $\frac{1}{2}$ ". This is one of the most compact arrangements ever offered to constructors. The circuit uses a space charge detector and the Bernard dynamic tuners. The set is selective, voluminous and sensitive. The two previous articles should be read by all desiring to build this remarkable receiver. Get the September 21st and 28th issues.—EDITOR.]

THE ONLY taxing problem regarding the construction of the HB Compact, AC Model, is the layout of parts. As was stated, it was necessary to "play checkers" with the parts until all were comfortably and effectively placed. But the solution finally was reached and the pictorial diagram of the constructional layout elucidates the situation.

In building the receiver it is well to use the steel cabinet, as that comes already drilled, including holes in the base flanges to match corresponding holes in the metal subpanel. This subpanel has sockets affixed, so one problem is disposed of at the factory, and also it has virtually all the holes drilled in it that will be required. Any additional holes may be drilled without trouble. When drilling, use reinforcement underneath, as the drill comes through with a jerk.

First mount the coils and pilot light bracket on the front panel. There are two types of commercial coils available, and the directions for winding your own coils, should you prefer to do this, were published in previous issue of RADIO WORLD, but the dimensions were the same as those of the two commercial types.

The two commercial types are made by National Company, Malden, Mass., and by the Screen Grid Coil Company. The National coils, which are de luxe coils and cost more than the others, must be insulated from the front panel, and insulating washers are provided for this purpose. The volume control under all circumstances must be insulated, no matter which coils are used. The Screen Grid Coil Company's coils do not have to be insulated.

Insulation by "Floating"

The cabinet holes are factory-drilled, purposely oversized, so that the coils and volume control may be held in place with an insulating washer, front and rear, when mounting is being done. Then tighten the locknut or other hardware so that the coil or volume control is secured to the washers, but "floats" in respect to the cabinet itself.

The cabinet being steel, and being connected by screws and nuts to the metal subpanel which is grounded, is itself grounded, and as the volume control and National coils are at other than ground potential, in fact one coil is at a high positive B potential, the necessity of insulation is obvious if otherwise the cabinet would be contacted.

Next mount the Dustproof tuning condensers, using four brackets for each condenser. These brackets are specially made for the purpose. It is necessary to insulate each point where such a bracket is used, hence four insulated points for each condenser are required. This holds true no matter what type of coil is used.

The first bracket is the main one, which renders strong support. Each coil has a shaft protruding at rear. Put a flexible coupler or link on this shaft, fix the shaft of the condenser into the link, and locate the bracket positions. On the left-hand condenser, as you view the front panel, the odd bracket is at left rear.

If the smaller mounting hole on the main, strong bracket is not quite large enough to pass the 8/32 condenser screw, you can scrape the hole with any pocket knife, to make it large enough. Ordinarily the screw can be turned through with a screwdriver, although it is a tight fit, and intentionally so.

Details on Mershon

The 1 mfd. high-voltage condenser is mounted right next to the main bracket, in front of it, hugging it, one might say, and standing upright, as there is plenty of room. The two low-voltage 1 mfd. condensers are laid flat, under the coil, with the live lugs facing to the right. They are mounted one atop the other by making their mounting feet meet, and passing a 1" screw through the subpanel.

Next mount the other tuning condenser. If an output filter is

used, it is placed under the second tuning coil, at the point where we are now operating. This filter would consist of an audio choke coil and a high-voltage 2 mfd. condenser as shown in the diagram published on page 7 of the September 21st issue. If a dynamic speaker is to be used this output filter should be omitted, because dynamic speakers have output transformers built in.

Now mount the Mershon condenser. A bracket serves the purpose. One of the holes for this bracket is the same hole used for one of the rear brackets on the condenser. It is necessary to have the Mershon bracket conductively attached to the subpanel, but just as necessary to have the condenser bracket insulated from the subpanel. Therefore sandwich an insulator between the subpanel and the condenser bracket in question, and another between the condenser bracket and the Mershon bracket. Insulating washers for subpanel work are black, and of two types. One is flat, the other extruded or having a "collar." The subpanel hole should be large enough to permit mounting the collar bracket. Then the flat type is placed under the condenser bracket. Then a collar type is put in the Mershon bracket, from bottom up, with a flat one atop the Mershon bracket. Then the joint is screwed down.

To insure correct mounting, and otherwise carry out the whole idea of symmetry and insulation, use washers to elevate the front bracket and remaining subsidiary brackets of the second tuning condenser, so one side will not be higher than the other. As the other condenser was insulated, the shafts of both will be in line on the front panel, and the drilled panel holes will be found correct.

At rear a part of the Mershon bracket protrudes, but there is plenty of room at rear, so let it be. At right, however, a small triangular-shaped piece sticks out, and while there is room for this, too, it is well to file off or saw off the excess. The reason is that the subpanel was made narrow enough—only 14 $\frac{1}{4}$ "—to permit the insertion and removal of the subpanel from the cabinet with all parts on it, without tilting. The whole outfit will be rather heavy, and if tilting or other awkward positioning had to be resorted to, the works would be cumbersome to handle. As it is, the subpanel clears the sides of the cabinet very easily, and to preserve this valuable asset remove the excess at right from the Mershon bracket.

As was stated, the Mershon bracket must be conductively attached to the subpanel, but this is automatically accomplished by the securing of the right-hand flap of the Mershon bracket to the subpanel and to the flange of the cabinet. The holes for this purpose in cabinet and subpanel coincide.

Now remove the subpanel from the experimental placement given it in the cabinet and put the voltage divider in place temporarily. Mount the Polo transformer-choke block next. Attach the clips to the insulators provided on the subpanel for creating mountings for leaks and plate resistors and attach the .01 mfd condensers. The tuning condensers are made permanent, the equalizing condenser is attached to the first tuning condenser by bending to a right angle and inserting screw, and you are all set to wire all leads except those that connect to the front panel.

Polo Block Treatment

The Polo 245 power supply, previously referred to as the transformer-choke block, has seven insulated openings, from which emerge thirteen wires. All windings of the transformer except the primary are center-tapped. The chokes are represented by two pairs of leads. Connect together one lead emerging from one of the choke holes and one lead emerging from the other choke hole, it matters not which one, and use the two remaining wires as the extreme ends of the choke pair, the joint as the midtap. When you finally come to solder to this midtap do not forget to insulate it, by wrapping some medical tape or bicycle tape around the joint.

The Polo leads are easy to handle. In the first place, the voltages are marked at the openings, and the center taps are red, and so stated on the block. You can make only one mistake even if you are only half watching your step. There are two windings, each marked 2.5 volts AC, each with red center-tap, and each trio of leads emerging from a different opening. One of these outlets is for 2.5 volts 12 amperes, and so marked. This must be used for heating the filaments of the three 224 tubes and the pilot light. The other winding is 2.5 volts, 3 amperes, and this is used for the power tube, with red lead to the 50-volt lug of the voltage divider. See the September 28th issue for details on lugs, resistance values and voltage equivalents on the voltage divider. The point marked C+5v should read S+5v.

You can wire up all the filaments and the power supply, with the subpanel outside, where it is handy to work at, save only the con-

COMPACT

Wiring for AC Model

Bernard

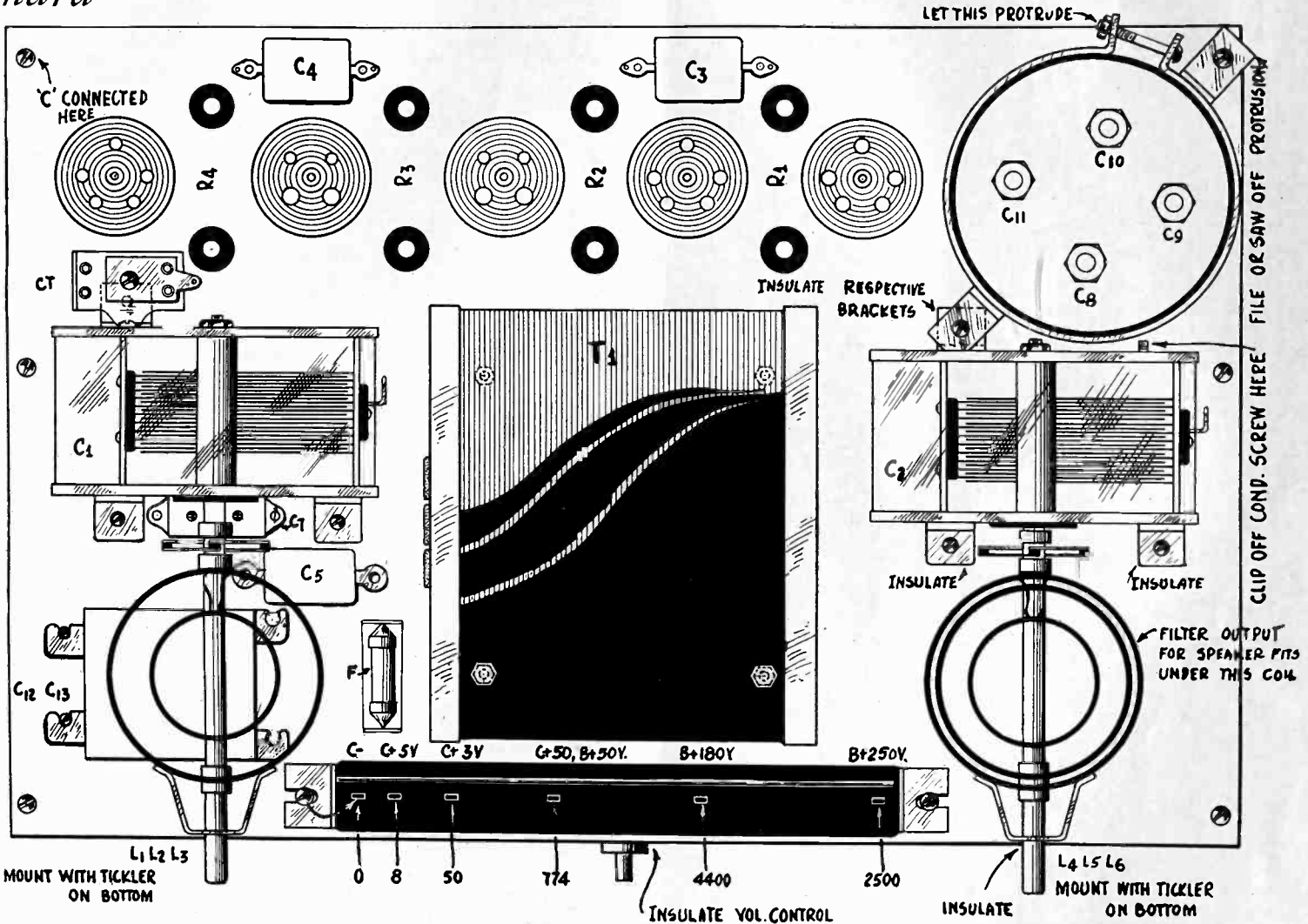

FIG. 9.

LAYOUT OF PARTS, VERY SLIGHTLY LESS THAN ONE-HALF SCALE. IF NATIONAL COMPANY'S COILS ARE USED THEY MUST BE INSULATED FROM THE FRONT PANEL. THE SCREEN GRID COMPANY'S COILS NEED NOT BE INSULATED, AND ARE THE ONES SHOWN IN THE DRAWING. THE ACCOMPANYING TEXT GIVES MUCH ADDITIONAL INFORMATION ON THE ASSEMBLY.

nections for the pilot light, volume control and tuning coils. On National coils the return of the tuned circuits is made to the large lug.

After this part, which is the main part, of the wiring is completed, you can fit the subpanel into the cabinet, using screws and nuts for anchorage through holes already provided, and, as for the voltage divider, simply removing the nut at each mounting foot and placing it underneath the cabinet flange instead.

One seeming difficulty may present itself, and that is that the Polo block has mounting feet that extend through the subpanel, and these are 3/4" long, whereas the depth from bottom of the cabinet to the table on which your installation rests, is only 1/2". The extra 1/4" may be taken up by putting extra screws between the subpanel and the flange that runs around the bottom of the cabinet, or by cutting the screws down to size with snippers, or by sawing or filing. They are heavy screws, but this reduction of extension can be worked all right.

Do not cut off too much, only just enough, as the mounting feet of the Polo block are used as the main central support of the subpanel. If you cut off too much you can make up the difference by putting soft rubber feet over the screw extensions at bottom.

The connections to the tuning coils, pilot light and volume control are now made. Follow the diagram as published September 21st.

There remains only the connection to the power line. This is made by bringing out the primary leads of the Polo 245 supply, connecting them to one side of a double-opening pendant switch, and connecting an AC cable at the other opening of the switch. There is a hole at rear of the cabinet for the emergence of the primary leads, and the switch hangs here, the set being turned on

and off from this switch which controls all A, B and C power—everything except tuning and volume control.

Some hints as to wiring: The Mershon condenser is in a copper case and this case is negative. The copper is connected to the bracket and the bracket is conductively attached to the subpanel which is grounded negative, so the negative connection of the Mershon is automatic. The larger and smaller capacities (two 18 mfd. and two 8 mfd.) are distinguished by noting the lugs nearer the edge of the copper case. This pair constitutes the two 8 mfd. condensers. The lugs at top of the case are positive, of course. They go to the choke midsection, to the choke system output and to two intermediate voltages on the divider.

The receiver seldom needs any antenna save that provided by connecting the condenser C5 from one side of the line to one side of the antenna coil. Be careful about this condenser, so that it is absolutely free of any risk of connection to the subpanel or any other place save its intended destination. AC cable wire should be used for making the connection from the fuse to the condenser. The encircled "A" on the diagram, September 21st, represents the point where an outdoor aerial may be introduced, if desired.

How to connect the coils and what dial readings should prevail were explained in previous issues. Be sure to read what was published in the September 28th issue, last week, and in the September 21st issue. Previously to September 21st there was considerable discussion of the battery model HB Compact, and many points equally applicable to the AC model were treated extensively. Those issues are dated August 24th, 31st, September 7th and 14th. Hence if the present issue is the first to come to your attention in which the HB Compact was discussed, get also the August 24th, 31st, September 7th, 14th, 21st and 28th issues.

A Question and Answer Department conducted by Radio World's Technical Staff. Only Questions sent in by University Club Members are answered. The reply is mailed to the member. Join now!

RADIO UNIVERSITY

Annual subscriptions are accepted at \$6 for 52 numbers, with the privilege of obtaining answers to radio questions for the period of the subscription, but not if any other premium is obtained with the subscription.

Too Many Cooks

THE other night I visited a friend's house and noticed that there were several rheostats on the front panel of his radio receiver. One controlled the radio frequency tube, another the detector and another the two audio tubes. I was wondering if there is some value in this versatility of control.—U. D.

His set must have been an old-timer, or a new-timer built along discarded lines. There is certainly no advantage in having a rheostat control the heating of the audio tube filaments. These tubes should be heated to the rated degree. Following rated voltages suffices. It is doubtful if the detector variation in this instance is of any value, for even if a detector works a little better with some other voltage on the filament than the one prescribed by the tube manufacturer, which sometimes happens, that unusual voltage may be attained by adjustment from sub-panel, and left thus, requiring no front panel control. The rheostat controlling the RF tube is all right as a volume control, but it is the only rheostat in this example that needs be on the front panel. The versatility that you refer to is rather an encumbrance.

* * *

Effect of Metal Cabinet

DOES it do any harm to build a set with a metal cabinet, where the coil, because panel mounted, is only 2 inches behind the metal?—I. D.

No. The effect of the steel on the coil, if at all appreciable, will be taken into account by the designer of the circuit. If the receiver had shielded coils it is quite unlikely any such ample distance as 2 inches would separate the coil from the walls of the shield. You can safely build the set without regard to any effect that the metal would have on a coil placed at such a respectable distance as 2 inches.

* * *

Push-Pull Easily Included

INTEND to build a circuit like the HB Compact, AC model, only I desire to use push-pull audio amplification in the last stage, as I have a pair of push-pull input and output transformers. Will you please enlighten me whether the Polo transformer block for 245s will stand the extra plate current and filament current, and whether it is necessary to have a different value of resistance for the biasing section that is now around 800 ohms?—H. D.

The Polo block will take care of the extra current very nicely. Its rated DC high voltage is obtainable, for plate supply, when the maximum current is 80 milliamperes through the biasing section you mention, which is the point between ground and the approximately 800-ohm tap. The filament current you will draw will not nearly overtax the block, either. As for the resistance of the biasing section, since the plate current of the push-pull pair will flow through this resistance, the current will be nearly twice what it would be if one tube were used, hence the resistance should be about halved. You will notice that in the HB Compact, AC model, the volume control is connected from the 50-volt tap to a cathode, and is 25,000 ohm potentiometer, a resistance value high enough not to reduce the effective resistance for biasing to any except a trivial extent. The two resistances are in parallel. Therefore you can use a 1,000-ohm, 5-watt potentiometer as volume control, such as Electrad's, in conjunction with the same voltage divider used for the HB Compact. Then your biasing of the push-pull pair will be automatically all right.

* * *

How to Get Regeneration

IN building the Schoolboy's one-tube set, described in the September 21st and 28th issues, I do not get regeneration, except except at the lowest wavelengths. Please tell me what to do.—S. W.

Provided your tube is in good condition, that is, can produce oscillation, you will get regeneration by connecting the tickler coil in the proper manner. This connection requires that the relative potentials be applied in the same relative order, when the coil windings are in the same direction. If the tickler and the secondary are in the same direction, then the top terminal of both windings should go to grid and plate, respectively. The

simplest way to handle the situation is to connect the tickler in either fashion, and, if regeneration is not obtained, reverse the tickler connections. That requires that the lead formerly going to plate now goes to B plus, and the lead formerly going to B plus now goes to plate.

* * *

Sensitive Meters Expensive

THE only meters I have are a 0-6 voltmeter and a 0-20 milliammeter. I would like to get closer readings on the milliammeter, say, a full-scale deflection of 1 ma. Please state the value of external resistor necessary and show how to connect.—H. W.

You can not use the 0-20 milliammeter as a 0-1 milliammeter by the introduction of any external resistance or by any other device. You can enlarge the range of such a meter to read 0-40, 0-400, etc., there being no limit to the enlargement, by shunt resistance. Reduced range is impossible. A 0-1 ma is a sensitive instrument, and this sensitivity is built into it, by special and painstaking construction, at considerable cost. A 0-1 ma usually costs from five to ten times as much as a 0-20 ma.

* * *

Use of Grid Suppressors

MY set squeals and I would like to make it stable at small cost. It is a battery-operated receiver, with two stages of RF.—L. S.

You may disconnect the lead joining the stator of the tuning condenser and its coil connection, in the first stage, from the grid of the first RF socket, and put a resistor between these points.

The value of the resistance will have to be obtained experimentally. Usually about 1,000 to 3,000 ohms will suffice. The value depends on the degree of instability present and on other factors. Often as low as 400 ohms give satisfactory stability. Repeat the process for the next stage. This method, known as grid suppression, will cure instability, but if the resistance values are too high the sensitivity will decline too much, therefore test carefully to obtain the correct values. It is possible almost to stop the signal completely, by use of a grossly inappropriate resistance value.

* * *

Color Effects on Dial

IS there a dial made that produces different colors on the scale as the knob is turned, and if so, who makes it?—J. S.

Such a dial is manufactured by the National Company, Malden, Mass., and has a color wheel through which the illumination from the pilot light passes before reaching the scale. This the company calls the "rainbow" feature. The dial is new on the market and has a modernistic escutcheon.

* * *

Best Book for Novices

PLEASE advise a novice which book he should study to get a good grip on radio technique, something simple but authoritative.—W. E.

The best book for this purpose is "Elements of Radio Communication," by Prof. J. H. Morecroft, of Columbia University. It is his latest book, recently published, and even contains some material not in his larger and earlier book for the technically-trained radioist, "Principles of Radio Communication."

* * *

Revamping Receivers

MY set is battery-operated, but I would like to have it AC. Please explain some simple way I can convert it.—Y. E.

There is no simple, valuable way. The better plan by far is to rebuild the receiver for AC. The use of adapter adjuncts is not very satisfactory. In general, it is a bad plan to try to revamp an old set, to make it AC, or even to introduce screen grid tubes. You can use nearly all the parts from your present receiver in the new one, and you will be far better satisfied with the results, not only electrically but aesthetically. This has always been our standard advice.

BOY'S SPEAKER SET

Three Tubes Costs \$11.10 and is Full of Pep

By Jack Tully

[Herewith is an article, complete in this issue, on the construction of a three tube circuit for operation of a speaker, using batteries. It is a good circuit, one any schoolboy will be glad to possess. He can build it if he will try. The full-scale pictorial diagram on the following two pages reveals constructional layout and wiring.

In the September 21st and 28th issues the construction of a one-tube earphone set for schoolboys was described. A full-sized picture diagram of the wiring was published. Read next week's issue, dated October 12th, for more data on circuits for boys.—EDITOR.]

A DANDY little three tube battery-operated set is the subject of this week's article for schoolboys. The receiver uses the screen grid tube as detector, with a high mu tube, type 240, as first audio amplifier, and a 112A power tube for output. Everything is placed on a 9x7" baseboard. There is no front panel, as none is needed. The tuning condensers, consisting of a double unit, are mounted on a strong bracket. In this bracket is a hole to accommodate also the rheostat that has a switch built in. In back of the condenser another bracket is used to make the support more rigid, and then everything is rugged, as it should be.

Considering the electrical side, we use the 222 screen grid tube as detector, tuning the input or grid circuit, and tuning the plate circuit as well. A coil coupled to the tuned inductance in the plate circuit is returned to the grid circuit, so as to make the selectivity obtained by the second tuning effective in the input. In that way the selectivity is good enough.

The circuit is not critical, either, although the rheostat has to be turned to a given position for maximum sensitivity to be obtained from the screen grid tube. Above and below this position the volume is less. Always operate the tube at the lower filament temperatures for volume reduction, not at the higher.

Two Must Tune As One

It is necessary to make the two circuits tune alike, that is, be tuned to the same frequency at a given setting of the single dial. This is accomplished by tuning in a low wavelength station and setting the trimming condenser, CT, which is an 80 or 90 mmfd. equalizer, using a screwdriver that has a wooden handle, or using an apexed dowel stick. When maximum volume is obtained leave the setting as is.

A plain full-vision dial is used for tuning. This is affixed to the shaft of the tuning condenser. Two lugs are used to provide a central dial pointer. One lug is screwed onto the condenser plate at front, in the process of mounting the condenser on the strong bracket. Then another lug is cut pointedly at the end, to be an indicator, and it is bent over the front of the dial experimentally. When the right cut and position are obtained the indicating lug is soldered to the other lug, and you have a dial pointer that is first-class.

Looking at the operation of the circuit from an electrical viewpoint, we find that the 6-volt A battery source is reduced to proper filament voltages for the screen grid tube and the two other tubes by means of filament resistors. One of these is 1.3 ohms and provides 5 volts for the 240 and 112A tubes. The other is 6.5 ohms and, with the aid of the rheostat, provides the correct voltage for the filament of the screen grid tube, which is 3.3 volts, but this voltage may be lowered by rheostat operation for purposes of volume control.

At the input side of the radio receiver we find an antenna coil. This has two windings, one about four times as large as the other. For instance, on a 2½" diameter tubing you may wind 14 turns for the primary L1, which is connected to antenna and ground, and for the other winding, L2, which begins ¼" away from the other, you may wind 65 turns. The wire may be No. 24, single or double silk covered.

Unusual Coil

This is a familiar type of coil, but the other coil, L3 L4, is unusual. It has the tuned winding, of 65 turns, in the plate circuit. Then a coupling coil is wound on a form 2½" in diameter, and on this are put 65 turns of the same kind of wire. Then the smaller form is secured to the larger and terminal lugs provided.

These directions are for tuning with .00035 mfd. double condensers, as that is the capacity most readily available for this circuit.

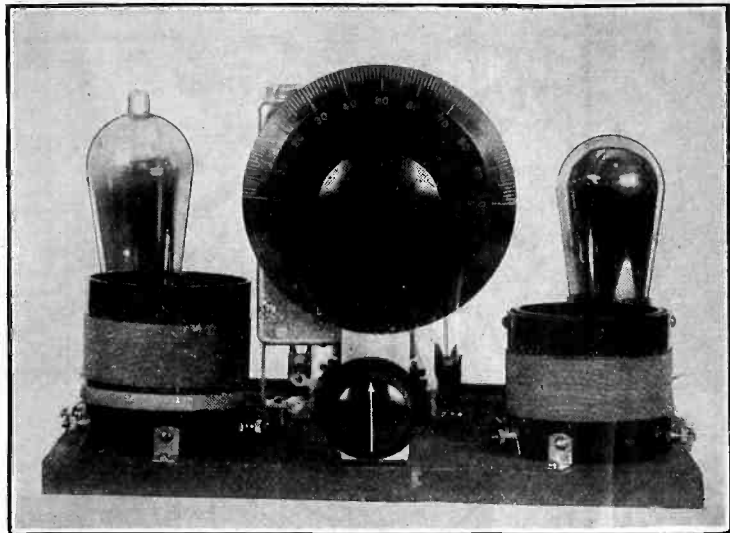

FIG. 1

FRONT VIEW SHOWS THE THREE TUBE SET ERECTED WITHOUT FRONT PANELS, AS A BRACKET SUPPORTS THE TUNING CONDENSER AND ACCOMMODATES THE SWITCH-RHEOSTAT.

The signal, therefore, is picked up by L1, transferred to L2 by mutual inductance, is tuned by C1 L2, goes through the tube to the plate circuit, where additional tuning is provided, and is returned to the grid circuit for repeated reinforcement of the original signal level. Although the first tube is a detector, it amplifies, too, as all detectors do. The amplification is not great, usually, but in this particular circuit it is very substantial.

Now we have been dealing with radio frequencies, which are the frequencies of the broadcasting stations, and are higher frequencies than the ear can hear. We must bring down the signal to the hearing level. This process constitutes detection or the elimination of the carrier frequency and the preservation of only the original microphone frequencies.

Radio frequency coils do not pass audio frequencies. We have taken radio frequencies out of the plate circuit and returned them to the grid circuit. Also we want to take audio frequencies out of the plate circuit of the same 222 tube. It is obvious, therefore, that if we are to succeed there must be two components or parts of the output of the first tube, one at radio frequencies, one at audio frequencies. This situation indeed exists.

Resistor Just the Thing

Now, to render the audio frequencies available we must have some constant—a resistor, a capacity or a coil—that suitably will handle audio frequencies. A coil would do it but would have to be large and rather expensive for a schoolboy. A capacity, we are sorry to report, won't do it. So we have left only a resistor to select, but it so happens that a resistor is most suitable above all for the output of a screen grid tube. We use 1.0 meg. (R3).

You can see quite plainly, therefore, especially by referring to the schematic diagram, Fig. 2, on page 17, that the dual composition of the plate circuit current (radio and audio frequencies) is utilized by having the coils L3 and L4 handle radio frequencies, and intercepting the L3's plate connection to B plus by the resistor R3. So we have the two necessary types of load, as they are called, or more technically, the right type of impedances. One, L3, offers a high impedance to radio frequencies and a low impedance to audio frequencies, hence handles only radio frequencies, because only high impedance produces volume and energetic transfer, and the other, R3, offers a high impedance to audio frequencies and a relatively low impedance to radio frequencies. To help make the impedance or, one might say, receptivity to radio frequencies still lower in R3, a bypass condenser C6 is used, which helps keep radio frequencies out of R3.

(Continued on next page)

SELECTIVITY IN SC

Screen Grid Tube's Tuned Plate Output

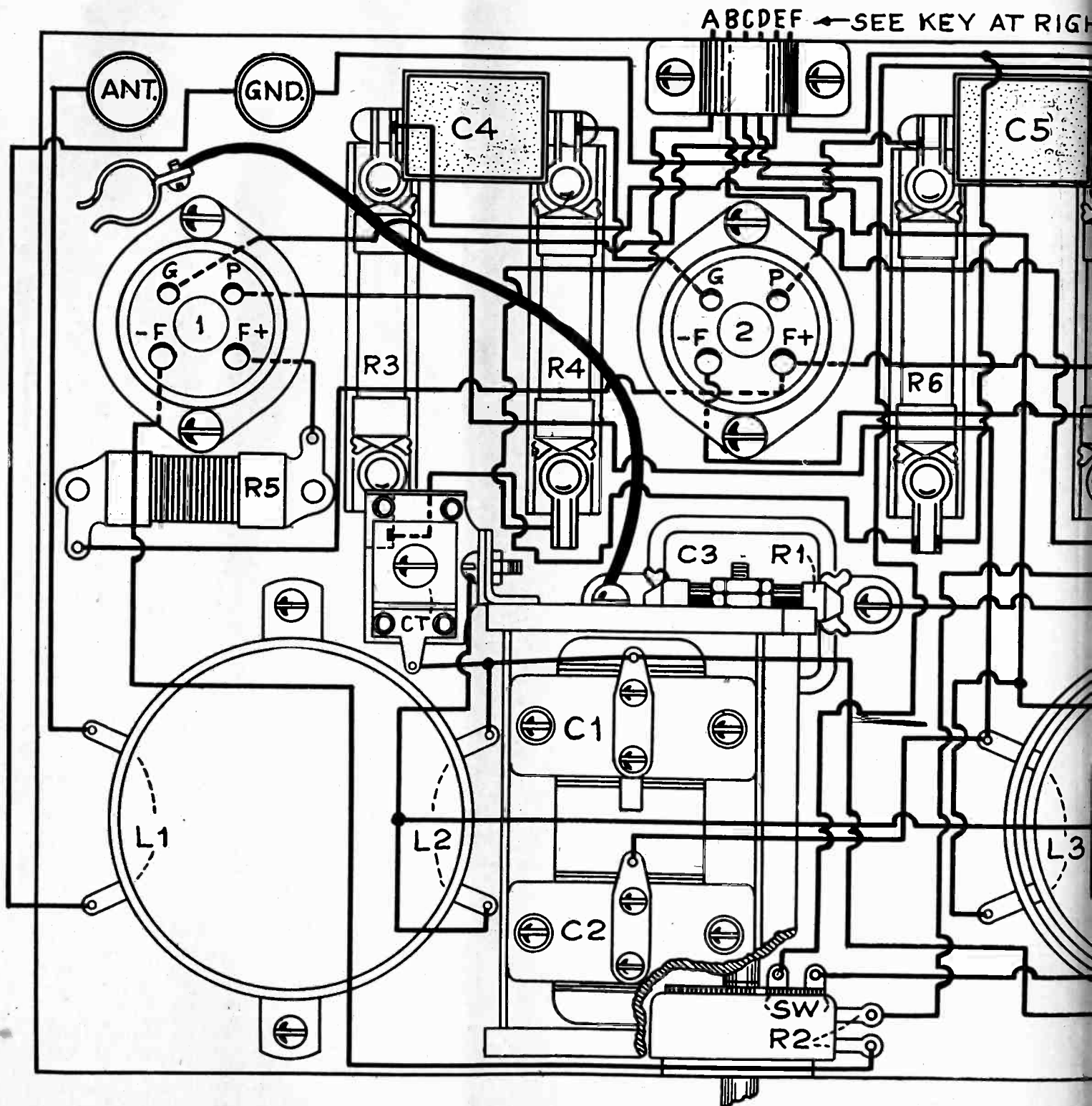

Pictorial diagrams of the wiring of the schoolboy's Three-Tube Set. This diagram is not only full and the method of connecting the wires. A new system of selectivity gain is used. Compare th

(Continued from preceding page)

It is nice to know the type of impedance required, high or low, and as your study of radio progresses these terms, that seem obstructive at first, will clear themselves up nicely, and you will find an enjoyable meaning in everything you read concerning technical radio matters.

Never mind if you do not understand right now the question of impedances, or the obstruction or assistance of the three different types of loads to current of changing values, as dis-

tinguished from currents of steady values, such as direct current. All you need do right now is follow the diagrams. If you can not even read the schematic diagram you can still build the receiver, because the pictorial diagram on the next two pages is full-sized and shows where every part should be placed and where each lead (pronounced leed) should be wired.

Well, we got as far as completion of the analysis of the detector plate circuit. Now we have the audio signal fluctuating across R3. There is a condenser of .01 mfd. between the

HOOVERBOY'S CIRCUIT

Returned to Grid Circuit in Novel Way

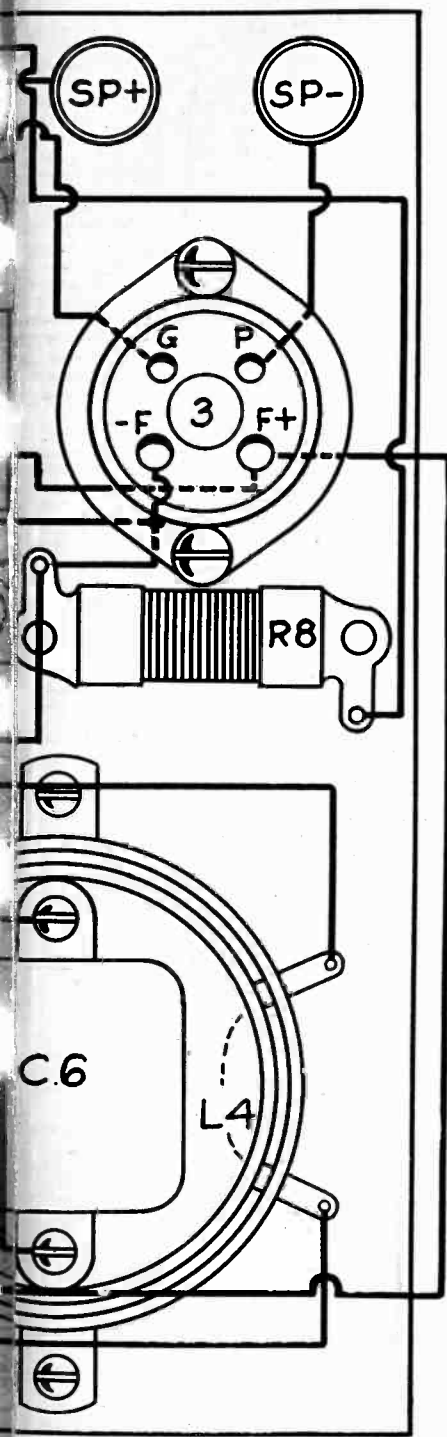

= KEY TO CABLE-

- A = C-1½ V.
- B = C-7½ TO 9 V.
- C = A-, B-, C+
- D = A+
- E = B+22½ TO 45 V.
- F = B+135 V.

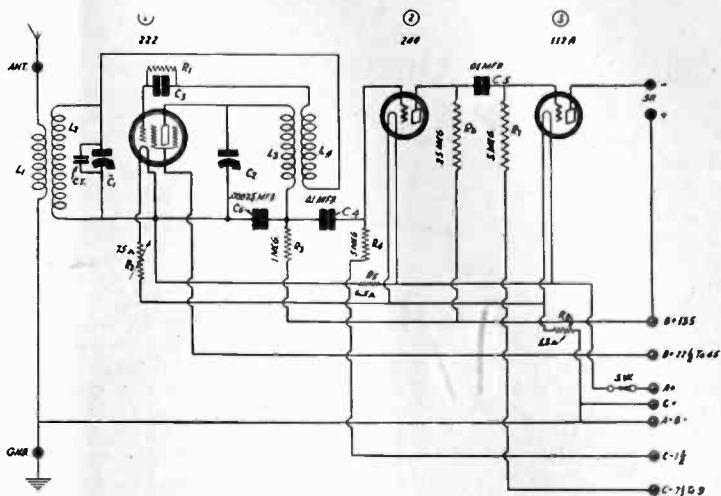

FIG. 3

SCHEMATIC DIAGRAM OF THE CIRCUIT, WITH THE C+ LEAD SHOWN AS SEPARATE. HOWEVER, THE C+ LEAD NEED NOT BE SEPARATE, BUT MAY BE CONNECTED FROM MINUS ON THE A BATTERY TO PLUS ON THE C BATTERY, THE METHOD SHOWN IN THE PICTORIAL DIAGRAM.

Hence the coupling takes place, let us say, by the parallel connection.

The audio signal is impressed on the grid circuit of the first audio tube in that way, and the same process is repeated in the next stage, until now the final or output tube is reached.

The plate of this tube is "Speaker minus" and the B plus connection of the battery, 135 volts, is "Speaker plus." You have heard it said that the plate is positive, so how can it be "Speaker minus"? Because when one speaks of a plate being positive he means it is positive in respect to the negative filament, and that it surely is in this instance, for even if 30 or 40 volts are dropped in the windings of the speaker coils, the remaining voltage, known as the effective plate voltage, is still positive in respect to the negative filament. But "Speaker minus" is negative in respect to the B battery, because at the source the voltage is always highest, and always less at any point due to the voltage drop in an intervening impedance—if I may use the word impedance to designate the speaker coils' windings and still make myself clear!

(Continued on page 20)

LIST OF PARTS

- L1L2—One antenna coupler, RF3.
- L3L4—One screen grid coupler, TP3.
- C1C2—One double condenser, each section .00035 mfd.
- CT—One 80 mmfd. equalizing condenser.
- C3—One .00025 mfd. mica grid condenser with clips.
- C4, C5—Two .01 mfd. mica fixed condensers.
- C6—One .00025 mfd. mica fixed condenser.
- R1, R4, R7—Three 5.0 meg. Lynch metallized grid leaks.
- R2, SW—One 75-ohm rheostat with switch attached.
- R3—One 1.0 meg. Lynch metallized resistor.
- R5—One 6.5-ohm fixed filament resistor.
- R6—One 0.25 Lynch metallized resistor.
- R8—One 1.3-ohm fixed filament resistor.
- Ant., Gnd., Sp.—, Sp. + Four binding posts.
- 1, 2, 3—Three UX sockets.
- One 7-lead cable.
- Four resistor mountings.
- One dial.
- One 7x9½" baseboard.
- Hardware: One main front support bracket for condenser and for switch-rheostat; one subsidiary bracket for rear condenser support, with elevating washer; two 1" screws for condenser mounting.
- Three Kelly tubes: One 222, one 240, one 112A.

2, but shows the correct position of each part diagram with the schematic (Fig. 3) at right.

two resistors, R3 and R4. This is not a coupling condenser. is, on the contrary, an isolating condenser, its purpose to keep the positive plate voltage, as applied to the detector tube, off the grid of the next tube, which is the 240 used as first audio amplifier. The first audio tube's grid should be returned to negative, and this is shown as 1½ volts C minus.

Then how does the coupling take place? Well, R3 is the coupling adjunct. R4 and C4 are in series with each other but in parallel, as a unit circuit, with R3.

A THOUGHT FOR THE WEEK

WELL, now that the big radio show is all over in New York, we can settle down with the knowledge that we have seen the latest offerings of the manufacturers and that the radio season has been officially opened.

Now let's go out for the biggest sales totals during the coming year that radio has even known.

RADIO WORLD

The First and Only National Radio Weekly

Eighth Year

Owned and published by Hennessy Radio Publications Corporation, 145 West 45th Street, New York, N. Y. Roland Burke Hennessy, president and treasurer, 145 West 45th Street, New York, N. Y.; M. B. Hennessy, vice-president, 145 West 45th Street, New York, N. Y.; Herman Bernard, secretary, 145 West 45th Street, New York, N. Y. Roland Burke Hennessy, editor; Herman Bernard, business manager and managing editor; J. E. Anderson, technical editor.

Wanted: Some Pat Words

RADIO never was blessed with a sensible and helpful terminology. All too often one says what he means and then must define what he said, due to the teasing obstacles created by rapid expansion of terms. A word means what it is commonly understood to mean, but the radio technician must sometimes ask himself what is it that it does mean, now that he has said it. Does the reader understand the meaning, or may he easily misconstrue it?

As radio technique developed it became necessary to invent terms. Random authors did much of the inventing, standard authors did much of it, and together they have left a heritage none too valuable. The Institute of Radio Engineers appreciates the situation and is constantly working toward standardization of terms. Enough persons will quarrel with proposed definitions to postpone their effectuation, if not to render a standardized terminology almost impossible. The persons who most frequently use the words and phrases defined, for the attainment of widest circulation, should be most respectfully addressed, to determine if they can be quickly won over. That much gained, the rest will be hard enough. It is one thing to have even the main cooks agree on the recipes, another thing to get the paying customers to swallow the course whole. Technicians like to chew their intellectual food. Oh, how they like to chew it!

One sore spot used to be the word *variometer*. Goodness knows how many writers complained that the instrument was not a meter of any type. The word *variodyuctor* was proposed instead. Then the suggestion was rendered antiquated by the virtual disappearance of any necessity of using the term.

Now the word cathode may be considered. In tube literature this is recognized as the electron emitter. It is not necessarily the filament. In battery-operated tubes, as 201A, the filament is the cathode. But a filament is a thin wire. It need not be an emitter. Some tubes have an independent heater, as the 227, 224 and 228, which heats the cathode, or electron emitter, by thermal radiation. Thus whenever the emitter is meant, cathode is the orthodox word. But orthodox with whom? Perhaps not with the majority of those who read the orthodox use of the word! They may want cathode used only to distinguish the emitter from the heater. So much of radio technical writing is in the popular vein that the readers may not grasp the meaning, if an expression is used that is correct and not self-revealing. The object of writing is to make one's self understood. The complaint of so many radio writers, as of so many wives, is that they are misunderstood!

Suppose some one told you he had "a DC set." What would you imagine he had? Perhaps a receiver that is powered from a 110-volt DC house line as to filament, plate and bias supply. The man next to you, just as well informed, might suppose that a battery-operated set was meant, since the tube filaments use DC from an A battery, instead of AC. If the person who originally imparted the illuminating information meanwhile had disappeared into a service station where batteries were recharged, the man next to you might debate with you the meaning, and the battery-set advocate would have at least some circumstantial evidence in his favor.

Baffle is all that its name implies. Is the box or console containing a speaker the baffle, or is only that part to which the cone ring is attached the baffle? Manufacturers are not in agreement on this subject. A baffle being anything that baffles, so anything may be a baffle. It depends on the point of view. Offhand we would say the board to which the cone ring is attached, and which prevents sound waves from travelling backward when they should go forward is the baffle. But offhand isn't the way to do it. We'll agree to that!

These are only fragments of petals. The woods are full of flowers of doubt growing from stalks of contention.

Over-Refinement

WHAT radio receivers looked like four years ago had better be forgotten in the delight to which the eye is treated to-day. Simplification of front panel, minimization of controls, neat and compact design of mechanisms, and a rage for glorious furniture effects have put us so far ahead of those other days, as adventurers in the realm of radio design, that we merely wonder whether the next four years possibly can bring about commensurate improvement. Such wonder is strongly tinged with the proverbial vanity of mankind. What wonders have we worked! And can anybody (even we) do as much again? Scarcely!

Alexander grieved that there were no more worlds to conquer, but it was not because of grief that he died at thirty. Radio technicians and decoration designers suffer no lack of worlds, or are versatile enough to create worlds, when needed, and conquer them as fast as quantity production demands. Hence they live well-preserved to the ripeness of ninety, being three times as great as Alexander in one direction.

An example of an invented world is push-button tuning. It is not obvious just what benefit this type of tuning bestows. In other words, the need for push-button tuning has not been made clear. The general idea is that, in addition to the regular method of tuning by dial operation, you may press any one of, say, a dozen buttons to obtain any one of a dozen stations previously chosen for button honor.

Virtually all commercially-made receivers are single-dial operated. To tune in the whole available number of stations by the dial method requires turning the dial, by rotating a knob. A few turns of the knob and you have attained the full deflection of the scale. Anybody in the household knows the dial numbers at which the favorite stations come in. What saving in effort exists when a button is pushed, rather than a knob turned say half a revolution, is not explained. Can it be more than the difference between tweedle-dum and tweedle-dee? And if instead of a button a lever is used, is there still a mere distinction, and not a real difference?

Should a stranger be within the gates, since the buttons or levers are marked with call letters, he or she could tune in one of the doughty dozen stations without so much as asking leave of the host. That would be tolerated, of course, since a stranger should be treated like a brother by Biblical axiom. Of course relatives need no encouragement.

So it is true enough, though incredible, that the person without the household, one who has to pay nothing whatever toward the purchase cost or upkeep of the receiver, may be a special beneficiary of push-the-button tuning. The innovation strikes one as being an over-refinement, rather than a real advantage. Fortunately this system is used in good receivers that suffer nothing for the presence of the novelty, though they may gain nothing, either.

Maybe the button method was invented first and the necessity for its existence created later. If so, invention for once was the mother of necessity.

Pressing the button, instead of turning the dial knob, may represent to some senior executives the introduction into their own homes of the business-office habit of getting things done by pressing a button. Instead of a buzzer bringing in a secretary, a non-buzzing set brings in a station. Anyway, something comes in, and that's what a business man likes.

Contrasted with button or lever tuning is remote control tuning, which enables the selection of stations from some point other than at the receiver, as well as at the receiver itself. This brings up the possibility of radio installations being confined to remote places in the home, out of reach of the run of young and old legs, with only the mechanism and the loudspeaker there to remind one that radio is not exactly self-sustaining and automatic in all its aspects. Then the console may give way to the little black box placed in cellar or attic or clothes closet. The money otherwise spent on a console for adornment may be spent instead on the remote controller, there being no need to adorn anything unseen.

Four Tubes and Batteries

ACURIOS over-estimate led some custom set builders and operators of service stations where considerable set-construction is done, to say six months ago that there was no demand for a four tube set, that AC sets were putting battery-operated sets in the remote background. But the first substantial responses in the present young season prove quite easily that many persons like the idea of a set consisting of only four tubes, and powered by batteries. Their acceptance is due, of course, to the facts they appreciate what can be done with four tubes, and they have no AC electricity in their homes.

While the AC set is indeed vastly popular, the rush to it by producers of all types left the battery-circuit field rather skimpily supplied, hence any who had the foresight to cater to the ever-present needs of the farm particularly, and the town and city incidentally, because absence of AC requires that distinction, have made a solid advance and performed a real service.

The advent of the screen grid tube opened new possibilities for high-grade performance by battery-operated receivers, including those of the four tube variety. The logical output tube is 112A or 171A, single or push-pull.

How One Man Broke Through

MY interest in radio's technical side was aroused about five years ago. I didn't know anything about radio but it did look like a fascinating hobby. I am surely glad that I followed it. Although I do not do as much building and experimenting as I did formerly (there's something running around the house now that takes much of my spare time), nevertheless I get at my soldering iron several times a month. I spend about \$250 a year on parts.

At first I had the interest and nothing else. I started to read technical articles in the radio press, including the radio supplements of newspapers, and also two monthlies and your own valuable weekly. Believe it or not, I read these periodicals virtually from cover to cover, without understanding anything. It was not the fault of the authors. They are fully and frankly exculpated here-with. It was my fault. I simply insisted on reading what I did not understand. How I read it! How I yearned to understand what it was all about!

Somebody published a one-tube set. I thought I'd try to build that. Nearly all was clearly set forth in text and diagram. I started work. I came to the filament wiring. On this alone the author was hazy, and the diagram did not actually show the connection. So I was stuck. I took the outfit around to a radio parts store, and a service man, during the boss's absence, charged me \$3 to complete the filament wiring. The work consisted only of soldering two leads, believe it or not. And I paid the \$3 gladly, believe it or not. The set worked. That part you must believe.

There was a set I had built, if not completely, then 95 per cent. of it. I glowed with pride. I became much more intensely interested in radio experimenting, and acquired real avidity in my reading. I sent in \$6 for a year's subscription for RADIO WORLD and essayed a three tube set with what I called success.

It was really surprising what a kick I got out of feeling my radio knowledge grow. Soon I had read so much that the meaning of what was written began to dawn on me, and by slow steps I advanced to that point where I dared read such books as Van der Bijl on tubes and Morecroft on principles.

At first I was a rather sloppy constructor—why not admit it?—but, by following expert design time and time again, I acquired some facility in this direction too, and now I can design an entire circuit both electrically and mechanically, and turn out a real job. And I get all the enjoyment that any hobby can afford, all from a beginning as aimless as wanderlust, but as fervid as it was random.

It is not a bad way to start—read everything on radio technique that you can lay your hands on. Read on, read on, read on, even if you do not understand a word. By slow stages the radio-minded become radio-informed. The zeal produces the result, however desultory the method.

It is therefore with keen appreciation of your good work that I notice you now publish weekly quite a display for the school-boy, although of course you inferentially invite the adult to read about or build the "schoolboy's" circuit if wife or grown son isn't looking.

The novice is a novice whether he is young or younger. It is fine to see you take the novice in hand. Rest assured many a wise one reads what is printed for the novice, if only to find out if anything is published therein that he does not fully understand. I picked up two scraps of information in one of your novice articles that I'd never heard of before.

JAMES HUNTER PHILLIPS,
Rye, N. Y.

* * *

A Thankful Tail-End

YOU print too much about battery-operated receivers. Those wanting such are in the meagre minority. Give us more and more about AC. This is an

Forum

AC age, only you don't know it. Please remember, too, in connection with AC circuits, that the 245 is not the only output tube in the world, and that the older 171A works just as well now as it ever did, and always will work just as well, no matter what new tubes are brought out.

I thank you, however, for your very interesting articles on the new 228 AC high mu tube. I liked the subject-matter and the way it was written.

BEVERLY BRADDOCK,
Tampa, Fla.

* * *

Impartial But Kind

IF I were to say that RADIO WORLD is the better magazine for home constructor, experimenter and student, I would not be saying much, as there are only two such magazines left—RADIO WORLD and "Radio News," but I will say that I subscribe for both of them and like them both. Yours is certainly fraught with originality. You are not content to publish what happens. You make the happening yourself as often as not. Thanks for this initiative. Your magazine is very stimulating.

HUDSON WORK,
Bangor, Me.

* * *

Collected Knowledge Instead

MY opinion may not weigh heavily with you, but RADIO WORLD's publication of lists of broadcasting stations is great stuff. It is, however, about the only interesting material you publish. Your contributors and editors must have worked in forests, collecting dry rot, before they fell to their present tasks. And fell is exactly what I mean.

JOHN DODD,
Minneapolis, Minn.

* * *

Yes, Interesting, if True

THAT was a fancy idea of Bernard's to invent a dynamic tuner, but the discovery of America by Christopher Columbus and the air-circumnavigation of the globe by the Graf Zeppelin were feats, also. Why not publish something about these? While they have nothing to do with radio they are at least interesting.

MARTIN MEYER,
Hoboken, N. J.

* * *

Education as a Limit

YOUR editorial suggesting that stations might enter larger spheres of activity, and promote welfare work, including aiding the blind, the deaf, the illiterate, and even animals trapped and left to die, was very radical for a conservative publication like yours. While I do not subscribe to all the suggestions made in the editorial, I appreciate the excellent motive behind it, the feeling of humanitarianism that pervaded it. Personally I would hesitate to see stations go much beyond adding education to their present entertainment. As for stations being organs of party politics, while I appreciate that in our form of government reforms are instituted because of advocacy by a particular party, and by the strength given by the party to the cause it supports, I'd hate to see stations be such abject slaves to party as most newspapers are. In a party-bound newspaper you never see a kind word for the other side, unless an opponent dies, and the party always is right, in print, whether right of wrong in fact. Stations have a higher responsibility and should be on a higher

plane. The fact that so many of them are cheap noise makers does not change the ideal.

OSCAR WATROUS,
St. Louis, Mo.

* * *

Then the Millenium

REFERRING to your article written by Herbert E. Hayden in the August 24th issue on 227 type tube serving as automatic volume control, it is so unusual in nature that out of curiosity I am writing to find out why you ask your readers to discuss and criticize this article when the circuit would fail from detector alone account of heater not being connected into circuit.

You have talked about the last tube being an audio and failed to show it as same, then give a simplified circuit which is entirely different even in action. It would be handy if voltage divisions could be made so easily, and just because a wire was hooked to positive voltage or not hooked to anything at all say that it received a known negative voltage. If circuits were made to function when made up with principles of electricity entirely disregarded, some of us might have been engineers.

P. E. METZNER, Mishawaka, Ind.

* * *

We Would

I CAN'T agree with everything you publish, but who would want to?

MAX LEVINE,
Brownsville, Texas.

* * *

Exceptionally Laudatory

EACH week RADIO WORLD becomes more interesting to me. I wonder how it is possible to publish a weekly, and make each issue fresh, interesting, appealing. Then along comes RADIO WORLD and shows me how it can be done. We usually do not have much to say publicly in favor of the products of the United States, as we have our own fine products to boost, but with RADIO WORLD I feel constrained to make an exception.

B. J. D. FERRUS,
Montreal, Can.

* * *

Fists Across the Sea

AFTER looking over a copy of RADIO WORLD we do not find any reason to exchange current copies of our magazine for copies of yours.

"WIRELESS WORLD,"
(London, Eng.).

* * *

On Slightest Provocation

UNDER what circumstances would you consider publishing anything worth printing?

GEORGE FARMER,
Beloit, Wisc.

* * *

One Trick We Nearly Missed

HAD I known RADIO WORLD was published seven and a half years ago I would have started reading it then. But you must have been too busy to acquaint everybody with your existence. I have been interested in radio technical matters for nine years. The other day I accidentally came across a copy of your magazine in the public library. Not only was it the first time I had ever seen a copy of it, but it was the first time I had ever even heard of RADIO WORLD. But this it is not the last copy I shall see, God being willing, and you folk permitting. Here's my \$6 for a year's subscription.

H. D. BARRY,
Roanoke, Va.

AIR CONTROL BY FEW INTERESTS FEARED BY DILL

Washington.

Criticism of the Federal Radio Commission's policy of granting clear channels to chain broadcasting stations and the assertion that if such a policy persists it will "force the Government to put radio stations under Government control," was made on the floor of the Senate by Senator Dill (Dem.), of the State of Washington, member of the Interstate Commerce Committee and co-author of the Federal radio act.

Mr. Dill's speech came one day after the Commission had announced postponement until December 31st, 1929, of its order which would limit duplicated operation of chain programs on cleared channels to stations more than 300 miles apart.

Mr. Dill quoted from a magazine article giving an account of recommendations just made to the Canadian Government by a commission which studied the radio situation in that country, the United States and other countries.

Cites Federal Control Plea

Senator Dill said that commission was composed of "hard-headed business men," and that it had urged the Canadian government to abolish private stations and to place them under Government control and operation, granting a subsidy to the stations and taxing receiving sets \$3 a year each.

The Canadian commission, he declared, had found that the only way the people can be assured of fair radio service is through Government operation.

In Hands of Few Soon

"I am not putting forth this information to advocate Government control," according to "The United States Daily," quotes Sen. Dill as saying, "but it is a most significant development. Unless our Radio Commission controls the air and prevents a monopoly by a few companies a situation will develop which will force the Government to put the radio stations in this country under Government control.

"This Commission is granting wavelengths now in such a manner that control of the air will be placed in the hands of a few corporations.

"Every time the effective date of the Radio

Chain Limitation Again Postponed

Washington.

Again the date of the order prohibiting the broadcasting of the same program from stations no more than 300 miles apart has been postponed by the Federal Radio Commission, this time to December 31st. The order was originally issued on September 8th, 1928, it being last postponed on May 15th.

The postponements are due to the repeated pleas of chain stations who say that this order would eliminate chain broadcasts in many localities except for an hour or two nightly.

Commission's order affecting clear channels is reached the order is postponed," Mr. Dill said. "The Commission now insists that high-powered stations on the Atlantic Coast, for example, must have clear channels and stations on the Pacific Coast are not permitted to broadcast on the same wavelength.

"In my judgment the law does not permit granting of these clear channels," he continued.

The Senator said there had been agitation for the repeal of sections 16 and 17 of the radio act which, he said, would make monopolistic control of the air an assured matter. He referred to efforts which, he said, had been made by the American Bar Association to have those sections repealed.

Sen. Dill said that if the United States Supreme Court of the United States upholds the vested rights of radio stations to certain wavelengths the situation will become "most serious."

PRESS PLEA WITHDRAWN

Washington.

The application of the National Radio Press Association, Inc., of New York for twenty continental short wave radio channels, with which it was proposed to provide news dispatches for radio broadcasting stations throughout the country and through them to the public, has been withdrawn.

TOURS WORLD ON TELEVISION

A round-the-world trip was recently begun by J. Levenson, Sydney, Australia, radio distributor. He will visit European and American radio centers. He intends to gather enough data to enable him, upon his return, to construct a television station.

PROGRAM FROM ABROAD SOON TO BE CASUAL

By C. W. HORN

General Engineer, National Broadcasting Company.

The impression seems to prevail that all that is necessary to give American listeners European programs, is to set up a short wave receiving station and then reroute the short wave programs to a network of American stations. Few persons realize that years of research were necessary to determine where a receiving station might be best located. Large tracts of land were purchased so that the best sites might be obtained for receiving plants and thousands upon thousands of dollars have been spent in experimental equipment.

While very little has been said about it, this work has been going on for years. Even at present we are reluctant to make extravagant claims, for we have yet to conquer disturbances that thus far have defied the engineers.

Can Get Good Results

However, with our present equipment and facilities and with atmospheric conditions at normal, we have reached a stage where we can present a program from London or Berlin or some other European point clearly and intelligibly.

Credit must go to the hardworking engineers for what has been accomplished in this field. Without the untiring energy of these men and the financial support afforded to these experiments which at first may have seemed futile, we would not now face an era of worldwide radio broadcasts.

In the coming year there will be a steady increase in the exchange of programs between the United States and Europe until the listener will be accepting the program originating in a foreign city as casually as he accepted the domestic network program of today.

Less Static Trouble

Static is less a problem on short wave broadcasts than on long waves. In place of static we have problems in fading and interference that must be solved and will be solved.

Great Kick in Dandy Circuit for Schoolboys

(Continued from page 17)

The schematic diagram, Fig. 3, shows C plus as a separate lead. This perhaps will clear up a point that is doubtful to some. The connection may be made that way, by having C plus joined to the A minus wire in the set, or may be left for connection between battery post and battery post at whatever point the batteries are placed. It makes no difference which method you follow, the connection still is the same. But it must be pointed out that the pictorial diagram leaves the C plus connection to be made at the batteries.

The wiring is so plain in the pictorial diagram that nothing need be said about constructing the set itself. Only one precaution is required—see that the proper connections are made to the coils, meaning that the antenna coil should be placed at left with primary (lugs of the small winding) facing the left, as you regard the outfit from the front, and with the lugs of the larger winding, for grid circuit connection, to the right. The other coil, placed at right-hand side of the layout, has its tuned winding at left and its untuned winding (for return to the grid circuit) at right. Watch out that the relative positions are the same as described, no matter where the coil's mounting feet may happen to be located. That precaution taken, all's well.

But the connections to batteries may need some clarifying words. Let us take the A battery. One post is positive (red), the other is negative. The corresponding diagram designations

are A plus and A minus. Three 45-volt B batteries are connected in series, positive of one to negative of the other, positive of the second one to negative of the third, leaving two unconnected extremes, one negative, the other positive. Negative is called negative B in this instance (B minus), and is connected to A minus and also to C plus. Now the voltages of the B battery are from 0 to 135, affording 22½ volts nearest to B minus, 45 volts at the positive post of the first battery, 67½ volts at the midsection of the second battery, 90 volts at the end of the second battery, 112½ volts at the middle of the third battery and 135 volts at the end of the third battery. We can select whichever voltage, 22½ or 45, works better on the screen grid (G post) of the 222 tube. I found 22½ volts better than 45 for this circuit.

The C batteries, if more than one, are connected in series, and the voltages add up in the same manner, but in a lower degree, as the voltages of the B batteries. Also, due to the method of connection, they are added in a negative direction.

My advice to all schoolboys experimentally inclined is to build this three tube receiver. You may think now that the volume will be low, but you're mistaken. It's loud, loud, loud! And the tone quality is exquisite. It will outclass nearly all commercial receivers in respect to tone quality, provided the 112A tube is not worked beyond its capacity to handle undistorted power. And that capacity is large enough for any home.

TWO STATIONS 100 MILES OFF TRY ONE WAVE

Washington.

Experiments to determine the practicality of synchronizing high-powered broadcasting stations on the same channel, with a view of conserving wavelengths, have been authorized by the Federal Radio Commission.

WABC, of New York City, "key" station of the Columbia Broadcasting System, and WCAU, of Philadelphia, also affiliated with the Columbia chain, have been granted the authorization at their own request.

The tests are designed to ascertain whether it is practicable for two stations of high power to operate simultaneously on the same frequency without causing ruinous interference. The engineering theory, it was brought out, is that actual "synchronization" can be obtained if the carrier waves emitted by the two stations exactly coincide, or deviate only a few cycles.

Tests from 1 A. M. to 5 P. M.

Under the special authorization, the stations are permitted to conduct the tests from 1 a. m. to 5 a. m., with the proviso that an extension will be granted if desired. WCAU, owned by the Universal Broadcasting Company, is authorized to change its frequency from 1,170 kilocycles to 860 kilocycles, WABC's cleared channel, for the tests only.

The New York station is authorized to broadcast with 5,000 watts power, while the Philadelphia station uses only 1,000 watts, but is authorized to transmit with 10,000 watts. In applying for permission to attempt the synchronization tests the stations said that special equipment devised for the experiments would be employed, designed to keep the stations constant on the 860-kilocycle channel.

Difference of Opinion

At previous engineering hearings held before the Commission, radio engineers testified that absolute synchronization is not practicable at this time, but that it is feasible when the signals between the two stations are controlled by land wire. This, it was pointed out, however, is an expensive process, and is prohibitive on a general basis.

Federal Radio Commissioners Ira E. Robinson and E. O. Sykes, however, support the theory that synchronization without the use of wires is practicable, when the two stations assigned to the same channel are widely separated geographically. The Commission recently authorized synchronization experiments between KVOO, at Tulsa, Okla., and WAPI, at Birmingham, Ala., but the reports received from them have been to the effect that as yet too little is known about the procedure, says "The United States Daily."

It was explained at the Commission's engineering division, that if a practicable means of synchronization is found, it would prove the salvation of broadcasting, since the broadcast spectrum now is exceedingly congested with broadcast stations.

Warning Issued to Curb Trust

Washington.

In a statement recently issued by Oswald F. Schuette, executive secretary of the Radio Protective Association, the radio listening and buying public was warned against the present campaign of propaganda to repeal the anti-trust provisions of the radio law.

"Because the Department of Justice has failed to enforce the Sherman and Clayton anti-trust laws, the anti-trust sections of the radio law are the only protection which the public has against the radio trust," the statement continues.

"That is why that monopoly is carrying on its present campaign of repeal.

"It was the prohibition against cable-wireless monopoly in the radio law that stopped the sale of the communication services of the radio trust for \$1,000,000 to the International Telephone and Telegraph Company.

"Had that deal been consummated, it would have compelled the users of these radio channels to pay interest upon a capitalization of \$1,000,000, although the trust obtained these wavelengths free from the United States Government."

PACENT LISTS 1930 FEATURES

Three high spots stand out in radio for the next year above others, according to Louis Gerard Pacent, one of the pioneers in the field. The most definite trend is the outstanding acceptance and use of the screen grid tube; second is the increasing development of the radio and the phonograph together as a combination; third, the further perfection of receivers through improvements in amplifying equipment, tubes, and speakers.

"The general use of the screen grid tubes," said Mr. Pacent, "is occurring at a logical and happy time. During the past three years, engineering development for the most part has been focussed on perfection of batteryless operation and on much-needed improvements in quality of reproduction.

"This year marks only the beginning of screen grid possibilities, in my opinion. We shall see much work along the lines of simplification of radio frequency stages, with more gain per stage. The final result will be much simpler receiving sets.

"Radio and radio broadcast entertainment has done much to reestablish the phonograph in thousands of American homes. Through the perfection of power amplification and electrically recorded records, an entirely new appeal and realm have been imparted to phonograph entertainment.

"The further perfection of tone apparent from this year's model receivers," Mr. Pacent concluded, "will do much to make this a great year from a sales point of view. Electrically operated sets with fine quality and simplified, certain operation at the prices prevailing this fall can only mean exceptional business."

SMITH PRAISES RADIO'S VALUE IN CAMPAIGNS

Alfred E. Smith, in his autobiography, published serially in "The Saturday Evening Post," discusses radio in respect to political campaigns, in the final instalment of the series. The four-time Governor of New York State, and Presidential candidate last November, entitles his autobiography "Up To Now." He says about radio:

"In my first campaign for the governorship I was compelled to rely almost entirely on newspaper accounts of my speeches and the word that would be passed along by the comparatively few citizens who would have an opportunity to hear me personally.

"Beginning in 1924 the radio came into play, but in a very restricted way. Campaign speakers were annoyed by the presence of what I called the 'pic plate.' That was at the ratification meeting for John W. Davis in Madison Square Garden in October, 1924. Amplifiers in the halls gave a metallic, tinny sound to the voice, which also was disconcerting to men speaking, particularly extemporaneously.

"Growth and development of the use of the radio were such that in 1928 it played probably the most important rôle in the national campaign.

Reading Only 1%

"To indicate the value of the radio, let us assume that a candidate for public office made a speech every night for thirty nights. In New York State he could not address more than an average of a thousand people a night. That would mean thirty thousand people, or 1 per cent of the electorate, the other 99 per cent being dependent upon what they heard or read about it in the newspapers.

"Back in the old days of campaigning, comparatively few people in the country heard the voice of the candidate or got the slightest idea of his personality or the force and effectiveness of his spoken word. In the recent campaign millions of people listened to both candidates every time they spoke, and acquired a familiarity with their characteristics and mannerisms of speech as well as of their voices.

The Same Voice

"While at Palm Beach this Winter a friend introduced me to her young daughter. As soon as I spoke the little girl turned to her mother and said, 'Oh, mamma, he has the same voice that he had on the radio.'

"The radio takes the place of the antiquated method of attempting to circularize the electorate by the mailing of speeches of acceptance and of debates. A large part of these documents was always wasted. Nothing makes such an impression on a person as the spoken word. Oratory and the power of speech will always be effective."

Pacent Electric Co.

A new type of adapter containing a change-over control, known as the Phonotrol, to be used with the Pacent Phonovox on screen grid electric sets, has just been brought out by the Pacent Electric Company, 91 Seventh Avenue, New York City.

The company manufactures a complete line of radio essentials.

PUBLISHERS CAN SUPPLY ALL 1929 SUMMER COPIES OF RADIO WORLD

If you have missed any copies of Radio World for the summer of 1929 and want to complete your file, let us know what issues you are short and we will mail them to you at 15c a copy, or any seven issues for \$1.00, mailed postpaid.

Circulation Dept., Radio World, 145 W. 45th St., N. Y. City.

WAVES TO SET WATCHES RIGHT BY A NEW IDEA

Washington.

The commercial production of watches and clocks which will be essentially miniature radio receiving sets capable of picking up signals which would adjust the watches and clocks to the exact time is the motive of a request by the Elgin National Watch Company for an experimental license on the 4795 kilocycle channel. This wave is one of the short waves reserved for experimental purposes.

The company has previously carried on work of a similar nature, operating a station on 8950 kilocycles. The license for this station was revoked last June.

Another possible use of the radio-controlled timepieces, according to Frank O. Urie, director of research of the Elgin Company, would be for the time signals to be picked up by a receiver adjusted to a particular wave, with an attachment to which the timepiece could be connected so that it could be corrected.

It was also brought out that the system could be used in military operations, such as for the automatic firing of torpedoes.

Only time "ticks," and code giving the station's call letters, and explaining the "ticks," are to be sent out, according to Mr. Urie.

Of the 20,000 jewellers in this country, 40 per cent, he explained, would take advantage of this service.

Couple Give \$50,000 Annual Fund to KCRC

Washington.

A broadcasting station is as highly important a public institutional factor as a college or other public educational center, in the opinion of Mr. and Mrs. H. H. Chamlin, of Enid, Oklahoma. They thus have set aside a \$50,000 annual fund for the upkeep of KCRC, at Enid, from which only programs of an entertaining and educational form will be sent.

To this end an application has been filed with the Federal Radio Commission, asking that the station be permitted to operate on 1190 kilocycles on a power of 5000 watts. It now uses 100 watts on 1370 kilocycles.

If the application is granted, the station may have to share time with WOIA, of San Antonio, Texas, which has applied for an increase of power to 5000 watts.

French and Hygiene Taught in Air Course

Cincinnati.

New courses in French for high school students and in hygiene for pupils in the fifth and sixth grades were begun in the second week of the Central School of the Air, broadcast every school day from 2 to 3 P. M. by WLW. The French course is conducted by Professor Price of the Ohio State University. The Health courses, given every other week, are conducted by Roy P. Emersin, dean of the School of Medicine of Indiana University.

Talks on other standard subjects, such as chemistry, music, geography, are also a part of the daily broadcasts.

Greatest Season Crosley Predicts

With the beginning of the Fall season, Powel Crosley, Jr., envisions a "radio boom" for the public and manufacturers.

"Radio is sweeping onward toward the greatest season in its history," he said.

"Broadcasters promise better and novel programs, receiving sets are in wider use both in this country and abroad, and the public is wide awake to the remarkable possibilities of the screen grid tube.

"Summer business was better than last Summer. My own faith in the future of the industry was reflected by the addition of two new factory units to our Cincinnati plant.

"To some of us pioneers in the industry, the miracle of radio is an ever-recurring one. As I recall the time when a daily output of ten receiving sets was a great day's work, and as I reflect that more than 350,000 persons are employed in radio today, not to mention the millions for whom it has furnished entertainment, education and culture, I hesitate to outline the future of this amazing industry which emerged from its swaddling clothes only a few years ago."

FRENCH TRAINS GET RECEIVERS

Washington.

Three of the principal express trains of the French State Railroad, operating between Paris and Havre, will be equipped with radio, according to a report of the American vice consul at Paris.

"A radio engineer, installed in a special cabin, will supervise the reception of programs on these trains," the report says.

"A headpiece will be made available for each passenger, at first only in first and second class coaches, but eventually it is planned to extend this service to the third class.

"A charge will be made to each user of the service, varying between 10 and 20 francs. The programs of Radio Paris, the Eiffel Tower, Daventry, England, and other European stations may be heard by the traveler, while the quotations on the Paris Bourse will be made available to the business man, so far as they are broadcast."

Panamanians Deem Sets Too Complicated

Washington.

A survey recently made in the Republic of Panama by the electrical equipment division of the Department of Commerce shows that the small number of receiving sets is due to the Panamanian considering radio as being too complicated.

There are only 300 sets here, most of which are of the home-built type.

The Balboa Radio Club, directly under the supervision of the U. S. Navy, directs the broadcasting, the station being partly owned by the club and partly by the Navy. It operates on 357.1 meters.

FORD WITHDRAWS REQUEST

Washington.

A request for renewal of its experimental license for a 1000-watt station operating from 515 to 530 kilocycles has been withdrawn by the Ford Motor Company of Detroit.

EXHIBITS TELL TUBE HISTORY, 1903 TO DATE

An outline of the history of vacuum tube was told in a series of models and documents, comprising one of the outstanding features of the Sixth Annual Radio World's Fair recently held at the Madison Square Garden.

Beginning with the gas flame detector, used by Lee DeForest in 1903, the history of radio exhibits covered in turn the first rectifier tube with filament and a pool of mercury, the first control electrode vacuum tube with control member in the form of a band on the outside of the glass bulb, and then the vacuum tube with the control member inside the glass bulb, this in the form of a second plate placed closer to the filament than the first plate.

The accompanying patent application of Dr. DeForest, covering this tube, showed the use of a grid bias voltage (1907). The most important invention in the entire history of radio development—the first audion, in the form of a glass bulb with a filament, zigzag wire electrode or grid, and a separate plate was seen next. A subsequent model presented the first commercial audion of 1907, followed by an improved type used from 1909 to 1917. This last audion is quite similar in general design to present-day tubes, with grid and plate placed on both sides of the filament.

It was this type of audion that Dr. DeForest used in the first cascaded amplifier which he demonstrated to the Bell Telephone System engineers in October, 1912. This was also the first tube to contain a vacuum approximating that used in present-day vacuum tubes, and was successfully used in the first oscillating tube circuits.

The exhibit also showed the advance of commercial tubes from 1917 to date.

N. J. Station Seeks To Share With Seattle

Washington.

An application for the use of 5000 watts on 970 kilocycles for simultaneous transmission with KJR, a 5000 watt station of Seattle, was recently made by WRNY.

According to Walter S. Lemmon, manager of WRNY, this 970 kilocycle channel is completely isolated from the Eastern part of the country, because of the mountainous Mid-Western barrier. To back this statement, he showed that WGY of Schenectady, N. Y., and KGO, at Oakland, California, operate on one frequency, 790 kilocycles, with much success.

The Chicago station, WCFL, also operates on 970 kilocycles, but on a limited time schedule.

NOTE SUPPLANTS DIRGE

The usual "There will now be a brief pause for station announcements," is now missing from the daytime programs of the National Broadcasting Company. In its place there is a musical note, which is obtained from a specially-designed four-note gong.

CALLS SOUTH RADIO-MINDED

The South has become definitely radio-minded, according to J. B. Knight, Jr., member of the engineering staff of the DeForest Radio Company, who recently returned from the Atlanta Radio Show.

Alphabetical List of Stations by Call Letters; Location and Frequency

[FROM FEDERAL RADIO COMMISSION LIST REVISED UP TO NOON, SEPTEMBER 25th]

Station	Location	Frequency	Station	Location	Frequency	Station	Location	Frequency	Station	Location	Frequency			
WAAF	Chicago, Ill.	920	WGES	Chicago, Ill.	1360	WMAL	Washington, D.C.	630	WTAQ	Eau Claire, Wis.	1330	KGHX	Richmond, Tex.	1500
WAAM	Newark, N. J.	1250	WGH	Newport News, Va.	1310	WMAN	Columbus, Ohio	1210	WTAR	Worcester, Mass.	750	KGIO	Twin Falls, Idaho	1320
WAAT	Jersey City, N. J.	1070	WGHP	Detroit, Mich.	1240	WMAQ	Chicago, Ill.	670	WTAW	College Station, Tex.	1120	KGIR	Butte, Mont.	1360
WAAW	Omaha, Neb.	660	WGL	Ft. Wayne, Ind.	1370	WMAZ	Macon, Ga.	890	WTAX	Streator, Ill.	1210	KGIV	Trinidad, Colo.	1420
WABC	WBOQ-N.Y. City	860	WGMS	See WLB-WGMS		WMBA	See WLB-WGMS		WTBO	Cumberland, Md.	1420	KGIX	Las Vegas, Nev.	1420
WABI	Bangor, Me.	1200	WGN	WLIB-Elgin, Ill.	720	WMBC	Detroit, Mich.	1420	WTFI	Toccoa, Ga.	1450	KGJF	Little Rock, Ark.	890
WABZ	New Orleans, La.	1200	WGR	Buffalo, N. Y.	550	WMBD	Peoria Hts., Ill.	1440	WVAA	Avon, Ct.	600, 1060	KGKB	Brownwood, Tex.	1500
WADC	Akron, O.	1320	WGST	Atlanta, Ga.	890	WMBG	Richmond, Va.	1210	WVME	Milwaukee, Wis.	620	KGKL	San Angelo, Tex.	1370
WAGM	Royal Oak, Mich.	1310	WGY	Schenectady, N. Y.	790	WMBH	Joplin, Mo.	1420	WVWA	Hammond, Ind.	1200	KGKS	Wichita, Falls, Tex.	570
WAIU	Columbus, O.	640	WHA	Madison, Wis.	940	WMBI	Addison, Ill.	1080	WVWJ	Detroit, Mich.	920	KGKX	San Point, Idaho	1420
WAPI	Birmingham, Ala.	1140	WHAD	Milwaukee, Wis.	1120	WMBJ	Pittsburgh, Pa.	1580	WVWL	New Orleans, La.	850	KGO	Oakland, Calif.	790
WASH	Gd. Rapids, Mich.	1270	WHAM	Rochester, N. Y.	1150	WMBL	Lakeland, Fla.	1310	WVWN	Asheville, N. C.	570	KGRC	San Antonio, Tex.	1370
WBAK	Harrisburg, Pa.	1430	WHAP	N. Y. City	1300	WMBN	Lakeland, Fla.	1310	WVWR	Woodside, N. Y.	1500	KGRS	Amarillo, Tex.	1410
WBAL	Baltimore, Md.	1060	WHAS	N. Y. City	1300	WMBQ	Brooklyn, N. Y.	1500	WVVA	Wheeling, W. Va.	1160	KGU	Honolulu, Hawaii	940
WBAP	Fort Worth, Tex.	800	WHAZ	Troy, N. Y.	1300	WMBR	Tampa, Fla.	1210	WVWA	Wheeling, W. Va.	1160	KGW	Portland, Ore.	620
WBAY	Nashville, Tenn.	1490	WHB	Kansas City, Mo.	950	WMC	Memphis, Tenn.	570	WVWA	Wheeling, W. Va.	1160	KGY	Lacey, Wash.	1200
WBAX	Wilkes-Barre, Pa.	1210	WHBC	Canton, Ohio	1200	WMC	Memphis, Tenn.	570	WVWA	Wheeling, W. Va.	1160	KHJ	Los Angeles, Calif.	900
WBBC	Brooklyn, N. Y.	1400	WHBD	Bellefontaine, O.	1370	WMC	Memphis, Tenn.	570	WVWA	Wheeling, W. Va.	1160	KHO	Spokane, Wash.	590
WBBL	Richmond, Va.	1370	WHBF	Rock Island, Ill.	1210	WMC	Memphis, Tenn.	570	WVWA	Wheeling, W. Va.	1160	KIK	Red Oak, Iowa	1420
WBMM	WJBT-Chicago	770	WHBL	Sheboygan, Wis.	1410	WMC	Memphis, Tenn.	570	WVWA	Wheeling, W. Va.	1160	KID	Idaho Falls, Idaho	1320
WBRR	Rossville, N. Y.	1300	WHBP	Johnstown, Pa.	1310	WMC	Memphis, Tenn.	570	WVWA	Wheeling, W. Va.	1160	KIDO	Boise, Idaho	1250
WBRY	Charleston, S. C.	1200	WHBU	Anderson, Ind.	1210	WMC	Memphis, Tenn.	570	WVWA	Wheeling, W. Va.	1160	KIT	Yakima, Wash.	1370
WBZ	Ponca City, Okla.	1200	WHBW	Philadelphia, Pa.	1500	WMC	Memphis, Tenn.	570	WVWA	Wheeling, W. Va.	1160	KJBS	San Francisco, Calif.	1070
WBZ	Ponca City, Okla.	1200	WHBY	W. De Pere, Wis.	1200	WMC	Memphis, Tenn.	570	WVWA	Wheeling, W. Va.	1160	KJR	Seattle, Wash.	970
WBZ	Ponca City, Okla.	1200	WHDF	Calumet, Mich.	1370	WMC	Memphis, Tenn.	570	WVWA	Wheeling, W. Va.	1160	KLCN	Blytheville, Ark.	1290
WBZ	Ponca City, Okla.	1200	WHDH	Gloucester, Mass.	830	WMC	Memphis, Tenn.	570	WVWA	Wheeling, W. Va.	1160	KLO	Ogden, Utah	1370
WBZ	Ponca City, Okla.	1200	WHDI	Minneapolis, Minn.	1180	WMC	Memphis, Tenn.	570	WVWA	Wheeling, W. Va.	1160	KLPM	Minot, N. D.	1420
WBZ	Ponca City, Okla.	1200	WHDL	Tupper Lake, N. Y.	1420	WMC	Memphis, Tenn.	570	WVWA	Wheeling, W. Va.	1160	KLRA	Little Rock, Ark.	1390
WBZ	Ponca City, Okla.	1200	WHDC	WABO-Rochester, N.Y.	1440	WMC	Memphis, Tenn.	570	WVWA	Wheeling, W. Va.	1160	KLX	Oakland, Calif.	1440
WBZ	Ponca City, Okla.	1200	WHFC	Cicero, Ill.	1310	WMC	Memphis, Tenn.	570	WVWA	Wheeling, W. Va.	1160	KLZ	Dupont, Colo.	560
WBZ	Ponca City, Okla.	1200	WHIS	Bluefield, W. Va.	1420	WMC	Memphis, Tenn.	570	WVWA	Wheeling, W. Va.	1160	KMA	Shenandoah, Iowa	930
WBZ	Ponca City, Okla.	1200	WHK	Cleveland, Ohio	1390	WMC	Memphis, Tenn.	570	WVWA	Wheeling, W. Va.	1160	KMB	Independence, Mo.	950
WBZ	Ponca City, Okla.	1200	WHN	New York, N. Y.	1010	WMC	Memphis, Tenn.	570	WVWA	Wheeling, W. Va.	1160	KMC	Medford, Ore.	1310
WBZ	Ponca City, Okla.	1200	WHO	Des Moines, Ia.	1000	WMC	Memphis, Tenn.	570	WVWA	Wheeling, W. Va.	1160	KMG	Inglewood, Calif.	1120
WBZ	Ponca City, Okla.	1200	WHP	Harrisburg, Pa.	1430	WMC	Memphis, Tenn.	570	WVWA	Wheeling, W. Va.	1160	KMJ	Fresno, Calif.	1200
WBZ	Ponca City, Okla.	1200	WIA	Ottumwa, Iowa	1420	WMC	Memphis, Tenn.	570	WVWA	Wheeling, W. Va.	1160	KMMJ	Clay Center, Neb.	740
WBZ	Ponca City, Okla.	1200	WIB	Madison, Wis.	1210	WMC	Memphis, Tenn.	570	WVWA	Wheeling, W. Va.	1160	KMO	Tacoma, Wash.	1340
WBZ	Ponca City, Okla.	1200	WIB	Madison, Wis.	1210	WMC	Memphis, Tenn.	570	WVWA	Wheeling, W. Va.	1160	KMOX	KFOA-St. Louis	1090
WBZ	Ponca City, Okla.	1200	WIB	Madison, Wis.	1210	WMC	Memphis, Tenn.	570	WVWA	Wheeling, W. Va.	1160	KMTR	Hollywood, Calif.	570
WBZ	Ponca City, Okla.	1200	WIB	Madison, Wis.	1210	WMC	Memphis, Tenn.	570	WVWA	Wheeling, W. Va.	1160	KNX	Hollywood, Calif.	1050
WBZ	Ponca City, Okla.	1200	WIB	Madison, Wis.	1210	WMC	Memphis, Tenn.	570	WVWA	Wheeling, W. Va.	1160	KOA	Denver, Colo.	830
WBZ	Ponca City, Okla.	1200	WIB	Madison, Wis.	1210	WMC	Memphis, Tenn.	570	WVWA	Wheeling, W. Va.	1160	KOC	Corvallis, Ore.	560
WBZ	Ponca City, Okla.	1200	WIB	Madison, Wis.	1210	WMC	Memphis, Tenn.	570	WVWA	Wheeling, W. Va.	1160	KOB	State College, N.M.	1180
WBZ	Ponca City, Okla.	1200	WIB	Madison, Wis.	1210	WMC	Memphis, Tenn.	570	WVWA	Wheeling, W. Va.	1160	KOCW	Chickasha, Okla.	1400
WBZ	Ponca City, Okla.	1200	WIB	Madison, Wis.	1210	WMC	Memphis, Tenn.	570	WVWA	Wheeling, W. Va.	1160	KOH	Reno, Nev.	1370
WBZ	Ponca City, Okla.	1200	WIB	Madison, Wis.	1210	WMC	Memphis, Tenn.	570	WVWA	Wheeling, W. Va.	1160	KOIL	Council Bluffs, Ia.	1260
WBZ	Ponca City, Okla.	1200	WIB	Madison, Wis.	1210	WMC	Memphis, Tenn.	570	WVWA	Wheeling, W. Va.	1160	KOIN	Portland, Ore.	940
WBZ	Ponca City, Okla.	1200	WIB	Madison, Wis.	1210	WMC	Memphis, Tenn.	570	WVWA	Wheeling, W. Va.	1160	KOL	Seattle, Wash.	1270
WBZ	Ponca City, Okla.	1200	WIB	Madison, Wis.	1210	WMC	Memphis, Tenn.	570	WVWA	Wheeling, W. Va.	1160	KOMO	Seattle, Wash.	1200
WBZ	Ponca City, Okla.	1200	WIB	Madison, Wis.	1210	WMC	Memphis, Tenn.	570	WVWA	Wheeling, W. Va.	1160	KOOS	Marshfield, Ore.	1370
WBZ	Ponca City, Okla.	1200	WIB	Madison, Wis.	1210	WMC	Memphis, Tenn.	570	WVWA	Wheeling, W. Va.	1160	KORE	Eugene, Ore.	1420
WBZ	Ponca City, Okla.	1200	WIB	Madison, Wis.	1210	WMC	Memphis, Tenn.	570	WVWA	Wheeling, W. Va.	1160	KOY	Phoenix, Ariz.	1390
WBZ	Ponca City, Okla.	1200	WIB	Madison, Wis.	1210	WMC	Memphis, Tenn.	570	WVWA	Wheeling, W. Va.	1160	KPCB	Seattle, Wash.	1210
WBZ	Ponca City, Okla.	1200	WIB	Madison, Wis.	1210	WMC	Memphis, Tenn.	570	WVWA	Wheeling, W. Va.	1160	KPJM	Prescott, Ariz.	1500
WBZ	Ponca City, Okla.	1200	WIB	Madison, Wis.	1210	WMC	Memphis, Tenn.	570	WVWA	Wheeling, W. Va.	1160	KPLA	Los Angeles, Calif.	1000
WBZ	Ponca City, Okla.	1200	WIB	Madison, Wis.	1210	WMC	Memphis, Tenn.	570	WVWA	Wheeling, W. Va.	1160	KPO	San Francisco, Calif.	680
WBZ	Ponca City, Okla.	1200	WIB	Madison, Wis.	1210	WMC	Memphis, Tenn.	570	WVWA	Wheeling, W. Va.	1160	KPFD	Denver, Colo.	880
WBZ	Ponca City, Okla.	1200	WIB	Madison, Wis.	1210	WMC	Memphis, Tenn.	570	WVWA	Wheeling, W. Va.	1160	KPPC	Pasadena, Calif.	1200
WBZ	Ponca City, Okla.	1200	WIB	Madison, Wis.	1210	WMC	Memphis, Tenn.	570	WVWA	Wheeling, W. Va.	1160	KPQ	Seattle, Wash.	1210
WBZ	Ponca City, Okla.	1200	WIB	Madison, Wis.	1210	WMC	Memphis, Tenn.	570	WVWA	Wheeling, W. Va.	1160	KPRC	Houston, Tex.	920
WBZ	Ponca City, Okla.	1200	WIB	Madison, Wis.	1210	WMC	Memphis, Tenn.	570	WVWA	Wheeling, W. Va.	1160	KPSN	Pasadena, Calif.	950
WBZ	Ponca City, Okla.	1200	WIB	Madison, Wis.	1210	WMC	Memphis, Tenn.	570	WVWA	Wheeling, W. Va.	1160	KPWF	Westminster, Calif.	1490
WBZ	Ponca City, Okla.	1200	WIB	Madison, Wis.	1210	WMC	Memphis, Tenn.	570	WVWA	Wheeling, W. Va.	1160	KQV	Pittsburgh, Pa.	1380
WBZ	Ponca City, Okla.	1200	WIB	Madison, Wis.	1210	WMC	Memphis, Tenn.	570	WVWA	Wheeling, W. Va.	1160	KQW	San Jose, Calif.	1010
WBZ	Ponca City, Okla.	1200	WIB	Madison, Wis.	1210	WMC	Memphis, Tenn.	570	WVWA	Wheeling, W. Va.	1160	KRE	Berkeley, Calif.	1370
WBZ	Ponca City, Okla.	1200	WIB	Madison, Wis.	1210	WMC	Memphis, Tenn.	570	WVWA	Wheeling, W. Va.	1160	KRGV	Harlingen, Tex.	1260
WBZ	Ponca City, Okla.	1200	WIB	Madison, Wis.	1210	WMC	Memphis, Tenn.	570	WVWA	Wheeling, W. Va.	1160	KRLD	Dallas, Tex.	1040
WBZ	Ponca City, Okla.	1200	WIB	Madison, Wis.	1210	WMC	Memphis, Tenn.	570	WVWA	Wheeling, W. Va.	1160	KRMD	Shreveport, La.	1310
WBZ	Ponca City, Okla.	1200	WIB	Madison, Wis.	1210	WMC	Memphis, Tenn.	570	WVWA	Wheeling, W. Va.	1160	KRSC	Seattle, Wash.	1120
WBZ	Ponca City, Okla.	1200	WIB	Madison, Wis.	1210	WMC	Memphis, Tenn.	570	WVWA	Wheeling, W. Va.	1160	KSAC	Manhattan, Kans.	580
WBZ	Ponca City, Okla.	1200	WIB	Madison, Wis.	1210	WMC	Memphis, Tenn.	570	WVWA	Wheeling, W. Va.	1160	KSCJ	Sioux City, Ia.	1330
WBZ	Ponca City, Okla.	1200	WIB	Madison, Wis.	1210	WMC	Memphis, Tenn.	570	WVWA	Wheeling, W. Va.	1160	KSD	St. Louis, Mo.	550
WBZ	Ponca City, Okla.	1200	WIB	Madison, Wis.	1210	WMC	Memphis, Tenn.	570	WVWA	Wheeling, W. Va.	1160	KSEI	Pocatello, Idaho	900
WBZ	Ponca City, Okla.	1200	WIB	Madison, Wis.	1210	WMC	Memphis, Tenn.	570	WVWA	Wheeling, W. Va.	1160	KSL	Salt Lake City, U.	1130
WBZ	Ponca City, Okla.	1200	WIB	Madison, Wis.	1210	WMC	Memphis, Tenn.	570	WVWA	Wheeling, W. Va.	1160	KSMR	Santa Maria, Calif.	1200
WBZ	Ponca City, Okla.	1200	WIB	Madison, Wis.	1210	WMC	Memphis, Tenn.	570	WVWA	Wheeling, W. Va.	1160	KSO	Clarinda, Iowa	1380
WBZ	Ponca City, Okla.	1200	WIB	Madison, Wis.	1210	WMC	Memphis, Tenn.	570	WVWA	Wheeling, W. Va.	1160	KSOO	Sioux Falls, S. D.	1110
WBZ	Ponca City, Okla.	1200	WIB	Madison, Wis.	1210	WMC	Memphis, Tenn.	570	WVWA	Wheeling, W. Va.	1160	KSTP	St. Paul, Minn.	1460
WBZ	Ponca City, Okla.	1200	WIB	Madison, Wis.	1210	WMC	Memphis, Tenn.	570	WVWA	Wheeling, W. Va.	1160	KTAB	Oakland, Calif.	550
WBZ	Ponca City, Okla.	1200	WIB	Madison, Wis.	1210	WMC	Memphis, Tenn.	570	WVWA	Wheeling, W. Va.	1160	KTAP	San Antonio, Tex.	1420
WBZ	Ponca City, Okla													

Be an Amperite for every tube.
Dr. Radio Engineer

The Prescription for Better Radio Reception

AMPERITE automatically maintains the most efficient tube voltage. Improves tone, sensitivity, volume. For every tube. \$1.10 with mounting (in U.S.A.). At all dealers.

AMPERITE Corporation
661 BROADWAY, NEW YORK

FREE—"Amperite Tube Chart." Write Dept. RW-20.

AMPERITE
REG. U.S. PAT. OFF.
The "SELF-ADJUSTING" Rheostat

This symbol in a radio diagram means—

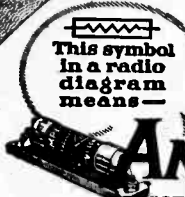

Component Parts for
Herman Bernard's
H B Compact

(BATTERY MODEL)
The Circuit of Circuits!
Only Four Tubes

Bernard Antenna Tuner BT5A.....	\$2.50
Bernard Interstage BT5B.....	2.50
Two Dustproof .0005 cond. pair with 4 support brackets	5.00
One 90 mmfd. equalizer35
Three .01 mfd. at 40c each.....	1.20
One .25 meg.30
Two 5.0 meg. at .3060
One .075 meg.....	.40
One 75-ohm rheo. with switch.....	.80
One 1.3 ohm.....	.15
One 6.5 ohm.....	.30
4 binding posts at .10.....	.40
Drilled steel cabinet 7x9x15".....	4.00
Satin aluminum subpanel, socketed, bracket, insulators, 4 resistor clips.....	2.00
Two dials at .70 ea.....	1.40
Two dial pointers at .10 ea.....	.20
7-lead cable50
Two links at .35 ea.....	.70

\$23.30

GUARANTY RADIO GOODS CO.
143 West 45th Street, New York, N. Y.
Just East of Broadway

FREE RADIO GUIDE

SEND FOR IT

This book tells about newest startling developments. How to take advantage of the new wrinkles in radio, television, short wave, etc. Pictures and descriptions of thousands of new ideas. Shows new A-C Sets, Grid tube and other sets, kits, parts, accessories and supplies at wholesale prices. Shows you how to save money on these and many home necessities besides. New edition now ready. Send for it today—NOW BARAWIK CO., 139 Canal St., Chicago, U. S. A.



RADIO TONIC

When it comes to making sick radios well, or good radios better, just remember—

CLAROSTAT

the name of a line of products dedicated to better radio results.

Clarostat Mfg. Co., 291 N. 6th St., B'klyn, N. Y.

TRUVOLT
Adjustable Voltage Divider



Connect the TRUVOLT DIVIDER to any eliminator output. Adjust from a simple chart. You get exactly the right B. & C. voltages without calculations. A resistance bank of distinctive Truvolt air-cooled construction with five output taps, individually controlled. Ventilated Bakelite case. Saves time and trouble for experimenters. Write Dept. RW12 for detailed description.

175 Varick St., New York, N.Y.
ELECTRAD
INC.

LYNCH

Manufacturers of LYNCH RESISTORS, EQUALIZERS, SUPPRESSORS, MOUNTINGS, RESISTANCE-COUPLED KITS, ETC.

Write for Booklet.
Lynch Mfg. Co., Inc., 1775 Broadway, N. Y.

All Parts for NATIONAL MB-29

as described and specified by J. E. Anderson—\$40.

245 PP Power Amplifier, built up, \$55.00
Thrill Box, Complete Parts, all 6 coils, cabinet—\$33

GUARANTY RADIO GOODS CO.
145 West 45th Street N Y City

NATIONAL

Velvet B Eliminator \$16.13
180 Volts (280 Tube Free)



Latest Model National Velvet-B, Type 8580, in handsome crackle finish black metal casing, for use with sets up to and including six tubes. Input 105-120 volts AC, 50 to 60 cycles. Output 180 volts maximum at 95 milliamperes. Three variable output intermediate voltages. (Det., RF, AF). Eliminator has excellent filter system to eliminate hum, including 30 henry choke and 18 mfd. Mersham condenser. No motorboasting! (Eliminator Licensed under patents of the Radio Corporation of America and associated companies.)

Guaranty Radio Goods Co.
143 W. 45TH STREET
(Just East of Broadway)
NEW YORK CITY

MORECROFT

New second edition of "Principles of Radio Communication," by Prof. John H. Morecroft, of the Electrical Engineering Department of Columbia University and past president of the Institute of Electrical Engineers. This is an outstanding and authoritative book on the subject.

This large book on radio principles and practice is something that you must not be without. Every set builder, every designer, every engineer, every service man, simply must have this book. Ready reference to all intricate problems makes this volume invaluable. Set builders, experimenters, distributors, dealers, salesmen and teachers, students and operators, all find Morecroft their standby, and now the new second edition awaits you. 1,001 pages and 87 illustrations in this cloth-bound volume.

Price \$7.50

RADIO WORLD
145 West 45th Street
New York City
(Just East of Broadway)

A COMPLETE CATALOG

containing detailed information on condensers and resistors may be had free on request.



74 1/2 Washington St., Bklyn., N. Y.

THE RESEARCH WORKER

will keep you abreast of developments in radio. It may be had free on request.

Quick Action Classified Ads

Radio World's Speedy Medium for Enterprise and Sales

10 cents a word — 10 words minimum — Cash with Order

BRAND NEW CROSLEY, Tip-Top Musicone, \$37.50 list, your price, \$3.90. Dandy magnetic speaker on walnut pedestal. P. Cohen, Suite 1214, at 143 West 45th Street, N. Y. City.

DIAMOND OF THE AIR, SCREEN GRID MODEL, battery operation, four tubes described in February 9th, 16th, 23d and March 2d issues, 1929. Send 50c for these four copies. Blueprint free with 8 weeks' subscription to RADIO WORLD at \$1.

AC DIAMOND, screen grid, 4 tubes, published in March 23d and 30th issues. Send 25c for these two numbers. Blueprint free with 8 weeks subscription for RADIO WORLD at \$1.

If you are renewing a present subscription please so state.
RADIO WORLD, 145 W. 45th St., N. Y. City

AGENTS WANTED

CARTER WINDOW WASHER. Exclusive Distributor wanted. **BIG PROFITS**. Cleans, Dries, Polishes, one operation. Territory closing fast. Act quick. **CARTER PRODUCTS**, 985 1/2 Front Street, Cleveland, Ohio.

HAVE AN EXPERT PUT YOUR SPEAKER IN SHAPE!

If your present speaker, no matter of what kind, is not giving proper results, send it to us prepaid. We will test it FREE and let you know what's wrong, telling you cost of repairs. Our charges are very reasonable. Six years' experience. Loudspeakers and units repaired. Burnt-out coils replaced. **Jaynox Laboratories**, 57 Dey Street New York City.

ARTISTS and Art Students are printing 250 signs or pictures an hour without machinery. Sample and particulars, 10c. **Straco**, 1014 Mulberry, Springfield, Ohio.

BARBECUE, Broil, Grill all meats, fowl, fish with electric table appliance size chafing dish. Chrome finish \$20, nickel, \$15. Also bakes waffles and cooks like stove. **Cleveland Neaco Products**, 2012 West 83rd St., Cleveland, O.

EVERYTHING IN RADIO

At attractive Prices Sets or parts
Orders shipped exactly as ordered. Prompt service. Write for prices. Inquiries invited. Send your address.

ALL RADIO CO., 417 North Clark St., Chicago



Start with This Issue!

RADIO WORLD and "RADIO NEWS"

Both for
One Year at **\$7.00**

RADIO WORLD alone for one year, 52 issues, one each week, is \$6. Send \$7.00 and receive both RADIO WORLD for one year (52 numbers) and "Radio News" for one year, 12 issues, one each month, total 64 issues. Send in your order now and get the September issue of "Radio News," and next week's issue of "Radio World."

This is a great bargain and opportunity. Keep abreast of latest radio news and circuits by subscribing for the two leaders!

You can thus obtain the two leading radio technical magazines that cater to experimenters, service men and students, the first and only national radio weekly and the leading monthly, for one year each, at a saving of \$1.50.

☐ If renewing RADIO WORLD subscription, put cross in square.

RADIO WORLD

145 West 45th Street,
(Just East of Broadway)
New York, N. Y.

THE NEW INDUCTOR SPEAKER CHASSIS

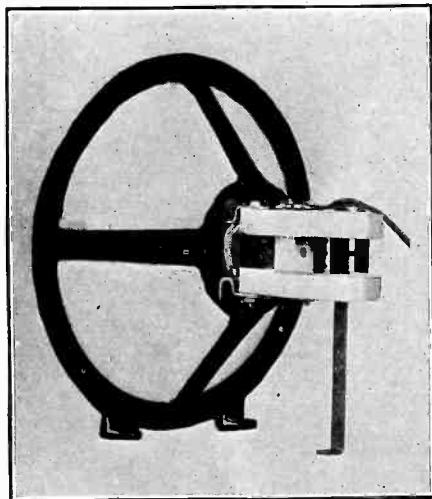

Absolutely the best tone quality, with amazing sensitivity, is assured when you use the Inductor Speaker on a fine audio amplifier. The chassis is sold completely erected with a supporting brace. The unit, cone spider and ring, are sturdily put together. Use a baffle board or box of your own choice. Baffle instruction sheet in each carton.

A new principle is involved in the Inductor Chassis. The armature moves up and down, in a wide gap, instead of from side to side in a tiny gap. Hence the armature does not strike the pole pieces.

The chassis is offered at professional discounts, the prices quoted being net. The outside diameters of the two different sized models are 9" and 12" respectively. The speaker should be selected, no matter which size, that matches the impedance of the output tube or tubes. See the list below.

For single 112, 112A or 210 output tube, 9" diameter, order Cat. NBR. For 111, 171A, 245 or 250 single output, or ANY push-pull output where you have an output transformer or midtapped impedance order Cat. N9G @ \$11.95 net.

Same as above, only 12" outside diameter, N12B for tubes in previous "B" Model, and N12G for tubes to previous "G" Model @ \$12.95 net.

For push-pull, where you have no output transformer or midtapped impedance, order N12PP at \$15.25 net, and the speaker is its own output device.

GUARANTY RADIO GOODS CO.

145 West 45th Street New York, N. Y.

DYNAMIC BAFFLE

Completely built up, for any type dynamic chassis. State what make dynamic you want it for. Cone sides, open back. Or luxe finish. Size, 24x24 inches. **\$12.00**

GUARANTY RADIO GOODS CO.
145 West 45th Street New York City

A Delight to Radioists

was the Show Number of RADIO WORLD, dated September 21st, and containing a fascinating assortment of features.

The first instalment of the constructional article on the AC Model HB Compact, five tubes, including rectifier, was published in that issue, with five photographic illustrations that clarify the layout of parts, and with an exceptionally brilliant exposition of the functioning of the Bernard Dynamic Tuners used in the circuit. Read every word of this description by Herman Bernard and become convinced that these coils perform wonderfully in this screen grid circuit.

The first instalment of the article on how to build the Schoolboy's One-Tube DX Set, by Jack Tully, is what every youngster wants to read, especially as the parts cost only \$4.28, and there is no end of fun experimenting with this circuit.

Coupling of screen grid tubes at radio frequencies is an important subject, and is treated in a most interesting manner by J. E. Anderson, technical editor, in his article, "Up Goes the Volume." He reveals the secrets of obtaining highest amplification from the screen grid tube as radio frequency amplifier.

"First Presentation of Detection by Linear Rectifier," by J. E. Anderson and Herman Bernard, being an instalment of their serially-published book, "Power Amplifiers," shows how to filter the plate circuit so as to get rid of the carrier frequency. The same principles applied to filtering a B supply to get rid of hum are used to eliminate the carrier and leave only the audio component, thus achieving detection with great selectivity and unlimited volume.

"Ohm's and Kirchoff's Laws Expounded." This is certainly an attractive subject, since one simply must not only know these two laws, but how to apply them. Bryant Holworthy has treated the subject masterfully.

STATIONS! STATIONS!

You are certainly interested in an up-to-date list of stations. How would you like several such lists? They're in the September 21st issue. There's the list of broadcasting stations by call letters, alphabetically arranged; the list of stations by frequencies and wavelengths; a list of U. S. short wave stations; a list of some foreign short wave stations, but the hours on the air of all of those published are included; then the lists of stations of the two big chains, with call letters, locations, frequencies and waves—the Columbia Broadcasting System and the National Broadcasting Company. And also there's a list of Canadian stations, with hours on the air!

Two full pages, with thirteen illustrations, reveal the new parts for the 1930 season, an attractive subject to all constructors.

Besides these, there's an editorial page and two full pages of Radio University, where technical questions are answered. The tuning curves of the HB Compact, either battery or AC model, are published in Radio University, and you can thereby tell just how to tune in the stations at the right dial settings. Other questions on the HB Compact are answered.

Send 15c for a copy of the September 21st issue, or start your subscription with that issue.

RADIO WORLD,

145 West 45th St., New York, N. Y.

O-600v, AC & DC

High Resistance Meter

ACCURATE TO 1%!

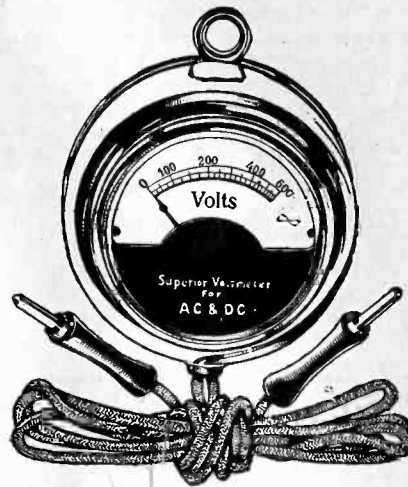

O-600 AC and DC Voltmeter—same meter reads both with 32" long flexible cords built in, and equipped with hanger. Extreme diameter (less hanger) 2 1/2".

MOST USEFUL!

Here is a meter that serves an abundance of uses, because it has a wide voltage range, 0 to 600 volts, and measures voltage of alternating current and direct current, and is accurate to 1%. In a meter its accuracy that counts.

You can measure not only the DC voltages of B eliminators, power packs and B batteries, with easily legible readings of 30 volts per division of the scale, with wide divisions between 100 and 600 volts, so that you can easily see to within 5 volts, but you can also measure the AC voltage across high-voltage power transformer secondaries. If full-wave rectification is used, you measure each of the two sections of the transformer secondary and add the voltages. Thus up to 1,200 total volts across the secondary may be read. For half-wave rectification, a secondary up to 600 volts is read across the total winding. You find out at once whether this winding is open or shorted, since no reading then would be obtained, or find out whether the voltage is right, or too high or too low. In all instances the AC voltage across the secondary should read higher than the desired DC output, due to the voltage drop in the coils and to the current in the entire voltage divider and its sections. The normal deduction from the AC voltage, to obtain the DC voltage, is at least 10%.

A REQUISITE FOR SERVICING!

Often service men, experimenters and students must know not only the transformer high voltage, but also whether the AC line voltage is the rated 110 volts or not. This meter tells you. Connect it across the 110-volt line. By reading this voltage and the voltage of the high-voltage secondary you can also determine the step-up ratio, by dividing the smaller reading into the larger.

Because this is a high-resistance meter you can rely on the accuracy of the readings.

Only a high-resistance meter can accurately measure the DC voltage of a B eliminator. Other meters draw so much current that the reading may be 50 volts less than what it should be, or still more inaccurate, and you could almost guess the voltage more accurately than a low-resistance meter would read.

MONEY-BACK GUARANTY!

This meter is sold on a 5-day money-back guaranty. Buy one, try it, test it thoroughly, compare it with other meters in performance and appearance. If not fully satisfied, send it back and your money will be promptly refunded.

The meter is full nickel plated, highest possible polish, has green cords, with red (positive) and black (negative) moulded bakelite tip-holders, and sturdy tips. The positive and negative indications are for DC measurements. For AC the meter may be connected at random.

This meter, which is of the moving vane type, is made in Germany and represents finest workmanship.

Cat. M600 AC-DC \$6.00

SEND NO MONEY!

GUARANTY RADIO GOODS COMPANY,

145 West 45th Street, New York, N. Y.

(Just East of Broadway).

Please ship at once C.O.D. one O-600 voltmeter, reading both AC and DC, on 5-day money-back guaranty. This meter must be exactly as advertised in Radio World. Cat. M600, price \$6.00

NAME

ADDRESS

City State

5-DAY MONEY-BACK GUARANTY

Surpassing Results from HB Compact!

Screen Grid Circuit for AC or Battery Operation Is a Knockout!

THE screen grid tubes, both AC and battery types, 222 and 224, promised much. They could be used to provide actual amplification of 150 per stage, as compared with 8 per stage for a general purpose tube. If only the screen grid tube could be used at full practical amplification! Then a few tubes would do the work of many! At radio frequencies it was found that tuning the plate circuit put the mule kick into the set.

Sensitivity

But the whole wave band could not be tuned in. So Herman Bernard invented a coil—the Bernard dynamic tuner—that accomplished the trick. Full amplification plus full wave-band coverage! That's why his HB Compacts, only four tubes (plus a 280 in the AC model) perform like eight-tube sets! The sensitivity is incredibly high.

It would be far short of an accomplishment to hook indifferent audio onto a grid leak-condenser detector. So in both models he used a power detector, two resistance audio stages producing undistorted volume exceeding that of any ordinary two-stage audio amplifier, amplification sufficient to load up the power tube in each instance. And in the case of the AC model HB Compact it is a 245, with 1,600 milliwatts maximum undistorted power output, standing enough gaff for a small hall! And what tone realism! Breath-taking! Nothing in radio ever excelled this tone quality! Nothing! Absolutely nothing!

Realism

As the prices quoted in the list of component parts show, these advantages may be obtained economically. The battery model draws only 21 milliamperes of plate current, .664 amperes of filament current. Large B batteries would last a year at that rate, for average use, and a small A battery require recharging only every two months to ten weeks!

Economy

And this amazingly sensitive, most thrilling and utterly economical circuit gives you all the selectivity you will require, unless you live close to a powerful broadcasting station. So you get a super-abundance of results, in an unusual but thoroughly tried and tested, positively proven circuit!

Selectivity

HB Compact, battery model, uses a 222 RF amplifier, a 240 (high mu) power detector, a 222 first audio and a 112A or 171A power tube. The RF tube's plate circuit is tuned by a new type coil that has a moving segment as part of the tuned inductance, with step-up ratio to untuned detector grid. The audio is resistance-coupled. A 7x14" front panel may be used, with baseboard, but the HB Compact Steel Cabinet, decorated brown, with satin aluminum subpanel, sockets affixed, is recommended.

HB Compact, AC model, uses a 224 RF amplifier, a 224 space charge power detector, a 224 first audio and a 245 output tube, with 280 rectifier. Except for the space charge feature, not suitable in the battery model, and the larger power tube, not economically powered by batteries, the two models are fundamentally the same. The AC model is still more sensitive, however.

The same steel cabinet is recommended for the AC model, while the aluminum subpanel has the five sockets affixed and the type of each tube (except detector) printed on each socket.

Order what individual parts you want.

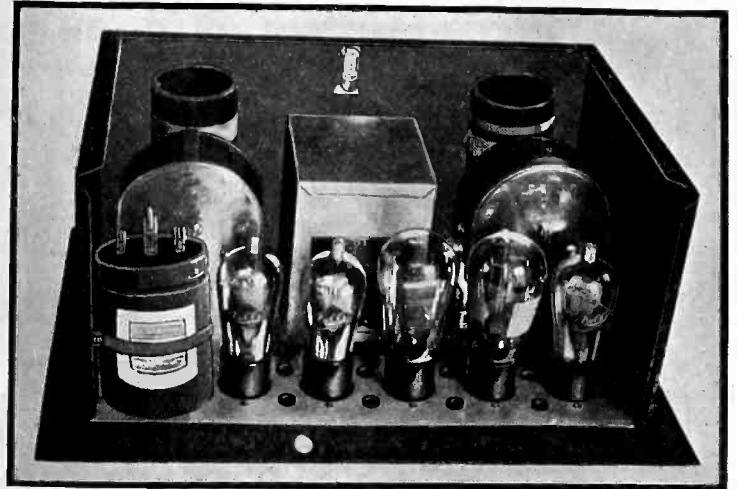

View of the HB Compact AC Model, the tubes being, left to right, 224 detector, 224 first AF, 245 power tube, 280 rectifier and 224 RF. The subpanel is only 9 1/2 x 14 1/4", yet everything save the speaker is in this small space!

Component Parts for HB Compacts

AC MODEL	
L1L2L3—Bernard Antenna Tuner BT5A.....	\$2.50
L4L5L6—Bernard Interstage Tuner BT5B.....	2.50
CT—One 80 mmfd. equalizer.....	.35
C1, C2—Two .0005 Dustproof @ \$2.50.....	5.00
C3, C4, C5—Four .01 mfd. @ .35.....	1.40
C7—One 1 mfd. 500V AC.....	.85
C8, C9, C10, C11—Merphon Q2-8, 2-18B.....	5.75
C12, C13—Two 1 mfd. 200 V. DC @ .50.....	1.00
R—One 25,000 ohm wire-wound pot.....	1.50
R1, R2, R3, R4—.5, 1.0, .05 5.0 meg. @ .35.....	1.40
T1—Polo 245 Power Supply Cat. P245PS.....	10.00
2500, 4400, 774, 50, 8 (20 watt) Voltage Divider.....	1.75
PL—Bracket and 2.5 v. AC lamp.....	.70
OC, C6—Output choke, 2 mfd. 500 v. AC cond.	3.85
SP—, SP+—Two binding posts @ .10.....	.20
Three National grid clips @ .06.....	.18
F—One 1 amp. cart. fuse with base.....	.50
Aluminum socketed subpanel, 9 1/2 x 14 1/4", 8 brackets.....	3.25
Steel cabinet, crackled brown finish, 7 x 15 x 9 1/2.....	4.00
3 Insulating washers @ .03.....	.09
Two full-vision dials with pointers @ 75c.....	1.50
One AC pendant switch, double opening.....	.40
One 12 ft. length AC cable.....	.72
Two rolls Corwico braidite @ .35.....	.70
Two flexible couplers (links) @ .35.....	.70
	\$50.79
Kelly tubes: Three 224 @ \$3, one 245 @ \$2.25, one 280 @ \$1.75.....	\$13.00
[National Company's coils, soon to be released Cat. BTS5, BTP5 @ \$5 each, may be used instead of BT5A and BT5B listed above @ \$2.50 each. National Velvet Vernier full-vision dials, instead of plain dials listed above, counterclockwise, @ \$1.75 each.]	
BATTERY MODEL	
L1L2L3—One Bernard Tuner for antenna circuit, for .0005 mfd. tuning (BT5A of Screen Grid Coil Co.).....	\$2.50
L4L5L6—One Bernard Tuner for screen grid interstage coupling, for .0005 mfd. tuning (BT5B of Screen Grid Coil Co.).....	2.50
C1, C2—Two .0005 mfd. Dustproof tuning condensers @ \$2.50.....	5.00
CT—One Hammarlund 80 mmfd. equalizing condenser.....	.35
C3, C4, C5—Three .01 mfd. mica fixed condensers @ .35.....	1.05
R1—One .25 meg. metallized resistors.....	.30
R2, R4—Two 5.0 meg. metallized resistors @ .30.....	.60
R3—One .075 meg. metallized resistor.....	.40
R5, SW—One 75-ohm rheostat with switch attached.....	.80
R6—Two resistors, one 1.3 ohms, the other 6.5 ohms (both).....	.45
Ant., Gnd., Sp.—, Sp.+ Four binding posts (all).....	.40
One drilled steel cabinet 7" high, 9 1/2" front to back, 15" wide.....	4.00
Two dials with pointers (both).....	1.50
One pilot light bracket with 6-volt DC lamp.....	.70
One 9 1/2 x 14 1/4" satin finish aluminum subpanel with sockets affixed, and supplied with insulated bushings, supporting brackets, and resistor clips.....	2.00
Two insulated links (flexible couplers) (both).....	.70
One 7-lead battery cable.....	.50
	\$23.75
Kelly tubes: Two 222, one 240, one 112A or 171A, total, \$9.20.	
[National Coils for the battery model, vernier condensers, see note under AC Model.]	

[The HB Compacts were designed and built by Herman Bernard. The battery model was described in the August 24th, 31st, September 7th and 14th issues of Radio World.]
 [The AC Model is now being described. See pages 12 and 13 of this issue.]

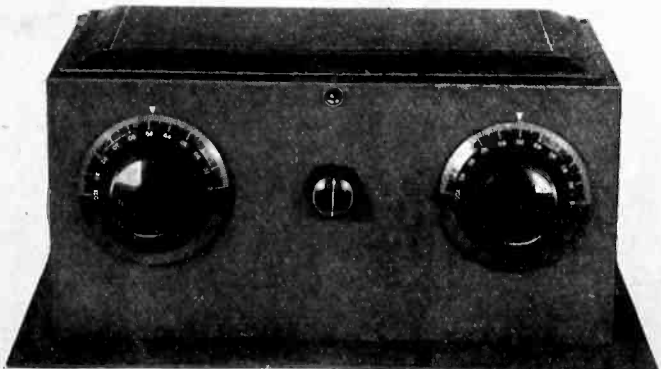

Front view of the HB Compact. The view is the same for AC or battery model. For batteries the switch is built in the rheostat. For AC a pendant switch is used at rear, in the AC cable.

Please Use This Coupon

GUARANTY RADIO GOODS CO.
 143 West 45th St., N. Y. City, Just E. of B'way.

Enclosed please find \$..... for which please send me component parts for the HB Compact as checked off above.

NAME

ADDRESS

CITY..... STATE.....

Polo 245 Power Supply

Scientifically Engineered, It Insures Superb Performance

THE Polo 245 Power Supply consists of a filament transformer, a high-voltage (plate) winding and two separate chokes, all built in a single cadmium-plated steel casing, for powering 224, 227, 228 and 245 tubes. The output may be a single 245 or two 245s in push-pull, because the chokes are large enough and strong enough to handle 100 milliamperes, while the power tube filament winding will easily take care of the two 245s. The entire supply is exceedingly compact and will fit in a cabinet that has the usual 7" high front panel. The high-voltage winding is of sufficiently high AC voltage to produce full 300 volts when the maximum direct current through any part of a voltage-dividing resistor is 80 ma. Of the 300 volts 250 are applied to the output tube's plate and 50 to its grid for negative bias.

All windings except the primary (110 volts, 50 to 60 cycles) are center-tapped, including the 5-volt winding for the 280 rectifier tube. The impedance bridge method is used for establishing the electrical center. Taking the positive rectifier voltage from the center of the 5-volt winding, instead of from either side of the filament, is a small extra advantage, but shows an extra stroke of careful workmanship to insure superb performance.

Another interesting point is that the high-current winding for all the 2.5-volt AC tubes to be used in a receiver or amplifier is rated at 12 amperes. This means that six heater type tubes may be worked well within the limits of the winding (total of 10.5 amperes used), while seven tubes may be used with the permissible excess of only .25 ampere over the rating (total 12.25 amperes). Of course the two or three other tubes (280, 245) are additionally supplied, from their individual windings. Hence a total of ten tubes may be worked (including 245 push-pull and 280 rectifier).

This is no mere estimate, but a scientific fact. The wire used on this 12-ampere winding is the equivalent of No. 9. Please read our chief engineer's report herewith.

The two chokes are 50 henries each, and each choke is on a separate core.

The 245 Power Supply weighs 16 pounds. The shipping weight is 17 pounds.

For 40-cycle current, 110 volts, a special supply 2" higher, is made. Cat. P245, S40 (Code Cyclone). Price \$13.50.

The 245 Power Supply, with chokes, is made also for 25 cycles, 110 volts. Only this particular combination is made for 25 cycles, although the filament-plate supply (less chokes) and the filament supply (less chokes and high-voltage winding) are made for 40 cycles.

For 25 cycles order Cat. No. P245 S 25 4 5/8" wide x 5 1/8" front to back x 9 1/8" high. Shipping weight 25 lbs. (Code Cypress) at.....\$14.50



Polo 245 Power Supply, including two chokes built in, size 4 5/8" wide x 5 1/8" front to back, 6 1/8" high. Cat. No. P245 PS 110 volts, 50-60 cycles (code Cyclops).....\$10.00
 Cat. No. P245, S40, for 40 cycles, 110 volts; size 4 5/8" wide x 5 1/8" front to back, by 8 1/8" high (code Cyclone).....\$13.50

Chief Engineer's Report on Polo 245 Power Supply

By Walter J. McCord, Chief Engineer

Every precaution has been taken to produce a 245 power supply of superb performance, and in proof thereof I take pleasure in submitting for close study by engineering minds the specifications followed, with advice to novices.

- (1)—Overall dimensions of the casing, 4 5/8" wide x 5 1/8" front to back x 6 1/8" high.
- (2)—Filament and plate secondary windings as follows: 724 volts at 100 mils, center tapped at 362; 5 volts at 2 amperes, center tapped; 2.5 volts at 3 amperes, center tapped; 2.5 volts at 12 amperes, center tapped.
- (3)—Two 50-henry chokes, DC resistance of each, 420 ohms.
- (4)—Primary draw with all secondaries worked at maximum, 88 watts.
- (5)—One transformer core with 1" x 1 1/4" cross-section; window opening 2 1/8" x 3/4". Two choke cores with 7/8" x 1 1/4" cross-section; window

- opening 1/2" x 1 1/4"; .014" air gap. The laminations are stamped from high-grade Silicon sheet steel having 1.92 watts loss per pound. The joints in the transformer are all overlapping, holding the magnetic leakage to a minimum.
- (6)—Size of wire and resistance of each winding as follows: Primary—No. 24 wire, DC resistance, 5.2 ohms. Plate Sec.—No. 30 wire, DC resistance, 104.5 ohms. 5 v.—No. 18 wire, DC resistance, .102 ohms. 2 1/2 v., 3 a.—No. 18 wire, DC resistance, .051 ohm. 2 1/2 v., 12 a.—.059 x .180 rectangular wire (equals approximately No. 9 wire), DC resistance, .008 ohm.
- (7)—Total weight of block 16 lbs.

- (8)—Casing is made of sheet steel and is cadmium plated. Four 3/4" mounting screws are placed in the bottom, permitting the block to be mounted to the base, in a very small space, as no space is required for mounting flanges.
- (9)—Care should be taken in connecting the leads so that none of the secondaries is shorted. A shorted secondary, either a direct short or through a defective condenser, soon will burn out a transformer. Care should be taken also in connecting the primary to the proper current. The primary should be connected to 110 v. 50-60 cycles AC, never to 220 volts, neither should it be operated on a line voltage of 130 or over.

FILAMENT-PLATE SUPPLY

The Polo 245 Power Supply, less the two built-in chokes, is available to those desiring to utilize chokes they now have, and who do not find the compactness afforded by the consolidated unit absolutely necessary.

The Filament-Plate Supply has the same voltages on the secondaries, at the same ratings, as does the unit that includes the chokes.

Polo Filament-Plate Supply, consisting of five windings; primary 110 v., 50-60 cycles. Cat. No. PFPS (code Cymbal), \$7.50.

Same as above, except for 40 cycles 110 v. AC and a little greater height. Cat. P40 FPS (code Cylinder), \$10.00.

FILAMENT SUPPLY

A filament transformer only, in a smaller container than any of the others, but with the same voltage and current ratings, provides 2.5 v. at 3 amperes, 2.5 v. at 12 amperes, 5 v. at 2 amperes.

The Polo Filament Transformer, consisting of four windings as described; primary, 110 v. 50-60 cycles. Cat. No. PFT (code Cyclist) \$4.25. Same as above, except for 40 cycle, 110 v. AC, Cat. P40 FT (code Cyanide), \$6.25.

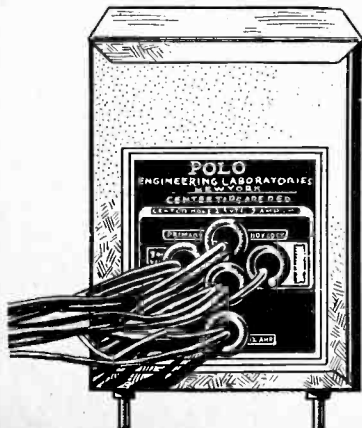

Polo 245 Filament Plate Supply (less chokes) is 4 1/2" wide, 5" high, 4" front to back. Weight 9 lbs.

NO C. O. D. ORDERS.

Polo Engineering Laboratories, 57 Dey St., N. Y. City. Enclosed please find \$—, for which ship at once the following:

P245 PS (code Cyclops).....	\$10.00
P245 S40 (code Cyclone).....	13.50
P245 S25 (Code Cypress).....	14.50
PFT (code Cyclist).....	4.25
P40 FT (code Cyanide).....	6.25
PFPS (code Cymbal).....	7.50
P40 FPS (code Cylinder).....	10.00

In ordering by telegraph use code designations.

Name

Address

City..... State.....

ALL PRICES ARE NET
 5-DAY MONEY-BACK GUARANTEE!

New High Mu AC Tube

228 Provides Higher Amplification and is an Excellent Power Detector



228 AC High Mu Tube, with an amplification factor of 45 is an exclusive contribution to tube science by Kelly laboratories.

WHEN signals are weak in an up-to-date AC receiver, using 227 tube as detector or audio amplifier, replace the 227 with the new 228 high mu AC tube and be amazed at the difference in volume.

The up-to-date receivers have high impedance primary in the first audio transformer, or have a resistor in the plate circuit, so the high mu tube is a boon indeed.

As a detector the 228 can be used with leak and condenser, with grid returned to cathode, or as a negative bias (power) detector. See table, lower left corner.

Since the 228 has the same base, same prongs and same heater voltage as the 227, it can be used for replacement and improvement, and without requiring any wiring changes or any other changes. Simply insert the 228 in the socket from which the 227 is removed.

228
\$2.50

CHARACTERISTICS OF THE 228

Heater voltage 2.5 volts AC.
Heater current 1.75 amperes.
Amplification factor 45.
Mutual conductance 1,000.
Plate voltage 180 volts.

Grid bias, detector -6 volts.
Grid bias, amplifier -2.5 volts.
Load resistance, 0.1 to 0.5 meg.
Internal plate resistance 45,000 ohms.

The plate current under normal operation is less than one milliamperere. Hence the 228 tube imposes minimum load on the B supply.

The 228 is not suitable as a radio frequency amplifier.

224 at \$3.00—245 at \$2.25—227 at \$1.50—226 at 95c

The screen grid tubes have proved not only their capability but their dependability, and in AC circuits the 224 AC screen grid tube is popularly used as amplifier and detector, with the 245 as output, singly or in push-pull. Safe and satisfactory, Kelly 224 tubes are made with the same expertness and precision that characterizes the entire line of Kelly tubes. Our products are used by laboratories, technicians, experimenters and general consumers because of proven merit.

The Kelly 224 screen grid tube is not only excellent as a radio frequency amplifier but as a detector, especially applicable as a space charge detector.

A suitable high impedance load should always be in the plate circuit of any screen grid tube. For RF a large untuned primary, or a tuned primary, for detection and AF a resistor of 50,000 ohms or higher, usually considerably higher, or a high impedance inductance. You will find Kelly 224 fully meets your most exacting requirements.

The 224 and 227 are 5-prong (UY) tubes, the 245 and 226 4-prong (UX) tubes.

Battery Type Screen Grid 222 at \$3.50

The battery operation the 222 screen grid tube is an important contribution, because enabling such high amplification that battery circuits are put on a par with AC circuits in performance. The 222 is the most popular battery-operated tube for up-to-date circuits and the Kelly model is made to produce clear reception and have exceptionally long life.

5-Day Money Back Guarantee!

You run no risk whatever when you purchase Kelly tubes. Not only are they expertly made but they are sold on a 5-day money-back guarantee. This exclusive form of protection enables you to be the ultimate judge in your own laboratory or your own home, with no appeal from your decision on our part. If you are not delighted with the performance of Kelly tubes, we are not even satisfied,

and will promptly refund your money on the foregoing 5-day basis.

If at any time after the five days expire, after receipt of tubes by you, there should develop any adverse condition for which you deem the tube at fault, you may communicate directly with us, and we will give the matter prompt attention. Our aim is to render a real service and through such efforts have we built up our volume of business.

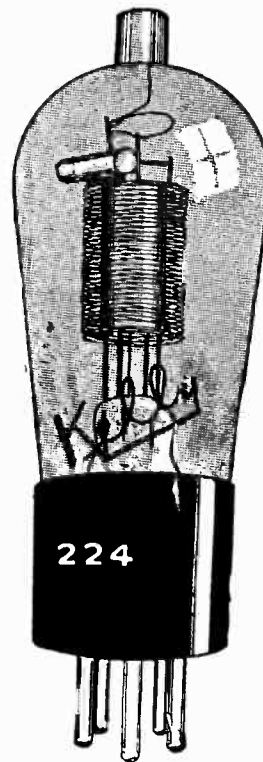

Kelly Tube Company, 143 West 45th St., N. Y. City
Embossed please find \$..... for which ship at once tubes marked below:

<input type="checkbox"/> 228 AC high mu. @.....\$2.50	<input type="checkbox"/> 222 battery screen grid.....\$3.50
<input type="checkbox"/> 224 AC screen grid @.....\$3.00	<input type="checkbox"/> 240 battery high mu.....\$1.25
<input type="checkbox"/> 245 AC power tube @.....\$2.25	<input type="checkbox"/> 112A battery power tube.....\$0.95
<input type="checkbox"/> 226 AC amplifier @.....\$0.95	<input type="checkbox"/> 171A battery power tube.....\$0.95
<input type="checkbox"/> 227 AC det.-amp. @.....\$1.50	<input type="checkbox"/> 201A battery tube.....\$0.85
<input type="checkbox"/> 171A AC power tube @.....\$0.95	<input type="checkbox"/> UX199 battery tube.....\$1.25
<input type="checkbox"/> 218 AC power tube @.....\$4.50	<input type="checkbox"/> Matched pair of 245s for push-pull (for both).....\$4.50
<input type="checkbox"/> 890 AC power tube @.....\$6.00	<input type="checkbox"/> Matched pair 171As for AC Push-Pull (for both).....\$1.90
<input type="checkbox"/> 890 AD rectifier @.....\$1.75	
<input type="checkbox"/> 281 AD rectifier @.....\$3.50	

ALL PRICES QUOTED ARE SELLING PRICES AND ARE NET

Name

Address

City State

Put cross here if C.O.D. shipment is desired.

Types of Tubes and Their Voltages

Tube	Fil. Volt	Amplifier		Detector		Remarks
		Plate Volts	Neg. Bias	Plate Volts	Neg. Bias	
228	2.5 AC	180	2.5	180	6	Heater type, 5 prong.
224	2.5 AC	180	1.5	180	6	Heater type; 80 volts, 75
245	2.5 AC	250	50.0	—	—	—
226	1.5 AC	135	9.0	—	—	—
227	2.5 AC	180	9.5	—	—	—
171A	5ACorDC	180	40.5	180	18-25	Heater type
210	7.5 AC	350	27.0	—	—	—
250	7.5 AC	450	84.0	—	—	—
280	5.0 AC	350AC	—	—	—	—
281	7.5 AC	700AC	—	—	—	Full-wave rectifier
222	3.3 DC	135	1.5	135-180	4-7	Half-wave rectifier
240	5.0 DC	135-180	3-4.5	135	1.5-3	80 volts, 45
112A	5.0 DC	135	9.0	135	Leak-cond.	—
UX199	3.3 DC	90	4.0	90	Leak-cond.	—

PARTS FOR PUSH-PULL DIAMOND

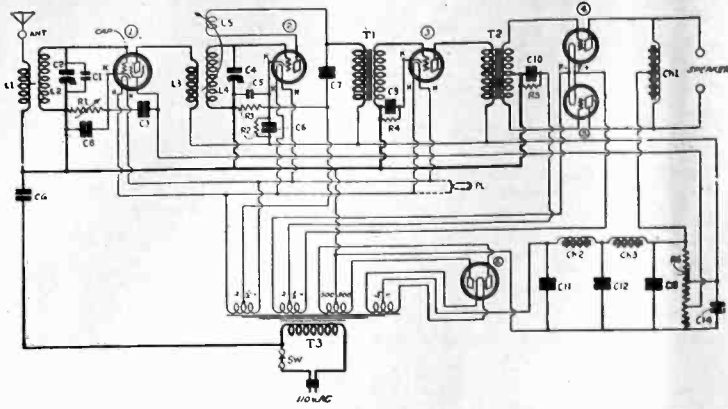

Circuit Diagram of AC Screen Grid Push-Pull Diamond of the Air

- | | | | |
|---|--------|---|-------|
| L1, L2—One antenna coil (Cat. AC5)..... | \$0.75 | R5—One 800 ohm Electrad resistance strip.. | .20 |
| L3, L4, L5—One SG 3-circuit tuner (Cat. SGT5) | 1.25 | R6—One Aerovox Pyrohm type B (750, 750, 2,800, 3,000) | 1.00 |
| C1—One Hammarlund equalizer, 70 mmfd.... | .35 | T1—One National A100 audio transformer.... | 5.70 |
| C2, C4—One Hammarlund dual condenser, .0005 (Cat. MLD23)..... | 5.50 | T2—One National push-pull input transformer 5.70 | |
| CG, C3, C5, C6, C8, C9—Six Aerovox .02 mfd. fixed condensers..... | .80 | T3—One power transformer (5, 2.5, 2.5, 300, 300v.) | 10.00 |
| C7—One Aerovox .0005 mfd. fixed condenser | .20 | Ch1—One push-pull output choke..... | 5.00 |
| C10—One Aerovox 4 mfd. bypass condenser | 1.50 | Ch2, Ch3—One S-M Unichoke 331..... | 4.80 |
| C11, C12, C13, C14—Merphon 8-18-18-8..... | 5.76 | Ant., Gnd., Speaker—, Speaker—four binding posts | .15 |
| R1—One Electrad Royalty variable resistor, 5,000 ohms, with 110-volt AC switch..... | 1.50 | One 7 x 21" front panel..... | 1.65 |
| R2, R3—One 25,000 ohm Electrad resistor type B (with 3 terminals)..... | .75 | One flat type dial, with dial pointer..... | .95 |
| R4—One 1,000 ohm Electrad resistance strip | .20 | Two knobs | .20 |
| | | One roll Corwico Braidite..... | .35 |
| | | One 2.5v AC pilot light, with bracket..... | .60 |

Above is complete, less baseboard, sockets, tubes and cabinet.

GUARANTY RADIO GOODS CO.

145 West 45th Street, New York City

(Just East of Broadway)

ARISTOCRAT FLOOR SPEAKER

With Melded Wood Horn of 8 ft. (one travel exponential type) with baffle and horn motor built in. Extraordinary bargain. **\$20.00**

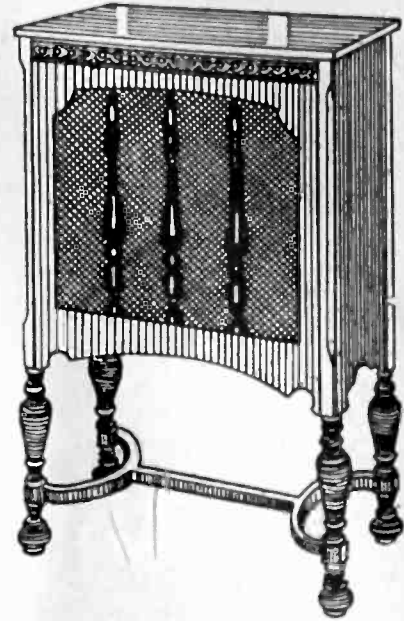

The speaker cabinet is walnut finish, 33" high, 24 1/2" wide, 17 1/2" deep, with carved legs. Golden cloth grille covers front opening. Built inside is No. 595 molded wood horn with baffle and No. 293 driving motor unit that stands 250 volts without filtration. Horn and motor removable. Table alone is worth price asked. Remit with order and we pay cartage on Aristocrat Floor Speaker.

Acoustical Engineering Associates

143 WEST 45th STREET
NEW YORK CITY

(Just East of Broadway)



GUARANTY RADIO GOODS CO.
143 West 45th Street, New York, N. Y.

FULL EXPOSITION OF HB COMPACT, BATTERY MODEL

Complete details on the theory and construction of the HB Compact were published in a four-part article in Radio World, written by Herman Bernard, designer of the circuit and inventor of the Bernard Dynamic Tuners used in the circuit. Full details on how to wind your own coils. Full-sized pictorial diagram of the wiring. Order the August 24th, 31st, September 7th and 14th issues, 60c—RADIO WORLD, 145 West 45th Street, New York, N. Y.

SUBSCRIBERS!

Look at the Expiration Date on Your Wrapper

Please look at the subscription date stamped on your last wrapper, and if that date indicates that your subscription is about to expire, please send remittance to cover your renewal.

In this way you will get your copies without interruption and keep your file complete.

SUBSCRIPTION DEPARTMENT
RADIO WORLD
145 WEST 45TH ST., N. Y. CITY

RADIO INFORMATION

Reliable, prompt, accurate, in every-day language, 25c per question. Radio Information Bureau, 1426 South Clifton Park, Chicago.

Center Accurately!

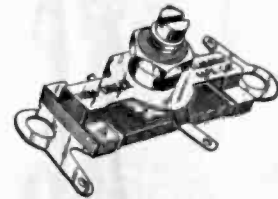

Get Rid of Hum!

In AC circuits accuracy of the electrical center, particularly with power tubes, is easily obtained through a fixed resistor with adjustable center tap. Then hum due to unbalance in the filament circuit is dispelled. Use the 30-ohm Humdinger, adjustable with knife or screw driver. Connect extreme ends across filament winding, biasing resistor to center lug. Then adjust. Also useful as 30-ohm filament resistor in battery sets, using extreme terminals, or 4 to 15 ohms adjustable, from center to one extreme terminal. Special!

Guaranty Radio Goods Co.
143 West 45th Street, New York, N. Y.

A Short Wave Set that Works on B-Eliminator

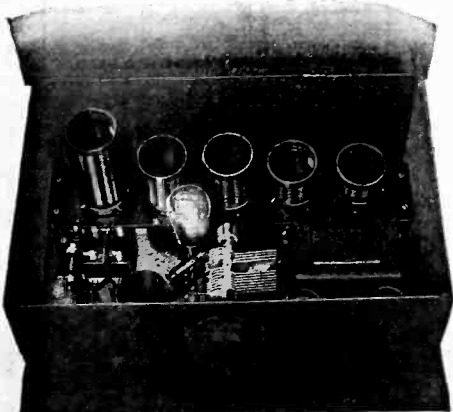

It gets short waves AND Broadcasts All in One

Here's a humless short-wave loudspeaker operation on a B-Power Supply—another NATIONAL achievement. Here's a new NATIONAL THRILL BOX embodying full range reception over both short-wave and broadcast bands. And it operates perfectly from the NATIONAL Velvet-B power supply. You will get a brand new kick out of the fine tone and different performance of this

NATIONAL

4 TUBE THRILL BOX SW-4

GUARANTY RADIO GOODS CO.,

143 West 45th Street, New York, N. Y.

(Just East of Broadway)

All parts, all six coils, cabinet @ more than 40% off list...\$33.00 net Velvet B, 3580; 280 tube free...\$16.13 net

FREE!

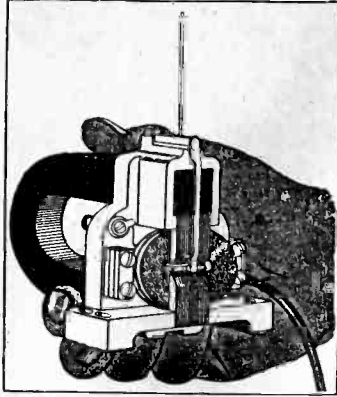

Send \$6 for year's Radio World Subscription And Obtain Unit FREE!

Radio World for one year (52 numbers, one each week) will keep you abreast of latest circuits and news. Act now. Offer revocable without notice.

If renewal put cross here.

Radio World, 145 West 45th St., N. Y. City. Enclosed please find \$6 for one year's subscription for Radio World (52 numbers). Send your "superb unit" free.

Name
Address
City State.....

RADIO WORLD and "RADIO NEWS"

BOTH FOR ONE YEAR @ \$7.00

You can obtain the two leading radio technical magazines that cater to experimenters, service men and students, the first and only national radio weekly and the leading monthly, for one year each, at a saving of \$1.50. The regular mail subscription rate for Radio World for one year, a new and fascinating copy each week for 52 weeks, is \$6.00. Send in \$1.00 extra, get "Radio News" also for a year—a new issue each month for twelve months. Total, 64 issues for \$7.00.
 If renewing Radio World subscription, put cross square.
RADIO WORLD, 145 West 45th Street, New York, N. Y.

FILL OUT AND MAIL NOW SUBSCRIPTION BLANK

RADIO WORLD

RADIO WORLD

145 West 45th Street, New York City

Please send me RADIO WORLD for months, for which

SUBSCRIPTION RATES:

- Single Copy.....\$.15
- Three Months..... 1.50
- Six Months..... 3.00
- One Year, 52 Issues..... 6.00
- Add \$1.00 a Year for Foreign Postage; 50c for Canadian Postage.

please find enclosed

.....
.....
.....

Wholesale Prices

—for Dealers, Agents and Set Builders

RASCO HAS IT—PROMPT DELIVERY



Our huge Wholesale Radio catalog No. 19 (2ND EDITION) is a valuable closed — a liberal Radio education. Mailed immediately on request — absolutely

FREE

1500 Illustrations and 6000 articles

From many years in the Radio Mail Order Business, we have learned how an organization must be efficiently run to gain and retain the good will of our customers. Radio Specialty

Co. ships orders promptly—offers you 100% quality merchandise on a strict money-back basis if not thoroughly satisfied and sells at rock-bottom net prices.

Our catalog contains the largest assortment of completely assembled all-electric AC Receivers at amazingly low prices, and other Radio Merchandise including such lines as Pilot—Silver—Marshall—Carter—Aero—Yaxley—Tobe—Hammarlund—Amer Tran—Cunningham—Dongan—Thordarson—Muter, etc., etc. The latest improvements in Radio are listed and thoroughly described in this great catalog: AC All-Electric Sets with self-contained ABC power supply—Public Address Amplifier systems—AC Set Converters—A and B eliminators—Dynamic Speakers and Units—Magnetic Speaker Chassis—250 Tube Amplifiers—Alrplane Cloth Speakers—Push-Pull Power Amplifiers—Electric Phonograph Turn-Tables—Combination Radio and Electric Phonograph Consoles—Speaker Tables—Short Wave Sets and Adapters—Shield Grid Tube Kits—Television Parts—Electric Household Appliances, Vibrators, Tools, Workshops—Cameras, etc., etc. Logically, how can you afford to be without our catalog. Send for one now!

RADIO SPECIALTY CO.

100R Park Place New York, N. Y.

Radio's Oldest Mail Order House

Blueprint FREE!

Get a free blueprint of either circuit listed on the coupon below, by sending \$1.00 for eight weeks' subscription for RADIO WORLD, or send \$1.50 for 13 weeks' (quarter of a year) and get both blueprints free!

- \$1 for which send RADIO WORLD for 8 weeks and send free blueprint of the battery model 4-tube Screen Grid Diamond of the Air.
- \$1 for which send RADIO WORLD for 8 weeks and send free blueprint of the 4-tube AC Screen Grid Diamond of the Air.
- \$1.50 for which send RADIO WORLD for 13 weeks and send both blueprints free. (If renewing a subscription put cross here)

NAME
ADDRESS
CITY..... STATE.....

BROADWAY-HOLLYWOOD

World's most intriguing places. Where famous stage, screen, radio stars live their lives. Intimate stories of their stage and personal doings in

NEW STAR National Illustrated Amusement Weekly

Edited by Roland Burke Hennessy. Clever writers cover comedy, tragedy, fascination of professional life. Portraits and unusual pictures of favorites. 10c copy, \$5 year (52 issues). SPECIAL: 13 issues \$1 and experts answer your questions, FREE. STAR, 1562 Broadway, New York.

RADIO WORLD, published every Wednesday, dated Saturday of same week, from publication office, Hennessy Radio Publications Corporation, 145 West 45th Street, New York, N. Y., just east of Broadway. Roland Burke Hennessy, President; M. B. Hennessy, Vice-President; Herman Bernard, Secretary. Roland Burke Hennessy, Editor; Herman Bernard, Managing Editor; J. E. Anderson, Technical Editor; Anthony Sodaro, Art Editor.

NEW Morecroft

"Elements of Radio Communication," by Prof. John H. Morecroft, of the Engineering Department of Columbia University, is the latest book on radio by this outstanding authority.

This book is entirely new and contains matter which never before has been published. It is written in plain language so that every radio novice can understand it, yet it is a complete course in the elements of radio.

It contains 266 pages, 170 illustrations and a complete index. Price \$3.00.
RADIO WORLD
145 West 45th St., New York, N. Y.

By JOHN F. RIDER

"The Mathematics of Radio" The Latest Book on This Important Subject

Price \$2.00



128 pages. 8 1/2 x 11". 119 illustrations. Printed and bound in a flexible cover.

Here is the first radio book that covers the field between the beginner and the college professor.

It is the first practical interpretation of radio technique and is written in a practical manner for the practical man. It is non-technical, yet it is not written for the veriest beginner although he, too, may obtain much valuable assistance and information.

It is the first book in which the latest data are converted into actual practical examples which apply to your tubes, receiver, amplifier, eliminator.

TABLE OF CONTENTS:

- OHM'S LAW: IR drop, DC and AC circuits, peak and effective AC voltages.
- RESISTANCES: Basis for resistance variation, atomic structure, temperature coefficient, calculation of resistance variation, expression of ampere, volt and Ohm fractions, application of voltage drop, plate circuits, filament circuits, filament resistances, grid bias resistances. Parallel, series, wattage rating, maximum permissible current flow, distribution of current, calculations of resistance in parallel, in series, C bias resistances in filament circuits, in B eliminators.
- DC FILAMENT CIRCUITS: Calculation of resistances.
- AC FILAMENT CIRCUITS: Transformers, wattage rating, distribution of output voltages, voltage reducing resistances, line voltage reduction.
- CAPACITIES: Calculation of capacity, dielectric constant, condensers in parallel, condensers in series, voltage of condensers in parallel, in series, utility of parallel condensers, series condensers.
- VOLTAGE DIVIDER SYSTEMS FOR B ELIMINATORS: Calculation of voltage divider resistances, types of voltage dividers, selection of resistances, wattage rating of resistances.
- INDUCTANCES: Air core and iron core, types of air core inductances, unit of inductance, calculation of inductance.
- INDUCTANCE REQUIRED IN RADIO CIRCUITS: Relation of wavelength and product of inductance and capacity, short wave coils, coils for broadcast band, coupling and mutual inductance, calculation of mutual inductance and coupling.
- REACTANCE AND IMPEDANCE: Capacity reactance, inductance reactance, impedance.
- RESONANT CIRCUITS: Series resonance, parallel resonance, coupled circuits, bandpass filters for radio frequency circuits.
- IRON CORE CHOKERS AND TRANSFORMERS: Design of chokes, core, airgap, inductance, reactance, impedance, transformers, half wave, full wave winding.
- VACUUM TUBES: Two element filament type, electronic tube, two element rectifying tubes, process of rectification, tungar bulb.
- THREE ELEMENT TUBES: Structure of tube, detector, grid bias, grid leak and condenser, amplifiers, tube constants, voltage amplification, resistance coupling, reactance coupling, transformer coupling, variation of impedance of load with frequency, tuned plate circuit.
- POWER AMPLIFICATION: Square law, effect of load, calculation of output power, undistorted output power, parallel tubes, push-pull systems, plate resistance.
- GRAPHS AND RESPONSE CURVES: Types of paper, utility of curves, types of curves, significance of curves, voltage amplification, power amplification, power output, radio frequency amplification.
- MULTIPLE STAGE AMPLIFIERS: Resistance coupling, design, calculation of values, effect of resistance, calculation of coupling capacity, effect of plate load, effect of input tube capacity, calculation, reactance coupling, tuned double impedance amplification, underlying principles, transformer coupling, turns ratio, voltage ratio, types of cores, plate current limitation, grid current limitation.
- ALTERNATING CURRENT TUBES: Temperature variation hum, voltage variation hum, relation between grid and filament, filament circuit center tap, types of AC tubes.
- SCREEN GRID TUBE: Structural design, application, amplification, associated tuned circuits, radio frequency amplification, audio frequency amplification.
- A AND B ELIMINATORS: Voltage regulation curves, sections of eliminator, rectifying systems, gaseous rectifier, sulphide rectifier, power B units, power A units.

RADIO WORLD, 145 West 45th St., New York, N. Y. (Just East of Broadway)

Enclosed please find \$2.00 for which please send me at once one copy of "Mathematics of Radio."

Name
Address
City State

MERSHON

Electrolytic Condensers
at Professional Discounts

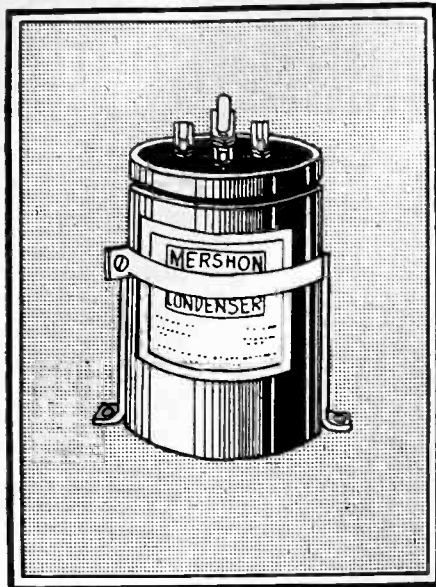

Mershon Electrolytic Condensers for Filtering Circuits of B supplies, rated at 400 volts D.C., or for by-pass condensers, give enormous capacities in compact form. We offer, at attractive discount, genuine Mershons made by the Amrad Corporation.

Cat. No. Q 8 **\$4.67**
Consists of four Condensers of 8 mfd. each, all in one small copper case (less brackets), List Price, \$7.95.....
NET

[Cat. Q 8B same as above, but includes mounting bracket. No brackets sold separately..... \$4.87]

Cat. Q 2-8, 2-18 **\$5.55**
Consists of four Condensers, two of 8 mfd. each, and two of 18 mfd. each, all in one small copper case (less brackets), List Price, \$9.45.....
NET

[Cat. Q 2-8, 2-18B, same as above, but includes mounting bracket. No brackets sold separately..... \$5.75]

Mershon electrolytic condensers are instantly self-heating. They will break down only under an applied voltage in excess of 415 volts D.C. (commercial rating; 400 volts D.C.) but even if they do break down because overvoltage, no damage to them will result, unless the amount of leakage current and consequent heating of the electrodes and solution cause the solution to boil. Voltages as high as 1,000 volts will cause no particular harm to the condenser unless the current is high enough to cause heating, or the high voltage is applied constantly over a long period.

High capacity is valuable especially for the last condenser of a filter section, and in bypassing, from intermediate B+ to ground or C+ to C-, for enabling a good audio amplifier to deliver true reproduction of low notes. Suitably large capacities also stop motor-boating.

Recent improvements in Mershons have reduced the leakage current to only 1.5 to 2 mils total per 10 mfd. at 300 volts, and less at lower voltages. This indicates a life of 20 years or more, barring heavy abuse.

How to connect: The copper case (the cathode) always is connected to negative. The lugs at top (anodes) are connected to positive. Where there are two different capacities the SMALLER capacity is closer to the copper case.

Mershons of equal capacity may be connected in series for doubling the voltage rating, or in parallel (any combination) to increase the capacity to the sum of the individual capacities, the rating remaining the same, 400 volts.

When series connection is used, the copper case of one condenser the anode of which goes to the high voltage should be connected to a lug or to lugs of the other condenser. The copper case of the second condenser goes to the negative.

In B supplies Mershons are always used "after" the rectifier tube or tubes, hence where the current is direct. They cannot be used on alternating current.

OTHER CAPACITIES OF MERSHONS

["S" stands for single condenser, "D" for double, "T" for triple and "Q" for quadruple. First figure between hyphens denotes quantity, second capacity per anode.]

- Cat. No. S-8, list price \$4.10; net, \$2.41
- Cat. No. S-9, list price \$4.25; net, \$2.48
- Cat. No. S-18, list price \$4.80; net, \$2.82
- Cat. No. S-40, list price \$5.40; net, \$3.17
- Cat. No. S-72, list price \$10.00; net, \$5.88
- Cat. No. D-8, list price \$5.25; net, \$3.08
- Cat. No. D-9, list price \$5.75; net, \$3.38
- Cat. No. D-18, list price, \$6.15; net, \$3.82
- Cat. No. T-8 list price \$6.30; net, \$3.70
- Cat. No. T-9, list price \$6.45; net, \$3.79
- Cat. No. T 1-8, 2-18, list price \$7.90; net, \$4.65
- Cat. No. 1-18, 2-9, list price \$7.50; net, \$4.41

[Note: Add 20c to above prices if bracket is desired. No brackets sold separately.]

No. C.O.D. orders on Mershon Condensers

GUARANTY RADIO GOODS CO.
143 West 45th Street, New York, N. Y.
(Just East of Broadway)

DO YOU LIKE

Dust in Your Eye?

HERE is a .0005 mfd. tuning condenser carefully encased in a housing consisting of metal front and back with transparent celluloid cross-piece sealed in between, all the way around, to keep out dust. The accumulation of dust on the stator and rotor plates of a condenser and about the bearings tends to build up a high resistance to radio frequencies. Keep out the dust and you keep the selectivity and sensitivity high, because of unimpaired efficiency.

Do you like dust in your eye? The condenser is the eye of the receiver, just as the tube is the heart.

The tuning is modified straight frequency line.

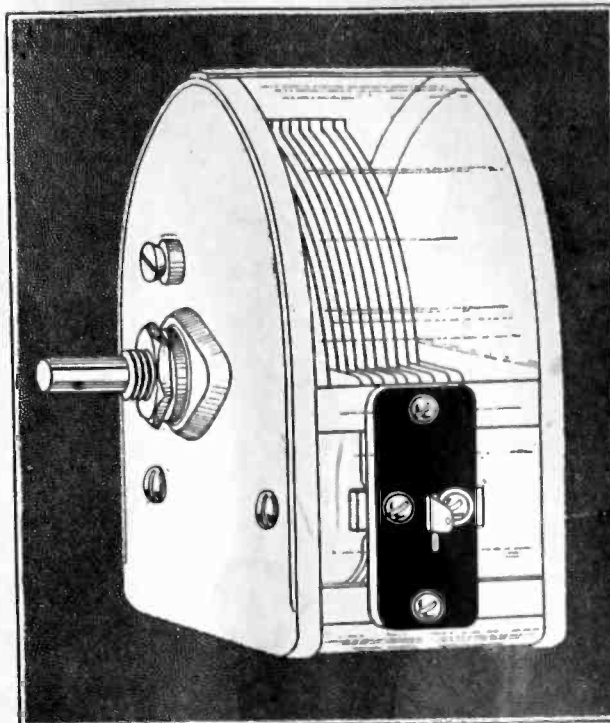

Easy-Turning Rotor

MADE to last, and to work at highest efficiency from first to last, this condenser is sturdily constructed. The plates are accurately soldered in place to make best contact and permanent, lasting, accurate alignment. The contact is positive.

The back and front metal housing pieces are connected to the rotor as a part of the construction of the condenser itself, and these metal pieces shield the built-in condenser from outside disturbances. The only dielectric insulation are two pieces of specially selected hard rubber, 1 1/4" x 1/4". This is a fine minimum, and it consists of the best insulator.

Connection to stator plates is made from the receiver to a tinned lug protruding from one of the insulators. At rear another tinned lug is for rotor connection.

Single hole panel mounting is provided with 1/4" shaft projecting. Two-hole mounting is optional. Sub-panel mounting, by means of brackets, is optional, the screws for this purpose being in tapped holes of the front and rear shields.

The rotor turns so easily that you'll be delighted at the result. Moreover, the tension of the rotor is adjustable at rear.

Helps You Get DX

NOT only is the dust-protected condenser sturdy and dependable, but it is handsome as well. Those who want excellence surely can obtain it from this condenser. Because of the retained efficiency, you will find this condenser helps you to bring in distant stations.

Equip your set now with dust-protected condensers. Order Cat. No. DUP5 at \$2.50.

Official Condenser for HB Compact!

GUARANTY RADIO GOODS CO.,
143 West 45th Street, N. Y. City
(Just East of Broadway)

Gentlemen: Please ship at once.....
dust-protected .0005 mfd. condensers, Cat. DUP5, at \$2.50 each.

- Enclosed please find remittance. You are to pay cartage.
- Ship C.O.D. I will pay cartage.

NAME

ADDRESS

CITY..... STATE.....

5-DAY MONEY-BACK GUARANTY

Two for the price of One

Get a FREE one-year subscription for any ONE of these magazines:

- CITIZENS RADIO CALL BOOK AND SCIENTIFIC DIGEST (quarterly, four issues).
- RADIO (monthly, 12 issues; exclusively trade magazine).
- RADIO ENGINEERING (monthly, 12 issues; technical and trade magazine).
- SCIENCE & INVENTION (monthly, 12 issues; scientific magazine, with some radio technical articles).
- YOUTH'S COMPANION (monthly, 12 issues; popular magazine).
- BOYS' LIFE (monthly, 12 issues; popular magazine).

Select any one of these magazines and get it FREE for an entire year by sending in a year's subscription for RADIO WORLD at the regular price, \$6.00. Cash in now on this opportunity to get RADIO WORLD WEEKLY, 52 weeks, at the standard price for such subscription, plus a full year's subscription for any ONE of the other enumerated magazines FREE! Put a cross in the square next to the magazine of your choice, in the above list, fill out the coupon below, and mail \$6 check, money order or stamps to RADIO WORLD, 145 West 45th Street, New York, N. Y. (Just East of Broadway).

Your Name

Your Street Address

City State.....

If renewing an existing or expiring subscription for RADIO WORLD, please put a cross in square at beginning of this sentence.

RADIO WORLD, 145 West 45th Street, New York, N. Y. (Just East of Broadway)

**DOUBLE
VALUE!**

New J-245 Trouble-Shooting Jiffy Tester

Tests All Modern Circuits at Plate Voltages up to 300 Volts, Finds Shorts and Opens, Judges Tube Performance—All in a Neat, Small Steel Case with Crackle Finish in Brown

THE handiest, dandiest compact Jiffy Tester is the J-245, especially designed to test up-to-date receivers, particularly those using screen grid tubes and 245 single or push-pull, testing out-of-date receivers just as well. It has an extensive usefulness and brilliant eye appeal. It tests sets with 201A, 200A, UX199, UX120, 240, 171, 171A, 112, 112A, 245, 224, 222, 228, 280 and 281 tubes without extra adapters.

Into the case are built the following meters: one reading O-20 ma. and O-100 ma, for plate current, change-over switch included; one reading O-60, O-300 volts DC for plate voltages and DC house line voltages; and one reading O-10, O-140 volts AC and DC (though the meter is marked AC), thus O-140 may be used for DC line voltage.

Two switches and nine tip jacks are on the panel. The jacks are marked to receive the four-tipped leads which emerge from the plugged cable connector. These leads are colored red, blue, brown and white, and so are little rings around the tip jacks that the leads connect to. All nine jacks are marked besides.

The switches are for change-over on the milliammeter, and for connecting and disconnecting the grid return to note a tube's "liveliness." How this is noted is explained in the instruction sheet accompanying the J-245.

Two sockets are on the panel, one 5-prong, the other 4-prong, for holding the UX and UY tubes, including screen grid tubes, both AC and battery types. To enable full test of screen grid tubes, including AC 224 and DC 222, a screen grid cable is supplied.

The compact J-245 therefore tests all plate voltages up to 300 volts, including B eliminators; all filament voltages, DC or AC, up to 10 volts; all plate current up to 100 ma. Besides, it provides close readings for plate current of 20 ma. or less and for B voltages of 60 volts or less, and AC voltage readings up to 140, including AC line voltage. Besides, it reads screen grid voltage.

The base that contains the meters has four feet on it, is only 1 1/4" high, and snugly receives the cover. Inside the cover is a spring clip to hold the plugged cable, with a 4-prong adapter, as well as the red and black separate test leads for use of each meter independently, and the screen grid cable. You have three separate double-range meters independently accessible, in other words, six-meter service, besides the plug-in feature for joint use of all meters in testing receivers, tubes, continuity, shorts, opens, etc., as described in the instruction sheet.

This outfit has a genuine leather handle on the top for carrying, and a braided strap for keeping the cover from coming off accidentally. It is the very thing that the service man, experimenter, student and teacher have been looking for.

Order Cat. J-245 and you will be surely overjoyed at the possession of such a handy, dandy, reliable and rugged Jiffy Tester, the neatest one you ever saw, and one that abundantly answers the purposes of service work. You don't need to know in advance how to use it. The instruction sheet gives a simple but comprehensive explanation. Besides, a tube data sheet tells how to determine if tubes are O.K.

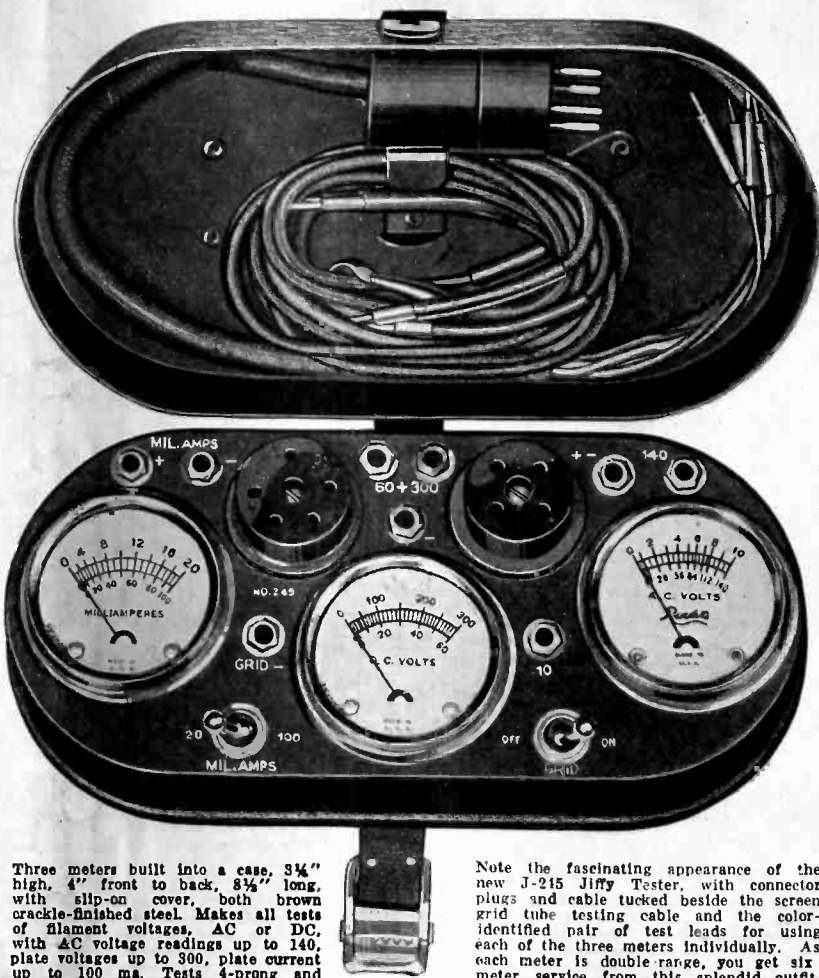

Three meters built into a case, 3 1/4" high, 4" front to back, 8 1/4" long, with slip-on cover, both brown crackle-finished steel. Makes all tests of filament voltages, AC or DC, with AC voltage readings up to 140, plate voltages up to 300, plate current up to 100 ma. Tests 4-prong and 5-prong tubes, including screen grid tubes. Test leads and instruction sheet included.

\$11.76

Note the fascinating appearance of the new J-245 Jiffy Tester, with connector plugs and cable tucked beside the screen grid tube testing cable and the color-identified pair of test leads for using each of the three meters individually. As each meter is double range, you get six-meter service from this splendid outfit. This is the most popular type of Jiffy Tester and the most desirable in the low price range.

Remit \$11.76 with order, and we pay cartage!

Successful Servicing Is Impossible Without Meters

IF you are a service man you are lost without meters. You may carry individual meters around with you and still remain perplexed, for lack of any means of obtaining access to the voltages or currents you desire to test. Therefore an analyzer like the J-245 is just the thing, and it is much more neatly made than you could possibly make a tester yourself, since, besides the engineering talent required to design such a device, thousands of thousands of dollars must be invested in dies. You reap the benefit of expert engineering design, quantity production and careful instruction as to use when you buy a J-245. It is unqualifiedly recommended as superior to any tester that is anywhere near so low in price. You could pay twice as much and get half as much value!

NEVER again need you be stumped for want of the necessary measuring equipment. Suppose you want to know the AC line voltage or DC line voltage—the right hand meter gives it to you. Simply plug the red test lead into the "140" tip jack, the black test lead into the "+" tip jack. If you desire to read the plate current of one tube, insert the tube in the proper socket of the J-245, connect the plug (with the aid of the 4-prong adapter, if necessary) into the emptied socket of the receiver, switch the milliammeter to "O-20" reading, insert the four-colored cable leads into the corresponding marked and colored tip jacks and turn on the set. These are only some of the fifteen tests you can make.

Independent Access to All Three Meters Insures Versatility

BESIDES fetching appearance, sturdiness, compactness and low cost, the J-245 affords versatility by rendering individual access to each meter. Use the red and black test leads for this purpose. Suppose you want to know the total plate current drain of all tubes of a receiver. Use the milliammeter at its "O-100" setting, connect the test leads to "milliamps +, -" and the other ends of the leads in the negative B line.

This accessibility of each meter—six-meter service, remember—heightens the value of the J-245 more than 100%, and is a new feature. The only limitations you will possibly encounter, and these are rare instances, apply to the testing of the B voltages on 210 and 250 tubes, and to testing the Kellogg tubes, which have filament emerging from a cap at top.

The plate voltage on a 210 is usually 350 volts while that on a 250 is usually 450 volts, and the B voltmeter reads up to 300 volts. But a series resistor will extend the range. This multiplier is an extra, and, those deeming it necessary may order

Cat. No. J-10; at 88c net, to increase scale to O-600 volts. Likewise, a Kellogg tube adapter is available, Cat. No. J-24 at 80c net. If UV199 tubes are to be tested, a pair of adapters is necessary, as these tubes have a unique base. The UX199 tubes can be tested without adapters. For UV199 tubes order Cat. No. J-19 at 80c net, which changes the UV socket of the receiver to accommodate the UX plug of the J-245, and Cat. No. J-20 at 36c net, to change the 4-prong socket of the J-245 to receive the UV199 tube.

NET PRICES AT MORE THAN 40% OFF LIST PRICE!
 J-245, consisting of the complete outfit, less multiplier, UV adapters and Kellogg tube adapter. Net price.....\$11.76
 J-106, resistor to be connected in series with O-300 voltmeter to increase reading to 600 volts. (Jack terminals optional. See coupon.) Net price J-106 only..... .88
 J-19 and J-20, pair of adapters for testing UV199 tubes. Net price for both..... .96
 J-24, Adapter for testing Kellogg and old Arcturus tubes. Net price..... .60

GUARANTY RADIO GOODS CO.
 143 West 45th Street, (Just East of Broadway), New York, N. Y.

- Gentlemen: Enclosed please find..... Send me at once at your expense:
- One J-245 with instruction sheet, net price.....\$11.76
 - One J-106 multiplier, net price..... .88
 - Jack Terminals optional for J-106, order JT, net price..... .30
 - One pair of UV adapters, J-19 and J-20, price of both, net..... .96
 - One adapter for testing Kellogg and old type Arcturus tubes, J-24, net price..... .60

All prices are net and represent extreme professional discount already deducted.

Your name..... City.....

Your address..... State.....

5-DAY MONEY-BACK GUARANTY

A Neat Carrying Case

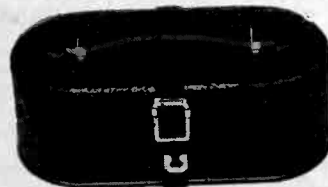

How the J-245 looks when the cover is slipped on and the strap is tightened. The handle is genuine leather.

Order a J-245 today. It is sold on a 5-day money-back guaranty, which nobody else offers. Try it out for five days after receipt. If not fully satisfied for any reason, or for no reason at all, send it back with a letter asking for refund of the money you paid. The refund will be made promptly. There are no strings to this guaranty!