

FEB. 11
1928

PHOTO BROADCAST TO HOMES

15
CENTS

Vol-12 No-21

RADIO WORLD

REG. U.S. PAT. OFF.

#307

The AC EQUAMATIC
Inductance Analyzed for Novice
The ADAMS 1-2-3
Tyrman's 70 Amplimax
Shielded Grid Diamond
How to Control Volume

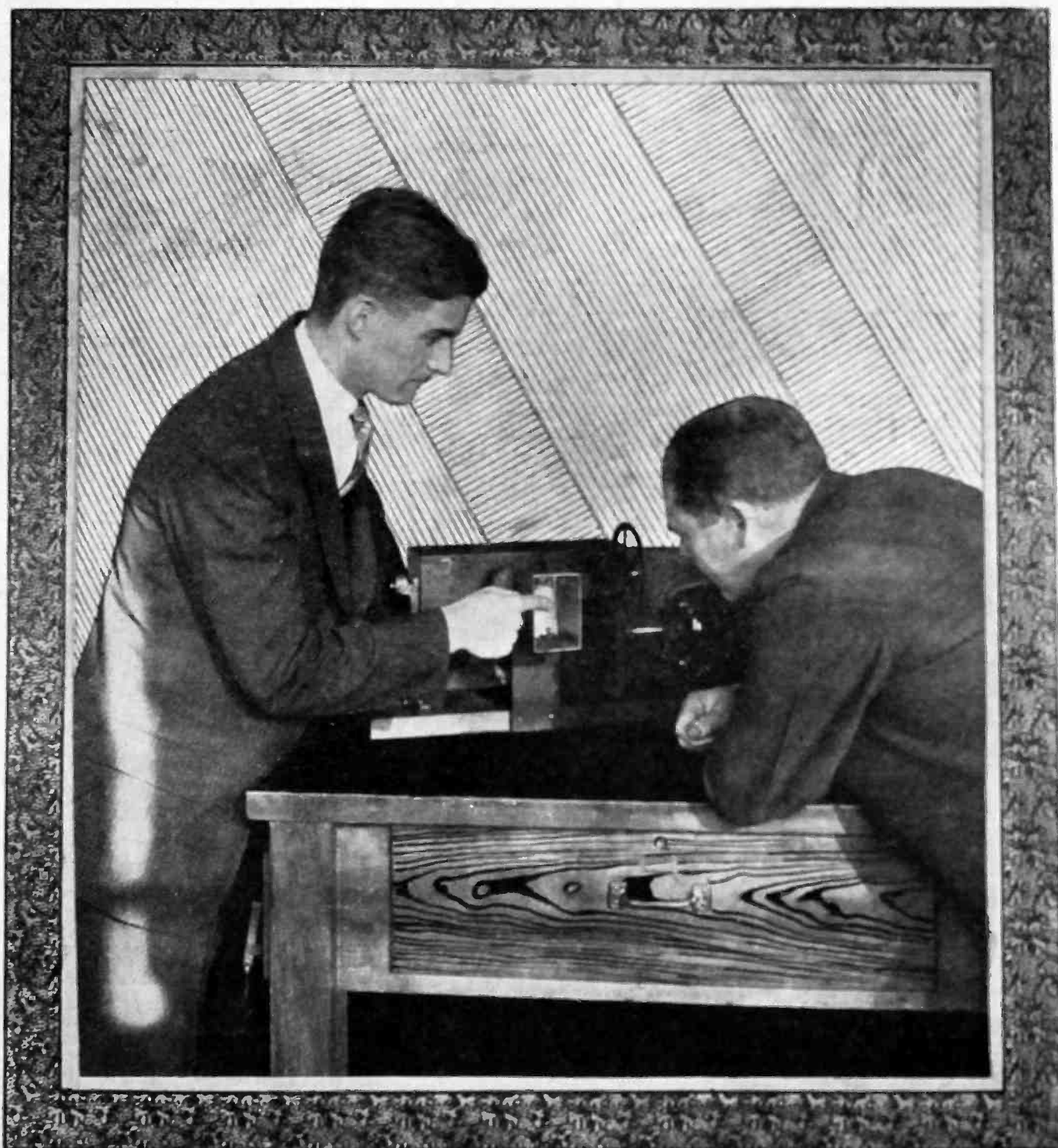

DR. E. F. W. ALEXANDERSON, inventor, watching his assistant, E. C. Ballentine, insert a Moore lamp in the reception of a photograph recently broadcast by WEA. See Page 3.

Tyrman "70"

Shielded Grid Amplimax

FOR A.C. or BATTERY OPERATION

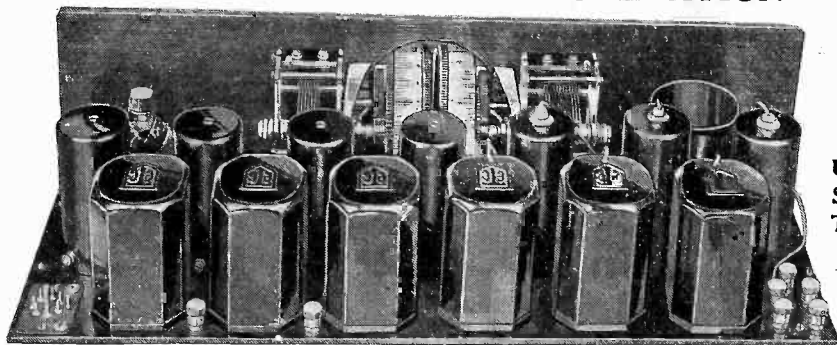

USING
SP-122
TUBES

Brings in AUSTRALIA and JAPAN with VOLUME and QUALITY

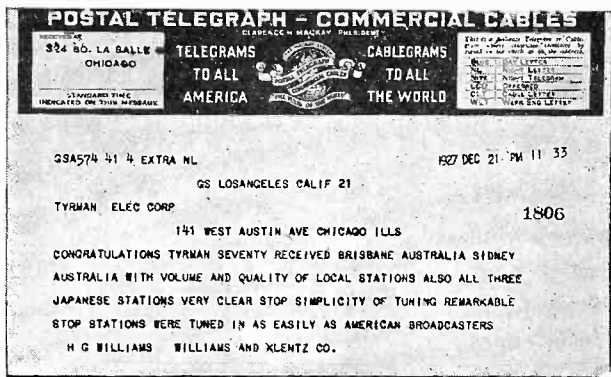

BUILD

this new receiver and benefit by this revolutionary improvement.

UNEQUALLED for DX reception and tone quality.

ASK YOUR JOBBER OR WRITE

TYRMAN ELECTRIC CORP. 141 W. AUSTIN AVE. CHICAGO, ILLINOIS

Tyrman "70"

Shielded Grid Amplimax

OFFICIAL SERVICE STATION

We Supply Tested Parts. Sets Custom Built to Your Order. Shipped Anywhere. Also MAGNAFORMER 9-8, New Shielded Grid DIAMOND OF THE AIR. H. & F. RADIO LABORATORIES, Inc. 168 Washington Street New York City

LYNCH

Book of Radio Helps, 25c
ARTHUR H. LYNCH, Inc.
1775 Broadway N. Y. C.

Take Your Choice of 7 Other Publications

For NEW RADIO WORLD Subscribers Ordering NOW

Radio World has made arrangements

—To offer a year's subscription for any one of the following publications with one year's subscription for RADIO WORLD—

RADIO NEWS or POULAR RADIO or SCIENCE AND INVENTION or BOYS' LIFE or RADIO DEALER or RADIO (San Francisco) or RADIO AGE.

This is the way to get two publications

- for the price of one:
- Send \$6.00 today for RADIO WORLD
- for one year (regular price
- for 52 numbers)
- and select any one of the other
- nine publications for twelve months.
- Add \$1.00 a year extra for
- Canadian or Foreign Postage
- Present RADIO WORLD subscribers
- can take advantage of this offer by
- extending subscriptions one year
- if they send renewals NOW!

Radio World's Special Two-for-Price-of-One Subscription Blank

RADIO WORLD, 145 West 45th Street, New York City.

Enclosed find \$6.00 for which send me RADIO WORLD for twelve months (52 numbers), beginning and also without additional cost, Popular Radio, or Radio News, or Science and Invention, or Radio Dealer, or Radio (San Francisco), or Radio Age, or Boys' Life (or \$10.00 for a two-year subscription to one address). No other premium with this offer.

Indicate if renewal. Name

Offer Good Until Street Address

March 15, 1928 City and State

CARTER

Fixed Condensers and other parts specified in

ADAMS 1-2-3 TYRMAN 70

for their well-known permanent accuracy. Any dealer can supply.

CARTER RADIO CO.
CHICAGO 2611-E.

YAXLEY

Specified for

Tyrman "70"

No. 915K—15 ohm Switching Rheostat.....	\$1.75
No. 125K—25 ohm Rheostat.....	1.35
No. 669—Cable Connector	3.25
No. 416—Pup Jack15
No. 815—15 ohm Resistance.....	.15
No. 4L—Resistance15

At Your Radio Dealers.

YAXLEY MFG. CO.
9 South Clinton Street CHICAGO

For Best Results

With the

SHIELDED GRID DIAMOND

and

TYRMAN 70 Receivers

Use only the

HAMMARLUND PARTS

Specified by the Designers

For Better Radio

Hammarlund

PRECISION PRODUCTS

Lignole Radio Panels are SPECIFIED for

TYRMAN 70

Write for Price List

THE LIGNOLE CORPORATION
508 So. Dearborn St. Chicago, Ill.

EVERY FRIDAY at 5.40 P. M. (Eastern Standard Time) Herman Bernard, managing editor of Radio World, broadcasts from WGBS, the Gimbel Bros. station in New York, discussing radio topics.

Still Photo Broadcast

Receivers Soon Available, Regular Transmission Will Start Then

How the Simple System Works Is Fully Described by Expert—Variety of Uses Listed—New Thrill, Says Fitzalan after W E A F Demonstration

By Neal Fitzalan

Radio Vision Editor

HAVE you ever heard the sound of a photograph? How do you suppose the features of your favorite movie actress would sound? Pleasant or unpleasant? Would they sound better than the features of a battlescarred prizefighter?

The sound of the features of various celebrities soon will be as familiar to radio fans as the sound from a neighbor's bloop. Still photographs and facsimiles soon will be put on the air as a regular feature of radio broadcasting, according to the tentative plans of the National Broadcasting Company, and inexpensive receivers will be made available to the public.

Broadcasting of still pictures is no longer a mere proposal; it is a historic fact. It was done for the first time in public the afternoon of January 26 when a photograph of Mayor James J. Walker of New York City was broadcast on the 610 kc wave of station W E A F from the studios of that station at 711 Fifth Ave., New York City, and received by Dr. Alfred N. Goldsmith, chief broadcast engineer of the Radio Corporation of America at his home at 450 West End Ave., 25 miles from the transmitting antenna of W E A F.

Dr. Alexanderson's Invention

The instruments used in the transmission and reception of the photograph of Mr. Walker were developed by Dr. E. F. W. Alexanderson, chief consulting engineer of the General Electric Co., and chief broadcast engineer of the Radio Corporation of America, assisted by co-workers. The instruments are extremely simple in principle and in construction and they can be made available to all who now have radio sets. The total cost of the receiver, exclusive of the radio set which is part of the equipment, is estimated to be about \$35.

One of the facts which in part account for the simplicity of the system is that synchronous motors are used for driving both the transmitter and the receiver. If these motors are connected to the same electrical distributing system they will run at exactly the same speed, which will

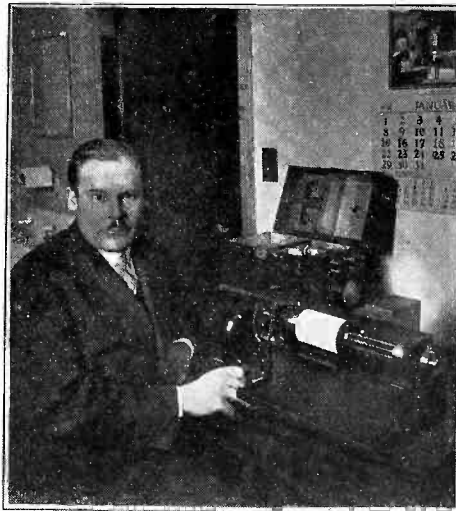

DR. E. F. W. ALEXANDERSON (AT LEFT), INVENTOR OF THE RADIO STILL PICTURE TRANSMITTER, WITH HIS HOME RECEIVER. THE CASE HAS BEEN OPENED AND THE SENSITIVE PAPER IS SEEN ON THE DRUM. THE AMPLIFIER IS BEHIND THE RECEIVER. THE RADIO PICTURE TRANSMITTER, OPERATED BY E. C. BALLENTINE, ASSISTANT TO DR. ALEXANDERSON, IS SHOWN AT THE RIGHT.

be determined by the frequency of the current in the system. There are only a few electrical systems in the entire country and these systems easily could be tied together or synchronized if picture transmission and reception should demand it.

Synchronizing Easily Done

Even if the transmitter were operated at 60 cycles and the receiver on 40 cycles, it would be a simple problem to synchronize the two, provided that the ratio of the two frequencies remained constant. The difference could be made up by a suitable gear.

The principles of the transmitter and receiver are easily explained with the aid of Fig. 1. D1 is a drum upon which the photograph to be sent is wound. The drum is driven by a small synchronous motor M1 through a speed reduction gear G1. The drum is moved axially as it revolves by a screw having 80 threads per inch.

Lt is a light concentrated on the photograph by the lens L2. The combination Lt and L2 is an automobile headlight which can be obtained in any auto supply shop. L1 is another lens, which in the model demonstrated was the objective of an ordinary microscope. This lens forms an image of the picture in front of a tiny window W in the side of a metal box B. In this box, just in front of the window, is a photo-electric cell P.

The Light Chopper

Ch is the edge of a large slotted wheel which is rotated rapidly in front of the window and is so mounted that the beam of light from the picture is interrupted

regularly 2,500 times a second.

The light from the picture that enters the photo-electric cell causes a certain electric current to flow through the anode circuit. This varying current is amplified by a five-stage resistance coupled amplifier A and then sent on to the radio transmitter. The amount of light that enters the cell, and hence the intensity of the photo-electric current, depends directly on the amount of light that is reflected from the picture. Where the picture is black, practically no light is reflected; where it is white, nearly all is reflected. Hence the intensity of the light reflected varies as the opacity of the picture, or as the lights and shades on the picture. The light beam entering the box B is thus picture modulated.

But this current is not easily amplified either at the transmitter or at the receiver, because it is more or less steady current. To overcome this difficulty, and to make ordinary radio amplifiers serve, the light beam is chopped up into regular light pulses occurring at the rate of 2,500 per second. This makes the current emerging from the photo-electric cell alternating with a frequency of 2,500 cycles per second. This is easy to amplify since it falls at the point where average amplifiers are most efficient.

Carrier Doubly Modulated

The light beam is picture modulated before it is chopped up. The radio frequency wave used by the broadcast station is modulated with the 2,500 cycle squeal, and it is that squeal which radio fans hear when they listen to a photo-

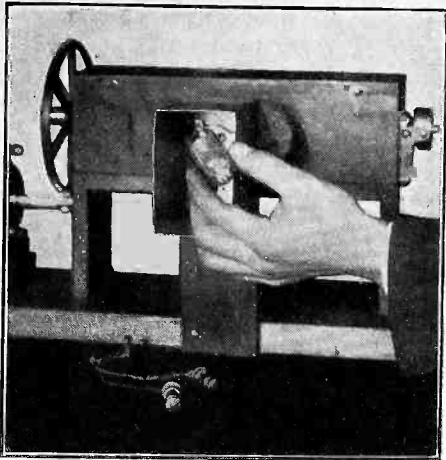

CLOSEUP VIEW OF THE MOORE NEON LAMP USED WITH THE PICTURE RECEIVER.

graph transmission. The radio wave is thus doubly modulated.

We now have a high-pitched squeal carrying a picture. What can be done with it? A transformer can be put either in series or in parallel with the loudspeaker, and the voltage induced in the secondary of this transformer by the signal current in the primary impressed on the grid of a rectifier tube. There results a current in the plate circuit of the rectifier which is essentially of the same shape as the electric current out of the photo-electric cell would have been had not the chopper been interposed. That is, the current in the plate circuit of the rectifier tube is unidirectional current which varies in the same proportion as the density of the original picture.

Moore Lamp Flickers

This varying current is impressed on a Moore lamp N, the light from which varies in proportion to the current impressed on it. D2 is a light proof box of the same size and shape as box D1. It contains a drum driven by synchronous motor M2 through a reduction gear G2, and this drum carries an unexposed sheet of bromide or other light-sensitive paper. D2 is in fact a camera so arranged that the image of the Moore lamp N is formed on the sensitive paper. This image traces a copy of the original picture on the sensitive paper as both the transmitting and the receiving cylinders rotate synchronously.

Framing of the Picture

There are two main problems connected with the reception of a photograph by this method. One is that of framing and the other is that of intensity of exposure.

The framing of the picture is necessary so that the received picture be not cut in two by the band holding the original picture on the drum. Framing means the bringing of the two drums in phase with each other. The framing takes but a few seconds and is aided by a signal from the transmitter, which interrupts the high-pitched signal once every revolution of the drum. The receiver operator can adjust his drum so that the interruptions occur at the proper position on the receiving drum.

The other problem is that of obtaining the correct light intensity for correct exposure of the sensitive paper. This is done by controlling the volume of the signal with ordinary volume controls until a milliammeter connected in the output circuit reads a definite value. When both the volume and the framing have been adjusted a start signal is given and the picture is transmitted. It takes 90 seconds to send and receive a picture 4½x8 inches, counting from the time the start signal is given. It takes about a minute to adjust.

When the sensitive paper has been ex-

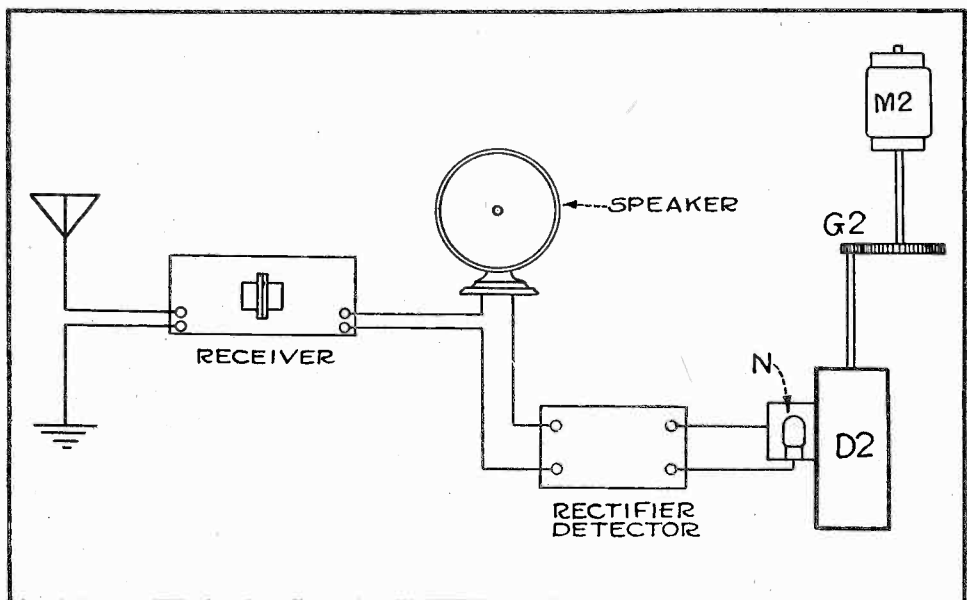
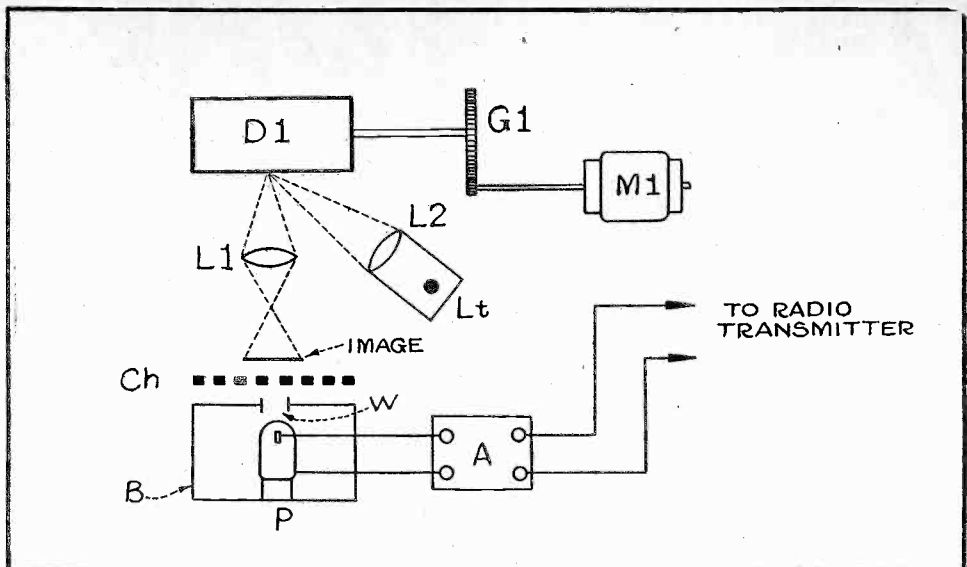

FIG. 1

THE SCHEMATIC OF THE TRANSMITTER (TOP) AND RECEIVER (BOTTOM) OF THE ALEXANDERSON SYSTEM OF BROADCASTING PHOTOGRAPHS. M1 AND M2 ARE SYNCHRONOUS MOTORS DRIVING THE DRUMS D1 AND D2, BY MEANS OF GEARS G1 AND G2. L1 IS A LIGHT SOURCE FOCUSED ON THE DRUM D1 BY A LENS L2. THE REFLECTED LIGHT FROM THE PICTURE IS CAUGHT BY THE LENS L1 AND FOCUSED NEAR A WINDOW W IN A BOX B CONTAINING A PHOTO-ELECTRIC CELL P. THE CURRENT FROM THE CELL IS AMPLIFIED BY A AND SENT TO RADIO TRANSMITTER. A CHOPPER WHEEL CH BREAKS THE LIGHT BEAM UP INTO 2,500 LIGHT PULSES PER SECOND. THE RECEIVER IS ESSENTIALLY THE SAME AS THE TRANSMITTER EXCEPT THAT A NEON LAMP IS USED IN PLACE OF A PHOTO-ELECTRIC CELL.

posed to the flickering Moore neon lamp it must be developed and fixed. This can be done in the ordinary photographic manner, but tank development is entirely suitable so that the process can be carried out even in daylight.

Developing

The reception of a picture is done under instructions from the transmitter announcer. The steps in the process are something like this:

"The next feature is the transmission of a facsimile of our program for today. The first high-pitched squeal you hear will be the volume control and framing signal. Adjust your volume until the milliammeter reads 17. Frame your picture."

For about one minute a shrill whistle sounds, except for regular interruptions to aid in framing. The preliminary signal stops and the announcer warns the receiver operator to be on the alert and ready.

"Start," he commands, and the picture buzzes for 90 seconds. "This is station WEAFL. Please stand by."

Socket Power Meter

Standard is Proposed

The Instrument Committee of the Radio Manufacturers Association, Engineering Division has proposed the following standard:

"Adjustments and tests on socket power supply devices shall be made using a voltmeter having a total resistance of not less than 175,000 ohms, and with a resistance of not less than 750 ohms per volt."

The total resistance may be computed by multiplying the full scale deflection in volts by the resistance per volt.

KOA JOINS N.B.C. NETWORK

KOA, Denver, Colorado, owned and operated by the General Electric Company, joined the network system of the National Broadcasting Company. Under a special arrangement, radio programs of the National Broadcasting Company from its New York, Chicago and Washington studios will be carried through to Denver.

The Tyrman 70

By Brunsten Brunn

[The gain factor of the shielded grid tubes in a Super-Heterodyne intermediate channel was discussed in Part I of this article, published last week, issue of February 4. The circuit design, as a whole, was analyzed, including discussion of the choice of the intermediate frequency and of the antenna as pickup.]

PART II

SHIELDING plays a highly important role in radio receiver design, yet there are many who still maintain that it is unnecessary. They contend that the set may be more sensitive, more selective and more dependable without shielding than with it, and consequently that it is uneconomical to employ shielding.

And they contend rightly when they confine themselves to the possibility of it. An unshielded receiver of simple construction may outperform a shielded one, tube for tube, coil for coil, but the probability is so small that we shall at once turn to a fine example of receiver design where shielding has been employed profusely and with fine results.

Shielding is Thorough

Glance at the interior of the Tyrman 70 Amplimax shielded grid tube receiver. The view is decidedly novel to those who are not familiar with Tyrman construction. Every tube is inclosed in a metal can which shields that tube from all the other parts in receiver and from electromagnetic disturbances arising outside the set. Every coupler of intermediate and audio frequency is similarly metal-encased. Thus there can be no interaction between stages to set up oscillation and to introduce noises. Quietness of operation is an inevitable sequel.

It might seem that this shielding would reduce the selectivity of the circuit, since a conductor is placed in the field of every coil. There may be a slight reduction of the selectivity of each stage in the circuit, but it is not that which determines the effective selectivity of the receiver. If the various fields of the coils are allowed to clash with each other, one of two things will happen. The fields may be so

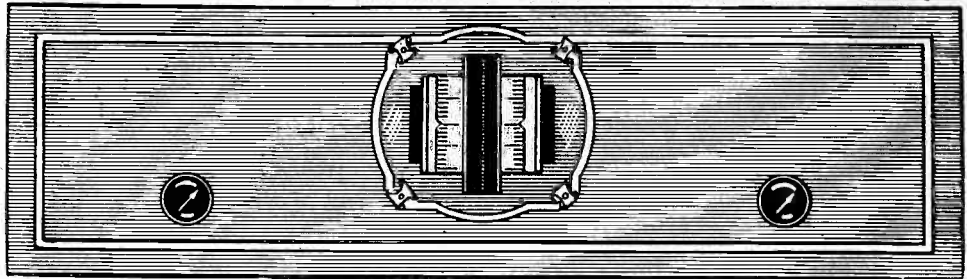

THE PANEL ARRANGEMENT OF THE TYRMAN 70 AMPLIMAX RECEIVER. THE CENTER DRUM DIALS ARE THE TUNING CONTROLS AND THE LOWER RIGHT AND LEFT KNOBS ARE THE VOLUME CONTROLS.

phased that the field of one will aid that of another in increasing the signal. Oscillation results. Or the fields may be so phased that the field of one will oppose the effect of another. Reduction in amplification, sensitivity, and selectivity is the result.

Shielded Grid Tubes

Thus shielding both prevents oscillation and maintains the effective selectivity at the desired high level.

Whereas many receivers using three element tubes have been built without any shielding and with no apparent detrimental effects, shielding cannot be omitted when the —22 type shielded grid tubes are used in the circuit. The supreme sensitivity of that receiver is dependent on the adequacy of the shielding.

The shields employed are made of sufficiently thick metal to make them effective not only against electric fields but also of magnetic fields.

The shields of the audio transformers and the intermediate couplers are identical in appearance and the shields are really the cases of the instruments. The shields for the various tubes are made of drawn aluminum thick enough to be effective against both electric and magnetic fields. These shields fit snugly over the vacuum tubes and sockets. Those shields intended for the shielded grid tubes have holes

with insulated bushings at the top, through which the control grids protrude.

Connection between the control grids and the couplers is made by means of flexible leads and spring clips. The shields must be in place before the control grids can be connected to the circuit.

Condensers Shielded

An annoying source of interstage coupling is sometimes found between the tuning condensers. This is always the case when the condensers are placed close to each other without any shielding between them. Both of the above conditions for interstage coupling have been avoided in this receiver.

The shielding is effected by large drum dials placed between the two Camfield condensers and by the condenser metal mounting plates. The interposition of the drum and the mounting plates between the two condensers keeps them at a large distance apart, and this still further decreases the electric coupling between the oscillator and the detector tuning condensers.

When an antenna is used for this receiver it is important to use the Hammarlund C3 50 mmfd. midget condenser. It helps to control the volume, increases the effective selectivity, and is an aid to sensitivity.

Not by Shielding Alone

Shielding alone is not sufficient to prevent all coupling between stages, because there are many places in a receiver where energy can be transferred from one circuit to another and where shielding cannot be used practically. This is particularly true of the leads to the batteries.

The resistance of the common portion of the circuits acts as a direct coupler between the stages, and no amount of shielding will nullify this coupling.

So by-pass condensers are used to prevent both the inductive coupling between adjacent wires and the direct coupling due to community of leads. The Carter condensers specified for this purpose in the receiver are 1 mfd. units, but it is not necessary to cling to these values if larger condensers are available.

While the filament switch S and the volume control rheostat R1 are in different parts of the circuit they are both mounted on the panel and are both contained in one unit and both are controlled with the same knob. They are the Yaxley Type 915K 15 ohm rheostat with switch.

[Part III next week.]

Great Chains Are Ready to Broadcast Pictures

By Merlin Hall Aylesworth

President National Broadcasting Co.

The successful transmission of photographs by radio by the National Broadcasting company heralds a wonderful new achievement and forecasts an altogether new and interesting phase in the radio art.

While the sending and reception of pictures by radio has been done before in an experimental way in our laboratory, this is the first that a broadcast station, using its regular wavelength, has publicly demonstrated the feat.

Just what the field will be for this development, we do not know. It provides a means for our vast radio audience to see the artists who broadcast. A picture,

taken in our studio, can be transmitted into the home in a minute and a half, either before or just after an artist has broadcast. Perhaps we might send a picture of our detailed printed program for the day at an early hour each morning. Time will reveal many other possibilities.

The art of radio broadcasting is progressing rapidly and the National Broadcasting Company is keeping in step with that progress. If visual radio is desired in the home, to supplement sound radio, the National Broadcasting Company will be ready to provide for this service, not only through WEAf but through its network of stations.

The Scientific Background

By J. E. Anderson

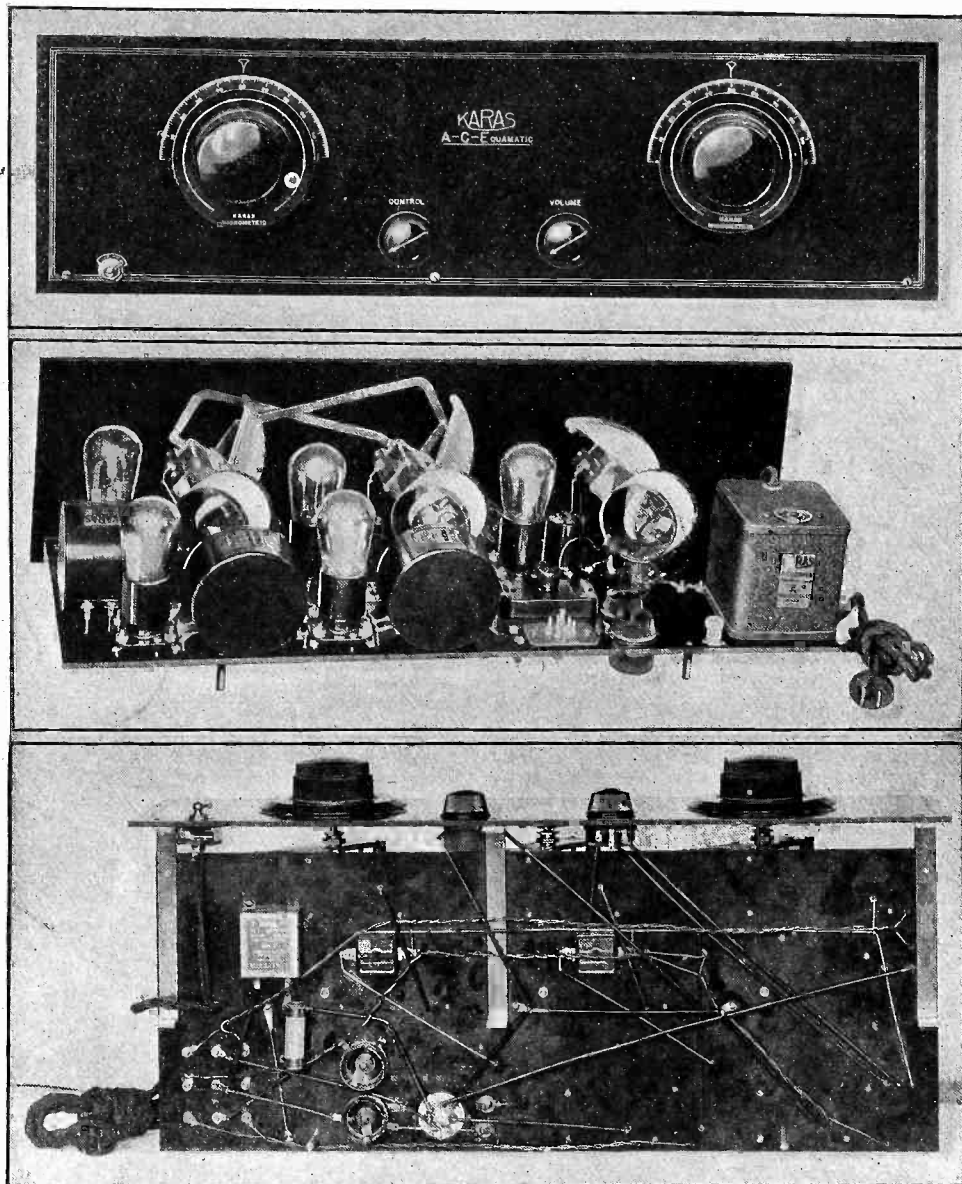

THREE VIEWS OF THE KARAS AC EQUAMATIC RECEIVER. TOP—ARRANGEMENT OF THE PANEL. MIDDLE—INTERIOR, REAR VIEW. BOTTOM—SUB-PANEL WIRING. NOTE THE EXQUISITE APPEARANCE AT ANY AND EVERY ANGLE OF VIEW. THE OPERATION IS IN KIND.

“**W**OULD any fan willingly return to the DC operated receiver after having given an AC receiver a thorough trial?”

So said a fan who recently built an AC Equamatic. He added:

“Acid-burned rugs and clothing, corroded terminals, battery exhaustion in the midst of a program, and charging annoyances must be dear to the heart of any one who would switch back.”

Certainly he does not find compensation for these disadvantages in the superiority of the DC operated set over the AC operated receiver. And certainly the AC operated receiver has no such great drawbacks that the DC job would be preferable notwithstanding its messiness.

The discussion here does not center about a so-called electrified job, but an all-electric receiver in which not a battery, not a drop of liquid is used.

It Excludes Hum

The AC Equamatic, a five-tube receiver comprising three tuned circuits and two stages of transformer coupled audio, is all-electric and AC operated and contains no compromises between DC and AC.

And this 100% AC operation is accom-

plished without any residual hum in the output that can be detected with the unaided ear. This is a broad claim for any AC circuit, but it can be justified for this circuit without difficulty.

The elimination of hum from any AC receiver follows scientific compliance with basic rules of design. Some of them are: The plate voltage must be thoroughly filtered before it is applied to the plates of the tubes in the set; the receiver must be effectively neutralized for all frequencies in the tuning range so that the circuit cannot oscillate at any setting of the controls; the filament circuits must be accurately balanced with respect to grid and plate returns so that the grid effect of the filaments cannot enter as a factor; the leads to the filaments must be twisted so that the tubes do not pick the AC hum by induction; the circuit must be adequately by-passed at the proper places; the proper tubes must be used for amplifiers and detector; the proper filament transformer must be employed.

Humless Conditions Satisfied

The freedom of hum in the plate voltage is largely a question of the amount

LIST OF PARTS

T1, T2, T3—Three Karas Equamatic coils.

T4, T5—Two Karas Type 28 audio transformers.

T6—One Karas AC-Former.

Ch3C11—One Karas output filter.

C1, C2, C3—Three Karas Type 17 variable condensers.

C4, C7—Two Carter .00015 mfd. by-pass condensers.

C5, C8—Two Samson .00003 to .0003 mfd. neutralizing condensers.

C6—One Carter .006 mfd. by-pass condenser.

C9—One Carter .00025 grid condenser with clips.

C10—One Carter 1 mfd. by-pass condenser.

C12—One condenser (optional) of 4 mfd. or higher capacity.

Ch1, Ch2—Two Hammarlund No. 85 RF chokes.

R1—One Carter M.W. No. 75 Rheostat.

R2—One Carter M.W. No. 1/5 rheostat.

R3—One Carter M.W. No. 2, 2,000 ohm potentiometer.

R4—One Electrad fixed resistor B-20, 2,000 ohms.

R5—One Durham 2 megohm grid leak.

P—One Electrad half megohm potentiometer.

Two Karas Micrometric dials.

Three Karas subpanel brackets.

One Karas control system with necessary hardware.

One Yaxley cable and plug.

Four Benjamin red top socket No. 9040.

One Benjamin green top socket No. 9036.

One Carter Imp 110 volt switch.

Two Carter No. 10 tip jacks.

One 7x24 drilled and engraved panel.

One 9x23 drilled and engraved subpanel.

Four XL binding posts.

of plate current that is drawn and the type of eliminator and filter that is used.

Since there are many good eliminator kits on the market, all capable of delivering ample current at the requisite voltages, and well filtered, it will be assumed that the builder of the AC Equamatic receiver will select one of them.

The neutralization problem is one of first importance because if the circuit oscillates ever so little the residual hum will be magnified to amplitudes comparable with the signal.

Oscillation must be kept out of the circuit.

In the Karas AC Equamatic it is accomplished very effectively by means of RF chokes Ch1 and Ch2 and condensers C5 and C8. Current from the plate is sent through C5 and Ch1 and the voltage thus set up across the RF choke is in series with the input voltage and phased so that oscillations are damped out by it.

The amount of this damping and thus the degree of neutralization is determined by the setting of condenser C5. It is possible to set it so the tube will not oscillate at any setting of the tuning controls and yet so as to get the benefit of all the regeneration permissible to use.

The same applies to the combination Ch2 and C8 and the second tube.

Filaments Balanced

The filament balance is obtained in the scientific construction of the supply transformer. The taps on the secondary windings are placed at the exact electrical

of the AC Equamatic

Technical Editor

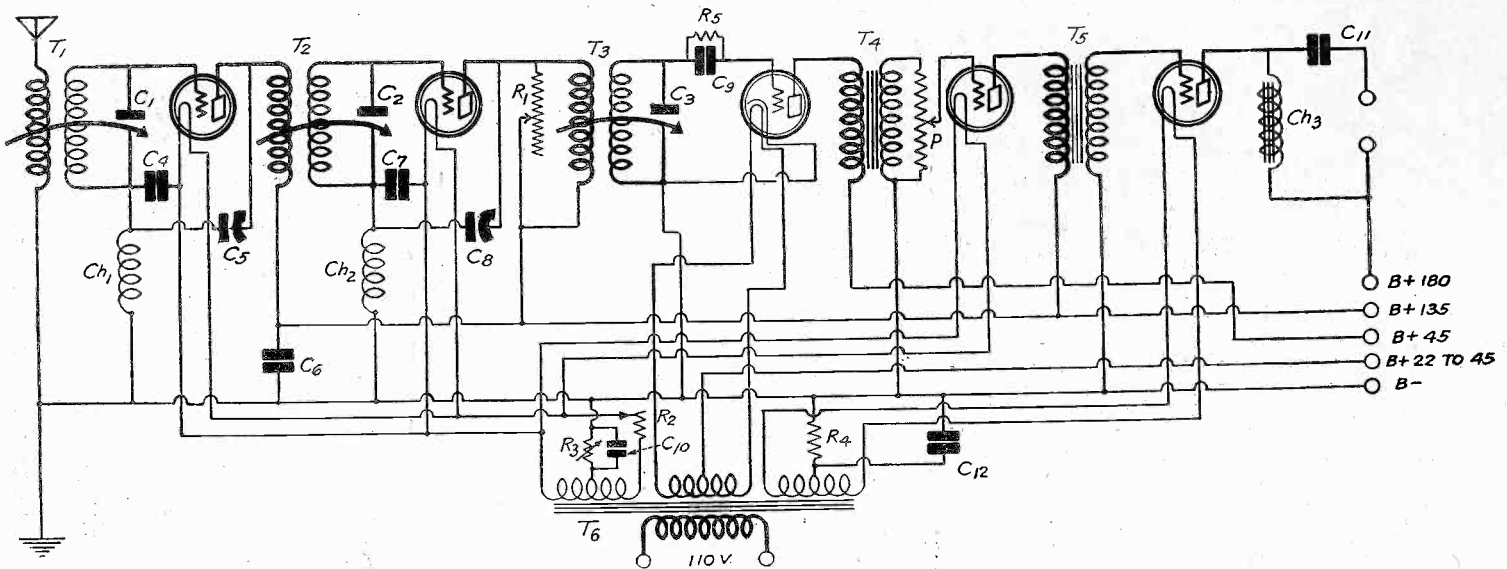

THE SCHEMATIC DIAGRAM OF THE KARAS AC EQUAMATIC RECEIVER.

mid-points both with respect to resistance and reactance.

Thus when the grid and the plate of a tube is returned to mid-point there is no chance for hum to affect the signal. No matter at what portion of the AC cycle the current may be, the mean potential of the grid or the plate with respect to the filament is equal to a constant determined by the grid bias or the plate voltage.

The pure DC circuit can do no better. It should be noticed that this accurate balance of the filament circuits is obtained without any balancing resistors connected across the line, which can be done on account of the special construction of the Karas AC-Former.

The Twisted Leads

The filament leads from the AC-Former to all the tubes are twisted so as to scramble and confuse the fields, thus reducing to a vanishing minimum the inductive effects between these leads and the plate and grid leads. Hum is thereby also eliminated.

By-passing is a necessary condition for the successful operation of any set operating on AC.

In the circuit diagram of the AC Equamatic two by-pass condensers, C4 and C7, are shown in corresponding positions in the first and the second stages. These two condensers are used more for stabilizing the set than for aiding in the AC operation. That is, they are a part of the neutralizing system. They are designed to prevent too great reverse feed back at the higher frequencies in the broadcast band. For this purpose they must be small, each having a capacity of .00015 mfd.

C6 is a true by-pass condenser for RF currents which aids not only in excluding hum but also in stabilizing the circuit. Its value should be .006 mfd. or more.

C10, connected across the grid bias resistor serving the three 1½ volt tubes, should be 1 mfd. or higher. At radio frequency this condenser serves to prevent the resistance R3 from acting as a coupler between the two stages and at audio frequency it serves to prevent the reduction in the amplification by reverse feed back through R3.

The higher the value of this by-pass condenser the more effective it is at audio

frequency. It is not necessary, however, to use a larger value than 4 mfd.

C12 serves a very important purpose as was suggested in connection with C10 and the first audio tube. But in the last tube, particularly when that has a low amplification constant like the -71 type tube, the by-pass condenser is indispensable.

R4 is the grid bias resistor which is both in the plate and the grid circuits of the tube. Since it is in the plate circuit it acts as a load in addition to the loudspeaker. The output voltage is thus divided between the useful load and R4. But that is only a minor portion of the total deleterious effect of R4. The signal current flowing in R4 produces a voltage drop across it and this is subtracted to the input voltage. The effect is that R4 reduces the output of the tube to a small fraction of what it should be.

C12 connected across the resistance reduces the voltage drop across R4 and hence increases the output toward normal value. But the condenser must be large if this is to be effective at the lower end of the audible scale. About 8 mfd. is suggested, and since the voltage is about 40 volts, a low voltage test condenser can be used.

As a condition for minimum hum, low voltage, high current tubes must be used as amplifiers. The two RF tubes and the first audio should be of the -26 type and the last tube should be either of the -71A or the -10 type. For detector only a heater tube should be used, as this alone is humproof in the detector position. Connecting the leads so that the heater of the tube is from 22 to 45 volts positive with respect to the cathode aids in excluding hum. This voltage prevents electrons from leaving the heater and reaching the cathode.

Any considerable bombardment of the cathode by the electrons from the heater would accentuate the periodic heating of the cathode and would thus nullify the principle of the tube.

The filament transformer T6 used in the receiver has been designed with especial care and precision and is therefore the proper one to use. It has been built on generous proportions so that it will not overload even if twice as much power is drawn from it as is required in

this circuit. Yet the transformer is so compact that it can be installed in the set together with the rest of the transformers.

All the secondary windings are accurately center-tapped.

Exclusive Features

This transformer has several exclusive and unusual features. It is provided with a universal socket into which the supply lead of the eliminator can be plugged. There is also a well insulated loop of wire, connected in series with the primary, which can be pulled out of the case and cut. In this breach a 110-volt line switch can be put for turning on and off both the filaments and the eliminator. The switch can readily be put on the panel. This is a very useful and convenient feature.

Other features are the provisions made for mounting the transformer. It may be mounted with all the terminal screws extending through the baseboard for making sub-panel connections. The screws are of ample length for making the connections with thumbnuts.

The transformer can also be mounted with the terminal strip in another plane. For this purpose detachable feet are provided. When these feet have been attached accurately to a baseboard the transformer can be mounted securely or demounted without any tools.

One of the characteristic features of the Equamatic system is that the coupling between the primaries and the secondaries is varied automatically as the condensers are turned, and this variation is such that the effective transfer of energy from one circuit to the next is virtually independent of the frequency of the signal, that is, upon the setting of the tuned circuits. This insures against low sensitivity at the low frequency end of the scale and against oscillation at the high frequency end. It insures uniformity of response throughout the tuning range of the circuit.

There are only two tuning controls on the panel. The first of these controls the setting of the first condenser and the coupling between the antenna and the first tuning coil. The next controls the two equal, tuned circuits and coupling between the primary and the secondary
(Concluded on page 22)

How Arborphone Expertly Utilized The Loftin-White Principle

By William Ingles

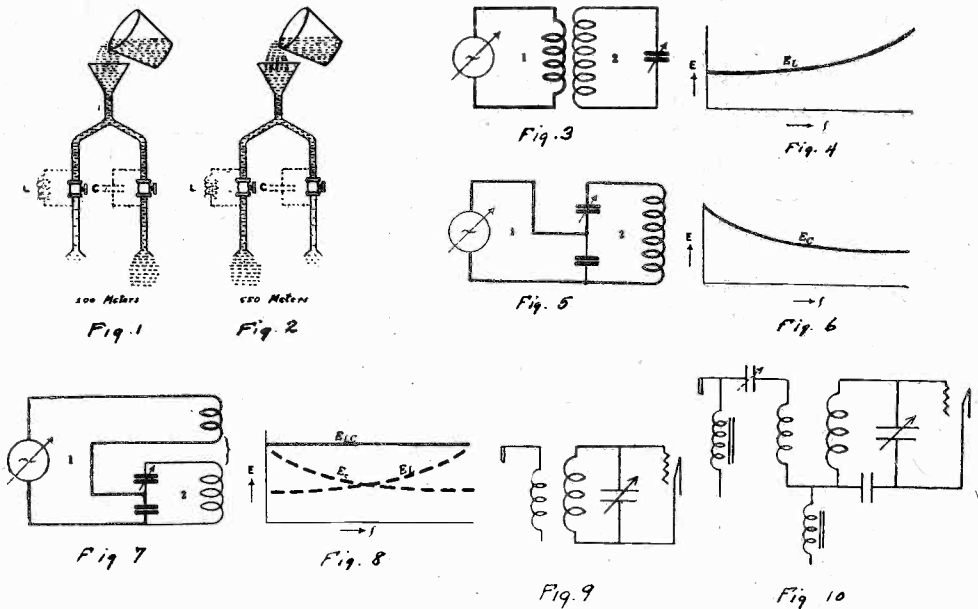

DIAGRAMS ILLUSTRATING THE THEORY OF THE CIRCUIT

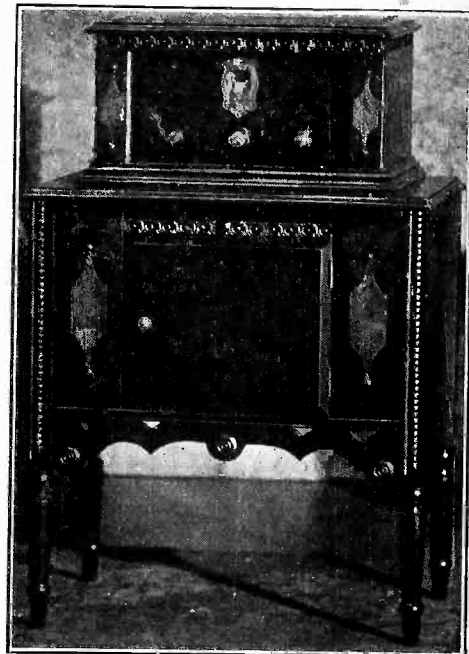

FIG. 11

NO contribution to radio science ever vaulted to fame more quickly than the Loftin-White Circuit, so important was it considered. Its outstanding twin virtues of constant energy transfer at all frequencies and automatic stabilization against oscillation, making it equally efficient over the entire broadcast wave-band and completely independent of tube capacities, were hailed as the greatest step forward since the advent of the broadcast receiver.

Now comes a progressive manufacturer with a perfected commercial adaption of the Loftin-White principle to manufactured broadcast receivers, and with some interesting constructional features of its own.

The Loftin-White circuit was developed by Edward H. Loftin, former Lieutenant-Commander, U. S. N., in charge of radio research and patent work, and S. Young White, a private experimenter of note in radio engineering circles. The circuit which bears their name was brought out as a result of their investigations aimed at overcoming the difficulties inherent in the tuned radio frequency circuit.

Uniformity Constituted a Problem

For several years tuned radio frequency has been almost universally adopted as the ideal circuit for broadcast reception. The greatest difficulty has been in designing the circuit to function with uniform efficiency over the entire tuning range.

It has always been necessary to introduce losses sacrificing efficiency and selectivity over a great portion of the wave-

length band to get satisfactory operation over the remainder of the broadcast wavelengths.

You have probably noticed on your own receiver that you do not get as good results on the longer wavelengths as on the shorter ones. This is no fault of the construction of your set, but is inherent in the circuit. It simply does not amplify the long waves (low frequencies) as well as the short waves (high frequencies).

If you tried to make the set more sensitive on the long waves, it would be too sensitive on the short ones and would run into the difficulty known as oscillation.

The highest point of sensitivity is just below this point of oscillation. Obviously, the ideal arrangement for maximum efficiency at all broadcast wavelengths would be some sort of purely automatic control which would maintain the receiver at its highest point of sensitivity, but always just below the oscillation point, irrespective of frequencies.

Opposite Effects Utilized

Many engineers for years have been trying to do this, but the best they had been able to do, until the Loftin-White circuit appeared, was to compromise, sacrificing sensitivity and volume on the longer waves in order to prevent oscillation on the shorter ones. Coils and condensers and many combinations of the two have been used in attempts to stabilize the circuits.

Then Messrs. Loftin and White successfully concluded their investigations.

They, too, used coils and condensers, but in a way that took advantage of the natural characteristics of each.

It is true that coils and condensers vary in reactance (resistance to an alternating current) with changes of frequency, but they vary in opposite directions. The resistance of a coil decreases as the wavelength increases, or frequency decreases, while the resistance of a condenser increases and vice versa.

A Graphic Analogy

Figs. 1 and 2 clearly show by means of a water pipe analogy how a capacity and an inductance will react differently at different wavelengths. It can be seen from these diagrams that at the higher wavelengths the current will predominate in the inductive leg (through the coil) of the circuit while at the lower wavelengths the current will be greater in the capacity leg (through the condenser). Obviously, the combination of both a capacity and an inductance must be used to allow free passage to the energy—or water—at all wavelengths, high, low, and intermediate, without variation of volume.

Figs. 3 and 4 illustrates with simple charts how the energy transferred by a coil, or, as it is called technically, an inductively coupled circuit, increases as the frequency is increased. Figs. 5 and 6 show how the energy transferred by a condenser, or technically, a capacitive coupling, decreases as the frequency is increased, being highest at the lower wavelengths.

(Continued on page 17)

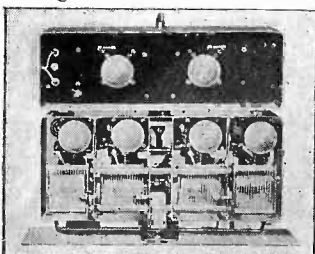

FIG. 12

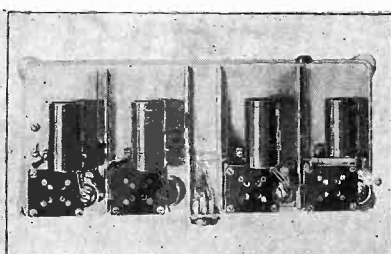

FIG. 13

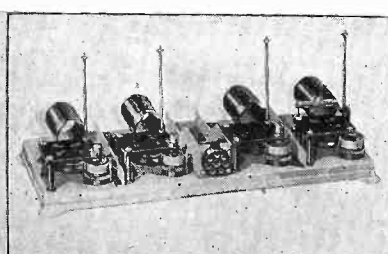

FIG. 14

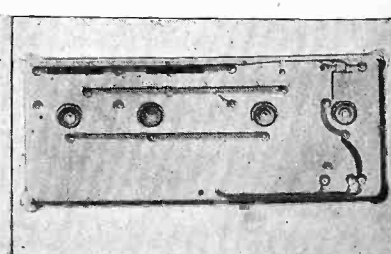
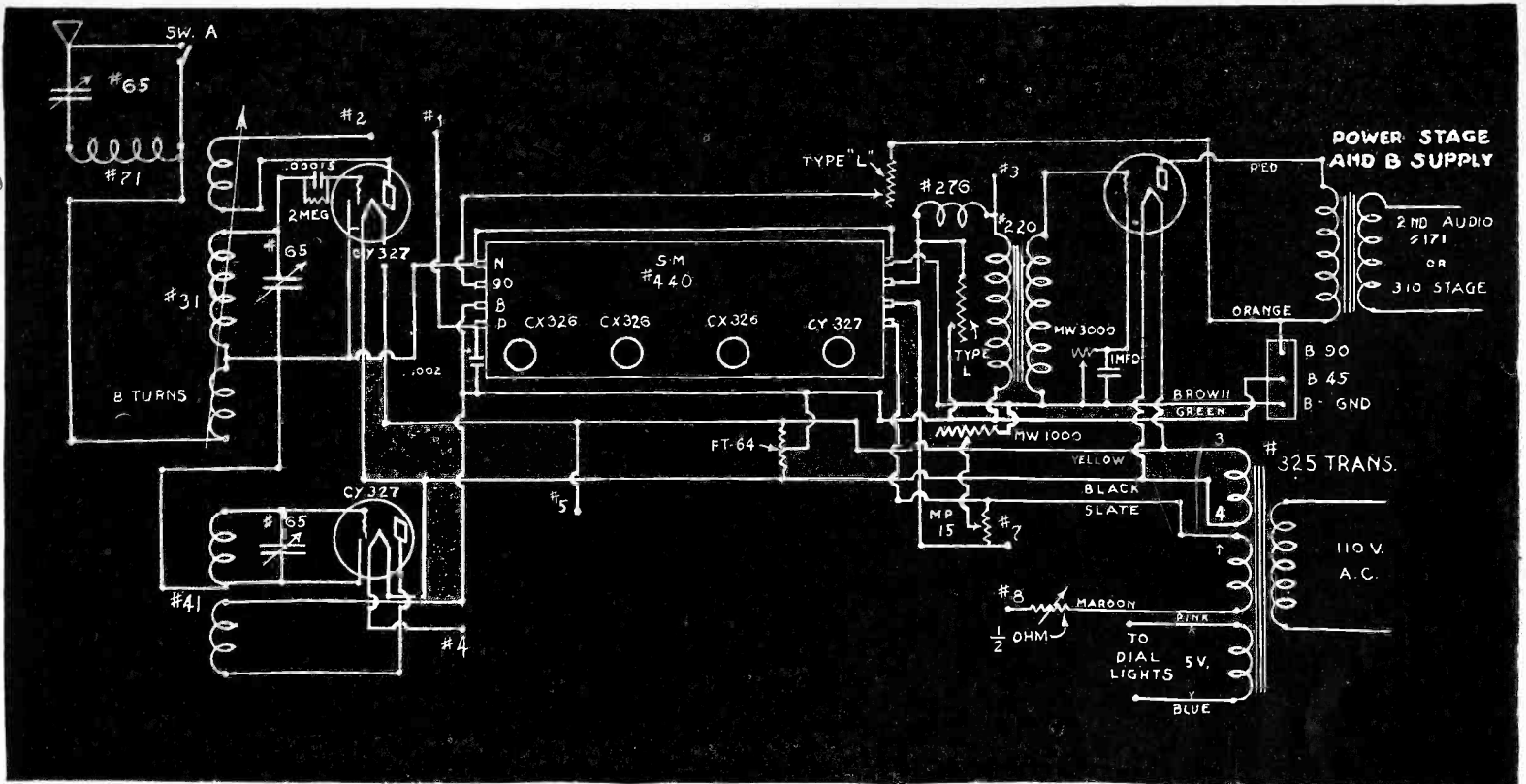

FIG. 15

The Adams 1-2-3

More Than a Mere Companionate Marriage Of Theoretical Considerations and Laboratory Tests



THE SCHEMATIC WIRING OF THE ADAMS 1-2-3, AN AC OPERATED SUPER-HETERODYNE, IS SHOWN, EXCEPT FOR THE INTERMEDIATE FREQUENCY AMPLIFIER. AS THIS IS THE FACTORY-CONSTRUCTED JEWELERS TIME SIGNAL AMPLIFIER, THIS CHANNEL IS SHOWN PICTORIALY. THE RECEIVER IS EXTREMELY SENSITIVE.

By Dana Adams

A FEW short years have seen a rapid development of the various phases of broadcast receiver design that have worked wonders in appearance and operation. The constant efforts of laboratory workers have steadily raised the standards of comparison by which a receiver is judged to a point that is nearly ideal. Not in the sense that further improvements will not appear—they are inevitable—but rather as applied to the theoretical and practical knowledge of the radio art available at present. With the inclusion of light socket operation, radio's latest innovation, and a thoughtful application of the advanced principles of modern radio practice, the construction of a receiver that is highly satisfactory from every standpoint is no longer a dream of the future. The fundamental principles that underlie receiver construction have been advanced to a level that precludes the possibility of the hopeless antiquation of a receiver that is truly modern.

Quite a Set

The design of such a receiver must necessarily include the principles of construction and operation that the advanced set builder looks for at the peak of their individual development. These include appearance, quality of reproduction, selectivity, sensitivity, ease of control, and electric operation, and they have been

given careful consideration in the design of the Adams 1-2-3.

The application of these principles to the receiver, together with the introduction of the several novel ideas, will doubtless enable the reader to suit his greatest needs. Its approach to the ideal of present day standards may be readily determined.

The appearance of the receiver is best illustrated by the photographs. The panel of grained walnut bakelite is gold engraved,

The standard panel size permits the use of a number of stock table cabinets or consoles from which a selection may be made.

The new Marco controls symmetrically arranged with the black knobs of the minor controls in relief against the brown background combine to make an outward appearance that delights even the highest aesthetic tastes.

Inside we find the apparatus well spaced and the cable system of wiring in force to insure best results. A wooden baseboard, well shellaced, is used as this affords the quickest and simplest method of assembly and wiring, at the same time being less expensive than other types. The fact that only one audio transformer is in evidence necessarily brings the second point to the reader's attention, quality of reproduction.

Ever since the time when a headphone

and a purloined phonograph horn were standard loudspeaker equipment, the improvement of reproduction has occupied a central place in the minds of engineers. While we find champions for every form of audio amplification, indicative of a wide variation of opinion of what is good music, the use of a power tube and a high B voltage in the last audio stage is recognized by all as essential.

Recommends Push-Pull

The push-pull system unquestionably provides the greatest amount of undistorted output, as it cancels out the tube harmonics generated at high output levels. The introduction of high grade transformers of the push-pull type to the market this season is a great step forward.

The marvelous quality of the public address systems as demonstrated at radio shows and other gatherings is now within the reach of everyone.

While the writer strongly recommends the use of such a power stage the 1-2-3 is readily adaptable to any power pack without changes in the design and wiring of the receiver itself.

Referring to the circuit diagram it will be noted that the plate of the first audio tube is included in the cable. By connecting this lead to one input terminal and the other to 90 volts from the power supply any modern pack may quickly be placed in operation. (See next page)

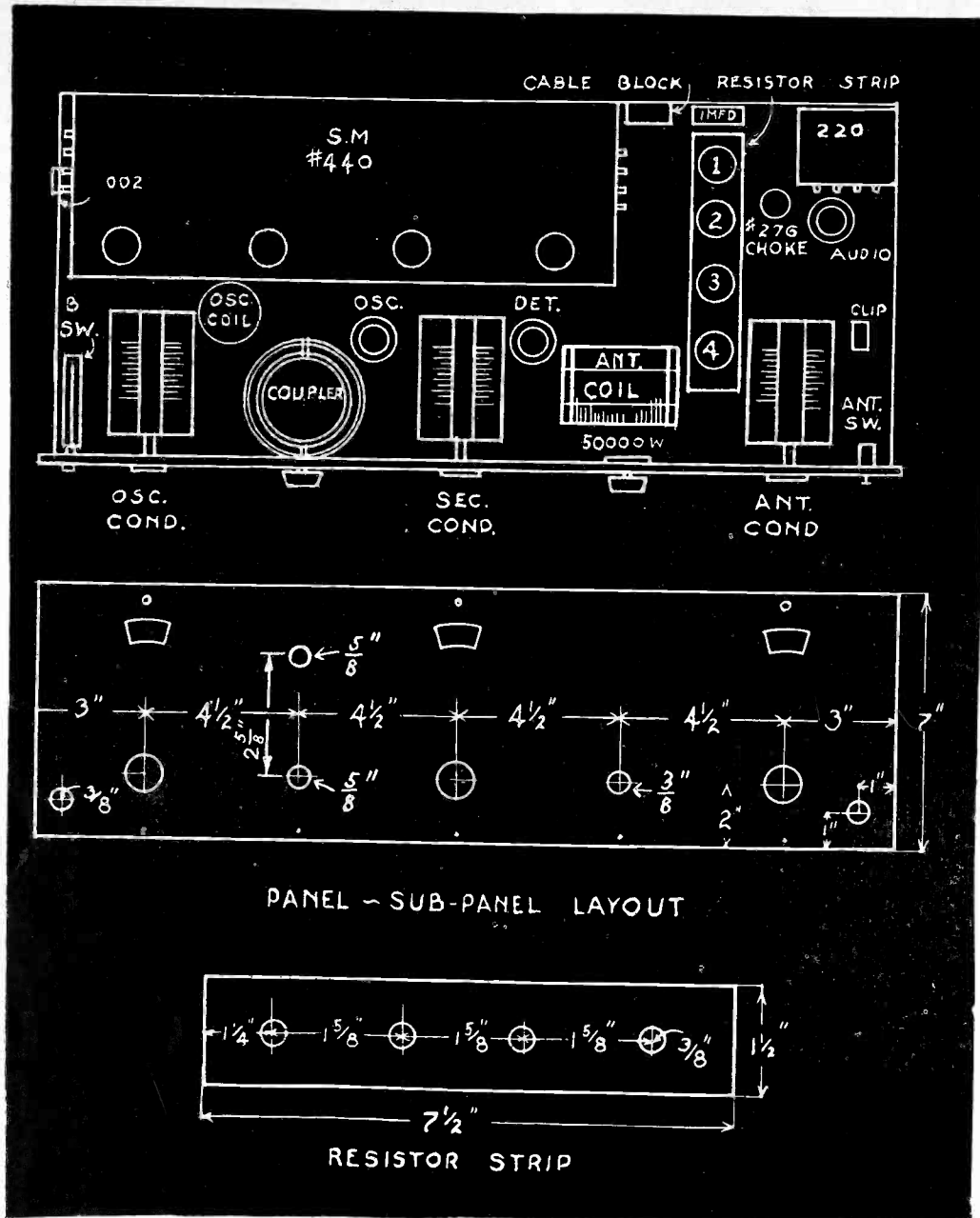

SUBPANEL, FRONT PANEL AND RESISTOR STRIP DETAILS.

(Continued from preceding page)

For best result the power supply should be obtained from a full wave rectifier that is well filtered. The use of a glow or voltage regulator tube is also recommended, as this keeps the voltage supplied to the receiver at a constant value. The Silver Marshall Unipacs meet these requirements in excellent fashion. Of course the fan that already has a pack may readily adapt it to the receiver, providing taps at 45 and 90 volts are brought out to supply the receiver.

The amount of undistorted output desired is the only consideration in selecting the power pack, assuming the audio transformers to be of excellent characteristics. Push-pull 171 tubes are slightly better than a single 210 and seems to make a more popular combination. Push-pull 210 tubes in the last stage accommodate tremendous volumes without distortion, while push-pull 250 tubes provide a remote extreme.

Selects the Super-Heterodyne

Selectivity, sensitivity, and ease of control are of the utmost importance in obtaining quick, positive reception of both local and distant programs. The methods employed get them at their very best and may be easily followed.

It is generally agreed that the Super-Heterodyne, when properly designed, is head and shoulders above tuned radio frequency systems when tremendous sensitivity and razor edge tuning are desired. The use of the Super-Heterodyne princi-

ple is also responsible for the new and remarkably simple system of control from which the receiver derives its name.

Instead of the conventional fixed number of controls, all of which are necessary for local, distant and coast to coast reception, a method radically different is employed.

For a time the trend was toward one dial reception, but the losses due to the variation in the first tuned circuit caused by the antenna and the practical impossibility of getting three perfectly matched condensers, has caused a return by home constructors and custom set builders to two controls in the better class of receivers. The use of one tuning condenser and consequently one dial with one volume control unquestionably provides the simplest means of bringing in local programs. Is it not logical to add another tuning control, providing additional selectivity and sensitivity for distant reception, with a third control available for trans-continental reception or similar extremely weak signals? This system of optional one, two, or three controls, providing a receiver satisfactory to the child or the expert DX fan, has been efficiently adapted to the Super-Heterodyne.

The manner in which this is accomplished may easily be followed.

With the single pole switch in the antenna circuit closed, the circuit will be recognized as the conventional aperiodic type. With the switch open, the condenser and tuning coil are brought into play, the values of capacity and induc-

LIST OF PARTS

- Three Samson No. 65 .0005 Condensers.
- One Samson No. 31 Coupler.
- One Samson No. 71 Antenna Coil.
- One Samson No. 41 Oscillator Coil.
- Three Marco No. 421 Illuminated Controls.
- One S-M No. 440 Time Amplifier.
- One S-M No. 220 Audio Transformer.
- One S-M No. 276 Choke Coil.
- Three S-M No. 512 Tube Sockets.
- One Yaxley No. 10 Antenna Switch.
- One Yarley No. 63 Triple Pole Switch.
- One Carter MW3M 3,000 ohm Potentiometer.
- One Carter MW1M 1,000 ohm Potentiometer.
- One Carter MP20 20 ohm Potentiometer.
- One Carter Cathode Adapter.
- One Carter .00015 Grid Condenser with Clips.
- One Carter Type L 50,000 ohm Hi. Ohm.
- One Carter .0002 Condenser.
- One Carter No. 210 1MFD By Pass Condenser.
- One Jones No. BM 410 Ten Wire Cable.
- One Cortlandt Panel 7 x 24 3-16 inches drilled and engraved.
- One Resistor Mounting Strip 1 1/2 x 7 1/2 x 3-16 inches drilled.
- One Base board 10x23x 1/2 inches plywood preferred.
- One Lynch 2 megohm Leak.
- Two Rolls Braidite Wire, 2 colors.
- One Fahnstock Clip and assorted screws.
- One Carter 1/2 ohm rheostat.
- One Frost FT64 resistor.

ADDITIONAL EQUIPMENT

- Four CY27.
- Three CX26.
- One S-M 325 filament transformers.
- One S-M 210 Power Pack or
- One S-M 171 Power Pack or
- One Fritts Cabinet 7x24x12 inches.

tance being such that the antenna may be tuned to any of the broadcast wavelengths. Thus the antenna may be tuned to the desired station in exactly the same manner as the grid circuit of a tube is tuned.

Big Gain

The gain in amplification of a tuned radio frequency stage over that obtained with an untuned stage is well known. The advantage of a tuned antenna over one of the aperiodic type is even greater, as it provides an increase in signal strength when it is needed most. An increase in selectivity is also obtained. The reactance of the antenna to the frequency to which it is tuned is greatly decreased, permitting a greater flow of energy, yet the reactance is considerably increased at all other and undesired frequencies, thus preventing forms of interference that would be encountered in an aperiodic antenna.

Measurements in the laboratory prove this gain in sensitivity and selectivity to be equal to that of one radio frequency stage.

Another control, with the gain in efficiency obtained by its use, may be cut in or out of the circuit without disturbing or affecting the operation of the remainder of the receiver.

The tuning or loading coil in the antenna circuit is placed at right angles to the double rotor coupler used in the detector circuit to avoid coupling between them. Variable antenna coupling is provided by one of these rotor coils. The use of the variable coupling is responsible for additional selectivity, as a reduction of coupling decreases the resistance effect introduced to the grid circuit by the antenna. The other rotor is employed as a tickler, enabling the operator to bring the detector to the point of greatest efficiency, just under the oscillation point.

The output or plate circuit of this highly efficient detector may be transferred to either the input of the audio or the intermediate amplifier. This is accomplished by means of three springs of a triple pole double throw switch. The seven numbered wires in the diagram connect to the switch, which was eliminated from the diagram to avoid confusion. When the detector plate is connected to the audio amplifier only the detector and audio tubes are lit. The result is a one-dial receiver for locals, consisting of a regenerative detector and a high grade audio amplifier. A turn of the antenna switch will bring the antenna tuning into action if additional sensitivity and selectivity are desired. Reception of the more powerful distant stations within a 1,000-mile radius may be expected with this combination.

With a change in position of the switch, the oscillator and intermediate amplifier tubes are lit and the first detector plate returned to the normal position in the circuit.

Novel Mixer

In the mixer circuit the design again departs from the ordinary in that no coupling coil between the oscillator and detector circuits is employed. Coupling is effected by a direct transfer of energy between the two coils, the large field of the oscillator permitting a greater spacing than is possible when a coupling coil is used. This eliminates the losses introduced by a coil tightly coupled to the detector grid circuit and decreases resistance and capacity to ground. The oscillator circuit is the familiar modified Hartley, the grounded rotor plates of the condenser insuring a complete absence of hand capacity while tuning.

Many readers will doubtless recognize the Jewelers' Time Signal Amplifier which is used as an intermediate amplifier unit. The high amplification and sharp cutoff of its three accurately tuned stages are sufficient in themselves to make a place for this remarkable device in the receiver. The further advantages of only eight connections, a C bias type second detector, and a perfect adaptability to electric operation insure it success. The frequency of amplification, 112 kc., keeps the first detector and intermediate frequencies apart, so that repeat points, commonly but erroneously termed harmonics, are conspicuous because of their complete absence.

Best Quality

After amplification and detection in the Time Signal Amplifier the radio frequency component in the detector circuit is by-passed to ground by means of a condenser included in the amplifier and by the radio frequency choke. This action insures a pure audio component passing through the primary winding of the audio transformer with the best quality the result. The output of the audio stage incorporated in the receiver is then fed to the power stage, as previously related. Three B supply wires and four filament and two dial light supply wires, also are included in the cable running to the power units. Removal of the cable from the receiver disconnects everything from it with the exception of the antenna, which is run in independently to a Fahnestock clip.

As the alternating current tubes were available for experimental purposes at the same time development of the 1-2-3 was started, they were incorporated in the circuit at the start rather than as a tentative conversion from a battery operated circuit. The deciding factor in their success is the length of life obtainable. Their hearty endorsement by the largest manufacturers in radio, after lengthy laboratory life tests, and the ever-increasing number of such tubes in use, is the best possible answer to this important question.

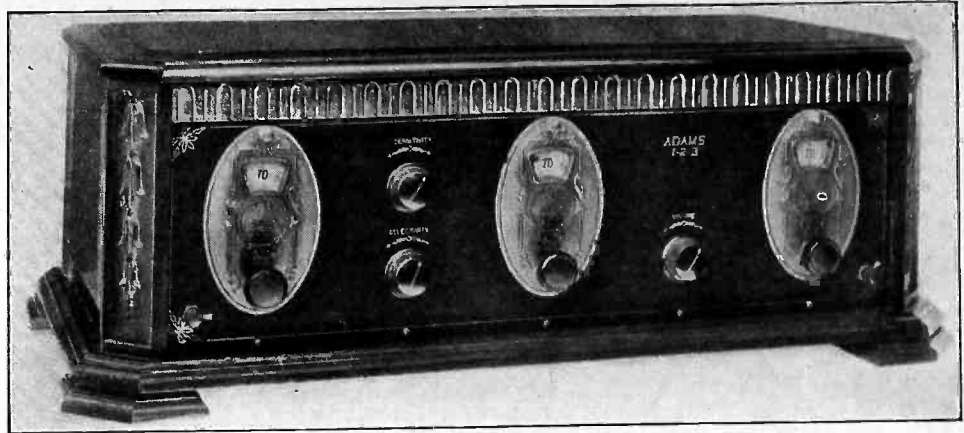

REGAL MAGNIFICENCE IS WHAT THE FINISHED PRODUCT SHOWERS GLORIOUSLY UPON THE STAR-EYED OBSERVER.

The cathode type tube is provided with an emitting element or cathode that not only gives a constant stream of electrons but is also free from connection to the source of current supply. With the grid return and the cathode connected to B minus it is possible to use the tube as a detector first, because the electronic emission is uniform, and second, because the grid is at a zero potential from an AC viewpoint. Such is not the case with the -26 type tube, for there the grid swings three-quarters of a volt on each cycle.

These important points necessitate the use of cathode tubes in the first detector and oscillator. This is true, because any hum in the mixer circuit would modulate on the "beat frequency" and be tremendously amplified in the intermediate stages.

The grid swing of the -26 tube, while preventing its use as a detector or oscillator, is highly satisfactory for amplification. With a slight C bias the tendency to hum is completely eliminated. This bias is obtained by the B battery drop method used to bias the power tube in the modern power pack.

The 15 ohm potentiometer supplies the artificial mid-tap at the zero voltage point. The 1,000 ohm potentiometer used as a variable resistor supplies a variable C bias for these tubes. While the bias voltage tends to stabilize the amplifier, additional means of suppressing oscillation are furnished the 50,000 ohm resistor in series with the B supply and the half ohm rheostat in the filament circuit.

Use Adapter

The second detector is also of the cathode type, its use in a four prong base is made possible by an adapter. Two wires are brought out that connect to the filament terminals of the oscillator tube socket. The grid and plate of the tube make the proper connection through the adapter pins. The positive filament pin is a dummy, while the pin normally used for the negative filament is used to bring out the cathode.

As this pin connects the cathode to the filament supply of the -26 tubes, the bond from shield to the filament terminal of the tube socket is removed. A wire is then run from this filament post out of the shield to the cathode of the audio tube.

Cathode Tube in Audio

The audio stage also employs a cathode tube for several reasons. The first is that it insures humless reception. The second reason is that a different bias is required on the audio stage than is necessary on the -26 grids. Another advantage of the independent emitter of the cathode tube becomes apparent. As the cathode is a free agent the B current drawn by the -26 tubes will not affect the bias on the audio tube. With a common filament supply the bias would change every time the intermediate tubes were turned on or

off, assuming a resistor with two variable arms were practical.

The 3,000 ohm resistor furnishes the variable voltage necessary to bias the second detector and audio stage. As the detector draws less than a milliampere of plate current, its plate current does not change the bias on the audio tube to any appreciable extent.

The mid tap resistor across the heater circuit of the cathode tubes puts a large positive bias on the heater, the midpoint connecting to B45, eliminating any chance of picking up the voltage change in the heater or filament circuit.

The resistors just described may be quickly adjusted once the receiver is in operation and require no further attention. Details of construction and operation of the power pack are well taken care of in the manuals furnished with these kits. The adaptation to electric receivers requires no additional comment.

Recapitulation

To summarize the features of the receiver in a few lines before proceeding with the constructional data will doubtless be of assistance to the reader. An external appearance that will harmoniously blend into the most tasteful surroundings with a reproduction as nearly perfect as possible, the most advanced principle being employed, are the two features that are most apparent. While the DX range may be praised with good reason, the simple operation of a 1-2-3 is the most convincing proof of its superiority over the conventional receiver.

The novel method of tuning provided permits easy handling and the accurate logging of stations near or far with minimum effort.

Electric operation is incorporated as an integral part of the receiver rather than as an afterthought. The complete absence of hum precludes the necessity of describing means of eliminating the bane of the electric set.

And the construction is divided into four independent stages that may be individually tested, thus bringing a large receiver within the reach of the fan whose knowledge limits him to the smaller outfits when outside assistance is unobtainable.

The first of the constructional steps is that of the first detector and first audio stage, the second that of the power pack, if this unit is not purchased as a built-up unit.

The oscillator circuit is the third simple step and the wiring of the Time Signal Amplifier with its eight connections is the last.

Assuming these steps to be wired and tested according to the directions given, the builder will find that the usual laborious check of the receiver, necessary if any troubles arise, is completely averted. The trouble may be readily pinned down

(Continued on next page)

in one of the four simple constructional divisions.

With the specified parts at hand for the first step, which must include the panel drilled as detailed in the sketch, the panel is fastened to the baseboard by $\frac{3}{4}$ inch wood screws. The two Marco controls are next mounted in the middle and right hand positions for the detector and antenna tuning.

The condensers are next in order. An effective method of mounting them is as follows. The slotted bars furnished with the controls are removed and a one-inch 6-32 machine screw is slipped through the slot in the dial frame. The three collars furnished with each dial are slipped over the screws, forming a long bushing. The condensers are now put in position, the stator plate terminals being placed at the bottom. The screws are then threaded into the holes provided in the condenser frames and the assembly tightened.

The tube sockets, the two switches, the audio transformer, the antenna coil, the 1 mfd. by-pass condenser and the antenna clip should be mounted as shown in the sketch. The Frost resistor used across the heater should then be mounted on the filament terminals of the audio tube socket.

The resistor strip is mounted two inches above the baseboard by means of Z brackets which may be fashioned from strip brass.

The 3,000 ohm potentiometer is mounted in the position designated as number one.

The assembly is completed by removing all but eight turns from one of the rotors of the coupler and then mounting the coupler with the smaller or antenna rotor at the bottom.

Wiring the First Step

The wiring of this initial step requires nothing but a few general instructions because of its simplicity. Twisted pairs should be run from the cable block to supply the dial lights and heaters of the two tubes with current. This effectively eliminates hum from the low voltage used in these circuits. This wiring as well as all other A, B and C circuit wiring should follow the main cable as shown in the photograph as closely as possible.

The wiring of the detector plate circuit to the switch and the audio transformer, together with the wiring in the antenna circuit, should be formed in a loose cable close to the panel. The numbered wires which connect to the triple pole switch are connected to its correspondingly numbered terminals. The terminal numbers are obtained by counting from left to right looking at the switch from the rear. The remainder of the wiring may be easily traced from the diagram.

While this step may be tested immediately, assuming ninety volts of B battery or other B supply are available, this step together with the power pack may be more readily checked when operated in unison. Any of the modern packs may be easily assembled by following the instructions furnished with the kit.

A saving in time and possible difficulty may be effected by purchasing the pack as a wired and tested unit. If the pack selected employs a gaseous type of rectifier tube, one tenth mfd. condensers must be connected from the plate terminal of the tube socket to the filament terminals, no matter if these condensers are omitted from blue prints. This is necessary, as the extreme sensitivity of the 1-2-3 will reproduce the sparks inside the tube as a disagreeable power leak, although omission of such condensers may cause no trouble in the average receiver. The condensers provide an effective quietus.

Test of Two Units

The test of these two units is but the work of a few minutes. Connect the yellow and black wires of the cable to terminals three and four of the filament

transformer. The pink and blue wires that supply the dial lights are connected to the two lugs that furnish five volts. Connect the transformer to the line and the cable block to the receiver.

Then insert the tubes and turn the dial light switches to the "on" position and switch on the current. These two circuits may be easily traced for open circuits if trouble occurs.

Remember, it takes a few seconds for the tubes to glow and about a minute before they will function. While waiting for them to warm up connect the B minus and B plus leads of the cable to the proper pack. A wire is also run from B plus 90 to one of the input terminals of the last audio transformer and the red lead of the cable connected to the other. The antenna connects to the clip and the ground to B minus at the binding post on the pack.

Close the antenna switch and be sure the other switch is in the position connecting the detector plate to the audio transformer.

The rotation of the tickler should cause a sharp click in the speaker, indicating that the detector is oscillating. A check of the B voltage at the plates of the tubes and a readjustment of the bias resistor, which should be set at the half way mark for trial, generally will bring any trouble to light. If no sound is heard connect the speaker in place of the audio input to the power stage and test the two tubes individually. In this manner it is possible to trace the trouble to its source and make any necessary corrections or repairs.

Some Efficiency Data

With the antenna rotor at a 45 degree angle, the middle dial should be rotated to tune in a local station. If a squeal is picked up readjustment of the tickler will clear things up.

The C bias resistor on the first audio tube should now be adjusted for best quality together with the resistor of the power stage, if a variable bias is provided there. Any appreciable hum may be attributed to excessive brilliancy of the cathode tubes. This condition may be easily corrected by inserting a few inches of rather fine wire in series with the low voltage AC feed. The wire removed from the antenna rotor is just right for the job. Best results with a long life are obtained with the tubes at a dull rather than a brilliant red.

With these adjustments taken care of the builder should thoroughly familiarize himself with this portion of the receiver from an operating viewpoint. Satisfactory reception of far distant stations is almost entirely dependent on how efficiently weak signals are accepted in the antenna and detector circuits of the Super Heterodyne. The fan who tunes in the more powerful distant stations within 1,000 mile radius, and a little practice makes it easy, may be assured that the range may be increased two or three times when the more sensitive receiver is employed. The only rule in tuning to keep in mind is that the antenna coupling should be kept as near to the zero point as possible, a slight readjustment of the dials being necessary when the coupling is changed.

While local stations may be brought in easily with the one dial, surprising results may be obtained, considering the number of tubes in use, when the antenna tuning feature is cut in.

The Next Assembly-Wiring Step

With two of the stages completed the oscillator assembly and wiring are next in order. The dial and tuning condenser are mounted in the same manner as detailed previously. Eight turns are removed from the outside end of the large or grid winding so that the dial setting will match that of the detector. The wire removed from this coil should be added

to the plate winding to insure sufficient feedback. With these changes made the coil should be mounted three-eighths of an inch from the coupler. The placement of the tube socket completes the assembly.

The dial light should be connected in parallel with the detector light by a twisted pair as shown. One side of the oscillator heater circuit goes through contacts 4 and 5 of the switch. The heater wiring should be picked up at the detector heater terminals. The grid, plate and B supply wiring may be easily traced from the diagram.

It is very important, however, that grid and plate connect to the outside ends of their respective coils, otherwise the tube will not oscillate. The circuit is tested in a few moments.

The set is turned on and a low wave station is tuned in. The switch contacts 4 and 5 which are open in this position are temporarily short circuited. After allowing time for the tube to warm up the dial should be rotated. A loud squeal beating with the incoming signal indicates correct functioning of the oscillator. In this test the two dial settings will not match. They will, however, when the two circuits are tuned 112 kc. apart, as they are when the Super-Heterodyne is in use. An open circuit or a defective tube are the only troubles that may arise if the wiring instructions have been followed.

Do not forget to remove the temporary short across the switch before going ahead with the final step.

The Time Signal Amplifier

The remaining construction stages, that of the intermediate amplifier, is greatly simplified by the use of the Time Signal Amplifier.

Its eight connections minimize the chances of mistake in this the heart of the super heterodyne to a new low level. The assembly is soon completed by mounting the time amplifier, then the 50,000 ohm resistor on the panel, the radio frequency choke and the three remaining resistors in the order named. The 1,000 ohm potentiometer in number 2 position, the 15 ohm potentiometer in the third place, and the remaining type L resistor in the fourth position, complete this part of the work.

The wiring, with the exception of the adapter for the second detector, is clearly illustrated in the diagram. The only precaution to take is to twist the filament supply leads and keep all wiring in the main cable as far apart as possible. The two flexible leads from the adapter are connected to the filament terminals of the oscillator tube socket. The bond to shield on the socket in the shield is removed and a wire run out to the cathode of the audio tube socket. With these simple connections the adapter may be inserted in the tube socket and the three 26 tubes and the remaining cathode tube put in place.

Another Test

To test this last step the B plus 90 cable wire is connected to the proper post on the pack in addition to the lead to the audio amplifier input.

The filament supply leads connect to terminals one and two of the filament transformer, the half ohm rheostat being connected in series with either one of these leads. The resistance should be cut out at first, allowing the tubes to burn at full brilliancy.

The 1,000 ohm resistor is set a quarter turn from the zero point, as is the 50,000 ohm series B resistor.

The 15 ohm potentiometer arm is set at the midpoint of the resistance and all the resistance of the shunt resistor on the panel is cut in to allow full volume. With these preliminary adjustments the power should next be turned on.

(Concluded on next page)

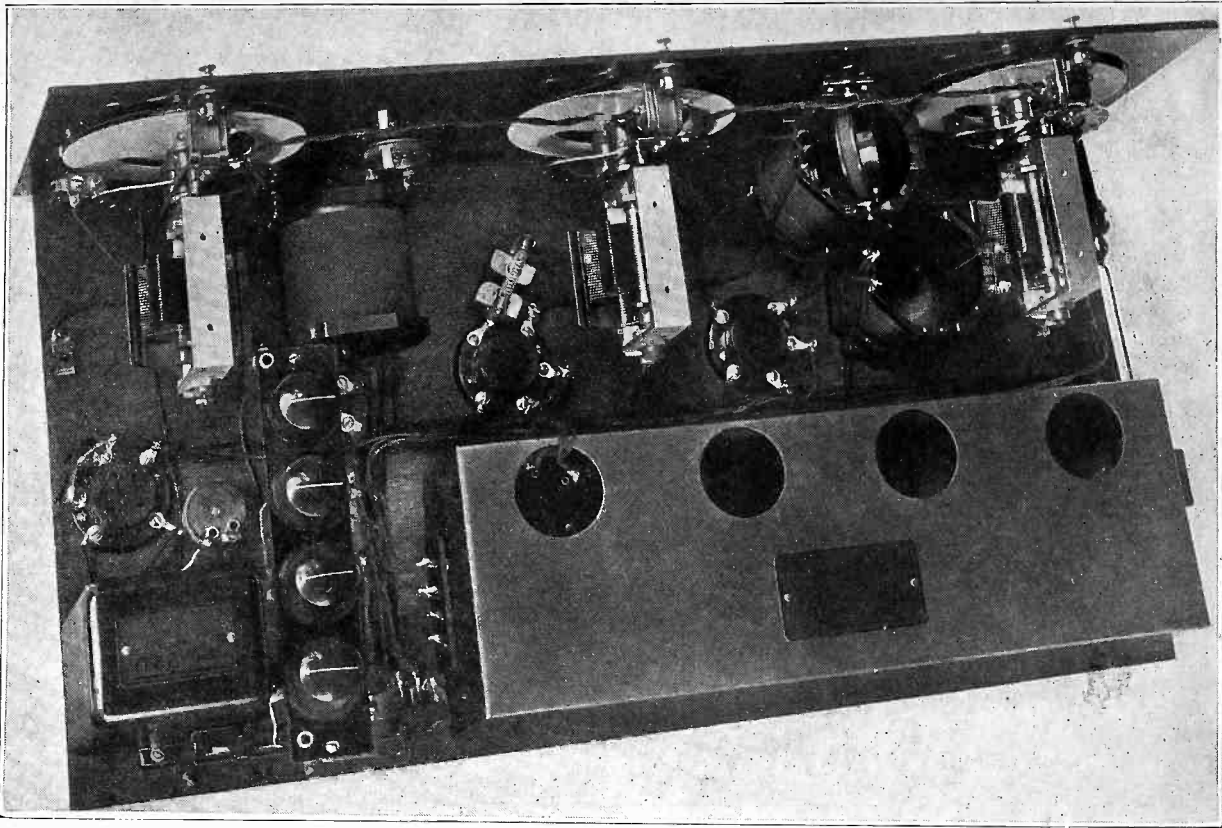

AN INTIMATE VIEW OF THE ADAMS 1-2-3 AC SUPER-HETERODYNE SHOWS HOW WELL THE PARTS ARE DISPOSED. THIS IS A PHOTOGRAPH OF THE AUTHOR'S PERSONAL RECEIVER.

After allowing the tubes to warm up set the detector dial for some local station and vary the oscillator dial around a corresponding setting. A signal of tremendous strength is the reward of careful adherence to the constructional data given on this last easy step. No response is a sure sign of trouble in the wiring of the Time Signal Amplifier, which should be easily corrected, or a faulty unit, which is very unlikely.

After tuning in a few locals to get the "feel" of the receiver a distant station should be tuned in. It is entirely possible that squeals have been noticed when tuning in locals when the oscillator dial is varied slightly. This indicates oscillation in the intermediate stages which may be readily corrected by reducing the filament voltage on the intermediate amplifier tubes.

Well Tried and Tested

The disappearance of such a squeal will enable the operator to tune in the weak stations without trouble.

Of course the 1,000 ohm and 50,000 ohm resistors controlling C and B supply to these tubes should be carefully readjusted for best results on a weak station and the filament voltage advanced so that the amplifier is in its most sensitive and selective position at all times. By means of the variable antenna coupling and the audio input resistor perfect control of the volume may be secured of both strong and weak signals.

The 1-2-3 as presented to the far flung family of RADIO WORLD readers is not a product which practical usage will subject to changes in design. But rather it is a time tested receiver, the result of the combination of theoretical principles and the experiences of a number of builders who have already completed the receiver. These fans, scattered in all parts of New York City, have not only furnished an interesting collection of data on results in most freakish of radio locations, but also by their questions and experiences enabled the writer to eliminate the kinks that ordinarily arise between the laboratory bench and the kitchen table.

Some Don'ts

A few of the don'ts, the results of actual

experience in a number of cases, will enable the builder to obtain perfect operation at once. Do not include an electric switch in the receiver as it will pick up an induction hum from the relatively high voltage. Provide a convenient switch alongside the receiver or turn it off at the socket.

Keep the power supply apparatus at least two feet from the receiver, further away, if convenient. On no account attempt to build the power pack into the receiver as it is not possible completely to shield the power supply due to the heat of the tubes.

And remember in tuning to keep the antenna coupling as loose as possible at all times for the best results.

While an entire story could be written on the results obtained in all parts of New York City, a general average of the range will enable the reader to see

that the theoretical principles of design worked out admirably in practice. Daylight reception of stations within a 150-mile radius with full loudspeaker volume is commonplace. In the better suburban locations Toronto, Cincinnati, Pittsburgh and like stations are often brought in during the early afternoon. With over twenty of the 95 broadcasting channels in use by local stations, fifty or more distant stations are available on an average within a 1,500 mile radius before midnight. With the Super Heterodyne and the antenna tuning feature a number of owners in the better locations bring in one or more West Coast stations under favorable weather conditions. These results, obtained by a number of fans rather than by one or two individuals, constitute to the writer's mind, a far better proof than any elaborate eulogy of his own on the desirability of the receiver.

MUST GET THEIRS AND THEY DO

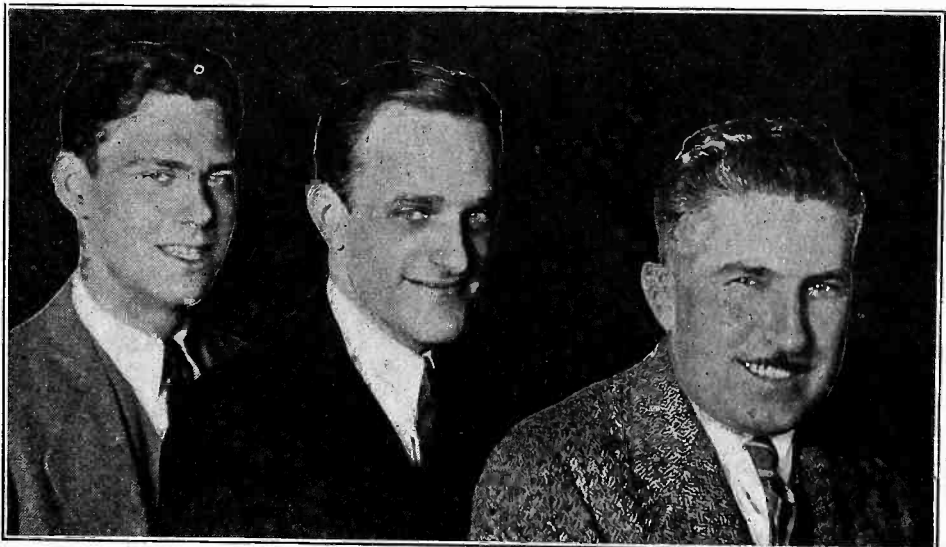

THE MELODY MUSKETEERS, HANSEN, HOWARD AND BRENNAN, VOCALISTS AND COMEDIANS, HEARD IN A PROGRAM BROADCAST BY THE NATIONAL BROADCASTING COMPANY THROUGH WJZ.

NEW AERIAL UP IN NINE HOURS

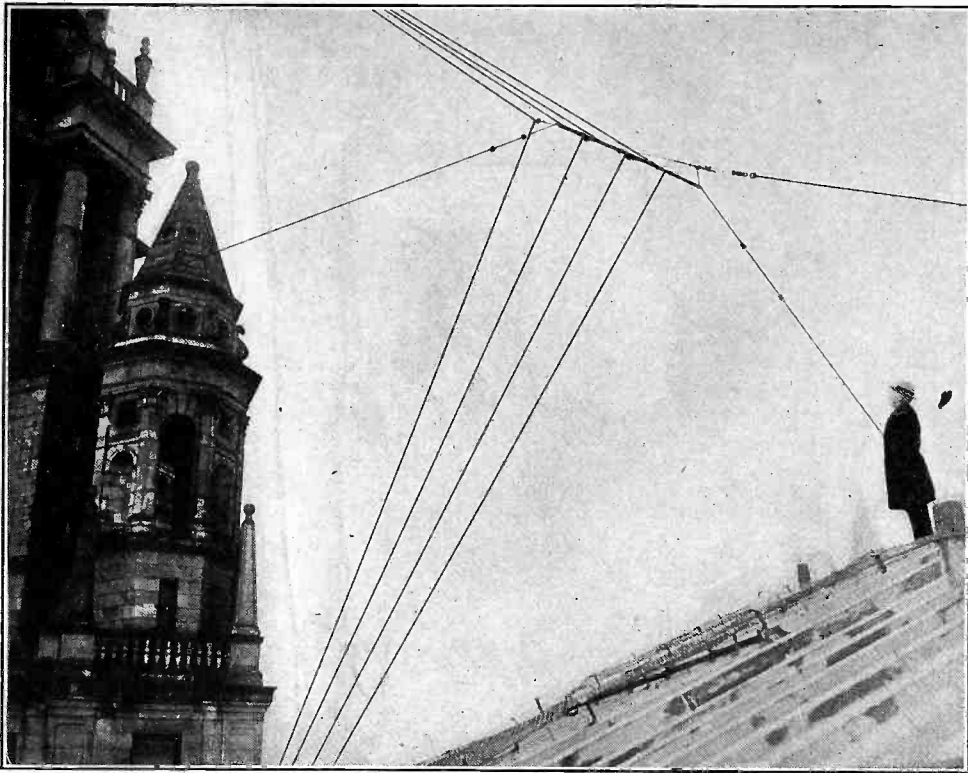

(Metropolitan Photo Service)

IT TOOK ONLY NINE HOURS TO REPLACE THE OLD-FASHIONED ANTENNA OF WNYC WITH AN UP-TO-DATE ONE. ISAAC BRIMBERG, THE STATION'S ENGINEER, IS SHOWN LOOKING OVER THE NEW AERIAL, WHICH HAS RESULTED IN BETTER TRANSMISSION. WNYC IS THE MUNICIPAL STATION IN NEW YORK CITY, ATOP THE MUNICIPAL BUILDING (RIGHT).

Concertrola produces such tremendous volume.

Notice that this is the first public appearance of a net with *controlable* super regeneration. Notice also on the diagram that the detector tube employs the grid condenser-gridleak method *in addition* to the C battery method of detection. This is new. The Yaxley No. 64 switch, and the method of connecting it into the electrical circuit is also new.

Some Expert Tips

The double resistances in the filament of the detector tube, and the potentiometer placed near the *first* tube are things you have doubtless never before read about. Why are these things so? Because the detector tube is the cause of *all trouble* in an electric set—except "hum," which is sometimes caused by the first radio frequency tube. The 75 or 100 ohm Carter potentiometer connected close to the first tube does away with ALL hum.

The Concertrola is one set that is properly connected with the house wiring circuit. Examine the Yaxley switch and notice that BOTH LEGS of the AC line are broken, when the switch is in the "off" position. After you have perused hundreds of other circuits you will agree that this feature is new with the Concertrola.

Perhaps you wonder if it is necessary to break both legs of the AC line? Well, if you ever do have a small fire in your electric receiver the chances are a hundred to one that it will be caused by the line short-circuiting in the set—through the aerial or ground side and the "live" leg of the line, which the single switching method does not cut-out.

This fire will doubtless be centered around the aerial coil.

Switch Explained

It can be caused by having your neighbor's aerial touch your aerial, upon the roof; it can also happen through a defective lighting arrester. Don't you see, the single switch on one side of the line only, merely cuts out or disconnects that side of the line. The other side of the line is alive and coming into your set through the B eliminator—not through the ground where you, foxily, have inserted a fixed condenser! But all this is avoided in the Concertrola because *both legs* of the house current are turned off with a single throw of the switch.

Fenway's Concertrola Makes Hit with Fans

The Concertrola, designed by Leo Fenway, noted radio engineer, and president of Leo Fenway for DX! Inc., has created a big impression on home constructors and custom set builders, because in its performance it has more than made good the claims made for it by Mr. Fenway. His illustrious series of constructional articles was published in the November 5, 12, 19 and 26 issues of RADIO WORLD, and also he described the circuit in battery model as well as AC operated.

In using AC tubes Mr. Fenway has found the fine way, and his design is recognized as outstanding. The receiver gets distance aplenty, has all the selectivity you need and then some, and gives great satisfaction.

A special feature is the construction on a "Mack truck" model chassis. This expression is Mr. Fenway's own and it describes well the solidarity of the chassis, with its strong metal frame supporting and shielding the front panel. The subpanel is so sturdily bracketed that you can hardly budge it with all your weight, much less by mere pressure of tube insertion. Mr. Fenway has some special information for RADIO WORLD readers, and all who desire to receive it without any obligation may address him as follows: Mr. Leo Fenway, 831 Eighth Avenue, N. Y. City.

Here are some of Mr. Fenway's remarks concerning his circuit:

You hear much talk about this set and that set being capable of getting DX stations. Did you ever hear of a set that couldn't get distance? Neither did I! There's talk going around about a set being capable of separating two or more stations. Does anyone believe that in de-

signing a set these days a man can possibly sign his name to an outfit that is not selective?

The next thing in the diagram that stands out is the fact that regeneration is on the detector tube, in addition to the radio frequency stage. *Double regeneration!* Exactly. That is why the

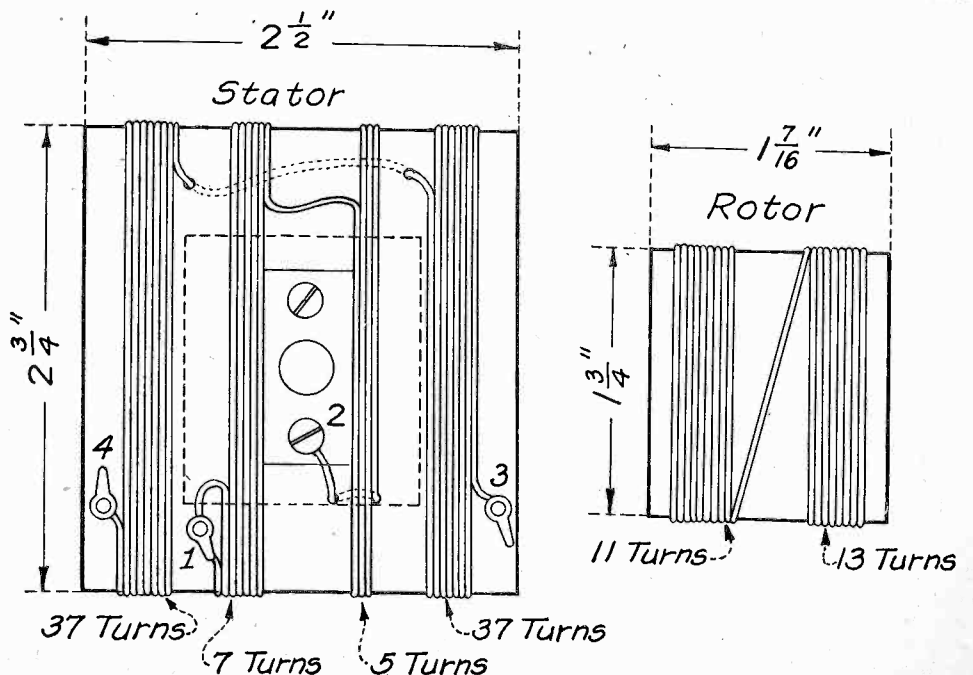

HOW TO WIND COILS FOR THE CONCERTROLA

Radio University

A FREE Question and Answer Department conducted by RADIO WORLD for its yearly subscribers only by its staff of Experts. Address Radio University, RADIO WORLD, 145 West 45th St., New York City.

When writing for information give your Radio University subscription number.

WILL YOU please tell me if it is possible to use —99 type tubes in either the 4 or 5-tube model Diamond of the Air?

(2)—If they can be used, what changes are necessary?

(3)—Can an indoor antenna be used with success?

(4)—Can I build the set on a baseboard, instead of the subpanel?

(5)—I have a couple of aluminum shields. Could I place the radio-frequency coil and variable condenser in one shield, and the tuner and variable condenser in another shield? To get the tuner in the same can with the conden-

The circuit diagram of such a receiver is shown in Fig. 595. The tuned radio transformer is used in the input circuit, the variable primary being inserted in series with the antenna. To prevent oscillation, a 400 ohm grid resistor GS is inserted in series with the grid of the tube. The three-circuit tuner is used in the detector circuit. Across the secondaries of both these coils, the .0005 mfd. variable condensers are shunted. In series with the negative leg of the radio frequency tube, a 20 ohm rheostat is used. The filament of the detector tube is controlled by a ¼ ampere ballast. The fila-

the grid of the last audio tube, use a 10-½ volt C battery, at 157½ volts B. The detector and first and second audio tubes receive 135 volts B.

I HAVE a 4-tube set. The detector is non-regenerative, and the radio frequency stage is tuned. Two transformer coupled audio stages are used. A 4½ volt A battery is used to supply the filament voltage to —99 type tubes and one —120 which is use 22½ volts. The radio frequency control a single 10 ohm rheostat is used. On the detector and first audio plate, I use 22½ volts. The radio frequency plate gets 90 volts, while the last audio plate gets 135 volts. Now the set works fairly well, but I thought I could improve it by adding another stage of radio frequency. I just used a 1 megohm resistor in the input circuit, instead of a transformer. But instead of improving the set, the strength of the signals was lowered. What could have happened? I

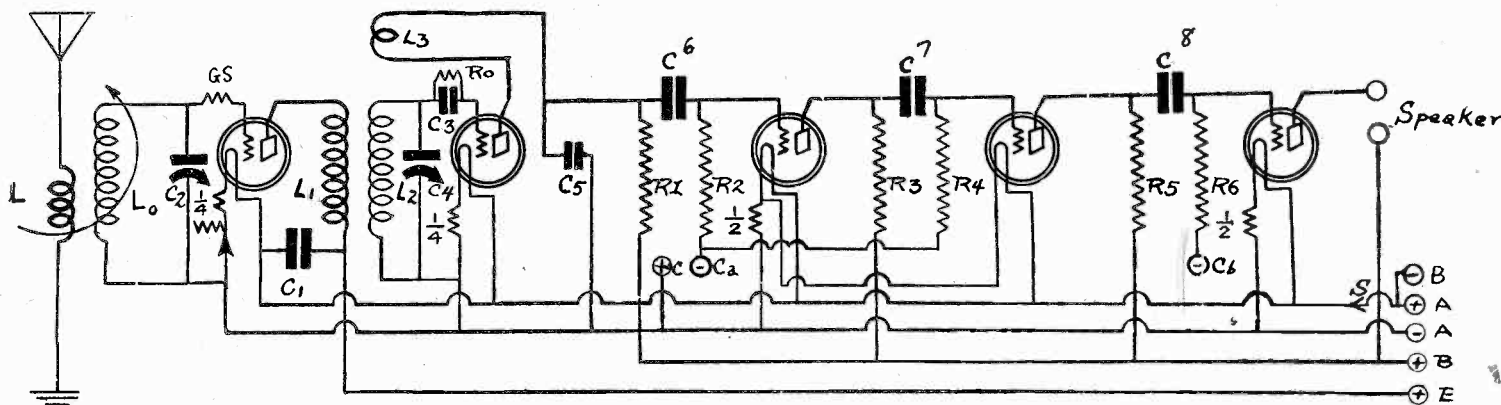

FIG. 595
THE CIRCUIT DIAGRAM OF THE FIVE TUBE RECEIVER REQUESTED BY RANDOLPH PHILLIPSON.

ser, I was thinking of placing the tuner in back of the condenser and communicating with the tickler by means of a long piece of cylindrical hard rubber. I would place coil a bit to the side of the condenser so that when the plates are entirely out of mesh, they would not strike the rod. Is this system all right?—**GEORGE REDDEY**, Detroit, Mich.

(1)—You can use the —99 tubes, but the signals will not be as loud as when the —01A tubes are used.

(2)—No changes are necessary if the —99's are to be used in the 4-tube model. When using them in the five tube model, it will be necessary to use 199 4-V Amperites in the filament circuits of each of the tubes. The same grid returns prevail.

(3)—Yes, provided the antenna has a length of at least 30 feet in a straight run. Of course, the results will never compare to those obtained with an outdoor antenna.

(4)—Yes, this is a very good idea. Don't forget to ground the shields as well as the minus A. If you use condensers which have a metal shaft, then you will have to get a plus return on the detector tube, by running the grid leak from the G post of the socket to the plus A. Otherwise, you will have a minus return, due to the grounding of the shields, which will touch the condenser shaft, or some part of the condenser connected here. Be careful not to connect the plus A post to the condenser shaft in the detector circuit, since you will cause a short circuit.

* * *

I WISH to build a five-tube receiver, using a three-circuit tuner, a tuned radio frequency coil with a variable primary, two .0005 mfd. variable condensers and three stages of resistance coupled audio, using the —40 high mu tubes and a 112. Please show the circuit diagram of such a set, stating the constants of the resistors, bypass condensers, etc.—**RANDOLPH PHILLIPSON**, Cottonwood, Ala.

ments of the first and second audio tubes are controlled by a single ½ ampere ballast. For the last filament circuit, another ½ ampere ballast is employed. The grid leak has a resistance of 4 megohms, while the condenser has a capacity of .0001 mfd. Between the end of the primary winding of the tuner and the plus A post, we have a 1 mfd. fixed condenser. Between the tickler coil and the minus A, we have a .0005 mfd. fixed condenser. Now as to the audio circuit. The plate resistors all have a resistance of .25 megohm. The first grid resistor has a resistance of 2 megohms. The next grid resistor has a resistance of 1 megohm and the last resistor has a resistance of ½ megohm. The stopping condensers all have a capacity of .006 mfd. A 1½ volt C battery should be used for the grids of the first and second audio tubes. For

think that something could be done with this extra tube.—**EDWARD KING-HORN**, Washington, D. C.

Are you sure that your A battery was live enough to supply filament voltage to an extra tube? It is very possible that when this tube was added, the drain was so great, that none of the tube filaments were operated at their proper temperature. The resistance you shunted across the antenna and ground should have had a resistance of only 1000 ohms. You don't give the plate of your detector tube enough voltage. Increase it to 67½. Also use a 10 ohm rheostat in series with the filament of the new tube. Use Amperites in each of the other filament legs, as well as the last. The first audio tube should receive 90 volts at least, with a 4½ volt C bias. Check up on the contact between the tube prongs and socket terminals.

Join RADIO WORLD'S University Club

And Get Free Question and Answer Service for the Coming 52 Weeks
This Service for Yearly Subscribers Only

Have your name entered on our subscription and University lists by special number. Put this number on the outside of the forwarding envelope (not the enclosed return envelope) and also put at the head of your queries. If already a subscriber, send \$6 for renewal from close of present subscription and your name will be entered in Radio University. No other premium given with this offer.

[In sending in your queries to the University Department please paragraph them so that the reply can be written under or alongside of each query. Write on one side of sheet only. Always give your university number.]

RADIO WORLD, 145 West 45th Street, New York City.
Enclosed find \$6.00 for **RADIO WORLD** for one year (52 nos.) and also enter my name on the list of members of **RADIO WORLD'S University Club**, which gives me free information in your Radio University Department for 52 ensuing weeks, and send me my number indicating membership.

Name

Street

City and State

Inductance Hard to Define

But Here Is a Clear Exposition of It for the Novice

By Brewster Lee

INDUCTANCE is a highly important property of an electrical circuit. It has the same importance in an alternating current circuit as capacity, and it occupies a complementary position to capacity. But inductance seems to be more abstract than capacity and therefore more difficult to explain.

What is inductance?

Or rather, what is the inductance of a circuit or of a coil?

The inductance of a circuit is the total magnetic field associated with that circuit when one ampere flows in it, and the inductance of a coil is the total magnetic field associated with that coil when an ampere flows in the coil.

If one ampere flows in a circuit the inductance of which is one henry, the inductance remains one henry when the current is doubled, although the magnetism surrounding the circuit is doubled, because you divide the doubled field by twice as much. Inductance is a property of the circuit and not of the current that flows in the circuit.

Mechanical Analogy

The behavior of a circuit having inductance can be compared with the behavior of mechanical systems, if mass is compared with inductance and velocity with current. Let us define mass, remembering the definition of inductance given above. The mass of a moving body is the total momentum of that body per unit velocity. If the velocity of the body is doubled the mass remains the same, but momentum is doubled.

Suppose two railroad cars, one empty and the other heavily loaded, be given a certain velocity and then let loose on a level track. Which will travel the farther, the loaded or the unloaded? It would seem that the light car would go farther, but it will not. The loaded car will go much farther before it comes to rest. It will go farther because it has a greater momentum at the beginning of the free movement. It has more energy stored up in its motion.

Which of the two cars is easier to give a certain velocity? The empty car. The locomotive can start that car very quickly, but it will require a much longer time, or greater power, to give the loaded car the same velocity. Thus it is harder both to start and to stop the loaded car, and the heavier the car is, the harder it is to make any changes in its velocity.

The Loaded Circuit

A certain type of inductance coil placed in a long telephone line is called a loading coil. In a loaded circuit it is much harder to stop and to start current, or to make any changes in the current. Any inductance in any circuit will have the same effect.

If a non-inductive circuit in which current is flowing is broken, the current stops instantly, and there is no spark at the terminals. But if an inductive circuit carrying current is broken the current keeps on flowing for a moment after a break, and this is manifested by a spark at the break.

The intensity of this spark depends on the inductance in the circuit and on the current that flowed just before the break. That is, it depends on the electrical momentum. The distance that the loaded car will travel after set free depends on

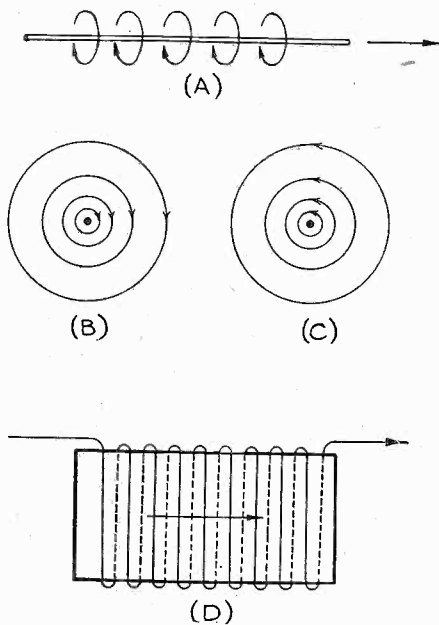

FIG. 1

(A.) The magnetism around a current carrying wire has the direction indicated by the arrows when the current is toward the right.

(B.) This represents a section of a current carrying wire and the accompanying field. Direction of field is clockwise when the current flows away from the reader.

(C.) Section of a current carrying wire and magnetic field when the current is flowing toward the reader. The field is counter-clockwise.

(D.) If the turns in a coil of wire are wound as a right-handed screw, the direction of the magnetic field inside the coil is the same as the current progresses.

the velocity and the mass, that is, on its mechanical momentum.

A circuit has inductance because magnetism is associated with electric current, but the circuit may be so arranged that the inductance is negligible. Magnetism surrounds a straight wire carrying current as shown in Fig. 1, A, B and C. In A the straight arrow shows the direction of the current in the wire and the curved arrows indicate the direction of the magnetic field. The field is strongest near the wire but it extends to infinity.

When Equality Exists

In B a section of the wire and field is shown with the arrows giving the direction of the magnetism when the current flows away from the reader. In C the case when the current flows toward the reader is represented.

It is clear that if B and C are parts of the same circuit and carry the same current their magnetic fields are equal. But owing to the opposite directions of the currents the magnetic fields are opposite. The two fields thus partly neutralize each other.

If the two wires could be made to coincide exactly there would not be any magnetic field around the wires at all. Yet current would flow.

We would then have a non-inductive circuit. It is not possible, of course, to make the two fields coincide exactly, but if the two wires are placed side by side with a very thin layer of insulating ma-

terial between them the ideal case would be approached very closely. It is in this manner that certain non-inductive resistance units are wound.

Cumulative Effect of Turns

But if the wire is wound in the form of a coil the fields around adjacent turns do not neutralize each other but reinforce. The inductance, or the magnetism per unit current, is proportional to the square of the number of turns in the coil provided that the turns are closely wound.

The direction of the field in the coil D can be determined by reference to case B. When the current is flowing away from the observer the direction of the field is clockwise. Let the current flow in the direction indicated by the arrow head at the right end of the wire. It is clear that the current flows down in the first half turn at the left.

Since the direction of the magnetism is clockwise about a wire carrying a departing current, the direction of the magnetism under the first half turn must be toward the right as shown by the long arrow in the middle of the coil.

"Keep to the Right"

The magnetism of every half turn on the front side of the coil is in the same direction. Hence the magnetism contributed by the turns visible from one side of the coil is toward the right back of the turns, which means inside the coil. No matter from what direction the coil is viewed the same conclusion is reached, that is, that the direction of the magnetic field inside the coil is toward the right when the stated conditions obtain.

If the flow of the current had been in the opposite direction, as by reversing connections at the coil ends, the magnetic field would also have pointed in the opposite direction. Also, if the direction of the winding had been left-handed instead of right-handed, with the flow of the current as indicated, the direction of the magnetic field would have been toward the left.

Belgium-N. Y. Phone

\$78 for Three Minutes

Telephone service between New York and Belgium was opened recently by the American Telegraph and Telephone Company. Belgium is the fifth foreign nation to be connected by wire with the United States.

The Belgian service is operated daily from 7:30 A. M. to 6 P. M., as is the London service. The rate is \$78 for the first three minutes and \$26 a minute thereafter from New York to either Brussels or Antwerp—\$1 higher per minute than the New York to London rate.

Dublinites Hear Cosgrave Speaking in Chicago

Dublin.

The broadcasting of the Chicago speech of William T. Cosgrave, President of the Irish Free State, aroused much interest among the radio enthusiasts, and many sat up all night to listen to Mr. Cosgrave's speech, most of which came over clearly.

Volume Control in AC Sets

New Problems Arise But Are Readily Solved

By Edgar Rambeau

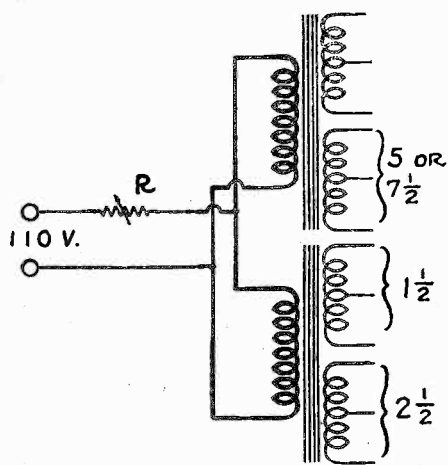

A DIAGRAM SHOWING A RESISTOR IN THE PRIMARY OF THE POWER TRANSFORMER OR IN THE SUPPLY LINE CAN BE USED TO CONTROL THE VOLUME IN AN OPERATED SET.

amount by which the voltage across the primary of the transformer is cut down by the rheostat.

This method is permissible as an auxiliary control but must not be relied on entirely, since cutting down the filament current limits the power handling capacity of the tubes.

If the last tube is not affected by the reduction in primary voltage then this method can be used safely over a much wider range of volume.

Uniform Control

But the rheostat in the primary line may be placed so that all the secondary voltages are affected by it, that is, it may be placed so that the plate and grid voltages as well as the filament voltages are reduced when the resistance in the primary is increased. In that event the rheostat can be used as a complete volume control because all the voltages are lowered in the same proportion, as is the amplification of the signal at every stage. Distortion remains at the original low level.

Another method of control is by a resistance in shunt with one of the primary windings in the radio frequency amplifier. When the rheostat is open, all the plate current flows through the primary coil; but when resistance is inserted, part of the signal flows by way of the shunt, and the transmitted signal is reduced. Hence the volume is decreased. This method will not introduce any hum because the more the volume is reduced the greater will the plate current be and the smaller will be the percentage of hum. If the hum was inaudible at full volume it remains inaudible for all fractional volumes.

A suitable value of resistance for this purpose is from 100 to 500 ohms, and may be one of the Centralab PR power rheo-

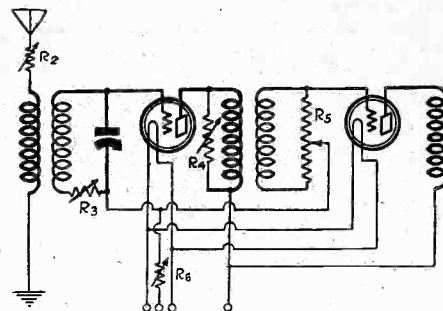

CIRCUIT DIAGRAM SHOWING FOUR DIFFERENT METHODS OF CONTROLLING THE VOLUME, ALL APPLICABLE TO AC OPERATED CIRCUITS. R6 IS NOT TO BE REGARDED AS A VOLUME CONTROL.

THE introduction of AC tubes has upset all the old methods of volume control. Most of the old favorite methods when used on AC sets will upset the delicate balance necessary in these sets to exclude hum. For example, it is not practical to use a filament rheostat in any of the tubes, for its use would introduce the resistance in one side of the circuit which would unbalance the circuit by the amount of resistance inserted.

The use of two equal rheostats, one in each branch of the circuit, would maintain the balance but it is difficult to get two equal rheostats and control them so that they remain equal at all settings.

Another method of volume control that is not suitable for all AC operated sets is a series resistance in the plate circuit of one of the tubes. This may be objectionable on the ground that the percentage of hum increases inversely with the plate current. If the current is cut down with a high resistance rheostat the hum would soon become comparable to the signal, although at full plate current the hum might be so small that it is entirely audible.

Resistor in Primary Circuit

But there are many methods which are especially suitable for AC sets, methods which cannot be used on DC sets. One of these is a rheostat in the primary of the supply transformer.

A 50-ohm power rheostat like the Centralab PR-050, for example, is inserted in the primary line and then placed in a convenient point on the set.

Now when resistance is inserted in series with the primary of the transformer the line voltage is divided between the impedance of the transformer and the resistance of the rheostat. The higher the resistance the lower will the primary voltage be. And as the primary voltage is cut down the secondary voltage is cut down in proportion.

If the rheostat is placed in series with the transformer which supplies the filament current alone, then the filament current of all the tubes on this transformer will be cut down in proportion to the

stats such as the PR-150 or the RX-100.

The volume can also be controlled by putting an RX-100 or an RX-025 in the secondary circuit of a tuned coupler. In this position the volume will be reduced when resistance is added, but the tuning adjustment will not be upset by the introduction of the resistance.

Again the RX-100 can be inserted in series with the antenna and used as an effective control.

Another volume control which can be used on AC sets as well as on DC receivers is a potentiometer of high resistance across one of the grid circuits, preferably across the grid circuit of the first audio amplifier. An adjustable unit having a total resistance of 500,000 ohms is suitable, for example, the Centralab M-500 or the MS-500. This method has practically no objectionable feature for either AC or DC sets.

Loftin-White Principle

(Continued from page 8)

Figs. 7 and 8 show a simple combination of a capacity and an inductance, i.e. a condenser and a coil, as used in the Loftin-White circuit, and the uniformly high energy transfer over the entire wavelength band, being at any wavelength the sum of the energy transferred by the coil and the condenser at that wavelength. In this way it is possible so to proportion and combine a coil and a condenser in the circuit that the energy transfer will be maintained at the maximum point at all wavelengths, the inherent losses by one being compensated for by the inherent gains by the other.

Coupling Does Not Vary

This is the backbone of the Loftin-White system of "constant-coupling," so called because the coupling between the circuits is constant, i.e. does not vary with frequency changes.

It is true that more parts are required to build a receiver embodying the Loftin-White circuit, but the results more than compensate this, and the character of the circuit is such that an actual simplification of design and a highly compact ar-

range is possible, though there are more parts.

Figs. 9 and 10 show a comparison of the equipment needed for one stage. To obtain the results possible with the Loftin-White arrangement it is necessary to have, for each stage, two additional choke coils, a phasing condenser, and a coupling condenser. These are illustrated diagrammatically in Fig. 10, and the compact grouping and permanent wiring of these is illustrated and described at another point in this article.

Single Dial Control

Every radio engineer immediately appreciated the tremendous possibility for improved reception in manufactured receivers, but it remained for the engineers and management of the Arborphone Division, Consolidated Radio Corporation, to set about the design and manufacture of a visualized perfect receiver, with the Loftin-White circuit as an inspiration.

In it they have incorporated some unique mechanical features of their own, which are interesting contributions to radio receiver layout and manufacturing practice. (Concluded next week)

How the Way to Success is 4-Tube Screen-

By H. B.

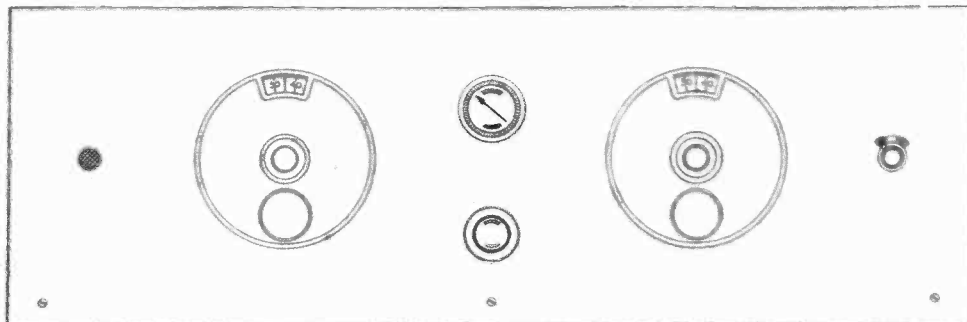

LEFT TO RIGHT ON THE FRONT PANEL ARE THE YAXLEY PILOT WINDOW, MAR-CO DIAL, TICKLER KNOB, VOLUME CONTROL CLAROSTAT KNOB (LOWER); MAR-CO DIAL AND YAXLEY NO. 10 SWITCH.

[In Part I of this article, published last week, issue of February 4, the author showed that the amplification obtainable from the four-tube receiver he is describing was increased forty-fold by using a screen grid tube as the radio frequency amplifier. The three other tubes used in the circuit are one A type, one special detector and one power tube. The schematic diagram of the circuit was published, as well as a pictorial representation and accompanying explanation of the structure and action of the screen grid tube.]

A SET that is easy to wire and which works abnormally well is attractive to the custom set builder and home constructor of receivers, particularly if, combined with these assets, is the always valuable one of good reception of distant stations. The Four Tube Shielded Grid Diamond of the Air brings in distance without straining nerves of arms or ears.

The circuit is a familiar one, with the exception of the screen grid tube, which is used as the radio frequency amplifier. While the tube is new on the market, and most readers are not familiar with its actual operation, all the builder need do is make the connections as recommended in last week's issue and as shown in the official blueprint, observe the textual precautions and gain the distinct advantage of the inclusion of this new and wonderful tube, increasing amplification 40 times.

The official blueprint, showing the layout of parts, including panel, panel instruments, and all the wiring, gives point to point connections. It is highly advisable to follow the blueprint, for the work is thereby greatly simplified and proper connections assured.

Keep Phases Right

The connections to the two RF coils are particularly important, and the blueprint shows how these must be made to duplicate the splendid results obtained from this receiver in the laboratory. Proper phasing of the fields of these coils is automatically taken care of when the blueprint wiring is followed exactly.

The front panel should be prepared first. Its appearance is shown herewith. The Yaxley pilot light is 3 1/4 inches down, 1 3/4 inches from the left, the hole being 7/16 inch. The same measurements obtain for the Yaxley switch 1 3/4 inches from right. The condenser shafts take 7/16 holes, while 3/4 inch below each of these two shaft holes is a drilled and

countersunk 3/16 inch hole for a screw, reinforced by a nut, to serve as anchor to the Marco dial. The shaft of the tickler takes a 5/16 inch hole, centered on the front panel width, 2 1/4 inches down from the top. The knob for shaft of the Volume Control Clarostat is in the same perpendicular alignment, and is 2 inches from bottom.

These are the main front panel operations, and all are clearly set forth, as well as all other details, on the official blueprint.

The front panel may be affixed immediately to the baseboard or subpanel (hard rubber or Bakelite), as there is plenty of room in which to work, and besides a little of the wiring is done by passing leads through holes already provided in the Karas S.F.L. .0005 mfd. tuning condensers.

Underneath Wiring Recommended

If desired, all the wiring may be done above the subpanel, but a neater appearance is provided, at somewhat greater pains, by drilling holes close to the contact points on parts, and passing the wire through the holes, continuing the leads underneath the subpanel. Flexible wire serves this purpose well.

In the official blueprint it will be noticed that some of the wiring is shown in heavy white lines and some of it in dotted white lines. Besides four of the fixed condensers are in dotted lines. The dots indicate that these parts and this wiring are underneath the subpanel. But in the case of the grid condenser and leak at the detector socket, an exception is made, these being placed above the subpanel.

Any builder, if properly guided by sound experience, may use his own taste in wiring, but the connections as shown in the blueprint will serve excellently to guide even experts in wiring.

In the construction of any receiver some points of caution are necessary, and inattention to these vital details may put a constructor to much trouble.

I well remember the first set I built. The diagram that I bought did not clearly show how the filament wires were to be connected and I had to spend a full hour before I "solved" the problem myself.

Took a Short Cut

Because the filament wiring is the the easiest of all the author had taken for granted that everybody knew exactly

LIST OF PARTS

Vital Kit

- L1L2, L3L4L5—Hammarlund HR 23, consisting of one antenna coupler and one three-circuit coil, both for .0005 mfd. tuning.
- C1, C4—Two Karas .0005 mfd. SFL condensers, type 23.
- AF1, AF2—Two Karas Harmonik audio frequency transformers.
- R1—One No. 622 Amperite with mounting.
- R3, R5, R6—Three No. 1A Amperites with three mountings.
- R2—One Lynch 5 meg. grid leak.
- R4—One Volume Control Clarostat.
- C2, C5, C7—Three Aerovox .006 mfd. fixed mica condensers. (Type 1450.)
- C3—One Aerovox .00025 mfd. mica grid condenser, with clips. (Type 1475.)
- C6—One .001 mfd. Aerovox mica fixed condenser. (Type 1450.)
- S—One Yaxley No. 10 battery switch.
- PL—One Yaxley No. 310 pilot light bracket (with lamp extra).
- PJ—Two Frost phone tip jacks, No. 253.
- Four Frost Bakelite sockets, No. 530.
- Two Eby binding posts (Ant., Gnd.).
- One 7 x 21 inch Bakelite front panel. (Cortlandt Panel Co.)
- One 10 x 20 inch sub-panel or baseboard.
- Two Mar-co dials. No. 210.
- One Pee-Wee clip (No. 45 Universal clip.)
- Set of three Karas subpanel brackets.
- One Vac-Shield for shielded grid tube.

ACCESSORIES

- One shielded grid tube (shieldplate 122, CX 322, UX 222) for socket No. 1.
- One Q. R. S. 200A detector tube or CeCo type H, for socket No. 2.
- One CeCo type A for socket No. 3.
- One CeCo type F (112) for socket No. 4.
- One roll flexible Acme Celatsite.
- One 7-lead battery cable.
- One set of cable markers.
- A, B and C supplies.

what to do. Also, unless special precautions were taken, the tuning condenser would strike a rheostat ring, and short the A battery. This short cut I innocently took. Also, I took the diagram and article back to the store where I had bought them and happened to meet the author there. I told him a few things in a determined but pleasant way and he vowed he would give full details in the next edition. But I promise you I will give full details about precautions in this edition, and you can go right ahead building the set from the text and blueprint, feeling certain of full satisfaction, no obscurity and no collision of parts.

In mounting the radio frequency transformer, L1L2 (also called the antenna coil), have the primary winding facing the back of the subpanel. The Hammarlund coil, (one of the two coils in the HR23 kit) has the primary wound inside the secondary, and near one end of the secondary. By following directions the grid lead is kept short, it being connected from the bottom lug nearer the front panel, to the stator plates of the first tuning condenser (C1). To the coil

Carefully Prepared for You in the Grid Diamond

Herman

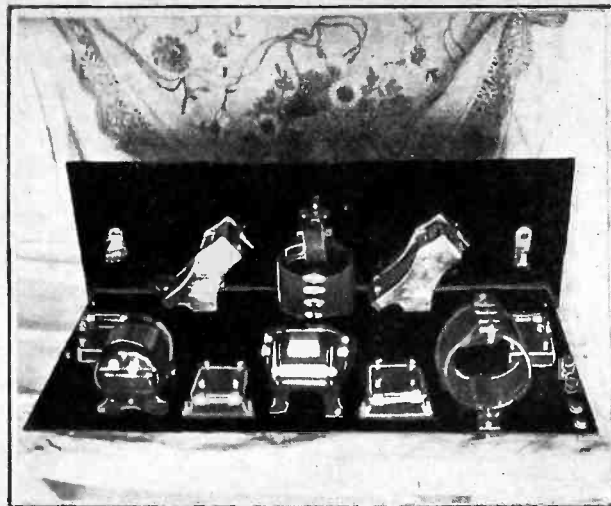
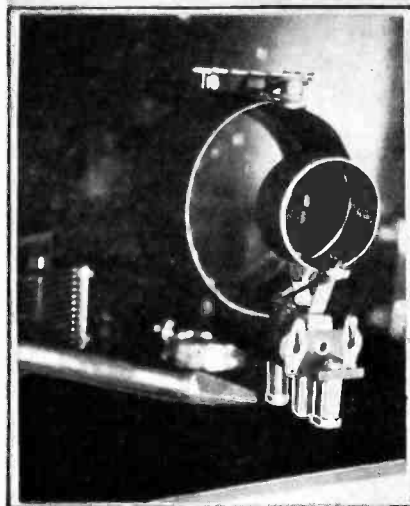
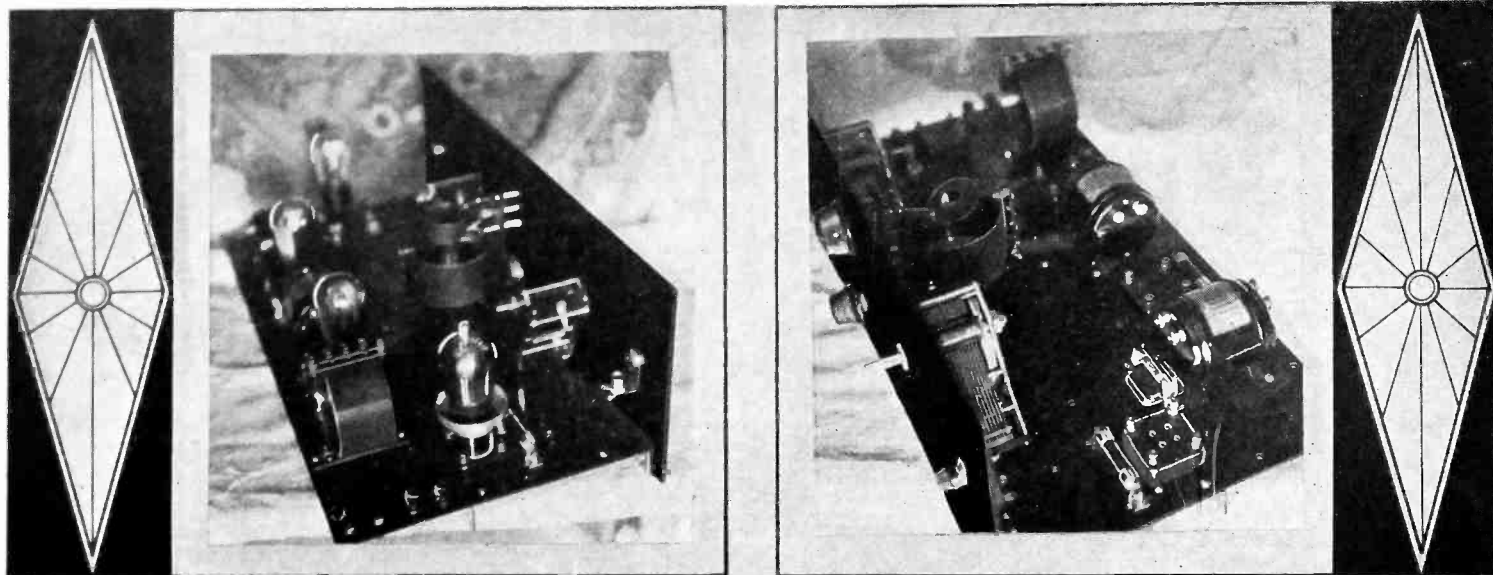

TOP LEFT—The shield grid tube requires a metal shield with a hole on top to permit the tube cap to protrude. To this cap a spring clip is attached. The base of the shield is shown. A binding post on the shield should connect to the minus filament post. Then the other part of the shield is slid over the collar base that is shown. Note position of the Amperite.

TOP RIGHT—How the Aerovox grid condenser and Lynch leak are mounted.

LOWER LEFT—Bit points to one of the extra hex nuts used for extending the Hammarlund coil 1/8 inch back to insure clearing the frame of the Volume Control Clarostat.

LOWER CENTER—Rear view of the receiver, showing particularly where the Frost sockets are placed.

LOWER RIGHT—The antenna coil is placed with primary toward the rear of the set.

lug also is soldered the insulated flexible lead at the other end of which is the spring clip to be snapped on the cap of the shielded grid tube.

Antenna Features

Another wiring pointer is that the antenna binding post is connected to the top lug nearer the front panel, and so much of the primary of this coil shorted as antenna conditions require. Usually the short consists of a connection to the adjoining top lug, but in case your antenna is extremely long, short some more by connecting to the third lug from front panel. (The front panel is 7 inches

away but it referred to simply as a means of determining directions.)

The more of the primary that is shorted the weaker the signals, the greater the selectivity and the more critical the regeneration in the detector circuit by tickler control. Hence the antenna primary may be used as a means of best suiting the receiver to the location, and temporary flexible connections made in the shorting process until actual operation for several nights discloses the most desirable connection.

Before mounting the three circuit coil (L3L4L5) to the front panel mount the Volume Control Clarostat (R5). The

lugs on both sides of the Clarostat frame are toed in, but the constructor of this receiver must bend them out as far as possible with the aid of a pair of pliers. This is one precaution necessary for providing sufficient room for the Hammarlund three circuit coil. The other is to put a hex nut on each of the two mounting screws provided for the threaded bushings on the coil. Two countersunk holes should be drilled to provide access for these screws.

How to Put on Nuts

The operation is as follows: Put one
(Concluded on page 23)

"Double-R" Meters With Resistance of 1,000 Ohms Per Volt to Measure Voltages of B Eliminators, Bias Resistors, Batteries

0-300 volts, handsome full nickel finish, convenient portable type meter, accurate to within 2% plus or minus, with a resistance per volt of a little more than 1,000 ohms, hence more than 300,000 ohms total resistance. Fully guaranteed. To manufacture this meter requires 35 different dyes. No voltmeter but a high resistance one will enable you to tell the voltages of B eliminators and across C biasing resistors. This meter is excellent for general D.C. use. It is furnished with long connecting cords. Catalogue No. 346 (illustrated).



\$4.50

0-500 volts, this meter, of same external appearance and general construction as the 0-300 voltmeter; particularly appeals to the custom set builder, service man, experimenter, etc., who deal with power packs, B supplies, etc., that feed 210 or 310 tubes and otherwise require measurements up to 500 volts. A meter with resistance of more than 1,000 ohms per volt; excellent for all D.C. measurements. Nickel finish; long connector cords. Catalogue No. 347.

\$5.50

It is absolutely necessary to use a high resistance voltmeter in measuring the voltage of B eliminators, either across the total output or at any intermediate voltage. A low resistance meter at least partly short-circuits the eliminator and causes the voltage reading to be away off. Sometimes the reading is as little as 25 per cent of the total actual voltage. The Double R meters 346 and 347 are accurate to 2% per cent plus or minus and have the highest resistance per volt of all popular priced meters for this work—more than 1,000 ohms per volt!

HERE'S OUR COMPLETE CATALOGUE

Cat. No.	Type	Price	Cat. No.	Type	Price
POCKET AMMETER					
No. 1	For testing dry cells, 0-40 ampere DC scale pocket meter.....	\$1.50			
POCKET AND PORTABLE VOLTMETERS					
No. 8	For testing A batteries, dry or storage, 0-8 volts DC scale.....	\$1.65			
No. 10	For testing A batteries, dry or storage, 0-10 volts DC scale.....	1.65			
No. 13	For testing A batteries, dry or storage, 0-16 volts DC scale.....	1.65			
No. 50	For testing B batteries, dry or storage, but not for B eliminators, 0-50 volts DC scale.....	1.65			
No. 39	For testing B batteries, dry or storage, but not for B eliminators, 0-100 volts DC scale.....	1.85			
No. 40	For testing A and B batteries, dry or storage, but not for B eliminators; double reading, 0-8 volts and 0-100 volts DC scale.....	2.25			
No. 42	For testing B batteries, dry or storage, but not for B eliminators; 0-150 volts DC scale.....	2.00			
No. 346	For testing B battery eliminators, grid bias voltage across resistors, batteries, etc.; 0-300 DC scale.....	4.50			
No. 347	For same as No. 346, except scale is 0-500.....	5.50			
No. 348	For testing AC current supply line, portable, 0-150 volts.....	4.50			
VOLTMETERS					
No. 18	For testing amperage of dry cell A batteries and voltage of dry or storage A batteries, double reading, 0-8 volts, and 0-40 amperes DC.....	\$1.85			
No. 35	For testing amperage of dry cell A batteries and voltage of B batteries (not B eliminators); double reading, 0-50 volts, 0-40 amperes DC.....	2.00			
6-VOLT A BATTERY CHARGE TESTER					
No. 23	For showing when 6-volt A battery needs charging and when to stop charging; shows condition of battery at all times.....	\$1.85			
PANEL AMMETER					
No. 338	For reading amperage, 0-10 amperes DC.....	\$1.65			
PANEL VOLTMETERS					
No. 326	For reading DC voltages, 0-6 volts.....	\$1.65			
No. 335	For reading DC voltages, 0-8 volts.....	1.65			
No. 310	For reading DC voltages, 0-10 volts.....	1.65			
No. 316	For reading DC voltages, 0-16 volts.....	1.65			
No. 337	For reading DC voltages, 0-50 volts.....	1.65			
No. 339	For reading DC voltages, 0-100 volts.....	1.75			
No. 342	For reading DC voltages, 0-150 volts.....	1.75			
No. 340	For reading DC voltages, double reading, 0-8 volts, 0-100 volts.....	2.25			
PANEL AC VOLTMETERS					
No. 351	For reading 0-15 volts AC.....	\$2.25			
No. 352	For reading 0-10 volts AC.....	2.25			
No. 353	For reading 0-6 volts AC.....	2.25			
(See No. 348 under "Pocket and Portable Voltmeters.")					
PANEL MILLIAMMETERS					
No. 311	For reading 0-10 milliamperes DC.....	\$1.95			
No. 325	For reading 0-25 milliamperes DC.....	1.85			
No. 350	For reading 0-50 milliamperes DC.....	1.65			
No. 390	For reading 0-100 milliamperes DC.....	1.65			
No. 399	For reading 0-300 milliamperes DC.....	1.65			
No. 394	For reading 0-400 milliamperes DC.....	1.65			
DC PIN JACK VOLTMETERS					
No. 306	For No. 25 and No. 28 Radiolas, 0-6 volts DC.....	\$2.50			
No. 308	For No. 20 Radiola, 0-6 volts DC.....	2.50			
No. 307	Desk type voltmeter with cord, 0-6 volts DC.....	2.50			
TUBE CHECKER					
No. 210	For experimenter, professional set builder, dealer and service man. Consists of 0-6 DC voltmeter, 0-10 DC milliammeter, grid bias switch, rheostat, socket and binding post, instruction sheet.....	\$6.50			
CORD AND PLUG					
No. 21	For connecting meters in A and B leads of a receiver without any disconnections. Terminals correspond with posts on No. 210 tube checker.....	\$1.85			

A pocket type meter will fit easily in a man's vest pocket.
A portable type meter will fit in his sack-coat outside pocket.
The other meters—panel type—are intended for panel mounting, 2 5/64-inch hole.

GUARANTY RADIO GOODS CO.,
145 West 45th Street, New York City.

Please send at once your meters, catalogue numbers:

.....
for which I will pay the postman the price as advertised in Radio World, plus a few cents extra for postage.

Name.....
Address.....
City..... State.....
RW-28

ALL METERS SOLD ON FIVE-DAY MONEY-BACK GUARANTY.

FEATURES TO FASCINATE and Inform You

Up-to-date Topics Masterfully Treated—
See Which Ones You Must Become Fully
Acquainted With to Round Out Your
Radio Knowledge and Experience

The following issues of Radio World, 15c each:

OCT. 29—The Victoreen Power Supply with Audio Channel, by J. E. Anderson; Beauty of Sound and Appearance in Reproducers, by H. B. Herman.

NOV. 5—Part I of a two-part article on The Fenway Electric Concertrola; The Lynch Five, by Arthur H. Lynch; The How and Why of 3-Ft. Cone, by James H. Carroll.

NOV. 12—The New Nine-in-Line Receiver, by John Murray Barron; Part II on how to construct the Electric Concertrola; Unbiased Facts About Underbiased Grids, by Roger C. Brooks; Data on Meters, by Frank De Rose.

NOV. 19—Part I on how to build the Improved Laboratory Model Super-Heterodyne (Silver-Marshall Jewelers Time Signal Amplifier), by E. R. Pfaff; Part III of a four-part article on the Electric Concertrola; New Model DC Set, by James H. Carroll.

NOV. 26—The Four Tube DX Fountain, by Herbert E. Hayden; concluding installment on the Fenway Concertrola; A Squealless 5-Tuber, by Joseph Bernsley; Secrets of DX in a Creative Receiver, by J. E. Anderson.

DEC. 3—How to Modernize the Phonograph, by H. B. Herman; Part I of two-part article on the Everyman 4, by E. Bunting Moore; Efficiency Data on 4 and 5-Tube Diamond (not Screen Grid Diamond), by Campbell Hearn.

DEC. 10—Seven-page article on the Magnaformer 9-8, the best presentation in the history of radio literature, by J. E. Anderson (this article complete in one issue); The Object of a Power Amplifier, by C. T. Burke, engineer, General Radio Co.; Constructional Data on the Everyman 4 (Part II); The 2-Tube Phonograph Amplifier, by James H. Carroll.

DEC. 17—Complete Official Call Book and Log; How I Tuned In 98 Stations in Six Nights with Magnaformer 9-8, by Thomas F. Meagher; Starting Facts About Harmonics, by H. B. Herman; The G.R. Amplifier and B Supply, by Stuart S. Bruno.

DEC. 24—The AC 300 (four tubes); How Service Men Cheat Radio Builders; Part I of two-part article on the Victoreen Power Supply with one audio stage.

DEC. 31—How DC Sets Are Converted to AC Operation, by W. G. Masson-Burbridge; Cures for Uncanny Noises, by J. E. Anderson; Part II of two-part article on the Victoreen with a Stage of Audio; Complete Driver for an AC Set, by Robert Frank Goodwin.

JAN. 7, 1928—The Shielded Grid Six, first national presentation of loop and antenna models of the new Silver-Marshall circuit, utilizing the new tubes of strong amplification, Part I, by McMurdo Silver; How to Build a Power Amplifier and 210 Push-Pull Unit, by A. R. Wilson, of General Radio Co.

JAN. 14—Assembly and Wiring of Shielded Grid Six, Part II, by McMurdo Silver; Meter Range Extensions, by Bramhall Torrence; Uses of B Batteries and Power Devices, by E. E. Horine, National Carbon Co.; A 5-Tube Set Costing but 2 Cents an Hour to Run, by Capt. Peter V. O'Rourke.

JAN. 21—Bias Resistor Fallacy Exposed, by J. E. Anderson; The Shielded Grid Six, Part III (conclusion); How the "Victory Hour," Reaching 30,000,000, Was Broadcast, by Herman Bernard.

JAN. 28—How to Build the AC Five, a Batteryless Receiver, by H. H. Chisholm; Technique of Home Television Machine, by Dr. E. F. W. Alexander; A Quality Analysis of Resistance Coupling, with Trouble Shooting, by Herman Bernard.

FEB. 4—Tyrman "70" with Shielded Grid Tubes (Part I of four-part article), by Brunsten Brunn; The Four Tube Shielded Grid Diamond, by H. B. Herman; Television's Stride, by Neal Fitzalan, Radio Vision Editor.

Any copy, 15c. Any 7 copies, \$1.00.
All these 15 copies for \$2.00, or start subscription with any issue. Any 8 of these numbers sent as premium with NEW yearly subscription. No other premiums allowed.

RADIO WORLD
145 West 45th Street New York City

FROST QUILS CUNNINGHAM

Herbert H. Frost, general sales manager of E. T. Cunningham, Inc., resigned, effective February 29. Mr. Frost will become vice-president, in charge of mer-

chandising, of Federal-Brandes, Inc., (Kolster). M. F. Burns, the New York manager of Cunningham.

So President E. T. Cunningham announced.

Director Handles Fiat Loop

Ben Director, room 201, 142 Liberty Street, New York City, has been appointed exclusive representative for New York and vicinity of the Fiat Console Loop. Rectangular in shape, with less than a 7-inch turning radius, this loop is handy for close quarters and small spaces. Gracefully made on Colonial lines on a solid American walnut frame with a hand-rubbed lacquer finish, it is bank wound with brown silk covered wire. The end pieces are of polished Bakelite.

Literature Wanted

- A. Taylor, 208 W. Ga. Ave., College Park, Ga.
- Wm. H. Johnson, 1222 Tatnall St., Wilmington, Del.
- "Clay" Norwood, 47 Beacon St., Gloucester, Mass.
- Francis G. Glead, Fifth Ave., West Hamilton, Ontario, Canada.
- W. M. Newman, 521 21st St., N. W., Washington, D. C.
- A. R. Hann, 1812 Grove Street, Berkeley, Calif.
- C. F. Jause, 31-35 104th St., Corona, L. I., New York.
- E. C. Hughes, 11 Montague Pl., Montclair, N. J.
- Ernest B. Wolf, 314 N. Main St., Telford, Penna.
- Wilbur Boley, 5243 47th Ave. So., Seattle, Wash.

SM The Finest Power Amplifier

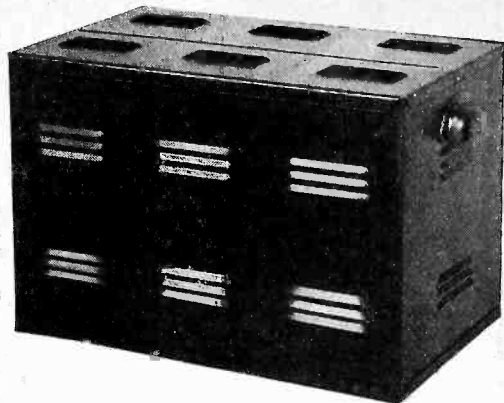

The new "680 Series" Unipacs are the finest power amplifiers, mechanically and electrically, you've yet to see. They operate directly from the light socket—deliver tremendous undistorted power output and furnish B current to the receiver as well. Certain models will furnish A, B and C power to any set equipped with standard A.C. tubes.

Model 681-210 is a single stage push-pull amplifier—with over 5,000 milliwatts undistorted power output—using two UX-210 tubes, two UX-281 rectifiers and an UX-874 voltage regulator. There is nothing finer for the last stage of any receiver you can build or for bringing an old set up to 1928 standards of tone quality. Model 681-210 KIT, ready to assemble, \$83.25; or 681-210, WIRED, ready to operate, \$93.25. Send 25 cents for blueprints or 10 cents for full information on the complete line of Unipac models—one and two stage amplifiers for every conceivable use.

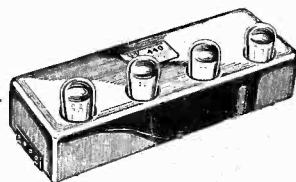

THE FAMOUS S-M 440 TIME AMPLIFIER

With a greater degree of selectivity, with a greater amplification factor—the 440 Jewelers' Time Signal Amplifier offers possibilities never before realized in long wave amplifier construction. It is more accurate—with a finer degree of calibration—than any long wave amplifier that may be built from standard parts today. It is housed in a copper and brass catacomb and its three radio frequency stages and detector are individually shielded. The 440 Time Signal Amplifier is tremendously popular already. Thousands have been sold, for it's the best long wave amplifier ever developed. It is tuned exactly to 112 K.C., the 2,677-meter wavelength of the Naval Observatory station at Arlington (NAA). Price, \$35.00.

SILVER-MARSHALL, INC.

878 West Jackson Blvd. Chicago, U. S. A.

CORWICO

BRAIDITE

HOOK-UP WIRE

"The Braid Slides Back"

To make a soldered connection the braid is simply pushed back while the soldering is done and then replaced, thus making the neatest possible connection. Made in red, green, yellow, brown and black.

SOLD BY ALL DEALERS
if yours cannot supply you, write direct.
25 Ft. Stranded...35¢ 25 Ft. Solid...30¢

CORNISH WIRE CO.
80 CHURCH ST. NEW YORK CITY

RECENT ISSUES of Radio World, 15c each. Be sure to give date of issue when writing. Radio World, 145 West 45th Street, New York City.

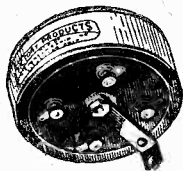

VICTOREEN

Super Coils

Send for Folder

Geo. W. Walker Co.
2825 Chester Avenue
Dept. B Cleveland, O.

1-2-3

Certified Blueprints!

To assist builders of this amazing receiver. Accurate, Detailed, Complete, \$2.00 postpaid. Receivers on demonstration prove Mr. Adams' claims conservative. All specified parts supplied. Write for price list.

KEYSTONE RADIO SHOP

101 WEST 43rd ST. NEW YORK CITY
Western Representative: J. H. DODMAN,
604 Davis Street, Evanston, Ill.

BLUEPRINT

and Instruction Sheet

for the Silver-Marshall

Shielded Grid Six

The New Receiver Utilizing the New Shielded Grid Tubes with Their Powerful Kick.

25 Cents

Guaranty Radio Goods Co.

145 WEST 45TH STREET
NEW YORK CITY

BIG REWARDS!

Big rewards await you in Radio if you want to make more money quickly. Millions being made by others. Get your share NOW. Get complete facts. Send for FREE complete booklet and guide of money-making opportunities. Be first to get this. BARAWIK CO., Dept 892, Chicago, U. S. A.

End Radio Bothers

DO YOU KNOW what's wrong when your radio set isn't working right? Ten to one, you don't. Twenty to one, you would if you had a copy of

Hoff's Radio Trouble Finder



Ever hear of M. M. Hoff, radiotrician, of Philadelphia? He was one of the very first "radio bugs" and has been building and studying sets ever since. And now, out of his broad experience, this man has written a book to tell radio owners how to keep their sets working right.

He tells in plain words and illustrations how a set is made, what the parts are called, what are the few usual troubles and how to fix them. Then he lists 103 troubles that sometimes happen and tells how to detect and fix each one.

The book is a regular cyclopedia of radio information—only it's in a language anyone can understand. Read it five minutes and you'll know more about radio than you ever dreamed of.

It will save you many a repair man. It will save you hours of guessing and fussing and fuming. It will help you to keep the tone of your set always sweet and strong. It will keep you from losing many programs. And, best of all—

IT WILL MAKE YOU STOP SWEARING—MUCH TO THE SURPRISE OF YOUR FAMILY—because radio repairs are expensive. Why hire them done when you can easily learn how to keep your set from needing them?

All It Costs Is \$1

Send cash with your order and you get also a Dictionary of Radio Terms and the latest list of Radio Broadcasting Stations with call letters and the new Federal Radio Commission wave lengths. Send your dollar today while the copies last. Six copies for \$4.00.

CHICAGO BARGAIN HOUSE

626 QUINCY BUILDING

CHICAGO, ILLINOIS

NOW YOU CAN BUILD THE NEW KARAS A.C. EQUAMATIC

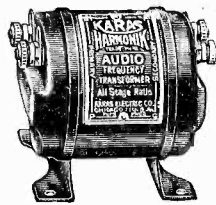
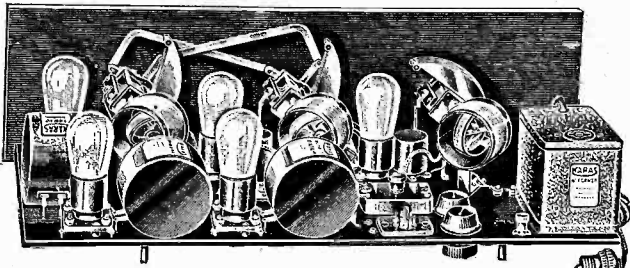

KARAS HARMONIK AUDIO TRANSFORMER provides maximum distortionless, pure, sweet audio amplification. Unequaled performance. Two are specified for Shielded Grid Diamond. NEW Harmonik. NOW, \$5.00 each.

It operates from any 110-volt house lighting circuit

The new **KARAS A.C. EQUAMATIC**, described by J. E. Anderson in this issue, is the only completely balanced and perfectly neutralized 5-Tube A.C. Kit using standard A.C. tubes. All of the "A" filament supply for this marvelous new set is furnished by the new Karas A.C-Former filament supply. Those who build this great receiver will have a set that is two years ahead of them all!

The Karas A.C-Equamatic does away with all need for "A" batteries and chargers, the Karas A.C-Former providing a constant, noiseless and unvarying filament supply of correct potential for each of the A.C. tubes used in the set. And this accomplished without the sacrifice of a particle of the matchless tone, remarkable selectivity, splendid distance-getting qualities and tremendous volume for which the Karas 2-Dial Equamatic has become famous.

Build this great receiver! Write us TODAY for full size wiring diagrams and complete instructions, which we mail FREE on request. Begin to build this matchless A.C-Equamatic right away.

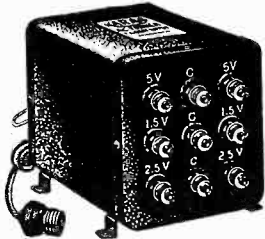

KARAS A.C-FORMER filament supply operates directly from 60-cycle 110-volt A.C. current to heat filaments of standard A.C. tubes. No hum. Used in Karas A.C. Equamatic and for converting any D.C. set to A.C. operation. Write for complete details. List price of A.C-Former Type 12, \$8.75; Type 13, \$13.50.

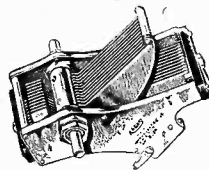

KARAS S.F.L. .0005 MFD. variable condenser. Absolutely straight line tuning. Two specified for Shielded Grid Diamond. Price, each, \$5.50.

KARAS ELECTRIC CO. 4039-M North Rockwell Street, Chicago, Ill.

AC EFFICIENCY

(Continued from page 7)

in each stage. The two ganged condensers are connected together mechanically with a positively acting coupling gear. This arrangement insures simplicity of two condenser tuning yet retains the sensitivity and selectivity of a three condenser circuit.

Two principal volume controls are used in the AC Equamatic receiver. R1 is a 75 ohm rheostat connected across the primary of the third RF transformer. The resistance used is about the same as the impedance of the primary winding at the lower end of the broadcast band and therefore it affords a satisfactory control.

The second control is the 500,000 ohm potentiometer P connected across the secondary of the first audio transformer.

Both of these controls can be used over their full range without admitting any hum into the signal. And both together constitute a control of adequate range.

The output of the receiver is delivered to the loudspeaker through a Karas output filter indicated in the diagram by C11 and Ch3.

The plate voltages recommended for the circuit are the maximum for each tube. Thus the last tube should have 180 volts, the three -26 should have 135 volts, and the detector should have 45 volts. The voltage between the heater and the cathode has to be determined by trial, and it may be that it is not necessary at all. It should be adjusted for minimum hum.

In measuring the plate voltages it should be remembered that the voltage between the plus B 180 binding post and the B minus post should be 220 volts, because this includes the 40 volts bias and the 180 volts plate voltage. The same applies to the voltage between the B plus 135 and B minus. It should measure 135 volts plus 9 volts, that is, 144 volts.

R3 should be a variable resistor of 2,000 ohms each as Carter M.W. No. 2, 2,000 ohm potentiometer. R4 should be a fixed resistor of 2,000 ohms, such as the Electrad B-20 unit.

The outstanding characteristic of this receiver is quality of reproduction. There is a truly remarkable absence of distortion. High and low frequencies came out with full strength just as they were in the transmitting studio. Neither were the middle notes accentuated. They were of the same strength as the other notes. On listening to the reproduction one did not feel that there was anything artificial about it but that it was the original. Indeed it was a copy of the original so faithful that an expert musical critic could not have differentiated between the two.

The ease of tuning and controlling the volume is another feature in which this receiver is outstanding. It is that ease which accounts for the large number of stations which could be tuned in with the set without any apparent difference between the local and the DX. All came in with a bang. And one station came after the other crowding each other. There was no jostling between the adjacent stations at all. Each station took its exclusive turn at the loudspeaker.

There is a great sense of satisfaction of owning and operating a receiver like the Karas AC Equamatic. I will send a complimentary blueprint to any reader.

POWERFUL UNIT

Drives Any Cone Speaker and Produces Delightful Tone at Great Volume



Try It for Five Days!

If not delighted with it, return it and your money will be refunded.

A Superb Creation At a Price That Fits All Purses **\$3.75**

GUARANTY RADIO GOODS CO.,
145 West 45th St., New York City.

Please send me one cone speaker unit as advertised. I will pay postman \$3.75, plus few cents extra for postage. Your 5-day money-back guaranty is accepted.

Name.....
Address.....
City..... State.....

VOLUME CONTROL CLAROSTAT

Here's Big Resistance

in small package—and at low cost. What's more—
RESISTANCE range of 0-500,000 ohms in several turns of knob for micrometric adjustment. Handsomely nickel plated with new style bakelite knob. One-hole mounting. Screw binding posts. Takes up little room. A real Clarostat through and through—noiseless, stays put, trouble-proof and lives long. And only \$1.50.

Ask your dealer to show you the Clarostat line. Or write us direct for the dope.

American Mechanical Laboratories, Inc.
MEMBER **RMA** Specialists in Variable Resistors
285-87 North 6th Street
Brooklyn, N. Y.

Improves-

tone fidelity, clarity, sensitivity—by automatically keeping tube filament voltage constant, despite "A" battery variations.

AMPERITE

The "SELF-ADJUSTING" Rheostat

eliminates hand rheostats. Simplifies wiring, tuning, panel design. Particularly essential with Battery Eliminators. Accept only Amperite. \$1.10 mounted (U.S.A.)



FREE—"Amperite Book" of latest circuits and construction data. Write Dept. R W 3.

RADIALL CO.
50 Franklin St., New York

Radio World's CLASSIFIED ADS for Quick Action

10 Cents a Word—10 Words Minimum—Cash With Order

FOR SALE—Grebe five-tube Synchronphase Radio. Single control. R. Schlegel, 1118 No. Negley, Pittsburgh, Pa.

WANTED: MEN to work with National Radio Service Organization. No selling scheme. Co-Operative Radio Doctors, Dept. W, 131 Essex St., Salem, Mass.

RADIO FURNITURE, direct from factory to you. Receiving set cabinets, any size. Consoles and tables. Free catalogue on request. Fulbright Cabinet Co., Hickory, North Carolina. W-2-18

COMPLETE DETAILS on the Laboratory-Super appeared in the Nov. 19, 26 and Dec. 3 issues of RADIO WORLD. Send 45c for these issues.

D.C. CHARGER—110-125 volts, D.C., 1/2 to 4 amperes, \$2.95. Redding, 554 West 50th Street, N. Y. City.

EVERY FRIDAY at 5.40 P. M. (Eastern Standard Time) Herman Bernard, managing editor of Radio World, broadcasts from WGBS, the Gimbel Bros. station in New York, discussing radio topics.

Shield Grid Diamond

(Concluded from page 19)

screw through a countersunk hole and turn one hex nut thereon until the nut strikes the back of the front panel. Then do the same in the other instance. Now you are ready to turn the screws into the threaded mounting sleeves of the coil support. Tighten the additional nuts against the back of the front panel. The coil is mounted, and, because of the turned-back lugs on the Clarostat and the extra depth of the hex nuts, the coil form is back far enough to clear the Clarostat completely.

In mounting the Karas condensers if Karas subpanel brackets are used the condenser shaft drill holes are just right to enable the condenser frame to touch the top of the subpanel. he condensers, by the way, are of the single hole panel mount type, so no extra drilling need be done on their account, unless unusual security is preferred, and then two holes are drilled in the subpanel to meet the corresponding holes in the bottom of the condenser frames. Screws and nuts anchor the condensers to the subpanel in that instance.

By tightening the front panel nut securely it will not be essential to use the additional mounting device on the condensers.

But in mounting the condensers be sure that the plane of the frame with the mounting holes on bottom is parallel with subpanel.

The two lugs on each condenser are stator connections, and the rotor connections may be made directly to the frame by threading a bared part of the insulated connecting wire through other holes (on the back, near bottom) already provided in the condensers, or even a screw, nut and lug may be put there and the connection soldered to the lug.

The grid condenser is fastened mechanically to the grid post of the detector socket and a part of the lug snipped off, if necessary, to clear the tube base. The Lynch grid leak is placed in the clips of the condenser. The plate lead of the detector tube and Karas audio transformer is close by, so this plate lead is made by running the wire from the P post of the audio transformer straight up for one inch, carrying it toward the front panel at that elevation for two inches or more, and dropping it. In that way the plate lead safely clears the grid lead.

A seven lead cable is used. In the set the cable ends are attached to firmly secured parts, and thus is fitting anchorage provided, but an additional safeguard against cable breakage by tension is to gather together the seven leads at rear center of the subpanel, drill two holes, through the subpanel, and, with the cable still underneath, pass around subpanel and cable two turns of the insulated wire used in wiring the set. Thus any strong tension on the cable from the battery ends will be taken up at the point of binding, rather than at the points of soldered connections to parts. Instead of wire as a binder, a clamp may be used. Have the clamp underneath the subpanel. Also, if wire is used, have the ends terminate under the subpanel, for improved appearance.

Connect the binding post of the Vac-Shield put on the shielded grid tube to filament minus.

When using a No. 45 Universal clip, for connection to the protruding cap of the shield grid tube, do not try to close the front jaws of the clip directly on the cap but open the clip as far possible and slide on sideways. No soldered connections should be made to the tube cap.

All due regard has been paid to appearance or, as some call it, eye value. Therefore by wiring neatly, soldering carefully and observing the motto, "When in doubt follow the blueprint," you will succeed beyond your expectations.

Ce-Co-ize your receiver!

Operating your Radio Set with a worn or defective tube, is like running your car with a missing cylinder!

Replace the defectives with CeCo Tubes. They will work in harness with any other unworn tubes you have.

But you'll get better results, clearer tone, greater volume, longer life if you CeCo-ize your receiver by putting a CeCo Tube in every socket.

Your dealer will help you select the correct types for your set. Ask him.



C. E. MFG. CO.
INC.
PROVIDENCE
R. I. U.S.A.

Stabilize Your Set "Vac-Shields" Bring in DX

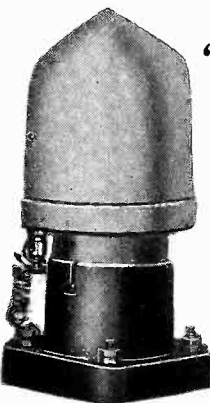

THE invention of these non-magnetic shields for Type 201-A or the new Type 222 Tubes prevents inter-stage coupling and electro-static effects, overcoming stray capacities that make tuning of distant stations so difficult. Guard tubes against breakage. Attached in a minute.

U. S. Patent
No. 1,564,694

Order today at your dealer's, or by mail, C. O. D., \$1.00.

ORANGE RESEARCH LABORATORIES
247-249 McKinley Avenue
East Orange, N. J.

FROST-RADIO

Exclusively Specified for
4-TUBE SHIELDED
DIAMOND OF THE AIR
RECEIVER

Described in this issue.

HERBERT H. FROST, Inc.
Main Offices and Factory:
ELKHART, IND.

New York Chicago

HERBERT H. FROST, Inc.,
160 N. LaSalle St., Chicago.

Mail me a copy of your free book, "What Set Shall I Build?"

Name.....
Address.....
City..... State.....

FORTY TIMES as Much Amplification!

The New Shielded Grid
4 - TUBE
DIAMOND
OF THE AIR

Designed by H. B. HERMAN
and described by him in the February 4
and 11 issues of RADIO WORLD.

The favorite four-tube design, simple as can be, takes a great step forward, so that home constructors of radio receivers, and custom set builders, can build a distance-getting and voluminous set, the parts for which list remarkably low.

The new shielded grid tube is used as the radio frequency amplifier. That is why the amplification is boosted forty times over and above what it would be if an -01A tube were used instead.

Such simplicity of construction marks the receiver that it can be completely wired, skillfully and painstakingly, in two and a half hours.

All you have to do is to follow the official blueprint, and lo! a new world of radio achievement is before you! Distant stations that four-tube sets otherwise miss come in, and come in strong. No tuning difficulty is occasioned by the introduction of this new, extra powerful, startling tube, but, in fact, the tuning is simplified, because the signal strength is so much greater.

When you work from the official wiring diagram you find everything so delightfully simple that you marvel at the speed at which you get the entire receiver masterfully finished. And then when you tune in—more marvels! 'Way, way up, somewhere around the clouds, instead of only roof high, will you find the amplification!

You'll be overjoyed. But you should place every part in exactly the right position. Stick to the constants given, and, above all, wire according to the blueprint!

Front Panel, Subpanel and Wiring Clearly Shown

When you work from this blueprint you find that every part is shown in correct position and every wire is shown going to its correct destination by the ACTUAL ROUTE taken in the practical wiring itself. Mr. Herman's personal set was used as the model. This is a matter-of-fact blueprint, with solid black lines showing wiring that is above the subpanel, and dotted lines that show how some of the wiring is done underneath.

Everything is actual size.

Not only is the actual size of the panel holes and instruments given, but the dimensions are given numerically. Besides, it is one of those delightful blueprints that novice and professional admire so much—one of those oh-so-clear and can't-go-wrong blueprints.

Be one of the first to send for this new blueprint, by all means, and build yourself this outstanding four-tube receiver, with its easy control, fine volume, tone quality, selectivity and utter economy. It gives more than you ever expected you could get on four tubes—and the parts are well within the range of anybody's purse.

The Four-Tube Shielded Grid Diamond uses only one shielded grid tube, the other tubes being two 01A and one 112, or equivalent, or a special detector tube may be used, one -01A for first audio and the power tube in the last stage.

The circuit consists of a stage of tuned RF shielded grid tube amplification, a regenerative detector, and two transformer coupled audio stages.

What a receiver!

\$1.00 for 27" x 27" Blueprint,
15c extra for Feb. 4 issue.

Send your order today!

RADIO WORLD,
145 West 45th St., N. Y. City.
Enclosed please find:
 \$1.00, for which send me at once one official blueprint of the Four-Tube Shielded Grid Diamond of the Air, as designed by H. B. Herman, and described by him in the February 4 and 11 issues of Radio World.
 15 cents extra for February 4 issue.

NAME.....
ADDRESS.....
CITY..... STATE.....

ARBORPHONE RADIO



A.C.
Lamp Socket
Operation

Loftin-White Circuit and Other Exclusive Features

For those in whom the pride of ownership is strong, for those who instinctively choose the best, the Model 35 AC Arborphone Radio is a revelation. A revelation in exact reproduction of broadcast programs, in the depth and range of tone that produce such fidelity, in engineering design and conscientious workmanship. It is available in a variety of cabinet and console styles. The famous Loftin-White circuit as perfected in the new Arborphone is described in a 24-page booklet. It is yours upon request.

- SEVEN TUBES
- SINGLE DIAL CONTROL
- NO BATTERIES
- NO ACIDS
- NO LIQUIDS

CONSOLIDATED RADIO CORPORATION

Arborphone Division

ANN ARBOR, MICHIGAN

Licensed under R C A and Loftin-White patents

RECENT ISSUES of Radio World, 15c each. Be sure to give date of issue when writing. Radio World, 145 West 45th Street, New York City.

EVERY FRIDAY at 5.40 P. M. (Eastern Standard Time) Herman Bernard, managing editor of Radio World, broadcasts from WGBS, the Gimbel Bros. station in New York, discussing radio topics.

A NEW AND IMPROVED VOLUME CONTROL FOR "AC" CIRCUITS

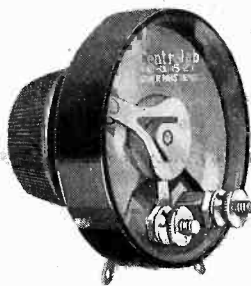

Centralab Radiohms RX-100 and RX-025 have been built with exact taper of resistance to give effectual control of volume smoothly, without jumps and sudden blasts. When the RX-100 is placed across the secondary of one of the R.F. stages it surely and positively controls the volume from a whisper to maximum on all signals—powerful locals notwithstanding. This Radiohm will also control oscillation very effectively.

The RX-025 has the exact taper of resistance for a volume control when placed in the antenna circuit, or across the primary of an R.F. transformer. One of these two Radiohms and the Centralab Power Rheostat are essential resistances for all "A.C." circuits. They help to maintain the delicate balance of voltages throughout the circuit and in no way affect the balance between plate and filament current, so necessary to maximum efficiency.

Write for new folder showing applications.

CENTRAL RADIO LABORATORIES

13 KEEFE AVENUE

MILWAUKEE, WIS.



POLYMET CONDENSERS

They Stand Abuse!

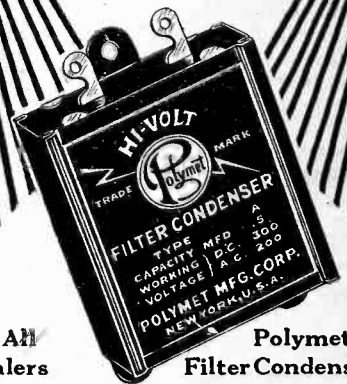

At All Dealers

Polymet Filter Condensers

They are selected by leading engineers and incorporated as standard equipment by nationally known manufacturers of receiving sets and power units. Follow the leaders.

Write for Polymet Catalog

POLYMET MFG. CORP.
597 Broadway, New York City

POLYMET

Professional Set Builders

Can secure the 28" x 34", two-color, X-Ray Magnaformer 9-8 Wiring Diagram by sending 25c to Radiart Laboratories Co., 19 S. La Salle St., Dept. 6, Chicago, Ill.

Name

Address

THE DIAMOND OF THE AIR

Using General Purpose Tubes

4 Tubes Set uses three type A tubes and one 112 type; has TRF stage, regenerative detector and two stages of transformer coupled audio. (This is not Shielded Grid Diamond.)

5 Tubes Same RF and detector as the other, but has one transformer and two resistance coupled audio. Especially suitable for B battery operation. (Not Shielded Grid Diamond.)

Guaranty Radio Goods Co.,

145 West 45th Street, New York City.

Please send me one newly printed official blueprint of the—

5-tube Diamond of the Air

4-tube Diamond of the Air

(Check off one you want.)

and the textual data giving full directions for construction.

Enclosed please find 25 cents to defray all expense.

NAME

ADDRESS

CITY..... STATE.....

(These are not Shielded Grid Diamonds.)