

MARCH 27

1926

15 CENTS

RADIO WORLD

Title Reg. U.S. Pat. Off.

209

Vol. 9 No. 1

ILLUSTRATED Every Week

AN ECONOMICAL 4-TUBE SET

FREQUENCY DIALS ANALYZED

MYSTERIES OF RADIO RECEPTION

A PRACTICAL "B" POWER UNIT

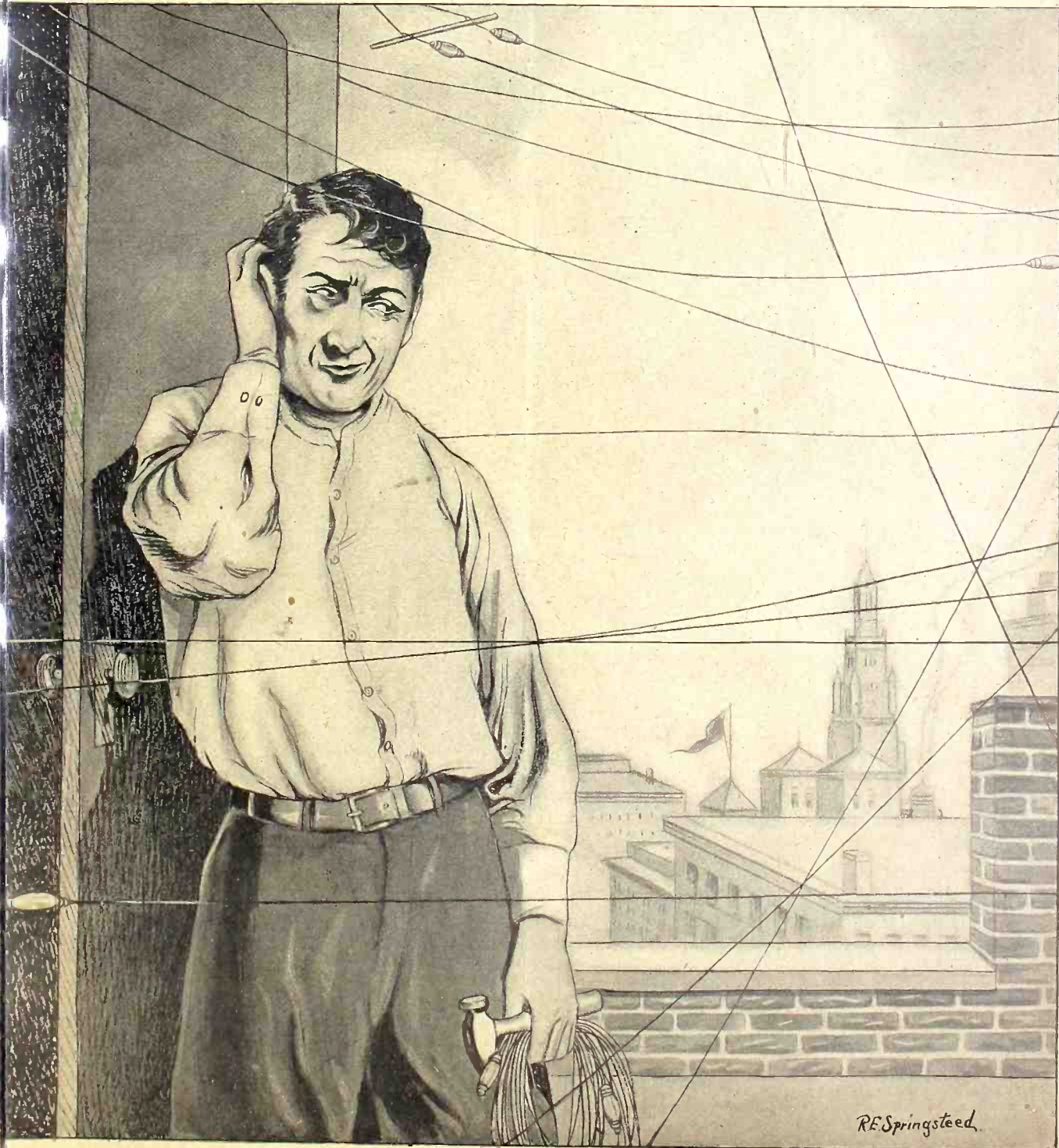

RE Springsteed.

"Love Thy Neighbor As Thyself."

Here Is FRESHMAN'S Greatest Accomplishment— This BEAUTIFUL CONSOLE

This Wonder Set which is spreading entertainment, education and contentment in hundreds of thousands of homes in all parts of the world now has many additional points of superiority.

New and Improved FRESHMAN MASTERPIECE

MODEL 6-F-3

A handsome piece of furniture made of carefully selected genuine five-ply mahogany. A radio receiver with the finest of built-in loud speakers, in a console model which provides ample room for all batteries, chargers, eliminators and everything else that could possibly be used in connection with a radio set. Not a single wire visible to mar the appearance of the room.

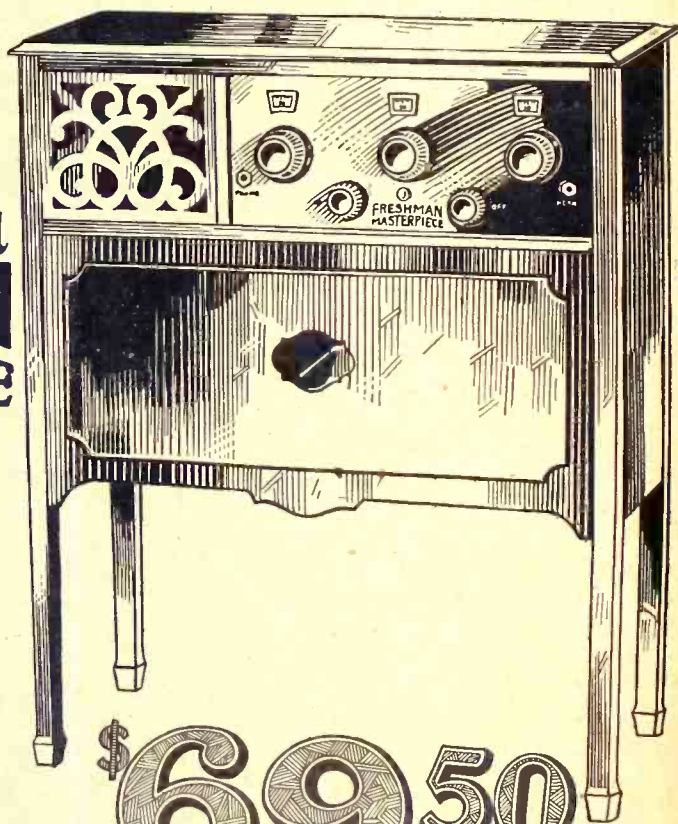

Sold on Convenient Terms—

Now on display by all authorized Freshman dealers who will install and service them

Write for new 8 page folder illustrating and describing all 1926-27 Models

CHAS. FRESHMAN CO. Inc., Freshman Building, New York

RADIO WORLD

[Entered as second-class matter, March, 1922, at the post office at New York, N. Y., under the Act of March 3, 1879.]

A Weekly Paper Published by Hennessy Radio Publications Corporation from Publication Office, 145 West 45th St., New York, N. Y. Just East of Broadway. Phones: BRYant 0558 and 0559.

Vol. IX. No. 1. Whole No. 209

March 27, 1926

15c per copy, \$6.00 a year

An Economical 4-Tube Set

By Edgar T. Collins

A 4-TUBE circuit which affords the most for the money is one that has a stage of tuned radio-frequency amplification, a regenerative detector and two transformer stages of audio. One form of this design is shown in Fig. 1. Here the regeneration is supplied through a variable condenser, C3, the correct adjustment being obtained, so far as dial readings go, by determination of the inductance of the feedback coil, L5. Thus combined capacity and inductive feedback is used.

Conditions today justify the stage of tuned RF preceding the detector tube, because of the greater selectivity and also the better radio-frequency amplification. While the regenerative action might be focused on the RF tube, and a little greater volume would result, the radiation would be too strong, and there might arise an unexpected criticalness of tuning. Better stability and a finer control of oscillation are enjoyed with the regeneration placed as shown in Fig. 1.

Tuning is Simplified

It will be noted that the condenser action in the plate to grid circuit of the detector tube enables a fine spreadout, instead of very closely adjusted setting, at the higher frequencies, since straight-line frequency condensers are used, or, if some different type is at hand, the same effect of spreadout will result from the use of the frequency tuning type of dials. The rear view, at the bottom of this page, shows inexpensive straightline frequency condensers, used in conjunction with honeycomb coils, with the front panel

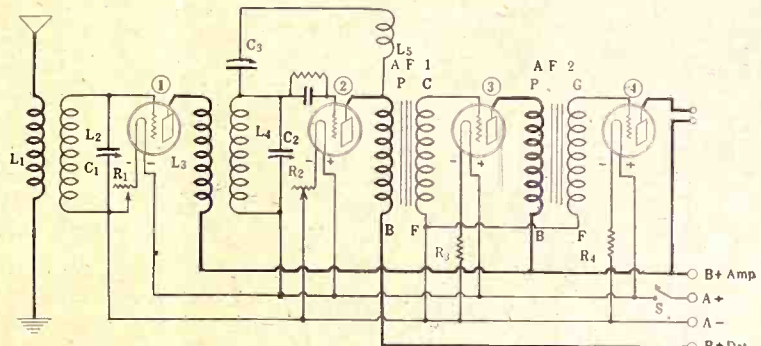

THIS 4-tube circuit is capable of very great volume (Fig. 1). Regeneration is obtained by combined inductive and capacitive feedback. (L5C3).

view, on next page, shows a vernier dial actuating each condenser. If condensers not of the same make or style are to be used, that is, a mixed assortment, a vernier dial may be used on the frequency condenser and on any other type of condenser—straightline capacity or straightline wavelength—a frequency dial with the same casing and external appearance as the vernier dial to give equalized tuning and utter identity of appearance.

The RF Transformers

Honeycomb coils were used because of their compactness. There are three. Two are of similar purpose and construction. Get two 75-turn and one 35-turn coils. The 75-turn inductances will have too many turns for easy tuning with a .0005

mfd. variable condenser (the type used) so remove 15 turns. This is easy. The honeycomb coil may be of the plain type, whereupon simply remove the sealing wax holding the end of the winding, and take off the 15 turns, cutting the wire, but leaving a 4" excess for connection purposes. Take the wire you have removed and wind it, one turn over another so far as possible, on a small vaseline bottle. Leave 6" excess at each terminal. If a piece of paper is placed on the bottle before the winding is begun it will be easier to slip off the new coil. When the coil is removed from the bottle, twine the ends of the wire around the winding in such a fashion as to prevent the coil from springing apart. This precaution, without the twining process, also should be taken when the coil is being removed from the bottle.

The new winding thereupon is placed inside the coil from which the same wire had been removed. The excess leads remaining on the small winding, which is the primary, are carried once or twice around the secondary, so as to make the primary stay snugly inside the secondary. It will be found that the diameter of the vaseline bottle is just a trifle less than the inside diameter of the honeycomb coil, hence the primary may easily be secured inside the secondary.

If the honeycomb coil has a fibre housing and is mounted on a base, then loosen one of the screws that hold the fibre frame to the Bakelite base, and pull out one end of the housing. The honeycomb coil may then be lifted sufficiently to reveal the two leads soldered to the connecting points that make contact with the prong and the socket of the base. Unsolder the lead that goes to the end of the coil. This lead may be identified readily, since it goes to the outside of the coil. Remove the 15 turns and cut the wire. Solder the new point to the open connection on the base and you are ready.

As both radio-frequency transformers are alike, the coil data apply to L1L2 and L3L4, where L1 and L3 are the respective primary windings, composed of the wire taken off the secondary. If .00035 mfd. condensers are used, do not remove any

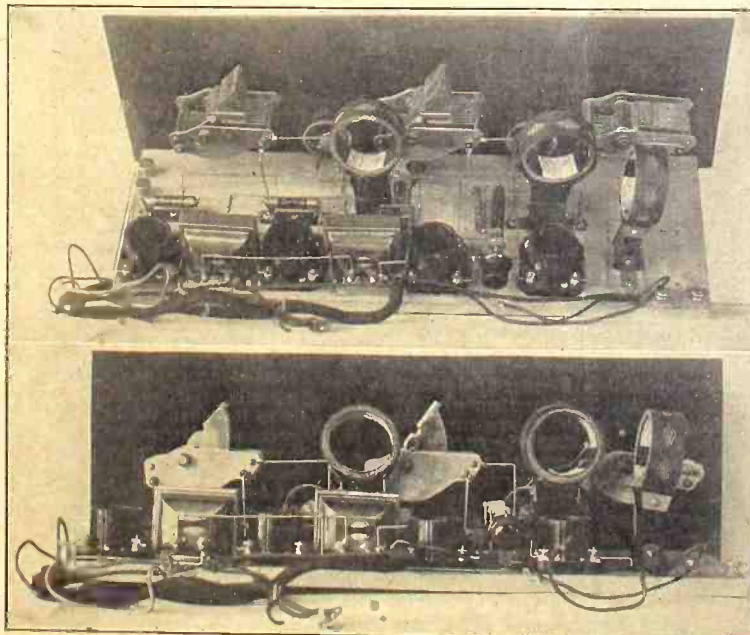

REAR VIEWS, the top one at an angle, the bottom one on a straight line.

The Panel and Top Views

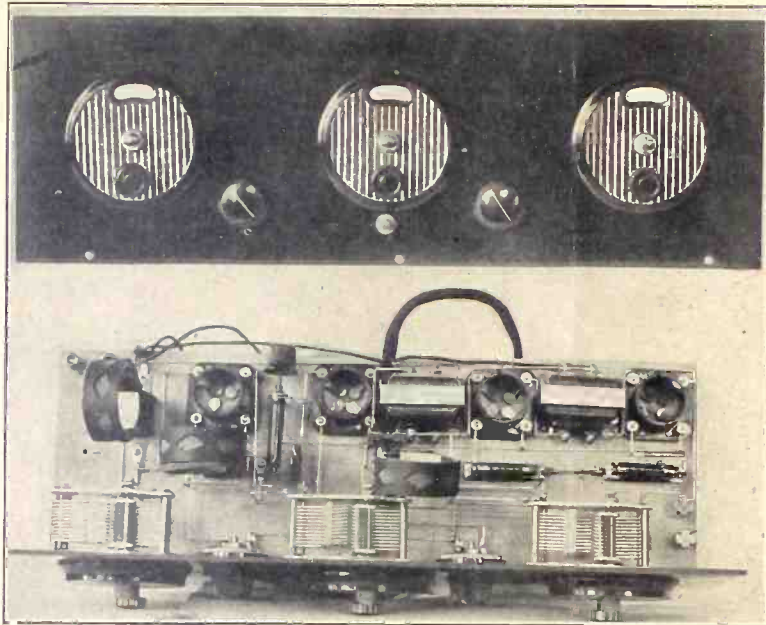

REAR VIEWS, the top one at an angle, the bottom one on a straight line.

wire, but wind about 17 turns of No. 24 single silk covered wire on the vaseline bottle to constitute the primary.

The Impedance Coil

The other coil, L5, is a single winding, and one may start with a 35-turn honeycomb coil, which will be more than enough inductance if C3 is .0005 mfd. However, after the set is completed one may take turns off this coil until C3, the regeneration condenser, tunes at approximately the same dial settings as do the other condensers. Those who find that the aerial circuit condenser, C1, does not run in step with C2 should not be surprised, as this is due to the different ratio between minimum and maximum capacity, the alteration resulting from the capacity coupling between L1 and L2, L1 being laden with much antenna-ground capacity.

In Fig. 1 some changes may be made, to suit the desires of the constructor. Further economy will be experienced if a C battery is used. With 90 volts on B plus amplifier, a 4½-volt C battery may be inserted in the grid return leads of the audio tubes. The line connecting the two F posts of the audio transformers is connected to C minus, while C plus is joined to A minus.

The set will oscillate freely, but this tendency is further controlled by the rheostat, R1, which is 30 ohms, for any type tubes. R2 may be 30 ohms, also, since the set operates well with the detector tube underheated. The audio stages have Amperites. If the tubes are of the 25 ampere, 5-volt type, then R3 and R4 are a 1-A Amperite each.

The B Minus Lead

The diagram does not show where B minus goes, as the constructor may make the connection to A plus or to A minus, direct from battery to battery. Otherwise connect A plus and B minus cable leads to the same point in the set, and join one cable lead to A plus at battery and the other to B minus at battery. This, of course, is the same inter-connection, but registered slightly different.

Points to Watch

The following points bear watching: The Bretwood Variable Grid Leak is mounted on the baseboard, and when the point of best setting is determined, that setting remains. As the Bretwood's resistance will remain unchanged almost indefinitely, there is no need of worry on this score. It is best to make a temporary adjustment of the Bretwood, then make a final one when a distant station is tuned in, or a local that comes in weakly, due to location conditions of shielding or other absorption.

The leads from the battery cable are soldered right onto the set wiring, and at the opposite or lug ends of the leads cable tags are pressed on, so that one may make battery connections without loss of time and without danger. If a 5-lead cable is used, and this will have identification by color scheme for each lead, the A plus and B minus connection may be made on the set, thus accounting for the five leads—A plus, B minus, A minus, B plus detector and B plus amplifier.

The regenerative action will be about as good, and in some cases better, if the return side of C3, represented by the stator plates, is made to A plus, instead of to the grid side of the coil L4. Also, if body capacity develops in C3 this change may be made.

Either phone tip jacks, as in the photographed set, or a single circuit jack may be used for the output.

For straightline frequency condensers, if used, Slo-Moshen Vernier Dials would be suitable, while if other than straightline frequency condensers are employed, then the Magic Dial should be chosen, and if there is an assortment of these types of condensers, get the proper dial for each condenser, and yet enjoy dials that have the same external appearance and which afford uniform tuning throughout.

The placement of the parts, both on panel and baseboard, is shown in the photographs. Mountings were used for the honeycomb coils, so that these coils might be plugged in, and left thus.

LIST OF PARTS

Two radio-frequency transformers, L1L2, L3L4, made from 75-turn honeycomb coils.

One 35-turn honeycomb coil, L5.

Three separate honeycomb mountings.

Three .0005 mfd. variable condensers, C1, C2, C3.

One 7x21" panel.

One 7x20" baseboard.

Four sockets.

Two 30-ohm rheostats, R1, R2, or one 30-ohm rheostat, R1, and one 20-ohm rheostat, R2.

One 5-lead battery cable, with tags (A+, B-, A-, B+Det., B+ Amp.).

One .00025 mfd. fixed grid condenser.

One Bretwood Variable Grid Leak.

Three 4" dials.

One A battery switch.

One pair of phone tip jacks.

Two mounted 1-A Amperites, R3, R4 (if -01A type of tubes are used).

Two audio frequency transformers (AF1, AF2).

In tuning the set the dial readings may be made to coincide as nearly as possible, and at many settings will be identical, if the coil matching is carried out carefully. It is well known that the machine wound honeycomb coils that are specified as having a given number of turns often vary from this number, although not seriously enough to avert covering the band of broadcast wavelengths. Yet for purposes of synchronized tuning this variation will prove objectionable, unless overcome. Therefore in constructing the set, if the best possible synchrony is desired, remove the turns as described, then temporarily connect L1L2 and L3L4 in the circuit. Tune in low wavelength stations, carefully noting the dial settings. Be sure that the dials are exactly adjusted, so that zero on the dial represents minimum or maximum capacity, as you prefer. Readings must be taken even to one-half of a division. If dial settings are not alike, remove a turn at a time from the secondary of the coil that required the lesser capacity setting (not necessarily the lower dial readings). If trouble of this sort is remedied at the higher frequencies it is unlikely to show up at the lower ones (high wavelengths), because of the comparatively small effect of larger capacity variations in respect to frequency change at that part of the broadcast belt.

The condenser C1 may tune what seems to be rather broadly, but this is not true in every case and depends largely on the oscillatory condition of the RF tube. At any event, it is the overall selectivity that counts, and one should not judge too severely any given stage.

To tune in a station move C2 slowly while C1 is moved from zero to 100 with a swifter motion. Leave C3 at minimum capacity setting. If no signal is heard, move C3 to less than the half-way point, or, if necessary, later give it a higher capacity setting. If a station within range is on the air it will cause a whistle to be heard, at least, or the signals will come in without a whistle. Then the tuning condensers, C1 and C2, may be adjusted until the signal is clearest, and C3 turned until the set is operated just below the point of over-oscillation. It may be necessary, on some of the low waves, to turn down the radio-frequency rheostat, R1.

The 1-Hour 3-Tube Set

By Chester Charlton

THE 1-hour set is not one that simply lasts an hour, but one that it takes only one hour to make. It will last for many years and will render excellent service.

The radio side of the circuit consists of the justly famous 3-circuit tuner. The audio channel comprises two stages of transformer coupled amplification. Hence the three tubes. All three sockets are a part of the Welty detector-amplifier unit. Only the radio side need be wired. The audio "works" are assembled at the Welty factory, and right smartly, too. The only change I made was to cut the 1" lead that came from the F posts of the two audio transformers to insert a C capacitor (as shown in diagram).

Coil Information

Any of the commercial 3-circuit tuning coils may be used in this circuit. The one shown tunes with a .0005 mfd. variable condenser. It has a pancake tickler. However, some other sort of tickler will do as well. For instance, if you wind your own coil, you may use a 3 1/2" diameter tubing for the stator, 4" high, placing 10 turns of No. 24 double silk covered wire near the top (L1). Terminate. Leave 3/4" space and wind 45 turns of wire in the same direction for the secondary (L2). The tickler would consist of as many turns of the same kind of wire as you can put on any tubing that will rotate inside the secondary. Remember that a shaft has to pass through the secondary, hence wind the tickler coil so as to leave anchorage room thereon for the shaft where it must be joined to the tickler form.

A straightline capacity tuning condenser was used. This has semi-circular plates. The fact that the condenser has an insulation end-plate does not mean that the condenser is not low-loss. It is. To make the tuning more convenient on the lower waves, and yet avoid crowding

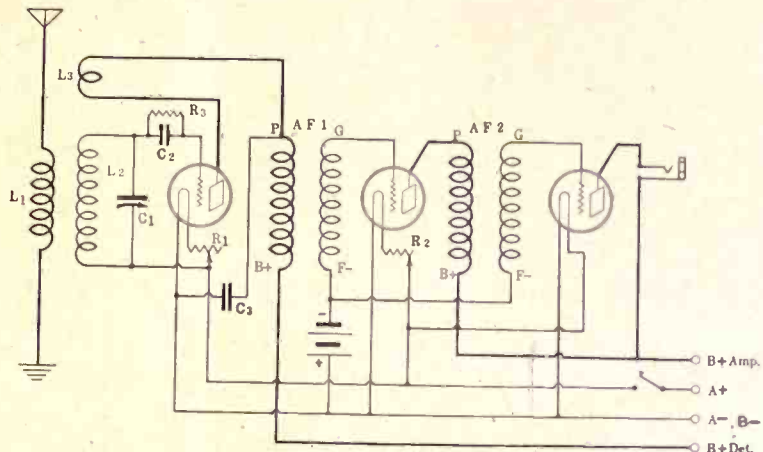

THE CIRCUIT DIAGRAM of the 3-tube set that was completed in one hour. Anybody can duplicate this result, as there was no wiring to be done in the audio channel, a completed unit being used.

on any part of the dial, a converter dial was used. The condenser and the dial are of the Rathbun make.

As the amplifier unit and detector socket are furnished by Welty, you need get only a 7x18" panel, a .0005 mfd. variable condenser, a dial (vernier, if you use frequency condensers, or a converter or Magic Dial if you use semi-circular coil, a 7x17" baseboard, a grid leak, and a knob.

The layout of the parts, as confirmed by the photographs, is very simple. As the condenser is the only real tuning element, it alone has a dial. The tickler coil is turned by means of a knob, even a rheostat knob, or, if desirable, a 2" dial may be used here. The rheostats, jack and even the fixed condensers, including the grid condenser, are part of the Welty outfit.

The wiring precautions include these:

connect the rotor plates of the variable condenser to the grid return side of the coil L2, the 45-turn coil, if you make your own. This is the connection made to A plus. Connect the aerial coil so that the ground and A plus connections adjoin. This accounts for two terminals, one each of primary and secondary, and the other connections of these windings go to aerial and grid condenser, respectively. The tickler or movable coil may be joined to the plate of the detector tube in either manner, that is, either terminal to plate.

Actual Time, 57 Minutes

The set shown in the photographs was completed in 57 minutes, but we will call it an hour. This included the drilling of the panel and the mounting of the dial, two items that require a little care and hence took a good fraction of the time. There are only about a dozen connections to make. The leads are brought out to binding posts on the unit, and a marked battery cable should be used for convenience in establishing contacts at the batteries.

Brushing Up Helps



A BRUSHING will do your batteries some good. Dirt and dust that may collect on terminals absorbs moisture from the air and may imperil contacts. (Hayden)

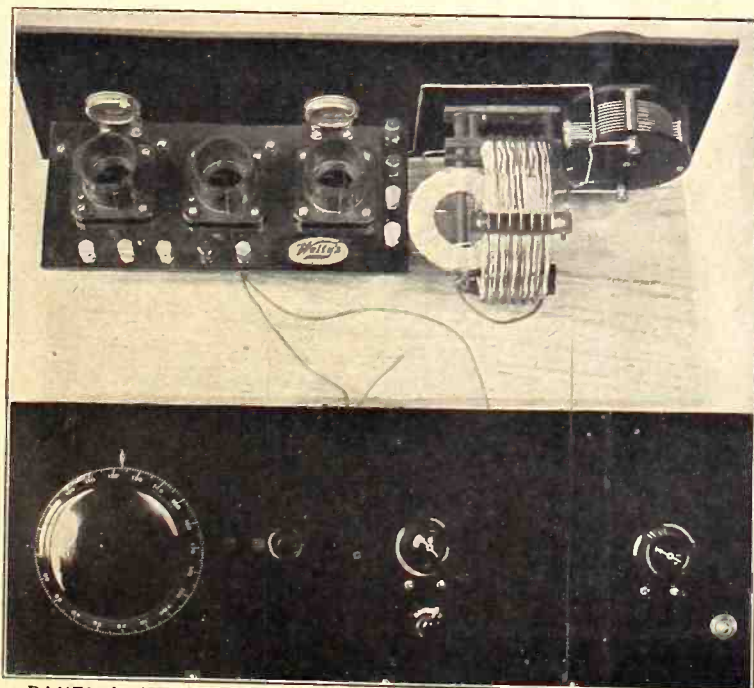

PANEL AND REAR VIEW of the receiver that was completed in one hour.

An All-Wave Regenerator

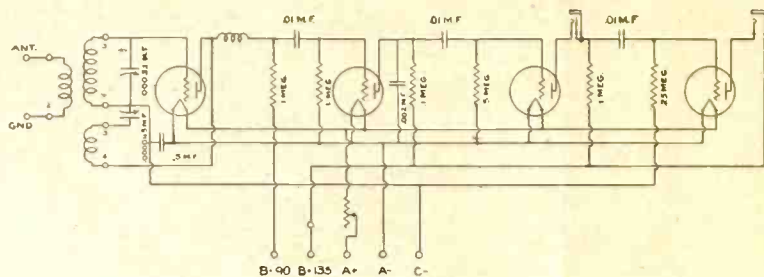

THE ALL-WAVE SET shown schematically. The coil in series with the detector plate is an optional choke, 300 turns of No. 32 DCC wire on a 1" diameter tubing. In nearly all instances it will not be necessary. The fixed condensers used for coupling (marked .01 mfd.) are a part of the resisto-coupler.

By *McMurdo Silver*

Associate, Institute of Radio Engineers

THE last ten years have seen the rise, fall and decline of the simple regenerative receiver in public favor, but strangely enough, this system, when the last sad rites were about to be said over its supposedly defunct form, became gradually imbued with new life and is now well on the road, not merely to recovery, but to enjoy at least in a measure, a certain amount of its former prestige.

It has been fairly conclusively demonstrated that a good regenerative receiver on wavelengths below 200 meters is about as efficient a set as is required, for the transmission efficiency of even low powers at high frequencies is very great. In another sphere the regenerator seems to be regaining its position slowly—that of reception in rural localities. Where a short time ago the farmer desirous of receiving distant stations felt it necessary to employ an expensive receiver of the tuned-radio frequency type, today finds the apportionment of broadcasting stations throughout the country such that there are few isolated areas where a good regenerator will not serve to bring in satisfactorily most of the 300 to 700 mile distant stations.

The popular regenerator of several years ago with a pair of massive variometers, a variocoupler and a miscellaneous agglomeration of dials and switches is now obsolete.

Control Amplification

In place of the many-control regenerator formerly used, the trend in design today is to the utmost in simplicity—not necessarily by the elimination of valuable controls, but rather by providing means of adjusting certain constants which of late have been discovered to be non-critical to the particular operating condition to be encountered, yet placing on the instrument panel only those few critical controls necessary for the operation of the set once it has been adjusted to individual local conditions.

Further, since one of the most important future spheres of the regenerator is in short wave reception, a practical receiver should be capable not only of covering the regular radiocast channels but also of tuning down to the lowest waves where broadcasting is in use. It should also be capable of having its wavelength range extended above the regular radiocast band so that the operator may at least listen for the longer wave European stations. Since the prospective builder will no doubt be more interested in broadcast reception than in amateur

work, to which such a receiver is nevertheless admirably adapted, the audio amplifier used should be capable of reproducing with a minimum of distortion all frequencies required for satisfactory speech and music transmission, assuming a good loud speaker to be used.

The Circuit Used

Such a receiver is illustrated in the accompanying pictures. The simplicity of the design is evident at first glance, for all unnecessary controls have been eliminated from the panel, with the questionable exception of the rheostat. The panel upon which the controls are mounted is a standard 7x18" size of Bakelite. The large central dial is the wave-length control, while the smaller knob to the left is the regeneration condenser. To the right is the rheostat controlling all tubes, and in the extreme right corner the on-off switch and output jacks.

Before considering the layout of the receiver, some attention should be given to the circuit. This consists of a standard feedback regenerative detector followed by three stages of resistance coupled audio amplification. The detector tube functions with a negative grid bias for rectification rather than the conventional grid condenser and leak. The reason for this is primarily one of convenience, for while theoretically a grid-biased detector provides lower circuit resistance with consequently greater selectivity, in actual practice this method of rectification produces the same resultant signal as a grid-condenser-leak rectifier and is accompanied by less noise. However, the chance of trouble with the leak and condenser is eliminated and the system consequently simplified, since the same C battery is used for both audio amplifier and detector.

The Tuning Condenser

A straight-line-frequency condenser of 350 mmfd. (.00035 mfd.) capacity is used for tuning, this size not being too small for good operation on the longer waves, nor is it so large as to make tuning unduly difficult on the lower waves. The regeneration condenser—a small standard midget—is so arranged that its rotor is at ground potential.

A slightly preferable method of controlling regeneration would be to eliminate entirely the balancing condenser and to connect windings 5 and 6 in place of the choke shown, with terminal 6 to the plate and terminal 5 going to the 1/10th megohm resistor. Then from terminal 5 to the minus side of the filament line would be connected a .002 fixed condenser. Regeneration could be controlled in an extremely smooth fashion by a 25,000 ohm

LIST OF PARTS

- One .00035 mfd. SF condenser (S-M No. 311).
- Three resisto-couplers.
- One 6-ohm rheostat (Yaxley No. 16K).
- One interchangeable inductance, 190-550 meters (S-M No. 111A).
- One inductance coil socket (S-M No. 515).
- One .5 mfd. bypass condenser.
- Four UX type sockets (S-M No. 510).
- Three .1 megohm micamold resistors.
- One 1.0 megohm Micamold resistor.
- One .5 megohm Micamold Resistor.
- One .25 megohm Micamold Resistor.
- One .002 mfd. Micamold fixed condenser.
- One 1-spring jack (Yaxley No. 1).
- One 2-spring jack (Yaxley No. 2A).
- One filament switch (Yaxley No. 10).
- One Vernier Dial (S-M No. 801).
- One 7x18x $\frac{1}{8}$ " Bakelite panel.
- One 7x17x $\frac{1}{2}$ " oak baseboard.
- Accessories: Twelve No. 6 R.H.N.P. brass wood screws, $\frac{3}{4}$ "; two No. 6 R.H.N.P. brass wood screws, $\frac{1}{4}$ "; five lengths bus bar wire, 12 feet total length; one 5 lead color cable—Belden.

resistance such as a Centralab Radiohm connected across windings 5 and 6. The writer personally prefers this method of control to the use of the small midget condenser.

The coil system is of a new interchangeable type, with winding forms of low-loss moulded Bakelite, 4" long. Each form, which is identical to every other, is arranged with six raised ribs on its surface so that the windings touch the periphery of the form only at six places. The bottom of each form consists of a reinforced ring carrying six contacts to which the winding ends are soldered, with the exception of two, which make contact with springs inside the form which hold a small adjustable rotor, which may be removed if desired. The coils plug into a special six-contact socket provided for them.

Efficiency is High

This provides not only a low-loss arrangement due to a favorable form factor and inductance design, but a very flexible one as well, for to shift the entire wave range of the receiver it is merely necessary to pull out one coil and plug in another—an operation consuming about ten seconds. Since no switching arrangement is employed other than this, and as consequently no dead coils are in the receiver when not in use, the overall efficiency of the arrangement is quite high, particularly at short waves.

The fact that the coil forms are provided with adjustable rotors used in the antenna circuit permits of adjustments which will afford greatest efficiency for each wavelength range to be covered. Further, it is possible to loosen up the coupling so that the radiating effects of the set may be reduced, if not entirely eliminated so far as other neighboring receivers are concerned in case the regeneration control is advanced too far.

The audio amplifier is of the three-stage resistance type using constants suited to standard tubes available. The coupling condenser—.01 mfd.—together with the grid leaks have a tune constant such that it will not interfere with the passage of the entire frequency range used in speech and music transmission. The condensers are large enough so that noticeable dis-

Silver's 4-Tube Circuit

crimination in favor of the higher frequencies will be absent, but not so large as to provide a combination with an unfavorable discharge period.

The schematic wiring diagram contemplates a UX112 tube in the last stage, with 9 volt C battery and if dry cell tubes were to be used, a UX120 tube, with 18 volts C battery and 150 volts B battery would be preferable in the power stage.

The Series Method

It will be noticed that according to the diagram the phones are cut into the output of the second stage in series with the coupling resistance, thus not disturbing the operating characteristics of this particular tube. Were this resistance to be cut out in favor of the phones as is customary in jack switching, then a C battery should be cut in to take care of the change in effective operating plate voltage due to the difference in phone and coupling resistances.

The actual assembly of the receiver is quite simple, and is well illustrated in the rear view of the set. The coil, with its rotor clearly visible, is at the right of the baseboard, while directly in front of it is a .5 mfd. bypass condenser across the C battery to prevent reaction, as it is used in both detector and amplifier circuits. The small mica condenser, visible in an upright position between the middle coupling resistance mounting and the tube socket, is a .002 bypass from plate to filament of the first audio amplifier. This condenser, normally connected from plate to filament of the detector, cannot be so connected in this circuit for in this position it would prevent regeneration. It frequently happens that the capacity of the set wiring, or of the primary of an audio transformer, is sufficient to accomplish this in a circuit of this type. Should this be the case, a choke coil as depicted in the diagram will be necessary, connected as shown and located some few inches away from the tuning coil system. Such a choke will seldom be necessary.

The tube sockets should be suited to any of the new UX tubes and due to the design of practically all UX sockets, the tube when being inserted should not be pushed directly down, but instead worked slowly around until it slips down naturally as otherwise the socket springs might be damaged and the tube burned out.

To build the receiver, the list of parts shows what material will be required. It is needless to suggest that substitution be not indulged in by the prospective builder unless he is thoroughly familiar with the electrical requirements of each item, particularly as all parts listed are of standard reputable manufacture.

Wiring Directions

In wiring the set it is necessary to remember that all possible wiring be installed on the baseboard and panel separately, then the two screwed together, and the few remaining connections made. No binding posts are shown, as the antenna and ground connects to posts 1 and 2 of the coil socket, and the battery leads come in through the color cable, the ends of which terminate directly in the set wiring.

For operation, four tubes will be required, three 45 and one 22 volt B battery, at least one 4 1/2 volt C battery and a 6 volt storage battery for the 201A type tubes, or six dry cells connected in series parallel for the 199 type tubes. An antenna from 60 to 100 feet long, preferably outdoors, will be entirely satisfactory.

In testing the receiver, only the A bat-

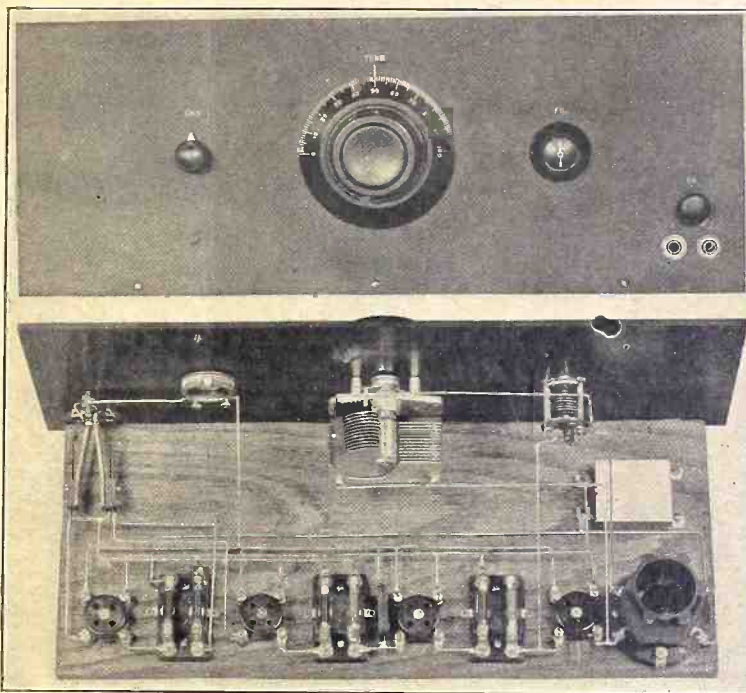

THE PANEL LAYOUT is simple and attractive. The baseboard arrangement is shown without the choke coil.

tery should at first be connected, a tube inserted, the switch turned on, and the rheostat barely turned on. If it lights in each socket, the wiring is probably O.K. It should be further checked by removing the A plus lead and substituting for it the B plus leads one after the other, with which connections the tube should not light if the set is wired correctly and everything O.K. If so, then the B and C batteries may be connected, the tubes inserted and the antenna and ground connected. For 199 tubes, the rheostat should be barely on—for 201A tubes practically all the way on.

Coil Data

For all waves from 50 to 500 meters the inductance coils may either be purchased or wound on forms available on the market. For other waves they must be wound by hand as none are available ready wound. The winding specifications are given below, it being borne in mind that 1-2 is the rotor, 3-4 one of the stator coils, and 5-6 the other. If ends 4 and 5 were connected where they are adjacent in the middle of the stator form, then a continuous winding would be formed with ends 3 and 6 and center tap 4-5. B and C coils are space wound, each turn being separated from the next by winding on two wires simultaneously, one of which is later removed. The rotor need not be space wound. No. 26 DSC wire is used, held in place by collodion, or anyl-acetate in which celluloid has been dissolved. The E size coil is layer wound, the stator having three layers.

Type	Range in meters	Coil 1-2 1 1/2" tube	Coil 3-4 2 1/4" tube	Coil 5-6 2 3/4" tube
110A	190-550	30T	45T	45T
110B	90-210	16T	17T	17T
110C	50-110	6T	8T	8T
110E	500-1800	60T	125T	125T

With one coil inserted in its socket, the regeneration condenser should be turned in until the set nearly oscillates, and the tuning condenser slowly rotated.

If a station is heard as a whistle, the set is oscillating and the regeneration condenser should be cut out until only the voice of music is heard, as an oscillating condition in the set should not be tolerated. Once heard, a station may always be tuned in at approximately the same dial setting providing the position of the small rotor coil has not been materially altered.

Locating Stations

It is fairly easy to locate a station not previously heard providing only its operating frequency is known, by the following method. To operate by this method, it is necessary to know the frequency range covered by given coil system. Let us take the coil which gives a range of roughly 1580 to 545 kilocycles. 545, the minimum frequency, subtracted from 1580, the maximum frequency, gives 1035, the number of kilocycles covered by a 100-degree rotation of the tuning dial. Obviously, one division on the dial is equal to 10.35 k.c. or, roughly, one transmission channel per dial degree.

Suppose, now that we wished to locate station WHT, operating on 400 meters or 750 k.c. 545 or the minimum frequency, subtracted from 750, the station frequency, leaves 205 k.c., which divided by 10.35, the number of kilocycles per dial division gives between 19 and 20 as a result. This means that station WHT will be heard at between 19 and 20 on the dial.

Father Seeks Son, Missing 19 Years

H. D. Bullock, of South Richmond, Va., wrote to RADIO WORLD:

"I wish you would try find my son. He has been gone nineteen years. His height is 5ft. 2 in., dark complected, dark hair, blue eyes, left arm stiff. I have tried to find him by radio with no results as yet. What you can do to find him will be appreciated. Any one locating him will be rewarded."

A Practical B Supply

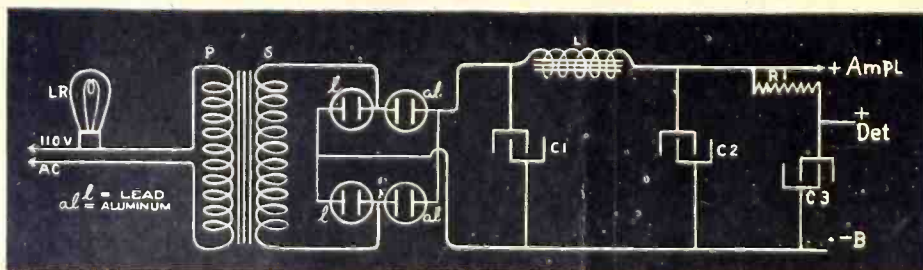

FIG. 1, the circuit wiring of the B power Unit,

By Capt. P. V. O'Rourke

At present there are available quite a number of B battery substitutes. These fall into three general classes depending on the principle of rectification; first, the two element rectifier tubes, second, the gaseous rectifier tubes and third the electrolytic rectifiers. The latter principle is, in my opinion, well suited for operating receivers and is, therefore, taken as the subject of this article.

One of the greatest advantages of the electrolytic rectifier is its ability to furnish a comparatively large output as compared to tube rectifiers. This quality allows the use of a highly refined filter system and elimination of AC hum or power noises.

In principle all B current supply units are alike. They consist mainly of three parts: the power transformer which steps up the house voltage, the rectifier and the filter system.

Transformer Favored

Some B units are being made without a step-up transformer but these are not practical, as the power delivered by them rarely is sufficient for good quality reception. Also, if such units are connected wrongly, there is a possibility of blowing out the tubes on the receiver. With a power transformer in the B unit the house voltage is insulated from receiver and even if connected wrongly, it is impossible to blow any tubes. Besides, to get as high as 90 volts on some receivers it is imperative to step up the line voltage to overcome the loss caused by the filter system. Right here it should be emphasized that B current supply units do not have the same voltage output on every receiver, as the voltage depends on the amount of B current drawn by the receiver. For this reason it is necessary to provide some sort of adjustment so that the B unit can be regulated to suit the receiver on which it is to work.

In the Molliformer B unit, which is described herewith, this is done by placing an ordinary house light in the primary side of the power transformer. If, for instance, the B unit has an output of 80 volts with a 10-watt lamp, the use of a higher wattage lamp will give a higher voltage. This feature also permits overcoming either a higher or lower line voltage.

Both Sides Rectified

Referring to Fig. 1, the secondary S of the power transformer is connected into what is technically known as a bridge rectifier. This arrangement provides rectification of both halves of the alternating current wave. The output of the rectifiers is now direct current, not a steady flow

but small shots or pulsations. If this current output were used as such it would cause a strong buzzing sound in the receiver. For this reason it will have to pass through the filter system. This consists essentially of a choke coil, called a Molliformer, where the pulsations are "ironed out." Associated with the choke coil are condensers of suitable capacity. These act as storage tanks and it is from them that the current is supplied to the receiver.

The lead coming from the posts marked "al" forms the positive tap and serves for the amplifier tubes. The lead from the posts marked "l" forms our negative tap. In order to get the necessary voltage for the detector tap a fixed resistance is tapped into the amplifier line and shunted with a by-pass condenser of 1 mfd. capacity or larger. If the receiver is operated with a soft tube (such as UV200) it is necessary to employ a Bradleyohm No. 10 in series with the fixed resistor. This allows a very fine adjustment of the plate voltage for soft tubes.

High Ratio Needed

The most important part of the Molliformer B unit are the rectifiers. These must be able to deliver a high DC AC ratio and should work for a long time without renewal of the solution. Much

improvement has been made along this line. The positive electrode consists of a rod of a specially refined aluminum, which has a purity of 99.80%. The use of pure aluminum is imperative, as ordinary metal will not work or only fair. For the negative electrode, which in the old type of rectifiers consisted of lead rods or strips, a special graphite rod is being made use of. This has the advantage over lead in that it does not corrode and the solution itself is not decomposed, as graphite will not combine with the chemical.

In the matter of electrolyte much progress has also been made. Where formerly the average amateur has been using ordinary borax solutions, far better chemicals are available today. These are mostly secret compounds, but can be had readily from various manufacturers. The salts used in the rectifiers supplied with the Molliformer B unit are chemically pure and give the aluminum electrodes a long lease of life. Borax on the other hand is hard on the aluminum and should, therefore, not be used.

The aluminum rod is provided with a sleeve of pure gum which exposes the right amount of metal to the solution and also prevents sparking at the surface of the electrolyte which in time would corrode the electrode.

Inductance 125 Henries

The inductance of a choke coil to be used in a filter system must be very large in order to remove all AC hum and other power noises. In the case of the Molliformer this has an inductance of 125 henries at 60 cycles and no coil of less than 100 henries should be used if DX reception is looked for with a B unit. With the Molliformer B unit there is so

(Concluded on page 30)



FIG. 2, a photographic view of the completed unit.

The Frequency Dials

By Herman Bernard

Associate, Institute of Radio Engineers

IN the evolution of tuning from the straightline capacity or straightline wavelength to straightline frequency it was only natural that, besides straightline frequency condensers that accomplish the desired spreadout of low wavelength stations, dials should be invented that achieve the same end, although used on straightline capacity condensers. That these new dials actually do what they are supposed to do is well proven by experience with them. Curves (Fig. 1) show how two of them operate on frequency tuning characteristics. The other line represents theoretical straightline frequency variation. The curve T represents the use of a Tunerite dial, manufactured by the Radiall Co., and the curve marked B is that of the Bruno Magic Dial.

Aids Existing Sets

The object served by this type of dial is largely to accommodate existing sets to the more convenient and popular method of tuning, without necessitating ripping the set apart to put in straightline frequency condensers. Many sets with the semi-circular plate condensers are very efficient, as they are, and their owners are well satisfied with them, excepting only that the tuning on the low wavelengths is made so difficult by the crowding together of these stations in respect to dial reading. The frequency type dial, therefore, is a converter, in that it alters the dial readings, and makes them about the same as they would be if a straightline frequency condenser were used. The theoretical straight edge shown in Fig. 1 represents something that no straightline frequency condenser can achieve under all conditions, and perhaps under few if any conditions.

Merits of the Method

On the subject of frequency tuning as a whole, no just denial can be made of the fact that the low wavelength stations are spread out, and that this is desirable. Please note, too, that the three great frequency dials—the Rathbun Converter, the Radiall Tunerite and the Bruno Magic Dial—turn through a full swing of 360 degrees, or a trifle less, so that not only are the low wavelength stations spread out on the dial because of the converted tuning, but the swing of the pointer or scale is double that encountered in the run of dials, hence here alone there is twice as much room in which to work. When one realizes that any spreadout of the lower waves must necessarily be at the expense of somewhat bunching the station dial readings on the higher wavelengths, the advantage of a longer dial roadway is clear. As a theoretical comparison, if a 10" ruler represented the scale of a dial, with stations of 100 different wavelengths represented thereon, most of them bunched near the lower end of the ruler, if the ruler were extended to 20" in length, the actual space between the dial readings for all the stations would be doubled. So the dial that turns through 360 degrees, instead of the usual semi-circle, in itself effectuates a 100 per cent. improvement on dial space distribution. Now, if a dial is so constructed that it uncrowds the low wavelength stations, as to dial readings, distributing stations comparatively evenly over the dial or ruler, the inequality is cured, but the higher wavelength stations will be made to come in at settings closer together than under the original condition. The question there-

Curves Showing Tuning Characteristics

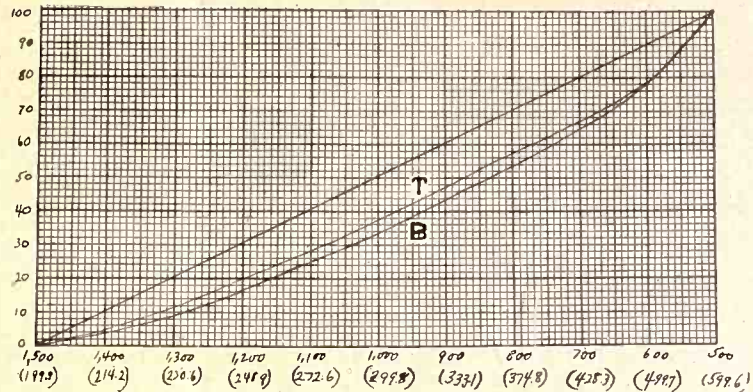

THE curves of two frequency dials, obtained by using them with a .0005 mfd. Rathbun semi-circular plate condenser, and compared with straightline frequency (Fig. 1). The straight edge is a theoretical curve while curve T shows the operation of Tunerite and Curve B that of the Bruno Magic Dial. The frequencies in kilocycles are shown horizontally (with wavelength conversion per kilocycle) and the dial settings vertically. The curves confirm the efficacy of this type of dial.

fore arises whether the unscrambling of dial readings at one end is not made at the expense of widely separated dial readings becoming scrambled at the opposite part of the scale. The frequency converting dial, with its combined unscrambling of the lower wavelengths, and an independent doubling of dial separation, preserves linear separation very well at the upper end, because the potential vice of shifting the crowd from one position to the other, while not getting rid of the crowd, is never existent.

The Frequency Condenser

Compare with this result the one obtained from the use of a straightline frequency condenser, with an ordinary vernier dial. The condenser in nearly every case rotates through an angle of 180 degrees from minimum to maximum capacity. The low wavelength stations are spread out, and this is true in the case of every straightline frequency condenser on the market. The higher wavelength stations come in closer together on the dial reading than if the straightline capacity or straightline wavelength condenser were used. How serious is this compression? Not at all serious. For example, the old tuning practice gives 10 degrees dial separation at the upper end, say, between WEAF and WJZ, with a frequency separation of 50 kilocycles, while between 1,400 and 1,450 kc, the same difference in frequency, there would be a dial separation of only two divisions. Hence there is ample room at the upper end for moving the stations closer together in point of dial reading, and this justifies the use of the straightline frequency condenser. Hence frequency tuning is preferable in any case, and the individual himself will decide whether to achieve this by frequency dials on semi-circular plate condensers or by plain dials on straightline frequency condensers. Most fans nowadays purchase straightline frequency condensers and plain vernier dials, unless they have a particular preference for some type of semi-circular plate condenser, for electrical and mechanical reasons, and still desire the convenience of frequency tuning. Then their

solution is the frequency dial, and they swell the other and larger group, representing those who want to use the converter dials on sets or condensers they have already.

On the subject of the superiority of frequency tuning to straightline capacity tuning (without conversion), the power question is often raised. The argument is that frequency tuning is not all that it is cracked up to be, because it ignores the power of the transmitting station and its distance from the point of reception, hence the power of the input into the receiver. Strong stations drown out weaker ones, and where one dial division approximately equals the frequency separation between channels, only theory is served, and practice ignored, on account of strong power making a station occupy what relatively amounts to several channels, thus upsetting the whole calculation. The answer is this: the power question is irrelevant, being beyond control by any receiver no matter which system of tuning is used.

The Frequency Dial Mechanism

When frequency tuning is accomplished by the dial method, it is always because of cams or gears so placed and used in the dial as to afford slow dial motion on the low waves and fast motion on the high waves, even with the condenser turning at the same rate of speed. The Bruno Magic Dial and the Rathbun Converter use the cam principle, although in different ways, while the Tunerite dial has gears.

How well the frequency dials accomplish this spreadout is shown in Fig. 1, which represents curves made with the aid of an oscillator and a current squared galvanometer, the oscillator producing the frequency, which is changed by rotating another condenser, and the galvanometer revealing maximum current flow, in other words being used as the indicating device. As no tube was used in the measured circuit, from which the curves were derived, the tube capacities were absent, hence the frequency or wavelength range was greater than it would be in a broadcast receiver, due to higher ratio between minimum and maximum capacity.

Mysteries of Fading, Body Capacity, Dead Spots and Static Remain Unsolved

By Hugo Gernsback

OF all the arts, radio presents more mysteries than any other. The reason is, perhaps, that the art is as yet quite young. To be sure, we have mysteries or rather things that we cannot explain in most of the arts. But in a world where we never will know the how and why of most things, it cannot surprise us that in such a complicated science as radio mysteries abound.

Of course, when we come right down to it, our knowledge is extremely limited. We have played with electricity for a century and a half and yet do not know what it is. We have known life and its mysteries for thousands of years and still we do not know what life really is. As a rule we only know the effects of things, but we do not know the reason for their existence.

The Problem of Fading

Turning to radio, take for instance, fading, one of the common radio mysteries. You listen in with your good three- or four-tube set to a station 1,000 miles away. You do not touch your set at any time, and the concert to which you listen and which comes in strongly suddenly starts to fade out, growing weaker and weaker until finally you cannot hear it at all. Soon the condition reverses itself and the concert comes in, faint at first, then loud, until it is back to normal audibility.

The radio expert will tell you that the answer to this mystery is a common, everyday garden variety of cloud. Says he, a cloud will be interposed between your radio set and the broadcast station, and while the cloud is in the way, the fading occurs. A good explanation.

A Different Case

However, your friend sitting at your elbow is using a supersensitive outfit, let us say a Super-Heterodyne. He does not use an outdoor aerial as you do, but just a loop aerial. He is listening to the same station, and he does not experience any fading at all. The expert will immediately tell you: "Ah, the second set is so sensitive that the few waves that get through the cloud are picked up by the Super-Heterodyne." Also a good explanation, but somehow not very convincing.

Next on the list are dead spots. For instance, if you are in a large city surrounded by skyscrapers or other large buildings, you will find that it is extremely difficult to receive from certain broadcast stations. In other words, you are located in a dead spot where receiving is extremely difficult. We know that large buildings absorb energy and tend to cast

a sort of shadow for electromagnetic waves over certain sections, which then become known as dead spots. On the other hand, there are large regions free from any obstruction, and these are also dead spots. Certain parts of the Atlantic coast, which are flat and without obstructions of any kind, are notorious for poor receiving. Here the explanation of build-ups as obstructions does not hold good, but these dead spots exist and even the radio expert is hard pressed for a plausible answer.

DX on Crystal Sets

Next we come to the crystal records—a deep thorn in the flesh of every radio expert since radio began, and particularly since the advent of broadcasting. The crystal set is supposed to work only within 15 and probably no more than 25 miles from the average broadcast station. No reputable manufacturer will claim a greater distance. Hundreds and thousands of crystal sets perform well within these limits, but increase the distance to 30 or 40 miles from the broadcast station, and a crystal set becomes as silent as a tomb. That, is 99.9 per cent. of them do. On the other hand, every radio paper is frequently in receipt of letters from crystal set owners who receive up to 500 and 1,000 miles without any trouble.

Moreover, they can cover these distances regularly at will; in other words, not because of freak atmospheric conditions. The radio editors promptly send out investigators to inquire into these extravagant statements, and to their surprise they find that the statements are true. Here, then, is an impossible situation. The radio expert steps in and says that the crystal set is simply receiving energy from some vacuum tube set nearby but this is also investigated and found not to be so, because in certain cases investigated there was not a vacuum tube set within a 50-mile radius. Furthermore, a crystal set owner can get stations he wants at will, consequently there could be no question of borrowing the energy from a nearby vacuum tube set. Moreover, the crystal sets that accomplish the impossible often are very mediocre, and as a rule, are home-made, being of the same old circuit with the same old galena crystal.

Body Capacity

We next turn our attention to body capacity. This also presents many conundrums. Body capacity, as every broadcast listener knows, refers to the howling heard in the phones or loudspeaker which is produced in your set, particularly when listening in to long distance stations, when the hand is brought near certain parts of

the outfit. It is not always necessary to bring the hand near the outfit. For instance, I once had a large set which was so sensitive to body capacity that when listening to a DX station, if I walked away from the set, the station faded out, but came in strong again when I walked toward the outfit.

Experts tell us that our bodies act as a sort of condenser plate which, having a certain amount of capacity, disturbs the very fine electrical equilibrium in a vacuum tube outfit. They also tell us that in certain cases the body acts as an aerial and collects waves which tend to upset the electrical balance in the radio outfit when the hand or other parts of the body are brought near it.

But we were not convinced by this explanation, so the other day we suspended a large piece of tin sheeting on a string which was attached to a walking cane, and moved the tin sheeting close to the radio outfit while it was in operation. The capacity of this tin sheet was actually larger than that of a man, but strange to say, nothing happened, and it did not disturb the reception to any great extent.

To be sure, there was a slight effect, but not at all to be compared with the effect produced by the human body—which causes me to question: Are there many kinds of body capacity, or does another element enter into it, when we put our hands on a condenser knob, bringing forth cat-calls and shrieks in the loud-talker? This statement is made with diffidence, because we may immediately start the spiritualists and others to work on body capacity effects. But, who knows, perhaps something will come of it if the phenomenon is really investigated by scientists and radio engineers—which so far has not happened.

Then we have our good old friend, or rather arch enemy, static. What our experts and scientists do not know about it would fill many heavy volumes. If you look through the literature on static, you come to the following results: 1, there is no static; 2, there is static; 3, we do not know the origin of static; 4, we know it; 5, static travels in a wave form; 6, static is an electrical surge, and so on, ad infinitum. In the meantime, when the conditions for static are really good, that is, in the winter time, when the air is really dry and when static electrical effects are much greater than in the summer, we have no static. But in the summer time, when electrical conditions are poor, and when theoretically, we should not have static, we have whole carloads full of it.

(Broadcast from WRNY)

SECOND CHILDHOOD

By Dan Napoli



A Simple 4-Tube Set

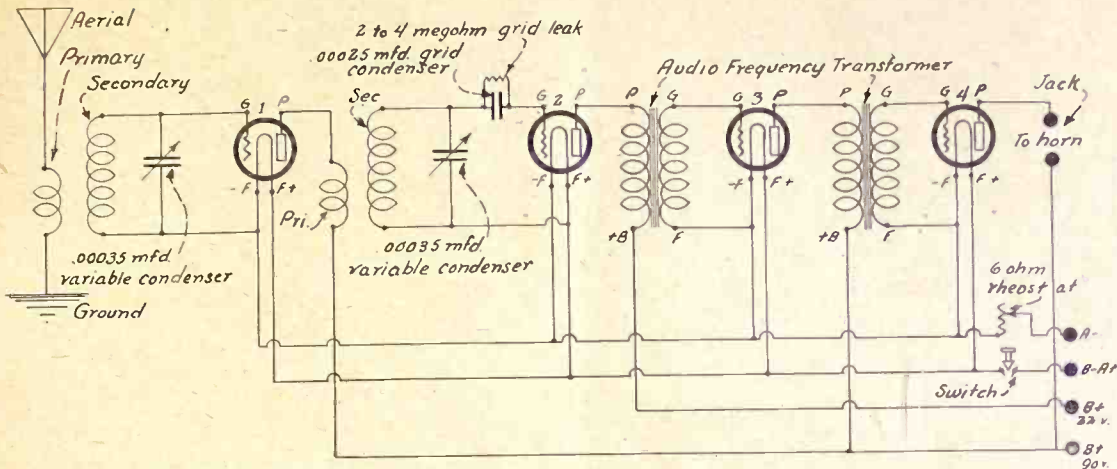

FIG. 1, showing the electrical diagram of the receiver

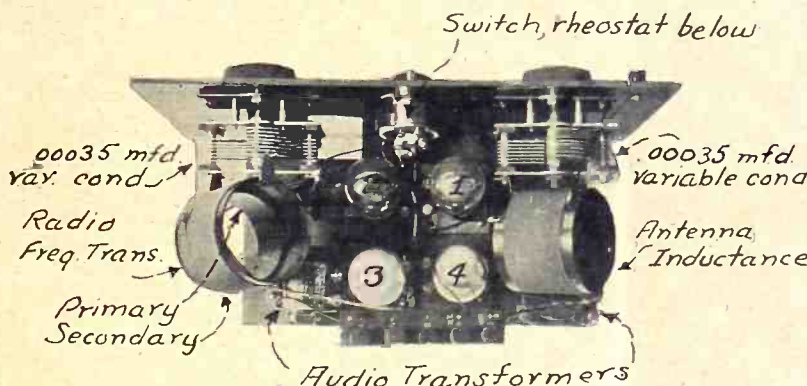

FIG. 2, looking down upon the set

By Capt. William Brill

A 4-TUBE receiver for receiving local stations, employing one step of tuned radio-frequency amplification, a non-regenerative detector and two steps of transformer coupled audio-frequency amplification, is shown in Figs. 1, 2, 3 and 4.

All the parts that comprise the receiver are placed so that they fit into a 7x18" cabinet. A baseboard is employed. Here the audio-frequency transformers, sockets and binding posts are mounted. This baseboard is 10" long and 7" wide. The first AFT is placed at the extreme left-hand corner, while the second and last AFT is placed at the extreme right-hand corner. This can be best seen in Fig. 3. The sockets are placed in between the AFT, in a square fashion. That is, the sockets holding the detector and RF tubes are next to each other and sockets holding tubes 3 and 4 are in back of 1 and 2 respectively. This can be seen clearly in Fig. 2. The binding posts are mounted on a pair of brass rods, which are about 6" from the baseboard. The coils are mounted on back of the variable condensers at an angle of 57.3 degrees. The holes for the shafts of both variable condensers are 3 1/2" from the left and the right hand, as well as 3 1/2" from the top and the bottom of the panel. The rheostat which controls the filament action of all the tubes is 9" from the left and right hand and top and bottom of the panel. In other words, it is in exactly the center. The switch is located at the top of the rheostat, or 2" from top and 9" from

both right and left-hand edges. The jack is 1 3/4" from the bottom and 9" from the right and left-hand edges. The antenna and the ground posts may be placed on the outside of the panel, as per photo, or on the same strip as the battery binding posts are located.

The coils are of the regular neutroform-type. Tubing 3/4" in diameter and

3" high are used to wind the secondaries, while the primaries are wound on tubings 3" in diameter and 2" high. The primaries are placed on the inside of the secondary winding. They consist of 10 turns. The secondaries consist of 58 turns. No. 22 double cotton covered wire is used. The primary winding is placed near the beginning of the secondary winding. The beginnings and the ends of the windings are brought to terminal lugs on the diameter of the outside or secondary tubings.

Wiring the Set

The beginning of the primary winding of the first RFT goes to the antenna post. The end of this same winding goes to the ground post. The beginning of the secondary winding goes to the rotary plates of the variable condenser and to the F minus post of socket 1. The ending of this winding goes to the G post of socket 1 and to the stationary plates of the variable condenser. The P post of socket 1 goes to the beginning of the primary winding of the second radio-frequency transformer. The end of this winding goes to the B plus 90 post. The beginning of the secondary of this RFT goes to the F plus post on socket 2 and

(Continued on page 24)

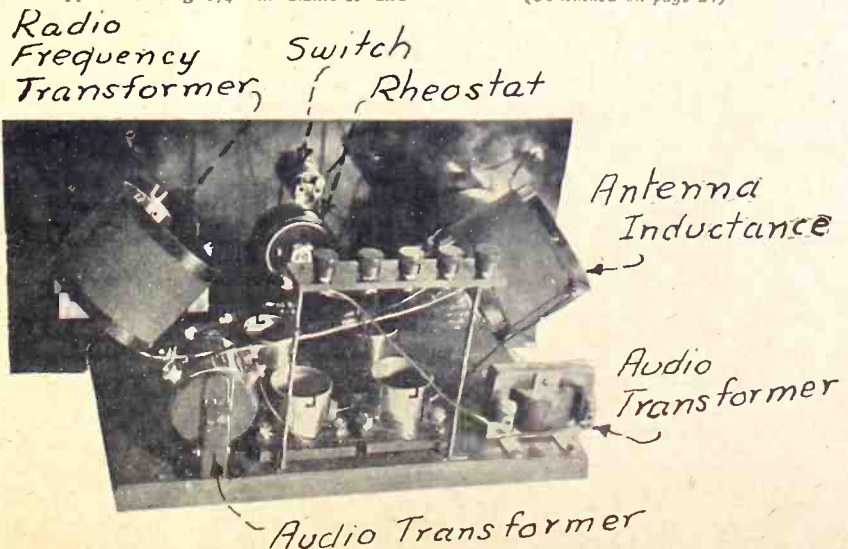

FIG. 3, the back view.

The Super-Heterodyne

[This is the third and final instalment of J. E. Anderson's article on "My Adventures with Super-Heterodynes. Parts I and II were published March 13 and 20 issues.]

By J. E. Anderson

Consulting Engineer

IN many Super-Heterodyne regeneration is used in the loop circuit and first tube as a means of increasing sensitivity, and sometimes this tube breaks into oscillation independent of the oscillator. If an R.F. amplifier is used in addition to the modulator tube this also is likely to break into oscillation. If there are two radio frequency oscillators in a Super-Heterodyne there will be considerable squealing even if the I.F. amplifier is silent and if there is no secondary cross talk. This type of squealing may be distinguished by the fact that it occurs when the loop or R.F. condensers are turned. This squealing is never so troublesome as that arising from oscillation in the I.F. as it does not occur in as many positions on the dials. If there is a regeneration control the remedy is simple, but if there is not, recourse must be had to shielding, proper placing of coils, neutralization of the R.F. stages, or to the use of closed field coils.

Best Type of Oscillator

There are three main types of oscillators used in Super-Heterodynes. These were shown in Figs. 2 and 3, and 4. Each has its points of advantage and of disadvantage. Fig. 2 requires only a single coil and is therefore probably the simplest. It does, however, require a small stopping condenser in the grid circuit and a grid leak. In addition to its simplicity it has the advantage that the intensity of oscillation may be adjusted somewhat by putting in various values of grid leak. A low value will make the amplitude of oscillation small and this makes the generated wave pure, that is, free from harmonics. A serious disadvantage of this circuit is that neither side of the tuning condenser is grounded, and therefore body capacity will be very bad. When this is used it is necessary to take special precautions to keep either side of the condenser away from the hand. Fig. 3 is like it in this respect, and it has the additional disadvantages of two windings and that a large by-pass condenser is required. This condenser is a part of the tuned circuit, which is also a bad feature. Fig. 4 is the ordinary tickler circuit. It is simple in construction and its main advantage is that one side of the condenser is, or may be, grounded. If this is made the rotor plates there is no body capacity effect. In my opinion this is the best oscillator for most types of Super-Heterodynes. The insertion of a grid leak and a stopping condenser does not alter this circuit to any great extent. Of course, the tickler coil may be wound permanently on the same form as the tuned winding, that is, no tickler variation is necessary.

The Modulator

Except in certain special circuits, either the grid bias method of tube modulation or else a crystal detector seem to work the best. If the grid bias on the modulator is adjusted to the proper value with respect to the plate voltage used, this method is very effective and it is stable in operation. A crystal of the more stable varieties is also very good, and there is no good reason why this method of modulation should be almost completely ignored by designers. There is only one

Example of Solution Of Medium Frequency

In the March 13 instalment I gave formulae for determining the intermediate frequency. Here is an example of how the result is obtained by applying a formula:

Typical Example of Calculation of the Intermediate Frequency

F	D-1	D-2	ΔD	f'	D-o	f
610	89.4	67.7	21.7	42.6	5.0	39.9
660	74.7	57.6	17.1	43.0	5.0	40.0
740	57.7	45.4	12.3	44.5	5.0	40.4
830	44.2	35.5	8.7	45.6	5.0	40.5
880	38.4	31.2	7.2	45.7	5.0	40.0
Mean 40.16 kc						

The column headed F gives the frequency in kilocycles of the stations received. The column headed D-1 gives the dial reading on the oscillator at which the signal came in corresponding to F-f, and the column headed D-2 gives the dial reading on the oscillator condenser at which the signal came in corresponding to F+f. The column-headed delta D gives the difference between the readings in columns D-1 and D-2. The third column, headed f' , gives the intermediate frequency as calculated from the formula disregarding the zero capacity of the oscillating circuit. A few trial calculations of the intermediate frequency showed that the zero capacity could be represented by 50 divisions on the dial. When this is added to each of the readings D-1 and D-2 and the intermediate frequency recalculated the result is that given under f, or the figures in the last column. These are all closely grouped about 40 kilocycles, and their mean value is 40.16 kilocycles, which is the frequency of the intermediate filter circuit. Observe the steady increase in the apparent value of the intermediate frequency f' caused by neglecting the zero capacity.

drawback to the use of a stable crystal, and that is its serious damping effect on the tuned circuit. This fact makes it imperative to use a radio frequency amplifier and another tuned circuit in order to increase selectivity in the radio frequency level. But, as was stated previously, this is required anyway to cut down secondary cross talk. The selectivity obtained with two tuned circuits in the radio frequency level is about enough to reduce an undesired wave to a point where secondary cross talk is negligible, even if one of these tuned circuits works into a crystal detector.

The Pick-up

Many types of pick-up have been recommended, and many questions have been asked by fans as to which is the best. There are three general types of pick-up—inductive, capacitive and direct or conductive. Inductive is the one most commonly used intentionally. Actually the pick-up in any Super-Heterodyne is a combination of the three in different proportions. The success or failure of a Super-Heterodyne depends to a great extent in what proportion these pick-ups occur. Which ever method is used, the coupling between the oscillator and the modulator should not be too close. If it is, the modulator might become overloaded, the interaction between the tuned circuits will be so great as to become a nuisance, and the oscillation will not be independent of these circuits. As long as the pick-up of either is pure it does not

matter particularly which type is used, because for equal coupling of either type the results will be the same, but it is very difficult to get one to the exclusion of the others. It will be found that if no special precaution has been taken to shield the oscillator completely from the rest of the circuit, the mere presence of the oscillator about the set is sufficient to make it operative in a fashion. The contact, intentional or accidental, may be in the batteries, in the grid circuits or in the plate circuits.

Everybody who has operated a Super-Heterodyne will have noticed that the volume is usually greater on one of the two oscillator dial positions than on the other, and chance seems to favor the position for which the frequency of the oscillator is the sum of the carrier and the intermediate, that is, the lower point on the ordinary dial. The difference may be barely noticeable or it may be so great that one of the points is missing altogether. Perhaps not so many fans have noticed that if the coil pick-up is reversed, either by reversing the leads or by turning the coil around with respect to the oscillator coil, the loud and the weak points will also reverse. That is, if the low dial point was the louder it becomes the weaker upon reversal. This fact indicates that the effect is a matter of phase and that the explanation of it is to be found in the mixture of inductive and capacitive pick-up.

Suppose that the intentional pick-up medium is a coil consisting of a few turns of wire in inductive relation to the oscillator coil. There is inevitably some capacity between these two coils; and hence one emf is introduced into the modulator circuit electro-magnetically and one electro-statically. If these are in opposition the volume will be weak, if they are in conjunction the volume will be strong. When the frequency of the oscillator is on one side of the carrier they will oppose, when it is on the other side they will aid; hence the difference in the volume at the two points. This phenomenon is exactly analogous to the case of combined antenna and loop reception of radio signals. The oscillator is a miniature transmitter and the pick-up coil is the loop of the receiver, the modulator circuit. The capacity between the pick-up and the oscillator coils is the antenna effect of the loop. As in the case of the combined reception by loop and antenna, if the emf introduced into the receiver by the loop is equal to that introduced by the antenna, signals from one direction will be completely eliminated while those from the opposite direction will be intensified, or doubled. If the emfs are not equal the signals from one direction will simply be weaker than those from the other.

This unbalance is a subject that should be given serious attention by builders and designers of Super-Heterodynes, particularly since it is of vital importance in cases where there is secondary cross talk at one of the points. Methods of balancing similar to those used to eliminate the antenna effect in direction finders might be employed. However, this is not necessary for ordinary purposes of reception. The unbalance may be simply minimized. If a coil pick-up is used its capacity to the oscillator coil should be made as small as possible by separating the two coils and by using fine wire in the pick-up. The inductive coupling may also be increased by using a larger number of turns in the pick-up. Then the electro-static pick-up through the resid-

(Continued on page 28)

Radio University

A FREE Question and Answer Department conducted by RADIO WORLD for its subscribers only, by its staff of Experts. Address Radio University, RADIO WORLD, 145 West 45th St., N. Y. City.

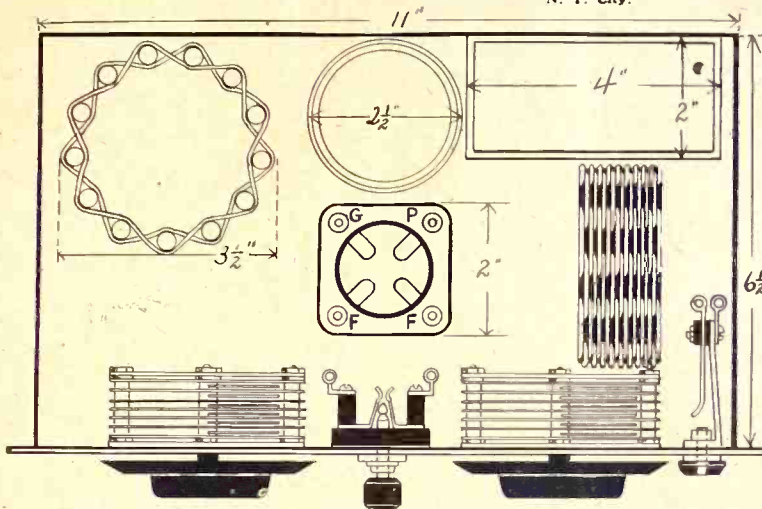

FIG. 279, showing the suggested layout for a 1-tube regenerative set, using a tuned plate method.

PLEASE PRINT a layout for a 1-tube regenerative receiver, the description of which is herewith given. This receiver is now hooked up on a breadboard and I would like to place it in a cabinet 6 1/2" wide and 11" long. The antenna post goes to the beginning of the primary of an antenna coil, which is wound on a basket weave form, 3 1/2" in diameter and 4" high. This primary consists of 10 turns. The end of this winding goes to the ground post. The beginning of the 45 turn secondary winding goes to the F post on the socket. While the ending of this winding goes to one terminal of a condenser and leak, other terminals going to G post of socket. A .0005 mfd. variable condenser is shunted to these secondary terminals. No. 22 double cotton covered wire is used in winding this coil. There is no separation between the windings, the primary being picked up with the secondary. Now the P post of the socket goes to the beginning of a coil, which is also wound on a basket weave form, 3 1/2" in diameter and 3" high, consisting of 35 turns, having a .0005 mfd. variable condenser shunted across the same. The end of this winding goes to the top of a single circuit jack, while the bottom of this jack goes to the B plus post. No rheostat is used. A filament switch is placed in series with the positive A. A WD12 tube is used. If it is possible to place a 1 1/2-volt dry cell and a 22 1/2-volt dry cell in this cabinet would be appreciated. The B battery is 4" long and 2" wide, while the A battery is 2 1/2" in circumference. In other words, I would like to place the two condensers, socket, two coils, filament switch, jack, A and B battery in this one cabinet.—W. Justers, Little York, N. J.

Fig. 279 shows the layout for these parts in the hookup mentioned by you. Note that the RF or antenna coil is mounted on the back of the variable condenser, which shunts the secondary. The filament switch is placed in between the two variable condensers. The plate coil is placed in the extreme left hand corner. The B battery is placed in the right hand corner, with the A battery right next to it which is also in back of the socket and the switch. The jack is at the extreme right hand corner of the panel, which is 7x14".

I WOULD be pleased to obtain full

constructional data on fixed radio frequency transformers, which have a wavelength range of from 200 to 550 meters. (2)—In what issue of RADIO WORLD did Capt. P. V. O'Rourke describe a receiver using three stages of untuned radio-frequency amplification, etc?—Paul Paulson, 40 North Hazel St., Youngstown, O.

(1)—The core made up of silicon steel laminations, each of which has a thickness of .003", and is 1/2" wide and 2 1/4" long. Enough laminations should be placed in a core form so that it is 1/2" thick. Before assembling the core, dip half the laminations in some insulating substance, such as varnish. This means that if there are 60 laminations, only 30 laminations should be dipped in the varnish. Then allow the laminations, which have been dipped, to dry. Now assemble, by first placing an insulated lamination on top, following with an un-insulated lamination and then with an insulated lamination, alternating, until the last lamination which is placed, is an insulated type. The core is then wrapped over with some bond paper, which has been dipped in varnish. The covering should be allowed to dry until the coating is gummy or sticky. Now the windings are made. The primary, which is wound on the left-hand portion of the core, consists of five separate sections, in each of which there are 30 turns of No. 36 enameled double silk covered wire. These sections are wound, so that there is a sort of a peak, at the conclusion of every winding, e.g., bank winding style. The secondary is wound on the same core and consists of the same number of sections, as well as the same number of turns in each section, but the number of wire is 40 double silk covered instead of 36. Between the primary and the secondary windings there is a separation of 1/4". Between each section, which takes up 1/16", there is a separation of 3/32". After all the windings are made, dip the entire transformer in some boiling paraffine allowing the leads of the primary and the secondary to be left open. The ends and the beginnings of all the sections (in the primary and in the secondary) are connected in series. After this operation, allow the paraffine to dry. The completed dry transformer is inserted in a box 3x1x1", the leads being brought to binding posts on the box. This transformer can be inserted in any receiver

where a fixed or untuned RFT is desired. (2)—A receiver employing such RFT was described by Capt. P. V. O'Rourke in the July 11 issue of RADIO WORLD. It is not necessary to have a variable condenser shunted across the secondaries of this type of RFT. These transformers have a wavelength peak at about 420 meters. That is, at that wavelength, the amplification of the radio-frequency signals will be greatest.

IN REFERENCE to the B battery eliminator, described by Lewis Winner in the Dec. 12, 19 and 26 issues of RADIO WORLD: (1)—In the electrical diagram, there is only one fuse employed, while upon looking at the photograph, it seems as if two are used. Now, how many are used? (2)—How is it possible to tell what voltage is being applied to the plates of both the detector and the amplifier tubes? A description of the method employed in doing so, will be greatly appreciated. (3)—Does the total voltage output, as well as the output in milliamperes decrease, with the increasing number of tubes? That is, if upon using 5 tubes, the total output voltage (at full load) is 135, then will the output, when employing 7 tubes be about 115 volts, the milliamperage at the same time also decreasing? (4)—Can the Raytheon tube be employed in this Eliminator, instead of the Rex Magnatron? (5)—Where can I purchase chokes and transformers?—Harry Wolff, care Globe-Wernicke Co., Cincinnati, O.

(1)—Only one fuse is employed. Another fuse may be placed in the other side of the line, but it is not necessary. (2)—The only method to tell of the voltage applied to the plates of the amplifier and the detector tubes is with the aid of two voltmeters or one voltmeter employing an internal or external switching system. When using two meters they are placed in shunt with the output line. The meters should never be connected permanently in the output of the set, as much power is wasted through the resistance of the wire, etc. A switch connected in series with one of the leads of the voltmeter should be installed. If you wish to use one meter, then you will have to use separate single pole single throw switches. These should be inserted in series with the voltmeter and the output of the eliminator. Connect the B minus, B plus detector and B plus amplifier posts from the eliminator to the set. Run the minus terminal of the voltmeter to the B minus post. Run a wire from the B plus detector post to a terminal connecting with the knife or the arm of a switch. Run a wire from the B plus amplifier post to a terminal connecting with the knife or the arm of the other switch. Connect the other terminals of the two switches to the B plus post on the voltmeter. This means that when the detector voltage is to be obtained, by pulling the switch connected in series with the terminal of the meter connected in the B plus lead, that reading will be obtained, the switch of the B plus amplifier lead being open. When the reading on the amplifier tube is to be obtained, both switches must be closed. Were it not for the fact that it is not a good policy to keep the voltmeter permanently connected, only a single switch would be necessary. This would be connected so as to read the detector voltage all the time and the amplifier voltage when the switch is pulled, or vice versa. Instead of knife switches, filament switches may be employed. (3)—Yes. (4)—No. A hookup using this tube was published in the Jan. 16 issue of RADIO WORLD, with a complete description by Lewis Winner. (4)—See advertising columns.

I WISH to build the 5-tube receiver, requested by Mr. Robbins, in the Radio

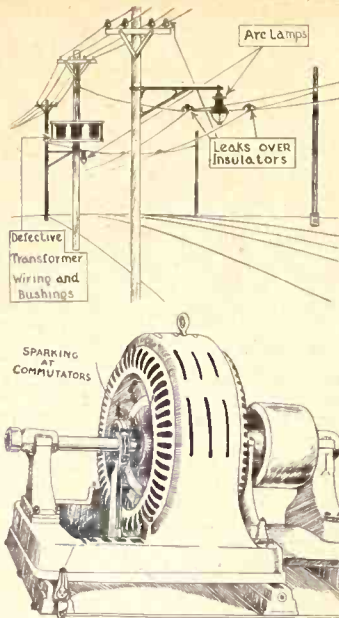

FIGS. 280 (top) and 281 (bottom), illustrating the two most common forms of power interference noises.

University columns of the Jan. 9 issue of RADIO WORLD, but wish to use .00025 mfd. variable condensers, instead of the .0005 mfd. variable condensers as specified. I would like to have, therefore, the number of turns to place on the RFT, using a basket weave form, $3\frac{3}{4}$ " in diameter, using No. 22 double cotton covered wire.—Jesse D. Frazier, Fairmont, Minn.

The primaries consist of 10 turns. The secondaries consist of 66 turns. The manner of winding these coils is different than with the solenoids. First 28 turns of the secondary are wound, then 10 turns of the primary are wound with 10 turns of the secondary, then the rest of the secondary winding or 28 turns is put on.

I AM building the 5-Tube Tuned RF Set, described by Capt. P. V. O'Rourke in the Dec. 26 issue of RADIO WORLD, but am in doubt as to the wiring of the coils. That is, I do not know where the beginning and the end of coils go to, etc. Please explain this. (2)—What changes are necessary to make so that a power tube may be employed?—Herbert Johnston, Box 1194, Yakima, Wash.

(1)—The beginning of the secondary winding of the antenna coil goes to a low potential point, e.g., F minus on the first socket. The ending of the same winding goes to the high potential point, e.g., G post. The beginning of the primary winding goes to a low potential point, e.g., Gnd. post. The ending of the winding goes to a high potential point, e.g., Ant. post. The beginning of the secondary of the second RFT goes to a low potential point, e.g., F minus post. The end of this winding goes to the high potential point, e.g., G post. The beginning of the primary winding goes to the low potential point, e.g., B plus Amp. post. The end of this winding goes to high potential point, e.g., P post. The other RFT is hooked in the same manner, except that the low potential point on the secondary winding goes to the F plus, (for detector) instead of to the F minus post. (2)—You will have to use a separate ballast resistor, connected in series with the negative leg of the filament of the last tube. A C battery, inserted in series with the F post of the last AFT will also be inserted. Now, if you are going to place as much as 135 volts on the plate of the last tube, you will have to use a 9-volt C

battery. The ballast resistor will have to be of the $\frac{1}{2}$ -ampere type.

I WOULD like to know the two most common causes of man-made electrical disturbances shown in pictorial form.—P. Traubein, Des Glaise, La.

Figs. 280 and 281 show the two causes clearly.

I HAVE a 3-circuit tuner, 3-tube receiver. (1) What is the best method to use in this set, so as to reduce the regenerative action of the tube to a minimum? That is, what can I do to make the signals come in without the tube breaking into fierce oscillations? (2) Is it advisable to shield a set of this type? If so, where? (3) If the wires are run over or underneath the tuning coils, will reception of the signals be interfered with? (4) How far apart should the variable condensers be from the tuning coil? (5) When changing a -00 type tube to the -01A type, should the resistance of the rheostat be changed? (6) Will a stage of radio-frequency amplification, when added ahead of the detector improve the reception of the signals?—Ed Cassidy, 496 Long Island City, Astoria, N. Y.

If you find that the receiver oscillates beyond control, there are several methods which may be employed to reduce the action, i. e., by reducing the number of turns on the tickler, by decreasing the amount of voltage on the plate, by inserting a variable resistance in series with one terminal of the tickler coil (in the plate circuit proper) and by reversing the leads of the tickler. (2) It is not necessary to shield a receiver of this type, provided a good variable condenser is used, the grid leak kept away from the panel (if panel type is used, then the terminal connecting with the arm, should not be brought to the grid post, but to the filament end of the winding) and all grid and plate wires kept away from panel as no body capacity will be prevalent. (3) No. Just see that the grid and the plate wires are not run parallel to each other. (4) There should be about a 5" separation between the two. (5) Yes. The -00 type of tube takes 1 ampere, while the -01A type of tube takes $\frac{1}{4}$ ampere. Therefore if you are using a rheostat, of 6 ohms resistance passing a $\frac{1}{4}$ ampere for the -01A, then you will have to use one of approximately the same resistance, but passing one ampere, if the -00 tube is to be employed. (6) Yes. See the Diamond of the Air hookup.

IS IT possible to build a chemical B battery eliminator, such as was described in the Jan. 2 issue of RADIO WORLD by Lewis Winner, so that it will supply 135 volts?—Paul Hamelt, Deposit, N. Y.

The step up transformer employed in this eliminator will deliver 150 volts. Although the cells will only rectify, as per text, 120 volts, due to the drop of 30 volts in the jars, etc., it was found that if the elements employed were pure enough, as much as 139 volts could be obtained at the output. However, in order to get high voltage output it will be necessary to wind the secondary of the transformer to give a voltage of about 20 more than that desired and increase the size of the jars, as well as the elements in the jars. By reading the data, given in the stated issue, this desired information can be obtained.

I AM enclosing a diagram of 5-tube receiver, which I am now using. I find that I am troubled by body capacity to a great extent. Toroid coils are used as RFT, whose secondaries are shunted by .000375 mfd. variable condensers. A 10-ohm rheostat is used to control the filament temperature of the detector tube. A .001 mfd. fixed condenser is brought from the plate post of the detector tube to the F minus post on the same socket. Low ratio AFT

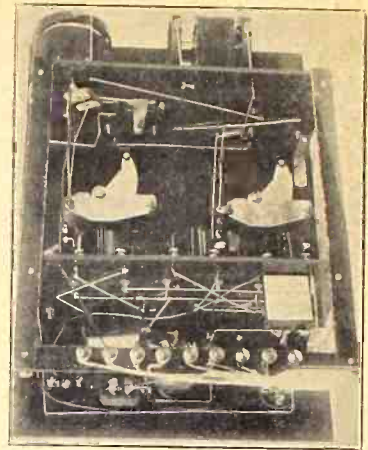

FIG. 282, showing the slanting back view of the Phonograph Set.

are used. How can the body capacity be reduced?—M. Munes, N. Y. C.

The rotary plates of the variable condensers in the case of the first two tubes should go to the potentiometer arm, and in the third case to A+. The grid terminals of the coils should go to the stator plates.

A BACK view of the Phonograph Set, described in the Oct. 24, Nov. 7 and 14 issues of Radio World, is requested.—George Warresters, Marlton, N. J.

Fig. 282, shows the photograph, you request. Note the wiring underneath the subpanel.

WHAT IS Faraday's First Law of Induction?—Richard Kirsch, Bx., N. Y. C.

"The electromotive force induced in a closed electrical circuit by a varying magnetic field is equal to the rate at which the total flux of magnetic induction linked with it positively is decreasing with respect to time."

I LIVE about one mile from WJZ, in Bound Brook, N. J. Now I would like to know if the Diamond of the Air, using a 100 foot antenna with a 10 foot lead-in and a 10 foot ground, will be selective enough to tune this static out.—William Soliday-Lincoln, N. J.

PLEASE GIVE me the necessary circuit changes to be made in the RX1, described in the October 17 issue of RADIO WORLD so that 99 type tubes could be used throughout. (2)—Is it possible to use SLF condensers instead of the SLW condensers?—Winfred L. Brooks, 52 Howe St., New Haven, Conn.

(1)—The resistances as mentioned in the article remain the same, R1, R2 being 30 ohm type and R3, 15 ohm type. (2)—Yes.

I HAVE built the Freshman 5-Tube TRF receiver and have fared well. I live only six blocks away from station WAHG and it is pretty difficult to tune them out. The set is not at fault, as there are folks around here who have Super-Heterodyne sets and have the same trouble. Will the Rider Wavetrap do the trick?—Ernest Liebell, 138 Hunter Ave., Long Island City, N. Y.

I AM going to build the 1926 Model Diamond of the Air. I have two .00025 mfd. variable condensers and tubings 2 11/16" in diameter, 3" high, on which I wish to wind the primary and secondary of both the RFT and the tuner. The tickler is to be wound on a tubing 1 3/4" in diameter. How many turns should be placed on these tubings? (2) Please state

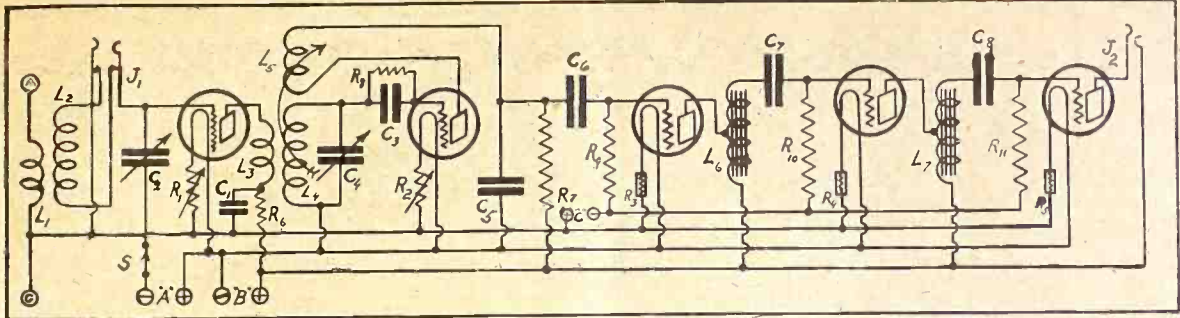

FIG. 283, showing the special 5-tube receiver, requested by Mr. Trubbens.

the number of wire used in all cases.—J. A. Glick, 1047 Baucroft Hall, Annapolis, Md.

(1) The primaries consist of 10 turns. The secondaries consist of 65 turns. The tickler consists of 40 turns. (2) No. 22 double cotton covered wire is used to wind the primaries and the secondaries. No. 26 single silk covered wire is used to wind the tickler.

I HAVE a 3-circuit tuner and a radio-frequency coil to match. Can I obtain a diagram through the columns of the Radio University, of a 5-tube receiver, employing the tuner and the RFT, with one stage of resistance coupled AF and two stages of autotransformer AF coupling? This diagram and the data on the resistors, condensers, etc., would be very much appreciated.—L. Clarence Trubbens, Brookman, Ga.

Fig. 283 shows the electrical diagram of the receiver you request. L1 and L2 are the primary and the secondary windings respectively of the RFT. L3, L4 and L5 constitute the 3-circuit tuner. Variable condensers having a capacity of .0005 mfd. shunt the secondaries, L2 and L4. Both rheostats, R1 and R2, have a resistance of 20 ohms. Both C1 and C5 are .001 mfd. fixed condensers. C3 has a capacity of .00025 mfd. R6 and R7 are 50,000 ohm resistances. R8 is a one megohm resistance. C6 is a .25 mfd. fixed condenser. R9 and R10 are 500,000 ohm resistances. R11 is a 250,000 ohm resistance. C7 and C8 are .5 mfd. fixed condensers. R3, R4 and R5 are ¼ ampere ballast resistors. J1 is a double circuit jack inserted for the purpose of connecting a loop. Only one B battery voltage is applied to the plates of the tube. However, by means of the resistances, R6 and R7, the voltage applied to the plate of the detector and the RF tubes, is materially lowered. By means of the autotransformers, L6 and L7, which contain a small amount of resistance, the voltage applied to the first and second audio tube, is also decreased. All the tubes used are of the —01A type. J2 is a single circuit jack. S is a filament control jack. High-mu tubes may be employed for the first two audio amplifiers. In case they are used the C voltage on these tubes must be adjusted separately from that on the last tube. At least 135 volts should be applied to the plates of the tubes. A C battery voltage of 7.5 should be used.

IN THE Feb. 13 issue of RADIO WORLD there appeared on page 31 a chart showing how to tune in stations with a stated capacity and inductance setup, provided a .0005 mfd. variable condenser is used across a 53 turn secondary, wound on a tubing 2½" in diameter, using No. 24 double cotton covered wire. Now I would like to know what kind of a coil this secondary was used in conjunction with to get the same readings.—John R. Craig, 235 No. 3d St., Steubenville, O.

This secondary winding was used in a 3-circuit tuner, with 10-turn primary,

53-turn secondary, and with 38-turn tickler on 1" diameter. Tickler wire, 26SSC.

I HAVE the information as to the construction of a chemical A battery charger. It is hooked up thus: A 18 watt step down transformer is connected in shunt to the 110V AC line. Now on the output, one terminal from the transformer goes to a lead electrode, which is 4"x2"x ⅝" and inserted in a quart of distilled water and ammonium phosphate. In the same jar and directly opposite is an aluminum electrode, which has the same dimensions as the lead electrode. This goes to the positive post on the A battery. The other terminal from the transformer goes to the negative post of the battery. Now will this rectifier charge the battery at the rate of 1 ampere per hour? If not what changes have to be made, etc.—Leonard J. Farrel, 3132 Decatur Ave., Bronx, New York City.

Your method of hooking up the charge is O. K. You will be able to charge your battery at the rate of 1 ampere per hour.

A DIAGRAM of a simple crystal set, employing a loosely coupled system, is desired. Please state the constants of the coils, condensers, etc.—Frank Sitten, Bridgewater, Pa.

Fig. 284 shows the diagram. The primary, L1, and the secondary, L2, are wound on one tubing 3¾" in diameter and 4" high. The primary consists of 20 turns, tapped at every second turn. The secondary consists of 60 turns, tapped at every 5th turn. There is a ¾" separation between the windings. No. 22 double cotton covered wire is used to wind the coil. A .0005 mfd. variable condenser is shunted across the secondary. C2 is a .001 mfd. fixed condenser. Five of the taps on the primary winding are connected in the antenna circuit, while the other five go to the ground

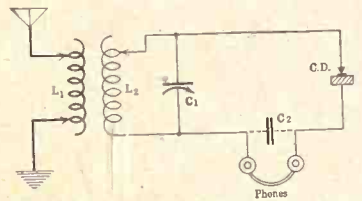

FIG. 284, showing the diagram of the crystal set desired by Frank Sitten.

circuit. A pair of phones having a resistance of at least 3,000 ohms should be employed.

IN THE Aug. 8 issue of RADIO WORLD, there is described by Herbert E. Hayden, a receiver called the Midget 3-tube set. I would like to build this set in a regular 7" x 21" cabinet. Please give constants of the tuner, with the primary and the secondary wound on a tubing 3" diameter tubing, with variable primary wound on a tubing 2" in diameter, the same size tubing as for the tickler.

No. 24 silk over cotton covered is to be used in all the windings. The secondary is to be shunted by .00035 mfd. variable condensers.—J. Holtkamp, 2528 Beekman St., Cincinnati, O.

The primary consists of 10 turns. The secondary consists of 56 turns. The tickler consists of 36 turns.

HOW MANY milliamperes does the UV 201 A tube draw, when 90 volts are supplied to the plate at a grid bias voltage of 4.5? (2) How many milliamperes does the same tube draw, when 135 volts are supplied to the plate at a grid bias voltage of 9? (3) Does the UX 201 A have the same characteristics as the UV201A?—J. Connelly, Pontiac, Mich.

(1) Three milliamperes. (2) Four milliamperes. (3) Yes.

Join RADIO WORLD'S University Club

And Get Free Question and Answer Service for the Coming 52 Weeks.

This Service for Yearly Subscribers ONLY

Have your name entered on our subscription and University lists by special number. Put this number on the outside of the forwarding envelope (not the enclosed return envelope) and also put at the head of your queries. If already a subscriber, send \$6 for renewal from close of present subscription and your name will be entered in Radio University.

[In sending in your queries to the University Department please paragraph them so that the reply can be written under or alongside of each query. Write on one side of sheet only.]

RADIO WORLD, 145 West 45th Street, New York City.

Enclosed find \$6.00 for RADIO WORLD for one year (52 Nos.) and also enter my name on the list of members of RADIO WORLD'S University Club, which gives me free information in your Radio University Department for 52 ensuing weeks, and send me my number indicating membership.

Name

Street

City and State

Costumes and Shadows Inspire Musicians



THE A. & P. GYPSIES, under the direction of Harry Horlick, who are heard through stations WEAJ, WEEL, WJAR, WCAP and WOO, every Monday evening from 9 to 10 p. m.

Air Talk on Talking



JOHN C. WILCOX, music teacher, broadcasting one of a series of talks on correct diction, breathing and resonance, through station KOA, Denver, Col., which are transmitted every Monday night.

Showing 'Em How



TOWNSEND H. FELLOWES, founder of a school of radio broadcasting in New York City, instructing a student how to stand before the microphone, so that her voice will transmit well. (Fotograms).

Preserving the Heat



When working on your outdoor antenna, the greatest difficulty is to keep the soldering iron hot. Above we have a very clever method of avoiding this, by lining a large size preserve jar with sheet asbestos and placing the iron in the jar. (Hayden)

A Phantom Lead-in

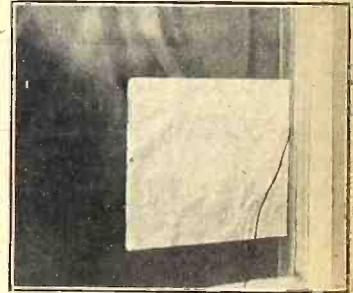

IF THE landlord refuses to allow holes to be drilled in the window sill, so that the antenna lead-in may be brought to the set, one may place two pieces of tin foil, one inside, the other outside of the window pane, connecting a lead-in wire to outside portion and wire from antenna post of set to inside portion. The pane acts as the dielectric, the tin foil as the plates of a condenser causing the current to go from one plate to other, through the medium of capacity coupling.

Tubes' Cozy Corner



A SMALL candy cardboard box may be employed as a tube rack. Tubes which have been removed from the set may then be placed in holes, punched or cut to the specific size of the bases of the tubes, instead of placing on the table and taking a chance of them being knocked off.

Wonder Time Switch

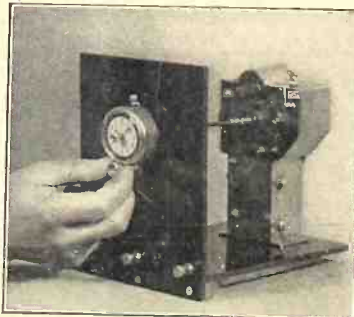

USCHICHIRO TOKUMI, Japanese, is the inventor of the radio clock switch shown above. It automatically turns the set off and picks out particular stations. A standard clock movement is employed. (Kadel & Herbert)

Tough Job Simplified



WORKING IN receivers, where sockets, etc., are very close to each other, makes it difficult to place thumb nuts on the binding posts. This can be remedied by forcing a lead pencil tip into the nut. It is thus started. A pair long nose pliers can tighten the nut up. (Hayden)

Lamp This Set



MISS HILLY GRUNBERG turned on a powerful 5-tube radio receiver, installed in the base of a lamp. The dial turns a special type of multiple condenser. The loud speaker is located in the shade. (Underwood & Underwood)

Beauty Transmits



DOROTHY KNAPP, famous beauty, talking through station 2XV of New York. (International Newsreel)

New Aerial of WGBS

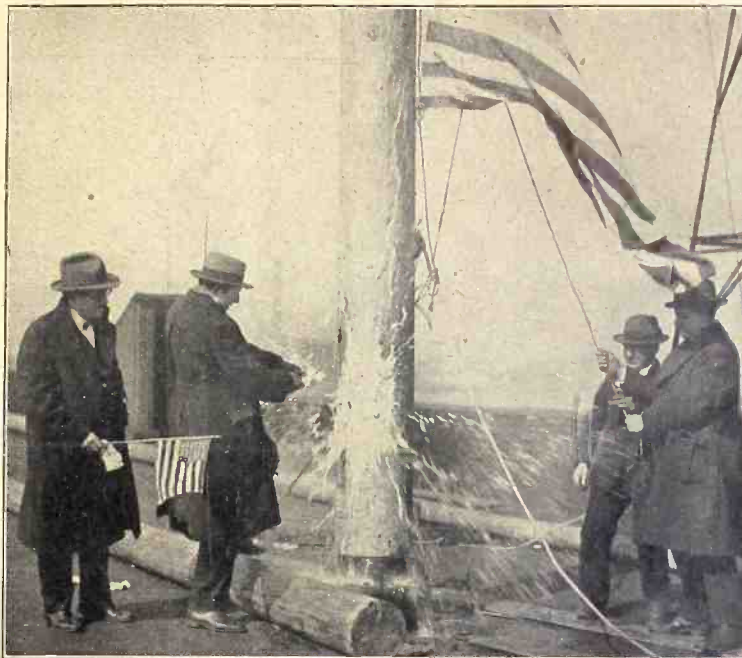

AFTER WGBS was satisfied its new aerial at Astoria, New York City, was a great advantage, the antenna was officially dedicated. A bottle was broken against the mast by Dailey Paskman, director of the station, in the presence of Edgar Wallace, Ferdinand Vecchio and Edward Harmon, engineers. The WGBS studio remains in the Gimbel Bros. store. (Kadel & Herbert).

Figures in Tests



MISS MILDRED LORENTSON whose private radio station, IAID, is to be used as a test of the efficiency of an army radio "net" designed to bring into contact the governors of the New England States, their National Guard and the Reserve Corps in time of emergency. Eighty amateur radio operators have been enrolled in this radio net for the test, which is the first of its kind ever to be made in New England. (International Newsreel)

Short Waves for Travel



THE TOP photo shows J. B. Brennan (left) explaining the compact short-wave radio receiver, which he constructed. Listening is Francis G. Smith, of the Museum of American Indian, who will study receiving conditions, etc., on his trip to South America. On the bottom we have a clear view of the internal wiring of the receiver, showing the layout of the parts. (Kadel & Herbert)

What Capacity is Best?



CONNECTING a set of fixed condensers, of varying values, in the manner shown above, i.e., terminals of each in parallel and other terminals of each open, one may find the proper value condensed required for antenna ground or grid circuits, etc. The test clip is brought from one condenser to another, to obtain the correct capacity.

Static Elimination Called Filter Problem

By Orrin Dunlap, Jr.

Radio Editor of "The New York Times"

There are 5,000,000 radio sets in use in the United States. In four years more there will be 5,000,000 more. There are 21,000,000 homes in this country without radio, thus you can realize that the saturation point is far from near. Indeed the ever increasing number of improvements on the radio will continually push the saturation point far into the future. Only 8.3 per cent. of all the farms in America are equipped with radio receiving or sending sets.

One of the greatest things which could be invented for the radio is some simple device for the elimination of static. Engineers have been tackling this problem ever since wireless began. It does not seem that the antenna is the logical place to look for the solution, because it is reasonable to surmise that a wire which will pick up radio waves is certain to intercept static. Rather some filter must be found which will automatically separate static from radio as chaff from wheat.

The American public today is highly receptive of current supply devices which eliminate all batteries in connection with a receiving set. There are millions of radio fans waiting to buy a simple combination of the A and B batteries. In

this connection the big problem which faces the electrical engineer is the elimination of the alternating current hum and the smoothing out of the current sufficiently to successfully operate the vacuum tube filaments. In the future the vacuum tube will be capable of working in direct connection with alternating current, thereby eliminating all batteries. This alternating current tube will function in connection with the house lighting mains just as the present tube operates with batteries.

At the present time research engineers are making rapid progress in developing an eye for broadcasting, so the television, or seeing distant scenes by radio, will soon be as common as tuning in music. It has been learned from reliable authority that the television apparatus will be placed on the market as soon as all the phases of the system are protected by patents. When the radio optic and its associate instruments are released to supplement broadcast service, it will work in conjunction with the microphone, the former picking up light waves so that they may be transformed into electricity and radio waves, and the latter doing likewise with the sound.

[From an address at Yale University under the auspices of the Yale student branch of the American Institute of Electrical Engineers.]

Dah—Dit—Dah—Dit—Dah!

By Irving Philip Wolfe

2APJ

Ex-2ati, Wm. A. Lang, has moved west and now resides at 133 East Avenue 44, Los Angeles, Calif. He was given the re-issued call 6bmm. We also hear that E. O. Knock, 6bjx, was heard in England while working pilhr on 40 meters. He has kept a continuous schedule with pilhr since October 9, 1925.

We herewith acknowledge the receipt of a letter from H. Thomas, 33, Harpendon Road, West Norwood, London, S.E. 27, England. His call is g6qb and he is now on 40 meters. We also herewith thank him for that "wow" of a Calls Heard that he sent in.

Now that the air seems to be clearing up across the Atlantic we believe that some of that French and English stuff will start in again. Using a UX210 with only 21 watts rac input on the plate of a five 2apd worked ilno. The Italian gave him an R6 report which is sure fb.

Another polar expedition has realized the need of radio in its travels and amateur radio is to be the sole means of communication. The call letters KFZH and KFZG have been assigned to this expedition and the wavelengths used will be the following: 24m (12,500 kc), 35.5m (8,450 kc), and 73m (4,100 kc). Tests are now under way from the base station at Point Barrow, Alaska. Our old friends, Howard Mason (7bu) and Robert ("Bob") Waskey (7uu) have charge of the "works" and want to get QSO with as many of the gang as possible, so if you hear them give them a buzz. The expedition is the one called the Detroit Arctic Expedition

and all news should be sent to the North American Newspaper Alliance, 63 Park Row, New York City.

There are many stations in the first and second districts that believe in sunrise work among which are 2all, 2ajj and laoa. These boys are sure stepping out quite a bit with everything from fivers (2all) to 250's (laoa).

With 750 volts rectified ac on the plates of a five Wm. Fuller, 1725 Fulton Ave., New York City, hopes to be QSO with the world. He is going to be on 80 meters using his call 2aoq and says he will QSL all cards.

We note that F. H. Schnell, formerly traffic manager of the American Radio Relay League, is now engaged with the Burgess Battery Co., of Madison, Wisc. He is going to keep in close contact with the amateurs through the company's stations, 9ek and 9xh. F. E. Handy, well-known because of his amateur activities with the A.R.R.L., is taking Schnell's place as traffic manager. We herewith wish both of them the best of luck in their new positions.

From our first district representatives comes the news that laox and lane are a couple of traffic hounds. We note that the first district has some more of this kind of hound in the Maine gang—latv, larv, lbig, lcsy and lvf. The gang has parked itself on the 40 meter band and of course will QSL all cards. Since lpe, Boston College, ran out of QSL cards the gang up there have writers' cramp from

writing letters to the many fellows reporting their station. lbjz, in Newport, is on the air once in a long, long while with fone on 83 and 175 meters. He is going to send us a drawing of his new fone hookup that is reported all over the eastern part of the U. S. It is a cross between the Reinartz-Zenith and the Colpitts and sure seem fb. lawz writes in and says that from now on he will send in news of upper first district. That's the way to put it over om. Tnx vy.

For the DX hound we have some new QRAs: f8aix, Radio Club of Algiers, Africa; Lljjw is located in Luxemburg (name unknown at present); p3gb, G. Branchio, Funchal, Madeira Island, Portugal. The last is being worked by many U. S. hams among which are laoa and Zamj. He has a pure dc note and can be heard just below the band.

Canadian amateurs handle their trans-Canada traffic on 52.51 meters now. They formerly used 120 meters for the same purpose, but because of their new low-wave work the Canadian Government has decided to permit the use of the new band. Test signals are now being sent by Government stations to permit the Canadian hams to adjust their transmitters and receivers.

A message started at g2LZ, F. A. Mayer, of Wickford, Eng., and addressed to Hiram P. Maxim of the A.R.R.L. at Hartford, Conn., went around the world. The route of the message follows: From g2LZ to pilHR (Lieut. H. P. Roberts, Fort McKinley, Rizal, Philippine Islands); pilHR to u6BJX, Ernest O. Knich at Los Angeles; the final jump was direct from u6BJX to ulAW, Mr. Maxim's station at Hartford, Conn. That sure was one of the best relays ever attempted in radio and the best part is that it went all the way through.

2 BW has so much trouble from some kind of a power leak in his neighborhood that he now has the Public Service Commission of his town, Woodcliffe-on-the-Hudson, N. J., helping him to find the QRM cause. Since this interference started he has hardly been on the air and that is the reason why the South Africans haven't put so many messages into the U. S. lately. BW was one of the most consistent U. S. amateurs heard in that locality until this interference started and his whistle is very much missed on the air.

Calls Heard

At 2 CJE, G. W. Linn, 151 W. 231st St., New York City. 6aak, 6adt, 6ahp, 6akm, 6akx, 6ann, 6aou, 6aqq, 6apq, 6ase, 6asm, 6auf, 6awt, 6ay, 6bcs, 6bde, 6bck, 6bgv, 6bhx, 6bls, 6bol, 6bpn, 6bur, 6bv, 6bvs, 6cae, 6cah, 6cco, 6cgv, 6che, 6cip, 6cpf, 6cpg, 6cqa, 6ctd, 6cto, 6cur, 6cuw, 6cv, 6daa, 6dag, 6dah, 6dam, 6dan, 6daq, 6dar, 6dex, 6fz, 6jp, 6ih, 6hu, 6kg, 6lr, 6ml, 6ol, 6rf, 6rw, 6sl, 6sz, 6ts, 6ue, 6vt, 6yd, 7df, 7gb, 7hd, 7ho, 7pv, 7sp, 7akv, 7aip, KFUF, NAJD, NOSN, NPL, NBA, NTT, NKF, NPM, NPG, NISP, NARI, NISM, huFX1, WYD, oA4Z, LX1, VZW, WVC, 99x, nPB3, PCLL, AIN, SMYY, s2co, sSDK, YY5, YY8, q2jj, mjj, m9a, b2B, b4rs, b4yz, FH4, fMAROC.

At 2 APJ, I. P. Wolfe, 643 W. 171st St., New York City. (lapz), (lcaa), (lca), (4fw), 4kj, 4rr, 5acv, 5avf, 5jd, (5uk), 5yb, 8aip, 8baa, 8brd, 8cbr, 8cjt, 8cmm, 8cqh, 8dae, 8dsy, 9aof, 9 bmm, 9kg, 9pn, FW.

Well, nm, so cuagn nzt wk, gang. Don't forget to send those Calls Heard, new QRAs, bits of news and queries to 2apj, Irving P. Wolfe, Amateur Editor, RADIO WORLD, 145 West 45th Street, New York City, or call 2apj on the air, 40, 80, and 150 metres.

Judges' Awards At New York Show Meet With Favor

The winners in the tests held at the Sixth Annual Radio Show and Convention of the Executive Radio Council, 2nd District, Inc., in the Hotel Pennsylvania, New York City, follow:

Amateur Short Wave Receiver

- First—E. C. Wilbur, 2bn, 25 Vermilyea Ave., New York City.
- Second—Morris Levy, 233 Division St., New York City.
- Third—H. F. Wood, 101-14 Madison Ave., Queens Village, N. Y.

Super-Heterodyne Receiver

- First—Irving Jacques, 118-10 Jamaica Ave., Queens, N. Y.
- Second—J. Willow, 512 West 47th St., New York City.
- Third—W. H. Bradshaw, 1549 East 49th St., Brooklyn, N. Y.

Broadcast Receiver

- First—Joseph Willis, 1471 State Street, New Haven, Conn.
- Second—J. Jacobson, 1291 Washington Ave., New York City.
- Third—David O'Sullivan, 104 Convent Ave., New York City.

The judges of the foregoing tests were Major J. Andrew White, A. J. Haynes, Keith Henny, H. T. Cervantes (Radio Zact), and Herman Bernard.

Amateur constructors were very much interested in the exhibits of short wave transmitters entered in groups of tests. There were three transmitters in action during the show, namely, 2zv of the A. H. Grebe Co., 2erc, the official show station, and 2qa, the most successful, operated by 2ctm and 2apj and owned by the Cardwell Condenser Co. A great amount of interest was shown also in the sets that were inoperative. There were three transmitting set tests the results of which follow:

50-watt Tubes

- First—Zaus, A. Welsh, Hudson Radio Club.
- Second—2ajq, N. G. Schutt, 420 Park Hill Ave., Yonkers, N. Y.
- Third—2gy, Ferd Mann, "Radio Broadcast," Garden City, Long Island, N. Y.

7½ and 5-watt Tubes

- First—Zai, R. S. Egolf, 45 Remsen Land, Floral Park, N. Y.
- Second—Zayo, D. Ligh, 612 Rockland Ave., New Dorp, N. Y.
- Third—Zapl, R. Gilbert, 600 Ocean Ave., Brooklyn, N. Y.
- Fourth—Zakg, I. J. Newman, 1570 Bathgate Ave., New York City.

Receiving Tube Transmitters (low power)

- First—Zact, H. T. Cervantes, 4541 Reiser St., Woodside, N. Y.
- Second—Zaoq, W. Filler, 4031 3rd Ave., New York City.
- Third—Zgl, E. Finck, 8501 124th St., Richmond Hill, L. I., N. Y.
- Fourth—Zeb, Boyd Phelps, 2120 Clove Ave., Grasmere, N. Y.

Bert E. Smith of the Cardwell Condenser Co., and F. C. Estey of the Priess Radio Corp., were judges of the transmitter tests.

William A. Bruno, of the Bruno Radio Corp., was added to the list of judges a bit later and with his help the Annual Club Booth award was chosen. Because of the great variety of club exhibits at the show this was a difficult task but the cup was won for the fourth successive year by the Bronx Radio Club of New York City. The Hackensack Radio Club was second, closely followed by the Radio Club of Long Island. The Bronx club showed a group of miniatures of the members' stations that was cleverly done,

Neutralization Advice For Sleeper's KB-8

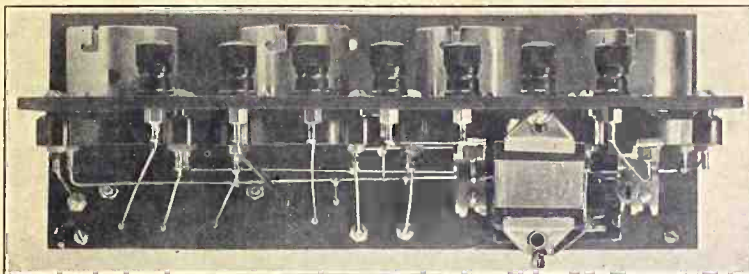

REAR VIEW of the detector-AM unit.

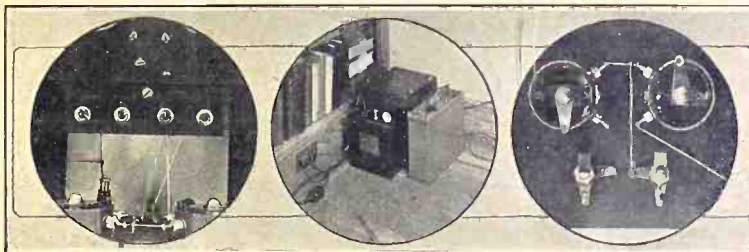

LEFT, the tip jack panel, for voltmeter connections. Centre, the Gould Unipower A and Acme B eliminator, connected up, for use with A. C. only. Right, closeup of the wiring details of the electrad rheostats, jack and switch.

[Parts I, II and III of this article were published in the March 7, 13 and 20 issues. The conclusion follows.]

By M. B. Sleeper

When the set has been completely assembled, put in the tubes and adjust the rheostats so that the correct voltage is applied to the terminals of the RF and detector tubes. The voltage must be measured directly at the socket contacts and not at the binding posts. A UX-199 should have 3 volts at the socket; the UV201A or Donle detector tube 5 volts. As a matter of fact, the Donle detector tubes which we have tested generally operate well below their rated filament voltage, say from 3½ to 4½ volts. This is an excellent feature about the tubes because it not only gives them unusually long life, but also reduces the current drain on the A and B batteries.

Test the voltage on the three AF tubes. This should be not less than 5½ or more than 6.1.

To neutralize the set, remove the cap nut from the Walbert neutralizing condenser on the front panel, tune in a station, and turn the left-hand condenser dial back and forth, while you adjust the neutralizing condenser screw with a short stick sharpened at one end, until no whistle is heard while the condenser is varied. It is well to adjust the set on a fairly low wavelength. If you have a UX199 tube for the RF amplifier, cut the RF tube rheostat out before you start neutralizing. Then you can reduce the volume by increasing the resistance in the rheostat. Once the set is adjusted, tighten up the cap-nut on the neutralizing condenser and leave it alone forever after. It may require readjusting if you change the antenna or the RF tube. Otherwise

it should not be touched. The dial readings on the KB-8 run almost alike. On any set with conductive coupling to the antenna it is not possible to make them run perfectly true, but the difference should not be appreciable.

Assembly Suggestions

The non-regenerative Browning-Drake set has been designed with the utmost care. It is only fair to expect the constructor to be just as careful in his workmanship when he assembles the set. It is not possible to make any design proof against carelessness. No set can be made successfully unless the instructions are followed accurately, the correct parts used, and real thought and care put into the work.

The original model has been wonderfully successful in its operation, even beyond our expectations, and these results can be duplicated by anyone who will follow the instructions. If, however, the parts are thrown together in an experimental set-up, it is not fair to complain if you are disappointed in the results.

The design of radio sets has become a real art, and we have done everything possible, at the same time, to present the designs in a way which anyone can copy if he will make the effort.

RESULTS EDITOR:

My name will have to ride with those who have previously praised that wonderful set, the 1926 Model Diamond of the Air. In one week's time I tuned in more than 60 stations, the locations ranging from the Pacific to the Atlantic Coast and Canada.

Long live the 1926 Model Diamond of the Air!

JOHN R. SAVAGE,
407 Path Avenue,
Pittsburgh, Pa.

the Hackensack gang put up an excellent exhibit of a miniature WJZ (Bound Brook style) and the Long Island Club had a striking display of ultramodern radio apparatus.

The test committee of the show consisted of I. P. Wolfe, manager, and J. J. Casale, assistant manager.

The decisions of the judges in all the tests proved popular.

A THOUGHT FOR THE WEEK

The technical and entertainment angles of radio are important, but in the final analysis it probably will be found that radio's humanizing process is the most important aspect of all.

RADIO WORLD



Radio World's Slogan: "A radio set for every home."

TELEPHONE BRYANT 0558, 0559
 PUBLISHED EVERY WEDNESDAY
 (Dated Saturday of same week)
 FROM PUBLICATION OFFICE
HENNESSY RADIO PUBLICATION CORPORATION
 145 WEST 46th STREET, NEW YORK, N. Y.
 (Just East of Broadway)
 ROLAND BURKE HENNESSY, President
 M. B. HENNESSY, Vice-President
 FRED S. CLARK, Secretary and Manager
 European Representatives: The International News Co.
 Breems Bldgs., Chancery Lane, London, Eng.
 Paris, France: Brentano's, 38 Avenue de l'Opera
 San Francisco: Lloyd B. Chappell, 656 O'Farrell St.

EDITOR, Roland Burke Hennessy
 MANAGING EDITOR, Herman Bernard
 TECHNICAL EDITOR, Lewis Winner
 CONTRIBUTING EDITORS, John F. Rider, L. E. Anderson

SUBSCRIPTION RATES

Fifteen cents a copy, \$6.00 a year, \$3.00 for six months. \$1.50 for three months. Add \$1.00 a year extra for foreign postage. Canada, 50 cents.
 Receipt by new subscribers of the first copy of RADIO WORLD mailed to them after sending in their order is automatic acknowledgment of their subscription order. Changes of address should be received at this office two weeks before date of publication. Always give old address; also state whether subscription is new or a renewal.

ADVERTISING RATES

General Advertising		
1 Page, 7 1/2 "x11"	462 lines	\$300.00
1/2 Page, 7 1/2 "x5 1/2"	231 lines	150.00
1/4 Page, 8 1/2 " D. C.	231 lines	150.00
1/4 Page, 4 1/2 " D. C.	115 lines	75.00
1 Column, 3 1/2 "x11"	154 lines	100.00
1 Inch		10.00
Per Agate Line		.75
Time Discount		
53 consecutive issues		20%
30 times consecutively or M. O. W. one year		15%
4 consecutive issues		10%
WEEKLY, dated each Saturday, published Wednesday.		
Advertising forms close Tuesday, eleven days in advance of date of issue.		

CLASSIFIED ADVERTISEMENTS

Ten cents per word. Minimum 10 words. Cash with order. Business Opportunities ten cents per word, \$1.00 minimum.

Entered as second-class matter March 23, 1922, at the Post Office at New York, N. Y., under the Act of March 3, 1879.

MARCH 27, 1926

Indorse the Diamond



HAVING MEASURED the efficiency of the 1926 Model Diamond of the Air, William Knipp (left) and Samuel Lager pronounced it great. (Chas. Curtis)

House Passes White Bill; Senate Discord Develops

By Thomas Stevenson

WASHINGTON.

The passage of the White radio bill by the House of Representatives by an overwhelming vote has put the question of radio legislation squarely up to the Senate. Public hearings have been held in the Senate Interstate Commerce Committee on the Dill radio bill, the main provisions of which are similar to those of the White bill.

The consensus among members of the Senate is that the fate of radio legislation depends almost entirely on Senator James E. Watson, of Indiana. Senator Watson is chairman of the Interstate Commerce Committee to which radio legislation is referred.

Importance is Realized

It is admitted that there is a general appreciation in the Senate of the importance of radio legislation, but there is also a corresponding lack of interest and knowledge as to the requirements. Senator Watson is very influential among his colleagues and they are depending on him to do what is best.

If Senator Watson actively sponsors a radio bill, it is expected there will be no difficulty in enacting a new radio law at this session of Congress. Unless Senator Watson gets behind a radio bill, the chances for radio legislation are very slim.

Senator Watson believes radio legislation is very important. His view is that control of the radio industry should be removed from the Department of Commerce and placed with the Interstate Commerce Commission, which has jurisdiction over all interstate communications other than radio and aeronautics.

No Objection to Hoover

Senator Watson said: "There is no objection on the part of the committee to Mr. Hoover personally. We think he is a man of magnificent ability, but no one man should have so much power. The Interstate Commerce Commission is about to be enlarged and it can handle the increased duties easily."

Senator Dill said: "I am unalterably opposed to Senator Watson's suggestion. In the first place, the Commerce Department has handled the radio subject up to now with reasonable satisfaction, and broadcasters are satisfied to continue as at present."

Bureau Well Equipped

"It is better for radio and for the public at large to continue with the present organization. The new radio bill contemplates a radio commission which shall have a veto power over the Secretary of Commerce when anyone is dissatisfied. This provision was put into the bill at Mr. Hoover's request."

(Copyright, 1926, by Stevenson Radio Syndicate)

Million Sets on Farms; 1924 Nearly Doubled

There are nearly 1,000,000 radio sets on farms in the United States, the Department of Agriculture estimates in a report on the growth of farm radio during the past five years. In some States, the department says, there are radio sets on 25 to 40 per cent. of all farms. Estimates made by the department in 1923 showed 145,000 sets in use on farms at that time; 365,000 sets in 1924, and 553,000 sets early in 1925.

Increased power and improved broadcasting, together with better receiving sets, the department believes, "will do much to aid in establishing the permanency of the use of radio for the benefit of agriculture." The report adds:

"One station alone in a period of three months broadcasting of market and weather reports received more than 3,000 letters of commendation from farmers, country banks, shippers of livestock, and small merchants in the towns in 12 agricultural States surrounding the station."

Interference Being Cut

Interference among stations may gradually be eliminated, the department believes, as many of the less active stations are being discontinued, and technical improvements are being made in both broadcasting and receiving equipment. Of 1,458 radio stations of all sizes licensed to broadcast since broadcasting began, only 536 were active on January 1 this year.

The department has made co-operative arrangements with more than 100 stations for broadcasting official market news gathered by department representatives in leading shipping and consuming areas. Since the first of the year the department has made arrangements with about 60

stations to broadcast on a regular schedule four additional services dealing with general agricultural information.

Literally hundreds of stations have requested the privilege of handling the government reports, but many of the requests have had to be refused, the department says, because the stations are remote from the department's market news branch offices.

High-priced Sets

The report continues: "During 1921, reports were furnished to three of the then very few radio telephone broadcasting stations. Since then, the service has grown by leaps and bounds until now there is practically no agricultural community in the country that is without official market reports on agricultural commodities. Well-established schedules of weather, crop and market reports are broadcast from more than 100 stations in all parts of the country."

Farmers, of necessity, the department says, have bought mainly high-priced sets capable of getting distant stations. The average cost of radio sets on more than 1,000 farms widely scattered over the country in 1923 was estimated by the department at \$175. Better and more easily operated equipment can be bought now for half this amount, the department says.

An authentic list of broadcasting stations the country over that broadcast market and crop reports has been prepared by the department for free distribution. Requests for the list should be mailed to the Bureau of Agricultural Economics, United States Department of Agriculture, Washington, D. C.

Tectron Trouble Shooting

By Lewis Winner

Associate, Institute of Radio Engineers

FOR those who have built the Tectron B battery eliminator but have not as yet placed it into the cabinet, due to either a hum or low voltage output being obtained, the following trouble shooting data are given.

It is taken for granted that all the material used to construct the eliminator was tested for shorts or open circuits, the trouble lying specifically in either some wrong wiring or peculiar characteristics of the tube, chokes or condensers causing the first mentioned troubles.

(1)—Due to characteristics of the tube, you will find that by changing the tubes around, the hum usually will disappear and the voltage will increase. This is due to the fact that one tube rectifies one side of the cycle more efficiently. Although both sides of the wave should have the same characteristics many times they do not. Therefore the rectifying action of the tube in one side of the line is better than in the opposite line.

(2)—By either placing both by-pass condensers, C1, C2, across the plate secondary, or placing one across either side of the tapped portion of this winding, the filtering action may be improved. In other words, by placing a .5 mfd. fixed condenser either across one section of the secondary plate winding or the other, or two such condensers across each portion, the hum may disappear.

(3)—By bringing the B minus lead to the ground post of your set, which in most receivers is connected to the A plus, the hum may be also eliminated. However, you will find that the A plus lead will have to be disconnected from the B minus, while the A minus goes to the B minus lead.

(4)—By running a wire from the core of the step-up transformer to the core of the choke to the ground, the hum may be eliminated. In other words, ground all the cores. By doing any of the following, the hum may be eliminated also.

(5)—Take R3, the fixed resistance, out.

(6)—Change the leads of the fixed condensers about, so that the 2 mfd. condenser C4 will be where the 6 mfd. condenser, C5, is, etc.

(7)—If you have a .25 or 1 mfd. fixed

LIST OF PARTS

One AC 220-volt step-up transformer (Shore).

Two 30-henry choke coils, L1L2 (Shore).

Two .5 mfd. fixed condensers, C1 C2 (Aerovox).

One .5 or 1 mfd. fixed condenser, C6 (Aerovox).

One condenser unit; one 3 mfd. fixed condenser, C3; one 2 mfd. fixed condenser, C4; one 6 mfd. fixed condenser, C5 (Aerovox).

One variable resistor, Clarostat, R2 (American Mechanical Laboratories).

One 10,000 ohm fixed resistor, R1 (Aerovox).

Two rectifying tubes (Tectron).

Two sockets, standard base.

One socket for input voltage.

One switch, S.

One panel.

One fuse, F.

One socket for holding fuse.

Accessories: Lamp cord, aluminum brackets, screws, nuts, cabinet, flexible wire, binding posts, insulating strips, etc.

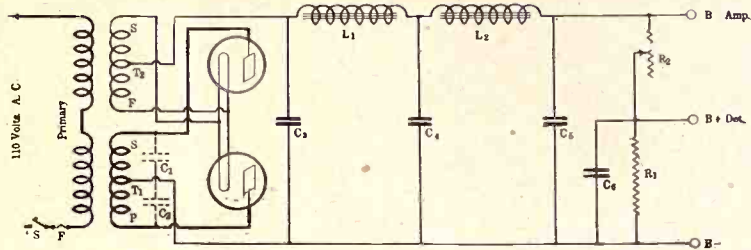

THE ORIGINAL diagram of the Tectron B Battery Eliminator.

condenser, laying around the house, place across the B plus detector and minus leads.

(8)—Try placing a 6 ohm, 1 ampere rheostat in each one of the legs of the filaments.

(9)—Reverse the leads of the choke coils, L1 and L2.

All of these hints might or might not help to eliminate the hum. Only by experiment, can the proper adjustment be made.

Only a 1-ampere 110-volt need be used in series with the primary leg. Be sure that none of the windings on the choke coils touch the metal baseboard or the ground wire.

In last week's issue, there appeared a

diagram showing how to obtain a variable detector voltage. However, the varying of one variable resistance changed the value of the other variable resistance, which prevented the adjustment of both variable resistances at the same time. Now this method can be modified, if the arms of the variable resistance in series with the B plus lead, is brought direct to one terminal of the choke coil, L2.

Be sure that when you hook up the leads from the line to the posts on the eliminator, they are not too close to each other, or a short will take place. This can be prevented, by taking off only a small portion of the cotton and rubber on the wire, leaving only small piece of pure copper bare wire.

High Current a Problem In an "A" Eliminator

"Why is it that so little is written about an A battery Eliminator, employing a tube?" is a common question among fans, anxious to get hold of such an appliance.

Practically every set used has the filament of the tubes connected in parallel. This is done because of the easy way to get a supply of power to operate the tubes e.g., the popular 6-volt storage battery. Due to the filaments being connected in this fashion, a great deal of current must be at hand. In an eliminator, this necessitates the use of an extremely large tube for passing the current, which when 8 tubes of the -01A type are employed runs as high as 2 amperes. A tube built to do this work is bulky and very expensive. Also there is a possibility, if one tube blows, of all the other tubes

blowing, as there will be a surge in the amount of current supplied. Now, if the filaments of the tubes are connected in series, the voltage output has to be high, but the amount of current that is to be passed is only that of one tube, e. g., one-quarter ampere (-01A type tube). Also when the tubes are connected in this manner, if one tube blows, the set automatically stops, as the circuit is then broken. The tube required to pass this amount of current is small and inexpensive.

In order to have a successful A battery eliminator, the filaments of tubes should be connected in series, while the voltage output should be variable up to as high as 50 volts, the current being stable. Of course, several types of eliminators, for different tubes should be made.

Tiny Quartz Crystal Keeps WGY to Its Wave

A piece of quartz crystal less than an inch square, ground to a thickness a shade less than an eighth of an inch, is controlling the frequency of the 50-kilowatt output of WGY's giant developmental transmitter. This is the first superpower transmitter to utilize crystal control and those who listened to broadcasting of WGY during the International week tests found the wave holding its frequency undeviatingly. In fact, the best available measuring instruments fail to record even a fractional departure from the 790 kc frequency assigned to the

station by the Department of Commerce.

Crystal quartz has been utilized for frequency control on the regular 5-kilowatt transmitter of WGY for several months. Special conditions had to be met in adapting this form of control to fix the frequency of 50 kilowatts output.

TIP FOR ANTENNA EFFICIENCY

It is best for loud and selective reception, to run the antenna and the ground wires as far away as possible or at right angles to each other, until the wires reach the antenna and ground posts of the set.

Literature Wanted

THE names of readers of RADIO WORLD who desire literature from radio jobbers and dealers are published in RADIO WORLD on request of the reader. The blank below may be used, or a post card or letter will do instead.

Trade Service Editor,
RADIO WORLD,
145 West 45th St., N. Y. City.

I desire to receive radio literature.

Name

City or town

State

Are you a dealer?

If not, who is your dealer?

His Name

His Address

W. T. Modlin, 2200 Perry Ave., Peoria, Ill.
Cherry & Beene, Henderson, Tenn. (Dealer).
T. Barton Harrington, 720 E. 33rd St., Baltimore Md.
Emmett Roewekamp, 3015 N. Jefferson Ave., St. Louis, Mo.
E. C. Wuest 1836 Eighth Ave., Jacksonville, Florida.
Earling Nelson, Washington St., Alexandria Bay, N. Y.
Lloyd Adcock, Box 1568, Lakeland, Fla.
E. A. Lowe, 155 Ramsey St., St. Paul, Minn.
C. H. Regan, 936 South Taylor Ave., Oak Park, Ill. (Dealer).
Dick Miller, 412 Emmet, Toledo, O.
R. A. Carroll, West Finley, Pa. (Dealer).
Hugh Allan, Box 5, Yarmouth, Nova Scotia, Canada.
Eric Lindborg, Box 14, Perla, Ark.
C. F. Rost, Wright Ave., Bixside, L. Is.
Chas. W. Veager, 1316 South Date Ave., Atham-bra, Cal. (Dealer).
A. B. Scribner, Negaunee, Mich.
C. K. Prickett, Fayette, O. (Dealer).
C. R. Yockstick, East St. Louis, Ill.
R. A. Norton, Edgartown, Mass.
R. E. Kessler, New Straitsville, O. (Dealer).
S. Frink, Wayne, Pa.
J. T. See, Box 17, Key West, Fla. (Dealer).
Charles Ernesse, 242 Jefferson Ave., Rochester, N. Y.
R. M. Stewart, 6 Prince St., Oshawa, Ont., Canada. (Dealer).
Philip R. Dixon, 223 Victor St., Cincinnati, O.
R. J. Sibley, 1526 Monroe, Memphis, Tenn.
J. E. Carlson, Jr., 1910 Snowden Ave., Memphis, Tenn.
D. C. Wooden, Paughquag, N. Y. (Dealer).
Alvin Kahle, Knox, Pa. (Dealer).
W. A. Amon, Farrelli, Pa. (Dealer).
A. J. Rosemary, 2132 EStaugh St., Philadelphia, Pa.
Petey J. Cox, 1282 3rd Ave., Watervliet, N. Y.
Frank P. White, 1519 West Colorado Ave., Colorado Springs, Col.
Arthur Kearney, 3525 Wallingford Ave., Seattle, Wash.
Herbert C. Martin, 65 Rutledge Rd., Mattapan, Mass. (Dealer).
M. K. Nielsen, 3016 Carr St., Des Moines, Ia.
Daniel Coffman, Tratwood, O.
Furlow Gruel, 3306 Whitney Ave., Detroit, Mich. (Dealer).
Thomas F. M. Scheffmeyer, 93 Wilkinson Ave., Jersey City, N. J.

Civil Service

Junior Radio Engineer

Receipt of applications for junior radio engineer will close April 17. The date for assembling of competitors will be stated on the admission cards sent applicants after the close of receipt of applications. The examination is to fill vacancies in various branches of the Government service throughout the United States. The entrance salary in the District of Columbia is \$1,860 a year. After the probationary period required by the civil service act and rules advancement in pay may be made without change in assignment up to \$2,400 a year. For appointment outside of Washington, D. C., the rates will be approximately the same. Promotion to higher grades may be made in accordance with the civil service rules as vacancies occur. The duties of this position are to perform such work as routine testing, preparing specifications for engineering material or apparatus assisting in conduct of experimental research tests, compiling reports, and handling technical correspondence. Competitors will be rated on general physics; pure mathematics; and practical questions on radio engineering, including applied mechanics.

Full information and application blanks may be obtained from the United States Civil Service Commission, Washington, D. C., or the secretary of the board of U. S. Civil Service Examiners at the post office or custom house, any city.

THE RADIO TRADE

Freshman Reveals His Success Secret

A New Free Edge Wall Cone Speaker

The latest development in acoustical science is now ready for the market. A large size cone, made from the best parchment paper the market affords, houses a large permanent magnet, assembled by experts, aged and adjusted to produce the best results. It employs a floating armature which is balanced between four magnetic poles and can be easily adjusted if out of centre. The unit is mounted on wood to prevent metallic vibrations and the entire ensemble is enclosed in a dust proof housing with only the driving rod exposed. The unit is placed in the cone and secured by means of a small thumb screw; it is then hung on the wall by the wall cord. The resonance of the cone is enhanced by its proximity to the wall and the musical notes are thrown off evenly throughout the room. The cone being free on the edges, the vibrations are undamped, the pitch is unchanged and the full musical scale is covered. If the unit gets out of adjustment, a slight turn of a screw in the back easily puts it in tone. If at any time the cone is broken, the user may procure a new one for a slight charge. Under test, this speaker easily took up to 350 volts out put and stood up under an overload of 500 volts. This cone is marketed by the Acousti-Cone Laboratories, 96 Church Street, New York City, and the inventor is one of the pioneers in this field. [Awarded RADIO WORLD'S Certificate of Merit No. 3799.]

The name of Charles Freshman is famous in radio. Mr. Freshman is president of one of the largest radio receiver manufacturing concerns in the world. As many as 2,000 sets a day are now being put out and next year as many as 3,000 sets per day will be made by this company. The success of this concern is due to the low priced and efficient sets made, there being seven models ranging in price from \$39.50 to \$115.

Mr. Freshman started his radio business in 1922 with a capital of \$500 common stock, making receiving sets and accessories, in a dingy loft building at 290 Hudson St., N. Y. City. In 1923 when still in this pany's gross sales small place, the com- were \$400,977. This year, it is estimated, the gross sales will be \$7,500,000. At present there are three plants where receiving sets are being made. One is located in the Bronx, where more than 1,100 persons are employed and where there are more than 56,000 square feet of manufacturing space. Another plant is in the Freshman Building on 40th Street, N. Y. City, where 40,000 square feet of space is occupied and the last is located in Chicago. Here there are 50,000 square feet of space.

Mr. Freshman states that this great success was due to surrounding himself with good men, whom he paid well.

Charles Freshman was born in Chicago. He was educated in Chicago and N. Y. City public schools and at the College of the City of New York.



CHARLES FRESHMAN

ISOFARAD REVEALED

A new development in radio by the Walbert Manufacturing Company of Chicago soon will be presented to the radio public. An interesting book on this unit, giving complete information on construction and adjustment and operation of five and six tube receivers incorporating this isofarad circuit, with full sized templates and wiring diagrams, may be had from Stoner & Heath, 122 Greenwich Street, New York City, for 25 cents. Mention RADIO WORLD.

HERZOG IN NEW FIELD

Harry Herzog is no longer connected in any way with the Herzog Radio Corporation. He is working on a new circuit also a type of loud speaker unlike anything else on the market. Both will be ready in the near future. Mr. Herzog is carrying on his experiments at his laboratory, 37 Brevoort Place, Brooklyn. Mr. Herzog is the inventor of an efficient 6-tube loop set and a cone speaker.

Dust-proof Condensers Are Put On the Market

A new dust-proof condenser has been recently placed on the market. The problem of producing a condenser that would be dust-proof was solved through the use of transparent pyralin sheeting. A strip of the sheeting, fitted tightly into grooves, extends around the unit to make a complete enclosure of the condenser plates inside. This material being water-proof also protects the plates against moisture, at the same time forming an effective dust barrier, without any appreciable loss of visibility. Condensers of this type range from the 10-plate to the 30-plate unit.

Business Opportunities Radio and Electrical

Rates: 10 c per word; Minimum, \$1.00; Cash with order

OUR STAMPING AND ASSEMBLING PLANT enlarged and equipped with more modern machinery; your ideas developed commercially by reputable engineers and toolmakers; member A. S. M. E., awarded gold medal Panama Pacific Exposition. Udall & Landan Manufacturing Co., 200 Canal St., N. Y. C.

RADIO ELECTRICAL BATTERY CHARGING STORE, sets and battery charging outfit, complete shop for building sets and repairing; well established; in Ridgewood, Long Island. Box 11, Radio World.

RADIO CONE SPEAKER MFG. BUSINESS for sale; established connection with distributors, near Newark; excellent facilities; principals only. For details Box 22, Radio World.

HARDWARE, ELECTRIC, AUTOMOBILE, radio supply store; best Broadway location; unusual offer to quick buyer. Box 33, Radio World.

DO YOU WISH TO BUILD THE VICTOREEN SET? Send 15c for a copy of RADIO WORLD dated Feb. 20, or start your sub. with that number. RADIO WORLD, 145 W. 45th St., N. Y. C.

DX Reception Better as Soft Coal Use Abates

Although the coal strike has been settled for several weeks, only now is the re-

ception of signals from distant stations showing signs of improvement, thus tending to corroborate the theory that the use of bituminous coal, as a substitute for unprocurable anthracite during the strike, did interfere with DX. The soot-laden air, as the result of the general use of soft coal, seemed to have had a grounding or screening effect upon radio waves. As many had stores of soft coal on hand, the atmosphere did not clear up until re-

cently. And even in many large areas where no soft coal was used, during the strike there was great difficulty in getting distant reception. The effect was country-wide, and the Chief Radio Supervisor gave it official attention, but did not state the cause. The fact that in localities free from beclouded atmosphere DX was just as hard to get as in the polluted areas led many to believe that the soft coal particles riding high and free in the air had nothing to do with the situation. But experts point out that the smoky areas naturally intervened between the cleaner surroundings and the far-off station that was vainly being sought. Anyway, DX reception has improved, and even at a time of the year when it is not supposed to be on the ascent. Good DX weather may be expected up to the middle of May.

DON'T USE "B" BATTERIES

A remarkable device just perfected. Easily built by any radio fan. Plugs into common light socket, uses no acids or tubes. Delivers powerful, absolutely noiseless "B" supply. Fully guaranteed. Complete drawings and instructions \$1.00
RADIO EQUIPMENT CO.
408 W. 11th Avenue Mitchell, S. D.

VEBY HIGH-MU TUBES

Made especially for Resistance Coupled Amplifiers. Now you can get more volume with greater clarity.
A. F. 20 for the 1st and 2nd Stage.....\$3.00
A. F. 6 Power Tube for the 3rd Stage.....\$4.50
VEBY RADIO CO.
47-51 Morris Avenue Newark, N. J.

BEAUTY-QUALITY-LOW PRICE

TYPE SSS \$45
5-Tube Tuned Radio Frequency.
TYPE 6RR
6-Tube Resistance Coupled Audio Tuned Radio Frequency. \$50
If your dealer cannot make immediate delivery we will ship direct from factory
American Interstate Radio Service
183 Greenwich Street, New York City
Distributors, Jobbers, Dealers, write for special trade terms

TECTRON TUBES

Should Be Used in the

Tectron "B" Eliminator

They will last longer and give greater Voltage and Amperage output than any tubes on the market.
PRICE \$2.50

Special Compact Model Tectron, smaller than a "B" battery. Fully guaranteed. Price, complete, ready to operate \$35

TECTRON RADIO CO.
1270 Broadway New York

The MOLLIFORMER "B" UNIT REPLACES "B" BATTERIES

Build the high-grade B battery supply unit described in this issue and be forever rid of B battery troubles. Unexcelled for clear tone quality and volume on distant stations.

Results are guaranteed on a money back basis.

GENUINE MOLLIFORMER PARTS

- 1 Power Transformer.....\$6.00
- 1 Molliformer choke (125 Services)..... 6.00
- 4 complete improved type rectifiers..... 3.30
- 2 filter condensers 2MF..... 3.30
- 1 filter condenser 1MF..... 1.30
- 1 fixed resistor for detector cap..... .75
- 1 socket..... .15
- Complete kit of above parts for 60 cycle, 110 volts AC.....17.00

25 cycle kits, \$2.00 additional
This unit will furnish as high as 120 volts with 15 milliamperes draw and will take care of the average five or six tube receiver. Fine for all Tuned Radio Sets.

Completely assembled unit for 60 cycle, 110 volts.....\$24.50

The Molliformer B Unit is guaranteed to deliver the necessary power without trace of hum to any five-tube receiver requiring no more than 100 volts of B current.

If unable to get at your dealers, send your order in direct! Accept no substitutes.

Dealers write for discounts

C. E. JACOBS, Mfr.

2803 N. Kedzie Ave. Chicago



TERMINALS LOCK ALL CIRCUIT CONNECTIONS PERMANENTLY; SAVE TIME AND LABOR; THEY ARE NEATER. ISN'T THAT GOOD?
William Stearns Co.
27 Hammett Road Roslindale, Mass.

SUPER-HETERODYNES

Victoreen—St. James—Remler
Complete parts in stock—Write
WALDEN ELECTRIC CO.
25 N. Dearborn St. Chicago



FIXED RESISTORS
Micamold
FIXED CONDENSERS
Accurate. Constant in Value Indestructible.
"Made of Mica and Moulded in Bakelite"
At good Radio Stores
MICAMOLD RADIO CORP.
Flushing and Porter Aves., Brooklyn, N. Y.
ACCURACY GUARANTEED
VALUES REMAIN CONSTANT
MADE UNDER PRESSURE OF 50 TONS

Powerful and Sharp Inexpensive and Highly Efficient The AMEL DISTANCER Tuned Radio Frequency Kit

is the heart of a 5-tube broadcast receiver and covers the entire wave length band from 200 to 600 meters. The variable condensers used are latest S. L. F. low loss type. The scientifically designed coil coupling results in powerful signals from distant List stations. Install this Kit in your old set and make it up-to-date. \$8.25

The AMEL 3-Circuit Tuner List \$4 Each
Coast to coast reception on 3 tubes, 200-600 meters. Best materials, American Lit-z windings in three colors.

The AMEL Distancer T. R. F. Transformer May be mounted on any type condenser. Tuning very sharp—same coils as used on our T. R. F. Kit. Compact and efficient. Distant signals clear and loud. Wound for .00035 MFD. condensers unless otherwise specified. List \$3 Three

FREE Three Dials on Kit orders Mailed before April 15th.
Amel Radio Laboratories
Dept. R.W. New York City
173 Greenwich St.

Locate at
RADIO CENTER
Bush Building
130 West 42nd St. New York City

We Specialize in Complete Kits
The M. & H. Engineering Service Will Supply Parts or Complete Sets of Any Hook-up
DESCRIBED IN THIS OR ANY OTHER RADIO MAGAZINE
M & H SPORTING GOODS CO.
512 Market St. Philadelphia, Pa.

Save 20 to 50% FREE RADIO CATALOG
LATEST IN HOOK-UPS AND RADIO
Get the lowest rock-bottom prices on radio parts, sets, kits. New free Radio Catalog and Guide brimful of standard, reliable, guaranteed goods. Over 100 latest hook-ups and illustrations. Be sure to get this thrifty book before you buy. It puts money in your pocket. Saves you as much as half on a set. Also please include name of radio fan. Send letter or postal NOW.
THE BARAWIK COMPANY
103-140 S. Canal St., Chicago, U. S. A.

\$4.75
APOLLO
A loud speaker of surprising musical quality and volume. In the class with high-priced speakers. Artistically designed. Swan neck type. Adjustable unit where volume and tone are at all times under control. Mail orders filled same day.
HARD RUBBER PANELS

Size	Black	Mahogany
7 x 10	\$.32	\$.42
7 x 12	.39	.48
7 x 14	.42	.54
7 x 18	.56	.67
7 x 21	.64	.78
7 x 24	.75	.87
7 x 26	.85	.98
7 x 30	.96	

MANY OTHER BARGAINS
Rix Radio Supply House, Inc.
5505 Fourth Ave. Dept. 46
Brooklyn, N. Y.

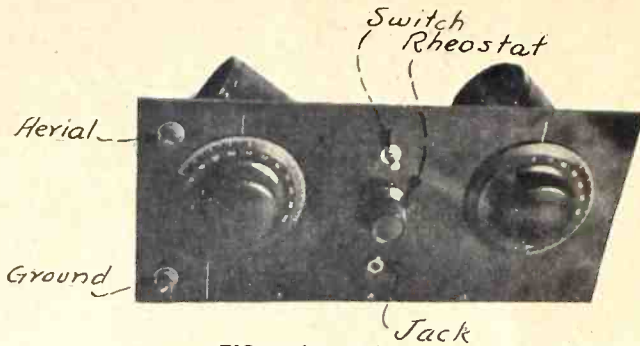

FIG. 4, the panel view.

The 2-Control 4-Tube Receiver

(Continued from page 11)

to the rotary plates of the variable condenser. The end of this winding goes to the stationary plates of the condenser and to one terminal of the grid leak and condenser. The other terminals of this combination goes to the G post on socket 2. The P post on this socket goes to the P post of the first AFT. The B plus post of this AFT goes to the B plus 2 1/2 volt post. The G post on the AFT goes to the G post on the third socket. The F post on this AFT goes to the F minus post on socket 3. The F plus post on this socket goes to one terminal of a filament switch. The P post on this socket goes to the P post on the last AFT. The B plus post of this AFT goes to the B plus



FREE!

12-Cell — 24-Volt Storage 'B' Battery

Positively given free with each purchase of a WORLD "A" Storage Battery. You must send this ad with your order. WORLD Batteries are famous for their guaranteed quality and service. Backed by years of successful manufacture and thousands of satisfied users.

2-Year Guarantee

Bond in Writing

Approved and Listed as Standard by Leading Authorities including Radio News Laboratories, Popular Science Institute of Standards, Popular Radio Laboratories, Radio Broadcast Laboratories, Radio News, and Lefax, Inc.

Send No Money

Just state battery wanted and we will ship day order is received, by Express C. O. D. subject to your examination on arrival. FREE "B" Battery included. Extra Offer: 5 per cent discount for cash in full with order. Buy now and get a guarantee in the home.

WORLD BATTERY COMPANY
1219 So. Wabash Ave., Dept. 17 CHICAGO, ILL.

World STORAGE BATTERIES
Set your Radio Dial at 210 meters for the new 1000 watt World Storage Battery Station, W5BC, Chicago. Watch for announcements.

ULTRA-LOWLOSS CONDENSER
SPECIAL CUTLASS PLATES DISTRIBUTE THE STRACTIONS EVENLY OVER THE DIAL SIMPLIFIES TUNING CAPACITY 0005 MFD
\$5.00
PHIENIX RADIO CORP., 116-F East 25 St., N.Y.C.

1000 "DIAMOND-OF-THE-AIR" PANELS, \$1.60 EACH
ALL DRILLED AND ENGRAVED
Regularly sold for \$5.00 or over. Not less than 1/2 doz. lots.
Cortlandt Panel Engraving Co.
79 Cortlandt Street New York City

Vacuum Tubes Rebuilt \$1.00 each
POSITIVELY GUARANTEED equal to new tubes in every respect. Money will be refunded if tubes prove unsatisfactory for any reason other than burn-outs.
Send us your broken and burned out tubes by parcel post. (Not necessary to insure or guard against breakage.) We make return shipments by parcel post C.O.D. and try to maintain 24-hour service.
HARVARD RADIO LABORATORIES
200 Old Colony Avenue South Boston, Mass.

CHANGES OF ADDRESS
should be sent to Subscription Department at least two weeks in advance of publication in order to insure early and proper attention. RADIO WORLD'S subscription list is so large that it is necessary that changes be sent in as requested. Address, Subscription Department, RADIO WORLD, 145 W. 45th St., New York.

TWO-FOR-ONE SUBSCRIPTION OFFER
Radio World has made arrangements
—To offer a year's subscription FREE for any one of the following publications with one year's subscription for RADIO WORLD:
—POPULAR RADIO or —RADIO (San Francisco) or
—RADIO BROADCAST or —RADIO AGE or
—SCIENCE AND INVENTION or —COLLIER'S or
—RADIO NEWS —RADIO DEALER or —BOYS' LIFE or
This is the way to get two publications
—for the price of one:
—Send \$4.00 today for RADIO WORLD
—for one year (regular price
—for 52 numbers)
—and select any one of the other
—nine publications for twelve months.
—Add \$1.00 a year extra for
—Canadian or Foreign Postage.
—Present RADIO WORLD subscribers
—can take advantage of this offer by
—extending subscriptions one year
—if they send renewals NOW.

RADIO WORLD'S Special Two-For-One Price-of-One SUBSCRIPTION BLANK
RADIO WORLD, 145 West 45th St., N. Y. City.
Enclosed find \$6.00, for which send me RADIO WORLD for twelve months (52 numbers), beginning.....and also, without additional cost, Popular Radio, or Radio Broadcast, Radio News, or Science and Invention, or Radio Dealer, or Radio (San Francisco), Boys' Life, or Radio Journal, Collier's or Radio Age (or \$10.00 for two yearly subscriptions).
Name
Street Address
City and State

90 volt post. The G post on this AFT goes to the G post on socket 4. The F minus post of the AFT goes to the F minus post on the socket. The F plus post goes to one terminal of the filament switch. Connect the F plus post of all the sockets together and then to the filament terminal switch. This means that
(Concluded on page 26)

Make Your Set Deliver its Best with
The WOUND WIRE AERIAL
Improved Reception and Greater DX Guaranteed!
Approved by Popular Radio and Radio World.
For indoor or outside aerials
Send postal for descriptive booklet "Something New in Radio"
THE WOUND WIRE AERIAL CO.,
Reedville, Virginia

NATIONAL SPORTSMAN
is a 68 page monthly magazine crammed full of hunting, fishing, camping and trapping stories and pictures, valuable information about guns, revolvers, fishing tackle, game law changes, best places to get fish and game, etc. Biggest value ever offered in a sporting magazine.
AND HERE'S THE Remington Sportsman's Knife with stag handle and two long blades especially designed to meet the exacting requirements of skinning and cleaning fish, game birds and fur-bearing animals. Blades are of superior quality steel with strong, durable, keen-cutting edges. The points are shaped just right for a good, clean job of skinning and skinning. Length 3 3/4 in. closed.
The name "Remington" on the blade is your guarantee of quality.
SPECIAL OFFER:
We will send this knife and National Sportsman for a \$1.00 whole year on receipt of.
NATIONAL SPORTSMAN MAGAZINE
1202 Newbury St., Boston, Mass.

This Year It's a Tidal Wave!



DIAMOND KIT

Every "Diamond Kit" contains parts carefully chosen by Herman Bernard himself. With the exception of the cabinet the Kit is absolutely complete, down to the very nuts and bolts. There is nothing else to buy. Kits will be shipped anywhere the day the order is received. The price is... **\$35**
The quality is priceless.

Did you ever notice the waves rolling in towards the shore? In one grand, majestic sweep, incessantly continuous. That's exactly how the 1926 "Diamond of the Air," Herman Bernard's epoch making super-circuit, is sweeping the radio waves.

This year it's a tidal wave! The 1926 improved circuit has carried so far beyond expectations there's no telling where it will stop.

Five tubes, that's all. Each one, thanks to Herman Bernard, an energetic jewel of sparkling action. Efficiency, selectivity and economy form the triumvirate that makes the "Diamond" a real gem!

Last year, the "Diamond's" popularity dazzled us.

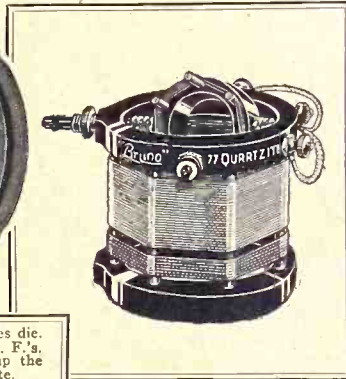
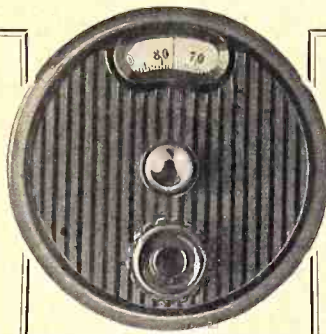
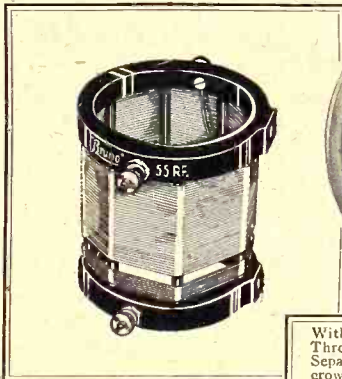

With "Bruno's Magic Dial" tuning troubles die. Through them all condensers become S. L. F.'s. Separate the low wave lengths. Open up the crowded spaces. Made of moulded bakelite.
Bruno Magic Dial.....\$2.50
Bruno Vernier.....2.00

Bruno Quartzite Inductances, as illustrated above and described in the following paragraphs, are the most efficient coils of their type made. They have to be. Herman Bernard chose them for his Diamond Circuit after heart-breaking tests for comparative efficiency. They match. Absolutely.

Bruno "55" or "99" R. F. coil, which is matched to tune with the Bruno "77" or "99" three circuit coil. Also wound on quartzite glass rods, which insure minutely small losses. The primary is green colored and the secondary is of orange color, giving this coil a handsome appearance. Price.....\$3.00

Bruno "77" or "99" interstage coupler wound on quartzite glass rods with newly designed tickler, giving maximum efficiency on all wavelengths. Tunes with .0005 condenser and covers range of from 175 to 575 meters. Price.....\$5.50

This is one of the finest lines of precision radio parts made. Real painstaking effort and sincere endeavor are put into the design of Bruno parts. We thought so well of them we had ourselves appointed mail order distributors.

BRUNO Powertone Kit, a 5-tube, single control receiver. \$22.50

Described in Radio World Aug. 29, Sept. 5, and Dec. 12.

Sidney E. Finkelstein's 25-110 Meter Short Wave 2-tube set, described Sept. 12 **\$12.95**

Bernard's Loudboy—distance and volume on 1 tube; described Feb. 21. **\$9.65**

SOMETHING UNUSUAL
A new 16-page booklet with full size blueprint on the construction, care and troubleshooting on the 1926 "Diamond of the Air," as compiled and edited by Sidney E. Finkelstein, A. M. I. R. E. 50 cents
Send stamps or money order.

RADIO RESEARCHES
A monthly bulletin in booklet form containing the reports of the previous month of the laboratory staff of the Bruno Radio Corporation can be had at 10 cents per copy with laboratory blueprints of a tested circuit \$1 per year.

B.C.L. RADIO SERVICE Co. 221 FULTON ST. NEW YORK N.Y.

The 2-Knob Receiver

(Concluded from page 24)

LIST OF PARTS

Two RFT, with secondaries wound to be shunted by .00035 mfd. variable condensers.

Two .00035 mfd. variable condensers.
One .00025 mfd. fixed condenser.
One 2 megohm grid leak.
One 6 ohm rheostat.
Two AFT of the low ratio type.
One binding post strip.
Four sockets.
One filament switch.
One single circuit jack.
One 7x18" panel.
One 6"x10" baseboard.
Two 4" dials.

Accessories: Connecting wire, tubes, A and B batteries, screws, nuts, etc.

all these F plus terminals go to a terminal of the filament switch. The other terminal of the switch goes to the A plus post on the strip. All the F minus posts go to the resistance wire post of the rheostat. The movable arm post goes to the A minus post on the AFT. The P post on the last socket goes to the top terminal of a single circuit jack or to a phone tip. The bottom of the single circuit jack or the other phone tip goes to the B plus 90 volt post on the strip.

Getting Results

Reverse the A battery leads, the leads of the secondary of the second RFT, change the tubes around and try placing an .001 mfd. fixed condenser from the P post on the first AFT to the F plus post on the same socket in case the signals are low. An antenna at least 100 feet long, in a single wire, and a water pipe ground should be employed. Using this 100-foot antenna, as much as a 50-foot lead-in can be used.

If you find that your B batteries run down too quickly, then insert a C battery. This is done by connecting the two F minus posts of the AFT together and connecting it to the minus post of the C battery. The positive post of the C battery goes to the minus post of the A battery.

A&B Battery \$2 Charger ONLY

SATISFACTION GUARANTEED



Ideal as a trickle charger for A battery or a regular charger for B battery, using only a few cents' worth of ordinary house current. Works on either alternating or direct current. Cannot injure battery and lasts for years. Complete directions enclosed—no expensive "extras" to buy.

Why pay \$10.00 to \$18.00 for a charger when you can get this splendid GUARANTEED R. B. Charger, made of molded Bakelite, by mailing us two dollars (bills, money-order, check or stamps), plus 10c. in stamps or coin to pay mailing costs. Charger will be sent postpaid. If you are not satisfied, return within five days and we will refund your money. Order at once—TODAY!

R. B. SPECIALTY COMPANY

Dept. 17

308 East Third St.
Cincinnati, Ohio

If you are using only 90 volts on the plate of the tube, then a 4.5 volt C battery should be employed.

A rheostat (10 ohms), in series with the negative leg of the detector tube, will help to control the action of this to a greater degree and give signals of a greater intensity. A separate B battery voltage for the RF tube might increase the strength of the signals also.

FENWAY BLUE PRINTS

"PICTURE" DRAWINGS
Easily the finest radio prints ever made.

Price, Postpaid—\$3.00

Build a Laboratory Set with
Fenway Blueprints!

LEO FENWAY

25 WEST 64TH STREET NEW YORK, N. Y.



New—Different

The Beautiful De Luxe Radio Log You've Always Wanted.

The Wonder Radio Log

Rich seal grain binding stamped in gold. Top edge gilt, 144 pages, size 5 x 7 1/2. Printed on heavy bond paper.

Lists the Broadcasting Stations three convenient ways—(1) by Call Letters; (2) by Locations and Owners; (3) by Kilocycles and Meters. Includes 24-page Wonder Radio Diary by months and days and Wonder Radio Distance Map. Ample space for keeping complete Log and for changes, additions and revisions.

Delights everyone who has it.

"I have sold or seen practically every Radio Log issued for five years, but never saw a complete one until the WONDER arrived. It has no rival."

"It IS a WONDER!—beautiful, complete and up-to-date. Check for \$5.00 is from five friends."

It will delight you. Order today.
Price \$1.00 Post Paid.

THE WONDER RADIO LOG COMPANY
705 So. Dearborn St. Chicago

FREE BOOKLET FOR INVENTORS
IF YOUR INVENTION is new and useful it is patentable. Send me your sketch.
Z. H. POLACHEK, 70 Wall St., New York
Reg. Patent Attorney-Engineer

KB-8

(Non-Regenerative Browning-Drake)

NO MORE BLOOPERS!

That's the new Golden Rule of radio. Your neighbors won't tear their hair when you tune in a KB-8, because it is non-regenerative. And you will get the quality of reception which only a non-regenerative set can produce. THE KB-8 WILL BRING IN AT FULL VOLUME ANYTHING THAT A SUPER-SENSITIVE SET CAN RECEIVE WITH GOOD QUALITY.

DATAPRINTS

for SET BUILDERS..... \$1.00

Detailed description and 12 photographs are given in Radio Engineering Magazine, March issue. Send 20c in stamps, or \$2.00 for a year's subscription. Radio Engineering is not sold on newsstands.

RADIO DEALERS

The KB-8 is the very latest thing in Browning-Drake development. Dataprints can be bought at full discount. Sell them to move parts. It is non-regenerative.

Dataprints Sold in Individual Tubes

M. B. SLEEPER, Inc.
TECHNICAL PUBLISHER
V-52 Vanderbilt Ave.
New York City

DEAD SPOTS !!

INTERFERENCE !!

THERE IS NONE

with the

—FENWAY—

CONQUERS DEAD SPOTS,
ANNIHILATES DISTANCE.

IT'S EVERYMAN'S RECEIVER. IS IT YOURS?

"LOOK UP DOWN"

He has all the parts for this remarkable receiver and will ship the same day order is received. All parts as specified.

Special Panel, Special Copper Cans, Special FENWAY Coupler, General Radio, Silver-Marshall, Yaxley, Royalty Resistance, National Dials (New Type), Jewell and Weston Meters, Micamold Condensers and Leaks and all other parts required.

SEND FOR COMPLETE LIST AND PRICES

"LOOK UP DOWN"

THE ONLY AUTHORIZED FENWAY DEALER AND SERVICE STATION
A COMPLETE RADIO TESTING LABORATORY FOR THE CORRECTION OF
RADIO TROUBLES

CHAS. W. DOWN

Super-Heterodyne Specialist
Wiring and Repairs with Guaranteed Results
Special Mail Order Dept.

(Wholesale prices quoted to bona fide dealers only.)

711 EIGHTH AVENUE
Bet. 44th and 45th Streets

NEW YORK CITY
Penn. 7779

TEAR OFF AND MAIL TODAY

8 Weeks' Trial Subscription, \$1.00

KEEP ABREAST OF THE LATEST
RADIO DEVELOPMENTS
RADIO WORLD
145 WEST 45th ST. NEW YORK CITY

DISTANCE AND VOLUME

At Your Command

Build a 5-Tube Tuned Radio-Frequency Set, Using the Streamline Kit **\$7.50**



Boxed Kit consists of 3 Streamline straight line frequency .00035 mfd. condensers, 3 basketweave coils, 3 mountings. Above, with 3 Bruno Slo-Moshen Vernier Bakelite Dials \$12.50

Streamline Condensers

Straight Line Frequency

.00025 mfd.	\$2.00
.00035 mfd.	\$2.25
.0005 mfd.	\$2.50

STREAMLINE RADIO CO.

213 FULTON STREET
New York City

THE VICTOREEN

How to build this 8-tube Super-Heterodyne described in February 20, 27, March 6 and 13 issues of RADIO WORLD. Send 60c for all four copies, including FREE blueprint. Send \$6 for year's subscription and get these four copies and blueprint FREE!

RADIO WORLD

145 W. 45th St. New York City

Loop Often Improves Stability of a Receiver

Many have noticed that the tendency toward free oscillation may be increased when an antenna-ground system is used.

JOHN F. RIDER

announces that his laboratory is now available as a service institution catering to the radio fan constructor and the broadcast listener.

Also his personal services are available to radio fans as consultant in matters pertaining to radio receivers in all their phases.

Mr. Rider is the author of the Laboratory Scrap Book appearing each Saturday in the New York Sun Radio Magazine, Contributing Editor of Radio World, and contributor to many other leading radio periodicals of the country.

LABORATORY OF JOHN F. RIDER
145 West 45th Street New York City
Telephone Bryant 2383

DISTRIBUTORS

VICTOREEN SUPER HET.
SAMSON TRANSCRIPT
SILVER-SIX
SILVER-COCKADAY
SILVER 7-TUBE IMPROVED SUPER HET.
MARCO DIALS and BROWNING-DRAKE KITS
DIAMOND OF THE AIR
THORDARSON Transformers
PRECISE
CLAROTUNERS-Roberts Knockout
SICKLES & EASTERN COIL CO. Roberts Knockout

Gold Seal Home Chargers
Modern B Eliminators and Transformers
Silver Raytheon B Eliminator Parts
Steinitz Inter. Eliminators
Tobe By-Pass Condensers
HAMMARLUND Condensers and Kits
Drilled and Engraved Panels for all Circuits
Other Lines as Well
Dealers Write for Discounts!
24-Hour Service

MAURICE SCHWARTZ & SON
710-712 Broadway Schenectady, N. Y.

Hints on Soldering



AN AERIAL insulator makes a safe resting place for a hot soldering iron.



SCRAPE OFF the polish or veneer on a brass angle or other metal before soldering.

as compared with a loop. The added strength of the incoming signal, due to the greater pickup by antenna-ground, is a leading cause. Many circuits that need no stabilizing device when a loop is used would operate more efficiently if there were some control or adjustment of oscillation when the outdoor antenna is substituted. Many experts believe that interchangeability is not advisable, because a set should be rated as a loop set, and used as such, e. g., the Super-Heterodyne, or it should be an outdoor antenna set. Many fans disagree with this.

Results Editor:

On Monday evening, March 1, 1926, I hooked up the 1-tube set as described by William Mercer in the Feb. 20 issue of RADIO WORLD. I tuned in more stations than I ever did before. Station KQW, San Jose, Calif., came in without any trouble, at about 11 p.m., while station WSB, which is only four miles distant, was on the air. This set is hooked up temporarily, with no soldered joints.

F. L. VOLBERG, JR.
102 So. Forsyth St., Atlanta, Ga.

VICTOREENFANS!

In the February 27th issue of Radio World, Leo Fenway, of "Fenway fame" challenged us to a contest to determine the relative merits of the "Fenway" and "Victoreen" Supers.

We have received a great number of letters from builders of the "Victoreen," claiming it to be the premier set for radio reception. It will now give us pleasure to have these "boosters" and others write in to the Technical Editor of this magazine, voicing their comments or criticisms, so that the radio public may benefit by learning the results and satisfaction derived from a real receiver.

Confidence has been placed in the radio fans possessing sets, and we are certain of their support. Write us immediately so that the chances of having your letters published promptly will be certain.

A folder explaining the exceptional merits of the Victoreen Super Transformers will be gladly furnished upon request.

The George W. Walker Co.

6515 Carnegie Ave.

Cleveland, Ohio

Branches in principal cities.

FREE RADIO CATALOG

WRITE for a copy of our NEW 100-Page Radio Catalog — Parts, Accessories — Kits — Sets — Everything for the Fan.

DEPT. R. W.

CHICAGO SALVAGE STOCK STORES

509 S. State Street, CHICAGO, U. S. A.

Detector and Audio In Super-Heterodynes

(Continued from page 12)

ual capacity should be made small by so placing the pick-up coil with respect to the oscillator coil that the nearest parts are at nearly the same potential. For instance, the pick-up coil may be placed on the grounded side of the modulator tuning coil and also near the grounded side of the oscillator coil. This is not customary for usually the pick-up coil is placed on the high potential side of the modulator coil and haphazardly with respect to the oscillator coil. In case the intentional pick-up is capacitative, the magnetic pick-up should of course be minimized. This might be more easily done since the various coils always can be placed experimentally at such angles that the mutual inductance between them is zero. If the pick-up is direct or conductive the unbalance is usually not so noticeable because phase is of little importance. Examples of direct coupling are the Pressley, the resistance method used in one of the Western Electric Super-Heterodynes, and methods based on the Heising scheme of modulation.

What Type of Detector?

It seems that in the majority of Super-Heterodynes published the second detector works on the principle of grid leak and stopping condenser. The method is no doubt the most sensitive, but is not necessarily capable of the greatest volume. A detector working on this method

blocks and overloads much more quickly than one working on the grid bias principle; and since the voltages delivered to the detector in a good Super-Heterodyne are often very high, the grid bias method of detection is more reliable and more stable. If the grid bias is carefully ad-

For Better Reception SHIELD Your RADIO

Perfect Shielding Materials.
Write for prices.
Stage Bros. Mfg. Co., Lincoln, Nebr.



The Edison Element "B" Battery has long been the marvel of battery users, thereby surpassing all others. The See-Jay Battery is constructed from genuine alkaline elements and connected with a non-corrosive connector. 100-volt Alkaline Rechargeable "B" Battery and factory made charger for \$12.00; 140-volt, \$17.00. Write for literature or send 20c for sample cell. Send no money—pay on delivery.
SEE-JAY BATTERY CO., 915 Brook Ave., N. Y. City

justed to the correct value there is not much difference in the sensitivities of the two methods. Personally I greatly prefer the grid bias method of detection in Super-Heterodynes. A detector of this type will give clear signals of moderate loud speaker volume.

The Audio Amplifier

If first-class audio transformers are used—ones of moderate turns ratio and a
(Concluded on next page)



CLAROSTAT
prescribed by LEWIS WINNER for the TECTRON "B" ELIMINATOR. Also O.K.'d by RAYTHEON and a host of other National Known Eliminator manufacturers. \$2.25.
American Mechanical Laboratories, Inc. 285 N. 6th St. Brooklyn, N. Y. Dept. R. W.

A book of valuable radio diagrams and information covering the above subjects will be mailed to you upon receipt of four cents in stamps.

Join the Happy Diamond Family!

Build This Famous 5-Tube Set
and Know Real Quality
Reception!

Easy to Build, Easy to Tune!

Herman Bernard, designer of this wonder circuit, has written an illustrated booklet on "How to Build RADIO WORLD'S 1926 Model Diamond of the Air." Send 50c and get this booklet, including a full-sized wiring blueprint. Also name plate, FREE.

Outstanding Features of Set:

- (1) Fans, charmed by tone quality, sensitivity and selectivity, report speaker reception of far-distant stations with great volume.
- (2) A 2-tube earphone set, a 5-tube speaker set, and a separate 3-stage audio-amplifier for immediate use with any tuner, are combined in one.
- (3) No rheostats are used.
- (4) The set is inexpensive to construct and maintain.

What the Circuit Is

The 1926 Diamond consists of one stage of tuned radio-frequency amplification, regenerative detector, one transformer-coupled audio stage, and two resistance audio stages—the utmost from five tubes!

Follow Bernard

You can't go wrong if you follow the directions as written by the designer himself, as contained in the booklet. The diagrams, including blueprint, are guaranteed 100% accurate. Play safe!

Send \$6 for year's subscription and get booklet blueprint and nameplate FREE.

[Newsdealers or radio dealers, order the booklets with blueprints included, in quantity, direct from American News Co. or branches.]

RADIO WORLD
145 West 45th St., New York City

AEROVOX

Is Specified
By LEWIS WINNER

for the TECTRON
AND ALL OTHER RADIO WORLD'S
"B" ELIMINATORS

Why? Because they are "BUILT TO BE BETTER."
Also FIXED MICA CONDENSERS, RESISTORS and
RESISTANCE-COUPLED UNITS.

AEROVOX WIRELESS CORP.

489-491-493 Broome Street

New York City



1925 BACK NUMBERS OF RADIO WORLD WANTED

Mail us copies of any of the following 1925 issues of RADIO WORLD, and we will send you a copy of a current issue for every copy sent us: January 10, February 21, March 21, April 4, 11, 25; May 16, 23, 30; June 6, 13, 20; July 4, 11, 18, 25; August 8, 15, 22; September 5, 26.

FILL OUT AND MAIL NOW SUBSCRIPTION BLANK RADIO WORLD

RADIO WORLD

145 West 45th Street, New York City,
(Just East of Broadway)

Please send me RADIO WORLD for months, for which
please find enclosed \$.....

SUBSCRIPTION RATES:

Single Copy \$.15
Three Months 1.50
Six Months 3.00
One Year, 52 Issues 6.00
Add \$1.00 a Year for Foreign
Postage; 50c for Canadian Post-
age.

Which Transformers? Air or Iron Core Type?

HARD RUBBER
SHEET—ROD—TUBING
Special Hard Rubber Parts Made to Order
RADION HARD RUBBER
PANELS ANY SIZE
Send for price list
WHOLESALE RETAIL
NEW YORK HARD RUBBER TURNING CO.
212 Centre Street New York

SHORE
TRANSFORMERS
CHOKE COILS
CONDENSERS
Will
Enable You to
Build Your Own
TECTRON
"B" BATTERY
ELIMINATOR
*As described by
Lewis Winner in this issue*
Full Instructions
Sent on Request
for
RAYTHEON
REX, and
CHEMICAL
RECTIFIERS
Prices on request
SHORE ELECTRIC CO., Inc.
64 University Place
New York City
*All types of special
transformers built
to specifications*

(Concluded from preceding page)
straight line characteristic—then only one stage should be used, as this will furnish sufficient volume for any loud speaker. If choke coil or resistance coupling be used then two or even three stages may be used. With a grid bias detector and resistance coupling, one high mu tube and one power tube should be enough to operate any loud speaker and should give good, clear signals.

Air Core or Iron Core

Will I get better results if I use air core or iron core transformers? For a compact set use iron core, place the trans-

RIGHT TO THE POINT!
Extreme accuracy of dial reading is assured when you use EUREKA DIAL POINTERS! Tuning in distance is simplified.
Polished Nickel or Gilt. 5/8" or 3/4" **10¢**
C. W. BUTTS, Inc.
40 Hedden Place East Orange, N. J.
Dealer Inquiries Solicited.

Long Distance Radio
Only \$2.95

200,000 SATISFIED OWNERS
—Getting stations 600 miles away on Lambert Radios. No batteries or tubes required. A real Radio—not a toy or attachment. One to four can listen at once. No howling or screeching noises. Hear local stations on bed-springs, light sockets or telephone. Fully guaranteed. Set, \$2.95—Phones, \$2.95—Aerial, \$1.00. Mail orders filled same day. We pay postage.
LEON LAMBERT RADIO CO.
212 So. Market St. Wichita, Kansas

**You Can Build a
Laboratory Receiver!**
**FENWAY BLUEPRINTS
SHOW YOU HOW**
Life-Size Drawings—Coil Data—Everything You Should Know About This Ultra-Modern Radio Receiver.
PRICE OF COMPLETE SET OF BLUEPRINTS—\$3.00 Postpaid
Others Give Their Radio Prints Away FREE!—Fenway Prints Cost You \$3.00—WHY?
Radio Division, The Columbia Print
147 West 45th Street New York City

formers close together, and balance out capacity feed-back a-la-Hazeltine. If a large sized receiver is to be built, use either type, don't place the transformers too close together, and get rid of capacity feed-back as above; and if you use air core transformers place the coils at right angles a-la-Atwater Kent or Neutrodyne angle a-la-Hazeltine.

If either air or iron core is used, and if they are correctly placed and adjusted, the completed circuit will give better results than the circuit using either type in which the transformers have not been properly adjusted, barring the receiver built by that lucky fellow who found the needle in the straw stack without looking for it.

RESULTS EDITOR:

Just a few words of comment on the 1-Tube Reflex for the novice, described by Feodor Rospatkin in the Feb. 21 and Oct. 10 issues of RADIO WORLD. The volume is great. It is a good distance getter also.

E. C. ASH,
Box 482,
Corinth, Mass.

SANGAMO
CONDENSERS
and
WESTON
INSTRUMENTS
all types and sizes carried regularly in stock for immediate delivery.
ROSSITER & CO., Inc.
Wholesale Distributors
136 Liberty Street, New York

Free Mailing Lists
Will help you increase sales and bring in FREE orders giving complete list of persons on thousands of classified names of your best prospective customers—Wholesale, Retail and Local—Individuals, Professionals, Business Concerns.
99% by refund of 5¢ each
ROSS-Gould Co. 30 N. St. Louis
10th St.

DO YOU WISH TO BUILD THE KB-6, (Non-Regenerative Browning-Drake Set), by M. B. Slepier that appeared in Radio World dated March 13 and 20, 15¢ per copy, or start sub. with any number. RADIO WORLD, 145 W. 45th St., N. Y. C.

OUT NEXT WEEK
The Greatest Issue of the Year
RADIO WORLD'S FOURTH ANNIVERSARY NUMBER
DATED APRIL 3rd
Radio World's weekly subscribers have doubled since our Third Anniversary Number. Still advertising rates remain the same—\$240 a page, or \$8 an inch, on yearly contract. With Radio World's 100,000 weekly circulation this advertising rate is only \$2.40 per page per thousand—a lower rate than any other 100% radio interest publication.
Last Advertising Forms Close March 24, A. M.
Last Red Form March 22, A. M.
On page copy received by Monday A. M., March 22, an extra color, red (two printings), will be given in this great anniversary issue without extra charge.
For space reservation write or phone F. S. Clark, Advertising Manager.
RADIO WORLD, 145 WEST 45TH STREET, NEW YORK
Telephone: Bryant 0558-0559

The B Unit That Employs Electrolyte

(Concluded from page 8)

little residual hum that it can hardly be detected with the headphones. Under no circumstances is there any hum loud enough to be heard on the speaker, even when high grade audio-transformers are being used.

The filter condensers C1 and C2 are 2 mfd. each. Larger condensers may have to be used in some cases, especially in the case of C2. Condensers for use in a B unit should be of the high voltage type. Do not use the ordinary by-pass condenser, as it will not stand up.

If it is desired to provide another voltage tap, as for instance for the radio frequency tubes, this can be done by connecting a Clarostat or Bradleymohm to the plus amplifier line and shunting the resistor with another condenser.

Fig. 2 shows a view of the B supply unit laid out on a baseboard. The arrangement is not very critical but it is advisable to keep AC and DC leads as far apart as possible.

With the employment of four rectifier jars a potential as high as 120 volts at a load of 15 mls can be taken from this B unit. This is sufficient for most receivers of the five or six tube variety. If more

current is drawn the voltage will drop accordingly, but at 90 volts from 25 to 28 milliamperes will be delivered. By increasing the secondary voltage of the power transformer and adding more jars to the rectifier bridge much higher outputs can very easily be obtained.

The Molliformer B unit requires but very little attention. If the solution is made with good chemicals and pure distilled water it will give service for about 1,000 hours without needing any renewal. It will be found that it does not even require any water to make up for the slight evaporation of the electrolyte. New chemicals cost little and the house current consumption is on the average only 1c for 15 hours.

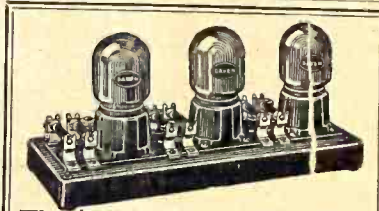

The Daven Super-Amplifier

for volume and tone quality
3 STAGES RESISTANCE COUPLED
ECONOMICAL DISTORTIONLESS
Easily added to any set
Saves Several Hours' Assembly
For Sale by All Good Dealers

LOUD SPEAKER RECEPTION

from either coast on three tubes
Blueprint and instructions.....\$1.00
Necessary low loss coil.....2.50
Beautiful finished instrument.....35.00

S. A. TWITCHELL CO.

1930 Western Avenue Minneapolis, Minn.

WELTY'S DETECTOR AMPLIFIER UNIT

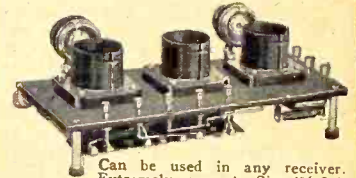

Can be used in any receiver.
Extremely compact. Size 4 1/2 x 3 1/2.
All strictly high class parts. Universal sockets. Distortionless transformers. Will handle the volume of any set. Only 4 connections necessary to hook up to any tuning apparatus. Price only \$19.50.

WILLIAM A. WELTY & CO.
36 South State Street, Chicago

KB-8

Browning-Drake Non-Regenerative

PARTS for SET BUILDERS

SET OF 6 PANELS
Genuine Celoron, drilled and decorated \$8.35

ALL HARDWARE
Lastites, screws, pillars, angle brackets, etc. \$3.80

DONLE DETECTOR
The most sensitive tube for KB-8 and RX-1 Sets \$5.00

WIRIT,
neatest and easiest for wiring radio sets 20 ft. .25c

RX-1 Construction Kit
Complete RX-1 Kit, and Donle Tube, latest improved design..... \$37.50

DEALERS

IMMEDIATE DELIVERY ON
DONLE DETECTOR TUBES
—FULL DISCOUNT—

DURRANT RADIO, Ltd.

R-52 Vanderbilt Ave.
New York City

FREE RADIO BOOK

Science has invented a new kind of coil. Now have it on your present set. Gives 4 great advantages otherwise impossible. Write for new book just published, showing many new ideas. Also 3 new circlid circuits. Address Electrical Research Laboratories, R.W., 2548 Cottage Grove Avenue, Chicago.

RADIO AGE BLUEPRINTS

The Magazine with

An eight page blueprint section in every issue of the RADIO AGE, with detailed information telling how to make these built and tested hookups in your own home.

Technical articles by unbiased radio experts, a complete list of broadcasting stations, a log chart, human interest stories of the broadcast world, photographs and drawings by the score.

All in one for only
25 cents a copy.
\$2.50 a year.

Use the coupon and get real value.

RADIO AGE, INC.
500-510 N. Dearborn Street
CHICAGO

RADIO AGE, INC.,
Dept. RW,
500-510 N. Dearborn St.,
Chicago, Ill.

Please send me the RADIO AGE, the magazine with blueprints, for one year beginning with the _____ issue. Check for Money Order for \$2.50 is enclosed.

Name
Address
City State

ACCUSTI-CONE SPEAKER

FROM FACTORY TO YOU

19-inch Full Size \$7.50
full floating cone

Would cost \$30. in a retail store. You save by buying direct. It is superior to any speaker made. Try it in your home; if not satisfied, return and get money back.

Accusti-Cone Laboratories
96 Church St. New York

How to Build THE FENWAY

The famous DX set that, by the turn of a switch, is a 4-tube tuned RF set, with regeneration, or a 9-tube Super-Heterodyne! Remarkably sensitive!

Described by Leo Fenway himself in the February 6, 13, 20 and 27 issues, including trouble shooting. Send 60c for all four issues, or send \$1 for year's subscription and get these four copies FREE!
RADIO WORLD, 145 W. 45th St., N. Y. C.

QUICK ACTION CLASSIFIED ADS

10 CENTS A WORD. 10 WORDS MINIMUM. CASH WITH ORDER

ONE YEAR TO PAY—Five tube receiver shipped anywhere to any one on easy terms. Free descriptive circular and payment plan on request. Send stamp. Serlin & Company, 1419 Broadway, Detroit, Mich.

BULLDOGS
BEAUTIFUL REGISTERED BULL PUPS, \$15.
Bulldogs, 501 Rockwood, Dallas, Texas.

HELP WANTED MALE
EARN \$110 to \$250 monthly, expenses paid as Railway Traffic Inspector. We secure position for you after completion of 3 months' home study course or money refunded. Excellent opportunities. Write for Free Booklet, G-161 Stand, Business Training Inst., Buffalo, N. Y.

PATENTS—Write for free Guide Books and "Record of Invention Blank" before disclosing inventions. Send model or sketch of your invention for our inspection and instructions free. Terms reasonable. Radio, Chemical, Mechanical, Electrical and Trademark experts. Victor J. Evans Co., 924 Ninth, Washington, D. C.

SOME OF THE ARTICLES that appeared in RADIO WORLD dated March 6: The Tube vs. The Crystal, The KB-8 Non-Regenerative Browning-Drake Set, The Tectron Eliminator, Curious Victoreen Troubles, etc. 15c per copy, or start sub. with that number. RADIO WORLD, 145 W. 45th St., N. Y. C.

Get the Utmost From Your Set!

Use a Bretwood Variable Grid Leak!

WHEN you realize that the voltage output of a set may be increased 25 per cent. by correct grid leak setting—when you realize that regeneration and oscillation control is finely achieved by the variable grid leak—when you realize that nobody knows in advance just what is the correct leakage for an individual detector tube—then you know that you must use the Bretwood Variable Grid Leak, else be content with less than maximum efficiency from your set. More volume, greater distant reception, clearer signals should be your goal. Bretwood is the solution. Adopt it to-day!

Price, \$1.50

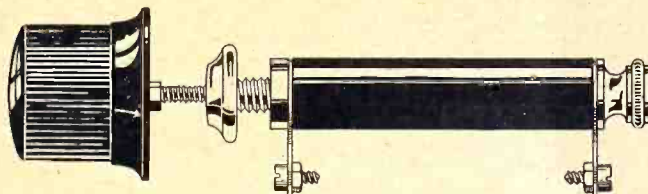

The Bretwood Variable Grid Leak
(Bretwood, Ltd., Sole Patentees and Owners)

Guaranteed Precision Range 1/4 to 10 Megohms

The Bretwood Variable Grid Leak Is Officially Prescribed for the 1926 Model Diamond of the Air

The North American Bretwood Co.

Telephone, BRyant 0559

145 W. 45th St., N. Y. City

Sole Distributors for United States

North American Bretwood Co., 145 West 45th St., N. Y. City.

Gentlemen: Enclosed find \$1.50. Send me at once one Bretwood Variable Grid Leak on 5-day money-back guarantee.

NAME.....
 ADDRESS.....
 CITY..... STATE.....

Inquiries Solicited from the Trade

Purchasers Are Delighted With Results

I received the Bretwood Grid Leak. Thanks for your promptness. The Bretwood is the best grid leak that I have ever had. Since I placed it in my 1926 Model Diamond of the Air I have received stations from nearly every part of the country. WMBF, WSB, KOA, 6KW, WBAP, WJAX, WOC, KFKX, PWX, KGO and KFI were all brought in on the speaker as soon as this instrument was put into the receiver. As for clearing up distortion, I have never seen anything to equal the Bretwood Grid Leak. I have placed one also across the primary of the first audio-frequency transformer and the results are marvelous.

E. HIGGINS,
130 Washington Ave.,
Elizabeth, N. J.

* * *

An obligation of gratefulness impels me to write you that any one who has not used the Bretwood does not know what a grid leak is.

BRUNO GONZALEZ,
General Staff Sergeant,
Cuban Army.

P. O. Box 910,
Havana, Cuba.

* * *

I think the Bretwood is the best grid leak I have ever used. Have made quite a few sets and this beats them all. Get DX very plainly and clearly.

WM. HEBERSON,
2510 N. Franklin St.,
Philadelphia, Pa.

* * *

Bretwood Grid Leak received and tested out. I find it is the only variable leak I ever used that is really variable.

Enclosed find \$1.50, for which please send me another one.

F. E. STAYTON,
Box 240, Ardmore, Okla.

* * *

With your grid leak I was able to bring in with good volume 15 W stations in one week with a Diamond of the Air set from a city hard to get out of.

Thanking you.

F. W. COLLINGWOOD,
3442 Sacramento St.,
San Francisco, Cal.

* * *

I received the Bretwood Variable Grid Leak last night and it sure did bring in stations. Denver was as far as I could get until last night, when, with the Bretwood in my set, I brought in KFI, Los Angeles, and KPO, San Francisco, Cal., clear and fine.

JOS. L. MARIE,
4026 Grezella St.,
Pittsburgh, Pa.

* * *

Do YOU Want to Get Results Like These? If so, the Bretwood Variable Grid Leak is the Answer! Indorsed by Leading Radio Engineers and Laboratories. It Is the World's Best Grid Leak!

BST-6

B - for Beauty of Cabinet
 S - for Selectivity
 T - for Tone purity
 6 - its 6 tubes for distance

"A thing of beauty is a joy forever"

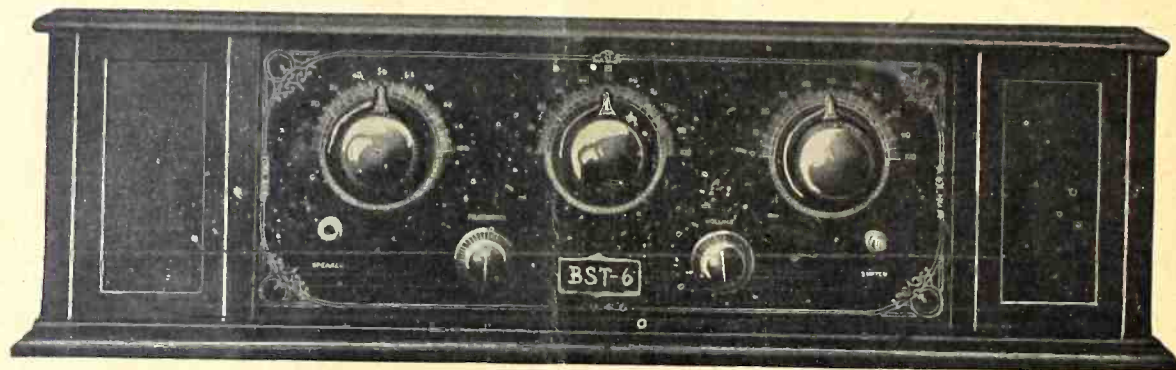

2 Feet 4 Inches Long. 9 Inches Inside Depth. 8 $\frac{3}{4}$ Inches High.

This marvelous six-tube tuned radio frequency receiver is Self-Equalized and built of low-loss materials thruout. Its clear, rich tone of astonishing volume is a revelation.

Direct from factory to you \$40.00

Saves Jobbers', Distributors', Dealers' Profits

Cheaper than building your own

SPECIFICATIONS

Bakelite Panel, Walnut Finish—
 With Etch-O-Gravure and Gold Decorations—
 Bakelite Sub-Base—
 Kurz-Kasch Bakelite-Walnut Pointers; Gold-filled, to Match—
 Kurz-Kasch Bakelite Gold-filled Rheostat Knobs—
 Lubree Straight Line Frequency Condensers—
 Special Coils; Double Silk Enameled, Primary and
 Secondary—
 Shore Audio Transformers—
 Caswell-Runyan Two-tone Walnut-Finished Cabinet.

GUARANTEE

Each receiver is tested and retested, boxed and inspected before leaving factory, and guaranteed to reach you direct in perfect condition. Workmanship thruout guaranteed the best. Assembled by experts.

IMMEDIATE DELIVERY

Send Check or P. O. Money Order to

Columbia Print, Radio Division **145 West 45th St.**

NEW YORK CITY

RADIO WORLD Guarantees the Responsibility of This Advertiser