

# RADIO WORLD

FEB. 27

Title Reg. U.S. Pat. Off.

15 CENTS

Vol. 8 No. 23 ILLUSTRATED Every Week

## THE 4-TUBE DX DANDY

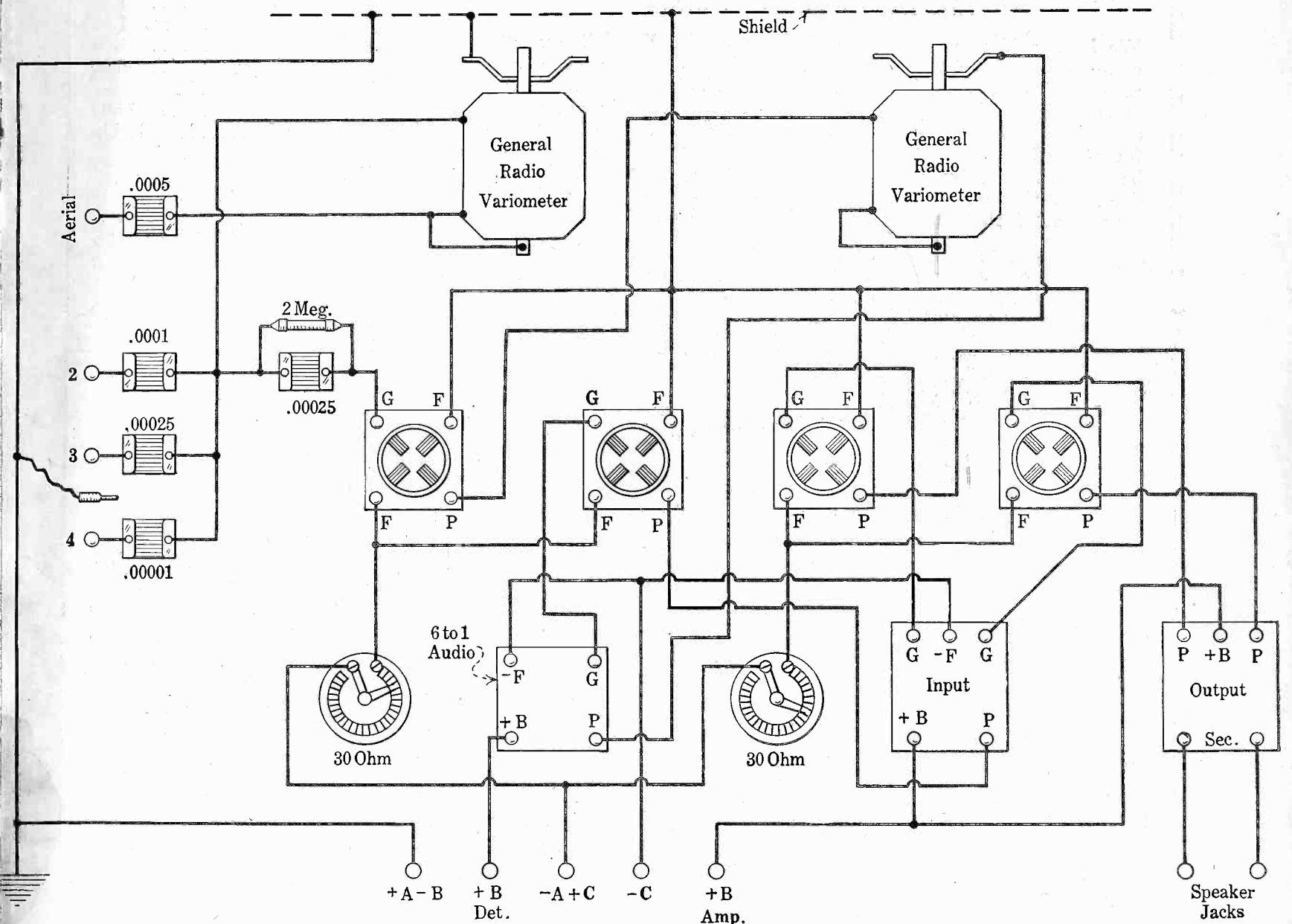

PICTORIAL DIAGRAM of the 4-Tube DX Dandy. See article on page 3.

Why People Want DX—And How to Get It  
 SYMPHONIC PROGRAMS IN HIGH FAVOR  
 New Tube Works Right Off the Main

# Cabinet and Panel Data

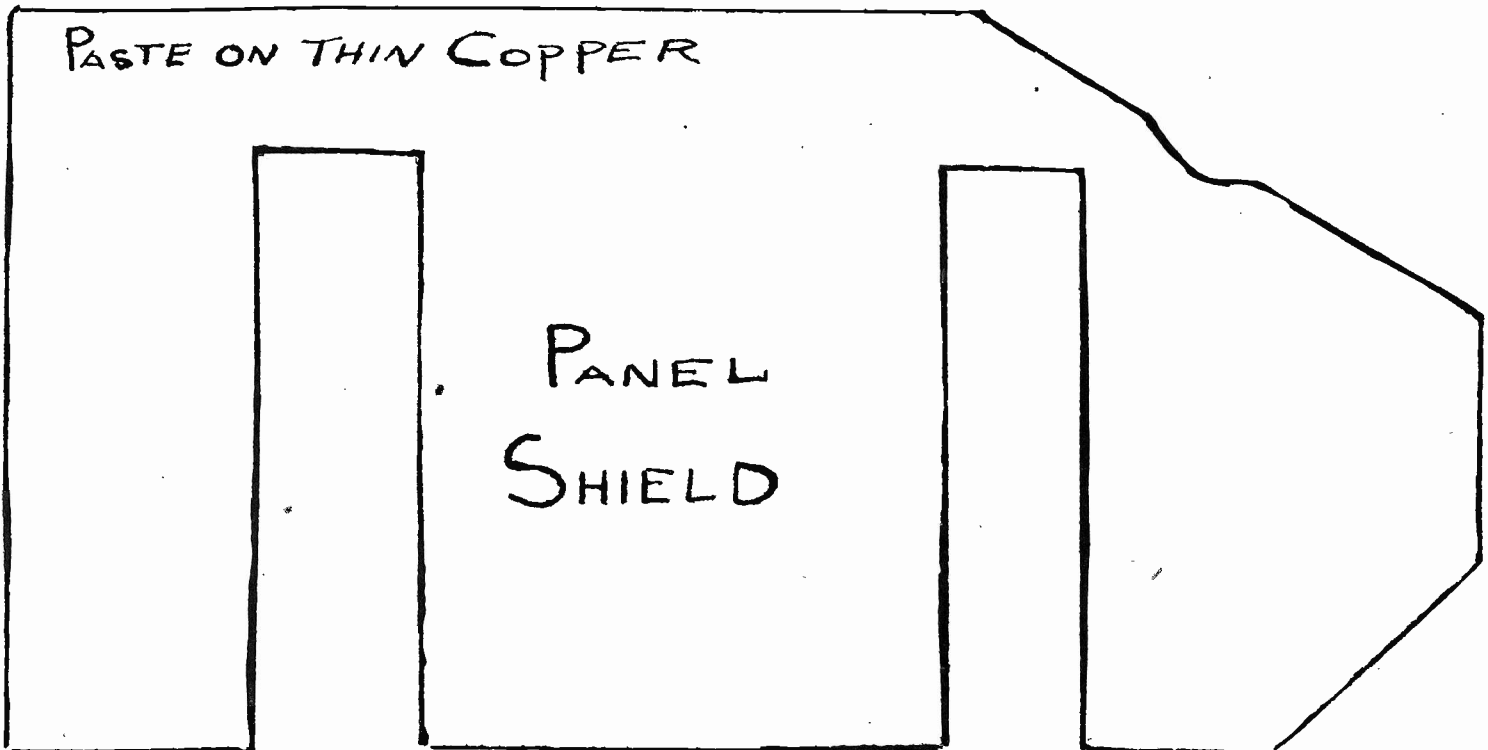

TEMPLATE for making the two shields used in the 1926 Model DX Dandy.

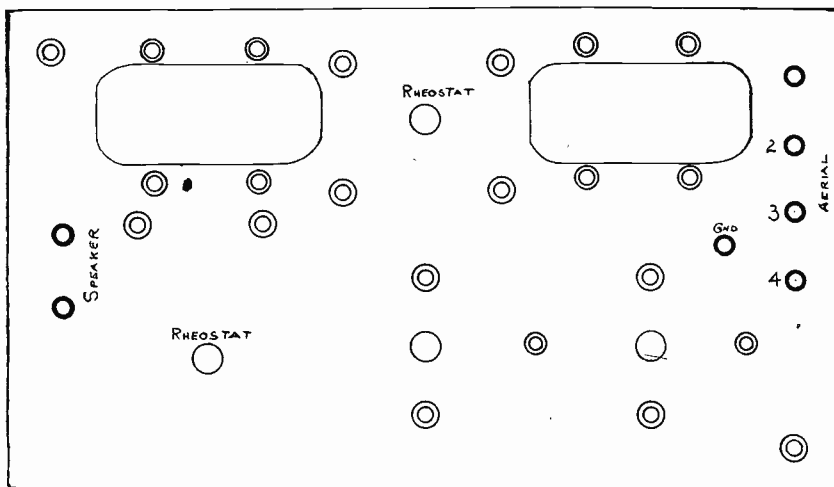

THE PANEL LAYOUT, one-third scale. The design provides for the cutout sectors.

into consideration the use of these instruments. Each weighs only seven ounces. Their inductance range is from 60 to 660 microhenries.

If one wants to make his own inductances, necessarily along somewhat dif-

ferent lines, stator forms  $3\frac{1}{2}$ " in diameter, 3" long, may be used, with shaped variometer rotors which have a central diameter of  $3\frac{1}{8}$ " or a little less. The wire used may be No. 24 single silk  
(Concluded on page 5)

## Three Rules for Telling Direction of a Field

Any core of iron, which is covered over with wire carrying a current, becomes a magnet. This remains magnetic only as long as the current continues to flow, and is known as an electromagnet. One end of the core represents the north pole while the other end represents the south pole. To ascertain which is the north pole and which is the south pole there are three general rules:

(1)—The most important and well known of these rules is the "right hand rule." If we put the palm of the right hand upon a coil, with the fingers pointing in the direction of the flow of current (whichever way the current is put into the coil), the thumb of this extended

hand will point in the direction that the flux or magnetic field flows and also to the north pole of the magnet.

(2)—A rule less known, although as effective is the "corkscrew rule." If we take a corkscrew and place it along side of the turns of wire on the core we will find that the flux advances through the core in exactly the same direction that the corkscrew would, were it turned to advance. The north pole is represented by the flow of the flux from the core.

A general and easy method to employ is by the use of a compass needle. If this needle is pivoted and left so that the action will be very free and easy, and it is placed over the core, it will point in the direction of the north pole.

### LIST OF PARTS

Two General Radio variometers, No. 269.

Five fixed condensers (one .0005, two .00025, one .0001 and one .00001 mfd.)

One 2-megohm grid leak.

One 6-to-1 Thordarson audio transformer.

One pair of Thordarson push-pull AF transformers (input and output).

Two 30-ohm rheostats.

Two knobs with pointers.

One 7x12" panel.

Four General Radio sockets for —99 tubes (299).

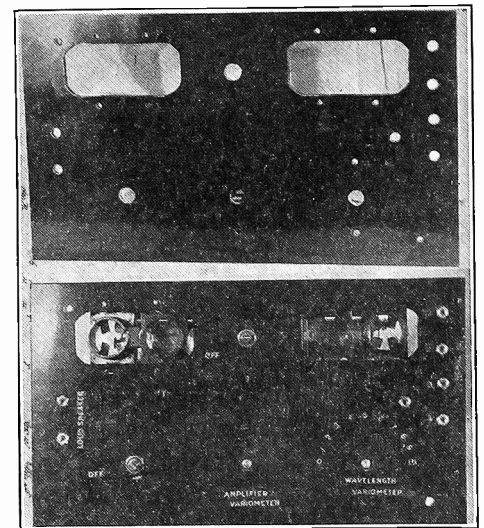
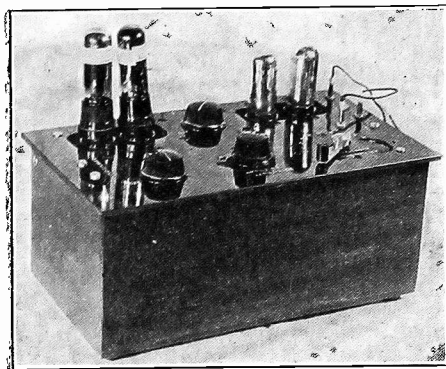

Fig. 4. Now we come to the panel. As the template is 1/3 size, it is simply necessary to draw this three times as large and paste it down on the standard 7x12 in. panel, cutting out the space for the tube sockets with a scroll saw. This operation is quite easy, as the panel is not as difficult to cut as some of the other insulating materials. The panel thus cut out and drilled is shown in this photograph.

Fig. 5. The panel with the necessary parts mounted underneath is shown, also the Bruno engravings which are applied very easily by the transfer process.

# The Layout of the Parts



**THE COMPLETED 1926 Model 4-tube DX Dandy, showing power tubes in the push-pull stage.**

(Concluded from page 4)

covered. The stator form would have 45 turns and the rotor form 65 turns. The inclusion of home-made coils would change the panel drilling arrangement to some extent and likewise would not provide as high degree of electrical efficiency as would the General Radio product.

The fixed condensers are easily procurable, except perhaps the .00001 mfd. type, although Sangamo and Dubilier condensers of this capacity are available.

The rheostats are 30 ohms each, which is a little more than necessary, but it is well to be on the safe side, as the set may be operated efficiently with low filament heating, less than the prescribed 3½ volts.

### The Push-Pull Audio

The push-pull transformer system may not be familiar to all. Two tubes are needed because there are two inputs, one to each terminal of the secondary of the input transformer (AF2), the grid return being made at the zero potential point, or midtap. This is the C minus connection. Likewise the output transformer (AF2) has two points of receiving the current, these being at the extremes of the winding, the midpoint going to B plus. Then, of course, the speaker connections are made to the secondary of the output transformer, so that no B battery current, in fact only the alternating current, flows in the speaker windings.

To have the two input points and the two output points two tubes, of course, are necessary.

[This concludes Part I of the article on the construction of the 4-Tube DX Dandy. Part II will be published next week. Construction of the cabinet and accessories will be dealt with then.]

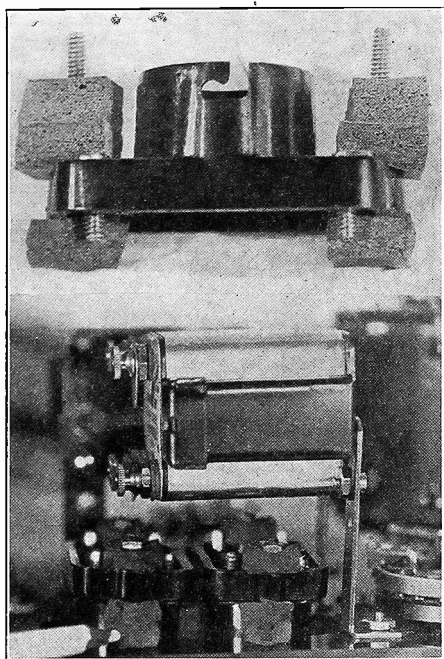

Fig. 6. The four sockets are specially prepared by reversing the terminal screws, so that the hexagonal nuts will be on the underside of the socket, next to the springs, and soldered thereto. The head of the screw is thus brought to the top of the socket. This is done so that the hexagonal nuts will not hit against the under side on the panel. One and a half inch 6-32 screws with flat heads will be arranged so that the screws pass through the panel, then through two-pieces of ¼ in. thick sponge rubber about 5/16 in. wide, then through the hole in the side of the socket, then through one piece of the ¼ in. thick sponge rubber, and finally terminating in a hexagonal nut. This nut is not tightened, but just brought up close enough to allow the socket to be mounted loosely. This effectively stops the tube noises.

Fig. 7. This feature is further illustrated in the close-up of the mounted sockets. The pencil points to the sponge rubber separation between the panel and the sockets.

### WHAT DOES polarity mean?

There are two ways in which this word can be used. One is to distinguish the north from the south pole. The other is to distinguish the plus from the minus of a battery.

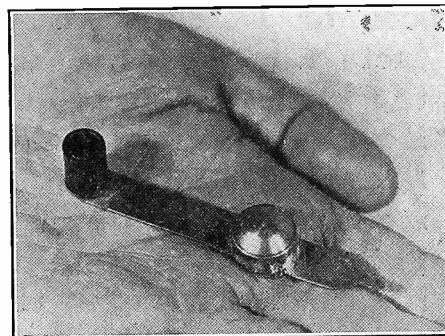

Fig. 8. The special handle for the tuning variometer is made of a 3 in. piece of 7/16 brass 1/32 in. thick. The little handle is fastened to this and made from a piece of 5/16 fibre tubing, ½ in. high. The center is drilled ¼ in. so as to accommodate the variometer shaft, and this is further "capped" with a crystal detector cup, turned upside down and soldered to the brass piece. One end of the handle is filed to a pointer as shown, and it is this end that travels over the scale on the panel. Of course any other arrangement will be satisfactory, such as a small dial of the conventional type.

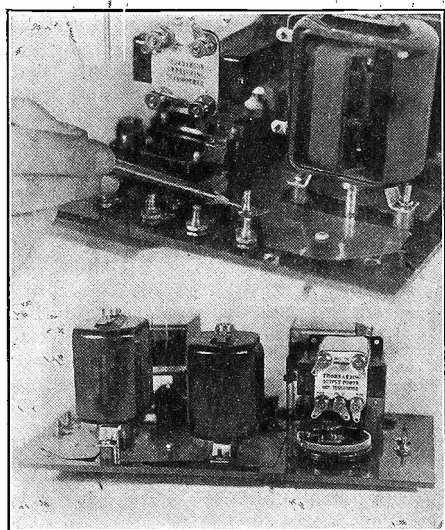

Fig. 9. In the diagram of connections the shield is shown, with a wire connecting the ground plug jack. As a matter of fact the jack is close to the shield, (about ½ in. away) and is directly soldered to the panel shield. The pencil points to this jack.

Fig. 10. View of panel with instruments.

### Infringement!



**RADIO BUG:** "They even make doors nowadays that amplify!"

## How Induction Arises In Electrical Circuits

A wire or other system of conductors when so arranged so as to pass through a field of magnetic lines of force will have generated in it an electric current. This current will be proportional in value to the number of lines of magnetic of force being cut by the system of conductors at any given instant and its polarity will be determined by the direction from which the system of conductors approach as the field of magnetic lines of force.

As the motion of the system of conductors is only relative with respect to the field of force, it is possible to induce electricity by two methods:

(1)—As in the electric generator, by

holding the field of force stationary. That is by sending a direct current through the stationary field windings of the generator and by mechanically revolving the system of wires known in this case as the armature through the field of magnetic lines of force.

(2)—As in the transformer by holding the wires stationary and by moving the field of force electrically. That is, by applying an alternating current to the so-called primary windings of the transformer.

An induced potential or current is always opposite to the current polarity which causes its induction.

# Barring Noise Immigrants

**Loose or Defective Contacts Cause Nearly All the Foreign Noises in a Receiver — These Are Present at Many Points, from the Carbon Microphone at the Station, to the Speaker Jack in the Set.**

By *J. E. Anderson*  
Consulting Engineer

THE greater part of foreign noise in a radio receiver is caused by loose or defective contacts. It is not much of an exaggeration to say that 99.94% of it arises from this cause. The loose contacts may not be in the set itself, but may be located in any electrical apparatus within the reception range of the receiver. The electrical equipment in and about the broadcasting station itself is not exempt as a contributory cause. In fact, a good share of the noise accompanying a program originates in the transmitting station. Let us consider a few of the sources of noise.

## The Microphone's Hiss

First of all, the microphone. Everybody has heard the characteristic hiss that accompanies the carrier wave from a transmitting station. This has been called frying, for obvious reasons, but is now often referred to as microphone hiss. That this noise comes from the transmitter, and does not originate in the receiver or in the space intervening, is obvious as it ceases the instant the station signs off. Now this hiss is due to defective contacts, millions of them perhaps. The carbon microphone, which is used almost exclusively in radio broadcasting, operates on the principle of loose contacts, and it is natural that noises characteristic of such defective contacts should accompany the signal. This microphone consists of a large number of small carbon granules loosely packed together in a little chamber. One side of this chamber is the diaphragm against which the sound to be transmitted impinges. As the diaphragm vibrates the various carbon granules are alternately compressed and expanded. A direct current is continually flowing through the mass of carbon granules, and this current changes as the pressure on the carbon changes. When the mass is compressed the resistance of the mass of carbon decreases and the current increases; when the pressure is released, the resistance increases and the current decreases. It is in this manner that the sound, which is a pressure variation in the air, is con-

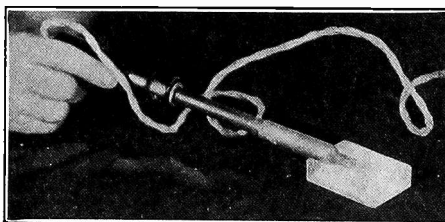

AS 99.94% of foreign noises in a set arise from loose or defective contacts, as J. E. Anderson computed the situation, be sure your soldering is done well. A clean tip is needed. A cake of sal-ammoniac serves the cleansing purpose.

verted into a pulsating or varying electrical current.

## Irregular Current the Cause

Now if the current which is flowing through the microphone when no sound impinges on the diaphragm were really steady, there would be no hiss. But it is not steady. It varies in the most irregular fashion. Every contact in the mass of carbon granules constitutes a miniature spark gap, across which the current sputters. The reason that we cannot hear the individual sputters is that there are so many of the tiny gaps that when all are taken together the sputtering sounds like one continuous hiss. But the fact that the sound is a hiss and not a clear note indicates that the current variation is very irregular. This hiss cannot very well be eliminated from the signal as long as the carbon microphone is employed. There are other types of microphones which are quiet in operation, because they do not depend on loose contacts, but these are so insensitive when compared with the carbon microphone that they are not practicable.

## Other Station Afflictions

Although the microphone hiss is the main noise that originates at the transmitting station, it is not the only one. Many broadcasting stations are operated in close vicinity to innumerable other electrical devices which continually close and open electrical circuits, and every time one of these devices operates, a disturbance is set up which may be, and often is, picked up by the radio transmitter. This disturbance is of course sped on to the receiver in which it produces a distracting noise which is usually blamed on static. This kind of disturbance may readily be eliminated by shielding the sensitive parts of the transmitter, or by shielding the entire rooms in which any part of the transmitter is located. Some stations have been built in open fields well isolated from all possible sources of disturbances of this nature, to clear up the transmitted signal.

## Intervening Electrical Devices

Even after the transmitted signal has been cleared of noise as much as possible, there remains plenty of it in the received

signal, noise that originates in electrical apparatus located within the reception range of the radio set, because the receiver picks up everything electrical that has a frequency to which the set is tuned. And disturbances caused by loose, defective and intermittent contacts contain practically all frequencies, so that no receiver is immune from this kind of interference. Arc lights, X-ray machines, electric vibrators, bells, buzzers, direct current generators and motors, spark plugs on gas engines, magnetos, telephone relays, some neighboring radio sets, defective high tension insulators on power lines, these are all profuse sources of noise, because they all spark and sputter, make and break electric circuits. Every radio transmitter employing spark, if it is located within a radius of 12,000 miles, may inflict noise at the broadcast listener. Every electrical light located within a wide radius is another source, and in congested districts millions of lights may be included in that radius. Every time a light is turned on or off the disturbance is in the set though not always heard. The same holds of every other electrical device, of course. A terrific racket may be caused by these devices even when they are supposed to be operating steadily. If the contact between the plug and socket is not firm and clean, there may be an arcing which will sound similar to the microphone hiss but much worse in intensity. If the trouble arises somewhere in your home it may be remedied by you, but if not, there is nothing else to do but to stand it or to turn off the radio set.

## The Third Rail Troublesome

Another prolific source of noises are electrical railways or street cars in which the third rail is on or above ground, and to a lesser extent those in which the third rail is underground. Every time the trolley or sliding brush leaves the third rail for an instant there is a flash and a spark that can be heard in every radio set for miles around. The disturbance is not confined to the immediate vicinity of the place where the spark occurs but extends throughout the circuit in which it occurred, and that may be a long circuit. The frequency of this trouble may be estimated by watching one car and counting the flashes and then multiplying the number obtained by the number of cars operating. Fortunately many of the disturbances are not serious over wide areas.

## The Apartment House Elevator

In large cities where elevators are used these are one of the chief sources of trouble. When the electrical circuit in these get out of order, it is practically impossible to receive anything on the radio for five minutes at a time without having the program completely ruined by the elevator. Every time the switch is thrown for starting the motor there is a racket in the receiver, and every time the switch is thrown for stopping the elevator the racket is infinitely worse. And in between starting and stopping there is a continual noise just like that produced by a buzzer, or by a spark transmitter when an inspector is testing it. There is yet no ready remedy for this trouble because the Secretary of Commerce has not the power to compel the landlord to replace or overhaul his elevator motor, and the landlord may not care to do it of his own volition as long as the elevator can be moved up or down.

## The Set A Frequent Cause

Although there is almost an infinite number of sources of noise external to

## Rectification Embodies Changing AC to DC

Any article that has for its purpose, a change in a portion or all of an alternating current, abbreviated AC, into direct current, abbreviated DC, is called a rectifier. The rectification is accomplished by suppressing one portion of the alternating

current. The tungar, rectigon and mercury vapor rectifiers, etc., operate on this principle.

The radio detector tube, in receivers, causes the current to be changed into pulsating direct current.

# Foreign Sounds Excluded

## Apartment House Elevators, Static Machines, X-rays, Third Rails and Beat Notes Present Problems of Elimination Almost Impossible to Solve, But They Are a Meager Minority.

the receiver, the set itself remains one of the chief noise makers. Loose or defective contacts again account for it. The number of such contacts between the antenna binding post and the loud speaker jack in a multi-tube set is greater than is commonly realized. Modern component parts of receivers are built for convenience of assembly rather than for sound connections throughout. Coils, condensers, sockets, rheostats and transformers are provided with binding posts rather than with soldering lugs. In some cases where lugs are provided they are merely placed loose under the binding post knobs and are not soldered to the wire terminals or the condenser plates. In many cases the terminal posts are so arranged that the connection is made by pressing two conductors together without the slightest wiping; that is, they are pressed together with a layer of dirt or oxide between them. The current must jump or break down this insulator, and there is likely to be sparking at the junction. Placing washers on either side of the wire does not help the matter but is likely to make the contact worse. Even a clean and firm contact established either by wiping or careful scraping of the surfaces will corrode in time and a defective connection is likely to develop.

Consider the filament circuit. The terminals on the storage battery are very often serious offenders. The acid has a habit of creeping up on the posts. If the connecting wires are bare copper or coated with certain other metals a thick layer of oxide is formed quickly, across which the current sparks. The resulting noise in the speaker is a buzzing like a fly had been trapped in the unit. This lasts until the current stops altogether. Even lead and tin are not free from the corroding effect, although they are much better than copper. Other points where trouble will arise are the filament switch and automatic filament jacks, rheostats or rheostat substitutes, and finally the socket springs. The switches or the jacks have at least one point each at which trouble may arise, and often does. The rheostats and their substitutes have at least two each. The sockets have two on the springs and at least two more on the binding posts.

The trouble may be studied by putting an ammeter in the filament circuit of one likely to execute a hula-hula when the various devices comprising the circuit are touched. That indicates noise in the speaker. Pressing on the tube changes the current by several percent in most cases. The remedy for all this variability and consequent noise is to solder at every possible place; even the tube prongs should be soldered to the leads for permanent connections.

### Ammeter As Trouble Shooter

In the grid circuits we have the spring and prong contact, the external binding post on the socket, the connections to the grid leak and grid condenser in the detector, the connections to the coil and

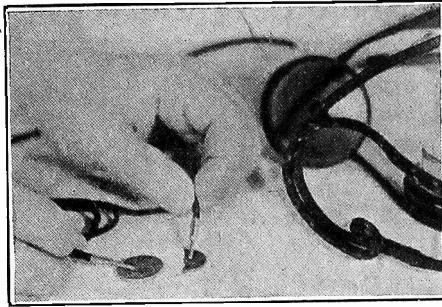

**DEFECTIVE windings in the ear-phones or speaker cause noises. Take a cent and a nickel. Put a piece of paper between them. Then touch the tips to the coins. A distinct click will result if the windings are continuous and sturdy.**

the tuning condenser or other input device, and the connection the grid battery or filament. The grid circuit is rarely a continuous metal path from the grid through the secondary to the filament. And wherever there is a break there is a chance for noise to creep in.

What is true of the grid circuit also holds for the plate circuit, even more so because there are many pressure connections in the plate battery, which do not have any counterparts in the grid circuit. The plate current does not encounter an unbroken metallic path from the plate to the filament. To test the unsteadiness of the plate current insert a milliammeter or a low range voltmeter in the plate circuit and experiment. Press down on the tube and the current jumps up. This is partly due to a change in the resistance of the plate and grid circuits, but mostly, probably, to a change in the filament circuit resistance at the prongs. It is easy to observe the effect on the plate current that the various faulty contacts have.

### Beat Notes

There are other noises in a radio receiver which cannot be ascribed to loose connections. There is the beat squeal between two transmitting stations which

operate at frequencies too close together, the beating between oscillating receivers and a carrier wave and the beating between two oscillating receivers. There is very little that the operator of a receiver can do to alleviate any trouble which he may experience from this source, except in so far as his own set is a party to the racket. Blocking of the grid in the detector is another source of noise. This sounds very much like a beat squeal and occurs mostly on the shorter waves in the tuning range of the receiver. The remedy is to decrease the grid leak resistance, (that is, lesser resistance, but greater leakage) or to decrease the regeneration. A similar noise in an amplifier stage indicates an open grid circuit or a too low grid leakage.

### Microphone Noise

There are also noises which are of mechanical origin. The worst is that caused by vibration of the grid with respect to the other elements in the tube. It usually indicates a broken glass stem. This sound is musical in nature and is not so unpleasant to listen to but more annoying. Sponge rubber mats for tube sockets or for the entire set will alleviate this trouble.

Magneto-mechanical noise may arise from loose laminae in the audio frequency transformers or from any loose iron parts which may be exposed to strong, varying magnetic forces. Similar electro-mechanical noise may arise from loose conductors exposed to strong, varying electric forces. Often the plates in by-pass condensers will start vibrating and give rise to noise. Sometimes shields made of tin foil are wrapped around transformers and left loose to vibrate and set up a racket.

### Soldering Advised

To remove noises in a set, solder all joints where possible. Where this is not possible, make a firm and clean contact and keep it so. Make fast everything that can rattle. Use tubes which are intact. Mount the set on sponge rubber. By carefully observing these precautions, it is possible to make a set which is as noisy as Niagara Falls as silent as a cat sneaking up on a mouse. A little effort in this direction is well worth while.

## White Bill Changed; Zoning Is Provided

### WASHINGTON.

**T**HE White Radio bill, as reported to the House by the Merchant Marine and Fisheries Committee, incorporates several new features. They follow:

1. A clause providing that a wavelength shall be made available for at least one broadcasting station in each state.

2. A clause making it unlawful to transport in the United States vacuum tubes or other radio apparatus or parts, patented or unpatented, upon which there is any restriction as to its use.

3. A clause dividing the United States into five radio zones.

4. The appointment of a commission of five members, one member from each radio zone, to which may be referred by the Secretary of Commerce matters regarding the allocation of wavelengths.

### Zoning Is Specified

The clause dividing the United States into zones follows:

"Section 9. For the purposes of this Act, the United States is divided into five zones as follows: The First Zone shall embrace the States of Maine, New Hampshire, Vermont, Massachusetts, Connecticut, Rhode Island, New York, New Jersey, Delaware, Maryland, the District of Columbia, Porto Rico, and the Virgin Islands; the Second Zone shall embrace the states of Pennsylvania, Virginia, West Virginia, Ohio, Michigan, and Kentucky; the Third Zone shall embrace the states of North Carolina, South Carolina, Georgia, Florida, Alabama, Tennessee, Mississippi, Arkansas, Louisiana, Texas and Oklahoma; the Fourth Zone shall embrace the states of Indiana, Illinois, Wisconsin, Minnesota, North Dakota, South Dakota, Iowa, Nebraska, Kansas and Missouri; and the Fifth Zone shall embrace the states of Montana, Idaho, Wyoming, Colorado, New Mexico, Arizona, Utah, Nevada, Washington, Oregon, California, the Territory of Hawaii, and Alaska.

# Umbrella Aerial for DX!

By Hugo Gernsback

**I**N the whole annals of human endeavor there has never before been a condition such as that in which most of humanity now finds itself. I refer to radio broadcasting and to the man who, although perhaps snowed-in somewhere in the hills, has the entire world laid open to him and so to speak, at his beck and call. He turns a dial or two, adjusts a knob, and listens in to the President of the United States speaking from Washington; or, by moving the dials a fraction of an inch, he may hear a singer from the Metropolitan Opera; or, if his set is sensitive enough, another twist will bring in an English or a Mexican station. This is the condition which we find, not only in this country, but in almost every other on the globe, as well, where close parallels to it abound.

## Is DX Interest Low?

During the past year or so it has been asserted, rather vehemently in some quarters, that DX listening is rapidly passing out, and that people are relying upon only their local stations for amusement. While there is, of course, some truth in this, I find no general evidence that all listeners wish local programs only. At first the man who buys a ready-made set is, of course, not aware of the intricacies and delights of fishing for distant stations with his set; so he will be satisfied for some time to listen to the various local stations or other nearby ones.

After a while, however, these begin to pall; and when his friends begin to tell him of this or that distant station which they have heard, he too will be bitten by the DX bug. Sooner or later he will fall the victim to the ever-increasing radio wanderlust; for the army of DX listeners is increasing rather than decreasing, as an unprejudiced investigation will show.

## DX Compels Interest

For instance every time "Radio News" publishes a description of a circuit or a set that is known to bring in distance, we immediately become deluged with thousands of inquiries from readers who already have a set, but wish to get another more sensitive than their present receiver. This is not, by any means, an unusual occurrence, but it is repeated continually, as every editor of a radio magazine or newspaper understands well.

Not only that but actual investigation among some of the foremost stores has revealed that the male purchaser, when

## Smoothing the Way

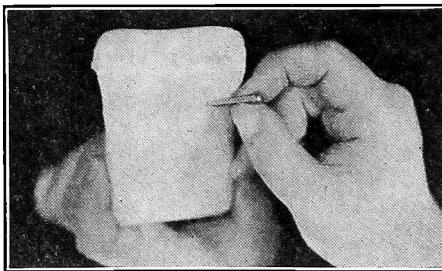

**IF a woodscrew "pinches" when you try to drive it into a baseboard or other piece of wood, do not hesitate to smooth the way by putting some soap on the screw.**

he comes to buy a set, insists that it must perform DX, otherwise he does not want it. Radio dealers will tell you that, when sets are sent on approval, the male members of the household, before committing themselves to the purchase of the set, insist upon having a demonstration that the set can bring in the distant stations; and while the buyer may, possibly, not try to fish for DX stations every hour of the night, he will do so much more frequently than suspected.

The studious young man, as well as the man with the investigating turn of mind, will sit before the set until the wee hours of the morning, filling up his log book with call letters of stations, hundreds and thousands of miles distant from his locality. I make bold to assert that, if any sets were to be placed upon the market, today, that could be guaranteed to bring in stations from the other side of the ocean, no manufacturer could make them fast enough to supply the demand; and if the truth were known, most of our manufacturers are always striving to attain that perfection. The sets to come out in the future will be more sensitive than anything that we have known up to today; because it really is possible to build sets to receive with fair regularity distance of 4,000 and 5,000 miles, and such sets will be built for the average customer in a not-too-distant future.

## Constancy Not Here Yet

At present, DX listening must always be taken with a grain of salt. Stations that come in excellently one night may be heard the next night only above a whisper, or not at all. The reason is, of

course, that it is not the set that is at fault, but, rather the vast ocean of ethereal disturbances which we term "atmospherics." This little-charted ocean changes from hour to hour and from minute to minute. Electrical stresses set up in the atmosphere are probably the reason for most of our poor DX reception. On a so-called good listening night, these electrical stresses are, probably, to a great extent neutralized, which makes the transmission of the electromagnetic radio wave much easier and, consequently, they will penetrate much further. Barometric fluctuations, electrical storms, snow storms, sudden changes of temperature, all reduce radio reception to a minimum; while the absence of these makes for better reception.

From this it can be seen that the best radio set may not be able to pull in the distant stations when such natural phenomena abound.

How can these effects be overcome in the future? In several manners. First, super-power will make it possible for the waves from a broadcast station to get through bad atmospheric, by sheer strength. On the other hand, receiving sets may be developed to a sensitivity so great that, even if the signals are very weak, they still may be received partly through the ground. It should always be remembered that, in all radio reception, the ground-wave is as important as the wave coming through the air.

As many broadcast listeners who own extremely sensitive sets know, radio reception can be had by the ground lead alone; and if this is used DX reception is frequently excellent, even though with the ordinary aerial it may not be good at all. James Harris Rogers, of "underground-aerial" fame, demonstrated this sufficiently by burying his aerial underneath the ground; and by this means even radio's worst bugaboo, static, was reduced to a very great extent.

Who knows, therefore, but that the coming radio receiver will be operated by the ground method entirely, without relying upon loops or aerials? This would certainly be an improvement, because the aerial and loop pick up not only nature's static, but man-made static, which escapes from electrical insulators, power houses, all sorts of electrical appliances, etc.

DX reception is always a more or less unknown quantity; but even during the best "radio weather" a set may bring in a station loudly a thousand miles away, while a station much nearer, say two hundred miles, will not be heard at all. Many persons are constantly puzzled as to this; but there is a rule, a simple remedy.

## Advocates Umbrella Aerial

The aerial commonly used in such cases is directional; that is, if your aerial runs in the direction of the station which you wish to receive, that station, as a rule, comes in the best. If you wish to receive DX stations from all points of the compass, it would be best to have what is called an "umbrella aerial," which is simply a vertical mast from which single wires, thirty or forty feet long, radiate in all directions. A description of such an aerial can be found in all radio text books.

By means of an umbrella aerial it is possible to receive equally well from all directions; although this type has the disadvantage of causing some interference, particularly between stations close together in their wave-lengths.

After all is said and done, my sympathies are entirely with the DX listener; for I can not imagine any greater thrill than that which comes to me when I listen, as I often do, to a station thousands of miles away.

(Broadcast from WRNY)

## How to Keep Selectivity Even in a Rainstorm

Many fans complain that during a rainstorm the tuning of their receiver is very much broadened. This is most often due to poor insulators and also the proximity of the lead-in wire to the side of the building. The insulators cause a leaking path between the antenna wire and the pole, which in most cases consists of wood. The wood is dampened by the rain and is another leakage factor. Through the poor insulators and the pole, the energy leaks into the building which is grounded and which has a high resistance. This of course causes the tuning of the set to be broadened. It also causes a difficulty of receiving low wave stations, because a portion of the building itself has added to the electrical circuit.

Use glazed porcelain insulators, which are quite large, but still not heavy enough to place a strain on the wire itself. The pole should consist of very heavy wood, such as cedar, that will withstand the dampness. It does not pay to use the block wood which comes with rugs, etc. This is a very soft wood and is also very weak.

The point where the lead-in wire is joined to the antenna proper should be well soldered or at least well tightened. A heavy covering of tin foil should be placed over the connection. This is to prevent corrosion of the connection proper. Over this covering rubber or plain tape should be wound. Be sure that no water can get to the connection.

# Definitions for Novices

## WHAT DOES C. W. mean?

It is the abbreviation for continuous waves.

## WHAT DOES pure C. W. mean?

When a radio transmitting station uses a vacuum tube as an oscillator, and places a key in the grid circuit, so as to make and break the oscillatory note that this tube is emitting, pure CW is emitted from the antenna. A note of this type or character can only be heard by an oscillating receiver.

## WHAT DOES modulated CW mean?

When an audio-frequency wave is impressed upon a pure radio-frequency continuous wave a modulated CW signal is obtained.

## WHAT IS a counterpoise?

A counterpoise is an artificial ground system or a network of wires similar to an antenna, which is suspended directly under it, a small distance above the ground and which is insulated.

## WHAT DOES bias mean?

A voltage which is applied to the grid of a tube to maintain the same at a potential which is different from the average potential of the filament and, nearly always a negative voltage, is known as a bias. It is applied by means of a small battery or by means of a voltage drop in a resistance in the filament circuit.

## WHAT IS bank winding?

Bank winding is a specific method of winding coils in vertical layers or in alternate relation. That is, three turns may first be placed on the form side by side and the fourth is wound on top and between the first three. The fifth is placed at the side of the third and the sixth on top of the fifth, beside the fourth, etc.

## WHAT DOES aperiodic mean?

Aperiodic relates to a system which is vibrating, which has no free period of oscillation of its own. That is, a pendulum which is suspended in heavy oil would be aperiodic, because it would not oscillate or swing. In perfect air, this pendulum would be periodic and would swing to and fro, just as the pendulum in a clock.

## WHAT IS a beat?

A beat is a periodic variation in the height of two vibrations of different frequencies, due to the interaction of the vibrations. When two tones of a musical nature or practically the same pitch are sounded together or at the same time, beats may be heard. In the heterodyne method a beat is produced with an incoming CW signal, by supplying a locally generated frequency. The difference between the two is the beat.

## WHAT ARE harmonics?

Harmonics are vibrations having frequencies of integral multiples of the frequency employed, which frequency is the fundamental. This frequency is sometimes called the first harmonic. The second harmonic would be twice the fundamental, etc.

## WHAT DOES M. M. F. mean?

This is the abbreviation for magneto motive force. It is the magnetic force, which makes a magnetic field about a conductor, which is carrying a current. It is proportional to the current strength flowing in the conductor and to the number of turns in the coil.

## A Versatile Meter

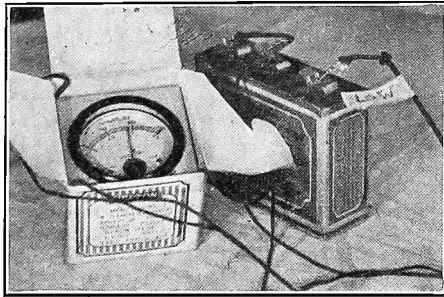

A LOW-AND-HIGH reading voltmeter may be left in its box and leads attached to the meter for general use. These meters will record the A and B voltage, the normal range being 0 to 7 and 0 to 140 volts.

## WHAT IS a D.P. and D.P.D.T. switch?

A D.P. switch is double-pole switch. A D.P.D.T. switch is a double-pole-double throw switch.

## WHAT IS the Heavyside Layer?

The Heavyside Layer is a theoretical layer of the upper atmosphere, which is supposed to be temporarily ionized, so that a reflecting power is obtained. The existence of this layer is supposed to cause the leaving of radio signals from the law of Inverse Squares, which is as per: "When a force is exercised through space from a point, its intensity varies inversely with the square of the distance. Thus the intensity of light radiated by a luminous point at twice a given distance therefrom is one-fourth the intensity it had at the distance in question." Gravitation, electric and magnetic attraction and repulsion are subject to this same law. The intensity of the signals are much greater, than they would be, were they defracted regularly through plain space.

## WHAT DOES amplification constant mean?

Amplification constant is the ratio of the plate voltage required to produce a given change in the plate current to the grid voltage required to give the same variation of plate current.

## WHAT IS an oscillograph and what is the simple construction of such a device?

An oscillograph is an apparatus for viewing or recording periodic changes in the strength of an electric current. It consists fundamentally of a galvanometer, which is as free as it is possible to get the same, from damping. A delicate band of conducting metal passes up between the poles of a strong electromagnet, over a small suspension and down to a point adjacent to the beginning. A small mirror not over 1/32" in diameter is attached to the middle of the bands. If the band is placed in an electric circuit, one element will try to move forward, the other backward. Consequently the mirror is given a rotary motion. Even if the current be alternating, the mirror will faithfully follow not only the motion of the fundamental of the wave form, but also those of the higher or lower harmonics. By directing the light of an arc lamp upon the mirror and viewing the reflection in a four-faced mirror revolving under the action of a synchronous motor, the true form of the real wave can be observed. This is only a brief description of one of the models of such a type of an instrument. More elaborate models, wherein the elements in a vacuum tube give off electrons, the wave form of which is noticed on a specially coated film of glass, in the dark room are now being made. These forms can be photographed.

## WHAT DOES mega mean?

Mega is a prefix meaning one million. That is, a megohm, would mean one million ohms.

## WHAT IS the most efficient method of placing neutrodyne RF coils in a Neutrodyne?

The most efficient way to place these coils is to mount them on angle irons, so that the neutralizing point, can be obtained by tipping the coils at various angles. The correct angle that the coils should be tipped with standard tubes is 57.3°. This angle will vary with the tubes that are different as to oscillatory action, from that angle or a few degrees beyond that angle to a few degrees above that angle. Another successful method, but one which takes up quite some room is to mount the coils at right angles to each other, with a separation of about 5" between the magnetic fields of the coils.

## Resonance Is Likened to Pendulum Action

Resonance, according to the "Standard Electrical Dictionary," is as follows:

"The condition of an electrical circuit for permitting the oscillatory flow of current. This will be the case when the ohmic resistance is relatively low and when the inductance and capacity of the circuit bear a particular and critical relation to each other. Two different circuits are said to be in resonance with each other when they have such values of these terms to yield the same period. The operation quite follows the behavior of a pendulum, especially one that is capable of swinging on an elastic support rather than of a simple pivot. Due to the elasticity of the suspension and the inertia of the bob, the swinging will be at a

certain rate. In the electric circuit, the condenser provides the elasticity, the coil of wire, the inertia. The absence of mechanical friction corresponds to the low ohmic resistance. It is to be observed, however, that electric oscillations to exist at all times must be of a very small period, that is have a high frequency. The actual numerical values of the inductance and capacity must therefore be small. The inductance must have relatively few turns and be entirely free from iron, for the hysteretic and eddy current effects of that metal would absorb all the energy. This experience has, however, lead to the construction of small high-frequency furnaces in which the heating effect is due to the extreme losses of this sort."

**I**N the preceding articles of this series (published in the February 13 issue) there have been presented in considerable detail the reasons why unusual fidelity of reproduction is required in radio reception if the listener is to enjoy the full benefits of modern broadcasting with its frequently excellent programs and individual performers of unusual merit. High quality reproduction, depending as it does on acoustic synchronizing or the production in the home of sound waves exactly duplicating those in the studio, is therefore one of the most essential factors in modern broadcasting transmission and reception. The possible contribution to complete acoustic synchronizing which can be given by a well-designed and carefully operated transmitting station is so considerable that it merits special consideration.

Fortunately for broadcasting, there are to-day a number of transmitting stations which have apparatus capable of sending out a wave which faithfully carries the program, and which are operated by skilled engineers and announcers so that the musical balance of the orchestra and other features giving "finish" to the program are not neglected.

The ideal transmitting station is one having sufficient power to give interference-free signals even at considerable distances and sending out radio waves which carry an accurate impress of the music or speech corresponding to the studio performance. Otherwise stated, the broadcasting transmitter must be omnitonal or capable of controlling or modulating the broadcast wave at all frequencies or pitches of sound from the lowest to the highest. It must also be equitonal or impartial in its treatment of notes of all pitches, exaggerating none and suppressing none, but giving to each its proportionate volume; and, as hinted above, it must radiate sufficient energy to give a signal clear riding above all disturbances in the home of the listener and capable of being amplified to any reasonable volume in the receiving set without introducing disturbing noises or other interference.

#### Defective Transmission

Some of the defects which may result from defective transmitting equipment or careless use even of good equipment are worth considering, as well as the precautions taken at high-grade broadcasting stations to avoid imperfect operation.

The broadcasting studio presents a whole series of problems in itself. It would not do to take a large echoing room and use it as a broadcasting studio. The reverberation which inevitably occurs in such a room blurs the sharpness of broadcast speech or music and produces an unsatisfactory effect in the listener's home. In order to keep such an echo effect or "room resonance," as it is more technically known, within satisfactory limits, it is necessary to muffle the studio acoustically by hanging heavy drapery or special materials around the walls, ceiling, and floor. While an acoustically correct broadcast studio sounds "dead" to the artists performing in it, nevertheless in the listener's home there is a sharp definition to music from such studios, which is missing in the case of

# Distortion Elimination

*Station must transmit properly, otherwise the listener is helpless—low-power stations over-modulate in futile attempt to span great distances—at the receiving end, set must not be too selective—20-kilocycle margin ideal; but profusion of stations makes 10-kilocycle channel separation a necessary compromise—sets should pass only this band.*

**By Dr. Alfred N. Goldsmith**

**Chief Broadcast Engineer, Radio Corporation of America.**

broadcasting from an ordinary room. The reverberating effect here mentioned is particularly conspicuous in the case of the broadcasting of sermons from certain churches where, unfortunately, the confusing effect of building the echo at times almost destroys the intelligibility of the sermons.

#### The Microphone Hiss

Broadcasting microphones have become a familiar article to American newspaper readers. The broadcasting microphone has to be a particularly precise form of telephone transmitter. Not only must it be omnitonal and equitonal, which is in itself a most difficult requirement, but it must be silent in operation. Some microphones produce a more or less steady hiss or background noise which detracts appreciably from the quality of music, particularly in the softer portions of a selection when the music does not stand out above microphone noise. Furthermore, microphones must have an unusual reserve capacity to avoid "blasting" or rattling when an extremely loud sound is produced in the studio in their vicinity, for example, at a musical climax or at a particularly emphatic portion of a broadcast speech. It is also necessary to place the microphone relative to the orchestra, performer, or speaker, with great discretion in order that the best and most natural effect is produced. As is here hinted, broadcasting is an art as well as a science.

#### The Vacuum Tubes

When we leave the microphone in sending out a broadcasting program, we next encounter vacuum tube amplifiers which tremendously increase the electric output of the microphone. As usual, these amplifiers also should be omnitonal and equitonal and should be provided with vacuum tubes having an ample capacity to carry the largest outputs which may be drawn from them.

In every broadcasting station there are certain tubes which are known as oscillators. These tubes produce the extremely high frequency electric vibrations which pump electricity into the antenna or aerial

wire system and permit it to flow out of the system with many alterations during each second. It is these electric vibrations in the antenna which produce the "ether oscillations" which we call radio waves. In other words, the oscillator tubes produce a steady flow of wave energy which pours from the transmitting antenna, flowing outward with the speed of light to the listeners on distant horizons.

However, somewhere in the transmitter there must also be what are known as modulator tubes. These tubes mould or control the output of the oscillator tubes, turning it on or off in accordance with the forms of the sound waves in the studio. This results in the radio wave being modulated or shaped so that it carries an accurate outline of the sound waves which fall upon the microphone. Obviously this is a delicate process and one which must be carefully controlled. If the modulation is low (that is, if the outgoing waves are but slightly controlled by the microphone), speech or music will be faint in the receiving station. If, on the other hand, modulation is excessive (that is, the control of the outgoing wave is too extreme and violent), the quality of the music suffers badly and various forms of distortion and rattling appear in the listener's home. The accurate control of modulation requires having ample modulator tube control available, a feature which is by no means universal.

#### Can Be Too Cautious

And suitable modulation also requires constant vigilance on the part of the station engineers since the variations in sound intensity which must be transmitted by radio are indeed great, varying from those corresponding to a whisper to those of a shout. Low power stations, carelessly administered, frequently over-modulate in a futile attempt to span great distances. The quality of reproduction under such conditions is execrable and utterly unfair to those desiring to promote broadcasting development. Some of the otherwise highest grade stations, on the other hand, become so cautious in their attempt to avoid overmodulation that they overdo the precaution and undermodulate. In many receiving sets this results in "choking" or "blocking" the detector tube and producing a different form of distortion and even a howling effect.

Many miscellaneous precautions are required in the transmitting station. The vacuum tubes used must be extremely free from gas so that the operation of the station may be quiet and without hiss or clicking effects. All batteries and electric generators used similarly must be silent in operation. The studio personnel must be careful to keep objectionable noises out of the studio. In some cases special problems arise, such as picking up other stations' programs on the control lines of a broadcasting station. For example, a broadcasting station situated in the central part of New York City and broadcasting from points in the same neighborhood is very likely to pick up powerful enough radio signals on its control lines, from other broadcasting stations nearby to cause it to send out not only its own program but the programs of several others. This can

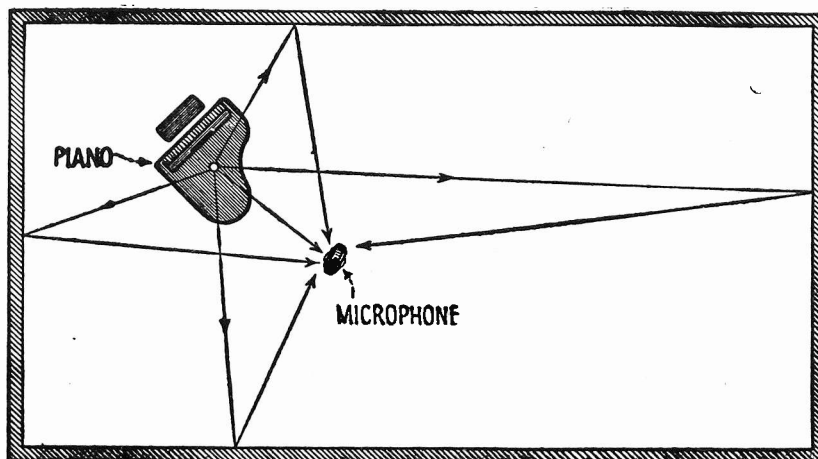

**MUSIC may be blurred because of poor acoustical conditions in the studio. For instance, echoes or "studio resonance," cause distortion. That is why studios are curtained.**



be avoided only by proper precautions in choosing the remote control lines and also by inserting radio-frequency blocking-circuits into the control lines to avoid this form of interference. Another peculiar feature which broadcast listeners should keep in mind is that it is not fair to judge the quality of distant stations by direct comparison with that of stations nearby. Static or other disturbances which are frequently present in distant reception greatly detract from musical quality. Furthermore, the comparatively faint signals from distant stations are incapable of producing a sufficiently strong response in the receiving set properly to actuate the loud speaker, so that the effect is not so natural as that from stations nearby.

It is also not generally appreciated that fading of the received signal is frequently accompanied by a marked distortion of musical quality which can not be charged either to the transmitting or receiving station. Listeners should be very suspicious of the quality of rapidly fading signals since rapid fading is frequently accompanied by quality distortion. It is a common experience to have a broadcasting station blamed by distant listeners for its supposedly poor quality although listeners nearby will insist, and entirely properly, that the quality is excellent. Unless a steady and clear signal is being produced it is unfair to judge the quality of a broadcasting station.

The introduction of super-power broadcasting stations having at least several tens of kilowatts in their antennas, will greatly improve service where fading is not too great, since the more powerful signals produced by such a super-power station will override static or other disturbances at any reasonable distance most of the time.

**Must Originate Well**

Let us assume that the transmitting stations from which the more fortunate listeners receive their programs are really acoustically synchronized so that they give a high quality musical output and do so reliably. Unless this is the case, the listener is helpless, because he can hardly systematically improve the poor output of low-grade stations. All that the listener can do is to choose sensibly the stations to which he will listen on the basis of the quality of musical reproduction which he can secure from them.

When we come to the home of the listener, however, we find that we have reached a point where the listener can and should take control of the quality of the musical and speech reproduction which he obtains by judicious choice and proper manipulation of his receiving set. It cannot be stated too emphatically that by far the greater portion of reception troubles result either from a poor receiving set or careless manipulation of the receiver. In this article only the

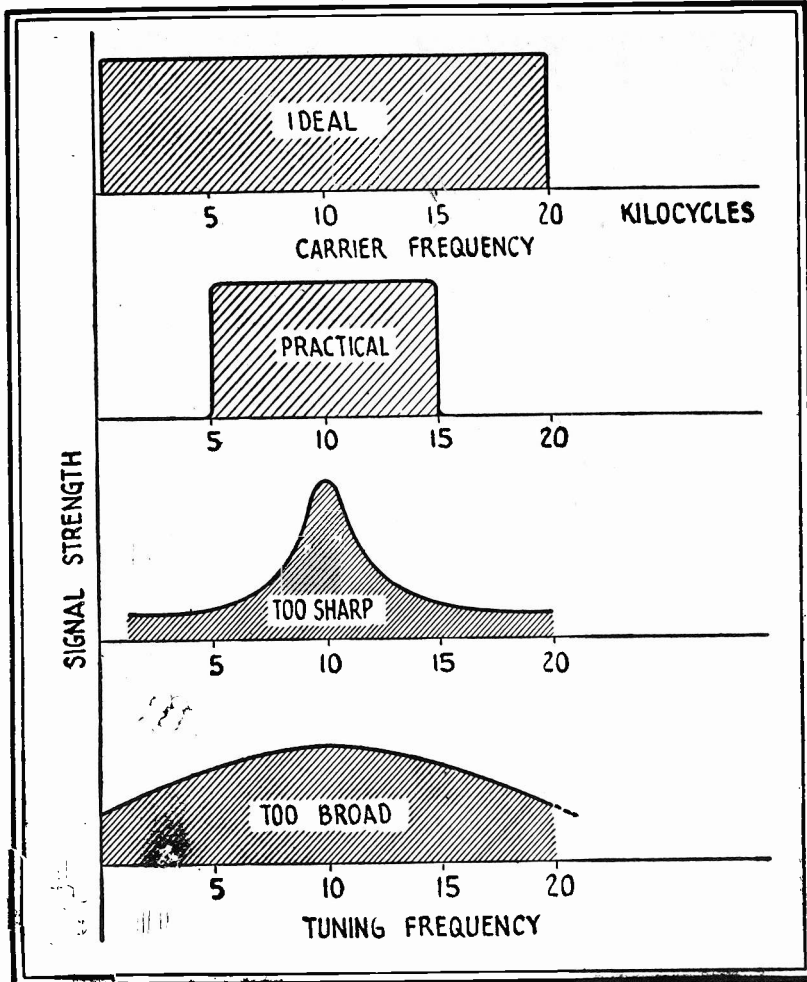

**THE FREQUENCY BANDS** admitted by various types of receivers. The 20-k.c. band is ideal, but not practical for present-day needs, since station channels are 10-k.c. apart.

receiving set will be critically discussed.

A perfectly proper question on the part of the broadcast listener is: "How can a receiver in itself produce poor musical quality, and what causes the receiver to produce such deficient results?" The ideal receiver has a few simple and important characteristics. It should permit waves of all frequencies within a band 20 kilocycles (20,000 cycles wide) to pass through it with an equality of admission of these frequencies over the entire band. Under such conditions, the quality of the music would be practically independent of tuning adjustments.

Unfortunately it has been necessary to space broadcasting stations in the United States 10 kilocycles apart in order to take care of the great number of determined prospective broadcasters. As a result, practical American receiving sets should admit a frequency band not much over 10 kilocycles wide, although this begins to impose a limitation on the quality of the received music or speech and also necessarily causes the tuning adjustment to have some influence on the tone quality which is produced.

Still another one of the characteristics of

an ideal receiver is that its final output is the same for all audible frequencies from the lowest tone of the organ to the highest overtone of the violin or piccolo. If the receiver does not respond proportionately to all audible frequencies, acoustic synchronizing is lost and the sounds in the studio and the corresponding reproduction of the sound in the home are no longer accurately alike.

**Too-Sharp Tuning Disastrous**

There are a number of places in a broadcast receiver where trouble may arise which detracts from the quality of reproduction. In every case there are necessarily supplied a tuning handle or handles, generally known as the radio frequency tuning adjustments. If the tuning of the receiving set is too sharp (that is, if there are too many sharply tuned radio-frequency stages in the receiving set and they are all accurately tuned to the same frequency), it will be found that there is a loss in tone quality and that either low frequency notes or high frequency notes will be slighted depending upon the setting of the tuning dials. A good way of finding out whether this fault exists to an appreciable extent in a receiver is to tune it, on a "quiet" night, when there is little static, to a fairly distant station and bring the signals up to the maximum intensity by sharp tuning and the manipulation of any additional controls (for example, the "tickler" handle) which brings the signal to its strongest value. If, after this has been done, slight shifts of the tuning dials in one direction or another (still keeping the signals reasonably loud) cause a noticeable change in quality (for example, from grave to sharp), the receiver is not completely acoustically synchronized when thus used.

**The Effect of Over-Regeneration**

Another fairly frequent fault in receivers which leads to the absence of acoustic synchronizing, particularly on distant signals, is excessive regeneration. Many receivers have a "tickler" or "volume control," which when brought up too far causes oscillations or "birdies." These characteristic whistling notes are well known. In such receivers, if the tickler control is brought up to a critical position just short of the "spill-over" point, where the whistle begins, it will be found that the quality of the music depends on the tuning. A peculiar swish will be heard as one tunes through the desired station and, under such conditions, acoustic synchronizing is not possible. Excessive regeneration should be avoided for high quality musical reproduction.

**Right Leak Value**

The choice of constants in the grid leak and condenser for the detector tube is also of importance since high frequencies may be relatively suppressed if wrong values of these parts are chosen.

**An Important Test**

**TUNE** your receiver on a "quiet" night, when there is little static, to a fairly distant station and bring the signals up to the maximum intensity by sharp tuning and the manipulation of any additional controls (for example, the "tickler" handle) which brings the signal to its strongest value. If, after this has been done, slight shifts of the tuning dials in one direction or another (still keeping the signals reasonably loud) cause a noticeable change in quality, the receiver is——"

**WHAT?**

Dr. Goldsmith gives the answer and the remedy in the accompanying article.

# Fenway Trouble Shooting

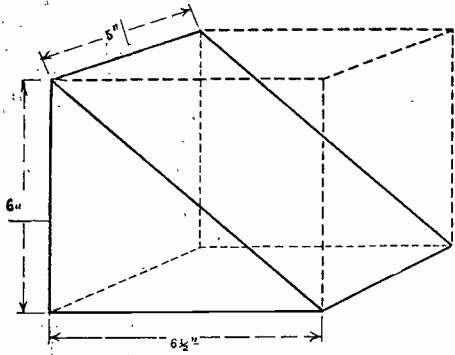

Detail of shields for Fenway.

By Leo Fenway

Copyright, 1926. All Rights Reserved.

FROM one end of the country to the other the truth about the Fenway seems suddenly to have dawned on thousands who previously thought that it was just another radio circuit. You know that there is an awakening in favor of this receiver because you hear of it everywhere you go; because the Fenway causes more fans to turn toward it, owing to its simplicity of construction. And there is something about this set that real radio men like. Perhaps it's the great sensitivity, the remarkable selectivity, the perfect quality, the tremendous volume on distance—whether it is all these and more, most real radio men, and nearly all kitchen table mechanics, like the Fenway.

For the benefit of those readers to whom this article is their first introduction to this receiver it might be well to reiterate my theory of the circuit as I set it forth in the three instalments published in RADIO WORLD on February 6, 13 and 20. It is simply this:

Broadly speaking, the Fenway consists of one stage of tuned radio frequency with regeneration, a non-regenerative detector, three stages of iron core medium frequency amplification—from 30 K C to 60 K C—a non-regenerative second detector and two stages of transformer coupled audio frequency—a total of nine tubes.

A radio receiver, whether factory made or home constructed, may be judged in two respects, viz., what the owner or constructor says about his set and what his set says for itself. Reading between the lines, after discounting the enthusiasm of certain Fenway super builders 75 per cent., the set still appears to be synonymous with volume, clarity, distance and selectivity. Schooled as most writers are to disappointments, it is a real delight to note the progress of a large number of Fenways built by average kitchen table mechanics.

"You cannot improve the quality," says one of the heads of the Federation of Musicians, in a letter sent from their offices at 1440 Broadway, New York City. The writer of that letter built the set after constructing fourteen other supers.

Other letters, telegrams and phone calls too numerous to detail proclaim the Fenway an easy and satisfactory set to build, provided that the preceding specifications and complete parts used are followed religiously.

Those who have met with grief, whose set has failed to respond right from the start, can doubtless trace their sorrows to mud sockets, cheap wire rheostats, crude bus wiring and to air core medium frequency transformers that have suffered from climatic changes. To make no bones about speaking bluntly there IS A TREMENDOUS DIFFERENCE between sockets, rheostats, transformers, fixed and variable condensers. Bear this in mind when you go looking for trouble in your

Fenway. Remember that the finest parts—the most efficient parts, regardless of cost—have been chosen for this set. If you took somebody's advice besides mine in choosing your Fenway parts this trouble shooting data will benefit you very little.

Remember that I know the Fenway from the antennae binding post to the last audio connection—I know what parts should be used and WHERE to use them. I KNOW that my receiver will out-perform any other receiver ever designed, and I will furnish proof of that statement to argue any man to a standstill. The Fenway combination 4 and 9 tube receiver as described in RADIO WORLD, is months ahead of anything even contemplated in radio sets. And the ONLY reason for publishing the exact instruments used in the original set was to save the belated builder from the turmoil of last-minute selection of material, then the doubts and the wonder if he selected the right part for the right place.

When one has a good circuit to follow, knows the exact parts to use and how to use them, the construction of a Super-Heterodyne ought to be as simple as that of a 3-circuit tuner; in fact, it really is much simpler, only there is more of it. For example, a wire leaves a tube socket (plate) and goes to a transformer (plate), it leaves that same transformer (grid) and goes to a tube socket (grid), and so on to the next transformer and the next tube. Could anything be simpler than that?

"Well, then," you say, "if the construction of the Fenway is so easy, where do the mistakes come in?"

### What the Answer Is

The answer is just a few lines back—in the parts used. The principal difference between your super and the set that is dumped upon the market for a price is cheap parts. Whenever it happens that the instruments used are not responsible for the set failing to percolate the trouble can usually be found in the way the set has been "slung together." Many of the letters stated that the writers were not building a finished product but were just "fooling around" trying to "get an idea what it was all about." Later (so they said) they would rebuild the set "on a real panel" and do a "real job." In between times the set isn't working well, and not infrequently a collection of high-class parts is being insulted by having a mass of alien wires thrown at them.

One chap in Boston remarked that his set was working perfectly without any meters on the panel. Well, you don't have to have meters to make a radio do its stuff. But every radioist knows that they mean safe running. Always in front of his eyes, their friendly figures give him that certainty and safety that come from knowing exactly about his batteries. It is even possible to get along without such seemingly humdrum things as fixed condensers and grid leaks, and yet these very things perform deeds no less wonderful than the magic carpet that transported Prince Houssain.

An electrician in one of the Broadway theatres wants to know if it wouldn't be better to have regeneration on the first detector instead of on the first radio frequency tube. The answer to that is, Have you ever tuned in a station and wished for another button or knob or dial which you could turn? You felt confident that if there was only something to turn, if merely another binding post, you could bring in that distance station with good volume! Well, regeneration on the first radio frequency tube is that button or knob—that something that does

## Now Comes The Radio "Tug O' War!"

SEVERAL weeks ago, RADIO WORLD'S editors said to me—

"Fenway: How does your Super compare with the Victoreen Super?"

I said: "I know how it compares! But—How are your readers going to find it out—unless they build both sets? Merely saying that one set is more efficient than the other is not enough. There must be concrete proof that one set is superior to the other."

"Well, then," said the editors, "what would you suggest?"

What I suggested resulted in RADIO WORLD publishing the Victoreen circuit simultaneously with the Fenway. And there you have it! There's the Victoreen Super with its air-core transformers—tuned to a precision of 1/3 of 1%—with its loop or aerial operation and its far-reaching claims for distance reception. And there's the Fenway with its stage of tuned radio with regeneration—its copper shielding—its iron-core transformers—its 4 or 9 tube feature—and it, too, operates from either loop or antenna.

Now, then, in the sense of being "best" there can be but one—

Is it the Victoreen or is it the Fenway?

What do you think? What is your actual experience with both?

Won't you join this "Radio Tug O' War" and send in your comments and suggestions?

If you need more data on the Victoreen or the Fenway, won't you please let us know?

Come on, now, fellows, toss your hat into the ring and pick your position in this Radio Tug O' War!

The Geo. W. Walker Company of Cleveland, Ohio, are with you—and so is the writer.

Come, come, now!

Tell RADIO WORLD which one you know is the greater radio set.

Leo Fenway.

the trick. It wouldn't be the same thing if it was on the detector. Of course, that's the practical side of it; the technical side will be the same a hundred years from now anyway.

### Two or Three Stages?

"Shall I use two or three stages of medium frequency amplification?" writes another. If you're building a Fenway use three stages. Three stages operating at almost maximum efficiency are decidedly better than two stages. By measuring the voltage gain per stage you will find that three stages in this receiver amount to something. It isn't as though the last stage was a dud—far from it, and a little experimenting by any one will prove this.

"Can the new Acme, Erla or Rauland Lyric audio transformer be used in the Fenway?" Certainly. While the writer uses General Radio audio transformers he wouldn't hesitate to recommend any of the new, large iron core audio transformers now on the market. In fact, a set has just been completed using one Acme Mu-2 in the first stage and an Amertram in the second stage. Needless to say, the volume and tone are perfect.

A gentleman from Chicago would like to know if air core medium frequency transformers can be used in this set. Well, if they are perfectly matched, well constructed and do not develop rheumatism on rainy days they ought to function very nicely. But don't get me wrong—

(Continued on page 28)

# The Victoreen

## Panel, Baseboard, Layout of Parts

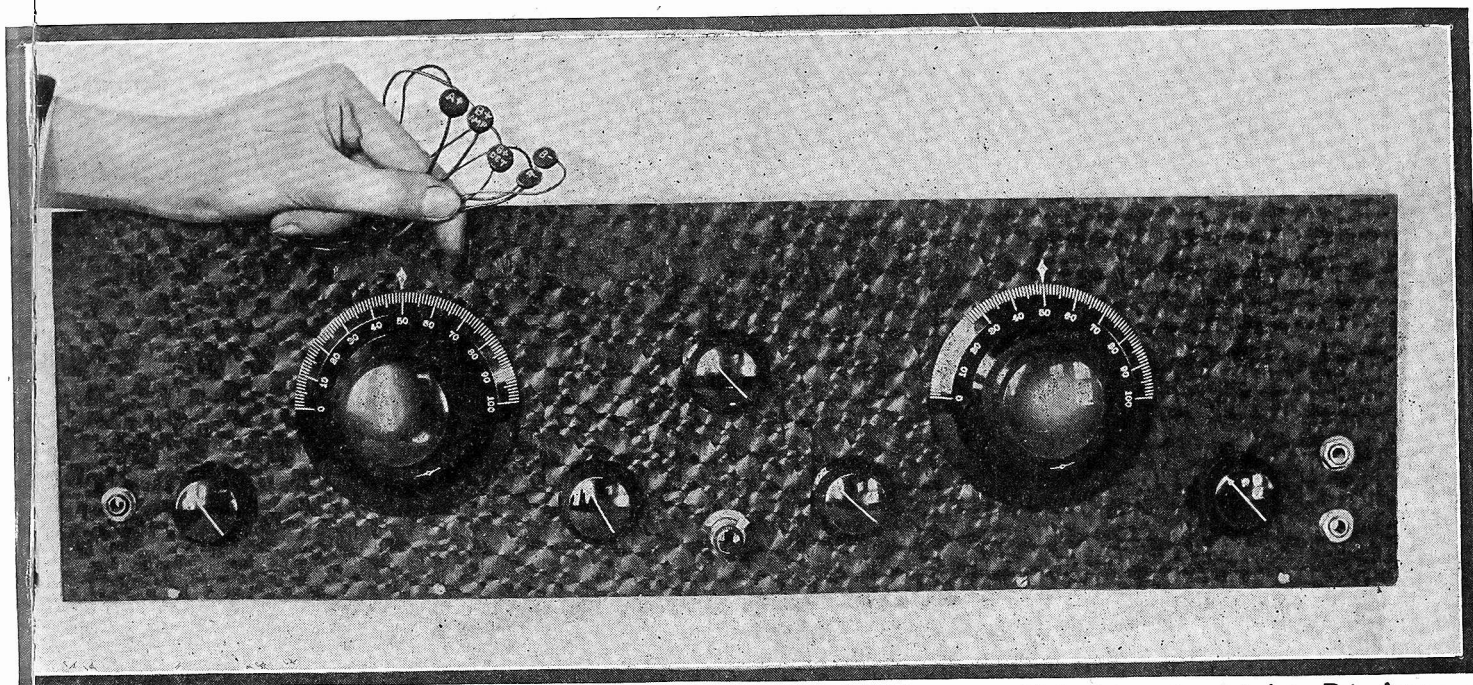

HOW the Victoreen panel looks when friezed hard rubber is used. The battery cableleads are tagged A+, B+ Amp., B+ Det., B- and A-.

### PART II

THE layout of parts, particularly on the baseboard, determines the physical simplicity of the wiring of a Super-Herodyne. Also, physical ease and electrical efficiency go hand in hand, for you seldom encounter any set that is extremely difficult and awkward to wire that does not prove tricky in operation. The Victoreen has been so arranged that convenience and efficiency are served. The panel is 7x24". Hard rubber may be used to advantage, either plain black or the frieze variety, according to the constructor's taste. While there are eight movable things on the panel it must not be supposed that tuning the set is accompanied by variation of all of them, for the rheostat settings, once established, seldom need be touched, often not for days, while the potentiometer is used preferably as a volume control and the tuning is done with the two dials on the variable condensers.

#### Panel Drilling Directions

While most constructors will prefer to obtain a panel already drilled and engraved, for the benefit of those who desire to do their own drilling the following directions are given:

There are four horizontal planes. One is 1" up from the bottom of the panel and on this line are located the switch, S, which is at center on a left-and-right measurement, and the final audio jack, J3, which is centered 1 1/4" from the right-hand side of the panel. On the next highest plane, 1 3/4" up from the panel bottom, are the loop jack, J1, and the four rheostats. Left to right, these rheostats actuate the filaments of the following tubes: tuner tube, or so-called modulator or first detector, designated (1) in the diagram, the rheostat being R1, 30 ohms; three intermediate amplifying tubes, governed by a 6-ohm rheostat, R4, and designed at tubes (3), (4) and (5); another 30-ohm rheostat, R2, this actuating the oscillator tube (2); and another 6-ohm rheostat, R3, which controls the detector and two audio tubes (6), (7) and (8). These four rheostats have their shafts positioned from the left-hand side of the panel as follows: 2 3/4", 9 5/8", 14 3/8" and 18 1/4", and in the same order their resistance is 30 ohms, 6 ohms, 30 ohms and 6 ohms. The

loop jack is on the same plane, 1 1/4" from left.

An exclusive horizontal plane is occupied by the first audio jack, J2, which is 2 3/8" up from panel bottom and 1 1/4" from the right-hand side of the panel, thus being directly above the final audio jack. As this final audio jack, J3, is of the filament-control type, it will be necessary when plugging in only one audio step to turn the rheostat next to this jack a little to the left, because the one less tube in the chain (two instead of three) makes it advisable to incorporate more resistance in the filament circuit.

The next or middle plane is occupied solely by the center shafts of the variable condensers, C1, C2. These are 3 1/2" from top or bottom of the panel and are located respectively 6 1/4" from left (for the tuner condenser) and 6 1/4" from right (for the oscillator condenser.) The final plane is exclusively occupied by the potentiometer, R3, which is directly above the switch, that is, on the middle perpendicular line, 4" up from bottom of the panel.

This accounts for everything that shows on the panel, with the exception of two dial pointers, which are placed so that the pointers all but graze the periphery of the dial, and the holes for baseboard mounting screws. These mounting holes are four in number, measured 2" and 6 3/4", in respective pairs, from left and right ends of the panel, and are of a diameter to be determined by the size of the mounting screws.

The 7x24" panel is ample, as the photograph shows and as the baseboard layout confirms. Some 5-tube sets barely get along on this size panel and baseboard, and it is therefore a tribute to the constructional design of the Victoreen that the 8-tube set is safely encompassed in this space.

As for the baseboard, it should be 23" wide and, if possible, about 3/4" thick, for then it is easier to secure it tightly to the panel by means of wood screws. No brass angles should be necessary to add security to the screw mounting method. As for the depth of the baseboard, although 8 3/4" usually is recommended, one should know first the depth of the cabinet he will use, for most cabinets are not more than 8 1/2" deep, hence trouble

would develop. It is well to know therefore that if you possess a cabinet which has an inside depth of 8 1/2" that you may procure a baseboard of that depth, or even 8 3/4" deep, or may saw down one which is deeper than desirable, not making it less than 8 1/4", however. The parts mounted on the baseboard will find their proper places if 8 1/4"x23" dimensions are used.

#### The Placement of Coils

The determining factor in the baseboard layout is the placement of the coils. These are six in number—the antenna coupler, L1L2, type 160, the oscillator coil, L3L4L5, type 150, and the four intermediate frequency transformers, type 170. There are four of these intermediate transformers, although only three intermediate stages, because one of the coils is used to couple the intermediate frequency chain to the detector tube, sometimes called the second detector.

Some may have noted that a diagram last week showed a filter designation at the input to the intermediate frequency channel, and this is for the guidance of any who possess the No. 175 Victoreen coil. Others, including all who purchase kits now, will receive four No. 170 intermediate frequency transformers, because experience has proven that no special filter is necessary, the four coils being sharply tuned and affording all the selectivity permissible within the safety zone of quality. The commercial coils are the antenna coupler being marked "coupler," so that no difficulty will be encountered in determining which is which. The four intermediate frequency transformers are interchangeable, but the antenna coupler and the oscillator coil are not.

#### The Position of the Encountings

Brass right-angles are provided with the coil kit for mounting the coils to the baseboard. An awl should be used to start the hole for the antenna coupler mounting. This hole is 1 7/8" from the left-hand side of the baseboard and 4 3/4" back from the panel edge of the baseboard. When the panel side of the baseboard faces you, a condition supposed throughout, the mounting is to the right of the antenna coupler, which is placed at right angles to the panel. Next place

# Schematic Diagram of Set

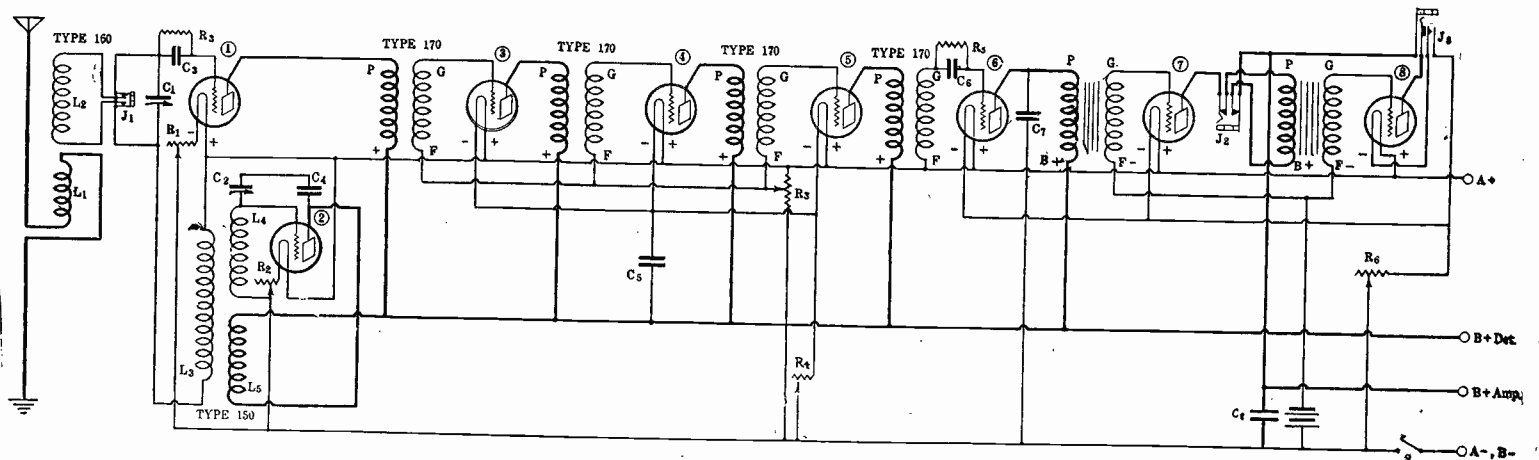

THE VICTOREEN Super-Heterodyne, shown in schematic form. The pictorial diagram of the same hookup was published last week. The tubes are (1) tuner or first detector; (2) oscillator; (3), (4), (5), intermediate amplifiers; (6), second detector; (7) and (8), first and second audio.

the oscillator coil. This is  $10\frac{3}{4}$ " from the left and  $3\frac{1}{2}$ " back, measured from the panel side of the baseboard. The mounting is behind the oscillator coil and the coil is placed parallel with the pane, that is, at right angles to the antenna coupler.

Now for the intermediate frequency transformers. These are mounted at an angle of about 45 degrees to the panel, (but they are secured to the baseboard). The holes for the mountings are to the left of the intermediate transformers and are located on a line  $6\frac{1}{2}$ " back from the panel edge of the baseboard, distanced as follows from the left-hand side of the baseboard: 5",  $8\frac{1}{4}$ ",  $11\frac{3}{4}$ " and 15".

The centers of the seven sockets are  $4\frac{3}{4}$ " back, that is, in line with the center of the antenna coupler, and are distant from the left as follows:  $3\frac{1}{2}$ ",  $6\frac{3}{4}$ ",  $10\frac{1}{4}$ ",  $13\frac{1}{2}$ ",  $16\frac{7}{8}$ ",  $19\frac{1}{2}$ " and  $22\frac{1}{4}$ ". The oscillator tube is in front of tube (5), the distance between socket centers being  $2\frac{3}{4}$ ".

The audio transformers are placed with their primaries (P) to the left and their secondaries (S) to the right.

This accounts for everything on the

panel and everything on the baseboard. Note the absence of any antenna-ground binding posts. Of course these may be included by any who so desire, otherwise the antenna and ground may be connected directly to the posts therefor provided on the antenna coupler. Also no terminal strip (binding posts for batteries) is used, since the cable carries uninterruptedly to the batteries. Where the A minus is connected from cable to set an extra lead, flexible of course, may be put in for the C plus connection, while C minus may be a flexible or stiff lead from the audio secondaries to the C battery itself. This will depend on where one locates the C battery. If there is room, put it inside the cabinet.

The introduction of the cable leads will be discussed in the next instalment as part of the wiring directions.

[This concludes Part II of the article on the construction of the Victoreen, an 8-tube Super-Heterodyne. Part I was published in the February 20 issue. Part III, which brings to a close the wiring data, will be published next week, issue of March 6, while subsequently tuning and trouble-shooting data will be printed].

## LIST OF PARTS

- Four Victoreen RF transformers, No. 170.
- One Victoreen antenna coupler, No. 160 (L1L2).
- One Victoreen oscillator coil, No. 150.
- Eight Kurz-Kasch standard Bakelite sockets.
- Two .0005 mfd. Hammarlund SLF condensers (C1, C2).
- Two Kurz-Kasch E-Z-Toon Vernier dials.
- Two .00025 mfd. grid condensers, with mountings (C3, C6).
- Two 2-megohm grid leaks (R3, R5).
- One .001 mfd. fixed condenser (C7).
- One 1.0 mfd. bypass condenser (C8).
- One 400-ohm Victoreen potentiometer (R3).
- Two 6-ohm Victoreen rheostats (R4, R6).
- Two Victoreen 30-ohm rheostats (R1, R2).
- Two Melofomers.
- One 7x24" drilled and engraved panel.
- One baseboard ( $8\frac{3}{4}$ x23" usually recommended, but even  $8\frac{1}{4}$ x23" will suffice and fit usual cabinets).
- Two No. 104. Carter double-circuit jacks (J1, J2).
- One No. 103 Carter single automatic filament control jack (J3).
- One Carter Imp. battery switch (S).
- Accessories include one Acme battery cable, 5-lead and multi-colored; seven cable tags, A+, A-, B-, B+ Det., B+ Amp., A+, C-.

## Why Care Is Needed Moving Set About

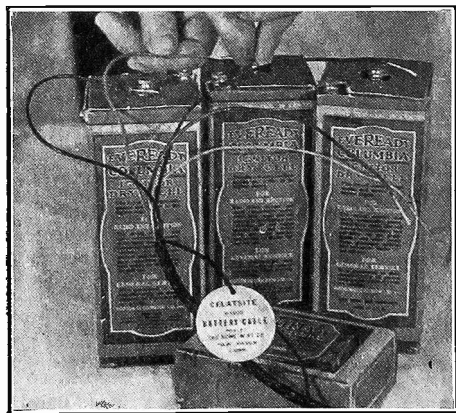

IN DISCONNECTING, first remove the cable leads at the battery end, whether the battery is composed of dry cells, as shown in the photo, or is a storage battery.

When a set is to be moved from one location to another be sure that the first

thing you do is to disconnect the loud-speaker. Usually the plug and jack system is used, so simply pull out the plug. Where phone tip jacks are used, remove the speaker tips from these individual jacks. Next remove the battery cable connections at the battery end, and the cable may be rolled up. It is a mistake to remove the battery cable connections at the set before removing them at the battery, because a couple of leads may collide for a fraction of a second and you may blow out your tubes.

The reason for removing the speaker connections before doing anything else is that this piece of work is sometimes forgotten entirely, and when one lifts the set he walks a few paces, then yanks the speaker from table to floor. Cone speakers in particular suffer dire consequences when this happens. Indeed, some of the articles published in magazines, describing how to "improve" your cone speaker by substituting soft cardboard for the normal paper diaphragm may have been inspired by a personal necessity following the aforementioned disaster.

### WHAT IS a damped wave?

A damped wave is a radio wave which is started off at a jolt by a discharge of a condenser or otherwise into an oscillatory circuit. These do not last long and are lost or flattened out very quickly by a high effective resistance in the circuit. It is a wave which is reduced in amplitude, as to intensity of strength. These waves die down, until they cease to exist.

### WHAT CAUSES a detector tube, having a high vacuum, otherwise known as an amplifier to choke up, very frequently and how can it be cured?

This is caused by too high a resistance being present in the grid circuit. It can be cured by reducing the amount of resistance in the grid resistor or leak. That is, if you are now using a resistance of 6 megohms, and the tube chokes up, then reduce the resistance to about 2 or 3 megohms.

# A Coupler for a Loop

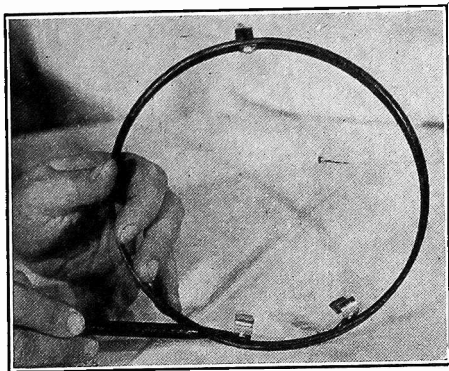

FIG. 1—A single-coil antenna coupler may be wound on an embroidery ring. First locate two clips for the wire terminals. The top brass angle is for mounting to the loop door.

By Herbert Erwin

WHERE one has a loop operated set, with the loop enclosed in a "swinging door," as in the Pressley described in the Dec. 12, 19 and 26 issues of RADIO WORLD, an antenna coupler may be easily made on an embroidery ring form. Get a pair of 7" diameter embroidery rings. Take the rings apart. The inner ring has a narrow piece of felt, about  $\frac{3}{8}$ " wide, by machine all around the surface (outer circumference) of the ring. Carefully remove the strip by pulling, and then clean up any fuzz left sticking to the wood, using a small knife.

Drill two holes in the ring to fit No. 6 machine screws, drilling them about  $2\frac{1}{2}$ " apart in the center of the groove. This will be the "bottom" of the finished coil. Next drill one more hole directly opposite to accommodate a hook (to be described later) fastened to the machine screw. This represents the "top" of the finished coil.

Now, before any winding is commenced, fit two No. 6 machine screws in the bottom holes and fasten two spring clip binding posts on the inside of this ring so that they protrude in the manner shown in Fig. 1. A No. 6 machine screw is placed through the third hole, the "top" one, and a special hook, cut from a piece of thin brass (Fig. 2) is fastened on the inside of the ring. After this has been done, the winding is placed on (Fig. 3) twelve turns of No. 22 DSC wire being wound in the groove. This means winding right over the heads of the No. 6 machine screws, which have been filed rather flat beforehand, so as not to make the winding path bumpy. The ends of this winding are soldered to the spring clips, and the coil is now complete.

The next step (Fig. 4) is to place a wide flathead screw,  $\frac{1}{4}$ " long, in the wooden door of the "loop box" of the Pressley or other set. Do not turn the screw up flat against the wood, but allow the head to stick up about  $1/16$ ". The coupler is simply slipped over this screwhead (Fig. 5). The aerial and ground leads are connected as shown.

The use of this device increases distant reception and the volume is made greater.

Remove the ring, and tune the set as usual with the loop. Then bring the ring near the door, holding it in the hand all the time, and notice the increase in strength as the ring now approaches the door. Now grasp the tuning dial (the one on the loop) and with the coupler in place as explained, slightly change the reading of the loop condenser. A new point will

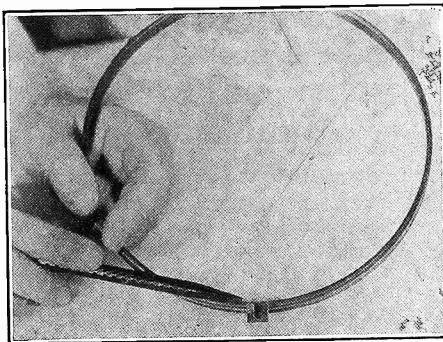

FIG. 2—Detail of the V-shaped angle which is used for "hanging" the coupler on the loop door.

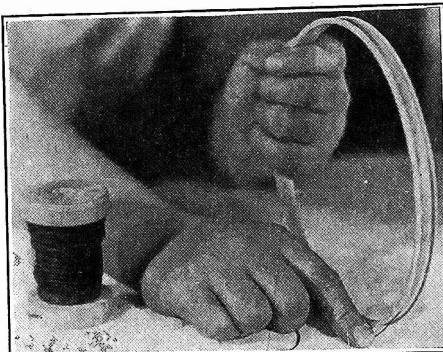

FIG. 3—Now begin the winding, using the method shown. Put in 12 turns of No. 22 double silk covered wire.

be established, bringing still greater strength of signals. The oscillator dial will remain about the same.

A device like this antenna coupler may be placed in inductive relationship to almost any other type of loop.

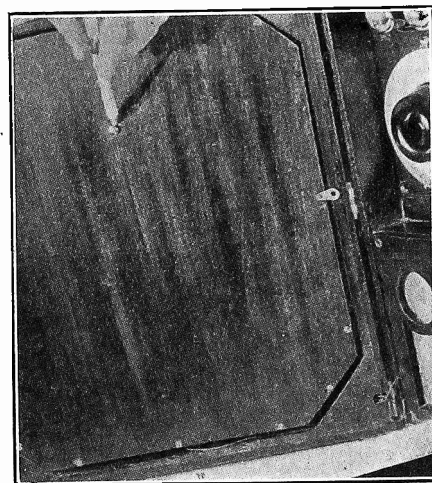

FIG. 4—Pencil points to the No. 6 screw to which the coupler angle is hooked.

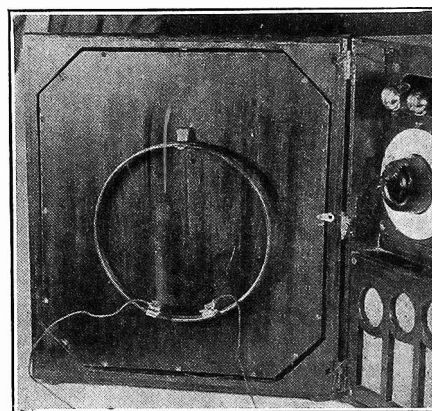

FIG. 5—The coupler in position. The two leads go to aerial and ground.

## WKRC Is Moving Into Magnificent Studio

Cincinnati will have one of the most modern broadcasting studios and transmission rooms in the country with the definite adoption of plans for moving the studios of WKRC, the Kodel Radio Corp. station in the present Hotel Alms, from the present location to the new \$5,000,000 Hotel Alms, where the studios will occupy almost all of the north wing. This will be completed in late February and it is probable that WKRC will be off the air for one week, during which final tests will be held in March.

Announcement of the plans followed a conference of C. E. Ogden, president

of the Kodel Radio Corporation and E. H. L. Haefner and Dan Meyers, of the Hotel Alms; with Eugene S. Mittendorf, studio director and John Church, Chief Radio Engineer of the Kodel Radio Corporation station.

The new studios were planned after twenty-six of the most modern broadcasting stations were visited by Church and Mittendorf and the best features of these stations combined in the plans for the new Kodel station. The new towers, 125 feet high, are already in place on the roof of the building, where the transmitting apparatus and operators' control room will be located.

## WEAF Losing Money; Expenses Are \$300,000

WEAF, the station of the American Telephone and Telegraph Company is operated at a loss of \$15,000 a year, according to testimony brought out in a hearing before the Public Service Commission, New York, relative to the application of the New York Telephone Company for an increase in rates.

The expenses of the station are \$300,000 a year, said Charles A. Heiss, comptroller of the company, and revenue is \$285,000, leaving a yearly deficit of \$15,000. The expense of maintaining the station comes out of the  $4\frac{1}{2}$  per cent. of gross revenue of subsidiary companies paid to the A. T. & T.

# Fenway Trouble Shooting

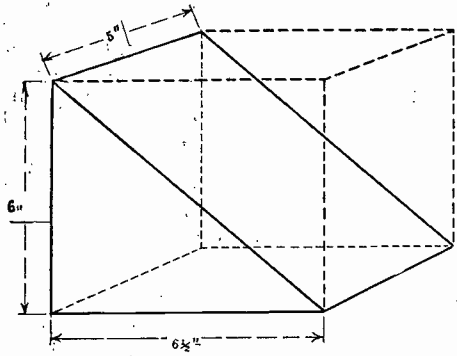

Detail of shields for Fenway.

By Leo Fenway

Copyright, 1926. All Rights Reserved.

FROM one end of the country to the other the truth about the Fenway seems suddenly to have dawned on thousands who previously thought that it was just another radio circuit. You know that there is an awakening in favor of this receiver because you hear of it everywhere you go; because the Fenway causes more fans to turn toward it, owing to its simplicity of construction. And there is something about this set that real radio men like. Perhaps it's the great sensitivity, the remarkable selectivity, the perfect quality, the tremendous volume on distance—whether it is all these and more, most real radio men, and nearly all kitchen table mechanics, like the Fenway.

For the benefit of those readers to whom this article is their first introduction to this receiver it might be well to reiterate my theory of the circuit as I set it forth in the three instalments published in RADIO WORLD on February 6, 13 and 20. It is simply this:

Broadly speaking, the Fenway consists of one stage of tuned radio frequency with regeneration, a non-regenerative detector, three stages of iron core medium frequency amplification—from 30 K C to 60 K C—a non-regenerative second detector and two stages of transformer coupled audio frequency—a total of nine tubes.

A radio receiver, whether factory made or home constructed, may be judged in two respects, viz., what the owner or constructor says about his set and what his set says for itself. Reading between the lines, after discounting the enthusiasm of certain Fenway super builders 75 per cent., the set still appears to be synonymous with volume, clarity, distance and selectivity. Schooled as most writers are to disappointments, it is a real delight to note the progress of a large number of Fenways built by average kitchen table mechanics.

"You cannot improve the quality," says one of the heads of the Federation of Musicians, in a letter sent from their offices at 1440 Broadway, New York City. The writer of that letter built the set after constructing fourteen other supers.

Other letters, telegrams and phone calls too numerous to detail proclaim the Fenway an easy and satisfactory set to build, provided that the preceding specifications and complete parts used are followed religiously.

Those who have met with grief, whose set has failed to respond right from the start, can doubtless trace their sorrows to mud sockets, cheap wire rheostats, crude bus wiring and to air core medium frequency transformers that have suffered from climatic changes. To make no bones about speaking bluntly there IS A TREMENDOUS DIFFERENCE between sockets, rheostats, transformers, fixed and variable condensers. Bear this in mind when you go looking for trouble in your

Fenway. Remember that the finest parts—the most efficient parts, regardless of cost—have been chosen for this set. If you took somebody's advice besides mine in choosing your Fenway parts this trouble shooting data will benefit you very little.

Remember that I know the Fenway from the antennae binding post to the last audio connection—I know what parts should be used and WHERE to use them. I KNOW that my receiver will out-perform any other receiver ever designed, and I will furnish proof of that statement to argue any man to a standstill. The Fenway combination 4 and 9 tube receiver as described in RADIO WORLD, is months ahead of anything even contemplated in radio sets. And the ONLY reason for publishing the exact instruments used in the original set was to save the belated builder from the turmoil of last-minute selection of material, then the doubts and the wonder if he selected the right part for the right place.

When one has a good circuit to follow, knows the exact parts to use and how to use them, the construction of a Super-Heterodyne ought to be as simple as that of a 3-circuit tuner; in fact, it really is much simpler, only there is more of it. For example, a wire leaves a tube socket (plate) and goes to a transformer (plate), it leaves that same transformer (grid) and goes to a tube socket (grid), and so on to the next transformer and the next tube. Could anything be simpler than that?

"Well, then," you say, "if the construction of the Fenway is so easy, where do the mistakes come in?"

### What the Answer Is

The answer is just a few lines back—in the parts used. The principal difference between your super and the set that is dumped upon the market for a price is cheap parts. Whenever it happens that the instruments used are not responsible for the set failing to percolate the trouble can usually be found in the way the set has been "slung together." Many of the letters stated that the writers were not building a finished product but were just "fooling around" trying to "get an idea what it was all about." Later (so they said) they would rebuild the set "on a real panel" and do a "real job." In between times the set isn't working well, and not infrequently a collection of high-class parts is being insulted by having a mass of alien wires thrown at them.

One chap in Boston remarked that his set was working perfectly without any meters on the panel. Well, you don't have to have meters to make a radio do its stuff. But every radioist knows that they mean safe running. Always in front of his eyes, their friendly figures give him that certainty and safety that come from knowing exactly about his batteries. It is even possible to get along without such seemingly humdrum things as fixed condensers and grid leaks, and yet these very things perform deeds no less wonderful than the magic carpet that transported Prince Houssain.

An electrician in one of the Broadway theatres wants to know if it wouldn't be better to have regeneration on the first detector instead of on the first radio frequency tube. The answer to that is, Have you ever tuned in a station and wished for another button or knob or dial which you could turn? You felt confident that if there was only something to turn, if merely another binding post, you could bring in that distance station with good volume! Well, regeneration on the first radio frequency tube is that button or knob—that something that does

## Now Comes The Radio "Tug O' War!"

SEVERAL weeks ago, RADIO WORLD'S editors said to me—

"Fenway: How does your Super compare with the Victoreen Super?"

I said: "I know how it compares! But—How are your readers going to find it out—unless they build both sets? Merely saying that one set is more efficient than the other is not enough. There must be concrete proof that one set is superior to the other."

"Well, then," said the editors, "what would you suggest?"

What I suggested resulted in RADIO WORLD publishing the Victoreen circuit simultaneously with the Fenway. And there you have it! There's the Victoreen Super with its air-core transformers—tuned to a precision of 1/3 of 1%—with its loop or aerial operation and its far-reaching claims for distance reception. And there's the Fenway with its stage of tuned radio with regeneration—its copper shielding—its iron-core transformers—its 4 or 9 tube feature—and it, too, operates from either loop or antenna.

Now, then, in the sense of being "best" there can be but one—

Is it the Victoreen or is it the Fenway?

What do you think? What is your actual experience with both?

Won't you join this "Radio Tug O' War" and send in your comments and suggestions?

If you need more data on the Victoreen or the Fenway, won't you please let us know?

Come on, now, fellows, toss your hat into the ring and pick your position in this Radio Tug O' War!

The Geo. W. Walker Company of Cleveland, Ohio, are with you—and so is the writer.

Come, come, now!

Tell RADIO WORLD which one you know is the greater radio set.

Leo Fenway.

the trick. It wouldn't be the same thing if it was on the detector. Of course, that's the practical side of it; the technical side will be the same a hundred years from now anyway.

### Two or Three Stages?

"Shall I use two or three stages of medium frequency amplification?" writes another. If you're building a Fenway use three stages. Three stages operating at almost maximum efficiency are decidedly better than two stages. By measuring the voltage gain per stage you will find that three stages in this receiver amount to something. It isn't as though the last stage was a dud—far from it, and a little experimenting by any one will prove this.

"Can the new Acme, Erla or Rauland Lyric audio transformer be used in the Fenway?" Certainly. While the writer uses General Radio audio transformers he wouldn't hesitate to recommend any of the new, large iron core audio transformers now on the market. In fact, a set has just been completed using one Acme Mu-2 in the first stage and an Amertram in the second stage. Needless to say, the volume and tone are perfect.

A gentleman from Chicago would like to know if air core medium frequency transformers can be used in this set. Well, if they are perfectly matched, well constructed and do not develop rheumatism on rainy days they ought to function very nicely. But don't get me wrong—I

(Continued on page 28)

# The Victoreen

## Panel, Baseboard, Layout of Parts

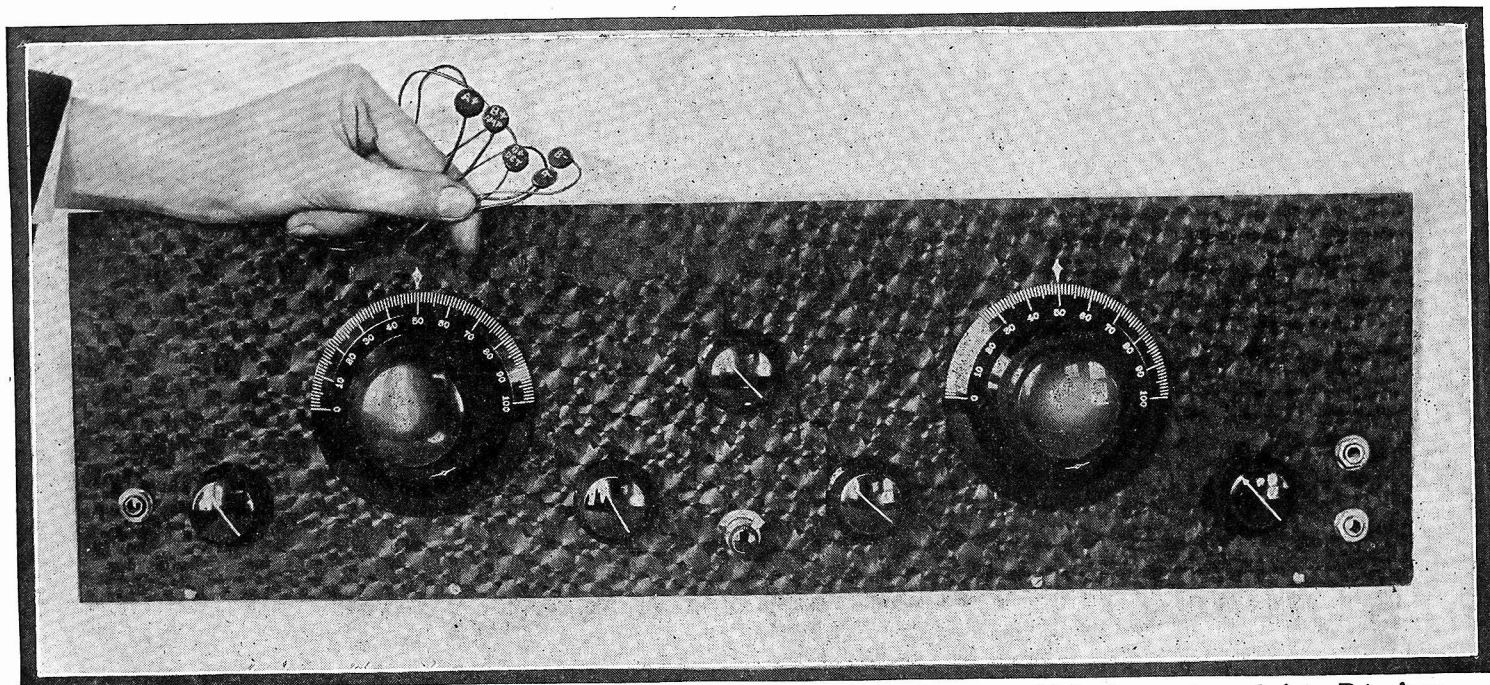

HOW the Victoreen panel looks when friezed hard rubber is used. The battery cableleads are tagged A+, B+ Amp., B+ Det., B- and A-.

### PART II

THE layout of parts, particularly on the baseboard, determines the physical simplicity of the wiring of a Super-Heterodyne. Also, physical ease and electrical efficiency go hand in hand, for you seldom encounter any set that is extremely difficult and awkward to wire that does not prove tricky in operation. The Victoreen has been so arranged that convenience and efficiency are served.

The panel is 7x24". Hard rubber may be used to advantage, either plain black or of the frieze variety, according to the constructor's taste. While there are eight movable things on the panel it must not be supposed that tuning the set is accompanied by variation of all of them, for the rheostat settings, once established, seldom need be touched, often not for days, while the potentiometer is used preferably as a volume control and the tuning is done with the two dials on the variable condensers.

#### Panel Drilling Directions

While most constructors will prefer to obtain a panel already drilled and engraved, for the benefit of those who desire to do their own drilling the following directions are given:

There are four horizontal planes. One is 1" up from the bottom of the panel and on this line are located the switch, S, which is at center on a left-and-right measurement, and the final audio jack, J3, which is centered 1 1/4" from the right-hand side of the panel. On the next highest plane, 1 3/4" up from the panel bottom, are the loop jack, J1, and the four rheostats. Left to right, these rheostats actuate the filaments of the following tubes: tuner tube, or so-called modulator or first detector, designated (1) in the diagram, this rheostat being R1, 30 ohms; three intermediate amplifying tubes, governed by a 6-ohm rheostat, R4, and designed at tubes (3), (4) and (5); another 30-ohm rheostat, R2, this actuating the oscillator tube (2); and another 6-ohm rheostat, R6, which controls the detector and two audio tubes (6), (7) and (8). These four rheostats have their shafts positioned from the left-hand side of the panel as follows: 2 3/4", 9 5/8", 14 3/8" and 18 1/4", and in the same order their resistance is 30 ohms, 6 ohms, 30 ohms and 6 ohms. The

loop jack is on the same plane, 1 1/4" from left.

An exclusive horizontal plane is occupied by the first audio jack, J2, which is 2 3/8" up from panel bottom and 1 1/4" from the right-hand side of the panel, thus being directly above the final audio jack. As this final audio jack, J3, is of the filament-control type, it will be necessary when plugging in only one audio step to turn the rheostat next to this jack a little to the left, because the one less tube in the chain (two instead of three) makes it advisable to incorporate more resistance in the filament circuit.

The next or middle plane is occupied solely by the center shafts of the variable condensers, C1, C2. These are 3 1/2" from top or bottom of the panel and are located respectively 6 1/4" from left (for the tuner condenser) and 6 1/4" from right (for the oscillator condenser.) The final plane is exclusively occupied by the potentiometer, R3, which is directly above the switch, that is, on the middle perpendicular line, 4" up from bottom of the panel.

This accounts for everything that shows on the panel, with the exception of two dial pointers, which are placed so that the pointers all but graze the periphery of the dial, and the holes for baseboard mounting screws. These mounting holes are four in number, measured 2" and 6 3/4", in respective pairs, from left and right ends of the panel, and are of a diameter to be determined by the size of the mounting screws.

The 7x24" panel is ample, as the photograph shows and as the baseboard layout confirms. Some 5-tube sets barely get along on this size panel and baseboard, and it is therefore a tribute to the constructional design of the Victoreen that the 8-tube set is safely encompassed in this space.

As for the baseboard, it should be 23" wide and, if possible, about 3/4" thick, for then it is easier to secure it tightly to the panel by means of wood screws. No brass angles should be necessary to add security to the screw mounting method. As for the depth of the baseboard, although 8 3/4" usually is recommended, one should know first the depth of the cabinet he will use, for most cabinets are not more than 8 1/2" deep, hence trouble

would develop. It is well to know therefore that if you possess a cabinet which has an inside depth of 8 1/2" that you may procure a baseboard of that depth, or even 8 3/4" deep, or may saw down one which is deeper than desirable, not making it less than 8 3/4", however. The parts mounted on the baseboard will find their proper places if 8 1/4"x23" dimensions are used.

#### The Placement of Coils

The determining factor in the baseboard layout is the placement of the coils. These are six in number—the antenna coupler, L1L2, type 160, the oscillator coil, L3L4L5, type 150, and the four intermediate frequency transformers, type 170. There are four of these intermediate transformers, although only three intermediate stages, because one of the coils is used to couple the intermediate frequency chain to the detector tube, sometimes called the second detector.

Some may have noted that a diagram last week showed a filter designation at the input to the intermediate frequency channel, and this is for the guidance of any who possess the No. 175 Victoreen coil. Others, including all who purchase kits now, will receive four No. 170 intermediate frequency transformers, because experience has proven that no special filter is necessary, the four coils being sharply tuned and affording all the selectivity permissible within the safety zone of quality. The commercial coils are the antenna coupler being marked "coupler," so that no difficulty will be encountered in determining which is which. The four intermediate frequency transformers are interchangeable, but the antenna coupler and the oscillator coil are not.

#### The Position of the Encountings

Brass right-angles are provided with the coil kit for mounting the coils to the baseboard. An awl should be used to start the hole for the antenna coupler mounting. This hole is 1 7/8" from the left-hand side of the baseboard and 4 3/4" back from the panel edge of the baseboard. When the panel side of the baseboard faces you, a condition supposed throughout, the mounting is to the right of the antenna coupler, which is placed at right angles to the panel. Next place

# Schematic Diagram of Set

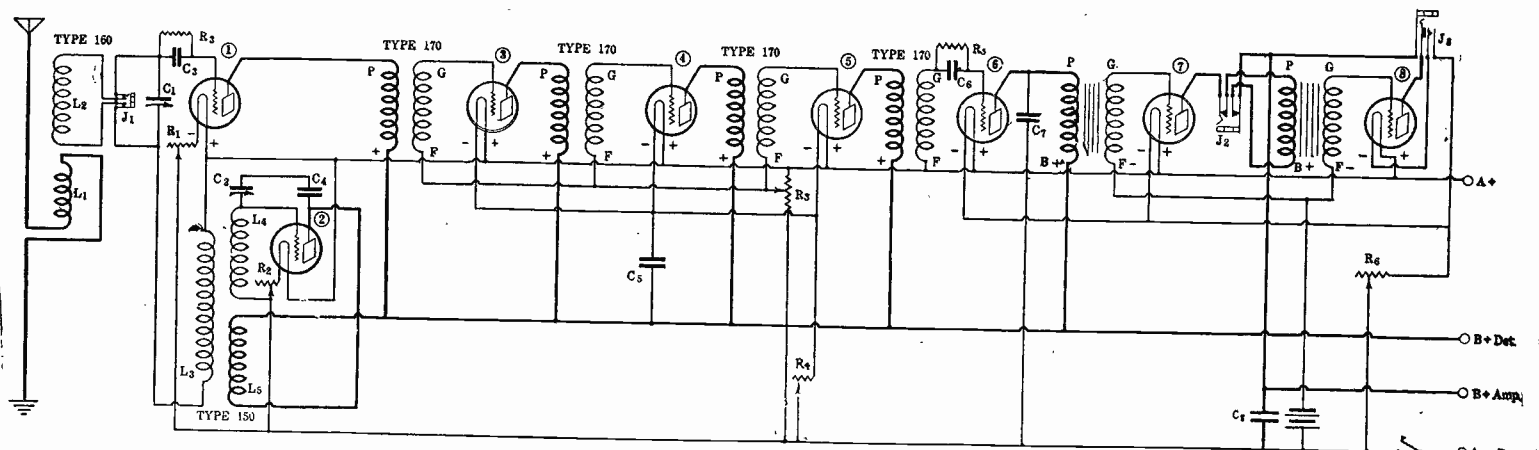

THE VICTOREEN Super-Heterodyne, shown in schematic form. The pictorial diagram of the same hookup was published last week. The tubes are (1) tuner or first detector; (2) oscillator; (3), (4), (5), intermediate amplifiers; (6), second detector; (7) and (8), first and second audio.

the oscillator coil. This is  $10\frac{3}{4}$ " from the left and  $3\frac{1}{2}$ " back, measured from the panel side of the baseboard. The mounting is behind the oscillator coil and the coil is placed parallel with the pane, that is, at right angles to the antenna coupler.

Now for the intermediate frequency transformers. These are mounted at an angle of about 45 degrees to the panel, (but they are secured to the baseboard). The holes for the mountings are to the left of the intermediate transformers and are located on a line  $6\frac{1}{2}$ " back from the panel edge of the baseboard. Distances as follows from the left-hand side of the baseboard: 5",  $8\frac{1}{4}$ ",  $11\frac{3}{4}$ " and 15".

The centers of the seven sockets are  $4\frac{3}{4}$ " back, that is, in line with the center of the antenna coupler, and are distant from the left as follows:  $3\frac{1}{2}$ ",  $6\frac{3}{4}$ ",  $10\frac{1}{4}$ ",  $13\frac{1}{2}$ ",  $16\frac{7}{8}$ ",  $19\frac{1}{2}$ " and  $22\frac{1}{4}$ ". The oscillator tube is in front of tube (5), the distance between socket centers being  $2\frac{3}{4}$ ".

The audio transformers are placed with their primaries (P) to the left and their secondaries (S) to the right.

This accounts for everything on the

panel and everything on the baseboard. Note the absence of any antenna-ground binding posts. Of course these may be included by any who so desire, otherwise the antenna and ground may be connected directly to the posts therefor provided on the antenna coupler. Also no terminal strip (binding posts for batteries) is used, since the cable carries uninterruptedly to the batteries. Where the A minus is connected from cable to set an extra lead, flexible of course, may be put in for the C plus connection, while C minus may be a flexible or stiff lead from the audio secondaries to the C battery itself. This will depend on where one locates the C battery. If there is room, put it inside the cabinet.

The introduction of the cable leads will be discussed in the next instalment as part of the wiring directions.

[This concludes Part II of the article on the construction of the Victoreen, an 8-tube Super-Heterodyne. Part I was published in the February 20 issue. Part III, which brings to a close the wiring data, will be published next week, issue of March 6, while subsequently tuning and trouble-shooting data will be printed].

## LIST OF PARTS

- Four Victoreen RF transformers, No. 170.
- One Victoreen antenna coupler, No. 160 (L1L2).
- One Victoreen oscillator coil, No. 150.
- Eight Kurz-Kasch standard Bakelite sockets.
- Two .0005 mfd. Hammarlund SLF condensers (C1, C2).
- Two Kurz-Kasch E-Z-Toon Vernier dials.
- Two .00025 mfd. grid condensers, with mountings (C3, C6).
- Two 2-megohm grid leaks (R3, R5).
- One .001 mfd. fixed condenser (C7).
- One 1.0 mfd. bypass condenser (C8).
- One 400-ohm Victoreen potentiometer (R3).
- Two 6-ohm Victoreen rheostats (R4, R6).
- Two Victoreen 30-ohm rheostats (R1, R2).
- Two Meloformers.
- One 7x24" drilled and engraved panel.
- One baseboard ( $8\frac{3}{4}$ x23" usually recommended, but even  $8\frac{1}{4}$ x23" will suffice and fit usual cabinets).
- Two No. 104. Carter double-circuit jacks (J1, J2).
- One No. 103 Carter single automatic filament control jack (J3).
- One Carter Imp. battery switch (S).
- Accessories include one Acme battery cable, 5-lead and multi-colored; seven cable tags, A+, A-, B-, B+ Det., B+ Amp., A+, C-.

## Why Care Is Needed Moving Set About

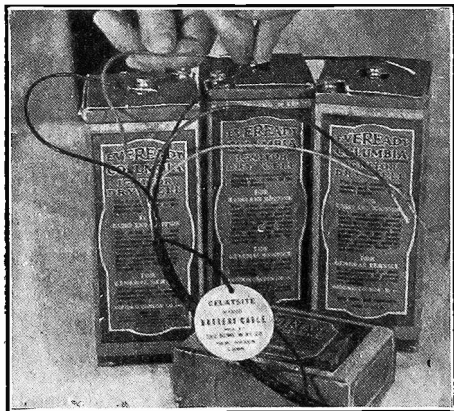

IN DISCONNECTING, first remove the cable leads at the battery end, whether the battery is composed of dry cells, as shown in the photo, or is a storage battery.

When a set is to be moved from one location to another be sure that the first

thing you do is to disconnect the loud-speaker. Usually the plug and jack system is used, so simply pull out the plug. Where phone tip jacks are used, remove the speaker tips from these individual jacks. Next remove the battery cable connections at the battery end, and the cable may be rolled up. It is a mistake to remove the battery cable connections at the set before removing them at the battery, because a couple of leads may collide for a fraction of a second and you may blow out your tubes.

The reason for removing the speaker connections before doing anything else is that this piece of work is sometimes forgotten entirely, and when one lifts the set he walks a few paces, then yanks the speaker from table to floor. Cone speakers in particular suffer dire consequences when this happens. Indeed, some of the articles published in magazines, describing how to "improve" your cone speaker by substituting soft cardboard for the normal paper diaphragm may have been inspired by a personal necessity following the aforementioned disaster.

### WHAT IS a damped wave?

A damped wave is a radio wave which is started off at a jolt by a discharge of a condenser or otherwise into an oscillatory circuit. These do not last long and are lost or flattened out very quickly by a high effective resistance in the circuit. It is a wave which is reduced in amplitude, as to intensity of strength. These waves die down, until they cease to exist.

### WHAT CAUSES a detector tube, having a high vacuum, otherwise known as an amplifier to choke up, very frequently and how can it be cured?

This is caused by too high a resistance being present in the grid circuit. It can be cured by reducing the amount of resistance in the grid resistor or leak. That is, if you are now using a resistance of 6 megohms, and the tube chokes up, then reduce the resistance to about 2 or 3 megohms.



# A Coupler for a Loop

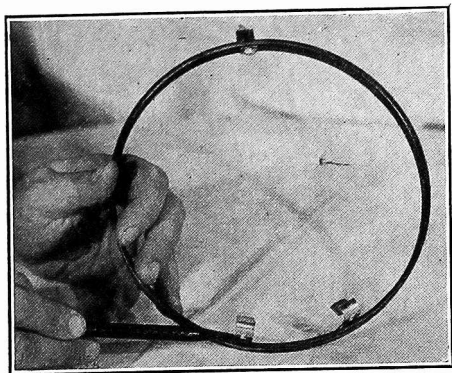

FIG. 1—A single-coil antenna coupler may be wound on an embroidery ring. First locate two clips for the wire terminals. The top brass angle is for mounting to the loop door.

By Herbert Erwin

WHERE one has a loop operated set, with the loop enclosed in a "swinging door," as in the Pressley described in the Dec. 12, 19 and 26 issues of RADIO WORLD, an antenna coupler may be easily made on an embroidery ring form. Get a pair of 7" diameter embroidery rings. Take the rings apart. The inner ring has a narrow piece of felt, about  $\frac{3}{8}$ " wide, by machine all around the surface (outer circumference) of the ring. Carefully remove the strip by pulling, and then clean up any fuzz left sticking to the wood, using a small knife.

Drill two holes in the ring to fit No. 6 machine screws, drilling them about  $2\frac{1}{2}$ " apart in the center of the groove. This will be the "bottom" of the finished coil. Next drill one more hole directly opposite to accommodate a hook (to be described later) fastened to the machine screw. This represents the "top" of the finished coil.

Now, before any winding is commenced, fit two No. 6 machine screws in the bottom holes and fasten two spring clip binding posts on the inside of this ring so that they protrude in the manner shown in Fig. 1. A No. 6 machine screw is placed through the third hole, the "top" one, and a special hook, cut from a piece of thin brass (Fig. 2) is fastened on the inside of the ring. After this has been done, the winding is placed on (Fig. 3) twelve turns of No. 22 DSC wire being wound in the groove. This means winding right over the heads of the No. 6 machine screws, which have been filed rather flat beforehand, so as not to make the winding path bumpy. The ends of this winding are soldered to the spring clips, and the coil is now complete.

The next step (Fig. 4) is to place a wide flathead screw,  $\frac{1}{4}$ " long, in the wooden door of the "loop box" of the Pressley or other set. Do not turn the screw up flat against the wood, but allow the head to stick up about  $1/16$ ". The coupler is simply slipped over this screwhead (Fig. 5). The aerial and ground leads are connected as shown.

The use of this device increases distant reception and the volume is made greater.

Remove the ring, and tune the set as usual with the loop. Then bring the ring near the door, holding it in the hand all the time, and notice the increase in strength as the ring now approaches the door. Now grasp the tuning dial (the one on the loop) and with the coupler in place as explained, slightly change the reading of the loop condenser. A new point will

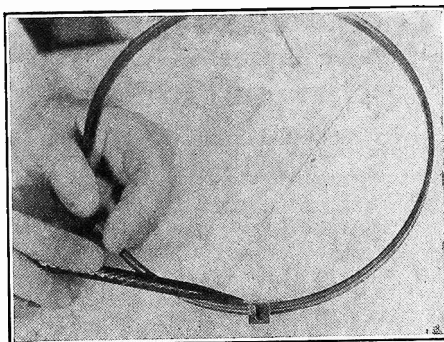

FIG. 2—Detail of the V-shaped angle which is used for "hanging" the coupler on the loop door.



FIG. 3—Now begin the winding, using the method shown. Put in 12 turns of No. 22 double silk covered wire.

be established, bringing still greater strength of signals. The oscillator dial will remain about the same.

A device like this antenna coupler may be placed in inductive relationship to almost any other type of loop.

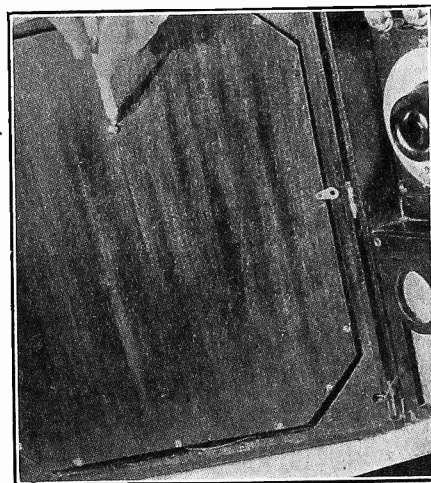

FIG. 4—Pencil points to the No. 6 screw to which the coupler angle is hooked.

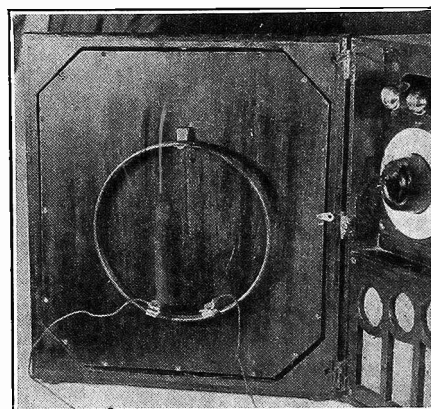

FIG. 5—The coupler in position. The two leads go to aerial and ground.

## WKRC Is Moving Into Magnificent Studio

Cincinnati will have one of the most modern broadcasting studios and transmission rooms in the country with the definite adoption of plans for moving the studios of WKRC, the Kodel Radio Corp. station in the present Hotel Alms, from the present location to the new \$5,000,000 Hotel Alms, where the studios will occupy almost all of the north wing. This will be completed in late February and it is probable that WKRC will be off the air for one week, during which final tests will be held in March.

Announcement of the plans followed a conference of C. E. Ogden, president

of the Kodel Radio Corporation and E. H. L. Haefner and Dan Meyers, of the Hotel Alms; with Eugene S. Mittendorf, studio director and John Church, Chief Radio Engineer of the Kodel Radio Corporation station.

The new studios were planned after twenty-six of the most modern broadcasting stations were visited by Church and Mittendorf and the best features of these stations combined in the plans for the new Kodel station. The new towers, 125 feet high, are already in place on the roof of the building, where the transmitting apparatus and operators' control room will be located.

## WEAF Losing Money; Expenses Are \$300,000

WEAF, the station of the American Telephone and Telegraph Company is operated at a loss of \$15,000 a year, according to testimony brought out in a hearing before the Public Service Commission, New York, relative to the application of the New York Telephone Company for an increase in rates.

The expenses of the station are \$300,000 a year, said Charles A. Heiss, comptroller of the company, and revenue is \$285,000, leaving a yearly deficit of \$15,000. The expense of maintaining the station comes out of the  $4\frac{1}{2}$  per cent. of gross revenue of subsidiary companies paid to the A. T. & T.

# Deaf for 22 Years, Girl Hears on Headphones



**ELSIE HAYES, 25, deaf and dumb for 22 years, who finally heard music and the human voice when she put on earphones. "Did you hear the music?" her mother asked. The girl nodded and articulated the word "mother."**

Elsie Hayes, 25, of Winnipeg, Manitoba, was induced by a friend to listen through a headset to a radio concert from station CNRW, of the Canadian National Railways at Winnipeg, a few weeks ago, though she had been totally deaf and dumb since she was three years old. At first there were no signs that she heard the concert, but as the broadcasting proceeded it became obvious that she was not only hearing sounds, but was able to distinguish between the notes of the different musical instruments and was hearing for the first time in 22 years a human voice.

At the conclusion of the program she heard her mother ask her if she had heard the music, and nodding to her in reply responded with a sound very closely ap-

## Diamond Makes Music Audible to Grandfather, Deaf Sixteen Years

RESULTS EDITOR:

Along with the other fans I must sing praise for the 1926 model Diamond of the Air. This was the first receiver that I ever built and it certainly is a peach. I have received over 20 DX stations, location of each ranging from New York City to Chicago.

I had a very interesting experience. My grandfather, who has been deaf for 16 years, heard music for the first time when I clamped the phones on his head. The surprised expression on his face was worth all the money and more than I spent on the construction of the set.

**CHARLES PERRY,**  
4 Bulfinch Place,  
Boston, Mass.

proximating the word "mother." The following morning on her way to work she was able to hear the rumble of street cars and she is now beginning to notice the music of a phonograph when played near her with a loud needle. The radio treatments are being continued.

Specialists in the treatment of the ear say it is quite possible that radio vibrations may have given her the first sound from the outside world even after 22 years, but that such a condition would only apply where the hearing actually remained without being used during that time.

Similar experiments have been carried out from station CNRV of the Canadian National Railways at Vancouver, B. C., among children in the deaf and dumb institution in that city. Several children are reported to have shown signs of hearing the transmitted sounds and the success attained has been sufficient to warrant continuation of the experiments.

# Metropolitan's Child Star in Radio Debut

Giovanni Martinelli, tenor, of the Metropolitan opera, Marion Tally, 19-year-old Metropolitan soprano, and Marguerite d'Alvarez, contralto, went on the air over the network of the Radio Corporation of America, February 19. This was the fourth concert in the 1926 series of the Victor Talking Machine Company.

With these artists were heard the Victor Salon Orchestra under the direction of Nathaniel Shilkret.

The concert was broadcast from the studio of Station WJZ, New York, and the other stations included in the network were KYW, Chicago; KDKA, Pittsburgh; WBZ, Springfield, Mass.; WGY, Schenectady, and WRC, Washington, D. C.

One of the interesting features of the coming concerts was the fact that it was Marion Talley's second debut of the week. Her first appearance before the microphone came just two days after her operatic debut at the Metropolitan. The extraordinary success of this young singer constitutes one of the most romantic stories of modern opera, and her

career, since her audition before Gatti-Casazza, at the age of fifteen, has been closely followed in this country.

Martinelli, one of the world's best tenors, has won signal triumphs in Europe, South America and the United States. He has been heard in many of the greatest dramatic tenor roles of opera, and among those in which he has appeared at the Metropolitan this season are: "Pagliacci," "La Juive," "Aida," "Fedora," and "Jewels of the Madonna." This will be his first radio broadcast.

Madame d'Alvarez, who made her debut in Brussels, has been heard in concert in this country, and with the San Francisco Opera Company and the California Opera Company last fall. She is another of the artists of international reputation to be brought before the radio audience for the first time by the Victor Company, as her broadcast next Friday night will be her initial bow to the microphone. She has a contralto voice of unusual color and brilliance—the type of voice which lends itself admirably to broadcasting.

## Anna Case Delights



**ANNA CASE, operatic and concert soprano, whose beautiful voice and diction were heard from WEAF and a chain of interconnected stations during an Atwater-Kent Music Hour.**

## Largest Audience Hears John Drew

A longing for the old-time thrill impelled John Drew to break the voluntary quiet into which he has retired. He was the feature of an Eveready Hour broadcast by WEAF.

His decision to go on the air from that station and allied stations meant that he faced the largest audience of his career. Capacity houses are no novelty to Mr. Drew, but now played for half the United States over a network of 15 stations.



**JOHN DREW**

The program was made up of several short readings from his most important roles, including excerpts from "The Taming of the Shrew," in which, as Petruchio, he was largely responsible for the remarkable run at Daly's some forty years ago.

The last part of the Eveready Hour was taken up by the final act of "Rosemary," a play that revived pleasant memories for those who were theatre-goers thirty years back.

"Rosemary" was selected because it provided an excellent opportunity for Mr. Drew to display the range of his talents. Virtually the entire act is a soliloquy, a recounting of long-quiet dreams stirred up by the finding of a sprig of rosemary in an old trunk. There is gentle comedy in the piece, pathos and human kindness.

The play, written by Lewis N. Parker, was first produced in New York in 1896, with a cast that included, besides Mr. Drew, Maude Adams and Arthur Byron. Ethel Barrymore, Mr. Drew's niece, was then starting on her career, and she had a minor role.

# New Tube On Horizon; Heated from the Main



DR. A. N. LUCIAN, assistant professor of physics at the University of Pennsylvania, operating a radio set with the radio vacuum tube developed by him. (Wide World.)

One of the greatest advances in the radio art, has been made by Dr. A. N. Lucian, assistant professor of physics at the University of Pennsylvania, according to persons who studied the operation of the tube. Dr. Lucian has invented a tube that all radio fans and engineers, have thought to exist only in dreams or what looked good on paper and nowhere else, by the doctor's friends. This device is a tube used in connection with radio receivers. It is heated directly from the alternating current line. It has no filament, as we know that word, thereby insuring an indefinite life, as there is nothing to burn out. No hum is produced when this tube is used, regardless of circuit, no matter if it is used as a detector or an amplifier, his friends say. A 2-tube set employing these tubes can be made to work as loud as an ordinary 4-tube receiver, they insist.

The idea for the making of a tube of this character was obtained from Dr. Lucian's long association with X-Ray tubes.

The so-called filament is a thimble of metal and not of the wire type commonly used in the present day tubes. This thimble has a special construction, which enables it to hold the electron emission coating. Barium and strontium oxides are used as the emitting substance. These substances give off the electrons at a low temperature. The heater inside of the thimble consists of turns of wire wound inductively or non-inductively. It does not make any difference which way the heater is wound, as it is completely encased within the solid metal. In this manner, no alternating current hum is

heard. This heater can be removed and another put in its place. This is due to the fact that it is not in the vacuum.

The grid is of a helical spiral shape, while the plate is of the ordinary shape. These are placed over one another in the same manner that is done in the present day tube. The leads from the cathode, plate and grid are brought out at the bottom of the tube in the manner as with all the receiving tubes. Therefore a regular sized base is used. This allows the tube to be inserted into the socket, which all have in these receivers are present. Heat is transmitted from the heater to the cathode, by means of conduction, convection and radiation. A copper radiator, situated near the heater, prevents the heat from breaking the glass, that is, the heat is dissipated before it reaches the seal, which holds the metal glass seal and which acts as heat reservoir. The tube just described is one of two models.

Dr. Lucian's other tube contains the same features as that of the tube just described, but in an order just the opposite. The heater is placed on the outside of the cathode and also outside of the vacuum as in the other tube. The plate is the center element and goes pretty far down into the vacuum of the tube. The helical grid is placed over the plate and extends to nearly the top of the surface coated with the electron emitting substance. These are mounted in a very rigid manner to prevent microphonic noises. An insulator serves as a mounting for the grid and the plate. The leads for the heater are brought out through the top of the tube, which has a porcelain insulating cap. A porcelain block also surrounds the heater, grid and plate.

## Dashing Vagabond



HAVING SUNG before microphones in stations from Coast to Coast, fetching June Lee is well entitled to her sobriquet, "Singing Vagabond of the Air." She made her radio debut four years ago. For the past year and a half she has been a regular radio performer. She is now in New York.

## Nine Cities Contribute to Novel WGY Program

An unprecedented demonstration of remote control broadcasting was made by WGY February 20, when the Schenectady station transmitted a program originating in nine cities. This program was broadcast on 50 kilowatts, ten times the normal power of WGY, and marked the fourth anniversary of the station.

For periods of fifteen minutes WGY sent out music from each of the following cities: New York, Cleveland, Poughkeepsie, Albany, Schenectady, Syracuse, Rochester, Buffalo and probably, Washington. Stations assisting were WJZ, WFBL, WTAM, WHAM, WMAK, and WRC.

Twenty-five persons, including announcers, line amplifier operators and control room and power house operators, were necessary to get the program on the air. The wire system covers a distance of 946 miles.

In addition to special musical features from the various cities in the chain WGY offered a few features that gained favor with its audience over the four year period of its existence. The WGY Players presented a one-act play; the Radio Four and the WGY Orchestra had a period each; Rose Mountain, contralto, and Ellsworth Page, bass, were heard and finally the Georgia Minstrel Boys. Among other features on the program were Charles Gilbert Spross, pianist-composer, the Eastman Theatre Orchestra, the Lennox String Quartet, Dr. Frank Sill Rogers, organist and dance music from Syracuse.

# Radio University

**A QUESTION and Answer**  
Department conducted by  
**RADIO WORLD** for its Read-  
ers by its staff of Experts.  
Address Radio University,  
**RADIO WORLD**, 145 West  
45th St., N. Y. C.

**I WOULD** like to have an electrical diagram of a 4-tube receiver, in which toroid coils are employed as radio-frequency transformers, a crystal as a detector, the RF stages being non-regenerative. Transformer coupled AF amplification should be used. The three condensers, which shunt the secondaries, should have a capacity of .000375 and be controlled by one dial.—R. Christ, 500 East 163rd St., N. Y. City.

Fig. 269 shows the electrical diagram of a receiver of that type. R1 has a resistance of 10 ohms with a carrying capacity of ½ ampere. R2 is of the same type. S is the filament control switch.

\* \* \*

**I HAVE** the following parts with which I wish to construct a 3-tube 3-circuit away from my 3-tube receiver and expect

good volume? At present, I am using two speakers on the set and the volume is very good.—Karl Simdquist, 1467 Palmer Boulevard, Muskegon, Mich.

You will have to use two more stages of audio-frequency amplification to get the same strength that you are now getting. The stages of audio-frequency amplification will have to employ low ratio type transformers and power tubes. At least 225 volts of B battery should be placed on the plate of the power tubes. Use No. 18 bell of annunciator wire to carry the output leads from this amplifier to the loud speaker.

\* \* \*

**I AM** going to build the Diamond of the Air with the loop jack. (1)—Will this set bring in distant stations, when the loop is used? (2)—Should the 200 or the

Capt. Peter V. O'Rourke, can .0005 mfd. variable condensers be employed? If so, how many turns should be placed on the forms?—Miss Gwen S. Hart, 1000 West Genesee St., Syracuse, N. Y.

These condensers may be used. The primary, L1, consists of 10 turns. The secondary, L2, consists of 52 turns. A form 3¼" in diameter and 4 or 4½" high should be used to wind these coils. No. 24 double cotton covered wire is to be used to wind the coils. The secondary is tapped at the 11th turn and again at the 28th turn.

\* \* \*

**WHERE CAN** I get information regarding the learning of all that is necessary to procure an Amateur Operator's License?—Leo Berkowitz, 148 Ave. C, N. Y. City.

See the June 27 issue of RADIO WORLD.

\* \* \*

**I HAVE** a 5-tube Neutrodyne, which I wish to rebuild into the 5-tube tuned radio-frequency receiver, which appeared in the Radio University columns of the

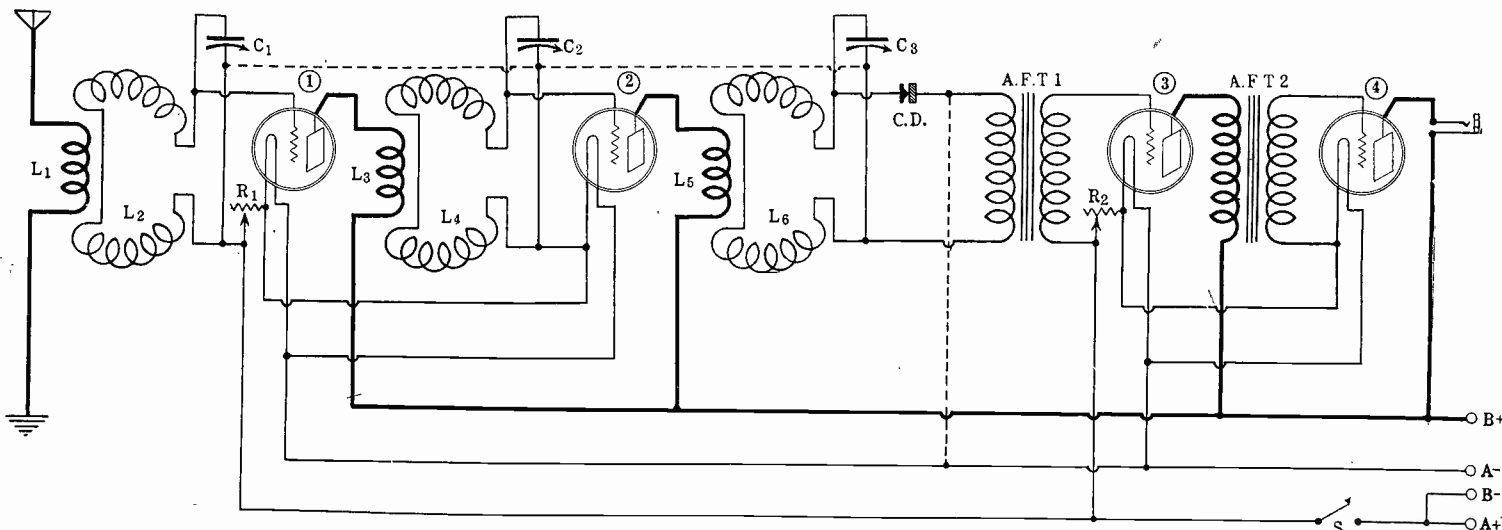

FIG. 269, shows the electrical diagram of a 4-tube toroid receiver.

tuner receiver: One .0005 mfd. variable condenser, one .00025 mfd. variable condenser, one 7x21" panel and cabinet, two Acme A-2 AFT, one 20-ohm rheostat, one 10-ohm rheostat, three Federal sockets, two Federal double circuit jacks, and one grid leak and condenser. Now did RADIO WORLD ever publish a receiver containing all these parts? I realize that I will have to purchase a 3-circuit tuner.—Anthony Cortese, 2363 Prospect Ave., Bx., N. Y. City.

A receiver containing nearly all of this material appeared in the Oct. 10 issue. The .00025 mfd. variable condenser would not be needed.

\* \* \*

**IS IT** possible to cure a 3-tube 3-circuit tuner set from receiving harmonics? (2)—What wires should be kept apart when wiring up a receiver?—Edwin Cassidy, 496 12th Ave., Astoria, Long Island City, N. Y. City.

(1)—No. This is due to the transmitting station. (2)—The grid and the plate wires should be kept away from each other or at right angles to each other.

\* \* \*

**I AM** thinking of constructing a 3-tube reflexed Roberts or a 4-tube Browning-Drake. Which is the better of the two for all around use? (2)—Which of these sets operates best with dry cell tubes, the Karas variable condensers and AFT being used? (3)—May the Sickles coils be used in either case?—R. L. Fary, Ordinary, Va.

(1)—They are both good receivers. For simplicity, avoid reflexing. (2)—Both operate equally well on dry cell tubes. (3)—Yes.

\* \* \*

**CAN I** place a loud speaker a block

201A tube be used as a detector tube?—Daniel Juwrat, St. Louis, Mo.

(1)—Stations within a range of 500 miles ought to be heard in a loop, provided your location is O.K. (2)—201A.

\* \* \*

**I WISH** to build the 4-tube Handsome Portable described by Herbert Hayden in the July 4 issue of RADIO WORLD. However before doing so I would like to get some things, which are puzzling me, straightened out. As the Handsome set apparently has three stages of radio-frequency amplification, is it more powerful than the 1925 Model Diamond of the Air using 299 type tubes? (2)—Can I use a Bruno RF coil to match the 3-circuit tuner, so that an outside antenna could be used, instead of the loop? (3)—What are the capacities of C3, of C4, of C5, and of C6? (4)—Would it be all right to use two Rauland-Lyric audio-frequency transformers in this set. (5)—How many feet of wire should be wound on a frame, the size of which would also be appreciated to make a loop, if the same were to be used? (6)—Would it be all right to use .0005 mfd. variable condensers made by the General Radio Co.?—F. L. Hutchins, Stratton, Me.

(1)—No. (2)—Yes. (3)—C3 is a .001 mfd. fixed condenser. C4 is a .00025 mfd. fixed condenser. C5 is a .001 mfd. fixed condenser. C6 is also a .001 mfd. fixed condenser. (4)—Yes. (5)—You will have to have 84 feet of No. 20 double cotton covered wire. The frame should be 2 feet square. (6)—Yes.

\* \* \*

**IN REFERENCE** to the 3-Tube Dry Cell Receiver, which appeared in the Nov. 7 issue of RADIO WORLD, described by

Feb. 6 issue. The RFT used in my receiver are wound thus: primary with 15 turns and the secondary with 64 turns. These are wound on bakelite forms 3¼" in diameter, with the primary winding on the same type of a form 2¼" in diameter, placed inside of the secondary winding. Signal condensers, having a capacity of .000375 mfd., shunt the secondaries. (1)—Can I use these same coils in the TRFT set of the Feb. 6 issue? (2)—Do any of the terminals on these coils have to be changed, with the exception of the taps? (3)—Do the coils have to be placed on any special angle? (4)—To what post of the AFT does the C minus go and to what post of the A battery does the A plus go?—H. G. Raveling, Warren, Minn.

(1)—Yes, the primaries should be reduced to about 10 turns. (2)—No. The tap terminal can just be left alone. (3)—Yes. Place the antenna RFT, L1L2, at right angles to the second RFT, L3L4, while the detector coupling coil is placed out of the field of both the coils. There should be a 6" separation between the coils. (4)—The C minus post goes to the F minus posts of the AFT. The C plus battery goes to the A minus post.

\* \* \*

**WHY IS** it that when I touch my receiver a metallic sound results? (2)—What value rheostat should be used for one 99 type tube? (3)—What value rheostat should be used for two 99 type tubes? (4)—What value rheostat should be used when three 99 type tubes are used. (5)—What value rheostat should be used when four 99 type tubes are used? The source of voltage is 4½ in all cases. (6)—What value rheostat should be used when one —01A type tube

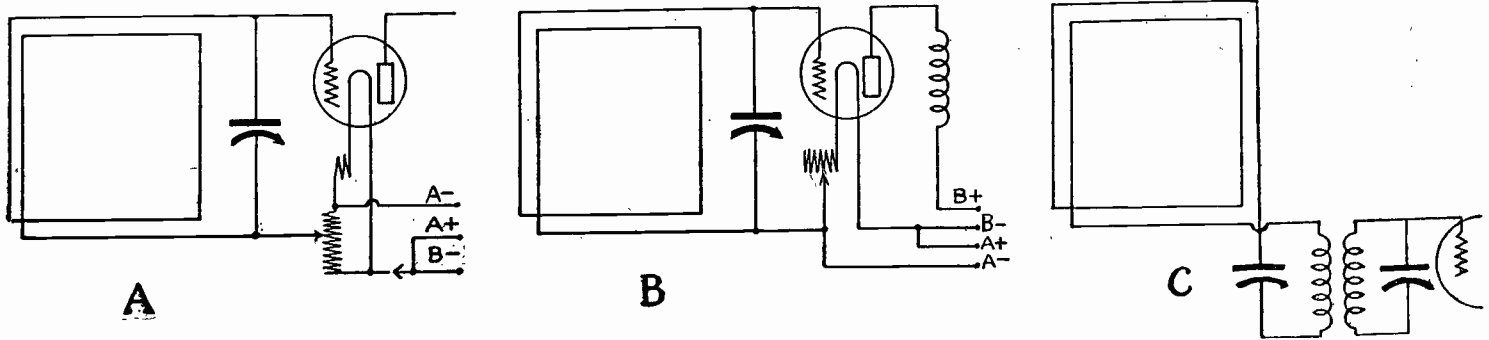

FIG. 270, showing the three methods of connecting up a loop.

is used? (7)—What value rheostat should be used when two —01A type tubes are used? (8)—What value rheostat should be used when three —01A tubes are used? The source of voltage is 6.2 for these tubes. (9)—Is it advisable to use a separate rheostat for the detector in any receiver?—M. Soutainar, East Providence, R. I.

(1)—Your tubes are microphonic. Mount the sockets on rubber cushions. Place the set itself on rubber cushions. Change tubes about. (2)—A 25-ohm rheostat. (3)—A 15-ohm rheostat. (4 and 5)—6 ohms. (6)—20 ohms. (7)—10 ohms. (8)—6 ohms. (9)—No.

\*\*\*

**GIVE THREE** diagrams which will demonstrate the three methods of connecting up a loop to obtain direction effect and explain each.—G. Clantes, Newark, N. J.

Fig. 270, A, B and C, show these diagrams. A and B represent the same method, whereby a loop may be connected, which method is the most efficient. In A, a potentiometer is used to stabilize the tube, to which the loop is connected. In B, a rheostat is used to control the oscillatory action of the tube. The loop as connected in C, is a very inefficient method and is shown by way of comparison. Here instead of the condenser, itself, being shunted across the loop, the primary of a tuned RFT is also shunted across the same. Using this method the loop acts as a simple antenna, the directional effects of which are poor. The directional effects of the loop, connected as in A and B, are very good.

**INFORMATION REGARDING** the 1-Dial 5-tube receiver which appeared in the Jan. 9 issue of RADIO WORLD is desired. (1)—I have an 180° variocoupler. The stationary form is 3 3/4" in diameter and 3 1/2" high. How many turns should be wound on the forms to constitute the primary and the secondary windings, L1 and L2? A condenser with each side having a capacity of .000375 mfd. capacity is to be employed. (2)—I wish to use a form 3" in diameter and 4" high to wind the primary and the secondary of the second RFT, L3 and L4. How many turns should be placed here? (3)—Will great volume be obtained with this set, when the 199 type tubes are used? (4)—Is a great range obtainable when the 199 type tube is used? (5)—I wish to use two steps of transformer coupled audio-frequency amplification, instead of three steps of resistance coupled. Therefore, I would like to get the dope on wiring up this portion of the receiver. A C battery should be included. (6)—What plate voltage should be applied, using the —01A type tubes? (7)—Will I be able to hear distant stations with this set, using the —01A type tubes?—J. Gramercy, Haleville, Ala.

(1)—The primary, L1, consists of 10 turns. The secondary, L2, consists of 55 turns. (2)—The primary, L3, consists of 10 turns. The secondary, L4, consists of 50 turns. (3 and 4)—The volume and DX obtained will not be great. (5)—Both

transformers should be of the low ratio type. The P post of the first audio-frequency transformer goes to the plate post of the second tube. The B+ post goes to the B+ Det. post. The G post on this AFT goes to the G post of the third socket. The F— post goes to the C— post. The P post on the second AFT goes to the P post on the third socket. The B+ post goes to the B+ AF Amp. post. The G post on this AFT goes to the G post on the fourth socket. The F— post goes to the C— post. This means that the C— posts go together. The plus post of the C battery goes to the A minus post. The P post on the fourth and last socket goes to the top terminal of a single circuit jack. The bottom terminal of this jack goes to the B+ AF Amp. posts. The filament circuits of the 2 amplifier and the detector tubes remain the same. That is, the minus posts of all these three sockets go to a terminal of the 3/4 ampere ballast resistor, while the other terminal of this resistor goes to the A minus posts. The plus posts of all these sockets connect together. (6)—At least 90 volts should be applied to the plates of the two amplifier tubes. The C battery should have a voltage of 4.5. (7)—Yes.

\*\*\*

**I BUILT** the 1926 Model Diamond of the Air and for a while the set worked great. Recently the volume died out. I cannot use the amplifier stages at all. When I place my finger on any one of the four binding posts of the AFT a loud squeal is heard. There are no loose connections. How can I remedy this trouble?—Norman Ellis, Raymond Ave., Roosevelt, Long Island, N. Y.

Test the primary and the secondary windings of the audio-frequency transformer for an open or short circuit with a pair of phones and a 1 1/2-volt battery. Also test the fixed resistors in the plate and grid audio circuits, as these may have gone bad. Of course be sure your tubes are O.K.

\*\*\*

**I HAVE** a 1925 Model Diamond of the Air and the results are fine. However, the tuning is too sharp. Is there any method that could be employed whereby the tuning could be broadened?—Jack Eddorts, Middle Valley, N. J.

Add five turns to the primary in the aerial circuit.

**ARE TWO** stages of tuned radio-frequency amplification with a non-regenerative detector better as to volume and distant reception, than one stage of tuned radio-frequency amplification with a regenerative detector?—Sydney McGraham, Falso, Ala.

No.

\*\*\*

**PLEASE STATE** the number of turns that should be placed on a form 3" in diameter to constitute the primary and secondary windings of a radio-frequency transformer to be used in a Neutrodyne, with .000375 mfd. variable condensers shunting the same. (2)—I would like to know the number of turns that should be placed on a form 2 1/4" in diameter, to

make a toroid RFT to be used in the same type of receiver, with .00037 mfd. variable condensers shunting the secondaries. No. 22 double cotton covered wire is to be used in both cases.—E. J. Pratt, 1449 Yelage St., Montreal, Canada.

(1)—The primaries consist of 10 turns. The secondaries consist of 57 turns. (2)—The primaries consist of 20 turns. The secondaries consist of 215 turns.

\*\*\*

**IS THE** 1926 Model Diamond of the Air as good as the 5-tube Neutrodyne in all respects? (2)—Where can the kit for this set be bought? (3)—Where can the blue print and definite instructions as to the building of the Diamond be obtained?—O. Moser, 1304 Washington St., Hoboken, N. J.

(1)—They are about equal, except that the Diamond audio aims at better quality. (2)—See the advertising columns of this issue. (3)—See Columbia Print advertisement in this issue.

\*\*\*

**WHAT THREE** types of radio receivers are there using a crystal or a tube as a detector?

All the types of receivers are classified according to the manner in which the primary and the secondary circuits are coupled. The types most commonly used are the inductive and conductive coupling. In the conductively coupled set (1), the radio-frequency currents being caught are transferred from the antenna to the detector circuit by direct physical wired contact. This type of receiver provides very broad tuning and is therefore limited as to selectivity. In an inductively-coupled receiver (2) the radio-frequency currents are generated in the antenna circuit. The antenna, primary of the coil, etc., act inductively upon the secondary, which is tuned to resonance with the antenna circuit by a variable condenser, or which secondary is variable and uses a condenser as a minute adjuster. This set is very selective, due to the fact, that the coupling between the antenna and the detector circuits may be varied from zero to maximum. In the capacity coupled receivers (3), the incoming radio-frequency currents are transferred from the antenna circuit to the detector circuit, through the means of an electrostatic field.

\*\*\*

**WHAT HAPPENS** when a radio-frequency wave train strikes the antenna of a 1-tube receiver?

When the antenna is struck by a radio-frequency wave train, a radio-frequency current is generated. This is transferred, by either of the methods, described in the Three Types of Receiving Circuits, to the secondary or detector circuit. The incoming radio-frequency currents are changed to uni-directional pulsating currents. It is these currents, which actuate the diaphragm of the telephone receiver.

\*\*\*

**CAN** Uncle Sam coils be employed in the 1926 Model Diamond of the Air? (2)—Is a .25 mfd. fixed condenser the

(Continued on page 26)

A THOUGHT FOR THE WEEK  
Congress may come and Congress may go  
—making new laws about radio—but the  
ether goes on forever.

# RADIO WORLD



Radio World's Slogan: "A radio set for every home."

TELEPHONES BRYANT 0558, 0559  
PUBLISHED EVERY WEDNESDAY  
(Dated Saturday of same week)  
FROM PUBLICATION OFFICE  
HENNESSY RADIO PUBLICATION CORPORATION  
145 WEST 45th STREET, NEW YORK, N. Y.  
(Just East of Broadway)  
ROLAND BURKE HENNESSY, President  
M. B. HENNESSY, Vice-President  
FRED S. CLARK, Secretary and Manager  
European Representatives: The International News Co.  
Breems Bldgs., Chancery Lane, London, Eng.  
Paris, France: Brentano's, 38 Avenue de l'Opera  
San Francisco: Lloyd B. Chappell, 656 O'Farrell St.

EDITOR, Roland Burke Hennessy  
MANAGING EDITOR, Herman Bernard  
TECHNICAL EDITOR, Lewis Winner  
CONTRIBUTING EDITOR, John F. Rider

### SUBSCRIPTION RATES

Fifteen cents a copy. \$6.00 a year. \$3.00 for six months. \$1.50 for three months. Add \$1.00 a year extra for foreign postage. Canada, 50 cents.  
Receipt by new subscribers of the first copy of RADIO WORLD mailed to them after sending in their order is automatic acknowledgment of their subscription order. Changes of address should be received at this office two weeks before date of publication. Always give old address

### ADVERTISING RATES

General Advertising

1 Page, 7 1/4" x 11"	462 lines	\$300.00
1/2 Page, 7 1/4" x 5 1/2"	231 lines	150.00
1/2 Page, 8 1/4" D. C.	231 lines	150.00
1/4 Page, 4 1/2" D. C.	115 lines	75.00
1 Column, 2 1/4" x 11"	154 lines	100.00
1 Inch		10.00
Per Agate Line		.75

Times Discount

52 consecutive issues	20%
26 times consecutively or E. O. W. one year	15%
4 consecutive issues	10%

WEEKLY, dated each Saturday, published Wednesday. Advertising forms close Tuesday, eleven days in advance of date of issue.

### CLASSIFIED ADVERTISEMENTS

Ten cents per word. Minimum 10 words. Cash with order. Business Opportunities ten cents per word, \$1.00 minimum.

Entered as second-class matter, March 23, 1922, at the Post Office at New York, N. Y., under the act of March 3, 1879.

FEBRUARY 27, 1926

## SUSPICIOUS



WIFE: "Who is this girl you talk so much about in your sleep?"  
HUSBAND: "Why - er - dear - I don't—"  
WIFE: "Yes you do! Her name is Elsie Ratio!"

# Symphony Concerts Are In High Favor

SYMPHONY concerts are the first choice of balloters in RADIO WORLD's program canvas, so far as it has progressed. This preference is pronounced. As voters are asked to cite the program features in the order of preference, a tally was made of the first choice of all who balloted during a given week, and this showed a preference for symphonic concerts. Instrumental trios were next in line, but twice as many favored symphonic music for first place.

The object of the canvas is to determine what radio listeners like best. The result will be laid before several important broadcasting stations and it quite likely that programs will be arranged on the basis of this registered choice, so that voting has a practical application, as it is a means to obtaining what you want.

### Preference Is Controlling

What a man likes or woman likes best is independent of what is actually heard from stations tuned in most frequently, as it depends on personal preference and taste, hence the result of the canvas will be truly representative. While some persons, for instance, may like jazz, they may be getting too much of it from the stations that they listen to most. This is not in derogation of their enjoyment of jazz, but a complaint against the stations. It is very difficult indeed to give human beings too much of what they enjoy most of all among the variety of entertainment that can be offered.

Many programs are makeshifts, especially with small stations that have no budget to support paid talent, nor any advertising revenue commensurate with the expense of giving programs of the highest type, day after day, night after night. This is a question involving rather the restriction of the number of stations than the improvement of the type of programs, since a station that simply can not offer anything worth while, or that must resort continuously to mediocrity to be able to broadcast anything, has no excuse for existence.

### Cast Ballot Now

Readers should cast their ballots with-

out delay, as the canvas is progressing rapidly and it will soon it will be time to render a decisive report. Of course, it will be impossible to approximate unanimity on anything, and it must be expected that wide divergence of taste will occasion conflicting preferences, yet there should be sufficient outstanding data.

In line with this expected variety first choice is registered by about an equal number for such listed items as organ recital, instrumental duet, short comedy play, vocal quartette, classical vocal solo, jazz orchestra, grand opera, football game and classical instrumental solo. Some balloters wrote in the as their preference old-time music, not listed in previous ballot blanks, but included this week. On the subject of talks, some liked travel while more preferred to hear radio engineers discuss how to improve reception.

Quite a few registered an emphatic no—by using capital letters or underscoring—on the subject of after-dinner talks, while almost as many voted against jazz. Only a few placed jazz first, and all of these insisted that the orchestra must be a good one.

### A Few of the Many

Some of those who voted, and whose names were not previously published, were W. C. Wolverton, M.D., Wolverton Hospital, Linton, N. D.; Merritt Oberholtzer, Box 195, Mifflintown, Pa.; F. W. Palmer, East Sumner, Maine; A. E. Leavitt, Harriman, Tenn.; Albert Walker, 2832 N. Swanson St., Philadelphia, Pa.; T. Fogar, 1143 S. Madison St., Indianapolis, Ind.; Lew C. Smith, 1722 Exposition Blvd., Los Angeles, Calif.; W. A. Jones, Arlington Hotel, Hot Springs, Ark.; Geo. A. Wright, 515 Stevens Ave., Portland, Maine; E. S. Frost, 437 N. Townsend St., Los Angeles, Cal.; Walter W. Meinzen, 1304 S. Anthony Blvd., Fort Wayne, Ind.; F. T. Mapes, 230 Forrest Ave., Muskegon Mich.; Elton Weiler, R. 2, Tremont, O.;

Here is the ballot. Fill it out to-day and mail it to the Program Editor:

Program Editor, RADIO WORLD, 145 West 45th Street, New York City:

My preference for entertainment and instruction on the radio is as follows, the numbers next to the listed items representing the order of preference:

- |                      |                           |                     |
|----------------------|---------------------------|---------------------|
| Grand opera.....     | Ringside                  | Football game.....  |
| Jazz Orchestra.....  | boxing report.....        | Hockey match.....   |
| Talk .....           | Classical instru-         | Recitation .....    |
| State subject        | mental solo.....          | Musical comedy      |
| of talk here.....    | State kind here.....      | (stage) .....       |
| Classical vocal      | Jazz songs                | Short play          |
| solo .....           | vocal .....               | (drama) .....       |
| State kind here..... | Waltz (orchestral).....   | Short play          |
| Musical saw.....     | Symphony concert.....     | (comedy) .....      |
| Vocal duet.....      | Instrumental duet.....    | Banquets, with      |
| Vocal trio.....      | Instrumental trio.....    | speeches .....      |
| Vocal quartet.....   | Instrumental quartet..... | Sermons .....       |
| Old-time music.....  | Brass quartet.....        | Market reports      |
| Q. & A. on           | Bedtime story.....        | Weather report..... |
| world topics.....    | Baseball game.....        | Organ recital.....  |

If you particularly dislike any of the above listed offerings, write "No" on the dotted line.

Other offerings (not listed above).....

Remarks (if any).....

Fill out and  
mail this  
coupon today!

Name .....

Address .....

City..... State.....

# Tubes for the Diamond

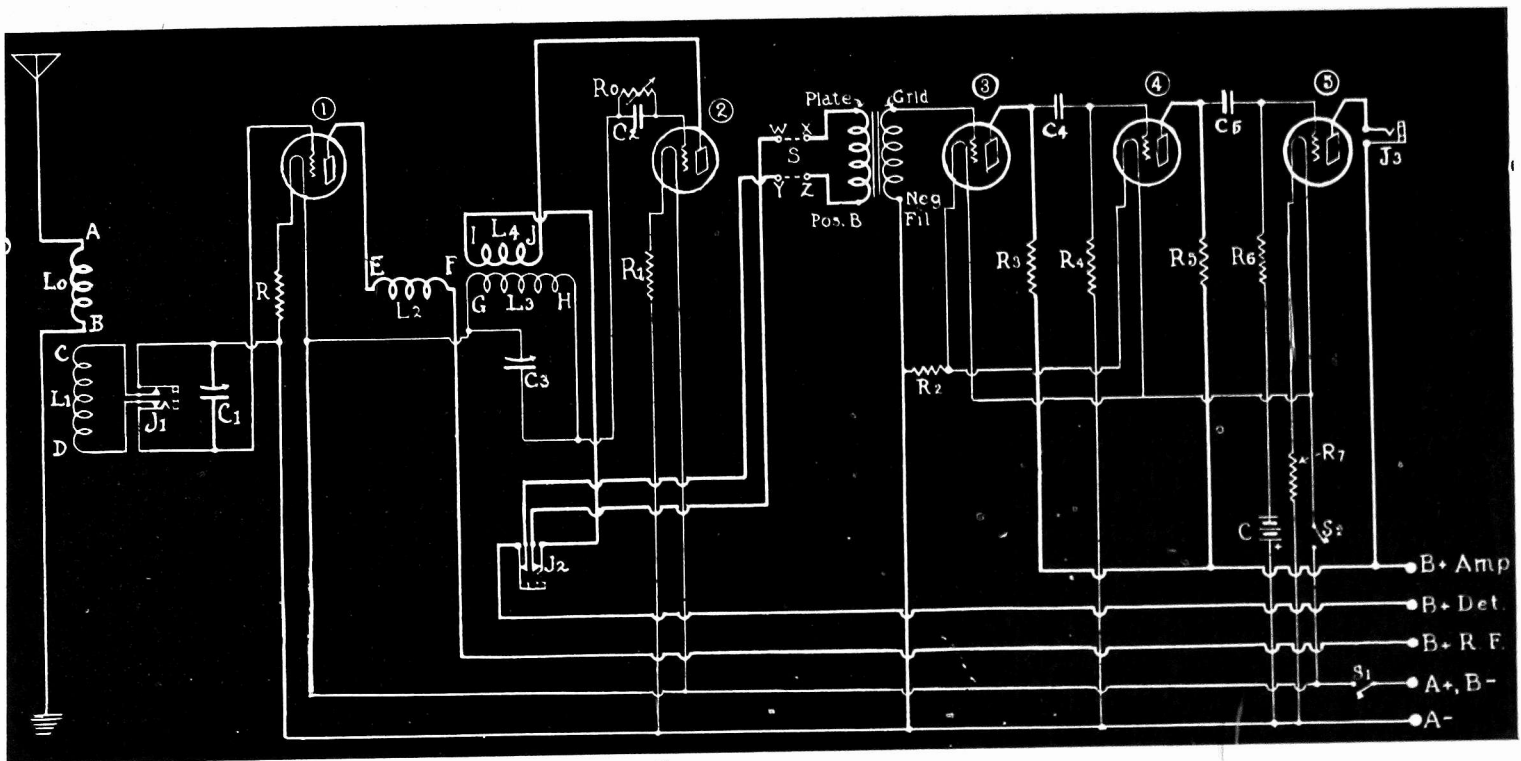

THE CIRCUIT DIAGRAM OF RADIO WORLD'S 1926 Model 1 Diamond of the Air. The construction of this set is fully described in a booklet written by Herman Bernard.

*By Herman Bernard*

Associate, Institute of Radio Engineers

THE 1926 Model Diamond of the Air, employing five tubes, operates very efficiently if the tubes are of the -01A type throughout. If dry cell tubes must be used they should be of the -99 type. A little less volume will result, but still it will be adequate. Where dry cell tubes are used it is particularly advisable to use the power tube of this class in the last stage. This is the 120. The reason is that the -99 type of tube is more easily overloaded, and this causes distortion, hence the power tube, which draws .12 ampere at the filament, at 3½ volts, is advisable. There is virtually no sacrifice on the radio side, as the -99 is a good RF amplifier and detector. However, the overall results from the use of the -01A tubes throughout, as compared with the -99 type, are better.

One of the reasons is that the audio channel includes two resistance-coupled stages and the larger element tubes are

better equipped for service in this direction. If the 5-volt tubes are used throughout and still greater volume is deemed preferable, high mu tubes may be used in sockets (3) and (4). These are the first and second audio tubes. In any case a power tube may be used in the last stage to handle the heaviest load with ease. Blasting of signals would be averted, even on strong notes.

The circuit is so designed that it is easy to incorporate a power tube. Some of the bulbs in this class require only 5 volts at the filament, like the 112, which, however, draws .5 ampere at the filament at that voltage, instead of the conventional .25 ampere of the -01A tubes. The power tubes that are generally designated low mu most commonly operate best at 6 volts on the filament, and also draw .5 ampere, and with this model all that is necessary is to short-circuit the No. 1A Amperite, R6, or omit it. For the 112 tube, instead of the No. 1A Amperite for R6 use the No. 112 Amperite, as this passes the necessary .5 ampere.

## U. S. Itself to Exhibit At N. Y. Show

The sixth annual Radio Show and Convention which the Executive Radio Council of the Second District will hold at the Hotel Pennsylvania the week of March 8 has been officially recognized by two branches of the United States Government, the Signal Corps of the U. S. Army and the Department of Commerce, announces George T. Droste, general manager of the affair.

The Signal Corps will maintain a large booth at the show, and will exhibit the latest apparatus developed by the Army for radio communication. Of particular interest will be the special short wave transmitter constructed for use at Governor's Island in the Army's amateur network system.

The Department of Commerce, which is the branch of the Federal Government charged with the administration of the radio laws, will have a separate room in the hotel where the members of the New York Custom House staff, under Mr. Arthur Batcheller, Supervisor of Radio for the Second District, will hold examinations for radio licenses and also supervise the various code speed contests. The world's champion radio operator will be determined by one of these competitions.

The amateur shows conducted yearly at the Hotel Pennsylvania are the only ones held in New York that are officially acknowledged by the Department of Commerce, and the only ones in which the Department participates, says Mr. Droste. They provide the government offices their only opportunity during the year for personal contact with the radio public whose interests they safeguard.

## How to Tell Amperage of Connected Dry Cells

If we connect a battery of two dry cells, each cell having a voltage of 1.5 and an internal resistance of 0.3 ohms, each battery will have a voltage of 3 and internal resistance of 0.6 ohms. If, however, the external resistance in the circuit is 0.2 ohms and a current of 5 amperes is to be established, how is the latter to be obtained?

$I \text{ equals } \frac{E}{R}$  or,  $I \text{ equals } \frac{3}{0.2+0.6}$  equals 3.75 amperes.

It is seen, though, that this is not the current that we desire to obtain. Therefore, two batteries in series are tried:

$I \text{ equals } \frac{6}{0.2+1.2}$  equals 4.28 amperes.

$\frac{0.2+1.2}{2}$

Even though the voltage has been doubled, the current is too small, so we try three batteries in series:

$I \text{ equals } \frac{9}{0.2+1.8}$  equals 4.5 amperes.

$\frac{0.2+1.8}{2}$

Here, even though the voltage was increased three times the original value, the current still remained too low. Therefore, we allow the voltage of the two batteries to remain and place them in parallel, which gives us this result:

$I \text{ equals } \frac{3}{0.2+0.6}$  equals 6 amperes.

$\frac{0.2+0.6}{2}$

$\frac{1}{2}$

# Dah—Dit—Dah—Dit—Dah!

By Irving Philip Wolfe

ZAPJ

3 LF, operated by R. P. Turner, a commercial radio "op," is now on the air with a 10-watt transmitter on 80 and 20 meters. He is using B battery plate supply.

\* \* \*

3 CKG, D. Basim, got that license he talked so mysteriously about. No, not a new station license, but a marriage license.

\* \* \*

2 AAU, Theron MacDowell, is now connected with the J. H. Bunnell Co. He was with the Manhattan Elec. Co., but decided to cross the street, hi!

\* \* \*

Chas. W. Hoff, L Box 203, Clinton, N. Y., is now on 40 meters. His call is 8 CGW.

\* \* \*

Worked 5 UK the other night and he reported my sigs very steady. He has a pure DC note and, believe me, it sure was necessary with all the QRM floating around that night. It seemed as if the entire 15,000 hams in the country and all the foreigners in eternity parked on his wave and then "sat on the key." But even with all the QRM I was able to get him.

\* \* \*

(Send all new QRAs, calls heard, news and queries to Irving P. Wolfe, Amateur Editor, Radio World, 145 West 45th St., New York City, or call 2 APJ on the air, 40 or 150 meters.)

## CLAROSTAT



is the most accurate variable resistance ever placed on the market. It has a continuously variable resistance ranging from practically zero to five million ohms—and all this without a single abrupt step! \$2.25

American Mechanical Laboratories, Inc.  
285 N. 6th St. Brooklyn, N. Y.

## VICTOREEN Super Heterodyne

Build the Right Set

COAST TO COAST-ON-A-LOOP

No Oscillations, Howls or Squeals

No Matching of Tubes

Range-Clarity-Selectivity-

Ease of Operation

KIT—  
COMPLETE PARTS—  
SPECIAL \$64.00

Including the Same Parts as Described in This and Other Issues of Radio World.

A demonstration will convince you. Tubes, batteries, cabinet and aerial, of course, not included. Packed, ready for you anywhere, with blue print instructions for connecting up.

Orders shipped same day as received.

JOHN C. RAU

522-524 12th St., N. W., WASH., D. C.



### RESULTS EDITOR:

Due to the fact that the 1926 Model Diamond of the Air has proven to be a receiver of unusual merit, at the request of Lieut. L. W. Gumz, U. S. N., Executive Officer, U.S.S. Reina Mercedes, Annapolis, Md., three more kits were ordered.

Mr. A. Knackstadt of the Department of Electrical Engineering and Physics, Naval Academy, Annapolis, Md., is also ordering a kit.

CHIEF GUNNER J. A. FEATHERSTON,

U. S. Naval Academy,

Dept. Electrical Engineering and Physics, Annapolis, Md.

1926 DIAMOND OF THE AIR BOOKLET with full instructions to make the Diamond, with blue print, 50c. Newsdealers and radio dealers can get supply from American News Co. and its branches. RADIO WORLD, 145 W. 45th St., N. Y. C.

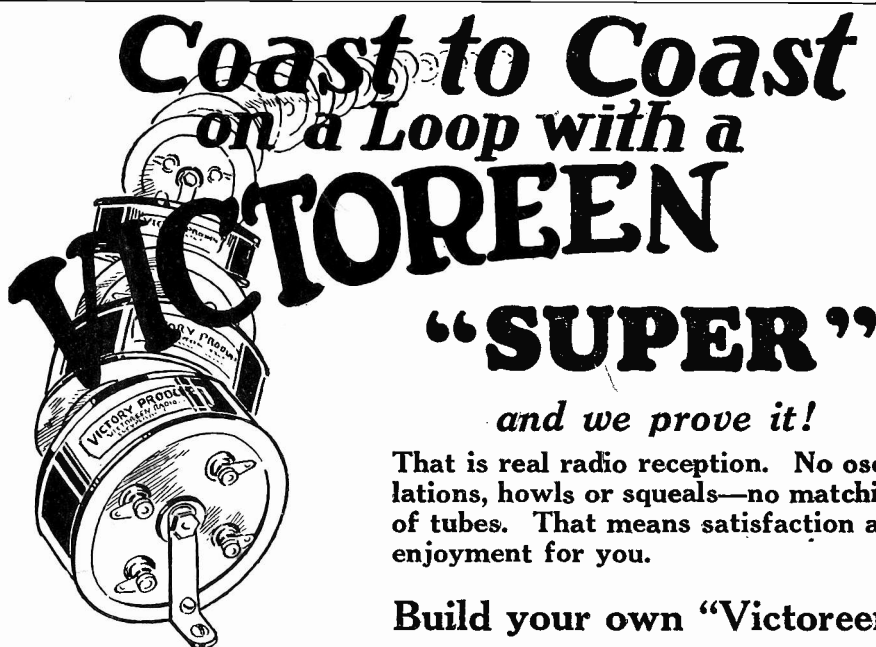

## "SUPER"

and we prove it!

That is real radio reception. No oscillations, howls or squeals—no matching of tubes. That means satisfaction and enjoyment for you.

### Build your own "Victoreen"

You can secure complete parts to build the "Victoreen" from your dealer at moderate cost.

Victoreen Air Core Transformers are more than matched—they are actually tuned to guaranteed precision of 1/3 of 1%—a Victoreen feature.

Either UV 199 or 201A tubes may be used—another Victoreen feature.

"B" Battery consumption is remarkably low—8-10 Milliamps, with Potentiometer at negative side—less than some three tube sets consume.

Range—clarity—volume—selectivity—ease of operation—that's what you get in a Victoreen Super Heterodyne.

### The Heart of the circuit

4 No. 170 R.F.  
Transformers at  
\$7.00 each.

1 No. 150 Coupling  
Unit at \$5.50.

Should use of aerial be preferred to loop, the Victoreen No. 160 Antenna Coupler is required at \$3.50 extra.

Ask your dealer for a free folder and hook-up of the Victoreen set or write directly to us. Your dealer can supply you with all necessary parts.

## The George W. Walker Co.

Branches in Principal Cities

6515 Carnegie Avenue

Cleveland, Ohio



# WGY Four Years Old; Keeps Apace of Progress

WGY, the radio broadcasting station with the 50,000 watt voice, celebrated its fourth birthday. In four years these call letters have found their way into many countries and languages. The call is that of the station of the General Electric Company at Schenectady, N. Y.

When WGY first went on the air it had a 1,000 watt voice. Today it is licensed to speak regularly with 5,000 watts power and on Saturday and Sunday the station may express itself with ten times greater power or super-power. Further, WGY sometimes speaks with four different voices simultaneously for its words and music may be picked up on 41 meters, 109 meters, 1,560 meters and 379.5 meters.

### "Up to Snuff"

Many advances have been made in the science of radio but WGY has never lagged behind, in fact it has generally been in the van so far as transmission was concerned. It is through the Schenectady station that the experiments of the great developmental station at South Schenectady have been carried on. It was WGY that broadcast for the first time in this or any other country, on 50,000 watts; it was WGY that conducted a series of experiments using alternating horizontal and vertical radiation; it was WGY that perfected successful 250-mile radio relay on 1560 meters wavelength.

### RESULTS EDITOR:

We have built the 1926 Model Diamond of the Air and are more than pleased with it. To date we have received more than 141 stations, including WKOQ, Porto Rico; PWX, Havana; KFI, Los Angeles; KGO, Oakland; KNX, Hollywood; KHJ, Los Angeles; WBZ, Springfield, and WJAX, Jacksonville. GORDON BENDSCHRUDU and FATHER, 911 S. Mason St., Bloomington, Ill.

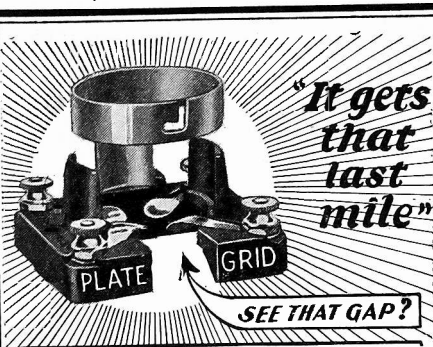

## The AIRGAP SOCKET

used in the  
**FENWAY**

Mr. Leo Fenway, designer and builder of the Fenway Superhet, uses the Airgap Sockets for greatest efficiency and maximum results. In the New York Sun on December 26th, 1925, Mr. Fenway says: "The success of the Fenway depends upon (1) that stage of radio frequency with regeneration. (2) those tin or copper cans and (3) those Airgap sockets."

In building your Fenway, be sure that you use Airgaps—then, and only then, will you get the results obtained by the designer himself.

Airgaps will free any set from those squawks and howls due to socket capacity. They prevent closed circuit, absorption of current, intercoupling of circuits, feedback and undesirable capacity. They make any set more stable and clearer tones with more volume particularly on distant stations.

At All Dealers 75c

If your dealer cannot supply you, send direct.

**Airgap Product Company**  
186 N. J. R. Rd. Avenue  
NEWARK NEW JERSEY

## PANELS

### The Famous FENWAY

Authorized by Mr. Fenway

PANELS FOR ALL CIRCUITS  
DRILLED—ENGRAVED—DECORATED  
Front and Base Panels

**National Radio Panel Co., Inc.**  
319 BROADWAY NEW YORK CITY

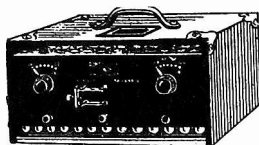

## E-F-F-I-C-I-E-N-C-Y

Until you own a Roberts "B" Battery you will not know what real radio joy you are missing. It is efficient, rechargeable and indestructible. You can't wear it out.

Price list as before.

**ROBERTS BATTERY COMPANY**  
1120 Myrtle Avenue Brooklyn, N. Y.

# CHOSEN FOR THEIR MERIT

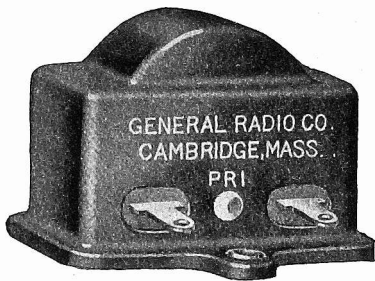

TYPE 271  
Medium Frequency Transformer.  
10,000 Meters. (50 K. C.) Price \$5.00.

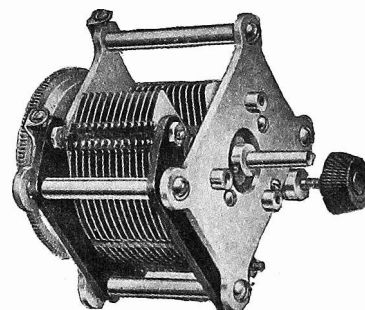

TYPE 334-N  
Variable Condenser. Price \$4.00  
334-P, with Gear, \$5.00

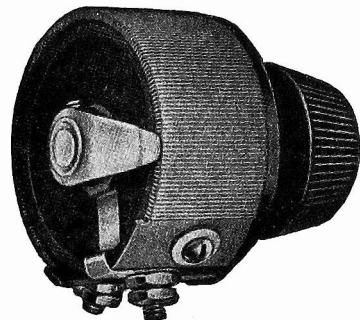

TYPE 301  
Rheostat Price \$1.25



TYPE 285  
Audio Amplifying Transformer. Ratios  
6 to 1 and 2 to 1. Price \$6.00 each.

Always remember in building a radio receiver that its performance depends primarily upon two things: efficient circuit and the use of good parts.

Wherever you find a popular circuit you will invariably find General Radio Parts.

General Radio Company has contributed more in scientific apparatus for laboratory use than any other one company in the history of radio.

The same outstanding craftsmanship and material are embodied in General Radio Parts for use in the construction of Broadcast receiver.

Through the merits of design, performance, and price, General Radio instruments for the scientist or set builder are universally recognized as the standard of excellence.

Every instrument made by the General Radio is thoroughly guaranteed.

**GENERAL RADIO COMPANY**  
CAMBRIDGE 39, MASS.

## GENERAL RADIO INSTRUMENTS

Behind the Panels of Better Built Sets

### Literature Wanted

THE names of readers of RADIO WORLD who desire literature from radio jobbers and dealers are published in RADIO WORLD on request of the reader. The blank below may be used, or a post card or letter will do instead.

Trade Service Editor,

RADIO WORLD,  
145 West 45th St., N. Y. City.

I desire to receive radio literature.

Name .....

City or town.....

State .....

Are you a dealer?.....

If not, who is your dealer?

His Name .....

His Address .....

- F. C. Himmel, 1150 South East Ave., Oak Park, Ill. (Dealer.)
- L. R. Saunders, 1124 First St., S. W., Mason City, Ia. (Dealer.)
- C. C. Bradew, 301 Clark St., Elyria, O.
- Dr. A. D. Mals, 4705 Troo St., Kansas City, Mo.
- Robert N. Zimmerman, R. F. D. 1, Aberdeen, S. D.
- F. L. Pittman, 108 Patent Office, Washington, D. C.
- Charles Fach, 1134 Jackson St., Camden, N. J.
- I. C. Baker, Osborn, Mo. (Dealer.)

### HARD RUBBER

SHEET—ROD—TUBING  
in various sizes  
Special Hard Rubber Parts Made to Order  
Send Sample or Sketch for Quotation

### PANELS ANY SIZE

RADION AND HARD RUBBER  
PRICE LIST FOR ALL RADION PRODUCTS  
MAILED ON REQUEST

WHOLESALE.....RETAIL

**NEW YORK HARD RUBBER TURNING COMPANY**  
212 CENTRE STREET NEW YORK

### NEW CORPORATIONS

Penn Electric Products Co., radios, Dover, Del., \$5,000; Nellie C. Ludwig, Philadelphia, Pa. (Capital Trust Co., of Del.).  
Invincible Radio & Battery Corp., Brooklyn, N. Y. \$10,000; G. and B. Marchese, T. Tommaso. (Attys., Ciaccio & Titone, 191 Irving Ave., Brooklyn, N. Y.).  
B. & C. Radio and Electric Co., Queens, N. Y., \$10,000; M. M. and E. B. Bonner, J. H. Kroeher. (Attys., Weil & Purvin, 291 B'way, N. Y. City).  
Crossley, Inc., general research work, Princeton, N. J.; 1,00 shares, no par value; Archibald M. Crossley, Dorothy F. Crossley, Princeton, N. J.; Charles E. Hillegass, Jr., Trenton, N. J. (Atty., Frank Transue, Trenton, N. J.).

### Gets Everything but Noise!

Amazing new Aerial guaranteed to eliminate all power noises such as leaky transformers, generators, motor hums, Delco Plants, etc. Cuts static, regeneration howls and squeals 1-2. Dr. Gehrig, Oakland, Cal., says improves reception 80%. Hundreds other testimonials. Wonderful results. Mr. Boock, Grand Haven, Mich., heard 3 foreign stations during tests with Kane Antennae. Easy to install.

**\$1.00** Brings BLUE PRINT—Working Drawings—Complete Instructions for Erecting—Just send dollar bill (or check). Limited quantity. Send TODAY.

**KANE ANTENNAE CO., Dept. 830, 3343 W. Monroe, Chicago**

### FIXED RESISTORS Micamold FIXED CONDENSERS

Accurate, Constant in Value  
Indestructible.  
"Made of Mica and Moulded  
in Bakelite"  
At good Radio Stores  
**MICAMOLD RADIO CORP.,**  
Flushing and Porter Aves.,  
Brooklyn, N. Y.

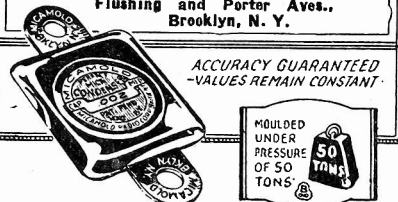

ACCURACY GUARANTEED  
—VALUES REMAIN CONSTANT—



### FENWAY BLUE PRINTS

ACTUAL SIZE LAYOUTS  
"PICTURE" DRAWINGS, COIL DATA  
EVERYTHING YOU SHOULD KNOW  
Price, Postpaid—\$3.00  
You Can't Go Wrong with Fenway Blueprints!

**LEO FENWAY**  
29 WEST 64th STREET NEW YORK, N. Y.

### A SUPER-RADIO-DYNE KIT \$17.50

With Perfectly Matched Transformer & Filter

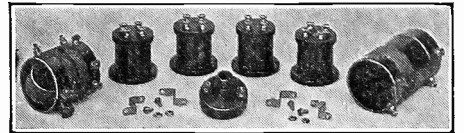

This Is a SUPERADIO Product—Your Guarantee of Satisfaction!

The most selective, the most powerful, longest ranged, finest toned 8 tube super ever designed. Intermediate transformers matched to identical peaks and filter tuned to same peak. Kit includes Antenna Coupler, Oscillator Coupler, Special Variable Condenser, Tuned Input Transformer, 3 matched intermediate transformers and hardware. Complete with booklet, diagrams and full sized working drawings which positively assure perfect success. Order now. Only \$17.50.

Write for our free Radio Catalog of newest parts

**William A. Welty Company**  
36-40 So. State St. Chicago

### Business Opportunities Radio and Electrical

Rates: 10c per word; Minimum, \$1.00; Cash with order

**\$100 WEEKLY UP.** We want experienced radio men to operate branch assembly plants. Part or whole time. Barfield Radio Co., 13 Tillary St., Dept. W. R., Brooklyn, N. Y.

### List of Parts for the "Fenway"

1 Special Drilled and Engraved Panel as specified.....	\$10.00
1 Special Hardwood Baseboard.....	1.00
1 Set of Four Special Copper Cans, Black Satin Finish, per set.....	11.00
1 Sub Panel, Drilled and Engraved.....	1.25
3 General Radio Variable Condensers, 00035, each \$3.75	11.25
1 General Radio Medium Frequency Input Transformer No. 331.....	5.00
3 General Radio Medium Frequency Input Transformers, No. 271, each \$5.00.....	15.00
2 General Radio 6-ohm Rheostats, No. 301, each \$1.25..	2.50
1 General Radio 400-ohm Potentiometer, No. 214.....	3.00
2 General Radio Audio Transformers I, No. 285 and 1 No. 285-L, each \$6.00.....	12.00
2 Silver-Marshall Changeable Coils, No. 110-A and 1 No. 111-A, each \$2.50.....	5.00
2 Silver-Marshall Coil Sockets for No. 110-A and No. 111-A, each \$1.00.....	2.00
1 Special R. F. Variable Coupler mounted on sub panel with switch and taps, all wound ready for use.....	6.00
3 Gem Fuses and Base.....	1.00
1 Royalty Type B Resistance.....	1.50
1 Yaxley Filament Switch.....	.50
1 Yaxley Filament Control Jack.....	.70
1 Yaxley 2 Circuit Jack.....	.80

### LOOK UP DOWN

The Fenway Specialist

Send your order for any or all the parts TODAY. ALL MERCHANDISE SHIPPED PARCEL POST PREPAID SAME DAY ORDER IS RECEIVED—NO WAITS—EVERYTHING IS READY—Your Money Back If Not Satisfied! Anyway, send for special circular and price list—IT'S FREE!

**CHAS. W. DOWN,**  
711 Eighth Avenue New York, N. Y.

(Wholesale Prices Quoted to Bonafide Dealers Only)

### Chas. W. Down

is the

# FENWAY SPECIALIST

1 Yaxley D. P. D. T. Switch No. 60.....	\$1.25
9 Air-Gap Sockets, each 75c.....	6.75
3 National Vernier Dials (new type), each \$2.50.....	7.50
Eby Binding Posts, each 15c.....	1.20
50-Foot Celatsite Wire, per foot, 4c.....	2.00
1 Jewell Combination Volt Meter 0 to 8-80-160.....	12.50
1 Jewell Meter 0 to 50 Milli-Amps.....	7.50
1 Micamold Condenser Grid .00025 .....	.35
1 Micamold Condenser Grid .0005 .....	.45
1 Micamold Condenser By-Pass .001 .....	.40
1 Micamold Condenser By-Pass .01 .....	.90
3 Micamold Condenser By-Pass .5, each 90c.....	2.70
1 Micamold Grid Leak 2 Megs. ....	.30
1 Micamold Grid Leak 5 Megs. ....	.30
1 Micamold Grid Leak Mount .....	.30

Total .....\$133.90  
NOTE—Silver-Marshall Transformers can be supplied at an additional cost of \$12.00 per set.

NOTE—For those desiring to wind their own coils, coupler and other special parts, the proper parts may be had on receipt of order for same. A Micamold .04 fixed condenser will make any cone speaker work better. Fenway recommends a cone speaker for the Fenway.

Cabinets for the Fenway now in stock... \$22.50

# THE RADIO TRADE

## Johnson in New Job As Show Executive

J. Chester Johnson, for four and a

**SHORE FOR CHOKE COILS & TRANSFORMERS** For All "B" Eliminators  
**REX, RAYTHEON, CHEMICAL, etc.**  
 PRICES ON REQUEST  
**SHORE ELECTRIC CO., Inc.**  
 64 University Place N. Y. City

half years vice-president and general manager of the American Radio Exposition Company, has resigned to become associated with U. J. Herrmann and G. Clayton Irwin, Jr., in the conduct of exhibitions under the auspices of the Radio Manufacturers' Show Association, 1475 Broadway, New York City. His energies are now devoted towards furthering the plans for the next Radio World's Fair to be held in the New Madison Square Garden, New York City, from September 13 to 18, inclusive.

Mr. Johnson is known to the radio industry in view of his experience as the manager, in association with Harold Bolster, of the annual expositions at Grand Central Palace, New York, and in

Los Angeles. He entered radio after long service in the automotive field.

Mr. Johnson said: "I believe that the next Radio World's Fair will be not only the largest, but by far the most interesting exposition tracing the tremendous development of radio that has ever been staged, advantageously located in the heart of New York, and will attract visitors from not only the entire North American Continent, but from South America and many countries of Europe."

## The Free List

Cleartron Vacuum Tube Co., of 28 W. 44th street, New York, the oldest independent radio tube manufacturer, has issued an interesting booklet entitled, "Radio Tubes in the Clear Light of Modern Research."

"A Word to the Wise," is a beautiful little booklet just issued by J. B. Ferguson, Inc., 41 East 42nd Street, New York. If you are interested in a 6-tube receiver with but one tuning control, drop a postal for this booklet.

Literature of great interest to those desirous of getting pure tone quality in radio is now available from the Accusticone Laboratories, 96 Church street, New York City. This concern has long been engaged in loud speaker research and has developed a new principle.

Blueprints on the Victoreen will be sent to those interested in this circuit. Address Paul Fernald, H. & F. Radio Laboratories, 168 Washington street, New York City.

**Panels and Sub-panels**  
 for Diamond of the Air  
**VICTOREEN—**  
 Browning-Drake, B-T Counterphase  
**FENWAY** Authorized by Leo Fenway, \$10 each.  
 Also Cut to Any Size. Mail Orders Promptly Filled.  
**Cortlandt Panel Engraving Co.**  
 79 Cortlandt Street New York City

## SM PARTS

### SM Low Loss Inductances

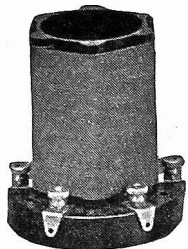

All-bakelite Low Loss Interchangeable Coils for 50-550 meters. These new coils may be used as oscillators, antenna adapters and RF transformers in standard circuits.

Price of all types, Each .....\$2.50  
 Sockets for any size Coils. Each..... 1.00

SM Type 316 Condensers are furnished, all brass plates, die-cast frame and double adjustable cone bearings. May be ganged by placing one socket behind another, the shafts interlocking in any desired relation. SLF .00035 mfd. capacity for all types of SM interchangeable coils. Price..\$5.75

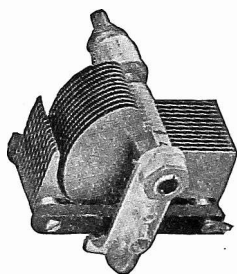

### SM Vernier Dials

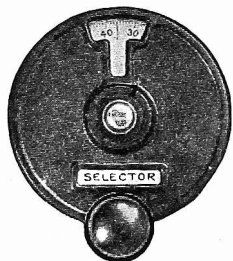

The SM Type 801 Vernier Dials are of all bakelite construction. Zero to 100 — clockwise — counter-clockwise or 360 degrees (for Remler Condensers) in a single type. In appearance and operation the SM is the finest vernier dial on the market. Price, each .....\$2.50

### SM 210 and 211 Transformers

Designed so that maximum amplification will be obtained at 60 Kilocycles. Available in matched sets of any number. No. 210 is iron-core type while No. 211 is of the air-core type supplied with measured tuning

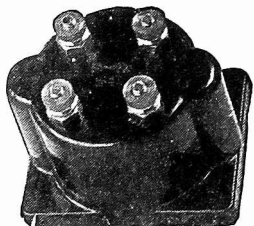

condenser. Each transformer is furnished with individual laboratory curve chart. Price: Both Types.....\$6.00 each

See these and other SM Parts at your Dealers or write for circulars.

### Silver-Marshall, Inc.

110-R South Wabash Avenue  
 CHICAGO, ILLINOIS

## SANGAMO CONDENSERS

Heat proof, moisture proof, fume proof. Guaranteed to be accurate to within 10% under all temperature and humidity conditions. The following capacities are regularly carried in stock:

0.00004	0.000175	0.0008	0.005
0.00005	0.0002	0.001	0.006
0.00006	0.00025	0.0012	0.007
0.00007	0.0003	0.00175	0.0075
0.00008	0.00035	0.002	0.008
0.0001	0.0004	0.0025	0.01
0.00012	0.0005	0.003	0.012
0.00015	0.0006	0.0035	0.015
	0.0007	0.004	

**ROSSITER & CO., Inc.**  
 WHOLESALE DISTRIBUTORS  
 136 Liberty St., New York

## The New NATIONAL Variable Velvet Vernier Dial

Positive Control  
 Easily Mounted  
 Gearless

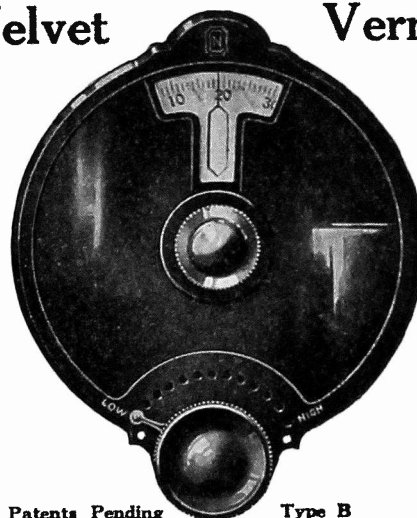

Variable Ratio  
 Velvet Smoothness  
 Ornamental

Patents Pending Type B

This dial embodies a modified application of our "Velvet Vernier" mechanism designed to facilitate mounting on the 1/4" shaft of any standard type of variable condenser, without the use of tools other than a screw driver. It will replace plain dials on any receiver where sharper tuning is desired.

Of special importance is a new and novel device which enables the user to adjust at will the reduction to any ratio from 6-1 to 20-1. This feature aids greatly in the separation of stations operating on the lower wave lengths. This new dial is moulded from black bakelite in a highly ornamental design.

Specifications	Price	Gold Finish
Counter-Clockwise 200-0 (360°)	\$2.50	\$3.00
Clockwise 0-200 (360°)	2.50	3.00

Send for Bulletin 109 RW

**NATIONAL CO., INC., 110 Brookline Street, Cambridge, Mass.**  
 W. A. READY, President

RADIO UNIVERSITY

(Continued from page 19)

same as a .25 mfd. by pass condenser? (3)—Will rheostats work as well as Amperites in this set? (4)—Will the C299 tubes function well in this set?—Wilfred J. Lindner, 166 Cummings St., Rochester, N. Y.

(1)—Yes. (2)—Yes. (3)—Yes. (4)—Yes. The volume however, will not be as great as that obtained by the use of the -01A type tubes.

\*\*\*

I HAVE a 5-tube Neutrodyne, which was constructed at home. The reception, when using the output of the first audio tube, is very clear. However, when using the complete output from the second audio tube the signals are distorted. I am using audio-frequency transformers with a 3-to-1 ratio in the first stage and 5-to-1 in the second stage. I have tried reversing these transformers so the lower ratio transformer was in the second stage and also reversed the tubes but cannot seem to get any better results. I would be pleased if I could find the trouble with my amplifier. My speaker is all right, as I tried it out on some other receiver and the signals came through very clear.—E. Robert Rex, 136 Oxford Ave., Dayton, O.

Try a .001 mfd. fixed condenser of the mica type across the plate and the grid posts of the last audio-frequency transformer, or use a power tube in the final audio stage.

\*\*\*

IN REFERENCE to the 1926 Model Diamond of the Air, is it possible to successfully use the Heath 3-tube amplifier?—Newton C. Eichelberger, 5123 Chestnut St., Philadelphia, Pa.

Yes.

\*\*\*

ARE THE alkaline B batteries as good B batteries using lead cells as to overall efficiency? (2)—Will any of these types give good service when used in conjunction with the 1926 Model Diamond of the Air?—Percy W. LaMore, 1520 Palmer Ave., Muskegon, Mich.

(1)—Yes. The alkaline battery will last practically a lifetime, if the elements employed are good and if good care is taken of the battery proper. This is not true of the lead cell battery, which will

last only a certain length of time, depending upon the quality of the elements, etc. (2)—Yes.

\*\*\*

I HAVE a 5-tube receiver, in which two steps of tuned radio-frequency amplification, a non-regenerative detector and two stages of transformer coupled AF are employed. Now, the signals will come forth from the loud speaker for about half an hour and then will suddenly stop for about half a second, coming back with the same intensity. The tubes are new. The batteries are O. K. The antenna is not swinging, etc. How can I remedy this trouble?—H. G. Bregades, West Point, N. Y.

Place a new grid leak of 2 megohm resistance across the grid condenser. Better, use a variable grid leak.

\*\*\*

WHAT IS the best length of antenna to employ for any standard receiver? (2)—What power tube will give satisfactory service in the last stage of audio-frequency amplification, where resistance coupling is employed? (3)—I have some trouble with interfering stations. Is there any special instrument that is recommended that could be employed?—Emil Martin, 101 New York Ave., Union City, N. J.

(1)—A 100 foot length antenna is suitable. (2)—Either 6-mu or the 112 or 120 tubes. (3)—Build the regenerative wave-trap described by John F. Rider in the Dec. 26 issue of RADIO WORLD.

\*\*\*

I HAVE a 3-tube 3-circuit receiver and find that I cannot receive stations below 240 meters. I can receive above (Concluded on page 27)

FREE RADIO BOOK

Science has invented a new kind of coil. Now have it on your present set. Gives 4 great advantages otherwise impossible. Write for new book just published showing many new ideas. Also 8 new circluid circuits. Address Electrical Research Laboratories, R. W., 2546 Cottage Grove Avenue, Chicago.

FREE BOOKLET FOR INVENTORS. IF YOUR INVENTION is new and useful it is patentable. Send me your sketch. Z. H. POLACHEK, 70 Wall St., New York. Reg. Patent Attorney-Engineer

RADIO TUBE RENEWER FOR USE ON FARMS OR IN CITIES. OPERATES ON THE BATTERIES OF THE RADIO SET. \$1.50. SEND NO MONEY. RAY POSTMAN ON DELIVERY.

LISTEN TO YOUR LOCAL STATIONS with THE TALKING BOOK. A complete radio set in the form of a book, bound in fine cloth with gold stamping. PRICE FIVE DOLLARS, sent prepaid.

The Daven Super-Amplifier. for volume and tone quality. 3 STAGES RESISTANCE COUPLED. ECONOMICALLY DISTORTIONLESS. Easily added to any set. Saves Several Hours' Assembly.

QUICK-ACTION CLASSIFIED ADS.

10 Cents a Word. 10 Words Minimum. Cash with Order.

\$6.50 APOLLO Parlor Model. Stands 22 inches high, has a ten inch bell, gives faithful reproduction and may be varied from a whisper to a torrent of sound by the adjustable unit control without the least loss of the sweet, mellow, clear tones that are found in the Apollo Speakers. Mail orders promptly filled. Send no money, just pay the postman. We can save you 20 to 50% on all radio parts and accessories. Write us for prices on articles you need. Rix Radio Supply House, Inc. 5505 Fourth Ave. Dept. 43 Brooklyn, N. Y.

DX FANS! Description of my famous super-selective super-DX set, 50c. Thurman, 3675 Madison, Oakland, Cal.

MAGNAVOX SINGLE CONTROL SET \$35.00. Five-tube set, \$20.00. Magnavox Speaker, \$10.00. Perfect condition. Raymond Schlegel, 1118 No. Negley Ave., Pittsburgh, Pa.

PATENTS—Write for free Guide Books and "Record of Invention Blank" before disclosing inventions. Send model or sketch of your invention for our inspection and instructions free. Terms reasonable. Radio, Chemical, Mechanical, Electrical and Trademark experts. Victor J. Evans Co., 924 Ninth, Washington, D. C.

1926 DIAMOND OF THE AIR COMPLETE with all accessories, ready to use, \$85.00, including Cone Speaker. B. Benson, Orchard Park, N. Y.

BULLDOGS BEAUTIFUL REGISTERED BULL PUPS, \$15. Bulldogs, 501 Rockwood, Dallas, Texas.

HELP WANTED MALE EARN \$110 to \$250 monthly, expenses paid as Railway Traffic Inspector. We secure position for you after completion of 3 months' home study course or money refunded. Excellent opportunities. Write for Free Booklet, G-161 Stand. Business Training Inst., Buffalo, N. Y.

FILL OUT AND MAIL NOW SUBSCRIPTION BLANK RADIO WORLD

RADIO WORLD 145 West 45th Street, New York City (Just East of Broadway) Please send me RADIO WORLD for ..... months, for which please find enclosed \$..... SUBSCRIPTION RATES: Single Copy ..... \$ .15 Three Months ..... 1.50 Six Months ..... 3.00 One Year, 52 Issues ..... 6.00 Add \$1.00 a Year for Foreign Postage; 50c for Canadian Postage.

# RADIO AGENTS WANTED

## 5 Tube Demonstrator FREE!

Earn \$25 to \$100 a week, part or full time. Everyone a prospect. Complete line standard sets and accessories, \$5 to \$30. Write today for illustrated catalog and exclusive selling plan for live dealers and community agents. 20TH CENTURY RADIO CO., 1101 Coca Cola Bldg., Kansas City, Mo.

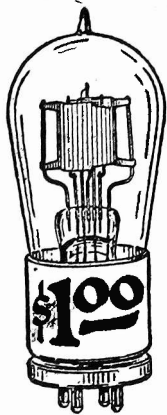

### Vacuum Tubes Rebuilt \$1.00 each

**POSITIVELY GUARANTEED** equal to new tubes in every respect. Money will be refunded if tubes prove unsatisfactory for any reason other than burn-outs.

Send us your broken and burned out tubes by parcel post. (Not necessary to insure or guard against breakage.) We make return shipments by parcel post C.O.D. and try to maintain 24-hour service.

**HARVARD RADIO LABORATORIES**  
200 Old Colony Avenue  
South Boston, Mass.

### NATIONAL SPORTSMAN



### NATIONAL SPORTSMAN

is a 68 page monthly magazine crammed full of hunting, fishing, camping and trapping stories and pictures, valuable information about guns, revolvers, fishing tackle, game law changes, best places to get fish and game, etc. Biggest value ever offered in a sporting magazine.

**AND HERE'S THE Remington Sportsman's Knife** with stag handle and two long slender blades especially designed both for \$1

to meet the exacting requirements of skinning and cleaning fish, game birds and fur-bearing animals. Blades are of superior quality steel with strong, durable, keen-cutting edges. The points are shaped just right for a good, clean job of skinning and skinning. Length 3 3/4 in. closed. The name "Remington" on the blade is your guarantee of quality.

**SPECIAL OFFER:**

We will send this knife and National Sportsman for a **\$1.00** whole year on receipt of.

**NATIONAL SPORTSMAN MAGAZINE**

1202 Newbury St., Boston, Mass.



(Concluded from page 26)  
600 meters. There are approximately 60 turns on my 3/4" diameter tubing, with a .0005 mfd. variable condenser shunting the same.—Reginald Travers, St. Louis, Mo.

Take 10 turns off the secondary.

I HAVE a 3-tube 3-circuit receiver which gives me very satisfactory service. However, as I have a long antenna it is necessary that I have a .0005 mfd. variable condenser in series with the antenna to get a low-wave stations. This condenser is not in the set and has no covering. Recently when I went to tune in a station, I found that I could not receive the low wave stations any more. I tested the condenser for continuity and found it all right. The high wave stations responded with the same volume that they always did. This shows that the set was right. The antenna was all right also. What could be the trouble?—Marta O'Hara, Denver, Col.

Dust may have accumulated between the plates and caused the capacity of the condenser to decrease, thereby allowing reception of the high wave stations only. It is a good idea to enclose the condenser in a small box.

WHILE LISTENING-IN for distance on my 1926 Model Diamond of the Air I heard a station whose call seemed to sound like KMOX. If there is such a station, I would like to know the location, power used, owner and wavelength in meters of this station.—Hertran Viantr, Kingston, N. Y.

KMOX is owned by the St. Louis Globe-Democrat, located in St. Louis,

### BEAUTY-QUALITY-LOW PRICE

TYPE 5SS 5-Tube Tuned Radio Frequency. **\$45**

TYPE 6RR 6-Tube Resistance Coupled Audio Tuned Radio Frequency **\$50**

If your dealer cannot make immediate delivery we will ship direct from factory

**American Interstate Radio Service**  
183 Greenwich Street, New York City  
Distributors, Jobbers, Dealers, write for special trade terms.

### ULTRA-LOWLOSS CONDENSER

SPECIAL CUTLASS PLATES DISTRIBUTE THE STATIONS EVENLY OVER THE DIAL SIMPLIFIES TUNING. CAPACITY .0005 MFD.

\$5.00

PHENIX RADIO CORP., 116-F East 25 St., N.Y.C.

Mo. It uses 1,000 watts of power and operates on 261 meters. This station is licensed experimentally to operate on 233 meters. The station is called "The Voice of St. Louis."

IN REFERENCE to Fig. 3, page 4 in the Oct. 10 issue of RADIO WORLD, what size coil and how many turns should be placed on the same so that a .00025 mfd. or 11 plate variable condenser can be employed?—Rodney Brown, 630 East 8th St., Portland, Ore.

There will be 26 turns on this coil. The diameter of the form will be 3 1/2" and while the height will be 4". The tap is made at the 7th turn.

I WANT to build the 1926 Model Diamond of the Air, but desire to make a modification. Instead of having a jack for the detector, I would like to place one after the first stage of transformer coupled audio-frequency amplification. If this can be done, I would appreciate the wiring directions.—Joseph R. Klauck, 428 West 54th St., N. Y. C.

Connect W to the I post on the tickler. Connect the Y post to the B post Det. This eliminates the first jack. Now to connect the jack after the transformer. Connect the top terminal of the double circuit jack to the P post on the third socket. Connect the second inner terminal from the top to the portion of R3 that formally went to the P post of this same socket. Connect the third inner terminal from the top to the other terminal of the resistance R3. This formally went to the B+ Amp. post. Connect the bottom terminal to the B+ Amp. post. Get the blueprint to make these directions clearer.

WHAT ARE the two principal effects whereby it is possible to detect the passing of current through a plain copper wire?—G. Roberts, Little Falls, N. J.

By means of the heating and the magnetic effects the detecting of current is possible.

## TWO-FOR-ONE SUBSCRIPTION OFFER

Radio World has made arrangements

—To offer a year's subscription FREE for any one of the following publications with one year's subscription for RADIO WORLD:

- POPULAR RADIO or
- RADIO BROADCAST or
- SCIENCE AND INVENTION or
- RADIO NEWS
- RADIO DEALER or

- RADIO JOURNAL or
- RADIO (San Francisco) or
- RADIO AGE
- COLLIER'S
- BOYS' LIFE

This is the way to get two publications

- for the price of one!
- Send \$6.00 today for RADIO WORLD
- for one year (regular price
- for 52 numbers)
- and select any one of the other
- nine publications for twelve months.

- Add \$1.00 a year extra for
- Canadian or Foreign Postage.
- Present RADIO WORLD subscribers
- can take advantage of this offer by
- extending subscriptions one year
- if they send renewals NOW.

### RADIO WORLD'S Special Two-For-Price-of-One SUBSCRIPTION BLANK

RADIO WORLD, 145 West 45th St., N. Y. City:

Enclosed find \$6.00, for which send me RADIO WORLD for twelve months (52 numbers), beginning.....and also, without additional cost, Popular Radio, or Radio Broadcast, Radio News, or Science and Invention, or Radio Dealer, or Radio (San Francisco), Boys' Life, or Radio Journal, Collier's or Radio Age (or \$10.00 for two yearly subscriptions).

Name .....

Indicate if renewal.

Street Address .....

Offer Good Until

City and State .....

March 17.

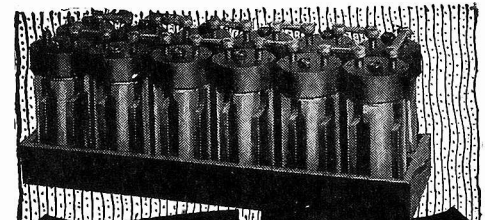

## FREE!

To Each Purchaser of a **WORLD 6V. Auto or Radio BATTERY**

**12-Cell — 24-Volt Storage 'B' Battery**  
Positively given free with each purchase of a WORLD "A" Storage Battery. You must send this ad with your order. WORLD Batteries are famous for their guaranteed quality and service. Backed by years of successful manufacture and thousands of satisfied users. Equipped with Solid Rubber Cases, an insurance against acid and leakage. You save 60 per cent and get a

### 2-Year Guarantee

**Bond in Writing** "I'll tell their friends." That's our best proof of performance. Send your order in today.

- Solid Rubber Case Radio Batteries**
- 6-Volt, 100-Amperes . . . . . \$11.25
  - 6-Volt, 120-Amperes . . . . . 13.25
  - 6-Volt, 140-Amperes . . . . . 15.00

- Solid Rubber Case Auto Batteries**
- 6-Volt, 11-Plate . . . . . \$11.25
  - 6-Volt, 18-Plate . . . . . 13.25
  - 12-Volt, 7-Plate . . . . . 16.00

**Send No Money** Just state battery wanted and we will ship day order is received, by Express C. O. D., subject to your examination on arrival. **FREE "B" Battery** included. Extra Offer: 5 per cent discount for cash in full with order. Buy now and get a guaranteed battery at 60 per cent saving to you.

**WORLD BATTERY COMPANY**  
1219 So. Wabash Ave., Dept. 17 CHICAGO, ILL.

## World STORAGE BATTERIES

Approved and Listed as Standard by Authorities including Radio News Laboratories, Popular Science Institute of Standards, Popular Radio Laboratories, Radio Broadcast Laboratories, Radio in the Home, and Lefax, Inc.

Set your Radio Dials at 210 meters for the new 1000 watt World Storage Battery Station, W.S.B.C., Chicago. Watch for announcements.

KOKA WEAF WGN WJLS KRLD KGO KRAL WJW KOP

# Locating and Curing Trouble in Fenway

(Continued from page 12)

am strongly in favor of iron core transformers.

The .5 mf. bypass condenser across the B battery 67½ volts is rather important and must not be left out.

"Should two sets of B batteries be used? Couldn't one get along without C batteries?" Two sets of B batteries, separate batteries for the radio and the audio, would be better, although a common battery will work equally as well. Regarding the C battery, whenever a writer mentions that such a battery should be used some people take it for granted that he's trying to advertise certain battery concerns. The main business of a C battery is to protect the tubes and the B batteries. That is, by preventing the tubes from being overloaded and by cutting down the plate current, thereby lengthening the life of the B batteries. That little Gem fuse will also protect the tubes and the B batteries, and a multi-tube set owner that is operating his set without it is merely playing with another form of gambling.

### Locating Trouble

Now let us suppose that you are one of the fans who has failed to make his set work. Wherein does the trouble lie? Well, how did you build your set, tube for tube? Then the easiest method of

locating your trouble is to go back over the set, beginning with the first tube. If you were to call in a professional trouble shooter—assuming that there was such an animal!—he would doubtless locate your trouble through the process of elimination. He would KNOW that only through the systematic elimination of probable defects in the set can the real cause or seat of the trouble be found. Hasty here-and-there quick-search methods generally result in failure. There is ALWAYS a "certain something" that one can put his finger on which explains beyond any further speculating why a Fenway will not "percolate"—fails to

### VEBY HIGH-MU TUBES

Made especially for Resistance Coupled Amplifiers. Now you can get more volume with greater clarity.  
A. F. 20 for the 1st and 2nd Stage.....\$3.00  
A. F. 6 Power Tube for the 3rd Stage..... 4.50

#### VEBY RADIO CO.

47-51 Morris Avenue Newark, N. J.

## Save 20 to 50% FREE RADIO CATALOG

**LATEST IN HOOK-UPS AND RADIO**  
Get the lowest rock-bottom prices on radio parts, sets, kits. New free Radio Catalog and Guide brimful of standard, reliable, guaranteed goods. Over 100 latest hook-ups and illustrations. Be sure to get this thrifty book before you buy. It puts money in your pocket. Saves you as much as half on a set. Also please include name of radio fan. Send letter or postal NOW.

### THE BARAWIK COMPANY

103-140 S. Canal St., Chicago, U. S. A.

### DON'T TRY TO TUNE BY GUESS

KNOW where to place your dials for each station in America.

KNOW what station you receive without waiting announcement.

You can do both with RADEX

Send 25c Coin or Stamps

RADEX, Box 143-M, Cleveland, O.

## Beautify Your Set

Use the **Bruno**

### Slo-Moshen Vernier Dial

Designed especially for straight-line frequency condensers, although it may be used on any kind of tuning condenser or tickler coil. Moulded of Bakelite, it is handsome to see and responds to the slightest touch.....\$2.00

**Powertone Cone Speaker \$14.49**

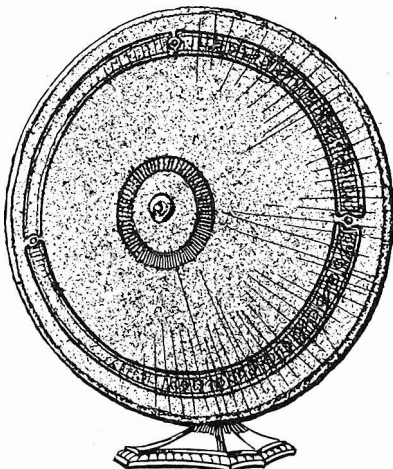

Brown Cone, 18 inches Diameter, with Gold-Braided Rim and Handsome Bronzed Base. Entrancing Tone. Five-Day, Money-Back Guarantee.

Inquiries Invited from the Trade

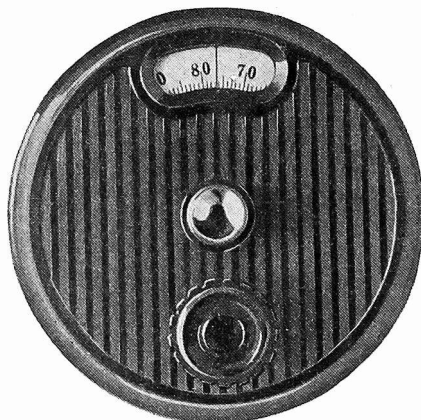

The Bruno Slo-Moshen Vernier Dial

Bruno Magic Dial (Makes any Condenser not SLF tune as if it were).....\$2.50

**Complete Kit for 5-Tube, 1-Dial POWERTONE \$22.50**

Build this set and enjoy acoustical synchronization—real tone quality. SLF condenser and Bruno Slo-Moshen Vernier dial. Blueprint FREE with each kit.

### Powertone Electric Co.

SUBSIDIARY OF BRUNO RADIO CORPORATION

223 Fulton Street New York City

bring home the bacon. Say you find C1, has no tuning value; you turn it this way and that way, but nothing happens. What's wrong? Well, look inside the first copper can. You see there a coil, a condenser and a tube socket—perhaps a tube. Which one of those three or four things isn't functioning? Test the coil for shorts and continuity of circuit; test the condenser for a short circuit; test the tube socket—is it grounded, anywhere, with the can? How about the tube? Are the condenser, coil and socket properly connected into the electrical circuit? Have you "hooked-up" a good ground on that first coil condenser?

### Tonic for sick tubes

from any lamp socket, A.C. or D.C., 110 volts

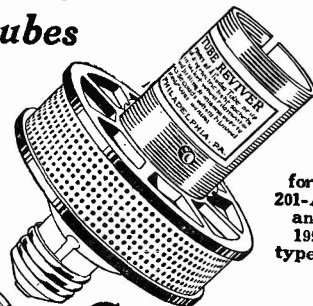

for 201-A and 199 types

## SOCKET Tube Reviver

\$4.50

and this coupon

Renew all of your tubes for less than the cost of two. Send no money. Reviver will be mailed C. O. D. to those sending coupon today—

### BRINGS QUICK RELIEF

International Resistance Co., Perry Bldg., Philadelphia.

Please send me by prepaid Parcel Post, C. O. D., one SOCKET Tube Reviver, type as noted. I will pay postman \$4.50—with the understanding that money will be returned if I am not entirely satisfied.

Cross out one 201-A 199

Name.....  
Address.....  
City..... State.....

## GET THE OFFICIAL BOOKLET ON HOW TO BUILD

Radio World's 1926 Model

# DIAMOND OF THE AIR

The text of the official Diamond booklet was written by HERMAN BERNARD, designer of the 5-tube circuit which offers the most in selectivity, volume, tone, quality and DX. Price, per copy.....

# 50c

### CERTIFIED BLUEPRINT

**FREE** with every copy OF THE OFFICIAL Booklet. Bernard's signature is an every booklet and every blueprint. Both sent FREE to new yearly subscribers.

News and Radio Dealers: Send for Wholesale Prices. Order direct from American News Co., Inc., 131 Varick St., N. Y. C., or American News Co. Branches.

RADIO WORLD, 145 W. 45th St., N. Y. C.

Enclosed find 50c. Send me copy official Diamond Booklet, with FREE blueprint. Or both free with \$6.00 for yearly subscription.

NAME.....  
ADDRESS.....  
CITY..... STATE.....

How about the little rotor in the S-M coil, No. 110A—is it making contact with both springs of the large coil?

After making these tests, break the circuit between the coil and the socket (binding post 3 of the coil socket and grid post on the tube socket). Now connect a grid condenser and leak between these two points. Connect a pair of phones to the plate of this same socket and to the B battery plus 45 volts. If that first circuit is working you will be able to hear the buzzer or a local station. Now take the second circuit, and test it

the same way. Next, the two circuits combined. Now test the oscillator the same way as you have already tested the first two circuits. Forget that it is an oscillator circuit. Treat it as if it was the first can—the antenna circuit. Here's how you do it: Plug one tip of the phone cord under the PLATE binding pots of the oscillator tube socket, connect 45 volts of B to the other; connect the antenna to the FIXED plates of the condenser, C3, and the ground to the can. (Of course you must put a grid leak and condenser in series with the grid of the socket and post 3 of the coil!) Forget the plate winding on the oscillator coil. Just imagine it isn't there. The oscillator now becomes an aerial circuit, and as such should enable you to hear broadcast programs, or the buzzer, as before. Next, connect the aerial to post 1 of the Silver Marshall socket, using the rotor of the coil for a variable, untuned primary.

Now test out the intermediate frequency amplifier, as explained earlier in these articles. Surely if you follow these instructions you can't go wrong, and the set simply **MUST** work, provided that the tubes are OK.

Don't forget that special coupler, L1-L2. If any of the leads from it are touching the can around it the second condenser will be "blooey." All three condensers can be made to tune alike by adding a few turns of wire. The last stage of audio should function perfectly without fixed condensers or resistances across the primary or secondary coils. The four tubes should usually operate a speaker up to 1,500 miles with good volume. I appreciate that you are going to try out some of your old tubes, just to see how the set works. Later you intend to buy new tubes. Right? Well, why not buy new ones to test the set with and then use the old ones when the set is functioning right?

To be sure, more than one enthusiast will devote considerable time and effort in making some changes in his receiver, only to find that no real improvement has been made. Of course, this time is not wasted, since he has a lot of fun in the process and learns several things that do not improve his set.

The fact that the baseboard layout appears as shown doesn't mean that other ideas haven't been tried. On the contrary, many, many other ideas have been tested, such as raising the sockets and placing the intermediate transformers underneath (I thought that would get you!), but, after all, the layout shown renders the set easier to build, not to mention as-

(Concluded on next page)

# FREE RADIO CATALOG

WRITE for a copy of  
our NEW 100-Page  
Radio Catalog—Parts, Accessories — Kits — Sets —  
Everything for the Fan.

DEPT. R. W.

## CHICAGO SALVAGE STOCK STORES

509 S. State Street, CHICAGO, U. S. A.

### LOUD SPEAKER RECEPTION

from either coast on three tubes

Blueprint and instructions..... \$1.00  
Necessary low loss coil..... \$2.50  
Beautiful finished instrument..... \$35.00

S. A. TWITCHELL CO.

1930 Western Avenue Minneapolis, Minn.

## Long Distance Radio

Only  
\$2.95

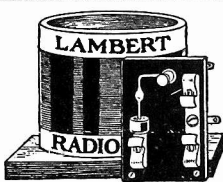

200,000 SATISFIED OWNERS  
—Getting stations 600 miles away on Lambert Radios. No batteries or tubes required. A real Radio—not a toy or attachment. One to four can listen at once. No howling or screeching noises. Hear local stations on bed-springs, light sockets or telephone. Fully guaranteed. Set, \$2.95—Phones, \$2.95—Aerial, \$1.00. Mail orders filled same day. We pay postage.

LEON LAMBERT RADIO CO.  
212 So. Market St. Wichita, Kansas

### RIGHT TO THE POINT!

Extreme accuracy of dial reading is assured when you use EUREKA DIAL POINTERS! Tuning in distance is simplified.

Polished Nickel or Gilt, 5/8 or 3/4" 10¢

C. W. BUTTS, Inc.  
40 Hedden Place East Orange, N. J.

Dealer Inquiries Solicited.

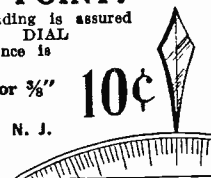

## RADIO AGE

The Magazine with  
BLUEPRINTS

An eight page blueprint section in every issue of the RADIO AGE, with detailed information telling how to make these built and tested hookups in your own home.

Technical articles by unbiased radio experts, a complete list of broadcasting stations, a log chart, human interest stories of the broadcast world, photographs and drawings by the score.

All in one for only  
25 cents a copy.  
\$2.50 a year.

Use the coupon and get real value.

**RADIO AGE, INC.**  
500-510 N. Dearborn Street  
CHICAGO

RADIO AGE, INC.,  
Dept. RW,  
500-510 N. Dearborn St.,  
Chicago, Ill.

Please send me the RADIO AGE, the magazine with blueprints, for one year beginning with the ..... issue. Check (or Money Order) for \$2.50 is enclosed.

Name .....  
Address .....  
City ..... State .....

# WINS Again!

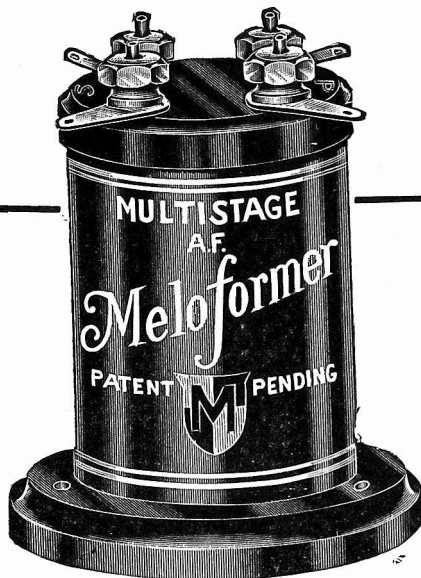

MELOFORMER was responsible for the granting of first and second prizes at the Amateur Set Exhibit of the Third Annual Radio Show at the Coliseum, Chicago. Mr. C. Mueller and Mr. B. Quaadman, winners, attribute their victories to MELOFORMER because the sets were judged for excellence in tone, volume, range and selectivity. MELOFORMER amplification was responsible for the prize winning *tone, volume and range*—three out of four points.

MELOFORMERS were used in the Victorian Circuit described in this issue.

Your set can be converted into one with the same perfect qualities as those of the prize winners by using MELOFORMER amplification. Easy to install in any set. For sale at all progressive dealers for \$4.00 each.

Write for Free Booklet A-2 showing MELOFORMER hookups.

Distributed by  
Paramount Electrical Supply Co.,  
132 Church St. New York, N. Y.

Lewis Radio Jobbers,  
2326 Columbia Ave. Philadelphia, Pa.

## ROBERTSON-DAVIS CO.

420 Orleans Street

Chicago, Ill.

### 1925 BACK NUMBERS OF RADIO WORLD WANTED

Mail us copies of any of the following 1925 issues of RADIO WORLD, and we will send you a copy of a current issue for every copy sent us: January 10, February 21, March 21, 28, April 4, 11, 25; May 16, 23, 30; June 6, 13, 20; July 4, 11, 18, 25; August 8, 15, 22; September 5, 22.

(Concluded from preceding page)

suring the builder of successful operation of the receiver as a whole.

Some few fans will insist upon wiring their sets with bus bar, instead of using the spaghetti-covered wire recommended. Theory says that spaghetti raises the resistance of the wire it covers (at radio frequency). In fact it does. But it alters the total resistance to such a slight extent that you cannot tell the difference in actual practice.

Far better if you forget resistance entirely, as far as the Fenway is concerned. At any rate, don't blame resistance if your set fails to operate. Remember that in any tuned circuit, resistance exists in every part of the circuit. You call a coil of wire. LI, for example, an inductance and a condenser, C1, say, a capacitance, but they both contain resistance. The actual amount of resistance they contain may be several times that contained in the wires connecting them, and so, even though the resistance of the wires is reduced to zero, the total resistance of the circuit is still very nearly what it was to begin with.

All in all, the Fenway will follow the wavebands whether they go up or down, and eventually it will be possible for the man who owns such a receiver to work stations from, say, 35 meters to 3,600 meters. Bear in mind that this set, with its copper cans and with its wonderful stage of tuned radio with regeneration, was designed with a thorough knowledge and understanding of the present broadcasting problems, including high power, harmonics, close wavelength separations, and, above all, a knowledge of receiving conditions in New York, Chicago, Philadelphia, Boston, Cleveland, Schenectady and St. Louis.

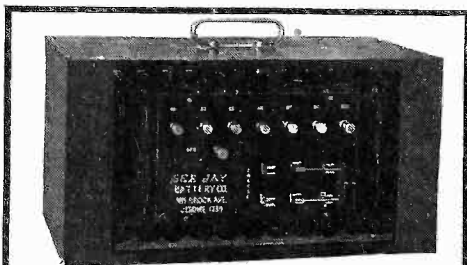

The Edison Element "B" Battery has long been the marvel of battery users, thereby surpassing all others. The See-Jay Battery is constructed from genuine alkaline elements and connected with a non-corrosive connector. 100-volt Alkaline Rechargeable "B" Battery and factory made charger for \$12.00; 140-volt, \$17.00. Write for literature or send 20c for sample cell. Send no money—pay on delivery. SEE-JAY BATTERY CO., 915 Brook Ave., N. Y. City

### Powertone Blueprint

The 1926 Model 50c  
1-Dial 5-Tube Set

This is the famous DX set as described in

RADIO WORLD  
COLUMBIA PRINT

145 West 45th Street N. Y. C.

DO YOU WISH TO BUILD THE 4-TUBE DIAMOND OF THE AIR? If so, get a copy of RADIO WORLD dated Jan. 23. Sent on receipt of 15c, or start subscription with that number. RADIO WORLD, 145 W. 45th St., N. Y. C.

HERMAN BERNARD, managing editor of RADIO WORLD broadcasts every Friday at 7 p. m., from WGBS, Gimbel Bros., N. Y. City, 315.6 meters. He discusses "What's Your Radio Problem?" Listen in!

CONSTRUCTION OF THE 4-TUBE A-A RECEIVER, by Herbert E. Hayden, appeared in RADIO WORLD dated Nov. 21. 15c per copy, or start your subscription with that number.

#### RESULTS EDITOR:

I have constructed five 1926 Model Diamond of the Air receivers and each has worked perfectly. Stations as far West as KOA, Denver, Col., and as far South as WBAP, Fort Worth, Tex., have

been heard. All the signals are loud and of good quality.

PROSPECT RADIO LABORATORIES, per W. F. Hagenloch, 912 President St., Brooklyn, N. Y.

# Get the Utmost From Your Set!

## Use a Bretwood Variable Grid Leak!

WHEN you realize that the voltage output of a set may be increased 25 per cent. by correct grid leak setting—when you realize that regeneration and oscillation control is finely achieved by the variable grid leak—when you realize that nobody knows in advance just what is the correct leakage for an individual detector tube—then you know that you must use the Bretwood Variable Grid Leak, else be content with less than maximum efficiency from your set. More volume, greater distant reception, clearer signals should be your goal. Bretwood is the solution. Adopt it to-day!

Price, \$1.50

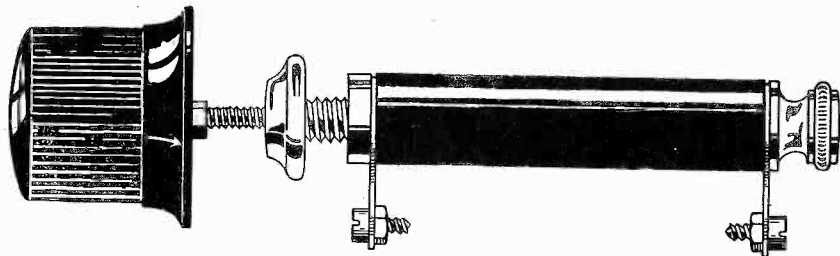

The Bretwood Variable Grid Leak (Bretwood, Ltd., Sole Patentees and Owners)

Guaranteed Precision Range 1/4 to 10 Megohms

### The North American Bretwood Co.

Telephone, BRyant 0559

145 W. 45th St., N. Y. City

Sole Distributors for United States

Canadian Representative, Radio, Ltd., Phillips Square, Montreal

North American Bretwood Co., 145 West 45th St., N. Y. City.

Gentlemen: Enclosed find \$1.50. Send me at once one Bretwood Variable Grid Leak on 5-day money-back guarantee.

NAME.....

ADDRESS.....

CITY..... STATE.....

Inquiries Solicited from the Trade



# Kits may come and Kits may go but the 1926 DIAMOND OF THE AIR KIT.....\$35.00 is still the choice of set builders the world over

Each B.C.L. boxed and sealed Kit bears the personal seal and signature of Herman Bernard. This is your assurance and guarantee that all parts included are the best obtainable and will give you a balanced receiver capable of great distance, combined with wonderful tonal qualities—a perfect receiver, worthy of the endorsement of the thirteen leading parts manufacturers it bears.

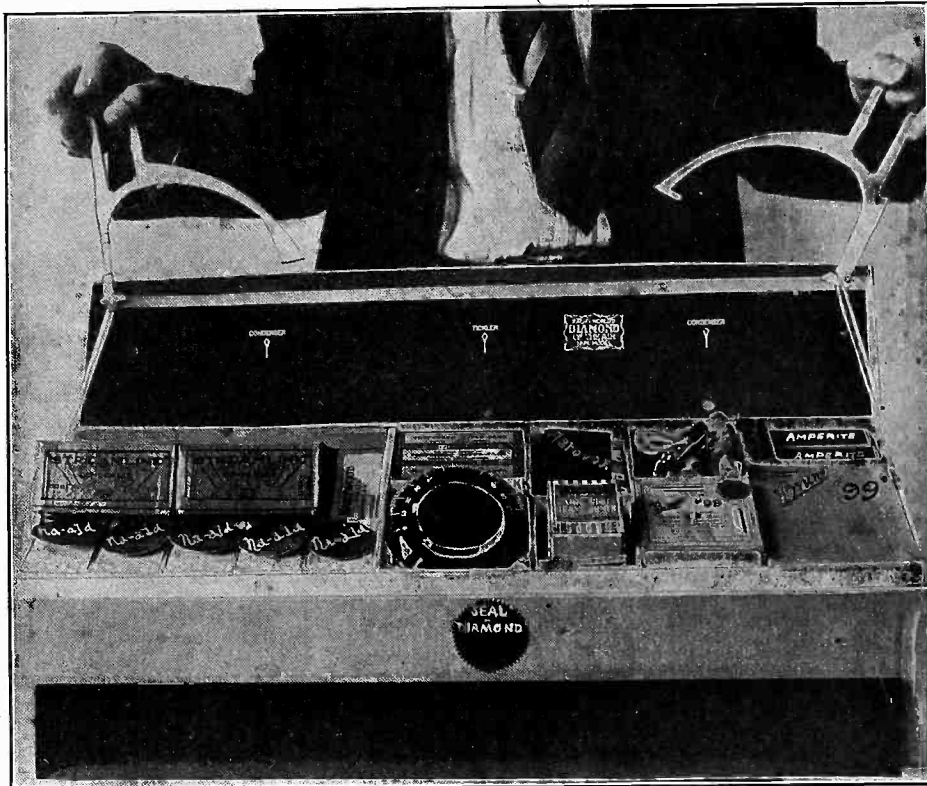

This is the way each kit is packed. Everything is included.

With the addition to our shipping department of new men we are once more able to catch up with deliveries on the Diamond of the Air Kits. Shipments can now go forward the same day received by any form of delivery you may desire. We wish to thank those patrons who were obliged to delay the construction of their kits about two days for their patience with us. We are doing all that is humanly possible to keep everyone satisfied.

We are pleased to announce that each kit will contain Sidney E. Finkelstein's special 16-page booklet, with a new full-size blueprint, which gives all data necessary for the construction, care and operation of the Diamond of the Air.

We are able to supply the consumers with a copy at 50 cents each.

## OUR MONEY-SAVING SPECIALS

KITS	
Bruno 3-Tube.....	\$18.00
Bruno 4-Tube.....	22.00
Ambassador 3-Tube.....	16.00
Ambassador 4-Tube.....	20.00
Browning Drake.....	19.00
Marcodyne Kits.....	22.50
Bernard's Loud Boy.....	9.65

CONDENSERS	
Bruno No. 18-22 Plate....	\$4.25
Hammarlund 23 P.S.L.F..	4.10
Hammarlund 11-43 Plate Ver. ....	2.25
General Instrument, Any Size .....	2.40
U. S. Tool 11-18-23-43 Plate Ver. ....	1.75
Heath 11-23-43 Plate Ver. ....	1.75
Murdock Enclosed 23-43 Plate .....	.95
U. S. L. 23-43 Plate Ver..	1.50
Preferred 11-23 Plate....	1.35
Preferred 11-23 Plate Ver.	1.65
Amaco 17 Plate S. L. F....	2.75
Amaco 23 Plate S. L. F....	3.25
King Cardwell 11 Plate....	2.10
Freshman Mercury.....	.95
Manhattan 13-23 Plate Ver.	2.95
Pacent 11-43 Plate.....	.75
Streamline S. L. F. .0005.	2.50
Streamline S. L. F. .00035	2.25
Streamline S. L. F. .00025	2.00
Wireless .0005 S. L. F....	1.95
Garco 23 Plate Ver.....	1.95
Comaco, All Sizes, Ver....	1.25

TRANSFORMERS	
All American 10 to 1.....	\$2.45
Jefferson Star 3 to 1.....	1.50
Amertran .....	3.75
Modern 4 to 1.....	1.95
Modern 10 to 1.....	2.25
Modern Push Pull, Pair..	6.50
Thordarson 3 to 1.....	2.95
Thordarson 6 to 1.....	3.10

Thordarson Push Pull, Pr.	8.50
Thordarson Autoformer...	\$3.75
Erla 3 to 1, 6 to 1.....	2.95
Federal No. 65 or 65A....	2.95
Rauland Lyric.....	6.25
Modern Symphony.....	4.50
Jefferson Star 6 to 1.....	2.10
Crescent 6 to 1, 3 to 1...	2.10

VERNIER DIALS	
Marco .....	\$1.60
Erla .....	1.95
Amsco .....	1.50
Univernier .....	.75
Gee-Haw .....	1.95
B. M. S.....	1.10
Accuratune .....	2.75
Pacent—Gold or Silver...	1.95
National 3 3/4" .....	1.85

LOUD SPEAKER UNITS	
Baldwin (Type C).....	\$3.95
Baldwin (Type H).....	4.95
Morrison .....	3.25
Western Electric.....	6.75
Baldwin Phones.....	7.25

LOUD SPEAKERS	
Farrand Jr.....	16.50
Manhattan, Large.....	11.50
Acme .....	22.50
Bosch Jr. ....	14.50
Thorola Jr. ....	13.95
Supreme Concert.....	13.95
B. C. L. Horn—Special..	5.50
B. C. L. Cone Speaker 20"	14.95
Crosley Cone.....	13.25

DIALS	
Naald Bakelite 4".....	\$0.50
Fada Bakelite 4".....	.45
Freed Eisemann Bakelite 4" .....	.45
Garod Bakelite 4".....	.45
Pathe 2", 3", 4" .....	.25

TUBES	
R. C. A. 201-A.....	\$2.00
Cunningham .....	2.00
DeForest .....	2.25
New Venus Blue, 201-A..	1.50
Schlickerling .....	2.25
Vebv Mu 20.....	2.95
Vebv Mu 6 Power Tube.	3.25

MISCELLANEOUS	
Cutler-Hammer 6-ohm Ver. ....	\$0.59
Turn-It Grid Leak.....	.65
U. X. Adapter.....	.30
Pacent Plug.....	.25
Soldering Iron.....	.95
"A" Battery Switch.....	.25
Jones' Single and Double Jacks .....	.40
Bruno Binding Post (per pkg. of 12).....	.40
Lightning Arrester.....	.40
Battery Cable.....	.45
Pacent Rheostat.....	.60
Dubilier By-Pass Com., 0.25 mfd. ....	.70
D. P. D. T. Switches....	.50
WD-11 Adapters.....	.50
S. P. D. T. Switches....	.45
Phone Plugs.....	.25
Bezels 1" Nickel.....	.05
Bezels 1" Gold.....	.10
Glass Insulator.....	.20
Toggle Switch.....	.20
Bruno Inductance Switch (14 Point).....	.35
Bruno "66".....	2.25
Hydrometers .....	.60
Bell Wire (Half Pound)..	.40
Na-ald UX Adapters....	.35
Aerial Kit (Complete)...	2.50
Crystal Detector.....	.50
Double Jacks.....	.40
Single Jacks.....	.30

Steinite Eliminator.....	\$0.80
Continental Midget Cond.	1.10
Continental Neutralizer ..	.45
Single Mount.....	.15
Double Mount.....	.30
Extension Plug.....	.30
Voltmeter Leader 0-50 Volts .....	.75
Voltmeter Ammeter Combination .....	1.10
Tower Scientific Headset.	1.95
Spitfire Scientific Headset	2.95
Triple Coil Mount.....	.95
Amrad Variometer.....	1.25
Betts & Betts Loop.....	2.50
Bruno WD-11 Socket.....	.25
Dayfan Potentiometer 400 ohm .....	.30
3" Dial.....	.20

PANELS	
Hard Rubber	Radiion Mahog-anite
7 x 10.....	\$0.50
7 x 12.....	.60
7 x 14.....	.75
7 x 18.....	.95
7 x 21.....	1.25
7 x 24.....	1.35
7 x 26.....	1.50
Drilled and Engraved for Diamond of the Air....	\$2.65
Power-tone, 7 x 18, Drilled and Engraved Panel...	2.15
3-Tube Bruno, 7 x 18, Drilled and Engraved Panel .....	1.45
SOCKETS—BAKELITE	
Federal .....	\$0.65
Naald De Luxe.....	.45
Hoosick Falls.....	.50
Hoosick Falls 199.....	.35
Hoosick Falls Triple 199..	.95
Eby UX .....	.60
Pacent UX Universal....	.55

Write for FREE Catalogue!

**B-C-L RADIO SERVICE CO., 221 FULTON STREET, N. Y. C. TELEPHONE CORTLANDT 4467.**

# FRESHMAN Announces! Another Sensation!

## MODEL 6-F-1

### New and Improved FRESHMAN MASTERPIECE

#### The World's Greatest Radio Receiving Set

Freshman's latest sensation, illustrated here, has a real appeal to the women of the home. It is built of five-ply genuine mahogany; a handsome piece of furniture that fits in any corner of any sized room. It is compact and comparatively small, giving it preference over clumsy consoles. Contains an especially large tone chamber,

#### With Built-in Loud Speaker of Great Volume and Superb Tone

When not used as a radio, this console can be entirely closed. The top is stationary and provides an attractive resting place for vases and other ornaments. Spacious compartments afford ample room for all batteries, etc.—not a single wire being visible.

#### Chas. Freshman Co., Inc.

Freshman Building  
2626 W. Washington Blvd.

New York  
Chicago

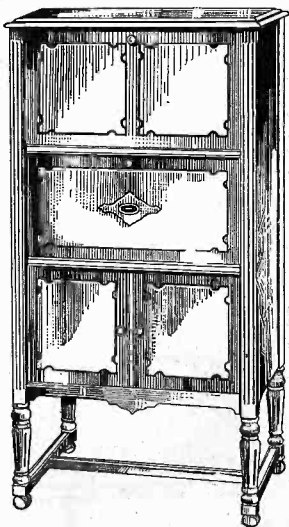

#### The Radio Receiver Women Have Been Waiting For

Here you see Model 6-F-1 entirely closed—real furniture for which no home is too pretentious and none too modest to afford.

Sold on Convenient  
Terms by Authorized  
Freshman Dealers,  
Who Also Install and  
Service Them.

Write for free illustrated booklet, describing this handsome console in detail.

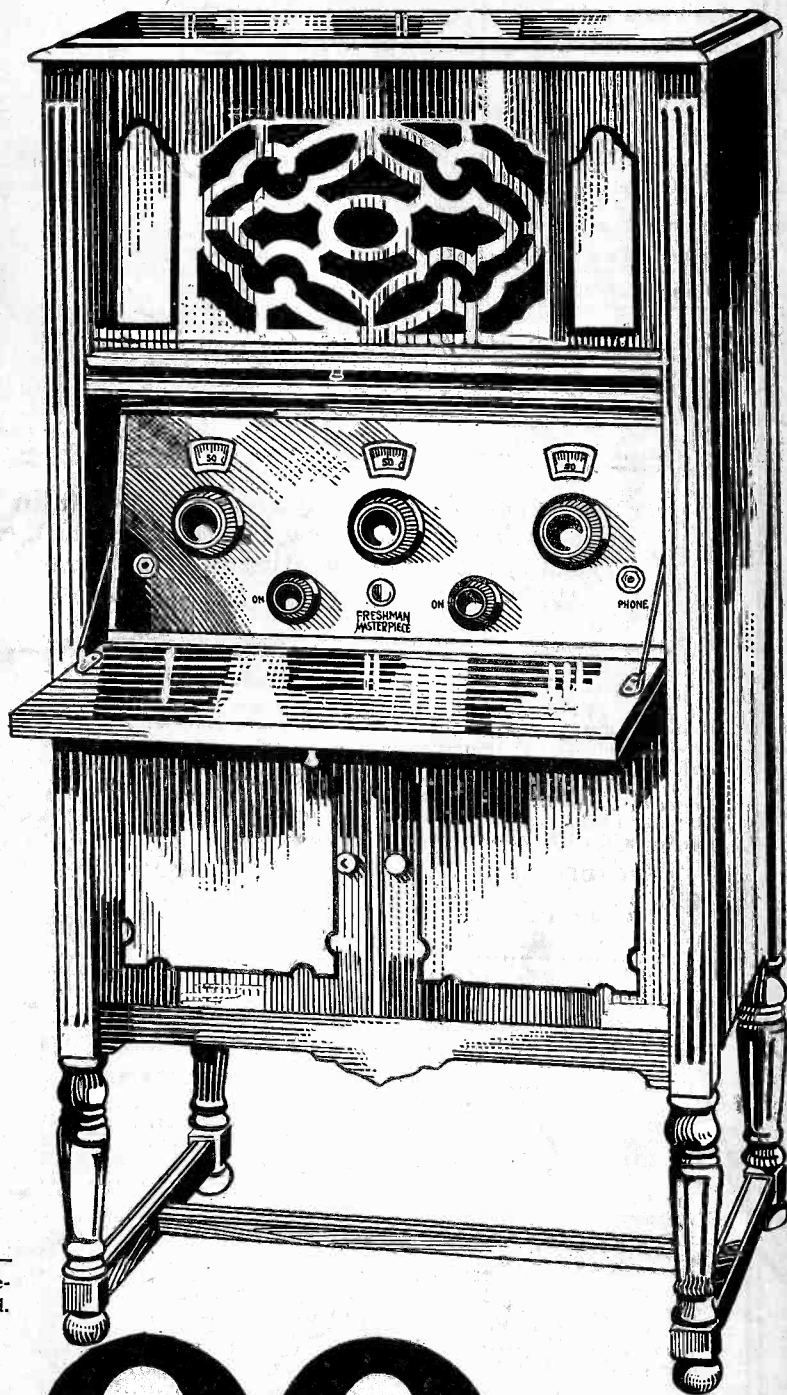

# \$ 99.50