

FEB. 13 1926 15 CENTS

RADIO WORLD

Title Reg. U.S. Pat. Off.

Vol. 8. No. 21 203 ILLUSTRATED Every Week

Current Economy in a 5-Tube Set

By J. E. Anderson

How to Build The Fenway

By Leo Fenway

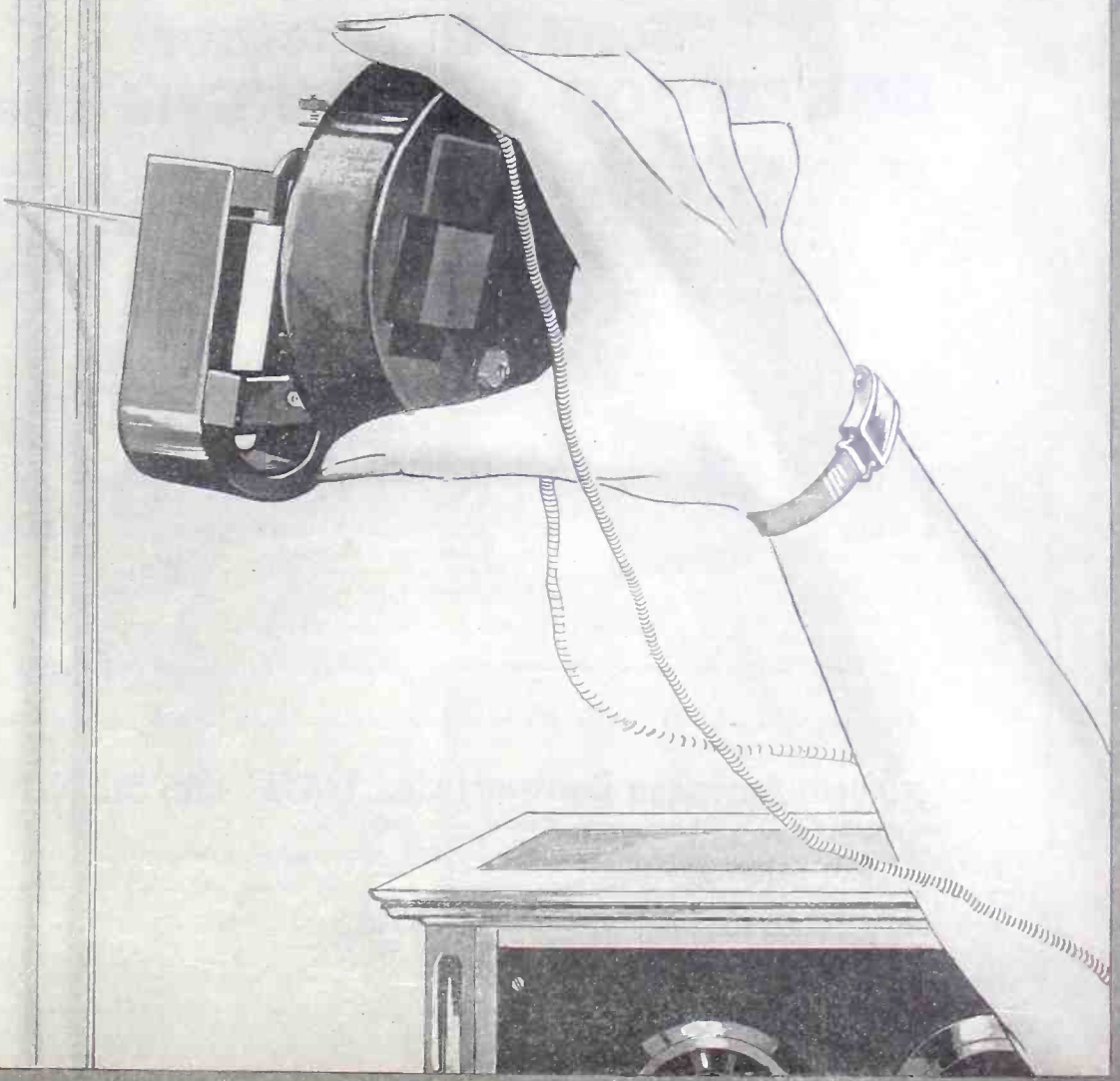
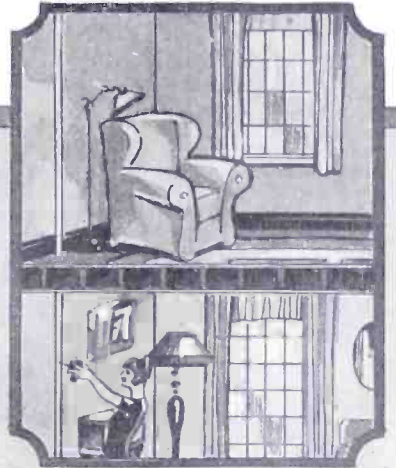

A STEAM HEAT PIPE, USED AS A DIAPHRAGM, SENDS MUSIC UPSTAIRS. (See Page 5.)

This Knob Brings in DX

A delightful expression of appreciation lights every countenance when the Bretwood Variable Grid Leak is put in a set and the result is judged *by your own ears!*

The Bretwood Variable Grid Leak may be used in any set employing a tube as detector. The single hole, panel mount enables one to put it in a set in five minutes.

When the King Wanted a Leak He Commanded Bretwood

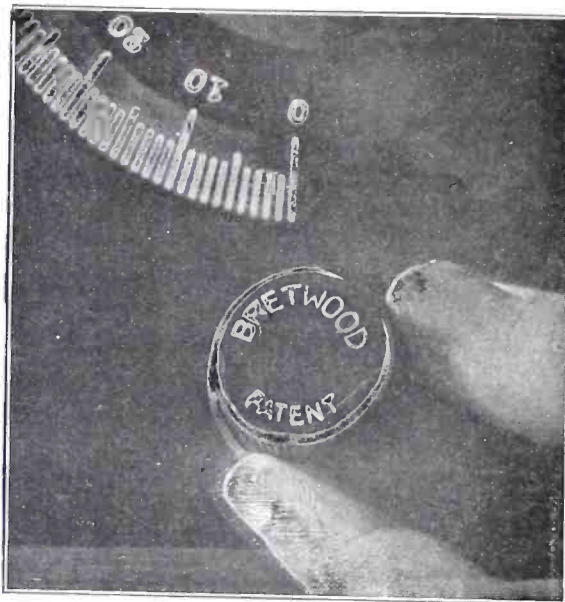

“Send Me Another BRETWOOD Variable Grid Leak

I received the Bretwood Variable Grid Leak last night and it sure did bring in stations. Denver was as far as I could get until last night when, with the Bretwood in my set, I brought in KFI, Los Angeles, and KPQ, San Francisco, Calif., clear and fine.

JOS. L. MAIRE,
4026 Grezella St.,
Pittsburgh, Pa.

I thank you for your letter in relation to the condenser. If this is as good as the Bretwood grid leak, I sure can wait. With your grid leak I was able to bring in with good volume 15 W Stations in one week with a Diamond of the Air set from a city hard to get out of.

Thanking you again,
F. W. Collingwood,
3442 Sacramento St.,
San Francisco, Calif.

Gridleak received and tested out, and find it is the only variable leak I ever used that is really variable.

Enclosed find \$1.50 for which please send me another one.

F. E. STAYTON,
Box 240, Ardmore, Okla.

I think it is about the best grid leak I have ever used. Have made quite a few sets and this beats them all. Get DX very plainly and clearly.

WM. HEBERSON,
2510 N. Franklin St.,
Philadelphia, Pa.

The plunger—the long screw that goes inside the barrel—should never be removed from the Bretwood.

Fit for a King

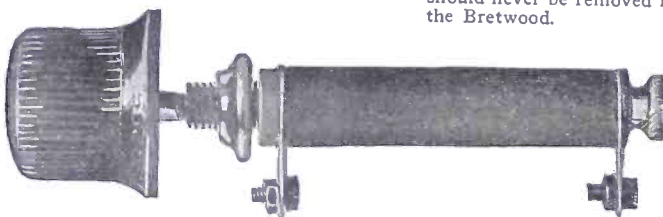

1/4 to 10 Megohms

Bretwood, Ltd., London, Eng., Sole Patentees and Owners

More DX, Clearer Reception, Smoother Control in Regenerative Sets Assured Price, \$1.50

The Bretwood Variable Grid Leak may be installed in any set in five minutes by single hole panel mounting.

The North American Bretwood Co., 145 W. 45th St., N. Y. City

Sole Distributors for United States

Canadian Representative, Radio, Ltd., Phillips Square, Montreal

NOTE TO RADIO MANUFACTURERS

Write for Wholesale Rates

A set with a FIXED Grid Leak may work perfectly where tested, while it needs a VARIABLE Grid Leak so that set may be adjusted to the locality where used.

THE NORTH AMERICAN BRETWOOD CO.,
145 West 45th Street, New York City.

Gentlemen: Enclosed find \$1.50 for which you will please send me one Bretwood Variable Grid Leak prepaid. Satisfaction guaranteed or my money back after trial within ten days of receipt by me.

NAME
STREET
CITY
STATE

RADIO WORLD

[Entered as second-class matter, March, 1922, at the post office at New York, N. Y., under the Act of March 3, 1879.]

A Weekly Paper Published by Hennessy Radio Publications Corporation from Publication Office, 145 West 45th St., New York, N. Y. Just East of Broadway
 Phones: BRyant 0558 and 0559.

Vol. VIII. No. 21. Whole No. 203

February 13, 1926

15c per copy, \$6.00 a year

Filaments In Series Afford Economy In 5-Tube Receiver

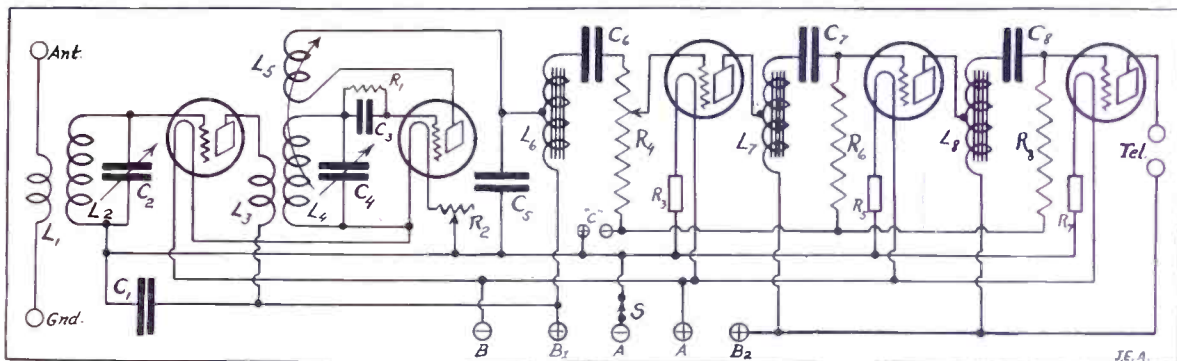

FIG. 2.—The filament of the first tube is connected in series with that of the second tube, both being of the 199 type. The other tubes are in parallel as usual. The source for both groups is 6 volts.

By J. E. Anderson
 Consulting Engineer

IT is not customary when designing and building radio receivers to employ tubes having different filament characteristics in the same set. Thus sets are built with any one of the following types throughout, WD11, UV199, or UV201A, but rarely is a set built which employs a mixture of these types of tube. There are no good reasons, however, why different types of tubes should not be used; and there are many cases in which sensible design demands that the same kind of tube should not be used throughout the set, but that special tubes should be used to perform specific functions.

If WD11 tubes are used throughout, the set will be economical in operation but the radio-frequency amplification will suffer since these tubes are not good RF amplifiers. The quality will also suffer, since these tubes are not able to handle loud speaker volume without overloading and consequent distortion. If UV199 type of tubes is employed throughout the set will also be very economical in operation, and it will also be efficient as an RF amplifier, but from the quality point of view this set will not be even as good as the set with all WD11 tubes, since the UV199 cannot handle as much of a load as the WD11. Now, if the set is built throughout for UV201A tubes, the operation will be more expensive, but the set will be as good an RF amplifier as the set built with UV199, and it will be capable of very much better quality of loud speaker volume, because these tubes are both good RF and AF amplifiers and they can handle a good deal of volume without overloading.

Small Tubes Good for RF

Now the radio-frequency voltages which the detector and the tubes preceding it are called upon to handle are very minute, well within the operating limits of such tubes as UV199. And since these tubes are good RF amplifiers and detectors they may well be used for these purposes, even

when a storage battery is available for heating the filaments and when larger tubes are used for audio-frequency amplification. The smaller tubes perform the functions assigned to them above as well as the larger, they are less expensive to operate, they require less room in the set, and they are not so excitable as to RF oscillation. Any one of these reasons is sufficient to warrant their use in the earlier stages of the set.

There are two methods whereby tubes of different filament characteristics may be used in combination in the same set and from the same voltage source. All the tubes may be connected in parallel across the filament battery and resistances used to take care of any excess voltage in the various filament branches, or tubes which require the same filament current, even though their terminal voltages are different, may be connected in series.

Thus WD11 and UV201A both require 25 ampere and therefore they may be connected in series, although the first requires a voltage of only 1.1 and the second a voltage of 5. One of each of these may be connected in series across a 6-volt storage battery and both will have the correct filament current as long as the source does not fall below 6.1 volts. This may well be done where trickle chargers are employed, which keep the battery in a fully charged condition all the time. UV199 tubes require 60 milliamperes at 3 volts. Hence two of these tubes may be connected in series and the two put across a 6-volt storage battery. These tubes will operate well until the voltage of the battery falls to about 5.8, when it may be considered as fully discharged. In that case the least voltage across the terminals of each tube will be 2.9, only .1 volt less than normal. The power saved when two are connected in series is 36 watt, and the current saved is, of course, 60 milliamperes.

LIST OF PARTS

- One antenna coupler, L1L2.
- One 3-circuit tuner, L3L4L5.
- Two variable condensers, C2 and C4, .0005 mfd. each.
- One by-pass condenser, C1, .005 mfd.
- One by-pass condenser, C5, .001 mfd.
- One grid condenser, C3, .00025 mfd.
- Three stopping condensers, C6, C7 and C8, .01 mfd. or higher capacity.
- Three auto-transformers, L6, L7, L8.
- One 500,000-ohm potentiometer, R4.
- One grid leak, R1, 1 meg.
- One rheostat, R2, 10 ohms.
- Three Ameripetes, R3, R5, R7 (Type 1-A for 201A tubes).
- One grid leak, R6, 0.5 meg.
- One grid leak, R8, 0.25 meg.
- Two grid leak mountings.
- Two small (99) sockets.
- Three large sockets.
- One filament switch, S.
- Eleven binding posts.
- One 7x24" panel.
- One 7x23" baseboard.
- One small knob or dial.
- Two 4 dials, vernier.

How Filaments Are Wired

Below is given a description of a 5-tube receiver comprising one stage of tuned RF amplification, a regenerative detector, and three stages of auto-transformer coupled audio-frequency amplification. In this receiver the first two tubes are of the UV199 type and their filaments are connected in series, while the three subsequent tubes are of larger type and their filaments are connected in parallel in the usual manner. The details of connections in the filament circuit may best be seen on Fig. 1, which depicts the heating circuit alone. It will be seen that the cur-

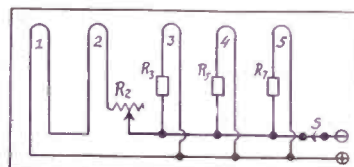

FIG. 1—How the filaments are wired.

Anderson's Economical Set

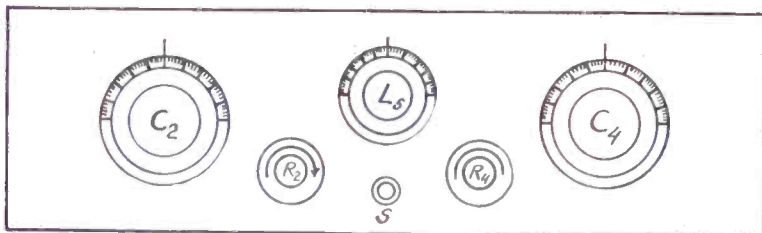

FIG. 3, the panel layout for 7x24".

rent intended to heat the first two tubes first enters the RF tube and then flows to the detector tube, thence through a small rheostat and back to the battery. This rheostat, R2, is not really necessary, as it may well be replaced by a fixed resistance of small ohmage, or even left out entirely. It is included as an auxiliary means of controlling volume and regeneration. It should have a maximum resistance of 10 ohms. The resistances R3, R5 and R7 are Amperites of the proper type, (1-A for 201A tubes). In case Daven MU20 and MU6 tubes are employed under conditions which will be discussed later, these resistances may be omitted and short circuit bars may be substituted for them. The filament switch S is placed in the negative lead to the storage battery.

When it comes to choosing radio-frequency coils the constructor has a large number of good ones to select from. Undoubtedly coils having an open form are the best and will give the best results provided that they are judiciously placed with respect to other conductors in the field. Whether they are wound on Bakelite, hard rubber, cardboard, or on nothing plus a wee bit of holder does not matter a great deal. Taken all around perhaps hard rubber is as good as any, and good coils on this material may either be purchased or wound by the constructor. Repeated experiments seem to indicate that the use of wire larger than No. 24 is unnecessary. No. 26 wire will make very good coils. If the form is such as to allow space winding without any danger of short-circuiting the turns, bare wire is the best, but for ordinary close wound coils the insulation should be either double cotton or double silk.

May Use Collodion

A little collodion judiciously applied will help in making the coil an all-weather performer and also in making its inductance constant without adding appreciably to its losses. A very good coil may be made by winding 45 turns of No. 24 double cotton covered wire on a hard rubber tubing, leaving the turns either untreated or covered with a very thin layer of collodion. This coil will have approximately the optimum shape ratio to give the greatest inductance for a given amount of wire. It will tune up to the upper wavelength limit of the broadcast range with a 500 micromicrofarad condenser, assuming average zero setting capacity. The 45 turns refer both to the secondary of the antenna coupler, L2, and to the secondary L4 of the detector input (See Fig. 2).

The antenna coil L1 should have from five to ten turns on the same form that L2 is wound on, and there should be a separation of about $\frac{1}{4}$ " between the two windings. If desired the coupling between these two windings may be variable. Many commercial coils are so arranged that the coupling may be varied to suit different requirements as to volume, selectivity and wavelength. The primary of the detector input transformer, L3, should

have from 15 to 20 turns placed in such a manner with respect to L4 that the capacity between the two windings is a minimum for a given amount of magnetic coupling. That is, L3 should preferably be placed inside L4 near the low potential end of the latter, and it should be wound with fine wire. Any size from No. 30 to No. 40 will do. The resistance in this coil is of no consequence, and if the wire is fine its capacity to ground or to the secondary of the secondary is negligible.

The tickler coil L5 may also be wound with fine wire for similar reasons, and it also should be placed on the low potential side of L4. If the wire in this coil is fine the eddy current losses in it induced by the secondary will be low, its capacity to the secondary will be small, and its effect upon the tuning of the secondary will be minimum. The resistance in the tickler wire, even when this is very fine, is negligible in comparison with the losses in the plate output impedance of the tube itself. No. 30 or No. 32 double silk wire is suggested. This would make a very small and compact tickler.

Uses .0005 Mfd. Condensers

The two tuning condensers C2 and C4 should each be of 500 mmfd. capacity, and both should of course be low loss. This does not mean that it should have metal end plates. Whether the capacity change in these condensers is straight line frequency or straight line capacity is unimportant. The SLF type is no more selective than the other. The shape of the plates has nothing to do with selectivity, (not even with the ease of tuning in a short wave station, now that slow motion dials are available). Condenser C3 is the usual .00025 mfd. grid condenser and the resistance across it, R1, is the customary leak of from 1 to 5 megohms. The bypass condenser C5 is a mica condenser of .001 mfd. to let the radio-frequency current across the primary of the auto-transformer L6. C1 is a similar condenser to keep the radio-frequency currents out of the plate and filament batteries. Its capacity may well be .01 mfd. but one-tenth that value serves almost equally well.

The three stopping condensers C6, C7 and C8 in the grid circuits of the three audio frequency tubes should be at least .01 mfd. each. Smaller values will suppress the low frequencies to a degree which would nullify the advantage gained by the semi-direct coupling of the auto-transformers. It is important that the insulation of these condensers be of the highest, otherwise the leakage would make it impossible to keep the grids sufficiently negative to make the tubes operate properly.

The Audio Circuit

The three auto-transformers, L6, L7 and L8 may be ordinary transformers properly connected, or they may be of the commercial type known as Autoformers. If ordinary transformers are used the two

windings should be connected in series aiding. The terminal marked plate should be connected to the grid, the terminal marked grid should be connected to the B battery, and the junction of the two windings should be connected to the plate. This puts the usual secondary winding in the plate circuit and this becomes the primary, while the two windings in series become the secondary. This method of connection produces a slight step-up of voltage and is, therefore, somewhat superior to the ordinary choke coil coupling in which there is no step-up. Since the windings in the plate circuits are of very high impedance it is possible to use high mu tubes in two of the stages and take advantage of the high amplification. The last stage should never be a high mu tube. Use 201A or, better, a power tube.

R4 in the grid circuit of the first audio frequency amplifier is a 500,000-ohm, non-inductive potentiometer for controlling the volume. It is placed in the first AF tube so the current level in the entire AF amplifier will be the lowest possible for a given output. This minimizes distortion due to overloading. This is superior to placing the volume control in the last stage, because then overloading might occur in the previous stages. Distortion due to overloading may be prevented, but it can never be removed once it has crept into the signal. The grid leak resistance R6 may be of 500,000 ohms, but R8 should not exceed 250,000 ohms. A larger value may cause blocking of the last grid. A value as low as 100,000 ohms may be used without much decrease in the volume.

Grid Bias Novelty

Attention is called to the manner in which a grid bias is obtained on the radio frequency amplifier. Its grid return lead has been connected to the minus side of the filament battery and the detector tube filament and the rheostat R2 have been placed between this point and the filament of the first tube. Hence the grid bias on this tube is the voltage drop in both the rheostat and in the detector tube filament. This amounts to about 3.4 volts when the storage battery is fully charged, and about 2.8 volts when the battery is discharged. This bias may be slightly too high for the ordinary plate potentials placed on the first two tubes, and in that event the grid return lead may be connected to the negative end of the detector tube filament. Somewhat higher plate potentials may also be used both on the first tube and on the detector. In any event the error is on the right side, because it is more economical to use too much rather than too little grid bias, and with the greater bias the RF tube is more stable.

For the audio frequency tubes two small binding posts at "C" have been provided so that the proper grid bias may be given the last three tubes. Now if high mu tubes are to be used in the first two audio tubes it may be best to connect the grid returns of these two tubes directly to the minus of "A" because these tubes do not require so much bias. Then the binding posts and the battery connected between them may be used solely for the power tube, which usually requires more grid bias.

The set has been designed for a utility receiver. Hence no superfluous jacks, binding posts or dials have been included. There are only two binding posts for the output, in the last tube, and there are also two each for the antenna-ground circuit and the "A" battery, and three for the "B" battery. All posts are placed at the rear of the cabinet.

More Selectivity

Gained by Two Devices In a Simple Crystal Set

By Herman Bernard

Associate, Institute of Radio Engineers.

FOR the reception of programs from local stations, say not more than 15 miles away, a crystal set is quite serviceable, provided it is selective enough. When you mention a selective crystal set to some radio engineers they smile, but it is a fact that the selectivity depends considerably on the crystal itself, perhaps as much so as on the hookup. Therefore, one need not smile or frown at the idea of a selective crystal set when one means by selectivity the ability to tune in a station without interference from another station. If two stations are three miles or less from the point of reception, and within six or fewer channels of each other on frequency assignment, of course one can not expect the crystal set to separate them. But one knowing the limitations that exist even with selective tube receivers, and who makes allowance for lesser selectivity from a simple crystal set, will know whether the hookup, Fig. 1, will be of any use to him.

Selectivity Gained

As for the range, this is beyond guarantee or even strict limitation. Some crystal set owners, even in present days of congested ether, have received signals from stations 100 miles away or more, but this must be considered freak reception. Generally a 25-mile radius is mentioned casually, but 15 miles would be safer.

The hookup aims at selectivity in two directions. First, although the two-part primary is tuned, only a small part of the winding, equivalent to the inductance of the usual run of untuned primaries, is magnetically coupled to the secondary. This reduces the capacity coupling effect between primary and secondary, and it is this capacity coupling which hinders selectivity in many instances. Secondly, the full voltage across the secondary is not utilized for input to the crystal detector, a mid-tap being employed for the return lead. In other words, although the entire secondary is tuned by a variable condenser, C2, only half of that secondary is used for delivering radio-frequency voltage to the crystal. This lessens volume slightly, but it increases selectivity, and as the volume is all-sufficient the proper end is gained.

The small winding at lower left in Fig. 1 and the larger winding to the right of it constitute a radio-frequency transformer of the tuned type. The primary should consist of about one-quarter the number of turns on the secondary. The number of turns on the secondary will depend on the capacity condenser used for C2. For the .00035 mfd. condenser, if a 3½" tubing is used, put on 13 turns for the primary and 55 for the secondary. For a .0005 mfd. condenser use a 45-turn secondary and a 10-turn primary. The wire is No. 22 or 24, S or DCC. The other coil, the one between the aerial and the beginning of the small extra primary winding, called an impedance coil, will depend for its electrical size on the antenna capacity, the capacity of C1 and the inductance on the small primary. A 50-turn honeycomb coil may be used, and turns taken off as required, so that C1 is made to give about the same dial settings as C2.

For C1, to make certain of tuning in the broadcast range, .001 mfd. is recommended, while for C2 either .00035 mfd. or .0005 will do nicely. A basket-weave coil or a Neutrodyne coil, with proper condenser, works satisfactorily.

The only other condenser in Fig. 1 is

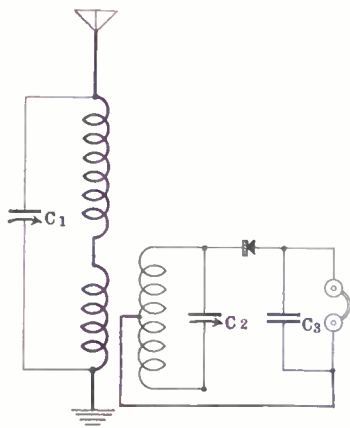

FIG. 1, the hookup of a crystal set that can be logged and which enables the reception of local stations with excellent audibility. It is one of the simplest crystal sets that render service in these days of congestion of the air.

a bypass one, which may be of any small capacity, say .0001 mfd., .00025, etc.

The crystal used was the Carborundum, which is a fixed detector.

The set has two controls and the setting of one does not affect the setting of the other.

No Baseboard Needed

First mount the two condensers. As the coils may be mounted on the panel or condensers no baseboard is necessary. Phone tip jacks will do well for the telephone connections and help to keep the cost of the completed set, including a small cabinet, below \$5. It is understood that the best apparatus is not to be used, but merely parts that work well and justify their inclusion in a crystal set.

The panel may be 7x10". If the size of the coils might occasion crowding, they may be mounted on the backs of the condensers.

Wiring Directions

Connect the aerial to the stator plates of the tuning condenser, C1, which is .001 mfd., and also to one terminal of the impedance coil, which for most conditions would consist of about 35 turns of No. 22

LIST OF PARTS

One impedance coil.
One RF transformer, secondary mid-tapped.
One .001 mfd. variable condenser (C1).
One .00035 mfd. variable condenser (C2).
One .00025 mfd. fixed condenser (C3).
One Carborundum crystal detector.
One 7x10" panel.
One pair phone tip jacks.
Accessories: Cabinet, phones, aerial wire, lead-in wire, ground clamp, connecting wire.

or 24 single or double cotton covered wire on a 3½" diameter tubing. This coil is not in inductive relationship to the radio-frequency transformer. The end of this coil connects to one terminal of the primary of the RF transformer. The end of this primary goes to ground and to the rotary plates of C1. That completes the antenna system wiring.

Secondary Connections

Now for the secondary. Connect one terminal of the secondary to the stator plates of C2 and to one side of the crystal detector (marked A on detector). The other terminal of the secondary goes to the rotor plates of C2. Now scrape off a little insulation from the wire on the secondary, about at the middle of the winding, and connect this to one phone tip jack. The other phone tip jack is joined to the remaining open side of the crystal detector (G on crystal). The fixed condenser C3 is joined, one side to one of the phone terminals, the other side to the other phone terminal. This is called shunting the phones.

This completes the wiring.

Trouble Hints

To tune in a station, rotate C2 slowly while C1 is moved much more quickly from maximum to minimum.

If you fail to hear any signals, and there is a station on the air that should be received, check over the wiring. Reverse connections to the secondary. If the wiring proves O. K., by test, then look to your phones. Usually a pair of phones will detect signals from a crystal but some phones, due to too low resistance, will not be actuated by a crystal, and many fans have condemned an otherwise serviceable crystal set when in fact the phones were at fault, and not the set.

Unit From a Cone Speaker "Pipes" the Program Upstairs

The unit used in cone speakers, where a needle or pin protrudes, affords interesting possibilities, like the one depicted on the front cover of this issue. There a girl is holding the needle against a steam heat pipe in her home. The pipe is forced to perform some diaphragm action, so that the vibrations are communicated to a room upstairs, and some audibility of the output of the set below is enjoyed. The volume will not be much unless there is considerably more power in the audio output of the set than in most home receivers. Also, if there is that much volume, of course the unit must be strong enough to handle it. To gain effect the artist made the unit on the front cover look abnormally large, in comparison to the size of the girl's hand, and it would not be a bad idea to use such

a large unit, if you can get one, to try the experiment. But with a smaller unit somewhat comparable results would be achieved.

Another possibility, which has special interest to radio storekeepers, is that the needle of the unit may be placed against the window pane. Thus music can be made to utter from the plate glass window, to the bewilderment of passers-by. Quite an increase in the number of window gazers and potential buyers would result, but to gain sufficient volume there should be power amplification behind the unit, and of course the unit should have a large current carrying capacity. The glass is usually hard to move, that is, it is difficult to set up the vibrations in it sufficiently to create more than a subdued result.

"Home-Servicing" a Receiver

By M. B. Strock

Physicist, Bureau of Standards

A RADIO set is in one respect very similar to an automobile. Both require service, and this is true irrespective of how good the product may be.

You can give home service to your radio set without having an intimate knowledge of radio or of the theory of operation of the circuit. If you do this you will not neglect the more common adjustments and repairs which are necessary for consistently satisfactory results. When trouble occurs which extends beyond your knowledge or experience you may fall back upon the service from a reliable radio shop, preferably the store where the set was purchased.

The Tinkering Habit

In the experimental group of broadcast listeners, the habit of tinkering with the set is all too common. Tinkering with the radio may be defined as the habit of meddling when there is no actual trouble in the circuit—in other words when the causes of the difficulty are external. Trouble in the radio set may be entirely imaginary. This emphasizes the importance of having in mind the fact that considerable variations in the strength of signals from distant stations will occur on different nights or even over very short periods of time during the same evening.

Before discussing the methods of trouble hunting, which must be applicable to all the more general types of receiving sets, let us divide the receiving apparatus into four distinct components. These are: the antenna or aerial; the ground connection; the source of power supply to the electron tubes in the set; the receiving set itself. One may say that this division is too general since the receiving set itself consists of many very special parts, each with a special duty to perform. It is true that the receiving set is in itself complex; nevertheless the general classification

Rough Stuff

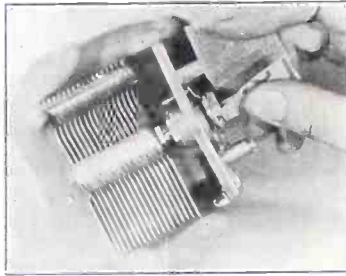

WHEN a condenser shaft and a dial shaft hole don't permit the easy-slide stunt that is so desirable, and you can't turn down the dial aperture, use emory paper on the condenser shaft.

given above is all that is needed in discussing the preliminary steps in trouble hunting. Consideration of the integral parts of the receiving set will be given as required, bearing in mind that this is not a technical treatise and that trouble arising from derangements of a complex nature or trouble peculiar to a particular type of receiving set should be referred to a reliable radio shop.

The method of diagnosis to be described will generally indicate one or more of the following conditions: (1) When the difficulties are entirely outside the receiving equipment; (2) the source of the trouble if within the receiving circuit; (3) when the correction of trouble is outside the scope of "home service." In detecting one of these three conditions attention will be given in turn to each of the four "parts" of the receiving equipment just mentioned.

Let us assume that the radio set has been giving satisfactory service for some time and then becomes noisy or insensitive. These two conditions cover a multi-

tude of sins. However, we will first turn our attention to the antenna, which for our purpose is specifically defined as the total length of wire leading out from the antenna binding post of the receiving set including the lightning arrester or grounding switch and all wires connecting to it. We will attempt to ascertain first of all whether or not the difficulty with the set is outside the complete receiving circuit.

The Antenna Set

Disconnect the antenna lead-in from the receiving set (receiving set adjusted for normal operation) and note if the disturbing noises are considerably reduced in intensity or cease altogether. If so, you may be reasonably sure that these noises are due to external causes. Their source may possibly be in your own home—electric motors or electric heating or cooking appliances. Again, these noises may be caused by more distant electrical disturbances of many sorts, or heterodyne whistles from broadcasting stations or receiving sets. Just before disconnecting the antenna you must note very carefully the character of these noises, otherwise you may confuse them with noises originating in the receiving circuit which are caused by its being thrown into an unstable condition by the removal of the antenna lead-in. With some receiving sets a readjustment to a condition of less sensitivity may be necessary before the antenna is disconnected.

Loose Connections Frequent

If the test just described fails to definitely locate the source of trouble, it should be repeated by disconnecting both the antenna lead-in and the ground wire from the receiving set. This brings up the question: "Assuming that the disturbing noises are now shown to come from the receiving circuit, how can one tell that they are not caused by some defect in the antenna or in the ground connection?" This question is a natural one, and since the antenna and ground are a part of the receiving circuit we are ready to begin the tests which bear upon the second point in the method of diagnosis—the location of the trouble within the receiving circuit.

An apparently "insensitive" condition of the receiving set may be caused by a loose connection in the antenna or ground wires. It is a simple matter to examine the ground wire and determine if it is intact. This should be done while the set is tuned to the local station, and particular attention should be given to the point of contact of the ground wire with the water or steam pipe. In the event of an insecure contact, a grating sound will be produced in the phones or loudspeaker when the wire is shaken slightly.

The Antenna Examination

An examination of the antenna is, for evident reasons, not nearly so convenient, and indeed many broadcast listeners prefer to leave this to a radio service man. This action should be taken only after tests upon the receiving set itself fail to indicate the difficulty. If the antenna has been carefully installed, it is not likely to give trouble. Most antennas are equipped with a lightning arrester, and this is a possible source of difficulty. While the receiving set is adjusted as for normal operation the wire leading from the light-

Flux Removes Barricade So Solder Will Make Joint

The function of the brown jelly-like paste which must be put on wires before they can be successfully soldered is a mystery to some radio fans. They all know from experience that the molten solder will stubbornly roll off the wires unless some paste is employed. What real action does the paste or "flux" perform? The paste itself does not make the solder adhere, but it does remove an agent which otherwise would prevent the soft metal from adhering, according to F. A. Klingenschmitt, head of the Service Department of the Sleeper Radio Corporation. This agent is a thin chemical compound film formed on the surface of the metal when the hot soldering iron is applied to it. The metal, under the influence of the iron's heat, combines with the oxygen that is part of the air, and its exposed surface becomes coated with an invisible layer of the new material, which is known chemically as an "oxide."

This newly created film effectively prevents the liquid solder from reaching the actual surface of the wires being connected. Unless the oxide is removed the

solder will not stick, regardless of the heat of the iron or the quantity of solder applied. The hotter the iron, in fact, the more oxide that is formed.

Now the specific purpose of the soldering flux is to absorb the film of oxide as quickly as it is generated. The paste combines with the film, the chemical reaction producing harmless substances which do not affect the soldering operation.

Soldering fluxes take the forms of solids and liquids. Muriatic acid in which pieces of zinc have been dissolved is a common liquid flux, but it is highly undesirable for fine radio connections because it is strongly corrosive. Ordinary rosin is regarded as the best flux for radio work because it does not corrode metal and causes no electrical leakage troubles.

One interesting thing, Mr. Klingenschmitt explains, is that aluminum cannot be soldered by ordinary means because it possesses a natural film of oxide which standard fluxes cannot dissolve. Special chemicals and solder must be used on this particular metal.

Radio World's Booklet on "1926 Diamond of the Air" mailed on receipt of 50 cents, including Blue Print FREE. Address: Diamond Editor, Radio World, 145 W. 45th St., New York City.

Trouble-Shooting for Novices

ning arrester to ground should be disconnected. If this causes a noise in the loudspeaker it indicates that the lightning arrester is defective.

So far no mention has been made of the coil antenna, more commonly called a loop, which in some receiving sets replaces the antenna and ground. Since this is simply a coil of wire the probability of its being defective is extremely small. If one terminal of the coil antenna is connected to one terminal of a B battery, and the terminals of the phone or loudspeaker are touched to the free terminals of the coil and B battery, a sharp click will indicate that the winding is continuous.

The Power Supply

We will now turn our attention to the power supply for the electron tubes in the receiving set, and although it may seem out of order to place this ahead of the receiving set in the discussion, the reason is that there is a greater probability of trouble here than in the set itself. The trouble originating in either the receiving set or the power supply may be evidenced by noise, insensitiveness or silence.

The power supply to the receiving set may come from batteries or from an attachment to the electric lighting circuit. The latter device is less likely to get out of order. An inspection of the rectifier tubes (in case alternating current is employed) to see that they are making proper contact in the sockets and that they are not burnt out and an examination of all external connecting wires is about all that can be done in the home service plan. This failing to disclose the trouble, the device may then be referred to the service station provided the subsequent examination of the set discloses no further difficulty.

Battery Tests

The battery supply for the receiving set may be storage batteries or dry cells. Examine the wires leading from the batteries to the receiving set to ascertain that there are no loose connections or misplaced wires. Storage batteries should be tested with a hydrometer for condition of charge. If the charging operation requires disconnecting the wires leading to the receiving set, be sure that these connections are not reversed.

Dry cell A batteries are rather limited in their length of service. Without having recourse to an ammeter, an idea of their condition may be obtained by noting the settings of the rheostats on the receiving set, assuming that the set is capable of receiving a local station. If the signals increase in volume as the rheostats are turned all the way around to the right, the dry cells should be discarded and replaced with new ones.

B batteries should, if possible, be tested with a voltmeter, and if the voltage of a B battery unit normally registering 22.5, drops below 17 or 18, the battery may be thrown away. The term "noisy" as applied to a B battery is a misnomer. The battery itself can produce no noise, but it may be in such condition that it delivers an unsteady current. Touch the tips of the phone cords to the B battery terminals, being careful to secure firm contact, and listen for any sounds other than those by the operation of making connections. This test will, incidentally, serve to indicate a break in the circuit of the phones or loudspeaker.

Cause May be External

The tests which have been discussed may disclose the fact that noise in the

Putting on the Quietus

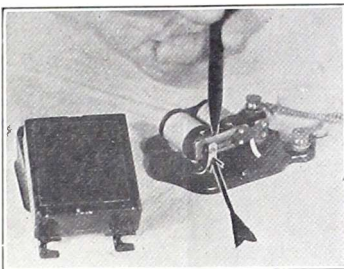

SOME folks can hear the door bell or buzzer through the speaker, due to the use of a sensitive set. Put a 1 mfd. condenser (shown at left) between the contact points (shown by pencil and arrow). One side of the condenser goes to arrow point, the other to pencil point. (Hayden.)

radio circuit is due to external causes or they may indicate that the source of trouble is in the antenna, ground, or power supply. In the latter event, if the trouble cannot be located and corrected, it will be necessary to call upon a service station.

We will now consider the receiving set itself, confining our attention to the most common sources of difficulty, which happily do not require an extensive knowledge of radio for their detection. The examination of the source of power for the electron tubes should have revealed any difficulty which would render the set entirely "dead." With this thought can be mentioned that unfortunate mistake of connecting the plate supply voltage to the A battery binding post of the set. It goes without saying that in this case it will be quite necessary to consult the radio store, not for service but for new tubes. If the tubes are intact and the set is incapable of producing sounds, it probably has some rather serious derangement which cannot be readily located by the home service plan.

Tubes and Sockets Lead

The most common source of trouble within the radio set is in the electron tubes or the sockets. Connect the phones to the set so that the minimum amount of amplification is used, then ascertain which tubes are functioning, by removing all others from the sockets. Let us say that the set is so constructed that two tubes are now in use. Substitute as many tubes as are available in turn in these sockets and note any difference in sounds produced in the head phones. This will not only serve to locate a defective tube but it will frequently disclose the fact

that the tube is making poor contact in the socket. Hence, examine the contact springs in the sockets and the pins on the tubes and if necessary clean the contact surfaces with fine sandpaper.

AF Stages Tested

The phones or loudspeaker are now plugged in so as to include another stage of amplification and the same tests are repeated. This procedure will often indicate that the trouble is in the audio stages of the receiving set.

Although the nature of this article prohibits going into a detailed discussion of all the various parts of the receiving set, nevertheless attention may be called to one particular part which is well known to the non-technical person, namely, the grid leak. This will usually be found mounted near one of the electron tubes. It should be removed to ascertain the effect upon any noises in the headphones. If possible, another grid leak should be substituted. Among other parts of the receiving circuit which may receive attention here are the variable condensers. If dirt has accumulated between the plates of these condensers it should be carefully removed. Loose connections to the rotating condenser plates are often a source of trouble. This will generally be made evident by rotating the condenser knobs and listening for scratchy sounds in the headphones. The reference to the variable condensers brings to mind the fact that every radio set should have a careful overhauling at least once a year, and although details of this overhauling process cannot be given here, it includes the important point of examining all connecting wires in the circuit to reveal any loose or broken connections.

Ask Neighbor's Report

In attempting to locate any difficulty with your receiving set which falls under the home service plan, keep in mind the fact that poor reception may be due to conditions outside your control. In many cases it would be preferable, instead of jumping to the conclusion that something has gone wrong, to get in touch with your neighbor and compare the results obtained with your set with the results which he secures from his own equipment. In some instances at least you will find that some apparent trouble in the radio circuit was due in part to a period of perhaps three or four days when receiving conditions were unusually poor. The radio set is, as previously suggested, similar to an automobile in that it requires servicing, but on the other hand the troubles arising from the use of the radio set may not be at all comparable to troubles with an automobile since in the former case they may be due to conditions beyond your control.

Sets Banned in Girls' College; President Airs Odd Ideas

BALTIMORE.

Goucher College had a radio bargain day, because President William W. Guth banned sets.

Radio is responsible for late hours and consequent loss of efficiency and "pep," Dr. Guth told the students. In the business world, he said, it is easy to pick out the men who own radios. In the morning their faces tell. Therefore the radio ban, "for the physical as well as the mental welfare" of Goucher girls.

Dill Bill Hearings Will be Resumed

WASHINGTON.

Hearings will be resumed in the Senate Interstate Commerce Committee on the Dill bill to give the Secretary of Commerce additional authority to regulate radio, according to Chairman James Watson. Senator Watson will not predict how long it may take his committee to decide on a radio bill.

The 2d Step in the Fenway

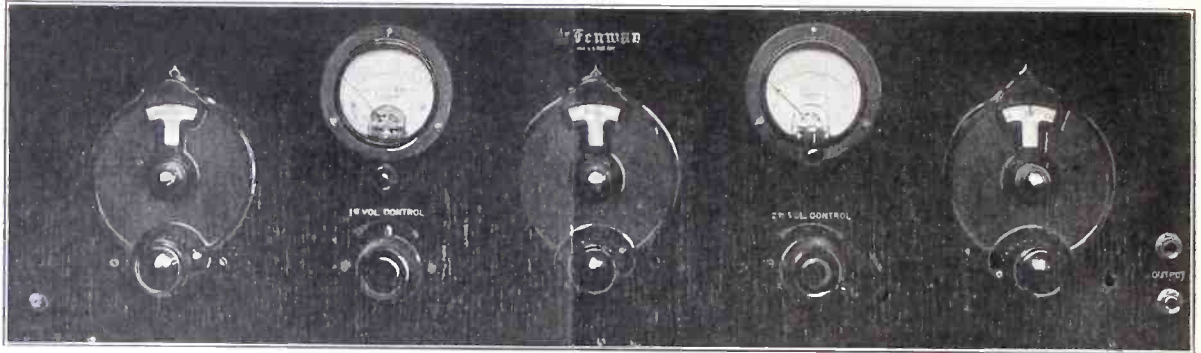

THE PANEL view of the Fenway, shown photographically. A $\frac{1}{4}$ scale dimensional layout was published in the February 6 issue.

By Leo Fenway

Copyright 1926, by the Author. All Rights Reserved.

PART II.

THE Fenway Super-Heterodyne is not a trick set; moreover, it is not the dream of an overenthusiastic radio bug. The receiver grew out of a series of private laboratory experiments on cascade amplification, which at first involved only a cascade amplifier working at the frequency of the incoming carrier wave. Naturally the writer looked with objective eyes at that first low wave amplifier; it was a mere youngster then, but it grew and nobody watched its growth with keener appreciation than the fellow who is writing this series of articles. Of course the number of tubes increased and the set gained in selectivity, sensitivity, clarity and power, as well as in musical and educational wealth of possession.

During the interim every known type, make, brand and name of medium frequency transformer was tested, and the characteristics and peculiarities of each noted. These tests lasted five years. Obviously many things pertaining to supers were revealed. Perhaps the most valuable discovery was the fact that ninety-nine one-hundredths of the supers that failed to give satisfaction were carelessly assembled.

How to Succeed

As often as not the parts used were O. K., the circuit itself was efficient, but the trouble lay in the man who constructed the set. When one has a good circuit to follow, knows the exact parts to use and how to use them, the construction of a Super-Heterodyne ought to be as simple as that of a 3-circuit tuner; in fact, it really is much simpler only there is more of it. For example, a wire leaves a tube socket (plate) and goes to a transformer (plate), it leaves that same transformer (grid) and goes to a tube socket (grid), and so on to the next transformer and the next tube. Could anything be simpler than that? But, of course, the home-constructor must know the exact parts to use. So, in order to save the belated builder from the turmoil of last minute selection of material—then the doubts and wonder whether he selected the right part for the right place, I am citing the exact instruments used in the original set from which these specifications were made.

I might mention here that in the original set special "sockets" were provided for the medium frequency transformers. These consisted of Bakelite strips, $1\frac{1}{2} \times 3$ ", upon which were mounted

four General Radio jacks, No. 274-J. General Radio contact plugs, No. 274-P, were attached to another and similar strip of Bakelite and this was fixed to the intermediate transformer. This scheme enabled the writer to test out any type of transformer, it being, as it were, merely a "plug-in" transformer. Silver Marshall and General Radio transformers proved most efficient.

Last week I told you how to construct the first three tubes of the Fenway super. This week I will explain the intermediate frequency amplifier and the second detector.

Now examine the wiring diagram in Fig. 7. Note that the Royalty high resistance is connected into the circuit of the B battery plus $67\frac{1}{2}$ volts. When the set is in operation this resistance will be advanced from one-half to three-quarter way on and under no conditions should it be necessary to use more than $67\frac{1}{2}$ volts in this part of the circuit.

Assuming that you have carried out the instructions given last week, and that you have the first two tubes working, you should now test the oscillator circuit. First of all, are you quite sure that you connected the Silver Marshall "socket" into the circuit rightly? And did you

LIST OF PARTS

For 2d Detector and Long-Wave Amplifier
Three Silver Marshall transformers, type 210.

One Silver Marshall tuned transformer, type 211.

Or three General Radio medium frequency transformers, type 271, and one General Radio tuned stage transformer, type 331.

Four Airgap vacuum tube sockets.

One General Radio potentiometer, type 214-A, 400 ohms.

One General Radio rheostat, type 301, 6 ohms.

One Royalty high resistance, type B.

One Yaxley single circuit filament control jack, No. 3.

One Yaxley double pole, double throw switch, No. 60.

One Micamold grid condenser, .0005 capacity, with clips. (Note capacity!)

One Micamold bypass condenser, .005 capacity.

Two Micamold bypass condensers, 0.5 mfd.

One Micamold resistor (grid leak), 5 megohms.

One Jewell double reading voltmeter, No. 55.

One special Jewell voltmeter, 0-8-80-160 volts.

Four Cunningham standard tubes.

scrape and file those contact buttons at the bottom of the coil? Well, that's fine! Because if you slipped on these things the chances are that your oscillator circuit will not work. The only other possible sources of trouble in the oscillator circuit are (1) a short circuited turn in any of the coils, (2) a short circuit or high resistance in the condenser C3, (3) grid and plate connections reversed, or (4) a "dud" tube.

Wavemeter Test

Now place the oscillator tube in the socket, and with the temporary connections still attached to the jack (as explained last week), put on your phones and listen again for the buzzer signal of the wavemeter. (Of course you constructed that simple wavemeter shown in the first assembly? If you didn't, by all means build one right away. There is no better way of building a multi-tube set than with a wavemeter as your guide).

Tune the two dials, condensers C1 and C2, from 0 to 100. Somewhere on these dials and at a certain setting of the oscillator dial the buzzer signal will become "muffled." In fact, this oscillation condition will be apparent at both the upper and lower ends of the two tuning condensers, C1 and C2, and should be in effect over the entire tuning range. If the oscillator fails to "mush" the buzzer signal over the whole range it indicates that one or both of two things are wrong. Either the range of the oscillator coils and condenser do not agree with the other two units (L and C1 and L1 and C2) or the oscillator tube is not working satisfactorily. The remedy is to add or take away turns of wire (only a few!) from the oscillator coils or put a new tube in the oscillator socket. You must get those first three tubes working before going farther. Otherwise you will likely be trying later on to amplify signals that the first tube does not receive or that the oscillator does not heterodyne. The average super is a "flop" right at this early stage of the game. You who build this super can profit from the mistakes of others—get those first three tubes working! The rest of the set will almost take care of itself. If you have been figuring out how you can save one tube by reflexing the first two or the first and third, forget it. It takes a genuine radio engineer one year to make a second harmonic super work, and even then the results are far from satisfactory.

Mounting Advice

You should now mount the parts for the intermediate frequency amplifier. Directly behind the special coupler mount the input transformer. (Whether you use

Schematic Diagram of the Fenway

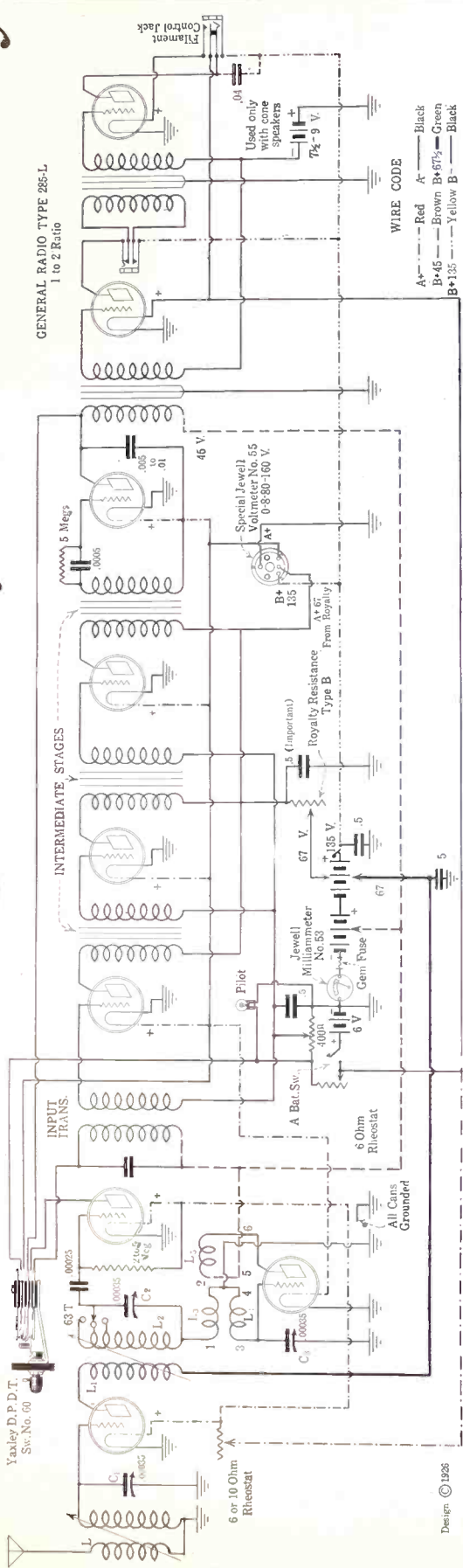

THE 9-TUBE FENWAY SUPER-HETERODYNE. The first tube, upper left, is on the stage of tuned radio-frequency amplification, at the original signal frequency. The tube next to it is the frequency-changer, sometimes called modulator or first detector. The tube below is the oscillator. The input transformer and the three other medium frequency transformers follow the frequency changer, left to right. The detector is the third tube from right, followed by the two audio tubes. The DPDT switch enables the use of a 4-tube tuned RF set or a 9-tube Super-Heterodyne at will.

Silver Marshall or General Radio transformers the INPUT must be tuned—not the output!

Next mount the Airgap sockets and the intermediate transformers. (The primary side of each transformer should face the subpanel.) Before mounting the last transformer the General Radio potentiometer should be screwed to the panel. If the wires that should be attached to this instrument are put in place before mounting it will save time and trouble. After the potentiometer, a 0.5 mfd. should be soldered to the last can, either inside or outside. Another 0.5 mfd. condenser should be placed in the center can and soldered.

The grid condenser, .0005 capacity, should now be soldered with a short piece of bus to the grid of the last transformer and to the grid of the second detector tube socket. The filament control jack comes next. Then, on the subpanel, the 6-ohm rheostat and the Royalty resistance. Once these last two instruments have been set they will not need to be changed—that explains why they have been placed on the subpanel instead of on the main panel. The Micamold .005 fixed bypass condenser should now be mounted from the plate of the second detector to the PLUS A battery. Now insert the grid leak, which should be a Micamold 5 meg. Mount both Jewell meters, placing the milliammeter directly over the special coupler, the voltmeter over the potentiometer. Now mount the Yaxley double pole, double throw switch on the subpanel. The connections for this switch are clearly shown in the diagram of Fig. 7.

The intermediate frequency amplifier should now be ready for wiring. It is advisable to use round bus on the grid and plate leads, and these leads should be clear of all other wires and free from spaghetti or other covering. All the filament wires, and all the wires not connected to live grid leads should be cabled or bunched together and tied very tightly with string. The plate lead that runs from the Yaxley switch, No. 60, to the first audio transformer (for the four tubes), should be included in this cable.

If you "hate" the job of soldering make an eyelet in the wire with round nose pliers and trust it to a binding post.

Resistance Factors

Most binding posts are capable of making perfectly good contact, and remember that contact is the thing desired. Mechanical strength and security are needed, of course; but, electrically, it makes no difference whether you use solder or a paperweight to hold two wires together.

If you're worrying about the amount of resistance that is likely to creep into your wiring, then use silver wire rather than copper wire. Silver is supposed to be a better conductor than copper, and theory says that the lower the resistance the better. However, the writer's set was wired with copper wire, and it sure does its stuff.

For the most part the leads will be very short, with low interaction among the radio circuits.

Now a little about the medium frequency amplifier. While all radio writers are forced to agree that the Super-Heterodyne approaches the ultimate in radio receivers, their ways part when they begin to discuss the number of intermediate stages to use or the frequency at which to operate, one group maintaining that two stages at such and such a frequency should be used because it is better (they claim) to operate two stages at maximum efficiency than to operate three stages at half efficiency. Another body of men maintains with equal stoutness that air core transformers are far more efficient than iron core transformers and vice versa. Engaging in such a contro-

Tests to Make in Building Set

versy is treading upon unsafe ground, for such a basis for classification simply does not exist in so far as the layman is concerned. Mr. Average Radio Fan builds a super thus and so, and, like his oscillator circuit, it either works or it doesn't. Two stages of medium frequency amplification were tried out in the Fenway, and while the volume was very good, the selectivity fine, the sensitivity was less than that obtained with three stages. As often as not a set is selective enough, in that there is a dead spot on the dials between local stations, but in that dead spot nothing apparently ever happens. Sensitivity renders such spots alive.

However, in order to use three stages of medium frequency amplification with—01A tubes there must be some means of suppressing or controlling oscillations. But any attempt at neutralizing the stages will certainly cut down the volume as well as the sensitivity of the set. In the case of the Fenway set violent oscillations in the intermediate stages will not take place because of the extremely short leads from grid to grid, plate to plate and because the amount of B battery actually used in the intermediate amplifier is very, very small.

Efficiency of Sockets

Everybody knows that tubes require sockets, except when working low waves. Then many amateurs not only omit the socket but take the base off the tube. The idea is to reduce the capacity between grid and plate themselves. It is common knowledge that insulation, however good it may be, creates material losses due to absorption in any varying magnetic or electrostatic field, the latter always being accomplished by a magnetic field if it is in motion. Obviously, then, the best insulator is dry air or glass. The Airgap socket used in the Fenway, with an air gap between grid and plate binding posts, has the same effect as omitting the socket entirely. You get air for the dielectric between the leads with less capacity effects across these points and a much higher resistance path, because no dust can collect. It is quite evident, then, that since you use your head for something else besides a place to hang your hat you should also use your tube socket

LIST OF PARTS FOR FOUNDATION UNIT

- One antenna coil, interchangeable for waves from 35 meters to 550 meters, Silver Marshall, type 110-A. (L.)
- One special coupler, General Radio, type 268. (This coupler to be rewound as shown in Fig. 4.)
- One special oscillator coupler, Silver Marshall, type 111-A (L3L4L5).
- Two Silver Marshall "Sockets," type 515, for above two couplers.
- Three General Radio straight-line wavelength variable condensers, type 334-F, or type 247-F, .00035 capacity (C1, C2, C3).
- One Bakelite panel, 8x28x3/16", drilled as per Fig. 2.
- One General Radio rheostat, type 301, 6 ohms.
- Three Airgap vacuum tube sockets.
- One Yaxley A battery switch.
- One Yaxley pilot light.
- One Yaxley double circuit jack.
- Three National Velvet Vernier Dials, type B, (new).
- One Micamold grid condenser, .00025 capacity.
- One Micamold .5 mfd. fixed condenser.
- One Micamold resistor (grid leak), 2 megohm.
- One Micamold grid leak mounting.
- One Subpanel, Bakelite, 4x12".
- One Gem safety fuse and fuse holder.
- One General Radio tap switch, No. 171F.
- Three General Radio taps, No. 138D.
- One piece of Bakelite, 2½x2½x3/16".
- Seven Eby binding posts, antenna, ground, minus A, plus A, minus B, plus B detector and plus B amplifier.
- One set of four special copper cans.
- One hardwood baseboard, 9½x27½x1½".
- ¼ lb. No. 32 copper wire, double silk or double cotton covered.
- Fifty feet of Celalstite wire or Western Electric printing telegraph wire. Colors used: Red, green, black, brown and yellow. This item should be purchased in the following lengths: Red, 15 feet; black the following lengths: Red, 15 feet; black, 15 feet; yellow, 10 feet; green, 5 feet; brown, 5 feet.
- Three Cunningham standard tubes, CX301A.

for something else besides a receptacle for the tube itself.

The Long-Wave Amplifier

The intermediate frequency amplifier and the second detector are usually tested at the same time. If the intermediate frequency amplifier is wired correctly and if the tubes are O. K. there is very little likelihood of trouble, when the proper battery voltages have been applied. If there is trouble of any nature in the amplifier it can be located through the process of elimination.

Beginning with the input transformer, test the primary and secondary for continuity of circuit. The voltmeter on the panel can be utilized for this purpose. With the minus A connected to the minus post on the voltmeter connect another wire it is possible, by noting the reading, ment to be tested in series with this plus wire it is possible, by noting the reading, if any, on the voltmeter, to tell the condition of all transformers. If a 6 volt battery is used the reading will be slightly less than 6 volts. If there is no reading on the voltmeter either the primary or secondary windings are defective. Fixed condensers can also be tested with the voltmeter, only, of course, there will be no reading when the condenser is O. K. Large bypass condensers tested in this way will give the voltmeter a slight kick as the condenser charges, but this does not indicate a defective condenser.

Test all the connections on the intermediate frequency amplifier; see that none of the connections between the transformers and sockets are reversed. (The terminals marked "G" on the transformer must be connected to the grids of the tube sockets.) The plate leads can be connected to either of the primary terminals; it is customary to connect plate to the terminal at the extreme opposite end of primary from grid. Test the intermediate frequency amplifier together with the rest of the set, using the buzzer as before. Keep moving the wavemeter further and further away until the signal is barely audible in the phones. Don't try to rush things.

[Part I of this article was published last week, issue of February 6. Part III will be published next week, issue of February 20.]

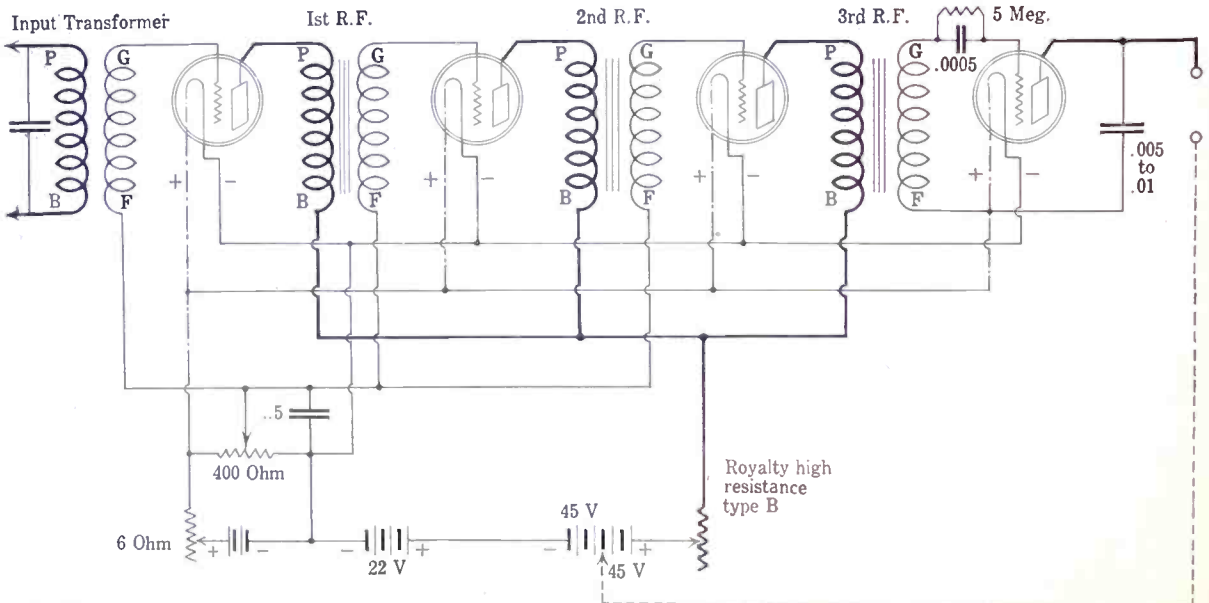

Better Phone Work Is Needed

It has always been our impression that the amateurs were doing altogether too little good phone work. The way they deserted the higher wave bands for those of 80 meters and less for C. W. shows this.

Now that phone work is permitted on the 80-meter band perhaps we will think things adjusted. It seems to us, however, that matters are made worse.

In the first place, our wholesale desertion of the 150-meter and above range shows that as a class, we are not interested in phone work. This gives those interested parties who want that region for their own work a very good argument against the amateurs holding it.

Besides, we really should not want to clutter up the low range with broad phone stations. This has already been decried for the 150-meter band when that was the amateur "low."

Get up on that original phone wave strip, say we, and save that band for the "hams." There's a lot of good phone developmental work to be done, and we may need it badly some day!

Dah—Dit—Dah—Dit—Dah!

By Irving Philip Wolfe

2APJ

Colonel Clair Foster of Carmel, Calif., is doing some remarkable DX work at present. He has a regular schedule with India 2 BG, owned and operated by G. W. G. Benzie at Udarband, Province of Cachar, and with NGY, the radio station aboard the USS Helena off the coast of China.

Lieut. H. P. Roberts at Fort McKinley, Rizal, Philippine Islands has a station that is consistently reported in the British Islands.

6 OI, Brandon Wentworth, is another prominent "ham" who is piling up records. He has been reported by g2 SZ in London and is in daily communication with NTT, the USS Scorpion, now cruising in Mediterranean waters. He also is one of the first hams in the sixth district to be QSO South Africa. He has established contact with Zero A3B located at Durban. Wentworth is using a maximum power of 200 watts.

The South Dakota State Radio Convention will be held on Feb. 12 and 13 at Vermillion, S. Dak., under the auspices of the University of South Dakota. Consistent with past practice at state radio conventions, various tests will be held. Anyone interested in the convention should write immediately to the Coyote Amateur Radio Club, c/o Elec. Eng. Dept., University of South Dakota, Vermillion, S. Dak.

While we are on the subject of conventions I want to remind you of the usual ERCO mystery night put over every year by the Executive Radio Council, Second District, at their annual convention. This year ERCO night will be on March 12, right in the middle of the convention week.

Next week I will describe the receiver used at 2AAU. He is now busy fixing up his new "place of business," and therefore could not get at him.

2 FZ, one of the best known hams in the world, is having quite a bit of trouble getting down to 40 meters. It's not like the old days on 200, eh? Some of you may remember when Frimmerman used to send out the "moosic." He was one of the first hams that used fone in New York City.

By the way, the Powerola Radio Corp., of 1845 Broadway, New York City, has issued a very interesting and practical booklet giving a complete history of the past and present effort along the lines of operating receivers from the electric light socket. It sure has some valuable information in it.

c5 GO worked 3h2 LD and got a wow of a report from him. Earle Chang, the owner of c5 GO is located in Vancouver and has also recorded authentic reception of Justno Justi, bz2 AB, Sao Paulo, Brazil. He also states that a friend of his living in Vancouver is consistently receiving England. This is the first report of British Columbia amateurs receiving England and makes another link in our chain of amateur achievements.

Manhattan fans find great pleasure in visiting 2 AAU at his office at 17 West 42nd St., Room 226. MacDowell is thinking of installing a short-wave receiver in the place.

[Address all news, calls heard and queries to 2 APJ, Amateur Editor, RADIO WORLD, 145 West 45th St., New York City, or call 2 APJ on the air, 40 or 150 meters].

CALLS HEARD

At 2 AAN, 19 Marshall Road, Yonkers, N. Y.

U. S.—6 AFG, 6 AAK, 6 AEL, 6 ALA, 6 API, 6 ASE, 6 AVJ, 6 BHZ, 6 BLS, 6 BQR, 6 BTL, 6 BVS, 6 CAX, 6 CCO, 6 CGW, 6 CIX, 6 CQA, 6 CRF, 6 CSR, 6 DAI, 6 DAH, 6 DAB, 6 DBE, 6 FM, 6 IH, 6 JP, 6 KB, 6 ML, 6 OH, 6 OI, 6 QR, 6 TN, 6 TS, 6 SB, 6 UE, 6 VC, 6 YB, 6 ARY, 6 CUW, 6 ALW, 6 AQP, 6 APK, 7 DD, 7 OZ, 7 JF, 7 SB, 7 TK, 7 UQ, 7 VV, 7 WU, 7 UZ.

A.—2 YI, 3 AD, 3 BM, 3 KB, 3 IM, 4 AN.

B.—4 RS, 4 YZ.

F.—8 AIX, 8 CA, 8 GI, 8 EU, 8 JN, 8 YOR.

G.—2 SZ, 2 KF, 2 WJ, 2 XY, 5 DH, 5 MA.

I.—1 GW, 1 ER, 1 MD, 1 NO, 1 RM.

CS, OKI.

N.—PC7, PCLL.

Q.—2JT.

S.—eAR6.

R.—aa 8.

M.—1 N, 1 b, 1 K, 1 g.

O.—(Zero)—A4L, A3E, A3B.

Z.—1 AO, 1 AX, 2 Ac, 2 ZA, 4 AK.

Bz.—1 AC, 1 Ab, 1 AN, 1 AP, 1 BC, 1 BD,

1 IA, 1 BU, RGT.

Pr.—4 JC, 4 UR.

Russia.—RRP.

NAH, NAW, NBP, NFV, NIVD, NISM, NISN, NOSN, NPL, NPM, MKF, NKF4, VVY, WYD, AF2, BFG, SDK, NTT, NARI, NPG, NVA.

L.—9K.

K.—Y8.

8 DNO, 60 East Ridge Ave., Crafton, Penna. (40 meters) U. S.—4 AAH, 4 FA, 4 FL, 4 FW, 4 KJ, 4 KN, 4 KX, 4 MV, 4 OY, 4 UZ, 4 WE, 5 AUA, 5 SW, 5 UP, 5 YB, 6 AAK, 6 AEL, 6 BA, 6 BAU, 6 BAV, 6 BIS, 6 BPN, N CHL, 6 CTO, 6 CUW, 6 DAI, 6 DAT, 6 DBL, 6 CT, 6 JI, 6 NX, 6 QD, 6 RV, 6 VR, 6 WT, 7 FL, 7 LU, 7 SF, 7 VQ.

Misc.—i1 AS, pr4 AB, hu6 BUC, f8 DK, f8 WW, m1 AA, m9A, m1X, PCJJ, WAW, NOSM.

1 AOA, H. B. Churchill, St. George's School, Newport, R. I. (40 meters, Jan. 30).

2 AGT is having some trouble with QRM from the trolley cars, electric division of the N. Y. Central, and the New York City subway system since he moved. He is right in the center of it all and the racket is ear-splitting.

COMING EVENTS

MARCH 8 to 13—Annual Convention and Show, Executive Council, Second District, at Hotel Pennsylvania, N. Y. City.

Casem's Walloper Shown in Its Lair

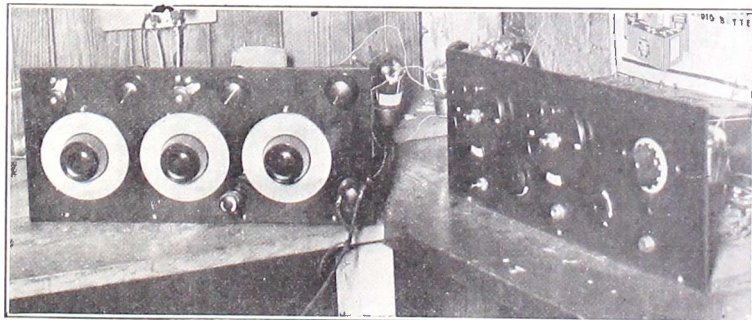

THE receiving equipment used at 2KW, the New York Evening Telegram's powerful amateur transmitting station. To the right, the short wave Reinartz receiver, which has a range of from 10 to 85 meters; to the left, the 5-tube receiver used to cover the broadcast wavelength stations from 150-600 meters. This receiver employs two stages of tuned radio-frequency amplification, a regenerative detector and two stages of transformer-coupled audio-frequency amplification. David Casem is the engineering genius of the station. (Foto Topics).

RADIO WORLD'S

Laboratory

Reports for the Guidance of Its Readers

Address problems to Laboratory Director, RADIO WORLD, 145 West 45th Street, New York City.

The Choice of Parts Rheostats, Sockets and Transformers

VERY often constructively inclined radio fans forego the construction of a radio receiver widely exploited and admittedly good because they cannot obtain the parts specified by the author of the article, being under the impression that it is imperative to use only the parts specified, that is, the identical manufacture. Were one to use a part of similar electrical characteristics but of different manufacture the proper results would not be obtained.

This paper is the culmination of a series of tests conducted to determine the necessity of adhering to the list of parts as specified by various authors. A large number of parts of the various units which comprise a receiver was tried and tested in various combinations to determine the detrimental effect of using parts of specified electrical characteristics, but of different manufacture. The results were both interesting and of economical value. A description of the methods of measurement and test are unnecessary, and we will delve into the facts as ascertained. The first item shall be the rheostat.

The Essence of the Rheostat

Essentially the rheostat is a control unit possessing a certain value of resistance designated in ohms and with a current capacity of a certain number of amperes, or a certain fraction of an ampere. The adherence to the use of the rheostat as specified is a problem having two aspects. The first and major is the control action of that rheostat in the complete receiver. Does its operating action manifest a big effect upon the operating characteristics of the receiver? Does it control oscillations, except until variation is necessary to set up local oscillations and thus render the receiver unstable? Is it used to control the filament of a tube which is critical in filament operation. Or is the rheostat just used as a means of applying the required filament voltage and is it to be left in that position without any variations, except until variation is necessary due to the decreased voltage output of the storage battery.

If the answers to the first four questions are to the affirmative the rheostat mentioned in the article should be used, as it possesses the proper electrical constants which are essential to the correct operation of the receiver. That is, it is known that the resistance unit specified has the correct constants, and further experimentation on the part of the fan constructor will be unnecessary insofar as the operation of that unit is concerned. Expressed differently, the rheostat quoted will afford the desired filament control.

Where Choice Range Exists

It is possible of course to have a rheostat of a different manufacture which will possess the same resistance and current capacity values and thus afford the same control action, but this necessitates a hunt by the fan for this rheostat. It is

entirely within reason that the author obviate the necessity of this uncertain hunt by specifying the name of the manufacturer of the product. On the other hand, where the rheostat is not of great import, such as the filament control of audio-frequency tubes, the name of the manufacturer has no significance, and it is not imperative that the fan follow the instructions and purchase the unit specified. Of course the unit should be of such electrical constant as to be adaptable to the work. That is, if a power tube is to be controlled, and a 2-ohm, 2-ampere rheostat of X manufacturer is specified, a 4- or 6-ohm rheostat with the same current carrying capacity, of B manufacture, is suitable. If another rheostat of C manufacture with 2 ohms and 2 amperes capacity is available, it can be used with perfect safety in place of the one specified in the article, since the resistance and current constants are identical. Thus we see that the important factors are the resistance and current constants, and all units of similar constants are interchangeable. This is made possible by the fact that efficiency factors play no part where rheostats are concerned, since the unit itself is intrinsically a lossier device.

Choice of Sockets

The item next in line is the socket. While there is a difference electrically between sockets of different manufacture, the general run is for all purposes and uses for reception on the regular broadcast band entirely satisfactory, and one socket is about as good as another. Therefore it is not necessary to use the socket specified. If another socket of known reputable manufacture is available, use it. No difference will be noted. Of course if the selection is very poor and the item is purchased simply because it is less expensive the deficiency will present itself, usually noticeable as poor stability, decreased volume and even distortion. Before concluding sockets, one fact must be brought to mind. This is the resiliency of the socket contacts. While this is not an electrical consideration it evolves itself into one during the operation. A contact lever of poor quality material after a certain period of usage will fail to spring back into normal position when the tube is removed, and upon reinsertion of the tube the contact between the tube prongs and the socket leaves will not be so good. The safeguard is the acquisition of reputable products.

Fixed condensers are akin somewhat to rheostats and sockets. As in the case of the rheostats, the position of the capacitive unit governs the exact choice. If it is used in a position where the capacitance value must be accurate, as in some wavelength tuning circuits, it is best to use the make specified, thus again benefiting by the experiences of the author. His selection is based upon the knowledge that the one he mentions has the desired accuracy. Furthermore in many instances

Removing Enamel

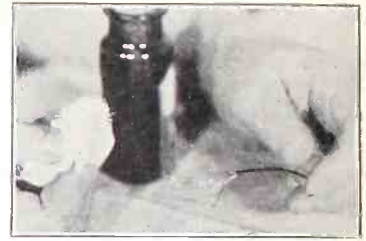

LITZ wire is enamelled. Hence getting off the enamel at the terminal to make connections is not so easy—unless you simply rub it off with amyl acetate.

these units are made especially for that circuit. However, if the condenser is used as a grid condenser or as a blocking or bypass condenser, the exact specified one need not be purchased, providing the one bought has the required capacitance value and is of equal efficiency. In this item efficiency is of importance. This is especially true of bypass condensers, since a bypass condenser which is not electrically efficient invariably will result in some costly effect, usually run down B batteries.

The selection of audio frequency transformers presents a much greater problem. Herein must be displayed the faith of the reader in the author, or the reader's knowledge pitted against that of the author. This is brought about by the fact that no two transformers of different manufacture will afford the same results. In this line one man can not specify to the majority the proper item, since tastes differ and various transformers certainly do produce different results in volume and tone frequency amplification. Hence if the reader is assured that the writer knows whereof he speaks and is sufficiently versed in the art to be able to select a satisfactory transformer, the fan cannot do better than follow the author's advice and buy the units mentioned. If, however, the reader too is in the "know" of transformers and has a pet of similar type, that is regular low ratio, high ratio or push pull as specified, he must decide for himself whether he will follow his ideas or those of the author.

When reflecting on such subjects one must not forget that the author of an article bases his choice of parts on facts beyond the knowledge of the fan, and if the fan is without the proper data relative to the various transformers available, it is safest to abide by the choice of the author. This is caused by the entry into the discussion of various technical details far beyond the knowledge of the average constructively inclined fan, which category includes those who have been "puttering" with receivers since the advent of regular broadcasting. And if the writer is acknowledged familiar with radio technique, he no doubt has taken those technical items into consideration before making his choice.

The above facts relative to audio frequency transformers are applicable in practically their entirety to audio frequency chokes utilized inchoke coil coupled audio frequency amplifying systems. The governing factor if the writer's selection is not followed is the reputation of the individual units available. They do not afford similar results. All of course amplify, but the degree of amplification, so far as voltage and frequency are concerned, differs and the output signal is different. To some fans, lost low notes or overamplified high notes are satisfactory, in fact unnoted. To others such conditions would be unbearable, so again the fan's auditory palate must be pitted against that of the author.

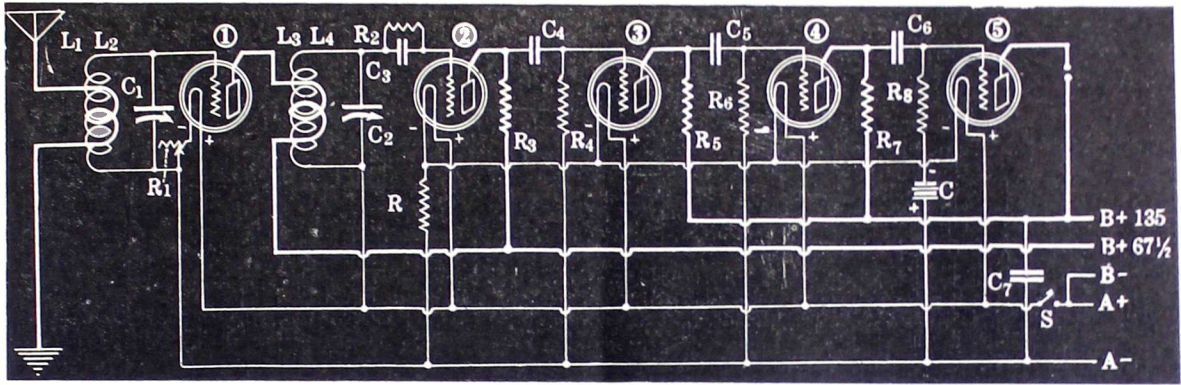

FIG. 257, showing the circuit diagram of a 2-control set.

Radio University

A QUESTION and Answer
 Department conducted by
 RADIO WORLD for its Read-
 ers by its staff of Experts.
 Address Radio University,
 RADIO WORLD, 145 West
 45th St., N. Y. C.

I WOULD appreciate having the circuit diagram of a 2-control set, using resistance AF.—Julian Joseph, 395 Riverside Drive, N. Y. City.

Fig. 257, shows the electrical diagram of this receiver. L1 and L3, the primaries, consist of 8 turns. The secondaries, L2 and L4, consist of 65 turns. Basket weave forms are used. These are 3" in diameter. No. 24 enamelled silk covered wire is used to wind these coils. C1 and C2 are both .00035 mfd. variable condensers. R1 is a 20 ohm variable resistance. R2 is a 2 megohm grid leak. R is a 1 ampere ballast resistor. R3, R5 and R7 are .1 megohm resistors. R4 is a .5 megohm resistor. R6 is a .25 megohm resistor. R8 is a .1 megohm resistor. C4, C5, C6 and C7 are all .25 mfd. fixed grid condensers. S is a filament control switch. C3 is a .00025 mfd. fixed grid condenser. Phone tips are used instead of the common single circuit jack. The —OIA type tubes may be used throughout this set. However hi-mu tubes may be used in the first and second AF stages and a power or lo-mu tube in the last stage. When employing these tubes, you will have to use a 1 ampere ballast resistor for the amplifier tubes alone, while a ¼ ampere ballast resistor for the detector tube, or where R is now. The ballast resistor is placed in series with the negative leg of the filament. In case you do not get enough signals strength, reverse the A battery leads.

I WOULD like to build the 1926 Model Diamond of the Air, but don't quite understand the double pole double throw switch, which is in the detector—audio-transformer side. In regard to J2, in Fig. 1, which appeared in the Sept. 12 issue of RADIO WORLD, can the signals be heard from the detector circuit, when the plug is placed in this jack? (2)—Can the input terminals of an external amplifier be placed to the terminals of a plug and then placed inside of this same jack, so that this amplifier can be used instead of the amplifier used in this set? (3)—In this set, two 20-ohm rheostats are used. In the Nov. 28 issue, rheostats are not recommended. Which is correct?—J. McKlim, c/o E. Klink, R. R. 1, Lorima, Wis.

(1)—Yes. (2)—Yes. (3)—This is optional. No rheostats are needed.

I AM building the 1926 Model Diamond of the Air and would like to ask a few questions. (1)—Can a double circuit jack be placed after the first audio-frequency amplifier stage? (2)—Is it not necessary when wiring up a set to use some type of insulation over the wires, so

as to present short circuits, etc.? (3)—Is plate glass all right to use as a panel? —B. R. McCullough, 144 Laura Avenue, Dayton, O.

(1)—Yes. Connect the top prong of the jack to the P post of tube 3. Connect the bottom or frame prong to the B+ Amp. terminal. Connect the inner top prong to the terminal of R3 that formerly went to the P post of tube 3. The 3rd prong from the top or the 2nd prong from the bottom goes to the other terminal of R3, which formerly went to the B+ Amp. terminal. (2)—No, unless wires are too close. (3)—Yes.

IS THE volume obtained from the 1926 Model Diamond of the Air using resistance coupled amplification with high mu tubes in the first and second AF stages and a power tube in the third or last stage as loud as that obtained from the receiver employing two stages of transformer-coupled amplification with 201A tubes? (2)—I tried to use the 4-tube 1925 Model Diamond of the Air with the UX120 as specified in the Sept. 5 issue of RADIO WORLD, but found that the volume was weaker than when using the —OIA type tube. What could be the trouble? —Wm. VanHoute, Okanogan County, Wash.

(1)—If the high mu tubes function with a constant of 20 the answer is yes. (2)—Test your B batteries. See if there is 135 volts registered. This is lowest voltage which should be placed on the plate of this tube. Be sure that the C battery is not connected in the grid circuit of the other AF tubes. See if all the terminals of the tube make solid contact with the prongs of the socket. See that the correct filament heating and C bias are applied.

I AM building the 1926 Model Diamond of the Air and am following the directions step for step as per specifications in the Dec. 12 issue of RADIO WORLD. Now as to the antenna and interstage coupler. What is the distance between the primary and the secondary windings? (2)—I am using 201A tubes throughout, with the exception of in the last stage where a 6-mu tube is used. Will Amperite R7 have to be changed for this power tube? (3)—I built the Rex B Battery Eliminator, which was described in the Dec. 12, 19 and 26 issues of RADIO WORLD by Lewis Winner and have obtained very good results. However, there is a very slight hum.—Fred Kernbu, 220 Lincoln Ave., Endicott, N. Y.

(1)—There is a 3/8" separation between the windings. (2)—Use Amperite No. 112. (3)—Be sure that the condenser which is

across the Det. B+ and B— posts is not shorted. Do not place the Eliminator near the set. Be sure that the prongs of the tube are touching the terminals of the socket.

I HAVE hooked up the 1926 Model Diamond of the Air in a very rough fashion. Now I would like to build it correctly, but before doing so, I would like to have the following queries answered: (1)—I wish to use Litz wire to wind the coils. What size Litz wire should be used instead of No. 24 double cotton covered wire? (2)—How many turns should be placed on a form 3" in diameter to constitute the primary and the secondary windings of the RFT and the tuner? (3)—The tickler is to be wound on a form 2 1/2" in diameter. How many turns should be placed here? (4)—Is Litz wire as efficient as No. 24 double cotton covered wire?—R. C. Hall, Room 207, Pennsylvania Building, Front and French Sts., Wilmington, Del.

(1)—Use the 32-strand No. 38 enameled Litz. (2)—The primaries consist of 10 turns. The secondaries consist of 50 turns. There is a 3/8" separation between the two windings. (3)—The tickler consists of 36 turns of the same wire. (4)—Yes.

IN THE Dec. 26 issue of RADIO WORLD on page 12 there appeared a circuit diagram of a 6-tube sensitive DX getter. I am going to try to make a portable out of it. (1)—I would like to know if it is O. K. to use iron core radio-frequency transformers. (2)—What size panel should be used? How should the parts be placed? (3)—What size loop should be used?—Herbert Stenstrom, Williams Bay, Wis.

(1)—Yes. (2)—See the July 11 issue of RADIO WORLD. (3)—Use the loop described in the Oct. 31 issue of RADIO WORLD.

IN THE Dec. 26 issue of RADIO WORLD John F. Rider described a regenerative wave trap wherein a variometer is used. I would like to know if I could use a 3-circuit tuner, instead of the variometer? —A. F. Leavitt, Harriman, Tenn.

Yes. See the article by Capt. P. V. O'Rourke in the Jan. 30 issue.

I HAVE a 1-tube regenerative receiver, in which two variometers, a .0005 mfd. variable condenser, a 201A tube, grid leak and a .00015 mfd. condenser are employed. They are hooked up thus: The antenna goes to the stator plates of the variable condenser. The other terminal (rotary plates of the variable condenser) goes to the rotor terminal of the variometer and to one terminal of the grid condenser and grid leak. The other terminal of the leak and condenser go to the G post on the socket. The rotor of the variometer in series with the antenna goes to a 6-turn stationary winding and thence to another

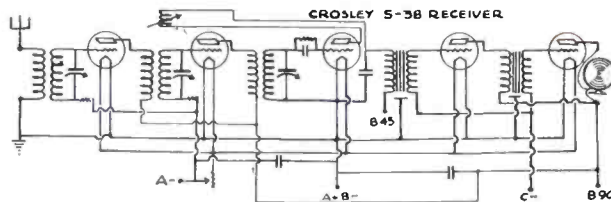

FIG. 258, shows the circuit diagram of the Crosley 5-38 receiver.

6-turn winding. These windings are placed on the same tubing as the stator winding, but separated $\frac{3}{8}$ ". The end of this stationary winding goes to the ground post, which goes to the A+ B-post. The other variometer is connected in series with the plate, or in shunt to the plate and one phone terminal. The rotors and the stators consist of 30 turns, wound on a $3\frac{1}{2}$ " tubing, using No. 26 double silk covered wire. Now my trouble is that I cannot make the tube oscillate over 250 meters. The stations that are received below that, come in with extreme volume.—Sidney Shatford, Jr., 39 South Park St., Halifax, N. S., Canada.

Take the two separate 6-turn windings off the stator winding. Decrease the number of turns on the rotor winding to 25. Increase the number of turns on the stator to 50. Place a .0005 mfd. variable condenser across the antenna and the ground posts. If you still do not get regeneration place a .0005 mfd. fixed condenser across the phone and the plate post of the socket.

I HAVE a Crosley 5-38 receiver which works very well. Could I have a circuit diagram of the set?—T. Bowman, Laurell Hill, La.

Fig. 258, shows the circuit diagram. The cores of the audio-frequency transformers are grounded. This is indicated by the T-shaped figure, underneath the core. Note that the grid of the second RF tube is inductively coupled to the plate in the detector tube.

I HAVE built the Pressley Super-Heterodyne as described in the April 18 issue of RADIO WORLD by Thomas Benson and have obtained fairly good results. However I feel that I should be getting better results. Some time ago, during one of my DX hunting periods, I started to tighten up a screw on the tapped portion of the top. As soon as the metal portion of the screw driver touched the head of the screw, KDKA came in with volume equal to that of a local. On turning the dial and still keeping the metal part of the screw driver on the head of the screw, many more DX stations were tuned in with great volume. I then tightened the screw, thinking that was the trouble, but upon taking the screw driver off, the volume became poor again. What could I do to bring back the volume which was received during the above mentioned period?—Joe H. Wheeler, 816 East 6th St., South Boston, Mass.

Place a .00025 mfd. fixed condenser across the variable condenser which is shunted across the loop. Also try a .0005 mfd. fixed condenser across this same point. Try placing a .00025 mfd. fixed condenser across one portion of the stator plates and the rotor plates of the compensating condenser.

WHEN CONNECTING up a coil, should the high potential (G and P posts) be farthest away from each other?—Joseph Mitchell, 7436 Prairie Ave., Detroit, Mich.

Yes, in nearly all hookups.

I WOULD like to make the toroidal coil, which was described in the Aug. 22

issue of RADIO WORLD, but wish to shunt the secondary with a .00025 mfd. variable condenser, instead of the .00035 mfd. variable condenser for the number of turns which are specified. (2)—Will these coils give better results in a tuned radio-frequency receiver in which spiderweb coils are used?—C. V. R. Dehart, 348 West Side Ave., Hagastuum, Md.

(1)—The primary consists of 12 turns. The secondary consists of 235 turns. (2)—The results are about equal.

IN THE Jan. 2 issue of RADIO WORLD there appeared an article on low-loss coils, in which I was very much interested. How many turns of No. 24 double cotton covered wire should be placed on a form $3\frac{1}{4}$ " in diameter, using a loose basket weave form, with a .00035 mfd. variable condenser shunting the secondary to constitute an RFT?—George Hierholzer, 510 Gordon St., Midland, Mich.

The primary consists of 10 turns. The secondary consists of 60 turns.

IN REGARD to the Reinartz receiver used by 2CTF and mentioned under the Amateur News Column by Irving Wolfe: (1)—What is the diameter of the forms that the tuning coils 1 and 2 are wound on? (2)—Would it be a good stunt to use .000275 mfd. variable condensers? (3)—Is it necessary to extend rods to prevent body capacity? (4)—Would it be all right to use two 30-ohm rheostats to control the filaments of 199 tubes, instead of using one rheostat to control the filaments of both the tubes?—Walter Smith, c/o W. H. See, Gramatan Court, Bronxville, N. Y.

(1)—They are $3\frac{3}{4}$ " in diameter. (2)—Yes. (3)—Yes. (4)—Yes.

I HAVE constructed the Midget 3-Tube Set as described by Herbert E. Hayden in the Aug. 8 issue of RADIO WORLD and have had very good success with it. When I had the set working as good as is possible, I built a 1-stage tuned radio-frequency amplifier using the RFT specified for the Diamond (large one) and added it to this set. It now works splendidly, except for the fact that I cannot tune the stations in with their maximum volume. When I do this, the detector tube begins to oscillate beyond control. How can I neutralize this stage of radio-frequency amplification to avoid this? (2)—Should this circuit work as well as the Diamond? (3)—Can I use the —O1A tube as a detector? (4)—Can I use the —O1A tube as a detector tube in the Diamond?—Chris Knudser, 119 N. Harvard, Vermillion, S. D.

(1)—Connect a neutralizing condenser between RF grid and the coil side of the grid condenser. (2)—Yes. (3)—Yes. (4)—Yes.

PLEASE ADVISE as to the following: (1)—Would a .005 mfd. fixed condenser and a .002 mfd. fixed condenser connected in parallel equal more than .006 mfd.? (2)—How would the following be spoken: .00025 and .006? (3)—Would taking 10 turns off the secondaries at the filament end of the RFT used in a Neutrodyne receiver, affect the location of the tap any? The coils are wound with 15 turns on the primaries; 60 turns on the secondaries,

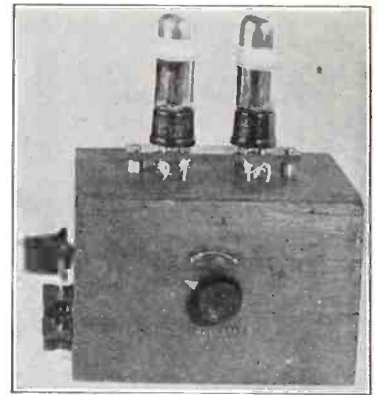

FIG. 259 showing the side view of the Amplifier unit, with the rheostat knob in front. The knob on the left side is that of the clarostat.



FIG. 260 showing how the parts for the AF Amplifier are placed.

and the tap made at the 15th turns. No. 24 double cotton covered wire is used.—William Bewhard, Bergen Station, Route 6, Jersey City, N. J.

(1)—Yes .007 mfd. (2)—Triple oh two five and double oh six. (3)—Not if the tap is nearer the end opposite the one where turns are to be removed.

PLEASE SHOW in pictorial fashion how to place the parts for the Hayden AF Amplifier, described in the Jan. 30 issue of RADIO WORLD. I would like to see how the side of the box, with the rheostat appears also.—J. Kramer, Bx., N. Y. City.

Figs. 259 and 260 show these two views.

I HAVE built the 4-tube 1925 Model Diamond of the Air and have had very good results with it until recently. I burned my D21 detector tube out and cannot replace this tube, due to its manufacture being discontinued. I replaced this tube with a 201A. Now I can only get local station reception. With the D21 I could hear stations over 1,500 miles away. What can I do to make this tube operate efficiently?—J. Beveridge, Detroit, Mich.

Change the grid return of the detector tube from negative, which was required for the D21 tube, to positive. Place a grid leak in shunt with the grid condenser.

WHERE CAN I get a 4 mfd. fixed condenser which is to be used in a B battery eliminator?—Ray Nicholas, Box 116, Williams Bay, Wis.

Write to the Aerovox Wireless Corp., 489 Broome St., N. Y. City.

I WISH to build the B Battery Eliminator described by Lewis Winner in the Jan. 2 issue of RADIO WORLD. How much does the wire needed for the choke coils and the transformer weigh?—George F. Bell, 105 Hill St., Barre, Vt.

The wire needed for the making of the step-up transformer weighs about 10 ounces. The wire needed for the making

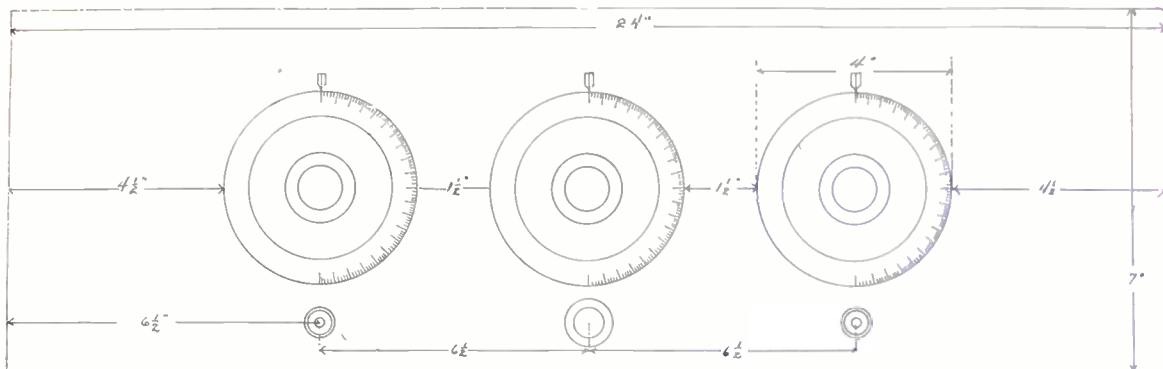

FIG. 261, showing the panel design Mr. Banton requested.

of the choke coils weighs about 3 1/2 pounds.

IN REGARD to the chemical B Battery Eliminator described by Lewis Winner in the Jan. 2 issues of RADIO WORLD. (1)—Can I use stove pipe iron to make up the core for the transformers and choke coils? (2)—It is stated that 14 feet of pure sheet or rod aluminum and lead, 1/8" thick should be used to make up the elements. Should not the 14 feet be 14 inches?—M. Green, 36 Elgin St., Lindsay, Ont.

(1)—No. (2)—Yes, that was a typographical error.

PLEASE GIVE me the panel layout of 5-tube Neutrodyne, employing only one rheostat, which controls the filament of the detector tube and two filament control jacks, which control the RF and AF amplifier tubes. The panel should preferably be of the 7x24" type.—N. Banton, Gridley, Cal.

Fig. 261 shows the suggested panel layout.

I HAVE constructed the 3-Tube 3-circuit tuner receiver described by Capt. P. V. O'Rourke in the Oct. 10 issue of RADIO WORLD. I cannot get loud speaker volume on distant stations. I am using a standard tuner. A 3 1/4" diameter tubing is used for holding the primary and secondary windings. The primary consists of 13 turns. The secondary consists of 40 turns. The tickler which is wound on a 2 3/4" diameter tubing, consists of 50 turns. The secondary is shunted by a .0005 mfd. variable condenser. I am using the UV199 tubes.—Jack Stinton, Mexico City, Mex.

Reduce the number of turns on the primary to 10. Increase the number of turns on the secondary to 45. Reduce the number of turns on the tickler to 40. Of course the volume of the DX stations with the 99 tubes is not as great as when employing the —OIA tubes.

WILL THE efficiency of the 4-Tube DX Antennatrol DX Set be impaired by the use of a hard wood panel, which has been impregnated with shellac?—Joseph Lawrence, El Paso, Tex.

No.

I BUILT the 1926 Model Diamond of the Air and am getting fine results on wavelengths from 200 to 375 meters. Above that I cannot make the detector tube oscillate. I can turn the tickler coil knob all the way round and it makes no difference, that is, except between the above two wavelengths. I am using the Uncle Sam Tuner in the detector circuit and another tuner without the tickler coil, in the RF portion of the receiver. The 199 type of tubes are employed. I am

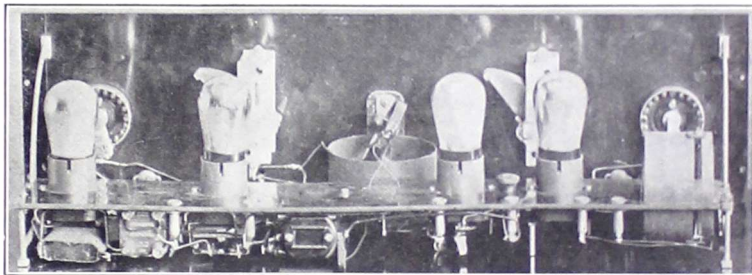

REAR VIEW of a 4-tube Diamond of the Air. (Fig. 262).

very sure that this fault can be corrected easily.—Paul K. Lawace, c/o Wm. H. Block, Indianapolis, Ind.

Place a .001 mfd. fixed condenser across the tickler coil. Increase the voltage of the detector tube. Increase the length of the antenna, or place a .0005 mfd. fixed condenser across the antenna and the ground terminals.

I HAVE two Ambassador 3-circuit tuners. Could I remove the tickler coils from one of these tuners and employ the same as an RFT in the 1926 Model Diamond of the Air? (2)—Will .0005 mfd. SLF variable condensers be all right to shunt across the secondaries of both the 3-circuit tuner and the RFT?—P. Manvillet, Reading, Pa.

(1)—Yes. (2)—Yes.

WHAT IS the distance between the radio-frequency transformer and the 3-circuit tuner in the 1926 Model Diamond of the Air?—J. W. Walker, c/o Nuback Co., 116 West St., Kansas City, Mo.

The outside diameters of both these coils are 6 1/2" from each other.

CAN I use Karas .0005 mfd. variable condensers and either Karas or Rauland Lyric audio-frequency transformers in the 1926 Model Diamond of the Air? (2)—Please show a back view of the 4-tube model.—A. I. Buchecker, 401 City Hall, Spokane, Wash.

(1)—Yes. (2)—See Fig. 262.

WHICH COILS ARE BEST?

The Bureau of Standards tested six, using different kind of wire on each. The results are very fully set forth in Jan. 16 and 30 issues of RADIO WORLD. Send 30c for both RADIO WORLD, 145 West 45th St., New York City.

Join RADIO WORLD'S University Club

And Get Free Question and Answer Service for the Coming 52 Weeks.

Have your name entered on our subscription and University lists by special number. Put this number on the outside of the forwarding envelope (not the enclosed return envelope) and also put it in your queries and the questions will be answered the same day as received. If already a subscriber, send \$6 for renewal from close of present subscription and your name will be entered in the Radio University.

[In sending in your queries to the University Department please paragraph them so that the reply could be written under or along side of each query. Write on one side of sheet only.]

RADIO WORLD, 145 West 45th Street, New York City.

Enclosed find \$6.00 for RADIO WORLD for one year (52 Nos.) and also enter my name on the list of members of RADIO WORLD'S University Club, which gives me free information in your Radio University Department for 52 ensuing weeks, and send me my number indicating membership.

Name

Street

City and State

Dawes Carries His Fight to 68 Cities



VICE-PRESIDENT CHARLES G. DAWES renewed his Senate rules fight, over the air, through station WRC, Washington, D. C. This address was rebroadcast to the Massachusetts Institute of Technology banquet and to banquets in 67 other cities from Oakland, Cal., to Boston, Mass. Left to right: Vice-President Dawes; W. W. Mills, of Marietta, O., and General James G. Harbord, president of the Radio Corporation of America, in the studio of WRC. (Henry Miller.)

My International Test

By Hall Finch

I YEARNED for the glory of foreign credentials
 And burned seven tubes to their highest potentials
 All the dials in turn I spun slowly, then faster,
 Then listened and turned
 And changed ev'ry tube, though it's court-
 ing disaster,
 But still they all burned;
 As I labored and listened the minutes
 were fleeting
 Like double-winged fowls
 But all that I heard was the Kilkenny
 greetings
 Of neighboring howls.
 At eleven and fifty they doubled their
 howling
 And tripled their power
 I sat in despair and my guests were all
 scowling
 And pointing the hour
 My neighbors were experts, but my set
 was much larger
 I played the game fair—
 I hooked up my aerial onto the charger
 And went on the air!
 My program that night was quite tem-
 peramental—
 But I fervently hope it was *Trans-
 Continental*.

Set in Small Space

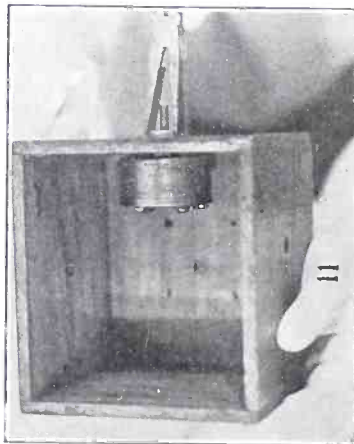

IN a 5½"x3½" box it is possible to make a 1-tube 3-circuit regenerative set. The variable condenser of the .0005 mfd. incased type, as shown, may be employed. The 3-circuit tuner, which should of the "baby" type, can be placed directly opposite the condenser. The socket can be placed on the top of the box, between the condenser the tuner. (Hayden).

Magic Lamppost



AN electric light or arc lamp in Essex, England, picks up the programs from 2LO and reproduces them with full volume. Engineers claim that the arc lamp acts as a detector, the elements as magnets and the glass as a diaphragm. Policemen, during the lonely hours of the night, gather around this post, to be entertained. (Wide World.)

Girls Lure in DX



GIRLS of Charlot's revue, who were guests of Col. Mapes, noted figure in the radio field, atop Bush Terminal, 42nd St., N. Y. City, at Radio Center tuning in on 2LO, London, during the International radio test week. (Harold Stein.)

Facilitates Mounting



IF a knob does not fit easily into a condenser or other shaft, a large jack-knife may be used to scrape off any possible burr.

Radio Detective



WITH the development of radio there has arisen the demand for a new kind of detective. He is the sleuth who trails down interference with radio reception. In this photograph is shown a government radio detective traveling in a flivver, while running down electrical noises, produced in your radio receiving sets. (Harris & Ewing.)

Radio Honeymooners



MR. AND MRS. HOWARD HUNTER, saying goodbye to the microphone, before sailing on their honeymoon to Bermuda. Mrs. Hunter was formerly Miss Winifred Barr, hostess and accompanist of station WEAJ, New York City.

Which is Which

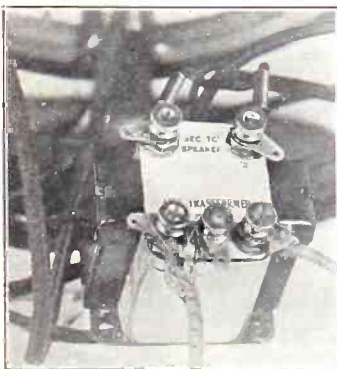

THE PRIMARY and the secondary of an audio-frequency transformer may be tested for a complete or short circuit, with the aid of a pair of phones and a single battery of the 1½-volt type. When the tips are placed across the secondary, a small click is heard. When the tips are placed across the primary, a loud click will be heard. (Hayden).

German Trains Have Radio Phones

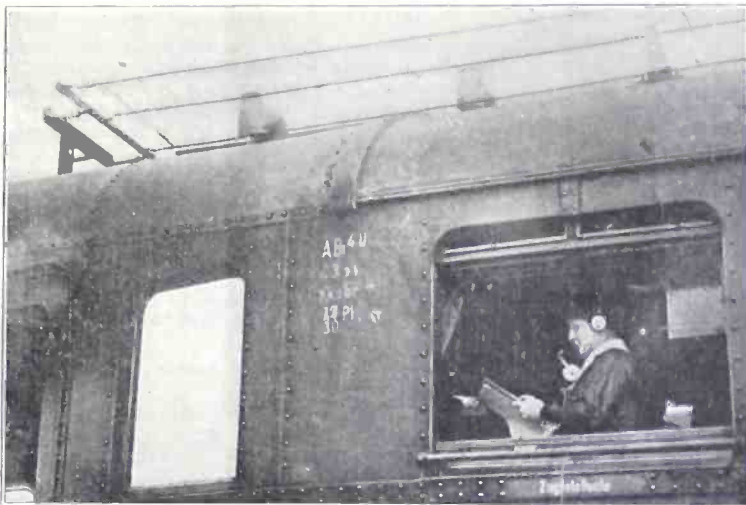

CONVERSING by radio telephone from train to train or to stationary points has become a reality. Above we have an exterior view of the railway car telephone exchange on the system which runs between Berlin and Hamburg. This is the only passenger railroad in the world employing this system. The operator is at her switchboard. (International Newsreel.)

A 1-Tube Assembly

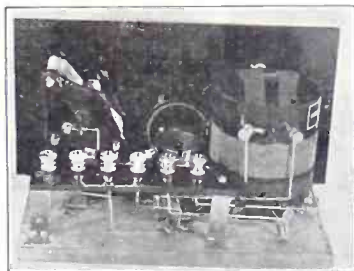

A REAR VIEW of a 1-tube 3-circuit tuner, showing the manner in which the parts can be mounted to obtain the greatest efficiency.

Rack Holds Drills

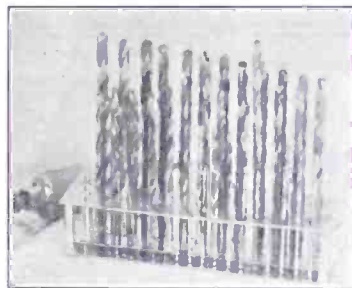

A RACK conveniently holds drills of various sizes.

Canadian Stations Combine to End Fees to Composers

All radio stations in Canada are represented in the Canadian Association of Broadcasters, which has been organized. The new Association has obtained a charter under the companies act. The necessary formalities were concluded here at a meeting of representatives of the Canadian Broadcasting stations. The following officers have been elected: J. N. Cartier, CKAC, Montreal, President; M. Johnston, CFCA, Toronto, Vice-President; A. R. McEwan, Canadian National Railways, Radio Department, Montreal, Secretary-Treasurer; G. M. Bell, CKCK, Regina, and P. H. Combs, CFCA, Toronto, Directors.

The announced purpose of the Association is to improve the standard of broadcasting, to promote the interests of the owners of receiving sets, and to spread by means of radio a wider knowledge of Canada, its advantages and opportunities. The Association will include the Can-

adian National Railways with ten radio stations from Moncton, N. B., to Vancouver, B. C., the manufacturing interests, the battery firms and all newspapers interested in radio; in fact, the strongest possible combination that could be organized in Canada at the moment and representing all the important radio concerns.

While the Association is to "protect the interests of the radio listener-in," it has been brought into being by the insistence of the copyright owners that radio stations should take out licenses from them and pay for the privilege. An effort is to be made at the present session of Parliament to amend the Copyright Act so as to include radio and permit the Reproducing Rights Association to issue licenses—no fees being mentioned, which is one of the handicaps of the business as experienced in the United States where license fees vary according to what the traffic can bear.

THE broadcast listeners of the United States, as the result of the rapid evolution of the broadcast program art, are now enjoying the artistry of the leading vocal and instrumental performers of the United States and of the best-known symphony orchestras and similar excellent musical organizations.

The discriminating broadcast listener, by choosing his programs, is now able to enjoy in his home musical and other program features which, until the advent of broadcasting, were necessarily restricted to the comparatively few persons who could form the collected audience in concert hall or opera house or civic forum.

Broadcasting has become a great public service and might be correctly termed a "domestic utility." This comparatively recent aspect of the field has brought with it a new listener outlook. Whereas formerly the eternal quest for barely recognizable call letters of distant stations occupied a goodly portion of the time of the listener, and the program quality and fidelity of musical production were secondary matters, conditions are now reversed. Tone quality and excellent programs are the prime desiderata, and only

The Musical Mirror

COUSTIC Synchronizing Makes the Radio Receiver Faithfully Duplicate the Studio Performance—Most Sets Fall Short of This—Why Women's Voices Sound Unnatural Over the Air and Bass Viol and Piccolo Notes in Orchestra Disappear—A Set Can Be Made to Reflect the Original, But Ideal Reproduction Has Not Yet Been Reached.

By **Dr. Alfred N. Goldsmith**

Chief Broadcast Engineer, Radio Corporation of America

transmitting and receiving equipment and broadcast station organization which can supply these elements to the broadcast listener will remain of permanent interest to the public.

Making It Sound Real

It is clear that the aim of broadcast reception is the production of a complete "illusion of reality." In a sense it is the same ideal as that of the legitimate theatre, the motion picture house and other divisions of the dramatic art. A broadcast program originates in the studio or concert hall and it is the wish of the broadcast listener to be released into this world of pure music through the agency of radio. He desires that the artists shall in effect perform in the quiet of the listener's home, even though actually many miles may separate the artist and his audience. We know quite well that this

true, most receiving installations are still far from being acceptable. It is often my embarrassing experience to be asked by the owner of a receiving set of more than dubious characteristics, how I like radio reception in his home. Politeness compels a diplomatic though evasive answer. It is a curious fact that until one has heard and become accustomed to really high quality radio reception, one can endure and even somewhat enjoy a seriously distorted and thoroughly imperfect rendition of the original performance. However, once one has been accustomed to really excellent quality, nothing less can be accepted or enjoyed.

Some of the Faults Listed

Among the faults which are encountered only too often in receiving equipment which has not been built according to sound electrical and acoustic principles are some of the following:

Music may sound scratchy or have a squeaky or tinny quality.

The lower notes may have a booming quality and speech may sound as if the speaker were talking through a barrel, or a considerable length of large pipe.

Queer rattles, clicks, and other objectionable disturbances, such as hisses may exist in the alleged music trickling from the loudspeaker.

Furthermore, the volume or loudness of the music may be too small to give satisfaction or naturalness or, on the other hand, the volume may be increased to such a point that the outfit can not properly handle it, and various sorts of sound distortion will result.

At its best, a good radio receiver is an excellent thing, but a poor radio receiver carelessly used is far from being "a joy forever."

Acoustics the Watchword

As has been stated already, the sophisticated radio listener desires the music in his home to be an exact copy of that being performed in the studio of the broadcasting station. To produce such an exact copy requires that the sound waves in the home shall be an accurate imitation of the sound waves in the studio. The process of matching these two sets of sound waves is called "acoustic synchronizing" and is the very foundation of modern radio. It is entirely safe to predict that acoustic synchronizing will be the watchword of the future and that, the more nearly radio broadcasting fulfills its aim, the more stress will be laid upon acoustic synchronizing. In less technical terms, acoustic synchronizing means exquisite fidelity of musical reproduction.

There are three major conditions which must be met in sound reproduction if acoustic synchronizing is to be realized. These are the following:

In the first place the entire transmitting and receiving system must be omnitonal. That is, every note, from the lowest pitch to the highest must be reproduced. None must be left out if perfect reproduction is to be had.

In the second place, the entire transmitting and receiving system must be equitonal. In other words, it must treat tones of every pitch from the lowest to the highest with complete impartiality, slighting none and favoring none. It is not sufficient that all notes should be reproduced—they must also be equally reproduced.

And third and lastly, the volume or loudness of the sound must be correct. The music or speech in the home must not be so faint as to be un-

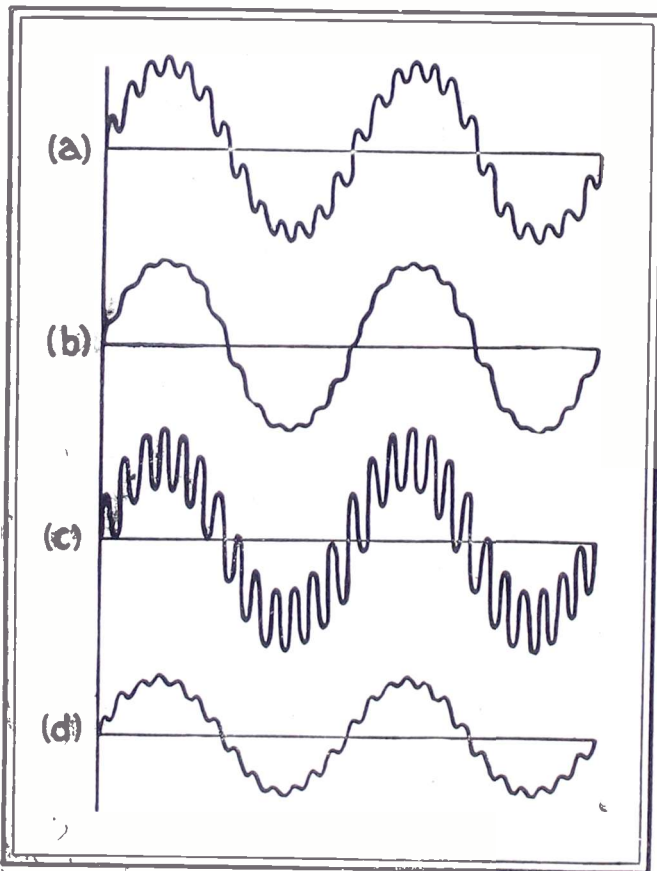

(a). The wave form of the original sound showing a low frequency and a high frequency note existing simultaneously.

(b). The sort of reproduction obtained by a loudspeaker which omits high notes and is therefore not omnitonal.

(c). The effect on reproduction of a loudspeaker which exaggerates high notes at the expense of low notes, and is therefore not equitonal.

(d). Reproduction, but without sufficient volume, and consequently with feeble and unsatisfactory results.

natural, nor yet so loud as to be oppressive, annoying or of rattling character. Fidelity of musical reproduction definitely requires a certain ample, but not an excessive volume of sound.

A Mirror Up to Nature

All of the preceding conditions, in a musical sense, amount to holding a mirror up to nature. But it must be a clear and flat mirror, and not a tarnished mirror bent like those in amusement parks which fantastically distort the form of the onlooker. A distorting mirror may be whimsical and momentarily entertaining, but it is no satisfactory substitute for a perfect mirror.

A great many radio listeners who, quite wisely, obtained radio equipment in the early days of the art and have since gotten much enjoyment from their receivers, are nevertheless no longer experiencing the full benefits of radio because their receivers are not capable of giving those results which can now be obtained by the use of thoroughly modern equipment. Mere possession of a radio set does not prove that the listener is getting up-to-date service, and in many cases it can be safely said that he is not getting such service. No radio auditor can say that he is enjoying to the full the benefits which broadcasting can bring him unless he has heard the finest examples of modern radio equipment in operation on a high quality station and is satisfied that he is getting equal results in his home. A brief period of listening to a truly acoustically synchronized radio system would tremendously astonish many radio listeners and would lead them to adopt recent equipment capable of more completely realizing the possibilities of modern radio reception.

The general purpose of acoustic synchronizing has been pointed out, but it is desirable to consider in greater detail the various faults in radio reception, the advantages of acoustic synchronizing, and the disadvantages of its absence.

The Unpleasant Side

Some idea of the importance of acoustic synchronizing can be gained by considering the typical faults in reception when the acoustic synchronizing is imperfect. Afterward, by way of contrast, the more fortunate results of achieved acoustic synchronizing will be set forth.

A multitude of unpleasant defects in reception arises so soon as acoustic synchronizing is absent. Speech becomes blurred, and the intelligibility of conversation is not perfect. Words or phrases are lost, particularly proper names, numbers, or other relatively disconnected portions of speech. This point can be readily tested by listening to a good station broadcasting a complicated speech where the context gives little assistance in guessing what the next word in the speech will be. Even if the intelligibility is perfect under such conditions, there may still be other faults present as a result of only partial acoustic synchronizing. One of these is an unnatural quality in the voice of women. Their speech may seem thin and not rounded or natural. Another frequent fault is that the voice of a male speaker is rasping or rough. Occasionally an opposite fault develops giving a metallic mechanical quality to the male voice.

The Missing Sibilants

A frequent fault is the relative or complete loss of the sibilant consonants: "s" and "f". These may be entirely missing, and yet many listeners will imagine they hear them (although there is always an unconscious strain and resulting loss of enjoyment involved in thus artificially supplying a missing portion of a word). Even if the quality of reproduction is somewhat better than that which results in the complete loss of the sibilant consonants, these consonants may nevertheless be confused with each other. Indeed it is quite difficult to obtain a system so perfectly synchronized acoustically as to permit unmistakable differentiation between "s" and "f".

The singing voice is also subject to serious deficiencies when acoustic synchronizing is imperfect. Sopranos will sound thin and shrill, whereas contraltos

will have a dull and uninteresting tone quality. The rather widespread prejudice against broadcasting selections sung by even fairly competent soprano performers must be in considerable measure charged against imperfect acoustic synchronizing since it is well known that a great soprano, heard directly, gives a most enjoyable performance.

The Male Voices

The tenor, baritone and bass voices are even more subject to quality distortion though the effects are not so serious from the viewpoint of enjoyment. Tenor singers often have a metallic quality in imperfect reception, and male singers in the deeper register sound rough and comparatively unpleasant. Great precision in sound reproduction is required to avoid these difficulties.

Passing to orchestral instruments, it is well known that a piano will sound like a harp or spinet if the loudspeaker is not omnitonal and drops out some of the lower notes. Omnitonal loudspeakers are required which reproduce all notes. A tinkling effect is then replaced by the full tone of the piano.

The Violin

Violins also are subject to marked distortion. There is in actual violin playing a certain sharp, but interesting quality resulting from the way in which the rosined bow grips and releases the strings. The effect is not readily described in words, but it constitutes a

considerable portion of the charm and individuality of the violin. When acoustic synchronizing is absent, violins become converted into instruments of a much purer but less interesting tone, and in some cases having almost the thin quality of a tuning fork. It is also noticeable in many cases that cellos and bass viols are practically missing from the orchestral reproductions because of deficiencies in the sound reproducing system. Similarly, the lower notes in pipe organ performances (particularly those of the pedal register) are a rarity in all but the best radio receiving systems.

The Effect on "Expression"

In addition to undesirable changes in the quality of individual musical instruments resulting from the lack of acoustic synchronizing, such a lack has another serious effect in that it spoils delicate rhythmic effects, proper emphasis, ensemble effects, and the whole series of musical touches which we call "expression" and which contribute to musical style. These undesirable effects can be most readily detected when listening to a full orchestra, particularly a symphony orchestra being broadcast from a high-grade station. With imperfect acoustic synchronizing, certain notes will "pop out" giving an irregular effect, interrupting the rhythm, and giving false emphasis. These are notes which are favored at the expense of others in such an imperfect sound reproducing system. Separate

(Continued on page 28)

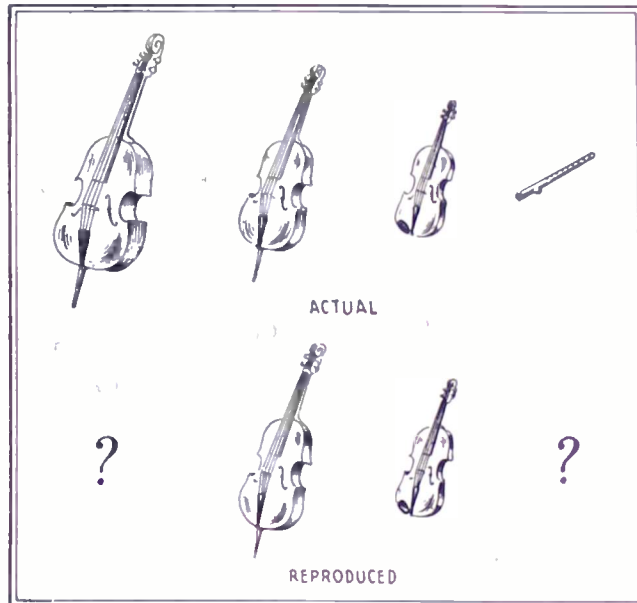

PART of the musical scale showing relative suppression of all but the middle register as the result of imperfect acoustic synchronizing is shown in the top illustration. The other drawing exemplifies "What Happened to a Part of the Orchestra When Acoustic Synchronizing Was Lacking." The bass viol and the piccolo are both practically missing, and even the cello and violin are imperfectly reproduced.

A THOUGHT FOR THE WEEK

The International Radio Week tests are over, but the adventuring by hundreds of thousands of eager listeners-in will not be forgotten for a long time to come. Now we're all set for the simpler but perhaps more satisfactory task of trying to get the nearest stations with the correct percentage of clarity and volume.

RADIO WORLD

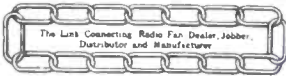

Radio World's Slogan: "A radio set for every home."

TELEPHONES BRYANT 0558, 0559 PUBLISHED EVERY WEDNESDAY (Dated Saturday of same week) FROM PUBLICATION OFFICE HENNESSY RADIO PUBLICATION CORPORATION 145 WEST 45th STREET, NEW YORK, N. Y. (Just East of Broadway) ROLAND BURKE HENNESSY, President M. B. HENNESSY, Vice-President FRED S. CLAIRK, Secretary and Manager European Representatives: The International News Co. Brema's Bldg., Chancery Lane, London, Eng. Paris, France: Brentano's, 38 Avenue de l'Opera Chicago: A. T. Sears & Son, Peoples Gas Bldg. Cincinnati Office: Radio World, 804 Provident Bk. Bldg., 7th and Vine Sts. Telephone Canal 753 and 379. San Francisco: Lloyd B. Chappell, 656 O'Farrell St.

EDITOR, Roland Burke Hennessy MANAGING EDITOR, Herman Bernard TECHNICAL EDITOR, Lewis Winner CONTRIBUTING EDITOR, John F. Rlder

SUBSCRIPTION RATES

Fifteen cents a copy. \$6.00 a year. \$3.00 for six months. \$1.50 for three months. Add \$1.00 a year extra for foreign postage. Canada, 50 cents. Receipt by new subscribers of the first copy of RADIO WORLD mailed to them after sending in their order is automatic acknowledgment of their subscription order. Changes of address should be received at this office two weeks before date of publication. Always give old address also. State whether subscription is new or a renewal.

ADVERTISING RATES

Table with 3 columns: Ad Type, Dimensions, and Price. Includes rates for 1 page, 1/2 page, 1/4 page, 1 column, and 1 inch, with various sizes and line counts.

Times Discount

52 consecutive issues..... 20% 26 times consecutively or E. O. W. one year..... 15% 4 consecutive issues..... 10% WEEKLY, dated each Saturday, published Wednesday. Advertising forms close Tuesday, eleven days in advance of date of issue.

CLASSIFIED ADVERTISEMENTS

Ten cents per word. Minimum 10 words. Cash with order. Business Opportunities ten cents per word, \$1.00 minimum.

Entered as second-class matter, March 23, 1922, at the Post Office at New York, N. Y., under the act of March 3, 1879.

FEBRUARY 13, 1926

Scout Program Heard From Chain of Stations

A thirty-minute radio program was broadcast from Station WEAJ among the principal features of the celebration of the sixtieth anniversary of the founding of the Boy Scouts of America. Eleven other stations were connected with the originating station. The time will be donated by the S. S. Kresge Company.

The program was opened with a call by an expert scout bugler. Anniversary greetings were extended by James J. Storrow, president of the Boy Scouts of America; Daniel Carter Beard, National Scout Commissioner, and Chief Scout Executive James E. West. The band of Troop 159 of Brooklyn played and songs were rendered by the Jolly Scout Quartet.

TOO FASCINATING - - - - By Dan Napoli



Mary Garden Sings From Station WJZ

Mary Garden, manager and prima donna of the Chicago Opera Company, broadcast for the third time in her career and enjoyed the experience, from WJZ, New York City. Miss Garden sang at the annual dinner of the Fred French Company at the Hotel Biltmore.

Her songs included "Depuis le Jour," an aria from "Louise," the opera in which she made her debut at the Opera Comique in Paris in 1900; "Habanera" from "Carmen"; "At Dawning," by Charles Wakefield Cadman; "Serenade," by Tosti, and a group of Scotch songs, among which was "Comin' Thro' the Rye."

The radio appearance was her first in New York for three years, Miss Garden said. "Oh, it has nothing to do with New York audiences," she explained quickly. "I belong to an opera company. And opera companies are worse than prima donnas."

She locked her fingers to indicate the rivalry of competing opera companies, explaining that the Chicago Opera Company stayed away from New York because of the Metropolitan.

"I only wish my New York audiences could hear me in my latest role, 'The Resurrection,'" Miss Garden said ecstatically. "That's a role for you. It's magni-

Mary Garden's Pose



MARY GARDEN, manager of the Chicago Civic Opera Company, made a great hit at WJZ, New York City. (International Newsreel.)

ficent. Tonight I leave for Boston on the sleeper to sing 'Pelleas and Melisande' tomorrow evening. So you see, I'm not a free woman—not when it comes to singing."

French Interest in Radio Low; Sleuth Finds Only Two Shops

Due to governmental restrictions, high cost of rather inferior apparatus and general lack of appreciation of its possibilities, radio interest in France is not as keen as in other European countries according to Eric H. Palmer of the Freed-Eisemann Radio Corporation, who recently returned from abroad.

A three days' tour about Paris revealed but two radio establishments. Buying a receiver is difficult, as compared with American opportunities; and then comes the Government requirements of a license for the privilege of tuning in, which is obtainable at small cost, however.

Hams Hear DX

Transmitting amateurs, on the other hand, listen in for foreign stations, and occasionally some report hearing the United States. But it can be safely asserted that a large number of Parisians do not sit up until the early hours of the morning trying to hear New York or Chicago.

The Government discourages broadcast listening, because of the fear of propaganda from the German stations, which,

with a good receiver, can be picked up without trouble.

Americans residing in Paris hesitate to believe the stories of the wonderful progress of the radio art in the United States, how interested the entire nation has become during the last few years.

Anchorage for Wire

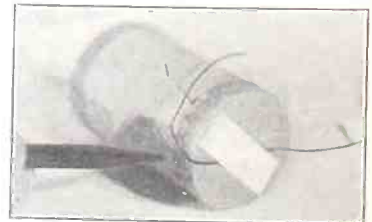

WHEN winding a coil you may temporarily secure the free end of the wire by using adhesive tape. This prevents the free end getting tangled up with the wire being wound. (Hayden.)

Few Hear Overseas Programs; Short-Wave Tests Advocated

By Samuel Lager

THE attempts to hear European stations during the International Radio Week tests did not prove so successful as many had hoped. From scattering sources reports of foreign reception were received, but there was nothing to support the idea that anything like success prevailed. Even in the exceptional instances of reception actually resulting, often the call letters were not heard, and it was a matter of conjecture what station was received. On calibrated receivers this conjecture was aided by the dial setting, which revealed the wave length of the transmitting station.

That a great many persons knew just where on their dials a given wavelength should come in was proven by the fact that there was a plentitude of heterodyne whistles at the target wavelengths. These noises were caused by radiating receivers. Many seemed to think that this radiation prevented foreign reception, but the better authority holds that the foreign waves did not get here, so that any interference caused by the radiating sets can not be blamed for failure of reception.

Fans Tried Hard

The general run of the public heard nothing of the foreign stations. Owners of specially sensitive receivers had poor luck too, but some of these did catch a few words or short strains of music.

Thousands of fans tried for one hour each night of the five overseas test nights to get the stations. The schedule comprehended the hour from 11 to 12 P. M., Eastern Standard Time, on Sunday, Monday, Tuesday, Wednesday and Thursday. During the hour on each of these nights American and Canadian stations were silent. The fact that during the first two nights there was an S O S on the air did not injure the chances of foreign reception, since the stations abroad were broadcasting just the same.

This year, as last, there was evidence of outlaw "humor," several sources broadcasting from local transmitters on wavelengths used by foreign stations, and giving call letters of such stations, as a hoax. Much of this broadcasting was done during hours when the impregnated stations were not on the air. For next year's tests a police service may be organized and these outlaws tracked down. There was talk of special legislation to provide jail penalties for offenders.

Friday and Saturday of the test week were devoted to domestic distance-hunting during the specified hour. During the first fifteen minutes Eastern stations were on the air, all others silent. Then the Central, Mountain and Pacific stations took their 15-minute turns, the others remaining silent. This enabled many persons on one Coast to bring in stations on the other for the first time on their sets.

An Interesting Week

All told, the test week was interesting to radio fans, although disappointing on the score of foreign reception. The first night evidently caused the highest interest, but when no foreign station was received fans lost a little interest, and fewer tried on the succeeding nights.

No better luck was experienced on the other side of the Atlantic. The opinion prevailed that higher power would have to be used next year, if any degree of success is to be achieved, unless receivers undergo a marked improvement in sensitivity, which is unlikely. Experts suggested that next year's tests be conducted on short waves, as amateurs have had no trouble in spanning the

ocean and traversing even greater distances—including half-way 'round the world—on 40 meters. The objection raised to this is that comparatively few persons have sets that will receive a 40-meter wave. Broadcast receivers could not pick it up.

Hamburg Hears U. S.

When it was learned that Americans had no luck receiving foreign stations it was assumed that as the radio waves travel with greater facility from West to East that overseas receivers probably would pick up American broadcasts. But when a repetition of American lack of results was reported from England and the Continent, the consensus was that greater power or short waves was the solution for next year.

The interspersed examples of reception proved interesting as news items. A man in Hamburg picked up an American station so that persons on the street could hear the program. J. L. Snyder, of Paton, Pa., reported having heard Prague, Buenos Aires, Brussels and Madrid, using a standard Sonora.

L. A. Nixon, secretary of the Radio Week Committee, said:

"Many of the American listeners were innocent victims of radio fakers within a block or two of their own homes. I

believe that most of the reports were honestly submitted, but out of the total of 5,000 letters, postal cards and telegrams I doubt if more than 2,000 really heard foreign programs. By tabulating the reports we can now see where the jokers were located. They were chiefly in New Orleans and Omaha.

"In New Orleans some one apparently inserted a microphone or transmitter in the antenna circuit or ground lead, making the set act as a small broadcaster, and then announced that he was station 2L.O. England, rebroadcasting an Australian concert. We had numerous reports on this case from the New Orleans district.

A New York Pest, Too

"In Omaha a faker announced that he was Cardiff and later switched to a wave which he announced as that of Aberdeen. There was apparently another fraudulent broadcaster around New York, because many reported that they heard Lyons, France, but this station was not on the air during the tests. One of the listening posts established by a New York manufacturer also heard this announcement of Lyons. We have a cable reporting that no French stations took part in the international program."

HERMAN BERNARD, managing editor of RADIO WORLD, broadcasts every Friday at 7 p. m., from WGBS, Gimbel Bros., N. Y. City, 315.6 meters. He discusses "What's Your Radio Problem?" Listen in!

Cast a Ballot for Your Favorite Kind of Program

LISTENERS have the chance of their lives to get the kind of programs they want. RADIO WORLD is conducting a canvass to determine what types of program are most attractive to the general public and is co-operating with broadcast stations, so that the will registered by the fans has a good chance of being carried into practice.

To get the run of opinion RADIO WORLD invites its readers to write to the Program Editor, telling what they like and dislike. Criticism of actual programs of particular station—either favorable or adverse—is

solicited. The letters may be as detailed as the writer desires. Also it is suggested that those not desiring to write a letter at least fill out and mail to the Program Editor the coupon published herewith.

Stations are eager to give the fans the kind of programs they want. In the early days of broadcasting a station's mail could be depended on to give the station the right course, but now fans write fewer letters, and a canvass such as being conducted will prove vastly beneficial.

Fill out this coupon today.

Program Editor, RADIO WORLD, 145 West 45th Street, New York City:

My preference for entertainment and instruction on the radio is as follows, the numbers next to the listed items representing the order of preference:

- | | | |
|--|---------------------------------------|---------------------------------|
| Grand opera..... | Ringside..... | Football game..... |
| Jazz orchestra..... | boxing report..... | Hockey match..... |
| Talk..... | Classical instru-
mental solo..... | Recitation..... |
| State subject
of talk here..... | State kind here..... | Musical comedy
(stage)..... |
| Classical vocal
solo..... | Jazz songs
vocal..... | Short play
(drama)..... |
| State kind here..... | Waltz (orchestral)..... | Short play
(comedy)..... |
| Musical saw..... | Symphony concert..... | Banquets, with
speeches..... |
| Vocal duet..... | Instrumental duet..... | Sermons..... |
| Vocal trio..... | Instrumental trio..... | Market report..... |
| Vocal quartet..... | Instrumental quartet..... | Weather report..... |
| Questions and
answers on
world topics..... | Brass quartet..... | Organ recital..... |
| | Bedtime story..... | |
| | Baseball game..... | |

If you particularly dislike any of the above listed offerings, write "No" on the dotted line.

Other offerings (not listed above).....

Remarks (if any).....

Fill out and
mail this
coupon today!

Name.....
Address.....
City..... State.....

DX Depends Much on Battery

By Charles H. M. White

Consulting Engineer

WHAT do we mean by radio pep in a battery? It is a new term, although it has existed as a reality ever since batteries have been used for radio. Many radio fans who are owners of storage-battery operated sets have noticed how flat and lacking of pep their batteries are when they are almost discharged, yet they light the tubes and give good reception on local stations. Therefore we cannot say that lack of voltage always means lack of pep, because many batteries have good voltage readings and still are incapable of furnishing a current of sufficient stability to give clear and continuous DX reception. Therefore it is not voltage but stability of voltage that is so important. I personally had noticed the result many times but never gave it very serious thought and research until a friend called me up one day and asked why his old automobile battery would light incandescent bulbs and also his radio tubes but would function poorly on his receiver. Surely, he argued, the battery was in condition, because it lit the tubes with ordinary brilliancy, yet local reception was the only passable reception. Although it was evident to me that his battery needed charging, still his argument had a tinge of logic and certainly there must be a hidden reason for such an action, because many persons have thought that as long as the tubes light brightly, results should be obtained.

Many Batteries Tested

To make my experiments as complete as possible I obtained as many different types of batteries as possible, including about a dozen brands of dry cells, some brands which the average radio fan never hears of, and, several types of storage batteries. These were connected up to a standard radio receiver that was capable of good distance reception, and, by means of a simple switching arrangement, it was possible to throw from one battery to another very quickly for comparison of results. Everything was arranged in a scientific manner to get a true comparative result as was possible. Of course accurate ammeter and voltmeters were used to insure that the tubes were working at a constant power input, otherwise the test would mean little in a comparative way. Also, among the varied types of batteries were some in various conditions of charge or depletion. There were half-exhausted dry cells and dry cells completely exhausted, or nearly so, as well as storage batteries in similar conditions.

These tests were confined to A batteries only. Various types of tubes were tried but the best comparative results were obtained with 201As and 199s, the most common tubes in use today.

We found that fresh dry cells of a certain manufacture recommended for radio use gave splendid results when fresh, but when half discharged there was a marked irregularity in our ability to hold a distant station on the loud speaker, yet, the power input to the tubes was kept constant.

Got Locals Only

But, when I tried the same brand of cells, almost completely exhausted, I found that local reception was the only clear reception. Of course in this state of discharge it was next to impossible to hold the current input constant, since the voltage as well as the stability of voltage was fast falling. I tried a brand of dry cell batteries that had been quite

JUSTIFIABLE DISTURBANCE



common in signal and telegraph work. From the very start these cells did not show the pep of the previous brand but as they were tried in different stages of charge their effectiveness was found to fall still lower. So I tried several makes in a comparative way. Then came the comparison between the various storage cells and dry cells. A new automobile type lead storage battery was first tried in various conditions of charge. When fully charged wonderful results were obtained and the same was true with half or three-quarters charge. I thought that better clarity existed at three-quarters charge than full charge. At discharge it was flat and lacking pep, the same as the almost depleted dry cell, capable of good local reception only. The so-called radio storage battery gave practically the same results, only it seemed to possess a little better stability on the lower condition of discharge, no doubt due to this particular make having thicker plates than the same make of automobile starting battery.

Comparable to Dry Cell

A non-acid type of storage battery was tried. It was found to resemble the dry cell for radio reception. It did not attain the high efficiency of the lead acid type of storage battery which is commonly used for A battery work. When nearly discharged its voltage as well as its "pep" or stability of voltage was rapidly falling. Even the so-called lighting type of lead acid storage battery was not so good as the automobile or radio special types when it came to "pep" and stability, especially at the discharge point. The wet storage battery of the acid type, when compared with dry cells, gave very much better results. This is not a reflection cast upon dry cells in general but is exactly what is to be expected, because a storage battery of the lead acid type has a better adaptability to radio. Even with the 199, a dry cell tube, better "pep" and clearer reception were obtained with storage batteries. This is not to be construed to wear that every owner of a dry-cell-operated tube set should throw away his dry cells, because the convenience as well as the low first cost of dry cells economically over-rid their slight fall-off in efficiency at partial discharge.

What's the Reason?

Now there are the results briefly, but now we must find a plausible reason for such an action and difference between various types of batteries and between various brands of the same type. Bat-

teries that were quite fresh gave much better results, it seemed, and, since the internal resistance became higher, with discharge, as well as the voltage dropping, it was quite evident that the radio "pep" should fall off greatly. This increase in internal resistance is especially true with storage batteries that have internal resistance that varies greatly with condition of charge, because at full charge the electrolyte in the battery is acid of a specific gravity reading 1.275 or 1.330, while at discharge it is 1.100, which is nearer water, or, chemically, there is more water and less acid at the discharge point. I was indeed surprised to find that this internal resistance law held very rigidly to the actual test results.

The Scientific Explanation

Now here is the theoretical reason. As a voltage is impressed upon the grid of a tube the emission from the filament to the plate is increased or decreased. This causes increase or decrease in the filament current, due to the filament being heated or cooled relatively, which causes a change of resistance in the filament wire, thus causing the filament current to change. This change is a very, very minute indeed with a receiving tube but is quite noticeable with a power amplifier tube. In the latter case the naked eye can detect the change in brilliance in the filament. Now, the rate of change in the terminal voltage of the battery is almost directly proportional to the internal resistance multiplied by the rate of change in the filament. Now, the rate of change in the terminal voltage of the battery is almost directly proportional to the internal resistance multiplied by the rate in the current. If the internal resistance were zero, then there would be no rate of change in the terminal voltage across the battery. If it so happens that this rate of change of voltage is greater than the rate of change or magnitude of the change on the grid a weak signal will only be "fuzzily" and not sharply amplified, or, it may be completely obliterated. Mathematically, it is very complicated, but the actual test result bears out this explanation to a remarkable degree. DX depends to a great extent on battery "pep."

Have you seen the Clinical Study of Low-Loss Coils, covered by the Bureau of Standards, that appeared in our Jan. 16 & 30 issues? Send 30c for both, or start your subscription with that issue. RADIO WORLD, 145 W. 45th St., N. Y. C.

BIG BARGAINS!!

WRITE NOW—for our NEW list of Big Radio Values! Prices on Standard Parts and Sets SLASHED TO NOTHING! BUY from US and SAVE! Radiotriangles and Dealers—Write Now! 24 Hour Service—No Delay! MAURICE SCHWARTZ & SON, 710-712 Broadway, Schenectady, N. Y.

BEAUTY-QUALITY-LOW PRICE

TYPE 5SS 5-Tube Tuned Radio Frequency. \$45
TYPE 6RR 6-Tube Resistance Coupled Audio Tuned Radio Frequency \$50
If your dealer cannot make immediate delivery we will ship direct from factory
American Interstate Radio Service
183 Greenwich Street, New York City
Distributors, Jobbers, Dealers, write for special trade terms.

New and Improved
FRESHMAN MASTERPIECE
AT AUTHORIZED
FRESHMAN DEALERS ONLY

STREAMLINE

Straight-Line Frequency Condensers
Are Accurate
.0005 mfd. \$2.50 .00035 mfd. \$2.25 .00025 mfd. \$2.00
STREAMLINE RADIO CO.
223 Fulton Street New York City



The Antennaphone
IMPROVES RECEPTION
Gives wonderful results with any radio set. Not attached to, but merely placed under the telephone. Price One Dollar. Complete with insulated wire and simple instructions. At Your Dealer or Mailed C.O.D. on 3 days approval.
ANTENNAPHONE CO.
90 West St. New York City

MAGIC DIAL



Makes condensers that are not straight-line frequency tune as if they were. Moulded Bakelite. No gears, no back lash..... \$2.50
Specify gold or white inlay.

For straight-line frequency condensers use "Bruno Slo-Moshen" Vernier Dial, \$2.00

POWERTONE KIT

Complete Kit for 5-Tube, 1-Control "Bruno" Powertone; Drilled, Engraved Panel; Bruno Dial; Free Radio World Blueprint, SELF Condenser..... \$22.50

Powertone Electric Co.
SUBSIDIARY OF BRUNO RADIO CORPORATION
223 Fulton Street
New York City

1926 DIAMOND OF THE AIR BOOKLET with full instructions to make the Diamond, with blue print. 50c. Or free to new yearly subscribers or renewals. RADIO WORLD, 145 W. 45th St., N. Y. C.

HERMAN BERNARD, managing editor of RADIO WORLD, broadcasts every Friday at 7 p. m. from WGBS, Gimbel Bros., N. Y. City, 315.6 meters. He discusses "What's Your Radio Problem?" Listen in!

HEAR JOHN F. RIDER, contributing editor of RADIO WORLD, broadcast every Thursday at 9 p. m. from WCCP, 252 meters. D. W. May, Inc., Newark, N. J. Mr. Rider discusses radio problems.

THE RADIO TRADE

A Perpetual Log

The Radio Printers, located at Marengo, Ill., have compiled a very interesting Perpetual Log. The first portion of this booklet is devoted to an alphabetically arranged list of stations in the U. S. and Canada, with special spaces alongside, for placing the dial settings and general remarks upon the reception of these stations. Stations arranged according to states and provinces in the U. S. and Canada, respectively, follows the above. An alphabetical list of stations in the U. S. and Canada with the owners of the same follows. A numerically arranged list of stations according to wavelength in meters and kilocycles is next. Hints as to the successful operation of the receiver, e. g., Trouble Shooting, Questions and Answers, etc., follow.

The important feature of this booklet is that it is revisable. The company sends sheets telling of discontinuance of stations, changes in wavelength, station name owners, station addresses, Tuning Suggestions, Trouble finders, Repair Hints, Questions and Answers, etc., every now and then, depending upon the frequent changes which take place. By means of a small screw and nut, sheets may be taken out and new ones inserted. In this manner, the booklet is kept up-to-date.

A Radio Index

The Radex Press of Cleveland, O., have issued a booklet called Radex or Radio Index. In the first portion of this booklet, all the stations in the U. S. and Canada are listed according to wavelength in meters and frequency in kilocycles, with the power used and the owner and the location of the station. These are so arranged that the dial settings may be marked alongside of the stations, so that these same stations can easily be found. A list of stations according to the location in the U. S., Canada, Cuba and Mexico make up the concluding pages of this interesting booklet.

New Corporations

Elite Radio Tube Co., Newark, N. J., \$100,000; Giuseppe Delsordo, Philip Santora, Generosa Palmarozza, all of Newark, N. J. (Atty., F. D. Masucci, Newark, N. J.)

Edison Radio Corp., N. Y. City, 100 common, no par; J. J. Fisher, E. Krasnoff. (Atty., S. I. Shapiro, 51 Chambers St., N. Y. City.)

Westchester Radio Service, White Plains, N. Y., 500 common, no par; L. Frankel, D. Cohen, A. C. Knoeller. (Attys. Hedges, Ely & Frankel, 165 Broadway, N. Y. City.)

G. and G. Victrola and Radio Corp., N. Y. City, \$1,000; J. M. Klein, H. L. Richer, S. Lipschitz. (Atty., M. Light, 71 Nassau St., N. Y. City.)

**Business Opportunities
Radio and Electrical**

Rates: 10c per word; Minimum, \$1.00; Cash with order

CAPITAL AND PLANT equipped for manufacturing metal goods or specialties desires connection with parties who have such articles to manufacture. Write for interview, Morris Levin, 380 Throop Ave., Brooklyn, N. Y.

RADIO AND ELECTRICAL business for sale; established 27½ years; situated in Yorkville section, doing \$50,000 to \$60,000 a year; owner wants to retire. Box 5, 1329 3rd Ave., New York.

ESTABLISHED RADIO tube factory with business, automatic equipment; partners disagree; quick sale. Box 121, RADIO WORLD.

Literature Wanted

The names of readers of RADIO WORLD who desire literature from radio jobbers and dealers are published in RADIO WORLD on request of the reader. The blank below may be used, or a post card or letter will do instead.

Trade Service Editor,
RADIO WORLD,
145 West 45th St., N. Y. City.

I desire to receive radio literature.

Name

City or town.....

State

Are you a dealer?.....

If not, who is your dealer?

His Name

His Address

- S. A. Spencer, Galion, Ala.
- Clyde L. Soper, Cameron, W. Va. (Dealer.)
- Robert Anderson, Ludlow Falls, O.
- A. Iseim, 14621 Cort Road, Cleveland, O. (Dealer.)
- Carl Jacobson, 634 N. State St., Painesville, O.
- Arthur Lane, Linden, N. J.
- R. E. Gannon, 93 Mt. Ida Road, Dorchester, Mass. (Dealer.)
- Rudolph Roos, Box 430, Grand Island, Neb. (Dealer.)
- Chas. A. Fisher, care Central Educational Bureau, Selinsgrove, Pa.
- Oscar Warner, care General Delivery, Fort Wayne, Ind.
- Anton Dyezus, 20 River St., West Lynn, Mass.
- Eureka Supply Co., 395 South Eureka Ave., Columbus, O. (Dealers.)
- William Hanksen, Jr., New Lexington, O.
- Wallace Graham, Marlborough, Mass. (Dealer.)
- W. R. Edwards, 1268-47th St., Norfolk, Va.
- C. R. Harmon, R. 4, Whitewright, Tex.
- L. E. Snyder, 1509 Hunter Ave., Columbus, O.
- Ewell Morrow, Box 144, Marlow, Okla.
- John J. Clifford, 4925 Broad St., Pittsburgh, Pa. (Dealer.)
- Elmer C. Testut, 256 Floral Ave., Ithaca, N. Y.
- Gray Roland, Crawford, Ga. (Dealer.)
- C. J. Weber, 1209 Washington St., Watertown, N. Y. (Dealer.)
- J. A. Holmes, 605 North 32nd St., Waco, Tex. (Dealer.)
- E. C. Cloud, Box 66, White Swan, Wash.
- R. M. Shlaes, care General Delivery, Omaha, Neb.
- F. H. Lennox, 1324 Brooklyn Ave., Ann Arbor, Mich. (Dealer.)
- Hiram C. Thomas, 263 E. Market St., Wilkes Barre, Pa.
- E. R. Hahnewald, 173 N. Peoria St., Chicago, Ill.
- Harry W. Bire, P. O. Box 12, Monongah, W. Va.
- Jack Mann, 321 First St., Macon, Ga. (Dealer.)
- Pasco C. Tilson, Box 727, Asheville, N. C.
- Richard Principate, Box 84, New Galilee, Pa.
- N. Straley, Box 438, Seattle, Wash.
- Frank L. Knox, Watrous, Saskatchewan, Canada.
- W. H. Raven, Box 489, Pictou, N. S., Canada.
- Ernest Hobson, 530 South Cedar St., Galesburg, Ill.
- Herman F. Johnson, P. O. Box 1221, Tallapoosa, Ga.
- Delmer L. Hansen, 423-8th Ave. S., St. Cloud, Minn.
- Peter Van Malsen, 1045 Atto Ave., S. E., Grand Rapids, Mich.
- C. A. Schreurs, 616 E. 5th, Muscatine, Ia.
- A. Brassard, 169 Elm St., Bridgeport, Conn.
- Fred Steib, 360 Van Buren St., Warsaw, Ill.
- M. E. Eichinger, Box 155, Nevada, Mo.
- D. E. Young, care of Niagara Falls Power Co., Niagara Falls, N. Y.
- L. F. Cleveland, Box 632, Terryville, Conn.

Powertone Blueprint

The 1926 Model 50c
I-Dial 5-Tube Set

This is the famous DX set as described in

RADIO WORLD

COLUMBIA PRINT

145 West 45th Street N. Y. C.

RESULTS

Readers report on their experiences with sets built from hookups published in RADIO WORLD. Address Results Editor, RADIO WORLD, 145 West 45th Street, New York City, and send photographs of sets, if possible.

RESULTS EDITOR:

I have built the 1926 Model Diamond of the Air and am really surprised at the results obtained. I expected a great deal from this set when I built it according to the directions in RADIO WORLD, but the results far exceeded my expectations.

SM PARTS

SM Low Loss Inductances



All-bakelite Low Loss Interchangeable Coils for 50-550 meters. These new coils may be used as oscillators, antenna adapters and RF transformers in standard circuits.

Price of all types:
Each \$2.50
Sockets for any size Coils. Each..... 1.00

SM Type 316 Condensers are furnished, all brass plates, die-cast frame and double adjustable cone bearings. May be gauged by placing one socket behind another, the shafts interlocking in any desired relation. SLF .00035 mfd. capacity for all types of SM Interchangeable coils. Price...\$5.75



SM Vernier Dials



The SM Type 801 Vernier Dials are of all bakelite construction. Zero to 100 — clockwise — counter-clockwise or 360 degrees (for Remler Condensers) in a single type. In appearance and operation the SM is the finest vernier dial on the market. Price, each \$2.50

SM 210 and 211 Transformers

Designed so that maximum amplification will be obtained at 60 Kilocycles. Available in matched sets of any number. No. 210 is iron-core type while No. 211 is of the air-core type supplied with measured tuning condenser. Each transformer is furnished with individual laboratory curve chart. Price: Both Types.....\$8.00 each



See these and other SM Parts at your Dealers or write for circulars.

Silver-Marshall, Inc.
110-R South Wabash Avenue
CHICAGO, ILLINOIS

Using only three tubes, or the RF, Det. and first AF tubes, I have received over 110 stations.

JAMES V. McMILLEN,
R. D. 2, Barnesville, O.

* * *

RESULTS EDITOR:

I have built the 1926 Model Diamond of the Air and find it wonderful. It is no difficult task for me to bring in Chicago stations. The volume is very good. The selectivity is also good. I wish to thank Herman Bernard for this wonderful hookup.

A. SAVAGE,
331 Weeden St.,
Pawtucket, R. I.

* * *

RESULTS EDITOR:

The impossible, or at least what I thought was the impossible, has been done with the Diamond of the Air. I was able to get loud speaker volume on signals coming from station WIOD, Miami, Fla., operating on a wavelength of 245 meters, while station WBAL, a local here operating on 245 meters and using 1,500 watts, without any interference. I could separate either station at will by simply turning the dials one notch.

W. D. WALLACE,
2436 W. Franklin St.,
Baltimore, Md.

* * *

RESULTS EDITOR:

I have been interested in radio since pre-war days and have been a reader of RADIO WORLD for three years. Some time ago, while reading some comments of other readers, I noticed a letter from some reader who evidently knew just enough about radio to be dangerous to himself. He went on to say that your hook-ups were of no value, etc. I have not built every set that has appeared in your pages, but I have tried a majority of them and I want to say that

I have yet to find any mechanical or electrical defects in the directions as given. True, some of the sets have worked better than others in my location, but it must be remembered that all sets will not function the same in one location. I have therefore no hesitation in saying that your various types of receivers all have merit. If they are made strictly according to the instructions, composed of quality parts and then balanced
(Concluded on page 25)

SANGAMO CONDENSERS

Heat proof, moisture proof, fume proof. Guaranteed to be accurate to within 10% under all temperature and humidity conditions. The following capacities are regularly carried in stock:

0.00004	0.000175	0.0008	0.005
0.00005	0.0002	0.001	0.006
0.00006	0.00025	0.0012	0.007
0.00007	0.0003	0.00175	0.0075
0.00008	0.00035	0.002	0.008
0.0001	0.0004	0.0025	0.01
0.00012	0.0005	0.003	0.012
0.00015	0.0006	0.0035	0.015
	0.0007	0.004	

ROSSITER & CO., Inc.

WHOLESALE DISTRIBUTORS
136 Liberty St., New York

for the FENWAY

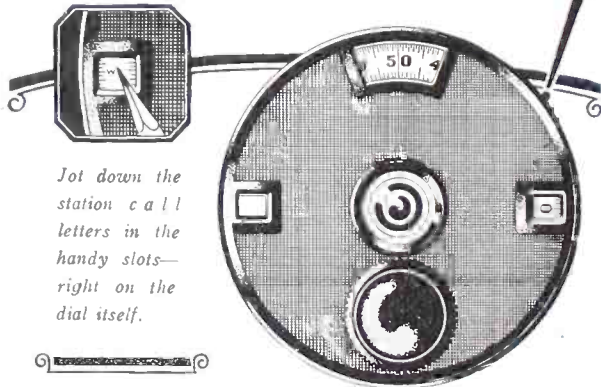

Not down the station call letters in the handy slots—right on the dial itself.

WHEN you build your Fenway Super—be sure to use MAR-CO dials, as specified by Leo Fenway himself. They, alone, provide the

searching, responsive tuning for today's needs. Put them on your present set, as well. They fit all sets. Martin Copeland Co., Providence, R. I.

Hair-trigger response

MAR-CO

Micrometer-like action



DIALS



The 1926 model tuning control

RESULTS EDITOR:

I hooked up the filter circuit of the Rex B Battery Eliminator, described by Lewis Winner in the Dec. 12, 19 and 26 issues of RADIO WORLD, and am very well pleased with it. I could not use the transformer-tube side, as I have DC in my home.

I find that this filter circuit makes an

ideal B Battery Eliminator for people who have DC. It is noiseless and powerful enough to use on an 8-tube super-heterodyne, with a minimum of cost.

Many thanks to RADIO WORLD.

DR. C. M. FRENCH,
1060 Greene Ave.,
Brooklyn, N. Y.

FENWAY BLUE PRINTS

ACTUAL SIZE LAYOUTS
CERTIFIED BY THE DESIGNER
PRICE, POSTPAID—\$3.00
You Can't Go Wrong with These

LEO FENWAY
711 EIGHTH AVENUE NEW YORK, N. Y.

(Concluded from page 24)

for the particular location wherein they are to be used, the maker and user of that set will not fail to get every satisfaction. Evidently your dissatisfied reader has tried to incorporate too many of his own ideas into the set that he was building.

I noticed Diamond of the Air in your magazine. I marked it with a red pencil as having possibilities, but it was only a week or two ago that I found the time to put it together. There are many Supers and other circuits using up to eight or more tubes that are really obsolete when compared with the Diamond.

As I am building practically all the time, it is not very often that I can sit down and go on a DX expedition, but I have received over 100 DX stations in the few odd minutes that I have been able to give to the Diamond. All of the above stations were all of ample volume. The above listed stations came through our locals without the least difficulty. As long as your present excellent instructions continue, you cannot help but have a top-notch among radio publications.

R. B. FOWLER,
200 A. Westminister Ave.,
Toronto 3, Canada.

* * *

RESULTS EDITOR:

I have completed the Diamond of the Air and find that quality and the volume of the signals whether from distant or local stations are wonderful.

H. O. BENFIELD,
c/o L. & N. Depot, New Orleans, La.

The New NATIONAL Variable Velvet Vernier Dial

Positive
Control
Easily
Mounted
Gearless

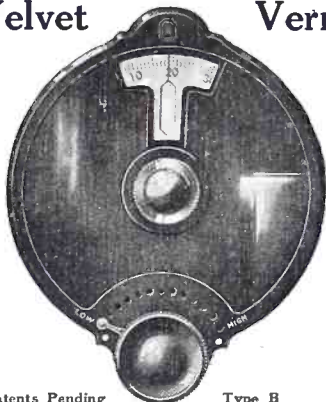

Variable
Ratio
Velvet
Smoothness
Ornamental

Patents Pending Type B

This dial embodies a modified application of our "Velvet Vernier" mechanism designed to facilitate mounting on the 1/4" shaft of any standard type of variable condenser, without the use of tools other than a screw driver. It will replace plain dials on any receiver where sharper tuning is desired.

Of special importance is a new and novel device which enables the user to adjust at will the reduction to any ratio from 6-1 to 20-1. This feature aids greatly in the separation of stations operating on the lower wave lengths. This new dial is moulded from black bakelite in a highly ornamental design.

Specifications	Price Nickel Finish	Gold Finish
Clockwise 200-0 (360°)	\$2.50	\$3.00
Counter-Clockwise 0-200 (360°)	2.50	3.00

Send for Bulletin 109 RW

NATIONAL CO., INC., 110 Brookline Street, Cambridge, Mass.
W. A. READY, President



CHAS. W. DOWN



is the FENWAY SPECIALIST

LIST OF PARTS FOR THE "FENWAY"

1 Special Drilled and Engraved Panel as specified.....	\$10.00
1 Special Hardwood Baseboard.....	1.00
1 Set of Four Special Copper Cans, Black Satin Finish, per set	11.00
1 Sub Panel, Drilled and Engraved, No. 214.....	1.25
3 General Radio Variable Condensers, .00035, each \$3.75.....	11.25
1 General Radio Medium Frequency Input Transformer No. 331	5.00
3 General Radio Medium Frequency Input Transformers, No. 271, each \$5.00.....	15.00
2 General Radio 6-ohm Rheostats, No. 301, each \$1.25.....	2.50
1 General Radio 400-ohm Potentiometer, No. 214.....	3.00
2 General Radio Audio Transformers 1, No. 285 and 1 No. 285-L, each \$6.00.....	12.00
2 Silver-Marshall Changeable Coils, No. 110-A and 1 No. 111-A, each \$2.50.....	5.00
2 Silver-Marshall Coil Sockets for No. 110-A and No. 111-A, each \$1.00.....	2.00
1 Special R. F. Variable Coupler mounted on sub panel with switch and taps, all wound ready for use.....	6.00
3 Gem Fuses and Base.....	1.00
1 Royalty Type B Resistance.....	1.50
1 Yaxley Filament Switch.....	.50
1 Yaxley Filament Control Jack.....	.70
1 Yaxley 2 Circuit Jack.....	.80

1 Yaxley D. P. D. T. Switch No. 60.....	\$1.25
9 Air-Gap Sockets, each 75c.....	6.75
3 National Vernier Dials (new type), each \$2.50.....	7.50
8 Eby Binding Posts, each 15c.....	1.20
50-Foot Celatsite Wire, per foot, 4c.....	2.00
1 Jewell Combination Volt Meter 0 to 8-80-160.....	12.50
1 Jewell Meter 0 to 50 Milli-Amps.....	7.50
1 Micamold Condenser Grid .00025.....	.35
1 Micamold Condenser Grid .0005.....	.45
1 Micamold Condenser By-Pass .001.....	.40
1 Micamold Condenser By-Pass .01.....	.90
3 Micamold Condenser By-Pass .5, each 90c.....	2.70
1 Micamold Grid Leak 2 Megs.....	.30
1 Micamold Grid Leak 5 Megs.....	.30
1 Micamold Grid Leak Mount.....	.30
Total.....	\$133.90

NOTE—Silver-Marshall Transformers can be supplied at an additional cost of \$12.00 per set.

NOTE—For those desiring to wind their own coils, coupler and other special parts, the proper parts may be had on receipt of order for same.

LOOK UP DOWN

The Fenway Specialist

Send your order for any or all the parts TODAY. ALL MERCHANDISE SHIPPED PARCEL POST PRE-PAID SAME DAY ORDER IS RECEIVED—NO WAITS—EVERYTHING IS READY—Your Money Back If Not Satisfied! Anyway, send for special circular and price list—IT'S FREE!

CHAS. W. DOWN, 711 EIGHTH AVENUE, NEW YORK, N. Y.

(Wholesale Prices Quoted to Bonafide Dealers Only)

THE INTERMEDIATES

I have so many requests for the International Intermediates, as used by amateurs before their call letters, that am publishing them herewith. I hope that this information may clear up somebody's DX mystery stations:

Standard International Intermediates

- | | |
|---------------------------|--|
| A—Australia | P—Portugal |
| B—Belgium | PI—Philippine Islands |
| BE—Bermuda | Q—Cuba |
| BZ—Brazil | R—Argentina |
| C—Canada and Newfoundland | RU—Russia |
| CH—Chile | S—Scandinavia: (Finland, Sweden, Iceland and Norway) |
| CR—Costa Rica | U—United States |
| D—Denmark | V—(Used as an intermediate and also as break signal by various U. S Army and Naval Stations) |
| E—Spain (Española) | Y—Uruguay and Jugoslovakia (unsettled) |
| F—France | Z—New Zealand (sometimes NZ) |
| G—Great Britain | |
| H—Switzerland (Helvetia) | |
| HU—Hawaiian Islands | |
| I—Italy | |
| J—Japan | |
| K—Germany | |
| L—Luxemborg | |
| M—Mexico | |
| N—Netherlands | |
| O or Zero—South Africa | |

The intermediates are placed between the station calling and the call letters of the called station, for example:

If United States 1 AOA wishes to call Mexican 9A, he uses the following procedure:

9A, 9A, 9A mu mu 1 AOA, 1 AOA, 1 AOA k.

In answering the call m9A would send: 1 AOA, 1 AOA, um um 9A, 9A (and start the conversation).

In case ul AOA had messages for Brazil and couldn't get a reply then he would send a CQ or general inquiry call and insert the intermediate as follows:

CQ CQ CQ bu bu 1 AOA 1 AOA 1 AOA, with a slight space between the bz and the u. If bz1 AB heard this all he

would reply as set forth in the second case (using bz instead of m of Mexico).

Foreign—nz4 AR, f8 YOR, s2 CO, f8 XP, g6 TD, e AR24, e ARN, il AS.—I. P. W.

Nine More Stations Stricken From List

WASHINGTON.

Nine broadcasting stations were discontinued, as follows:

500 watts—KFGH, Stanford University, California.

100 watts—KFGC, Baton Rouge, La.; KGB, Tacoma, Wash.; WDCH, Hanover, N. H.; WIBC, St. Petersburg, Fla., and WRAC, Escanaba, Mich.

50 watts—KFUJ, Breckenridge, Minn.

10 watts—WJBN, Sycamore, Ill.

5 watts—WGBK, Johnstown, Pa.

FIXED RESISTORS

Micamold

FIXED CONDENSERS

Accurate, Constant in Value
Indestructible.

"Made of Mica and Moulded
in Bakelite"

At good Radio Stores
MICAMOLD RADIO CORP.
Flushing and Porter Aves.,
Brooklyn, N. Y.

ACCURACY GUARANTEED
—VALUES REMAIN CONSTANT

MOULDED UNDER PRESSURE OF 50 TONS

HEAR JOHN F. RIDER, contributing editor of RADIO WORLD, broadcast every Thursday at 9 p. m. from WGCP, 252 meters. D. W. May, Inc., Newark, N. J. Mr. Rider discusses radio problems.

HERMAN BERNARD, managing editor of RADIO WORLD, broadcasts every Friday at 7 p. m., from WGBS, Gimbel Bros., N. Y. City, 315.6 meters. He discusses "What's Your Radio Problem?" Listen in!

Plenty of Power for the FENWAY

Build the MAGNATRON-REX "B" ELIMINATOR

- SEE RADIO WORLD, DEC. 12th AND 19th ISSUES
- | | |
|---|--------|
| Transformer, Complete for Magnatron Rex "B" Eliminator..... | \$4.50 |
| Transformer, Complete for Raytheon "B" Eliminator..... | 5.50 |
| Choke Coils for Magnatron Rex "B" Eliminator..... | 3.50 |
| Choke Coils for Raytheon "B" Eliminator..... | 3.00 |

COMPLETE KITS for MAGNATRON-REX or RAYTHEON "B" Eliminators

with full instructions for Assembly. Write for Prices. Shore Transformers and Chokes are Substantially Built. Transformers made for Chemical Rectifiers or for all Rectifying Tubes, such as Magnatron Rex, Schicklering, Neon, Raytheon, 201-A, etc., etc. Chokes in sizes up to 400 Henry made to specification. Prices quoted on request. All goods sent anywhere in the United States prepaid on receipt of price.

SHORE ELECTRIC CO., Inc.

64 University Place New York

Makers of the Shore Audio Transformers and Specialists on Transformers in General

FILL OUT AND MAIL NOW

SUBSCRIPTION BLANK

RADIO WORLD

RADIO WORLD

145 West 45th Street, New York City
(Just East of Broadway)

Please send me RADIO WORLD for months, for which

please find enclosed \$.....

SUBSCRIPTION RATES:

Single Copy.....	.15
Three Months.....	1.50
Six Months.....	3.00
One Year, 52 Issues.....	6.00
Add \$1.00 a Year for Foreign Postage; 50c for Canadian Postage.	

PANELS

For the Greatest Circuit
THE FENWAY

Authorized by MR. FENWAY
PANELS AND BASE PANELS SUPPLIED
Decorated or Engraved
WHOLESALE AND RETAIL
National Radio Panel Co., Inc.
319 BROADWAY NEW YORK CITY

\$6.50

APOLLO

Parlor Model



Stands 22 inches high, has a ten inch bell, gives faithful reproduction and may be varied from a whisper to a torrent of sound by the adjustable unit control without the least loss of the sweet, mellow, clear tones that are found in the Apollo Speakers. Mail orders promptly filled. Send no money, just pay the postman.

We can save you 20 to 50% on all radio parts and accessories. Write us for prices on articles you need.

Rix Radio Supply House, Inc.
5505 Fourth Ave. Dept. 43
Brooklyn, N. Y.

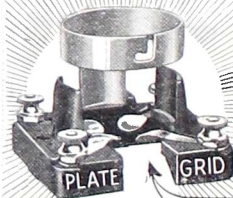

"It gets that last mile"

SEE THAT GAP?

The AIRGAP SOCKET

used in the

FENWAY

Mr. Leo Fenway, designer and builder of the Fenway Superhet, uses the Airgap Sockets for greatest efficiency and maximum results. In the New York Sun on December 26th, 1925, Mr. Fenway says: "The success of the Fenway depends upon (1) that stage of radio frequency with regeneration (2) those tin or copper cans and (3) those Airgap sockets.

In building your Fenway, be sure that you use Airgaps—then and only then, will you get the results obtained by the designer himself.

Airgaps will free any set from those squawks and howls due to socket capacity. They prevent closed circuit, absorption of current, intercoupling of circuits, feedback and undesirable capacity. They make any set more stable and sharpen tuning, resulting in purer and clearer tones with more volume particularly on distant stations.

At All Dealers 75c

If your dealer cannot supply you, send direct.

Airgap Product Company
186 N. J. R. Rd. Avenue
NEWARK NEW JERSEY

RESULTS EDITOR:

I have built four Diamonds of the Air receivers and they certainly are all wonderful. I use an inside antenna attached to the bed spring and get great results. I

have received stations as far as Denver, Canada and Florida. I have never tried an outside antenna yet. The result with the inside antenna suit me. The tone is wonderful. While I am writing this letter I am listening to a station in Miami, Fla. It can be heard all over the house. I certainly thank RADIO WORLD for the hookup.
GEO. H. ROESE,
642 Washington St.,
N. Y. City.

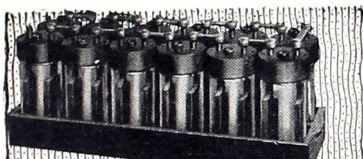

FREE! To Each Purchaser of a WORLD 6 V. Auto or Radio BATTERY

12-Cell — 24-Volt Storage 'B' Battery

Positively given free with each purchase of a WORLD "A" Storage Battery. You must send this ad with your order. WORLD Batteries are famous for their guaranteed quality and service. Backed by years of successful manufacture and thousands of satisfied users. Equipped with Solid Rubber Case, an insurance against acid and leakage. You save 50 per cent and get a

2-Year Guarantee

Bond in Writing "tell their friends." That's our best proof of performance. Send your order in today.

Solid Rubber Case Radio Batteries
6-Volt, 100-Amperes . . . \$11.25
6-Volt, 120-Amperes . . . 13.25
6-Volt, 140-Amperes . . . 14.00

Solid Rubber Case Auto Batteries
6-Volt, 11-Plate . . . \$11.25
6-Volt, 13-Plate . . . 13.25
12-Volt, 7-Plate . . . 16.00

Send No Money Just state battery wanted and we will ship day order is received, by Express C. O. D. subject to your examination on arrival. FREE "B" Battery included. Extra Offer! 5 per cent discount for cash in full with order. Buy now and get a guaranteed battery at 50 per cent saving to you.

WORLD BATTERY COMPANY
1219 So. Wabash Ave., Dept. 17 CHICAGO, ILL.

Set your Radio Dials at 210 meters for the new 1000 watt World Storage Battery Station, WBSB, Chicago. Watch for announcements.

World STORAGE BATTERIES
WKA WEAF WGN WJWS KHL KGO KFAF WJW KOB

Panels and Sub-panels
for Diamond of the Air
BROWNING-DRAKE,
B-T COUNTERPHASE.

FENWAY Authorized by Leo Fenway, \$10 each.
Also Cut to Any Size. Mail Orders Promptly Filled.

Cortlandt Panel Engraving Co.
79 Cortlandt Street New York City

TROUBLED WITH INTERFERENCE?

We have the cue. Build the Rider Wave Trap.

Sold in kit form, with Money-Back Guarantee Complete kit, including panel and hookup. **\$8.95**

JOHN F. RIDER LABORATORIES
145 West 45th Street New York City
Telephone BRYant 2383

SEND 4c FOR DEC. 12, 19 AND 26 covering RADIO WORLD'S B BATTERY ELIMINATORS. RADIO WORLD, 145 W. 45th St., N. Y. C.

Nameplates

Here is a new list of names and addresses of fans who requested a nameplate for the Diamond of the Air:

Allen Duncan, Box 31, Capital Hill Station, Oklahoma City, Okla.
W. J. Smith, c/a Western Union Telegraph Co., New Orleans, La.
Wm. Roney, 326 Pilgrim Ave., Highland Park, Mich.
Geo. W. Hersey, 353 Plymouth St., Buffalo, N. Y.
V. Gillogly, Villa Grove, Ill.
Rocco P. Grordano, 294 19th St., Bklyn., N. Y.
Elton E. Weiler, Route 2, Fremont, O.
Andrew Barren, 129 Walter St., Buffalo, N. Y.
F. J. Campbell, Fairlee, Vt.
Otto E. Bruening, R. R. 2, Box 444, Clayton, Mo.
James C. Branwell, R. R. 1, Box 85, New Castle, Del.
W. G. Davies, 312 N. St., Centralia, Wash.
Fred G. Wring, 312 High St., Watertown, N. Y.
Jos. M. Swartz, 14118 Kinsman Rd., Cleveland, Ohio.
R. A. LaRoche, 16 Massasoit Rd., Worcester, Mass.
Ed. J. Cruickshank, 1706 Palmetto St., Bklyn., N. Y.
J. F. Ross, 24 Waverly Ave., Everett, Mass.

Latest Patents

1,564,694—Shield for Amplifier or Detector Tubes. Edward H. Lerchen, East Orange, N. J. Filed Oct. 10, 1922.
1,564,807—Radi Signalling System. Ernst F. W. Alexanderson, Schenectady, N. Y., assignor to General Electric Co. Filed May 4, 1918.
1,564,851—Dynatron Synchronous Detector. Albert W. Hull, Schenectady, N. Y., assignor to General Electric Co. Filed Nov. 13, 1920, renewed Feb. 5, 1925.
1,564,852—Electron Discharge Apparatus. Albert W. Hull, Schenectady, N. Y., assignor to General Electric Co. Filed Sept. 8, 1921.
1,565,206—Radio Coil Mount. George F. Ruzicka, Bohemia, N. Y. Filed Jan. 14, 1925.

CLAROSTAT



is the most accurate variable resistance ever placed on the market. It has a continuously variable resistance ranging from practically zero to five million ohms—and all this without a single abrupt step! \$2.25

American Mechanical Laboratories, Inc.
285 N. 6th St. Brooklyn, N. Y.

CHOSEN FOR THEIR MERIT

Always remember in building a radio receiver that its performance depends primarily upon two things: efficient circuit and the use of good parts.

Wherever you find a popular circuit you will invariably find General Radio Parts.

General Radio Company has contributed more in scientific apparatus for laboratory use than any other one company in the history of radio.

The same outstanding craftsmanship and material are embodied in General Radio Parts for use in the construction of Broadcast receiver.

Through the merits of design, performance, and price, General Radio instruments for the scientist or set builder are universally recognized as the standard of excellence.

Every instrument made by the General Radio is thoroughly guaranteed.

GENERAL RADIO COMPANY
CAMBRIDGE 39, MASS.

GENERAL RADIO INSTRUMENTS



TYPE 271
Medium Frequency Transformer.
10,000 Meters. (30 K.C.) Price \$5.00.



TYPE 214
Rheostat. Price \$2.25.

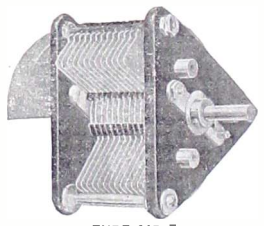

TYPE 247 F
Variable R L W Condenser. Price \$4.00.



TYPE 285
Audio Amplifying Transformer. Ratios
6 to 1 and 2 to 1. Price \$6.00 each.

Behind the Panels of Better Built Sets

Dr. Goldsmith Discusses Tone Quality in Receivers

(Continued from page 19)
instruments may also not be distinguishable from each other, and whole sections

FREE RADIO BOOK

Science has invented a new kind of coil. Now have it on your present set. Gives 4 great advantages otherwise impossible. Write for new book just published showing many new ideas. Also 8 new circlard circuits. Address Electrical Research Laboratories, R. W., 2548 Cottage Grove Avenue, Chicago.

RADIO TUBES FACTORY PRICES!

LOW IMPEDANCE, genuine thirtled filament, quarter ampere 201-A type. Silvered and tipless. Will imitate any set. GUARANTEED.

75c Each, Postpaid

TRELLCOTT CO.

2118 Hale Ave. Louisville, Ky.



HARD RUBBER

SHEET—ROD—TUBING

In various sizes

Special Hard Rubber Parts Made to Order
Send Sample or Sketch for Quotation

PANELS ANY SIZE

RADION AND HARD RUBBER
PRICE LIST FOR ALL RADION PRODUCTS
MAILED ON REQUEST

WHOLESALE RETAIL

NEW YORK HARD RUBBER TURNING
COMPANY

212 CENTRE STREET NEW YORK

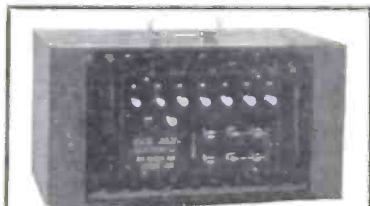

The Edison Element "B" Battery has long been the marvel of battery users, thereby surpassing all others. The See-Jay Battery is constructed from genuine alkaline element and connected with a non-corroding connector. 100-volt Alkaline Rechargeable "B" Battery and factory made charger for \$12.00; 140-volt, \$17.00. Write for literature or send 20c for sample cell. Send no money—pay on delivery.
SEE-JAY BATTERY CO., 915 Brook Ave., N. Y. City

of the orchestra (for example, the relatively suppressed accompaniment) may be lost. When the full orchestra strikes a crashing chord the effect may be that of noise rather than increased tone volume, and even rattling sounds may be produced in extreme cases.

A brief consideration of all the objectionable results of imperfect acoustic synchronizing makes it clear that the attention of the radio audience can not be held under such circumstances. And nothing is more likely to be fatal to satisfactory reception than the wandering of the attention of even a part of the audience. One auditor will shift unnecessarily in his seat or speak to his neighbor. This detracts still more from the already unsatisfactory reception and, in a discouragingly short period of time, the entire audience has lost interest, is talking about other matters, and the musical evening is spoilt beyond recall. Nevertheless, these limitations of imperfect receiving equipment can be removed, and when they are removed the attention of the audience can be riveted on the performance itself if it has any intrinsic merit. Acoustic synchronizing produces clearly chiseled "human-sounding" speech, with every vowel and consonant readily distinguishable and with all the little human touches, (such as the breathing of the speaker) proportionately audible to the listeners. Singers retain their capability of fully entertaining the audience, and this applies even to the relatively difficult sopranos. Pianos hold their rich, deep quality, and violins their keen, appealing tone. Orchestral performances seem to be in the room, with the individual instruments blending and yet separately distinguishable. The rendition of orchestral selections is smooth with all notes equally faithfully reproduced. Thematic development is possible under such circumstances. And, at the

RADIO AGENTS WANTED 5 Tube Demonstrator FREE!

Earn \$25 to \$100 a week, part or full time. Everyone a prospect. Complete line standard sets and accessories, \$5 to \$50. Write today for illustrated catalog and exclusive selling plan for five dealers and community agents. 29TH CENTURY RADIO CO., 1101 Loca Oala Bldg., Kansas City, Mo.

grand climaxes, the full orchestra still retains its naturalness.

The Innocent Orchestra

It is little wonder that, given acoustic synchronizing, the radio audience instinctively listens to any worth-while programs and radio broadcasting "comes into its own." It is interesting to watch the respective reactions of the audience to inaccurate and correct acoustic synchronizing. A news item will be read from

FREE BOOKLET FOR INVENTORS
IF YOUR INVENTION is new and useful it is patentable. Send me your sketch.
I. N. POLADNER, 79 Wall St., New York
Reg. Patent Attorneys-Engineers

Vacuum Tubes Rebuilt \$1.00 each
POSITIVELY GUARANTEED equal to new tubes in every respect. Money will be refunded if tubes prove unsatisfactory for any reason other than burn-outs.
Send us your broken and burned out tubes by parcel post. (Not necessary to insure or guard against breakage). We make return shipments by parcel post C. O. D., and try to maintain 24-hour service.
HARVARD RADIO LABORATORIES
200 Old Colony Avenue
South Boston, Mass.

ELIMINATE STATIC!
Enjoy perfect reception regardless of weather conditions.
"The Static Eliminator," the newest and most startling thing in radio, cuts out practically all static with little loss of volume!
And in addition it will help increase selectivity, tune out local stations, sharpen signals, remove noise, lessen interference and prevent re-radiation.
Use it with any receiving set—simply hook it up between aerial and ground in accordance with our instructions and enjoy perfect reception unmarred by static.
SATISFACTION ABSOLUTELY GUARANTEED
Mail order today
100 Postpaid
STATIC ELIMINATOR COMPANY
625 United Bank Bldg. Cincinnati, O.

TWO-FOR-ONE SUBSCRIPTION OFFER

Radio World has made arrangements
—To offer a year's subscription FREE for any one of the following publications with one year's subscription for RADIO WORLD:
—POPULAR RADIO or
—RADIO BROADCAST or
—SCIENCE AND INVENTION or
—RADIO NEWS
—RADIO DEALER or
—RADIO JOURNAL or
—RADIO (San Francisco) or
—RADIO AGE
—COLLIER'S
—BOYS' LIFE
This is the way to get two publications
—for the price of one;
—Send \$6.00 today for RADIO WORLD
—for one year (regular price
—for 52 numbers)
—and select any one of the other
—nine publications for twelve months.
—Add \$1.00 a year extra for
—Canadian or Foreign Postage.
—Present RADIO WORLD subscribers
—can take advantage of this offer by
—extending subscriptions one year
—if they send renewals NOW.

RADIO WORLD'S Special Two-For-One SUBSCRIPTION BLANK
RADIO WORLD, 145 West 45th St., N. Y. City:
Enclosed find \$6.00, for which send me RADIO WORLD for twelve months (52 numbers), beginning.....and also, without additional cost, Popular Radio, or Radio Broadcast, Radio News, or Science and Invention, or Radio Dealer, or Radio (San Francisco), Boys' Life, or Radio Journal, Collier's or Radio Age (or \$10.00 for two yearly subscriptions).
Name
Street Address
City and State

Indicate if renewal
Offer Good Until
Mar. 3.

IN THE WEST it's "RADIO"

For Seven Years the Best
Practical Radio Magazine.
**A Free
Sample Copy
for the asking**
PACIFIC RADIO PUB. CO.
Pacific Bldg. San Francisco

the broadcasting station. The strained listeners in one case will miss half the names and fail to get the entire drift of what might otherwise be an interesting item. With good reproduction, however, the full significance of the item is instantly appreciated and without effort. The contrast between fine quality and poor quality is particularly noticeable in the reading of baseball scores where clarity determines the entire value of reading.

When an orchestral selection is listened to, it takes very little to make the average audience start commenting sarcastically on the supposedly inferior quality of the orchestra although this may be the result

of lack of acoustic synchronizing of the receiving equipment and not at all chargeable either to the orchestra or the broadcasting station. With high quality reproduction, however, the full beauty of the music and the perfection of its performance are immediately appreciated.

Even in the musically humbler realm of popular selections as rendered by the typical "jazz orchestra," the same distinction holds. A dull and dragging effect, without inspiration and with imperfect rhythm, is obtained where acoustic synchronizing is lacking; but with faithful reproduction the audience instinctively brightens up and it is not difficult to start a late evening dance.

The Radio Doctor's Prescription

In view of the fundamental differences between acoustically synchronized reception and imperfect reception, it is obviously undesirable to continue to maintain receiving equipment which is incapable of giving high-grade results meeting modern standards. Music in the home can only be the result of acoustically synchronized receiving equipment and careful manipulation of it. Anything else throws a fog veil over the musical performance. Radio doctors would be quite justified in prescribing acoustic synchronizing for most radio listeners who show signs of dissatisfaction or lack of interest in programs.

One of the important factors in acoustic synchronizing is, naturally, the transmitting station. The contribution which the transmitting station can make will be more fully explained in the next article of this series. It is a fact, however, that the better modern stations have met their obligations in this regard to a far greater extent than do most receiving sets and loudspeakers. This latter condition, however, can be remedied only by the radio audience as a result of its appreciation of the musical importance of fidelity of reproduction.

**Weather Service
Covers the Country
WASHINGTON.**

The Department of Commerce is cooperating with nearly 150 broadcasting stations in sending out weather reports

and practically all parts of the United States are within their range. The daily weather forecasts are sent out from each of these stations on announced schedules at least once daily, and several times a day in many cases. Warnings of cold waves, frosts, floods, heavy snows and other unusual weather conditions are included whenever they are issued.

LOUD SPEAKER RECEPTION
from either coast on three tubes
Blueprint and instructions..... \$1.00
Necessary low loss coil..... \$2.50
Beautiful finished instrument..... \$35.00

S. A. TWITCHELL CO.
1930 Western Avenue Minneapolis, Minn.

RIGHT TO THE POINT!
Extreme accuracy of dial reading is assured when you use **EUREKA DIAL** POLYMER! Tuning in distance is simplified.

Polished Nickel or Gilt, $\frac{1}{2}$ or $\frac{3}{8}$ " **10c**

C. W. BUTTS, Inc.
40 Hedden Place East Orange, N. J.
Dealer Inquiries Solicited.

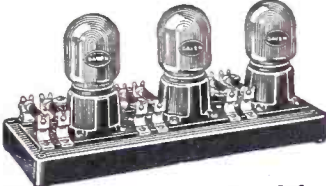

The Daven Super-Amplifier
for volume and tone quality
3 STAGES RESISTANCE COUPLED
ECONOMICAL DISTORTIONLESS
Easily added to any set
Saves Several Hours' Assembly
For Sale by All Good Dealers

GET THE OFFICIAL BOOKLET ON HOW TO BUILD
Radio World's 1926 Model
DIAMOND OF THE AIR

The text of the official Diamond booklet was written by **HERMAN BERNARD**, designer of the 5-tube circuit which offers the most in selectivity, volume, tone, quality and DX. Price, per copy **50c**

CERTIFIED BLUEPRINT
FREE with every copy OF THE OFFICIAL Booklet. Bernard's signature is on every booklet and every blueprint. Both sent FREE to new yearly subscribers.

News and Radio Dealers: Send for Wholesale Prices. Order direct from American News Co., Inc., 131 Varick St., N. Y. C., or American News Co. Branches.

RADIO WORLD, 145 W. 45th St., N. Y. C.
Enclosed find 50c. Send me copy official Diamond Booklet, with FREE blueprint.

NAME
ADDRESS
CITY..... STATE.....

THOUSANDS OF BARGAINS
FACTORY GUARANTEED MDSE. BY MAIL
Genuine New Raditron or Cunningham Tube
UV-100—200—301A—VD-11—12 **\$1.98**
C298—300—301A—C11—12
Fresh Burgess or Eveready "D" Batteries
25 1/2 Volt large size \$1.30—15 Volt large size \$2.50
Write for Free new Complete Catalog on Sets and Parts.

STONE ELECTRIC CO., 714 Pine St., St. Louis, Mo.
All Misc. F.O.B. St. Louis, Mo. Dept. W

Stop Tuning by Guess

Use **RADEX** and get stations you never got before

RADEX shows—
your dial positions for more than 600 stations
the name of the station received without announcement.
the wave length to which your set is tuned at any time.

25c at most good radio stores postpaid, coin or stamps

THE RADEX PRESS
Box 143 B Cleveland, Ohio

1926 RADIO CATALOG & LOG BOOK

Get Our 1926 Beautiful Illustrated Catalog!

Which contains all latest Standard Radio Merchandise AT SLASHED PRICES!!
And Up-to-Date Log Book
IT WILL PAY YOU TO BUY FROM US. We carry one of the largest lines of Radio in the East. Don't miss the wonderful opportunity to participate in this Great Sale.
Rush your request at once.
To cover the cost of mailing enclose 10c.

ECONOMY RADIO SALES COMPANY
285 6th Ave. Dept. E New York
DEAL DIRECT AND SAVE REAL MONEY
(No Dealers)

For Better Radio
Hammarlund
PRECISION PRODUCTS



For more than fifteen years, Hammarlund has manufactured precision products for telephone, telegraph and radio use.

That ripe experience is placed at your disposal in Hammarlund Condensers and Low-Loss, Space Wound Coils —of which the radio world can boast no superior.

Send 25 cents for booklet describing "How to Build the Hammarlund-Roberts Receiver."

The Hammarlund S-LF Condenser
Made in all standard capacities

HAMMARLUND MFG. COMPANY
424-438 W. 33rd St., New York

Quick Action Expected In Case Against WJAZ

WASHINGTON.

Speedy action in the case of the Government against E. F. McDonald, presi-

dent of the Zenith Radio Corporation and owner of WJAZ, Chicago, is prophesied by Acting Secretary of Commerce Stephen Davis. The Department of Commerce requested the Department of Justice to prosecute Mr. McDonald for operating his station on a wavelength which he was not licensed to use.

Mr. Davis has just returned from a speaking engagement in the Middle West. In Chicago he held a short con-

VEBY HIGH-MU TUBES

Made especially for Resistance Coupled Amplifiers. Now you can get more volume with greater clarity. A. F. 20 for the 1st and 2nd Stage.....\$3.00 A. F. 6 Power Tube for the 3rd Stage..... 4.50

VEBY RADIO CO.

47-51 Morris Avenue Newark, N. J.

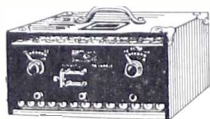

E-F-F-I-C-I-E-N-C-Y

Until you own a Roberts "B" Battery you will not know what real radio joy you are missing. It is efficient, rechargeable and indestructible. You can't wear it out.

Price list as before.

ROBERTS BATTERY COMPANY
1120 Myrtle Avenue Brooklyn, N. Y.

A SUPER-RADIO-\$17.50 NEW DYNE KIT

With Perfectly Matched Transformer & Filter



This is a SUPERADIO Product—Your Guarantee of Satisfaction!

The most selective, the most powerful, longest ranged, finest toned 8 tube super ever designed. Intermediate transformers matched to identical peaks and filter tuned to same peak. Kit includes Antenna Coupler, Oscillator Coupler, Special Variable Condenser, Tuned Input Transformer, 3 matched intermediate transformers and hardware. Complete with booklet, diagrams and full sized working drawings which positively assure perfect success. Order now. Only \$17.50.

Write for our free Radio Catalog of newest parts

William A. Welty Company
36-40 So. State St. Chicago

Long Distance Radio

Only \$2.95



200,000 SATISFIED OWNERS

—Getting stations 600 miles away on Lambert Radios. No batteries or tubes required. A real Radio—not a toy or attachment. One to four can listen at once. No howling or screeching noises. Hear local stations on bed-springs, light sockets or telephone. Fully guaranteed. See, \$2.95—Phones, \$2.95—Aerial, \$1.00. Mail orders filled same day. We pay postage.

LEON LAMBERT RADIO CO.
212 So. Market St. Wichita, Kansas

LISTEN TO YOUR LOCAL STATIONS with THE TALKING BOOK

Reg. U. S. Pat. Off. A complete radio set in the form of a book, bound in fine cloth with gold stamping. Equipped with Towers head phones and antenna. Guaranteed range fifteen miles.

An ideal auxiliary to a tube set. Costs nothing to operate and lasts forever.

Just the set for the children and fine for the traveling man.

PRICE FIVE DOLLARS, sent prepaid. Approved by the Popular Radio Laboratory Mfd. by

LISTEN-IN PUBLISHING CO.
110 Main St. Cambridge, Mass.

Publishers of the Listen-In Radio Record. If you live within ten miles of a broadcasting station write for exclusive agency.

ULTRA-LOWLOSS CONDENSER

SPECIAL CUTLASS PLATES DISTRIBUTE THE STATIONS, EVENLY OVER THE DIAL, SIMPLIFIES TUNING, CAPACITY 0005 MFD \$5.00

PHENIX RADIO CORP., 116-F East 25 St., N.Y. C.

ference with the local radio supervisor and the United States Attorney. The failure of the U. S. Attorney to take immediate action against Mr. McDonald was due to the fact that no such case had previously arisen, and the U. S. Attorney was not entirely sure of the proper procedure.

Isle of Pines Suffers From Static Complaint

WASHINGTON.

Static is terrible on the Isle of Pines and has been largely responsible for the slow development of radio among the natives, according to a report to the Department of Commerce. The nearest broadcasting station to the Isle of Pines is at Havana, 100 miles distant. Stations in the United States and Porto Rico are heard frequently.

RADIO INVENTIONS

Protected by U. S. and Foreign Patents.

Mason, Fenwick & Lawrence

Patent and Trade Mark Lawyers
Washington, D.C., New York, Chicago
Established over sixty years.

REFERENCES:

- Life Savers, Inc., Port Chester, N. Y.
- Stephen F. Whitman & Son, Philadelphia.
- Pacific Coast Biscuit Co., Seattle, Wash.
- Loft, Inc., New York City.
- Sprague, Warner & Co., Chicago.
- The Warren Co., Atlanta, Ga.
- A. Baldwin & Co., New Orleans, La.
- Joseph Burnett Co., Boston.

Send description and sketch.

Save 20 to 50% FREE RADIO CATALOG

Get the lowest rock-bottom prices on radio parts, sets, kits. New free Radio Catalog and Guide brimful of standard, reliable, guaranteed goods. Over 100 latest hook-ups and illustrations. Be sure to get this thrifty book before you buy. It puts money in your pocket. Saves you as much as half on a set. Also please include name of radio fan. Send letter or postal NOW.

THE BARAWIK COMPANY
103-140 S. Canal St., Chicago, U. S. A.

OFFICIAL LIST OF STATIONS BY WAVELENGTH AND FREQUENCY appeared in RADIO WORLD dated Feb. 6, 1926, per copy, or start subscription with that number. RADIO WORLD, 145 W. 45th St., N. Y. C.

RADIO WORLD'S QUICK-ACTION CLASSIFIED ADS.

10 Cents a Word. 10 Words Minimum. Cash With Order.

TYPE 110 KENNEDY RECEIVER COMPLETE with type 525. Amplifier range 150 to 25,000 meters. A real bargain. Only \$90.00. The Radio Sales and Service Co., 17 West 42nd Street, New York.

RADIO FAN WANTED to sell Standard Radio Apparatus. H. A. Roberts & Co., 180 Broadway, New York City.

1926 DIAMOND OF THE AIR BOOKLET with full instructions to make the Diamond, with blue print, 50c. Newsdealers and radio dealers can get supply from American News Co. and its branches. RADIO WORLD, 145 W. 45th St., N. Y. C.

RADIO WORLD'S GREAT HOLIDAY GIFTS NUMBER dated Dec. 12, full of interesting constructive data. A great guide to radio buyers. 15c per copy or start sub. with that number. RADIO WORLD, 145 W. 45th St., N. Y. C.

BULLDOGS BEAUTIFUL REGISTERED BULL PUPS, 15. Bulldogs. 501 Rockwood, Dallas, Texas.

DO YOU WISH TO BUILD THE 4-TUBE DIAMOND OF THE AIR? If so, get a copy of RADIO WORLD dated Jan. 23. Sent on receipt of 15c. or start subscription with that number. RADIO WORLD, 145 W. 45th St., N. Y. C.

HEAR JOHN F. RIDER, contributing editor of RADIO WORLD, broadcast every Thursday at 9 p. m. from WGCP, 252 meters. D. W. May, Inc., Newark, N. J. Mr. Rider discusses radio problems.

HERMAN BERNARD, managing editor of RADIO WORLD, broadcasts every Friday at 7 p. m., from WGBS, Gimbel Bros., N. Y. City, 315.6 meters. He discusses "What's Your Radio Problem?" Listen in!

CONSTRUCTION OF THE 4-TUBE A-A RECEIVER, by Herbert E. Hayden, appeared in RADIO WORLD dated Nov. 21. 15c per copy, or start your subscription with that number.

PATENTS—Write for free Guide Books and "Record of Invention Blank" before disclosing inventions. Send model or sketch of your invention for our Inspection and Instructions Free. Terms reasonable. Radio, Chemical, Mechanical, Electrical and Trademark experts. Victor J. Evans Co., 924 Ninth, Washington, D. C.

RADIO WORLD'S B BATTERY ELIMINATORS appeared in Radio World dated Dec. 12 (Part I). Part II in issue of Jan. 19. Sent on receipt of 15c a copy, or start sub. with Dec. 12 issue. RADIO WORLD, 145 W. 45th St., N. Y. C.

ALL ABOUT APARTMENT HOUSE AERIALS in Aug. 22 issue. 15c per copy. RADIO WORLD, 145 W. 45th St., N. Y. C.

HELP WANTED MALE EARN \$110 to \$250 monthly, expenses paid as Railway Traffic Inspector. We secure position for you after completion of 3 months' home study course or money refunded. Excellent opportunities. Write for Free Booklet, G-161 Stand. Business Training Inst., Buffalo, N. Y.

TEAR OFF AND MAIL TODAY

8 Weeks' Trial Subscription, \$1.00

KEEP ABREAST OF THE LATEST RADIO DEVELOPMENTS
RADIO WORLD
145 WEST 45th ST. NEW YORK CITY

Good Back Numbers of RADIO WORLD

The following illustrated articles have appeared in recent issues of RADIO WORLD:

- RADIO WORLD:**
- 1925:
- July 4—The Handsome Portable, by Herbert E. Hayden. The Freedom Reflex, by Capt. P. V. O'Rourke. 8-Tube Super-Heterodyne, by Abner J. Gehlin.
- July 11—The Baby "Super," by J. E. Anderson. A 1-Dial Portable Receiver, by Capt. P. V. O'Rourke.
- July 18—Anderson's 6-Tube Super-Heterodyne. The 3-Tube Marconi Receiver, by Percy Warren. A Good Battery Connector, by Herbert E. Hayden.
- Aug. 1—Enormous Volume on DX Stations, by Sidney E. Finkelstein. The Metropolitan Local Set, by J. E. Anderson. 4-Tube DX Divided Circuit, by Herbert E. Hayden. Series and Parallel Effects, by Herman Bernard.
- Aug. 8—The Evolution Reflex, by Capt. P. V. O'Rourke. The A-3-Tube Set in Sewing Machine Cabinet, by Herbert E. Hayden. How to Build Your First Set, by Herman Bernard. The Loop-Jack in The Diamond, by Herman Bernard.
- Aug. 15—A 2-Tube Speaker Reflex, by Brewster Lee. Capt. P. V. O'Rourke's Favorite Audio Amplifier. A Set That Takes Ingenuity, by Lewis Winner. The Loop Jack in The Diamond, by Herman Bernard.
- Aug. 22—The 5-Tube Diamond, by Sidney E. Finkelstein. A Home-Made Toroidal Coil, by George E. Hostetter. The Electrostatic Regenerator, by Percy Warren. Crystal Sets That You Can Log, by Herman Bernard.
- Aug. 29—The 1-Dial Powerstone, by Herman Bernard. A Set a Baby Can Build, by Herbert E. Hayden. A Fine Meter Switchboard, by Lewis Winner. A Powerful 1-Tube Set, by Percy Warren.
- Sept. 12—The 1926 Model Diamond of the Air (Part 1), by Herman Bernard. An Oscillating Warmeter, by J. E. Anderson. A 25-to-110 Meter Receiver, by Sidney E. Finkelstein.
- Sept. 19—Diamond of the Air (Part 2), by Herman Bernard. A 1-Dial, 3-Tube Speaker Set, by Percy Warren. A Tube B Battery Eliminator, by Lewis Winner. A Home-Made Volume Control, by Herbert E. Hayden.
- Sept. 26—The 8-Tube Super-Heterodyne, by Sidney E. Finkelstein. Diamond of the Air (Part 3), by Herman Bernard. The 5-Tube Brown-Ing-Drake, by Capt. P. V. O'Rourke. A 1-Control Regenerative Set, by Percy Warren.
- Oct. 3—The Thordarson-Wade Set (Part 1), by Herman Bernard. A Fixed Grid Leak, by Herbert E. Hayden. Trouble Shooting for Diamond of the Air.
- Oct. 10—Hookups for the Short Waves, by Percy Warren. The 3-Tube, 3-Circuit Tuner, by Capt. P. V. O'Rourke. The DX Set That Thrilled Jack, by Lewis Winner. The Thordarson-Wade Set (Part 2), by Herman Bernard.
- Oct. 17—The Thoroughbred (1-Tube DX Set), by Herbert Hayden. O'Rourke's Favorite SW Set, by Capt. Peter V. O'Rourke. The Thordarson-Wade Set (Part 3), by Herman Bernard. Trouble Shooting Article.
- Oct. 24—The 8-in-1 RF Receiver, by Sidney Finkelstein. A Phonograph Cabinet Set, by Lewis Winner. The Thoroughbred, by Herbert Hayden (Part 2).
- Oct. 31—The Pathfinder, by Sidney E. Finkelstein. A Snap-Catch Terminal Strip, by Herbert Erwin. A Simple Loop, by Herbert E. Hayden.
- Nov. 7—A 3-Tube Dry-Cell Circuit, by Capt. P. V. O'Rourke. One of the Best Crystal Sets, by Herbert E. Hayden. 1-Tube DX Set, Herman Bernard. A Flexible Short-Wave Set, by Percy Warren. The 4-Tube Roberts Receiver, by Neal Fitzalan.
- Nov. 14—The 4-Tube DX Special, by Herbert E. Hayden. The Set That Water Louended, by Capt. P. V. O'Rourke. A Receiver for Music Lovers, by Lewis Winner.
- Nov. 21—A DX Super-Heterodyne, by J. E. Anderson. A Resistance-Controlled Set, by Percy Warren. A 4-Tube A-A Receiver, by Herbert E. Hayden.
- Nov. 28—The Zero Potential Loop, by Frank Freer. The 1-Tube Headset Receiver, by J. E. Anderson.
- Dec. 5—A Toroid RF Set, Using Crystal, by Lewis Winner. A 70-to-1208 Meter Receiver, by Robert Force. The Diamond of the Air (in Text and Diagram), by Herman Bernard.
- Dec. 12—A Self-Contained Receiver, by H. E. Hayden (Part 1). B Battery Eliminator, by Lewis Winner (Holiday Gifts No.).
- Dec. 19—The Lemnits Entertainer, by Ed. Spiegler. Feldman 5-Tube Set, by Lewis Feldman.
- Dec. 26—The Regenerative Wave Trap, by John F. Hilder. The 5-Tube Tuned RF Set, by Capt. P. V. O'Rourke.
- 1926:
- Jan. 2—The 2 C Set for Simplicity, by Capt. P. V. O'Rourke.
- Jan. 9—The 4-Tube DX Symphony Set, by A. Irving Wita. A Skillfully Made 1-Dial Set, by Herman Bernard.
- Any copy, 15c. Any 7 copies, \$1.00. All these 26 copies for \$3.50, or start subscription with any issue. Radio World, 144 W. 45th St., N. Y.

How Stations Tune in with Given LC Setup

If a .0005 mfd. tuning condenser is used across a 5-turn secondary, 2 1/2" diameter, using No. 24 DCC wire, the following will represent the tuning:

Call Letter	Dial No.	Location
WMCA	41	N. Y. C.
WEAF	85	N. Y. C.
WOR	57	NEWARK, N. J.
WAAM	26	NEWARK, N. J.
WGBS	34	N. Y. C.
WJZ	73	N. Y. C.
WNYC	96	N. Y. C.
WGY	51	SCHENECTADY, N. Y.
CNRO	67	OTTAWA, CAN.
WHN	45	N. Y. C.
WRNY	26	N. Y. C.
WAHG	35	RICHMOND HILL
WMBF	52 1/2	MIAMI, FLA.
WHAP	22	N. Y. C.
WCCO	61	ST. PAUL, MINN.
WFRL	15	FLATBUSH, BLYN.
WBBH	48	CHICAGO, ILL.
CKAC	60	MONTREAL, CAN.
WIP	90	PHILA., PA.
WSAI	37	CINCINNATI, OHIO
PWX	39	CUBA
WOAX	22	TRENTON, N. J.
WFBH	26	N. Y. C.
WLWL	29	N. Y. C.
WGAB	23	FREEPORT, L. I.
WBBM	19	CHICAGO, ILL.
WGBU	28	FULFORD, FLA.
WOK	18	CHICAGO, ILL.
WFBC	16	CHICAGO, ILL.
WHT	56	CHICAGO, ILL.
WLW	63	CINCINNATI, OHIO
WSB	64	ATLANTA, GA.
WJY	57	N. Y. C.
KDKA	33	PITTSBURGH, PA.
WGCP	24	N. Y. C.
WBBR	25	STATEN ISLAND, N. Y.
WBZ	39	SPRINGFIELD, MASS
WRBA	25	RICHMOND, VA.
WOKO	20	N. Y. C.
WJAZ	36	CHICAGO, ILL.
WFI	55	PHILA., PA.
WEAR	53 1/2	CLEVELAND, O.
WDAF	47	KANSAS CITY, MO.
WLIT	55	PHILA., PA.
WODA	19	PATERSON, N. J.
WEAN	25	PROVIDENCE, R. I.
WGN	32	CHICAGO, ILL.
WPG	31 1/2	ATLANTIC CITY, N. J.

RESULTS EDITOR:

I have just finished building the 1926 Model Diamond of the Air and on the first test it worked great. The volume obtained was tremendous. The selectivity was perfect. I have built sets using practically all the best circuits, including the Super-Heterodyne principle, but never was so well pleased as I am with the Diamond.

W. L. NEAR,
Humberstone, Ont.

CROSLLEY
ILLUSTRATED RADIO CATALOG FREE!
Describes fully the complete Crosley line of radio frequency sets, regenerative sets (licensed under Armstrong U. S. Patent No. 1,118,149) and parts.
THE CROSLLEY RADIO CORPORATION
Cincinnati, Ohio

FREE RADIO CATALOG

WRITE for a copy of our NEW 100-Page Radio Catalog—Parts, Accessories — Kits — Sets — Everything for the Fan.

DEPT. R. W.

CHICAGO SALVAGE STOCK STORES

509 S. State Street, CHICAGO, U. S. A.

NOW \$3.50 COD.



Direct from factory to you

THE RABAT SENIOR
4200 MIL. AMPS. CAPACITY

A TWO YEAR GUARANTEE

We guarantee this battery to have a capacity of 4200 mil-amps. at a 30 mil-amp. per hour. discharge. It will operate on any set from one to nine tubes, and will give service from four to eight weeks on a five tube set without recharging. More volume, clearer and more distinct reception and greater distances are assured by using Rabat Senior Batteries. Batteries are shipped out fully charged and ready to use when received.

BUILT IN TWO SIZES:

12 cell, 24 volt size.....	\$3.50
24 cell, 48 volt size.....	7.00
RABAT SUPER CHARGER FOR "B" BATTERIES.....	\$3.00
RABAT DOUBLE DUTY "A" AND "B" CHARGER.....	1.00

THE RADIO RABAT CO.

1243 OREGON AVENUE

CLEVELAND, OHIO

A POPULAR KIT AT A POPULAR PRICE

ONE REASON FOR THE TREMENDOUS SALE OF THE BOXED AND SEALED 1926

DIAMOND OF THE AIR KIT.....\$35.00

Each B.C.L. boxed and sealed Kit bears the personal seal and signature of Herman Bernard. This is your assurance and guarantee that all parts included are the best obtainable and will give you a balanced receiver capable of great distance, combined with wonderful tonal qualities—a perfect receiver, worthy of the endorsement of the thirteen leading parts manufacturers it bears.

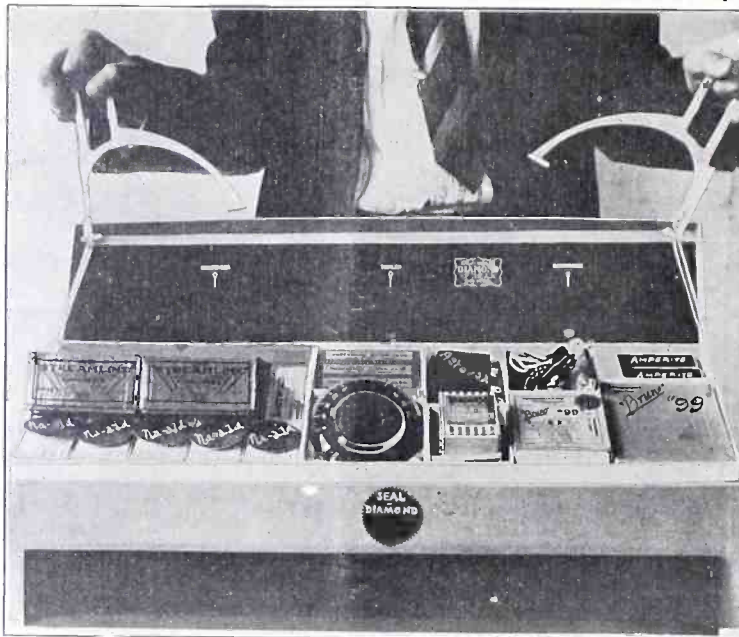

With the addition to our shipping department of new men we are once more able to catch up with deliveries on the Diamond of the Air Kits. Shipments can now go forward the same day received by any form of delivery you may desire. We wish to thank those patrons who were obliged to delay the construction of their kits about two days for their patience with us. We are doing all that is humanly possible to keep everyone satisfied.

This is the way each kit is packed. Everything is included.

We are pleased to announce that each kit will contain Sidney E. Finkelstein's special 16-page booklet, with a new full-size blueprint, which gives all data necessary for the construction, care and operation of the Diamond of the Air.

We are also able to supply set builders at 50 cents per copy.

OUR MONEY-SAVING SPECIALS

KITS		TUBES		STEINITE	
Bruno 3-Tube.....	\$18.00	R. C. A. 201-A.....	\$2.25	Continental Midget Cond.....	1.10
Bruno 4-Tube.....	22.00	Cunningham.....	2.25	Continental Neutralizer.....	.45
Ambassador 3-Tube.....	16.00	DeForest.....	2.25	Single Mount.....	.15
Ambassador 4-Tube.....	20.00	New Venus Blue, 201-A.....	1.50	Double Mount.....	.30
Browning Drake.....	19.00	Schicklering.....	2.25	Extension Plug.....	.35
Freshman T. R. F.....	7.95	Veby Mu 20.....	2.95	Voltmeter Leader 0-50.....	.75
Marcodyne Kits.....	22.50	Veby Mu 6 Power Tube.....	3.25	Voltmeter Ammeter Combination.....	1.10
Bernard's Loud Boy.....	9.65			Tower Scientific Headset.....	1.95
CONDENSERS		MISCELLANEOUS		PANELS	
Bruno No. 18-22 Plate.....	\$4.25	Cutler-Hammer 6-ohm Ver.....	\$0.59	Hard Rubber.....	Radion
Hammarlund 23 P.S.L.F.....	4.10	Turn-It Grid Leak.....	.65	Amrad Variometer.....	Mahogany
Hammarlund 11-43 Plate Ver.....	2.25	U. X. Adapter.....	.30	Triple Coil Mount.....	anite
General Instrument, Any Size.....	2.40	Pacnet Plug.....	.25	Amrad Variometer.....	1.25
U. S. Tool 11-18-23-43 Plate Ver.....	1.75	Soldering Iron.....	.95	Betts & Betts Loop.....	2.50
Heath 11-23-43 Plate Ver.....	1.75	"A" Battery Switch.....	.25	Bruno WD-11 Socket.....	.25
Murdock Enclosed 23-43 Plate.....	.95	Jones' Single and Double Jacks.....	.40	Dayfan Potentiometer 400 ohm.....	.35
U. S. L. 23-43 Plate Ver.....	1.50	Bruno Binding Post (per page of 12).....	.40	3" Dial.....	.20
Preferred 11-23 Plate.....	1.35	Lighting Arrestor.....	.40		
Preferred 11-23 Plate Ver.....	1.65	Battery Cable.....	.45		
AmSCO 17 Plate S. L. F.....	2.75	Pacnet Rheostat.....	.60	7 x 10.....	\$0.50
AmSCO 23 Plate S. L. F.....	3.25	Dubilier By-Pass Con., 0.25 mfd.....	.70	7 x 12.....	.60
King Cardwell 11 Plate.....	2.10	D. P. D. T. Switches.....	.50	7 x 14.....	.75
Freshman Mercury.....	.95	WD-11 Adapters.....	.50	7 x 18.....	.95
Manhattan 13-23 Plate Ver.....	2.95	S. P. D. T. Switches.....	.45	7 x 21.....	1.25
Pacnet 11-43 Plate.....	.75	Phone Plugs.....	.25	7 x 24.....	1.35
Streamline S. L. F. .0005.....	2.50	Bezels 1" Nickel.....	.05	7 x 26.....	1.50
Streamline S. L. F. .00035.....	2.25	Bezels 1" Gold.....	.10	Drilled and Engraved for Diamond of the Air.....	\$2.65
Streamline S. L. F. .00025.....	2.00	Glass Insulator.....	.20	Powertone, 7 x 18, Drilled and Engraved Panel.....	2.15
Wireless .0005 S. L. F.....	1.95	Toggle Switch.....	.20	3-Tube Bruno, 7 x 18, Drilled and Engraved Panel.....	1.45
Garco 23 Plate Ver.....	1.95	Bruno Inductance Switch (14 Point).....	.35		
Comsco, All Sizes, Ver.....	1.25	Bruno "66".....	2.25	SOCKETS—BAKELITE	
TRANSFORMERS		Hydrometers.....	.60	Federal.....	\$0.65
All American 10 to 1.....	\$2.45	Bell Wire (Half Pound).....	.40	Naald De Luxe.....	.45
Jefferson Star 3 to 1.....	1.50	Na-ald UX Adapters.....	.35	Hoosick Falls.....	.50
Amertran.....	3.75	Aerial Kit (Complete).....	2.50	Hoosick Falls 199.....	.35
Modern 4 to 1.....	1.95	Crystal Detector.....	.50	Hoosick Falls Triple 199.....	.95
Modern 10 to 1.....	2.25	Double Jacks.....	.40	Eby UX.....	.60
Modern Push Pull, Pair.....	6.50	Single Jacks.....	.30	Pacnet UX Universal.....	.55
Thordarson 3 to 1.....	2.95	Westinghouse R. C. Set (2 only).....	29.50		
Thordarson 6 to 1.....	3.10	Neutralizing Cond.....	.35		
Thordarson Push Pull, Pr.....	6.50				
VERNIER DIALS		LOUD SPEAKER UNITS		DIALS	
Marco.....	\$1.60	Baldwin (Type C).....	\$3.95	Naald Bakelite 4".....	\$0.50
Erla.....	1.95	Baldwin (Type H).....	4.95	Fada Bakelite 4".....	.45
Amsco.....	1.50	Morrison.....	3.25	Freed Eisemann Bakelite 4".....	.45
Univernier.....	.75	Western Electric.....	6.75	Garod Bakelite 4".....	.45
Gee-Haw.....	1.95	Baldwin Phones.....	7.25	Pathe 2", 3", 4".....	.25
B. M. S.....	1.10				
Accuratone.....	2.75				
Pacnet—Gold or Silver.....	1.95				
National 3/8".....	1.85				
LOUD SPEAKERS					
Brands Table Talker.....	\$4.50				
Farrand Jr.....	16.50				
Jewett Super.....	19.50				
Manhattan, Large.....	11.50				
Acme.....	22.50				
Bosch Jr.....	14.50				
Thorola Jr.....	13.95				
Magnavox M4.....	10.95				
Supreme Concert.....	13.95				
B. C. L. Horn—Special.....	5.50				
B. C. L. Cone Speaker 20".....	14.95				
Crosley Cone.....	13.25				

Write for FREE Catalogue!

B-C-L RADIO SERVICE CO., 221 FULTON STREET, N. Y. C.