

Nov. 28 1925

15 Cents

RADIO WORLD

Title Reg. U.S. Pat. Off.

Vol. 8. No. 10. ILLUSTRATED Every Week
155-192



FAY BANTER, the actress, broadcasting through WGBS, New York City, from the Friars' Club, at a benefit for hospital patients, principally soldiers. (Kadel & Herbert)



Five Tubes, Tuned Radio Frequency

RELY UPON EXPERIENCE TO PRODUCE QUALITY AT LOW COST

Sleeper

REG. U. S. PAT. OFF.

RADIO RECEIVING SETS

—are better built of better materials to the most exacting specifications by an organization that has engaged exclusively in the manufacture of fine radio equipment since 1919.

Super
RADIO
Reception

Only experience and "pride of product" could have built such a set as the Serenader at so low a cost. For this is a new kind of radio set. Not until now has a receiver combined such tonal quality with such volume, selectivity and sensitivity. Your first twenty minutes with the Serenader will give you a wholly new conception of radio reception.

The Scout, \$75.00. The Monotrol, \$130.00.
The Super-Symphonic, \$150.00.

TURN the switch and the softened glow of the concealed visored lights illuminate the tuning controls. Move the silver pointers to the designated wave length of your favorite station and you will hear it loud and clear, as distinctly and as naturally as though the artist were at your side—then, and only then, you will realize what Super Radio Reception means.

Other Sleeper models:



Serenader with console table, \$135.00

The table has a compartment for "A" battery and one for charger with switch for instantaneous change to charger. A better, more convenient radio installation at a remarkably low price.

If the Authorized Sleeper Dealer in your community has not yet received his quota, write us for descriptive literature and catalog "W"

SLEEPER RADIO CORPORATION
438 WASHINGTON AVENUE, LONG ISLAND CITY, NEW YORK

Nov. 28 1925

15 Cents

RADIO WORLD

Title Reg. U.S. Pat. Off.

Vol. 8. No. 10. ILLUSTRATED Every Week
155-192



FAY BAINTER, the actress, broadcasting through WGBS, New York City, from the Friars' Club, at a benefit for hospital patients, principally soldiers. (Kadel & Herbert)

To promote the HOME CONSTRUCTION of Radio Receivers these

13 Leading Manufacturers

Aerovox Wireless Corp.
Alden Mfg. Co.
Bruno Radio Corp.
Cornish Wire Co.

Cortland Panel Eng. Co.
De Luxe Sales Co.
Kurz-Kasch Co.
No. American Bretwood Co.
Preferred Radio Prod. Corp.

Radiall Co.
Streamline Radio Co.
Thordarson Elec. Co.
Veby Mfg. Co.

have combined their products to make a newer and greater

DIAMOND OF THE AIR KIT

Each boxed and sealed kit bears the personal signature of **HERMAN BERNARD** and contains the following parts:

One antenna coupler, L0L1 (Bruno 99 or 55 RF).
One 3-circuit interstage coupler, L2L3L4 (Bruno 99).
Two .0005 mfd. SLF condensers, C1, C3 (Streamline).
Two 1/4-amp. ballasts, R2, R7 (Ampertics, type 1-A).
One 3 1/2-to-1 AF transformer, AFT (Thordarson).
One 1/2-amp. ballast, R1 (Veby).
Two 0.1 meg. resistors, R3, R5 (Veby).
One 0.5 meg. leak, R6 (Veby).

One variable grid leak, R0 (Bretwood).
Three 4 moulded Bakelite dials (Kurz-Kasch).
Two double-circuit jacks, J1, J2 (Preferred).
One single-circuit jack, J3 (Preferred).
One 7x24 drilled and engraved panel (Cortland).
Five standard sockets (Na-ald).
One socket shelf and brackets (Bruno).

Two 0.25 mfd. fixed condensers, C4, C5 (Aerovox).
One 5-strand multi-colored battery cable (De Luxe).
Two battery switches, S1, S2.
One .00025 mfd. grid condenser, C2.
Four binding posts, W, X, Y, Z.
Five battery cable markers.
Ten lengths of busbar (Cornish).
Two flexible leads for C battery.
Screws, nuts, spaghetti.

No kit is genuine without the seal of **Herman Bernard**
BOXED AND SEALED KIT

\$35.00

Our Stock of these Dials is Low—Only a few more left

The B-C-L Special Metal Vernier Dial. Ratio 20-1 makes tuning a pleasure

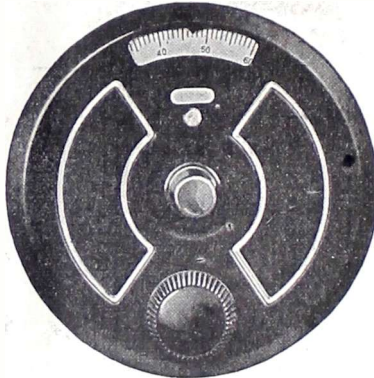

Now is the time for distance. Get those hazy stations "in" with this Vernier Dial



"Bruno 55" matched radio frequency coil for 99 and used in the Diamond of the Air. \$3.00



"Bruno 99" 3-circuit tuner wound on quartzite glass and specified in the Diamond of the Air. \$5.50



"Bruno 77" 3-circuit tuner wound on quartzite glass with special tickler for smooth regenerative control. \$5.50



"Bruno" short wave coil. Tunes from 25-110 meters with .00025 condenser. Wound with flat ribbon wire. \$5.50

Only 5 to a Customer, 59c each

BRUNO BRACKETS

Give your Set that professional appearance

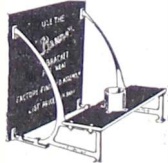

Simplifies wiring and construction of any set. Price per pair \$1.00

COMPLETE KITS	
Hayden's Thoroughbred	\$7.50
Erne "77" 3-tube DX	19.50
Ambassador 3-tube	17.50
Bernard's 1-tube DX	7.75
RX-1 using Bruno Coils and S-L-F Condensers	22.25
Bernard's Audio Amplifier	10.50
Freshman Kit—coils and condensers	7.50
Thordarson-Wade	41.50
VARIABLE CONDENSERS	
Bruno 3-section (.00025 each section)	\$5.95
Preferred .005 mfd.	1.75
U. S. Tool (all sizes)	1.95
Wade .0005, .001, .00025	7.75
Amsec Allocating .0005, \$3.95; .0035	3.75
Hearth Radiant vernier all cap.	1.95
King Cardwell all cap.	2.95
Continental Midcot	1.00
SOCKETS	
5 Gang socket shelf (for Diamond)	\$2.50
4 Gang socket shelf	2.00
3 Gang socket shelf	1.50
Panel mount triple	.75
Federal	.65
Na-ald De Luxe	.50
Bruno WD-11	.35
Na-ald small space, 3 for	1.00
Socket shelf and prongs	.25

AUDIO TRANSFORMERS	
Thordarson Auto-former	\$4.25
Thordarson Push Pull, per set	9.50
Federal 65 and 65A	3.75
Eria 3x1 and 6-1	3.50
Thordarson 2 to 1	3.50
Thordarson 6-1	3.10
Thordarson 3-1	2.95
Rauland Lyrie	6.95
Crescent 6-1, 3-1	2.25
Acme 4 1/4 to 1, A2	2.50
All American 10 to 1	3.75
Amertran 5 to 1, 3 to 1	3.85
De Forest 5 to 1	3.95
COILS	
Bruno "66" 3-circuit tuner	\$2.25
Clarotuner	3.50
Eria Balloon Circloid	3.65
Yankee 3-circ-11	1.65
Sickles coils for Roberts circuit	6.25
Sickles coils for Browning Drake	9.95

Coils for Journal 1 knob set	\$7.45
GI be Low Loss	4.50
Acro Coils	each 3.95
SPEAKERS	
Amplion type	\$4.50
Crosley Musicon	13.50
Thorola Jr.	13.95
Eria	19.95
RHEOSTATS	
Bruno 6, 10, 30 ohms	\$5.50
Pacont all sizes	.45
Cutler Hammer	.45
Klosner vernier 6 ohm	.59
Klosner plain 6 ohm	.45
Fada 6 or 30 ohm	.59
Federal 6 ohm	.39
Parker 1 hole mount	.75
JACKS	
Firth SC or DC	\$3.30
Jenes SC or DC	.45
Federal SC	.50

FIXED CRYSTAL	
Carborundum	\$1.50
Rasia	.95
Yellow tip	.95
DIALS	
Kurz-Kasch Bakelite 4"	\$.50
Univert	.95
B. W. S. Metal Vernier	1.10
Na-ald 4"	.50
TUBES	
Venus Voltron 201A and 199 types	\$1.45
R. C. A. tubes 201A, 199, WD12, UX120	2.25
HARD RUBBER PANELS	
7x10	\$.60
7x12	.70
7x14	.80
7x18	1.00
7x21	1.25
7x24	1.50
7x26	1.65
1925 Diamond Drilled and Engraved	2.65
Powertone 7x18 Drilled and Engraved	2.15
3 tubes Bruno 7x18 Drilled and Engraved	1.45
MISCELLANEOUS	
Betts & Betts Loop	\$2.25
Bradleystat	1.65
Aerial Kit	2.00
Galdwin type C	3.95
Tower head sets	1.95
Bretwood leak	1.50
D. P. D. T. switch	.45

GENERAL INSTRUMENT PYREX CONDENSERS, ALL SIZES, \$2.45

Write for Free Catalogue

B-C-L RADIO SERVICE CO., 221 FULTON ST., N. Y. C.

RADIO WORLD

[Entered as second-class matter, March, 1922, at the post office at New York, N. Y., under the Act of March 3, 1879]

A Weekly Paper Published by Hennessy Radio Publications Corporation from Publication Office, 145 West 45th Street, New York, N. Y. Just East of Broadway. Telephones: BRYant 0558, 0559

Vol. VII. No. 10. Whole No. 191 192

November 28, 1925

15c per copy, \$6.00 a year

The Zero Potential Loop

By Frank Freer

TWO reverse-wound solenoid coils connected at the center constitute a zero potential loop. So used they cease to be solenoids and are known as an astatic coil system. The coupling may be tight or loose.

To use the zero potential loop connect the two terminals together as in Fig. 3 and connect your lead to the antenna post. This lead is marked "To Set." Connect your ground in the usual manner and don't use a variable-condenser across it for tuning as is the custom with a standard wound loop. Your lead from the loop to receiving set should be about 10 feet, and preferably should run at right angles to the set. If this lead is connected and the end carried around towards the set forming a circle a magnetic field will be set up which cuts down the volume about 75 per cent. Using this loop with a regenerative set you may require a variable condenser to control oscillations. It is placed in series between the loop and the receiver.

Freer's Theory

Fig. 1 is a schematic diagram of this loop, showing how the power is delivered at its ends. This is due to the two reverse wound coils (or halves) of the loop being connected at the center.

This causes the power received to rebound from the center and delivers it at the ends.

The amount of power delivered is more than that delivered by a standard wound loop of the same size.

This is due to the almost total elimination of the self-inductance in the standard wound loop.

Fig. 2 shows the winding of a box type of this loop, and the way to connect it when using it with a loop set. In this case, of course, no ground wire is needed. This loop having more power than a standard loop will require less wire to run a loop set.

A standard Neutrodyne set requires a box loop not larger than 6"x6", and not more than 15 turns each side of the center, if No. 22 DCC wire is used. The number of turns required is determined by the size of wire used, the spacing between turns and the size of the frame.

Making the Loop

An easy way to make an astatic loop is to take two pieces of $\frac{3}{8}$ " laminated veneer 2" larger than the size loop you are building. Mark the four corners of the loop 1" from the edge of the veneers. Be sure that the centers marked are an equal distance on each side of the loop. This is important unless you are winding this loop on a tubing. Bore a $\frac{1}{2}$ " hole $\frac{1}{16}$ " deep at each corner, cut four $\frac{1}{2}$ " dowels the length required for the width. This will be determined by the number of turns of wire used. Bore a $\frac{1}{8}$ " hole through the center of the $\frac{1}{2}$ " holes in the veneers and countersink on the outside for a No. 5 screw. Insert the $\frac{1}{2}$ " dowels in the $\frac{1}{2}$ " holes in the veneers and fasten them with $\frac{5}{8}$ " No. 5 screws. Put a $\frac{3}{8}$ " No. 2 round-head screw in the center of

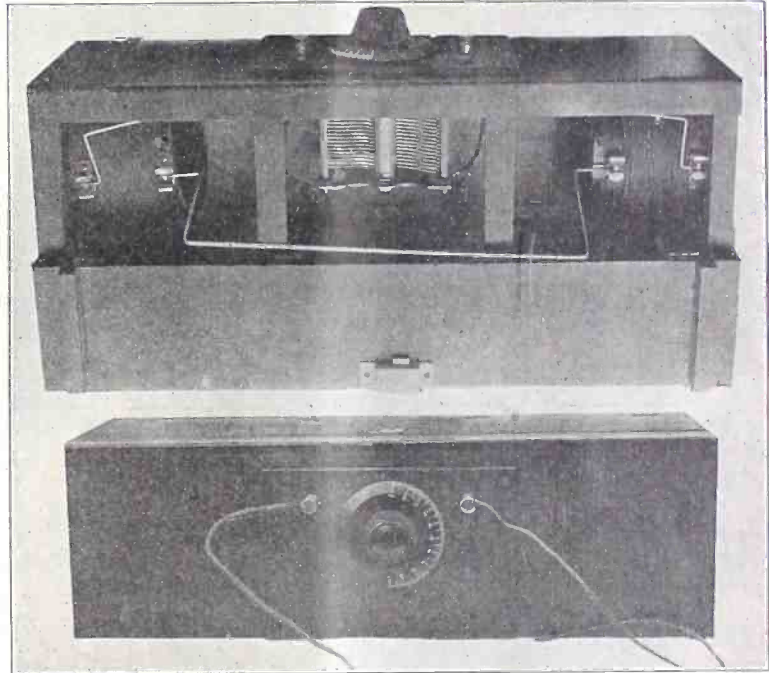

THE constructed Zero Potential Loop, loosely coupled type. See Fig. 4. Note how simply the loop wiring is done. The top photo shows the internal construction. The bottom photo shows the panel view.

one dowel. This is to reverse your wire when winding. Now start from the center and mark the number of turns you intend to use in winding. Take a saw-file and file notches in the dowels to hold the wire in place. Drill two holes through the sides of your veneer at the bottom to anchor the wire.

You are now ready to wind the loop.

Run the wire through the holes on one side of the loop and leave 6" excess for a connection. Put on a cotton working glove, take a turn of wire around your hand and wind until you reach the center screw. Turn the wire around this screw and wind in the reverse direction. Be sure you have an equal number of turns on each side of the center. Anchor by passing the wire through the holes on the other side the same as when you started to wind and leave 6" for a connection.

Take a piece of veneer the width of the finished loop and about 2" longer. Screw it fast to sides of the loop at the bottom, and let the 2" extend out on the end of loop where the wires are anchored. Cut a piece of hard rubber $\frac{1}{2}$ " wide and as long as the width of the loop. Fasten two binding-posts to this strip and screw it fast to the 2" extension. Connect your terminals to the binding post and the loop is completed.

The Tubing Method

Fig. 3 shows how to use this loop wound on a tubing. It can be wound on any size tubing.

The larger the tubing the fewer number of turns required.

Good results for local reception are obtained by using $2\frac{1}{4}$ "x6" tubing, and No. 18 annunciator wire. Paraffin the tubing if you use fiber or cardboard. Get a piece of $\frac{3}{8}$ " wood the diameter of the inside of tubing, fasten with two tacks and put a round-head screw in the center at one end of this stick to reverse your winding. Use clips or a binding post at each end of the tubing to fasten the wire terminals and to connect your lead to set. Two or three of these coils in series run a crystal set for me and for local reception run a loud speaker with almost any 3-tube dry-cell or storage battery set.

The Loosely Coupled Loop

Fig. 4 shows how to use this winding loosely coupled. It requires a 43-plate condenser to tune it. If you use a 3-tube set you connect a short lead from one terminal of the loop to the grid condenser. To the other terminal you fasten a short piece of wire and run it at right angles to the A— connection of the set. The length of this wire will be determined by the amount required to balance the inductance in your receiving set.

In using this coil loosely coupled the two halves are moved apart until the maximum volume is obtained, which is about 10".

Fig. 5 shows three coils connected in series, a battery across them. So con-

B Battery Eliminator Hookup

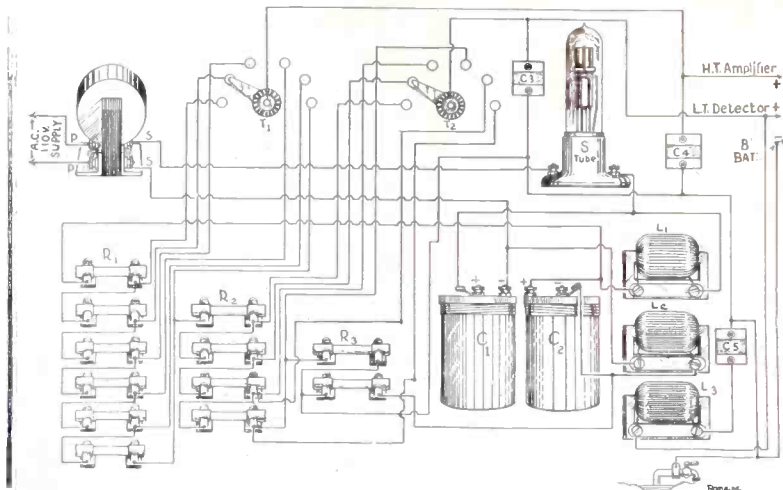
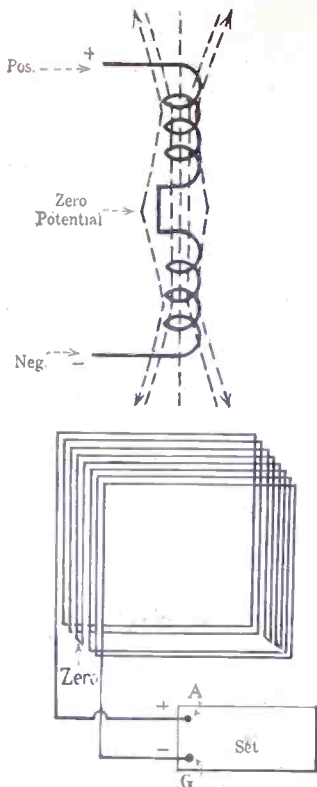

R1 CONSISTS of six 750 ohm units. R2 consists of four 125 ohm units. R3 consists of one 1000 ohm unit and one 5000 ohm unit. Each of these units is connected in series. C1 and C2 are both 28 mfd. electrolytic condensers. L1, L2 and L3 are 10 henry choke coils. C3 and C4 are .005 mfd. fixed condensers. C5 is a 1 mfd. fixed condenser.

A 2-Tube Regenerative Reflex

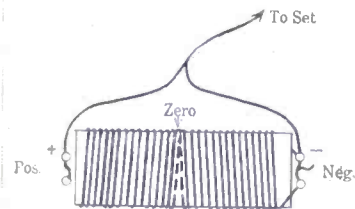
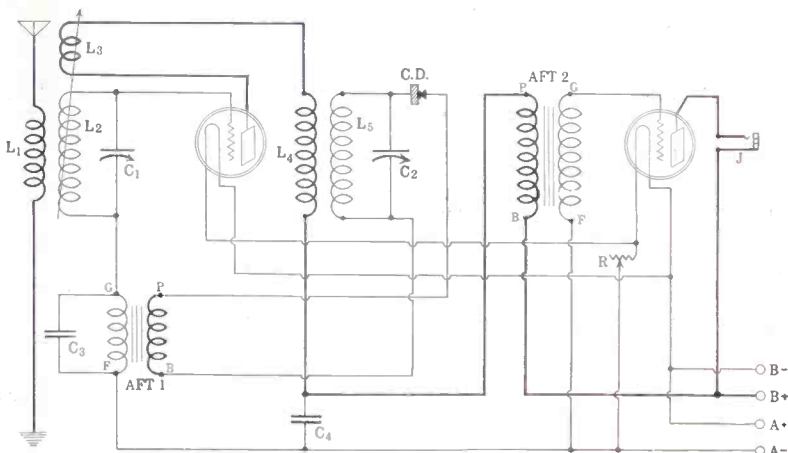

FIG. 1 (top), the zero potential loop theory. Fig. 2, how a box loop of this type may be connected to a set. A is the aerial post, G the ground post. This design is for loop sets. Fig. 3 shows a loop for a simple regenerative set, but the lead to set should be about 10 feet.



A 2-TUBE 3-Control Reflex Receiver using a crystal as a detector. The RF tube is regenerative. A 3-circuit tuner is used. C1 and C2 are both .0005 mfd. variable condensers, C1 and C3 are .001 mfd. fixed condensers. R is a 10 ohm rheostat.

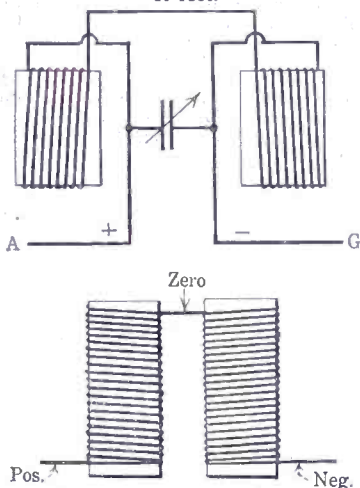
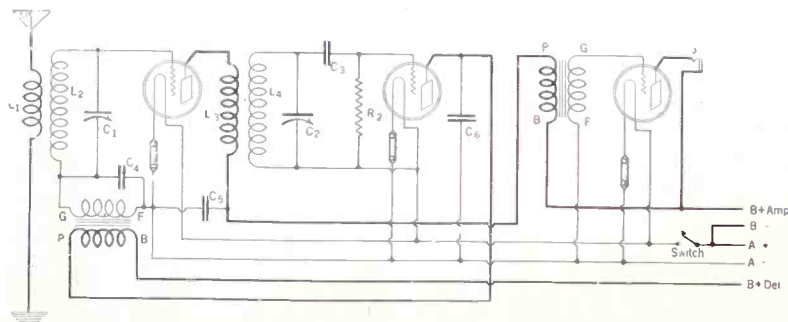

FIG. 4, the loosely coupled loop. Fig. 5, the binocular method.

Freedom Reflex, Easy to Make



A 3-TUBE REFLEX set in which a tube is used as detector. L1L2 and L3L4 are standard tuned radio-frequency transformers. C1 and C2 are both .0005 mfd. variable condensers. C3 is a .00025 mfd. grid condenser. C4, C5 and C6 are all .001 mfd. fixed condensers. Ballast resistors are used instead of rheostats.

nected each coil preserves its individuality by showing its own zero potential and negative at each end.

[Republication rights reserved by author.]

The 1-Tube Headset Receiver

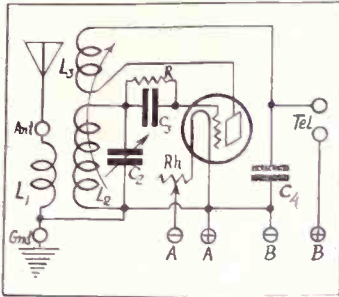

FIG. 1, the wiring diagram of the 3-circuit tuner.

By J. E. Anderson
Consulting Engineer

AS there is still considerable demand for single tube receivers which will bring in local and moderately distant stations on a headset with a minimum of equipment, a description of such a set will not be untimely.



J. E. ANDERSON

The most satisfactory single tube receiver is one which employs some form of regeneration, particularly the tickler method. Hence a circuit of this type has been selected. The circuit diagram of the receiver is shown in Fig. 1.

The parts required for the construction of the set are as follows: One three-circuit, low-loss tuning coil, comprising a primary winding L1, a secondary L2, and a tickler winding L3, a low-loss tuning condenser C2, preferably a straight-line frequency type of condenser, of maximum capacity .0005 mfd., a grid condenser C3 having a capacity of .00025 mfd. and mica dielectric, a grid leak of from one to five megohms, a filament rheostat of 30 ohms, a mica dielectric by-pass condenser C4 of .001 mfd. capacity. In addition will be required a 199 or similar vacuum tube with a socket to match, three No. 6 dry cells for heating filament, one 45-volt B battery, small size, eight binding posts, a headset, a 7x12" panel, a small cabinet, preferably deep enough to admit the batteries as well as the set proper, and a baseboard about 6x11x1/2". Then there will be required a three or four inch dial for tuning the condenser and a small knob for the tickler. The dial should preferably be one equipped with vernier or slow motion, and the tickler knob should be of the same design and size as the rheostat knob.

Fig. 2 shows the panel layout which may be used, and this figure also gives the dimensions and locations of the various centers and shafts. As will be noted the layout of the panel is symmetrical. The condenser dial is in the middle somewhat about the median line. The tickler and the rheostat knobs are placed one either side at equal distances from the center and somewhat below the median line. The antenna and ground binding posts are placed directly under the tickler knob, and the two telephone binding posts are placed in a corresponding position under the rheostat knob. These four binding posts may of course be placed at the rear of the cabinet, where the battery binding posts should be placed in case the batteries are not "built in."

A ground lead consisting of heavy weather proof wire long enough to reach

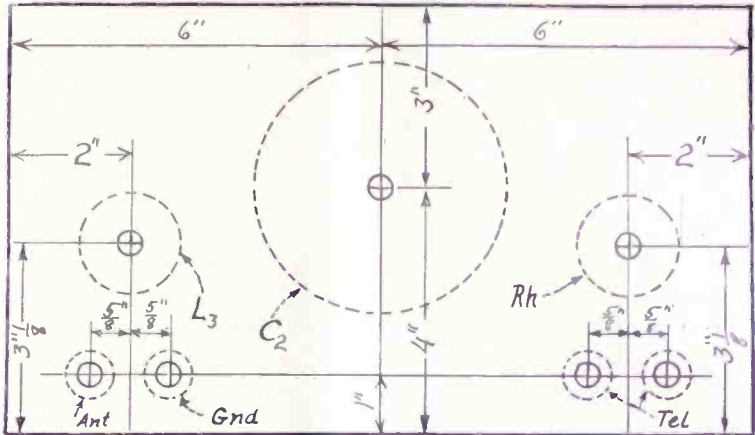

FIG. 2, the panel drilling layout.

from the nearest cold water pipe, a ground clamp, an antenna wire of about 100 feet and a few good insulators complete the equipment necessary.

No layout of the baseboard is given because this is determined by the panel

layout. There is very little besides the tube socket on the board, and if a certain type of socket be used it may be mounted on the panel, under and back of the rheostat, and the baseboard may be omitted.

Tube Called 'Most Important Tool of Science in 3 Decades'

By Dr. Peter I. Wold

Professor of Physics Department, General Electric Co.

The easiest way to heat metal is to have it in the form of a wire and send an electric current through it. If we put a metal plate near the wire and connect the negative end of a battery to the wire and the positive end to the plate, the electrons will be attracted by the positive charge on the plate and will flow from the wire to it across the intervening space and so constitute an electric current. It is preferable to have the wire and plate enclosed in a highly evacuated vessel in order to avoid collisions with gas molecules. This effect was first discovered by Edison.

DeForest found that if, between the wire and the plate, he put a metal screen or grid, he could control the current to the plate, i.e., the number of electrons coming from the filament. If it were charged positively, the current increased, and if it were charged negatively, it decreased. Not only this but he found it would respond to the high-frequency waves which we call "radio" and most of you have such a device as a detector of the

radio message. Some years after his first discovery, DeForest found that this vacuum tube device would act as an amplifier of weak electric impulses, such as telephone currents, and as a result of improvements made in its structure, many of you are using vacuum tubes for amplifying the radio signals after these have been detected by a tube of the same form, operating in a somewhat different manner.

It is scarcely necessary for me to recite the other common uses of this device, how it is used as a generator of the high-frequency oscillations or waves which are being broadcast from this and other stations tonight, how it is used for impressing the signals on these high-frequency oscillations, how it is being used for relaying the long-distance telephone currents all over the length and breadth of this country, or how it is being used in any place where one wishes to amplify electric impulses. The vacuum tube in the form just described is permitting us to enter into fields which we had never hoped to enter before, and has opened up such vast possibilities for research and investigation that I believe it is a true statement to say that it is the most important tool placed in the hands of science in the last three decades. And it all arises out of the discovery and the study of the electron.

Radio Club Asks City to Act on Fans' Interference Complaints

WILMINGTON, N. C.

Radio owners and radio fans, at a meeting held here, decided to appoint a committee to ask the city government to name a commissioner, or commissioners, to act on legitimate complaints filed by radio enthusiasts in the city. A large attendance of the Wilmington Radio Club, presided over by Raymond Hunt, was present.

Those who will form a complaint committee are J. A. Hobbs, Charles Whaley and

C. H. McAllister. Efforts will be made to reduce the interference on radio outfits here and also to improve other conditions.

A publicity committee will be named to obtain as soon as possible a broadcasting station for this city.

Among the speakers was Jack Fogarty, of Charlotte, who told of his own broadcasting station.

Meetings of the club will be held the first Monday in each month.

Distortion Present in Most Sets

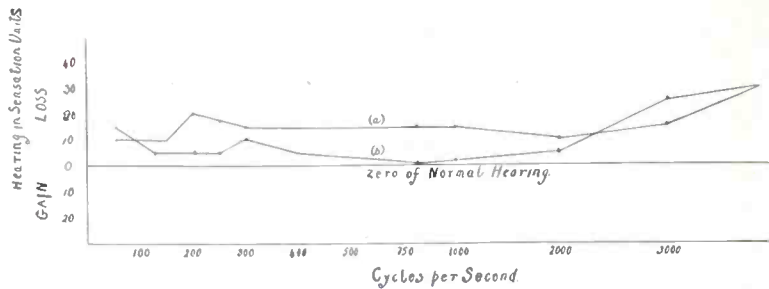

CHART showing the difference between the same man's ears as to acuteness in hearing (Fig. 1).

85% of Receivers Suffer Badly at Frequencies Below 160 Cycles, While at Upper Audible Range Same Effect Is Noted—Some Persons' Ears Found to Have Dissimilar Keeness for Hearing.

By William H. Fortington
Owner and Operator of British 6AG

MUCH has been said of late regarding the comparative merits of transformer, impedance and resistance coupled amplifiers. Amplifiers of every description have undergone some radical changes during the past season, and at the present time it is an open discussion as to which is the most acceptable standard of the three methods of coupling in audio-frequency amplifiers. Transformer coupling has, of course, led in the point of quantity since the inception of radio in the household, but it is now gradually recognized that resistance amplification by far supersedes every other method for amplification at audio-frequencies.

The Range of Hearing

By audio-frequencies is implied the band of speech or tone frequencies ranging from 50 to 4,000 cycles per second. Many persons consider 10,000 as the limit to the audibility of the human ear. In my opinion, based on experiments conducted on many persons with a view to ascertaining their range of hearing, this estimate is not sufficiently conservative. It was found that, as an average, the human

ear could detect without irritation 50 to 4,000 cycles per second, above which no sound was audible. Even at 4,000 cycles per second, the note gave an objectionable tickling sensation to one of the persons upon whom experiments were conducted.

Here it might be mentioned that no two ears are alike, as the accompanying graph will show. It is interesting, too, to note that many animals can hear notes entirely out of the range of the human ear. The domestic cat is a notable example of this. Experiments conducted upon it prove that the cat, under exceptional circumstances, can hear notes at 9,000 cycles per second. On the other hand, the ear of the dog can detect much lower than those audible to the human ear. Many persons are under the impression that birds have no ears. Without entering upon a discussion of what bird's ears are like, it might be mentioned that the sensitivity of the bird's ears is very acute, as they can hear notes of much higher frequency than we can.

Difference Between Two Ears

Fig. 1 is an audiogram, (a) denoting the left ear and (b) the right ear. It will be seen that even with the average person the two ears can vary considerably. It was not until these experiments were conducted that I realized that I was partly deaf in the right ear.

The ear itself may be considered as subdivided into three parts—the outer, the middle and the inner ear. The outer ear includes the drum, the ear canal and the lobe.

The middle ear is a fairly small hollow space, which contains what is called the anvil, the stirrup and the hammer. These are a chain of three small bones that carry the ear vibrations to the inner ear. The inner ear takes the form of spiral space encased in a bone compartment which is filled with a fluid. This is called the cochlea. It is at the cochlea that the auditory nerves are located. When vibrations of an audible frequency are set up in the

ear, these vibrations are transmitted through the small bone and impressed upon the cochlea, which gives us the sensation we interpret as sound.

Power of Hearing

We may assume for all practical purposes that the average person may be placed under one of three classifications, according to the quality of his hearing. Persons who have good hearing require very little sound variation to detect sounds. This has been ascertained to be 1/1000 dyne per square centimeter. Persons who are slightly deaf require 1/10 dyne per square centimeter to produce the sensation of sound. The deaf require 10 or more dynes per square centimeter of sound variation to produce hearing.

These tests took the form of the transmission of a series of audible notes ranging from 15 to 3,700 cycles per second. The object of these tests was to ascertain the efficiency of the average receiver, amplifier and loudspeaker (and also the human ear), and their ability to detect and reproduce the different audible frequencies.

Test of Reception

Through the courtesy of WOR I was given permission to conduct these tests at midnight. Altogether, 16 notes were transmitted, ranging from 3,700 cycles per second down to 15 cycles per second. The lowest note audible to anyone was No. 15, which was 22 cycles per second. These notes, which were perfectly pure, were obtained through a low frequency vacuum tube oscillator which took the form of many thousands of turns of very fine wire, wound on an iron core. By varying the inductance and capacity values in the grid and plate circuits, the various notes are produced. It might be of interest to the reader to know what these notes were:

Frequency of Notes Transmitted

No. 1.....	3700 Cycles per second
No. 2.....	2000 Cycles per second
No. 3.....	950 Cycles per second
No. 4.....	750 Cycles per second
No. 5.....	650 Cycles per second
No. 6.....	550 Cycles per second
No. 7.....	400 Cycles per second
No. 8.....	300 Cycles per second
No. 9.....	200 Cycles per second
No. 10.....	160 Cycles per second
No. 11.....	130 Cycles per second
No. 12.....	100 Cycles per second
No. 13.....	75 Cycles per second
No. 14.....	40 Cycles per second
No. 15.....	22 Cycles per second
No. 16.....	15 Cycles per second

The transmission of these notes occupied about twenty-five minutes, after which the test was repeated and listeners were asked to write to the broadcasting station, giving reports as to their reception of these notes. The response of the radio public was most gratifying, for no fewer than 150 letters were received, of which the writer chose 120 as being thoroughly reliable and authentic reports. The majority of these reports were most comprehensive; in fact, some of them too much so, since some over-zealous listeners even sent pictures of their receivers. After sorting and analyzing all the reports, which, incidentally, required several days, I was able to compile a curve of the average efficiency of 120 sets over the entire band of speech frequencies.

Results Analyzed

Peculiarly enough, the curve obtained reminded one of a curve of a bad audio-frequency transformer. The best reports came from the users of the cone type loudspeaker, which in turn depended upon

Radio Waves Will Be Used As Fire Extinguisher, He Says

BOSTON.

Radio waves will be used to put out fires, was the prophecy of Howard Coonley, civilian director for the Chemical Warfare Service in the New England district, in an address delivered at the Women's Republican Club of Massachusetts.

"It is possible in time that the tone wave of every building in a great city could be ascertained and at a central fire station a tuning fork would be set up,"

Mr. Coonley said. "In case of fire the tuning fork would be vibrated and in a few minutes the fire would be extinguished."

"That sounds extravagant, but many of you will live to see it done."

Experiments, he said, had already been conducted on his own house. The reason why the vibrations would not shake the house into a mass of ruins was that the adjustment would be just enough out of tune.

A Plea for Audio Quality

the type of amplifier used with the speaker. Many experimenters employing transformer coupling with some of the latest transformers obtained very good results, but were easily outclassed by the users of resistance amplifiers, which, by the way, were greatly in the minority, since the number of users of resistance amplification was under 10 per cent of the total. Their reports showed, however, that the select few obtained by far the best results. Out of the 150 reports received not one was using impedance coupling—a thing at which the writer is rather surprised, since, in his opinion, this is the happy medium between the transformer and resistance methods.

Frequencies numbers 1, 2, 3 and 4, increased greatly in strength, according to the radio audience. For the benefit of the reader who might misconstrue such a report, it may be said that all the notes were constant in amplitude; that is to say, they were all of the same strength when they left the broadcasting station. Notes numbers 5 to 16 were reported as declining greatly in volume as the lower frequencies were reached, disappearing entirely at No. 16. Reports from listeners using speakers of the horn type stated that frequencies below 160 cycles per second sounded rough. They were described by some of these listeners in terms such as "an aeroplane in the distance," "a motorboat in the distance," "a roll on the drum" and other such appropriate phrases. The notes, however, did not leave the broadcasting station in such a form, and it is quite obvious that these listeners were getting bad distortion in their amplifiers. Some of the reports stated that low notes were louder than some of the high ones, which must have been due to deficiencies in those particular listeners' receivers.

From an analysis of reports, it was quite apparent that over 85 per cent of the receivers in use suffered badly from waveform distortion at frequencies below 160 cycles; at the higher frequencies, similar results were noted by many listeners. Distance, apparently, had nothing to do with the quality of reception, since one report coming from Los Angeles gave exactly the same results as the station located a few blocks away from the broadcasting station, with the exception that the distant receiver noted great fading, which was only to be expected at that time of the year.

Special Production

As to the transmission of these notes, they were produced from a specially built cone type speaker and put through the microphone. This was done with a view to ascertaining any deficiencies in the transmitter also. With experiments of this description the reader will see how difficult it is to sort out reports and find the good ones as distinguished from the bad, since the human ear cannot really be relied upon.

The signal amplitude was classed under seven classes, according to strength. The majority of reports gave expression to such opinions as: "Number 4 note was twice as loud as No. 1," etc., which gave a reasonable idea as to what kind of reception each particular listener obtained.

Apart from the great reception this test received from the radio fan, it was arranged for official listening stations to co-operate with us in these tests. One was located at Philadelphia, one at Buffalo, one in Newark and one in New York City. Fig. 3 shows the curve of the reception at these stations, which, of course, was checked on measuring instruments, since it was considered unwise to trust to the ear. Official listening appar-

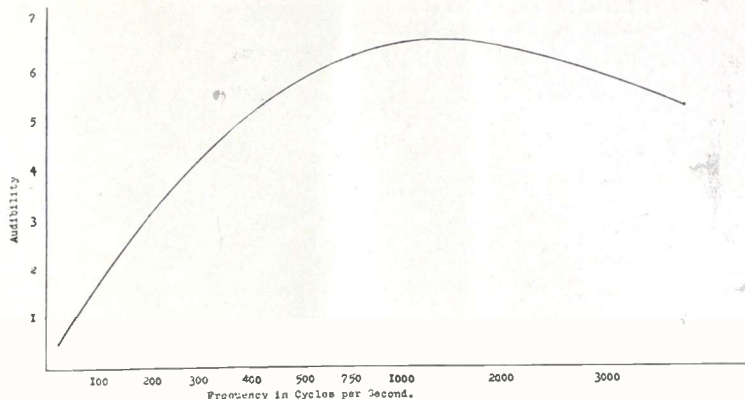

THE AUDIBILITY CURVE of 120 average receivers (Fig. 2).

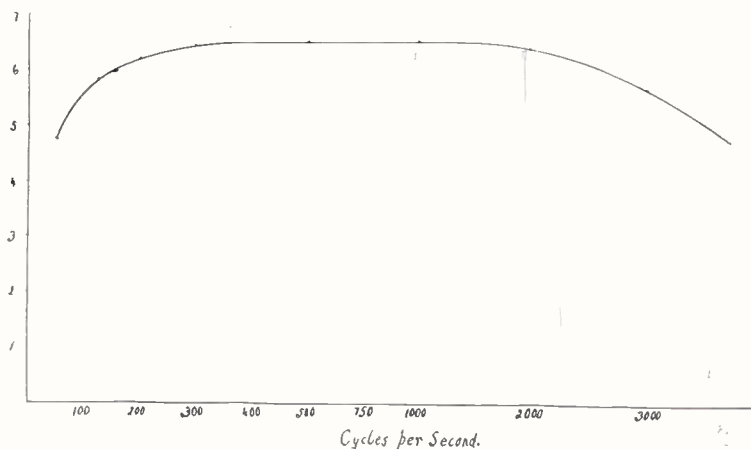

THE CURVE showing reception by stations (Fig. 3).

atus in each case consisted of two stages of tuned radio amplification and non-regenerative detector tube, together with three stages of resistance amplification, the output going into a 540 A. W. cone type speaker.

Average Set Deficient

Without any scrutiny of these two curves, the deficiency of the average receiver owned by the radio fan becomes apparent. Such deficiencies can only be remedied by improved amplifier and loud speaker design, to which much attention is being paid by the big engineering bodies at present. It will be seen by the second curve that the lower frequencies drop considerably. It was found that this drop was due to the loudspeaker and not to the amplifier itself, but with the coming advancement of certain loud speakers with which I am familiar, there is no doubt

that within the next year we shall see some wonderful reproducing instruments.

Meanwhile, the radio fan should look to his set and particularly to his amplifier and speaker. How many of them reproduce faithfully the very low notes of the organ? The answer is: not five per cent. At least, this is the conclusion I was forced to draw as a result of the tests.

It appears that the efficiency of the European set is higher than that of the American, since I conducted similar experiments over my own transmitter in Great Britain many times and in each instance the responses from the radio public tallied with each other and showed almost no variation.

Summarily, it might be said that the radio fan cannot measure sound by ear. It remains for the laboratory, equipped with delicate instruments, to make satisfactory acoustic measurements.

How to Solder a Joint That is Secure and Neat

A difficulty that the novice hits when constructing his radio set is soldering. Most folks use electric irons. The tip of the iron should be composed of a good grade copper. This should always be kept bright, by sandpapering it. The iron should not get overheated. Heat the iron up. Dip it into a small amount of soldering paste. Now take some solder, and

drop it all over the iron so that the iron will be completely covered with solder. In other words it will be tinned. The iron should always have plenty of solder on it for a connection. Place a tiny bit of paste on the connection, and apply the iron. Where the wires have been already tinned, the paste will not be necessary. But be very sparing with paste.

The Diamond Audio Circuit

By Herman Bernard

Associate, Institute of Radio Engineers

THE audio circuit in the 1926 Model Diamond of the Air consists of one stage of transformer coupling followed by two stages of resistance coupling. The audio circuit comprises the main point of difference between the 1925 Diamond and the 1926 model. The gain is a good one, since the public today is showing a fine appreciation of qualitative audio amplification, which leads it away from the conventional two steps of transformer coupling.



HERMAN BERNARD

Cone vs. Horn

Such good quality does this audio hookup produce that one may use the cone type of speaker without fear. Usually the cone speakers come in for condemnation from persons who do not understand the principle of their action nor the results that they are designed to produce. A cone speaker of the better type will reproduce the audio output with faithful impartiality. If the receiver is delivering fine, clear signals, such is what you will hear. If the receiver is distorting, the cone speaker will show up the distortion. In this way it differs from the horn type, which is designed to subdue distortion effects due to 2-stage transformer shortcomings and produce a net result that sounds pleasing. But the cone speaker does not disguise the output.

The design of audio-frequency transformers of the better class—and that means higher price—has improved considerably within the last six months or so. But it is still characteristic of all transformers of the conventional type that they behave well on the middle band of audible frequencies but are not so good on the upper and lower frequencies. When one couples two transformer stages the defect is cumulative. It is hardly possible to achieve faultless reproduction using any two transformer stages of audio, even if the transformer in the last stage is of very low ratio.

Great Amplification

Now, even where only one stage of transformer coupling is used the result still is that the lower and upper notes are not handled as well as the middle ones, but there is a great gain in volume by

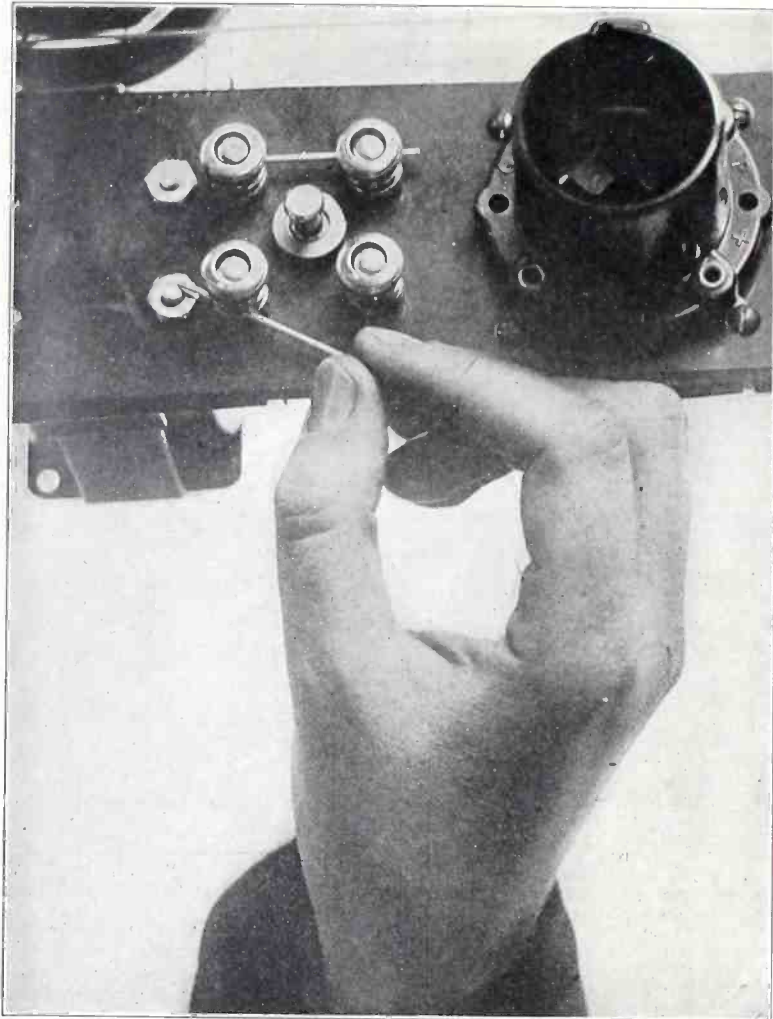

A SECTIONAL VIEW of the rear of RADIO WORLD'S 1926 Model Diamond of the Air. The strap of bus bar across posts Y and Z is being removed. The switch S2 is shown in the center of the four binding posts, W, X, Y, Z. The other switch, S1, (not shown), which controls the set as a whole, is panel-mounted. This photo, and all others in this series, is of the laboratory model as wired by Lewis William Feldman, of 273 Buffalo Avenue, Brooklyn, N. Y.

using a transformer in the first stage. Followed by two resistance steps, this produces quality such as to delight the ear. By meter tests, with proper tubes, resist-

ors and coupling condensers, three resistance stages would give a flatter curve, and less volume, but not show such a difference that the average ear could detect it, hence the enjoyment is just as keen and the amplification, even with ordinary tubes, is very great. With 201A tubes used throughout the audio amplifier, the last grid properly biased, the amplification is more than 450, while with 201A in the first AF stage, hi-mu in the second and a power tube in the third it is more than 1,000. This is a very considerable increase in volume. It may be further enhanced, without fear, by using a hi-mu tube in the first transformer stage.

The transformer method therefore becomes risky only where two such stages are used, so that the second stage contributes its own shortcomings while amplifying those of its predecessor.

There is no volume control in the set. No rheostats are provided and hence these may not be used for volume control, nor should they ever be, so long as they are connected to govern the heating of the tube filaments. If a rheostat is used in

Ammonia and Vaseline Cure A Battery Failure

Sometimes when you are listening to a set that is operated from a storage A battery the tubes will go out. The immediate fear is that there has been a short-circuit of the B batteries across the tender filaments and that the tubes are gone beyond redemption. Most likely, however, the tubes are safe, and contact has been disestablished at the batteries, due to corrosion.

The positive pole of the battery is more likely to corrode than the negative pole. The greenish substance created by chemical action may be so microscopic

that the eye does not see it, but there it gets, between the clip on the battery cable and the pole itself. Ammonia may be used to get rid of this corrosion. Then, if a ring of vaseline is placed on the screw of the battery pole, after the corrosion has been taken off both pole and clip, it will act as a safeguard against corrosive effects passing beyond this ring. The principle is the same as that employed on trees, where cotton batting is wrapped around the trunk, so that worms can not creep up the tree to destroy its branches. The method is a form of insulation.

Correct Constants for Hookup

series with a plate circuit that might be a different story.

But in the present case, assuming correct bias on the final grid, and preferably the use of a power tube in the last stage, such as UX112, 6 mu, Western Electric 216A, VT2 or UX120, the set will handle all the volume easily. It is assumed that most persons want to have the signals as loud as possible without distortion and such can be accomplished by this set. The volume is particularly attractive when one listens to orchestras and bands, for if these are subdued they lose their zest. The volume, therefore, will depend on the intensity with which signals are receivable from given stations, and this will vary even among local stations, while it will be possible to hear on the speaker any station that one might hear on earphones plugged into the detector output.

Capacities Important

In keeping with the design of the audio hookup along quality lines the coupling condensers, C4 and C5, shown in the full-page schematic wiring diagram in two colors last week, and which will be printed in blueprint form next week, should be large. The capacity often used for this purpose is .006 mfd., but this is not large enough, since a lower impedance is necessary, to avoid consequent distortion. At the lower audible frequencies the .006 mfd. coupling condenser will show a steepness in the curve of voltage amplification plotted against frequency. The use of too low a capacity here has given rise to the belief that resistance amplification is not the enemy of distortion that it is advertised as being. We are on the safe side, indeed, if we use 0.25 mfd. It is wrong to venture below .05 mfd.

The Resistors

The resistors used in the plate and in the grid circuits (called leaks in the latter instance) must be of good manufacture. The plate resistors serve the purpose of providing a means of maintaining a potential difference, so the audio fluctuations may take place. The audio signals are, of course, alternating current. A value of 0.1 megohm (100,000 ohms) is correct here, and the same value prevails in any step of resistance coupling. The resistance must be high enough to establish a sufficient divergence in potential and yet not so high as to whittle down the effective voltage applied at the plate to well nigh the zero point. The voltage drop in 0.1 megohm resistor is large enough. Reckoning the direct current resistance of the plate of the tube along with the resistor's resistance, the total impedance is sufficient to cut the net B voltage, as applied to the plate of the tube, by almost 75 per cent. This is not to be rated as a total loss, since the entire difference is not dissipated in the resistor.

The Leaks

As for the leaks in the audio circuits, these are fixed, and they are R4, which is 1.0 megohm and R6, which is 0.5 megohm. The higher resistance is used in the first stage so that the leakage path will be less, because in this stage little or no excessive voltage is to be expected, while in the last stage the lower resistance is used so that the leakage path will be more rapid. If both of these leaks were less than the



THE PANEL view of the 1926 Diamond of the Air, 1/4 scale

smaller of the two, say 0.25 meg. (250,000 ohms), there would be a still more rapid grid-to-filament leakage in both stages, the volume might be a little less, but there would be no impairment of quality. Thus any one having leaks of a lower order than those specified may embody them in the circuit in line with these suggestions as to the right direction in which to proceed. Do not use higher value resistors than those specified, however.

The Grid Bias

The biasing battery in the final grid circuit of the audio hookup is important, as the millimeter test, or makeshift voltmeter test, described last week, will prove. The sharp voltage reduction due to the plate resistors, and the presence of the two leaks, eliminate the necessity of otherwise biasing the first and second

audio bulbs. The final plate, however, has no such resistor in its circuit, hence, if 135 volts are used for B plus amplifier, the same general rules for biasing will obtain as in the case of any other amplifier circuit. If a power tube is used the bias will have to be greater. The manufacturers give data on the subject in the circulars they enclose in the tube boxes, but as pointed out last week, these data are not always controlling, especially in regard to the UX120.

The Correct Amperite

The Amperite, R7, which governs the filament heating of the last tube, if a UX120 is used in that socket, should be the 120, style Z, mounted, while for the UX112 the correct Amperite is the No. 112, style Z, mounted. Those desiring to

(Continued on page 26)

Filament Rheostats Fail As Good Volume Controls

The practice of using a rheostat as a volume control, by increasing or decreasing the filament heating, is one widely indulged in, but it is against the better practice. A tube should have its filament heated to the temperature which affords best results, and these may be determined by ear, if no meters are available. Then, if volume control is desired, other means should be adopted. The idea that ballast resistors are not good because they deprive one of the advantage of rheostat volume control merely argues that the wrong manner of control has been used.

Persons living in cities, where local stations abound and come in with great volume on the last stage of audio, may appease their desire for lesser volume by having a jack in the first audio output, to cut out the final stage, if two transformer stages are used, for then speaker volume will be comfortably low, though all-sufficient for audibility.

Another way would be to put a variable resistor in the primary circuit of the first audio-transformer, connecting one side of the resistor to the P post, where the plate lead goes and remains, the other side of the resistor to the B post. This would cut down the impressed voltage to any desired extent, even short-circuiting it completely, which, of course, never would be done, since the cheapest way not to hear signals is to turn the set off completely.

The location of the volume control at that point is good practice because then the makeshift of cutting down volume after previous tubes have been overloaded is avoided. The previous overloading would cause distortion and the volume drop subsequently created would not diminish the actual previous distortion, but

simply prevent it from being further magnified. A circuit consisting of a first stage of resistance or impedance coupling the volume may be cut down in the first or second stage, although the first stage probably still is preferable. With such audio hookups always three stages are necessary for maximum volume, comparable to two transformer stages, hence a method of cutting out the final tube may be utilized, as previously explained. But the rheostats, once set right, should be left severely alone.

If a power tube is used in the last stage, then the speaker connections always must be to that stage, because if the preceding tube were plugged in instead, then there would be no power tube in the last stage.

The filament heating should be such that the maximum response in the plate circuit is obtainable from a given impressed voltage on the grid, and no shift from the correct operating point should be made at the expense of efficiency. Distortion will result from rheostat-controlled volume, even howling.

In the audio circuit, and usually in RF circuits too, as distinguished from the detector tube, it is advantageous to heat the filaments too generously, but without overheating, for the amplification action is made the better thereby, and indeed under-heating often produces the result of almost zero gain in the amplifying stage.

Therefore the consumption of A battery juice is not cut down when the rheostats cause the tube to be lighted too low. Less current is not consumed, only less voltage by the filament. And the difference in voltage is represented almost entirely by the drop in the rheostat.

Radio University

A QUESTION and Answer Department conducted by RADIO WORLD for its Readers by its staff of Experts. Address Letters to The Radio University, RADIO WORLD, 145 West 45th St., New York City. Just East of Broadway.

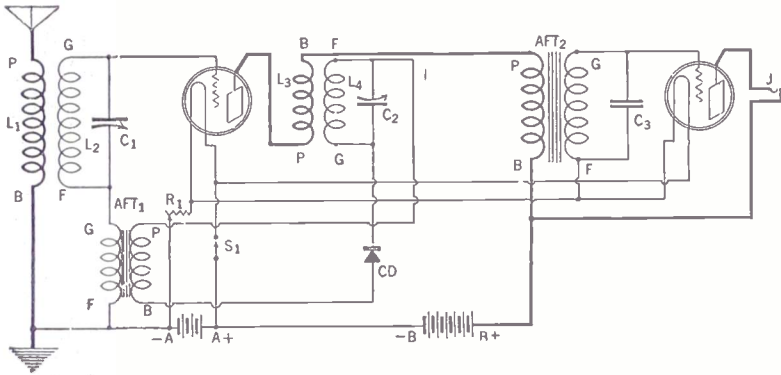

FIG. 231, showing the electrical diagram requested by Mr. Lators.

PLEASE GIVE me a diagram of a 2-tube loud-speaker reflex set, using a crystal as a detector.—P. Lators, Allegheny, Pa.

Fig. 231 shows the diagram that you desire. The antenna RFT is wound on a tubing $3\frac{1}{2}$ " in diameter and 4" high. The primary, L1, is wound first and there are 10 turns put on. The secondary L2 is wound adjacent to this winding and there are 45 turns put on. The second RFT is also wound on a tubing $3\frac{1}{2}$ " in diameter and 4" high. The primary, L3, contains 10 turns, and the secondary, L4 contains 45 turns. No. 22 DCC wire is used. C1 and C2, the variable condensers, are of the .0005 mfd. capacity type. These normally should each contain 23 plates. The first audio-frequency transformer, AFT1, is of the high ratio type. The second audio-frequency transformer, AFT2, is of the low ratio type. The rheostat, R1, is of the 10 ohm type. This is provided you are going to use a 201A type tube, with a 6 volt A battery. If you use a 199, with a 6 volt battery to light the filaments, you will need a 40 ohm rheostat. The fixed condenser, C3, is of the .001 mfd. type. S1 is a filament switch. The jack is of a single open circuit type. The crystal detector may be of the fixed or variable type. There are 67½ volts placed on the plates of both tubes. In case you do not get loud signals, reverse the crystal leads, CD, also try reversing the secondary leads of L3. A very short aerial should be used with this set, for loudest results. If the tuning is broad, take the connections from the ground terminal to the F post on AFT1 off.

I WOULD very much like to have a diagram of a 1-tube set using a variometer to tune the grid circuit, with no variable condenser shunting it, and a tickler coil in the plate circuit, to control the regeneration. Also would like to have the constants of the parts in the set.—Y. Trains, Shasta, Cal.

Fig. 232 shows such a diagram. The antenna coil, L1, is wound on a form 3" in diameter and 2" in length. One-half inch from the end of the form, start winding, and put on 10 turns. L2 is the stator and L3 is the rotor of the variometer, while L4 is the tickler. Take a form, 3" in diameter, and 8" long. Now wind L2, with 56 turns, 28 turns in each

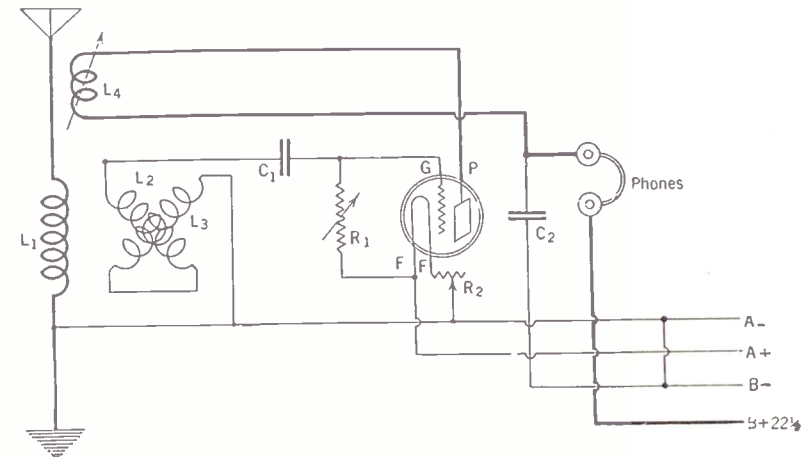

FIG. 232, showing the electrical diagram Mr. Trains desired.

section with a $\frac{1}{2}$ " space between the two windings. Drill a $\frac{3}{16}$ " hole, where the space was left. The rotor, L3, is wound on a form 2" in diameter. There are 72 turns placed here. If you find that you cannot place all these windings on the form, resort to bank or haphazard winding. Connect the ending of L2 to the beginning of L3. This will then give you the two necessary leads. The variometer will take up about 5" space on the tubing. Leave 1" and make a dot. One inch from this mark, or 1" from the tubing end, drill a hole for the tickler shaft, which is $\frac{3}{16}$ " in diameter. The form used here is of the same type as used for the rotor. There are 35 turns on the form, 17 turns on one half and 18 turns on the other half. No. 22 DCC wire is used. The condenser, C1, is of the .00025 mfd. grid type. The grid leak, R1, is of the variable type. The condenser, C2, is of the fixed type, the value being .001 mfd. There are several makeshifts that you may employ to make the set louder. Place the grid leak across the condenser, C1. Place 45 to 67½ volts on the plate of the tube and reverse the A battery.

I WOULD like to have two diagrams showing how a key may be placed in a

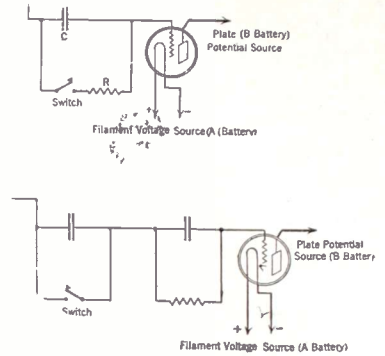

FIG. 231A (top) and 231B (bottom) showing a key is inserted for both high and low power, in pure CW transmitters.

CW transmitting circuit. One diagram should show how the key is connected when using high power, and the other when using low power. Please give constants also.—H. Heit, Washington, Ind.

Fig. 231A illustrates how the key is inserted when using low power only. C is a .002 mfd. fixed condenser. R is a 5,000 ohm resistor. The key should be durably constructed, and be able to withstand a load, without heating. Fig. 231B (bottom)

illustrates how the key is inserted when using high power. The condensers, with the grid leak shunted across it, have the same value as above. Here, though, the key is shunted across a large 2 mfd. fixed condenser. This is to prevent any voltage surge. This system is used when placing many tubes in parallel, which is very common when using more than 250 watts output, such as in present-day broadcasting equipment. The key used here should be of larger dimensions than the one used for the above, as the load carried is immense, and breakdowns are very common. The key, of course, is always placed in the oscillator grid circuit. Circuits of this character emit pure continuous waves (CW).

I AM contemplating building the Dynamic Radio Amplifier described in the July 25 issue of RADIO WORLD by P. E. Edelman. (1) How many turns of wire should I place on forms 3" in diameter for all the coils? (2) Will the Acme R2, which is used as the second RFT, cover the broadcast band? (3) I note that the output for the reflex action of tube is from the plate side of the untuned RFT. Would it be better if this output came

from the B+ side, so that the primary of this transformer would act as a choke coil? (4) Should the UX120 be used for tubes 1 and 2? Mr. Edelman states that the greatest trouble is experienced in the overloading of the tubes. (5) Would you suggest the Grimes inverse-reflex idea for equalizing the duty of tubes to be employed in this set?—Frank A. Gloster, 744 Bennington St., East Boston 28, Mass.

(1) The first input coil to the first tube is wound on a tubing 3" in diameter, with 53 turns, of No. 22 DCC wire. The primary aerial-ground coil is wound with 7 turns of No. 22 DCC wire, over the middle of this first input coil. The spider feedback coil is held at the ground end of this first coil, and comprises 4 turns, the outside diameter being 3". Again use No. 22 DCC wire. The output coil from the second tube comprises a 5 turn spider coil wound with No. 22 DCC wire, outside diameter 3". This is placed inside the last input coil, at about its middle. The last input coil is made up of 53 turns of No. 22 DCC wire wound on a 3" diameter tubing 3 1/2" long. (2) Yes. (3) No. (4) No. (5) No.

CAN I use the 199 tubes in the RF detector and AF stages and the UX120 in the last stage of audio-frequency amplification in the Diamond? (2) Will there be any change in the wiring necessary? (3) Will the UX120 give good results when 90 volts are used on the plate?—W. G. Clark, 356 Tulane Road, Columbus, Ohio.

(1) Yes. (2) The C battery and the ballast. See Nov. 21 issue. (3) No better than a regular 199.

PLEASE answer the following: (1) Is the Diamond any better than the Powertone? (2) Will 201A tubes work well in these sets? (3) Will the hi-mu tubes work well in the second stage of AF, in the Diamond, and in the Powertone? (4) Will the hi-mu tubes work O. K. in the transformer stages?—John C. Hughey, Idalia, Cal.

(1) The Diamond is better, more expensive and has three controls. The Powertone is excellent and has only one control. (2) Yes. (3) Yes, in first and second AF. (4) No advantage there.

I HAVE built "The Three-Circuit Tuner That You Can Log," described in the June 27 issue by Capt. P. V. O'Rourke. The set works great, except that the squealing is very hard to control. Could you please help me out?—E. Hartley, 620 Olive St., North Little Rock, Ark.

Reduce the number of volts on the plate of the detector tube. Reduce the filament heating. Remove by-pass condenser across detector output. Use a higher resistance grid leak. Increase the number of turns on the primary of the tuner to 15.

WILL THE Diamond work as a portable? (2) Will the loop described by Herbert E. Hayden in the Oct. 31 issue of RADIO WORLD with the above set? (3) Will the set give loud speaker results using the loop? (4) Will two Crosley Sheltran transformers work O. K. in the amplifying portion? (5) Will this set get distance?—M. C. Jones, Box 48 DeQuincy, La.

(1) Yes. (2) Yes. (3) Yes. (4) Yes. (5) Yes.

CAN THE Bremer-Tully .00025 mfd. variable condensers be used with the coils matched for this condenser in the Diamond? (2) Is it advisable to use a separate ballast resistor for each individual tube in the AF circuit? (3) Is a Thordarson 3 1/2-to-1 ratio AFT O. K.? (4) Would it be O. K. if the complete set were mounted

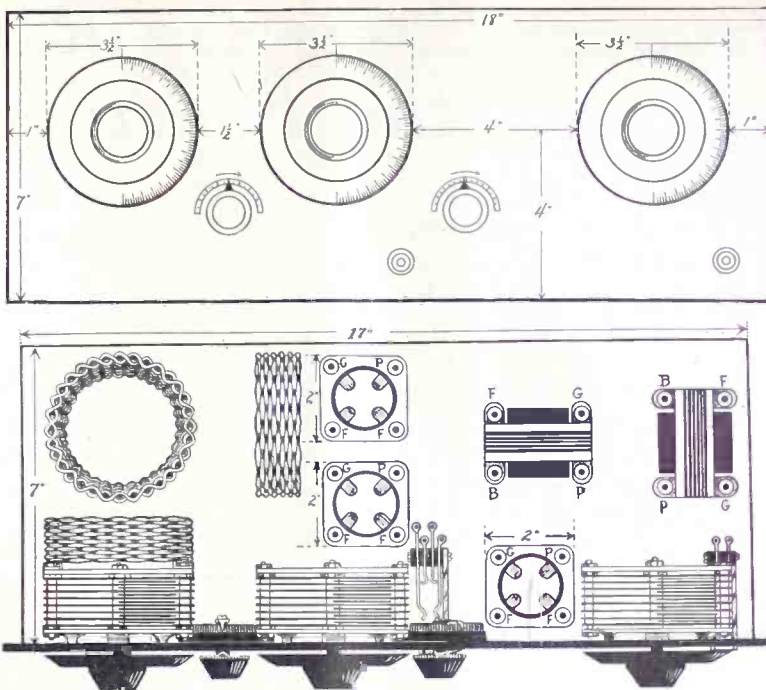

FIG. 234, baseboard layout for a 3-tube regenerative reflex, using the tuned plate method.

on a baseboard?—Karl V. Miller, Waterloo, Ia.

(1) Yes. (2) Not necessary. (3) Yes. (4) Yes.

IS THE Diamond more selective than the Superdyne? (2) I cannot receive signals below 250 meters.—J. H. Heine-mann, Foley, Mo.

(1) Yes. (2) Either reduce the length of your antenna or remove three turns from secondaries.

KINDLY ADVISE if I can employ the Ambassador 3-circuit tuning coil minus the tickler in the Bernard 1-Tube DX set published in the October 24 issue of RADIO WORLD?—Louis Davis, 176 Ave A., N. Y. City.

Yes, but be sure to tap the secondary. You may use the erstwhile tickler in the aerial circuit. Connect aerial to one terminal of the variable coil, the other end of that coil to beginning of the aperiodic primary, and end of that small winding to ground.

CAN I expect distance from the Diamond on a loop?—P. McSephney, 648 Park Ave., Farrel, Pa.

Yes.

PLEASE show baseboard and panel layouts for a 3-tube reflex, using the tuned plate method of obtaining regeneration.—A. Krupp, 311 West 54th Street, New York City.

Fig 234 shows the layouts. The antenna coupler is behind the first condenser, at left. The interstage coupler is in the rear of that coil. The plate coil is to the left of the pair of sockets.

I WOULD like to know if the 8-tube Super-Heterodyne described in the July 4 issue of RADIO WORLD radiates? (2) Is there a considerable drain on the B batteries?—C. O. Wellman, 32 Mulberry St., Binghamton, N. Y.

(1) Yes. (2) This is dependent upon the type of tube used. Also upon the amount of C battery and other negative biases used. Were the 201A tube used, with the proper biases, the plates would draw approximately 35 mills.

I HAVE a prominent manufacturer's 4-tube Neutrodyne but have never obtained the volume that I desired. This set fits into the phonograph. (1) Would the above set, with one stage of power (Concluded on page 28)

Join RADIO WORLD'S University Club

And Get Free Question and Answer Service for the Coming 52 Weeks.

Have your name entered on our subscription and University lists by special number. Put this number on the outside of the forwarding envelope (not the enclosed return envelope) and also put it in your queries and the questions will be answered the same day as received.

RADIO WORLD, 145 West 45th Street, New York City.

Enclosed find \$6.00 for RADIO WORLD for one year (52 Nos.) and also enter my name on the list of members of RADIO WORLD'S University Club, which gives me free information in your Radio University Department for 52 ensuing weeks, and send me my number indicating membership.

Name

Street

City and State

Hoover Sums Up Results of the Fourth Conference

Declaration That Public Interest is Paramount Declared the Most Important Step Taken by the Members—Interference Problem Boldly Met—Legal Limit on New Stations Recommended Until the Art Develops New Channels—Radio Needs No Czar.

By Herbert C. Hoover

Secretary of Commerce and Radio Chief
of the United States.

WE have just completed the Fourth National Radio Conference in Washington. As I have been the chairman of that conference, I have been requested to report the results of the conference to the radio listeners, for you are the people most vitally concerned in its conclusions. You, the listeners, were represented at the conference through listeners' clubs in different parts of the country and through the radio press, who to a great degree reflect your views. The conference also included representatives of the broadcasting stations; it included representatives of the manufacturers of equipment; it included representatives of many government departments, that is, the army, the navy, agricultural, postoffice, the merchant marine and the Department of Commerce; it included representatives of neighboring foreign governments. Some 500 men and women left their homes and business affairs in all parts of the country to spend three days of hard work, searching for solution of our many radio problems.

Interference Must Be Cut

The major subject of this whole three-day conference was interference. In the practical terms of the listener interference is the different howls, growls, noises and whistles that come along with programs. We know from the experience of the last few years in this new art that many of these noises can be done away with, but the doing away with them takes us into a dozen varied difficult fields. It involves questions of legislation by Congress to further control the traffic in the ether. It involves treaties with foreign governments to eliminate interference of code signals from their ships at sea and to coordinate the broadcasting in foreign countries with our own. It involves many complicated and complex questions in the operation of broadcasting stations. It involves co-operation from the electric light and power companies, that electric currents will not go astray. It involves co-operation of the listeners themselves that they shall keep their own receiving sets so that they do not occasionally make them into sending sets, and thereby disturb their neighbors.

The Wave Channels

All radio listeners know that messages

over the radio are carried on a specific wavelength. They also know that there is only a certain band of these wavelengths from about 200 to 550 meters which can be used for telephone broadcasting. Many of you, perhaps, do not realize the enormous amount of commercial and other radio work that is carried on outside of the broadcasting band.

But in the broadcasting band there are only a certain number of paths over which broadcasting messages can travel from the station to the ears of the listener; and only one of these paths can be used by one station at one time, unless they are a long way apart. Some of these paths are used by our neighbors in Canada for Canadian stations, and ours have come to be an integral part of a single network. To speak in actual figures for all the broadcasting in the United States there are practically eighty-eight wavelengths which can be used at the present development of the art, and we now have nearly 600 broadcasting stations clamoring for their use.

The air today is overcrowded. And even worse, we are faced with the desires and demands of nearly 200 new broadcasters who wish to erect stations and to force their way into the already congested lanes. There are now more vehicles on the road than there is room for and more are crowding it. Unless something is done the whole traffic will be jammed.

Public Interest First

This was the primary problem with which the conference had to deal. It is the cause of major interference. The conference faced it boldly. It looked at it solely from the attitude of the listener, exclusively from the viewpoint that it was the duty of every one to think and act with one goal in view; that is, that a clear, intelligible, valuable signal free from conflict with other stations should reach the ear of the listener.

The conference declared that the public interest, as represented by service to the listener, should be the basis for every broadcasting privilege. And it therefore determined that it would ask the Congress of the United States to enact legislation in your interest to the effect that there must be a legal limit upon the total number of broadcasting stations until the art further develops new channels.

I take pride in the fact that in this conference, made up as it was not only of representatives of the listeners, the amateurs, the great newspaper and magazines of the United States, but of the manufacturers and broadcasters, with millions of dollars invested in their enterprise and at stake in this situation, not a dissenting voice was raised against the resolution by which they formally recognized that your interests are dominant in the whole situation.

Recognition First

It was significant to me that the resolution which so declared was introduced and advocated by a high official of one of the greatest radio companies in the United States, and I want to assure you that this resolution represents the real sentiment of the conference. It is honest and it is sincere.

I think, therefore, that if I were asked what are the two outstanding results of the conference, I would say that they lie, first, in the recognition of the listeners' dominant interests in radio, and second, as a corollary, in the determination

Fewer Stations and Better Ones Demanded, With No Increase Over Present Numbers—Legislation Asked, With Strict Supervision Over Broadcasters—Class Distinctions Among Stations to Be Stopped—No Increase in Wave Band.

that the amount of interference must be reduced. That means fewer stations and better ones, or at least no increase in numbers, and it must result in more efficient service and better programs. This request to Congress was that these stations are to be under strict governmental regulation; that each one shall obtain his license from the Department of Commerce, and before the applicant does so he must demonstrate that his operation will serve the public interest. His license may be cancelled or revoked at any time for violation of its terms or infraction of law. He must conform to law and regulations. He must perform the service which he had promised or his life as a broadcaster will end.

Freedom of the Air

It may be that we shall hear a great deal about freedom of the air from some of the people who want to broadcast and who will not be able to show that their desires accord with your interests. But there are two parties to freedom of the air, and to freedom of speech, for that matter. There is the speechmaker and the listener. Certainly in radio I believe in freedom for the listener. He has much less option upon what he can reject, for the other fellow is occupying his receiving set. The listener's only option is to abandon his right to use his receiver. Freedom cannot mean a license to every person or corporation who wishes to broadcast his name or his wares and thus monopolize the listener's set.

We do not get much freedom of speech if fifty people speak at the same place at the same time, nor is there any freedom in a right to come into my sitting room to make a speech, whether I like it or not. So far as opportunity goes to explain one's views upon questions of controversy—political, religious or social—it would seem that 600 independent stations, many competing in each locality, might give ample opportunity for great latitude in remarks. And in any event, without trying out all this question, we can surely agree that no one can raise a cry of deprivation of free speech merely because he is compelled to prove that there is something more than naked commercial selfishness in his purpose.

A Public Medium

The ether is a public medium and its use must be for public benefit. The use of a radio channel is justified only if there is public benefit. The dominant element for consideration is in the radio field and always will be, the great body

of the listening public, millions in number.

At the outset of the conference I think there was some fear on the part of the small stations, which serve chiefly local communities, lest they were to be crowded out by the larger and more powerful stations. There was some feeling as between the Class A stations on the one side and the Class B stations on the other. It was soon found that any such fear was groundless. The distinction between Class A and Class B is wholly arbitrary. It goes back to ancient times in radio history of four years ago when the favorite occupation of the broadcaster was the transmission of phonograph music. Some of the more progressive stations declared that there was a higher form of entertainment and they were put into a separate class, designated as Class B, on the condition that they would provide better programs.

No Class Distinction

The conference, therefore, resolved to wipe out this arbitrary distinction between the two classes. From now on all stations will be on the same basis. There is to be only one test, if Congress passes the necessary legislation, that is, service to the listener and this test will be applied to every station, big or little. There is full recognition of the fact that many of the smaller stations perform a real service to their communities which can be given in no other way and there is no desire on the part of anybody to disturb them.

It was suggested that we might make room for more stations if we widened the broadcasting band. Your instruments would not cover new stations outside the present band, and if this suggestion were adopted it would mean that we should have to invade the band which has been assigned to amateurs, of whom there are thousands. The conference agreed with me that radio has a useful contribution to the fine development of the American boy. None of us wishes to minimize his position in growing American life and therefore the conference confirmed here his province.

Not Immediate Panacea

While the recommendations of the conference should ultimately result in tremendous betterment to broadcasting, we must not expect radical improvement too soon. The conference was merely an advisory body. It had no final power. It expressed the views of every one interested in radio. Before most of its recommendations can become effective they must be enacted into law by the Congress of the United States. I hope that this legislation will be given us by Congress at its next session.

I hope, likewise, that it will impose regulation only to the extent absolutely essential. It has been the pride of the radio industry that it has been largely self-governing and I believe this condition may well continue. I know of no finer example of the true spirit of American industry than the voluntary recognition by the men engaged in radio communication of the public interest in their enterprises. That sentiment has characterized radio since its birth.

Radio has grown up in the spirit of service. It has been the world's greatest example of self-government in business. It has needed no czar, no iron hand of control.

There is, of course, a return in publicity to be had from broadcasting. Broadcast stations are not and do not necessarily claim to be philanthropists. They, like the great magazines and newspapers, are a great public service. Let us give the broadcast managers their full meed of praise for having created and freely given to us a radio service better than in any country in the world.

The problems of those radio listeners,

Advertising Overdone; Warning Is Issued

The Advertising and Publicity Committee reported:

It was the consensus that both direct and mixed advertising were objectionable to the listening public. In fact, indirect advertising could be made detrimental to the interests of both the public and the broadcasting station.

Advertising to achieve its best results must create the good will of those to whom it is addressed.

The following resolution was unanimously adopted by this committee for the guidance of all broadcasting stations:

Resolved, That the conference deprecates the use of radio broadcasting for direct sales effort, and any form of special pleading for the broadcaster or his products, which forms are entirely appropriate when printed or through direct advertising mediums.

Resolved, That the conference concurs in the suggestion of the Secretary of Commerce that the problems of radio publicity should be solved by the industry itself and not by government compulsion or by legislation.

Resolved, That the conference urges upon all owners of radio broadcasting stations the importance of safeguarding their programs against the intrusion of that publicity which is objectionable to the listener and consequently detrimental to others in the industry as well as to the reputation of the individual broadcasting station.

isolated from the city communities, were especially considered in the conference. Methods were recommended by which we can secure an extension and improvement of the service to our farmers. There is no greater purpose of radio than to bring to our farmers a mass of information that may be of use to them in the conduct of their work, but it is of equal importance to bring into their homes the majority of those things by way of entertainment which have for so many years been limited to those who live in the towns.

The navy must have wavelengths by which they communicate with their ships at sea. They must have wave lengths by

which they communicate with their aeroplanes in the air.

Other Uses

The army must have wavelengths by which they communicate with forces in the field and with their airplanes. We must have wavelengths assigned for international telegraph, for we are now in daily radio communication by code with every important country in the world. One of the greatest services radio has performed is communication between ships and shore and between ships at sea. Radio has enormously reduced the loss of human life at sea, and we must provide full facilities for that at all times. There has been a very wonderful invention called "the radio compass" which takes the place of the old magnetic compass by which ships have been navigated for centuries. We must provide wavelengths for use on the ships.

We must bear in mind that radio broadcasting is the birth of the last five years and that our previous conferences have been largely concerned with trying to get the service established; to create an effective service that could reach every home. The agency is now established. When I called the first conference only thirty people were present. There were then only two or three broadcasting stations and only a few hundred thousand listeners. Today there are nearly 600 stations and about 25,000,000 listeners. The problem of the present conference was to perfect that service.

The Summary

In general the conference, representing every phase of this question, was unanimous that there must be new legislation to give more control in the protection of public interest and in the perfection of the service. The conference recognized that radio has introduced a new element in the American life, that it possesses great value in home entertainment, in education and the spirit of religious thought; that it contains a great moral purpose not only to bring many new things into the lives of our people but to cement them together in a greater common understanding, and that the obligation of the industry is to provide these services.

LISTEN IN every Friday at 7 P. M. and hear Herman Bernard, managing editor of RADIO WORLD, discuss "Your Radio Problem," from WGBS, Gimbel Bros., New York City, 315.6 meters.

Selling of Wavelengths Is Denounced In Report

The Committee on Operating Regulations reported:

Resolved, That it is the opinion of this conference that further division of time among stations is not in the interest of public service, and that the Department of Commerce should decline to grant any more licenses until the present number of broadcasting stations shall have been substantially reduced.

Resolved, That it is the sense of this committee that duplication of frequencies in the present broadcast band should not be permitted in the case of stations of greater than 500 watts, and that in the case of stations of 500 watts or lower duplication should be permitted; stations separated by a sufficient electrical distance to avoid beat notes or interference in the territory covered.

Resolved, That this committee recommends that rebroadcasting of programs should be prohibited except with the permission of the originating station.

Resolved, That it be the sense of this committee that, with a view to minimizing interference to large groups of listeners, the

Department of Commerce shall, in licensing all broadcasting stations, use discrimination looking towards the locating of such stations outside of congested centers.

Resolved, That it is the sense of this committee that the band of frequencies now assigned to broadcasting is overcrowded, causing serious interference. Therefore the committee recommends, in the interest of public service, that no new stations be licensed until through discontinuance, the number of stations is reduced and until it shall be in the interest of public service to add new stations.

Resolved, That it is the view of this committee that public interest as represented by service to the listener shall be the basis for the broadcasting privilege.

Resolved, That this conference views with considerable apprehension and disfavor any practice contemplating the sale of a wavelength and that we earnestly recommend that all future propositions of this kind be scrutinized most carefully by the Department of Commerce so as to eliminate the possibility of speculating in wavelengths.

Must Stop Squealing Sets; Threat of Law Against Them

The Committee on Interference reported:

One form of interference to broadcast reception is that which may be caused by certain types of receiving apparatus. The elimination of interference from radiating receivers already in use should preferably take the form of persuasion rather than coercion. It is felt that one of the most effective means of eliminating such interference is to give publicity to methods of operating receivers in such a manner that they will not radiate.

The committee also believes that the press might stimulate the organization of broadcast listeners to assist each district supervisor, thereby forming a clearing house for the local elimination of sources of interference.

This committee urgently recommends that at some definite and reasonable future date the manufacture and sale of all radiating receivers for broadcast reception be discontinued. Because of the benefits which will accrue to the radio public from the suppression of radiating receivers it is urgently recommended that if the manufacture and sale of such receivers be not discontinued within a reasonable period legislation to that end be sought.

Check on Frequencies

Frequency allocations have been made on the basis of narrow margins between adjacent stations, and this calls for maintenance of frequency within the closest possible limits. A better check on the use of unauthorized frequencies is being provided. Regular measurements and reports should be made of the frequencies actually used by radio transmitting stations throughout the United States. Work of this character is a proper duty of the Department of Commerce radio service.

Apparatus is now available for maintaining and checking the frequency of transmitting stations. It is recommended that the Department of Commerce require all stations to use some means of frequently checking their transmitted frequencies with a properly calibrated instrument.

It is recommended that all offending transmitting stations emitting harmonics shall be compelled to install suitable means to suppress harmonic radiation.

The solution of this portion of the radio interference problem, in so far as the solution seems to be possible at this time, apparently involves such subjects as the education of a portion of the public in all parts of the United States and the co-operation with companies and individuals who render electric supply and communication services. In other words, it is a matter for self-service and helpful co-operation on the part of the public.

This education of and action by the listening public can be brought about, as has been found experimentally, through the formation of local broadcast listeners' clubs which have been guided by information from those who have made a special study of the subject.

Clubs Encouraged

The establishment and maintenance of systematically and conservatively conducted radio clubs in all communities should serve as a fundamental factor for solving this and other radio problems that have to do with the giving of the best possible radio service to the public.

In addition, it is recommended that each district be supplied with sufficient personnel and an automobile equipped with apparatus suitable for finding interference and making measurements necessary to good radio broadcast service.

From the standpoint of overriding inter-

ferences, the increase of power at broadcasting stations should help to solve the radio interference problem.

The interference resulting from the use of damped wave transmitters is gradually being reduced by the improvement of equipment but is still rather serious in isolated cases. If the number of damped wave transmitting sets can be gradually reduced and the remaining sets of this class gradually improved in the quality of their transmission the situation will be still further improved with little hardship to the owners of such stations.

High Power Interference

Unquestionably much interference now experienced is the result of using higher transmitting power than necessary. There is a noticeable tendency to provide sufficient power to maintain communication under unfavorable conditions and then to continue with that power through all the more favorable seasons. The happy medium between maximum power and insufficient power can only be achieved by constant supervision of operations by the responsible management, assisted so far as possible by government inspectors.

Interference from careless testing is similar to that from the use of excessive power in that it is usually under the direct control of an operator without due appreciation or respect for the rights of others. Care on the part of responsible managements that their operators are properly instructed in testing methods, combined with vigilance, and report to supervisors on the part of all cognizant of such abuses are about the only remedies which can be suggested.

New Stations in Cities Banned

The fear which was felt a year ago that high power would adversely affect the reception of a large number of listeners has been shown to be without foundation. The increase of power by transmitting stations has improved general conditions of reception. It is recommended that the present attitude of the Department of Commerce of authorizing experimental development of high power broadcasting stations be continued. It is also recommended that all future stations which radiate frequencies within the broadcasting band be located away from congested centers of population, the distance depending on the field strength produced in the congested area.

It is recommended that the Department of Commerce endeavor to secure the enactment of legislation which will permit the establishment of uniform regulations regarding the use of radio transmitters by ships in ports and territorial waters, and the conclusion of international agreements covering the use of radio by ships in the vicinity of the United States.

Interference Reduced

The recommendation of the Third National Radio Conference that 500 kc (600 meters) be reserved for calling and distress only has materially reduced interference. This could be carried still further through adoption of uniform methods of operation so that this frequency is used as little as possible in establishing communication without reducing the number of marine stations which habitually listen on this frequency.

In view of the great congestion which exists at the present time within the limits of broadcasting frequencies, it is urgently recommended that the Secretary of Commerce withhold further licenses within these limits, pending Congressional legislation to that end.

Need Seen for Decrease of Present Stations

WASHINGTON.

Although the recommendations of the Fourth National Radio Conference provide for a limitation of stations, the only provision made to accomplish this end was to refuse licenses to new stations until the congestion has disappeared through stations dropping out.

It is the fear of officials here that the present congestion may not be materially removed by the Conference action. There are at present entirely too many stations. Increased value is bound to be attached to a wavelength after the recommendation limiting stations, and existing broadcasters are expected to hang on for dear life.

The deletion of a few 5, 10, 25 and 50-watt stations will not help much. It is thought likely that Congress may be asked to provide some method for decreasing the existing number of stations.

Domestic Silent Hour Favored During Tests

WASHINGTON

The National Association of Broadcasters in special session at the Washington Hotel here, just prior to the Fourth National Radio Conference, indorsed the International Radio Week Committee, which is handling the radio week January 24 to 30, and conducting the international radio broadcasting tests which will be a feature of this week.

More than 400 broadcasters were represented at the conference, and many weighty and important problems discussed by the members of the broadcasters' association at the two sessions held before the national radio conference opened.

Debate on the proposition of the broadcasters of the country observing a silent hour each night during the week was spirited, and while no official action was taken by the broadcasters agreeing to observe the silent hour of 11 to 12 each night during the radio week period, the indorsement of the movement by the association was considered as a tentative agreement to observe the silent hour to permit the local listeners to hear overseas stations who will broadcast from over fifteen countries. A. H. Lynch, editor of "Radio Broadcast," and in charge of the overseas tests arrangements, pointed out the great interest in the tests. Arthur H. Halloran, of the Pacific Coast Radio Trade Association; George Schubel, of New York; L. A. Nixon, of the Radio Week Committee, and others spoke.

Radio Writers Form National Association

WASHINGTON.

The National Association of Radio Writers, composed of radio editors, correspondents and writers, was organized here during the National Radio conference.

The first official act of the Association was to commend Secretary Hoover and his staff for their administration of radio affairs.

The officers elected by the Association were Harry La Mertha, of the St. Louis "Globe Democrat," president; Stephen L. Coles, of the New York "Herald Tribune," vice-president; Thomas Stevenson, of the Stevenson Radio Syndicate, Washington, secretary; and Stuart C. Mahaney, of "The Country Gentleman," Philadelphia, treasurer.

The Report That Killed Amateur Band Invasion

The Committee on General Allocation of Frequency reported:

In view of the fact that radio development during the last year has been in general harmony with the allocation of communication channels suggested by the Third National Radio Conference, the present committee has had to recommend only minor changes in that allocation. The discussions have involved three major problems.

The first of these is the matter of extending the band of frequencies assigned to broadcasting. The committee recognizes that extensions of this kind would permit the operation of additional broadcasting stations, or the relief to some degree of the present condition of overcrowding. Nevertheless, no additional channels were found available for broadcasting except by sacrifice of the major wavelength band used by the amateurs; and careful analysis showed that even if this entire band were to be transferred to broadcasting, the contribution toward the reduction of interference would be relatively slight. Furthermore, any such change in broadcasting channels would inevitably render at least partially obsolete the millions of broadcasting receiving sets now in use. No benefit proportionate to the certain damage could be found, and consequently the broadcasting wavelength was not changed.

Compilation of Number Of Sets in Large Centers

It is estimated that 43 per cent. of the country's population is reached by the programs broadcast by WEAf and about a dozen large stations usually connected in its chain. "Radio Retailing" has compiled the following figures on the population within a 100-mile radius of each of the stations named together with the estimated number of radio receivers within these areas:

City	Station	Population 100-mile area	No. of radio sets
N. Y. City	WEAF	10,626,000	468,000
Philadelphia	WOO	5,509,000	202,000
Boston	WEEL	4,792,000	219,000
Pittsburgh	WCAE	4,694,000	158,000
Cincinnati	WSAI	4,302,000	124,700
Detroit	WWJ	3,826,000	154,000
Washington	WCAP	3,097,000	101,000
Cleveland	WEAR	3,092,000	116,000
Atlanta	WSB	2,143,000	20,000
Buffalo	WGR	1,907,000	87,000
Mpls.-St. Paul	WCCO	1,878,000	67,000
Davenport	WOC	1,750,000	74,000

Baby Station Erected To Test Factory Sets

One of the smallest practical broadcasting stations and one which works six days a week is in use at the King Quality Products radio plant at Buffalo, N. Y., and possibly duplicates of it are in use by this time in other localities. It was put in service to meet an insistent demand for morning broadcasting.

At the King plant it is necessary to begin giving receiving sets their final tuning up early in the morning before any of the large broadcasting stations with their varied programs are on the air. To meet the difficulty Howard A. Gates, in charge of one of the King laboratories, built a miniature broadcaster, mounting it on a panel eight and one-half inches square and this is now used, attached to a phonograph, for morning testing.

The station has a wavelength of from 200 to 600 meters and a range of about a

Law to Give Hoover Full Power Over Stations Is Recommended

The Committee on Legislation reported:

It has been the pride of the radio industry that it has been to a large extent self-regulating, most of the regulatory features necessary for its efficient functioning being discussed and agreed upon at these annual conferences rather than imposed by governmental authority. It is highly desirable that this condition shall continue to the greatest measure possible. Nevertheless, it must be recognized that in the widespread network of stations that now exists throughout the country, each a potential destroyer of the messages of the other, regulation to keep open the traffic lanes is absolutely essential and that regulation can be imposed efficiently only by the central authority of the Federal government, which must have the right through issue of licenses, control of power, assignment of wavelengths and other appropriate measures, to handle as a whole the interstate and international situation. This power should be vested in the Secretary of Commerce, as it is to a limited degree at present. But governmental authority should not be extended to mere matters of station management, not affecting service or creating interference, nor should it under any circumstances enter the forbidden field of censorship.

As to the specific matters referred to this committee, we respectfully submit the following report:

It is the opinion of this committee that: (1) Existing Federal statutes are inadequate to permit proper administration of radio communication activities.

(2) The Congress of the United States is empowered by the statutes to enact legislation necessary to provide such adequate administration.

(3) Present conditions and the public interest require that such legislation be enacted.

Your committee therefore, recommends that Congress do enact such legislation, incorporating therein the following principles:

(1) That the administration of radio legislation shall be vested in the Secretary of Commerce, who shall make and enforce rules and regulations necessary to the proper administration of the provisions of such legislation.

(2) Such administration shall be exercised by the Secretary through the officers or employees of the Department of

Commerce, except that the Secretary may appoint such boards or committees as he may consider necessary or desirable to assist him in an advisory capacity in the administration of problems of national scope.

(3) That the doctrine of free speech be held inviolate.

(4) That no monopoly in radio broadcasting shall be permitted.

(5) That the legislation shall contain provisions for due appeal from final decisions of the Secretary of Commerce to the appropriate court.

(6) Except in the case of governmental stations, the Secretary shall be empowered to classify all stations and to fix and assign call letters, wave length, power, location, time of operation, character of emission and duration of license.

Provided, further, that the term of a license to operate a broadcasting transmitting station, the character of which is to be defined in the act, shall be not to exceed five years, with the privilege of renewal for like periods, and provided further, that the Secretary may suspend or revoke any license for failure to maintain regular operation of a transmitting station without just cause.

(7) That the act should define the following terms, to wit: Commercial stations, broadcasting stations, amateur stations and experimental stations.

(8) That the Secretary shall have the power to revoke or suspend any license whenever he shall determine that the licensee has violated any of the terms of his license, regulation of the Secretary, Federal radio law or international treaty.

(9) That rebroadcasting of programs shall be prohibited except with the permission of the originating station.

(10) The Secretary of Commerce shall be empowered to make and enforce such rules and regulations as may be necessary to prevent interference to radio reception emanating from radio sources.

Value of Variable Leak

One of the ways in which regeneration can be controlled is by the varying of the grid leak. If the set oscillates too freely, increase the resistance of the leak. This impedes the oscillatory flow in the grid circuit. If the action is vice versa, decrease the resistance. The resistance can be reduced to such a point where only the plate tuning element will completely control the oscillations of that tube.

A Huge Variometer

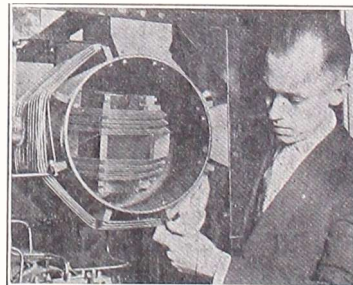

THIS variable inductance, recently exhibited at the American Marine Show, New York, differs from the small instruments of its type in its construction, as well as in size. Ordinary variometers are wound with cotton or silk-covered wire, but this one is wound with copper tubing.

(Kadel & Herbert.)

HOW TO BUILD THE POWERTONE. 1 dial, 5 tubes, described in RADIO WORLD, issues of Aug. 29 and Sept. 5. Powertone Trouble-shooting, Sept. 12. Send 45c for all three. Special diagrams and "blueprint in black" included among the many illustrations. RADIO WORLD, 145 West 45th St., N. Y. C.

The Radio Train Stopper

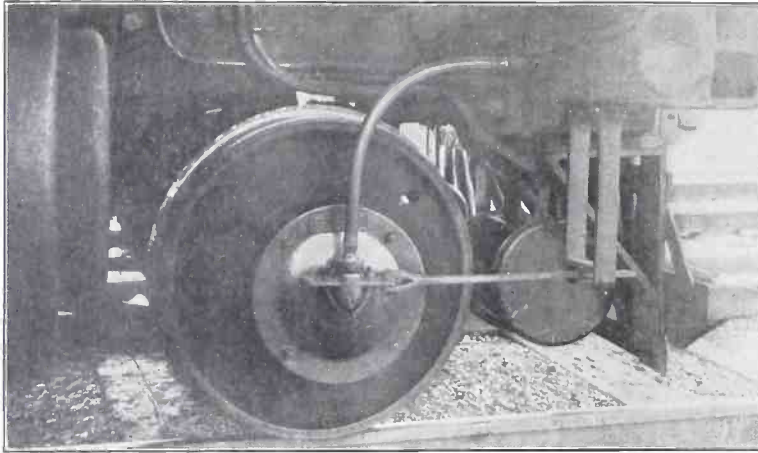

THE RADIO train-stopping device. (Fotogram)

Continuous train control by means of a radio-operated safety device was demonstrated when a locomotive traveling at a speed of fifty miles an hour was stopped by automatic application of the brakes by means of an appliance weighing less than 100 pounds.

With a system of radio-controlled signal lights installed in the cab of the locomotive it was demonstrated that the engineer can be forewarned of impending disaster.

The demonstration was on a ten-mile stretch of track of the Pere Marquette railroad. The device was invented by Thomas E. Clark.

The photo shows two-position pick-up, one for clear and one for caution; danger condition being when there is no energy in the track. Speed governor is shown on pilot wheel which is coupled in with control circuits of locomotive so that permissive speeds may be incorporated in control.

Middies Mus



BEFORE a midshipman can be graduated at Annapolis, Md., he must master his radio standing of radio principles. Every midshipman must pass a series of examinations. Above we see some midshipmen at work on a radio which transmits as well as receives.

Light Produces Sounds in WGY Broadcast Test

The possibility of creating a new musical instrument by utilizing the photo-electric effect was brought out by Dr. Peter I. Wold, professor of physics at Union College, when he introduced the radio audience of WGY to the song of the electron.

A photo-electric cell was connected to the broadcast circuit and a disc with many rows of perforations was placed between the cell and a light source. The photo-electric cell is coated on its inside surface with metal potassium which is very sensitive to light. At the center of the cell is a plate of tungsten. A battery of 135 volts has its negative terminal connected to the potassium coating and its positive terminal to the tungsten plate. When light falls on the potassium coating electrons are given off and travel to the tungsten plate, thus constituting a current. By means of a motor the disc with circular rows of holes was rotated between the light and the cell. When the disc was revolved slowly a low pitched note was given off, rising gradually as the speed of the disc increased.

Four Rows of Holes

In Prof. Wold's demonstration the disc contained four rows of holes, the outer row with 48 holes, the next row with 36, the third with 30 and the inside row with 24 holes. By covering one row or another he secured different notes. By moving backward, that is, by covering first the inside row and then the last, he produced the major chord. By uncovering the rows he obtained two notes and then by uncovering all four rows he secured

notes of good organ quality. For organs the ingenious experimenter would need only to have rotating discs with rows of holes of the right numbers and arranged so that the light could pass through the holes to the photo-electric cell. Any row or combination of rows could be uncovered by small slides operated from a keyboard and the loudness of the notes might be controlled conveniently by regulating the brightness of a lamp. A loudspeaker could be used to convert the electrical vibrations into sound vibrations. One of the important features of the photo-electric cell is that it is practically instantaneous in its action. It does not require time to build up as in the case of some other electric musical instruments, and this improves its possibilities.

Allen, Radio Expert Killed in

George Y. Allen, who was killed when the Pennsylvania flier telescoped the rear of the express train two miles west of Monmouth Junction, N. J., was a radio expert engaged in developing radio safety systems for railways. As technical assistant to the manager of the radio department of the Westinghouse Electric and Manufacturing Company, he recently demonstrated his wired-wireless system on the Virginian Railway. He devised a method whereby the high frequency carrier current replaced the whistle as a means of signaling from the engineer's cab to the caboose or the helping locomotive on the rear of long freight trains.

Mr. Allen was a member of the American Railway Association's committee investigating the possibility of employing

Weather and Stock Reports Thrill Farmers, Cold to Jazz

While western farmers eat their dinners, at mid-day, they listen in to the weather report from KGO, General Electric Pacific Coast Station, and decide what best to do on their way back to the fields.

Weather and stock reports alone make radio sets on western farms invaluable, many letters received at KGO indicate, and the entertainment received in outlying districts, and educational lectures from Agricultural experts, come into the farmhouses as additional good measure. An

Idaho correspondent wrote KGO recently: "We farmers here do not use your live stock report, but we do appreciate your potato market reports, as lots of our Idaho spuds go to Coast markets. We believe your market service is the best part of your broadcasting, and the weather reports from KGO are accurate and dependable. Last winter in extreme cold weather we got the weather report every night, and next day we were prepared to act accordingly."

Know Sets



from the U. S. Naval Academy at Annapolis. He is given a thorough understanding of the principles of radio and must build a set to pass examination in connecting up a special regenerative set, and receiving. (Fotograms)

Engineer, Train Wreck

to safety and warning signals on the coast. He was on his way home from the Fourth Annual Radio Conference in New York when he was killed.

Mr. Allen was one of the few amateurs who intercepted the news of the Titanic disaster when the ship flashed its call for help in April, 1912.

He was born in Bernardsville in 1893 and was graduated from Stevens Institute of Technology, Hoboken, in 1915, with a mechanical engineering degree.

He was engaged in radio research work for the Western Electric Company after graduation, and at the outbreak of the World War was appointed radio aid to the United States Navy Engineering Bureau.

He entered the radio department of the Westinghouse Company in 1919. He was a member of the Institute of Radio Engineers, the American Institute of Electrical Engineers, the National Electric Light Association and the Associated Manufacturers of Electrical Supplies.

When Mr. Allen met his death he was returning from the fourth annual radio conference, called at Washington by Secretary Hoover. He represented the radio manufacturing industry in the design of technical features of the new radio law recommendations to be presented for congressional action this winter by Secretary Hoover.

Mr. Allen lived at 23 Waldo avenue, Bernardsville, N. J. He is survived by his wife and two children. The funeral will be held Sunday from the home of Mr. Allen's father, Watson Allen, at Bernardsville, N. J.

Microphone in the Belfry

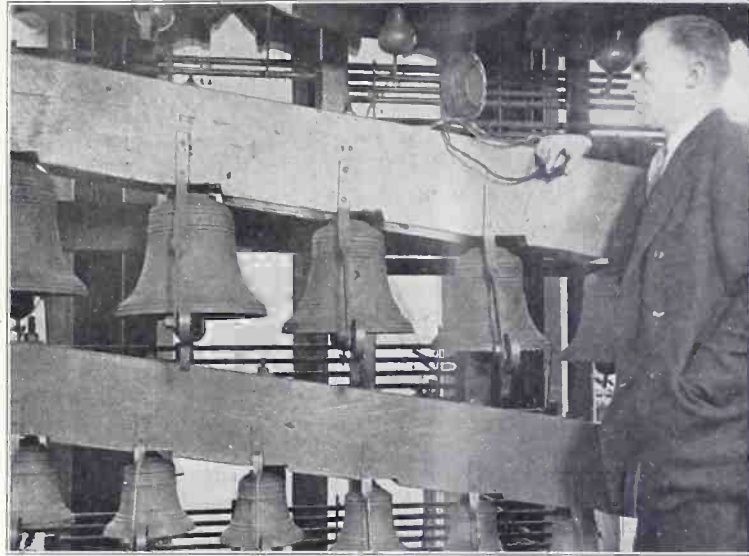

CHIMES of the Park Avenue Baptist Church, New York City. (Kadel & Herbert.)

In the belfry of the Park Avenue Baptist Church, New York City, where the carillon, the gift of John D. Rockefeller, are broadcast every Sunday evening, by Station WJZ. These bells are the most perfect of their type, and register over the air excellently. Herbert Glover, the announcer, is seen before the microphone that picks up the chime's lively notes.

Radio Controls Dispatching of Tugs in N. Y. Harbor

The operations of many of the tugs along the seventy-five-mile waterfront of New York harbor are now controlled by radio as a result of tests conducted recently by the New York Central Railroad and the Radio Corporation of America, with the assistance of the Federal Government.

The system used, as explained by an official of the railroad, is a simplified form of two-way transmission that can be used by the dispatcher's office on shore. The sets installed in the office and on the tugs are low-power tube transmitters, using a standard Radiola receiver with a loud speaker. The only operation necessary for transmitting or receiving is the manipulation of a small switch on the base of a desk type microphone.

With radio telephony, it was explained, orders can be given at any time, at any point, to any tug. Tows can be augmented after they have started, boats can be dropped if the shipper changes his order,

and labor saved by the elimination of dispatchers. Tests have proved, according to the official, that the average time saved to tugs is more than thirty hours a month, or about a saving of \$500 a month per tug.

The Federal Government assisted the experiments by allocating the wavelengths between 109 and 120 meters for the tests and, the official said, the Department of Commerce has passed a fifth-grade rating for operators, the only qualification for license being the ability to distinguish S O S signals.

The final test was witnessed by many shipping and railroad officials, Government officials and engineers. Some of the party went aboard a tug which had been ordered to report to Pier A at the Battery, the others remaining at the dispatcher's office. From the time the tug left the pier for a trip around the harbor until its return it was in constant communication with the office.

Broadcasting Bird's Song Makes Cat Dive Into Horn

Broadcasting a singing bird before noon, when cats and dogs in homes are asleep and likely to be awakened, may not prove to be good policy.

Recently when a mocking bird sang at KGO trouble happened all over the map, according to reports sent into the station.

"Felix, our black cat," wrote one radio fan, "awoke from mousey dreams this

morning and straightway dived into our loudspeaker, when he heard a mocking bird singing."

Another wrote: "Our pet terrier always sleeps near our radio. This morning he awoke with a start when he heard a bird singing, and tried to tear our radio to pieces, he was so mad."

A score of letters was received.

Panatrope, Radio Device, Improves the Phonograph

The use of radio to make the phonograph better, incorporated in the Panatrope, a new invention, was demonstrated in Aeolian Hall, New York City. The instrument was developed by the Radio Corporation of America, the Westinghouse Electric and Manufacturing Company, the General Electric Company and the Brunswick-Balke-Collender Company.

The Panatrope's radio tubes and loudspeaker were hooked up to the built-in radio receiver to repeat the address made in Washington by Dr. Alfred N. Goldsmith, chief broadcasting engineer of the Radio Corporation of America, describing the new invention.

Stands Severe Test

After that the Panatrope was subjected to a severe test. It played a series of phonograph disk records after the first movement of Brahms B Major Trio had been performed by the Elshuco Trio and before a selection from "L'Africana" had been sung by Mario Chamlee.

The first performance of the new instrument on the same program with noted artists who appeared in person was a Godowsky rendition of "Liebestraum."

The volume of music which issued from the Panatrope was regulated so that it first filled the hall and was then subdued

to the point where it would be suitable for an apartment. This was possible because radio tubes were used for amplification and the music may be amplified little or much. At the end of the Godowsky record the audience applauded liberally. The next record to be played was Schubert's "Ave Maria" on the violin by Albert Spalding.

Uses Electricity

The records are electrically cut by the new process now in general use. The reproduction is by a new system which discards the sound box and the horn. The vibrations of the needle traveling in the groove do not directly produce the sound, as in other phonographs, but the vibrations are translated into oscillations of electrical current, which are stepped up by the vacuum tubes to actuate a disk loudspeaker.

The demonstration was given under the auspices of a committee including Mrs. Vincent Astor, Clarence H. Mackay, Eugene Allen Noble, Mrs. Arthur Sachs, Brig. Gen. Guy Eastman Tripp, Otto H. Kahn, H. B. Tremaine, Frederick Steinway, David Sarnoff, Mrs. Charles S. Guggenheimer, John Hays Hammond, Jr., Dr. Goldsmith and C. W. Stone of the General Electric Company.

Charms With Violin



DAISY KENNEDY (Mrs. John Drinkwater), Australian concert violinist, and favorite of Station 2LO, England, who made her American "air debut" in the seventh Atwater Kent Radio Hour broadcast by WEAf and twelve other stations.

Regular Cross-Ocean Programs On the Verge of Realization

WASHINGTON.

An international exchange of broadcast programs is in prospect for the next year. This is the promise of David Sarnoff, Vice-President and General Manager of the Radio Corporation of America.

"We have reached agreements with several countries," says Mr. Sarnoff, "for the exchange of programs. There remains the problem of getting the programs back and forth across the ocean with sufficient clarity to rebroadcast.

"We are proceeding with an energetic program for the exchange. We are building a receiving station at Belfast, Maine, because we have found that reception is better there. We can hear the foreign stations now, but we cannot get their signals well enough to rebroadcast them.

"Just as soon as our Bound Brook station is completed we think we can get our programs across the ocean. A station is to be constructed in Germany with sufficient power to bring the German programs to us. The new British station at Daventry is equipped to use 40,000 watts and, it is believed, will be able to furnish Americans with their programs.

"The programs picked up by our Maine station will be transmitted by wire to New York and from there sent out over the entire country either by land wire for rebroadcasting or by radio."

BROADCASTING STATIONS TO DATE

Complete list appeared in RADIO WORLD dated Nov. 14. 15c copy, or start your sub. with that number. RADIO WORLD, 145 W. 45th St., N. Y. C.

RECENT BACK NUMBERS of RADIO WORLD, 15c each. RADIO WORLD, 145 West 45th St., N. Y. C. price. RADIO WORLD, 145 West 45th St., N. Y. 45th Street, New York City.

Star of Joint Recital



MABEL GARRISON, soprano, formerly with Metropolitan Opera Company, heard during joint recital in the seventh Atwater Kent Radio Hour, broadcast by WEAf and twelve other stations.

Boca Raton Station to Open in January

The controversy in Washington about the number of radio stations will not affect the station that the Mizner Development Corporation is building at Boca Raton, Fla. George Sheffield returned to Boca Raton from Washington after a conference with Secretary Hoover and made the announcement. He said:

"It was the original intention of Secretary Hoover to limit the number of stations that could use the air to the number now in actual operation. The fact that we had our contracts let for the construction of the station and had contracted for the air, on a 252 meter wavelength, caused the Secretary to lift the restriction for the Mizner Corporation.

"We expect to have the plant ready by January 1."

Mr. Sheffield stopped in Atlanta and made arrangements for Lamdin Kay to open the new station at Boca Raton.

Another Station For Borough of Manhattan

The Borough of Manhattan, New York City, will have another broadcaster when station WHAP, now in Brooklyn, moves. The new transmitter at 426 West Thirty-first Street, has been under test, using the call 2XAJ. The license of the station is in the name of the Taylor Finance Corporation, and the studio is in Room 1115 of the New York Equitable Building, 393 Seventh Avenue. The wavelength will be 241 meters.

Another broadcaster with the call WKCB, Kings County Broadcasting Company, Inc., will be located in WHAP's previous location at 275 Flatbush Avenue, Brooklyn.

The Reinartz Plug-in SW Set

By Lewis Winner

Associate, Institute of Radio Engineers

A NOVEL thing about the Reinartz receiver, shown in Fig. 1 is that stations from 28 to 590 meters can be tuned in.

This is done with the aid of the plug-in coils.

Up until recently the only type of a receiver that could do a trick of this character was the old reliable Honeycomb or a Super-Heterodyne.

Figs. 2, 3 and 4 give clear views of this receiver. The panel layout is simple, with only two major controls.



LEWIS WINNER

The panel is 14" long and 7" high. The baseboard is 12" long and 12" wide. The width of the baseboard must be extraordinary. This is due to the spaced parts, requisite for short waves, for which special purpose this receiver was built. The sockets are made out of special pyrex bases. This is to prevent losses. The condensers are of the geared SLC type.

Wiring the Set

The beginning of the antenna coil, 2, goes to the antenna tip on the terminal strip. The end of this coil goes to the ground binding post on the terminal strip. The beginning of the secondary coil, 1, goes to the stator plates of the variable condenser, 4. The tap adjacent to the ground terminal post goes to the A+ B- tips on the terminal strip. Now the rotor plates of 4 go to the plate post of 8, which is the tube socket. This lead goes to one terminal of the high frequency choke coil, 7. The other terminal of this coil goes to the P post on the audio-frequency transformer. The stator plates of the variable condenser, 3, go to tapped portion of the coil. This tapped portion is not to be confused with the other tap, which goes to the stator plates of the variable condenser, 4. The end of the coil, 1, goes to one terminal of the grid condenser, 5, and to one terminal of the grid leak, 6. The other terminal of this combination goes to the G post on the socket, 8. You will note in Fig. 3 that there is a piece of bus bar sticking up from the grid leak and condenser. This is for connecting the stator plates of 3, instead of to the tap, to the end of the coil 1. The only way to find if this connection is required is to try it. The F+ post on the socket, 8, goes to the A+ B- post tip on the terminal strip. The F- on this same socket goes to the resistance of the rheostat, 11. The arm of this rheostat goes to the top terminal of the filament jack, 12. The F- post on socket 9, goes to the F- post on socket, 8. The F- post on this same socket goes to the resistance wire of the rheostat, 11. This means that both tubes are controlled by one rheostat.

The B post on the audio-frequency transformer goes to the B+ 45 tip on the terminal strip. The G post on this transformer goes to the G post on the socket, 9. The F- post on this transformer goes to the resistance of the rheostat, 11. This gives the amplifier tube a negative grid return. The plate post on socket, 9, goes to the third terminal from the top, on the filament control jack, 12. The second terminal from the top of this jack goes to the A- tip on the terminal strip. The

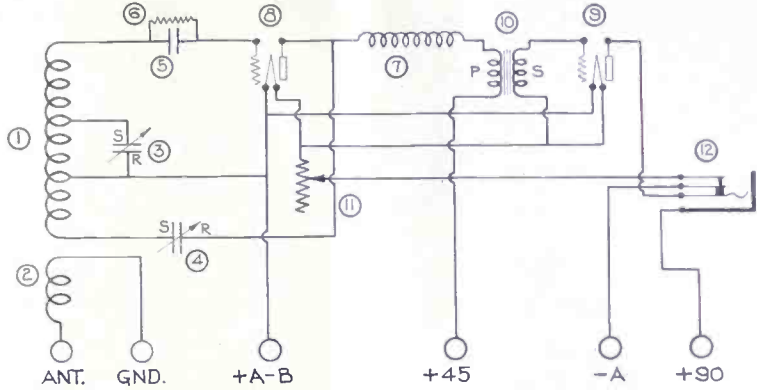

FIG. 1, showing the electrical diagram of the Reinartz SW set.

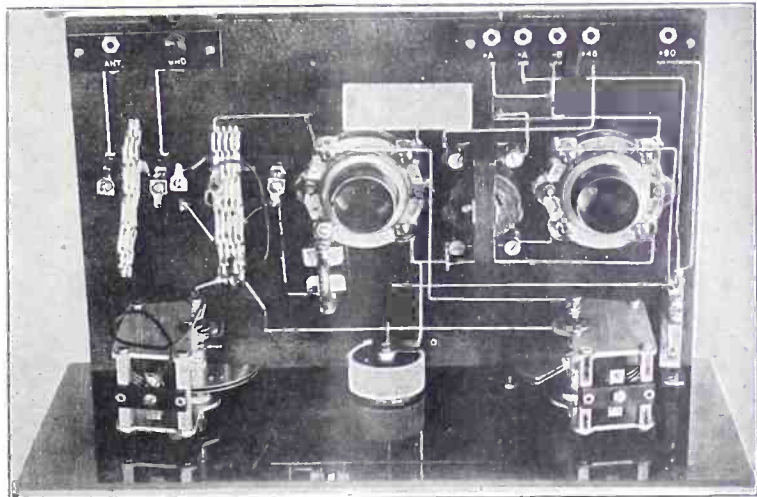

FIG. 2, showing the top view. Note the pyrex base sockets.

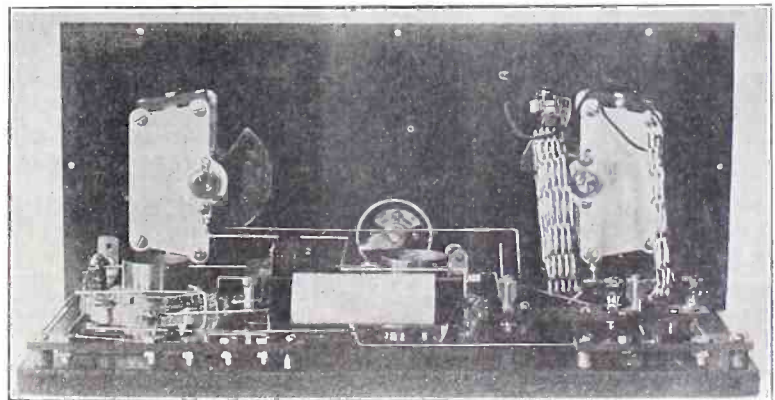

FIG. 3, showing the back view of the completed receiver.

last bottom terminal goes to the B+ 90 tip on the strip.

Procure a basket weave form, which is 3 3/4" in diameter, and 1/2 lb. of No. 18 double cotton covered wire. Three pieces of bakelite, hard rubber or wooden strips, 2 5/8" in length and 3/8" width should also be obtained.

The primary consists of 6 turns. This is wound over two rods and under two rods. That is, there will be three turns on the top and three turns on the bottom.

The secondary for the short waves consists of 24 turns, wound in the same fashion as for the above coil. The coil

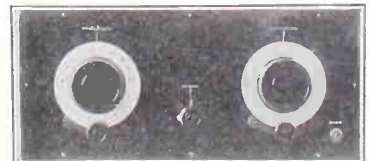

FIG. 4, the panel view.

is tapped at the 6th (for the filament) and at the 18th (for the grid) turns.

The secondary for the broadcast waves
(Concluded on page 30)

A THOUGHT FOR THE WEEK

In 1913 the late Elbert Hubbard, while discussing a labor problem, said he had been "endeavoring to train some rather delinquent villagers to abjure the comatose state and get radioactive." Fra Elbert thought originally and frequently in terms of the future.

RADIO WORLD



Radio World's Slogan: "A radio set for every home."

TELEPHONES, BRYANT 0558, 0559 PUBLISHED EVERY WEDNESDAY (Dated Saturday of same week) FROM PUBLICATION OFFICE HENNESSY RADIO PUBLICATIONS CORPORATION 146 WEST 45th STREET, NEW YORK, N. Y. (Just East of Broadway) ROLAND BURKE HENNESSY, President M. B. HENNESSY, Vice-President FRED S. CLARK, Secretary and Manager European Representatives: The International News Co., Breans Bldg., Chancery Lane, London, Eng. Paris, France: Brentano's 38 Avenue de l'Opera. Chicago: A. T. Sears & Son, Peoples Gas Bldg., Cincinnati Office: Radio World, 304 Provident Bk. Bldg., 7th and Vine Sts. Telephone, Canal 763 and 879. San Francisco: Lloyd B. Chappell, 656 O'Farrell St.

EDITOR, Roland Burke Hennessy MANAGING EDITOR, Herman Bernard

SUBSCRIPTION RATES

Fifteen cents a copy. \$6.00 a year. \$3.00 for six months. \$1.50 for three months. Add \$1.00 a year extra for foreign postage. Canada, 50 cents. Receipt by new subscribers of the first copy of RADIO WORLD mailed to them after sending in their order is automatic acknowledgment of their subscription order. Changes of address should be received at this office two weeks before date of publication. Always give old address also. State whether subscription is new or a renewal.

ADVERTISING RATES

Table with 3 columns: Ad Type, Lines, Price. Includes General Advertising, Times Discount, and Classified Advertisements.

CLASSIFIED ADVERTISEMENTS

Ten cents per word. Minimum, 10 words. Cash with order. Business Opportunities ten cents per word. \$1.00 minimum.

Entered as second-class matter, March 28, 1922, at the Post Office at New York, N. Y., under the act of March 3, 1879.

NOVEMBER 28, 1925

An Active Antenna



New kind of aerial: wire-haired terrier!

Three Useful Hookups for Fans

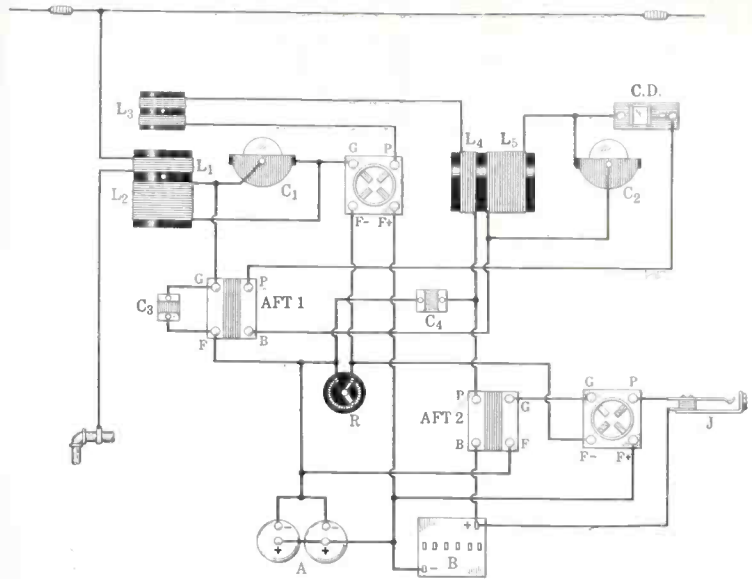

A PICTURE DIAGRAM of a 2-tube reflex set, where a crystal is used as a detector. The first tube is regenerative. L1L2L3 is a standard 3-circuit tuner. L4L5 is a standard R.F.T. C1 and C2 are .0005 mfd. variable condensers. C3 and C4 are .001 mfd. fixed condensers.

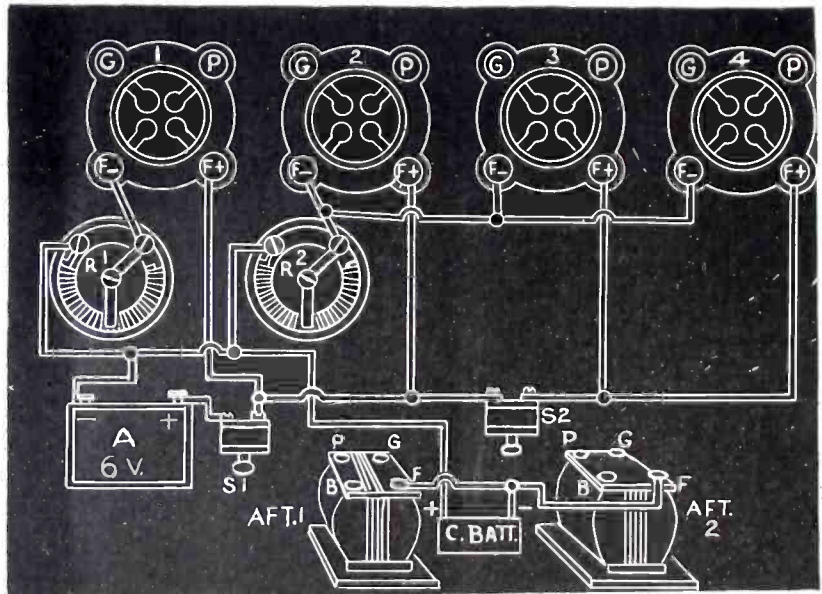

HOW TO CONNECT up the filament circuit of a 4-tube set, where a separate rheostat is used for the R.F. tube and a single rheostat for the detector and two A.F. tubes. There are two filament switches in the A main lead, one for the R. F. and detector tube and one for the two A.F. tubes.

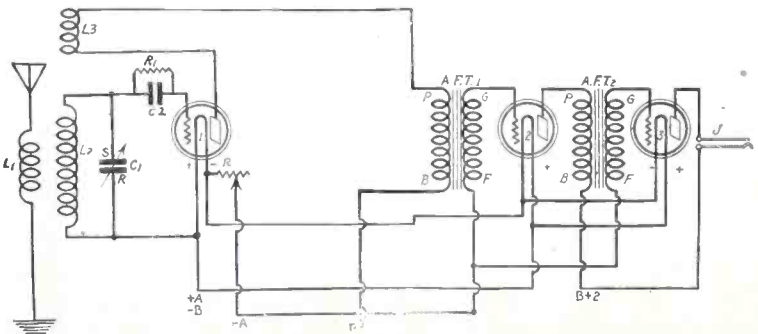

THE POPULAR 3-circuit tuner receiver, with the two transformer stages of audio-frequency amplification. C1 is a .0005 mfd. variable grid condenser. C2 is a .00025 mfd. grid condenser. R1 is a 2 megohm grid leak. Note that only the whole three tubes can be used. If you wish to use the detector, place a double circuit jack in the detector circuit.

Table for Conversion of Frequencies and Meters

kc or m	m or kc	kc or m	m or kc	kc or m	m or kc	kc or m	m or kc	kc or m	m or kc	kc or m	m or kc	kc or m	m or kc	kc or m	m or kc	kc or m	m or kc	kc or m	m or kc	kc or m	m or kc
10	29,982	1,010	296.9	2,010	149.2	3,010	99.61	4,010	74.77	5,010	59.84	6,010	49.80	7,010	42.77	8,010	37.43	9,010	33.28	10,010	30.24
20	14,991	1,020	293.9	2,020	148.4	3,020	99.28	4,020	74.58	5,020	59.73	6,020	49.70	7,020	42.71	8,020	37.38	9,020	33.24	10,020	30.24
30	9,994	1,030	291.1	2,030	147.7	3,030	98.95	4,030	74.40	5,030	59.61	6,030	49.72	7,030	42.72	8,030	37.40	9,030	33.25	10,030	30.25
40	7,496	1,040	288.5	2,040	147.0	3,040	98.62	4,040	74.21	5,040	59.52	6,040	49.74	7,040	42.73	8,040	37.42	9,040	33.26	10,040	30.26
50	5,997	1,050	285.5	2,050	146.3	3,050	98.30	4,050	74.03	5,050	59.37	6,050	49.56	7,050	42.53	8,050	37.24	9,050	33.17	10,050	30.13
60	4,997	1,060	282.8	2,060	145.5	3,060	97.98	4,060	73.85	5,060	59.25	6,060	49.48	7,060	42.47	8,060	37.20	9,060	33.09	10,060	30.06
70	4,243	1,070	280.2	2,070	144.8	3,070	97.66	4,070	73.67	5,070	59.13	6,070	49.39	7,070	42.41	8,070	37.15	9,070	33.06	10,070	30.06
80	3,788	1,080	277.6	2,080	144.1	3,080	97.34	4,080	73.49	5,080	59.02	6,080	49.31	7,080	42.35	8,080	37.15	9,080	33.02	10,080	30.02
90	3,331	1,090	275.1	2,090	143.5	3,090	97.03	4,090	73.31	5,090	58.90	6,090	49.20	7,090	42.29	8,090	37.06	9,090	33.00	10,090	30.00
100	2,998	1,100	272.6	2,100	142.8	3,100	96.72	4,100	73.13	5,100	58.79	6,100	49.15	7,100	42.23	8,100	37.01	9,100	32.95	10,100	30.00
110	2,726	1,110	270.1	2,110	142.1	3,110	96.41	4,110	72.95	5,110	58.67	6,110	49.07	7,110	42.17	8,110	36.97	9,110	32.91	10,110	30.00
120	2,499	1,120	267.7	2,120	141.4	3,120	96.10	4,120	72.77	5,120	58.56	6,120	48.99	7,120	42.11	8,120	36.92	9,120	32.88	10,120	30.00
130	2,306	1,130	265.3	2,130	140.8	3,130	95.79	4,130	72.60	5,130	58.44	6,130	48.91	7,130	42.05	8,130	36.88	9,130	32.84	10,130	30.00
140	2,142	1,140	263.0	2,140	140.1	3,140	95.48	4,140	72.42	5,140	58.33	6,140	48.83	7,140	41.99	8,140	36.83	9,140	32.80	10,140	30.00
150	1,999	1,150	260.7	2,150	139.5	3,150	95.18	4,150	72.25	5,150	58.22	6,150	48.75	7,150	41.93	8,150	36.79	9,150	32.77	10,150	30.00
160	1,874	1,160	258.5	2,160	138.8	3,160	94.88	4,160	72.07	5,160	58.10	6,160	48.67	7,160	41.87	8,160	36.74	9,160	32.73	10,160	30.00
170	1,764	1,170	256.3	2,170	138.1	3,170	94.58	4,170	71.90	5,170	57.99	6,170	48.59	7,170	41.82	8,170	36.70	9,170	32.70	10,170	30.00
180	1,665	1,180	254.1	2,180	137.5	3,180	94.28	4,180	71.73	5,180	57.88	6,180	48.51	7,180	41.76	8,180	36.65	9,180	32.66	10,180	30.00
190	1,578	1,190	252.0	2,190	136.9	3,190	93.99	4,190	71.56	5,190	57.77	6,190	48.44	7,190	41.70	8,190	36.61	9,190	32.62	10,190	30.00
200	1,499	1,200	249.9	2,200	136.3	3,200	93.69	4,200	71.39	5,200	57.66	6,200	48.36	7,200	41.64	8,200	36.56	9,200	32.59	10,200	30.00
210	1,428	1,210	247.8	2,210	135.7	3,210	93.40	4,210	71.22	5,210	57.55	6,210	48.28	7,210	41.58	8,210	36.52	9,210	32.55	10,210	30.00
220	1,363	1,220	245.8	2,220	135.1	3,220	93.11	4,220	71.05	5,220	57.44	6,220	48.20	7,220	41.53	8,220	36.48	9,220	32.52	10,220	30.00
230	1,304	1,230	243.8	2,230	134.5	3,230	92.82	4,230	70.88	5,230	57.33	6,230	48.13	7,230	41.47	8,230	36.43	9,230	32.48	10,230	30.00
240	1,249	1,240	241.8	2,240	133.8	3,240	92.54	4,240	70.71	5,240	57.22	6,240	48.05	7,240	41.41	8,240	36.39	9,240	32.45	10,240	30.00
250	1,199	1,250	239.9	2,250	133.3	3,250	92.25	4,250	70.55	5,250	57.11	6,250	47.97	7,250	41.35	8,250	36.34	9,250	32.41	10,250	30.00
260	1,153	1,260	238.0	2,260	132.7	3,260	91.97	4,260	70.38	5,260	57.00	6,260	47.89	7,260	41.30	8,260	36.30	9,260	32.38	10,260	30.00
270	1,110	1,270	236.1	2,270	132.1	3,270	91.69	4,270	70.22	5,270	56.89	6,270	47.82	7,270	41.24	8,270	36.25	9,270	32.34	10,270	30.00
280	1,071	1,280	234.2	2,280	131.5	3,280	91.41	4,280	70.05	5,280	56.78	6,280	47.74	7,280	41.18	8,280	36.21	9,280	32.31	10,280	30.00
290	1,034	1,290	232.4	2,290	130.9	3,290	91.13	4,290	69.89	5,290	56.68	6,290	47.67	7,290	41.13	8,290	36.17	9,290	32.27	10,290	30.00
300	999.4	1,300	230.6	2,300	130.4	3,300	90.86	4,300	69.73	5,300	56.57	6,300	47.59	7,300	41.07	8,300	36.12	9,300	32.24	10,300	30.00
310	967.2	1,310	228.9	2,310	129.8	3,310	90.58	4,310	69.56	5,310	56.46	6,310	47.52	7,310	41.02	8,310	36.08	9,310	32.20	10,310	30.00
320	936.9	1,320	227.1	2,320	129.2	3,320	90.31	4,320	69.40	5,320	56.36	6,320	47.44	7,320	40.96	8,320	36.04	9,320	32.17	10,320	30.00
330	908.6	1,330	225.4	2,330	128.7	3,330	90.04	4,330	69.24	5,330	56.25	6,330	47.39	7,330	40.90	8,330	36.00	9,330	32.14	10,330	30.00
340	881.8	1,340	223.7	2,340	128.1	3,340	89.77	4,340	69.08	5,340	56.15	6,340	47.29	7,340	40.85	8,340	35.95	9,340	32.10	10,340	30.00
350	856.6	1,350	222.1	2,350	127.6	3,350	89.50	4,350	68.92	5,350	56.04	6,350	47.22	7,350	40.79	8,350	35.91	9,350	32.07	10,350	30.00
360	832.8	1,360	220.4	2,360	127.0	3,360	89.23	4,360	68.77	5,360	55.94	6,360	47.14	7,360	40.74	8,360	35.86	9,360	32.03	10,360	30.00
370	810.3	1,370	218.8	2,370	126.5	3,370	88.97	4,370	68.62	5,370	55.83	6,370	47.07	7,370	40.68	8,370	35.82	9,370	32.00	10,370	30.00
380	789.0	1,380	217.3	2,380	126.0	3,380	88.70	4,380	68.47	5,380	55.73	6,380	46.99	7,380	40.63	8,380	35.78	9,380	31.96	10,380	30.00
390	768.8	1,390	215.7	2,390	125.4	3,390	88.44	4,390	68.30	5,390	55.63	6,390	46.92	7,390	40.57	8,390	35.74	9,390	31.93	10,390	30.00
400	749.6	1,400	214.2	2,400	124.9	3,400	88.18	4,400	68.14	5,400	55.52	6,400	46.85	7,400	40.52	8,400	35.69	9,400	31.90	10,400	30.00
410	731.3	1,410	212.6	2,410	124.4	3,410	87.92	4,410	67.99	5,410	55.42	6,410	46.77	7,410	40.46	8,410	35.65	9,410	31.86	10,410	30.00
420	713.9	1,420	211.1	2,420	123.9	3,420	87.67	4,420	67.83	5,420	55.32	6,420	46.70	7,420	40.41	8,420	35.61	9,420	31.83	10,420	30.00
430	697.3	1,430	209.7	2,430	123.4	3,430	87.41	4,430	67.67	5,430	55.22	6,430	46.63	7,430	40.35	8,430	35.57	9,430	31.79	10,430	30.00
440	681.4	1,440	208.2	2,440	122.9	3,440	87.16	4,440	67.53	5,440	55.11	6,440	46.56	7,440	40.30	8,440	35.52	9,440	31.76	10,440	30.00
450	666.3	1,450	206.8	2,450	122.4	3,450	86.90	4,450	67.38	5,450	55.01	6,450	46.48	7,450	40.24	8,450	35.48	9,450	31.73	10,450	30.00
460	651.8	1,460	205.4	2,460	121.9	3,460	86.65	4,460	67.22	5,460	54.91	6,460	46.41	7,460	40.19	8,460	35.44	9,460	31.69	10,460	30.00
470	637.9	1,470	204.0	2,470	121.4	3,470	86.40	4,470	67.07	5,470	54.81	6,470	46.34	7,470	40.14	8,470	35.40	9,470	31.66	10,470	30.00
480	624.6	1,480	202.6	2,480	120.9	3,480	86.16	4,480	66.92	5,480	54.71	6,480	46.27	7,480	40.08	8,480	35.36	9,480	31.63	10,480	30.00
490	611.9	1,490	201.2	2,490	120.4	3,490	85.91	4,490	66.78	5,490	54.61	6,490	46.20	7,490	40.03	8,490	35.31	9,490	31.59	10,490	30.00
500	599.6	1,500	199.9	2,500	119.9	3,500	85.66	4,500	66.63	5,500	54.51	6,500	46.13	7,500	39.98	8,500	35.27	9,500	31.56	10,500	30.00
510	587.9	1,510	198.6	2,510	119.5	3,510	85.42	4,510	66.48	5,510	54.41	6,510	46.06	7,510	39.92	8,510	35.23	9,510	31.53	10,510	30.00
520	576.6	1,520	197.3	2,520	119.1	3,520	85.18	4,520	66.34	5,520	54.32	6,520	45.98	7,520	39.87	8,520	35.19	9,520	31.50	10,520	30.00
530	565.7	1,530	196.0	2,530	118.7	3,530	84.94	4,530	66.19	5,530	54.22	6,530	45.92	7,530	39.82	8,530	35.15	9,530	31.46	10,530	30.00
540	555.2	1,540	194.7	2,540	118.0	3,540	84.70	4,540	66.04	5,540	54.12										

Literature Wanted

THE names of readers of RADIO WORLD who desire literature from radio jobbers and dealers are published in RADIO WORLD on request of the reader. The blank below may be used, or a post card or letter will do instead.

Trade Service Editor,
RADIO WORLD,
145 West 45th St., N. Y. City.

I desire to receive radio literature.

Name

City or town

State

Are you a dealer?

If not who is your dealer?

His Name

His Address

- F. Willocks, 586 King St., Hamilton, Canada.
John R. Minges, 133 E. Maple St., Stockton, Cal.
Charles Wilfert, Reading, Pa.
Raymond F. Clover, Victor, N. Y.
D. A. Peterson, Potsdam, N. Y.
Smith's Radio Shop, 1521 Gaines St., Davenport, Ia. (Dealer).
P. T. Carpenter, Leeds, Mass.
H. O. Shelley, 36 Early St., Morristown, N. J.
C. D. Benjamin, 303 W. 42d St., N. Y. City.
Raymond Scoggins, Box 146, Henderson, N. C. (Dealer).
Mac Reid, 906 25th St., Watervliet, N. Y.
William Wells, 93 E. Dearborn, River Rouge, Mich.
William Robb, 1124 West 16th St., Topeka, Kan.
Frank C. ReLay, R. F. D. 61, Norwalk, Conn.
C. B. Collins, Box 12, Unionville, Mo.
C. W. Hart, R. D. No. 1, Temple, Pa.
Walter Blasak, 2338 W. Carver, Chicago, Ill.
Lynn H. Fairfax, Cambridge, Mass.
Henry A. Westremeyer, Cleveland, Wis.
R. W. Gerlach, Kohler, Wis.
D. E. Theel, 881 19th St., Milwaukee, Wis.
K. S. Menoher, Pittsburgh, Pa.
W. L. Hammett, 25 Bradford Ave., Mansfield, Ohio.
E. A. Burgi, Wichita, Kan.
R. L. Eollette, 3054 Burgundy St., New Orleans, La.
Clemens Schwartz, 12 Regina Place, Buffalo, N. Y. (Dealer).
R. S. Forry, Lebanon, Pa.
Walter Davenport, Palestine, Tex.
William G. Wicklund, 103 Russell St., Marinette, Wis.
A. J. Robinson, 3936 North Fairhill St., Philadelphia, Pa.
Erik Johansson, Repslagaregatan 16, Linköping, Sweden. (Editor of Oestergostlands Dagblad or the Agency of Radio).
W. H. Randall, 2042 81st Ave., Oakland, Cal.
D. Scroggs, Mayflower, Ark.
H. R. O'Leary, P. O. Box 426, Gulport, Miss.
Joe McDevitt, 221 Rodney St., Brooklyn, N. Y.
George Pelletieri, 213 Reidhurst Ave., Nashville, Tenn.
P. O. Boucher & Son, Claremont, N. H. (Dealer).
Paul W. Brown, Sycamore, O.
Edward Johnson, 905 Buttonwood St., Reading, Pa. (Dealer).
Cluff Brothers, Price, Utah. (Dealer).
Harry E. Cohen, 17 Market St., Pittston, Pa.
J. J. Wilson, 1425 Roscoe St., Chicago Ill.
Lennis B. Hoops, Bedford, Ia. (Dealer).
Harvey L. Betts, Pemberville, O. (Dealer).
Floyd Buesinger, Taylorville, Ill.
L. U. Gianettino, Jr., New Hartford, Conn.
Callam Brothers, Rt. 8, Box 86, Pawnee City, Neb. (Dealer).
R. S. Tandish, 247 Russell Hill, Toronto 5, Ontario, Canada.
J. Koenig, El Campo, Tex. (Dealer).
L. A. Tucker, Azle, Tex.
E. V. Mayo, Roxbury, Mass.
Glenn C. Barber, 1322 Franklin St., Keokuk, Ia.
J. R. Praetorius, Richmond, Ind. (Dealer).
F. L. Howell, Box 391, Hollidays Cove, W. Va.
John J. Matecek, 105 Marne St., San Antonio, Texas.
William Norman Kearney, 2918 North 6th St., Philadelphia, Pa.
G. W. Curtess, Sr., 830 West Main St., Raverman, O.
Dan Carothers, Jr., 813 West Main St., Raverman, O.
A. C. Baker, 2106 Aiken Ave., Cleveland, O.
William Pope, 220 Court St., Binghamton, N.Y.

HOW TO BECOME AN AMATEUR OPERATOR—A comprehensive, illustrated article appeared in issue of June 27, 1925. 15c per copy, or start your subscription with this number. RADIO WORLD, 145 West 45th St., N. Y. C.

HAVE YOU BEEN AWAY?—Have you missed We can supply you with any copies of RADIO WORLD any of the summer copies of RADIO WORLD. WORLD published during the summer at our regular price of 15c per copy, or any seven copies for \$1.00, or start your subscription with any number. NEWSDEALERS: We will fill your orders for back numbers at regular wholesale City.

THE RADIO TRADE

Retail Business Better by 70%, Says Crosley

WASHINGTON.

"The radio retail business is 70 per cent. better this month than for the corresponding month of last year," said Powel Crosley, Jr., Cincinnati radio manufacturer, in addressing one of the sessions of the fourth national radio conference here last week. Mr. Crosley, who is head of one of the largest manufacturing concerns in the radio industry, amplified his statement in a special interview after the adjournment of the session.

"Radio sales, not only for our company, but for our dealers and jobbers covering all their sales, have shown a steady increase over the corresponding period for last year with a nation wide universalness that is most gratifying to us and that should be gratifying to every radio fan.

"While it is true radio broadcasting is not affected directly by increased sales by manufacturers, yet for every increase in the number of sets there is a logical increase in the number of listeners with increased benefits to the broadcasters, who in turn are able to increase their investments in stations and program material. Broadcasters who are finding their audience increasing are glad to amplify their efforts to please the audience in order to win a still larger percentage of the listeners."

Mr. Crosley pointed out also a steady development in public taste in radio apparatus and ventured the opinion that in another year and a half the number of radio sets daily in use on the air lanes would be as great as the number of automobiles on the roads of the country.

Bruno Corporation Opens Third Factory

Due to their rapidly increasing business the Bruno Radio Corporation, main office 223 Fulton street, New York City, has opened its third large factory, this one in the heart of New Haven, Conn. The factory will have shifts working night and day, including Sundays and holidays, to meet the demand for the Bruno Magic Dial, the Powertone Set, the Powertone Boxed Kit, the quartzite coils, the ultra-vario condensers and the brackets, all

manufactured by this concern. The dial is being cast in six 8-cavity moulds, to insure a production of 500,000 dials this season. The first 100,000 dials have just been completed.

The manufacture of the complete Bruno line represents an investment of \$250,000 in cash and the production requires a present payroll of \$6,500 a week, which will be increased by 10 per cent. next month.

De Forest Tube Suit Against R. C. A. Quashed

WILMINGTON, DEL.

Judge Morris in United States District Court dismissed the suit of the De Forest Radio Telephone & Telegraph Company against the Radio Corporation of America.

The suit involved millions of dollars in patent rights. Infringement of a patent on a vacuum tube used in radio machines was the chief point.

NEW CORPORATIONS

Radio Compak Co., Asbury Park, N. Y. City, manufacturing supplies, etc., \$100,000; Clinton B. Hook, Phineas Proctor, Wilfred E. Haynes, Asbury Park. (Attys., Geran & Matlack, Asbury Park, N. J.)

Audalion Co., N. Y. City, radio, 100 common, no par; H. Bogdich, B. Fisher, E. F. Meisler. (Attys., Fisher & Deimel, 331 Madison Ave., N. Y. C.)

Selectron Corp., N. Y. City, radio, 13,000 common, no par; E. Friedman, R. Shoemaker. (Atty., M. B. Rich, 66 Broadway, N. Y. City).

Radio Music Temple, Newark, N. J., \$100,000; Alfred C. King, Albert J. Morris, Ida Morris, Newark. (Atty., Israel B. Greene, Newark, N. J.)

NAMEPLATES

Following are the names of some who have just requested Diamond nameplates:

- Leo Morrissette, 1636 South Main St., Fall River, Mass.
Lester James, 230 Elm St., Marion, O.
Fred Fedok, 2908 Sunset Ave., Atlantic City, N. J.
A. Howat, 2314 Haste St., Berkeley, Cal.
Wm. R. Friedtone, 319 Vandervoort St., North Tonawanda, N. Y.
Fred A. Mulford, 160 Chestnut St., Corning, N. Y.
C. J. French, 705 W. 27th St., Oklahoma City, Okla.
Leslie James, 4113 Beck Ave., Cleveland, O.
Wm. Metzger, 1310 E. Price St., Philadelphia, Pa.
P. E. Pfeffer, Covington, La.
R. A. Treusch, Box 45, Mansfield, O.
J. B. Bower, Box 134, Sioux Lookout, Ontario, Canada.

Business Opportunities Radio and Electrical

Rates: 10c per word; Minimum, \$1.00; Cash with order.

\$100 WEEKLY UP. We want experienced radio men to operate branch assembly plants. Part or whole time. Barfield Radio Co., 13 Tillary St., Dept. W. R., Brooklyn, N. Y.

RADIO AND ELECTRICAL: good opportunity to rent floor space and window in store; best section of Main St. M. Fixel, White Plains, N. Y.

RADIO DEPARTMENT FOR RENT in a live, popular priced store; commission basis or will handle same on consignment. Communicate at once with B. A. Linn, 135 Main St., Paterson, N. J.

RADIO PRODUCTION MANAGER. Thoroughly experienced manufacturing condensers, rheostats, jacks, etc., desires connection with reliable manufacturer; investment if desired. S. Seiden, 1,340 Morris Ave., Bronx.

Better Heard Than Seen



Gyp's Days Are Numbered; Stability Near, Says Crosley

The gyp is essentially an opportunist who can exist only where the opportunity for large quick profits exists. When the industry has progressed to the point where profit accrues from mass production methods and from careful marketing rather than from the glamour which up to the present has surrounded the radio business the art will settle down

into a stabilized, rational trade, upon which a bigger and better industry may be built. And that time is fast approaching.

Prospective buyers of radio equipment should make sure the dealer who sells apparatus is reliable and likely to be in business for some time. This is important, when it is considered that dealer guarantees mean nothing if the dealer goes out of business in a short time. There is, however, a way in which the prospective purchaser may be sure of getting satisfaction and service and that is by purchasing merchandise which has been made by a long-established and reliable manufacturer who stands back of his goods.

Radio enthusiasts should beware of equipment which has not had the endorsement of reliable people. Thousands of dollars have been spent by people who thought some apparatus would eliminate static or be able to bring in signals from distant stations without the proper sort of receiver. A reliable merchant will not sell equipment which he does not believe in or cannot guarantee. Buy from dealers who are known for their honesty and who can give service whenever it is necessary and much money and grief will be saved.

HOOVER SAYS:

Higher power has greatly strengthened the service to listeners, but it has aggravated the problem of providing lanes through the traffic, for geographical separation must be greater. Heretofore it has been possible to duplicate channels geographically to a large extent among those using 500 watts, but with the increase of power, this system becomes more and more difficult, for the borderland of interference is wider spread. We must face the actualities frankly. We can no longer deal on the basis that there is room for everybody on the radio highways. There are more vehicles on the roads than can get by, and if they continue to jam in, all will be stopped.

Greater Distance Greater Selectivity With Fynur Dial

The Fynur dial operates by traction (not gears) so that no backlash or lost motion is possible. Moreover, the dual control permits of a quick general setting as well as the infinitely fine vernier adjustment. A quality dial for those who want the best—beautiful, mechanically perfect, and durable. If your dealer can't supply you, write to us.

AUGUST GOERTZ & CO., INC.
270-286 Morris Ave., Newark, N. J.



Price \$3.50

FYNUR VERNIER CONTROL

Some Recent Numbers

A 1-CONTROL PORTABLE, by Capt. P. V. O'Rourke; A Baby Super-Heterodyne, only 4 Tubes, by J. E. Anderson; A More Powerful Diamond, Still only 4 Tubes, by Herman Bernard. Other features in RADIO WORLD, dated July 11, 1925, 15c a copy, or start your subscription with that number. RADIO WORLD, 145 West 45th St., N. Y. C.

ANDERSON'S 6-TUBE SUPER-HETERO-DYNE, by J. E. Anderson; the 3-Tube Marconi Broadcast Receiver, by Percy Warren; How to Make a Good Battery Connector; other features in RADIO WORLD, July 18, 1925. 15c a copy, or start your subscription with that number. RADIO WORLD, 145 West 45th St., N. Y. C.

RECENT BACK NUMBERS of RADIO WORLD, 15c each. RADIO WORLD, 145 West 45th Street, New York City.

ASSEMBLED KITS

OUR SPECIALTY

For all popular circuits—complete, exactly as specified. Kits—K.D. or Assembled, ready for wiring—at same prices. Wiring can be completed and set ready for use in one hour.

Radio World, 1925 Diamond, 5 tube... \$36.50
Browning Drake, 4 tube... 40.50
Browning Drake, 5 tube... 45.50
All Amer. 1925 De Luxe Superhet,
8 tube... 69.00
Thordarson-Wade, 5 tube... 40.95

Write for full description of these kits and also our price lists, showing other kits and radio parts.

THE MAIL-O-RADIO CO.
25 Maiden Lane New York, N. Y.

THE CHOICE OF EXPERTS

The G-K Spring Cap Binding Post is Approved by leading radio Engineers because—

- An automatic spring action insures a vise-like grip.
- Simplicity of use; no turning down of any nut or knob; only lifting is necessary.
- No cramping of fingers to make contacts.
- The knob, genuine Bakelite, is built into the post.

The G-K Binding Posts are available engraved or plain. For engraved ones, specify from following: Ant., Gnd., A—, A+, B—, B+ Det., B+ Amp.

15c EACH

Binding Post strip complete for this hook-up, by mail \$1.25.

If your dealer can't supply you, write direct. Inquiries Solicited from the Trade.

GANIO-KRAMER COMPANY, Inc.

238-R WEST 53rd STREET

NEW YORK, N. Y.

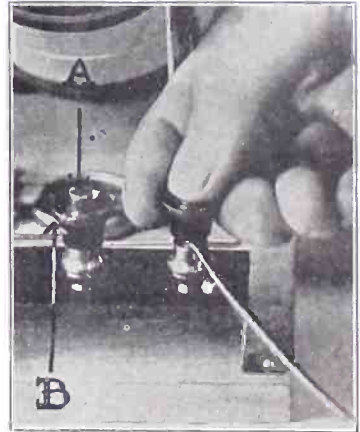

How to hook up the antenna after completing the A-A Set. All one need to do to make contact with a G-K post is to lift the knob. The post at left shows where opposite pressure is exerted by the fingers at A and B. Let go and the knob snaps down. The contact lasts forever.

FILL OUT AND MAIL NOW

SUBSCRIPTION BLANK

RADIO WORLD

RADIO WORLD

145 West 45th Street, New York City
(Just East of Broadway)

Please send me RADIO WORLD for..... months, for which please find enclosed \$.....

SUBSCRIPTION RATES

Single Copy..... \$ 15
Three Months..... 1.50
Six Months..... 3.00
One Year, 52 Issues..... 6.00
Add \$1.00 a Year for Foreign Postage; 50c for Canadian Postage.

Scrape Off Paint from Pipe Before Attaching Ground Clamp

Be sure that you have a good ground clamp on the cold water pipe. Before putting the clamp on, scrape off all the paint. Then sandpaper the pipe. After you have the pipe looking clean and shining bright, place the clamp on. Make a solid connection, either by soldering it or by screwing it down tight. Then run the wire to the ground post of the set. The antenna should be of the single-wire type,

and the lead-in should be a direct portion of the antenna proper. The lead-in should be at least 1 1/2 feet away from the side of the wall. When it reaches the window sill, let the wire run through an improved type of insulator (the porcelain type with the large hole in the center) or through a lead-in clamp. It is well to have a stick on the window sill. The length of this stick will depend upon the length that

IT HELPS

Make the 1926 Model Diamond of the Air Better. It Improves Any Set.

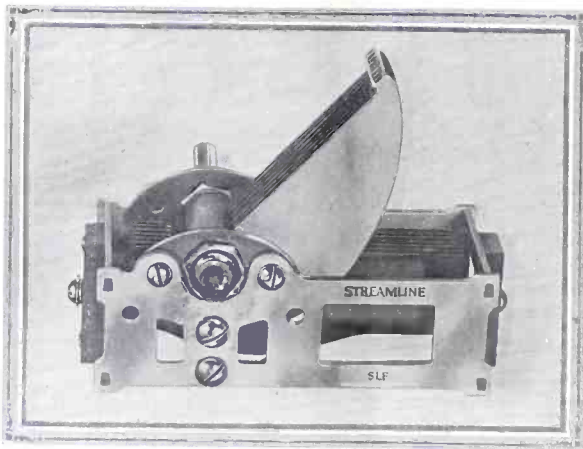

The Streamline Straight-line Frequency Condenser—Rugged in Construction, Precise and Unfailing in Action

.0005... **\$2.50** .00035... **\$2.25** .00025... **\$2.00**

Immediate Delivery—Absolute guarantee on every box.

STREAMLINE RADIO CO.
223 FULTON STREET
New York City

Streamline Radio Co., 223 Fulton St., N. Y. City.
Enclosed find \$.....for which send me by return mail.....
Streamline SLF condensers, capacity.....
NAME CITY
ADDRESS STATE

The Weekly Rebus

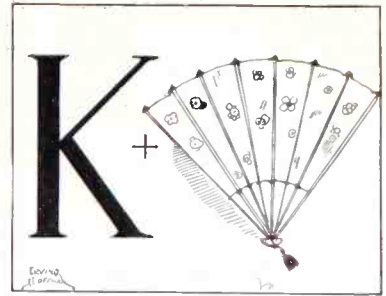

WHAT station does this represent?

Send your answer to Rebus Editor, RADIO WORLD, 145 West 45th Street, N. Y. City.

the wire is away from the wall. At the end of the stick place a screw, which is insulated. The lead-in wire is then run right through this hole, and thence to the clamp. It is then brought through the window and to the set. Do not, if possible, bring the antenna and the ground wire parallel at any point, except when near the two binding posts on the set.

FREE RADIO BOOK

Science has invented a new kind of coil. Now have it on your present set. Gives 4 great advantages otherwise impossible. Write for new book just published showing many new ideas. Also 8 new circlloid circuits. Address: Electrical Research Laboratories, R.W., 2548 Cottage Grove Avenue, Chicago.



Every Tube Full of Life!

What a wonderful difference AMPERITE makes! Every tube is so brimful of snap, so eager to deliver 100% value. Individual tube regulation to meet each tube's individual needs is the answer. And only AMPERITE can fill that requirement. Permits the use of any type or combination of tubes. Specified in all popular construction sets. Price \$1.10. There is an AMPERITE for every tube

Write for free hook-ups

Radiall Company

Dept. R.W.-14 50 Franklin St., N. Y. City

AMPERITE
REG. U.S. PAT. OFF.
The "SELF-ADJUSTING" Rheostat

ULTRA-VERNIER TUNING CONTROL

A VERNIER DIAL ON WHICH YOU CAN PENCIL RECORD THE STATIONS. GEARED 20 TO 1. SILVER FINISH \$2.50—GOLD FINISH \$3.50

PHENIX RADIO CORP., 116-F East 25 St., N.Y.C.

HAVE YOU BEEN AWAY?—Have you missed any of the summer copies of RADIO WORLD. We can supply you with any copies of RADIO WORLD published during the summer at our regular price of 15c per copy, or any seven copies for \$1.00.

DIAMOND EDITOR:

I have just recently completed the 1926 Model Diamond and am absolutely delighted with it. I had no trouble in assembling the set or in operating it afterward. I never knew there were so many stations in the world. I have tuned in six stations in Chicago with wonderful volume. I have built seven different hookups from RADIO WORLD and have had excellent results from every one. I made the Powertone for a friend of mine and the set works great.

I wish you would tell Mr. E. S. Hancock that he should be a little surer that the fault does not lie at home before he starts knocking.

HAROLD E. BEAU,
61 Mt. Vernon Ave.,
Braintree, Mass.

DIAMOND EDITOR:

I wish to let you know that I am among the many fans who have been captivated by the Diamond.

It is without doubt the most efficient set, tube for tube, that any one could build. I was a Superdyne bug, but read-

ARE YOU THE MAN

to be first in your town to sell and demonstrate POWEROLA, the famous 5-tube, no-battery electric light socket radio receiver (not an attachment), universal for D.C. or A.C. (100-115 v. 40-60 cycle), now sold and demonstrated by the New York Edison Co., public utility companies and radio, electric and music dealers everywhere. Absolutely dependable, fully guaranteed, powerful, practical, perfect in performance.

Are You the Man Who Sees Opportunities Ahead for Real Money Making?

Write for literature, terms and prices at once.

POWEROLA RADIO CORP.

1845 BROADWAY NEW YORK CITY

NAMEPLATES

FOR

RADIO WORLD'S 1926

Diamond of the Air

NOW READY FOR DELIVERY

Those who have already ordered these nameplates will receive them in the course of a few days.

If you are building the Diamond of the Air, and have not already requested a nameplate, send us your name and address and we will send you one.

RADIO WORLD

145 W. 45th St. New York City

DIAMOND GLITTERINGS

ing every week of the wonderful results every one was having with the Diamond, I thought I would try it. Believe me I am not sorry.

WM. MITZER,
1310 E. Price,
Philadelphia, Pa.

DIAMOND EDITOR:

I have been a subscriber to your wonderful magazine since January 1 and have every copy. It is the best radio magazine for the home constructor I have ever seen. I built the Anderson Superdyne and had very good success with it. When the issue came out with the Diamond of the Air I immediately built the Diamond because the hookup looked good to me. It sure was good. It was such a success that I have used it ever since. I have tried a great many hookups in the last three years and the Diamond is the best. I wouldn't trade it for any other circuit. It is sure a wonder. The following is a list of stations I have listened to on the loud speaker: CFCN, KTCL, KHJ, KFSG, KFVB, KGW, KFON, CNRV, KJR, KFOA, KFI, KNX, WDAF, WOAW, WSMB, KOA, KGO, KFCE, KLX, KSL, KJBS, KTBI, WOAI, KTAB, KPO, KFPG, KFUR, KFUU, WBAP, KFVD, WOC, KDKA, CYL, KFJR, WGN, WLS, WGY, KFAU, KFVB, KFVO, KFRC, KNRC.

I think a set that will bring in these stations on a speaker ought to be good enough for anybody. I have an antenna 50 feet high, 110 long, including lead in. Thanks very much for the hookup. Send me a name-plate as the set is sure worth it.

J. W. BOYER,
Sparks, Nevada.

The Victory Six

A new 6-tube receiver is being placed on the market. It is primarily designed for the fan who wants to enjoy quality on both local and distant stations, combined with ease of tuning. It is the Victory Six. The manufacturers claim that the circuit is exclusive, it having been developed in their laboratories after intensive research. It contains two stages of radio-frequency, detector and three stages of special tone frequency amplification. In demonstration remarkable results have been achieved. The tuning range is from 175 to 550

meters, covering the entire broadcast range. The set can be used with battery eliminators or dry cells with results claimed to equal those from storage battery operation. A volume control regulates the output from a whisper to the full capacity of the speaker without distortion. Among the innovations incorporated are universal sockets which fit the new UX and CX tubes, also accommodating the UV type; and an automatic filament system. Formica engraved panels are used. The set may be logged, as stations always come in at the same setting. It is enclosed in a solid walnut cabinet. This set is being made and marketed by the United Radio Manufacturing Co., 191 Grenewich Street, New York, a concern of long standing in the radio field.

(Tested and approved by RADIO WORLD Laboratories)

Bruno Magic Dial



Makes any semi-circular plate or straight-line wavelength condenser tune like the straight-line frequency type. Smooth vernier over 340 degrees of the dial. No gears, no backlash.

\$250

BRUNO RADIO CORPORATION
Dept. W 221 Fulton St., New York City
Inquiries Solicited from the Trade

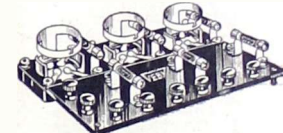

The New VEBY AMPLIFIER

A Resistance Coupled Amplifier that will truly fit within the cabinet of any commercial receiver. Just seven inches long and five inches deep. It is fully assembled and ready to attach. The price is.....\$12.00

VEBY Hi Mu Tubes A. F. 20 or R. C. Amplifiers\$3.00

VEBY Power Tubes A. F. 6 for the last stage\$4.50



47-51 MORRIS AVENUE, NEWARK, N. J.

IN PREPARATION—RADIO WORLD'S MOST IMPORTANT ISSUE OF THE YEAR

RADIO GIFTS NUMBER

This Will Be a Radio Christmas

Regular Advertising Rates as Follows:

Page	\$300.00
Half-page	150.00
Third page (one col.)	100.00
Quarter page	75.00
Per inch	10.00
Per agate line75
Times discounts:	
22 consecutive issues.....	20%
26 times consecutively, or	
8, 0, w, one year.....	15%
4 consecutive issues.....	10%

Radio Gifts Number will be dated Dec. 12, issued Dec. 9. Last color form closes Dec. 1. Last black form closes Dec. 2, noon.

It is estimated that our RADIO GIFTS NUMBER of 1924 sold more than \$100,000 worth of radio goods for advertisers who used these columns. It is the intention of the publishers to make the 1925 issue of the RADIO GIFTS NUMBER so much better than last year, and to give it so much larger a distribution that the sales through its columns will be increased heavily over last year's figures.

RADIO WORLD'S HOLIDAY GIFTS NUMBER OF 1925 will have a list of notable contributors, a special holiday cover in colors and other special features that will be worth advertising in papers of nearly 5,000,000 circulation throughout the country. There is bound to be a larger sale than usual, because the selling price will not be increased.

If you want to sell your goods to the millions of holiday gift buyers who will purchase radio goods this year, don't fail to use the columns of this RADIO GIFTS NUMBER.

FOR SPECIAL POSITIONS, PHONE OR WIRE IMMEDIATELY!

RADIO WORLD, 145 WEST 45TH STREET.

Phones: Bryant 0558-0559

Scrape Off Paint from Pipe Before Attaching Ground Clamp

Be sure that you have a good ground clamp on the cold water pipe. Before putting the clamp on, scrape off all the paint. Then sandpaper the pipe. After you have the pipe looking clean and shining bright, place the clamp on. Make a solid connection, either by soldering it or by screwing it down tight. Then run the wire to the ground post of the set. The antenna should be of the single-wire type,

and the lead-in should be a direct portion of the antenna proper. The lead-in should be at least 1½ feet away from the side of the wall. When it reaches the window sill, let the wire run through an improved type of insulator (the porcelain type with the large hole in the center) or through a lead-in clamp. It is well to have a stick on the window sill. The length of this stick will depend upon the length that

IT HELPS

Make the 1926 Model Diamond of the Air Better. It Improves Any Set.

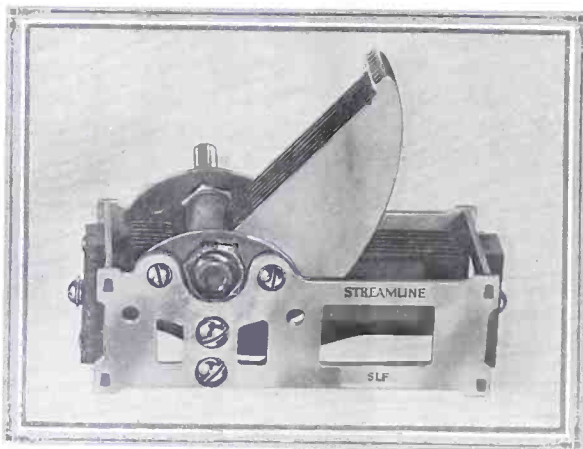

The Streamline Straight-line Frequency Condenser—Rugged in Construction, Precise and Unfailing in Action

.0005... \$2.50 .00035... \$2.25 .00025... \$2.00

Immediate Delivery—Absolute guarantee on every box.

STREAMLINE RADIO CO.
223 FULTON STREET
New York City

Streamline Radio Co., 223 Fulton St., N. Y. City.
Enclosed find \$..... for which send me by return mail.....
Streamline SLF condensers, capacity.....
NAME..... CITY.....
ADDRESS..... STATE.....

The Weekly Rebus

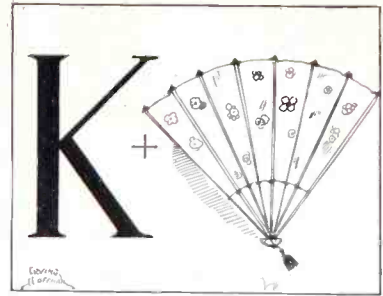

WHAT station does this represent?

Send your answer to Rebus Editor, RADIO WORLD, 145 West 45th Street, N. Y. City.

the wire is away from the wall. At the end of the stick place a screw, which is insulated. The lead-in wire is then run right through this hole, and thence to the clamp. It is then brought through the window and to the set. Do not, if possible, bring the antenna and the ground wire parallel at any point, except when near the two binding posts on the set.

FREE RADIO BOOK

Science has invented a new kind of coil. Now have it on your present set. Gives 4 great advantages otherwise impossible. Write for new book just published showing many new ideas. Also 8 new circlloid circuits. Address Electrical Research Laboratories, R.W., 2548 Cottage Grove Avenue, Chicago.



Every Tube Full of Life!

What a wonderful difference AMPERITE makes! Every tube is so brimful of snap, so eager to deliver 100% value. Individual tube regulation to meet each tube's individual needs is the answer. And only AMPERITE can fill that requirement. Permits the use of any type or combination of tubes. Specified in all popular construction sets. Price \$1.10. There is an AMPERITE for every tube

Write for free hook-ups

Radiall Company

Dept. R.W.-14 50 Franklin St., N. Y. City

AMPERITE
REG. U.S. PAT. OFF.
The "SELF-ADJUSTING" Rheostat

ULTRA-VERNIER
TUNING CONTROL

A VERNIER DIAL ON WHICH YOU CAN PENCIL RECORD THE STATIONS. GEARED 20 TO 1. SILVER FINISH \$2.50—GOLD FINISH \$3.50

PHENIX RADIO CORP., 116-F East 25 St., N.Y.C.

HAVE YOU BEEN AWAY?—Have you missed any of the summer copies of RADIO WORLD. We can supply you with any copies of RADIO WORLD published during the summer at our regular price of 15c per copy, or any seven copies for \$1.00.

DIAMOND EDITOR:

I have just recently completed the 1926 Model Diamond and am absolutely delighted with it. I had no trouble in assembling the set or in operating it afterward. I never knew there were so many stations in the world. I have tuned in six stations in Chicago with wonderful volume. I have built seven different hookups from RADIO WORLD and have had excellent results from every one. I made the Powertone for a friend of mine and the set works great.

I wish you would tell Mr. E. S. Hancock that he should be a little surer that the fault does not lie at home before he starts knocking.

HAROLD E. BEAU,
61 Mt. Vernon Ave.,
Braintree, Mass.

DIAMOND EDITOR:

I wish to let you know that I am among the many fans who have been captivated by the Diamond.

It is without doubt the most efficient set, tube for tube, that any one could build. I was a Superdyne bug, but read-

ARE YOU THE MAN

to be first in your town to sell and demonstrate POWEROLA, the famous 5-tube, no-battery electric light socket radio receiver (not an attachment), universal for D.C. or A.C. (100-115 v., 40-60 cycle), now sold and demonstrated by the New York Edison Co., public utility companies and radio, electric and music dealers everywhere. Absolutely dependable, fully guaranteed, powerful, practical, perfect in performance.

Are You the Man Who Sees Opportunities Ahead for Real Money Making

Write for literature, terms and prices at once.

POWEROLA RADIO CORP.

1845 BROADWAY NEW YORK CITY

NAMEPLATES

FOR

RADIO WORLD'S 1926

Diamond of the Air

NOW READY FOR DELIVERY

Those who have already ordered these nameplates will receive them in the course of a few days.

If you are building the Diamond of the Air, and have not already requested a nameplate, send us your name and address and we will send you one.

RADIO WORLD

145 W. 45th St. New York City

DIAMOND GLITTERINGS

ing every week of the wonderful results every one was having with the Diamond, I thought I would try it. Believe me I am not sorry.

WM. MITZER,
1310 E. Price,
Philadelphia, Pa.

DIAMOND EDITOR:

I have been a subscriber to your wonderful magazine since January 1 and have every copy. It is the best radio magazine for the home constructor I have ever seen. I built the Anderson Superdyne and had very good success with it. When the issue came out with the Diamond of the Air I immediately built the Diamond because the hookup looked good to me. It sure was good. It was such a success that I have used it ever since. I have tried a great many hookups in the last three years and the Diamond is the best. I wouldn't trade it for any other circuit. It is sure a wonder. The following is a list of stations I have listened to on the loud speaker: CFCN, KTCL, KHJ, KFSG, KFVB, KGW, KFON, CNRV, KJR, KFOA, KFI, KNX, WDAF, WOAW, WSMB, KOA, KGO, KFCE, KLX, KSL, KJBS, KTBI, WOAI, KTAB, KPO, KFPG, KFUR, KFUU, WBAP, KFVD, WOC, KDKA, CYL, KFJR, WGN, WLS, WGY, KFAU, KFVB, KFWO, KFRC, KNRC.

I think a set that will bring in these stations on a speaker ought to be good enough for anybody. I have an antenna 50 feet high, 110 long, including lead in. Thanks very much for the hookup. Send me a name-plate as the set is sure worth it.

J. W. BOYER,
Sparks, Nevada.

The Victory Six

A new 6-tube receiver is being placed on the market. It is primarily designed for the fan who wants to enjoy quality on both local and distant stations, combined with ease of tuning. It is the Victory Six. The manufacturers claim that the circuit is exclusive, it having been developed in their laboratories after intensive research. It contains two stages of radio-frequency, detector and three stages of special tone frequency amplification. In demonstration remarkable results have been achieved. The tuning range is from 175 to 550

meters, covering the entire broadcast range. The set can be used with battery eliminators or dry cells with results claimed to equal those from storage battery operation. A volume control regulates the output from a whisper to the full capacity of the speaker without distortion. Among the innovations incorporated are universal sockets which fit the new UX and CX tubes, also accommodating the UV type; and an automatic filament system. Formica engraved panels are used. The set may be logged, as stations always come in at the same setting. It is enclosed in a solid walnut cabinet. This set is being made and marketed by the United Radio Manufacturing Co., 191 Grenewich Street, New York, a concern of long standing in the radio field.

(Tested and approved by RADIO WORLD Laboratories)



Magic Dial



Makes any semi-circular plate or straight-line wavelength condenser tune like the straight-line frequency type. Smooth vernier over 340 degrees of the dial. No gears, no backlash.

\$250

BRUNO RADIO CORPORATION
Dept. W 221 Fulton St., New York City
Inquiries Solicited from the Trade

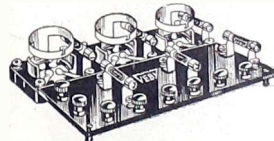

The New

VEBY AMPLIFIER

A Resistance Coupled Amplifier that will truly fit within the cabinet of any commercial receiver. Just seven inches long and five inches deep. It is fully assembled and ready to attach. The price is.....\$12.00

VEBY Hi Mu Tubes A. F. 20 or R. C. Amplifiers\$3.00

VEBY Power Tubes A. F. 6 for the last stage\$4.50



47-51 MORRIS AVENUE, NEWARK, N. J.

IN PREPARATION—RADIO WORLD'S MOST IMPORTANT ISSUE OF THE YEAR

RADIO GIFTS NUMBER

This Will Be a Radio Christmas

Regular Advertising Rates as Follows:

Page	\$300.00
Half-page	150.00
Third page (one col.)	100.00
Quarter page	75.00
Per inch	10.00
Per agate line75
Times discounts:	
12 consecutive issues	20%
28 times consecutively, or	
5 c. w. one year	15%
4 consecutive issues	10%

Radio Gifts Number will be dated Dec. 12, issued Dec. 9. Last color form closes Dec. 1. Last black form closes Dec. 2, noon.

It is estimated that our RADIO GIFTS NUMBER of 1924 sold more than \$100,000 worth of radio goods for advertisers who used these columns. It is the intention of the publishers to make the 1925 issue of the RADIO GIFTS NUMBER so much better than last year, and to give it so much larger a distribution that the sales through its columns will be increased heavily over last year's figures.

RADIO WORLD'S HOLIDAY GIFTS NUMBER OF 1925 will have a list of notable contributors, a special holiday cover, in colors and other special features that will be worth advertising in papers of nearly 5,000,000 circulation throughout the country. There is bound to be a larger sale than usual, because the selling price will not be increased.

If you want to sell your goods to the millions of holiday gift buyers who will purchase radio goods this year, don't fail to use the columns of this RADIO GIFTS NUMBER.

FOR SPECIAL POSITIONS, PHONE OR WIRE IMMEDIATELY!

RADIO WORLD, 145 WEST 45TH STREET.

Phones: Bryant 0558-0559

Expert Advice on Diamond Audio-Frequency Circuit

(Continued from page 9)

use either of these tubes should specify the correct Amperite. The 216A requires the No. 1 Amperite, (not the 1-A). The general run of hi-mu and mu (last stage) tubes takes the 1A Amperite.

Transformer Connection

In connecting the audio circuit, although the transformer shows a designation "Neg. Fil.," the lead should not go to the

negative filament but to minus A. The diagrams show the correct connection. The leak R4 helps keep the second AF grid slightly negative, the bias being equal to the voltage drop in between the two ends of the leak. As there is no resistor in the grid circuit of the first AF tube, it is well to take advantage of this slight biasing effect by establishing the potential difference across the secondary of AFT.

Use With External Detector

The audio circuit of the 1926 Diamond may be used in connection with any external detector circuit, or the earphones may be used at the detector output of the Diamond, and the audio tubes extinguished by means of the switch S2. This switch is located on the socket strip, in the center of the four binding posts W, X, Y and Z. A view of a section of the receiver shows the first AF socket at right with the binding post arrangement between this socket and the audio transformer. A short length of bus bar is used to connect W and X and another piece for connecting Y and Z. As the set nearly always will be used to run a speaker, these "straps" of bus bar are left in that position, not to be removed unless some external detector circuit is to be incorporated for test purposes. This feature was included as an aid to experimenters who, trying out some hookup new to them, would like to hear how it sounds on the speaker. If a crystal rectifier is used in this experimental detector circuit, then both straps would be removed in every

PRECISION LOW WAVE COILS

Red Primary, blue tickler, four white secondary coils, tunes 15 to 120 meters. Nothing better for selectivity and DX. Positively no crowding of stations. Verified reception using these coils from British 2CC, 2nb; Dutch O-ba; French 8dp; Q2my; 6cae, 6awy, 6bby, lately. Price \$3.00. Complete 3-tube kit, \$15.00 postpaid. Catalogue and circuit diagram free on request.

PRECISION RADIO EQUIPMENT CO.
4 Shelby St., Johnson City, N. Y.



THE SUPERIOR SIX

2 stages of Radio, and 3 stages of special tone frequency amplification give you real distance, perfect quality and ample volume on all stations.

Range 175 to 550 Meters

FEATURES—Universal Sockets, A and B Battery Meter, Volume Control, Low Loss Parts, Straight Line Condensers, Seld Walnut Cabinet.

PRICE, \$100

Write for Literature

UNITED RADIO MFG. CO.

191 GREENWICH ST. NEW YORK
DEALERS and JOBBERS write for attractive proposition.

SOMETHING NEW IN RADIO! EUREKA SOLDERLESS AERIAL LEAD-IN CLAMP

Now you can have a joint equal to a soldered one without any trouble. Handles one to four aerial leads besides the lead-in wire. Your set deserves one. Obtain at your dealers. Or sample mailed upon receipt of stamps.

25c
EACH

Ask your Dealer for Eureka Dial Pointers.

Manufactured by
C. W. BUTTS, INC.

40 HEDDEN PLACE EAST ORANGE, N. J.



LIST OF PARTS

- One antenna coupler, L0L1 (Bruno 99 RF).
- One 3-circuit interstage coupler, L2L3L4 (Bruno 99).
- Two .0005 mfd. SLF condensers, C1, C3 (Streamline).
- Two 1/4-amp. ballasts, R2, R7 (Amperites, type 1-A).
- One 3 1/2-to-1 AF transformer, AFT (Thorardson).
- One 1/4-amp. ballast, R1 (Veby).
- Two 0.1 meg. resistors, R3, R5 (Veby).
- One 1.0 meg. leak, R4 (Veby).
- One 0.5 meg. leak, R6 (Veby).
- One variable grid leak, R0 (Bretwood).
- Three 4" moulded Bakelite dials (Kurs-Kasch).
- Two double-circuit jacks, J1, J2 (Preferred).
- One single-circuit jack, J3 (Preferred).
- One 7x24" drilled and engraved panel (Cortland).
- Five standard sockets (Na-ald).
- One socket shelf and brackets (Bruno).
- Two 0.25 mfd. fixed condensers, C4, C5 (Aerovox).
- One 5-strand multi-colored battery cable (De Luxe).
- Two battery switches, S1, S2.
- One .00025 mfd. fixed grid condenser, C2.
- Six single mounts.
- Four binding posts, W, X, Y, Z.
- Five battery cable markers.
- Ten lengths of busbar (Cornish).
- Two flexible leads for C battery.
- Screws, nuts, spaghetti.

instance. But if a tube detector is present in the test hookup, the B plus connection thereto may be used right from the Diamond, only the strip WX need be removed, the plate of the experimental circuit being joined to X.

When the audio circuit is used in conjunction with another detector circuit the

NO MORE "B" BATTERIES!

Waage "B" Eliminator solves all "B" Problems
Build it yourself! Complete Kit or Parts—Transformers, choke coil, etc. Full instructions with each kit. Also sold completely assembled. Write Dept. 86 for full particulars TODAY.
A. H. WAAGE
6 Reade St. New York, N. Y.



TWO-FOR-ONE SUBSCRIPTION OFFER

Radio World has made arrangements

—To offer a year's subscription FREE for any one of the following publications with one year's subscription for RADIO WORLD:

- RADIO NEWS or
- POPULAR RADIO or
- RADIO BROADCAST or
- SCIENCE AND INVENTION or
- RADIO DEALER or
- RADIO JOURNAL or
- RADIO (San Francisco) or
- THE EXPERIMENTER or
- RADIO AGE

This is the way to get two publications

- for the price of one:
- Send \$6.00 today for RADIO WORLD
- for one year (regular price
- for 52 numbers)
- and select any one of the other
- nine publications for twelve months.
- Add \$1.00 a year extra for
- Canadian or Foreign Postage.
- Present RADIO WORLD subscribers
- can take advantage of this offer by
- extending subscriptions one year
- if they send renewals NOW.

RADIO WORLD'S Special Two-For-Price-of-One SUBSCRIPTION BLANK

RADIO WORLD, 145 West 45th St., N. Y. City.

Enclosed find \$6.00, for which send me RADIO WORLD for twelve months (52 numbers), beginning.....and also, without additional cost, Radio News, or Popular Radio, or Radio Broadcast, or Science and Invention, or Radio Dealer, or Radio (San Francisco), or The Experimenter, or Radio Journal, or Radio Age (or \$10.00 for two yearly subscriptions).

Indicate if renewal.

Offer Good Until

December 20, 1925.

Name

Street Address

City and State

Get Your Coil Connections Right

When You Build

The Powertone

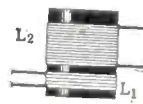

Construction of this 1-dial, 5-tube quality receiver fully described and illustrated, with "blue print in black" included, in Aug. 29 and Sept. 5 issues. Special discussion of how to connect the coil terminals. Trouble-shooting in this set, Sept. 12 issue. Send 45c. Get all three.

RADIO WORLD

145 West 45th St., N. Y. City

BROADCASTING STATIONS TO DATE—Complete list appeared in RADIO WORLD dated Nov. 14. 15c a copy, or start your sub. with that number. RADIO WORLD, 145 W. 45th St., N. Y. C.

two tubes in the RF circuit of the Diamond will have to be removed from their sockets (1 and 2). As this experimental feature will not be used steadily it was not necessary to incorporate another switch just to "put out the lights" in these two instances.

[This concludes the second of a series of three articles by Herman Bernard, reporting laboratory results obtained from a scientific study of the operation of the 1926 Model Diamond of the Air. The first was published last week, issue of November 21. Next week the final article on this subject will be published. Those contemplating constructing this receiver should obtain also the issues of RADIO WORLD dated September 12, 19 and 26, in which full constructional data were given.]

A Laboratory Product



**CRESCENT
LAVITE
RESISTANCES**

Used in 50 big broadcasting stations. 12,000, 48,000, 50,000 and 100,000 ohms. For distortionless amplification. Order a Crescent today at \$1.50. Special sizes made to order. Discounts to dealers.

CRESCENT RADIO SUPPLY CO.
9 Liberty Street Jamaica, N. Y.

**Get a
NAMEPLATE
Free!**

Your 1926 Diamond of the Air will not be complete without the nameplate, which will be furnished free to all who ask. This nameplate is of the transfer type. Immerse it in a tumbler of water for a minute, then place it on the panel, with the nameplate facing you. The paper may be easily pulled away and only the nameplate remain. When the nameplate dries it will be found securely pasted to the panel.

Send in your request to Diamond Editor, RADIO WORLD, 145 West 45th Street, New York City, or come in and get one at the office, which is just a few steps east of Broadway.

**The New
and Better
Diamond
of the Air**

DX, Selectivity, Volume and Quality —All Marvelously Combined in RADIO WORLD'S 1926 Model

**DIAMOND
OF THE
AIR**

5 tubes, including Bernard AF hookup. Sept. 12, 19 and 26 issues of RADIO WORLD, including picture diagrams of wiring.

Send 45c. for these three numbers or start your subscription with the Sept. 12 issue. Send \$6 for yearly subscription and get these three issues FREE. Address Circulation Manager, RADIO WORLD, 145 W. 45th St., New York City.

LISTEN IN every Friday at 7 P. M. and hear Herman Bernard, managing editor of RADIO WORLD, discuss "Your Radio Problem," from WGBS, Gimbel Bros., New York City, 315.6 meters.

JOIN THE A. B. C.

A. B. C. stands for American Broadcast Club, an organization of fans banded together to promote the welfare of radio. There are no dues, no obligations. Address A. B. C. Editor, RADIO WORLD, 145 West 45th St., N. Y. City. The names and addresses of new members follow:
H. C. Smith, 508 No. Indiana Ave., Atlantic City, N. J.
Wm. Schwarze, 29 Nagy St., Middle Village, L. I., N. Y.
W. E. Linscott, 1168 Maysville Ave., Zanesville, O.
A. E. Stackweather, Chatham, Mass.
Kenneth Giles, 8828 195th Place, Hollis, L. I., N. Y.

John Sporma, Box 24, Escatawpa, Ala.
Otto Giese, 538 Milwaukee St., Milwaukee, Wis.
C. McLaren, Box 5006, Cristobal, Canal Zone.
Robert J. Hough, 26 Ellenton Ave., New Rochelle, N. Y.
Harold C. Baker, 23 West Tremont Ave., N. Y. City, N. Y.
Raymond Massott, 7421 Palmetto St., Philadelphia, Pa.

**EVEREADY
Radio Batteries**
—they last longer



Tested Parts

All parts offered in our catalog including those combined in knockdown KITS have been carefully tested and approved by our graduate Radio Engineers. Satisfactory results are guaranteed.



Panels for Kits

A completely drilled and engraved panel is included with each of our kits. Makes set building easy and sure. No other concern gives this FREE service.

Just Out!
Our Latest
FREE
RADIO CATALOG
BEFORE you build be sure to consult our latest 100 page radio catalog. A dependable guide for set-builders. Knock-down sets and kits for all the latest circuits. No finer or more complete assortment to be found anywhere. Latest designed parts—Acme, All-American, Bremer-Tully, Carter, Freshman, Frost, General Instrument, Walbert, etc. And the prices—every one quoted means a big saving for you!
Write for your FREE copy today!



Blueprints

Complete BLUEPRINTS and easy-to-understand INSTRUCTION BOOK included with each of our KITS. No technical knowledge required to build your own set.

Save Money

Our enormous buying power permits us to pay spot cash and get rock-bottom prices. Be sure to see our catalog before you buy—save money. Write for your free copy today.

CHICAGO SALVAGE
509 South State Street
Dept. RW-6

STOCK STORES
CHICAGO, U. S. A.

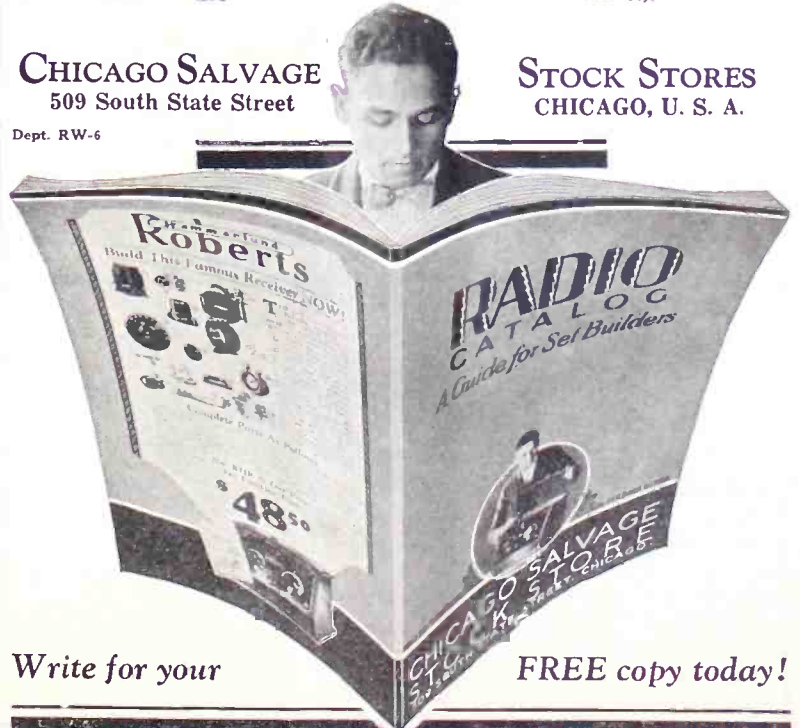

Write for your

FREE copy today!

THE RADIO UNIVERSITY

(Concluded from page 11)
amplification, give me louder results than the Phonograph Set described in the Oct. 24 and 31 issues?—F. B. Manhart, 1331, South 5th, Terre Haute, Ind.
The volume on both will be the same,

although the Phonograph set will give you better quality.

I HAVE built the Diamond and cannot get the loop to work.—William Luscomb, 130 Nepperlian Ave., Yonkers, N. Y.

First test the double circuit jack for a short circuit. That is, see if the top terminal does not touch the terminal below when the plug is inserted. This is done by testing with a battery and phones, which are connected in series. If you get a click there is a short. This would prevent signals from being received. The antenna coil and also the variable condenser which are all in this circuit would also be shorted. Test your plug for a short also. Take the two leads from the loop, and place them across the variable condenser, at the same time disconnecting the antenna, ground and the coil connections. If the loop is O. K. then the set will work with this arrangement. This should be only temporary, and will help you find out the trouble.

I BUILT the Pressley Super-Heterodyne, described in the April 18, 25 and May 2 issues. (1) The set works O. K., except that I have trouble in controlling the body capacity. (2) I noticed in the hookup that the rotor of D, the variable condenser, goes to the stator of R, the split stator condenser and the rotor of

the same to the stator of the loop tuning variable condenser, C, go to the A+, while in the text it says it should go to the A.—Dr. A. Douglas Dudley, 518-519 Medical Arts Building, Norfolk, Va.

(1) Ground the A—. Place hard rubber bushings on the screws that hold the condenser in place on the panel. This will push the condenser back. Be sure that you have the stators of the variable condenser C and D going to the G portion of the first tube, and not vice versa. (2) It does not matter.

I AM going to build the Powertone Receiver, described by Herman Bernard in the Aug. 29, Sept. 5, and Sept. 12 issue. (1) I have two American Brand condensers, both of which have a capacity of .0005 mfd. Could these be used successfully in this set, instead of the double condenser?—E. D. Barnhills, Fontanelle, Ia.

(1) Only if you use two controls, one for each of your condensers. The result will be O. K.

I WANT to build the Diamond, but wish to use a Dayton .001 mfd. variable condenser shunted across the secondary instead of a .0005 mfd. How many turns should I place on this tuner so that this may be utilized?—Harry Jones, 1271 West St., Topeka, Kan.

The primary and secondary are wound on a form, 3/4" in diameter and 2" high. There are 9 turns on the primary, and 38 turns on the secondary for your condenser. The tickler is wound on a tubing 2 1/2" in diameter and 2" high. There are 28 turns wound. No. 22 double cotton covered wire may be used.

WHAT IS the best detector tube to use in the Diamond?—Albert Newman, 44 Bushnell St., Hartford, Conn.
A hard tube like 201A or 199.

CAN THE Eastern coils be used in the Superdyne or the Diamond?—J. J. Riemersina, Hoppers, Ia.

I AM going to build the Diamond and would like to know if I can use a 9-to-1 and a 3 1/2-to-1 AFT in the AF stages.—F. J. Fewings, R. A. Box 170, Poway, Cal.

FREE BOOKLET FOR INVENTORS

IF YOUR INVENTION is now and useful it is patentable. Send me your sketch.
Z. H. POLACHEK, 70 Wall St., New York
Reg. Patent Attorney-Engineer

PANELS
RADIO and HARD RUBBER
RETAIL ANY SIZE WHOLESALE
PRICE LIST MAILED ON REQUEST

HARD RUBBER SHEETS—RODS—TUBING
Special Hard Rubber Parts Made to Order.
Send Sample or Sketch for Quotation.
NEW YORK HARD RUBBER TURNING CO.
212 CENTRE ST. NEW YORK



A. J. Vernier
PAT. PEND.

ANew product on a new principle, introduced by the manufacturers of the famous Accurate Controls. Like the latter it has the dual adjustment feature and its high ratio, 150 to 1, is an assurance of actual vernier adjustment. All parts genuine Bakelite and covered by the Accurate unqualified guarantee of satisfaction.

MYDAR RADIO COMPANY
23 Campbell Street NEWARK, N. J.

RADIO CATALOG also LOG

FREE SAVE on all the latest standard radio merchandise. No exceptions. Our 1926 Beautifully Illustrated Catalog

JUST OFF THE PRESS!
Everything new in Radio AT SLASHED PRICES. Write for it today, before you buy anything. Delay means losing exceptional chance to participate in this great BARGAIN SALE. Rush your name and address at once and get also a

LOG BOOK FREE!
ECONOMY RADIO SALES COMPANY
288 6TH AVE., Dept. E. NEW YORK
Deal Direct and Save Real Money (No Dealers)

DOUBLE-TOROID COILS



"Doubletoroids" can be mounted at any angle or spaced at any distance.

"Doubletoroids" make more selective sets possible, since they do not form miniature loop aeriels.

"Doubletoroids" hold static and other disturbances to a minimum since no current from an external source can influence them.

Patented March 31, 1925
Price \$2.75

Patented June 16, 1925

It's Variable
The Nonoise Gridleak improves reception because it can be adjusted for every station. Plus standard brackets. Absolutely noiseless. At all dealers and in the better sets. Price, 85c.

NONOISE GRIDLEAK

Outstanding Features of the "Doubletoroids"
Both primary and secondary are true toroids.
The magnetic path is shortest.
It is the most compact.
Write for booklet in which Professor J. H. Morescroft gives his opinion of these coils.

22 1/2 volt un-acid overcharging rechargeable "B" Storage Battery

\$2.95

includes chemical



45 volts, \$5.25; 90 volts, \$10.00; 112 1/2 volts, \$13.50; 135 volts, \$14.75; 157 1/2 volts, \$16.00. Truly the biggest buy today. Easily charged on any current, including 22-volt systems. Any special detector plate voltage had. Tested and approved by leading authorities such as Popular Radio Laboratory. Over 3 years sold on a non-refund basis, 30-day trial offer with complete refund if not thoroughly satisfied. Further guaranteed 2 years. Knock-down kits at great savings. Complete "Hawley" "B" battery charger, \$2.75. Sample cell, 35c. Order direct—send no money—simply pay the expressman when on delivery. Or write for my free literature, testimonials and guarantee. Same day shipments. B. Hawley Smith, 518 Washington Ave., Danbury, Conn.

REMOVAL NOTICE!
Radio World has moved to more spacious offices at No. 145 W. 45th St., near Broadway, New York City.
Telephones: BRYant 0558, 0559

RADIO FOUNDATION, INC.
25 WEST BROADWAY NEW YORK

RESULTS EDITOR:

Talking about results, well I got some and more, too. In the July 4 issue of RADIO WORLD your Capt. O'Rourke gave us the Freedom Reflex. Until I tried this hookup I was a little peeved at the thought of reflex.

I have hooked up a number of the Captain's circuits and I have failed to make a fizzle yet, although some worked better

CROSLLEY
 ILLUSTRATED RADIO CATALOG FREE!
 Describes fully the complete Crosley line of radio frequency sets, regenerative sets (licensed under Armstrong U. S. Patent No. 1,118,149) and parts.
 THE CROSLLEY RADIO CORPORATION
 Cincinnati, Ohio
RADIO



RADIO Storage 'B' Battery
 Lasts Indefinitely—Pays for Itself
 Economy and performance unheard of before. Recharged at a negligible cost. Approved and listed as Standard by leading Radio Authorities, including Pop. Radio Laboratories, Pop. Sci. Inst. Standards, Radio News Lab., Letaf, Inc., and other important institutions. Equipped with Solid Rubber Case, an insurance against acid and leakage. Extra heavy glass jars. Heavy, rusted plates. Order yours today!

32 Cells 24 Volts
 Economy and performance unheard of before. Recharged at a negligible cost. Approved and listed as Standard by leading Radio Authorities, including Pop. Radio Laboratories, Pop. Sci. Inst. Standards, Radio News Lab., Letaf, Inc., and other important institutions. Equipped with Solid Rubber Case, an insurance against acid and leakage. Extra heavy glass jars. Heavy, rusted plates. Order yours today!

SEND NO MONEY Just state number of batteries wanted and we will ship day order is received. Extra Offer: 4 batteries in series (96 volts), \$12.75. Pay expressman after examining batteries. 5 per cent discount for cash with order. Mail your order now!

WORLD BATTERY COMPANY
 1219 So. Wabash Ave., Dept. 92 Chicago, Ill.
 Makers of the Famous World Radio "A" Storage Battery
 Prices: 6-cell, 120 Amp. \$11.25; 120 Amp. \$18.50; 150 Amp. \$14.00.
 All equipped with Solid Rubber Case.

Set your Radio Dials at 210 meters for the new 1000 watt World Storage Battery Station, W5BC, Chicago. Watch for announce-ments.

Get the New MATCHED AERO COILS
 T. R. F. Kit Matched Coils \$12.00



For SELECTIVITY and DISTANCE
 Regardless of how good your sets seem to be, you can make it many times more selective and much more powerful by replacing your T. R. F. transformers with Aero Coils. Get Aero Coils now — and tune through strong locals and bring in DX with tremendous loud speaker volume!

95% AIR DIELECTRIC
 The secret of Aero Coils' markedly superior performance is its precise construction which makes possible the correct use of 95% air dielectric and nonporous, air-spaced windings with the consequent advantages of lower high frequency resistance and distributed capacity.

AT YOUR DEALERS OR DIRECT
 T. R. F. Regenerative Kit... \$11.00
 3 Circuit Kit... 8.00
 Wave Trap Coil... 4.00
 Oscillator... 5.50

Write for the Aero Booklet

AERO PRODUCTS, Inc.
 217 N. Desplaines Street, CHICAGO

KESTER Radio SOLDER
 (Rosin-Core)
 If your dealer cannot supply you send us 25c in postage
CHICAGO SOLDER COMPANY
 CHICAGO, U. S. A.

RESULTS
Readers report on their experiences with sets built from hookups published in RADIO WORLD. Address Results Editor, RADIO WORLD, 145 West 45th Street, New York City, and send photographs of sets, if possible.

than others. But when I tried the Freedom I was utterly surprised and also overjoyed at the results I obtained from three tubes.

I made a little change or so from the path he gave us. In building the set I put in a potentiometer to control the volume. Had I not I could not stay in the house.

I have no trouble in tuning in the following stations: WJAZ, KOIL, WWJ, WEBB, WGB, KSD, KTHS, WJJD, KOA, WCBD, WHB, WOA, WHAS, WSAI, WLW, WQJ, WJR, KYW, WHO, WMC, WLIB, KDKA, WSMB, WFAA, WOK, WBAP, WOAI, WBBM, WRR, KPRC and KFRU.

The interference was pretty bad at times and selectivity was not so good until I used 22 ft. of twisted pair lamp cord hung around the room next to the ceiling. The location where I live is against good reception, being on a tank farm full of 55,000 bbl. steel tanks. Also the buildings are built mostly of corrugated iron with iron framework.

Have been able to pick up KFKX without any aerial at all. If WLS, WFAA, WJAD, WOAI or WBAP are not in operation I can easily pick up KFI with plenty of loudspeaker volume for the living room.

We must also take into consideration part of my equipment is seven years old and the connections are nearly worn out from making so many different hookups. I have a UV201 that is five years old and has done from three to six hours nearly every day since I owned it.

If the man who thinks RADIO WORLD hookups are N. G. comes here I'll show him a set that gets all I claim and more, too. Good luck to you and especially to Capt. O'Rourke.

C. E. DUTTON,
 Box 86, Mexia, Tex.

RESULTS EDITOR:

A few days ago I built the 8-tube Super-Heterodyne as described in RADIO WORLD of Sept. 26, by Sydney E. Finkelstein and it is a hummer. I have built some four or five Super sets all the way from six to ten tubes and I have never found one that will work as well and is as easy to operate as this circuit. Also it is the quietest Super I have ever heard. I get stations all over the country every night.

CHAS. J. KNAPP,
 Moultrie, Ga.



CONDENSERS VERNIERS RHEOSTATS
AMSCO PRODUCTS, Inc. New York City

LOUD SPEAKER RECEPTION
 from either coast on three tubes.
 Blueprint and instructions.....\$1.00
 Necessary low loss coil.....\$2.50
 Beautiful finished instrument.....\$35.00

S. A. TWITCHELL CO.
 1930 Western Avenue Minneapolis, Minn.

IMMEDIATE DELIVERY
 "VICTOREEN" Super Heterodyne Parts
 "SAMSON" TC Parts and Kits
 "SILVER-SIX" and Silver-Marshall Parts
 Now in Stock. DEALERS! Write for discounts and literature on these wonderful circuits.
 Orders Filled Same Day Received
 DISTRIBUTORS
MAURICE SCHWARTZ & SON
 710-712 BROADWAY SCHENECTADY, N. Y.

A.I.R. SERVICE
 sets are guaranteed for
Tone-DX-Clarity

5 Tube Tuned Radio Frequency.....	\$34
6 Tube Resistance Amplification.....	50
6 Tube Rambler Portable.....	90
6 Tube Console.....	125

If your dealer cannot make immediate delivery we will ship direct from factory.

American Interstate Radio Service
 183 Greenwich Street, New York City
 Distributors, Jobbers, Dealers, write for special trade terms.

HAVE YOU ANYTHING TO SELL OR EXCHANGE? Use RADIO WORLD'S Classified Department and get great results. 10c a word. RADIO WORLD, 145 West 45th St., N. Y.

A NEW SUPER-HET KIT \$17.50
 With Perfectly Matched Transformers and Filter



This is a SUPERADIO Product—Your Guarantee of Satisfaction!
 The most selective, the most powerful, longest ranged, finest toned 8 tube super ever designed. Intermediate transformers matched to identical peaks and filter tuned to same peak. Kit includes Antenna Coupler, Oscillator Coupler, Special Variable Condenser, Tuned Input Transformer, 3 matched intermediate transformers and hardware. Complete with booklet, diagrams and full sized working drawings which positively assure perfect success. Order now. Only \$17.50.

SAVE MONEY ON THIS COMPLETE OUTFIT
 Every Kit Made Up of Individually Tested Parts as Follows:

Superadio Inductance and Transformer Kit, 2 Heath Radiant Condensers, 2 Keystone Audio Transformers, 8 Benjamin Sockets, 2 Carter Rheostats, 1 potentiometer, all necessary fixed condensers, 2 "Megits" Grid Leaks, 1 Mounted Binding Post Board, 1 Base Board, 1 Drilled Panel, 3 "Dialog" Vernier Dials, 3 Truflux Rheostat Dials, 3 Carter Jacks, 1 Carter Filament Switch, Soldering Lugs, Buss Wire and wood screws, diagram and instructions.	\$73.50
Write for our free Radio Catalog of newest parts	

William A. Welty Company, 36-40 So. State St., Chicago

Short-Wave Set

(Concluded from page 19)

consists of 70 turns. The filament tap is taken at the 20th tap. The grid tap is omitted.

In each case the winding is slipped off these rods, so that the coil is self-supporting. Grocer's cord may be used for sewing coil together securely.

Take the strip and run it through one of the loops, preferably near the one where the winding was completed. Now $\frac{1}{8}$ " from each edge drill $\frac{1}{16}$ " holes. Take a screw and nut and run through. Place a lug for soldering when doing this. Now take a piece of bus bar 2" long. One-quarter inch from edge make a loop. Place around screw and tighten down. Make a $\frac{1}{8}$ " bend. Now bend the bus bar up so that you have a sort of a clip. Do this at both ends. Solder the beginning and the end of the winding on the lugs.

EVERY SET BUILDER NEEDS THIS



"Morsing Bus-Bar Union"

Makes for quick assembling. Repairs can be made by using Morsing Bus-Bar Union without taking set apart.

Assemble round or square Bus-Bar and solder three wires at a time. Order No. 1 for No. 14, No. 2 for 12 wire. Send 15 cents for enough for building one set, or ten dozen for \$1.00.

Newark Watch Case Material Co.
15 Ward Street Newark, N. J.
DISTRIBUTORS WANTED

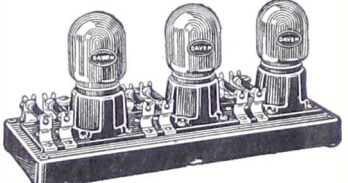

The Daven Super-Amplifier

for volume and tone quality.
**3 STAGES RESISTANCE COUPLED
ECONOMICAL. DISTORTIONLESS**

Easily added to any set.
Saves Several Hours Assembly
For Sale by All Good Dealers

- LIST OF PARTS**
- Two variable condensers, .0001 mfd. capacity (3, 4).
 - Plug-in coils (1, 2).
 - One .00025 mfd. grid condenser, (5).
 - One 2 megohm grid leak (6).
 - One 20 ohm rheostat (11).
 - One RF choke coil (7).
 - One low ratio AFT (10).
 - One single circuit filament control jack (12).
 - Two sockets.
 - Two 3" dials.
 - One A and B battery terminal strip.
 - One 7x14" panel.
 - One 12x12" baseboard.
 - Accessories: Connecting wire, A and B batteries, mounting terminal for coils, etc.

The base to fit these clips should be purchased. If to be made at home procure a strip 6" long. Drill holes at points so that clips will fit. Place phone tip jacks here. Solder lugs on jacks, for connecting purposes. Place a small angle iron on each end for mounting.

Tuning the Set

This receiver, like all other short-wave receivers, is difficult to tune, as there are few local stations operating on short waves, with the result that nearly every station that you tune in is a distant one. Stations on short waves are very easily missed, because there is a tendency of the set to oscillate too much. The condenser, 4, controls the regeneration, while the other variable condenser controls the wavelength. The rheostat plays a very small part in tuning of a station. The radio-frequency choke makes oscillation easier to control and blocks the escape of RF current. The more turns you place on this coil the more readily the tube will oscillate. Therefore if the tube chokes, add more turns to this coil. The 201A type tube is used.

The RF choke consists of 135 turns of No. 24 wire on a $\frac{1}{2}$ " form.

DEALERS BIG DISCOUNTS

Radio's biggest season is here. Get our new catalog showing huge stocks of radio parts, sets, kits at lowest rock-bottom prices. Quick service. Wonderful special offer on best sets, tubes, batteries. Write for free copy.



W. C. Braun Co., 30-60 Clinton St., Chicago, U. S. A.

QUICK ACTION CLASSIFIED ADS

10 CENTS A WORD. 10 WORDS MINIMUM. CASH WITH ORDER

HELP! The Bruno Radio Corp. of New York needs a reliable, capable, honest radio man in every city, town and village of the U. S. to build the Bruno Powertone from the Bruno Powertone Kit. We are literally swamped with orders for Powertone sets. We need help quickly! We want to organize a number of young men to build it for our customers—give them a chance to earn real money in their spare time with no investment and with the backing of a reputable concern. A postal card will bring you further details. Give us your references in the first letter to save time, Bruno Radio Corp., Dept. P, 221 Fulton Street, New York City.

SALESMEN—We furnish you a new Ford car immediately and set you up in business. You own both car and business. No capital required. Profits \$50 to \$150 per week easy. Exclusive territory, city or country. Biggest opportunity ever offered hustlers. Territory going fast. Write quick for details. W. & H. Walker, Inc., Dept. 42, Herr's Island, Pittsburgh, Pa.

HONEY, MICHIGAN'S BEST—Clover or buckwheat. Five pounds, \$1.60; ten pounds, \$2.75, with honey receipt book, delivered fourth zone. Order direct from producers. (An appreciated gift). SHADY LAWN APRIARIES, Milan, Mich.

AGENTS—No competition selling spectacles, guaranteed to satisfy, only \$3.98. Pay daily. We deliver collect. Nearly everybody buys. \$10.00-\$25.00 daily easy. True-Fit Optical Co., CW, 116 1528 W. Adams St., Chicago.

SALESMEN!

MAKE \$100 WEEKLY IN SPARE TIME. Sell what the public wants—long-distance radio receiving sets. Two sales weekly pay \$100 profit. No big investment, no canvassing. Sharpe of Colorado made \$95 in one month. Representatives wanted at once. This plan is sweeping the country—write today before your county is gone. Ozarka, Inc., 126-J, Austin Ave., Chicago, Ill.

COMPLETE LIST OF BROADCASTING STATIONS appeared in RADIO WORLD dated Nov. 14. 15c per copy, or start your subscription with that number. RADIO WORLD, 145 W. 45th St., New York City.

RADIO FANS WANTED to sell Standard Radio apparatus. H. Roberts & Co., 180 Broadway, New York.

PATENTS—Write for free Guide Books and "Record of Invention Blank" before disclosing inventions. Send model or sketch of your invention for our inspection and instructions free. Terms reasonable. Radio, Chemical, Mechanical, Electrical and Trademark experts. Victor J. Evans Co., 924 Ninth, Washington, D. C.

THE KENMAN 5-TUBE T.R.F. RECEIVER. None better for power, selectivity, clearness and distance. Handsome two-toned cabinet. Price \$29.75, postpaid. Satisfaction guaranteed or money refunded. Precision Radio Equipment Co., 4 Shelby St., Johnson City, N. Y.

"HOW TO MAKE—"

The following illustrated constructional articles have appeared in recent issues of RADIO WORLD:

- Jan. 3, 1925—A 3-Tube Portable That Needs No Outdoor Aerial, by Abner J. Gelula.
- Jan. 17—A \$25 1-Tube DX Wonder, by Abner J. Gelula.
- Jan. 24—A Selective \$15 Crystal Set, by Brewster Lee. A Variometer-Tuned Reflex, by Abner J. Gelula. An \$18 1-Tube DX Circuit for the Beginner, by Feodor Rofpatkin.
- Jan. 31—A Regenerative Neutrodyne for More DX, by Abner J. Gelula. A Transcontinental 2-Tube Set, by H. E. Wright. An Experimental Reflex, by Lieut. P. V. O'Rourke.
- Feb. 7—A 1-Tube Reflex for the Nervous, by Feodor Rofpatkin. A Set for Professional Folk, by Lieut. P. V. O'Rourke. A Honeycomb Crystal Receiver, by Raymond B. Wallis.
- March 14—The Refined 3-Circuit Tuner That You Can Log, by Herman Bernard. The Right Way to Put Coils and Condensers in a Set, by Hyri C. Caldwell.
- March 21—A Variable Leak, by Herbert E. Hayden. A 4-Tube, 3-Control Set That Gets the Most DX, by Lieut. P. V. O'Rourke.
- May 2—The Twynplex, by J. E. Anderson.
- May 9—A Set to Cut State, by Feodor Rofpatkin. Toroid Circuit with Resistance AF, by E. I. Sidney. A Push-Pull AF Amplifier, by Lieut. Peter V. O'Rourke.
- June 6—The Smokstack Portable, by Neal Fitzgerald. A and B Battery Eliminators, Using DC (Part 1), by P. E. Edelman. A Wave-meter, by Lewis Winner. Full List Broadcasting Stations.
- June 13—Simple Short-Wave Circuits, by Herbert E. Hayden. A Simple Push-Pull Rheostat, by A. C. G. Force. A and B Battery Eliminators, Using AC (Part 2), by F. E. Edelman. A Portable Super-Heterodyne, by Wainwright Astor.
- June 20—The Diamond as a Reflex, by Herman Bernard. A 2-Tube Reflex, by Herbert E. Hayden. A Reflex for 49 Type Tubes, by L. R. Barbley.
- June 27—The Pocketbook Portable, by Burton Lindheim. The Pocketbook Set, by John L. Munson. Lesson on Learning the Code.
- July 4—The Handsome Portable, by Herbert E. Hayden. The Freedom Reflex, by Capt. P. V. O'Rourke. 8-Tube Super-Heterodyne, by Abner J. Gelula.
- July 11—The Baby "Super," by J. E. Anderson. A 1-Dial Portable Receiver, by Capt. P. V. O'Rourke.
- July 18—Anderson's 6-Tube Super-Heterodyne. The 3-Tube Marconi Receiver, by Percy Warren. A Good Battery Connector, by Herbert E. Hayden.
- Aug. 1—Enormous Volume on DX Stations, by Sidney E. Finkelstein. The Metropolitan Local Set, by J. E. Anderson. 4-Tube DX Divided Circuit, by Herbert E. Hayden. Series and Parallel Effects, by Herman Bernard.
- Aug. 8—The Evolution Reflex, by Capt. P. V. O'Rourke. The Midget—A 3-Tube Set in Sewing Machine Cabinet, by Herbert E. Hayden. How to Build Your First Set, by Herman Bernard. 2-Year-Old Wins DX Stake, by Lewis Winner.
- Aug. 15—A 2-Tube Speaker, by Brewster Lee. Capt. P. V. O'Rourke's Favorite Audio Amplifier. A Set That Taxes Inexpensively, by Lewis Winner. The Loop Jack in the Diamond, by Herman Bernard.
- Aug. 22—The 5-Tube Diamond, by Sidney E. Finkelstein. A Home-Made Toroidal Coil, by George R. Hostetter. The Electrostatic Regenerator, by Percy Warren. Crystal Sets That You Can Log, by Herman Bernard.
- Aug. 29—The 1-Dial Powertone, by Herman Bernard. A Set a Baby, by Herbert E. Hayden. A Fine Meter Switchboard, by Lewis Winner. A Powerful 1-Tube Set, by Percy Warren.
- Sept. 5—The Loop Model Powertone, by Herman Bernard. A 3-Tube Gated Receiver, by Lewis Winner. The UN120 Model Diamond, by Capt. P. V. O'Rourke.
- Sept. 12—The 1925 Model Diamond of the Air, (Part 1), by Herman Bernard. An Outstanding Wavemeter, by J. E. Anderson. A 25-to-110 Meter Receiver, by Sidney E. Finkelstein.
- Sept. 19—Diamond of the Air (Part 2), by Herman Bernard. A 1-Dial 2-Tube Speaker, by Percy Warren. A Tube R Battery Eliminator, by Lewis Winner. A Home-Made Volume Control, by Herbert E. Hayden.
- Sept. 26—The 8-Tube Super Heterodyne, by Sidney E. Finkelstein. Diamond of the Air (Part 3), by Herman Bernard. The 5-Tube Brown-Box-Drake, by Capt. P. V. O'Rourke. A 1-Control Regenerative Set, by Percy Warren.
- Oct. 3—The Thorndarson-Wade Set (Part 1), by Herman Bernard. A Fixed Grid Leak, by Herbert E. Hayden. Trouble Shooting for Diamond of the Air.
- Oct. 10—Hookups for the Short Waves, by Percy Warren. The 3-Tube, 3-Circuit Tuner, by Capt. P. V. O'Rourke. The DX Set That Thrilled Jack, by Lewis Winner. The Thorndarson-Wade Set (Part 2), by Herman Bernard.
- Oct. 17—The Thoroughbred (1-Tube DX Set), by Herbert Hayden. O'Rourke's Favorite SW Set, by Capt. Peter V. O'Rourke. The Thorndarson-Wade Set (Part 3), by Herman Bernard. Trouble Shooting Article.
- Oct. 31—The Pathfinder, by Sidney E. Finkelstein. A Snap-Catch Terminal Strip, by Herbert Erwin. A Simple Loop, by Herbert E. Hayden.
- Nov. 7—A 3-Tube Dry-Cell Circuit, by Capt. P. V. O'Rourke. One of the Best Crystal Sets, by Herbert E. Hayden. 1-Tube DX Set, Herman Bernard. A Flexible Short-Wave Set, by Percy Warren. The 4-Tube Robers Receiver, by Neal Fitzgerald.
- Nov. 14—The 4-Tube DX Special, by Herbert E. Hayden. The Set That Water Lounded, by Capt. P. V. O'Rourke. A Receiver for Music Lovers, by Lewis Winner.
- Nov. 21—A DX Super-Heterodyne, by J. E. Anderson. A Resistance-Controlled Set, by Percy Warren. A Tube A-A Receiver, by Herbert E. Hayden.

Any copy, 15c. Any 7 copies, \$1.00. All these 32 copies for \$4.25, or start subscription with any issue, Radio World, 145 W. 45th St., N. Y.

Believe Your Own Ears!

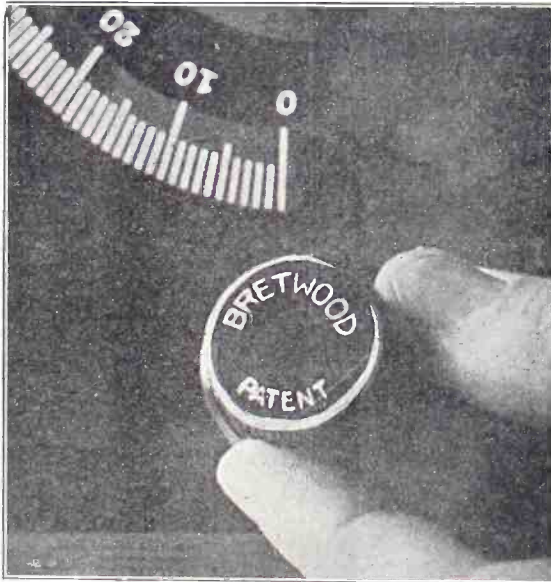

That delightful expression of appreciation lights every countenance when the Bretwood Variable Grid Leak is put in a set and the result is judged *by your own ears!*

The Bretwood Variable Grid Leak may be used in any set employing a tube as detector. The single hole, panel mount enables one to put it in a set in ten minutes.

*When the King Wanted a Leak He
Commanded Bretwood*

Turn the Knob to the Right Setting—Quickly Determined—and Leave It in That Position.

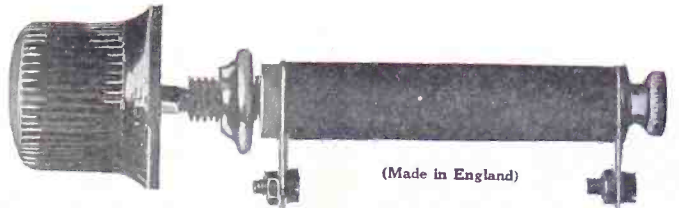

Guaranteed Precision Range— $\frac{1}{4}$ to 10 Megohms.

North American Bretwood Co., 145 W. 45th St., New York City.—Enclosed find \$1.50. Send one Bretwood Variable Grid Leak on 10-day money-back guarantee.

Name

Street

City..... State.....

North American Bretwood Co.

145 West 45th Street

New York City

Canadian Distributor: RADIO, LTD., Phillips Sq., Montreal

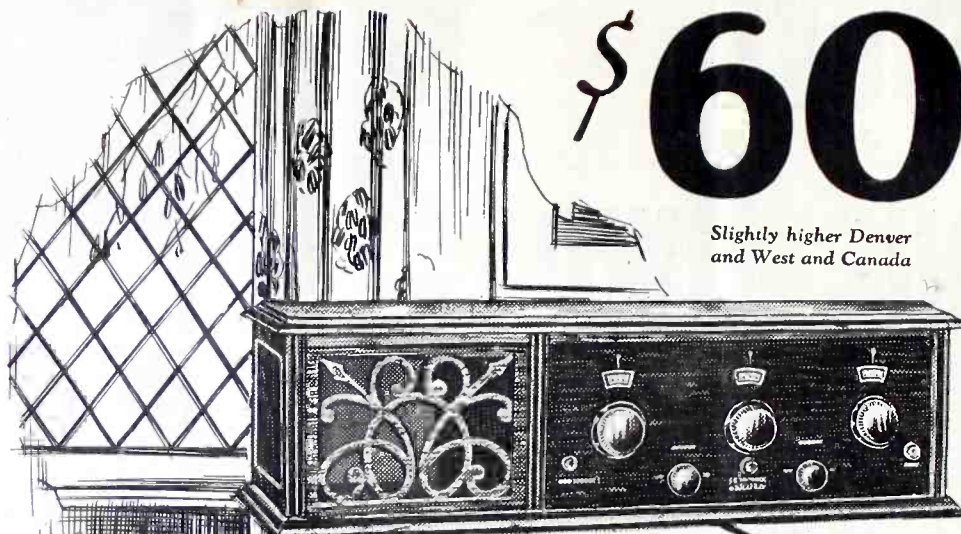

Slightly higher Denver
and West and Canada

Model 5-F-5

The World's Greatest Radio Receiver

New and Improved
**FRESHMAN
MASTERPIECE**

**With Built-in Loud Speaker of
Great Volume and Superb Tone**

A five tube tuned radio frequency receiver encased in a heavy, genuine five-ply mahogany cabinet.

Equipped with the new Freshman straight line wave-length condenser with vernier adjustment, permitting you to tune in the station you want, without interference, over the entire broadcasting range.

**For Sale by Authorized FRESHMAN Dealers
only, who also install and service them.**

*Write for 24-page illustrated booklet full
of useful information for all radio fans.*

CHAS. FRESHMAN CO., INC.

Freshman Building, New York
2626 W. Washington Blvd., Chicago