

1925

RADIO WORLD

Title Reg. U.S. Pat. Off

Vol. 8. No. 9. ILLUSTRATED Every Week

135-191



C. E. MISKA

THANKSGIVING

SAVE MONEY

Order right from this page. These special values are only a few examples of the many Barawick bargains shown in our new Catalog and Radio Guide.

In ordering, simply write down the article numbers you desire, their name and price and enclose remittance with your order. All goods guaranteed.



GUARANTEED "A" STORAGE BATTERIES
Shipping weights, 40 to 65 pounds.
7L1591—6 volt 60 amp. \$7.85
7L1592—6 volt 100 amp. 9.95
7L1593—6 volt 120 amp. 11.85

AUTO BATTERIES
7L1594—6 volt, 100 amp., 11 plate. \$9.85
7L1595—6 volt, 120 amp., 13 plate. 11.85
7L1596—12 volt, 7 plate. 15.85

Shipped from warehouses in Chicago, St. Paul, Kansas City, New York, Baltimore, Dallas, Oakland, Portland, Ore., or Atlanta, Ga., whichever is nearest to you.

STORAGE "B" BATTERIES
7L1576—24 volts Dry. Each. \$3.65
7L1577—48 volts Dry. Each. 6.95
7L1578—24 volts Wet. Each. 4.15
7L1579—48 volts Wet. Each. 7.70
Shipping weights, 18 to 45 pounds.



L396—E-Z Plugs. 28c
Postage 3c extra



FAMOUS MARVELO TRANSFORMERS
Equal or superior in tone quality and volume to any audio frequency transformer at any price. Regular models.

COMPLETELY SHIELDED
L1121—2 to 1 \$2.75
L1120—3 1/2 to 1 2.25
L1119—6 to 1 2.50

SEMI-SHIELDED
L1124—2 to 1 \$2.50
L1123—3 1/2 to 1 2.00
L1122—6 to 1 2.25

MANUFACTURERS' MODEL
L1101—2 to 1 \$2.25
L1102—3 1/2 to 1 1.75
L1103—6 to 1 2.00

SUB-PANEL MOUNTING MODEL
For sub-panel mounting connections below panel. Completely shielded.
L1106—2 to 1 \$2.65
L1107—3 1/2 to 1 2.15
L1108—6 to 1 2.40

LONG MODEL
Semi-shielded, for use where longer and narrower model is desired.
L1116—2 to 1 \$2.85
L1117—3 1/2 to 1 2.15
L1118—6 to 1 2.40

CHAMPION LOUD SPEAKER
Biggest Value on the Market



IL 613—Special Price \$4.59
Shipping weight 6 pounds, postage extra
IL1727—Special \$10 Speaker only \$6.95
IL1725—Radialamp Loud Speaker \$19.75
IL1733—Rhamstine or Dulcetone Phonograph Speaker \$7.65
IL 620—Baldwin Speaker, Std. Model \$18.25
IL 619—Baldwin Speaker, Utility Model \$12.75
IL 621—Utah \$25 Loud Speaker \$18.95
IL 618—Brandes \$10 Table Talker \$8.65
IL 610—Frost Musette \$9.95
IL1729—Utah Bee Hive Speaker \$11.25
IL 605—Cabinet \$25 Radio Speaker \$13.95
L174—Disc Speakers—Pathe, Crosley, Far- rand or Spartan. \$13.95
Average shipping weight, 10 pounds.
L 602—Baldwin Loud Speaker Unit \$6.95
L 607—Utah Loud Speaker Unit 7.45
L 757—Morrison Loud Speaker Unit 6.35
L 758—Special Loud Speaker Unit, Special 2.58
L 755—Baldwin Type C Unit 4.75
L 756—Baldwin H. Unit 4.80

OUR LEADER Console Radio Cabinet

The Best Buy Ever Offered on a Radio Console

A fine looking high grade article of furniture especially designed to conveniently hold any radio set with batteries, charger and all accessories. Elegant polished mahogany finish. Upper compartment for set, length 33 inches, height 10 inches, depth 10 1/2 inches, takes set 1 cabinet or on panel only. Lower compartments both 12 inches high, 16 inches long, 12 1/2 inches deep. Overall height 42 inches, length 37 inches, depth 14 inches. Wiring slots in rear for easy connections. Strong durable construction. Paneled doors. Front leaf opens flat and serves as arm rest. Can be entirely closed and locked.
\$35.00
IL902—List price, \$60.00. Each, net.

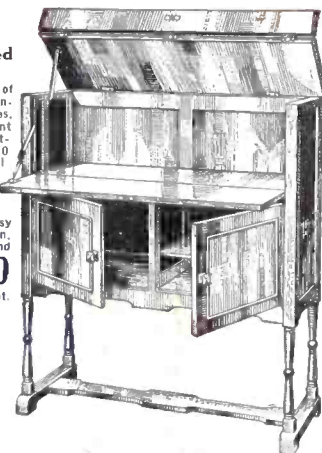

Shepherd Guaranteed Tubes

Fully guaranteed equal of any other standard \$2.50 tube.
L1532—0199 Type Tube
L1530—0201A Type Tube
Each, \$1.55
Lots of 10, \$1.35



Our Special Phones

L 770—Good Headset with 5 ft. cord. Special \$1.75
L 768—Brandes 2000 Superior 3.85
L 769—Brandes 3000 Navy 4.85
L 754—Baldwin Type C 8.19
L 764—Frost 174, 2000 Ohm. 2.29
L 766—Frost 175, 3000 Ohm. 2.95
L 765—Frost 172, 3200 Ohm. 4.85
L1710—Ekko Double Adapters 1.68

Postage each 8c extra



The Very Latest
Radio Book
Free

This Book Full of Radio Bargains.

Shows Big Savings on parts, sets and accessories.

Our prices are lowest on highest quality standard goods.

Send for your copy today

ALL ORDERS SHIPPED SAME DAY RECEIVED

Mail This Coupon for Free Radio Guide

Name

Address

Name of Radio Fan

Address

The Barawick Co.
102 So. Canal St., Chicago, Ill.

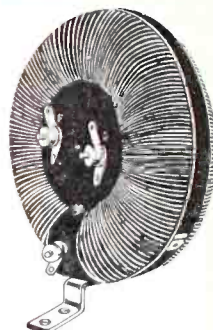

MARVELO TOROIDAL COIL KIT
A complete kit of three Marvelo Toroidal or Balloon Shape Coils, sufficient to change over or build a 5-tube radio frequency circuit set to this new and popular method.
L2106—Marvelo Toroidal Coil Kit, complete set of three **\$6.85**
Postage 10c extra.

COIL AND CONDENSER KIT
Kits equipped with the famous Marvelo type of condenser, a combination that works in perfect harmony. The condensers are the low-loss, straight-line frequency type in improved design.
L2107—Complete kit of **\$14.50**
three
Postage 20c extra.

ERLA PRODUCTS
L 578—Erla \$5.00 Reflex Transformers for 1 to 3 Tube Sets—Special \$2.59
L 579—Erla Reflex No. 2 for 2 and 3 Tube Sets—Special 2.59
L 599—Erla Selector, \$5.00 list—Special 2.69
L 598—Erla A. F. Transformer 3 1/2 to 1—Special 2.98
L 597—Erla A. F. Transformers 6 to 1—Special 2.98

OTHER TRANSFORMER BARGAINS
PL533—All American 3 to 1 \$4.05
PL532—All American 5 to 1 4.25
PL531—All American 10 to 1 4.25
PL534—All American Push Pull 10.80
L533—Bautman Lyrac 8.10
L 589—Thordarson 2 to 1 3.95
L 587—Thordarson 3 1/2 to 1 3.30
L 580—Thordarson 6 to 1 10.35
L 586—Thordarson Push Pull 3.95
L1872—Karas Harmonik 5.95
L1131—Jefferson Type 45 5.10
L1132—Jefferson Type 41 3.45
L1134—Jefferson Star 3 to 1 2.20
L1133—Jefferson Star 6 to 1 2.40



ECLIPSE "B" BATTERIES
Exceptional Values
IL1553—45 -Volt, Large Size, Special \$2.53
IL1551—22 1/2 -Volt, Large Size, Special 1.30

BRIGHT STAR "B" BATTERIES
IL184—22 1/2 -Volt, Large \$1.55
IL179—22 1/2 -Volt, Medium 2.65
IL188—45 -Volt Horizontal 1.25
IL183—45 -Volt Upright 2.75
IC176—45 -Volt, Jumbo 3.80
L 181—22 1/2 -Volt, Upright 1.22
L 180—22 1/2 -Volt, Portable95
L 204—Dry Cell "A" Battery37
L 184—4 1/2 -Volt "C" Battery38
L 197—7 1/2 -Volt "B" Battery73
L 189—Battery Meter 0-50 Volts.76

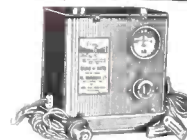

A AND B AUTOMATIC HOMCHARGER
The new improved model. One of the best known. A fool-proof, shock-proof, self-polarizing battery charger for both A and B storage batteries. Charges at from 5 to 7 amperes.
L1201—For 6-volt battery. List, \$19.50; Net \$12.57
L1203—For 12-volt battery. List, \$19.50; Net \$12.57
L1634—For 6-volt battery—for use on 110-volt, 25 cycle A. C. current. List, \$19.50; Net \$12.57
Shipping weight, 12 pounds. Postage extra.
IL1642—Junior Vibrator Charger \$8.45
IL1628—Sterling Super-Charger \$8.45

RADIO WORLD

[Entered as second-class matter, March, 1922, at the post office at New York, N. Y., under the Act of March 3, 1879]

A Weekly Paper Published by Hennessy Radio Publications Corporation from Publication Office, 145 West 45th Street, New York, N. Y. Just East of Broadway Telephones: BRyant 0558, 0559

Vol. VIII. No. 9. Whole No. 190. 191

November 21, 1925

15c per copy, \$6.00 a year

The DX Super-Heterodyne

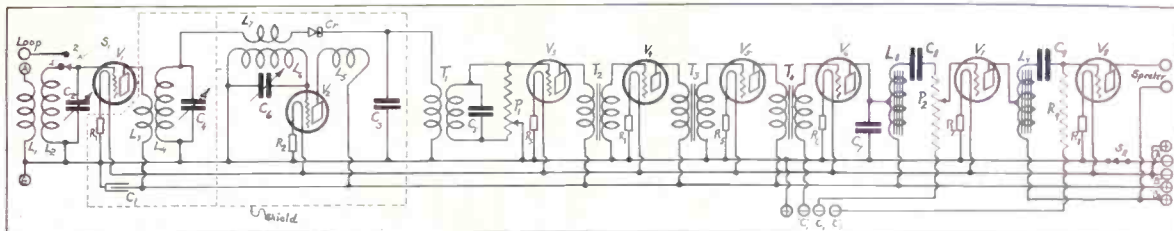

WIRING DIAGRAM (Fig. 1) of the 8-Tube DX Super-Heterodyne described by J. E. Anderson

Receiver Especially Designed for Picking Up European Stations During International Week (Jan. 24)—First Detector is a Crystal, Second is a Tube, Using the Grid Bias Method, Instead of the Leak-Condenser Combination—No Rheostats Used—What Tubes Are Best.

By **J. E. Anderson**
Consulting Engineer

NOW is the time to begin preparations for participation in the international radio tests that will take place in January.



J. E. ANDERSON

Everybody will want to try his luck in logging London, Aberdeen, Berlin, Paris, and stations in other European cities. To be reasonably sure of success the fan must have a very sensitive receiver. The ordinary broadcast set will not be sensitive enough. Previous international tests have shown that the Super-Heterodyne receiver gives the best chance of success, and consequently the majority of the fans who will try for the European stations will equip themselves with receivers of this type.

But even with a Super-Heterodyne, if positive results are to be obtained the receiver must be built along sound lines and good parts must be employed in its assembly. I have had good results with circuits of the type shown in the accompanying diagram, both with completely assembled receivers and with the various component parts. A circuit of this type will give a good account of itself during the tests. The receiver is much more sensitive than required for ordinary broadcast reception, but volume controls have been

provided so that it may be used for even the closest transmitting stations, and the audio frequency amplifier has been designed for quality reception.

Uses Loop on Outdoor Aerial

The input circuit has been so arranged that either an outdoor antenna or a loop may be employed according to requirements. The antenna coil L1 and the secondary coil L2 are built in permanently in the set and may be any good commercial RF transformer, such as an Aero, a General Radio, a Bruno or one of a number of other good makes. While a variable coupling arrangement is not necessary it is desirable for reasons which will be brought out later. The usual method of employing a double circuit jack for changing from antenna to loop has been avoided in this circuit on account of the losses which occur in jacks. In place of this a switch S1 has been provided. When an outdoor antenna is to be used this switch is set on point No. 1 and the antenna is connected to binding post A and the ground to post G. When a loop is to be used the switch is set on point No. 2 and the loop is connected between the posts marked loop and G, the antenna, of course, being disconnected. The switch merely consists of a short length of flexible wire permanently connected to the condenser and grid, with the free end provided with a midget plug or a connecting lug which may be connected to either point No. 1 or No. 2.

The type of coils to use for L3 and L4 depends on the individual. If three main tuning controls are not objectionable then three condensers should be used, L3L4 should be similar to L1L2. This is capable of the greatest sensitivity and the greatest selectivity. But most persons prefer only two main tuning controls in a Super-Heterodyne. For these there are two courses. The first two tuning condensers may be geared together so that L2 and L4 are tuned simultaneously, or L3L4 may be an aperiodic radio frequency transformer. In the first case the two condensers must be identical and the two sets of tuning coils must also be identical. This requires careful adjustment of the distributed capacities of the circuits and of the inductances of L2 and L4. This adjustment may easily be made with a little care, and it will be facilitated if the coupling between L1 and L2 is variable and made loose. This arrangement also requires that the loop be adjusted to have the same inductance and distributed capacity as L4. This, too, may be brought about without very much trouble. When these adjustments have been accomplished the arrangement is just about as sensitive and selective as if two separate condensers

were used, and it is vastly simpler to operate. If an aperiodic transformer be used for L3L4 this adjustment is not necessary and condenser C4 may be omitted. The arrangement will not be quite as selective or as sensitive as the other two but the receiver will still be good and it will be simple to tune.

The coils associated with the oscillator, L5L6L7, may be of the same type as the previous coils. There are many good oscillator coils on the market which may be used, and may be obtained in any radio store. The coupling between the grid and the plate coils should be fixed, but the coupling between the grid coil L6 and the pick-up coil L7 should preferably be variable.

Crystal is First Detector

It will be noticed that a crystal detector is used as a modulator for changing the frequency. The writer has found that this gives fully as good results as a tube detector, and in addition it is much more economical in operation and eliminates the tendency of the first tube to oscillate. In order, however, that the use of a crystal detector be satisfactory it must be of the fixed variety. The new type Carborundum detector was found quite satisfactory, as this remains in adjustment indefinitely.

The intermediate frequency input transformer should be of the air core type and should be sharply tuned to some desired frequency. The next three intermediate frequency transformers should be of the shielded, silicon core type. There are several good makes of transformers on the market which may be employed, but of whatever make all should be of the same so that they will be accurately matched. The General Radio intermediate frequency air core and iron core transformers are especially suggested as suitable. These are adjusted to be most efficient at a frequency of 30,000 cycles. At this low intermediate frequency the amplification per stage is high, the selectivity attainable is very good, and there is very little tendency for the amplifier to oscillate. The iron core and the shielding also help to minimize this tendency.

The detector, V6, employs the negative grid method instead of the usual grid condenser and leak. This method is more stable in operation and is usually more satisfactory on strong signals. The correct grid bias to be used for best operation is somewhat critical, but may be easily found by trial. It should be considerably more than the bias necessary for best operation when the tube is used as an amplifier. When the correct value has been found there is very little difference between the two methods as to sensitivity, but for stability and quality the

Grid-Biased Detection Used

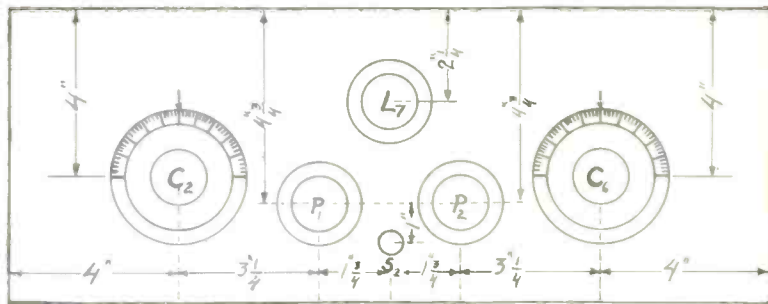

THE PANEL LAYOUT (Fig. 2) of the 8-Tube Super-Heterodyne

grid bias method is superior. If it is desired to use the other method, a grid condenser and a grid leak of the usual values may be inserted in the grid leak of the detector tube and the grid return lead should be connected to the positive end of the filament instead of to the grid battery.

Use Low-Loss Condensers

The three tuning condensers (or two, if L3L4 is aperiodic) should each have a maximum capacity of .0005 microfarad, and they should be equipped with vernier dials. Whether they are of the straight-line capacity, wavelength, or frequency depends on the preferences of the fan himself. The condensers should be of the low-loss variety.

Condenser C1 is merely a by-pass for radio-frequency currents across the batteries. It helps to reduce stray couplings. Its value should be anywhere from .001 mfd. up. Condenser C3 is also a by-pass, or it may be used as a tuning condenser for the primary of the I. F. input transformer. If it is used merely as a by-pass it may be a fixed value .001 mfd. capacity condenser. If it is used for tuning it may be an XL variable condenser of the proper range. The range depends on the coils which are used in the intermediate frequency filter as well as on the inductance in the primary of the input transformer. The correct value must be found by trial. Condenser C5 is a tuning condenser and may be an XL Vario Denser. Its correct value also depends on the other coils as well as on the inductance of the winding across which it is connected. If General Radio coils are used throughout it may be omitted since the correct value condenser is built into the transformer. It is a .0005 mfd. condenser in this case.

Condenser C7 is a by-pass for the intermediate frequency current across the primary portion of choke coil L8. The correct value to use is about .002 mfd. The two stopping condensers C8 and C9 should be very large, preferably not less than 1.0 mfd. each. Four mfd. each would be better. The smaller these two condensers are the greater will be the suppression of the low notes in the signal, and the poorer the quality. It may also be said that the larger the value of condenser C7, the greater will be the by-pass effect on the high notes, and again the quality will suffer. Hence C7 should be no larger than necessary, and C8 and C9 should be as large as possible.

The Volume Controls

Volume is controlled by means of two high resistance potentiometers P1 and P2. These are placed respectively in the input or grid circuits of the first intermediate-frequency amplifier and the first audio-frequency amplifier. These positions are important because they make possible the operation of each section of the amplifier at the lowest current level consistent with a given output in the loud speaker, that is, so that the signal fluctuation in any one tube is the least for a given output. This is in the interest of quality, since the overloading effect in each tube is the minimum. This is a point which

is not very often realized, the control being put in haphazardly, or in many cases in the last tube, which is the worst possible position. When the potentiometer is placed in the last stage it will control the volume in the last stage, but not in the previous tubes; and if any one of the first tubes becomes overloaded the quality of the signal is ruined, and no amount of manipulation of the potentiometer will improve it. The potentiometers should be of 1/2-megohm resistance like the Centralab, or similar instruments if available.

Uses No Rheostats

It will be observed that not a single rheostat has been used in the set. This may not meet with the approval of those who have acquired the turn and twist it mania, but it does meet with the ideas of those who prefer to confine their twisting to the necessary controls. It is consistent with simplicity of construction and operation, with uniform results, with long life of tubes, with quality of signal, and with the trend of modern design. Eight Amperites R1 to R8 are used instead of rheostats. There are other forms of ballast resistances which may be used in place of these. The type of Amperite or ballast resistance to use depends on the tubes which are used and on the voltage of the filament battery.

The tubes recommended in this receiver are UV199 type for the first five and UV201A for the last three. A power tube may be used in the last stage to good advantage and a high mu in the second from the last. This combination of tubes requires a 6-volt filament supply, and since three volt tubes are used on a six volt battery, the Amperites in the first five tubes should be No. 6V199 and in the last three No. 1A, unless special tubes are used in either or both of the last two stages.

The grid return leads of the first five tubes have been connected to the negative side of the A battery. This places a grid bias on these tubes, if small tubes are used. The plate voltage on these tubes must therefore be adjusted for this bias. From 60 to 67 volts is about the right value, but various voltages may be tried to determine which gives the best results. The plate voltage on the detector is about the same as that on the previous tubes, since its plate return lead is connected to the same supply bus-bar. But the grid bias of the detector must be different, as has already been stated. For that reason the grid return lead from that tube terminates in the binding posts marked C1. This is one of the terminals on the small C battery. Binding posts C2 and C3 are for the grid bias on the last two tubes. If these two tubes are of the same type they should have the same grid bias, and these two posts may be joined together. The plate voltage on the last two tubes should be very high—135 volts or more—and the grid bias should be adjusted to give the best results for the plate voltage used.

The two coils L8 and L9 are auto-transformers like the Thordarson Autoformers.

LIST OF PARTS

- (Based on the use of a double condenser)
 One double condenser, each half .0005 mfd.
 One single condenser, .0005 mfd.
 Two dials, 4", preferably vernier.
 One mica by-pass condenser, C1, .001 mfd. or larger.
 One by-pass, C3, .001 mfd. or an XL Vario Denser.
 One by-pass, C7, .002 mfd.
 Two stopping condensers, C8 and C9, 1.0 mfd. each or larger.
 Two low-loss tuning coils, L1L2 and L3L4; Aero coils.
 One low-loss oscillating coil, L5L6L7, with variable pickup; Aero.
 One Carborundum crystal detector.
 One filter transformer intermediate frequency; General Radio.
 Three iron-core intermediate frequency transformers; General Radio.
 Two auto-transformers, L8 and L9; Thordarson autoformers.
 Two 500,000 ohm potentiometers, P1 and P2; Centralab.
 One 500,000 ohm grid leak, R9, with mounting.
 Five Amperites No. 6V-199 and three No. 1A Amperites with mountings.
 Five small standard sockets and three large standard sockets.
 Five UV199 or similar tubes and three large tubes.
 One switch S1 made of two pup jacks and one pup plug, Yaxley.
 One filament switch, S2, Yaxley.
 Ten binding posts or push posts.
 Four small binding posts for C battery connections.
 Sheet metal for shielding.
 One panel 7x18".
 One cabinet to match, depth 10".
 One baseboard to match panel and cabinet.
 One small knob for pick-up coil to match potentiometer knobs.
 One specially adjusted loop aerial.

This type of audio-frequency amplification is rapidly gaining favor on account of its advantages of high quality reproduction and economy in operation. The quality obtainable with this type is like that obtainable with resistance coupled stages and the required plate supply voltage is only a fraction of that required for resistance coupling to get the same effective voltage on the plates.

In assembling this receiver one of three methods may be followed. The tubes and transformers may be strung out in a long string and housed in a box as long as a railroad car. This is fine for those who have a long reach or for those who have no objection against traveling while operating the set. The set may also be assembled in two stories using a cabinet of moderate length and height. The third way is to assemble the receiver in two rows on the same level, one back of the other. The set may then be built on a 7x18" panel with a cabinet about 10" deep. This method is my preference. A suggested panel layout for such an assembly is shown in Fig. 2.

In the circuit diagram of Fig. 1 the dotted lines represent shielding. This is usually very desirable but not always necessary. If it is used it should be put in thoroughly and the material should be fairly heavy sheet metal such as aluminum, brass or copper. The locations of the shielding in the drawing is merely suggestive. The idea is that the oscillator and associated parts should be shielded from the rest of the circuit and that the modulator circuit should also be isolated. The first tuned circuit need not be—should not in fact. The shielding must be placed at some distance from the tuning coils.

A Set That Stresses Quality

By Lewis Winner

Associate, Institute of Radio Engineers

ONE stage of radio-frequency amplification is usually all that can be safely put ahead of a crystal detector without introducing distortion. This is done in the circuit shown in Fig. 1. A regeneration or self-oscillation control is provided by introducing a variable primary in the interstage coupler. The purity of tone that the crystal detector provides needs no argument. The quality of tone is well preserved by using three stages of a *auto*-transformer coupled AF.



LEWIS WINNER

The hookup is along the same general lines as the one I discussed in last week's issue but affords a little better stability and tone quality.

Two and then three steps of RF were tried. These were found to be of little value, as the crystal could not stand the load. The added stages of RF were only found to increase the selectivity of the set, which was not necessary.

The receiver shown in the diagram is a bit less selective than the one described last week, but there is more volume. The signals which were obtained from this set were much better as to quality. The same selectivity as that obtained from last week's set can be had if the antenna coil is used with the two separate windings. In this manner the grid circuit will not be connected to the antenna as is with this set. This is what causes the set to be more voluminous.

Winding the RFT

The antenna coil, L1, is wound on a form 3 1/4" diameter, and 4" high. This form may be of the air type, containing only 3 or 4 strips for supporting the windings. Beginning at either end, anchor the winding in a binding post, which is placed on one end of the circular form. Wind 8 turns, and make a tap. This is done by pulling out the wire two or three inches. A loop is then made by a twist of the wire. Then the winding is continued. There are 53 turns placed on the coil, the 8 for the primary and then 45 for the secondary, counting from the tap.

No. 22 single cotton covered wire is used. Be sure when winding this coil to keep the turns very close to each other. Keep them as tight as possible. After the coil has been completely wound and the beginning and the end of the winding have been safely anchored in respective pin holes and at binding posts, the tap should be attended to. With a knife scrape off the insulation at the top. Place a drop of solder on the tap, joining a 5" flexible lead thereto. This tap lead goes to a binding post which is situated near the coil and connects to antenna.

The RF transformer with the variable primary is the next one to be wound. First procure a form 3 1/4" in diameter and 3" high. All that is wound on this form is the secondary L3, where 45 turns are placed. Now the primary L2 is wound on a form, 2" in diameter and 2" high.

Special attention should be paid to the construction of the coil as it is a bit different from any other. On the stator form, on one of the circumferences, drill a 1/8" hole. A hole of the same dimensions should be drilled on the opposite side of the same circumference. Now take the

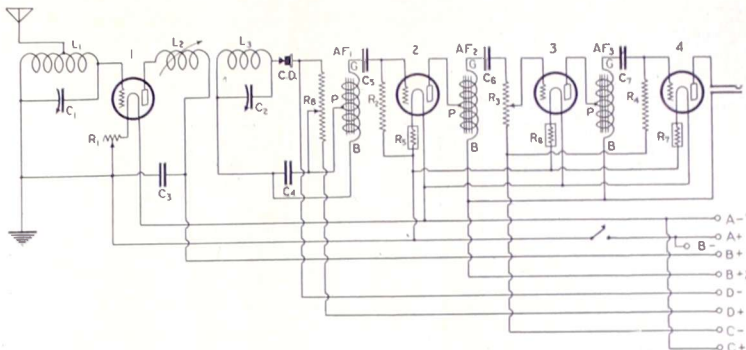

A VARIABLE PRIMARY L2 is used in the above 4-tube circuit to control oscillations in this tone quality set. (Fig. 1).

LIST OF PARTS

- One Antenna Coil (L1).
- One RF transformer, with a variable primary (L2L3).
- Two variable condensers, .0005 mfd. (C1, C2).
- Two .001 fixed condensers (C3, C4).
- One 400-ohm potentiometer (R8).
- Two 500,000 ohm grid leaks (R2, R4).
- One 500,000 ohm potentiometer (R3).
- Three ballast resistors (R5, R6, R7).
- Three Thordarson Autoformers (AF1, AF2, AF3).
- One 10-ohm rheostat (R1).
- One single circuit jack.
- One crystal detector (CD).
- Three 1 mfd. fixed condensers (C5, C6, C7).
- Four sockets.
- One 7x24" panel.
- Two 4" dials.
- One extension shaft.
- One pair of brackets.
- One socket shelf, 22x2 1/2".
- Accessories: Terminal strip, connecting wire, 5 tubes, loud speaker, etc.

rotary form. Drill a hole, 1/8" in diameter at one circumference. Now drill a hole directly opposite on the same rotor form. Take a piece of brass tubing, 4 1/2" in length, and 1/8" in diameter. See if this tubing passes through these holes. Now take the small primary form and wind 8 turns. Bring the beginning and the ends of the winding to binding posts on the stator form by means of flexible wire. These flexible leads should be 5" in length. Take care that the lead is not broken as a great deal of trouble will be encountered otherwise. There will be four posts on the stator form. Place the beginning lead of the primary near the end winding of the secondary or on one end of the form, while the two other posts should go to the other side of the form.

The shaft is again placed through the drilled holes, and soldered in place, so that the primary coil moves about without any difficulty.

If 1/4" rod is handier to get, drill 1/4" holes.

Placing the Parts

When drilling the panel you automatically place the parts. The same panel layout as given for the set last week may be used. There are two articles taken off the front of the panel. This is the double circuit jack and one switch. Those who desire to place the variable primary dial on the front of the panel may do so. A small knob attached to an extension shaft may be used. The knob is placed on the left hand side of the panel, midway between the C1 dial and the end of the

panel. There is no absolute necessity for placing this control on the front of the panel, as the rotary primary is not necessarily moved after once being set.

For the placing of the parts refer to last week's issue. The only change that takes place is the putting of the new Autoformer on the top of the shelf, the audio-frequency transformer being omitted. Socket 2 is then shifted over. The coil which has the variable primary can be placed underneath the subbase, with the small adjustable knob sticking up from the top. This will give you more room for the large transformers. It will also place the coil out of the field of the other coil.

Wiring the Set

The beginning of the antenna coil, L1, goes to the ground terminal on the terminal strip. The tap, on this coil goes to the antenna post of the terminal strip. The end of this coil goes to the G post on socket 1. The ground post also goes to the rotary plates of the variable condenser, C1, and to the arm of the rheostat, R1. This also goes to one terminal of the fixed condenser, C3. The stator plates of this variable condenser goes to the G post on socket 1. The beginning of the variable winding, L3, goes to the P post on socket 1. The end of this winding goes to the other terminal of the fixed condenser, C3. The resistance wire of the rheostat, R1 goes to the F- post on socket 1. The F+ post of this same socket goes to the F+ post of socket 2. The beginning of the secondary winding, L3, goes to rotary plates of the variable condenser, C2. It also goes to one terminal of the fixed condenser, C4, and to the B post of the Autoformer. The end winding of this secondary goes to the stator plates of the same variable condenser, C2, and to the catwhisker of the crystal detector. The base of this detector goes to the resistance wire of the potentiometer, R8. It also goes to the D- post on the terminal strip. The other terminal of the fixed condenser, C4 goes to the arm of the potentiometer, R8. The other resistance terminal of the potentiometer R8 goes to the D+ post on the terminal strip. The arm of this potentiometer goes to the P post on the Autoformer. Were you to use a pair of phones, you would take the P and the B post connections off, and attach them to the two leads of the phones. The G post on AF1 goes to one terminal of the condenser C5. The other terminal of the condenser goes to the resistance, R2, and to the G post of the socket 2. The other terminal of the resistance, goes to one terminal of the resistance, R5. The other terminal of this resistance goes to the F- post on socket 2. The F+ of this socket goes to the F+ post on the next socket 3. The P post

(Concluded on page 26)

A Resistance-Controlled Set

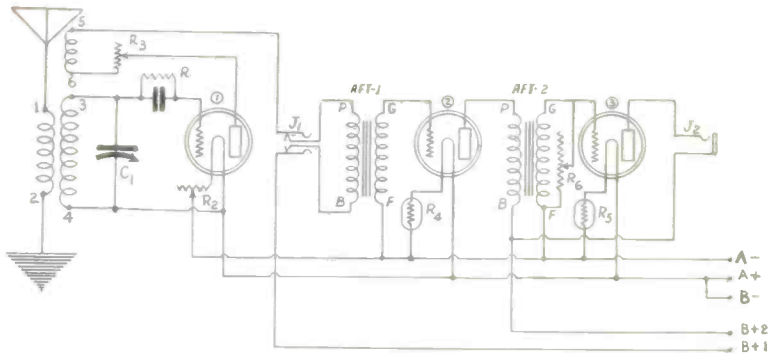

FIG. 1, the electrical diagram of the receiver.

By Percy Warren

THE most that can be accomplished on three tubes, in volume and DX, is by the use of the 3-circuit tuner, followed by two transformer stages of audio. There are many variations of the fundamental design of the detector part and there are respective advantages in each. The set shown herewith has the following main features:

(1) A variable resistor controls regeneration.

(2) A variable resistor controls volume on the audio side.

Smooth regeneration control is obtained by using a fixed tickler with the variable resistor in parallel or, as in this case, in series with the plate coil.

The tickler, placed in inductive relation to the grid of the tube, produces feedback, which makes the tube oscillate when the resistance is not high enough to prevent that.

One terminal of the variable resistor R3 should go to the plate and the other to the coil. Now as we vary the resistance of this, we can increase or decrease the effective inductive value of the tickler.

Wiring the Set

On the Clarotuner, used in the detector circuit, there are six posts, each one of which is numbered. Post 1 goes to the antenna clip on the terminal strip. Post 2 goes to the ground clip. Post 3 goes to one terminal of the grid condenser and to the grid leak, R. The other terminal of this combination goes to the G post of socket 1. Post 3 also goes to the stationary plates of the only variable condenser, C1. Post 4 goes to the rotary plates of this same condenser, and to the F+ post of socket 1. Post 6 is internally connected to one terminal of the stationary tickler winding. One terminal of the resistance R3 goes to the P post of socket 1. This has 6 marked on the post. Post 5 goes to the top terminal of a double circuit jack, if such a jack is to be used. Otherwise connect this terminal to the P post of the AFT1.

The B post of this AFT goes to the B+1 post (Det. on strip). If the jack is to be used, connect the B post to the inner terminal, and the bottom to the B+ Det. clip. The G post on AFT 1 goes to the G post on the socket 2. The F post on AFT 1 goes to the A- clip. The P post of AFT 1 goes to the P post of socket 2. The B post goes to the B post of AFT 2, and to the bottom terminal of the single circuit jack. The G post goes to the arm of the Clarostat, and to the G post of socket 3. The resistance wire post of this Clarostat goes to the F- post on the AFT 2. The B posts of both AFT goes to the B+ Amp. clip. Now you can use two individual ballast re-

sistors, R4 and R5, as per diagram, which are placed in the negative leg of the amplifier tubes filaments. All the F+ posts go to the A+ clip. Connect the A+ to the B-.

LIST OF PARTS

- One Clarotuner (includes coils and R3).
- One .0005 mfd. variable condenser (C1).
- One 2 meg. leak (R).
- One .0025 mfd. grid condenser.
- Two low ratio audio-frequency transformers (AFT1, AFT2).
- One single circuit jack (J2).
- One double-circuit jack (J1).
- Two Amperites (1A or 99), R4, R5).
- One Clarostat (R6).
- One 4" dial.
- Two knobs.
- One 20-ohm rheostat (R2).

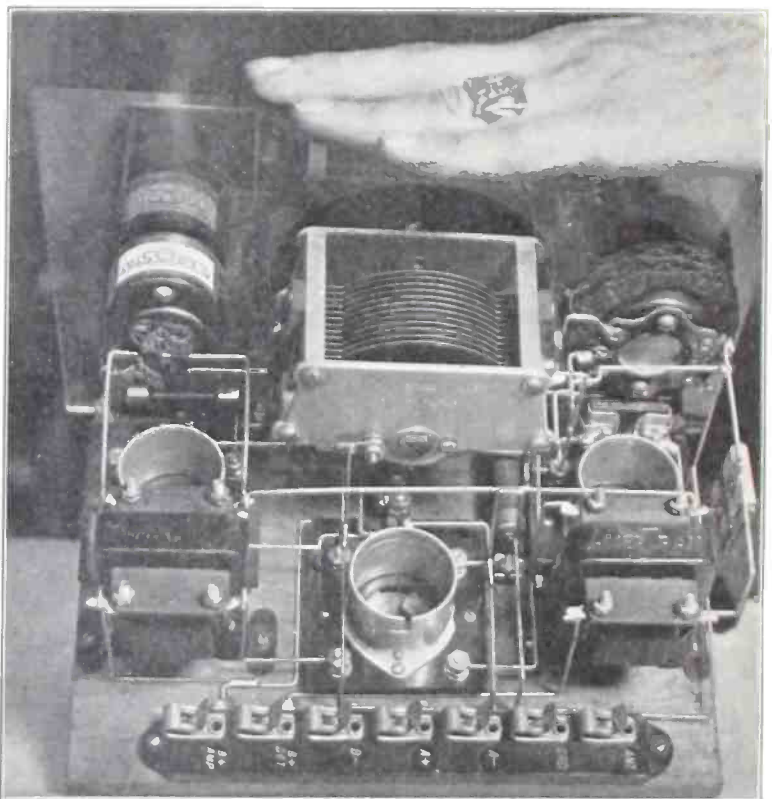

FIG. 2, showing the back view of the set.

Broadcasters Want More Copyright Benefits

A ballot sent from the National Association of Broadcasters to owners of broadcasting stations petitions Congress to extend the meaning of certain sections of the copyright law to include radio broadcasting. The section under discussion is that restraining owners of copyrights from contracting with only one manufacturer of phonograph records and player-piano rolls.

The proposal of the ballot is as follows: "Believing that the doctrine incorporated in the portion of the present copyright law having to do with mechanical production should be applied to broadcasting, we herewith petition Congress to amend section 1, paragraph (e) of the law so that recognition is made of the rights of copyright owners with respect to broadcasting and a fair payment be stipulated for the use of such rights by broadcasters."

Roxy Theatre On Way; Will Have Own "Mike"

Armed with a chisel and hammer, S. L. Rothafel, popularly known as Roxy, inaugurated the demolition of the old car barns at 50th Street and 7th Avenue, New York, where his new theatre, "The Roxy," the largest in the world, is to be erected. This movie house will cost \$8,000,000.

A broadcasting studio will be one of the features of the Roxy Theatre. Here Roxy with his gang will broadcast.

HOW TO BUILD THE POWERTONE, 1 dial, 5 tubes, described in RADIO WORLD, issues of Aug. 29 and Sept. 5. Powertone Trouble-shooting, Sept. 12. Send 45c for all three. Special diagrams and "blueprint in black" included among the many illustrations. RADIO WORLD, 145 West 45th St., N. Y. C.

LISTEN IN every Friday at 7 P. M. and hear Herman Bernard, managing editor of RADIO WORLD, discuss "Your Radio Problem," from WGBS, Gimbel Bros., New York City, 315.6 meters.

An Exposition of Earphones

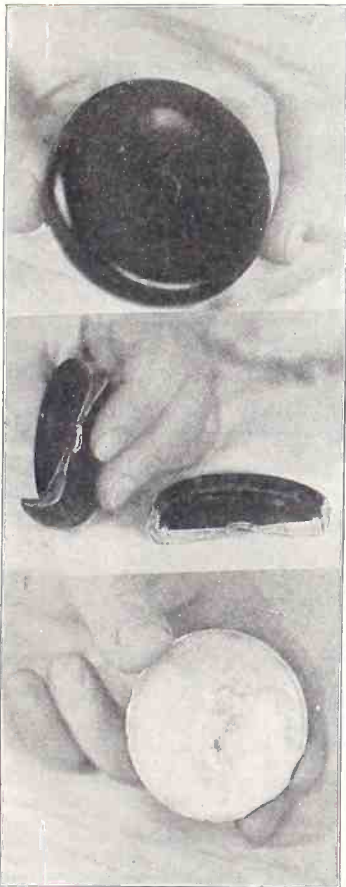

FIG. 1 (top) shows the rubber cap of the telephone. Fig. 2 (center) shows the cap cut in two. Note the thickness of the cap. This is to prevent over-vibration from loud signals. Fig. 3 (bottom) shows the metal diaphragm.

By *Sidney E. Finkelstein*
Associate, Institute of Radio Engineers

ONE of the most useful pieces of radio apparatus is the head telephones, also known as receivers, headphones and earphones. They are very important.



SIDNEY E. FINKELSTEIN

In fact no laboratory is complete without a pair of them. Yet very little is generally known about their operation. Another thing which many fans do not know is how to re-magnetize the permanent magnet, temporarily, when the phones do not give forth signals as loud as they should.

The standard earphone consists of an iron diaphragm, shown in Fig. 3, an electromagnet, with a core, which is permanently magnetized (Fig. 4). The pole pieces are placed close to the iron diaphragm. This is done so that the magnetic leakage may be placed as near to zero as is possible. Since the pole pieces are placed close to the diaphragm, they

are also magnetized by the permanent magnet. This causes the diaphragm to be drawn to the magnet.

Within certain limits, a given amount of flux lines, or the total number of magnetic lines of force in a specified space, may be gotten from a coil which has been magnetized, carrying a strong current, or from a coil having an immense number of windings carrying a comparatively weak current. The strength of the current which flows in the telephone circuit of a crystal receiver is very weak, and amounts to only 1 or 2 microamperes. Loud signals can be obtained only from a telephone having a large number of turns. If you used a tube as a detector, then the current strength is greater, and a telephone having a smaller amount of turns may be used successfully. The amplitude of vibration of an earphone diaphragm with a current of stated strength is dependent upon the product of the current and the number of turns of wire in the magnet coils. That is, this height depends upon the number of ampere turns in the electromagnet. A receiver used in a crystal set should have a resistance of from 2,000 to 4,000 ohms. Very fine wire is used in the electromagnet to produce this high resistance, No. 36 or 38 enameled wire being common. Those receivers having a resistance of 1,000 ohms do not contain enough turns to obtain the greatest magnetic effect from weak currents, as in crystal sets. Yet for tube sets such phones are all right. Because phones have a relatively high resistance does not mean that the signals that will be obtained will be great. That is, there are some phones that have a resistance as high as 6,000 ohms. These phones do not give any louder signals, because there is so much resistance that energy is dissipated into heat and wasted. This often results in weakening the signals instead of increasing them. The phones with 3,000 ohms resistance will be found good in all cases.

Now as to how the phones work. Suppose that a direct current is flowing through the coils of the electromagnet. The magnetism manufactured here is an aiding factor to that given off by the permanent magnet. The diaphragm is then drawn close to the magnet. If the current that flows through the coils is reversed, the complete amount of magnetic lines of force stirred up by the current, opposes those lines of force generated by the permanent magnet. In this manner the pull on the diaphragm is reduced. Therefore, a current which changes in amplitude causes the diaphragm to follow these variations. The resultant sound variations are then given off.

By varying the distance of the diaphragm from the magnet the volume and the quality of the signals can be completely controlled. This is a feature of most loud speakers, where only a phone unit which can stand up under an enormous load is placed in the base. A small adjustable knob sometimes protrudes from the base for regulating the distance of the diaphragm from the magnet. If this is placed too near the pole pieces the signals will be very poor in strength and distortion is present, particularly rattling.

There are many things that may occur in a telephone receiver that will impair it to such a degree that the signals will be very poor. None of these may be cured permanently at home, but they can be aided. If the diaphragm is bent, the only cure is to get a new one and not fiddle around with it, because, you will never get it working right.

Suppose you have dropped the phones

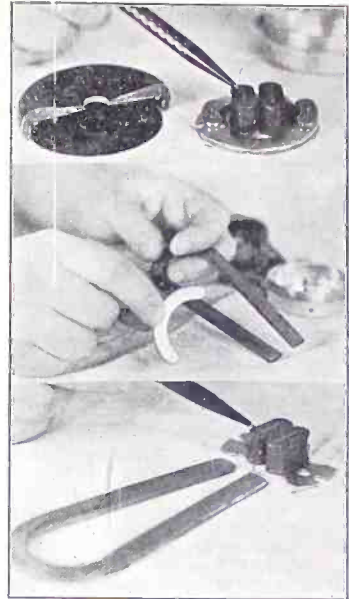

FIG. 4 (top) shows the pencil pointing to the core of the electromagnet, just where the hole piece protrudes. The metal diaphragm and the cap are to the left. Fig. 5 (center) shows the permanent magnet being remagnetized with another permanent magnet. Fig. 6 (bottom) showing the difference between a permanent magnet (the horse shoe) and an electromagnet (the pencil pointing to the electromagnet).

(Photos by Hayden.)

and the magnet has lost its magnetism. This may be cured temporarily by taking a horse shoe magnet and running it up and down the permanent magnet of the phones. This will of course be only a temporary help. Fig. 5 shows how this is done. There are many firms that re-magnetize the phones inexpensively. This however does not give the phone its original strength, and the author advises the owner to get a new phone, as the results in the end will be worth it.

The type of phone unit described here is the standard make. There is another type of phone, invented by Baldwin. This is the type commonly used in the bases of speakers and its operation is entirely different from that of the above type.

Those units possessing a large horse shoe magnet are also capable of reproducing large amounts of volume without distorting the signals, because the magnet generates a large field, and therefore aids the electromagnet, either when pulling down or vice versa. In either direction the pull is very strong.

Indicted as Operator of Unlicensed Station

DAYTON, O.

As innovation in criminal annals was inaugurated when Roger Daugherty was indicted by the United States Grand Jury for operating a radio broadcasting station without a license.

Daugherty's arrest resulted from investigations conducted by agents of the Secretary of Commerce. Prosecution was brought, according to U. S. District Attorney Mau, under an act passed by Congress in 1912. Under this act, the maximum penalty is five years in prison and \$500 fine.

The 4-Tube A-A Receiver

[Part I of this article was published last week. Part II, the conclusion, follows].

By **Herbert E. Hayden**

PART II.

THE variable primary, L1, in the antenna circuit of the A-A Set plays an important part, as it will facilitate the reception of distant stations, may be used as a volume control on DX or locals, and when the set is placed in a regenerative state will control oscillations in a most satisfactory manner. The volume will be found excellent, in fact it is necessary to have a speaker that will stand tremendous volume, otherwise detuning will be necessary to prevent the speaker from being overloaded.

The regenerative condition is certain if the detector B lead is placed at about 45 volts, while no regeneration need normally be expected if this is put at 22½ volts. If no regeneration is obtained at 45 volts probably the tube being used as detector is slow to oscillate, in which case use 67½ volts or thereabouts.

Another aid to a detector tube that responds sluggishly to the temptation to regeneration is the use of a by-pass condenser, shown as C5 in a dotted line in last week's issue. This should be .001 or .002, but should not be incorporated unless found necessary.

Remarkable DX-Getter

When the set is working right it will be found to be a remarkable DX-getter. Moreover, it is a simple set to operate, this end being aided by the omission of rheostats. Note that the three amplifier tubes, one RF and two AF, are controlled as to filament heating by a ¾-ampere ballast resistor, while a ¼-amp. ballast is used for the detector tube.

The circuit diagram last week showed a jack in the final output, used in conjunction with a switch to turn the set on or off, but a filament-control jack may be substituted, to combine both functions, and then there is no danger of pulling the speaker across the floor when you want to put some experimental hookup on test, and decide to remove your pet set for a while. It often happens that the speaker connection is forgotten, the set is lifted, and bang! That noise you heard was your \$32.50 speaker crashing to the floor, perhaps irreparably damaged.

The Wiring

The antenna coil is at bottom, the coupler being mounted that way. Hence connect aerial to the lower terminal of L1, ground to the other terminal thereof. The terminal of the secondary nearer the primary goes to the rotor plates of C1 and to A minus. This A minus lead connects to one side of the ¾-amp. resistor, R3, the other side of which goes to F minus of the three amplifier sockets, 1, 3 and 4. The other ballast, R1, is connected, one side to minus A, the other side to F minus of the detector socket. The A plus lead goes to one side of the switch S, the other side of which connects to the F plus post on all four sockets. A plus and B minus are joined. The stator plates of C1 go to the remaining unconnected terminal of L2 and to grid of tube 1. The plate of this tube is linked with the lower

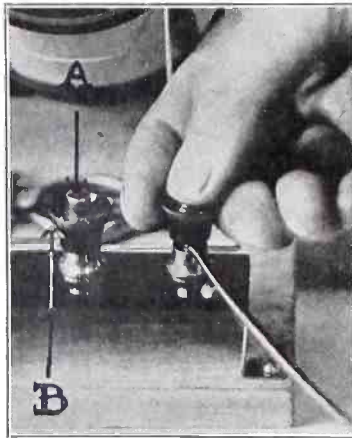

FIG. 4, the antenna lead-in is shown at right, being inserted in the binding post Ant. At left, the arrows indicate the points at which the fingers exert opposite pressure to lift the Bakelite collar (A and B). A wire is inserted in a hole in the shaft, but a lug would fit around the shaft. The post at right will snap into place when the fingers are removed.

terminal of the aperiodic winding which otherwise would be the antenna coil in a 3-circuit tuner. The other side of this coil goes to one side of C3, the .0005 mfd. fixed condenser, the other side of which condenser connects to the terminal of L2 that went to rotary plates of C1. The plate lead of tube 1 also connects to one terminal of the primary L3 of the interstage coupler, the end of which goes to B plus amplifier voltage, say 90. The terminal that goes to B plus should be the end of the winding, and the terminal of L4 that goes to the rotor plates of C2, should be the one nearer L3. This lead to rotor plates continues to A plus, while the other end of L3 is joined to the stator of C2 and to one side of the grid leak-condenser combination, the other side of which combination goes to the grid of the detector socket.

Plate Connection

The plate of the detector tube is connected to P or P1 of the first audio transformer, the B or P2 terminal to B plus detector, say 22½. G of this transformer, otherwise S1, goes to grid of socket 3, while F of this transformer and of the other audio transformer is connected to a common lead, a flexible wire, later joined to C minus. To the A minus lead connect a flexible wire so that it will easily reach the C battery, this being the lead for C plus.

Plate of tube 3 goes to P of AF2, the B post of which goes to B plus amplifier. G goes to grid of the last tube. The F of AF2 has been taken care of. The plate of the last tube goes to one side of the single-circuit jack, the other side of which goes to B plus amplifier.

Use of An FCJ

The jack and switch wiring presupposes the omission of a filament-control jack. If such a jack is used, omit the switch and connect the A plus to one of the two upper prongs of the jack, the other of these two to the common F plus lead to all four sockets. Then the lower part of the jack is wired like the single-circuit jack. Be careful to connect the A plus to one of the two prongs insulated by a piece of hard rubber, fiber or Bakelite.

LIST OF PARTS

- One Aero antenna coupler, L1L2.
- One Aero Wave Trap Unit, L3L4.
- Two .0005 mfd. Amoco Allocating Straight-line Frequency Condensers, C1, C2.
- One Daven Leakandenser, R2, C4.
- Seven engraved G-K Spring Cap binding posts.
- Two Fynur dials.
- One knob for ¼" shaft.
- One .0005 mfd. Hilco fixed condenser, C3.
- One .001 mfd. Hilco fixed condenser, C5.
- Four standard sockets.
- One 7x21" Radion panel.
- One 7x19" baseboard.
- Two Ambassador Low-Boy AF transformers, AF1, AF2.
- One ¾-amp. Daven ballast, R3.
- One 1-A Amperite, R1.
- One Yaxley filament-control jack (or one A battery switch and single-circuit jack, J).
- Two Eureka dial pointers.

WJZ Tries 40 KW

The Radio Corporation of America conducted an unannounced experiment one recent night from its new fifty-kilowatt WJZ transmission station at Bound Brook, N. J. The station is expected to have double the volume of the 500-watt station over which WJZ has transmitted its programs.

Only forty kilowatts were used in the test which was observed by representatives of the Radio Corporation of America at Boston, Washington and Philadelphia to determine whether it came up to expectations. No advance announcement was made of the increase in the strength of the transmission in the hope that radio fans at distant points would report having received the station in better volume without being aware that the increase had been made.

It was feared that the superpower station would interfere with programs transmitted by other stations, but no reports of the kind were received. It is the second fifty-kilowatt station opened in the last year, WGY at Schenectady being the first.

NEW WAVE FOR WBAL

WASHINGTON.

Baltimore's new station, WBAL, which is now experimentally using 375 meters, will be compelled to take a lower wavelength within a short time, according to radio officials of the Department of Commerce. On the 375 meter wavelength there is already KTHS, Hot Springs, Ark., while a new station, KVOO, Voice of Oklahoma, will soon take the air on that wavelength. Bristow is said to have the prior right to this wavelength. It is believed the Baltimore station will be assigned the 245 meter wavelength.

THREE NEW STATIONS

WASHINGTON.

Three class A stations were licensed recently. They follow:

KFAF—A. E. Fowler, San Jose, Calif.....	213.3	50
WNBH—New Bedford Hotel, New Bedford, Mass.....	248	250
WJBP—Seneca Vocational School, Buffalo, N. Y.....	218.8	50

RECENT BACK NUMBERS of RADIO WORLD. 15c each. RADIO WORLD, 145 West 45th Street, New York City.

Full Text of Hoover's Address to the Fourth National Radio Conference

Following is the complete text of the speech delivered by Secretary of Commerce Hoover to the Fourth National Radio Conference, over which he presided, and which he summoned into session:

This is the fourth annual occasion upon which I have had the pleasure of calling together the National Radio Conference for consultation with the Department of Commerce in the solution of the ever new problems which have developed in the growth of this astonishing industry.

We have great reason to be proud of the results of these conferences. From them have been established principles upon which our country has led the world in the development of this service. We have accomplished this by a large measure of self-government in an art and industry of unheard-of complexity, not only in its technical phases, but in its relations both to the government and the public. Four years ago we were dealing with a scientific toy, today we are dealing with a vital force in American life. We are, I believe, bringing this lusty child out of its swaddling clothes without any infant diseases. We have not only developed, in the conferences, traffic systems by which a vastly increasing number of messages are kept upon the air without destroying each other, but we have done much to establish the thics of public service and the response of public confidence.

Some of our major decisions of policy have been of far-reaching importance and have justified themselves a thousand fold. The decision that the public, through the government, must retain the ownership of the channels through the air with just as zealous a care for open competition as we retain public ownership of our navigation channels, has given freedom and development in service that would have otherwise been lost in private monopolies. The decision that we should not imitate some of our foreign colleagues with governmentally controlled broadcasting supported by a tax upon the listener has secured for us a far greater variety of programs and excellence in service free of cost to the listener. This decision has avoided the pitfalls of political, religious and social conflicts in the use of speech over the radio which no government could solve; it has preserved free speech to this medium.

While we have reason to congratulate ourselves on the success of past conferences and on the results that have come from them, we still have difficulties to face and overcome. But before I come to a discussion of them it seems proper to describe some of the progress in the various branches of radio during the twelve months past. We will thus logically arrive at existing conditions and present problems which now press for solution.

Telegraphic Radio

Expansion of International Communication By Radio Telegraph. The rapid extension in the international field by American radio telegraph companies, which has already given us a dominant position, has continued during the past year. Public service has been inaugurated with Colombia, Honduras, Costa Rica and Nicaragua. We have reason to hope that connection with Guatemala will soon be effective, thus forging another link in the communication chain which binds us to our friends in Central America. Direct service with Sweden commenced last December, and other European, South

Local Option On Stations Proposed

Local communities should be granted power to decide who shall broadcast from within their domain, Secretary Hoover said in the keynote speech, opening the Fourth National Radio Conference. The Federal Government, under this plan, would retain control of air traffic, but the scramble for a place on the air, and the treatment of existing stations, would be a matter of local option.

Opposition was registered by speakers to any form of radio censorship other than that afforded by public opinion. There also was a suggestion that the radio industry should reform itself by the appointment of a director who should exercise authority similar to that vested in Judge Kenesaw Mountain Landis in the baseball world and Will H. Hays in the motion picture industry. This suggestion came from H. M. Neely, of Philadelphia.

Secretary Hoover's proposal that local communities should participate in a determination as to who should use the channels available for broadcasting in their localities aroused protest. Complaint was made that under such a system radio activities eventually would come under political control that would destroy the usefulness of the whole structure.

Acting for the National Association of Broadcasters, Paul Klugh presented one resolution opposing local, State or Federal censorship of radio programs and another opposing the adoption of any special form of announcement in connection with paid programs as contrasted with unpaid programs.

American, and transpacific services have continued their effectiveness. Enterprises have been undertaken in the Philippines and in China. Altogether we will, by another twelve months, have systematic radio telegraphic communication with nearly every important country in the world—a matter of vast importance, for it increases the movement of ideas as well as business. We have no pressing problems before us in this field.

Clearing the Broadcasting Band of Code Signals. There has been a gratifying improvement in the character of equipment used in marine communication, which has tended somewhat to reduce annoying interference to broadcasting from this source and to improve that service itself. The recommendations made by the conference a year ago that ships and shore stations should cease to use 300 and 450 meters have been carried out as to our own vessels, and reciprocal arrangements have been entered into with Great Britain, Canada and Newfoundland, by which the vessels of those countries will no longer use these troublesome channels in Morse code communication off our coasts. I am hopeful that like understandings may be reached with other nations whose ships visit our shores. A few months ago we reached an informal agreement with Canada relating to radio use by vessels and shore stations on the Great Lakes, by which 600 meters were abandoned, spark sets discouraged, and communications placed on 715 and 875 meters—one more example of the friendly co-operation between ourselves and our northern neighbor, which has always characterized our radio relationships.

The 600-meter wavelength is today used

almost exclusively for calling and distress work, there being very little other traffic handled on it. Individual working channels have been assigned to the North Atlantic coastal stations and traffic is handled more readily and with considerably less interference. This plan is being extended to the South Atlantic, Gulf, and Pacific stations. It is a very real advance both in the clearing up of another of the sources of interference with telephone broadcasting and in the introduction of more order into marine communication.

Telephonic Radio

It is in broadcasting, of course, that we have again seen the most important changes and in which we again develop the most pressing problems. There has been some improvement on the technical side. Better means of enabling the stations to maintain their assigned frequencies have eliminated much beat note interference. Increase in the frequency range of receiving sets is making the shorter wavelengths of the broadcasting band more available. Improvement in sets has given far greater perfection in tone and quality. Experimental work in the high frequencies is giving encouragement to the further development of the art.

The most profound change during the year, however, has been the tremendous increase in power and the rapid multiplication of powerful stations. When the conference assembled a year ago there were 115 stations equipped to use 500 watts or more. Now we have 197 such stations, an increase during the year of over 70 per cent. This mere numerical expansion of stations falls far short of telling the whole story. A year ago only two stations were equipped to use an excess of 500 watts. Of the new stations, 32 are equipped to use 1,000 watts, 25 to use 5,000 watts, and two still higher power, making 59 in all against two last year. Taking the situation as a whole, we find that a year ago all stations of 500 watts and over were using a total of 67,500 watts. Today, they use 236,500 watts, or a 250 per cent. increase.

A year ago, we were fearful of the effect of greater power. We were told by some that the use of anything more than 1,000 watts would mean excessive blanketing, the blotting out of smaller competitors, the creation of large areas into which no other signals could enter. Some of the most pessimistic even warned us that our tubes would explode under the impact, but our experience so far leads to the opinion that high power is not only harmless in these respects but advantageous. Power increase has meant a general rise in broadcasting efficiency; it has meant clearer reception; it has helped greatly to overcome static and other difficulties inherent in summer broadcasting, so as to give us improved all-year service. Whatever the limit may be, I believe that substantial power increase has come to stay, and the public is the gainer from it.

Service Area

Our experience during the year has somewhat more clearly defined the geographical area within which a single broadcasting station can give complete service. And by "complete service area" I mean the territory within which the average set can depend upon getting clear, understandable and enjoyable service from the station day or night, summer or winter. I do not include radio golf around the edge of these areas in our conception of public service—that game is an

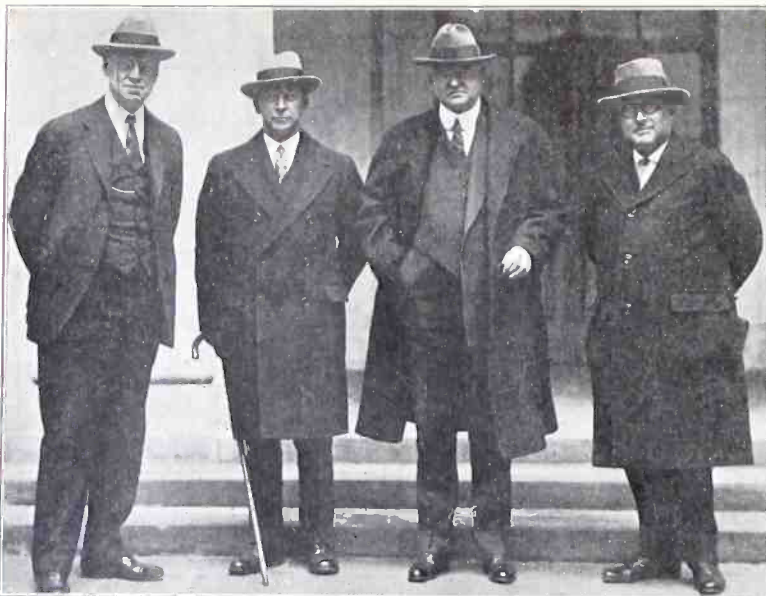

PROMINENT at the Fourth National Radio Conference, (left to right) were W. E. Harkness, Assistant Vice-President, American Telephone & Telegraph Co., in charge of Station WEAF; A. Atwater Kent; Secretary of Commerce Herbert Hoover and Representative A. M. Free, of California.

exercise of skill and the efficiency of your set plus a gamble on the radio weather. But we are not here concerned with it. Actual operation of high powered stations has proven advantageous in broadening the "complete service area," but this area is much more limited than many expected. Subjected to the test of positive and reliable service at all times and all weathers it will be found that the real effectiveness of a station falls within a comparatively small zone.

What these maximum areas of positive service are we do not yet know with any precision. The Bureau of Standards has recently carried on some rather extensive tests, and has accumulated some interesting information, though it is not yet ready to give us any definite figures. If, however, we set up the most rigid standard of complete service in adverse atmospheric conditions and all times of day and year for the average crystal set, then the Bureau's actual intensity measurements would seem to indicate that this radius of the circle served by a 500-watt station will not exceed ten miles, and that a 5,000-watt station will cover about thirty miles and 50,000-watt stations will not cover much over one hundred miles. Obviously more sensitive receiving sets or better atmospheric conditions at once greatly extend these distances.

For some reason or other the area is not always a circle, as you know, and it varies in different parts of the country for the same power. The Department is undertaking the important task of determining these service areas, and you will have an opportunity while here of inspecting some of the equipment we are using for this purpose. I am in hopes that we can secure the resources this year to continue the study further. It will give us information on which to base more efficient allocation of wavelengths. In any event it is obvious that, barring revolutionary discoveries, it is certain that the country must continue to be served with local stations.

Scientific Investigation

No discussion of progress in radio would be complete without an appreciation of the intensive scientific and industrial research now in progress in our universities and in the great laboratories of our commercial concerns, notably the General Electric, Western Electric, Westinghouse and others, and, I might add, in our own

Bureau of Standards. The vast expenditure of money and skill in our great industrial laboratories is not only advancing the application of the art, but has been conceived in a fine sense of contribution to fundamental science itself.

Problems for the Industry

The problems in broadcasting are, as ever before in these conferences, of two categories: Those on the one hand which the industry can and should solve for itself in order to safeguard the public service and its own interest, and, on the other hand, those which can only be solved in cooperation with the government. And again, as before, we should find the solution of as many of our problems as we can in the first category. I have no hesitation in discussing these questions because, as I have said, the more the industry can solve for itself the less will be the burden on the government, and the greater will be the freedom of the industry in its own development.

Interconnection

One of the problems which we considered at the last conference was that of interconnection. This has proceeded during the year in splendid fashion without any necessity of artificial stimulation. A year ago interconnection between stations was only occasional and was a great curiosity. Now it is commonplace. It is becoming more systematized and has gone far toward the creation of long linked systems which will finally give us universal broadcasting of nationwide events. The number of people who throbbed with joys and sorrows at the dramatic presentation of minute-to-minute events of the world's series is one of the most astonishing landmarks in radio broadcasting.

Advertising

Another problem for solution by the industry itself and which now rests prominently on the public mind is that of advertising. There lies within it the possibility of grave harm and even vital danger to the entire broadcasting structure. The desire for publicity is the basic motive and the financial support for almost all the broadcasting in the country today. Publicity largely provides the cost of broadcasting which might otherwise fall upon the listener, who now pays nothing, much as the advertiser pays in the case of the newspaper or magazine. Whether an individual accomplishes his

purpose through the building and operating of his own station or by hiring time on one already built by somebody else makes little difference.

But the radio listener does not have the same option that the reader of publications has to ignore advertising in which he is not interested, and he may resent its invasion of his set. It has been pointed out over and over again in previous conferences, and it might well be reiterated by this one, that advertising in the intrusive sense will dull the interest of the listener and will thus defeat the industry. Furthermore, it can bring disaster to the very purpose of advertising if it creates resentment to the advertiser. If we can distinguish on one hand between unobtrusive publicity that is accompanied by a direct service and engaging entertainment to the listener and unobtrusive advertising on the other, we may find solution. I believe the conference could well consider a definition of this distinction all along the line.

Removal of Stations from Congested Areas by Remote Control

Another problem that the industry could quite well stimulate is the removal of stations from congested centers. Blanketing of reception is inevitable within some short range of every station, and when it is in town it affects thousands of people. Remote control has developed to the point where city studios operate perfectly with the transmitters far outside the city limits. I look forward to the not distant time when all stations of sufficient size to cause disturbances will be banished from the cities and when their blanketing annoyances will cease. The conference could render a definite service by formulating proposals to that end.

Problems for Solution by Cooperation With the Government

My major purpose today is to discuss those problems which must be solved in cooperation with the government.

The Air Today Overcrowded

Up to the present time, we have had a policy of absolute freedom and untrammelled operation, a field open to all who wished to broadcast for whatever purpose desired. I am convinced that policy was sound. It resulted in a wonderfully extensive development which could have been obtained in no other way. We have today 578 stations, and as no more than four of them are under the same management, no one can say there is not plenty of competition. Today every solitary channel in the ether is occupied by at least one broadcasting station and many of them by several. Of the 578 stations, 197 are using at least 500 watts of power, and there are now pending before the Department of Commerce over 175 applications for new licenses.

It is a simple physical fact that we have no more channels. It is not possible to furnish them under the present state of technical development. It takes no argument to demonstrate that 89 wavelengths (and no more are available) cannot be made to serve innumerable stations, no matter how ingenious we may be in arranging time divisions and geographical separations. It is not a question of what we would like to do, but what we must do.

One alternative, which would only partially solve the problem, would be to increase the number of stations by further dividing the time of the present stations down to one or two days a week or one or two hours a day. From the listener's viewpoint, and that is the only one to be considered, he would get a much degenerated service if we were to do that. It is quality of program, location, and efficiency of transmission that count. None of these will be improved, and in most cases they will be ruined by introducing more stations to traverse the same channels. A half dozen good stations in any community, operating full time, will give as much service in quantity and a

far better service in quality than eighteen, each on one-third time.

As the art progresses the capital investment in a good station has risen to upwards of \$150,000, and to provide technical staff, good talent and interconnection the cost of operation has risen to as much as \$100,000 per annum, and frequently even more. The costs are in large part the same whether the station works one day in a week or seven. If we impose more division of time than at present we shall drive the best stations out of action and the public will be more poorly served. The choice is between public interest and private desire, and we need not hesitate in making a decision. There are of course some stations of special character which can divide time, but they do not often lie in congested territory.

It has been suggested that the remedy lies in widening the broadcasting band, thus permitting more channels and making it possible to provide for more stations. The vast majority of receiving sets in the country will not cover a wider band. Nor could we extend it without invading the field assigned to the amateurs, of whom there are thousands and to whose constant experimentation radio development is so greatly indebted. Radio in this branch has found a part in the fine development of the American boy and I do not believe anyone will wish to minimize his part in American life.

If we did absorb the upper amateur band from 150 to 200 meters it would not even solve the immediate difficulties. All these things bring us face to face with the problem which we have all along dreaded and for which we have hoped the development of the art might give us a solution. But that appears to be far off, and we must now decide the issue of whether we shall have more stations in conflicting localities until new discoveries in the art solve the problem.

We hear a great deal about the freedom of the air. But there are two parties to freedom of the air, and to freedom of speech for that matter. There are the speech maker and the listener. Certainly in radio I believe in freedom for the listener. He has much less option upon what he can reject, for the other fellow is occupying his receiving set. The listener's only option is to abandon his right to use his receiver. Freedom cannot mean a license to every person or corporation who wishes to broadcast his name or his wares and thus monopolize the listener's set.

We do not get much freedom of speech if 50 people speak at the same place at the same time, nor is there any freedom in a right to come into my sitting room to make a speech whether I like it or not. So far as opportunity goes to explain one's views upon questions of controversy, political, religious or social, it would seem that 578 independent stations, many competing in each locality, might give ample opportunity for great latitude in remarks. And in any event, without trying out all this question, we can surely agree that no one can raise a cry of deprivation of free speech if he is compelled to prove that there is something more than naked commercial selfishness in his purpose.

The ether is a public medium and its use must be for public benefit. The use of a radio channel is justified only if there is public benefit. The dominant element for consideration in the radio field is and always will be, the great body of the listening public, millions in number, countrywide in distribution. There is no proper line of conflict between the broadcaster and the listener, nor would I attempt to array one against the other. Their interests are mutual, for without the one the other could not exist.

There have been few developments in industrial history to equal the speed and efficiency with which genius and capital have joined to meet radio needs. The great majority of station owners today

Radio Used As Aid To Defective Eardrums

Dr. Max A. Goldstein, director of the Central Institute for the Deaf at St. Louis, has developed an acoustic method by which sound stimulation of various types through the human voice and musical instruments and radio amplified sounds are used to awaken and re-educate the defective nerve of hearing. He uses the radio in his work. A radio principle has been perfected for the construction of various instruments by which the actual pitch and volume of sound in the defective ear can be accurately measured. This applies as well to the congenitally deaf child and to the adult who has lost his hearing.

Dr. Goldstein, three teachers and the nine children, pupils of the Institute who accompanied Dr. Goldstein to New York to demonstrate the method at the New York Academy of Medicine.

Dr. Goldstein believes the radio will play an important part in the scientific development of sound stimulation for the improvement of the defective eardrum for the deaf child.

recognize the burden of service and gladly assume it. Whatever other motive may exist for broadcasting, the pleasing of the listeners is always the primary purpose. There is a certain analogy to our newspapers and periodicals but the analogy is not complete. A newspaper survives upon the good will of its subscribers. It has intimate knowledge of their number and there is a delicate and positive sensitiveness in the reflex of their good will or ill will. But the broadcasting station has little knowledge of the number of its listeners and much less ability to judge their ill will or good will. There is no daily return of rise and fall in circulation. If someone could invent a method of accurate touch it might solve our problems, for I am convinced that some stations are broadcasting not to receiving sets, but only to the ether.

The greatest public interest must be the deciding factor. I presume that few will dissent as to the correctness of this principle, for all will agree that public good must overbalance private desire. But its acceptance leads to important and far-reaching practical effects, as to which there may not be the same unanimity, but from which, nevertheless, there is no logical escape.

What Are We to Do?

We simply must say that conditions absolutely preclude increasing the total number of stations in congested areas. It is a condition, not an emotion. But this implies a determination of who shall occupy these channels in what manner and under what test.

I can see no alternative to abandonment of the present system, which gives the broadcasting privilege to everyone who can raise the funds necessary to erect a station, irrespective of his motive, the service he proposes to render, or the number of others already serving his community. Moreover, we should not freeze the present users of wavelengths permanently in their favored positions irrespective of their service. That would confer a monopoly of a channel in the air, and deprive us of public control over it. It would destroy the public assurance

that it will be used for public benefit. There are, indeed, many difficult issues to be solved, but we have to face them just the same.

It seems to me we have in this development of governmental relations two distinct problems. First is a question of traffic control. This must be a Federal responsibility. From an interference point of view every word broadcast is an interstate word. Therefore, radio is a 100 per cent interstate question. And there is not an individual who has the most rudimentary knowledge of the art who does not realize that there must be a traffic policeman in the ether, or all service will be lost in complete chaos of interference. This is an administrative job, and for good administration must lie in a single responsibility.

The second question is the determination of who shall use the traffic channels, and under what conditions. This is a very large discretionary or a semi-judicial function which should not devolve entirely upon any single official, and is, I believe, a matter in which each local community should have a large voice—should in some fashion participate in a determination of who should use the channels available for broadcasting in that locality.

In other words the ideal situation, as I view it, would be traffic regulation by the Federal Government to the extent of allotment of wavelengths and control of power and the policing of interference, leaving to each community a large voice in determining who are to occupy the wavelengths assigned to that community. It is true, of course, that radio is not circumscribed by state lines and still less by city boundaries. But it is possible, nevertheless, to establish zones which will at least roughly approximate the service areas of stations, and to a very considerable extent to entrust to them the settlement of their local problems.

I am seeking your view as to how far this can be made practicable, or what other basis may be found for handling the problem. I have no frozen views on radio—except that the public interest must dominate. As many of you know I am not one of those who seek to extend any sort of government regulation into any quarter that is not vital, and in this suggestion I am even endeavoring to create enlarged local responsibility.

Much work has been done in past sessions of Congress looking to radio legislation. I cannot speak too highly of the constructive effort expended by Representative Wallace White and his committee associates in the study of radio needs and the preparation of measures to meet them. But until the present time I think we have all had some feeling of doubt as to the precise course which legislation should take, for changes have been so rapid and conditions so shifting that no one was ready to try to chart an exact course. I am glad that Congressman White and other members of the House and Senate Committees are with us in this conference. I am certain that they have a hearty sympathy with, and understanding of, the actual needs of the radio public.

To sum up, the major problems for consideration are, to my mind: (a) Is public interest paramount? (b) Shall we limit the total number of stations in each zone pending further development of the art? (c) What basis shall be established for determining who shall use the radio channels? (d) What administrative machinery shall we create to make the determination?

Canada Keen on Radio

WASHINGTON.

Public interest in radio broadcasting and the consequent demand for apparatus has created a new industry in Canada, according to a report to the Department of

Commerce. Production of radio sets and parts in Canada during 1924 amounted to \$3,201,103 and exports of similar commodities from the United States to Canada showed a good gain, too.

Laboratory Tests of Diamond

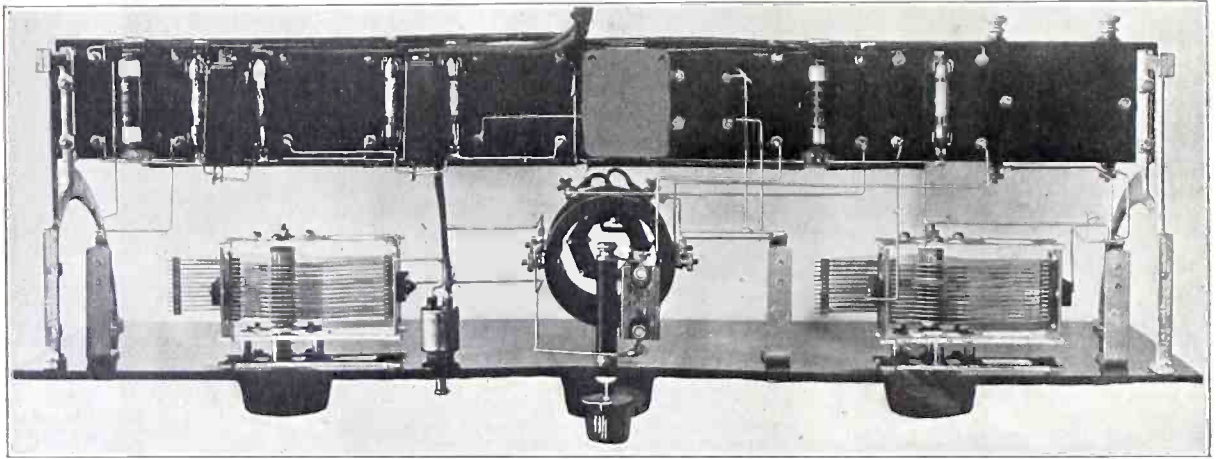

LOOKING at the bottom of the 1926 Model Diamond of the Air. Note the short leads and neat wiring.

Amplification of 10 Obtained Easily From Tuned RF Stage—Stray Magnetic Coupling Completely Avoided by Proper Manner of Coil Mounting — Rheostats Eliminated — Provision Made for Optional Use of UX or Other Power Tubes in Last Stage—Hi-Mu Tubes Recommended For First and Second AF

By Herman Bernard

Associate, Institute of Radio Engineers

WHAT a receiver will accomplish depends a great deal on the way it is wired. Granting the same hookup is used, and the set wired well in one case and poorly in the other, the possessor of the badly constructed receiver may well wonder at the cause of excitement over the hookup while the other fan sits back, thrilled by his marvelous set.



HERMAN BERNARD

It is characteristic of the hookup of the 1926 Model Diamond of the Air, so long as the wires are run to the right places, and the antenna, ground, tubes and batteries are in fairly good condition, that satisfactory results will be obtained. But that should not be the goal. Mere satisfaction is little enough to expect from the receiver. Results that surpass those obtainable from most sets, quality that reaches the very pinnacle and which is not a whit less than that produced by the new orthophonic Victrola, and astonishingly great receiving range, even on a

loop, should result in every case where local conditions permit. Against the barrier of shielding by steel buildings, unaccountable dead spots and other strange and annoying effects, the Diamond has nothing to offer, but will do as much under adverse conditions as any other set. If an outdoor aerial is used the receiver will about equal a Super-Heterodyne on a loop, if the Super is made in the most approved style.

Stray Feedback Avoided

One of the harmful effects experienced in receivers employing tuned radio-frequency amplification, if the set is poorly made and badly wired, is stray feedback due to magnetic coupling. Against this vice little relief is offered save by the reconstruction of the receiver, or the introduction of shielding which otherwise would be wholly unnecessary. It pays to rewire a set if you have run into any of the troubles that stray magnetic coupling induces. They include poor selectivity, not enough volume, lack of sensitivity, body capacity effects and very critical tickler adjustment.

The manner of placing the coils is important, for they may be tilted at such an angle or so mounted in respect to each other that there will be no feedback discernible even on reading a sensitive meter. There are several ways of accomplishing this. The angle may be of the popular Neutrodyne inclination, 57.3 degrees, or the coils may be placed with circumferences atop each other at one point only, or right-angle mounting may be utilized. The Neutrodyne method of former days is not standard for all sets but depends on following exactly the specifications of the particular makes of Neutrodynes to which the angle was to apply. The end-on-end method interferes somewhat with the wiring scheme in the present instance, hence the right-angle manner was selected. This is very effective because of the inherent distance between the two coils. There is no coupling between stages in reverse fashion, which this objectionable stray feedback amounts to, whereby the current that should flow only with the oscillatory circuit otherwise is sent back in part to its point of origin in the set.

Where Magic is No Good

The antenna coupler, L0L1, being mounted horizontally and the interstage coupler, L2L3L4, being mounted vertically, the problem is easily solved, and the loop effect is at a minimum. In fact, with antenna and ground disconnected it

was found by laboratory tests that the receiver picked up no energy, even from powerful broadcasting stations nearby, and this is electrically sound. It is indeed somewhat on the order of legerdemain to be able to astound guests at one's home by operating a receiver without aerial or ground. The tincture of uncanniness that characterizes this radio potion is confirmed by the expression "phantom input" sometimes used in connection with such theatrical-like performances. Historically this stunt may be delightful, but from an engineering viewpoint it is very bad, because it proves that the inductances in the receiver are functioning as loops, which they should not do. A set should pick up energy only from sources external to the tuning coils—that is, either from an outdoor or indoor antenna, the latter class including the coil antenna or, as it is better known, the loop. One reason is that the same condition that facilitates phantom reception aids squeals getting into neighbors' sets.

When placing a coil in a receiver it is well to keep in mind that if the field of the windings is in the same direction as the incoming waves from given stations, then the inductance may function as a loop. The horizontal method of mounting a solenoid puts the coil in most favorable condition for functioning as a stray loop. Naturally, if two coils are to be mounted at right angles one of them will be in a position favorable to the introduction of this vice, and although there is divided opinion on the subject among the authorities, it was found by careful laboratory tests that the detector input coil had better be mounted in the position least favorable to loop-like reception. That the burden of the problem rests here was shown experimentally by making a Diamond in such fashion as to introduce the highest possible loop effect at both points. Then, when the effort was concentrated on the interstage coupler, it was possible to receive some locals, faintly of course, without any tube being in the radio-frequency socket, indeed even with the aerial ground and antenna coupler removed. When the relative coil positions were reversed it was more difficult to pick up any energy even with the RF tube and aerial coupler functioning (without antenna or ground) than in the previous test.

The Capacity Test

The fact that no magnetic coupling effects were produced, in fact, no injurious effects at all, in the right-angle mounting method previously described, cast the

The Schematic of the 1926 Diamond, With Coil Terminals Explicitly Shown

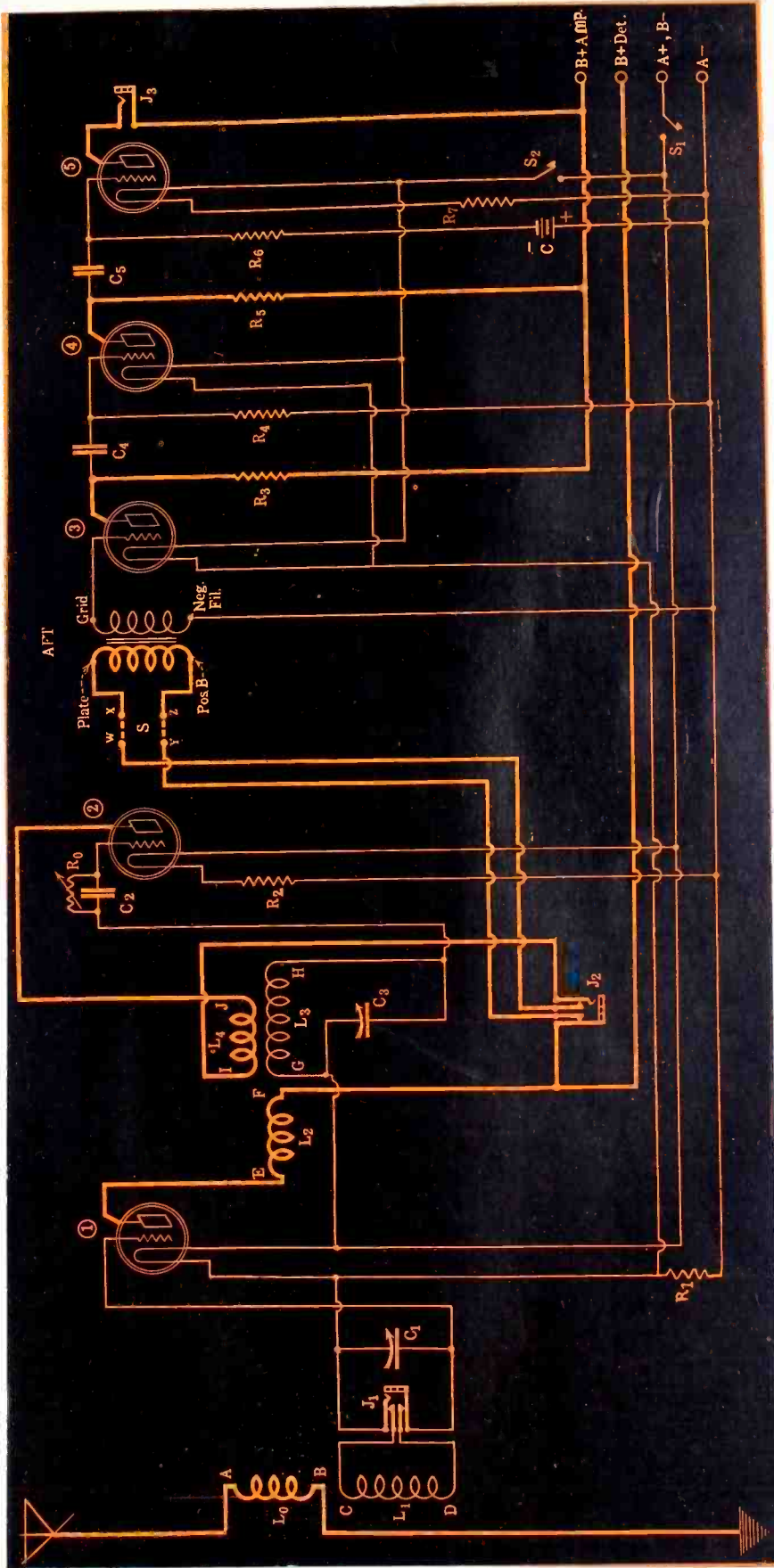

THE CIRCUIT DIAGRAM of the 1926 Model Diamond of the Air, shown in schematic form, with the coil terminals designated by letters.

The 1926 Model Simplified

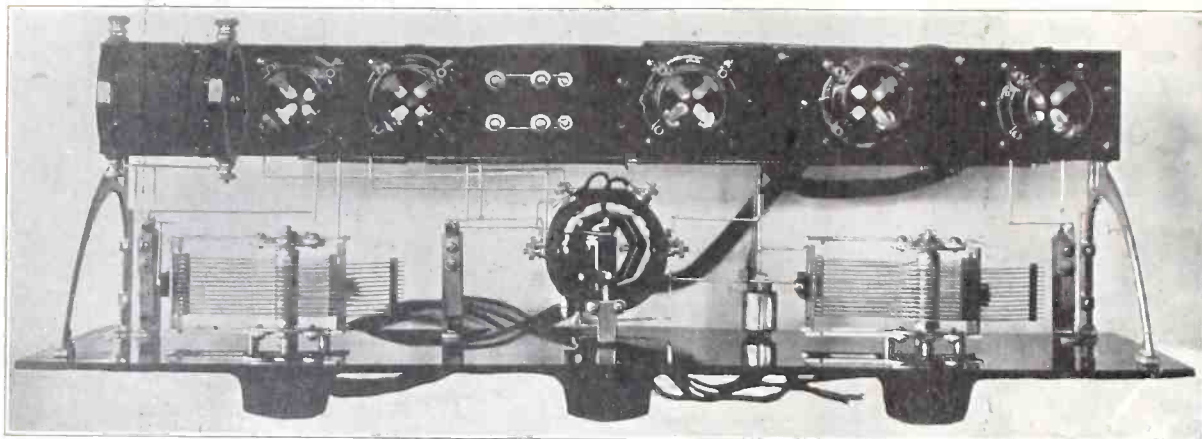

THE TOP VIEW—Note two extra strong binding posts on the antenna coupler.

burden of proof upon the capacity coupling. Inside of every tube are the terminals of the filament, grid and plate, constituting four in all, and these are joined at the stem to the respective tips that make contact with the socket-prongs. Between these elements—that is, between filament and plate, filament and grid and between grid and plate—there exists a capacity effect. It is enough in most cases to transfer quite an appreciable amount of chance energy. This is what causes self-oscillation in tubes in RF amplifiers, and it is this condition that the neutralizing condenser commonly corrects. But there were no injurious capacity coupling due to the RF tube elements in the 1926 Diamond subject to test, and no need to balance out self-oscillation, as the tickler coil that governs feedback in the detector tube also automatically functions as a stabilizer of the RF tube. This is due to the detector tube not functioning as an independent bulb but as a detecting device already greatly influenced by the tube ahead of it. The orthodox coupling, by means of L2L3L4, aids this effect, while the connection of the plates of both tubes to a common block of B batteries is an important item, too, functioning as a resistance or balancing agent. That is why some sets that do not suffer self-oscillation when B batteries are used over-oscillate when a B battery eliminator is used, for the resistance of the B battery block has been taken out of the circuit.

Neutralization

The circuit as shown in the diagram, has no neutralizing condenser, because none is necessary. Stray magnetic coupling being avoided, the circuit is rid of its worst possible nuisance. If the set were subjected to so-called neutralization by means of a small capacity between plate or grid of the detector tube and grid of the RF tube, and magnetic coupling existed, the set would be unstable, would radiate, despite the delicately adjusted neutralizing condenser, and would be subjected to losses. There is no objection to neutralization when stray magnetic coupling is avoided, but it is rather difficult properly to neutralize some receivers, and the set may be deprived of some of its keenness due to neutralization for some lower wavelength, like 250 meters, which is common, causing a somewhat lower efficiency on the higher waves.

Amplification of 10

The amplification, produced by the tuned RF stage will be about 10, if the

laboratory set is followed closely. This is of course independent of the amplification-attributable to the tube, which may be rated at 6. The construction of the aerial coupler, or radio-frequency transformer, governs the coupling amplification. The coil should be low-loss, with terminals connected to proper points. The diagram of the wiring identifies these terminals by letters, but the diagram is not to be read pictorially, since the aerial coupler is shown vertical for convenience in draughtsmanship, and the interstage coupler horizontally, the opposite course being followed in actual construction.

The right-angle method of coil mounting is further justified by the experiment of removing the RF tube from its socket while all the rest of the set is in operation. With WEAf, 3,500 watts, only five miles away, and WNYC, 1,000 watts, about the same distance from the point of reception, no signals whatsoever were heard with the RF tube removed. This guarantees the absence of stray magnetic coupling. The minimum amount of capacity coupling, due to the elements of the RF tube, may be gauged by putting a piece of paper on one of the filament springs of the RF socket, and inserting the RF tube, which will not light under such circumstances. It was scarcely possible to hear any signal, even when earphones were used at the final output, J3.

The two stations, WNYC and WEAf, also were used in a selectivity test. Any receiver that establishes a silent point

between these two stations at this particular location is bound to be selective enough for the needs of the day, and this accomplishment was easy with the Diamond. Even the low-wavelength stations, hard to separate in New York City, were cut in and out individually, without cross-talk or other interference, except that in two instances the whistling caused by the wave of one station beating against that of another was heard. This was not due in any way to the receiver but either to the fact that the stations were too close to the point of reception, geographically speaking, to allow the spreading effect at the transmitter to settle down, or, more likely, because one or both of these two stations were off their assigned frequency.

Fine DX Reception

The selectivity question was settled definitely by the record of reception of distant stations and by the reception of stations nearby that for shielding or dead spot reasons otherwise come in very faintly, if at all. Two of these are WJZ and WGBS, both of which were heard on the 1926 Diamond with good speaker volume, although most receivers will fail to pick them up at all.

The hookup as shown in the full-page diagram was found to work with splendid efficiency and proved once again that the answer to the question of adding another stage of RF must be no. That extra stage will intrude trouble, not benefit, unless both stages of RF are neutralized, in which case the extra tube simply makes up for the losses introduced by neutralization. In other words, the set as shown is superior to the regenerative Neutrodyne.

Rheostats Omitted

You will notice that no rheostats are used in the model as presented. The receiver was described in the September 12, 19 and 26 issues of RADIO WORLD, and those desiring to construct it should consult the information therein contained, but embody the present changes. That set used two rheostats, however, and it is in the interest of simplification to omit these, and to adhere to the list of parts as published herewith. The circuit is fundamentally the same in both cases. Notice that the jack J2 is a listening post for the detector, while the detector is coupled to the audio transformer through binding posts W, X, Y and Z. By removing the bus bar from points W and X and points Y and Z it is possible to hook

(Continued on page 18)

Get a
NAMEPLATE
Free!

Your 1926 Diamond of the Air will not be complete without the nameplate, which will be furnished free to all who ask. This nameplate is of the transfer type. Immerse it in a tumbler of water for a minute, then place it on the panel, with the nameplate facing you. The paper may be easily pulled away and only the nameplate remain. When the nameplate dries it will be found securely pasted to the panel.

Send in your request to Diamond Editor, RADIO WORLD, 145 West 45th Street, New York City, or come in and get one at the office, which is just a few steps east of Broadway.

13 Leading Radio Manufacturers

Have combined their technical skill and engineering ability and selected "Radio World's"

DIAMOND OF THE AIR



THE PANEL view of the 1926 Model Diamond of the Air, one-quarter scale

as the BEST Receiver for Home Construction

This newest and greatest Diamond of the Air contains parts of proven superiority made by the following nationally known manufacturers:

Aerovox Wireless Corp.

Alden Mfg. Co.

Bruno Radio Corp.

Cornish Wire Co.

Cortland Panel Eng. Co.

De Luxe Sales Co.

Kurz-Kasch Co.

No. American Bretwood Co.

Preferred Radio Prod. Corp.

Radiall Co.

Streamline Radio Co.

Thordarson Elec. Co.

Veby Mfg. Co.

The boxed and sealed Kit which bears the *personal indorsement* of HERMAN BERNARD is nationally distributed only by the

B. C. L. RADIO SERVICE CO., 221 FULTON ST., N. Y. CITY

 See Following Pages

WAS THERE EVER A GREATER

These leading manufacturers have combined their products and

A Basic Need in Every Circuit

Chosen for the Diamond of the Air because of its durable construction and high standard of efficiency



Used to govern precisely the heating of the detector tube and also in the last audio stage permitting the use of any make of tube, including the new U. X. power tube.

Aerovox



FOR
ACCURACY
FOR
QUALITY
FOR
RESULTS

the contribu-
tion of experts
for the

DIAMOND OF THE AIR

Na-ald

Moulded Bakelite spring
sockets used exclusively in
the Diamond of the Air

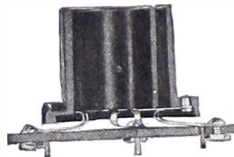

"It's the contact that counts"

De Luxe Cable

The finishing touch to the
Diamond of the Air

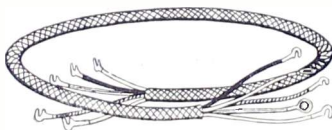

Multi-Colored Battery Cable
Supplied by

De Luxe Sales & Mfg. Co.
NEW YORK

Cortland Panel Engraving Co., N. Y.

Drillers and Engravers
of the panels for the

Diamond of the Air

Long experience has produced
no finer workmanship
than this.

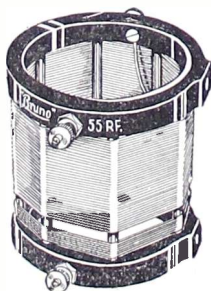

"Bruno" Quartzite Coils

were selected for the
Diamond of the Air



because of their high efficiency, low losses and rugged construction.

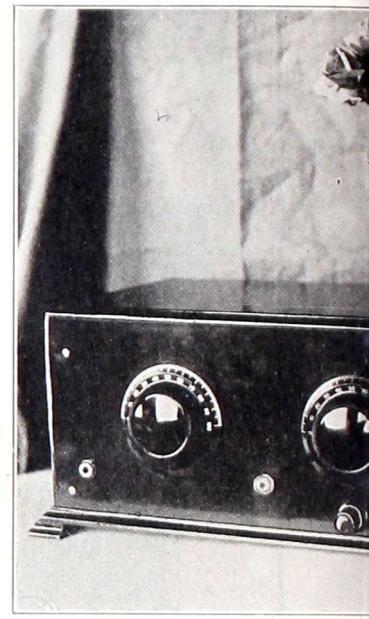

England's Finest Craftsmen

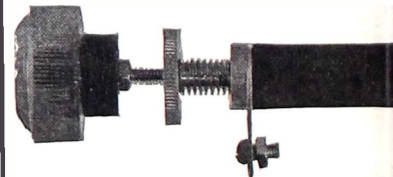

The Diamond of con

- One antenna coupler, L0L1 (Bruno 99 or RF).
- One 3-circuit interstage coupler, L2L3 (Bruno 99).
- Two .0005 mfd. SLF condensers, C1, (Streamline).
- Two ½-amp. ballasts, R2, R7 (Amperite type 1-A).
- One 3½-to-1 AF transformer, AFT (Thordson).
- One ¾-amp. ballast, R1 (Veby).
- Two 0.1 meg. resistors, R3, R5 (Veby).
- One ¼-amp. ballast, R1 (Veby).
- One 0.5 meg. leak, R6 (Veby).
- One variable grid leak, R0 (Bretwood).
- Three 4 moulded Bakelite dials (Kurz-Kasco).
- Two double-circuit jacks, J1, J2 (Preferred).
- One single-circuit jack, J3 (Preferred).
- One 7x24 drilled and engraved panel (Cortland).

The Greatest K
Nationally I

B-C-L Radio Service

KIT ASSEMBLED THAN THIS?

Make this Diamond of the Air the **GREATEST** kit ever assembled



THORDARSON
ELECTRIC MFG. CO.

America's oldest transformer Manufacturers contribute their best for the Diamond of the Air.

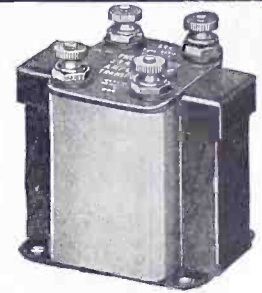

The Thordarson 3 1/2-1 Transformer

Veby for Precision
Leaks, Resistors and Bal- last supplied for the Diamond of the Air by



Veby Radio Co.

PREFERRED JACKS

Instruments of sterling ability.



Preferred single jack.



Preferred double jack.

Contributed to the new Diamond of the Air by **Preferred Radio Products Co.**

Donate Their Best in the

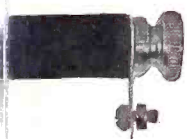

BRETWOOD
VARIABLE
GRID LEAK

New the Air Kit

- Includes:
- Five standard sockets Na-ald).
 - One socket shelf and brackets (Bruno).
 - Two 0.25 mfd. fixed condensers, C4, C5 (Aerovox).
 - One 5-strand multi-colored battery cable (De Luxe).
 - Two battery switches, S1, S2.
 - One .00025 mfd. fixed grid condenser, C2.
 - Four binding posts, W, X, Y, Z.
 - Five battery cable markers.
 - Ten lengths of busbar (Cornish).
 - Two flexible leads for C battery.
 - Screws, nuts, spaghetti.

Boxed and Sealed Kit

\$35

Ever Assembled

Contributed by the

Co., 221 Fulton St., N.Y.C.



Radio Wire Products
supplied by
Cornish Wire Co.



KURZ-KASCH ARISTOCRAT

"Aligns rite—Holds tite"

To set off the beauty of the Diamond of the Air



STREAMLINE

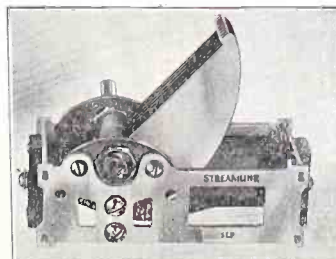

.0005 mfd. SLF Condensers are officially certified for use in the 1926 Diamond.

They contribute the accurate, easy tuning, whereby both wavelength dials read exactly alike.

Streamline Radio Co.
NEW YORK

Parts for the 1926 Diamond

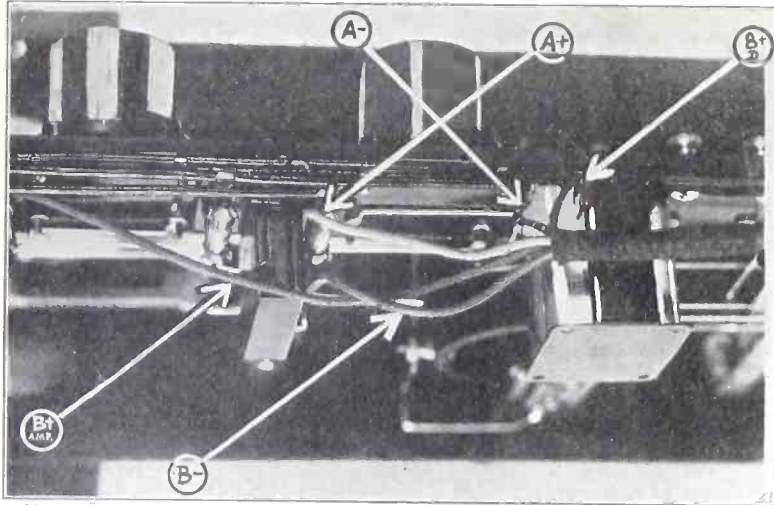

THE CABLE leads are soldered direct to the most convenient points on the set. A— goes direct to the Neg. Fil. post of the audio transformer and from that point the lead is carried by bus bar to the resistors. A+ and B— are connected to the switch S1, the glistening object shown in part beneath the by-pass condenser. B+ Detector goes to the AFT post, while B+ Amp. is carried farther to the left than any of the other leads.

(Continued from page 14)

in an external detector at points X and Z, to use only the audio circuit of the Diamond to afford speaker volume for any other set. In that event remove tubes 1 and 2. This feature was incorporated originally and provides a ready audio hook-up for experimenters who want to put some set of the moment to the audio test on the speaker.

Some fans found that volume was not quite enough when an extra resistor was placed in the plate circuit of the last tube (September 12) and a condenser used to couple the tube's output to the speaker, one terminal of which went to the condenser, the other to A minus. This is a good hookup, if the B battery voltage on the plate resistor is high enough, say 150 volts or more, but for fans who do not want to go that high in the investment field, the standard hookup as shown in the full-page diagram this week should be followed.

B Battery Voltages

The audio hookup as shown this week is as good as the other because it has a C battery in the grid circuit of the last tube, an item the other hookup was intended to avoid. With the plate B battery voltage on in the last tube encountering only the impedance of the speaker windings and of the plate element of the tube, the net effective voltage on the plate is very much higher than if a plate resistor were used, as in the other method. Hence this high net voltage at the plate, necessary for adequate volume and quality, must be met with a correspondingly high negative bias, otherwise distortion or poor volume or both will result, due to tube overloading. Also, the actual drain on the B battery in milliamperes is cut down. The plate resistors, R3 and R5, in the cases of the two other audio tubes, render unnecessary the use of a C battery there. The 135 to 150 volts represented by B+ amp. actually amount to about 45 net effective volts at the plate, due largely to the voltage drop in the 100,000 ohm resistors. However, the current drain is no greater, usually, than by other methods of audio amplification.

The B+ Det. lead should be connected to about 45 volts on the B battery block, and the same voltage used on the detector

plate is all-sufficient then for the RF plate. But do not use a tube that functions best at very low B voltage as a detector, such as the 200, 300 and DV5. The 201A or equivalent are to be preferred for sockets 1 and 2, while in the interest of avoiding overloading the first and second AF tubes, sockets 3 and 4 had better be occupied by hi-mu tubes.

In the last socket one may use the UX112, the new power tube, or the 261A, the Western Electric power tube, which is hard to get. The C battery connections in the last stage of audio render the inclusion of the UX power tubes very convenient, and the solitary Amperite used to govern the filament heating of this tube

(Concluded on next page)

LIST OF PARTS

One antenna coupler, L0L1 (Bruno 99 RF).

One 3-circuit interstage coupler, L2L3L4 (Bruno 99).

Two .0005 mfd. SLF condensers, C1, C3 (Streamline).

Two ¼-amp. ballasts, R2, R7 (Amperites, type 1-A).

One 3½-to-1 AF transformer, AFT (Thorardson).

One ¾-amp. ballast, R1 (Veby).

Two 0.1 meg. resistors, R3, R5 (Veby).

One 1.0 meg. leak, R4 (Veby).

One 0.5 meg. leak, R6 (Veby).

One variable grid leak, R0 (Bretwood).

Three 4" moulded Bakelite dials (Kurz-Kasch).

Two double-circuit jacks, J1, J2 (Preferred).

One single-circuit jack, J3 (Preferred).

One 7x24" drilled and engraved panel

Five standard sockets (Na-ald).

One socket shelf and brackets (Bruno). (Cortland).

Two 0.25 mfd. fixed condensers, C4, C5 (Aerovox).

One 5-strand multi-colored battery cable (De Luxe).

Two battery switches, S1, S2.

One .00025 mfd. fixed grid condenser, C2.

Four binding posts, W, X, Y, Z.

Five battery cable markers.

Ten lengths of busbar (Cornish).

Two flexible leads for C battery.

Screws, nuts, spaghetti.

NEW EXPORT RECORD

WASHINGTON.

Exports of American radio apparatus continue to increase by leaps and bounds. The total for September, 1925, was \$785,337, says the Statistical Division of the Department of Commerce. This is a new record for the month of September.

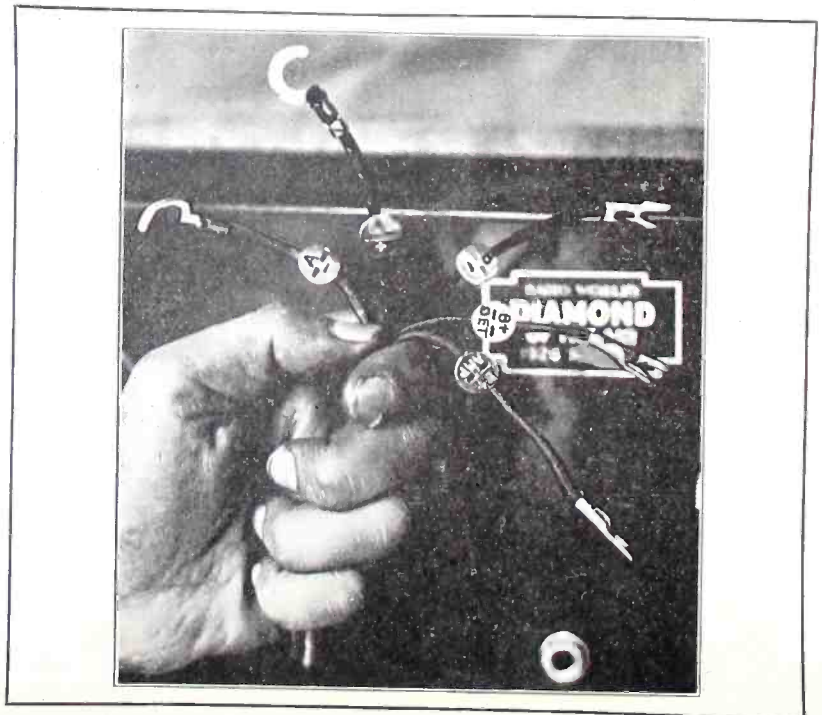

THE CABLE leads are tagged by metal markers at the battery ends.

Both Tuning Dials Read Alike

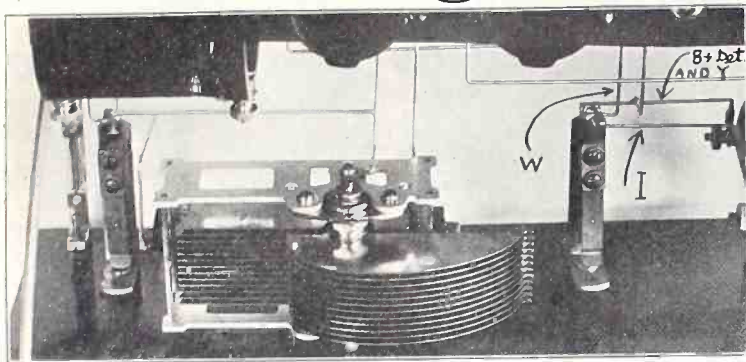

DETAIL showing how jack J2 may be wired with only three connections instead of four.

alone enables one to use a tube requiring any filament voltage of 5 or less. Hence the less expensive so-called power tube, the UX 120, drawing .06 ampere as compared with the .25 ampere of the UX112, and requiring only about 3 volts at the filament, is easily available. Instead of the 1-A Amperite, R7, the 6v-199 Amperite is used for the UX120, and an adapter is purchased for a few cents, so that the standard base of the last tube socket, in conjunction with the adapter, receives the UX base tubes.

On the subject of the two new power tubes, UX112 and UX120, the manufacturers in the circulars enclosed in the boxes containing these tubes recommend negative biasing of the grid that has proven by tests to be somewhat excessive. For instance, 22½ volts negative bias is recommended by the manufacturer for the UX120, while a negative bias of 12 volts proved best in a given case. The test was made by placing a milliammeter in the plate circuit of the last tube, disconnecting one speaker cord for that purpose, and re-establishing the connection through the meter. At 12 volts the needle ceased to fluctuate, thus showing that the tube was not overloaded, whereas increasing the negative bias caused the volume to drop and the needle to wiggle. The best rule regarding negative grid bias is to do your own experimenting, using only your ear as if no meter is handy, as it seems that tubes vary in this respect, and the manufacturers' best intentions as to guiding the tube purchaser sometimes cause more hindrance than help.

Those who have no milliammeter may use an ordinary voltmeter as a makeshift. The resistance of meters differs, of course, due to the difference in manufacture, but a fair though broad assertion would be that one registered volt would approximate two milliamperes. The voltmeter has to be connected in a given direction, otherwise the needle will deflect to the minus zero point, instead of giving a positive reading. Reverse the connections from the terminals of the meter. That is, the terminal you had connected to the speaker cord should go instead to the jack and the one that went to the jack should go to the free speaker cord. Then the positive reading will be obtained. The volume of the signals will drop slightly, due to the inclusion of the meter in the circuit.

[This concludes the first of a series of articles by Herman Bernard, reporting laboratory results obtained from a scientific study of the operation of the 1926 Model Diamond of the Air. Next week another article on this subject will be published. Those contemplating constructing this receiver should obtain also the issues of RADIO WORLD dated September 12, 19 and 26.]

Dials of the Diamond Tune Exactly Alike

Those who construct the 1926 Diamond of the Air should add five more turns to the secondaries, compared with the number of turns recommended in the September 12, 19 and 26 issues of RADIO WORLD, where the construction of this receiver was described. This is due to the inclusion now of straight-line frequency tuning condensers, the idea being to use coils matched for the condensers, to assure straight-line frequency tuning. The dial readings of both tuning condensers will be in step and the readings will correspond to the following, obtained in the laboratory model:

Station	Meters	C1	C3
WNYC	526	94	94
WEAF	492	89	89
WJZ	455	82	82
WMCA	341	55	55
WGBS	316	47	47
WGBU, Fla.	278	38	38
WAAM	263	33	33
WGCP	252	28	28

These readings should be understood to refer to straight-line frequency condensers, concerning which there is some misconception in the public mind. Although 526 meters comes in at 94, the remaining six divisions on the dial are ample to enable one to tune in KSD, 545 meters, the highest wavelength broadcasting station. The capacity change is very rapid at the upper end of the counter-clockwise dials used.

The Growth of an Idea

Little did the Editor of RADIO WORLD, when he presented the idea of a National Radio Week at a meeting of important radio men in lower Broadway in the autumn of 1922, know how wholesqued would be the response and support for the idea, nor could he have foreseen with any degree of accuracy to what size and importance the idea would grow.

It is gratifying to learn that the Executive Committee of International Radio Week are functioning more enthusiastically than in any former year. According to an official announcement sent out a few days ago by L. A. Nixon, secretary of the executive committee and one of the hardest-working and most resourceful of the committee officials from the inception of the idea, the various sub-committees are already working hard in an effort to eclipse all former efforts. These committees are as follows:

1. International Radio Broadcasting Tests Committee, with the duty of ar-

Words of Praise

DIAMOND EDITOR:

I have just completed the Diamond of the Air and I must tell you that it is all I expected of such a set. On the first night's trial I logged nineteen stations on the loud speaker with very good volume. I expect that after I am a bit more used to the tuning, I will be able to tune in twice as many stations.

The circuit is satisfactory as far as selectivity is concerned. The volume is very good, in fact, it is loud enough to hear it across the street. I am using the 199 type tubes.

Such a good receiver deserves a nameplate, and I would be very much obliged if you could send me one.

I hope that your magazine will continue its good work and advice. I wish it every possible success.

Please add my thanks to that of the many others who have lauded the inventor of this circuit.

ARTHUR GOYER,
Drummond Building,
511 St. Catherine St. West,
Montreal, Quebec, Canada.

DIAMOND EDITOR:

I have built the Diamond of the Air and have had fine success with it. I can tune in WHT with WOR on the air. I can separate WAAM from WRNY. I can cut WGBS from CNRA, KDKA, WJAR, and many others. As for distance, I have had Havana, San Antonio, Kansas City, Hastings, Detroit, Chicago, Montreal, Moncton, Boston and Miami Beach. I expect to reach farther this winter. All of the above was received on the loudspeaker, as I never use the phones. I would like to have one of the free nameplates.

W. B. CROWELL,
72 Dumont Ave., Dumont, N. J.

DIAMOND EDITOR:

I built the 1926 Diamond of the Air and it sure is the best yet.

Its volume, clarity, and selectivity can't be beat, and for DX, it hasn't reached its limit, although it has brought entertainment from as far as KFKX to the West, WFAA to the South and CNRW to the North, all with real volume.

Thanking you for all favors extended. I am a constant reader of RADIO WORLD.

AL W. LEEK,
60 Burling St.,
Flushing, L. I., N. Y.

range all details in connection with the tests and with such sub-committees here and abroad as might be considered necessary by the chairman, Mr. Lynch.

2. American Broadcasters Committee, to be appointed by the National Association of Broadcasters with the duty of correlating the activities of American broadcasters so as to present the greatest cooperation possible.

3. Broadcasting Programs Committee, charged with the duty of persuading American broadcasters to make every effort to give programs of the highest type possible during radio week, it being pointed out that the greatest audience of the year was that during the hour before the tests began.

Thus from the little acorn has grown the full-grown, sturdy oak. Now for a long, hard pull by everybody, to the end that intelligence as well as main strength will make the coming International Radio Week, Jan. 24-30, the greatest success.

A THOUGHT FOR THE WEEK

There was a strike recently in England when the wireless operators walked out—and won. There will be a strike of fans in this country if the broadcasters don't cut out some of those freak performers on combs, dishpans and nine-stringed bazoulas. Let's stick to the instruments that can be found in a Conn catalogue.

RADIO WORLD



Radio World's Slogan: "A radio set for every home."

TELEPHONES, BRYANT 0558, 0559
 PUBLISHED EVERY WEDNESDAY
 (Dated Saturday of same week)
 FROM PUBLICATION OFFICE
HENNESSY RADIO PUBLICATIONS CORPORATION
 145 WEST 45TH STREET, NEW YORK, N. Y.
 (Just East of Broadway)
 ROLAND BURKE HENNESSY, President
 M. B. HENNESSY, Vice-President
 FRED S. CLARK, Secretary and Manager
 European Representatives: The International News Co.,
 Breams Bldg., Chancery Lane, London, Eng.
 Paris, France: Brentano's 28 Avenue de l'Opera.
 Chicago: A. T. Sears & Son, Peoples Gas Bldg.
 Cincinnati Office: Radio World, 304 Provident Bk. Bldg.,
 7th and Vine Sts. Telephone, Canal 753 and 379.
 San Francisco: Lloyd B. Chappell, 656 O'Farrell St.

EDITOR, Roland Burke Hennessy
 MANAGING EDITOR, Herman Bernard

SUBSCRIPTION RATES

Fifteen cents a copy, \$6.00 a year, \$3.00 for six months, \$1.50 for three months. Add \$1.00 a year extra for foreign postage. Canada, 50 cents.
 Receipt by new subscribers of the first copy of RADIO WORLD mailed to them after sending in their order is automatic acknowledgment of their subscription order. Changes of address should be received at this office two weeks before date of publication. Always give old address also. State whether subscription is new or a renewal.

ADVERTISING RATES

General Advertising

1 Page, 7 1/4" x 11"	482 lines	\$300.00
1/2 Page, 7 1/4" x 5 1/2"	231 lines	150.00
1/2 Page, 8 1/2" D. C.	231 lines	150.00
1/4 Page, 4 1/2" D. C.	115 lines	75.00
1 Column, 2 1/2" x 11"	154 lines	100.00
1 Inch		10.00
Per Agate Line		.75

Times Discount

52 consecutive issues	20%
26 times consecutively or E. O. W. one year	15%
4 consecutive issues	10%

WEEKLY, dated each Saturday, published Wednesday. Advertising forms close Tuesday, eleven days in advance of date of issue.

CLASSIFIED ADVERTISEMENTS

Ten cents per word. Minimum, 10 words. Cash with order. Business Opportunities ten cents per word, \$1.00 minimum.
 Entered as second-class matter, March 28, 1922, at the Post Office at New York, N. Y., under the act of March 3, 1879.

NOVEMBER 21, 1925

The Weekly Rebus

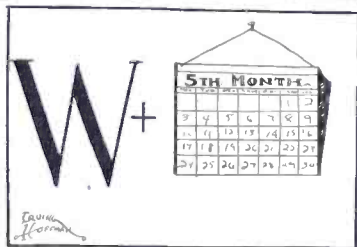

Send your answer to Rebus Editor, RADIO WORLD, 145 West 45th Street, N. Y. City.

RECENT BACK NUMBERS of RADIO WORLD, 15c each. RADIO WORLD, 145 West price. RADIO WORLD, 145 West 45th St., N. Y. 45th Street, New York City.

A Puzzle to Radio Fans, Mary Lewis of the Opera Proves to be Ex-Follies Girl

"Mary Lewis, the American opera singer."

When that announcement from WEAF and fourteen allied stations recently preceded charming singing by the artist, some radio fans thought that here was another famous operatic singer they had never heard of. Persons versed in affairs operatic wondered who this Mary Lewis was. Especially were they annoyed by their own "ignorance" when they heard her warm, thrilling voice.

The occasion of her American appearance as an operatic singer was during an Atwater Kent Hour of Music on a Sunday night.

The performance ended with no further biographical enlightenment.

Who was the great Unknown Mary Lewis?

Great she was indeed—but not unknown, only unknown as an operatic singer here. Otherwise, it is now disclosed, she is the same Mary Lewis famed as a Follies girl. Yes, Mary Lewis, lately of the Ziegfeld Follies, is now with the Metropolitan Opera Company! And she is only 25, heard grand opera for the first time only five years ago, and began to study for opera only three years ago!

From Chorus to Opera

From chorus girl to grand opera star in six years! She's in the operatic star class quite safely, for in January she will sing the role of Mimi in "La Boheme" at the Metropolitan.

And to think that the American radio audience was the first one to be treated to operatic renditions—even before the social lights heard her as they lounged in the Diamond Horseshoes at the Metropolitan!

Miss Lewis, who was born in Little Rock, Ark., broke all traditions by making her debut in Vienna in 1923, a little more than a year after she had first taken up the study of grand opera, and, according to cables from Vienna, she was acclaimed as "greater than Jeritza."

Began at Age of Eight

She sang in public at the age of 8 years in the choir of the Methodist Church at Dallas, Texas. During the next eleven years she sang and played the violin and pipe organ in church at Dallas and Little Rock. Her musical career outside the church began six years ago when she ran away from her home in Little Rock to appear in the chorus of the traveling musical show "Reckless Eve." Two years ago she was a star of Ziegfeld's "Follies."

On her return six weeks ago from suc-

cesses in Europe, the statement was made that the Metropolitan Opera Company planned to engage her for appearances a year from now. The Chicago Opera Company, however, made Miss Lewis an offer to sing there in important roles this season. This changed the situation. A month ago the Metropolitan Opera Company gave the young American singer an audition, and now the contract is signed. Miss Lewis said that it called for her appearance in star parts only. She has a repertoire of fifteen.

Ambition Realized

In less than three years after hearing grand opera for the first time Miss Lewis was singing Marguerite in Vienna.

"The first opera that I heard was 'Madame Butterfly,'" said Miss Lewis yesterday afternoon at the Metropolitan. "I was in the Greenwich Village Follies at the time and went with another girl to the Metropolitan one afternoon, Farrar was singing. At the time I said to my friend, 'that's what I want to do, and some day I'll do it.' A little later Mr. Ziegfeld gave me a part in his midnight show on the roof at the New Amsterdam, where I did not have to appear until 11 o'clock. I put in most of the day up to that time preparing myself under Mr. Thorner and studying French and Italian."

One Year, Then Debut

A serious training of only one year preceded her debut in Vienna. The tradition that it requires long years of study and long years of training in minor roles did not hold good in this case. Miss Lewis has jumped to the top twice—first in the revues, then in grand opera. She sang in the chorus and in leads, but never in a minor part.

Started Stage Life at 19

In 1919 she went into theatricals by the rapid method of running away from home to join the chorus of "Reckless Eve." The show was stranded in San Francisco and she sang in a cabaret there to keep going financially. She was in the movies for a brief spell in Hollywood, later on, then went to New York and got a job as chorus girl in the "Greenwich Village Follies." Before the show opened she was prima donna in it.

She made her biggest hit in the Ziegfeld Follies and earned enough to be able to study under Thorner, teacher of Galli-Curci and Rosa Ponselle. She studied French and Italian. She went abroad, made her debut in 1923 as Marguerite in Faust, at Monte Carlo, and in 1924 sang in opera in England.

Surprise Is Promised for International Week

Radio interests the world over are already beginning to focus their attention on International Radio Week, to be observed January 24 to 30, when it is expected that many startling disclosures in the business methods and scientific advance of the industry, of interest to every country, will be made known to the world. Leaders behind the movement to weld the nations of the world into a common bond of understanding for the progress of radio declare that the principal results it is hoped to accomplish will be to unify business methods for simplifying export and import, and to compare the scientific

advance of radio as it applies to the various countries, with the idea of allowing one nation to profit by another's experience for the benefit of all. Many organizations have already come out with wholehearted support of the movement. Among the first of these was The Radio Manufacturers' Association, which contributed a check for \$500 as an initial donation toward the support of International Radio Week. It is planned during the week to conduct many broadcasting tests of an international nature contributed a check for \$500 as an initial donation toward the Week.

A Radio Compass

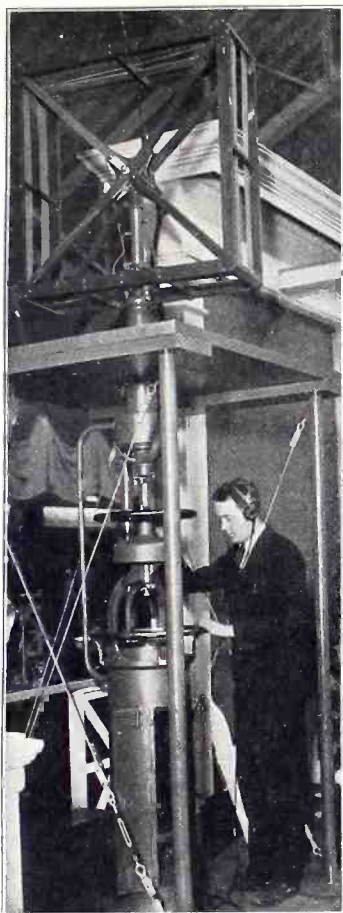

A RADIO COMPASS, such as is used on the Leviathan, and also on the President Harding which recently rescued the crew of the Italian freighter Ignazio Florio in mid-Atlantic. (Underwood & Underwood.)

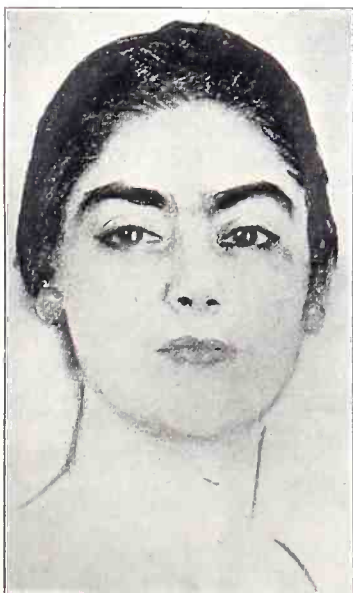

MME. EVA GAUTHIER, who broadcast during the sixth Atwater-Kent Radio Hour, through WEAf and twelve other stations. She is a gifted Canadian singer.

Expert Revives Swooning Tubes



R. P. BATTLE, of the Radio Laboratory of the Bureau of Standards, reactivating an XL (Thoriated) filament electron tube. The transformer changes the 110-volt alternating current to the proper voltage for reactivation as indicated by the voltmeter. This process consists of boiling additional atoms out of the interior of the tungsten filament. This forms a new layer of thorium atoms on the surface. The boiling is done by operating the filament for a very brief interval at a specified high voltage followed by a low voltage. (Harris and Ewing.)

Obliging Artist's Chances Better Than Announcer's

By Floyd Neal

Chief Announcer and Program Director, WGBS, N. Y. City

Next on the program—the Armenian Hour! Where are the chorus of thirty, the band of weird and tickling Oriental instruments promised and verified and advertised for weeks? Only one swarthy, sad-eyed individual on the vast and shopper-deserted floor of the broadcasting department store! And a whole hour to fill! The announcer can play the piano with such limited technique he is able to keep up with the press of official duties, but his duties as filler-in have exhausted his repertoire. He can sing to his own accompaniment with the mike at his elbow for company in these rather hideous occasions, but his intelligent sympathy with his precious radio audience and for himself as an idealistic musician denies him refuge even under the lie of disguised names which might not stand the revealing uncovering of psycho-analysis. His music is not in his head or not at least there to be trusted alone with mike. He paws frantically through its torn, tattered, floppy sheets to find one appropriate to the temperature out in the limbo of the host of listening wraiths, or in the mood of all who wait and wait and wait—for the Armenian Hour! No fame-stricken shamble of orphan bones ever suffered such tortures!

Well, he plays and plays for ten, fifteen, sixteen long, blue seconds multiplied by sixty. He sings and sings and sings until huskiness of despair nearly creeps into "the pleasant voice." Then he stalls for time in his announcements. He recalls the blissful hours long ago he passed in the Peterborough Hills, where the first great American composer, MacDowell, whose compositions he has been playing,

is glorified. He lards his announcements with not too rich remarks. He relates his own fanciful interpretations of "To a Water Lily," as culled from a page of Maeterlincks. He looks out liquidly through the plate glass side of the studio into the vast floor of the piano salesroom and the serried lines of ebony grands grin at him, showing their white keys. Then appears the blessed face of a staff artiste, radiant with potential understanding of the predicament. In another thirty seconds a contrasting voice is saving the program from banality.

Most radio artists are so genuinely interested in their new form of art and so enthusiastic over it, time means only so much more fun. These arrive at a studio a half-hour or more in advance of their scheduled broadcast. There is never an exception taken by this sincere, unsnobbish, progressive type of artist, when asked to go on the air ahead of his schedule to fill in the time of a conscienceless defaulting artist. By the old, old rule of compensation, this type of artist is bound to reap the golden first-fruits of this new and mysterious art, radio. His chances are far, far better than the announcer's.



INTERIOR VIEW of motor truck maintained by Department of Commerce which travels about investigating interference, (Underwood.)

INDEX

Issues of August 22 to November 14

AUGUST 22

A Home-Made Toroidal Coil, with picture diagram, by George B. Hostetter.
The Electrostatic Regenerator, a 1-Tube, 2-control DX set, by Percy Warren.
Crystal Sets That You Can Log, a complete

discussion of wave trap types of crystal receivers, by Herman Bernard.

Efficient Antenna Installation, by Lewis Winner.
Allied Supremacy in Radio Revealed as Key to Victory, Part I, of a war article, by Thomas Stevenson.

AUGUST 29

The 1-Dial Powertone, a remarkable 5-tube set, by Herman Bernard.

A 1-Tube Set A Baby Can Build, by Herbert E. Hayden.

How I Built My Diamond, by J. E. Anderson.
How to Make a Fine Meter Switchboard, with complete diagrams, by Lewis Winner.

How to Wind a Coil on Air, by The Masked Man.

Power and DX on One Tube, by Percy Warren.

The Part Radio Played in the War, Part II, conclusion, by Thomas Stevenson.

How to Connect Coil Terminals, a Study of

Stray Couplings and Phase Relations, by J. E. Anderson.

The Loop Model Powertone, by Herman Bernard.
A 5-Tube Geared Receiver, Part I, by Lewis Winner.

Heaviside Layer Theory Confirmed.

SEPTEMBER 12, THE SHOW NUMBER

The 1926 Model Diamond, Part I of a 3-part article, by Herman Bernard.

A Low Loss Skeleton Coil.

An Oscillating Wavemeter, by J. E. Anderson.

Powertone Trouble Shooting, by Herbert E. Hayden.

The Rush to the Dial's Rescue, a discussion of the SLF SLW and SLC condensers, by Capt. Peter V. O'Rourke.

A 25-to-100-Meter Receiver, by Sydney E. Finkelstein.

The 5-Tube Geared Receiver, Part II, conclusion, by Lewis Winner.

SEPTEMBER 19

Coils for the 1926 Diamond, Part II of a 3-part article, by Herman Bernard.

A 1-Dial, 2-Tube Speaker Set, by Percy Warren.

Set Combines DX and Volume, a 3-Tube Superb Reflex Set, by Bertram Pierce.

Anderson's Theory of Fading, by J. E. Anderson.

A Tube B Battery Eliminator, Part I, by Lewis Winner.

A Home-Made Volume Control, by Herbert E. Hayden.

The Way of the Frequency Dial, a study of SLF dials, by Capt. Peter V. O'Rourke.

SEPTEMBER 26

How to Wire the Diamond, Part III, conclusion, by Herman Bernard.

A Home-Made Neutralizing Condenser, by Herbert E. Hayden.

An 8-Tube Super-Heterodyne, by Sydney E. Finkelstein.

The 5-Tube Browning-Drake, by Capt. Peter V. O'Rourke.

A Tube B Battery Eliminator, Part II, by Lewis Winner.

A 1-Control Regenerative Set, by Percy Warren.

Using the Secondary of an RFT as a Loop, by J. E. Anderson.

Making the Interfretz, by Hugo Gernsback.

OCTOBER 3

The Thordarson-Wade Set, Part I of a 3-part article, by Herman Bernard.

How to Make a Fixed Grid Leak, by Herbert E. Hayden.

The Mechanism of Meters, by Lewis Winner.

Trouble Shooting in the Diamond.

Audio Circuits Compared, Part I of a 2-part article, by J. E. Anderson.

Complete List of Stations.

OCTOBER 10

Hookups for Short Waves, by Percy Warren.

The 3-Tube, 3-Circuit Tuner, by Capt. Peter V. O'Rourke.

The DX Set That Thrilled Jack, a 5- or 6-Tube DX Set, Part I of a 2-part article, by Lewis Winner.

Audio Circuits Compared, Part II, conclusion, by J. E. Anderson.

How to Determine Series Aiding With AFT.

The Coils and the Wiring for the Thordarson-Wade, Part II, by Herman Bernard.

A Compact 1-Tube Reflex, by Franz von Stiefel.

OCTOBER 17

The Thoroughbred, a Simple 1-Tube Set, Part I of a 3-part article, by Herbert E. Hayden.

O'Rourke's Favorite SW Set, by Capt. Peter V. O'Rourke.

Working the Thordarson-Wade, Part III, conclusion, by Herman Bernard.

The Wonders of the Tube, by C. B. Jolliffe.

How to Wire the Set That Thrilled Jack, Part II, conclusion, by Lewis Winner.

Regenerative Set Operation.

The RX-1, Part I of a 2-part article, by H. C. Hight.

OCTOBER 24

The 3-in-1 RF Receiver by Sydney E. Finkelstein.

A Phonograph Cabinet Set, 5 Tubes, Part I of a 3-part article, by Lewis Winner.

Plate Voltages for the RX-1 by H. C. Hight.

The Thoroughbred, Part II, by Herbert E. Hayden.

How and Where to Use All Kinds of Fixed Condensers, by J. E. Anderson.

The Bernard 1-Tube DX Set, Part I of a 2-part article, by Herman Bernard.

OCTOBER 31

The Pathfinder, a 4-Tube Set, Employing Balloon Coils, by Sydney E. Finkelstein, Part I of a 2-part article.

A Snap-Catch Terminal Strip, by Herbert Erwin.

How to Make a Simple Loop, by Herbert E. Hayden.

Winding Data for Short Waves, by J. E. Anderson.

The Phonograph Cabinet Set, Part II, by Lewis Winner.

Completing the 3-in-1 Set.

How to Make a 2-Control 4-Tube Set, by Percy Warren.

Writing the Thoroughbred.

NOVEMBER 7—HOOKUP NUMBER

A 3-Tube Dry-Cell Circuit, by Capt. Peter V. O'Rourke.

Measuring Inter-Frequency, by J. E. Anderson.

Photos of the Phonograph Set.

One of the Best Crystal Sets, by Herbert E. Hayden.

Four Pages of Hookups of All Types of Sets.

A Flexible Short-Wave Set, by Percy Warren.

The 4-Tube Roberts Receiver, by Neal Fitzalan.

The 4-Tube Erla Pathfinder, Part II, conclusion.

NOVEMBER 14

The 4-Tube DX Special, Part I of a 2-part article, by Herbert E. Hayden.

How to Wind a Coil Tightly.

The Set That Water Loudened, by Capt. Peter V. O'Rourke.

A Receiver for Music-Lovers, by Lewis Winner.

How to Build the Ultradyne, by B. B.

2-Tube Set Heard McMillan From Sydney, Australia

C. H. CLARK, La Perouse, SYDNEY, N.S.W., AUSTRALIA

To Radio WAP Ur CW Sigs Hrd here on Abt 36 metres
At 8.39 PM S.M.T. Calling Radio Z2AC Ur Strength 5
QRM Bad QRN Bad QSB Ruff QSS Nil
RECEIVER 3-Coil Used Detr + 1 step on Ur Sigs.
TRANSMITTER _____ Rad. _____ T. C Amps. Input _____ Watts
AERIAL 5 Wire T Cage 80 ft. Long and 45 ft. High
COUNTERPOISE Earth used on ur Sigs.
REMARKS Your Sigs are strong and very steady. But
Ur Note is Ruff. Ven Hrd to read through QRM
Big X Storm Spoilt for transmission on 3015 om
Ur Sigs Hrd every Experimental Station 602
Evng. Pse Confirm
PSE QSL this report TN x Date 29. 8. 25

REPRODUCTION of Clark's report card, telling of receiving McMillan's ship.

Recently the Brighton Laboratories, Inc., 73 Winthrop street, Newark, N. J., manufacturers of True Blue tubes, received a very interesting letter from C. H. Clark, operator of an experimental station in Sydney, Australia. This station is known as Experimental Station 602. Clark reports he heard WAY, the McMillan radio station, when the ship was in the frozen North. The experimenter used only two tubes.

This is the deciphering of what the experimenter states in his report card:

"To Radio WAP: Your continuous wave signals were heard here on about 36 meters at 8.30 P. M. Standard Mountain Time, calling Radio Station Z2AC. The signals were fair. The static and the interference were bad. Your tone was rough. The signals did not fade. I used a 3-circuit tuner, with a detector and one step of AF to hear your signals. I used a 5 wire T cage 80 foot long antenna, which is 45 feet high. I did not use a counterpoise, but the plain earth as a ground. The special remarks are as per: Your signals are strong, and very steady. You have a rough note, though. It is very hard to read your signals through the interference. A big storm spoiled your transmission on the 30th. Your signals are heard every evening. Will you please confirm this report? Experimental Station 602. Please acknowledge this report. Thanks. Best regards from C. H. Clark. Date—August 29, 1925."

The following letter from Clark to Brighton Laboratories accompanied this report, which report was sent to the Brighton

Laboratories for forwarding to the McMillan Expedition:

Old Customs House, LaPerouse,
Sydney, Aust., 3-9-25.

Dear Sirs:

I am enclosing herewith a card for station WAP. I am at a loss to know where to send it to make sure of its arrival O.K.

Hearing that WAP is using True Blue valves supplied by yourselves I thought I would not go far wrong by sending this card to you. I hope you will see your way clear to forward it to WAP. I am anxious for a confirmation card. I might state that the set I was using was a 2-valve Lo-Loss and that the amplifier was a True Blue. They are the most clear amplifiers and the volume is equal to, if not better, than the standard 201-A, which is noisy microphonic. I find that the filament adjustment is somewhat critical though I use about 3 volts filament to 90 volts plate. This same tube was also tested in my friend's transmitter, which is a series feed Hartley, the power being supplied by a Ford (1/2 inch) spark coil. The input (in plate circuit) was about 8 watts. After the filament was adjusted it was found that the radiation was increased 50 to 75 milliamperes, giving 375 milliamperes on 170 meters, where a U V 201-A hung around 300 ma. radiation. I think this was a good, severe test to put the tube to.

I find it impossible to work my Lo-Loss with any other tube in the amplifier circuit as microphonic noises drown signals. My best DX to date is a British station (G2LZ) on about 25 meters in daylight. I am at present waiting on a card from him.

I would be glad if you could forward me a copy of the curve of these valves. This would be interesting. Do you know the power at WAP? Hoping you will not be offended at the liberty I take to write to you, I am,

Yours truly,

C. H. CLARK.

P.S.—The Code No. of my tube is V.069

BROADCASTING STATIONS TO DATE

Complete list appeared in RADIO WORLD dated Nov. 14. 15c copy, or start your sub. with that number. RADIO WORLD, 145 W. 45th St., N. Y. C.

Prop Audience of 50 Enspirits Chaliapin

LONDON.

Lest he be nervous before a microphone, Feodor Chaliapin, the great Russian basso, had an audience of 50 persons gathered before him at the British Broadcasting Company's station here. This enspirited him and he sang with fervor that others might have been lacking. The audience's applause surprised listeners, until they learned that the object of the auditors' presence was to take the mechanical aspect away from the microphone.

PATENT SUIT DECIDED

Federal Judge Campbell in New York signed a decree awarding to the Western Electric and Manufacturing Company and the Radio Corporation of America three times the total profit of the Amsco Products, Inc., of New York, from the Amsco's use of the so-called Armstrong patent. This patent, it was alleged, was infringed upon in the manufacture of the Melco Supreme set by the Amsco concern.

The patent was granted to the plaintiff on Oct. 6, 1914, and has been infringed upon for three years, according to the complaint. Judge Inch also granted the plaintiffs a permanent injunction restraining the Amsco concern from using the patent. A special master was to be appointed to fix damages.

FREIGHT CASE REOPENED WASHINGTON.

The Interstate Commerce decision increasing the freight rate on radio sets has been reopened on petition of the radio manufacturers on the ground that their products should not bear a higher rating than analogous musical instruments, which take a first and sometimes second class rate. Witnesses for both the railroads and the radio industry have been heard and a decision will probably be forthcoming within a short time.

DOWNEY'S WIFE DIES WASHINGTON.

Mrs. W. E. Downey, wife of the Assistant Chief Radio Supervisor, died. She was buried at Arlington, N. J. Mr. Downey

ASSEMBLED KITS OUR SPECIALTY

For all popular circuits—complete, exactly as specified. Kits—K.D. or Assembled, ready for wiring—at same prices. Wiring can be completed and set ready for use in one hour.

- Radio World, 1925 Diamond, 5 tube...\$36.50
 - Browning Drake, 4 tube..... 40.50
 - Browning Drake, 5 tube..... 45.50
 - All Amer. 1926 DeLuxo Superhet, 8 tube..... 69.00
 - Thordarson-Wade, 5 tube..... 40.95
- Write for full descriptions of these kits and also our price lists, showing other kits and radio parts.

THE MAIL-O-RADIO CO.
25 Malden Lane New York, N. Y.



CONDENSERS
VERNIERS
RHEOSTATS

AMSCO PRODUCTS, Inc. New York City

Mailing Lists

Will help you increase sales. Send for FREE catalog giving complete list of prices on thousands of classified names of your best prospective customers—National, State and Local—Individuals, Professions, Business Concerns.

99% Guaranteed by refund of 5¢ each

ROSS-Gould Co. 10th St. St. Louis

is prominent in Washington radio circles. He was an amateur when a boy, taught radio in Los Angeles, was radio inspector in charge at Seattle, Washington, radio inspector at Baltimore, and for four years has been assistant radio supervisor at the Department of Commerce.

**PHILHARMONIC TO PLAY
FOR WGY AND WJZ SATURDAYS**
WGY's 379.5 meter wave will carry another exceptional musical treat to the listeners, Saturday evenings during the

CROSLEY
ILLUSTRATED RADIO CATALOG FREE!
Describes fully the complete Crosley line of radio frequency sets, regenerative sets (licensed under Armstrong U. S. Patent No. 1,113,149) and parts.
THE CROSLEY RADIO CORPORATION
Cincinnati, Ohio

RADIO

EUREKA DIAL POINTERS
10c EACH
Polished Nickel or Gilt.
D-X Owl Pointer: Nickel 10c
Gold Plated..... 15c
Samples for Stamps.
C. W. BUTTS, INC.
40 HEDDEN PLACE
EAST ORANGE, N. J.

Long Distance Radio \$2.95



Lambert's newest crystal success. No tubes. No batteries. No grief. Always ready. Works 600 miles. Fully guaranteed. We pay postage. Order direct from this ad. Leon Lambert. Wichita, Kansas.

winter. The Philharmonic Society's Student Concerts will be broadcast by WGY in cooperation with WJZ of New York on the following dates: Nov. 28, Dec. 19, Jan. 2 and 30, Feb. 6 and 13, Mar. 20 and 27 and Apr. 3. Willem Mengelberg will conduct the concerts.

NO MORE "B" BATTERIES!

Waage "B" Eliminator solves all "B" Problems



Be the first in your town to sell and demonstrate it. Big Sales — large profits. Busy season ahead. Write us for full particulars TODAY.

A. H. WAAGE
6 Reade St. New York, N. Y.

2 1/2 volt un-acid everlasting rechargeable "B" Storage Battery

\$2.95

includes chemical



45 volts, \$5.25; 90 volts, \$10.00; 112 1/2 volts, \$12.50; 135 volts, \$14.75; 157 1/2 volts, \$16.80. Truly, the biggest buy today. Easily charged on any current, including 32-volt systems. Any special detector plate voltage had. Tested and approved by leading authorities such as Popular Radio Laboratories. Over 3 years sold on a non-refund, 30-day trial offer with complete refund if not thoroughly satisfied. Further guaranteed 2 years. Knock-down kits at great savings. Complete "Hawley" "B" battery charger, \$2.75. Sample cell, 55c. Order direct — send no money — simply pay the expressman cost on delivery. Or write for my free literature, testimonials and guarantee. Same day shipments. B. Hawley Smith, 318 Washington Ave., Danbury, Conn.

Our Stock of these Dials is Low—Only a few more left

The B-C-L Special Metal Vernier Dial. Ratio 20-1 makes tuning a pleasure.



Now is the time for distance. Get those hazy stations "in" with this Vernier Dial. 59c each

GIVE YOUR SET THAT PROFESSIONAL APPEARANCE WITH BRUNO BRACKETS

This does away with the old-fashioned baseboard



Simplifies wiring and improves the looks of any set. Per pair, \$1.00



"Bruno 55" matched radio frequency coil for 99 and used in the Diamond of the Air...\$3.00



"Bruno 99" 3-ohm tuner wound on quartzite glass with special tickler for smooth regeneration control.....\$5.50



"Bruno 77" 3-ohm tuner wound on quartzite glass with special tickler for smooth regeneration control.....\$5.50



"Bruno" short wave coil. Tunes from 25-110 meters with .00025 condenser. Wound with flat ribbon wire.....\$5.50

Write for Free Catalogue.

B-C-L Radio Service Co., 221 Fulton St., New York City

THE RADIO TRADE

LOUD SPEAKER RECEPTION

from either coast on three tubes.

- Blueprint and instructions.....\$1.00
- Necessary low loss coil.....\$2.50
- Beautiful finished instrument.....\$35.00

S. A. TWITCHELL CO.

1930 Western Avenue Minneapolis, Minn.

OUR NEW CATALOGUE

Just completed—listing hundreds of BARGAINS, will be mailed to you upon receipt of name and address.



GET YOUR NAME ON OUR MAILING LIST
SIMPLEX RADIO SUPPLY CO.
 1806 LAFAYETTE AVE. Dept. D. ST. LOUIS, MO.



Receivership Asked for Liberty Chain Stores

Suit was filed in the New York Supreme Court asking for the appointment of a receiver for the Liberty Radio Chain Stores, Inc., a Delaware corporation, operators of radio stores in New York, Washington, D. C., and Providence, R. I. The company manufactures the Clearfield radio set.

Gaillard Smith, who owns 12,000 shares of the capital stock, brought suit on behalf of himself and other stockholders.

The defendant corporation has a capital of 150,000 shares of no par value, of which 120,000 shares have been issued.

The plaintiff alleges that he has deposited his shares with the Corporation Trust Company, subject to an option to purchase by Frank T. Stanton & Co. of 52 Wall Street at \$2.50 a share. The option expires Feb. 1, 1926.

The corporation took over the business of David Kanofsky, to whom was issued 62,000 shares of stock, and it is alleged that the Stanton Company has an agreement to acquire the right to purchase 88,000 shares at \$2.50.

The company had as subsidiary the Sherman Radio Distributing Company.

You Save 50%

Approved!

Listed as Standard by Leading Authorities including Radio News Laboratories, Popular Science Institute of Standards, Popular Radio Laboratories, Radio Broadcast Laboratories, Radio in the Home Lab., Inc.



Successful manufacture and thousands of satisfied users. Equipped with Solid Rubber Case, an insurance against acid and leakage. You save 50 per cent.

Radio Station W 5 B C
 Set your Radio Dials at 210 meters for the new 1000 watt World Storage Battery Sta., W5BC.

- World Radio and Auto Batteries are famous for their guaranteed quality and service. Backed by years of experience.
- 2-Year Guarantee Bond in Writing**
- WORLD Battery owners tell their friends: "That's our best proof of performance. Send your order in today."
- Solid Rubber Case Radio Batteries**
- 6-volt, 100 Amperes.....\$11.25
- 6-volt, 120 Amperes.....13.25
- 6-volt, 140 Amperes.....14.00
- Solid Rubber Case Auto Batteries**
- 6-volt, 11-Plate.....\$11.25
- 6-volt, 18-Plate.....13.25
- 12-volt, 7-Plate.....16.00

SEND NO MONEY

Just state battery wanted and we will ship day order is received, by Express, C. O. D., subject to your examination on arrival. Extra Offer 5 per cent discount for cash in full with order.

WORLD BATTERY COMPANY
 Dept. 17
 1219 So. Wabash Ave., Chicago, Ill.

World

RADIO FACTORY wishes to connect with responsible party having sales ability. \$1,000 required. Box A10 Radio World.

PANELS

RADIO and HARD RUBBER RETAIL ANY SIZE WHOLESALE PRICE LIST MAILED ON REQUEST

HARD RUBBER SHEETS—RODS—TUBING

Special Hard Rubber Parts Made to Order. Send Sample or Sketch for Quotation.

NEW YORK HARD RUBBER TURNING CO.
 212 CENTRE ST. NEW YORK

GEM TUBE

A Guaranteed Radio Tube Within Reach of All

Every tube guaranteed. A tube for a dollar of \$2 value. A trial order will convince you as it has thousands of others. Send your orders at once. Orders sent C.O.D. parcel post.

\$1.00

Type .199A EACH
 Type .199 Type .200 Type .201A (with standard base) EACH
 Dealers, Write for Discounts.

GEM TUBE CO.

Dept. W. 200 B'way, N. Y. C. 220 So. State St., Chicago, Ill. Lafayette Bldg., Detroit, Mich.



Literature Wanted

THE names of readers of RADIO WORLD who desire literature from radio jobbers and dealers are published in RADIO WORLD on request of the reader. The blank below may be used, or a post card or letter will do instead.

Trade Service Editor,
RADIO WORLD,
 145 West 45th St., N. Y. City.

I desire to receive radio literature.

Name

City or town

State

Are you a dealer?.....

If not who is your dealer?.....

His Name

His Address

- Jack Rolfe, 3637 Market St., Philadelphia, Pa.
- J. W. Barry, Hamphan, Ia.
- Bodier Bros., 1418 Edgerton St., St. Paul, Minn.
- I. C. Dickover, Wabash, Ind.
- C. Lawrence, 401 Washington Bldg., Seattle, Wash.
- Ray Massott, 7421 Palmetto St., Philadelphia, Pa.
- M. C. Schoonmaker, Jr., P. O. Box 352, Morris-town, N. J.
- R. L. Sullivan, Goldville, S. C. (Dealer.)
- O. P. Hernandez, P. O. Box 1658, Havana, Cuba.
- C. H. Waltner, 120 South Monument Ave., Hamilton, O. (Dealer.)
- D. C. Armstrong, Madisonville, Ky.
- The Phonograph and Radio Shop, 125 South State St., Painesville, O. (Dealer.)
- Arnold Fitzsimmons, 1242 Lane St., Topeka, Kan.
- E. Leeds, care M. E. Blatt Co., Atlantic City.
- James R. Reed, Auburn, Ala. (Dealer.)
- C. F. Wissler & Son, Kingsley, Ia. (Dealer.)
- Carl Finrich, 60 Dole St., Oshkosh, Wis.
- Wm. S. Bourne, Box 118, Ware Shoals, S. C.
- Harry J. Donle, Fairmount, Mo. (Dealer.)
- L. Harrison, Sioux City, Ia.
- Gilbert B. Lutz, 3134 N. Columbia Ave., Philadel-phia, Pa.
- Charles D. Myers, P. O. Box 546, New Ken-nington, Pa.
- Kenm. E. Talmadge, Lock Box 152, Apollo, Pa.
- J. B. Bicksworth, 3213 Myrth Ave., Dallas, Tex.
- J. T. Litzer, 507 Borthwick St., Portland, Ore.

Business Opportunities Radio and Electrical

Rates: 10c per word; Minimum, \$1.00; Cash with order.

\$100 WEEKLY UP. We want experienced radio men to operate branch assembly plants. Part or whole time. Barfield Radio Co., 13 Tillary St., Dept. W. R., Brooklyn, N. Y.

RADIO AND ELECTRICAL; good opportunity to rent floor space and window in store; best section of Main St. M. Fixel, White Plains, N. Y.

RADIO DEPARTMENT FOR RENT in a live, popular priced store; commission basis or will handle same on consignment. Communicate at once with B. A. Linn, 135 Main St., Paterson, N. J.

IN PREPARATION—RADIO WORLD'S MOST IMPORTANT ISSUE OF THE YEAR

RADIO GIFTS NUMBER

This Will Be a Radio Christmas

Regular Advertising Rates as Follows:

- Page.....\$300.00
- Half-page.....150.00
- Third page (one col.).....100.00
- Quarter page.....75.00
- Per inch.....10.00
- Per agate line......75
- Times discounts:
- 52 consecutive issues..... 20%
- 26 times consecutively, or e. w. one year..... 15%
- 4 consecutive issues..... 10%

Radio Gifts Number will be dated Dec. 12, issued Dec. 9. Last color form closes Dec. 1. Last black form closes Dec. 2, noon.

It is estimated that our RADIO GIFTS NUMBER of 1924 sold more than \$100,000 worth of radio goods for advertisers who used these columns. It is the intention of the publishers to make the 1925 issue of the RADIO GIFTS NUMBER so much better than last year, and to give it so much larger a distribution that the sales through its columns will be increased heavily over last year's figures.

RADIO WORLD'S HOLIDAY GIFTS NUMBER OF 1925 will have a list of notable contributors, a special holiday cover in colors and other special features that will be worth advertising in papers of nearly 5,000,000 circulation throughout the country. There is bound to be a larger sale than usual, because the selling price will not be increased.

If you want to sell your goods to the millions of holiday gift buyers who will purchase radio goods this year, don't fail to use the columns of this RADIO GIFTS NUMBER.

FOR SPECIAL POSITIONS, PHONE OR WIRE IMMEDIATELY!

RADIO WORLD, 145 WEST 45TH STREET.

Phones: Bryant 0558-0559

Increases DX on Super-Heterodyne

The Superadio Co., 136 Liberty Street, New York, has brought out something that every Super-Heterodyne owner has been waiting for, an antenna coupler that will enable him to really bring in all the distance his super is capable of getting; as the makers phrase it, "the link between the Super-Heterodyne and the outside aerial," for, it is estimated that a good outdoor aerial will pick up about ten times the energy that the average loop gathers. A loop built to equal a good aerial would measure approximately 40 feet square. The antenna coupler will also work efficiently on a good indoor aerial. Following their custom, as they did on the Pressley, this concern will either furnish the complete unit in a handsome cabinet, the kit of complete parts, parts separately, or blueprints with full directions. This unit designed for any type of Super-Heterodyne, has brought the Superadio Co. many letters of commendation from Pressley fans who have installed it. This is the first in a series of new radio devices to be produced by this company.

(Tested and Approved by RADIO WORLD Laboratories)

Electric Phonograph Reproducer Invented

The panatrope, a new musical reproducing instrument, has been perfected by scientists of the Radio Corporation of America, the General Electric Company, the Westinghouse Electric & Manufacturing Company and the Brunswick-Balke-Collender Company.

The panatrope, which harnesses the force of electricity to the reproduction of music, is said to be the only purely electrical musical reproducing instrument in the world. It operates on the light wave system, and synchronizes, for the first time, electrical reproduction with electrical recording of sound.

NEW STORAGE BATTERY

The Liberty Storage Battery Co. has opened a new radio battery service station and retail department at 806 Bedford Ave., Brooklyn, N. Y. They are specializing on a good 120-amp, 6-volt battery in a rubber case at a very reasonable price. This is a real 33-plate battery and carries an 18 months' guarantee.

(Tested and Approved by RADIO WORLD Laboratories)

The new WELTY Detector-Amplifier UNIT

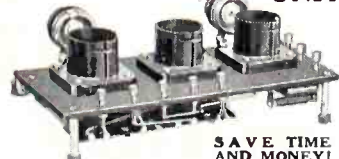

SAVE TIME AND MONEY!

Here is what you have wanted. A small, compact, ready wired, super powerful, detector-amplifier unit. Absolutely distortionless and a perfect performer, because built of world's finest quality parts. At your dealer's or direct. Only \$19.50.

The Welty Practically-Wired 3-Tube Set

Consists of the above detector-amplifier unit and Buell or General Tuner and Heath, Gleason, or Barrett & Paden Condenser, all mounted on bakelite panel. No diagram needed. Only 4 connections to make. An ideal 3-tube set for DX and tone. \$28.50.

The same outfit supplied with either Aero Coil Tuner or Lopez Tuner for \$32.50. Get yours now!

WM. A. WELTY & COMPANY

38-40 S. STATE ST.

CHICAGO

ANDERSON'S 6-TUBE SUPER-HETERODYNE, by J. E. Anderson; the 3-Tube Marconi Broadcast Receiver, by Percy Warren; How to Make a Good Battery Connector; other features in RADIO WORLD, July 18, 1925. 15c a copy, or start your subscription with that number. RADIO WORLD, 145 West 45th St., N. Y. C.

NEW CORPORATIONS

Long Island Radio Supply Co., Freeport, L. I., N. Y., \$7,500; F. W. Fraser, G. A. Gissell, C. W. Raynor, (Atty., L. Schloss, Freeport, L. I., N. Y.

Branler Radio Corp., Hoboken, N. J., supplies \$10,000, in preferred and 1,000 common, no par; Geo. S. Brengle, Arlington; Perry A. Hull; P. J. R. McWintegart, New York. (Atty., Bingham, Englar & Jones, New York).

Marvodyne Radio Corp., Del., radio receiving sets, \$6,000,000; Raymond J. Gorman, New York, (U. S. Corp, Del.)

Syracuse Radio Telephone Co., Syracuse, N. Y., 5,000 common, no par, to 500 shares \$100, and 5,000, no par.

C. Huberts, N. Y. City, make radios, \$6,000; C. J. and S. Hubert F. Klein, Atty., N. Y. City. A. J. Argondizza, 2 Rector Street, N. Y. City.

Veby Resistors and Grid Leaks

Radio Engineers and Experimenters find that the VEBY PRODUCTS give greatest satisfaction. The Home Set Builder will be wise to profit by the experience of the learned insist on VEBY resistors and grid leaks—accept no substitute.

"Quality Resistors"

VEBY RADIO COMPANY

47-51 Morris Avenue

Newark, N. J.

EVERY SET BUILDER NEEDS THIS



"Morsing Bus-Bar Union"

Makes for quick assembling. Repairs can be made by using Morsing Bus-Bar Union without taking set apart.

Assemble round or square Bus-Bar and solder three wires at a time. Order No. 1 for No. 14, No. 2 for 12 wire. Send 15 cents for enough for building one set, or ten dozen for \$1.00.

Newark Watch Case Material Co. 15 Ward Street Newark, N. J.

DISTRIBUTORS WANTED

RADIO PRODUCTION MANAGER. Thoroughly experienced manufacturing condensers, rheostats, jacks, etc., desires connection with reliable manufacturer; investment if desired. S. Seiden, 1,340 Morris Ave., Bronx.

COMING EVENTS
NOV. 19 to 25—Milwaukee Radio Exp., Civic Auditorium. Write Sydney Neu, of J. Andrae & Sons, Milwaukee, Wis.
NOV. 17 to 22—4th Annual Chicago Radio Exp., Coliseum. Write Herrmann & Kerr, Cort Theatre, Bldg., Chicago, Ill.

FREE BOOKLET FOR INVENTORS
IF YOUR INVENTION is new and useful it is patentable. Send me your sketch.
Z. H. POLACHEK, 70 Wall St., New York
Reg. Patent Attorney-Engineer

Depend on ROSSITER

& COMPANY INC. 136 Liberty Street, N.Y.

DISTRIBUTORS OF

Sangamo Condensers for accuracy that endures. Heat proof, moisture proof, fume proof.

McCullough A. C. Tubes for the elimination of "A" batteries. Operate directly from house current.

Harper Metaloids The original "Canned Coil." For use in Tuned Radio Frequency circuits. Sharper tuning and no inductive coupling.

LABORATORY TESTED RADIO Products

Passed by the Engineering Laboratory of Rossiter, Tyler & McDonell, Inc.

5 Tube Radio Set



\$29.50

AMERICAN RADYNOLA

The Biggest 5 Tube Value on the Market

Positively the world's greatest 5-tube radio bargain. Regular \$75.00 value, fully built and wired in beautiful mahogany cabinet of latest design, sloping Bakelite panel, Satin finish, handsomely etched and engraved. Constructed of the finest choice models with loud speakers built right in cabinets of genuine mahogany and walnut. All sets guaranteed. Constant receiving range. Also contains everything in radio supplies including batteries, chargers, rheostats and any other parts you may want for improving your set or building a new one. Guaranteed service to you of 1 to 12. We are the world's largest exclusive radio mail order house.

Send For This Radio Book FREE

Contains thousands of bargains in radio sets, semi-finished sets and radio kits of all styles, sizes and approved circuits. Beautiful models of latest designs and types. Elaborate choice models with loud speakers built right in cabinets of genuine mahogany and walnut. All sets guaranteed. Constant receiving range. Also contains everything in radio supplies including batteries, chargers, rheostats and any other parts you may want for improving your set or building a new one. Guaranteed service to you of 1 to 12. We are the world's largest exclusive radio mail order house.

RANDOLPH RADIO CORPORATION 189 North Union Ave., Dept. 152 CHICAGO



1926 Catalog Containing 64 Illustrated pages of Radio Bargains Write for It Today

WINNER'S SET

(Concluded from page 5)
of AFT2 goes to the P post on socket 2. The B post on this AFT goes to the B+ 2 post on the terminal strip. The G post on this AFT goes to one terminal

RADIO DEALERS
GET THAT NEW CATALOGUE FROM VAN-ASHE!
New circuits—new parts—new sets. All the hard-to-get items — and extra-good discounts!
VAN-ASHE RADIO CO.
204 N. 10th Street St. Louis, Mo.



RADIO AGENTS WANTED

5 Tube Demonstrator FREE!

Earn \$25 to \$100 a week, part or full time. Everyone a prospect. Complete line standard sets and accessories, \$5 to \$30. Write today for illustrated catalog and exclusive selling plan for live dealers and community agents. 20TH CENTURY RADIO CO., 1101 Coca Cola Bldg., Kansas City, Mo.

of the large fixed condenser, C6. The other terminal of this condenser goes to the resistance wire of the potentiometer R3. The other resistance wire post goes to the C— post on the terminal strip. The arm of this potentiometer goes to the G post on socket 3. One terminal of the resistance, R6, goes to the A— post. The other terminal of this resistance goes to the F— post on the socket. The F+ post

LINK YOUR SUPER
to an **OUTDOOR AERIAL!**
A good aerial collects many times the energy that a loop picks up. For **INCREASED RANGE-VOLUME-CLARITY**, use this extra energy.
Write today for full information.
139 LIBERTY ST.
The Superadio Co. NEW YORK CITY

Jones
MULTI-PLUG
THE STANDARD SET CONNECTOR
HOWARD B. JONES
618 S. CANAL STREET CHICAGO

of this socket goes to the F+ post on the last socket, 4. The P post on AFT3 goes to the P post on socket 3. The B post goes to the B+ 2 post. All the connections on this post also go to the bottom terminal of the single circuit jack, J1. The G post on this AF goes to one terminal of the fixed condenser, C7. The other terminal of the fixed condenser goes to the fixed resistance R4 and to G post of socket 4. The other terminal of this resistance goes to the C— post. We now have connected the two resistances, R3 and R4 to the C— post. The ballast resistor, R7, as usual is placed in the F— side of the socket. The F+ post goes to the A— post on the terminal strip. Now all the F+ posts are connected together. The C+ post goes to the A— post on the terminal strip. The A+ post is connected to the B— post. In the diagram the A leads are reversed.

It does not matter in which leg the resistors are placed as long as the C+ goes to the A+ post on the terminal strip. A+. Sometimes the set will work better with the resistors in the positive leg. The only way to really find out the above is to try it. The switch is placed in the A+ lead, although it is not important, in which lead it is placed.

The stations are a bit easier to tune in than with the set last week. The two dials tune in step. The variable primary need only be adjusted once and then left alone. If, however, you find that there is too much squealing in the set, the occasional adjusting of this coil will help considerably. The crystal detector need not be fiddled around with, as once set it is left alone. This is provided you have a crystal which is sensitive all over the surface. The arm of the potentiometer is turned around until you hear a hissing sound, and then left alone. The variable resistance, R3, plays an important part in the controlling of the volume of the set, and should be carefully adjusted.

TROUBLE-PROOF!

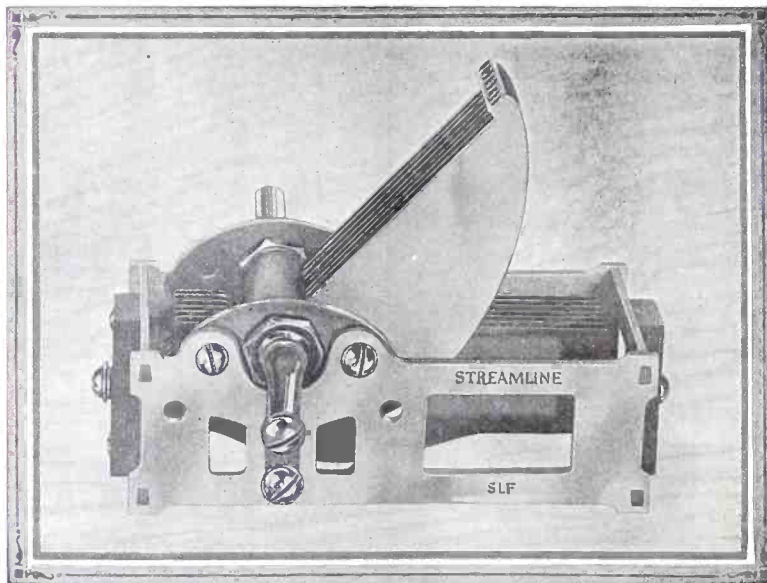

"Built to Last a Lifetime"

The Streamline Straight-Line Frequency Condenser assures you of the greatest possible tuning ease, with wide separation between stations otherwise crowded together on the dial. The rotor plates turn gently and are safeguarded against touching the stator plates. Rigid mechanically, low-loss electrically, the Streamline is also a thing of beauty and a joy forever!

.0005 Mfd. **\$2.50** .00035 Mfd. **\$2.25** .00025 Mfd. **\$2.00**
immediate Delivery—Absolute guarantee on every box.

STREAMLINE RADIO CO.
223 FULTON STREET
New York City

Enclosed find \$..... for which send me by return mail Streamline SLF condensers, capacity
NAME CITY
ADDRESS STATE

NEW IMPROVED
FRESHMAN MASTERPIECE
AT AUTHORIZED FRESHMAN DEALERS ONLY

Basket Wound Tuners
Variable tapper, positively lowest loss. Tunes 200 to 600 meters. Latest and best three-circuit tuner for broadcast reception. One hole panel mounting. Also, variable primary and tapper, takes two hole panel mounting. Special mail order price \$2.00 either one. Low loss basket wound coils for tuned radio frequency sets, \$1.00 each. Set of three, \$2.50.
Straight Line Frequency Condensers, lowest loss, grounded rotor, spring pigtail connection, one hole mounting. This type condenser will get stations all over the dial that never came in before. 13 plate (.00035) \$2.00; 24 plate (.0005) \$2.25. Absolutely guaranteed. Catalogue of broadcast and low wave equipment on request. Buy direct and save money.
Precision Radio Equipment Co.
Johnson City, N. Y.

ULTRA-VERNIER
TUNING CONTROL
A VERNIER DIAL ON WHICH YOU CAN PENCIL RECORD THE STATIONS, GEARED 20 TO 1. SILVER FINISH \$2.50—GOLD FINISH \$3.50
PHENIX RADIO CORP., 116 East 25 St., N.Y.C.

EVEREADY
Radio Batteries
—they last longer

Inventor Explains Radio Device That Stops Trains

Thomas E. Clark, of Detroit, inventor of a radio-operated device that stops speeding locomotives when danger lurks, explained his invention as follows: "The success of continuous control depends on the propagation of electromagnetic waves flowing in the track rails, these waves being picked up by loop collector coils under the pilot. The waves are pumped into the rails by a roadside unit. They are transmitted at a wave

length of 28,000 meters to give a clear indication signal and at a wave length of 22,000 meters to give a caution signal. "The loop collector coils are equipped with variable condensers for tuning each coil to the wave length propagated in the rails. These coils transmit the various wave lengths to the visual signal device in the engine cab. This consists of three lights, red for danger, yellow for caution and green for clear track ahead. These signals give the engineer advance information on the condition of the track ahead.

GREAT DX RECORD!

Mr. Sterling Hess of the D. L. & W. R.R., in Binghamton, N. Y., has received cards from amateurs in Holland, France, England and many other far distant points reporting his reception of their signals O. K. He used coils made by Precision Radio Equipment Co., of Johnson City, N. Y., in a three-tube set.

DEALERS!

We can give you IMMEDIATE DELIVERY and best trade discounts on

- | | |
|------------------------|-------------------------|
| Silver-Marshall | Sixties Cells |
| Vaxley | Carter Products |
| Marco Dials | Gem Radio Tubes |
| Montrose Sets and | Micamold Fixed |
| Condensers | Condensers and Leaks |
| Nazley | Fitch Speakers |
| Coco Radio Tubes | Walzone Speakers |
| Patent | B-M-S Dials |
| Premier Elec. Co. | Phonix Radio |
| Precise Condensers | Pruno |
| and Transformers | Pennsylvania Speakers |
| Centralab | and Phones |
| Premier Elec. Products | Pal Phones |
| Town Crier Speakers | N-K Speakers and Phones |
| Amperites | Diclograph Products |
| Samson Transformers | Artes Sets |
| and Kits | Superola Sets |
| Neilslide Condensers | Amerex Sets |

Shipments made same day we receive your order

MAURICE SCHWARTZ & SON
RADIO DISTRIBUTORS
710-712 BROADWAY, SCHENECTADY, N. Y.

ARE YOU THE MAN

to be first in your town to sell and demonstrate POWEROLA, the famous 5-tube, no-battery electric light socket radio receiver (not an attachment), universal for D.C. or A.C. (100-115 v. 40-60 cycle), now sold and demonstrated by the New York Edison Co., public utility companies and radio, electric and music dealers everywhere. Absolutely dependable, fully guaranteed, powerful, practical, perfect in performance.

Are You the Man Who Sees Opportunities Ahead for Real Money Making

Write for literature, terms and prices at once.

POWEROLA RADIO CORP.
1845 BROADWAY NEW YORK CITY

The New and Better Diamond of the Air

DX, Selectivity, Volume and Quality—All Marvelously Combined in RADIO WORLD'S 1926 Model

DIAMOND OF THE AIR

5 tubes, including Bernard AF hookup, Sept. 12, 19 and 26 issues of RADIO WORLD, including picture diagrams of wiring.

Send 45c. for these three numbers or start your subscription with the Sept. 12 issue. Send \$6 for yearly subscription and get these three issues FREE. Address Circulation Manager, RADIO WORLD, 145 W. 45th St., New York City.

broadcast its anniversary program Nov. 3. In contrast with the first studio, KDKA now has wire circuits connecting the transmitter with fifty outside points, such as churches, auditoriums and banquet halls.

THOUSANDS OF BARGAINS
FACTORY GUARANTEED MSDE. BY MAIL
Genuine New Radlotron or Cunningham Tubes
UV-199—200—201A—WD-11—12..... **\$1.98**
C299—300—301A—C11—12.....
Fresh Burgess or Eveready "Big" Batteries
22½ Volt large size \$1.30—45 Volt large size \$2.80
Write for Free new Complete Catalog on
Sets and Parts.
STONE ELECTRIC CO., 714 Pine St., St. Louis, Mo.
All Mds. F.O.B. St. Louis, Mo. Dept. W.

A.I.R. SERVICE
sets are guaranteed for
Tone-DX-Clarity

5 Tube Tuned Radio Frequency.....	\$34
6 Tube Resistance Amplification.....	50
6 Tube Rambler Portable.....	90
6 Tube Console.....	125

If your dealer cannot make immediate delivery we will ship direct from factory.

American Interstate Radio Service
183 Greenwich Street, New York City
Distributors, Jobbers, Dealers, write for special trade terms.

Broadcasting Celebrates Its Fifth Birthday

The fifth anniversary of broadcasting was celebrated Election Day at KDKA. On Nov. 2, 1920, that station radiated the first program and won the title, "The Pioneer Broadcasting Station of the World." It was Presidential election day that year and KDKA featured the election returns on the initial program. In order that the anniversary could be celebrated by broadcasting election returns KDKA

Why Hayden Chose G-K

In the construction of the A-A Receiver, described in this issue, Herbert E. Hayden, noted radio authority, selected G-K Spring Cap Binding Posts because—

- An automatic spring action insures a vise-like grip.
- Simplicity of use; no turning down of any nut or knob; only lifting is necessary.
- No cramping of fingers to make contacts.
- The knob, genuine Bakelite, is built into the post.

The G-K Binding Posts are available engraved or plain. For engraved ones, specify from following: Ant., Gnd., A—, A+, B—, B+ Det., B+ Amp. **15c EACH**

Binding Post strip complete for this hookup, by mail \$1.25.

If your dealer can't supply you, write direct. Inquiries Solicited from the Trade.

GANIO-KRAMER COMPANY, Inc.

238-R WEST 53rd STREET NEW YORK, N. Y.

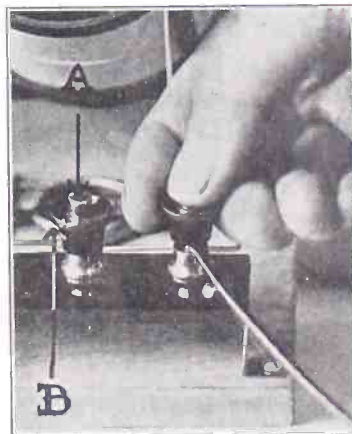

How Hayden hooked up the antenna after completing the A-A Set. All one need to do to make contact with a G-K post is to lift the knob. The post at left shows where opposite pressure is exerted by the fingers at A and B. Let go and the knob snaps down. The contact lasts forever.

FILL OUT AND MAIL NOW

SUBSCRIPTION BLANK

RADIO WORLD

RADIO WORLD

145 West 45th Street, New York City
(Just East of Broadway)

Please send me RADIO WORLD for..... months, for which

please find enclosed \$.....

SUBSCRIPTION RATES

Single Copy.....	\$.15
Three Months.....	1.50
Six Months.....	3.00
One Year, 52 Issues.....	6.00
Add \$1.00 a Year for Foreign Postage; 50c for Canadian Postage.	

THE RADIO UNIVERSITY

I HAVE a 180° Haynes variocoupler. I would like to use it in the Superdyne, with a double condenser. The stator form

is 3 1/2" in diameter and 2 3/4" high. The tickler is 3" in diameter and 1 1/4" high. Kindly advise me if I can rewind the coil. If I can, what are the proper amount of turns to place on the coils?—George M. Hunsberger, Box 45, Station 45, Tacoma, Wash.

You can use this coil. The primary should be wound on the stator form and consist of 10 turns. The secondary should be wound right next to the primary and consist of 45 turns. The tickler consists of 30 turns. No. 22 double cotton covered wire is used, when winding all these coils, except the tickler, where No. 26 SSC wire is used.

I WISH to use the 3-circuit tuner, the constructional data which is given below, in the Diamond. The diameter of the primary and the secondary form is 3 3/4". The diameter of the tickler form is 3". There are 12 turns wound for the primary and 40 turns for the secondary. The tickler consists of 30 turns. (1) Is this all right. (2) Will you please tell me the number of turns to place on the primary and the secondary of the radio-frequency transformer to match this tuner? (3) Which is the better, the basket weave or the solenoid type of form for winding the RFT?—Harold J. Smart, 71 John St., Dalton, Mass.

(1) This may be used with success. (2) Make the RFT just like the primary and secondary of the 3-circuit coil. (3) The solenoid is preferred for this set.

I HAVE built the 3-tube reflex set published in the July 4 issue of RADIO WORLD and described by Capt. Peter V. O'Rourke. This set works great, but I cannot receive above 470 meters. Will you please help me?—Joseph J. Schreiber, 16 Casper Place, Corona Place, L. I., N. Y.

Add 9 turns to each secondary.

I HAVE built the "\$30 1-Tube Set," described in the January 24 issue of RADIO WORLD by Capt. Peter V. O'Rourke. (1) The C2 condenser to the right does not seem to have any effect on the tuning whatever. I have shunted it with a .00025 mfd. fixed condenser and

still can see no difference. (2) Can you tell me why I cannot get DX?—W. J. Rawls, 2747 Grand Ave., Dallas, Tex.

(1) Increase the number of turns on the plate coil (2) This is because the set does not regenerate enough. By adding turns this will be cured. Also try placing a .0005 mfd. fixed condenser across the variable condenser, C2.

* * *

I WOULD like to know whether I can put SLF condensers into the Diamond in place of the SLC condensers that I have now. (2) If this be the case, then

DEALERS

Write us for the name of the jobber who will sell you

Double Toroid Coils

NO-NOISE VARIABLE GRID LEAK

RADIO FOUNDATION, INC.

25 W. Broadway New York, N. Y.

Patented for your protection as well as ours

AERO COIL

Low Loss Inductance

AERO PRODUCTS, INC.

1772 WILSON AVENUE. CHICAGO

"Bruno" Magic Dial



Makes any semi-circular plate condenser tune like the straight-line frequency type. No gears, no backlash.

\$250

BRUNO RADIO CORPORATION

Dept. W103 221 Fulton St. New York City

Inquiries Solicited from the Trade

"EAGLE" ALL-METAL

RADIO TOWERS

Adjustable to Fit Any Type of Roof

Get better reception with a good outside Aerial. Long distance sets, including ships at sea use the best possible Aerial. Eagle Radio Towers are handsome and sturdy. We ship on a money-back guarantee. Ask your dealer or write us for literature.

J. R. Burrell Co., 714 N. Cambridge Ave., Milwaukee, Wis. Dept. 15



Ask an Owner He Knows

MOUNTFORD

FITS ANY MOUNTING

50¢

PLUNGER TYPE VARIABLE GRID LEAK

Perfect graduation obtains all fractions of a megohm from 1/4 to 20 inclusive. Increases selectivity and sensitivity. Unaffected by heat or cold and when properly adjusted is guaranteed to maintain accuracy of range and consistency of resistance. An asset to any set. At your dealers or sent post-paid upon receipt of price. Satisfaction guaranteed or money refunded.

C. E. Mountford
465-67 Greenwich St.
New York City

CLAROTUNER

The ONLY three circuit tuner made that incorporates the latest development in tuner design—tickler fixed and resistance controlled. Gives more volume and gets more distance because it is capable of a HIGHER DEGREE OF REGENERATION. Its selectivity is a revelation! Its freedom from distortion makes it a blessing!

Model TCH (three circuit tuner).....\$4.50

Model 2 RK (two units) for 1 stage of tuned R. F. and regenerative detector, Roberts, Radio Broadcast Phonograph and Aristocrat receivers..... 7.50

Model TCH and CLAROSTAT are responsible for the success of the RESISTANCE CONTROLLED SET described in this issue.

AMERICAN MECHANICAL LABORATORIES, Inc.

285-7 N. Sixth Street, Brooklyn, N. Y.



Clarostat is a universal Resistor that meets all resistor needs. Range from 10 to 5,000,000 ohms.

If your dealer cannot supply you

ORDER DIRECT

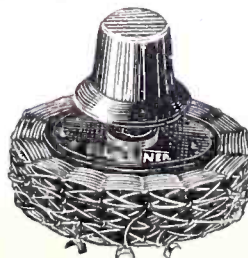
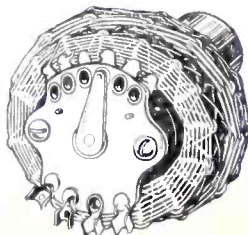

Price \$3.50

FYNUR VERNIER CONTROL

what type would you suggest?—F. Joseph Reetz, 523 Liberty St., Allentown, Pa.

(1) Yes. (2) Any well-advertised .0005 mfd. make.

WILL YOU please give me information on the 3-circuit tuner. This tuner is to be used in the Diamond. (1) Outside diameter of tubing. (2) Size and kind of wire to use for winding the primary. (3) Number of turns wound for the primary. (4) Space between the primary and the secondary. (5) Size and kind of wire for winding the secondary. (6) Number of turns to be used for winding the secondary. (7) Height of the tubing on which the primary and the secondary is to be wound. (8) Outside diameter of the tickler tubing. (9) Height of the tickler tubing. (10) Size and the kind of wire to use when winding the tickler. (11) Number of turns to be wound on the tickler.—S. Sansons, San Diego, Cal.

(1) The outside diameter of the tubing is 3/4". (2) No. 22 double cotton covered wire. (3) There are 10 turns wound. (4) About 1/4" or less. (5) No. 22 double cotton covered wire. (6) There are 45 turns on the secondary. (7) This tubing is 4" high. (8) The outside diameter of the tubing is 2 1/2". (9) The tubing is 1 1/2" high or a little more. (10) No. 22 double cotton covered wire. (11) There are 35 turns to be wound. Use No. 26 SSC wire.

WILL .0003 mfd. SLF variable condensers work in the Meissner Short Wave Set described by Percy Warren in the Oct. 10 issue of RADIO WORLD. (2)—Is there any change in the number of turns? (3) Will a .0003 SLF variable condenser work in the Modified Meissner, described by Mr. Warren in the same issue?—C. V. R. De Hart, 348 West Side Ave., Hagerstown, Md.

(1) Yes. (2) No. (3) Yes.

WOULD YOU kindly give me the information on how to make the choke coils for use in the B battery eliminator Fig. 1, published in the June 6 issue of RADIO WORLD, and described by P. E. Edelman? I am only interested in the 1 and the 10-henry chokes.—J. G. W. Wales, 3604 Indiana Ave., Chicago, Ill.

The 1-henry choke coil consists of 1,200 turns of No. 30 DCC wire wound on the core of an old audio-frequency transformer. The 10-henry choke coil is also wound on an old audio-frequency core. There are 2,400 turns of No. 38 single

cotton covered wire. The core should be 1/2" square.

I WOULD like to have the following questions answered: (1)—My antenna runs parallel to another, whose owner has a regenerative set. This causes squeals in my set. Will this be cured if I run my antenna at right angles to his? (2)—Could I use an indoor antenna with any kind of success? (3)—Would adding two stages of push-pull AF do much good?—J. D. Hioely, R. F. D. No. 1, McGuffey, O.

(1)—Yes. (2)—Yes, but the signal strength will be decreased. (3)—No.

I BOUGHT 3 RF basket weave coils, but would like to build a different set than the one presented. (1)—Would you please give me a diagram of a set where these coils can be used?—F. E. Martin, Linden, N. J.

See the Oct. 10 and 17 issues of RADIO WORLD, where such a set was described by Lewis Winner.

I HAVE built the Diamond of the Air, but am not getting the volume that I desire. (1)—The radio-frequency coil was

THE Antennaphone
IMPROVES RECEPTION
Gives wonderful results with any radio set. Not attached to, but merely placed under the telephone. Price One Dollar. Complete with insulated wire and simple instructions. At Your Dealer or Mailed C.O.D. on 3 days approval.
ANTENNAPHONE CO.
90 West St. New York City

wound on a Bakelite tubing with double silk covered wire. (2)—I made my own 3-circuit tuning coil. This was wound on a Bakelite tubing. The tickler coil was wound on a cardboard soaked with paraffin. I used No. 24 double silk covered wire. I placed 45 turns of No. 26 double silk covered wire on the tickler. I cannot get enough regeneration on the high waves. I can turn it through the entire 360° and still get no volume due to the lack of regeneration. (3)—I am using two

Crescent Lavite Resistances
for Distortionless Amplification
Used in America. All capacities 12,000 ohms and up. Special sizes made to order. Write today for full information. Liberal discounts to dealers.
Crescent Radio Supply Co., 9 Liberty St., Jamaica, N. Y.

RADIO CATALOG also **LOG**
FREE SAVE on all the latest standard radio merchandise. No exceptions. Our 1926 Beautifully Illustrated Catalog **JUST OFF THE PRESS!** Everything new in Radio AT SLASHED PRICES. Write for it today, before you buy anything. Delay means losing exceptional chance to participate in this great **BARGAIN SALE**. Rush your name and address at once and get also a **LOG BOOK FREE!**
ECONOMY RADIO SALES COMPANY
288 6TH AVE., Dept. E, NEW YORK
Deal Direct and Save Real Money (No Dealers)



Vigilance

Constant vigilance is the price of uniformity and constant vigilance is maintained over Magnatrons. That is why Magnatrons are uniform, and uniformly good.

The Magnatron DC-201A, DC-199, and DC-199 (large base) now list for only \$2.50 each

Connewey Electric Laboratories, Magnatron Bldg., Hoboken, N. J.
West Coast supplied from complete stocks carried by Pacific Radio Laboratories, 256 South Los Angeles St., Los Angeles, California.

MAGNATRON REX the new tube for B battery eliminators



FREE two unusual RADIO CATALOGS

FOR "FANS"

OUR new 64-page Radio Catalog including all the best and latest Kits, Parts and Accessories for broadcast receiving sets. Lowest prices in the country.

FOR "HAMS"

NEW 32-page booklet of Army and navy transmitting apparatus and miscellaneous "hams" specials for "hams" such as W. E. Choke Coils, Generators, Resistance Boxes, etc.

More than 1,000,000 fans and hams make our store their headquarters—get these books and find out why.

Write for either or both

509 South State Street
CHICAGO SALVAGE STORES
Dept. R. W. 6 Chicago Ill.

MAGNATRON

BY DR. J. H. DELLINGER

Chief of Radio Laboratory, United States Bureau of Standards

Radio Paradise Is Here Now — "Some of the More Expensive Sets Now Give Substantially Perfect Quality, With Volume As Great As the Original Performance."

PERFECTION is a rare thing in this world. When you experience it—perhaps in the beauty of a flower, the flash of a light from a dewdrop or a jewel, the smooth silent sight of an efficient machine, the polished perfection of exalted art—in any of these things, you may see a corner of paradise. Radio paradise is the condition under which radio attains perfection. Will we ever get there? How do we get there? Are we there now? Many a disillusioned radio fan will rise up here and say—oh, foolish question. The wives of some fans will say that purgatory is the name of the place, not paradise. There are people whose experience with radio is such that they can not possibly take seriously a man who talks of radio and paradise in the same breath. Nevertheless, two or three years ago, to the man in the street, the paradise of radio, and the millennium, seemed to be just about the same thing. Was this promise entirely vain?

Radio Paradise Is Here Now

It is usual to think of paradise as in some very remote time or place. We speak of the millennium; a thousand years from now we shall reach perfection. However, just as there is a religious philosophy which declares that paradise can be entered here and now, so we can say that in limited times and places radio paradise, or perfection, can already be found. Here in Washington we approximate this condition. While listening with a first-class receiving set to some of the fine musical programs or nationally important events broadcast by a local station with no other closer than a hundred miles to offer interference, it would be a dead soul that never got a thrill from the experience. On such occasions one can participate, at a distance, in the excitement of a world's series; or, again, all the power and majesty of musical art is actually brought to one's own fireside. The role of radio, in these experiences, is close indeed to perfection. There is, therefore, a challenge to enlarge and extend the places and the times of such achievement, and to bring about the conditions that will let more people participate. For it is evident that radio has a high mission, a promise of great contribution to progress.

In order to increase the area of radio paradise, what must be done? Is it possible for the government, for example, to rearrange the broadcasting system so that everyone who chooses may know the thrill of listening in on perfection? While the answer is no, of course, this goal is being steadily pursued. Some of the difficulties that block the way to a rapid reaching of the goal are quite interesting and I believe there are means of meeting and overcoming all these difficulties.

The Enormity of the Problem

Few people realize the complexity of the problem radio presents to the government, on which rests the responsibility of guiding its development. This complexity arises fundamentally because of interfer-

ence of one radio wave with another. All the radio signals are conveyed along a single track, the ether, and very skillful dispatching is required to avoid collisions. At the present time every conceivable interest wants to broadcast, simply because radio is the best means of publicity yet devised.

It would not be nearly so bad if everyone wanted to start a newspaper, because the printing of one newspaper does not get in the way of the printing of another; but in radio only so many can operate at one time. When this physical condition, which unfortunately the scientist can not alter, is generally realized, people will perhaps be at least willing to hold back from erecting stations as from starting newspapers. Not everyone who has a message for the public starts a newspaper; he usually uses for his purpose the newspapers already existing.

Overcrowding Is Serious

The thing that most stands in the way of radio perfection just now is this overcrowding of the ether because too many kind souls aspire to serve the public through the ownership of broadcasting stations. If America is not convinced from her own experience in the way of radio traffic jams, what is happening in Europe may supply proof that there must be iron-handed limitation of the number of stations. There is today serious interference among the broadcasting stations of Europe; to cure this by giving every station a separate frequency would require that broadcasting have all the waves from 500 to 2,000 kilocycles (600 to 150 meters) and in addition all those from 100 to 375 kilocycles (3000 to 800 meters). To seriously suggest this would be to propose, in essence, that broadcasting monopolize the whole of radio; away with the amateurs; away with ship communication; away with radio aids to navigation. Such a proposal is unthinkable. Faced by this, a conference of the radio engineers of Europe, which just met at Geneva, has taken the bold step of agreeing and declaring that the only solution of broadcast station congestion is to get rid of some of the stations. Whether America will take so drastic a step remains to be seen, but it is clear that a definite program of some kind must and will be adopted to preserve radio in the future from choking other ether channels.

Too Much Commercialization?

Another present limitation on radio is its commercialization. Listeners are beginning to be uneasy over the too rude intrusion of soap, bonbons and typewriters in the midst of otherwise beautiful programs. The ruthless hand of commercialism is seen also in the occasional announcement that a performance has to be interrupted because of a demand for exorbitant royalties from the holder of

Hearing Programs from Europe a Likely Development of the Near Future, Although Present Beginnings Are Crude—Program Interruption Because of Demands of Copyright Owners Shows Ruthless Hand of Commercialism.

copyright on some musical selection. These problems are serious at the moment, but unquestionably time will solve them.

For most people there can be no illusion of paradise when listening to radio programs until the quality of sound delivered by the receiving set is greatly improved. This can be done. Some of the more expensive sets now give substantially perfect quality with volume as great as the original performance. These sets readily tune in a desired station without disturbance from any other. It remains to bring apparatus of such perfection within reach of the ordinary pocketbook, and there are steady advances in that direction.

There is one problem which baffles radio engineers at present. That is fading, or the irregular fluctuation of receiving signal strength which you notice when listening to programs from distances of 50 miles or more. The only answer at present is that perfection can not be experienced in reception at such distances and so the effective service area of a station is now limited to a small area around it.

Expects Cross-Ocean Reception

While radio is already rendering noteworthy service, it will, of course, be made to do far more than at present. It is expected that programs from across the seas will be re-broadcast from American stations. The development of this undertaking from the crude beginnings it has already had to satisfactory perfection is a considerable undertaking, but it is going on. Another advance, which is more remote, but which I believe will come, is supplementing radio by some form of appeal to the eye. Prophecies that we should have radio motion pictures have already been fulfilled. They have been achieved in very elementary form, but it will probably be a long time until they reach anything like a real service basis; and some less direct solution of this problem may be developed.

(Copyright 1925 by Stevenson Radio Syndicate.)

Hears Trieste

Amateur radio station 2CV, owned and operated by Irving Korenman, 1,465 Sixtieth Street, Brooklyn, N. Y., talked with the U. S. destroyer Scorpion, anchored in Trieste Harbor, Italy, for an hour from 12:30 A. M. C. Olson, operator on board the destroyer, signed off by saying that he would have to leave the wireless key and go to breakfast. The Brooklyn operator bashed back that it would be six hours before breakfast would be served at his home.

The 40-meter wavelength was used. The transmitter and receiver of station 2CV were of the Reinartz.

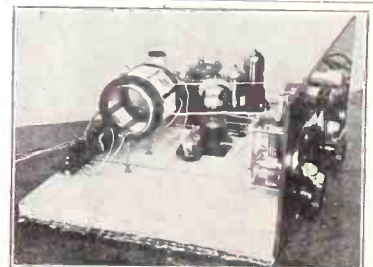

THE Reinartz receiver, with two stages of audio, on which amateur station 2CV, Brooklyn, N. Y., received code signals more than half-way 'round the world. (Fotograms.)

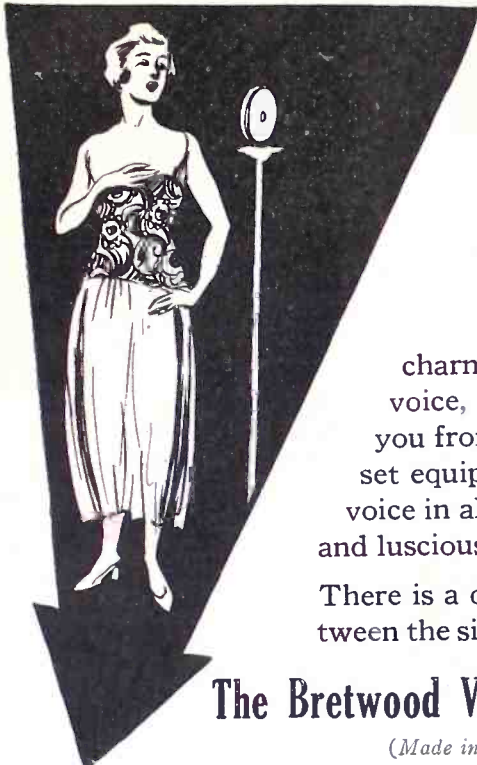

WITH ALL THE BEAUTY

charm and power of her voice, the soprano sings to you from the studio. Is your set equipped to reproduce her voice in all its faithful shadings and luscious quality?

There is a direct relationship between the singer and the set. It is

The Bretwood Variable Grid Leak

(Made in England)

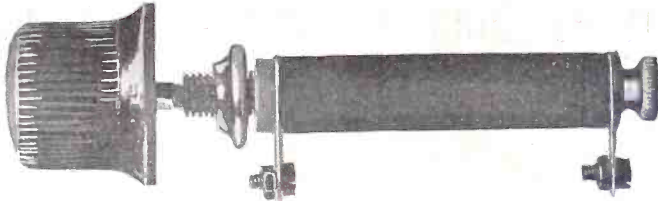

Guaranteed Precision Range— $\frac{1}{4}$ to 10 Megohms.
Put One in Your Set—Marvel at the Difference!

Price \$1.50

North American Bretwood Co., 145 W. 45th St., New York City:—Enclosed find \$1.50. Send one Bretwood Variable Grid Leak on 10-day money-back guarantee.

Name

Street

City..... State

North American Bretwood Co.

145 West 45th Street
New York City

Canadian Distributor:
RADIO, LTD.
PHILLIPS SQ., MONTREAL

CLASSIFIED ADS.

PRECISION LOW WAVE COILS. Basket wound, positively lowest loss. Triple cotton-covered paraffined wire. Three coils, red primary, white secondary, blue tickler. Same primary and tickler but four different secondaries used on different wave bands. Tunes 15 to 120 meters, with two condensers. We hear all foreign countries using these coils on three-tube set with 25 ft. indoor aerial. Our hook-up furnished. Price for all above coils, \$3.00.

Kit for three-tube set consisting of all above coils, two straight-line frequency condensers, three sockets, two transformers, grid leak and condenser, binding post strip, 7x18" panel, baseboard, angles, two rheostats, jack, hardware, hook-up, etc. All good low loss parts same as used in

test sets. Price \$15.00. Wired and tested, price, \$20.00. Kit for two-tube low wave set described by Percy Warren in Radio World Nov. 7, same grade parts as above kit, price, \$13.00. Red, white or blue wire, for coils, 65 cents pound; coils, three for \$1.85. Free, 13-hole 3-in. template. Catalogue of low wave and broadcast equipment on request. Everything guaranteed. Goods sent prepaid on receipt of price. Buy direct and save money.
PRECISION RADIO EQUIPMENT CO.
Johnson City, N. Y.

HONEY, MICHIGAN'S BEST—Clover or buckwheat. Five pounds, \$1.60; ten pounds, \$2.75, with honey receipt book, delivered fourth zone. Order direct from producers. (An appreciated gift). **SHADY LAWN APRIARIES** Milan, Mich.

3 1/2-INCH FORMICA TUBING, 60 cents foot; 3-foot lengths, \$1.50. Wt. 1 lb. W. J. Ferris, 551 Seymour, Jackson, Mich.

RADIO FANS WANTED to sell Standard Radio apparatus. H. Roberts & Co. 180 Broadway, New York.

(Concluded from page 29)

Airline APT. One has a 6 to 1 ratio and the other has a 3 1/2 to 1 ratio. (4)—After listening with the phones, I plugged in the loudspeaker, and found that the settings were different. (5)—Are the 201A tube O. K.? (6)—Is the O'Rourke 3-tube 3-circuit set of Oct. 10 a good distance getter? (7)—Are the 201A tubes louder than the 199? (8)—Would you advise placing shielding on the panel and grounding this shielding to the A—?—Stanley A. Wallace, c/o Newport High School, Newport, N. Y.

(1)—This is all right. (2)—Put a .001 mfd. fixed condenser across the tickler or add more turns. Reverse tickler windings experimentally. Increase B+ detector voltage. Change tubes about in the set. (3)—These need not be substituted for others. (4)—This is due to the impedance of the speaker windings and cord. (5)—Yes. (6)—Yes. (7)—Yes. (8)—No.

WHAT CAUSES my set to make a peculiar make-and-break noise, e. g. plop, plop, when I am listening in? This noise increases as the stations are brought in louder.—K. E. McCowin, 445 N. Bluff St., Butler, Pa.

The grid leak. A lower value grid resistance will cure this. Use a variable grid leak.

COULD THE 199 tubes be used with success in the Diamond?—C. F. Judge, 729 Robeson St., Fall River, Mass.

I AM building the Diamond and would like to know if I can use the Bremer-Tully coils in this set? (2)—What tube should I use as a detector?—J. F. Robinson, 1922 California St., Omaha, Neb.

(1)—Yes, but be sure to get the right capacity condensers (.00025). (2)—The 201A.

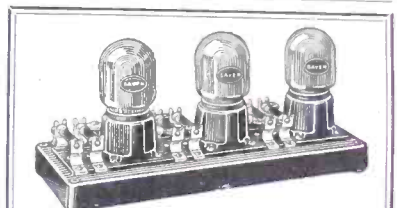

The Daven Super-Amplifier

for volume and tone quality.
3 STAGES RESISTANCE COUPLED
ECONOMICAL, DISTORTIONLESS
Easily added to any set.
Saves Several Hours Assembly
For Sale by All Good Dealers

S. HAMMER RADIO CO.

303 Atkins Avenue, Brooklyn, N. Y.

Please send me FREE, Your NEW

RADIO CATALOG

Name

Address

City

FILL OUT AND MAIL

SALESMEN!

MAKE \$100 WEEKLY IN SPARE TIME. Sell what the public wants—long-distance radio receiving sets. Two sales weekly pay \$100 profit. No big investment, no canvassing. Sharpe of Colorado made \$955 in one month. Representatives wanted at once. This plan is sweeping the country—write today before your county is gone. Ozarka, Inc., 126-J, Austin Ave., Chicago, Ill.

AGENTS—No competition selling spectacles, guaranteed to satisfy, only \$3.98. Pay daily. We deliver collect. Nearly every buy. \$10.00-\$25.00 daily easy. True-Fit Optical Co., CW, 115, 1528 W. Adams St., Chicago.

HELP!! The Bruno Radio Corp. of New York needs a reliable, capable, honest radio man in every city, town and village of the U. S. to build the Bruno Powertone from the Bruno Powertone Kit. We are literally swamped with orders for the Powertone. We need help quickly! Bruno Radio Corp., 221 Fulton Street, New York City.

Here is the new
Sleeper Serenader
\$100!

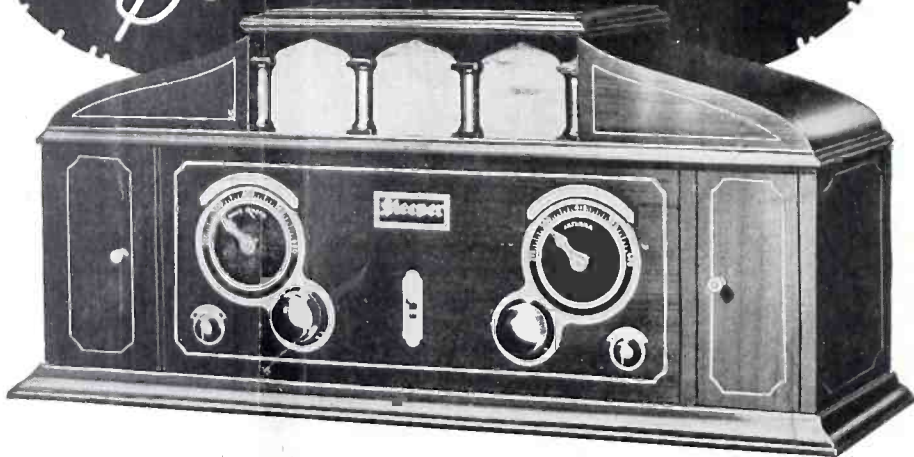

Five Tubes, Tuned Radio Frequency

RELY UPON EXPERIENCE TO PRODUCE QUALITY AT LOW COST

Sleeper

REG. U. S. PAT. OFF.

RADIO RECEIVING SETS

—are better built of better materials to the most exacting specifications by an organization that has engaged exclusively in the manufacture of fine radio equipment since 1919.

Super
RADIO
Reception

Only experience and "pride of product" could have built such a set as the Serenader at so low a cost. For this is a new kind of radio set. Not until now has a receiver combined such tonal quality with such volume, selectivity and sensitivity. Your first twenty minutes with the Serenader will give you a wholly new conception of radio reception.

The Scout, \$75.00. The Monotrol, \$130.00.
The Super-Symphonic, \$150.00.

TURN the switch and the softened glow of the concealed visored lights illuminate the tuning controls. Move the silver pointers to the designated wave length of your favorite station and you will hear it loud and clear, as distinctly and as naturally as though the artist were at your side—then, and only then, you will realize what Super Radio Reception means.

Other Sleeper models:



Serenader with console table, \$135.00

The table has a compartment for "A" battery and one for charger with switch for instantaneous change to charger. A better, more convenient radio installation at a remarkably low price.

If the Authorized Sleeper Dealer in your community has not yet received his quota, write us for descriptive literature and catalog "W"

SLEEPER RADIO CORPORATION

438 WASHINGTON AVENUE,

LONG ISLAND CITY, NEW YORK