

CORRECTED LIST OF BROADCASTERS IN THIS ISSUE

15c. a Copy

October 13

\$6.00 a Year

1923

RADIO WORLD

Title Reg. U. S. Pat. Off.

ILLUSTRATED

EVERY WEEK

THE STUDIO ACTION OF A BROADCAST RADIO DRAMA



(Photo from General Electric Co.)

This is a busy moment in the broadcasting of the radio drama, "The Great Divide," by the WGY Players of the Schenectady, N. Y., station of the General Electric Company. Steven Ghent and the two ruffians have battered their way into the cabin occupied by the unprotected heroine. One of the performers, jamming his foot through a packing case, is producing the sound of rending wood as the door is smashed in. This is accentuated by means of the conventional wood crash machine and the sand board. The player at the left is following the manuscript preparatory to firing the shots in the pistol duel which follows. Those in the picture are, left to right: Edward E. St. Louis, Frank Oliver, Edward H. Smith and Ruth Shilling.

C. WHITE ON RADIO-FREQUENCY (See Inside)

THE SONOCHORDE
TRADE MARK

RADIO LOUD SPEAKER
PATS. PEND.



GUTTA-PERCHA FLARE

TYPE R
HEIGHT
20 in.

**A NON-VIBRATING,
NON-RESONANT HORN**

**The Reproducing Unit with
15 EXCLUSIVE FEATURES**

**Clear, Natural, Reproduction
of Broadcasting**

**Untainted by the Resonance or
Vibrations of Wood, Metal, etc.**

**AMERICA'S BEST
RADIO LOUD SPEAKER**

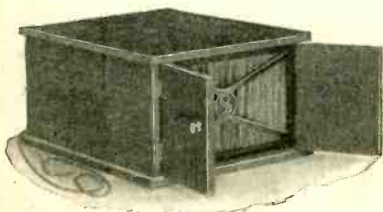

Type C. Size 16x13x8

Originality of Design
Mahogany or Walnut

"It Speaks For Itself"

Watch the following issues for the
52 Points of Sonochorde Superiority.
These will be sent on request.

Type R. \$40
Type C. \$50

**Factory Representatives
and Warehouses**

Cotton Apparatus 126 High St. Boston, Mass.
L. D. Pangborn Co. 1601 So. Michigan Blvd. Chicago, Ill.
Leo H. Craig & Co. 75 Fremont St. San Francisco, Cal.

Boudette Manufacturing Co.
77-79 Beach St., REVERE, MASS.

The Wireless Oracle

By Hirsch M. Kaplan

Meyer Davis and his orchestra, through station WCAP, of the Chesapeake & Potomac Telephone Co., Washington, D. C., rendered a fine program of dance music.

You'd have to be stuffed not to appreciate such artists as Ernest Lecuono, Yasha the "Sheik," Louise, Dr. Billy, Dr. Ormandy sans Blau, "Wee Willie" and the rest, but, after all is said and done, we'd miss our "Roxy" more than anybody else. "Roxy" we've got to admit you are there!

Have you noticed how "International Sunday School Services" are becoming a weekly feature of all broadcasting stations? Another station to join this class is WOR. The broadcasting is done at this station by the Rev. Samuel D. Price.

WDAR is another station following the footsteps of WGY, in regard to the broadcasting of plays and acts. The other evening they came through with a play offered by the Greenbough Players, and between acts Howard Lanin's Orchestra offered several selections. Some class to them!

Bob Shaffer and Frank Goodman, popular songsters, amused us with some of the latest hits.

Last week I told you of the western stations billing their headliners as of New York. Did you hear the attraction broadcast by WJZ the other night? They were Wendall Hall and Harry Gerse, "The KYW Melody Makers." If they are an example of the class of talent offered by our western friends, then we would like to hear more of them.

The other night the air was full of so many good things that it was hard for us to make up our mind which one to listen to. WEAJ was on the air with "Roxy" and his clique, WJZ broadcast from Carnegie Hall a program offered by our "President's Own," the U. S. Marine Band, WHN rendered a program of popular selections. Can you beat it?

New York City's Police Commissioner Enright gave a talk on the interesting phases of police work through WEAJ and will continue weekly.

Another of our ocean-going steamships had its orchestra render for us an excellent program of dance music. This time it was the orchestra of the S. S. Belgenland of the White Star Line. They played through WJZ.

A stellar attraction for us DX "bugs" was the Carlson Brothers' Saxophone Quartet, assisted by Laura Statska, soprano, and Mrs. M. E. Good. They were from KDKA, the "Pioneer Broadcasting Station."

The first street carnival and parade to be broadcast was that of the Veiled Prophet, taking place at Kansas City, Mo. This novel event was put on the air by KSD on 546 meters.

Now that the cold weather is approaching many of our DX friends are coming through in excellent fashion. You B. C. L's, who have laid your radio sets away during the warm weather, better get them ready for the big events that are to come. What you will miss now, you may never have the chance to hear again.

**Federal Standard
Radio Products**

Standard of the Radio World, 130 separate units, each fully Guaranteed.

Write for Catalog.

Federal Telephone and Telegraph Co.,
BUFFALO, N. Y.

BRISTOL AUDIOPHONE

MORE THAN A LOUD SPEAKER

Bristol Audiophone, Sr., 15-in. Horn..\$32.50

Bristol Audiophone, Jr., 11-in. Horn..\$22.50

Bristol Single Stage Power Amplifier..\$25.00

Write for Bulletin 3006-W

The Bristol Company

Waterbury, Conn.

**ALL LINES OF
RADIO MERCHANDISE**

ARE IN OUR STOCK

New York Prices Direct to You

Just Tell Us What You Want

GLOBE RADIO SHOP

115 West 23rd Street

New York

RADIO TUBE SPECIALISTS
WE SAVE YOU MONEY



RADIO DEALERS

If you are looking for real repair service write us. Also, wonderful line of new tubes.

RADIO PRODUCTS CO.

115 W. Broadway, Dept. R., N. Y.

RADION

PANELS **BLACK**
AND
DIALS-KNOBS **MAHOGANITE**

20 Stock Size Panels and Also

CUT TO ANY SIZE

"Radion" Tubing: 2", 2 1/2", 3", 3 1/4", 3 1/2",
4", 5"

Cut to Any Length

Special Parts Experimental Work

Made to Order

N. Y. Hard Rubber Turning Co.

212 CENTRE STREET

NEW YORK

**HUNT'S UNIVERSAL HAIR-LINE
RADIO TUNING DEVICE**

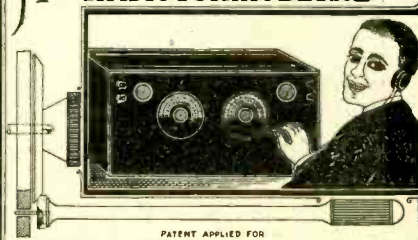

PATENT APPLIED FOR

**OVERCOMES
BODY CAPACITY**

Gives micrometric adjustment outside the field of inductivity.

Tested and approved by amateurs and experts. Enables you to tune distant stations easier and more clearly. Simple as A B C. Installed from outside, no dismantling of your set necessary. Audibility made more natural or less distorted by the fine adjustments obtained. One Hunt's Device handles all dials on set or several sets. Costs only one dollar on guarantee of money refunded if not satisfied. Ask your dealer or order direct from Hunt Co., 486 Shrine Bldg., Memphis, Tenn.

You can make money by using the
Classified Dept. of Radio World.

RADIO WORLD

[Entered as second-class matter, March 28, 1922, at the Post Office at New York, N. Y., under the Act of March 3, 1879]

A Weekly Journal Published Every Wednesday and Dated Saturday, by Hennessy Radio Publications Corporation from Publication Office, 1493 Broadway, New York, N. Y. Telephone: Lackawanna 6976.

Vol. IV, No. 3. Whole No. 81

October 13, 1923

15c. per copy, \$6.00 a year

Improved Selective Double Feed Back Receiver

By H. H. Lerchen

FOR the last two years I have been experimenting with a single circuit regenerative receiver with the object of developing a set which would not only be sensitive to weak signals, but one which would also be selective and without capacity effects. This has always been the bugaboo with single circuit sets. In the diagram herewith some radical changes over the ordinary single circuit set will be noted, but I assure you that unless you follow out in detail the hook-up shown you will be wasting my entire two years' experimenting and the spending of many dollars in making changes in parts.

This set is very selective, easy to tune, has three controls, but in tuning from station to station it is only necessary to use two of them and you can get the different stations night after night on the same settings on the two dials. This set has been built by a great many of my friends and has brought in all of the stations in the country from California to and including Cuba. All summer long I have tuned in stations from Chicago and west night after night without any trouble and only using one step. A description of the set and its construction follows. This set should be of the utmost interest to those who have been troubled with interference and capacity effects.

The necessary parts for the construction of this super-selective receiver are as follows, and while I do not like to specify the names of the makers of these parts I feel it is my duty to do so, as I have found these types the best after numerous changes: 1 43-plate vernier condenser (Wisco or Heath), 1 23-plate vernier condenser (Wisco or Heath), 1 switch tap lever and points (Aetaco), 1 variocoupler with 60 to 80 turns on primary, tapped every 10 turns, and with 40 turns on rotor such as the Coast coupler or Fischer types; ½ lb. No. 26 double covered green silk wire for spiders; 2 spider web forms, 4" diameter (Radio Specialty Co.); 2 variable grid leak condensers, .00025 (Freshman); 1 variable grid leak condenser,

.0025 (Dubilier); 1 fixed condenser, .001 (Dubilier); 3 tube sockets (Radio Corporation); 3 rheostats (Bradleystats or Filkostats); 1 Thordarson transformer, 7½ to 1 ratio; 1 Thordarson transformer, 4 to 1 ratio; 3 phone jacks (Radio Improved); 3 C301A tubes (RCA); 1 cabinet, 7" x 24", and bakelite panel; 1 threaded brass rod, 5" long, for spider webs; 1 thin sheet of aluminum, same size as panel; 3 "Vac-Shields" for vacuum tubes.

First wind each spider web form with 30 turns of the No. 26 green silk wire, putting two small binding posts on each form for the beginning and ending of the winding. Be sure to leave a 1" space from the center of the coil before starting the winding. Do not shellac or varnish these coils when finished.

Mount these two spider web coils 4" apart in a vertical position running the threaded rod through the center of the coils to hold them apart, using a lock nut on each side of the coil. Make two upright standards

from fibre board to support the ends of the rods. In mounting the coils be sure the windings are running in the same direction on both coils, and when placing these coils in the set be sure to keep them at least 10" away from the variocoupler, and when adjusted to 4" they must remain at that distance and are not to be varied.

To have this set work properly your antenna, including your aerial

lead-in wire and ground wire, must not exceed 150 feet. In other words, a 75-foot flat top aerial with 30-foot lead-in and, say, 35-foot to your actual ground, would mean that you have a 150-foot antenna system, as it is a mistaken idea to only count the wire you have in the air as being your aerial. Be sure to connect rotary plates of variable condensers to the aerial.

This set operates without any capacity effects by connecting the three Vac-shields on the tubes in series and also connecting them to the metal shields on the transformers together with the aluminum panel shields to the ground connection in the set.

(Concluded on next page)

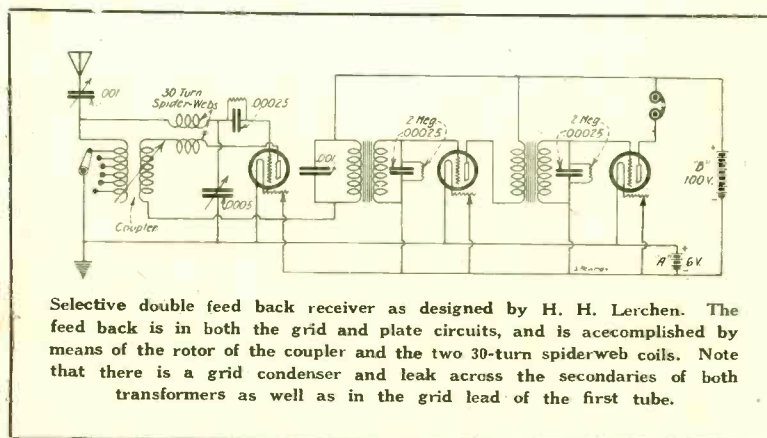

The Radio Store Owner and the Salesman

By Old Timer

THIS coming year will see a great increase in the radio business—so great, according to advices of various large manufacturers who have been making inquiries, that it will tax even their facilities to the utmost to keep production up near the demand point. It has already shown itself in various fields, especially in the manufacture of parts and tubes; the production of the latter, thanks to past experiences, has been enlarged to meet the demand, or more correctly, it has been planned in such a manner so as to anticipate the demand.

You will, if you are a wise salesman, do three basic things in selling your goods. One is to recommend only the parts that you absolutely know are necessary to the different sets that the buyer is going to build. It is far better to sell a man what he needs, and have him come back later for something else that he may have thought of as an improvement, than to oversell him and have him carry the impression that he has been "stuck by a slick salesman."

Assume the prospective buyer to be an average intelligent human being, and unless he shows that he is a thorough technician do not flood his mind with a hundred and one technical phrases and explanations that you know he doesn't "get." When you are teaching children to read, you do not start in by giving them "The Hunchback of Notre Dame," but start in with the "First Reader for Little Folks." You may think that you know all there is to know about radio, and maybe you do—but he doesn't. Confine your extra energy to the intelligent selling of goods. You do not have to sell him theories. You are behind the counter to sell him the best variable condenser you have in stock, and if he comes in with the idea of buying a cheap one, your salesmanship should be confined to convincing him that he is wasting money, and sell him the best you have in the store. That is salesmanship.

Another point to be carefully considered: Are you a salesman or are you just a mechanism which responds to the desires of the customer? When a man asks you for a particular make of transformer, which you think is not suited for his particular work, do you try to convince him that he should take another make, or do you simply nod, grab the piece he asked for and hand it over to him? As long as you are a salesman, sell your goods, and sell the type that you know will best suit the purchaser's needs. Do not try to argue with him if you see that he is intent on one thing and will fight with

(Concluded from preceding page)

This set operates best without the use of a grid leak, but it is sometimes necessary to use a one-half megohm for the detector tube due to the fact that there are no two vacuum tubes with the same characteristics.

You can use the same B battery voltage on all three tubes. This should either be 45, 60 or 100 volts, 45 volts to be used for DX work and the higher voltages for local reception. Shunt the two variable grid leak condensers across the secondary of each transformer. With the above arrangement on my set using a Stromberg-Carlson phone receiver in a 12" fibre horn, it is possible to hear the local broadcasting stations at a distance of 150' from the horn, and by this I do not mean noise, but speech and music.

you in order to get it. A nice example of this is the little Irish salesman selling lace to the Jewish cloak-maker. "I tell you that you will be foolish to try and save just one cent per yard on that buy. You will get so much better value and much better looking goods if you take this." "Vell, Mr. Man, as long as you try to spend my money, I guess I better turn over my bank account to you and let you do what you think is best. Nu? Do I get what I want or do I take what you want to sell me? I got to sell the goods later—not you." This, of course, is an example of a man set on getting one particular thing, coupled by his desire to save money—and he is hopeless, but just the same he like the Irish salesman, and give him a try-out anyway.

Now as to the store owner. Have you prepared your stock in such a manner that your salesman can sell? Have you selected the parts and sets that you know from past experience and wide advertising are the standard among the experts and novices? Have you included enough of the cheaper (not in quality—but in price) parts that you know are good, among your stock? Can your salesman intelligently sell a man and at the same time have a sufficient stock and range of stock back of him to give the customer the best service?

Stock up with plenty of standard parts, sets, accessories, to assure yourself of satisfying every customer who walks into your store. A customer unsatisfied is not a good ad for your store, because he will tell his friends (and take it from one who knows—the radio fan has lots of friends and can talk it around a neighborhood) that you only carry a certain grade of goods, and not a complete stock at that. A satisfied customer is sure to bring in more trade, because he will be one of the best ads you can have.

Arrange your stock intelligently and have it so placed that the salesman does not have to hunt through a cellarful of stuff in order to find a certain make, brand, or price of goods.

Display goods intelligently. A window full of goods is all right—for a jewelry shop—but ostentatious display never sold much in a radio store. An artistic, nicely arranged and lighted window, not crammed full of tubes, rheostats, bus wire and other things will attract more attention and cause more shoppers to stop, look, and inquire than anything you can do. Push your sales through your displays.

Arrange your store neatly. No one likes to go into a store that is ill-kept and resembles an auction room. If possible have a corner marked off for demonstration rooms, and arrange them with comfortable chairs and good light.

Finally, and of no less importance—employ intelligent, well-appearing salesmen, not mere clerks. Be sure you hire enough to take care of your trade, so that one man won't have to handle a dozen at a time. By this, you will give your salesman a chance to sell, and that is what he is there for—to *turn your stock over quick*.

Make your customers your friends. Invite them to come in and talk things over with you, even if they do not buy every day. A good live radio fan can oftentimes give you a lot of little tips, and besides he tells his friends that you are a "regular fellow" and they will be glad to patronize your store.

A Good One-Stage RF Amplification Circuit with Regeneration

By F. E. Mayberry, M. D.

THE following is a description of a one-stage radio-frequency amplification circuit with regeneration that has given me such satisfactory results, especially during the summer months, that I think it worth while giving it to the radio fans.

It gives a volume with one-stage audio amplification equal to any two-stage regenerative set with which I am familiar and in quality, distance, selectivity and freedom from outside disturbances including static, is much superior.

The inductance is a spiderweb coil wound on a 5" form with No. 24 silk covered wire. By winding in every other slot instead of every one the required number of turns can be wound on this sized form.

The inside winding (plate-coil) is 40 turns and between this and the antenna-ground winding of 12 turns is an insulating thread. The filament coil is continuous with the antenna-ground winding and may be tapped at the 25th, 30th, 35th, 40th and 45th turns, although if 35 turns are used without taps and a 23 plate condenser, it will cover the present broadcasting range. If shorter wave lengths are required, taps may be taken off the plate coil at about the 10th and 20th turns and connected to switch-points, the lever of which is connected to the grid. When the coil is completed with proper insulation between the sections, it should be connected as per diagram and care taken that the leads are not reversed.

The radio-frequency tube is very critical and requires fine adjustment to give the best results. The "C" battery as well as the small neutralizing condenser shown by the dotted lines help to stabilize this circuit and it sometimes helps to use a high resistance grid leak. This can be done by drawing a pencil mark on the base of the tube between the grid post and the post to which the positive terminal of the "A" battery is connected.

Hard tubes should be used and about 60 to 90 volts. I have found the DeForest DV6A very satisfactory for the radio-frequency tube. The UV20IA does not seem to function well here, at least in this set, but as a detector or audio-frequency amplifier it is all that could be desired.

Tuning the set is rather critical and is very selective. If too much current is turned on the first tube it will howl like an Indian, therefore it requires some patience to get

the maximum results of which this circuit is capable, but once mastered it is certainly worth while.

Place the condenser "C," which tunes rather broadly, the potentiometer and the inductance switch on the middle points, turn on the detector tube until the filament is fairly bright red and gradually turn on the rheostat to the first tube until a sharp click is heard in the receivers, then turn back slightly. Turn the condenser "B" gradually until a station is brought in, then bring to a maximum by means of the vernier and the potentiometer.

The potentiometer and rheostat to the first tube should be so placed as to keep the tube close to the point where it "slops over" and goes into violent oscillation. These adjustments, together with the vernier on the condenser "B,"

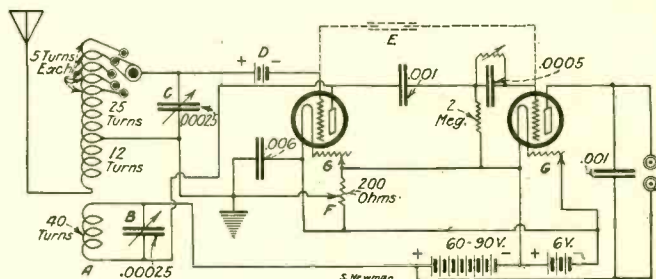

Circuit diagram of a stage of tuned radio-frequency amplification in incorporating regeneration. A—Inner end of spiderweb winding. B—11-plate condenser (vernier). C—11 plate variable condenser. D—4½ to 6 volt C battery. E—Neutralizing capacity. F—200 ohm potentiometer. G—25 ohm rheostats.

are essential for best results both as to volume, quality and distance.

One or more stages of audio-frequency amplification may be added in the usual way. One is sufficient as a rule.

Of course, the entire scheme of things depends upon the ideas of the builder himself, but I would not advise more than two. If more than that are used the distortion is so great that the original quality is entirely lost in a jumble of squawks and howls.

To give the prospective builders of this circuit an idea of how they might plan their panels I am including a photograph of my completed receiver. Of course, you do not have to follow it exactly.

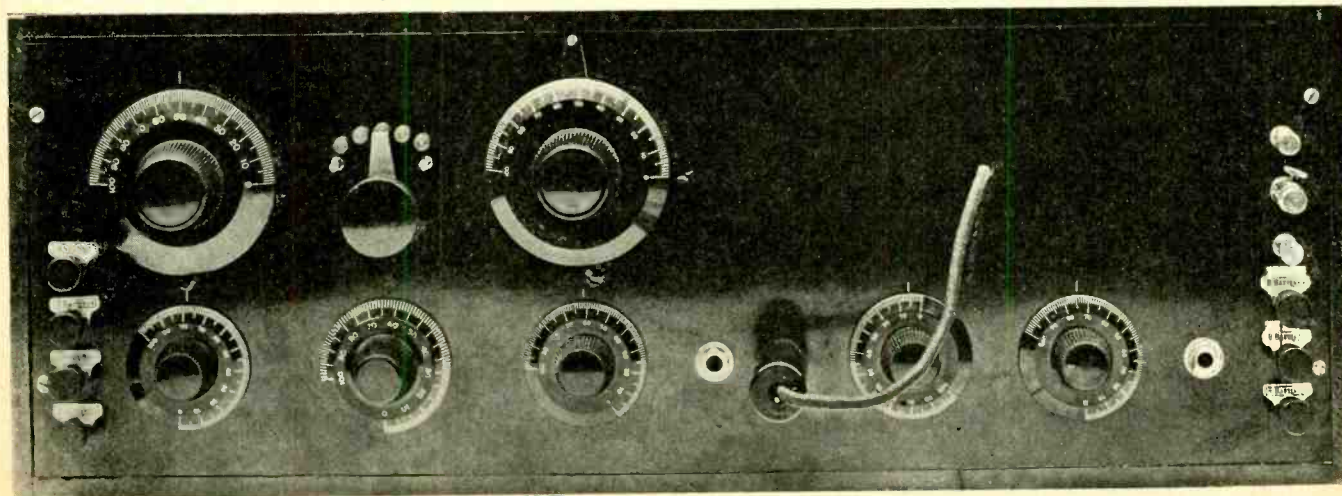

Neat appearance of the completed receiver. Note the manner of placing the jack. The phones or loud speaker are jacked in directly from the panel, connection being made by means of the binding posts on the right hand side of the panel above the battery posts.

Two Simple and Satisfactory Circuits

By J. E. Anderson, M. A.

THE radio enthusiast who is looking for simple and efficient single tube receivers will do well to try the two circuits given herewith. They are simple to build and easy to operate. Their selectivity is very good and the loudness of the signals they give is all that could be expected from a single tube regenerative circuit. The two circuits are identical except in the way they are coupled to the antenna. In Fig. 1 the antenna is coupled directly to the positive side of the filament through a variable condenser, and in Fig. 2 it is coupled inductively to the secondary circuit. In the second the antenna may be tuned, which adds a little to the selectivity of the circuit. It will be observed that both circuits are based upon the simple Hartley oscillator.

The secondary tuning coil should consist of 40 turns of heavy copper wire, preferably No. 18 double cotton covered, wound on a tube 3.5" in diameter. The lower half of the coil, that is, that portion which may be included in the plate circuit, should be tapped every other turn. This permits a variation of the regeneration by two turns at a time, which is usually sufficient. However, a finer variation may be obtained in both circuits by manipulating the

circuit considerably at a very slight sacrifice in convenience in tuning.

In Fig. 2 the rotary plates of both condensers C_1 and C_2 should be grounded. In Fig. 1 the rotary plates of C_2 should be grounded, while the rotary plates of C_1 should be connected to the positive side of the filament. Besides these precautions it is well to place a grounded shield between the entire circuit and the operator. Condenser C_2 in both circuits should be provided with vernier adjustment because the circuits are very sharp in tuning. The capacity of condenser C_4 should be anywhere from .0001 to .00025 microfarad while that of condenser C_3 may be either a .0005 or .001 microfarad fixed condenser.

The grid leak may have any value from two to five megohms for a hard tube, and about one megohm for a soft detector tube.

The filament supply voltage and the filament rheostat depend on the tube used. For a UV199 the voltage should be 4.5 and the rheostat should be 30 ohms; for WD-11, WD-12 and a Western Electric peanut tube the filament voltage should be 1.5 and the resistance of the rheostat should be about four ohms. For the larger tubes that re-

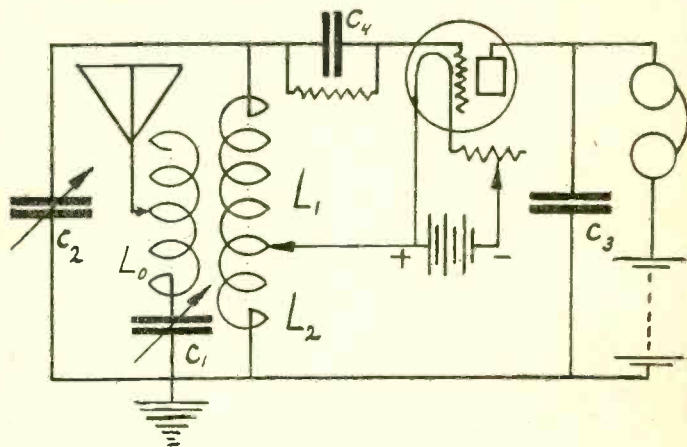
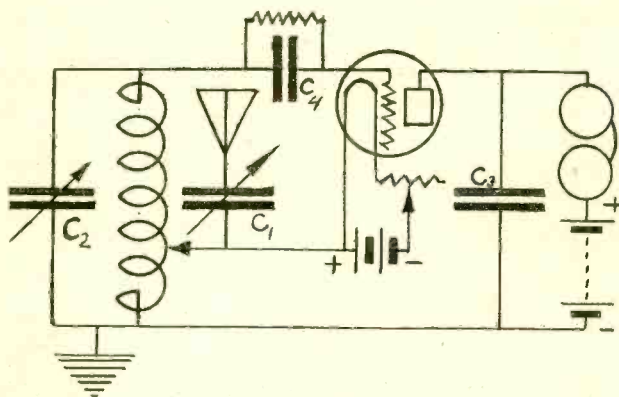

Figs. 1 and 2. Two single tube receivers which are adaptations of the Hartley oscillator. The one on the right is a single circuit, tuning being done by means of the condensers. That on the left is more loosely coupled and is slightly more complicated to tune, but at the same time is simple enough for the amateur.

antenna circuit. Thus a tap on the secondary coil may be found such that the circuit will oscillate for all settings of the condenser C_2 when the condenser C_1 is set at minimum, and it will not oscillate for any setting of C_2 when C_1 is set at maximum. Thus by adjusting both C_1 and the inductance switch a very sensitive combination may be found. This applies particularly to Fig. 1 but it also applies to Fig. 2 for any given setting of the antenna inductance switch.

The primary inductance coil in Fig. 2 may be wound on the same tube as the secondary, in which case the two coils should be separated by about $1\frac{1}{4}$ ". It should be wound with about 60 turns of the same kind of wire as the secondary. Taps should be taken at the 10th, 30th, 45th and 60th turns. The tap at the 10th turn is provided in case it is desired to use the tuner in connection with a loop antenna, in which case the 10 turns become a coupling coil. If the loop is connected between the ground and antenna terminals, the primary condenser may be used to tune the loop. The coil L_0 is placed above the primary condenser in order that the primary inductance switch may be dispensed with. If the leads are brought from the taps to binding posts on the panel the switch is not necessary. In place of it there will be four antenna terminal posts on the panel. This simplifies the construction of the cir-

quire six volts on the filament the rheostat may be six ohms.

If it is desired to simplify the circuit a fixed resistance of 1.5 ohm may be used for the rheostat in the WD tubes and the peanut tube, while a filament voltage of three without any resistance in series with the filament for the UV199 may be used. A small plate battery of 22.5 volts is sufficient for local reception on the headphones.

If the operator is satisfied with a fair volume of signal the antenna circuit may be entirely done away with for local reception. The little tuning coil itself will usually pick up sufficient energy to make local broadcasting stations heard, providing the coil is properly placed. If slightly more volume is desired a loop antenna may be used.

One and the Same

NUMEROUS inquiries come to the publishers of RADIO WORLD naming articles and requesting either circuits, or hook-up, or connections, or wiring plans. Upon looking them up, ninety-nine out of a hundred are found to be complete and containing just the thing that the inquirer has asked for. A circuit is the same as a hook-up, wiring diagram, or connections, and is the technical manner of showing it.

Northern Lights Are Fickle

By T. E. Phillips, Member A. R. R. L.

THE Northern Lights are as fickle and changeable as a sixteen-year-old school girl. One style starts out on the horizon to the northward in searchlight fashion; darts and zig-zags; spreads out fan shape, sweeps, floats, or drifts. The colder the night the quicker the action and always the motion is fast. At times lights show all colors of the spectrum. They are as good as a lantern.

Sometimes the lights stay steadily fixed overhead for hours and they cut the darkness into two walls, the light showing the trail for miles with a black wall on either side. Apparently they are not more than 1,500 feet above the valleys, and on the mountain trails, travelers can get into the heart of things with them.

Once I came from Steel Creek to Jack Wade,

Alaska, about sixteen miles, along a high mountain trail with the mail man for this route. It was 9 p. m. We were in the lights for an hour. A light crackling could be heard, as when a cat's fur is rubbed the wrong way, and at times the horses would show blue fire at their ear tips, although they appeared not to mind. The other packer and myself felt no untoward sensation, save possibly a slight warmth. It was — 34.

The lights show up commonly from September to April, though April is getting late and warm for them. They are always different in their daily movements and never fail to attract attention, even from the old timers who have been in the far north since '98. We have men who came to Jack Wade in 1882 and '87, and one old man, Ludecker, raised the American flag when Russia sold out in 1867.

An Unusually Small Yet Practical Coupler

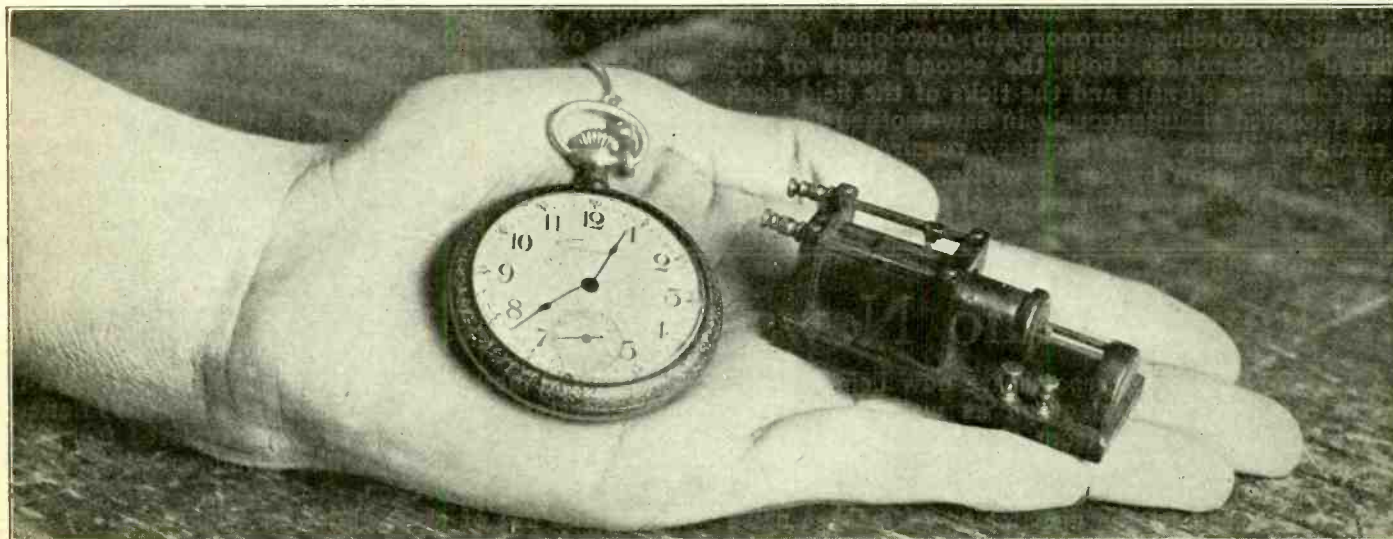

(C. Kadel and Herbert)

The builder of this miniature loose coupler, M. W. Obermiller, claims that it is the smallest yet made, and while we cannot acquiesce in that statement, we most certainly will say that it is a very neat piece of construction. What is more important than anything is that it works! The secondary slides in and out of the primary on tiny brass rods and is tapped. The wire, of course, is very small size, but at the same time the coupler has been made to work on the broadcasting wave lengths on both crystal and tube, which is a feat when considering that most small models do not work, but are just an exhibition of fine craftsmanship. Compare the entire instrument with the watch, or better yet, with the index finger of the hand holding it, and then think how small it must be, and the time that was spent in making it. Anyone that can devote time and energy to making small apparatus so perfectly must be a "crackerjack" when it comes to making man-sized apparatus.

Guinea Hens Predict Radio Weather

SHREVEPORT, LA.—You have heard of the Old Timer who can forecast weather conditions by the threatening twinge in his game leg, and not infrequently he has done quite as well as the U. S. Weather Bureau, but are you acquainted with the 82-year-old farmer near Madison, Miss., who predicts radio reception for the evening by the manner in which his guinea hens go to roost? If not, then you do not know that the Old Timer has found a new field of prophecy.

If common practice proves this to be true, we may expect that the radio bugs on the farm will replace chickens with guineas, and the effect may be a change of diet in city restaurants. Bradford Hearn of this place, member of the American Radio Relay League, has just received a letter from his grandfather in Madison saying: "When the guineas go to roost mak-

ing a lot of noise, we know the atmosphere conditions will interfere with 'listening in,' but if they go quietly to roost, we know there is to be a fine radio evening."

"Now isn't that something new for the radio bugs to ponder over?" asks Mr. Hearn. "I am only a broadcast listener so far, but the bug has bitten me bad and I am thoroughly inoculated with the germ. Pretty soon there will be another fifth district man on the air, re-laying in real style. I am an old Morse line-wire operator and the International Morse code comes mighty easy with me.

"My grandfather never took to the modern scheme of things and lives twelve miles from the nearest town. You should see how enthusiastic he is over radio. Imagine farmer folk, whose bedtime is with the chickens, or guineas, sitting up until 3 a. m., listening on his radio. He received it last Christmas."

Radio Time Used in Survey Work May Aid in Determining Earth Movement

By Carl H. Butman

TIME is an essential element in establishing basic triangulation stations on the earth, where exact latitude and longitude are plotted and recorded for further reference in making maps and charts, but exact time is difficult to secure at many out-of-the-way points, and radio is now employed in this scientific work.

Radio was the means of sending Standard Eastern time signals 3,000 miles to a Geological Survey party which has just finished its field work in Alaska, after establishing seven triangulation stations on the coast between Dixon's Entrance and Skagway. Cable and land line were not available, but by special arrangement the navy, through the Annapolis radio station, sent signals every night between 3:55 and 4:00 a. m., an hour when they could be used advantageously. The work is now completed and Annapolis has ceased to send the time.

By means of a special radio receiving set with an automatic recording chronograph developed at the Bureau of Standards, both the second beats of the Annapolis time signals and the ticks of the field clock were recorded simultaneously in saw-toothed lines on a revolving drum. The accuracy required being too close for detection by ear, a written record was required, and by this system errors of only two or three

thousandths of a second were included. These records were compared with local astronomical observations taken simultaneously at the several stations established. Corrections for the Eastern Standard signals amounted to only one or two 100ths of a second.

In the not distant future the transmission of radio time signals used in establishing exact longitudes may enter into the calculations of whether or not continents and islands move east or west. Heretofore longitudinal bearings have been made far too inaccurately, it is stated by some authorities, explorers not having the means of determining the exact time. With radio time, this will be obviated and in years to come data such as have just been recorded by the Alaskan field party led by Lt. G. D. Cowie of the survey, can be compared with new observations and movements of known spots on the earth's surface noted it thirty feet or more. Some geographers contend that Greenland has moved westward as much as three miles, but due to unreliable observations, though probably the best that could be made at the time, this fact cannot be disputed scientifically until a series of exact longitudinal bearings taken several years apart is available. Radio is a particular boon in this connection. Within ten or a dozen years, it may enable us to learn whether or not the continents and islands are shifting appreciably.

Farm Radio News Covers the Country

AGRICULTURAL reports are now being broadcast by radio telegraph as well as by radio telephone direct from the United States Department of Agriculture at Washington, D. C., through the Arlington radio station. The new service is designed to speed up the dispatching of market news and is the result of co-operative arrangements with the Navy Department to establish remote control stations in the Department of Agriculture.

A similar remote control station was recently established in the San Francisco office of the department for the broadcasting of market advices by radio telegraph through the Navy station at San Francisco. The New Orleans and Great Lakes stations of the Navy Department broadcast agricultural reports received from Department of Agriculture offices at New Orleans and Chicago.

The broadcasting of market news from the four long wave, high powered radio-telegraph stations of the Navy Department makes it possible for radio telegraph operators virtually anywhere in the United States to receive up-to-the-minute agricultural price quotations. The Department of Agriculture plans to arrange with a number of these operators for rebroadcasting the news by radio telephone. More than 90 radio telephone stations throughout the country are already broadcasting crop and market reports furnished by the various branch offices of the department.

Reports distributed among farmers by the Rochester office of the department are now based entirely upon the messages broadcast by the Arlington station. An experienced radio operator in the Rochester office picks up the messages by radio telegraph, prepares mimeograph copies of the reports, and distributes the copies

by mail and messenger to several hundred farmers in the Rochester farm section. Similar service is in effect at Los Angeles based upon reports received from the San Francisco station. A like arrangement is to be made at Portland, Oregon.

With the use of radio and wire telegraphy the Department of Agriculture has established the most complete and efficient market news service to farmers and other agricultural interests developed anywhere in the world. Farmers in practically any section of the country can now receive reports of agricultural prices and movements at the leading market centers the same day, and in many cases within a few hours after the news develops. Trained market reporters in the markets collect the information and file it for immediate dissemination by telegraph and radio.

More about Condensers

NUMEROUS articles relative to making fixed condensers for receiving sets have been published. Naturally the readers are out to save money, so going by the diagrams and tables, they very carefully make up a condenser to the correct capacity, and then wonder why a set doesn't function. The making of condensers is a rather delicate job, and while it does not compare with the making of a phone, still it should not be tackled by the average amateur. In order to make a condenser correctly you must know the absolute thickness of your dielectric, its dielectric co-efficient, the thickness and exact size of your plates, and a dozen other things in order to get the correct capacity. Unless you are good at mathematics and understand the formulae thoroughly do not tackle it.

Regeneration and Transformer-Coupled Radio-Frequency

By C. White, Consulting Engineer

RECENTLY I have been spending much time examining some of the latest creations in radio sets and I must admit they are great. Some are, of course, better than others but the general average of the lot is exceedingly high. And it so happens that all the development is exactly along the lines predicted by many radio writers more than a year ago; namely, the perfection of radio-frequency amplification in its various forms. At the present time the development of radio is more dependent upon the perfection of sensitive receivers than more powerful transmitters, and it seems as though the pinnacle of sensitivity is near at hand. But, nevertheless, there will always be a great number of radio fans who will delight to play around and try out the new circuits and variations, although they may own a de luxe receiver which sits in state in the parlor for regular routine reception of the broadcast concerts. Last winter and fall we played around with "flivver" and "pup" circuits, but this winter the style will be radio-frequency amplification either alone or coupled with regeneration in some form. Those who have built the simple single circuits are now going to build the more complex and selective radio-frequency circuits.

There are many forms of radio-frequency amplification for amateur use and these forms are generally designated by the style of coupling between each succeeding tube and the next. The three salient classifications can be given as the tuned plate circuit method, the transformer coupled method, and the resistance coupled method. The first method makes use of a radio-frequency tuned circuit between the plate of the first tube and the next, while the second method uses an untuned transformer much similar to the common method of audio-frequency amplification. The third method is seldom if ever used in short wave lengths for radio-frequency amplification. Manufacturers and radio experts experienced quite a bit of trouble in developing a good radio-frequency transformer to cover a sufficient wave band and still be relatively unselective in this band. If the transformer is selective it will mean that more radio-frequency amplification can be had on one particular wave length than on the others. This fact not only means an unbalancing of the amplification for various wave lengths but also means that since the transformer is selective it will create a greater tendency for the tubes to oscillate at that particular frequency to which it is tuned.

Various methods have been resorted to in order to make the transformer unselective. One method is to use a very high grade of steel laminations for a magnetic core, and another is to use an air core and place a short-circuited copper band around the core of the transformer. The first renders the transformer remarkably constant in amplification over the particular wave band specified by the manufacturer by introducing a variable inductance in the circuit by means of the magnetic core. A coil with an iron core has a variable inductance as frequency varies owing to the varying magnetic action of iron for different frequencies. Then it is obvious that the transformer will be untuned to any particular frequencies because the inductance is not fixed but changes as frequency changes within certain limits. The second method accomplishes the same end by a different means. The inductive coupling action between the short circuited copper band and the main coils changes with frequency since the current flowing in the copper band changes with frequency; therefore, the effective inductance will vary making the transformer coils untuned.

It is plain to see that these transformers are precise instruments and can not be made at home where the scientific convenience of a laboratory is generally wanting.

The circuit described in this article makes use of regeneration and untuned transformer repeated radio-frequency amplification. The tuning circuit is not inductively coupled to the first tube but is a simple single circuit tuning element with a parallel arrangement of the tuning condenser C-1. By placing the condenser in parallel with the tuning inductance far greater selectivity is obtainable than when the condenser is placed in series. It will be necessary to employ a five or seven plate condenser instead of the customary 23 plate size, which is used in the series type of tuning circuit. The inductance L is wound with No. 22 S.C.C. magnet wire on a 4" bakelite tube. The coil should have a total number of 50 turns. The upper portion (Ant. side) of the coil is tapped for switchpoints at every tenth turn, while the lower portion (Gnd. side) has the first 10 turns tapped at every turn in order to provide a fine

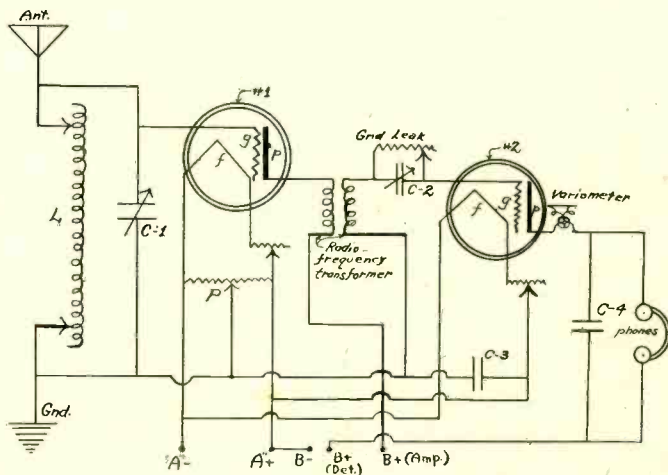

Schematic diagram of a two-tube circuit, using one stage of radio-frequency amplification with tube detector, and using a variometer in the plate lead of the second tube to produce regeneration.

adjustment of the number of effective turns on the coil. The potentiometer P should have a resistance of 300 ohms or more.

Regeneration is obtained by using a standard variometer in the plate circuit of the detector tube (No. 2). The control of regeneration and radio-frequency amplification is afforded by the potentiometer P and the condenser C-2. The condenser C-2 should have a maximum capacity of .00025 mfd., which will be a five or seven plate condenser, depending upon the size and spacing of the condenser plates. This variable grid condenser allows a remarkable control of regeneration and quality of the signal. It is extremely advisable to shield the panel with copper foil near the two condensers, and the fixed plates should always be connected nearest the grid side of the circuit. A variable grid leak is advisable in order to make the circuit flexible and adaptable to different types of detector tubes. The condensers C-4 and C-3 are identical and have a capacity of .0025 mfd. apiece.

This circuit is especially adaptable to operation with the new UV199 tubes, which are splendid radio-frequency amplifiers as well as good detectors. Do not use WD11s
(Concluded on next page)

RADIO PRIMER—For the New Army of Radio Beginners

By Lynn Brooks

HOW TO CUT DOWN THE LOSSES IN YOUR RADIO RECEIVER: In the designing of receivers certain basic ideas must be incorporated in the apparatus in order to eliminate the minute losses that cut down the efficiency. Unfortunately, there are many losses which, while small in themselves, cannot be eliminated no matter how you attempt to do it.

The first and foremost necessity in the building of a good receiver is the use of good apparatus. Use couplers and variometers that have as little binder to hold the wires rigid as possible. The reason for this is that the binding material forms a dielectric between turns. This causes the turns to act as plates of a condenser, the effect of distributed capacity being felt. This makes itself known by broad tuning. If you can obtain apparatus that does not use any material for holding the turns tightly in place do so by all means. It is for this reason that spider web coils are so efficient—the distributed capacity is minimum, and the maximum inductance may be used, cutting down the back E. M. F. of the coil and making sharp tuning possible when the proper tuning capacity is used.

The same principle applies to the use of fixed or variable condensers. Do not use cheap ones that offer great chances for leakage. Condensers using fiber or cheap composition ends are great dissipaters of minute energy. They offer chances for leakage that can easily ruin an otherwise good receiver. When purchasing a condenser take note of the manner in which the bearings are made. They should be so constructed that the movable plates can be tightened to prevent any end-play due to the bearing itself wearing out. Condensers that have pig-tail connectors, the ends of which are firmly soldered or welded to the elements, are to be preferred. The losses are cut down greatly when this type of connector is used instead of relying upon a bearing that is independent of the unit for connection. In fixed condensers select those that are strongly made and whose capacity cannot be changed by pressing the sides together. Here again fiber should not be used to hold the plates together, as fiber has the ability to absorb moisture, due to its being porous, and when this occurs the capacity is changed.

When selecting panels for the set select standard panel material that has been tested and found suited for the work. Wood, while it may be used in extreme cases, is not suitable. Even when thoroughly dried and soaked in

paraffin it offers a path to the minute currents. The best material you can purchase is cheap when considering the fact that it will safeguard your receiver against that great bugaboo of all radio receivers—energy losses.

Another point that is not thoroughly understood in the construction of an efficient receiver is to use as few tapped connections as possible. While a fairly good connection may be possible between a switch arm and a tap, there is nevertheless a loss due to resistance. This makes itself felt when after a period of use the taps form a slight layer of corrosion on their faces. Pig-tail connectors firmly soldered under the heads of the taps and to the shaft of the switch arm and a good stiff contact will cut down loss also. The best way of getting around the whole matter is to use as few tapped coils as possible. Design your inductances to cover the waves that you desire and use condensers for tuning. Large coils with multitudinous taps and bank windings cut down the efficiency due to "dead-end" losses. This is because unused turns of the coil absorb part of the energy, wasting it in a manner that is surprising. To prove this fact to yourself, take a coil that is made for use on say 500 meters and tune in your station. Note the strength of signals on an audibility meter, if possible or if not take mental note of it, as well as the sharpness of the tuning. Then substitute a tapped coil that will allow the reception of signals up to say 1500 to 2000 meters, and again tune in the station on 500 meters. The losses will immediately make themselves known and you will understand where "dead-end" losses cut down the range and the audibility.

It is unnecessary to state that soldered connections should always be employed. Short leads of heavy or large sized wire also contribute to the cutting down of the losses. The No. 14 bus bar wire is generally employed and its resistance is low but still it has resistance so do not use any longer leads than are absolutely necessary. Where it is impossible to obtain this type of wire, the ordinary single cotton covered soft or hard drawn copper wire, either No. 12 or 14, should be used.

New Broadcasters

THE following new stations and transfers were made in the Department of Commerce broadcasting lists during the past ten days:

		Meters	K/cs	Watts
WTAM	The Willard Stor. Battery Co., Cleveland, O.	390	770	1000
New Class A Stations				
KFJY	Tunwall Radio Co., Fort Dodge, Iowa	246	1220	50
KFJZ	Texas Nat'l Guard, 112th Cav., Ft. Worth, Tex.	254	1180	20
WTAR	Reliance Electric Co., Norfolk, Va.	226	1330	13
WTAT	Edison El. Ill. Co., Boston, Mass. (portable).	244	1230	100
Transferred From C to A				
WCAZ	Carthage College, Carthage, Ill.	246	1220	50
WRAH	Read, Stanley N., Providence, R. I.	231	1300	10
WHAK	Roberts H'dware Co., Clarksburg, W. Va.	258	1160	15

(Continued from preceding page)

or WD12s in this circuit since these tubes do not function nearly so well in radio-frequency circuits. The UV201As work better than any tubes tried in the circuit, but owing to the fact that they are not readily adaptable to dry cell operation many prefer to use UV199 or C299 for the sake of portability.

Do not forget to apply a high plate voltage on the amplifier tube (No. 1). To obtain efficient radio-frequency amplification you must use the maximum voltage allowable for the tube used. Do not apply, however, excessive voltage to the plate of the detector. It is often true that even "hard" or high vacuum tubes work best as detectors with voltages as low as 20. For the UV201A, 35 to 40 volts on the plate generally gives the best detector action. If you follow the construction tips given in each issue of RADIO WORLD you will experience no difficulty in assembling radio-frequency circuits and making them work from the start.

Radio Music On a Long Island Sound Steamer

By Gilbert Bunnell

PASSENGERS aboard the Fall River Line steamer "Priscilla" on recent Saturday and Sunday nights heard history being made in the air. For the first time in coastwise navigation radio programs, music from a boat's orchestra, and even the ancient call, "All ashore that's going ashore!" sounded everywhere on a boat by virtue of modern knowledge of the electron.

The experiment on the "Priscilla" steamed through the waters of three states. It was made possible by the cooperation of the Fall River Line and the Western Electric Company which installed a complete public address system, supplied a crew of amplificationists, and kept a careful check on results.

A radio receiver was installed on the "Priscilla's" freight deck. Through the public address system the programs were made clearly audible in the grand saloon, the saloon deck forward and aft, the main deck, the dining room and the forecabin. These programs, broadcast by WEA and WNAC, were interspersed

of the Fall River Line is through Long Island Sound and Narragansett Bay, one of the most beautiful salt water trips available. The "Priscilla" and the other steamers are capacious and comfortably fitted, so that many different audiences were to be found on them at the same time—in the dining room, the grand saloon and on the decks where travellers choose the scenic side of life.

The volume of sound was so controlled that those in each part of the boat were under the impression that they heard the renditions direct. As a matter of fact, the radio receiver was far away on the freight deck among the bales and barrels. The music of radio program and orchestra were amplified several thousands of times before being projected through distributors inconspicuously mounted on each deck.

On the decks there was frequently the impression that music came from across the water, a fact which added much to the effectiveness of the programs. Blinking lighthouses and music from afar and the gen-

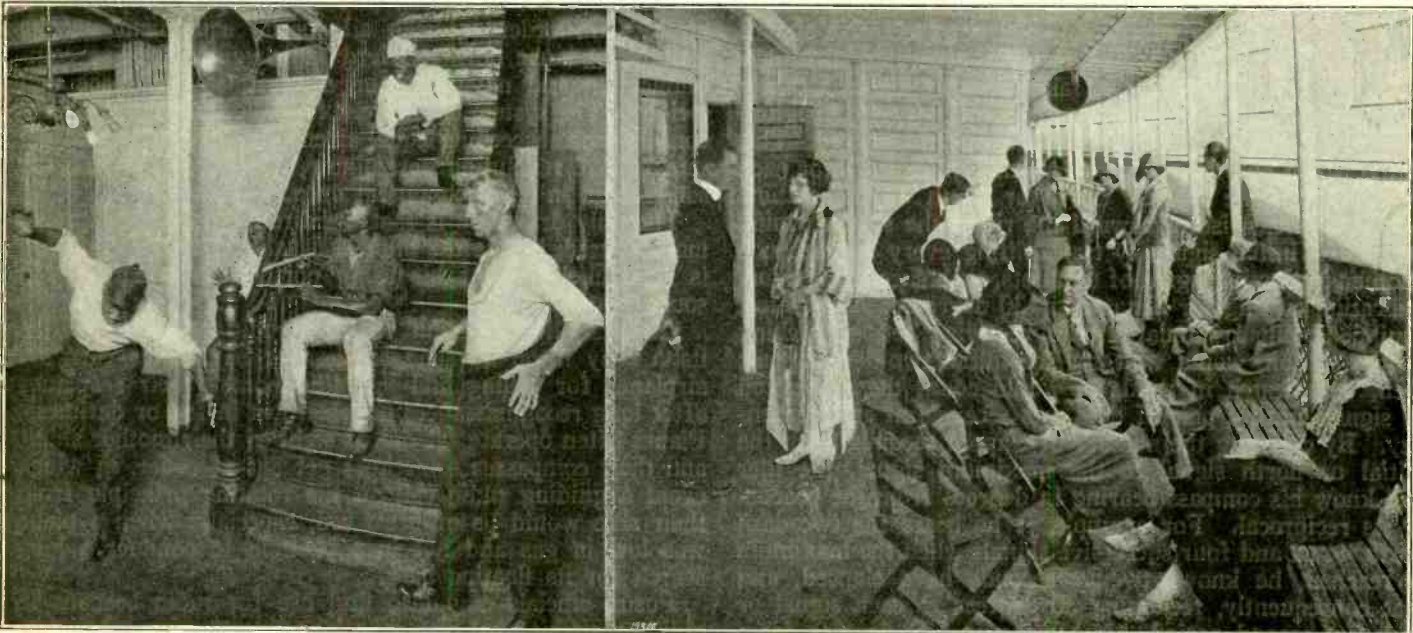

(C. Western Electric Co.)

Radio music enjoyed on the Long Island Sound steamer "Priscilla" by the passengers, and some of the crew in the forecabin.

with musical numbers by the "Priscilla's" own concert orchestra. This was accomplished by connecting a microphone in front of the musicians on the gallery deck with the vacuum tube amplifier on a truck parked on the freight deck forward.

"Dance music played by folks who wasn't no place on the boat" astonished but delighted members of the crew and galley forces who had their own concert in their own quarters and shuffled a step or two while they were off watch.

Many passengers were not sure that the source of all the music was not on the boat itself until they investigated. The Capitol Theatre program was reproduced on the "Priscilla" on Sunday night and an elderly gentleman, boarding the boat at Newport, thought he had absent-mindedly strayed into the wrong place.

"If I believed my ears, I'd think I was sitting in the front row of the orchestra in the Capitol," he said.

The experiment was carried on aboard the "Priscilla" primarily because of the excellent opportunities for testing the effectiveness of reproduction. The route

movement of the boat threw a glamour about travel from New York to Boston which it does not have in other forms.

The first seagoing trip of the public address system on a coastwise vessel was highly satisfactory to the Western Electric crew as proving the flexibility and success of operation under different conditions.

Begin Right—End Right

MANY an amateur has bought a fine set and then put up a fine antenna—probably it has a run of every bit of 100 feet clear of everything. It is nice and high and well insulated. Then he wraps the lead-in wire around it and expects the set to work right. It probably will, while the wire is new—but how about two weeks from then when the antenna wire is black with corrosion? The little leaks and resistances are what count around a set. Solder each connection, even in the ground lead.

Radio Beacons Will Help Airplanes Locate Their Positions

By Carl Hawes Butman

WASHINGTON, D. C.—American transcontinental air pilots will fly on cross-country trips guided from field to field by radio beacons when the plans of the Army Air Service and Signal Corps are perfected. This new radio navigational development for aiding fliers along the army model airways is not yet ready for use, but work on the first radio beacon at Wilbur Wright Field at Fairfield, Ohio, will be undertaken shortly by the Army.

The new aerial radio beacon is the result of experiments conducted at the radio laboratory of the Signal Corps under the direction of Capt. W. H. Murphy, of the army, during the past several months. A model directional radio transmitter was tried out at the laboratory and found operative and later used in practical tests at McCook Field, Dayton, Ohio, up to distances of about 40 miles. Experiments with both single and crossed loops were employed, the best results being obtained with the latter.

The apparatus to be installed at the first station will be a 5 KW transmitter which will send out successive signals of a distinct type every five seconds, separated directionally by 30 degrees. That is, taking the station as a center and the exact north bearing as 0 or 360 degrees, a significant code signal, such as two dashes, is transmitted. This signal would only be audible at maximum strength for each dash on the line directly north or south of the station. Rotating clock-wise or toward the right, the station would follow the initial signal by transmitting every five seconds another distinctive signal of two dots, each successive signal indicating an angular distance of 30 degrees. An aviator, equipped with a standard radio receiving set, on picking up the station, would wait for the initial two-dash signal; then, with watch in hand, he would count the succession of signals until a pair of dots was received at equal intensity. By counting the number of elapsed seconds from the initial or north signal to the maximum signal, the flier will know his compass bearing in degrees from the beacon, or its reciprocal. For example, if he hears the two-dash north signal and four successive signals when the maximum is reached, he knows twenty seconds have elapsed, and that consequently, reckoning 30 degrees to each signal or each five-second period, his bearing is 120 degrees from

the station or approximately southeast by east on the old compass card. If, at the end of fifteen seconds, the third signal is the maximum and each dot is of equal intensity, he knows he is directly east of the station; similarly, the sixth, after 30 seconds, would place him south.

The double coils used in sending are fixed, but the effect of the rotating signal is obtained by varying the current strength in each coil by means of a rotating coupler in the station. After a complete rotation, 360 or zero degrees is again reached and the double dash signal is again emitted.

With the new station in operation, air service and signal corps experts expect pilots within a range of approximately 200 miles can be served with a directional signal. When each air field is so equipped, it will be possible for fliers to travel from field to field in bad fog or at night with increased safety.

Fixed ground beacons of this type are favored against the development of special direction finding equipment on aircraft, in order to keep all special equipment on the ground, and use only standard radio equipment for communication and navigation on aircraft, saving space and weight. The system is different from lighthouse radio beacons in that succeeding equal strength signals rotate at the rate of one revolution per minute, whereas the lighthouse sends them in all directions at once.

The only drawback is that the direction or its reciprocal may be used, but as the pilot is usually approaching, there is little likelihood of his being north and thinking he is south or vice versa.

One useful adaptation for this radio beacon signal is its use by naval airplane carriers or battleships carrying airplanes for calling and "guiding home" their seaplanes after long reconnaissances or when lost in fog or darkness. Planes often operate far out of sight of their mother ships, and their compasses sometimes get out of order, in which event a guiding radio call on the rotating principle from their ship would be of great aid, especially when a plane was low in gas and not in a position to conduct a long search for its floating base.

Postal officials may also find use for radio beacons in aiding their air mail planes on long transcontinental flights.

Shipping Board Needs Radio Operators

RADIO operators seeking employment will find excellent opportunities this fall for real radio work on board ships of the U. S. Shipping Board which sail the Seven Seas and call at every port in the world.

It is understood that approximately 100 first-class radio operators can be placed on government vessels alone during the next few months.

On the first of last July, the government increased the pay of all its commercial operators approximately 15 per cent. The monthly rates of pay now in effect range from \$85 per month to \$125.00. A few positions pay a higher salary.

Radio operators aboard Shipping Board ships are classed as officers and, in addition to their regular monthly pay, receive free lodging, meals and such other accommodations as are accorded to ships' officers.

Applicants for berths as radio operators must hold

commercial first-class radio operators' licenses, which are issued by the Department of Commerce. Examinations for such licenses may be taken any time at the offices of the Department of Commerce's Radio Supervisors, located at the following places: Custom House, Boston, Mass.; Custom House, Baltimore; Custom House, New Orleans; L. C. Smith Bldg., Seattle, Wash.; Custom House, New York; Federal Bldg., Atlanta, Ga.; Custom House, San Francisco, Cal.; Federal Bldg., Detroit, Mich., and Federal Bldg., Chicago, Ill.

Radio operators who desire employment on board Shipping Board vessels and holding required licenses should communicate with the radio companies which employ operators for the board. These companies are: Radio Corporation of America, Ship Owners' Radio Service, Inc., and Independent Wireless Telegraph Company, all of which have offices in large American ports.

A Tuned Radio Frequency Reflex Set

By LeRoy Western

ONE of the greatest objections which the writer has found to the standard type of reflex circuit is that all radio-frequency transformers will not give results when used in this way. He experienced considerable trouble in making reflex circuits work with the standard radio-frequency transformers on the market today and, therefore, the circuit illustrated herewith was tried. It consists of a vario-coupler as a tuner, one stage of tuned radio-frequency amplification, and one stage of audio-frequency amplification. This is accomplished with the use of one tube and a good crystal detector.

A variometer is used as a tuned impedance coupling between the tube and the crystal detector and a standard audio-frequency amplifying transformer is employed. The values of the fixed condensers should be experimented with, although a .002 mfd. will usually give good results. However, if results are not as desired, the value of the condensers should be changed, whereupon better results should be obtained.

After the circuit is hooked up, it may be found necessary to reverse the primary connections to the audio-frequency transformer in order to obtain the loudest signals.

By means of the potentiometer used across the "A" battery, the grid potential of the amplifying tube may be varied at will. However, with each variation of the potentiometer it will usually be found necessary to re-tune the set in order to bring in the signals loudest.

The vacuum tube used should be of the hard variety and the "B" battery voltage should be experimented with in order to decide just what value is best. The writer found that 100 volts on the plate of a UV201 gave excellent results for all around work.

In regard to the variocoupler, it was found that a standard type would under all conditions give very good results, but in order to simplify the amount of

apparatus used, the stator should be tapped in both units and tens. By doing this it will be unnecessary to use a variable condenser in series with the antenna or in shunt with the primary. If, however, the coupler will not tune to as high a wave length as the builder may desire, he should then shunt the primary with a variable condenser having a maximum capacity of .0005 mfd. The variable condenser across the rotor is quite necessary in order to tune the secondary circuit and balance it up with the primary.

A word in further reference to the audio-frequency transformer. In the course of his experiments, the writer found that one type of audio-frequency transformer seemed to give better results than others. He will be glad to help the readers of RADIO WORLD if they are unable to obtain results with the transformers which are available.

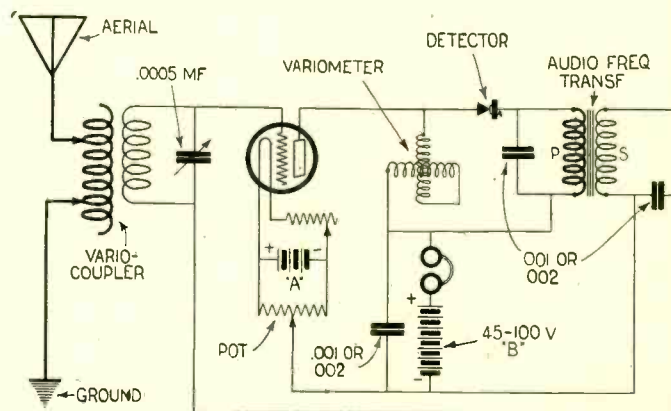

Schematic diagram of a single tube reflex, using tuned radio frequency amplification on the amplifying tube. The variometer takes the place of the transformer, making possible extremely sharp tuning and consequently less interference. Use a good synthetic crystal capable of standing the high plate voltage.

RADIOGRAMS

Station **KDKA**, Pittsburgh, during the recent voyage of the navy dirigible ZR-1 from Lakehurst, N. J., to St. Louis, kept in radio contact with the big airship and broadcast bulletins every 15 minutes giving her position to thousands of listeners.

Charlie Chaplin, the movie comedian, talked from Station **WOR** on Wednesday evening of last week on "Impersonations." Since his very recent advent as a scenario writer and a director his publicity announcements refer to him as Charles Spencer Chaplin.

Stations **WGM** and **WSB**, Atlanta, Ga., kept out of the air one night recently when Maddalena Hanff, known throughout Georgia as the "Nightingale of the South," sang from Station **WJZ**, New York. This was done so that "the folks back home" could tune in without interference.

Dr. Francis A. Cave, of Boston, made a prediction at a convention of the Middle States Society of Electronic Medicine. He quoted a British physician as saying that in the future there would come a time when diners would get their sustenance from electricity instead of food. In other words one would take in electrons instead of calories.

In response to urgent cables from important Japanese interests, two of the highest Westinghouse officials, General Guy E. Tripp, chairman of the board of directors of the Westinghouse Electric & Manufacturing Company, and Loyall A. Osborne, president of the Westinghouse International Company, sailed from San Francisco on October 10 in the S.S. "Shinyo Maru," and will visit Shanghai, Hongkong, Peking and the Philippines before returning home.

It is announced from Paris that the first wireless newspaper in France will be issued during this month. It will be edited by Leo Poldes, one of the most fervent supporters of wireless developments. He plans to give the news by wireless with some of the most prominent writers and speakers in the country reading out the information, which will cover everything from politics to sports.

"Svenska Rundradioaktiebolaget" is the name of a new firm in Sweden for broadcasting. The organizers of the company are Elektriska Aktiebolaget, A. E. G. Allmänna Telefonaktiebolaget, L. M. Ericsson and others. The minimum capital of the company has been fixed at 100,000 kroners and the maximum at 300,000 kroners. The company has applied to the government for a concession to transmit information by radio.

Apparatus recently perfected by engineers of the Western Union Telegraph Company reduces the number of hands through which a cablegram must pass from six to two, thus speeding up transmission and reducing the possibility of error. A message sent by The World from New York to its London office at 11:47 a. m. one day recently reached its destination twelve minutes later. The radio report of the Dempsey-Firpo fight travelled from the ringside in New York to Buenos Aires in 15 seconds.

John Gilmartin, of Glasgow, Scotland, was on a motoring tour through England when his mother, who had been ill, suddenly took a turn for the worse. In an attempt to locate him—for he had left no address—his family communicated with the London radio broadcasting station, which sent out a call that night for the driver of an automobile bearing license number GB-4204. The appeal was broadcast three times during the night, the last call evoking a response from an Oxford garage. The owner communicated with Gilmartin at the local hotel.

Here Are Good Broadcast Programs

Station KYW, Chicago

October 13—Central Standard Time—536 Meters.

- 9:30 A. M.—Late news and comment on the financial and commercial world.
- 10:00 A. M.—Market reports.
- 10:30 A. M.—Late financial news and comment.
- 10:58 A. M.—Naval observatory time signals.
- 11:00 A. M.—Market reports.
- 11:05 A. M.—Weather report.
- 11:30 A. M.—Late news and comment of the financial and commercial world.
- 11:35 A. M.—Table talk by Mrs. A. J. Peterson of Peoples Gas Company.
- 12:00 M.—Market reports.
- 12:10 P. M.—Final market reports.
- 12:20 P. M.—Final stock reports.
- 12:30 P. M.—Late financial comment and news bulletins.
- 2:15 P. M.—Financial comment and news bulletins.
- 2:30 P. M.—Closing stock quotations, Chicago Stock Exchange.
- 3:00 P. M.—Late news and sport bulletins.
- 3:30 P. M.—News and sports.
- 4:00 P. M.—Late news and sport bulletins.
- 4:30 P. M.—News and sport bulletins.
- 5:00 P. M.—Latest news of the day.
- 6:30 P. M.—News, financial and final market and sport summary. Financial summary furnished by the Union Trust Company and Chicago Journal of Commerce.
- 6:50 P. M.—Children's bedtime story.
- 8:00 to 8:58 P. M.—Musical program.
- 8:58 P. M.—Naval observatory time signals.
- 9:00 P. M.—News and weather reports.
- 9:05 P. M.—Under the Evening Lamp, service including stories, articles and humorous sketches furnished by the Youth's Companion.

Station WLW, Cincinnati

October 15—Central Standard Time—309 Meters.

- 10:30 A. M.—Weather Forecast, Business Reports.
- 1:30 P. M.—Business Reports.
- 3:00 P. M.—Special Music by Jennie Kehrt. Babson Reports.
- 8:00 P. M.—Program Arranged by the Editorial Staff of Sunday School Publications, Methodist Book Concern.
1. Introductory Musical Number by the Cincinnati String Quartet.
 2. General Announcement.
 3. Ganzonetta, Mendelssohn—The Cincinnati String Quartet.
 4. The Religious Significance of Current Events—The Rev. A. D. Moore.
 5. Menuette, Beethoven—Cincinnati String Quartet.
 6. "Pioneer," Kipling—Read by the Rev. A. D. Moore.
 7. "Old Black Joe," Arranged by Pochon—Cincinnati String Quartet.
 8. The Common Work of the Churches—The Rev. Henry Pearce Atkins, Executive Secretary, Cincinnati Federation of Churches.
 9. The Cincinnati String Quartet.
- 9:00 P. M.—Entertainment by the Roger Hill Dance Orchestra.
- 9:30 P. M.—Review of the Leading Productions at the Cincinnati Theatres.

Station WGI, Medford Hillside, Mass.

October 13—Eastern Standard Time—360 Meters.

- 6:00 P. M.—New England Weather Forecast, Furnished by the U. S. Weather Bureau. New England Crop Notes, Furnished by V. A. Saunders, Statistician. Late News Flashes, Early Sports News—Boston American.
- 6:15 P. M.—Code Practice, Lesson Number 135.
- 6:30 P. M.—Boston Police Reports, Boston Police Headquarters.
- 7:30 P. M.—Evening Program.
1. Twenty-eight of a series of talks on New England Business Problems, by Arthur R. Curnick, of the New England Business Magazine.
 2. Musical Program, Arranged by Mrs. Catherine Chisholm, Pianist and Teacher, and Assisting Artists.
- Sunday, October 14.
- 4:00 P. M.—Twilight Program.
1. "Adventure Hour," Conducted by the Youth's Companion.
 2. Concert Program by the Edison Laboratory Phonograph.
 3. Stories by Arturo.
- 8:30 P. M.—Evening Program.
1. Concert by the Temple Israel Choir, Mr. Henry Gideon, Director. "From the Cradle to the Chuppe" (Wedding Canopy), a Concert of Jewish Folk Music, by Constance and Henry Gideon and a Double Quartet, and Rabbi Samuel Wolk, Assistant Rabbi, Temple Israel, Boston. Speaking on "Folkways: The Soul of a People."

Station WBZ, Springfield, Mass.

October 13—Eastern Standard Time—337 Meters.

- 11:55 A. M.—Arlington time signals; weather reports; Boston and Springfield market reports.
- 2:00 P. M.—World Series results play by play beginning at 2:00 P. M. and every 15 minutes until game is finished.
- 7:00 P. M.—Results of the World Series. Dinner concert by the Hotel Kimball Trio, under the direction of Jan Geerts direct from the Hotel Kimball dining room.
- 7:30 P. M.—Twilight tales for the kiddies. "Bringing the World to America," by "Our World." "This Week's Judge."
- 8:00 P. M.—Concert by Mrs. George Howes, soprano; Margaret Haskins, pianist and accompanist.
- 9:00 P. M.—Results of the World Series. Bedtime story for grown-ups by Orison S. Marden.
- 9:30 P. M.—Progress of Dance Music by Boton and Capriano Orchestra of New Haven.

Station KSD, St. Louis Post-Dispatch

October 13—Central Standard Time—546 Meters.

- 8:00 P. M.—Orchestra Concert, Organ Recital, Vocal and Instrumental Specialties Broadcast Direct from the Missouri Theatre.

Station WOR, Newark, N. J.

October 13—Eastern Standard Time—406 Meters.

- 2:30 P. M.—Soprano solos by Alice Burns.
- 2:45 P. M.—Contralto selections by Mabel H. Schroeder.
- 3:00 P. M.—Continuation of soprano solos by Alice Burns.
- 3:15 P. M.—Contralto selections by Mabel H. Schroeder.
- 3:30 P. M.—Songs by Daniel J. Moore, baritone.
- 6:15 P. M.—"Sporting News Up to the Minute"—a talk by Fred J. Bendel, Sporting Editor of the Newark Morning Ledger.
- 6:30 P. M.—Clarence Talisman, popular violinist of Newark.
- 6:45 P. M.—Piano solos by Margaret Brady, pianist of the Russell Studios, Newark College of Music.
- 7:00 P. M.—Clarence Talisman, popular violinist of Newark.
- 7:15 P. M.—Piano solos by Margaret Brady, pianist.
- 8:00 P. M.—"Fire Prevention and Fire Protection"—a talk by Charles W. Greenfield, President, New Jersey State Fire Chiefs' Association.
- 8:15 P. M.—Jimmie Clark's Whiteway Entertainers.
- 9:15 P. M.—Joint recital by Marion Estelle Adam, contralto soloist of the Church of the Redeemer, Newark, and Marie Langdon Andrews, soprano soloist of the First Presbyterian Church, Summit, N. J. Solos to be announced.
- 9:30 P. M.—Herman Heidrick, the well-known electrical "old timer," in his third battery talk.
- 9:45 P. M.—Joint recital by Marion Estelle Adam, contralto, and Marie Langdon Andrews, soprano.
- 10:00 P. M.—Dance music by Anna Shaw's Ideal Girl Orchestra.

Station KDKA, East Pittsburgh, Pa.

October 13—Eastern Standard Time—326 Meters.

- 10:00 A. M.—Music. Union Live Stock Market Reports, Furnished by the National Stockman and Farmer.
- 12:30 P. M.—Music. Weather Forecast.
- 12:50 P. M.—U. S. Bureau of Market Reports, Furnished by the National Stockman and Farmer.
- 3:00 P. M.—Pitt-West Virginia Football Game, Broadcast Direct from Forbes Field.
- 3:15 P. M.—Baseball Scores of Games Being Played Today.
- 6:00 P. M.—Baseball Scores.
- 6:15 P. M.—Dinner Concert by the Westinghouse Band Under the Direction of T. J. Vastine.
- 7:00 P. M.—Baseball Scores.
- 7:05 P. M.—Dinner Concert, Continued.
- 7:30 P. M.—"Bringing the World to America," Prepared by "Our World."
- 7:45 P. M.—The Children's Period.
- 8:00 P. M.—Baseball Scores.
- 8:05 P. M.—Humor from Judge.
- 8:30 P. M.—Concert by the Westinghouse Band under the direction of T. J. Vastine, assisted by W. C. Raim, baritone.
- 9:55 P. M.—Arlington time signals. Weather forecast.

Corrected Official List of Broadcasting Stations in the United States

FOLLOWING is the first installment of a corrected list of commercial broadcasting stations in the United States as issued by the Department of Commerce. The list will be continued in next week's RADIO WORLD.

Call	Station	Frequency Kcys.	Wave Length Meters	Power Watts	Call	Station	Frequency Kcys.	Wave Length Meters	Power Watts
KFAV	Abbot Kinney Co., Venice, Calif.	1,160	258	5	KRE	Berkeley Daily Gazette, Berkeley, Cal.	1,080	278	50
WEAK	Abercrombie, Julius B., St. Joseph, Missouri	833	360	100	KJS	Bible Institute, Los Angeles, Cal.	833	360	750
KFCB	Azbill, W. K., San Diego, Calif.	1,080	278	20	KFHB	P. L. Boardwell, Hood River, Ore.	1,070	280	10
KFDA	Adler's Music Store, Baker, Ore.	833	360	5	WKAY	Brenan College, Gainesville, Ga.	833	360	20
WTAW	Agriculture & Mech. College, College Station, Texas	1,180	254	50	KFFB	Brinkley-Jones Hospital Assn., Milford, Kan.	1,050	286	500
WMAV	Alabama Polytechnic Institute, Auburn, Ala.	1,200	250	250	WMAN	Broad Street Baptist Church, Columbus, Ohio	833	360	10
WSY	Alabama Power Co., Birmingham, Alabama	833	360	500	WQAH	Brock-Anderson Elect. Eng. Co., Lexington, Ky.	1,180	254	10
WCAR	Alamo Radio Elect. Co., San Antonio, Texas	833	360	150	KFIY	Brott Laboratories, Seattle, Wash.	1,270	236	15
KFTU	Alaska Elect. Light & Power Co., Juneau, Alaska	1,330	226	10	KFIV	Broyles, V. H., Pittsburg, Kan.	1,250	240	20
WGAW	Albright, Ernest C., Altoona, Pa.	1,150	261	100	KFDR	Bullock's Hardware & Sporting Goods, York, Neb.	833	360	10
KZM	Allen, Preston D., Oakland, Cal.	833	360	100	KFEY	Bunker Hill & Sullivan Mining & Const. Co., Kellog, Idaho	833	360	10
WSAN	Allentown Radio Club, Allentown, Pa.	1,310	229	10	WIAS	Burlington Hawk Eye-Home Elect. Co., Burlington, Iowa	833	360	150
WRAU	Amarillo Daily News, Amarillo, Texas	833	360	20	WDZ	Bush, James L., Tuscola, Ill.	1,080	278	10
WJAB	American Radio Co., Lincoln, Neb.	833	360	250	KFBB	Buttrely & Co., F. A., Havre, Mont.	833	360	50
WGI	American Radio & Research Corp., Medford Hillside, Mass.	833	360	500	WQAO	Calvary Baptist Church, New York	833	360	100
KFEZ	American Society of Mechanical Engineers, St. Louis, Mo.	833	360	500	WSAU	Camp Marienfield, Chesham, N. H.	1,310	229	10
WEAF	American Telephone & Telegraph Co., New York, N. Y.	610	492	500	WJAQ	Capper Publications, Topeka, Kan.	833	360	50
WIAU	American Trust & Savings Bank, Le Mars, Iowa	833	360	15	KFJJ	Carrollton Radio Shop, Carrollton, Mo.	1,270	236	50
KFI	Anthony, Earl C., Inc., Los Angeles, California	640	469	500	WQAW	Catholic Univ. of America, Washington, D. C.	1,270	236	50
WRAV	Antioch College, Yellow Springs, O.	833	360	200	KFHf	Central Christian Church, Shreveport, La.	1,130	266	150
WOAG	Apollo Theatre, Belvidere, Ill.	1,340	224	20	WDAD	Central Kansas Radio Supply, Lindsborg, Kansas	833	360	10
KQP	Apple City Radio Club, Hood River, Ore.	833	360	10	KFJA	Central Power Co., Brand Island, Neb.	1,230	244	100
WFAT	Argus-Leader, Sioux Falls, S. D.	833	360	50	KFJU	Central Power Co., Kearney, Neb.	1,280	234	10
KFGL	Arlington Garage, Arlington, Ore.	1,280	234	5	WNAQ	Charleston Radio Elect. Co., Charleston, S. C.	833	360	20
WABG	Arnold Edwards Piano Co., Jacksonville, Fla.	1,210	248	10	KFGP	Cheney Radio Co., Cheney, Kan.	1,310	229	10
WSB	Atlanta Journal Co., Atlanta, Ga.	700	429	500	WCAP	Chesapeake & Potomac Tel. Co., Washington, D. C.	640	469	500
WDAJ	Atlanta & West Point R. R. Co., College Park, Ga.	833	360	500	WAAF	Chicago Daily Drivers Journal, Chicago, Ill.	1,050	286	200
WPAM	Auerbach & Guettel, Topeka, Kan.	833	360	5	WMAQ	Chicago Daily News, Chicago, Ill.	670	448	500
KFEX	Augsburg Seminary, Minneapolis, Minn.	1,150	261	100	WJAZ	Chicago Radio Laboratory, Chicago	670	448	600
KFER	Auto Electric Service Co., Ft. Dodge, Iowa	1,300	231	10	KFGD	Chickasha Radio & Elect. Co., Chickasha, Okla.	1,210	248	20
KDZF	Automobile Club of Southern California, Los Angeles, Calif.	1,080	278	500	KFBS	Chronicle News, Gas & Electric Supply Co., Trinidad, Colorado	833	360	150
WHAE	Automotive Electric Service Co., Sioux City, Iowa	833	360	20	WIAQ	Chronicle Pub. Co., Marion, Ind.	1,330	226	10
KFBC	Azbill, W. K., San Diego, Calif.	833	360	20	WDM	Church of the Covenant, Washington, D. C.	833	360	100
WEAR	Baltimore American & News Pub. Co., Baltimore, Md.	833	360	50	KUS	City Dye Works & Laundry Co., Los Angeles, Cal.	833	360	100
WOR	Bamberger, L., & Co., Newark, N. J.	740	405	500	WBU	City of Chicago, Chicago, Ill.	1,050	286	500
WABI	Bangor Railway & Elect. Co., Bangor, Maine	1,250	240	50	WRR	City of Dallas, Police & Fire Signal Dept., Dallas, Texas	833	360	20
WBBD	Barbey Battery Service, Reading, Pennsylvania	1,280	224	50	KFAQ	City of San Jose, San Jose, Calif.	833	360	250
KFFZ	Al. G. Barnes Amusement Co., Dallas, Texas	1,330	226	20	WSAC	Clemson Agricultural College, Clemson College, S. C.	833	360	500
WQAA	Beale, Horace A., Jr., Parkesburg, Pennsylvania	833	360	500	KUY	Coast Radio Co., El Monte, Cal.	"A" 1,170	256	50
WMAM	Beaumont Radio Equipment Co., Beaumont, Texas	833	360	100	WHAC	Cole Bros. Elect. Co., Waterloo, Ia.	833	360	50
KDZR	Bellingham Publishing Co., Bellingham, Wash.	1,150	261	50	WQAL	Cole County Tel. & Tel. Co., Mattoon, Ill.	1,160	258	10
KFIF	Benson Tech. Student Body, Portland, Ore.	833	360	200	WOAK	Collins' Hardware Co., Frankfort, Kentucky	833	360	20
WEB	Benwood Company, Inc., The, St. Louis, Mo.	833	360	500	KFCK	Colorado Springs Radio Co., Colo. Springs, Col.	"A" 1,240	242	10
					KFHA	Colorado State Normal School, Gunnison, Col.	833	360	50

(To be continued. Readers who preserve these installments as they appear in RADIO WORLD will have a complete and up-to-date list of broadcasters in the United States.)

Where Radio News Occurs, There

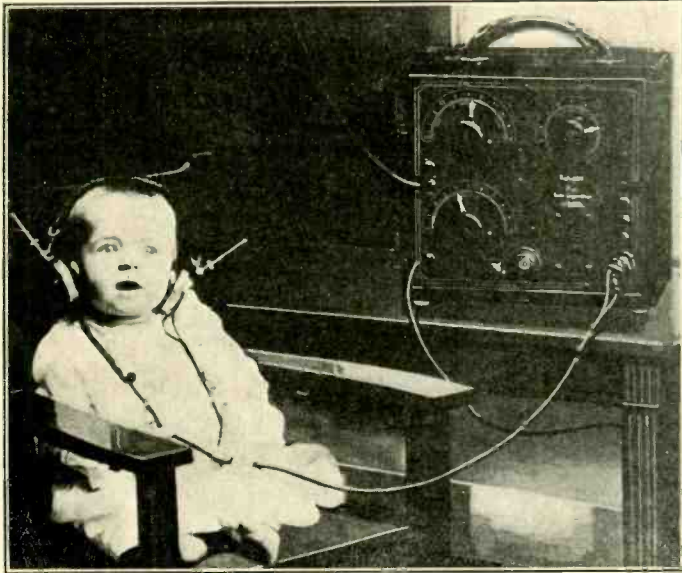

(C. Photonews)

William Gordon Yadon (WGY), aged six months, and a resident of Delavan, Wis., who bears the distinction of being the first American to be named in honor of the General Electric Company's station at Schenectady. Master Yadon is shown listening intently on a portable Radiola II to the program from Station WGY, after which he was named. It seems to be the popular style nowadays to name children after broadcasting stations, but the infant who is named after KDKA or any other famous station of four letters will carry "some cognomen."

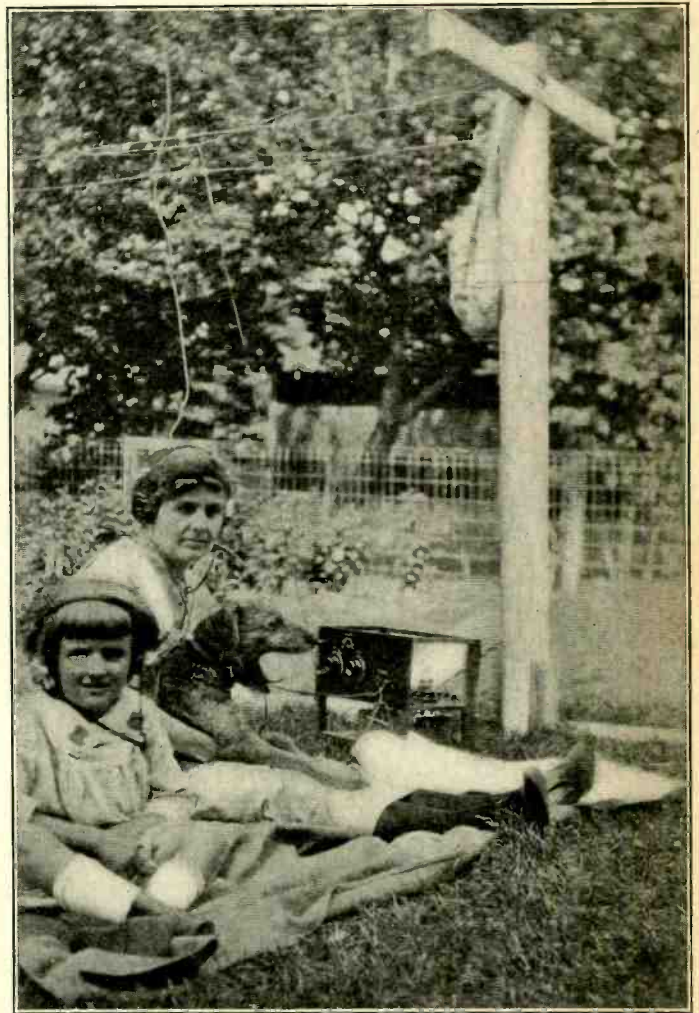

(Photo by Hatfield)

Here is a picture submitted by one of our readers, H. D. Hatfield, 2735 West 38th Street, Denver, Colo., who described the occasion as follows in his letter accompanying the photo: "Place: Our back yard. Time: July 4th, 1923. Occasion: Broadcasting of the Dempsey-Gibbons fight. Equipment: My experimental simplified Reinartz with clothes line counterpoise, 30 feet of wire over the limb of a tree as an aerial. Girls: Mrs. H. D. H. and Daughter. Boys: One Airedale pup bearing an extremely bored look."



(C. Gilliams Service)

A night watchman's job is one that is dreary and tiresome at its best, and when you are the night watchman of a theatre it is an especially lonesome one. There is no place as dreary as a theatre when the show is over. Bill Besser, the night watchman of one of the large Newark theatres, being a radio fan, thought that he could relieve the monotony of his duties between rounds if he were to bring his radio set along with him. Now he sits, pipe in hand, phones over his ears and snatches bits of programs from the air during the minutes between inspection tours.

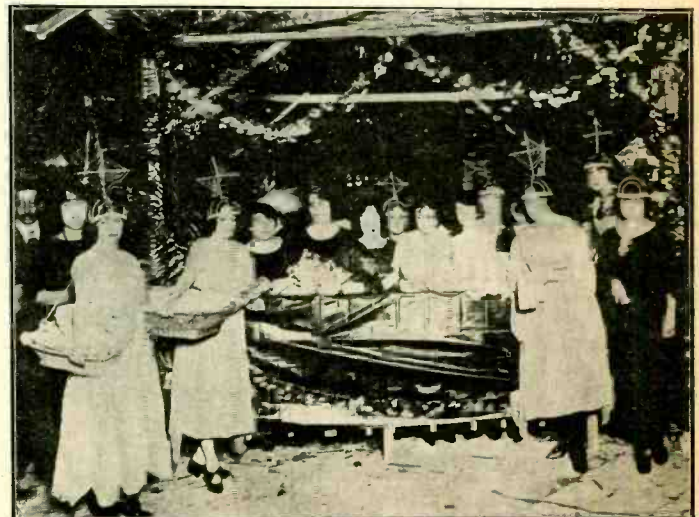

(C. Gilliams)

Mexico City, Mexico, recently held its first radio show, just to prove that radio is popular in that country. Notables from all over Mexico attended, and dark-eyed señoritas were appropriately dressed for the occasion by having small loop antennae attached to their headgear. They acted as ushers and answered the questions of the visitors to the show. Exhibits were shown from many lands. At present Mexico is a great field for the sale of radio apparatus due to intense interest on the subject in that country.

Is a Radio World Camera Man!

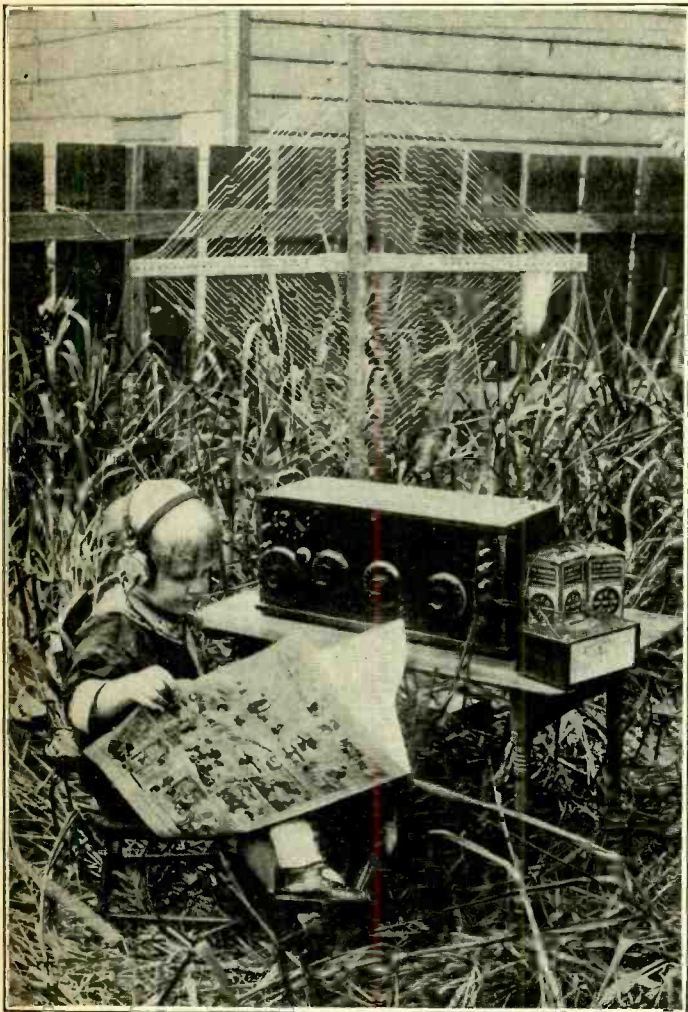

(C. Keystone Views)

No more playing "hunter" or "cops and robbers" for the younger generation these days. Instead they listen in on some radio and peruse the daily or weekly comic sheet. Little Bernard Annmuller, Jr., of North Bergen, N. J., is shown eagerly listening to the weekly comic drawing talk by "Jolly Bill Steinke" from WOR at the same time "looking them over in the paper" to see what it is all about. The set used is a one tube reflex working on a loop and sure gets 'em for the edification of Master Annmuller.



(C. Foto Topics)

Miss Frances Mayer, of New York City, is playing a Radio Dust by using her piano wires as an antenna and accompanying the radio artist on the piano. The use of the wires of a piano is a new and novel means of supplying the need of an antenna, which anyone that has a piano may utilize, but accompanying the radio artist is again something different. Girls, the next time you are lonely, tune in on a nice melodious tenor, request the station to have him sing your favorite melody and accompany him.

Captions by Robert L. Dougherty

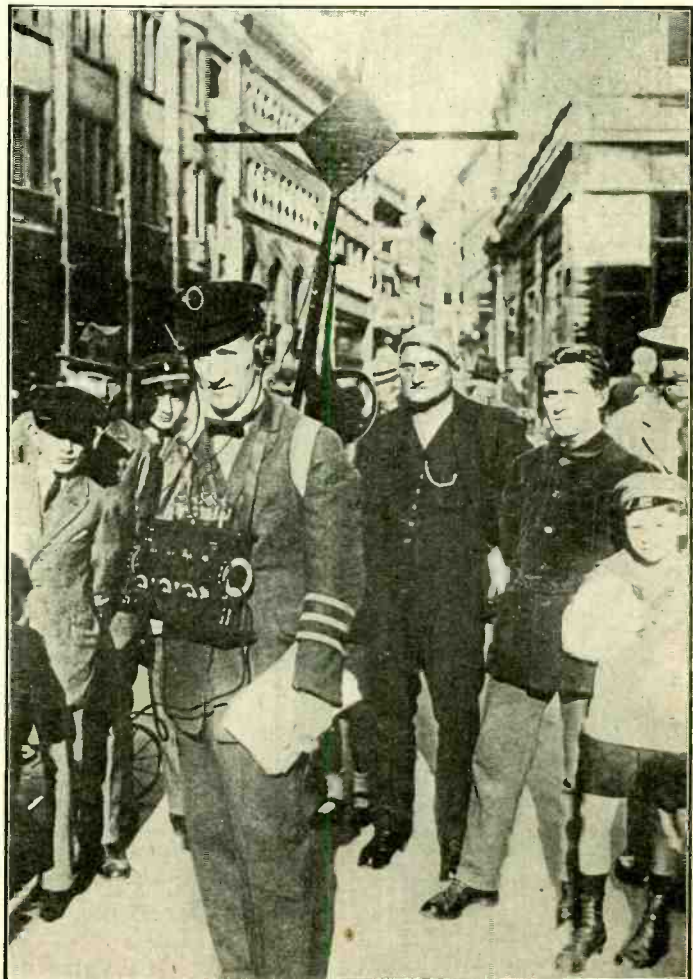

(C. International)

The recent commercial fair at Leipzig, Germany, proved a rather dismal failure as far as merchandising was concerned. The reason for this was that there were thousands of exhibitors and extremely few buyers or even onlookers. No foreign buyers attended after the opening day. The illustration shows one of the "walking exhibits"—a portable radio set with loud speaker, which was only one of the many ingenious and fantastic displays utilizing radio as an attraction. This particular exhibit headed the procession through the streets.

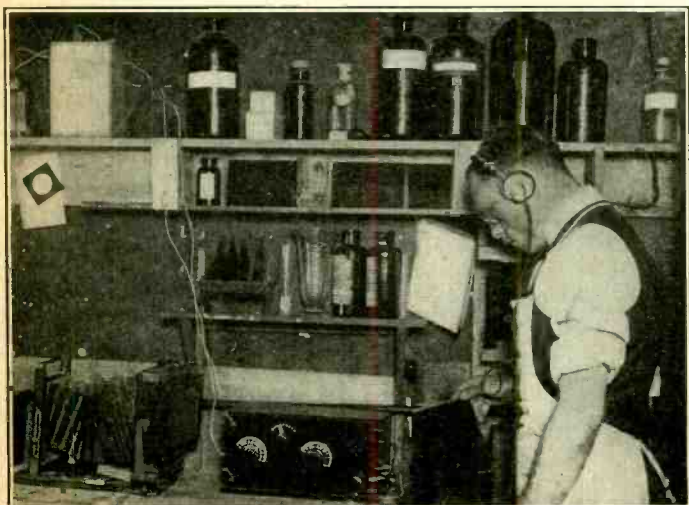

(C. Kadel and Herbert)

Night work developing negatives in a commercial photographic plant is at best dull, tiresome work, considering that the work has to be performed in a dully lighted room. So thought T. E. Styles, who is the dark room man of Kadel and Herbert, so he connected up a small radio set for his use when developing negatives nights. Now he works 'way into the "wee sma'" hours of the A. M., listening to the near and distant programs while watching the high lights and shadows of the negatives taken in the afternoon develop into interesting pictures for your ultimate consumption.

Transmitting and Receiving Apparatus for Wireless Telegraphy

No. 1,461,754: Patented July 17, 1923. Patentee: G. H. Clark, Brooklyn, N. Y.

This invention relates to transmitting and receiving apparatus for wireless telegraphy. One object is to increase the

at the end of each dot or dash when the signal is being transmitted so that sharp dots and dashes will be sent from the transmitting station.

Still another object of the invention is

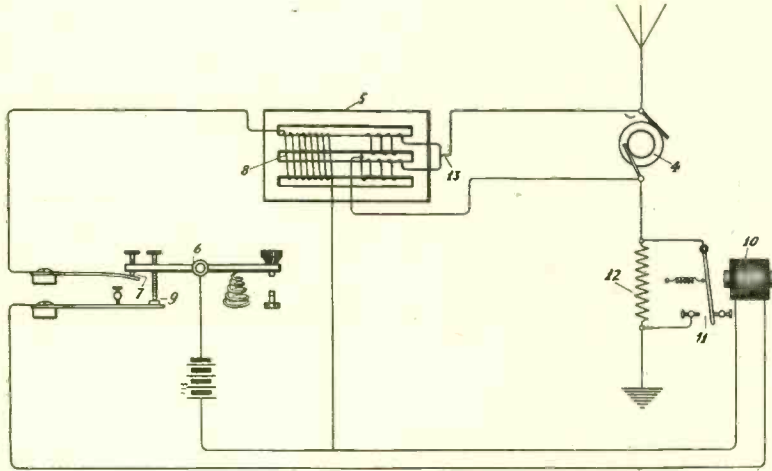

Method used to increase the speed of transmission and obtain better damping of the signals of a transmitting station.

speed of signal transmission by means of the Morse, or similar code, without running dots and dashes together.

Another object of the invention is to cause the quick dying out of the current

to cause the current, induced in the receiving apparatus by the electromagnetic waves, to die down very quickly so that there will be no "tailing" out at the ends of the dots and dashes.

High Frequency Modulation Device

No. 1,467,596: Patented September 11, 1923. Patentee: P. I. Wold, East Orange, N. J.

The object of this invention is to provide a means and method for producing modulated high frequency oscillations.

This invention relates to a system wherein a condenser transmitter is associated with an electronic or other potential operated device for modulating or otherwise varying oscillations in accordance with variable wave signals.

In one aspect the invention resides in associating a condenser having an electrode adapted to vibrate at the frequency of sound waves with a thermionic or equivalent repeating device having a feed-back connection.

One object is to so associate a condenser transmitter with a high frequency generator that the condenser may be polarized to a sufficiently high degree for efficient action

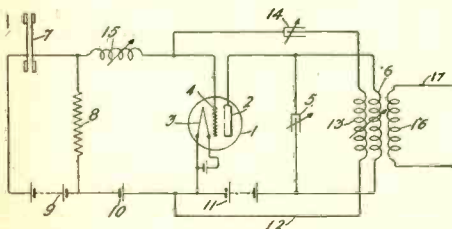

System to provide better modulation in regard to telephonic radio transmission or radio telephony, without disturbing the action of the generator.

The invention as herein exemplified, resides in a system in which a condenser transmitter is associated with a typical form of oscillation generator of the audion or equivalent electronic discharge type for modulating the oscillations generated thereby in accordance with speech or other signals.

Condenser transmitters have heretofore been of slight value for practical application because, while they are quite free from dis-

tortion, the systems in which they were employed were of small efficiency from an energy standpoint. However, with the development of voltage operated modulating devices of the type herein disclosed which require practically no current but only a change of potential to secure effective modulation, the utilization of condenser transmitters for practical operation in modulating systems becomes possible. This invention has for a primary object the provision of means for accomplishing this purpose. This highly desirable result is further assisted by the development and utilization of substantially distortionless and very efficient amplifying devices whereby modulated oscillations of small energy may be amplified once or successively before utilization. The use of such amplifiers is, however, well known in the art and constitutes no part of the present invention which broadly relates to means for associating a device of the thermionic discharge type with a condenser telephone as a means for varying repeated or generated oscillations.

Substation Circuit

No. 1,461,183: Patented July 10, 1923. Patentee: Harvey Fletcher, New York City.

The invention relates to a substation signaling circuit and has for an object to prevent side tone in the receiver due to currents generated by the local transmitter.

This is accomplished by automatically switching the receiver out of the circuit when talking and in response to the locally generated talking currents. The switching apparatus is of such a nature, however, that talking currents received from a distant station are ineffective to operate the switching means whereby the incoming signal will be transmitted to the receiver.

Advantage is taken of the fact that the mean resistance of a transmitter when quiet is different from its resistance when agitated by sound waves. In circuit with

the transmitter is a relay which is so adjusted that it will be operated when the transmitter is agitated by talking and will release when the transmitter is idle. This switching system is employed to effectively remove the receiver of the sub-set from the circuit during transmitting and to remove the transmitter from the circuit during receiving.

Aside from the anti-sidetone feature another advantage of this arrangement is

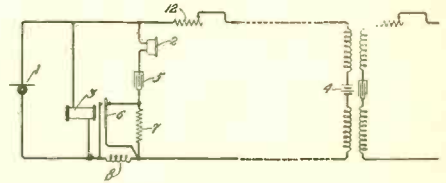

Device preventing the issuance and interference of side tones in a radio telephone transmitter.

that an appreciable gain in transmission can be secured due to the fact that when receiving substantially all of the incoming currents are supplied to the receiver, and when transmitting all of the generated currents are sent to the distant station.

High Frequency Signaling System

No. 1,467,988: Patented September 11, 1923. Patentee: C. A. Hoxie, Schenectady, N. Y.

My present invention relates to signaling systems and more particularly to a system for receiving and detecting high frequency signals.

One of the objects of my invention is to provide a simple and efficient means for detecting high frequency signals. A more specific object of my invention is to provide a means for detecting signals produced by means of high frequency continuous currents.

In the specification which follows, I have described my invention with particular refer-

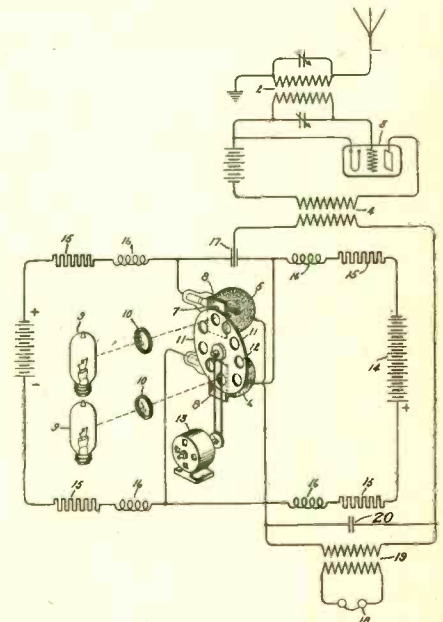

Apparatus and circuit for the detection of high frequency currents, both in wireless or line work.

ence to radio signals. It will be understood, however, that it is not limited in its usefulness to that particular field, but that it may equally well be employed for the detection of high frequency signaling currents.

In carrying my invention into effect, I employ in a circuit upon which the signaling waves may be impressed, a light sensitive device or devices which has the property of permitting current to flow therethrough when an electrode thereof is subjected to the influence of light.

Answers to Readers of Radio World

In RADIO WORLD, September 22, you describe an anti-interference circuit by C. White. Can I add one stage of radio-frequency and two stages of audio-frequency to this? If so, kindly furnish a diagram.—D. W. Braden, 1616 Peabody Avenue, Dallas, Tex.

This cannot be accomplished with the circuit you mention as far as radio-frequency amplification is concerned. The audio-frequency amplification can be added. A hook-up for this has appeared in numerous issues of RADIO WORLD and we refer you to any of our back numbers for a suitable two-stage amplifier.

Can you furnish me with all details of the Davidson receiver as sold at the present time?—J. H. Cochran, Box 85, Lockport, N. Y.

The information you desire is not available at present.

Would you please publish a hook-up for a detector and one stage of tuned R. F. amplification, using UV199 tubes? If a

back to the manufacturer and have him reset it. Also incorporate a "C" battery in the grid lead of your amplifiers.

Have constructed the long distance crystal receiver that was described by R. B. Wilbur in RADIO WORLD July 28 and have not succeeded in getting it to work. What can you do to help me?—George Renno, 203 South Locust Street, Marengo, Ill.

In crystal sets as well as the multi-tube sets, success depends on the construction, parts used and the faithfulness with which the instructions are carried out. If you have carefully constructed the set and followed all the instructions the set should work. Check yourself up.

Please give me a diagram for the following: Five tubes, three radio frequency amplifying transformers, one audio frequency transformer, one loop, necessary tuning condensers. Will the set you are describing enable me to do distance work with an inside loop? What tubes are the best for radio frequency? Detector? Audio fre-

quency?—Bert Kalish, 2070 Broadway, New York City.

The condenser should be .001 mfd. No.

Enclosed please find a diagram of my receiver to which I have added two stages of audio-frequency amplification. I have been unable to pick up any outside or DX stations and also experience difficulty in picking up locals, even though I get them on with loud speaker volume when using my two stages. What can you suggest as a remedy for my trouble?—A. E. Goldberg, 1309½ West 36th Place, Los Angeles, Calif.

Your diagram as it appears without the amplification is correct. It is the Greene circuit which is known as a selective tuner of the single circuit type. We note in your diagram that you have your 45-volt battery arranged to feed both the detector and amplifier. Arrange your B leads so that the detector is only supplied with 22½ volts. Also examine the grid leak and condenser. Do not use a

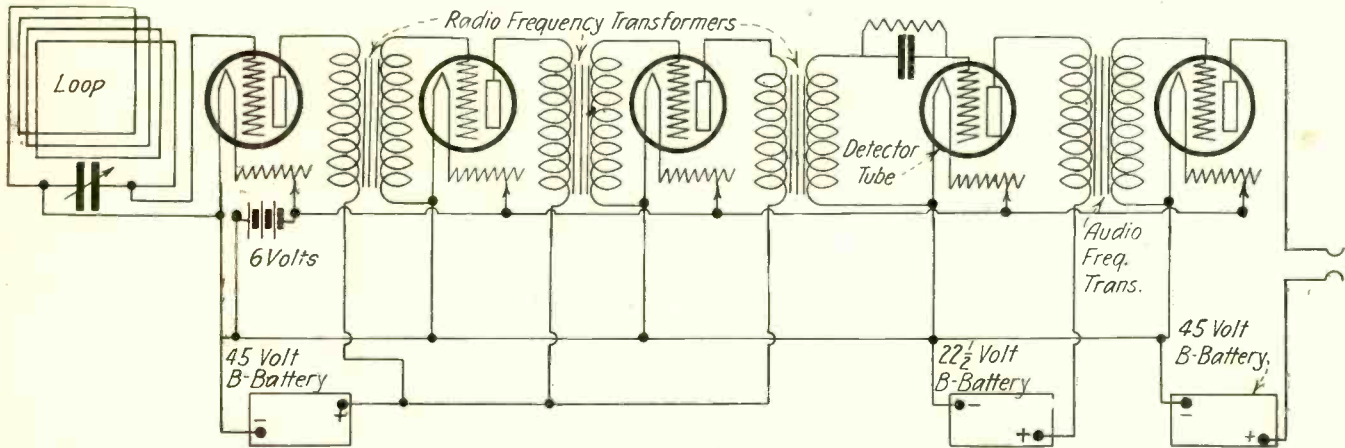

Schematic diagram of a 5-tube radio-frequency, detector and audio-frequency amplifier circuit operating on a loop, given in answer to the request of Bert Kalish. It is advisable to use a loop with this circuit, although a tuner and antenna and ground may be used by hooking it across the condenser and discarding the loop. Note the separate B batteries for each circuit.

3.5" coil with 60 turns of No. 22 S. C. C. wire is not a satisfactory R. F. coil kindly explain the proper values.—J. H. Cochran, Box 85, Lockport, N. Y.

A circuit such as this has appeared in back numbers of RADIO WORLD, and we refer you to our issue dated July 14, where you will find an article by L. W. Bishop on tuned radio-frequency; in RADIO WORLD, August 11, you will find two articles, one by A. E. Herron and one by R. L. Dougherty, on pages 6 and 15, respectively. In the issue for September 22, page 12, there is an improvement on the two-tube radio-frequency receiver described by R. L. Dougherty, with regeneration added. All of these are proven circuits and include two, three and five tubes.

Can you suggest any way of getting rid of the tinny rattle that I notice so much in my loud speaker? At times the voices are completely lost in a haze of rattles and harmonics.—Jake Spielman, 166 Houston Street, New York City.

The tinny rattle you note comes from the diaphragm of the loud speaker, or the arm of the lever hitting the magnet. If you cannot regulate the magnet so that you can separate it a slight distance, take

quency?—Bert Kalish, 2070 Broadway, New York City.

The hook-up you desire is published herewith. The set will be capable of operation on distance stations and with a loop if carefully constructed and the proper tubes and transformers are used. The tubes should be: for radio frequency use amplifying tubes, a soft tube as a detector and either a power tube or a hard amplifying tube for the audio frequency.

A dealer recently told me that I could not use a crystal detector in my radio-frequency audio-frequency amplifier set and get good results. Is this true? Could I get better by the use of the tube? My distance so far is 21700 miles this month. Would I improve it by using a tube so very much that it warrants it?—Kennedy, La Platte Street P. O., Davenport, Ia.

Of course a tube would help you to get louder signals, but it is doubtful if you would get as clear reception as you will with a crystal. If you can use a crystal detector and get good distance and clarity, stick to it.

What is the capacity of the condenser shunting the loop in the article, "A Great Loop for a Crystal Set," by Kenneth Mal-

.00025 just because your friends use it. Many tubes although standardized to a very great extent operate better on values between .0001 and .0006. Try out different values and find out if this is not your trouble. Examine your variometer and see if the windings are shellacked. If they are, throw the instrument out and purchase one that has no binder on the windings.

Enclosed is the drawing of a type of socket I am using. I have marked the connections (filament — and +). I have seen several different ways of connecting, as I show. Which is the correct way? In some of the drawings the grid is shorn on the left with the filament between it and the plate and others twist them around as shorn. In the sockets and tubes do they always make the minus side of the filament (in the tube) the same?—Edwin R. Fisk, West Springfield, Mass.

Tubes and sockets are standardized as to markings and manufacture, so no need to worry on that. For explanation of why they show different connections as to filament leads and filament and grid leads, see article by J. Anderson in RADIO WORLD September 22.

Reradiation Presents Radio's Greatest Problem

By *Howard E. Campbell, M. I. R. E.*

Chief Radio Engineer, The Detroit News Radio Station WWJ.

WHAT place is held today in the United States by regenerative detector receiving sets? Why is the use of regenerative detector receiving sets prohibited by law in England?

It is estimated that three-fourths of all vacuum tube receiving sets in use today in the United States operate on the regenerative detector principle. There are more of these sets in operation than there are crystal detector sets. Why? Because at a relatively small expense the old crystal detector set can be rebuilt or replaced by a single-tube outfit which will enable the radio amateur to hear stations from 10 to 20 times as far distant. Because the idea of making a single tube perform the double duty of detector or rectifier and amplifier, appealed almost universally to the shrewd American public.

With the advent of vacuum tube radio telegraph transmitting sets, code signals were sent in "CW," which is an abbreviation of "continuous waves" of radio frequency. Crystal detector sets could not distinguish these modern signals, but a regenerative tube detector can; hence its popularity with amateur radio telegraphers.

These statements answer to a certain extent the question, but there is another side to the question which is demanding universal attention. Simple as these regenerative sets are, they have a characteristic fault. In regeneration they act as miniature transmitters and send out into space an interference during the entire time they are in operation which is picked up by other receiving sets within a radius of from two to three city blocks to 18 or 20 miles, depending on the circuits used in the regenerative receiver interfering and the sensitiveness of the sets picking up the interference. If one set does this, hundreds and thousands of them in a large city generate a veritable bedlam of interference which affect each other and every other type of receiving set, from the cheap crystal outfit to the thousand dollar six to nine-tube outfit.

This interference is a hundred times more extensive and dangerous to the future development of the art than most radio enthusiasts realize. The average experienced operator of such a set will tell you that he never allows his regenerative tube to oscillate, and therefore does not retransmit or send out interference. He means that he has passed the experimental or amateur stage where the tube "spills" or oscillates violently in his crude attempts at tuning and does not send out those disagreeable whining sounds which we all know so well.

It will, therefore, come as a distinct shock to such enthusiasts to be told by radio engineers that no tube will regenerate without oscillating, and that unless he makes adequate provision in his circuit to prevent retransmission, his set will send out a constant interfering wave of noticeable intensity even while it is considered stably adjusted to receive a program from a certain station. This interference is very sharp; that is, it covers a very small band of frequencies, but given from three to ten sets in an immediate locality all receiving a program from one particular station, it is a foregone conclusion that each set will be

tuned just a little differently from all the others with the result that the entire band of audible frequencies from this station is blanketed, and any super-sensitive receiving set in that neighborhood is completely and effectually barred by interference from receiving this program. Furthermore, it is entirely too much to expect that these retransmitting receiving set operators will all stick to the program from one station and send out a band of interference on that wave length alone. They will have different tastes, and divide their attention about equally between all stations within range which are broadcasting, thus blanketing all of them.

The example of the effect upon a super-sensitive receiving set is cited, because it foreshadows the dire result imminent unless the growth of this evil is checked and finally eliminated. The super-sensitive set will pick up an amount of interference today which the average set would not pick up for a year or two to come when the number of sets in operation is double or treble, and providing, of course, that retransmitting sets are then used in their present proportion.

With the average set in operation today, a lot of dissatisfaction with the quality of transmission of programs from distant stations is directly due to distortion caused by interfering waves from neighboring retransmitting receiving sets, and finally a lot of more or less momentary periods of inaudibility of programs from distant stations, which is generally attributed to the phenomena of fading, is in reality caused by pronounced periods of interference as explained above, when a number of operators are concentrating on that particular broadcast.

The idea is not supported by proof, and the suggestion would no doubt cause general surprise that possibly certain stations locally noted for pronounced fading may in reality be so near the middle of the tuning range, and so popular, that they draw this concentrated fire of radio receiver interference. Trouble due to fading from natural causes is serious enough at certain times of the day without its being increased by artificial means.

The above indictment is written around the regenerative detector single tube or triple tube sets where two stages of audio frequency amplification are employed, because they are by far the most numerous offenders, but retransmission is not confined to them entirely. Freely oscillating radio frequency amplifiers, ahead of any type of detector with or without audio frequency amplifiers, create disturbances of various degree, according to the size of the antenna or loop system used in conjunction with them.

All of the above statements which are made positively are supported by fact. The questions raised are of extreme importance to all radio enthusiasts and amateurs, and if you, for one, are not satisfied that they are true, then investigate until you are convinced and govern yourself accordingly.

Are we individually going to allow the radio engineer or manufacturer of radio equipment to solve this problem for us? They can only take care of new installation and new equipment. We must take care of our own existing equipment and call an immediate halt on this woeful

impediment to progress. We must do it now for mutual protection, and not wait until the whole structure of radio business topples over from sheer lack of a sound foundation or defective first story.

This citing of conditions, causes and effects, would not be complete without offering solutions to problems, and remedies for abnormalities. Your attention is invited to the opinions of various reputable radio engineers and designers that the use of "neutrodyne" or compensating capacities across the elements of radio frequency amplifier and regenerative detector tubes will prevent undesirable "feed-back" or regeneration, and resultant retransmission.

A single stage of transformer coupled radio-frequency amplification ahead of the ordinary regenerative detector will damp out to a great extent the retransmission of interference, and at the same time increase sensitivity to a marked degree. Other methods for inexpensive improvement of existing retransmitting circuits will doubtless be discovered and developed. Where there is a will there is a way. Every amateur radio enthusiast or expert should appoint himself a committee of one to faithfully consider this problem and become a center of sentiment and promoter of improved conditions in order to insure that radio find and hold its own. When the public is sufficiently and thoroughly aroused to the crying necessity for solving this problem, retransmitting receiving sets will be doomed to almost immediate extinction.

Two Big Stations in Army Net Building

THE first of November will witness the inauguration of the big new Army Signal Corps radio station at Fort Douglass, near Salt Lake City, Utah. This will be the largest radio telegraph station of the army; it will have but one tube but that is to be a water-cooled KW tube. The General Electric Company is building this equipment.

Another similar station is being erected at Leavenworth, Kansas, by the Western Electric Company, but this station will operate with two tubes and will have a telephone circuit as well as the radio telegraph. The radio circuit between these two stations, the Arlington, Va., station and a land line from Leavenworth to San Francisco, will span the United States. Each of the two interior stations will be equipped with two steel 300' towers.

It is the plan of the army radio service not to use coastal stations, that part of the work being handled by the Naval Communication Service, and the army does not desire to interfere with ship to shore communication.

New York Police Ask for Radio Station

POLICE COMMISSIONER RICHARD E. ENRIGHT of New York City appeared before the Board of Estimate and Apportionment last week to urge favorable consideration of the requirements of his department for 1924. Included in his budget was an item of \$30,000 for radio equipment.

Choice of a Receiving Tube

By C. D. Wagoner

THE General Electric Company manufactures for the Radio Corporation of America three popular types of receiving tubes. These are Radiotrons UV199, UV200 and UV201A.

These tubes cannot be used interchangeably and each has a distinctive field of usefulness.

The choice of a tube to use for a particular purpose depends in general upon three main considerations:

(1) The purpose for which the set is to be used: (a) Broadcast listening for the enjoyment of entertainment programs. (b) Experimentation on apparatus and circuits. (c) Long distance code reception.

(2) The type of set in which the tube is to be used; that is, the electrical circuits involved, number of tubes used and whether a loud speaker is included in the equipment.

(3) Whether storage batteries, No. 6 dry cells or flashlight dry cells are to be used for filament operation.

Radiotron UV199—This tube requires a minimum of filament energy. In fact, it uses only .18 of a watt.

The bulb is of small size and a special base and socket suitable for such a small tube are used. On account of the small size of this tube the capacity between electrodes is lower than in either of the other tubes.

This tube is particularly suited for portable sets in which it is necessary or desirable to use flashlight cells for filament operation.

It is recommended for sets in which there are three tubes or more and where dry cells only are available for filament operation.

For self-contained sets it is also very desirable because all of the necessary batteries can be placed in the cabinet with the rest of the equipment.

The small electrical capacity between the electrodes makes it a very satisfactory tube for radio-frequency amplification.

This tube does not require critical adjustment of plate voltage and tapped plate batteries are not necessary, whether the tube is used as a detector or as an amplifier. (Add (c) battery data same as UV201A except omit 120 volts.)

Radiotron UV200—This tube is particularly desirable for the skilled radio experimenter interested in code work and reception over very great distances.

It is not suitable for dry cell operation because the filament requires one ampere at five volts.

Its action as a detector is very critical in respect to filament voltage and plate voltage. Its action as a detector is not as uniform between different tubes of the same type or as constant in any one tube as in the case of the high vacuum tubes UV199 or UV201A.

It is very sensitive to weak signals, especially spark and modulated CW signals, when skillfully handled by experienced operators in a circuit particularly equipped for the proper voltage operation of filament and plate. The plate battery should be provided with taps and a potentiometer should be used across the filament in order to secure proper voltage adjustment.

It is not to be recommended for audio or radio-frequency amplification and should never be used with a plate voltage greater than that obtainable from a single block "B" battery at full voltage.

This tube requires a little patience and skill in adjustment for the reception of weak signals. Under certain conditions it has a tendency to be slightly more noisy in

operation than either of the high vacuum tubes which are practically free from such disturbances.

Radiotron UV201A—This tube is a powerful amplifier and inherently a better one than the UV199, and is particularly suitable for loud speaker operation.

It is designed to give the best possible amplification for general use, its amplification property not being sacrificed to any extent to give a minimum of filament energy.

The operation of this tube is free from variations in results due to slight changes in plate and filament voltage. It is, accordingly, quiet in operation and it has a longer operating life than either the UV199 or UV200.

It is equipped with a standard base and thus fits in many sets already constructed.

The filament requires a much greater amount of electrical energy for its operation than does the UV199, but the UV201A tube can be operated from dry cells in the case of one or two tubes used only a few hours per day at a lower expense than with the use of a storage battery.

As an audio-frequency amplifier, this tube is somewhat superior to the UV199.

As a detector, the UV201A is about the same in response as the UV199 and is to be recommended over the UV200 for most general purposes, except in equipment specifically designed for the latter tube as regards potentiometer adjustment for plate voltage and very fine adjustment for filament voltage.

It is very sensitive when used in the oscillating condition for reception of CW telegraph signals.

The UV201A Radiotron is ideal for a one-tube set and it is also ideal for a multi-tube set when a storage battery is available for filament operation.

Critical adjustment of filament and plate voltages are not required, and it is not necessary to have taps on the plate batteries.

Although the capacity between the electrodes of the UV201A is somewhat greater than the UV199, its greater inherent amplification makes it just as satisfactory in radio-frequency amplification.

When used for audio-frequency amplification, a negative grid bias or "C" battery should be used, the "C" battery voltage depending upon the plate voltage employed. The following table gives the correct value of "C" battery with different plate voltages:

Plate Voltages	"C" Battery Voltage
40	0.5 to 1.0
60	1.0 to 3.0
80	3.0 to 4.5
100	4.5 to 6.0
120	6.0 to 9.0

Electrical Exports Show Big Increase

THE increasing demand for electricity for light and power which prevails throughout the United States is shown to exist abroad as well by a total of \$34,514,924 worth of electrical equipment exported by this country during the first six months of the present year.

This total, according to preliminary figures given out by the Department of Commerce, represents an increase of nearly seven per cent over the total for the first half of 1922, which was \$31,620,512.

Items in this year's exports include such widely diversified articles as electric locomotives, electric fans, lighting plants, batteries, switchboards, motors, lamps, radio apparatus and household devices.

MAGNAVOX

Radio Products



A1—\$27.50

MAGNAVOX Audio-frequency Power Amplifiers

THESE instruments offer the most ideal method for amplification of audio-frequency waves before they are reproduced into sound.

Wherever ordinary audio-frequency is replaced with Magnavox Power audio-frequency, stations previously out of range can be reproduced in excellent volume.

The new one-stage Magnavox Power Amplifier A1, illustrated above, is just what is needed in many cases to bring in the distant stations.

Magnavox Reproducers

- R2 with 18-inch curvex horn \$60.00
- R3 with 14-inch curvex horn \$35.00
- M1 with 14-in. curvex horn. Requires no battery for the field . \$35.00

Magnavox Combination Sets

- A1-R consisting of electro-dynamic Reproducer with 14-inch curvex horn and 1 stage of amplification \$59.00
- A2-R consisting of electro-dynamic Reproducer with 14-inch curvex horn and 2 stages of amplification \$85.00

Magnavox Power Amplifiers

- A1—new 1-stage Power Amplifier \$27.50
- AC-2-C—2-stage Power Amplifier \$55.00
- AC-3-C—3-stage Power Amplifier \$75.00

Magnavox products can be had at Registered Magnavox Dealers everywhere. Write for new 32-page catalogue.

The Magnavox Company
Oakland, California

New York Office: 370 Seventh Avenue
Canadian Distributors
Perkins Electric Co., Ltd., Montreal

National Radio Week, November 25 to December 1, 1923

Radio Merchandising

Advertising Rates: Display, \$5.00 an inch, \$150.00 a page. Classified Quick-Action Advertising, 5 cents a word.

Telephone Lackawanna 6976

Radio Trade Notes

Ellis Wrote, 1622 Fifteenth Street A., Moline, Ill., will establish a retail radio business and would like to hear from manufacturers.

* * *

Walter M. Jacobson has been appointed receiver for the H. C. Spratley Radio Co., Inc., of Poughkeepsie, N. Y.

* * *

O. C. Ashford, Cassadaga, N. Y., states that he will start a small retail radio business this fall.

* * *

The Specialty Service Co., formerly at Fourth Avenue and Pacific Street, Brooklyn, N. Y., announce that they are now located at their new and spacious sales-room, 9 Hanson Place, opposite L. I. R. Station, Brooklyn, N. Y. Their temporary phone is Prospect 8932-J. This firm handles DX crystals and a complete stock of many standard lines of radio.

* * *

D. N. Kent, Talamagouche, Nova Scotia, Canada, would like to represent in his district a radio firm which has a distributor in Canada.

* * *

A petition in bankruptcy has been filed against the Central Electrical Supply Co., Inc., 4 West Sixteenth street, New York City, M. Helfand has been appointed receiver. Liabilities, about \$65,000; assets, about \$15,000.

* * *

Randall Radio Co., 156 Pulaski St., Brooklyn, N. Y., states that it is in the market for all kinds of radio goods.

* * *

Lord & Taylor, the fashionable New York women's and men's store, has opened a radio department, located on the seventh floor. Demonstrations of radio sets carried in stock are given from 2:30 to 5:30 p. m. daily.

* * *

A petition in bankruptcy has been filed against the Signal Radio & Electric Corp., 64 University Place, New York City, Lloyd Garrison has been appointed receiver. Liabilities, about \$20,000; assets, about \$5,000.

* * *

A petition in bankruptcy has been filed against the Starobin Electrical Supply Co., Inc., 113 4th Avenue, New York City. Liabilities, about \$115,000; assets, about \$60,000.

* * *

Virgil Henthorn, 142 Fourth Ave., Paden City, W. Va., is interested in becoming a radio distributor for West Virginia and a dealer in his immediate vicinity.

Coming Events

NATIONAL RADIO WEEK, November 25 to December 1, 1923.

SECOND ANNUAL RADIO SHOW, Coliseum, Chicago, November 20-25.

AMERICAN RADIO EXPOSITION, Grand Central Palace, New York City, October 6 to 13, 1923. J. C. Johnson, general manager.

Radio Trade Association Meeting

OPEN meetings of the Radio Trade Association, at which a goodly attendance of radio business men was present, were held on the afternoons of October 9 and 10 at Grand Central Palace, New York City. President Henry M. Shaw occupied the chair. Topics covering a wide range of radio interests were discussed.

Among those who spoke at the meetings were Dr. Lee DeForest, Powel Crosley, Jr., H. H. Eby, W. E. Harkness, Benjamin Gross, K. B. Warner, C. B. Cooper, Paul Weil, Allan D. Cardwell, H. T. Melhuish, and Major J. Andrew White.

For Prospective Builders

THE Horne Electric & Manufacturing Company, Mercer and Colgate Streets, Jersey City, N. J., have put out a booklet showing fourteen of the most popular circuits using, or adapting for use, in these circuits their own apparatus. The circuits are all done in "pictures" to make it easy for the novice to hook up the receivers. Explanations are given as well as a complete list of all the parts needed.

The circuits described are the Grebe C. R. 12; combined tuned radio-frequency and regeneration; one and two tube radio-frequency reflex circuits; Cockaday four-circuit regenerator; tickler feedback circuits; Flewelling super-regenerator; tuned plate regenerator; single circuit regenerator; ultra-audion; Reinartz, and several Horne circuits and combination circuits. All of these exemplify the Horne make of apparatus and its use in the various circuits.

Fundamentals of Radio

UNDER this title D. Van Nostrand & Co., New York, have published a 260 page, cloth bound, pocket size book, designed to be of especial value to the beginner in radio. It is well illustrated with over 100 diagrams and half-tones. The author is James L. Thomas, A. B., formerly radio officer and instructor in radio, United States Army. His efforts to find a suitable text book for class work led to his preparation of the present volume. It is designed to be a complete simple course for radio operators and radio mechanics both professional and amateur.

New Radio and Electrical Firms

Queens Electric Service Corp., Mineola, N. Y., \$10,000; J. V. Miller, E. I. Popp, B. A. Lokke. (Attorney, H. A. O'Brien, Jamaica, N. Y.)

Hoyt Electric Service, New York City, make electric appliances. \$5,000; N. Friedman, R. F. O'Keefe, M. S. Brotman. (Attorneys, Sperry & Yankauer, Knickerbocker Building.)

W. C. Ragan will manage the new radio department just opened by the Empire Electric Co., of Houston, Texas.

Radio Literature Wanted

Manufacturers of and dealers in radio apparatus and accessories are notified that literature and catalogues describing their products have been requested, through the Service Editor of RADIO WORLD, by the following:

George H. Martin, Main St., Lenox Dale, Mass. (Retailer.)

G. F. Schuneman, 194 West Central Ave., St. Paul, Minn. (Wants agents' propositions.)

Bert O. Heath, pharmacist, Rochester, N. Y. John Ballantyne, 4 Union Court, New London, Conn.

J. A. Sims, 8519 Jamaica Ave., Woodhaven, Long Island, N. Y. (Makes, installs and repairs sets.)

Irving Westin, 638 Faile St., Bronx, New York City.

Ellis Wroe, 1622 Fifteenth St. A., Moline, Ill. (Retailer.)

Allen Radio Laboratory, Minford, Ohio. (Makes and deals in sets and parts.)

James F. Rinke, 220 East Market St., Jeffersonville, Ind.

H. W. Cook, P. O. Box 43, Alliance, Ohio.

Loren Foote, Parkersburg, Iowa.

J. E. Brown, East Marion, Long Island, N. Y.

J. F. Havilla, R. F. D. No 122, Niantic, Conn.

Austin Reibel, 1317 North Ave., Elizabeth, N. J.

Pauly Drug & Jewelry Co., Logan, Kansas. (Dealers.)

Geo. L. Frederickson, 353 Ellicott St., Buffalo, N. Y.

Lawson Shaw, 460 14th Ave., Newark, N. J.

Hegerman Radio Service, 414 Hegeman Ave., Brooklyn, N. Y.

V. Keller, 4305 Griscom St., Philadelphia, Pa.

O. C. Ashford, Cassadaga, N. Y.

Frank Banghart, 320 Tenth Ave., Long Island City, N. Y.

D. R. Witherspoon, General Delivery, Davy, W. Va.

Jacob Ziegler, 1420 Prospect Ave., Bronx, New York City.

C. H. Mansfield, The Times, Pendleton, Ind.

Reed Farrar, P. O. Box 89, Palmer, Texas. (Builds sets.)

Job H. Terry, South Main St., Assonet, Mass.

Dr. Wm. N. Vreeland, 62 Madison Ave., Jersey City, N. J.

Fred W. Koerber, Farmers & Mechanics National Bank, Washington, D. C.

W. A. Goudy, Portland, Ontario, Canada.

Radio Service Co., Norwalk, Conn. (Distributors and retailers.)

F. J. Langton, Box 196, Fulton, N. Y.

S. Ray Martin, Drawer G, Benton Harbor, Mich.

J. Maranon, Alameda S. Mames, 18-3°, Bilbao, Spain.

H. R. Wright, Ferguson, W. Va.

Harry Klein, 999 Boston Road, Bronx, N. Y. (Will build set.)

R. C. Hunter, Box 33, Gashland, Mo.

Randall Radio Co., 156 Pulaski St., Brooklyn, N. Y.

S. Anketell, Jr., 1440 Broadway, Brooklyn, N. Y.

R. Scheffermuller, 1416 Putnam Ave., Brooklyn, N. Y.

J. F. Ginna, 256 91st St., Brooklyn, N. Y.

C. P. Young, R No. 1, Box 36, Kentwoods, La.

D. N. Kent, Talamagouche, Nova Scotia, Canada.

E. W. Kent, P. O. Box 263, North Sydney, Cafe Breton, Canada.

Dalton Atherton, P. O. Box 87, Fullerton, Calif.

Will M. Kellogg, New Boston, Ill. (Dealer.)

Wm. Townsend, 92 W. Second St., London, Ohio.

Walter Altmann, 568 Pacific St., Brooklyn, N. Y. (Wants to buy a radio set for Christmas.)

Benj. Shreibman, 473 F Street, Washington, D. C. (Dealer. Installs sets.)

John B. Whitehead, 5644 South Eye Street, Tacoma, Wash. (Retailer. Repairs sets.)

The Stanley Radio Service Co., 1755 East 13th Street, Brooklyn, N. Y.

F. T. Peach, Bay Roberts, Newfoundland, Canada.

John F. Ayers, Box 178, Pleasantville, N. Y.

J. Sanford Cross, High Falls, N. Y. (Will build a five-tube neotrodyne set.)

Carl O. Anderson, 550 South Seventh Avenue, Mt. Vernon, N. Y.

P. H. Andrews, 707 Fifteenth Street, Franklin, Pa.

Thos. Feenev, 415 Fred Street, Whiting, Ind.

Walter W. Mielke, Canary, Oregon.

The Netherlands as a Radio Market

RADIO telephony, particularly for amateurs, has enjoyed increasing popularity in the Netherlands during recent years. According to opinions in the trade, the next few years should see even greater development in amateur radio telephony in that country. The main activities in Holland are centered in the sale of parts and accessories, but the number of complete sets sold is relatively small, since most amateurs purchase the parts and erect their own stations.

According to best estimates there are at present no less than 4,000 amateur receiving stations in Holland; following the war there were only a score or more receiving stations. The Management of Posts and Telegraphs advises that there are about 477 other receiving and transmitting wireless stations in the country.

Permits for receiving stations are readily granted in Holland. Dealers in radio materials are now negotiating with the government for authority to erect a general broadcasting station. The plan is to broadcast concerts and news on a much larger and better scale than is done at present by any Netherlands broadcasting service of amateurs.

Germany has been getting the bulk of Holland's import business, but the greater portion of German goods coming into the country are old war stocks. These goods cost usually anywhere from 40 to 50 per cent below American and other competitors in price. Germany, of course, has advantages in the Netherlands on account of proximity of market.

The United States is gaining a better foothold in this market, however, and imports of radio material are increasing. Whereas in the full year 1919 the United States sent only \$1,600 worth of radio material to this market, during the first half of the year 1923 there were \$12,800 (normal) worth entered.

American goods will probably continue to enter the country on an improved scale, and competent observers express the opinion that if American parts and systems were made to conform more to local needs a much larger business would be done. American instruments in this market are as a rule designed for wave lengths averaging around 360 meters. In Holland most radio owners desire around 1,050 meters average, and in a good many cases, up to 2,000 meters is required.

Ready entry of radio material is provided for in Holland, since there are no governmental regulations or restrictions governing imports. The import duty on parts and whole sets is 5 per cent ad valorem.

Electrical Industry Uses Most Copper

COPPER used in the United States in 1922 amounted to 1,091,397,000 pounds, according to estimates by the American Bureau of Metal Statistics, as against 904,753,000 pounds for 1921.

Of this entire production the electrical industry consumed 486,500,000 pounds, or nearly one-half of all the copper used in the country.

The copper used in the manufacture of electrical goods was divided as follows:

	Pounds
Generators, motors, etc., (exclusive of telephone and telegraph)	269,000,000
Telephone and telegraph	120,000,000
Light and power lines	97,500,000

Merrimack Valley Radio Show

NOVEMBER 8th, 9th and 10th, under the auspices of the Lawrence Radio Club, there will be held in New Winter Garden, Lawrence, Mass., the first Merrimack Valley Radio Show. Exhaustive plans and preparations have been made to insure its success. Feature advertising will be used to cover towns with a total population of half a million potential radio enthusiasts from which this show will draw its attendance.

The recently remodelled and beautifully decorated Winter Garden provides a centrally located and conveniently arranged hall for a "Radio Show." The total floor space is 110 feet wide by 144 feet in depth. There is a large stage and a balcony with seating capacity of 750.

J. C. Dowd, 354 Essex Street, Lawrence, Mass., is the representative in charge for the Lawrence Radio Club.

British Radio Problems Solved

RECENT statements of the British Postmaster General indicate that a solution has been found to the problems connected with the establishment of the British Empire wireless chain, says Consul General Skinner, London, in a report to the Department of Commerce. Not all points connected with the issuance of wireless licenses have been disposed of, but there is every indication that the government has adopted a policy which will permit private radio companies to establish high-power stations both in the United Kingdom and in the colonies. At the same time the Post Office will proceed with its own plans for a high-power station at Rugby.

The private interests which have applied for licenses are the Marconi's Wireless Telegraph Company, Limited, and the Eastern Telegraph Company, the latter being the largest unit in the British cable system. The Marconi company has contracted with the Union of South Africa and the Dominion of Canada, and is associated with the Amalgamated Wireless which has a similar contract in Australia.

The Eastern Telegraph Company is the first cable concern of any size to take up radio transmission as an adjunct to its cable service.

The arrangement reached by the Post Office with the Marconi Company is believed to be unique in the history of telegraph operation. The telegraph services of the empire are to be conducted by the wireless pool, consisting at present of the Marconi Company and the Post Office, although it seems certain that the Eastern Telegraph Company will be taken in at a later date should its plans for stations in India and China meet with success. The wireless stations necessary for the proposed imperial service will be furnished in certain agreed proportions by the two parties to the contract, the company furnishing two stations in the first instance and the government one. The position of the government in the communication field is greatly strengthened by the consummation of this agreement, and it is probable that the approaching coordination of land telegraphs, international radio, and submarine cables will form a worldwide system of communications for the British Empire that will result in very effective government control of the whole field.

Farmers Have 145,000 Radio Sets

THE speed with which farmers have taken up radio for practical and social purposes is shown in a recent survey made by the United States Department of Agriculture. County agricultural agents estimate that there are approximately 40,000 radio sets on farms in 780 counties. This is an average of 51 sets per county. Applying the average to 2,850 agricultural counties a total of more than 145,000 sets on farms throughout the country is estimated.

The county agents' estimates cover every state. In New York it is estimated that in 37 agricultural counties there are 5,502 sets on farms. The county agent for Saratoga County, New York, reported 2,500 sets in the county. In 51 counties in Texas there are 3,085 sets. Forty-three counties in Illinois show 2,814 sets; 26 counties in Missouri, 2,861 sets; 42 counties in Ohio, 2,620 sets; 40 counties in Iowa, 2,463 sets, and 26 counties in Kansas, 2,054 sets. New Jersey, Pennsylvania, Michigan, and Minnesota have between 1,000 and 2,000 sets each.

Federal weather forecasts, crop reports, and market quotations are now broadcast from 150 radio stations throughout the country. Special agricultural news in the form of so-called "Agriograms" and talks on various phases of work of the Department of Agriculture is also sent out regularly from 250 broadcasting stations.

Radio Development in China

CHINA will soon have five commercial radio stations and may develop broadcasting also, according to information received in Washington, D. C. Contracts have been signed for a high-power station, similar to the French Lafayette Station, to be built at Shanghai, and four others of lower power to be located at Peking, Harbin, Canton and Shanghai. They will be built by the Federal Telegraph Company. The last four will serve as feeders for the big Shanghai trans-Pacific station.

Four attempts to establish radio broadcasting in China have been made at Shanghai, and although one 50-watt set is still in operation the right to continue is questioned by the Chinese Ministry of Communications. Trade Commissioner Smith advises the Department of Commerce.

The first effort to institute modern broadcasting was made by the Radio Corporation of China from a set on the roof of the Robert Dollar Building; but the scheme was short-lived. A little later the Electric Equipment Company installed a 50-watt set on the top of its building on Nanking Road, ostensibly for experimenting and for demonstrating radio sets for its customers. This station is still operating. Broadcasting programs were next offered to the public by the Shanghai Evening News, and recently the Wing-on Co., Ltd., a large department store, installed a station.

Broadcasting development in China is said by the U. S. Commissioner to have been retarded by the fact that the importation of wireless apparatus was prohibited by the Chinese Government in March, 1923. This embargo was based on an earlier mandate which stipulated that all telegraphs and telephones, whether wire or wireless, were electrical communications and as such should be operated solely by the government. An organization known as the Shanghai Amateur Radio Society has been active with propaganda for radio for the past few months but little success is reported.

Latest Discovery!
SCHICKERLING
 LATEST TYPE
SUPER DX. TUBES
 ELIMINATE DISTORTION, CLEAR AS A BELL
 DETECTORS AND AMPLIFIERS 1.5-3-6V.
 LOW AMPERAGE - FULLY GUARANTEED
 \$ 6.50 LIST, AT AUTHORIZED DEALERS ONLY
 OR MAILED PROMPTLY UPON RECEIPT OF MONEY.
 RAYO PADDLEY'S CO.
 SCHICKERLING 313 HALSEY ST. NEWARK, N. J.

10 Initialed Binding Posts \$2
 Beauties—Sent anywhere by mail
 on receipt of price. Fine panel de-
 sign and wiring advice Free.
 Panels drilled. Wood for Beautiful
 Cabinets cut to size, with instruc-
 tions for assembling and finishing
 like rosewood or mahogany. Will
 secure anything you want in the
 Radio Line and ship by parcel post,
 C. O. D., anywhere in the U. S.
 Satisfaction Guaranteed.
**MAITLAND AND
 SPENCER ROACH**
 2905 Columbia Ave.
 Philadelphia, Pa.

Head Set **\$4.50** Loud Speaker **\$12.00**

"ROYALFONE"
 KING OF ALL

A head set far su-
 perior to the aver-
 age and just as
 good as the best.
 Equally good for
 all distances.

A loud speaker of
 superior qualities.
 Reproduces signals
 with no distortion
 at high amplifica-
 tion. A home in-
 strument at a very
 moderate price.

Royal Electrical Laboratories
 207 Market Street Newark, N. J.

Royalfone

**Radio Instructions for
 Naval Officers**

THE Naval Communication Office at the
 Navy Department, Washington, D. C.,
 is giving a course of instruction of two
 weeks' duration for officers taking the Post-
 graduate Courses in radio. The course con-
 sists of: (a) forty-five minute lectures given
 by officers and civilians connected with the
 different sections, dealing with the growth
 of radio and naval communications, radio
 compasses, codes and signals, commercial
 traffic, etc.; (b) study of communication
 instructions and explanations of the articles
 contained therein, together with the correct
 use of naval procedure; (c) visit to the
 Arlington Radio Station; (d) inspection
 of the Navy Department including the radio
 apparatus and the Main Center of Naval
 Communications; and (e) visit to Com-
 mercial Institutions. A final examination is
 given on the twelfth day.

Radio Fools the Cat

IT may be possible, soon, to turn over
 a few household tasks to radio broad-
 casting stations. For example, it is con-
 ceivable that the cat may be put out at
 night by an order delivered at a given
 hour by a radio broadcasting station.

WGY, the Schenectady station of the
 General Electric Company recently broad-
 cast a "Farmers' Program." The numerous
 numbers were introduced as part of a
 celebration of the fiftieth wedding anni-
 versary of Josh Quinby and his wife
 Samantha. The announcements were all
 very informal and instead of signing off in
 the usual formal manner "Josh," after
 speeding the departing guests, called to
 the cat preparatory to locking the
 kitchen door and blowing out the lights.
 His call "kitty, kitty, kitty" was carried
 to a great many homes with the follow-
 ing result as related in two letters re-
 ceived by WGY:

"To convince you how perfectly we re-
 ceived your program," wrote Mollie Ches-
 brough of Addison, N. Y., "I will tell
 you that our pet kitty was lying on the
 sofa asleep. When the groom of fifty
 years ago was calling kitty to put her
 out, our kitty immediately got up to see
 who was calling him and for two or three
 minutes did not remove his gaze from
 the magnavox."
 Charles J. Chase who runs the gen-
 eral store at Sebec Station, Maine, writes:
 "Our cat heard you call and knew it
 was bedtime and hid away and did not
 want to be put out."

PATENTS
 promptly procured. Trade
 Marks designed & registered
**FREE INVENTION RE-
 CORDBING BLANK**
 Phone Vanderbilt 7912

**FREE MANUFACTURERS
 PATENT CO., INC.**
 520 FIFTH AVE.
 NEW YORK

**DUPONT
 MAKES PYRALIN
 SHELSTONE**

Loud Speaker
 With Complete
**Nath.
 Baldwin
 Head Set
 Type C
 Perfect
 Results**



Shelstone is made of Dupont's Pyralin, is trans-
 parent and one of the most attractive Loud
 Speakers on the market.
 It is built differently to take advantage of the
 most correct acoustic principles and reproduces
 music and speech with a clear tone.

Loud Speaker with phones...\$15.00
 Loud Speaker postpaid..... 3.00

Satisfaction guaranteed. C. O. D. or cash
 with order. Dealers write for discounts.
 Distributors for Nathaniel Baldwin, Inc.
THE SHELSTONE COMPANY
 181 Clinton Ave. NEWARK, N. J.

A Complete Loud Speaker
 FOR
\$9.50



Heavy metal horn, 21
 inches high, 11-inch bell,
 complete with special
 loud speaking unit and
 5 ft. cord.

Colors: Plain Black or
 Brown, also special All-
 gator Grain in Black and
 Green or Black and Yel-
 low.

Price of Horn Only, without Loud
 Speaking Unit \$5.50

Sold on Money-Back Guarantee.

Ackerman Bros. Co., Inc.
 301 W. 4th St. (Dept. "R.W.") New York

EXTRAORDINARY DOUBLE SUBSCRIPTION OFFER

**RADIO WORLD AND OTHER POPULAR RADIO PUBLICATIONS FOR THE
 PRICE OF SUBSCRIPTION FOR RADIO WORLD ALONE**

- Radio World has made arrangements
- by which it is possible
 - to offer a year's subscription for
 - any one of the following publications
 - with one year's subscription for
 - RADIO WORLD:
 - RADIO NEWS or
 - POPULAR RADIO or
 - WIRELESS AGE or
 - RADIO DEALER or
 - RADIO (San Francisco).

- This is the way to get two publications
- for the price of one:
 - Send \$6.00 today for RADIO WORLD
 - for one year (regular price
 - for 52 numbers)
 - and select any one of the other
 - four publications for twelve months-
 - Add \$1.00 a year extra for
 - Canadian or Foreign postage.
 - This offer good only up to and
 - including October 20, 1923.
 - Present RADIO WORLD subscribers
 - can take advantage of this offer by
 - extending subscriptions one year NOW.
 - Or order thru your newsdealer.

RADIO WORLD'S SPECIAL TWO-FOR-PRICE-OF-ONE SUBSCRIPTION BLANK

RADIO WORLD, 1493 Broadway, New York City.

Enclosed find \$6.00, for which send me RADIO WORLD for twelve months (52 numbers), beginning
 and also, without additional cost, Radio News, or Popular Radio, or Wireless Age, or Radio Dealer, or Radio for twelve months, beginning

**This Offer Good
 Only Until
 October 20th, 1923.**

Name

Street Address

City and State

Luminous Paint for Panel Marking

EDITOR RADIO WORLD: I have just read the article on "Solving a Domestic Radio Difficulty," written by Anna Leo, and wish to comment upon the fact that if such a lamp were placed upon the panel as in the diagram on page ten of RADIO WORLD, September 29th, 1923, the amperage and power drawn by the lamp would greatly weaken the storage battery, and furthermore, what would the folks do who use sets which employ the dry cell tubes? The idea is good, but I think it is impractical.

Perhaps this suggestion may be of some interest to both you and readers of your splendid magazine. While in training at the southern camp for reconnaissance practice we used a sort of luminous paint for marking trees and other objects of interest along the road of travel. This paint, I understand, can be purchased at any paint shop for a very small amount.

With this go over all the markings on all dials, including the numerals on the indicator of all rheostats. A small circle can be scratched on all the knobs of the dials and rheostats with the use of a pair of dividers. This circle in turn can be filled with the paint and left to dry. Also go over the engravings on your panel.

If you take your time and don't rush your work a very neat job can be turned out that will look almost like a manufactured article.

RICHARD W. ABELES.
445 McDonough St., Brooklyn, N. Y.

Radio Drama Prize Offer Creates Interest

SEVERAL manuscripts have already been received by WGY in the competition which the General Electric Company broadcasting station is conducting in an effort to encourage and promote a new form of dramatic art. A prize of \$500 will be awarded the author of the best radio-drama submitted during the three months period ending November 30. Additional prizes in varying sums up to \$100, depending on the merit of the plays, will be awarded at the option of the General Electric Company for other plays deemed suitable for radio production.

The management of WGY has found that the radio drama has become one of the most popular features of its program but it has also found that the average stage production does not lend itself readily to "air" production. The competition is inaugurated, therefore, for the purpose of developing a literary and dramatic form that is as distinctly different from the stage drama as the stage drama now is.

The author of the radio drama must keep in mind that the players are unseen; that the scenery is constructed by the imagination of the listener, influenced by the spoken word; that action must be conveyed by sound; that only the lines and the voice can be relied upon to build up a character. If it is desired to test the suitability of a play for radio production it is suggested that the author listen to a reading of his play by two or three friends in an adjoining room. The radio drama makes its appeal to the ear and the imagination; the scenic limitations are only the limits of the individual imagination.

The prize winning play will be produced by the WGY Players and through this production the author will receive an introduction to an international audience. Details of the competition will be furnished on application by WGY.

Full of Opportunities
Radio World's Classified Dept.

COMO DUPLEX TRANSFORMERS

The COMO DUPLEX SYSTEM of audio-frequency amplification gives the maximum volume without distortion and tube noise.



Type "I" Type "O"
COMO APPARATUS COMPANY
446 TREMONT STREET BOSTON, MASS.

There is a combined filtering action which assures perfect results when ordinary amplification fails.

It can be added to your present amplifier, giving you power amplification on the weak signals that more of the ordinary amplification would kill.

Sold only in matched Pairs, \$12.50

A copy of C. White's "HOW TO MAKE A POWER AMPLIFIER" is yours for the asking.

AMATEURS! FANS! ATTENTION!

ALL BROADCASTING STATIONS—Complete with the call, location, wave length, frequency of the station, and power used started in Radio World of June 8.

This list is most complete, and no amateur or fan should be without it. It will be completed in following issues, and as revisions or changes are made the list will be kept up-to-date, so that you will always have an up-to-date list to which you can refer. Don't miss any issue. Send 15c to

RADIO WORLD, 1493 BROADWAY
New York City, or start your subscription with that number.

DO IT NOW—DON'T DELAY!

FOR RELIABLE UP-TO-DATE RADIO MAILING LISTS

Use Our Card Catalog Directory in use now with over 200 Radio Manufacturers and Jobbers
Your ENVELOPES ADDRESSED At \$2.00 per 1,000

Write for Particulars

Sydell's Radio Trade Directory
406 W. 31st St., New York. Watkins 5987

THE TRINITY LOUD SPEAKER



TYPE "A1"
21" FIBER HORN
\$25.00

TYPE "B"
(For Phonographs)
\$12.50

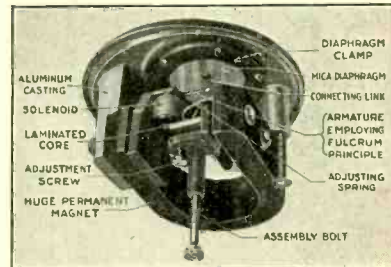

INTERIOR CONSTRUCTION

An ear phone is an ear phone no matter how fancy the horn that covers it may be, and, due to the delicate construction of an ear phone it is utterly incapable of giving true tone reproduction, especially, when relatively large currents are passed thru its coils, such as the output of a two-stage or power amplifier.

The Trinity Loud Speaker element embodies the well-proven and tested principles of the phonograph reproducer with the soundest principles of electromagnetic design best adapted for loud speaker operation. It is not an ear phone when placed on a head band and a loud speaker when covered with a horn. It is a sturdy loud-speaking element ALWAYS.

Send for Literature.

TRINITY RADIO CORPORATION

446 TREMONT STREET, BOSTON, MASS.

FILL OUT AND MAIL NOW

SUBSCRIPTION BLANK

RADIO WORLD

RADIO WORLD

1493 Broadway, New York City

Please send me RADIO WORLD for months, for which

please find enclosed \$.....

SUBSCRIPTION RATES:

Single Copy \$.15
Three Months 1.50
Six Months 3.00
One Year, 52 Issues 6.00
Add \$1.00 a Year to Foreign Postage; 50c for Canadian Postage.

.....
.....
.....

Don't Blame it all on Static

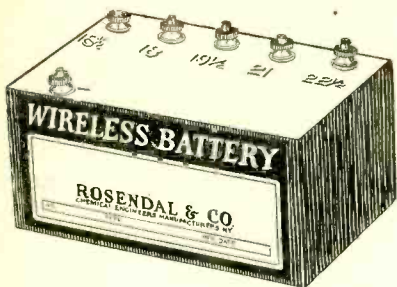

A run down "B" Battery plays more havoc with efficient reception than the grandest static you ever heard.

Rosendal "B" Batteries are not two days old when they're sent to you. And they are built right. Made of finest materials to give extra service. After you've used them if you don't feel they're the best buy, send them back and your money will be refunded.

Send M. O. or order for C. O. D.

	Large	Med.	Small
22 1/2 V. Plain	\$1.25	\$1.00	\$0.70
22 1/2 V. Variable	1.38	1.13	0.79
45 V. Plain	2.50	1.75
45 V. Variable	2.75	2.00

ROSENDAL & CO.

Chemical and Radio Engineers
2 and 4 Stone Street New York

Dramatic Season at WGY Begins

THE WGY Players opened their second season (1923-1924) at the General Electric Company's broadcasting studio, Schenectady, N. Y., on October 4. The play was "Three Live Ghosts." During the previous season forty-three plays were presented.

Plans for the new season include the acting of one play weekly. As a result of the receipt of over 6,000 letters over a four-day period "The Sign of the Cross" will be repeated. Among the other productions planned will be a special adaptation of "County Fair," by Neil Burgess.

Several new features will figure in the 1923-1924 season. Plays selected from those written especially for radio as a result of the WGY \$500 prize contest will be put on, the winning play being featured. Many other specially prepared radio dramas will be produced, several of which will have their initial performance at WGY.

Edward H. Smith, director of the players, with the assistance of engineers, carpenters, etc., is planning and constructing new devices allowing the more vivid representation to the radio fan of new scenes and actions. One of these novelties will be a horse race.

A new method of directing plays has been effected at the WGY studio, which will be put into practice during the coming season. During rehearsals the director, in a separate room, will listen in with a pair of headphones, hearing the performance exactly as would the listeners throughout the country on the night of the performance. Corrections will be made and instructions given by means of a loud speaker installed in the studio where the rehearsal is conducted.

The cast of WGY Players for the season of 1923-1924 will be as follows: Edward H. Smith, director and leading man; Rose Cohn, playing opposite Mr. Smith; Lola Sommers, Margaret V. Smith, Arline Montgomery, Helen Campbell, Edward E. St. Louis, Frank Oliver, Jerome Lovenheim, John Loftus, Charles S. Baumas.

Six new members have been added to the cast. Five of these were selected from the student players, who were given an opportunity to develop their talents during the summer months of this year. Among these five is Rose Cohn, who, under the instruction of Mr. Smith, developed such marked talent that she was selected to play leading parts during the new season. The other four are: Arline Montgomery, dialect or character work; Jerome Lovenheim, "heavy" man or "villain"; Charles Baumas and John Loftus, who will play miscellaneous parts.

A noteworthy addition to the ranks of the WGY Players for the coming season is Helen Campbell, a stock actress of recognized standing. She has been for a number of years a very successful character actress, being exceptionally well adapted for such work. She has been variously associated on the stage with Bert Lytell, Leonore Ulrich, Mahlon Hamilton, Clara Joel, Fay Bainter, and others.

Station WBAP, Ft. Worth, Texas

WBAP, the Fort Worth, Tex., Star-Telegram broadcasting station, went on the air September 17 at 7:30 p. m., with its initial 1923-24 season musical programs, presenting the Rotary Club Orchestra, Brook Morris, director. WBAP now has 750 watts power instead of 500, as formerly, and expects to break its long distance transmitting record of last winter by several hundred miles. Two programs will be given each evening, 7:30 p. m. to 8:30 p. m., and from 9:30 to 10:45 p. m., Central Standard time, except Saturday and Sunday. Its wave length is 476 meters.

WEIGHS ONLY 8 OZ

The Scientific

SEND NO MONEY!

20,000 TURNS EQUIVALENT TO 3,000 OHMS

Order TODAY by Postcard and Pay Postman on arrival

\$2.95

LOUD SPEAKER UNIT \$1.95

POST-PAID

THE PHONE IT TOOK A SOLID YEAR TO DESIGN

We Guarantee The Scientific Headset to be the greatest value on the market. Try it for five days. If not satisfactory send it back and your money will be refunded immediately. Circular on request. Dealers wanted.

THE SCIENTIFIC ELECTRIC WORKS
98 Brookline Ave. DEPT. D BOSTON, MASS.

LISTING RELIABLE SOURCES OF SUPPLY FOR EVERY RADIO NEED

THE RADIO DEALER YEAR BOOK

1923-24

WILL BE OUT IN A FEW DAYS

Sold only to members of the radio trade.
Attach business card or letterhead to your order.

Circular free over 200 pages.

ONE DOLLAR THE COPY

Issued by the publishers of the Radio Dealer, the trade's Leading Monthly magazine, and the Radio Dealer WEEKLY, for Manufacturers. Address orders to:

THE RADIO DEALER YEAR BOOK

1133 BROADWAY

NEW YORK CITY

First Canadian Broadcast
Heard in England

MANY reports have reached CKAC, the broadcasting station of La Presse, Montreal, during the past year from every State in the Union, every Province in Canada, from far-off Juneau, Alaska; Copenhagen, and even from the Bay of Biscay, France, but never any from England, stating that they had heard this station.

On October 1 a cablegram from London, England, bearing the signature of the General Radio Company, reached CKAC's office and imparted the news that the station's anniversary concert of September 29 had been clearly heard in London, although there was considerable interference.

MARTIAN BIG FOUR

\$7.50 Crystal Receiving Set.
Something Entirely New in Crystal Sets.

WHITE MANUFACTURING CO.
93-107 Lafayette Street Newark, N. J.

RUSONITE

CRYSTAL RECTIFIER

(Patent Pending)
THE PERFECT SYNTHETIC CRYSTAL DETECTOR—SENSITIVE OVER ENTIRE SURFACE
No Hunting for "Spots." Loud and Clear. Endorsed by Thousands of Satisfied Users.
Sensitiveness Price 50c
Guaranteed Mounted
14 K Gold Supersensitive
RUSONITE CATWHISKER, Price 25c
Permanent. Will not Oxidize.
RUSONITE REFLEX CRYSTAL
Manufactured Expressly for Reflex Circuits. Will Stand Up Under Heavy Plate Voltage.
Price \$1.00
Guaranteed Mounted
Order from your dealer or direct from
RUSONITE PRODUCTS CORP.
15 Park Row New York, N. Y.

USE A C H SHARP
TUNER DIALS

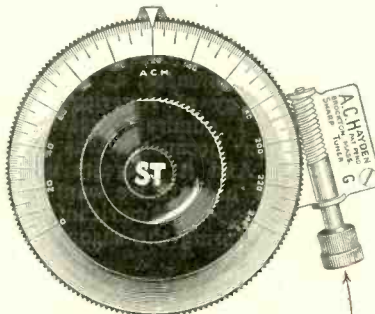

Why the A.C.H. is different

3 in. DIAL (156-10-1)
4 in. DIAL (215-10-1)

Rough tuning with dial or one thousandth of an inch in either direction.

ASK YOURSELF THIS

Would W. S. Brooker, Alberta, Canada, write, "Held Ft. Worth, Texas, one hour steady," and purchase another if he were not satisfied? Would L. M. Cope, Connellsville, Pa., send check, saying, "Send another of those wonderful Dials," if he were not satisfied?

Would J. E. Byron, Loveland, Colo., say, "I heard WMAF, S. Dartmouth, Mass., and picked up five new stations," and recommend same to his friend, Dr. R. E. Wright, who purchased one, if he were not satisfied?

To retain your good will you must be satisfied or money back.

The ACH will improve any set.
Send for circular No. 3 on RV Loud Talker and Detector Set. A truly wonderful set.

All ready for you to put together.
A. C. HAYDEN RADIO & RESEARCH CO
Brockton, Mass., U. S. A.
Mail Orders sent prepaid in U. S. A.

It Costs You No More
to Buy

Columbia Bakelite
Moulded Apparatus

The All-Circuit Variometer

The Columbia Variometer is fully bakelite moulded, green silk, pigtailed, and provides for all circuits of today and tomorrow; the stators may be split. You cannot obtain a finer tuning variometer. Body capacity minimized. Regenerative, Ultra-Audion, Flewelling, Reinartz and Reflex Circuits all provided for. Diagrams with each instrument.

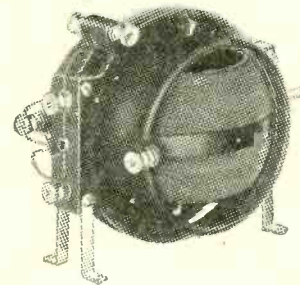

Type C109A, Price.....\$5.50

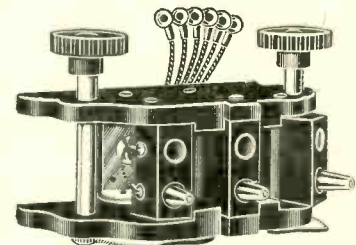

The Geared Coil Mounting you have been looking for. Moulded of genuine bakelite; geared 5 to 1 reduction; 6 inch silk leads. A True Columbia Product.

Type C401, Price.....\$5.00

A Few More Columbia Products:
Bakelite Moulded Variocoupler, Type C120 \$6.00
Bakelite 180° Variocoupler, Type C105 5.00
Bakelite 3 Coil Geared Mounting, Type C401 5.00
Bakelite 2 Coil Geared Mounting, Type C402 3.50
Inside Coil Mount Geared and "Vernier" Type C403 6.00
Coil Plugs 50
All Meter 180° Couplers 7.00
and complete line of mounted coils.

All good dealers have Columbia Products.
Insist on them.

Columbia Radio Corp.

155 N. Union St. Chicago

ROCKY MOUNTAIN
RADIO PRODUCTS

Crystals

Any Style of
Radio Material
at Lowest Prices!

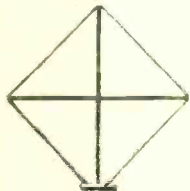

NEW K-D
SPRING
LOOP
AERIAL
LIST PRICE

\$1.00

Distributors
Bus, Aerial, Magnet

WIRE

Write for Discounts
Rocky Mountain Products Co.
9 Church St., New York



RADIO FANS:

Get your name on our mailing list and receive our weekly special price list. We are better equipped to supply your mail order wants than any dealer in New York.

SWITCHES	
Federal anti-capacity	\$2.10
PORCELAIN	
SPST	\$0.25
SPDT	.30
DPST	.30
DPDT	.50
Cutler-Hammer Battery Switch	.75
MAGNET WIRE	
22 SCC 1/4 lb.	\$0.27
22 SCC 1/2 lb.	.55
24 SCC 1/4 lb.	.32
24 SCC 1/2 lb.	.60
22 DCC 1/4 lb.	.30
22 DCC 1/2 lb.	.55
24 DCC 1/4 lb.	.35
24 DCC 1/2 lb.	.65
ADAPTERS	
W.D. J1—Marco	\$0.80
U.V. 199—R. C.	.90
CONDENSERS—SPECIAL	
Radio Stores 23 Plate	\$1.95
Radio Stores 43 Plate	2.45
23 Plate Vernier	2.35
43 Plate Vernier	2.90
17 Plate Vernier	3.25
SOCKETS	
Radio Corp.	\$0.90
Firth	.35
Eagle Bakelite	.60

TRANSFORMERS	
R. C. 712	\$5.90
R. C. 1714	5.60
Seco 7-1 Ratio	3.95
National 3-1 Ratio	3.25
Amerfran 10-1 Ratio	5.95
All American 5-1 Ratio	4.30
RHEOSTATS	
C-H Plain	\$0.80
C-H Vernier	1.20
Tillman 6 Ohms	.50
Tillman 30 Ohms	.60
Pacent 6 Ohms	.90
Pacent 30 Ohms	.90
PLUGS	
Pilot	\$0.55
Firth	.95
LOUD TALKERS	
Magnavox	\$29.50
Sunbeam	8.75
W. Electric 10 D	47.50
PHONES	
Holtzer-Cabot	\$8.50
Holtzer-Cabot	5.50
Auth	3.35
Royal	3.50
PANELS—HARD RUBBER	
7 x 10	\$0.75
7 x 12	.90
7 x 14	1.05
7 x 18	1.35
7 x 21	.90
7 x 24	1.60
	1.75

Select your set and write us for prices. We'll do the rest.

SUNBEAM ELECTRIC COMPANY

71 THIRD AVENUE

NEW YORK

FOR DX FANS!

Now is the time to rebuild your set. Use the standard circuits that have proved themselves by their past performances. If you are in doubt as to just which one you want, you can find the Armstrong, Flewelling, Beinartz, Hazeltine, Cockaday, Grimes, and many others in our special issue of Oct. 6, 1923. Other features of interest in this number. Send 15c now, or better still, start your year's subscription with that number and be assured of 52 crackin' good issues delivered right to your door.
RADIO WORLD, 1493 Broadway, New York City

DON'T LOSE A SINGLE NUMBER.
Send \$6.00 for RADIO WORLD and get 52 issues without a break.

DO YOU WANT PLANS FOR MAKING THE SLEEPER DUOTOL RECEIVER, USING THE SLEEPER TWINS. —Two Variometers and the fixed Coupler? SEND 10c for the June issue of RADIO AND MODEL ENGINEERING.

SLEEPER RADIO CORPORATION
88 W. Park Place New York City

FREE



RADIO SET WITH DOUBLE HEAD PHONES

This wonder RADIO SET in special metal cabinet with double head phones, complete ready to hook up. **ABSOLUTELY FREE!**

Listen in on concerts, sports, lectures, etc. Send your name for wonderful Free Radio Plan.

GUARANTEE SALES CO.
26-28 Washington Pl., Dept. 103, New York

THE ORIGINAL PEANUT TUBE
WELSH PEANUT TUBE
W. T. 501

Resembles a peanut in size and shape.
A Sensation Last Season—
A Real Business Getter This Year

LOWER COST
BETTER RESULTS



List Price \$2.00

Sockets40c
Adaptors ..75c

Operates either on storage battery or three dry cells. Sent by parcel post prepaid on receipt of price if your dealer has not stocked them.

WELSH ELECTRIC LAMP CORP.
69 BOYLAN STREET NEWARK, N. J.
BEWARE OF IMITATIONS

SPECIAL
Direct from Manufacturer to Consumer
Improved Model
LOUD SPEAKER
With Unit and Cord
Price **\$8.00**
(For a limited time only.)



Genuine Wood Fibre Horn
Entirely eliminates that annoying metallic sound. Positively the only WOOD FIBER HORN on the market today.
10-inch Bell with Standard Attachment; Complete. Height 24 inches. Colors, Black, Mahogany and Olive Green.
Delivered to any part of the United States and Canada.

EMIL DeCLYNE
15 Park Row, Room 2525, NEW YORK CITY
Send M.O. or C.O.D. Dept. M.M., Tel. Barclay 6298

IT HAS HAPPENED TO ALL OF YOU IN A FRACTION OF A SECOND!

WHEN the filament burns out, at least \$5.00 goes with it to put the set in operation again.

WHY not save nearly one-half the cost of a new tube by sending us your burned out or broken tube to be repaired?

WE REPAIR EVERY TYPE OF tungsten wire filament receiving tube. All our tubes are TESTED and GUARANTEED to function as well as when new. All tubes returned P. P., C. O. D.

HARVARD RADIO LABORATORIES
P. O. Box 1781
BOSTON MASS.

Tubes at One-Half Cost

Name of Greatest American Drama Wanted

By Fred Smith, Studio Director of WLW

WHAT is the greatest American drama?

What are the ideals of the United States of America, and what is Americanism?

A most graphic answer was given to me for these latter questions a short time ago when I saw that most marvelous of motion pictures, "The Covered Wagon." Most of you know that this picture deals with the great emigration movement of 1849. In it is revealed the heroic spirit of the American pioneer, as well as the courageous energy of American women of that day. I admired greatly "The Covered Wagon" because it was distinctly American. And it interests us especially at WLW because we want to produce some distinctively American radarios, or radio plays, during the season which is now at hand.

The great play of any age is that which crystallizes most artistically the dominant ideas of its time. For example, there are "The Girl of the Golden West," "Ramona," "Way Down East," "Uncle Tom's Cabin" and "Main Street." The soul of a nation is revealed in its art. A poem, a novel, a painting, a drama becomes popular because it touches sympathetic emotions. In spite of Nietzsche, the great test for value remains with the popular voice. Not that momentary applause of the mob which lasts but a day, to be sure, but that perpetual approval of well balanced human intelligence is to be considered as the popular voice. Many and many a monumental work of art, such as "Don Quixote," of Cervantes, did not become popular overnight, but it has been constantly popular for more than three hundred years, and for that reason alone, if need be, could be classed as one of the great monuments in literature.

We have presented from WLW some of the greatest masterpieces of foreign literature—works of Benavente, Ibsen, Maeterlinck, Moliere and Wilde—but as yet we have scarcely touched the great American dramas. What are they? Or, better still, what is the greatest American drama in your opinion? You should be just as much interested in the progress of the radio as we are, because radio has taken its place with the theatre and the motion picture. Radio broadcasting can quicken the finer sensibilities of all of us, it can stimulate our imaginations which have been almost lost in the labyrinth of material conveniences of our age.

There is a form of patriotism which is more heroic than that displayed on the battlefield. It is that form of patriotism which endeavors to create from the noblest sentiments of a nation's soul a living philosophy of every day existence. And when an artist is able to portray in his work characters actuated by such worthy aspirations, he has caught the spirit of his times and placed his name amongst the very rare, but nevertheless true historians.

Who, then, are the great American playwrights, and what are their best works? Write to the Crosley Manufacturing Company, Cincinnati, Station WLW, give us your opinion, and so assist us in selecting for radio presentation the masterpieces of our times.

Prize Contests at WRW

HEREAFTER each Wednesday evening at 9:30 station WRW, Tarrytown, N. Y., will broadcast a series of prize contests. A number of manufacturers have donated prizes such as receiving sets, loud speakers, head phones.

LATEST BROADCASTING MAP IN COLORS FREE to NEW RADIO WORLD SUBSCRIBERS

The latest radio broadcasting map of the United States and Canada, containing all the new allocations and changes, is offered *free* to subscribers for Radio World who send in their subscriptions within the coming four weeks. This map is printed on fine map paper stock and has just the information you want regarding broadcasting stations throughout the continent, including army and navy stations.

If you are already a subscriber you can get this map by renewing your present subscription now.

Send direct to this office or you may subscribe thru your newsdealer who can send your subscription direct to us.

Use the coupon attached. Offer open until Oct. 23, 1923.

RADIO WORLD FREE MAP SUBSCRIPTION BLANK

Radio World,
1493 Broadway, New York.

For the accompanying \$3.00 please send me Radio World for six months (26 numbers) beginning with issue dated and also, without any expense to me whatsoever, the latest radio map as advertised.

Address

City and State.....

If you wish two maps, one for yourself and

Name

one for a friend, send \$6.00 for a yearly subscription and the two maps will be sent to different addresses if you wish.

10c

Brings you our new catalogue and radio information booklet illustrating and describing the Super-Regenerative and other latest and popular circuits. Our technical staff is at the disposal of our customers. Make use of their knowledge. Merchandise shipped immediately on receipt of order.
 U. S. Bureau of Standards "Radio Book." Special65c.
FREMONT RADIO SALES CO.
 227 FULTON STREET, NEW YORK CITY

Improved Neutrodyne Circuit



By eliminating Electro Static effects between Tubes non-magnetic
 Patent "VAC-SHIELDS" Pending
 Prevent Interstage Coupling. Make it easy to tune in DX. Your set should have them. By Mail Post Paid direct from our Laboratories. \$1.00.
ORANGE RESEARCH LABORATORIES
 41 North 16th East Orange, N. J.

\$1.25

Loop Antenna

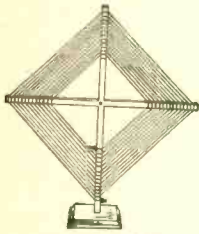

Post Paid in U. S. A.
 A highly efficient complete indoor aerial.

Write for literature describing Radio Cabinets and other products.

Robbins Woodworking Co.
 502 SECOND ST. LIBERTYVILLE, ILL.

WE REPAIR RADIO TUBES



WD-11... \$3.50	UV-199... \$3.50
WD-12... 3.80	C-299... 3.80
UV-200... 2.75	UV-201A... 2.50
UV-201... 3.00	C-301A... 3.50
C-300... 2.75	UV-202... 4.00
C-301... 3.00	C-302... 4.00
DV-6A... 3.50	

Mail orders solicited and promptly attended to.
 Dealers and agents write for special discounts.

H. & H. RADIO CO.

P. O. Box 22-B

Clinton-Hill Station Newark, N. J.

THE GOODMAN

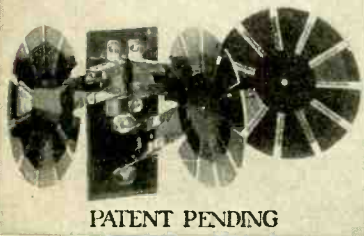

PATENT PENDING

The Niftiest Short Wave Tuner on the Market Only \$6.00 & PP on 1 lb. Send for pamphlet.

L. W. GOODMAN
 DREXEL HILL, PA.

Mr. C. H. Jenkins, Audubon, N. J., writes: "On July 13th, tuned in WBAP, Fort Worth, Texas, (478 meters), with the GOODMAN, while WDAK (396 m.) and WOO (509 m.), powerful local stations, were broadcasting dance music."

THERE IS A BRAND-NEW CRAM'S RADIO MAP
 (New Edition)

Just issued with all the very latest broadcasting stations and information.

ALL THE STATIONS OF THE UNITED STATES AND CANADA

Scale 100 miles to the inch in two colors—Size 34x28"

PRINTED ON HIGH-GRADE MAP PAPER UP-TO-THE-MINUTE INFORMATION INDICATING ALL AMATEUR AND STANDARD BROADCASTING STATIONS WITH COMPLETE INDEX OF STATIONS 35c (POSTPAID)

THE COLUMBIA PRINT

1493 BROADWAY NEW YORK CITY

RADIO WORLD

TELEPHONE, LACKAWANNA 6976
 PUBLISHED EVERY WEDNESDAY (Dated SATURDAY OF SAME WEEK) FROM PUBLICATION OFFICE, 1493 BROADWAY, NEW YORK, N. Y. BY HENNESSY RADIO PUBLICATIONS CORPORATION
ROLAND BURKE HENNESSY, President and Editor
M. B. HENNESSY, Vice-President
FRED S. CLARK, Secretary and Manager
 1493 BROADWAY, NEW YORK, N. Y.
 Boston Representative: Chas. H. M. White, 1367 Commonwealth Avenue, Allston, Mass.
 European Representatives: The International News Co., Breems Bldgs., Chancery Lane, London, Eng. Paris, France: Brentano's, 37 Avenue de l'Opera.

Managing Editor: Stephen L. Coles
 Technical Editor: Robert L. Dougherty

SUBSCRIPTION RATES

Fifteen cents a copy, \$8.00 a year, \$3.00 for six months, \$1.50 for three months. Add \$1.00 a year extra for foreign postage. Canada, 50 cents.
 Receipt by new subscribers of the first copy of RADIO WORLD mailed to them after sending in their order, is automatic acknowledgment of their subscription order.

ADVERTISING RATES

One page: One time—\$150.00.
 Half, Quarter, Third and Two-thirds pages at proportionate rates.
 One inch, one time—\$5.00. Per space line \$0.40.
 On four consecutive issues, 10% discount.
 On thirteen consecutive issues, 15% discount.
 Cover and preferred-position rates made known on application.
 Terms: 30 days net, 2% 10 days.

CLASSIFIED ADVERTISEMENTS

Five cents per word. Minimum, 10 words. Discount of 10% on 4 consecutive issues—15% on thirteen consecutive issues. Cash with order.

Entered as second-class matter, March 28, 1922, at the Post Office at New York, New York, under the act of March 3, 1879.

IMPORTANT NOTICE

While every possible care is taken to state correctly matters of fact and opinion in technical and general writings covering the radio field, and every line printed is gone over with a scrupulous regard for the facts, the publisher disclaims any responsibility for statements regarding questions of patents, priority of claims, the proper working out of technical problems, or other matters that may be printed in good faith and on information furnished by those supposed to be trustworthy. This statement is made in good faith and to save time and controversy in matters over which the publisher cannot possibly have control.

Naval Day Entertainment Via Radio

WASHINGTON, D. C.—A dozen or more radio broadcasters in as many cities will spread tidings and entertainment pertaining to Navy Day through the ether on the evening of October 27, according to officials of the U. S. Naval League.

The second celebration of Navy Day will be aided throughout the country by the officials and officers of the navy and Navy League, assisted by the marine and ships' bands in practically every port. Eighteen broadcasters have been invited to participate, and to date five had indicated their desire to cooperate by donating their stations for at least an hour on October 27th, when speeches and entertainment will be furnished by naval personnel.

Stations KFJC, The Post Intelligencer at Seattle, Wash.; WOAW, Woodmen of the World, at Omaha, Neb.; KFAF, Western Radio Corporation, at Denver, Colo.; WMC, Memphis Commercial-Appeal; WRC, Radio Corporation at Washington, D. C., and KSD, St. Louis Post-Dispatch, have signified their willingness to co-operate. No special programs or details have yet been worked out, but the night promises plenty of naval entertainment and lore for all who listen in.

Among the other stations invited to participate are WBZ, Springfield; WJZ, New York; WGY, Schenectady; KDKA, Pittsburgh; WSB, Atlanta; WMC, Memphis; WLAC, Raleigh, WFAA, Dallas; KDN, San Francisco; KFI, Los Angeles; KYW, Chicago; WFAW, Miami; and WAAC, New Orleans.

Subscribe for RADIO WORLD, \$6.00 a year, \$3.00 six months, \$1.50 three months.

Don't Ask for Rheostat—Say

FIL-KO-STAT
 FOR REAL FILAMENT CONTROL



ON APPROVAL FOR 30¢
ZOBEL-STEIN LABORATORIES
 322 9TH ST. BROOKLYN, N.Y. SOUTH 2650

Cockaday Coil Set \$2.50

Including full size blue prints of panel layout, complete picture hookup, and fully illustrated instructions for construction and operation. Coils are fully assembled, made exactly as specified by Mr. Cockaday, D coil bank wound. Far more efficient than any home made coils.

Standard parts for this sensational circuit—panel, coils, condensers, verniers, variable resistance, vernier rheostat, socket, double jack, dials, switch, contact points, posts, busbar, wire, spaghetti, etc. (no tubes or phones).

Complete for \$11.65
 Postage additional on all shipments.
 Send no Money. PAY THE POSTMAN.
 All Goods Shipped Parcel Post C. O. D.

RADIO SURPLUS STORES
 HELENA, MONTANA

IMPROVED GROUND CLAMP

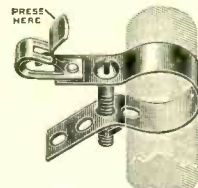

Equipped with **FAHNESTOCK PATENT** Wire Connectors Easily Attached

No Soldering—For Radio Use Only

AT YOUR DEALERS
FAHNESTOCK ELEC. CO.
 LONG ISLAND CITY, N. Y.

GAMBLING?

YOU ARE IF YOUR RADIO TUBES ARE UNPROTECTED

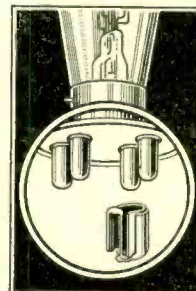

Your Vacuum Tubes are the most delicate parts of your Radio Set. They are easily blown out—you have probably already had this exasperating experience—it is apt to happen at any time.

"B" Battery wires accidentally crossed for only an instant with the filament leads or sudden excess current from the "A" Battery will do it.

You can prevent this and save yourself money and inconvenience and relieve your mind at a trifling cost.

INSTALL RADECO SAFETY FUSES

on all your tubes. Applied in an instant to one at the filament terminal. Will fit any standard tube going in any standard socket.

Price 50 cents each, sent postpaid and fully guaranteed. Do not delay. Order now. Specify type of tube used.

Dept. 5
RADIO EQUIPMENT CO.

Manufacturers and Distributors of Standard Radio Equipment

630 Washington Street Boston, Mass.

New England's Oldest Exclusive Radio House
 Dealers:—Write for our proposition

DO YOU WANT TO BUY, SELL OR EXCHANGE RADIO OR OTHER GOODS? TRY THIS DEPARTMENT AT 5c A WORD

RADIO WORLD'S QUICK-ACTION CLASSIFIED ADS

This department is intended for everybody who wants quick action on short announcements covering the buying, selling, exchanging or general merchandising in the radio and other fields. Readers of RADIO WORLD will find that it pays to read these columns every week. Advertisers will get an eight-day service here—that is, copy received for this department will appear in RADIO WORLD on the news-stands eight days after copy reaches us.

The rate for this RADIO WORLD QUICK-ACTION CLASSIFIED AD. DEPT. is 5c. per word (minimum of 10 words, including address), 10% discount for 4 consecutive insertions, 15% for 13 consecutive insertions (3 months). Changes will be made in standing classified ads. if copy is received at this office eight days before publication. RADIO WORLD, 1493 Broadway, N. Y. C. (Phone, Bryant 4796).

WANTED—Scientists to furnish money to develop an electrical discovery. Opportunity for the right parties to make some unusual investigations. P. O. Box 12, Ft. Collins, Colo.

EXCHANGE JOLLY, INTERESTING LETTERS THROUGH OUR CLUB. Betty Lee, Inc., 4254 Broadway, New York City. Stamp appreciated.

DON'T RISK TIME, MONEY and PLEASURE! Get radio for you, for your home, for money-making or science, complete. Radio Encyclopedia and Directory Illustrated; 20th Century Illustrated Radio, picture entire radio of the whole world best of all. Price for the whole thing only \$2.75. Address E. JULIUS & COMPANY, 2309 West Grand Avenue, Chicago, Ill.

EDISON STORAGE BATTERIES—350 amperes. Worth \$48. 824 North Fifth, Philadelphia, Pa.

EVERY RADIO FAN should have these two books, "101 Receiving Circuits" and "Six Successful Receiving Sets." By M. B. Sleeper. They are the most up-to-date radio books for the fan who likes to make his own, and will help you out and save you many times their cost. Both books are full of illustrations. Price, 50c. each, with 10c. extra for postage, or both for \$1.00 sent postpaid. COLUMBIA PRINT, 1493 Broadway, New York City.

BUILD YOURSELF A STORAGE "B" BATTERY from Edison Elements that will last you a lifetime. Complete units for making a 100 Volts 1500 Milliampere battery, consisting of a cabinet, switch, elements, glass tubes, nickel wire, electrolyte and blueprints for assembly \$12.50. Drilled elements 6c a pair, glass tubes 2c, separators 1c, nickel wire 1c per length. W. ROBERTS STORAGE "B" BATTERY, 41 Jefferson Street, Brooklyn, N. Y.

DRACO Tube Protectors, 15 cents each, postpaid. DUANE RADIO APPLIANCE CO., 31 Liberty Street, San Francisco, Cal.

RENEW OLD "B" BATTERIES—Simple instructions, 25c. (Coin). CONRADIO, 76 Boylston Street, Jamaica Plain, Mass.

DO YOU WANT A POWER AMPLIFIER?—You can build one from complete details given on page 6 of Radio World, dated June 9, 1923. Send 15c., or start your subscription with that issue. RADIO WORLD, 1493 Broadway, New York City.

STATEMENT OF THE OWNERSHIP, MANAGEMENT, CIRCULATION, ETC. REQUIRED BY THE ACT OF CONGRESS OF AUGUST 24, 1912.

Of Radio World, published weekly at New York, N. Y., for Oct. 1, 1923.

State of New York,
County of New York, ss.:

Before me, a Notary Public, in and for the State and County aforesaid, personally appeared Roland Burk Hennessy, who, having been duly sworn according to law, deposes and says that he is the Editor of the Radio World, and that the following is, to the best of his knowledge and belief a true statement of the ownership, management (and if a daily paper, the circulation), etc., of the aforesaid publication for the date shown in the above caption, required by the Act of August 24, 1912, embodied in section 443, Postal Laws and Regulations, printed on the reverse of this form, to wit:

1. That the names and addresses of the publisher, editor, managing editor, and business managers are: Publisher, Hennessy Radio Publications Corporation, 1493 Broadway, N. Y. C.; editor, Roland Burk Hennessy, 1493 Broadway, N. Y. C.; managing editor, Stephen L. Coles,

MAGNAVOX TYPE R3. Latest nationally advertised reproducers. List \$35. Introductory offer, \$25. The factory sealed carton is your guarantee. Radio Central, Dept. W, Abilene, Kansas.

15c. LETTERED BINDING POSTS, complete set eight, 60c; two sets, \$1.00. Prepaid, same day. Stamps accepted. Everything in radio. Ask for quotations. List for stamp. Kladag Radio Laboratories, Kent, Ohio.

GENUINE EDISON ELEMENTS (new) for making "B" Batteries. Obtained from U. S. Government. A positive and negative element—6c.; glass tube—3c; all other parts at reasonable prices. Postage, etc., 50c. extra per order. Free instructions. TODD ELECTRIC COMPANY, 103 West 23rd Street, New York.

DO YOU WANT to build a two-stage, three-circuit, regenerative set, with complete plans and all details to guide you, and nothing to guess at? Send for Radio World of June 30, 1923, and see the article by C. C. Hermann, E.E. Send 15c., or start your yearly subscription with that number. RADIO WORLD, 1493 Broadway, New York City.

LONESOME! MAKE NEW AND TRUE FRIENDS. Confidential. Write DOLLY GRAY AGENCY, Box 186B, Denver, Colo.

MAGNAVOX R3 or M1. Latest nationally advertised reproducers. List \$35. Introductory \$25. The factory sealed carton is your Guarantee. Radio Central, Dept. W, Abilene, Kansas.

ARE YOU AFTER DISTANCE THIS YEAR?—If so, get a copy of Radio World of July 7, 1923, and see the article by J. E. Anderson, M.A. Simple to operate and sure as shooting. Send 15c., or start your subscription with that issue. RADIO WORLD, 1493 Broadway, New York City.

BROADCASTERS APPRECIATE THANKS for free entertainment furnished. Our "Radio Applause Cards" make this convenient. Just mark them ballot style, address and mail. 20 for 25c.; 50 for 60c.; 100 for \$1.00, postpaid. Stamps not accepted. ERNEST F. DOW, West Newton, Mass.

WIRING A HOUSE. By Herbert Pratt. Shows a house already built; tells just how to start about wiring it; where to begin; what wire to use; how to run it according to insurance rules; in fact, just the information you need. Directions apply equally to a shop. Sixth edition. COLUMBIA PRINT, 1493 Broadway, N. Y. C. Price, 35 cents.

1493 Broadway, N. Y. C.; business manager, Fred S. Clark, 1493 Broadway, N. Y. C.

2. That the owners are: (Give names and addresses of individual owners, or, if a corporation, give its name and the names and addresses of stockholders owning or holding 1 per cent. or more of the total amount of stock): Hennessy Radio Publications Corp., 1493 Broadway, N. Y. C.; Boland Burke Hennessy, 1493 Broadway, N. Y. C.; M. J. McArthur, Statler Hotel, Cleveland, Ohio.

3. That the known bondholders, mortgagees, and other security holders owning or holding 1 per cent. or more of total amount of bonds, mortgages, or other securities are: (If there are none, so state.) None.

4. That the two paragraphs next above, giving the names of the owners, stockholders, and security holders, if any, contain not only the list of stockholders and security holders as they appear on the books of the company but also, in cases where the stockholder or security holder appears upon the books of the company as trustee or in any other fiduciary relation, the name of the person or corporation for whom such trustee is acting, is given; also that the said two paragraphs contain statements embracing affiant's full knowledge and belief as to the circumstances and conditions under which stockholders and security holders who do not appear on the books of the com-

WANTED—Scientists to furnish money to develop an electrical discovery. Opportunity for the right parties to make some unusual investigations. P. O. Box 12, Ft. Collins, Colo.

TRIPLE CIRCUIT, ATWATER-KENT REGENERATOR—including bulb and phones (\$40.00). Also slightly used \$48.00 loud speaker (\$25.00). Tubes, Transformers, Rheostats, Sockets and Variable Condensers. Cheap. Write for prices. ROBERT REED, Corning, N. Y.

CHEMICAL WONDERS—Secrets and Mysteries fully explained. New Book, 10c. 150 Funny Parodies on latest songs, 25c. R. W. COLLINS CO., 197 Fulton Street, Brooklyn, N. Y.

VACUUM TUBE RESULTS FROM A CRYSTAL SET! A "PT" Ultra-Sensitive Contact will increase the range and audibility of your crystal receiver. The most sensitive catwhisker in the world. It will not jar out. Thousands in use. Record, 1,000 miles on phone; 3,000 miles on spark. Price twenty-five cents in coin. "PT" CRYSTAL CONTACT COMPANY, BOX 1641, BOSTON.

STOP EXPERIMENTING—GET RESULTS with circuit used in leading WD11 tube set on market. Paragon of simplicity in design and construction. Circuit and specifications, 50c. OKAYED SUPPLIES CO., ELWOOD, IND.

THE SHEBOYGAN COIL tunes sharper than any other. Only the turns needed are in the circuit—no dead ends. It can be made in tube, spider-web or any other form. Fine for loading. Drawings sent for \$1.00 M. O. E. GUEHNA, 118 1/2 North 8th Street, Sheboygan, Wis.

DOES TUNED RADIO FREQUENCY PUZZLE YOU?—If so, and you want to build a set incorporating this very efficient means of getting long distance volume on either crystal or tubes, send 15c for issue of July 14, 1923, or start your subscription with that number. RADIO WORLD, 1493 Broadway, New York City.

WOULD YOU LIKE TO RECEIVE RADIO LITERATURE? Are you in the market for radio goods of any kind, either as a consumer, a distributor or a retailer? If so, send us your name and address on a post card and we will see that your name reaches the right people so that you will receive pamphlets, circulars, etc., regarding the goods you want. Address SERVICE EDITOR, RADIO WORLD, 1493 Broadway, New York City.

pany as trustees, hold stock and securities in a capacity other than that of a bona fide owner; and this affiant has no reason to believe that any other person, association, or corporation has any interest direct or indirect in the said stock, bond or other securities than as so stated by him.

5. That the average number of copies of each issue of this publication sold or distributed, through the mails or otherwise, to paid subscribers during the six months preceding the date above shown is: weekly. (This information is required from daily publications only.)

ROLAND BURKE HENNESSY, Editor.
(Sworn to and subscribed before me this 1st day of Oct., 1923.

KARL E. GOTTFRIED, Notary Public, New York County, New York County Clerk's No. 304, New York Registers No. 4228. Commission expires March 30, 1924.

Note.—This statement must be made in duplicate and both copies delivered by the publisher to the postmaster, who shall send one copy to the Third Assistant Postmaster General (Division of Classification), Washington, D. C., and retain the other in the files of the post office. The publisher must publish a copy of this statement in the second issue printed next after its filing.

LEARN RADIO

Get into the world's greatest field of profit and pleasure. Big money-making opportunities. Easy to learn. Trained men are in demand—mechanics, operators, designers, inspectors. Qualify for these high salaried positions, or make big money in your spare time. Unlimited possibilities on land and sea.

I WILL TRAIN YOU AT HOME TO BE A RADIO EXPERT

You, too, can learn, quickly and easily, to design, construct, install, operate, repair, maintain and sell all forms of Radio apparatus. No previous experience necessary. My methods are the latest and most successful in existence.

FREE Wonderful home construction tube receiving set, of the latest design. **Write Today** "Radio Facts" **FREE**

A. G. Mohaupt, Radio Engineer, AMERICAN RADIO ASS'N, Dept. 910, 4513 Ravenswood, CHICAGO



To Radio World readers who may have missed recent numbers

The newsstand sales of Radio World have increased so rapidly for several weeks past that some of our readers were disappointed to find their regular newsdealers had sold out their supplies. This is for you; if you are among the disappointed ones: Send 15c. per copy and we will mail you any of the recent issues that you may have missed, so that you can complete your files.

RADIO WORLD
1493 Broadway New York

Back numbers of Radio World supplied at regular price of 15c. a copy. Any 7 copies for \$1.00. Radio World, 1493 Broadway, New York.

FRESHMAN NOISELESS TESTED MICA CONDENSER
MFG. BY CHAS. FRESHMAN CO. Inc. NEW YORK CITY
ALL CAPACITIES—WRITE FOR LEAFLET

FOR CLEAR AND LOUD RECEPTION

Defiance Laboratory
MICA
TESTED PHONE COND
OOI MFD

Defiance Mica Condensers
Whose Quality is Guaranteed.
Made in the full capacity. Mail orders filled.
.001 25c. .0005 20c.
.002 30c. .0025 20c.
.0005, .00025, made with 1/2, 1 and 2
Meos G. L. 25c.
Dealers write for discounts.
DEFIANCE LABORATORY
65-67 West Broadway New York City

FADA

Complete markdown parts for the 5-tube Fada Neutrodyne Receiver, including drilled engraved Bakelite Panel and Base Board \$65.00
Absolutely guaranteed on our money-back basis.

Amperite—Automatic Filament Control.
Unmounted \$0.70. Mounted \$1.10
Langbein and Kaufman Variometers \$6.00
Langbein and Kaufman Variocouplers \$6.00

Our stock consists of a most complete line of all standard radio apparatus. Just let us know what you want and we will ship it to you immediately at regular manufacturers' prices.

Rametra CORPORATION 23 Warren St. New York City

PATENTS

To the Man with an Idea

I offer a comprehensive, experienced, efficient service for his prompt, legal protection, and the development of his proposition.

Send sketch or model and description, for advice as to cost, search through prior United States patents, etc. Preliminary advice gladly furnished without charge.

My experience and familiarity with various arts frequently enable me to accurately advise clients as to probable patentability before they go to any expense.

Booklet of valuable information, and form for properly disclosing your idea, free on request. Write today.

RICHARD B. OWEN
Patent Lawyer
32 Owen Building, Washington, D. C.
2276-P Westworth Bldg., New York City

Radio World as a Gift

Do you know of any young man who is building a set and requires how-to-make information? Why not send him Radio World for one year?
Send us \$6 and we will forward Radio World to any name and address you send us and will also mail a card announcing that the subscription goes forward with your compliments.

Address RADIO WORLD, 1493 Broadway, New York City.

Central Church Resumes Broadcasting of Services

AFTER a silence of several months, the regular Sunday services of Central Church will be broadcast again from Station KYW, Chicago. This feature was resumed following many inquiries and letters asking why it was discontinued.

These services, which were extremely popular, were broadcast up to the beginning of the summer through Station KYW, and were clearly heard in every state of the Union, in Canada, Cuba, Central America, and by many ships at sea. They were especially appreciated by those who lived in isolated areas, and who were unable to attend church every Sunday, as well as those persons who are invalids, or otherwise unable to attend the services at their neighborhood church.

The services of the Central Church will be broadcast every Sunday morning at eleven o'clock from Orchestra Hall, Chicago, through the installation of a special sealed telephone wire connecting the Hall with the station located on the roof of the Commonwealth Edison Building. The program will include the address of Dr. Frederick F. Shannon; organ recitals by R. W. Ermeling, one of the leading organists of America, and the music furnished by the choir of 85 voices will again be under the direction of Daniel L. Protheroe.

WGY Symphony Orchestra Begins Its Season

THE WGY Symphony Orchestra, re-organized for the season of 1923-24, will give the first of a series of five weekly concerts to be broadcast by WGY, the General Electric Company radio station at Schenectady, N. Y., on October 14, at 3:30 o'clock. Leo Kliwen, director last season, will again direct the orchestra of twenty-five men. Guest directors will be invited to take charge during the series of concerts.

Arrangements have been made with the management of the State Theatre in Schenectady to have the concerts in the large auditorium of that theatre. Pick-up devices will gather in the sound waves and the theatre will be connected to the transmitting equipment of WGY by telephone lines. The listeners will not only hear the music but also the applause which will follow the numbers.

The concerts by the WGY Symphony Orchestra last spring proved very popular with the radio fans and the continuance of the work of this organization is prompted by the many requests which have been received for a first class Sunday musical program.

Station WTAM, Cleveland

THIS is the new station just put on the air by the Willard Storage Battery Co., Cleveland, Ohio. It has 1,000 watts energy and operates on 390 meters. Its range is 2,000 miles. The scheduled program, on Eastern standard time, is as follows: Wednesday, 8:00 P. M., classical, vocal and instrumental; Saturday, 9:00 P. M., dance program by Willard orchestra.

YOU SAVE 50% OF THE USUAL COST

WORLD RADIO
Batteries Are Guaranteed 2 years in Writing
Will ship C. O. D. subject to inspection, or allow 5% discount for cash with order. Order shipped same day received. WRITE TODAY.
World Battery Co.
Dept. 17
1219 So. Wabash Ave. Chicago, Ill.

2 VOLT STORAGE BATTERY for
WD11—WD12 \$5.00
6 V., 60 Amps. \$8.50
6 V., 80 Amps. 10.00

6 Volt, 100 Amps. \$12.50
6 Volt, 120 Amps. 14.50
6 Volt, 140 Amps. 16.00

WD-11 and WD-12 TUBES REPAIRED

WD-11 or WD-12 \$2.50
C-300 or UV-200 2.75
C-301 or UV-201 3.00
C-302 or UV-202 3.50
C-301A or UV-201A 3.50
Moorshead Detectors 3.75
Moorshead Amplifiers 4.00
DY-6 or DY-6A 3.00
Also the new UV-199 3.50
All tubes guaranteed to work like new.
Mail Orders Given Prompt Attention
"24 Hour Service"

NEW DX 1 1/2 VOLT TUBES \$4.00

RADIO TUBE CORP.
70 Halsey Street Newark, N. J.
TUBES SENT PARCEL POST, C. O. D.

Whatever Your Question

Be it the pronunciation of Bolsheviki or soviet, the spelling of a puzzling word—the meaning of blighty, fourth arm, etc., this Supreme Authority—

WEBSTER'S NEW INTERNATIONAL DICTIONARY

contains an accurate, final answer. 400,000 Words. 2700 Pages. 6000 Illustrations. Regular and India Paper Editions.

G. & C. Merriam Co., Springfield, Mass.
Write for specimen pages, prices, etc., and FREE Pocket Maps if you name Radio World.

HOOK-UP AND CIRCUIT HOUNDS

Did you miss it? Do you want it? If you do you can get it by writing in to Radio World for any one of these back numbers, as per dates:

Satterlee Circuit Feb. 3
G. W. May's Wonder Circuit Feb. 17
Multi-tube Reflex Circuits March 3
One tube Superregenerative March 3
Lewis Three Tube Circuit March 10
Regenerative Radio Frequency Circuit for 5 tubes March 24
Hazeltine Neutrodyne Receiver March 31
2VK'S Transmitter circuit April 21
Compact Universal Receiver April 28
Stockelburg Pup receiver May 3
Cockaday receiver May 12
Improved Grimes Circuit, A. D. Turnbull's Long Distance Circuit, Combined Receiver and Transmitter, Improved 1 tube Rlenartz May 19

Any number for 15c. Any 7 numbers for \$1.00.
All 12 numbers for \$1.50. Or start subscription with any number. Radio World, 1493 Broadway, New York City.

M R . A M B A S S A D O R

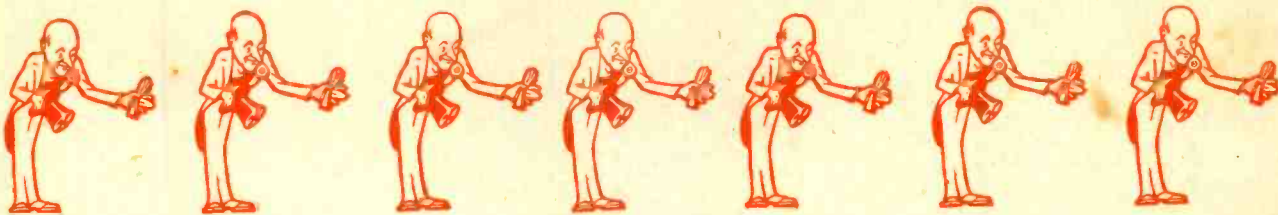

VALUE
\$6.00

AMBASSADOR TWIN TONE PHONES

BEST FOR SIX BIG REASONS

1. Are natural in tone. No distortion.
2. Are superior as to sensitiveness.
3. Are feather light and very comfortable.
4. Are better balanced as to volume.
5. Are permanently magnetized.
6. Are sold under a written money back one year guarantee.

Tower Mfg. Corp., 99 Brookline Ave., Boston, Mass.

BRANCH OFFICES:

Ambassador Sales Co., 78 Cortlandt St., New York City
Phone: Cortlandt 6296

Ambassador Sales Co., 204 Erie Bldg., Cleveland, Ohio
Phone: Prospect 3984

Ambassador Sales Co., 1261 Monadnock Bldg., Chicago, Ill.
Phone: Harrison 1633

Derby Radio Co., 1104 Marquette Ave., Minneapolis, Minn.
Phone: Geneva 7452

IF YOUR DEALER CANNOT SUPPLY YOU, WE WILL SHIP WITHOUT CHARGE BY PARCEL POST, C. O. D., THE SAME DAY THE ORDER IS RECEIVED.

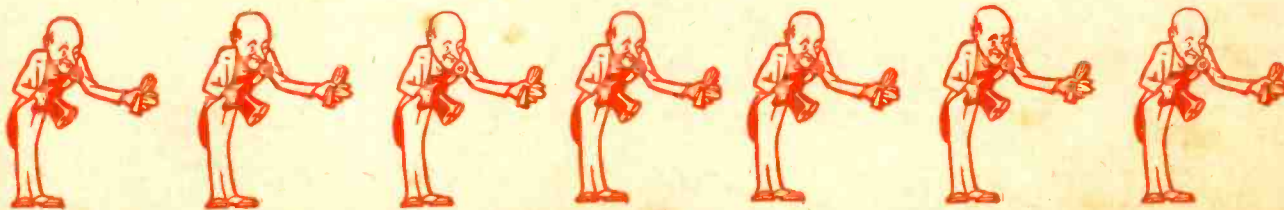

M R . A M B A S S A D O R

OUR SALES POLICY AND HELPS MEAN QUICK TURNOVER TO DEALERS