

RADIO & TELEVISION NEWS

MARCH
1951
35¢
In Canada 40¢

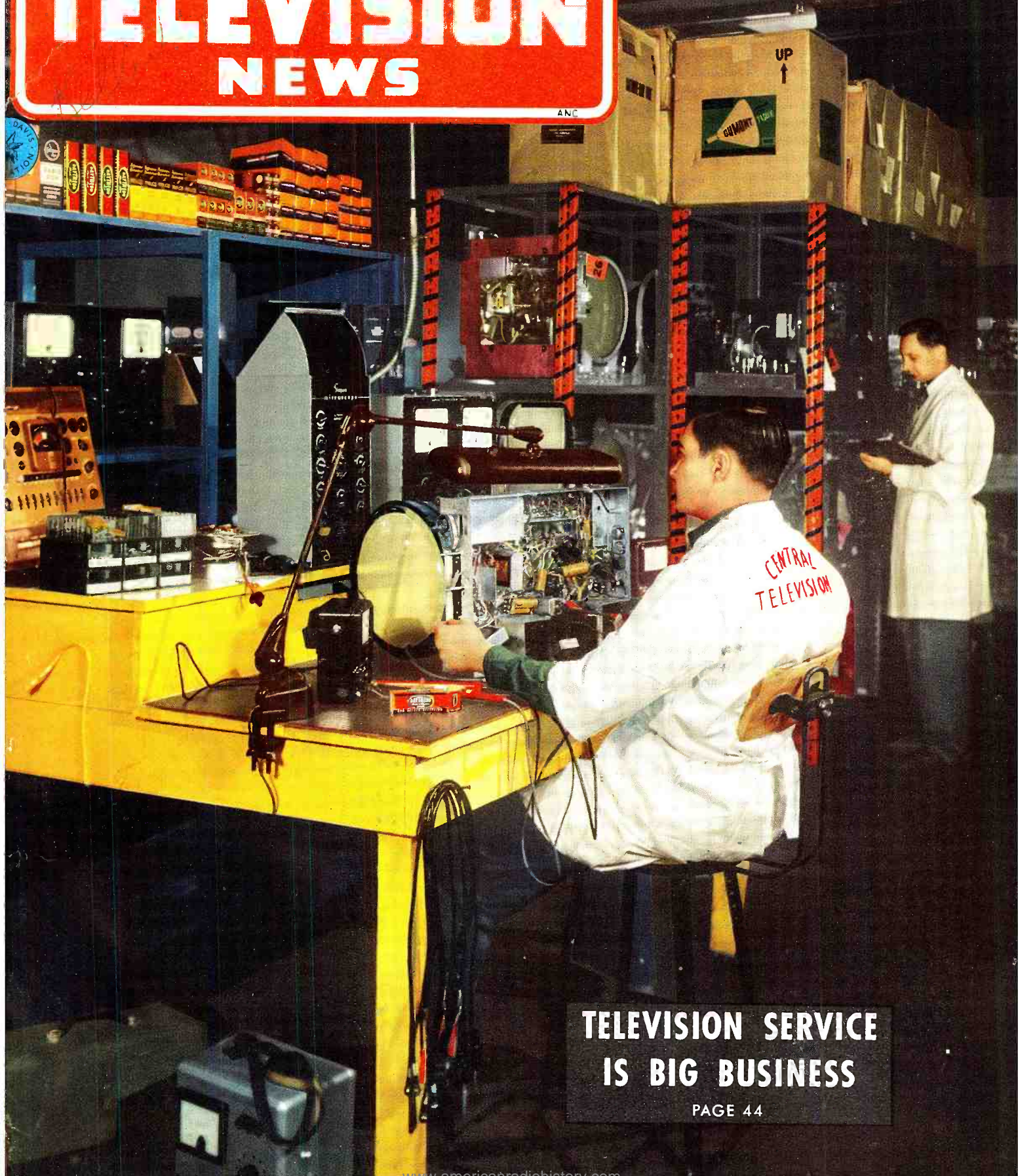

TELEVISION SERVICE
IS BIG BUSINESS

PAGE 44

THE QUALITY OF RCA TUBES IS UNQUESTIONED



Extra Performance

as a matter of course... with RCA tubes

EXPERT ENGINEERING and careful quality control are inseparable ingredients that contribute to the *extra* performance of RCA tubes. A case in point is the *double helical coil heater*... developed by RCA. By its use, hum level is greatly reduced. This feature has made possible the design of amplifier tubes having greatly increased sensitivity.

The double helical coil heater—shown in red—is designed so that the heater current flows in one circular direction to the top of the heater and in a reverse circular direction to the bot-

tom of the heater. Thus, the current flowing through the heater sets up opposing magnetic fields which effectively neutralize each other.

In addition to the helical coil construction, each tungsten or tungsten-alloy heater is coated with a pure aluminum oxide having extremely high insulation qualities, and pioneered by RCA. The use of this insulation is a major factor in reducing heater-cathode leakage—another cause of hum.

Though it adds to the complexity of manufacture, the double helical coil heater is incorporated in the design of

all RCA high-gain tubes of the 6.3-volt, 0.3-ampere, heater type intended for audio use. This is another reason why you can count on *extra* performance and long life from RCA tubes.

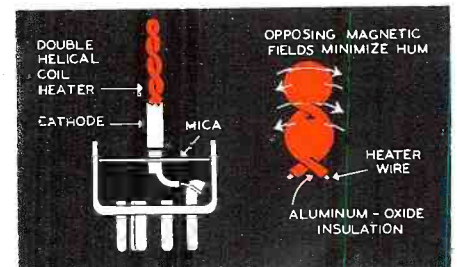

Keep informed—stay in touch with your RCA Tube Distributor



RADIO CORPORATION of AMERICA
ELECTRON TUBES
HARRISON, N. J.

NEW



I'LL TRAIN YOU FOR YOUR FCC LICENSE

A Federal Communications Commission Commercial Operator's License puts you in line for a good job in Radio or Television Broadcasting, Police, Marine, Aviation, Two-way, Mobile or Micro-wave Relay Radio. Mail coupon below for 64-page book FREE. It will give you complete facts about my NEW Communications course.



YOU BUILD THIS TRANSMITTER

with parts I send. With this Transmitter you practice how to put a station "on the air." You perform procedures demanded of Broadcast Station Operators, conduct many experiments, make many practical tests.

LEARN COMMUNICATIONS by PRACTICING at Home in Spare Time

with MANY KITS of RADIO EQUIPMENT I SEND



MY COURSE INCLUDES TELEVISION

Course Is New! Different!

Mail coupon now for facts about my NEW, intensely practical course in Radio-Television Communications. Let me send you FREE book. Read outlines of 78 lesson texts written by leaders in Communications and edited for you by my practical staff. See the nine big Kits of Parts I send that "bring to life" theory you learn. Read about the Transmitter you build and operate, about the Electronic Multitester you get. All equipment yours to keep. My NEW course covers Theory thoroughly and you get Practical Experience building units like those shown at the left. It's backed by N. R. I.—the world's oldest and largest home study Radio-Television school.



YOU BUILD this Transmitter Power Supply used in the basic experiments in RF and AF amplifiers, frequency multipliers, buffers, etc.



YOU MEASURE current, voltage (AC, DC and RF), resistance and impedance in circuits with Electronic Multitester you build. Shows how basic transmitter circuits behave; needed to maintain station operation.

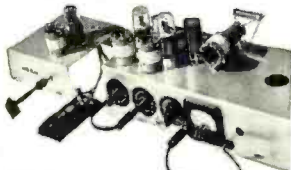

YOU PRACTICE setting up code, amplitude and frequency modulation circuits (put voice, music, etc., on "carrier signals" you produce). You learn how to get best performance.

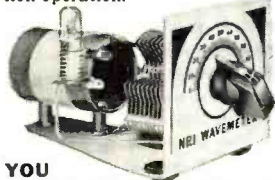

YOU BUILD this Wavemeter and use it to determine frequency of operation, make other tests on transmitter currents.

Ever think HOW FAST Radio-Television Communications is changing, developing, growing? Have you considered what this amazing progress can mean to you?

Look at these facts. In 1946 only 6,000 Television sets were sold. In 1950, over 5,000,000. By 1954, 25,000,000 Television sets will be in use, according to estimates. 100 Television Stations are operating in 35 states. Authorities predict there will be over 1,000 Television Stations. This rapid growth means new jobs, more jobs, good pay for qualified men all over the U. S. and Canada. Then add development of FM, Two-way Radio, Police, Marine, Aviation and Micro-wave Relay Radio! Think what all this means! New jobs, more jobs for beginners! Better jobs, better pay for experienced men!

Are you a beginner who wants steady work in this growing field? My NEW course can help you get an FCC License and prepare for the job you want. Are you a man with some training in Radio or Radar, or a Licensed Operator? My NEW course modernizes, increases the value of your knowledge and experience!

Servicing Training Also Offered by N. R. I.

If you prefer a good-pay job in Radio-Television Servicing or your own money-making Radio-Television Sales and Service Shop, I'll train you at home. My famous Servicing Course also includes many Kits of Radio Parts. You use them to get PRACTICAL EXPERIENCE with circuits common to Radio and Television. I also show you how to make \$5, \$10 a week or more EXTRA MONEY fixing neighbors' Radios while training. Full information in my 64-page book. Mail coupon.

Mail Coupon For Book FREE

Send today! See what my NEW course is like. Find out how I get you ready for a brighter future, better earnings, more security in Radio-Television. Send coupon now in envelope or paste on a postal. NO OBLIGATION. NO SALESMAN WILL CALL! My book, sent to you FREE, tells the full story. J. E. SMITH, President, Dept. 1 CE, National Radio Institute, Washington 9, D. C.

VETERANS Get this training under G. I. Bill MAIL COUPON!

I TRAINED THESE MEN



"N.R.I. has been my stepping stone from a few hundred to over \$4,000 a year as a Radio Engineer."—ALTON B. MICHAELS, Trenton, Georgia.



"I am employed by WKBO as transmitter operator. Have more than doubled salary since starting in Radio full time!"—A. HERR, New Cumberland, Penna.



"Am Broadcast Engineer at WLPN. Your NEW Communications course shows the kind of equipment we use."—J. BANGLE, JR., Suffolk, Virginia.



"4 years ago, I was a book-keeper with hand-to-mouth salary. Am now Radio Engineer with ABC network."—N. H. WARD, Ridgefield Park, N. J.

MAIL NOW-BOOK FREE

MR. J. E. SMITH, President, Dept. 1 CE National Radio Institute, Washington 9, D. C.

Mail me your 64-page Book about Radio and Television Communications opportunities and training. (No salesman will call. Please write plainly.)

Name.....Age.....
 Address.....
 City.....Zone.....State.....
 Check if Veteran Approved Under G. I. Bill

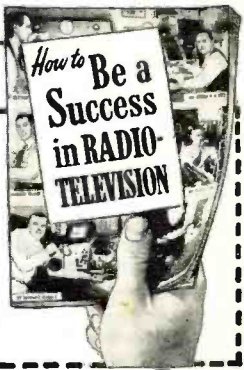

Editor
OLIVER READ, D. Sc., D. Litt., W9ETI

Managing Editor
WM. A. STOCKLIN, B.S.

Technical Editor
H. S. RENNE, M.S.

Associate Editor
RAY FRANK, W9JU

Eastern Editor
HAROLD BECKER

Television Consultant
MILTON S. KIVER

Short-Wave Editor
KENNETH R. BOORD

Editorial Assistants
I. M. CARROLL

E. V. HITZEL

P. B. HOEFER

Staff Artist
R. S. KUPJACK

Chief Draftsman
B. L. NEWMAN, W9ROB

Advertising Manager
L. L. OSTEN

Midwest Adv. Manager
JOHN A. RONAN, JR.

Art Director
HERMAN R. BOLLIN

RADIO & TELEVISION NEWS

First in
radio-television-electronics

Average Paid Circulation over 200,000

Radio News Trademark Reg. U.S. Pat. Office No. 521506 • Television News Trademark Reg. U.S. Pat. Office No. 517465
Radio & Television News Trademark Reg. U.S. Pat. Office No. 517025

CONTENTS

MARCH, 1951

How TV Came to Panther Valley.....	E. D. Lucas, Jr.	31
Motor Speed Controls.....	Ed Bukstein	35
An Ultraviolet Probe.....	C. E. Atkins	36
Tube Substitutions in Home Receivers.....	Meyer Chertock	38
A High-Quality Audio System.....	Howard T. Sterling & Alan Sobel	39
Low Cost Vest Pocket Radio Receiver.....	Mark A. Coppin	43
TV Servicing Is Big Business.....	Carl Korn	44
Distortion Measurements without Tubes.....	Lawrence Fleming	46
Compact 3-Band Mobile Converter.....	Robert Lewis, W8MQU	48
Resistance Decade Applications.....	Rufus P. Turner, K6AI	50
Practical Sound Engineering (Part I).....	H. M. Tremaine	52
A Unitized Band-Switching Transmitter.....	Carl V. Hays, W6RTP	56
Mac's Radio Service Shop.....	John T. Frye	60
Horizontal Pulling (Part I).....	John R. Meagher	61
Servicing Intersync Circuits.....	Solomon Heller & Peter Orne	64
A New V.F.O. Keying Method.....	Ed Miller, W7JBK	69
Increasing Bandwidth of Older Oscilloscopes.....	James Kauke	104
Radio-TV Service Industry News.....		158
The Ad-Viser (Part 7).....	Irving Settel	164



COVER PHOTO: One of the two completely equipped service laboratories of Central Television Service, Inc. This progressive Chicago firm handles 30,000 television servicing contracts. (Kodachrome by Black Box Studio Inc.)

Chairman of the Board and Publisher
WILLIAM B. ZIFF

President
B. G. DAVIS

Secretary-Treasurer
ARTHUR T. PULLEN

Vice-Presidents
MICHAEL H. FROELICH
Dir. Eastern Div.

H. J. MORGANROTH
Production Director

LYNN PHILLIPS, Jr.
Advertising Director

H. G. STRONG
Circulation Director

BRANCH OFFICES
NEW YORK (17)
366 Madison Ave., MUrray Hill 7-8080

LOS ANGELES (14)
815 S. Hill St., TUcker 9213
Manager, WILLIAM L. PINNEY

DEPARTMENTS

For the Record.....	The Editor	8	Technical Books.....	98
Spot Radio News.....		16	New TV Products.....	122
Within the Industry.....		24	Manufacturers' Literature.....	132
Short-Wave.....	K. R. Boord	55	MARS.....	140
What's New in Radio.....		80	AFCA News.....	144



COPYRIGHT 1951
ZIFF-DAVIS PUBLISHING COMPANY
185 North Wabash Ave., Chicago 1, Ill.
VOLUME 45 • NUMBER 3



Member
Audif Bureau of
Circulations

RADIO & TELEVISION NEWS is published monthly by the Ziff-Davis Publishing Company at 185 N. Wabash Ave., Chicago 1, Ill. Entered as second-class matter July 21, 1948, at the Post Office, Chicago, Ill., under the act of March 3, 1879. Entered as second-class matter at the Post Office Department, Ottawa, Canada, under the act of March 3, 1948. SUBSCRIPTION RATES: in U. S., Canada, Mexico, South and Central America and U. S. Possessions, \$4.00 for twelve issues; in British Empire \$5.00; all other foreign countries, \$5.00 for twelve issues. RADIO-ELECTRONIC ENGINEERING EDITION SUBSCRIPTION RATES: in U. S., Canada, Mexico, South and Central America and U. S. Possessions, \$6.00 for twelve issues; in British Empire \$7.00; all other foreign countries, \$7.00 for twelve issues. Subscribers should allow at least two weeks for change of address. All communications about subscriptions should be addressed to the Director of Circulation, 185 N. Wabash Ave., Chicago 1, Ill. CONTRIBUTIONS: Contributors are advised to retain a copy of their manuscripts and illustrations. Contributions must be accompanied by return postage and they will be handled with reasonable care, but this magazine assumes no responsibility for their safety. Any copy accepted is subject to whatever adaptations and revisions are necessary to meet the requirements of this publication. Payment covers all author's, contributor's and contestant's rights, title, and interest in and to the material accepted and will be made at our current rates upon acceptance. All photos and drawings will be considered as part of the material purchased.

RADIO & TELEVISION NEWS

**NOW... GET EVERYTHING YOU
NEED TO LEARN AND MASTER**

TELEVISION

**RADIO-ELECTRONICS
...AT HOME!**

**Use REAL commercial-type equip-
ment to get practical experience**

Your future deserves and needs every advantage you can give it! That's why you owe it to yourself to find out about one of the most COMPLETE, practical and effective ways now available to prepare AT HOME for America's billion dollar opportunity field of TELEVISION-RADIO-ELECTRONICS. See how you may get and keep the same type of basic training equipment used in one of the nation's finest training laboratories... how you may get real STARTING HELP toward a good job or your own business in Television-Radio-Electronics. Mail the coupon today for complete facts — including 89 ways to earn money in this thrilling, newer field.



**Here's the
REAL THING!**

**SET UP YOUR OWN
HOME LABORATORY**



Oscilloscope

R-F Signal
Generator

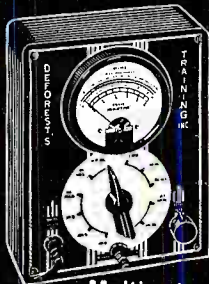
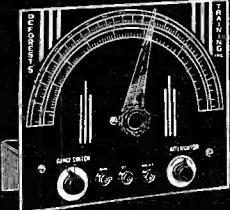

Multimeter

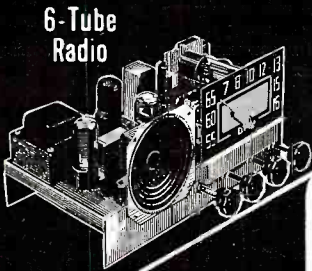

6-Tube
Radio

**HOME
MOVIES**

De FOREST'S TRAINING, INC.
CHICAGO 14, ILLINOIS
A De VRY INSTITUTION

ABOVE: Build and keep a real 16 INCH commercial TV receiver. Optional after completing regular training at slight additional cost.

D.T.I., ALONE, INCLUDES BOTH MOVIES and HOME LABORATORY
In addition to easy-to-read lessons, you get the use of HOME MOVIES — an outstanding training advantage — plus 16 big shipments of Electronic parts. Perform over 300 fascinating experiments for practical experience. Build and keep real commercial-type test equipment shown at left.

**Get BOTH of these
information packed
publications FREE!**

MODERN LABORATORIES
If you prefer, get all your preparation in our new Chicago Training Laboratories—one of the finest of its kind. Ample instructors, modern equipment. Write for details!

MILITARY SERVICE!
If you're subject to military service, the information we have for you should prove doubly interesting. Mail coupon today.



ACT NOW! MAIL COUPON TODAY!

DeFOREST'S TRAINING, INC., Dept. RN-3-H
2533 N. Ashland Ave., Chicago 14, Ill.

Without obligation, I would like your late News-Bulletin showing 89 ways to earn money in Television-Radio-Electronics... and how I may prepare to get started in this thrilling field.

Name..... Age.....
Street..... Apt.....
City..... Zone..... State.....



Service Clinic!

Latest information to help you better service Raytheon TV

HOW RAYTHEON ELIMINATES RETRACE LINES

It's common practice in TV receivers to depend on the transmitted blanking pulse to sufficiently stop vertical retrace lines from appearing in the picture.

However, certain conditions of picture transmission (fade out, thin films, receiver adjustment, etc.)

allow retrace line interference . . . interference that would not be tolerated in motion pictures or photography. This would appear in the TV picture as illustrated in Figure 1.

To eliminate this in TV, Raytheon has incorporated the following circuit.

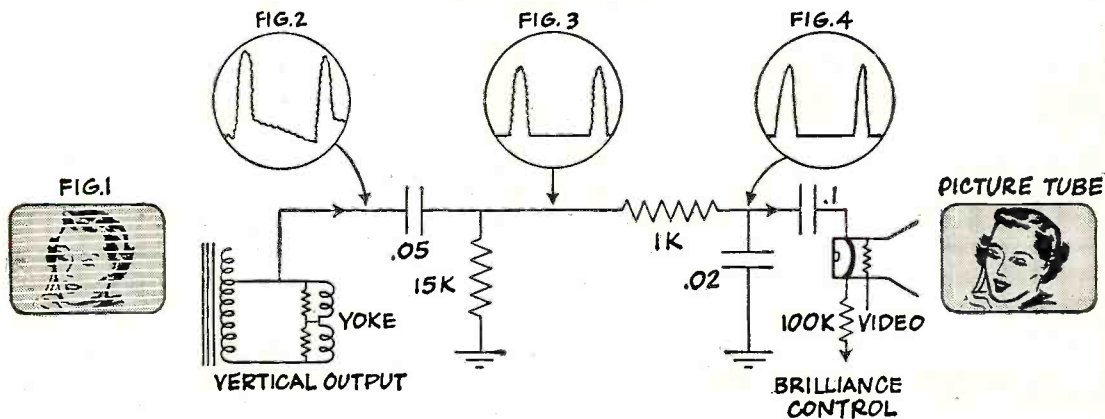

The above circuit utilizes the vertical output voltage wave-shape as shown in Figure 2. This wave shape is modified in the following manner:

a) The vertical saw-tooth component is removed, as shown in Figure 3, by a differentiating filter consisting of the .05 mfd. condenser and the 15,000 ohm resistor.

b) Any undesirable higher frequency components are removed, as shown in Figure 4, by an integrating filter consisting of the 1000 ohm resistor and the .02 mfd. condenser.

This modified positive vertical flyback pulse will

bias the picture tube cathode beyond illumination cutoff during the period of vertical retrace. This circuit will prevent retrace lines from appearing regardless of the vertical hold adjustment either on picture or on raster.

Here again is another example of how Raytheon engineering works toward improving the quality of Raytheon TV and, at the same time, helps ease the serviceman's burden.

This is one of many reasons why you can always feel free to recommend Raytheon television to a friend or a customer.



Dependably Built for Dependable Performance



THE STARLIGHT—Model RC-1720

Belmont Radio Corporation, 5921 W. Dickens Ave., Chicago 39, Ill.
Subsidiary of Raytheon Manufacturing Company

YOUR OPPORTUNITY IS HERE NOW! LEARN

TELEVISION

RIGHT AT HOME!



By the new method of **TRANSPONDENCE**

training on film and tape recordings

Now the De Forest-Sanabria Corporation—a division of the world's largest television training school—brings class-room instruction to you right in your own home! You actually hear your instructor's recorded voice. At the same time you watch "blackboard" size projected pictures, diagrams and illustrations. It's the quick, easy way to equip yourself for the big earnings in television—today!

LOOK . . . You get the tape recorder and projector right at the start of your course!



HEAR your instructor

It's even better than the classroom, because you can repeat the instructor's lectures until they're thoroughly understood.

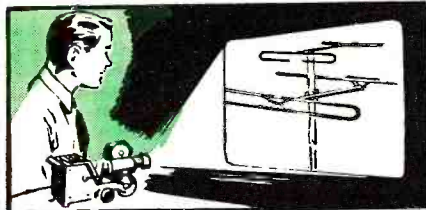

SEE 2000 illustrations

You learn quicker when you see diagrams and illustrations in black-board size.

You get the famous "TRANSPONDER" precision built, high fidelity tape recording machine with your very first lesson—and a powerful projector with which you can view diagrams and illustrations enlarged to a size that makes them easy to see and understand.

APPROVED FOR VETERANS UNDER G.I. BILL



READ from reference library

You receive complete books, pamphlets and manuals to supplement your instructor's lessons.



ASK your questions on tape

Tell your instructor about anything that puzzles you and get his answers back pronto.



BE A SUCCESS . . . ACT NOW!

Millions of television set owners are demanding qualified television technicians to service their sets. There is a tremendous shortage of such qualified men today and will be for many years to come. Get in on the ground floor of this booming industry and be prepared to accept a steady, big pay job for life. We can qualify you quickly, easily, surely—and help get you a job when you complete your course. Send for illustrated booklet that gives the complete details.

MAIL COUPON TODAY!

De Forest-Sanabria Corporation **FREE BOOK**
Dept. RN-3
5050 Broadway, Chicago 40, Ill. **TELLS HOW**

Dear Sirs:

Please send me copy of your free illustrated booklet which describes the new TRANSPONDENCE method of learning television at home under the direction of Dr. Lee de Forest and U. A. Sanabria.

NAME _____ AGE _____

ADDRESS _____

CITY _____ STATE _____

(Mail in envelope or paste on a postcard.)

The De Forest-Sanabria Corp.

An affiliate of American Television, Inc.

5050 North Broadway, Chicago 40, Illinois



It's the newest convenience in soldering. *Twin Spotlights* on your new 135-watt WELLER Soldering Gun completely eliminate shadows; you see clearly even in the darkest chassis.

Pull the trigger of your WELLER Gun, heat and light come on together—in just 5 seconds! No more waiting, wasted current, or blind soldering. Your WELLER Gun pays for itself in a few months!



NEW
135-WATT
WELLER
SOLDERING
GUN

Specially Designed for TV and Radio Work

- **DUAL SOLDERLITE**—Two prefocused spotlights completely eliminate shadows—let you see clearly what you are soldering.
- **OVER/UNDER DESIGN**—Tube construction braces tip and improves visibility.
- **5-SECOND HEATING**—No waiting. Saves power. Pull the trigger and you solder!
- **LONGER REACH**—Slides easily into deep chassis, reaches the tightest corners.
- **GREATER CAPACITY**—Smaller, lighter, with greater soldering capacity.
- **TRIGGER-SWITCH CONTROL**—Adjusts heat to the job. Saves current—no need to unplug gun between jobs.
- **DUAL HEAT**—Single heat 100 watts; dual heat 100/135 watts; 120 volts, 60 cycles. Handles all light-duty soldering.

See new Models WS-100 and WD-135 at your distributor, or write for bulletin direct.

- **SOLDERING GUIDE**—Get your new copy of "Soldering Tips"—revised, up-to-date and fully illustrated 20-page booklet of practical soldering suggestions. Price 10¢ at your distributor, or order direct.



WELLER
ELECTRIC CORP.

810 Packer Street, Easton, Pa.

For the RECORD.

BY THE EDITOR

AMATEUR RADIO TO BOLSTER CIVIL DEFENSE

EVERY so often, when things seem relatively quiet, there comes a phone call with information on some pet subject that really hits the jackpot. The afternoon of January 17 was one of these moments. A "long-distance from the FCC in Washington" was on the wire. This one, unlike routine reports, was very special and timely. So much so that at its conclusion, and after confirmation, we set to the task of contacting Amateur Radio Civil Defense personnel, the press, and hams known to be vitally interested in the contents of the message. In a matter of minutes, the news had spread via short and long skip, and via news broadcasts in the mid-west. Both coasts were given the long-awaited news (from Chicago) over the amateur bands.

The news made headline copy on a television program—just a few hours later. The "scoop," as it was referred to on AM and TV, had indeed sparked a new interest in amateur radio and had given answer to the all-important question "will the Government again crack down on ham radio in the present or greater emergency?"

The answer is now known. For the benefit of inactive hams and other interested communicators we quote the release dated January 17, 1951 in its entirety:

"FEDERAL COMMUNICATIONS COMMISSION, Washington 25, D.C., Frequencies Available for Amateur Participation in Civil Defense Communication.

"The Civil Defense Administration has brought to the attention of the Commission the fact that licensed radio amateurs may be requested by the appropriate local Civil Defense authorities to provide civil defense communications or to supplement other existing communications systems for civil defense purposes.

"The matter of permanent availability of specific frequency bands within the regularly allocated amateur bands for eventual use by amateurs in providing civil defense communications, after any suspension of normal amateur activity which may later be found to be necessary because of war or other national emergency, has been the subject of particular study by the Commission, the Civil Defense Administration and the Armed Forces of the United States.

"After consideration of all factors known to be involved at this time, including frequency requirements of other radio services in time of war or other national emergency, certain fre-

quency bands already allocated to amateurs have been selected for their retention and use for the purposes described in the preceding paragraph. The extent to which these bands meet the actual requirements for amateur participation in civil defense communications may be reviewed after a sufficient number of local communities have established appropriate civil defense plans, conducted communications drills or otherwise accumulated data which will permit such a review.

"The frequency bands which will remain available for civil defense use by amateurs are tabulated herewith:

1200—2000 kc.	50.35— 50.75 mc.
3500—3510 kc.	53.35— 53.75 mc.
3990—4000 kc.	145.17—145.71 mc.
28.55—28.75 mc.	146.79—147.33 mc.
29.45—29.65 mc.	220 —225 mc.

"In addition to the above bands, the band of frequencies 1750-1800 kc. will continue to be available for use by properly qualified amateurs and others to provide a Disaster Communications Service, but it should be noted that such a service is intended as a permanent one for use in a disaster occurring at any time, to assist in handling communications within or with a disaster area, whereas the frequencies listed above are designated for amateur use for the handling of such communications as may be required in the interest of civil defense.

"This notice is primarily intended to make clear which portions of the regularly allocated amateur bands will continue to be available for amateur use to provide civil defense communications after any suspension of normal amateur activity. It is not intended to deal with the various other phases of the problem, such as eligibility for continuing operation in these bands, operating regulations and procedures, and other related matters. However, to the extent that knowledge of frequency availability is required for planning purposes, such planning may proceed on the basis of this announcement for the organization of civil defense communication networks.

"Nothing herein should be construed to alter in any way the present availability of amateur frequency bands or the normal operation of amateurs in these bands as presently being practiced in accordance with existing Commission rules."

The above public release, received in the mail the following morning, ended the incident—long after the news had spread via amateur radio, the press, television, AM, and local phone calls. Yes—good news travels fast! . O.R.

RADIO & TELEVISION NEWS

new

1951 ALLIED catalog

free!

the only complete
up-to-date catalog for
Everything in Radio, Television
and Industrial Electronics

212 value-packed pages



Send for it today!

Here's the only *complete, up-to-date* Buying Guide to TV, Radio and Industrial Electronics—packed with the world's largest selections of quality equipment at lowest, money-saving prices. See the latest in TV, AM and FM receivers; radio-phonos; new Sound Systems and P.A. equipment; High-Fidelity Custom Sound components; recorders and accessories; full selections of newest Amateur receivers and station gear; test instruments; builders' kits; huge listings of parts, tubes, tools, books—the world's *most complete stocks* of quality equipment.

ALLIED gives you *every* buying advantage; speedy delivery, expert personal help, lowest prices, assured satisfaction, liberal time payment terms. Get the latest 1951 ALLIED Catalog. Keep it handy—it will save you time and money. Send for your FREE copy!

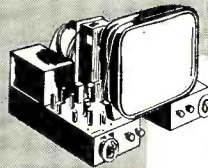

**THE WORLD'S
LARGEST STOCKS**



Radio Parts Unlimited
Test Instruments
Television & Home Radios
P.A. and Hi-Fi Equipment
Amateur Station Gear
Supplies for Industry

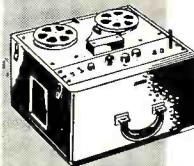

QUICK, EXPERT SERVICE



SEND TODAY FOR RADIO'S
LEADING BUYING GUIDE

ALLIED IS YOUR TELEVISION HEADQUARTERS



To keep up with TV, depend on ALLIED! Count on us for the latest releases and largest stocks of picture tubes, component parts, antennas and accessories—plus the latest in TV tuners and kits. If it's anything in TV—we have it. So remember —for TV—it's ALLIED First!

free



ALLIED RADIO CORP.
833 W. Jackson Blvd., Dept. 1-C-1
Chicago 7, Illinois

Send FREE 212-page 1951 ALLIED Catalog No. 126

Name _____

Address _____

City _____ Zone _____ State _____

ALLIED RADIO

the World's Largest Radio Supply House

EVERYTHING IN ELECTRONICS

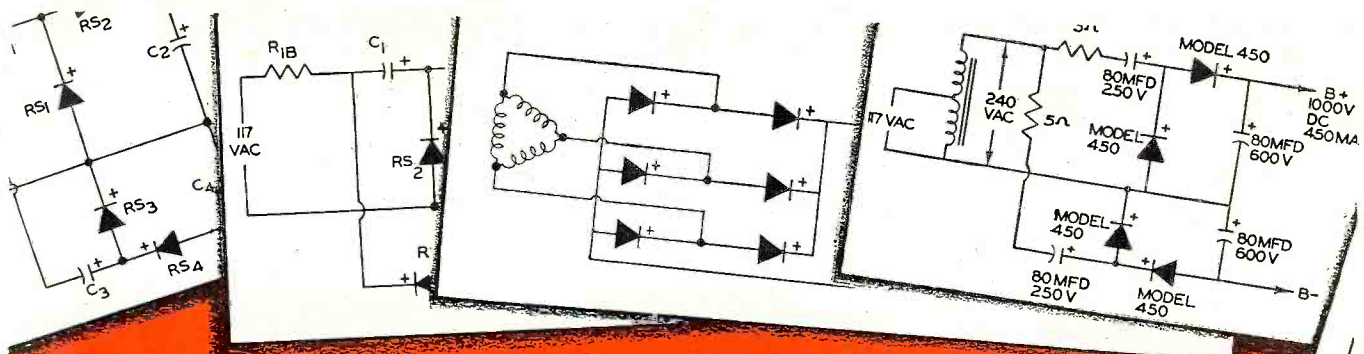

**For D C Power – the trend is to
SELENIUM RECTIFIERS**

**And In SELENIUM RECTIFIERS –
the trend is to**

**Sarkes
Tarzian**

**"Centre-Kooled"
SELENIUM RECTIFIERS
(Radio Type)**

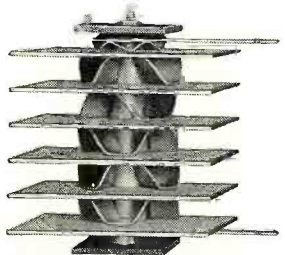

**HIGH VOLTAGE
SELENIUM RECTIFIERS**

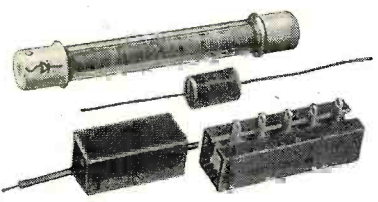

POWER RECTIFIERS

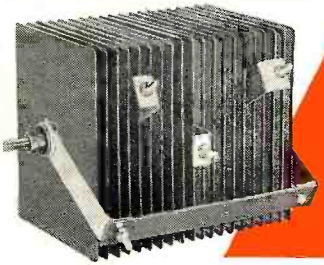

**Sarkes
Tarzian**

Over 3,000,000 Centre-Kooled rectifiers are now in use in radio and television receivers as well as all types of electronic and control equipment.

The field performance is unexcelled and typical units on life test in the laboratory have operated continuously for nearly 9,000 hours at plate temperatures of approximately 100 degrees Centigrade.

Whatever your application—consult with Sarkes Tarzian engineers for the selenium rectifier to fit your needs.

Remember—the Sarkes Tarzian 64 page Selenium Rectifier Handbook containing the most complete rectifier information ever published is now available. (Price 25 cents)

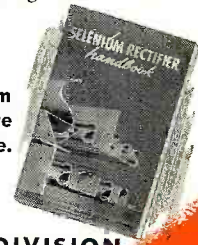

**SARKES TARZIAN, INC., RECTIFIER DIVISION
Dept. L, 415 North College Ave., Bloomington, Indiana**

Where   are used, Specify 



Learn RADIO

TELEVISION, ELECTRONICS

by

SHOP METHOD HOME TRAINING

Let **NATIONAL SCHOOLS**, of Los Angeles, a practical Technical Resident Trade School for almost 50 years, train you for today's unlimited opportunities.

You receive all parts, including tubes, for building this fine, modern Superheterodyne Receiver. This and other valuable standard equipment becomes your property.

these two FREE books will tell you how



**WE BRING
NATIONAL
SCHOOLS TO YOU!**

GOOD JOBS AWAIT THE TRAINED RADIO TECHNICIAN

You are needed in the great modern Radio, Television and Electronics industry! Trained technicians are in constant and growing demand at excellent pay—in Broadcasting, Communications, Television, Radar, Research Laboratories, Home Radio Service, etc. National Schools Master Shop Method Home Study Course, with newly added lessons and equipment, can train you in your spare time, *right in your own home*, for these exciting opportunities. Our method has been proved by the remarkable success of National Schools-trained men all over the world.

You Learn by Building Equipment with Standard Radio Parts We Send You

Your National Schools Course includes not only basic theory, but *practical* training as well—you *learn by doing*. We send you complete standard equipment of professional quality for building various experimental and test units. You advance step by step until you are able to build the modern superheterodyne receiver shown above, which is yours to keep and enjoy. You perform more than 100 experiments—build many types of circuits, signal generator, low power radio transmitter, audio oscillator, and other units. The Free Books shown above tell you more about it—send for them today!

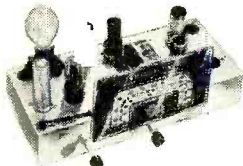

NOW! NEW PROFESSIONAL MULTITESTER INCLUDED

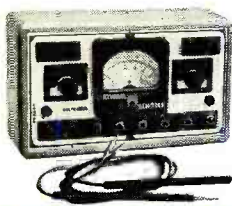

This versatile testing instrument is portable and complete with test leads. Simple to operate, accurate and dependable. You will be able to quickly locate trouble and adjust the most delicate circuits. You can use the Multitester at home or on service calls. It is designed to measure AC and DC volts, current resistance and decibels. You will be proud to own and use this valuable professional instrument.

GET THE DETAILS - SEND THE COUPON →

Lessons and Instruction Material Are Up-to-date, Practical, Interesting

National Schools Master Shop Method Home Training gives you basic and advanced instruction in all phases of Radio, Television and Electronics. Each lesson is made easy to understand by numerous illustrations and diagrams. All instruction material has been developed and tested in our own shops and laboratories, under the supervision of our own engineers and instructors. A free sample lesson is yours upon request—use the coupon below.

TELEVISION TRAINING

A complete series of up-to-the-minute Television lessons is an integral part of your course, covering all phases of Television repairing, servicing and construction.

Here are just a few of the interesting facts you learn with the

FREE SAMPLE LESSON

1. How radio receivers operate.
2. How the antenna circuit is constructed.
3. Converting signal currents into sound.
4. How the R-F transformer handles the signal.
5. How the tuning circuit functions.
6. The Radio "bands."

**APPROVED
FOR
VETERANS**
Check
coupon below.

NATIONAL SCHOOLS

LOS ANGELES 37, CALIFORNIA EST. 1905



MAIL OPPORTUNITY COUPON FOR QUICK ACTION

National Schools, Dept. 3-RN
4000 South Figueroa Street
Los Angeles 37, California

(Mail in envelope or
paste on penny postcard.)

Mail me FREE the book "Your Future in Radio-Television" and the sample lesson of your course. I understand no salesman will call on me.

NAME _____ AGE _____

ADDRESS _____

CITY _____ ZONE _____ STATE _____

Check here if veteran of World War II



Model 666-R

NOTE the wide ranges of this compact pocket-size instrument. Note controls—flush with panel. Then study the inside view. Nowhere will you find, in design and manufacturing quality, the equal of 666-R.



A BASIC TOOL

**POCKET-SIZE: VOLT-OHM-MIL-AMMETER
WITH SELF-CONTAINED RESISTANCE RANGES TO 3 MEGOHMS**

1. Resistance Ranges from 0-3000 Ohms (.5 Ohm low reading) to 3 Megohms, self-contained. Also A.C.-D.C. Volts to 5000, 10 ranges; and 3 Direct Current ranges.

2. Enclosed Selector Switch, molded construction. Keeps dirt out, and retains contact alignment permanently.

3. Unit Construction—Resistors, shunts, rectifier, batteries, are housed in a molded base integral with the switch. Direct connections without cabling. No chance for shorts.

4. Resistors are precision film or wire-wound types, each in its own compartment.

ONLY \$26.50—at your Distributor

In Canada: Triplett Instruments of Canada, Georgetown, Ontario.

FOR THE MAN WHO TAKES PRIDE IN HIS WORK

Triplet

TRIPLETT ELECTRICAL INSTRUMENT CO., BLUFFTON, OHIO, U. S. A.

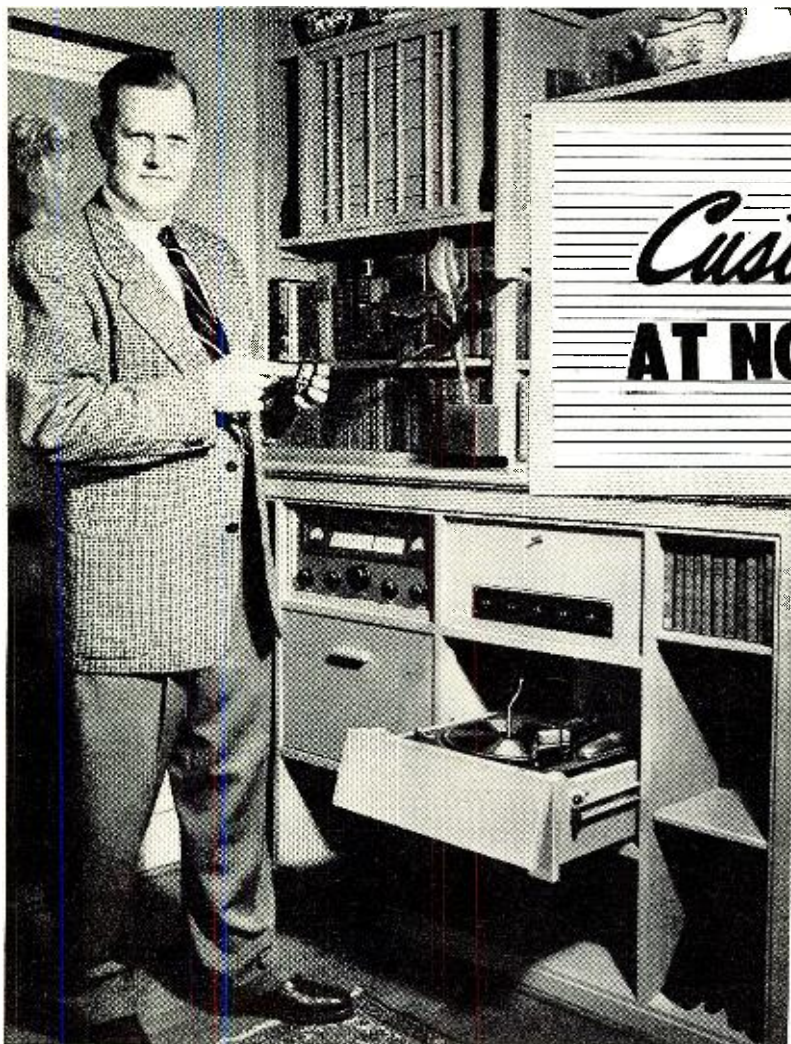

Custom Quality
AT NO EXTRA COST!



VARIABLE RELUCTANCE CARTRIDGES

WHERE cost is no problem, custom designers specify the best. Philip C. Kelsey of Guilford, Connecticut, shown here beside one of his made-to-order FM phonograph installations, says:

"Customer satisfaction means everything in my business. That's why G-E cartridges are standard in all my installations. I know they are the best."

This same cartridge—with diamond or sapphire tip—belongs in your line and in your customers' sets. More than 100,000 G-E cartridges were sold last year—a better score than all other VR cartridges combined! Today, more than ever before, dealers will push quality merchandise backed by a name people believe in—General Electric.



Build Your Profits... Build Your Reputation

Stock the complete G-E Parts Line now—let your customers know you can put new life into radios, phonographs, TV sets, with General Electric

- Speakers
- Styli
- Tone Arms

Call your G-E distributor today, or write: *General Electric Co., Electronics Park, Syracuse, N. Y.*

JUST OUT! GET YOUR COPY NOW!

General Electric Company
 Section 931
 Electronics Park, Syracuse, N. Y.
 Send me your new stylus booklet
 "Why You Should Use a Diamond."



NAME _____
 ADDRESS _____
 CITY _____ STATE _____

GENERAL  ELECTRIC

March, 1951

NOTHING... ABSOLUTELY NOTHING...



Beats a "Surprise" TRADE-IN ALLOWANCE ON YOUR USED TEST AND COMMUNICATION EQUIPMENT

In exchange for a new

hallicrafters

Get your trade-in deal working today!
Wire, write, phone or use handy coupon.



HALLICRAFTERS SX-71

\$199⁵⁰

Shpg. wt. 33 lbs.....Only

For the very thriftiest way to buy your new SX-71, trade your used equipment. Profit with a "Surprise" trade in!

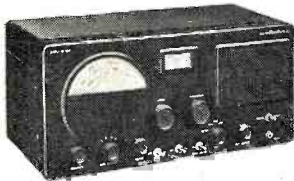

HALLICRAFTERS S-77

Improved AC-DC version of the famous S-40B—the world's most popular Ham receiver. And with a "Surprise" trade-in you can save plenty.

\$99⁹⁵

Shpg. wt. 32 lbs.....Only



HALLICRAFTERS S-38B

For amazing savings apply our "Surprise" trade-in allowance against this price.

\$49⁵⁰

Shpg. wt. 14 lbs.....Only



HALLICRAFTERS SX-62

But you can buy it for less when you take advantage of a money saving "Surprise" trade-in allowance.

\$289⁵⁰

Shpg. wt. 70 lbs.....Only

All prices f.o.b. St. Louis
Phone: CHestnut 1125



HALLICRAFTERS S-76

Apply our liberal "Surprise" trade-in allowance against the above price. What have you got to trade?

\$169⁵⁰

Shpg. wt. 44 lbs.....Only

Values are better because trades are higher at Walter Ashe, originators of "SURPRISE" trade-ins. Take advantage now of the one and only "SURPRISE" allowance on used factory-built equipment. Remember, there is nothing else to compare with it, absolutely nothing. So act now!

FREE

New 1951 catalog. The "treasure chest" of values in everything in Radio and Electronics.

Walter Ashe
RADIO CO.
THE HOUSE OF "SURPRISE" TRADE-INS
1125 PINE ST. • ST. LOUIS 1, MO.

Walter Ashe Radio Co.
1125 Pine St., St. Louis 1, Mo. RN-51-3

O. K. Walter, Rush "Surprise" Trade-in offer on my _____
(describe used equipment)

for _____
(show make and model No. of new equipment desired)

Rush Free Copy of your new 164 page Catalog.

NAME _____
ADDRESS _____
CITY _____ Zone _____ STATE _____

SEND FOR YOUR COPY TODAY!

RADIO & TELEVISION NEWS



BONDED ELECTRONIC TECHNICIANS

have the answer to articles like this. Their cash bond of protection and code of ethics inspire customer confidence in their integrity and ability. Ask your Raytheon Tube Distributor if you can qualify for this vitally important sales asset.

RAYTHEON RADIO AND TELEVISION TUBES — RIGHT... for Sound and Sight!



RAYTHEON MANUFACTURING COMPANY

Receiving Tube Division

Newton, Mass., Chicago, Ill., Atlanta, Ga., Los Angeles, Calif.

Excellence in Electronics

RADIO AND TELEVISION RECEIVING TUBES, CATHODE RAY TUBES, SPECIAL PURPOSE TUBES, SUBMINIATURE TUBES, MICROWAVE TUBES

Use Sprague TELECAPS®
on TV replacement jobs.
Avoid costly callbacks!



Of course there's a reason why more Sprague Telecap molded tubular capacitors are used in leading television sets and by leading service shops than any other brand! Telecaps are especially designed for TV. They stand the gaff!

Write for Bulletin M-474

SPRAGUE
PRODUCTS COMPANY
DISTRIBUTORS' DIVISION OF THE SPRAGUE ELECTRIC COMPANY
51 MARSHALL ST., NORTH ADAMS, MASS.

Spot Radio News

★ Presenting latest information on the Radio Industry.

By RADIO & TELEVISION NEWS'
WASHINGTON EDITOR

NATIONAL DEFENSE, the seething topic of the day, has not only been dominating activities in the Pentagon, but in the New Post Office Building, the home of the FCC. Notwithstanding the pressing problems of allocations, color, and a volume of other domestic items, the ether patrolmen have had to spend many hectic moments with defense procedure. In addition to maintaining liaison with the communications divisions of the National Security Board, the Department of State, the Interdepartment Radio Advisory Committee, and the Telecommunications Committee, the air cops have increased their disaster-emergency coordinated work with the Coast Guard, Navy, Army, Air Force, Red Cross, state and municipal police organizations, and particularly the amateurs.

The hams have been allotted ten bands for civil defense, in addition to the 1750-1800 kilocycle bands set aside for the disaster communications service: 1800-2000, 3500-3510 and 3990-4000 kc., and 28.55-28.75, 29.45-29.65, 50.35-50.75, 53.35-53.75, 145.17-145.71, 146.79-147.33 and 220 to 225 mc. These bands are only to be used for the handling of such communications as may be required in the interest of civil defense, and after any suspension of normal amateur activity.

The civil defense operation which will become a large-scale affair, with over 80-million dollars allocated to state and city organizations for mobile and portable units, fixed station equipment, and transmitters, will require close governmental supervision, in which the FCC will play a key role.

Air-raid warning studies have also been added to the agenda of the FCC, with several techniques involving the use of subaudible and coded frequencies being probed. Dress rehearsal tests, in conjunction with the Continental Air Command and broadcasters, have been held in several centers.

Reviewing the striking status of our communications facilities at the present time in their sixteenth annual report, issued shortly after new year, the Commission said: "The country's radio and wire installations, which have been greatly augmented and improved since the last war, constitute an important and speedy media for Government and mass communication in time of national emergency. Indeed, no other nation is so well equipped with

civilian radio facilities, facilities which can be used to help insure our national security in war as well as contribute to our efficiency, economy, and enjoyment in peace."

THE ANNUAL REPORT* also disclosed in a detailed numerical analysis the unusual growth of the services. For instance, more than 100,000 operator authorizations were issued in one year. Issued and currently** there are over 630,000 radio ops and over 88,000 stations licensed to amateurs and individual citizens. Over 400,000 hold commercial tickets and 120,000 private flyers hold special aircraft radiotelephone authorizations.

For the first time, the number of AM licensed stations passed the 2000 mark, with 2336 now on the books. Despite deletions which reduced FM broadcast authorizations from 865 to 732, the year did close with 493 licensed stations, a gain of 116. At present there are a total of 711 in operation.

The safety and special radio services approvals took on a real spurt, with almost fifteen times the number of all broadcast authorizations provided. The largest single classification appeared in the marine services, in which ship and coastal stations total nearly 28,000. Aeronautical stations, both aircraft and ground, approximate 27,000. There are over 8100 in the public safety services, comprising police, fire, forestry-conservation, highway maintenance and special emergency. Stations in the industrial group, such as power, petroleum, forest products, relay press, and motion pictures, exceed 7000.

Citing that the foregoing figures do not reflect the actual number of transmitters involved, since authorizations can cover hundreds of portable and mobile units, the report pointed out that in addition to ships and aircraft, there were nearly 60,000 portable or mobile units in the public safety services, including over 47,000 police units; nearly 52,000 in the land transportation services, including nearly 48,000 taxicabs and almost 34,000 in the industrial field, with over 23,000 in power activities.

THE HEATED DEBATES in the House of Representatives may soon be

* For the fiscal year ending June 30, 1950.
** Up to October, 1950.

RADIO & TELEVISION NEWS

"CALL-BACKS CAN WIPE OUT PROFITS!"

"Quality tubes mean
fewer call-backs—
protect income.

That's why we use G-E."

Says

Joseph F. Lauinger, President
CONLAN ELECTRIC COMPANY
1042 Atlantic Ave., Brooklyn, N. Y.

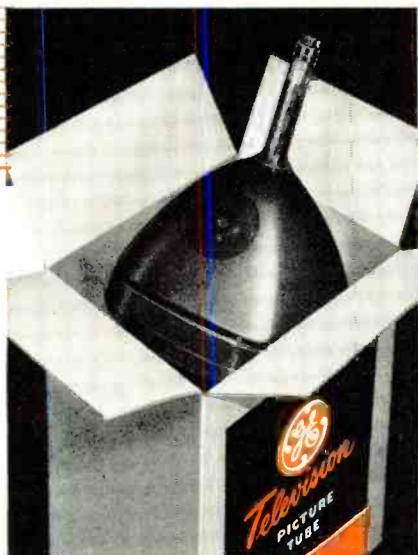

Conlan Electric Company and other service firms—large and small—find that customers ask to see the G-E label on tube cartons. It's proof to set-owners that they're getting highest tube quality, as well as competent radio-TV service.



Typical of General Electric tube quality, is the glass beading of the electron gun in G-E picture tubes. Unlike cheaper, porous ceramics often used, glass will not readily contaminate. Result: much less chance of voltage breakdowns.

"Call-backs on TV-service customers consume working time, and working time is what we have to watch at Conlan Electric. With 40,000 owners on our contract list in Greater New York, extra service calls can multiply to a cost figure that changes black to red. . . . Tube failures are a common cause of call-backs. We've found that good tubes—quality tubes—perform better, give much less trouble. G-E tubes have a top record with Conlan Electric. We feature them. We know that when one of our men installs a G-E picture tube or receiving type, chances are that customer will *stay satisfied!*"

FOR QUALITY TUBES TO CUT DOWN YOUR CALL-BACKS, SEE YOUR G-E TUBE DISTRIBUTOR!

GENERAL  ELECTRIC

181-KA3

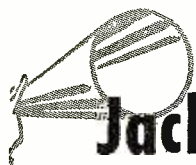

Announcing a NEW Jackson 5-inch Oscilloscope

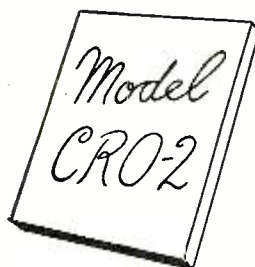

What's New...

Input Calibration Voltage—provides a standard for measuring unknown voltages. Vertical polarity switch allows you to reverse the polarity of vertical deflection voltage. New return trace blanking—all electronic—provides clearer, sharper image. New styling—helps you locate controls more quickly, matches Jackson Television Generator.

Plus All These Important Features...

Dual purpose vertical amplifier. Wide band, flat within 1.5 db, 20 cycles through 4.5 megacycles. Vertical deflection sensitivity .018 rms volts-per-inch. Saw tooth sweep, 20 cycles to 50 kilocycles. Intensity modulation, either 60 cycle or from external source. Direct connection through capacitors to deflection plates. Removable calibration screen. Many more important features.

See your distributor, or write

JACKSON ELECTRICAL INSTRUMENT CO.

DAYTON 2, OHIO

Represented in Canada by: The Canadian Marconi Co.

seen and heard in our homes, if Representative J. K. Javits' (N. Y.) resolution, recently introduced, passes. The legislator told his colleagues that his enthusiasm for radio and TV stemmed from the successful coverage of the debates of the United Nations Security Council and General Assembly. In his opinion the coming sessions of the House are also likely to produce vital debates . . . "regarding America's role in leading the defense of the free peoples against the totalitarian challenge of the Soviet block, which will determine the fate of world peace and the destiny of our country for centuries to come." He felt that the . . . "people should have the most effective means which modern science can make available for personally seeing and hearing these debates, and this means the full use of television and radio."

Recalling that members of Congress are . . . "constantly faced with the problem of keeping their constituents informed as to the positions they are taking on public issues and of being sure that this information is accurate" . . . the Congressman cited that TV and radio can provide such reporting. Through these media, he added, which can supplement newspaper and magazine coverage, every member . . . "has an opportunity to reach in a direct and effective way his own home community."

The four networks were specifically mentioned in the resolution as the key telecasters and broadcasters who could participate in the House broadcasting. However, also provided is representation from . . . "each of such other radio or television broadcasters as the Speaker may from time to time consider to be appropriate in the interests of the adequate coverage of debates and proceedings . . ."

FREEZE-LIFT PREDICTIONS, which have been bouncing around for nearly two years received some official revealing comment a short while ago from one who should know, FCC Spokesman Wayne Coy.

Speaking before the New York State Publishers Association in Buffalo, N. Y., the chairman declared: "I have made so many wrong predictions when the freeze will be over that I should have been cured of making predictions in this field a long time ago." However, he added: "I do hope and expect and predict that we will be out of the freeze and granting applications before the third anniversary of the freeze is upon us, unless (and like all good prognosticators I want to make a reservation)—unless the mobilization program is so large by late summer that it will not be possible to utilize raw materials in the building equipment and construction necessary to get television stations on the air."

Another phase of television, also in the prediction book for years, received a bit of caustic commentary from the Commission's headman; *color*. With the Commission now in a legal row
(Continued on page 111)

Be Sure of Your Installations... Next Year

Use *Aptitude-Tested*
MIKE CABLE Now

Now, you can be sure of your installations with Belden Microphone Cables. They are *Aptitude-Tested* and rated to give you safe and complete knowledge of their characteristics. Furthermore, Belden Mike Cables are built for maximum service. Put them to work for you now—and be sure . . . specify Belden.

Belden Manufacturing Company
4681 W. Van Buren Street
Chicago 44, Illinois

No. 8411
Nominal Capacitance 37 mmf per ft. Use for lapel microphone.

No. 8401
Nominal Capacitance 25 mmf per ft. For crystal, ribbon, carbon microphones.

No. 8422
Nominal Capacitance 32 mmf per ft. Use for carbon microphones.

No. 8410
Nominal Capacitance 33 mmf per ft. Use for crystal, ribbon, and carbon microphones.

No. 8424
Use for Interconnecting power cable for all electronic uses. Also used as a microphone cable.

No. 8423
Nominal Capacitance 54 mmf per ft. Use for carbon microphones.

No. 8412
Nominal Capacitance 68 mmf per ft. Use for carbon microphones.

Belden
Radio WIRE

The
Aptitude-Tested **LINE**



THE TENSION'S TERRIFIC



FEEL LIKE THIS AGAIN TODAY? Back in '43, when Hytron first ran this ad, Hytron tubes were worth their weight in gold. T'aint that bad today. But, despite quadrupled production, it's bad enough. Hytron tubes are more in demand than ever before.

Defense . . . TV . . . radio . . . industry want more tubes than all the tube manufacturers can make. We know how it is. And how vital your needs for replacements are.

Despite the crazy demand . . . and the irritating shortages of materials, we're straining every effort to increase production for you. We'll give you more Hytron replacement tubes yet, or "bust a gut" trying.

OLDEST MANUFACTURER OF RECEIVING TUBES
HYTRON
 RADIO AND ELECTRONICS CORP.



MAIN OFFICE: SALEM, MASSACHUSETTS



Probing made Natural... Quick... Safe!

Pestered by elusive intermittents, shorts, opens, noise, feedback? Want to probe for them — with set operating? Without danger? Without detuning effects? Try new Hytron Probing Tweezers. The precise . . . safe . . . natural extension of your own fingers long sought for this job. Of rich, tough polystyrene with ideal electrical and mechanical characteristics. This contest prize winner saves time, money . . . *maybe your life.* Only 35¢ from Hytron jobbers. Get your Probing Tweezers today.

It's a Cinch! As natural as using your bare fingers. With set on, Hytron Probing Tweezers probe, grasp, and manipulate suspected wiring and components. Easily, surely ferret out: intermittents, shorts, opens, noise, feedback from adjacent wiring, etc. Free from danger of accidental shocks and shorts. Without disturbing normal performance of set.

Jaws of Probing Tweezers grip firmly. Have fine and coarse serrations for different sizes of wires, condensers, resistors, etc. High dielectric constant of polystyrene minimizes capacitive detuning. No pull by strong magnetic fields. Safely long for TV. Handily compact for burrowing into tight spots. Heat resistant, too, if you avoid very hot irons and components. You'll like this unique Hytron tool "by servicemen, for servicemen."



NEW!
HYTRON

Probing Tweezers
35¢ net

EIGHTH MEMBER OF
 THE HYTRON SERVICE TOOL KIT!

RADIO & TELEVISION NEWS

Motorola

Emerson

Admiral

Magnavox

Hallicrafters

Capehart



HILCO

ZENITH

CROSLEY

Olympic

All Big users of **LITTELFUSE**

RAYTHEON

RCA

STROMBERG
CARLSON

Tele King

ROUND

Ford

Buick

Lincoln

OLDSMOBILE

Kaiser-Frazer

PACKARD

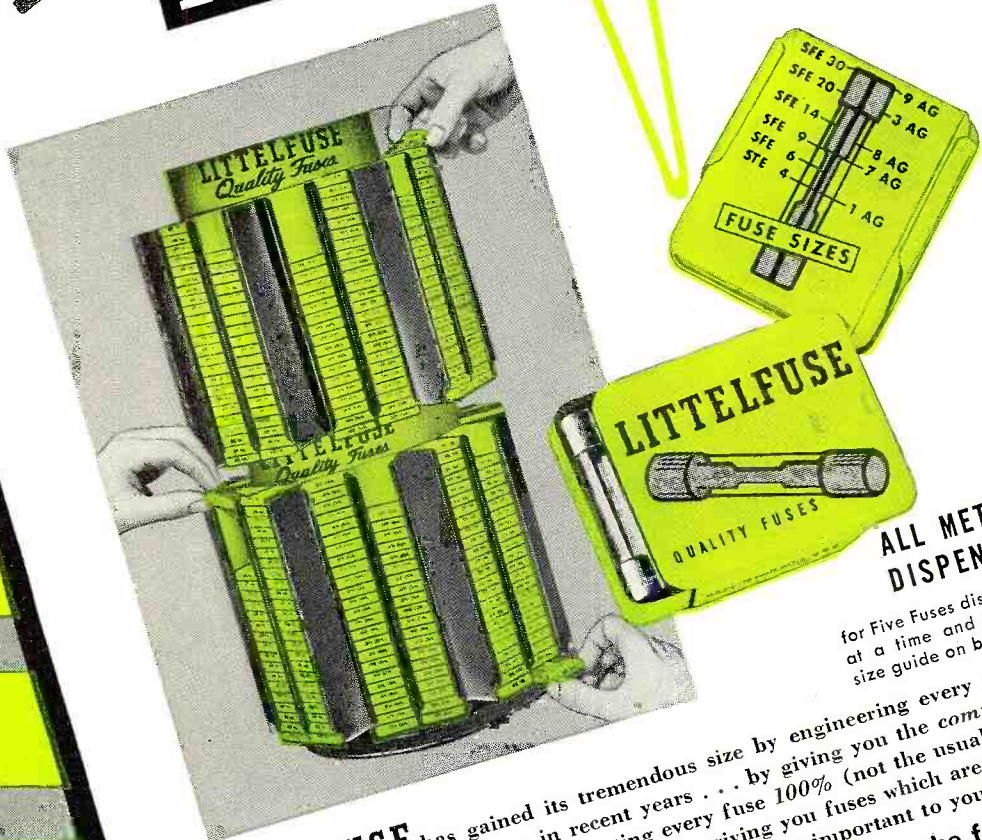

ALL METAL FUSE DISPENSER BOX

for Five Fuses dispenses one fuse at a time and has handy fuse size guide on back of every box!

LITTELFUSE has gained its tremendous size by engineering every major improvement in small fuses in recent years . . . by giving you the complete line of fuses and associated items . . . by inspecting every fuse 100% (not the usual one-out-of-a-thousand inspection) . . . by giving you fuses which are, of course, **UNDERWRITERS' (UL) Tested . . .** but most important to you because **LITTELFUSE is the only merchandiser in the fuse business!**

REVOLVING FUSE DISPENSER MEANS . . .
CONTROL—Makes stock inventory automatic • Makes ordering automatic • Eliminates unnecessary shortages
MERCHANDISING—Order catching display • Reminds customer fuses • Customer sees more fuses • Customer buys more
PROFIT—Regular sales • Extra sales • Plus business • Right fuse right time means more regular customers

BURTON BROWNE ADVERTISING

LITTELFUSE, INC.

TEL. LONGBEACH 1-4970 • 4757 N. RAVENSWOOD AVE. • CHICAGO 40

SPEED YOUR SERVICE.

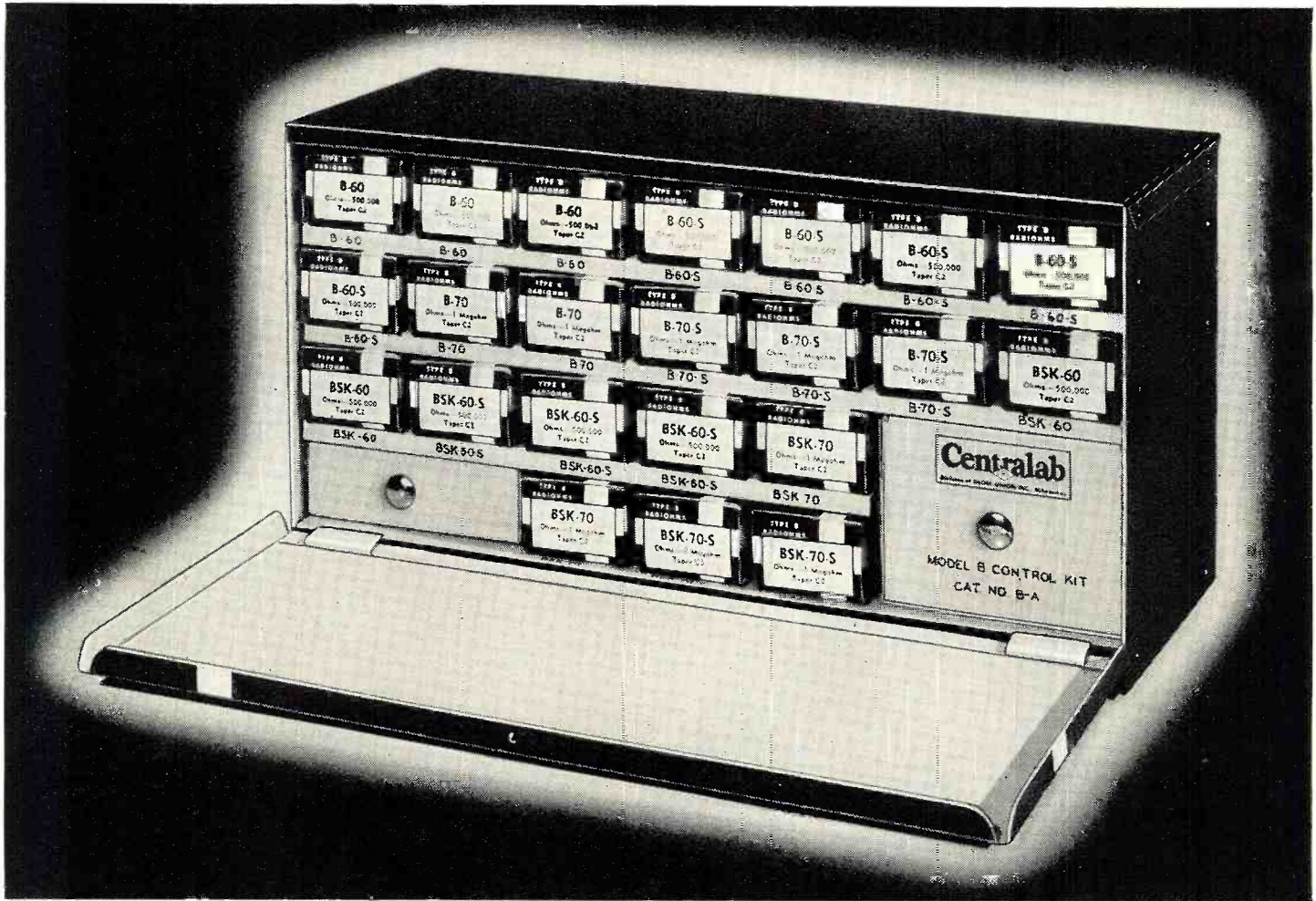

Your choice of two new Blue-Shaft quickest-for-servicing Control Kits

These two new kit assortments of Centralab new Blue Shaft controls, contain 22 fast-moving modern service items — including factory attached switches . . . ready for you to install — complete in metal cabinets.

KIT DEAL B-A — 22 CONTROLS

½ Meg and 1 Meg

All C2 (audio) taper. The B types have standard 3" shafts, full length fluted mill. The BSK types have 2½ split knurl shafts.

PLAIN TYPE		SWITCH TYPE	
3 B-60	½ meg	5 B-60-S	½ meg
2 B-70	1 meg	3 B-70-S	1 meg
2 BSK-60	½ meg	3 BSK-60-S	½ meg
2 BSK-70	1 meg	2 BSK-70-S	1 meg
1 Metal Cabinet			

LIST PRICE \$29.40

KIT DEAL B-B — 22 ASST. CONTROLS

All have standard 3" shafts, full length fluted mill.

PLAIN TYPE		SWITCH TYPE	
1 B-31	50,000 ohms C1	1 B-31-S	50,000 ohms C1
1 B-40	100,000 ohms C1	1 B-40-S	100,000 ohms C1
1 B-51	250,000 ohms C2	1 B-51-S	250,000 ohms C2
1 B-59	½ meg C1	1 B-59-S	½ meg C1
1 B-60	½ meg C2	2 B-60-S	½ meg C2
1 BT-67	½ meg C13 tapped	1 BT-67-S	½ meg C13 tapped
1 B-70	1 meg C2	2 B-70-S	1 meg C2
1 BT-73	1 meg C13 tapped	1 BT-73-S	1 meg C13 tapped
1 B-76	2 meg C2	1 B-76-S	2 meg C2
1 BT-80	2 meg C13 tapped	1 BT-80-S	2 meg C13 tapped
1 Metal Cabinet			

LIST PRICE \$35.60

RADIO & TELEVISION NEWS

USE CENTRALAB KITS

All Centralab Kit Parts are selected according to modern TV and Radio requirements . . . All Fast Moving Stock No "Sleepers"

The kits you see here are stocked by leading parts distributors everywhere. Each kit has been carefully selected so that each item can currently be used in modern radio or TV sets. Kits are packed in handy metal or plastic containers — later useful for many purposes.

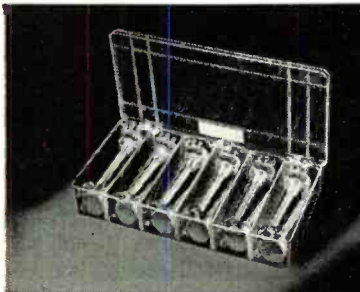

Plasti-paks contain your choice of eight different assortments of 12 controls each.



Adashaft kits contain basic controls and switches. You add the exact shaft needed.



Rotary switch kit contains parts and hardware to make your own switch assemblies.



Model 414 switch kit. Extra large assortment of rotary switch parts. Much in demand by labs.



Ceramic capacitor kit DW 200. Has 200 items. Values from 10 to 10,000 mmf.



Kit DK-100 contains 100 ceramic capacitors (20 of each of 5 values.)

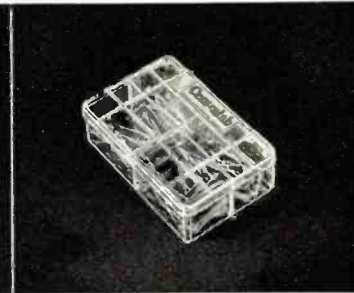

Plasti-Pak No. 40 contains 40 different ceramic tubulars — 4 different values.



Kit DK-25 or kit DDK-25. Your choice of 25 ceramic tubulars or 25 disc Hi-Kaps.

Centralab

Division of GLOBE-UNION INC. Milwaukee, Wis.

CENTRALAB Division of Globe-Union, Inc.
910 East Keefe Avenue, Milwaukee 1, Wisconsin

Please send me complete details on Centralab kits.
 Also include new Centralab Catalog No. 27.

Name.....

Address.....

City..... Zone(.....) State.....

PLEASE! I am a Service Engineer Ham Jobber TV Set Owner

new!

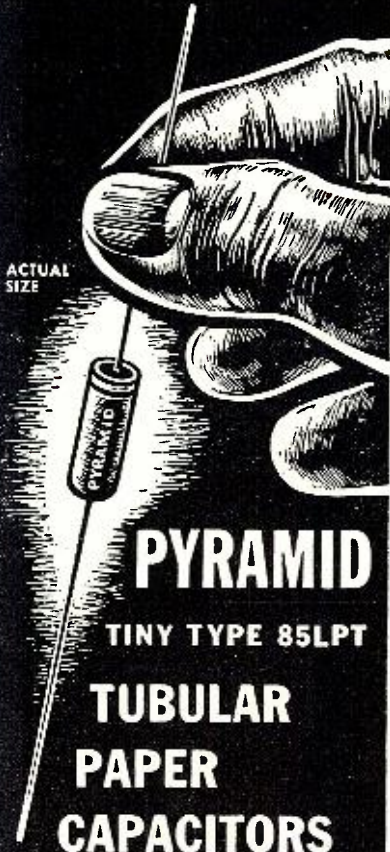

ACTUAL SIZE

PYRAMID TINY TYPE 85LPT TUBULAR PAPER CAPACITORS

Fit anywhere!
Suitable for
85°C. operation!

CAPACITANCE RANGE:
.0001 TO .5 MFD.

VOLTAGE RANGE:
200 TO 600 V., INCLUSIVE

Sturdily built in phenolic-impregnated tubes. Ends are plastic-sealed.

WRITE FOR COMPLETE LITERATURE
Representatives and Distributors
Throughout the U.S.A. and Canada



PYRAMID

PYRAMID ELECTRIC COMPANY

1445 Hudson Boulevard

North Bergen, N. J., U. S. A.

TELEGRAMS: WUX North Bergen, N. J.
CABLE ADDRESS: Pyramidusa

Within the INDUSTRY

A. E. SINCLAIR has been named industrial relations director of *Federal Telephone and Radio Corporation*, Clifton, New Jersey associate of *International Telephone and Telegraph Corporation*.



Mr. Sinclair has been engaged in industrial relations for more than twenty years, having been associated with *Zenith*, *P. R. Mallory*, and other companies. Before joining *Federal*, he was with the *Philadelphia Transportation Company*.

A native of Cedar Rapids, Iowa, Mr. Sinclair was educated at Princeton University.

* * *

THE 1951 PARTS DISTRIBUTORS SHOW to be held May 21-23rd at the Stevens Hotel in Chicago will again feature conference and seminar sessions for distributors, a service of the Show Corporation which proved to be so popular last year.

The educational committee, headed by Jack A. Berman of *Shure Bros., Inc.*, has been conducting a survey among the 1500 distributor firms represented at last year's show to determine just what topics are considered most vital by the distributors.

First results of the poll indicate that sessions on "methods of compensating and training salesmen" and "availability of material and equipment" would be most welcome while discussions of inventory control, how to determine whether the distributor is getting his share of the market, merchandising of service, open-forum and question-and-answer sessions with manufacturers, industry's future growth, and store layout were close runners-up.

According to Mr. Berman, these and other suggested topics will be given careful consideration by the committee.

* * *

LESLIE F. MUTER, president of the *Muter Company* of Chicago, has been elected president and director of the newly-reactivated organization, *Radar-Radio Industries of Chicago, Inc.*

Originally formed during World War II, this non-profit organization helped to develop a cooperative effort among Chicago radio manufacturers which resulted in the production of approximately 40 per-cent of all electronic equipment used throughout the conflict.

Serving with Mr. Muter as vice-presidents and directors of the group are: Raymond C. Durst, executive vice-president of *The Hallicrafters*

Company; Richard C. Dooley, vice-president of *Admiral Corporation*; Paul V. Galvin, president of *Motorola Inc.*; and James P. Wray of *Croname Incorporated*. Charles M. Hofman, vice-president of *Belmont Radio Corporation*, will serve as a director while Leonard J. Shapiro, Chicago attorney, has been named executive secretary.

* * *

AMERICAN INSTITUTE OF MANAGEMENT has awarded "Certificates of Management Excellence" to three firms in the electronic field.

Among the 238 firms honored were the *General Electric Company*, *Sylvania Electric Products Inc.*, and *Westinghouse Electric Corporation*. The awards, which will be given annually by the Institute, are based on its continuing study of more than 2000 leading concerns, a study designed to provide a base for research into corporate policies and procedures.

In weighing the merits of each management, credits were given for excellence in ten separate fields—economic function, corporate structure, health of earnings growth, fairness to stockholders, research and development, directorate analysis, fiscal policies, production efficiency, sales vigor, and executive evaluation.

* * *

GORDON U. POOLE has been named manager of the contract division of *Philharmonic Radio and Television Corp.* of New Brunswick, New Jersey.



In his new position Mr. Poole will handle all of the company's government contracts and direct the corporation's recently expanded special equipment program.

Mr. Poole, who has been associated with the electronics industry for many years, was with Signal Corps procurement during World War II, and has since held the position of purchasing agent for *Espey Manufacturing Co., Inc.* and *Ansley Radio and Television, Inc.*

He will make his headquarters at the company's new plant at 235 Jersey Avenue in New Brunswick.

* * *

CORNING GLASS WORKS is commemorating its hundredth anniversary this year with appropriate ceremonies.

Founded in Somerville, Massachusetts in 1851 as the *Union Glass Company*, the firm moved to Brooklyn in 1864. Four years later the entire operation was transferred to Corning, New York by canal boat.



for greater speed and
accuracy of TELEVISION INSTALLATIONS
in any locality use the new

Simpson

MODEL 488

TV FIELD STRENGTH METER

In addition to location of maximum signal areas, the Simpson Model 488 Television Field Strength Meter is also ideal for antennae orientation, comparison of antennae systems, adjustment of TV signal boosters and checking antennae and lead-in installations to list but a few of the many functions available . . . THE 50 MICROVOLT FULL SCALE RANGE IS AN OUTSTANDING FEATURE FOR THOSE CONCERNED WITH FRINGE AREA INSTALLATIONS WHERE MAXIMUM EFFICIENCY MUST BE ATTAINED . . . The 500, 5,000 and 50,000 microvolt ranges extend the usefulness of the Simpson Model 488 into areas of higher signal strength. The large 4½-inch modernistic meter is easily read from a considerable distance and all controls and connections are arranged for greatest accessibility. Model 488 is housed in a beautiful gray hammerloid finished case for greater portability. LINE VOLTAGE: 105-125 volts, 50-60 cycles. SIZE: 8" x 11" x 8½".

WEIGHT: 11½ lbs. Shipping weight 15 lbs.
DEALER'S NET PRICE, including operating instructions and shoulder strap \$89.50

SIMPSON ELECTRIC COMPANY

5200 WEST KINZIE STREET, CHICAGO 44, ILLINOIS

Phone: COlumbus 1-1221

In Canada: Bach-Simpson, Ltd., London, Ontario

CONSERVE
CRITICAL
MATERIALS

THE RIG on THE ROOF*

AMPHENOL — IN LINE — ANTENNA

* REISSUE PAT. NO. 23,273

Polished mahogany cabinets and good picture tubes are important . . . But don't let customers forget the rig on the roof! Everyone — manufacturer, jobber, dealer, serviceman and customer — benefits when a TV set produces the best possible picture. Precise engineering laboratory and field tests prove Amphenol's patented IN LINE Antenna gives the greatest over-all channel coverage, the best pictures, regardless of station location . . . so don't overlook the rig on the roof!

AMPHENOL

AMERICAN PHENOLIC CORPORATION
1830 SOUTH 54TH AVENUE • CHICAGO 50, ILLINOIS

Today the company employs over 8000 persons in the Corning area and over 4000 in other cities where it maintains plants.

The newest of these branch operations is the recently-opened television glass bulb plant in Albion, Michigan. Nearly 100 representatives of leading television tube manufacturers were guests of the company at the luncheon and specially conducted tour of the plant which were features of the dedication.

* * *

SIDNEY E. WARNER has joined *La Pointe-Plascomold Corporation* as director of engineering and research.

Now in complete charge of the company's expanded program of development and research on electronic products, Mr. Warner formerly was a partner and chief engineer of *Aircraft Electronics Associates*, a company engaged in development work in radar, communications, and electronic controls.

Mr. Warner obtained his master's degree from Rensselaer Polytechnical Institute in 1934 and for five years was a member of the faculty of that school, teaching electronic engineering and physics. He has served as a radio engineer for several radio stations, been a consulting engineer for the State of New Jersey, and a consultant to the *F. M. Link Company*. During World War II he was associated with the Airborne Instrument Laboratory at Columbia University and later served as chief radio engineer at the *Crystal Research Laboratories* in Hartford, Conn.



* * *

STEWART-WARNER ELECTRIC, radio and TV division of *Stewart-Warner Corporation*, has acquired a single story plant at 1300 North Kostner Avenue in Chicago in order that manufacturing operations, now located at the company's main plant, can be conducted at this more convenient site . . . **THE TELE-TONE RADIO CORPORATION** has moved its entire New York City operation to Bayway Terminal, Elizabeth, New Jersey. The need for increased production space and the need for decentralization in the New York area were the reasons given for the move . . . **ELECTRONIC MEASUREMENTS CORPORATION** has moved to new and larger quarters at 280 Lafayette Street, New York 12, N. Y. Both the offices and factory facilities are affected . . . Construction is currently underway on the initial unit of *CBS Television City* being built by the **COLUMBIA BROADCASTING SYSTEM** at Gilmore Island, in Hollywood near Beverly Hills . . . **THE SHELDON ELECTRIC COMPANY** is erecting a two-story addition to its main building in Irvington, New Jersey . . . **CONDENSER PRODUCTS COMPANY** of Chicago has moved to new and larger quarters at 7517 North Clark Street following the destruction of its factory by fire . . . **WELLS SALES, INC.** was one of the firms burned out in a recent fire at 320 N. LaSalle St., Chicago. The business has been resumed at 833 W. Chicago Avenue, Chicago 22 . . . **OLYMPIC METAL PRODUCTS COMPANY, INC.** has recently acquired new and enlarged plant facilities at Phillipsburg, New Jersey.

* * *

NEAL F. HARMON, former *General Electric* sales engineer in Atlanta, Georgia, has been appointed to the post of civil defense planning coordinator for the company.

This newly-created department has been established to direct a broad program of assistance in the electronics field to civil defense organizations. Mr. Harmon will supervise all requests for services of electronics experts to help communities and regions or states plan efficient emergency communications systems which may be used both in peace and war. He will also keep all of the company's communications experts in the field informed as to national civil defense authority communications requirements.



(Continued on page 70)

New SUPREME 195 TV Manual

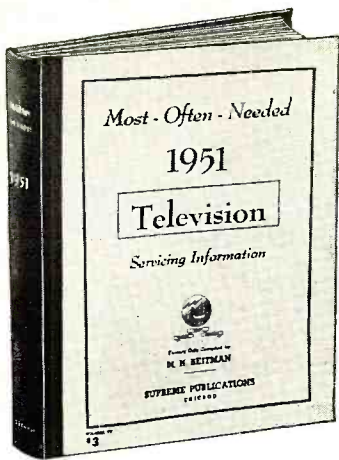

New 1951 Television Manual

This newest giant volume of the series covers 1951 factory data on all popular television sets of all makes. There are circuit explanations, 192 pages of alignment procedure, test patterns, response curves, pages of waveforms, voltage charts, service hints, and dozens of large double-page circuit diagrams. Manual style binding. At your parts jobber or by mail, only..... **\$3**

1950 T-V Manual. Includes service material on all popular TV sets of all makes from Admiral to Zenith. Large size: 8 1/2"x11", plus ten mammoth 11x15" blueprints. Amazing bargain at only..... **\$3**

1949 T-V Manual. Similar to the volume listed above. Has 192 extra-large pages, plus 9 double-spread giant blueprints. To order see coupon below, only..... **\$3**

1948 T-V Manual. Earlier volume has material on all popular T-V sets of this period. Large size: 8 1/2"x11". Remarkable value. Including 8 fold-out blueprints, only..... **\$3**

1947 FM and T-V Manual. Covers all needed FM and television sets including popular R.C.A. 630TS. Size: 8 1/2"x11". Data on 192 pages. Only..... **\$2**

INCLUDES ALL POPULAR SETS

The new 1951 TV manual has complete service material on every popular television set of every important manufacturer. Here is helpful, practical, factory-prepared data that will make servicing and adjustment easy for you. This new giant manual, as well as the previous volumes listed at left, has complete circuits, alignment facts, test patterns, response curves, service hints, voltage charts, waveforms, recommended changes for improvement, and many double-spread diagram blueprints. Here is your TV service material to help you become an expert, and at only \$3 and \$2 per manual.

FIND—FIX ALL T-V FAULTS

Use the new 1951 TV manual and the earlier volumes (see listing at left) to help you with all TV repairs. Cuts hour-wasting jobs to pleasant moments. Use test patterns for quick adjustment, or look up probable cause of trouble in the pages of hints after simply observing fault in video picture. No equipment needed with these tests. Or use your voltmeter and compare values with many voltage charts included. With an oscilloscope you can get waveforms similar to hundreds illustrated using test points suggested and in a flash locate what used-to-be a hard-to-find fault. Order at our risk for a 10-day trial. Use coupon at bottom of page.



All Supreme Publications TV and Radio manuals are compiled by M. Beitman, radio engineer, teacher, author, and serviceman.

AMAZING BARGAIN OFFER

The new 1951 TV manual is the most remarkable value offered by Supreme Publications in their 17 years of business. This giant-size television servicing manual at only \$3, or the TV manuals for previous years for only \$3 and \$2 each, are amazing bargains and defy competition. There is nothing else like them. Each manual is a virtual treatise on practical television repairs. By normal standards, each such large manual packed as it is with practical facts, hundreds of illustrations, diagrams, charts, photographs, and expensive extra-large blueprints, should sell for \$10—but as SUPREME special values they are priced at \$3 and \$2 each. Only a publisher who sold over one million TV and radio manuals can offer such bargains based on tremendous volume-sales.

YOURS TO USE ON TRIAL

Be ready to repair any TV set by having in your shop all five Television Manuals described at left. Or try the new 1951 TV manual to see what an amazing bargain you get for only \$3. Order on no-risk trial by using coupon at bottom of page.

SUPREME RADIO MANUALS

New 1950 Radio Diagrams

Now you can benefit and save money with Supreme amazing manual scoop. This one giant volume has all the service data you need on all recent radio sets. Here you have clearly-printed large schematics, needed alignment data, parts lists, voltage values, and information on stage gain, location of trimmers, and dial stringing illustrations. This is the help you need to find tough faults in a jiffy. The new 1950 radio manual is a worthy companion to the 9 previous volumes used to an advantage by over 128,000 shrewd radio men.

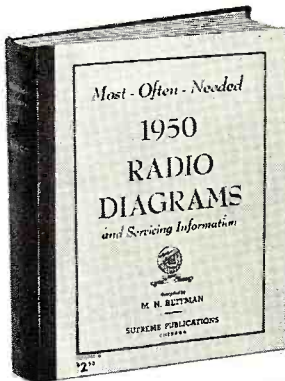

BIGGEST BARGAIN IN SERVICE DATA

Wise servicemen know that Supreme Publications manuals have all the material needed at the lowest prices. For the remarkable bargain price (only \$2 for most volumes) you are assured of having on hand needed diagrams and all other essential repair facts on almost all sets you will ever service. Every popular radio of all makes, from old-timers to new 1950 sets is covered. Select manuals wanted, see list below.

SUPREME RADIO MANUALS for PREVIOUS YEARS



1949 1948 1947 1946 1942 1941 1940 1939 1926-1938
SUPREME Most-Often-Needed RADIO DIAGRAMS
 Each Manual only \$2. (1949 is \$2.50); 192 pages of diagrams, alignment data, voltage values, parts lists, and service hints; large size, 8 1/2" x 11". To order, see coupon below. **RADIO Diagrams 240 Pages Price \$2.50**

RADIO-ELECTRONICS HOME-STUDY COURSE

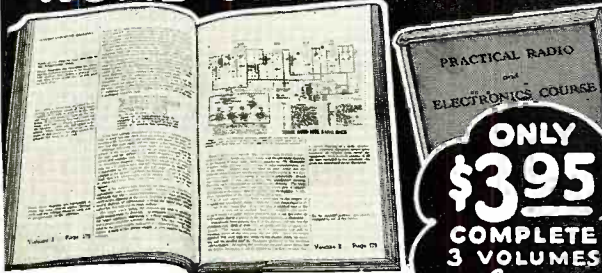

ONLY \$3.95 COMPLETE 3 VOLUMES 53 Lessons

NEW AMAZING OFFER

Here is the most amazing bargain in radio training. The price scoop of the year. For only \$3.95 (full price) you receive a complete radio-electronics course of 53 large, fact-packed lessons. Covers every topic of radio fundamentals, practical servicing, TV, FM, audio, and industrial electronics. Published in three giant books, bound in one super-mammoth volume. Printed in 1951. Compares lesson by lesson with the best \$200 home-study correspondence courses; but here you get all lessons at one time at the unheard-of bargain price of only \$3.95; nothing further to pay or buy.

THREE COURSES IN ONE

The complete training of these 53 large lessons is really THREE distinct courses on: (1) Practical Radio, (2) Applied Electronics, and (3) Radio Servicing. The lessons are clear, practical, easy to master and use. Early lessons will make fundamentals clear even to a beginner, while other lessons will give you the practical "know-how" of an expert. Notice in the illustration of the manuals, at top, that the wide column on each page has the text, while the narrow column contains pertinent explanations usually supplied by a teacher. These teacher stress points of importance, tell you how to perform practical experiments using any home radio. There are hundreds of review self-testing questions, 427 drawings, pictures, diagrams, and over a thousand service hints.

YOURS TO TRY FOR 10 DAYS

Just send no-risk coupon, at right, and receive the 3-volume COURSE for a free examination. Use all this material a full 10 days in your own home. Read a few lessons, examine the hundreds of illustrations, apply some of the hints to fix a couple of radios. Only then, if you are pleased, the complete course of 53 lessons, in three volumes, is yours to keep for only \$3.95, full price; otherwise, it costs you nothing for the use and examination. Fair enough? Please rush coupon or ask your jobber while your special price is still only..... **\$3.95**

Supreme Publications

Sold by All Leading Radio Jobbers

March, 1951

NO-RISK TRIAL ORDER COUPON

SUPREME PUBLICATIONS, 3727 W. 13 St., Chicago 23, ILL.

Send on trial the manuals checked below and at right. You guarantee complete satisfaction.

- New 1951 Television Service Manual . . . \$3.
- 1950 Television Manual, \$3. 1949 TV, \$3.
- 1948 TV, \$3. 1947 TV & FM, only \$2.
- Radio & Electronics Course, 53 lessons . . . \$3.95

- I am enclosing \$ Send postpaid.
- Send C.O.D. I am enclosing \$. . . deposit.

Name:
 Address:

- Most-Often-Needed Radio Diagram Manuals**
- New 1950 Manual, \$2.50
 - 1949 Radio Manual, \$2.50
 - 1948
 - 1947
 - 1946
 - 1942
 - 1941
 - 1940
 - 1939
 - 1926-1938 Manual, \$2.50

PRICED AT ONLY \$2 EACH

IT'S "LOADED" WITH BETTER TELEPHONE SERVICE

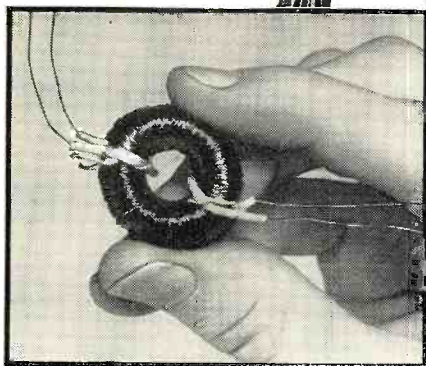

Twenty of the Bell System's newest small loading coils—like the one at the left—are housed in the long black case, mounted in a cable splice. This type of installation permits the economical extension of city cables to serve out-of-town subscribers.

MANY more wires can be crowded into a cable sheath when the wires are fine. But normally, wires don't transmit as well when they are fine and closely packed.

Bell engineers long ago learned to make wires do better work by loading them with inductance coils at regular intervals. The coils improve transmission and let messages travel farther. But originally the coils themselves

were large, heavy and expensive. The cases to hold them were cumbersome and costly too.

So year after year Bell scientists squeezed the size out of coils. To make magnetic cores of high permeability they developed Permalloy. Tough but extra-thin insulation permitted more turns to a core.

New winding machines were developed by the Western Electric Com-

pany. Coil size shrunk to one-fiftieth. Some—like the one shown above—can be mounted right in cables themselves.

The 15,000,000 coils in the Bell System today mean thinner wires, more wires in a cable—more economical service for you. They demonstrate once more how Bell Telephone Laboratories work continually to add to your telephone's value.



BELL TELEPHONE LABORATORIES

WORKING CONTINUALLY TO KEEP YOUR TELEPHONE SERVICE BIG IN VALUE AND LOW IN COST

RADIO & TELEVISION NEWS

A RAULAND EXCLUSIVE!

New.
"Tilted-Offset" Gun
WITH
**INDICATOR
ION TRAP**

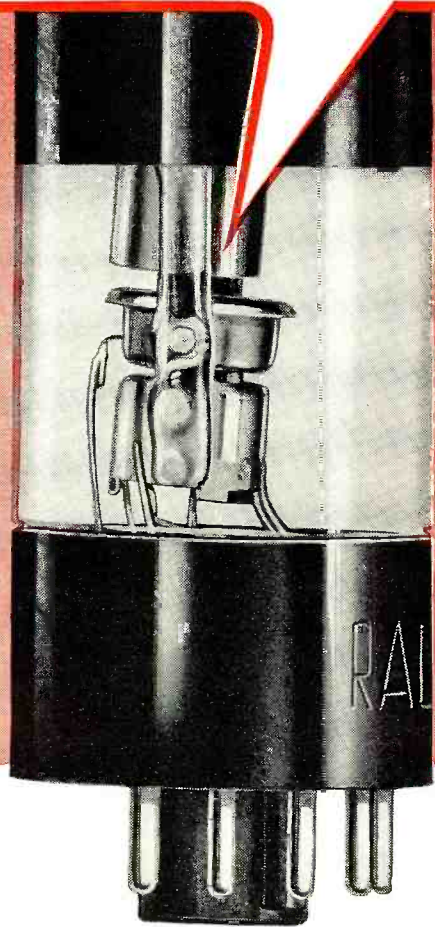

For Faster Service—Bigger Profits

More and more dealers and service men are swinging to Rauland picture tubes because of Rauland's exclusive development—the Tilted Offset Gun with mistake-proof Indicator Ion Trap.

This new feature—the most recent of many Rauland firsts in picture tube design—saves time and trouble in Ion Trap Magnet adjustment, eliminates mirrors and guesswork. A vivid green glow on the anode tube signals when adjustment is incorrect. The service man simply moves the magnet until the glow is reduced to minimum. Adjustment becomes a matter of complete precision, yet one accomplished in a matter of seconds without equipment of any kind.

In addition, the Tilted Offset Gun offers the advantage of maximum sharpness of focus and requires only a single Ion Trap Magnet.

Only Rauland offers these important advancements. For further information, write to . . .

RAULAND

The first to introduce commercially these popular features:

Tilted Offset Gun

Indicator Ion Trap

Luxide (Black) Screen

Reflection-Proof Screen

Aluminized Tube

THE RAULAND CORPORATION



Perfection Through Research

4245 N. KNOX AVENUE • CHICAGO 41, ILLINOIS



EICO

TEST EQUIPMENT

guards

Tele-tone

HIGH STANDARDS OF TELEVISION PRODUCTION QUALITY

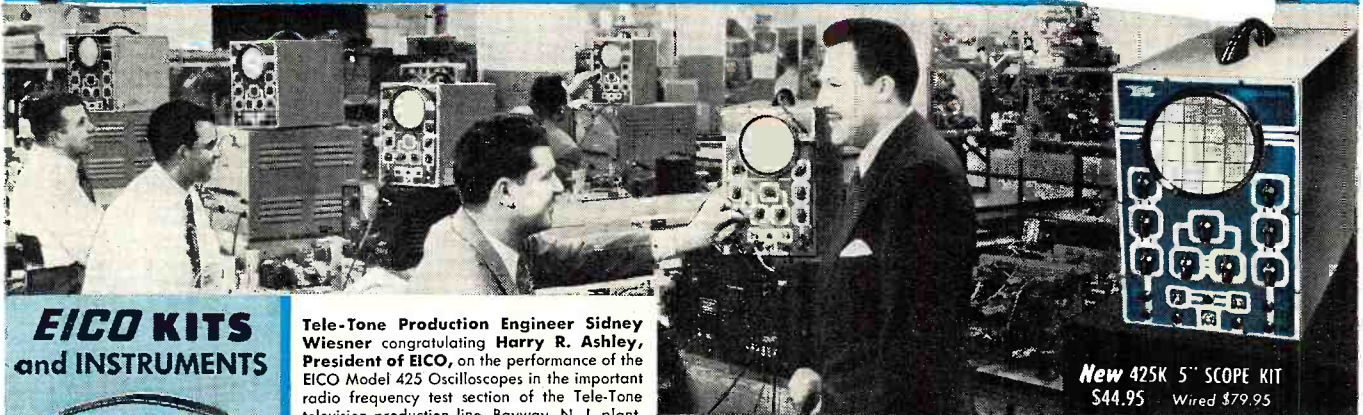

EICO KITS and INSTRUMENTS

Tele-Tone Production Engineer Sidney Wiesner congratulating Harry R. Ashley, President of EICO, on the performance of the EICO Model 425 Oscilloscopes in the important radio frequency test section of the Tele-Tone television production line, Bayway, N. J. plant.

New 425K 5" SCOPE KIT
\$44.95 Wired \$79.95

For Laboratory Precision at Lowest Cost—the Leaders Look to EICO!

IN the whole world of electronics, no taskmasters enforce more stringent standards of test equipment performance than the factories making TV sets. Fiercely competitive, they daily train sharp critical eyes on their production efficiency, quality and economy. Of their test equipment they demand the highest precision, utmost speed, lowest cost and certain dependability — *without compromise.*

In the new giant Bayway, New Jersey television plant of the great Tele-Tone Radio Corporation — at the many vital constant-duty testing positions along the production line—EICO instruments stand guard. One of the world's foremost volume manufacturers, Tele-Tone knows that for speed, accuracy and day-after-day dependability, at maxi-

mum economy, EICO instruments always deliver the fullest measure of value.

From coast to coast, in one leading TV factory after another, this is the experience—*this is the proof of EICO superiority*—that is demonstrated again and again. The top-flight TV set makers have discovered—just as over 65,000 servicemen have learned—that for the industry's greatest instrument values, at the industry's lowest costs — *it's EICO!*

Be sure you look at the EICO line *before you buy any higher-priced equipment!* Each EICO product is jam-packed with unbelievable value. *YOU* be the judge — compare EICO at your local jobber today—and *SAVE!* Write **NOW** for free newest Catalog 3-R.

See the complete EICO line at Booth 362, IRE Show, Grand Central Palace, N.Y. C., March 19-22.

EICO

ELECTRONIC INSTRUMENT CO., Inc.
276 NEWPORT STREET, BROOKLYN 12, NEW YORK

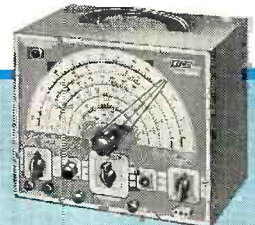

360K SWEEP GEN. KIT \$34.95
Wired \$49.95



511K VOM KIT \$14.95
Wired \$17.95



New 315K DELUXE SIG. GEN. KIT \$39.95
Wired \$59.95



New 625K TUBE TESTER KIT \$34.95
Wired \$49.95



145K SIG. TRACER KIT \$19.95
Wired \$28.95



New 221K VTVM KIT \$25.95
Wired \$49.95

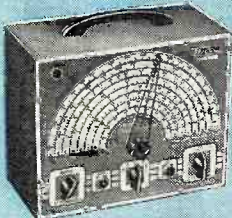

320K SIG. GEN. KIT \$19.95
Wired \$29.95

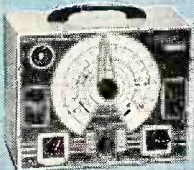

New 950K COND. RES. COMP. BRIDGE KIT \$19.95
Wired \$29.95



New 1040K BATTERY ELIM. KIT \$25.95
Wired \$34.95



RF PROBE KIT \$3.75
Wired \$5.95



C-5 5MC CRYSTAL \$3.95



HV PROBE (Wired only) \$6.95

Prices 5% higher on West Coast. Due to unsettled conditions, prices and specifications are subject to change without notice.

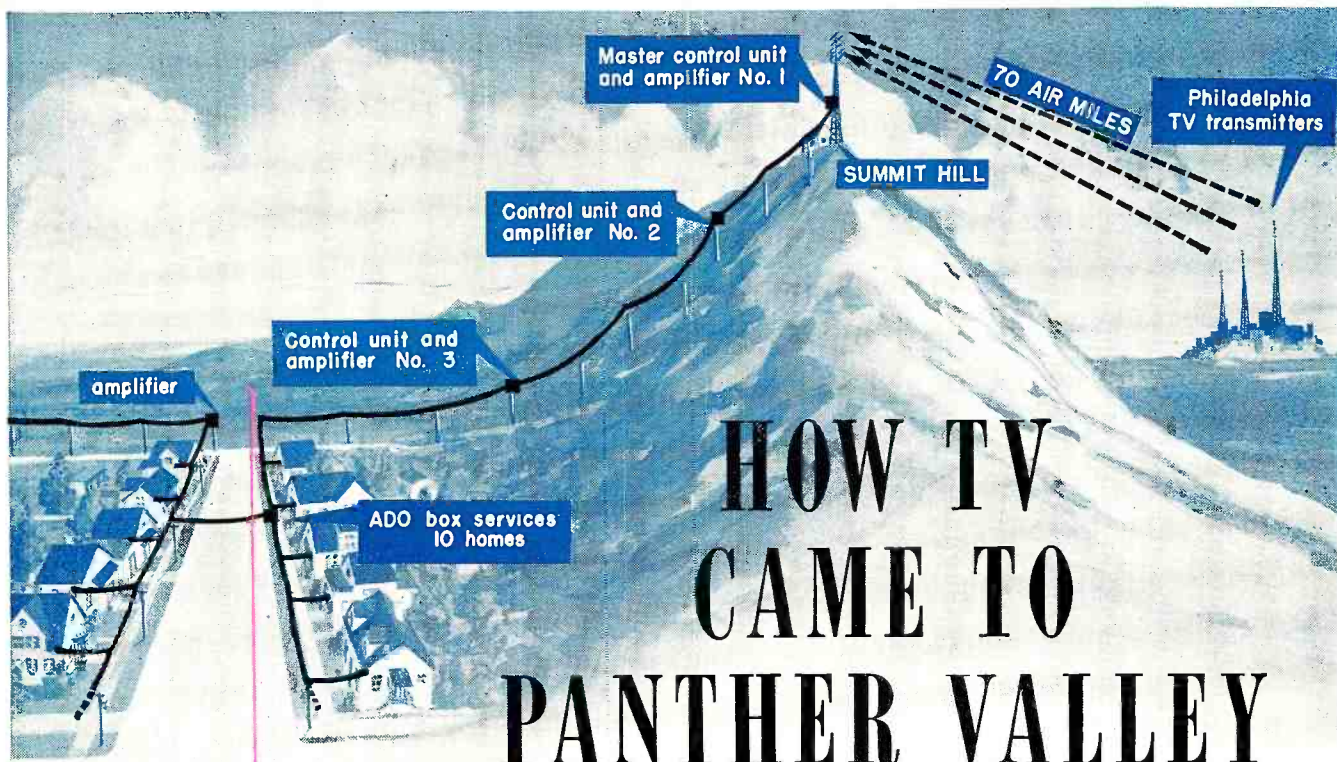

HOW TV CAME TO PANTHER VALLEY

By
E. D. LUCAS, JR.
 Philco Corporation

Fig. 1. Final layout showing how the community aerial serves as the connecting link between the three Philadelphia television transmitters and Lansford's 100 TV sets.

A detailed report on America's first community aerial system—how five men of initiative brought television to what was once an isolated TV area.

THIS is the story of how communities beyond the fringe of television reception now receive clear, strong television signals from transmitters 75 to 125 airline miles away. It is the exciting story of the first "community aerial"—telling how a single master TV antenna system can serve an entire city, just as one master aerial brings television reception to all the tenants of a large apartment building.

The community aerial is a particularly important new development because of the "freeze" on new TV station construction. This freeze is now in its third year and likely to continue for some time in view of the national emergency. Meanwhile, with the community aerial, a new pattern has been established for widely expanding television coverage from existing stations—for bringing television to hundreds of towns now blind spots on the TV map.

In this article, we present a detailed case history of a typical community aerial system in a typical town. Lansford, Pa., in the heart of Panther Valley, is a coal-mining community of 10,000 persons and until recently was "beyond the fringe" of television reception for two reasons: *distance*, about 75 airline miles northwest of the nearest TV stations in Philadelphia; and *location* in a valley, blocked off

from these stations by the Blue Mountains.

This case history of how good television reception has come to Panther Valley tells of the initiative of a group of small-town businessmen, four radio dealers and a lawyer, and how they have solved the variety of problems, technical, legal, political, financial, which confronted them in building a community aerial system. Such information has already proved useful to other towns planning their own community aerials and will, we hope, be helpful to many other communities now TV-blind. For here is the story of how television can reach new audiences by the million, just as television has come to Panther Valley.

The Problem of Panther Valley

There was no television in Panther Valley a few months ago. This is easily understood if you glance at a map, which shows the towns of Mauch Chunk, Nesquehoning, Lansford, Coaldale and Tamaqua, strung along the valley on a line roughly from northeast to southwest in the hard-coal region of east-central Pennsylvania, some 75 airline miles northwest of Philadelphia and about 33 miles south of Scranton.

Between Panther Valley and the three television stations in Philadelphia are interposed, as mentioned

before, both distance and the formidable bulk of the Blue Mountains—a range of the Appalachians that has effectively blocked off the valleys behind it from TV reception.

What made the 45,000 people living in these towns in Panther Valley feel especially irritated was that their neighbors, up on the hills a short distance to the east, could put up antennas and receive television programs from the three Philadelphia transmitters: WPTZ (Channel 3); WFIL-TV (Channel 6); and WCAU-TV (Channel 10).

For instance, at Summit Hill, a village less than a mile up the mountain from the much larger town of Lansford, the people on the hill could enjoy television. Their much more numerous neighbors down in Panther Valley felt as if nature—and television—had discriminated against them. As Mayor Evan H. Whildin of Lansford expressed it, "The signals used to go right over our heads."

The radio dealers of Lansford were doubly irked about this situation. They couldn't watch television and, even worse, they couldn't sell TV sets in the valley. So they decided to do something about it.

One of these dealers, Robert J. Tarlton, remembered reading about master antenna systems for apartments, hotels and other multiple-set installations. Tarlton went into a huddle with the other three radio and appliance dealers in Lansford, William McDonald, Rudolph Dubosky, and George Bright, vice-president of *Bright's Stores, Inc.*, leading department store in Panther Valley. The group agreed

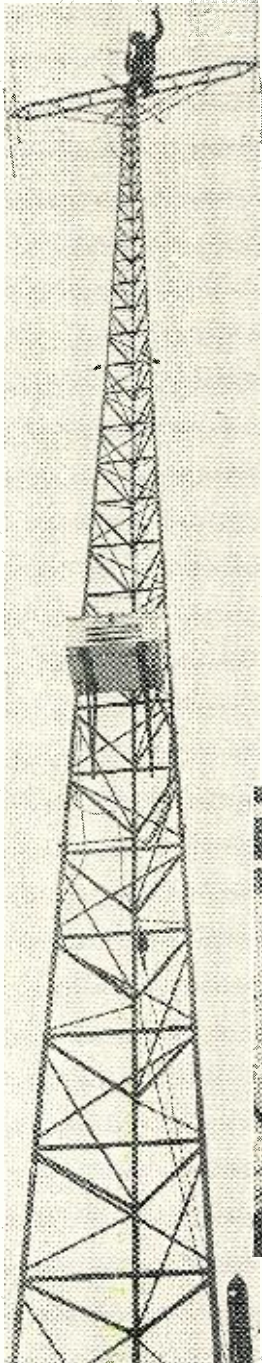

Fig. 2. Lansford's "community aerial" is located on Summit Hill atop this 85 foot tower. Three separate double-stacked yagi antennas are oriented to pickup Channels 3, 6, and 10 from Philadelphia. The MC-1 master control and amplifier unit may be seen about half-way down the antenna mast.

to do some experimenting. They got a truck with an antenna that could be extended to a height of about 40 feet. They also bought some equipment, including master control and amplifier units, distribution outlets, and several hundred feet of cable.

Their plan was to erect a tower at Summit Hill, where they knew they could get clear signals from the three Philadelphia stations. From the tower they would amplify the signals and "pipe" them downhill by cable to outlets in the town of Lansford. The basic

idea was as simple as that. But would it work?

To test their theory, they took their truck with its extensible antenna tower, the amplifier and distribution units, and several hundred feet of RG/11U cable up to Summit Hill. They connected all this equipment together, looping the cable around over the ground—merely to get the right length for a run downhill to Lansford—finally hooking up a TV receiver to the cable-end furthest away from the antenna on the truck. It worked! Even this crude test proved they could bring television reception down the mountain from Summit Hill to Lansford.

Now they were ready to go ahead with their pioneer community aerial, using the plan shown in Figs. 1 and 4.

Construction of a Community Aerial

After completing their tests on Summit Hill last September, the four Lansford dealers realized that they needed a business organization to bring television down the hill to Panther Valley. So they enlisted a fifth associate, William Z. Scott, leading local attorney and a member of the Pennsylvania State Assembly, who could help solve both the legal and political problems.



Fig. 3. The five founders of Panther Valley Television Company, Inc. From left to right: Rudolph Dubosky, George Bright, William Z. Scott, Robert J. Tarlton, and William McDonald. Scott is a state assemblyman and the others are Lansford TV dealers.

With his help, they named their enterprise *Panther Valley Television Company, Inc.*, and incorporated it under the laws of the Commonwealth of Pennsylvania. Tarlton was elected president; Bright and McDonald, vice-presidents; Scott, secretary; and Dubosky, treasurer. See Fig. 3.

Each of the five officers of the company—which everyone now calls "PV-TV"—provided \$500 as his share of the capital. To this \$2500, they added \$10,000 which they borrowed from a local bank.

The Antenna Tower

First project for the "PV-TV" group was constructing an antenna tower on a site they obtained at Summit Hill. They were fortunate in finding a location where electric power was readily available, near the poles of the local

power company leading down the hill to the town of Lansford.

They consulted with engineers and learned that it would be desirable to have a separate high-gain antenna for each of the three television channels they planned to receive, Channels 3, 6, and 10 from Philadelphia. At first they planned to stack the three antennas, one above the other, on a mast at the top of the tower. But then they realized it would be almost impossible to service the topmost antenna on a slim mast above an 80-foot tower, particularly since this tower is on the summit of an extremely windy hill.

The final design of the tower is shown in Fig. 2. Above the top of the tower is the central mast topped by a double-stacked yagi antenna for Channel 10, a high-gain antenna that picks up WCAU-TV in Philadelphia about 75 miles away.

Below this central mast is a sturdy, all-welded cross-member at each end of which is mounted a double-stacked yagi antenna, one for Channel 3 (WPTZ) and one for Channel 6 (WFIL-TV). This welded girder across the top of the tower is supported by bars attached to the tower and bracing it, as well as by guy wires to the ground which prevent the wind from twisting

this cross-member and thus converting the whole tower into a giant pretzel. Such careful engineering is important in designing a tower for any exposed and windy location, naturally. The antenna tower of "PV-TV" is so well designed that when a hurricane struck the area last November, as George Bright says: "We didn't have a nickel's worth of damage!"

The Amplifier System

All of the equipment used in setting up Panther Valley's "community aerial" was designed and built by *Jerrold Electronics Corporation* of Philadelphia with *Philco Corporation* engineers serving as consultants.

In a multiple-television system, as installed in apartment houses and other buildings, a separate antenna is used for each channel to be received,

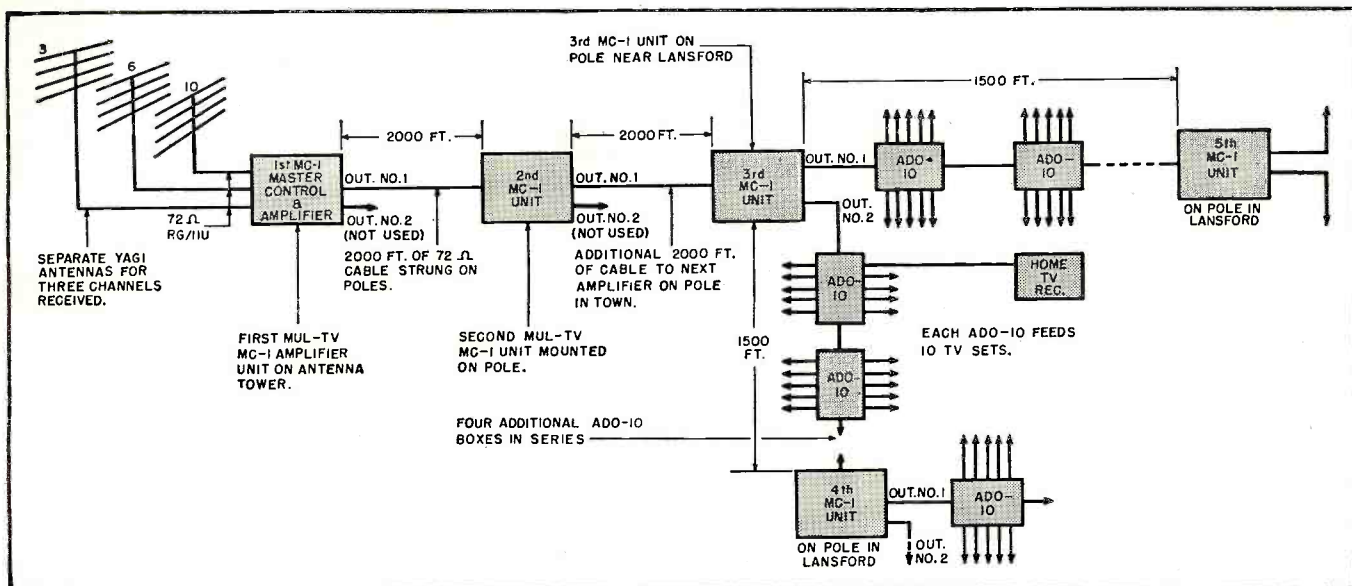

Fig. 4. Block diagram of the multiple receiver distribution system used by the Panther Valley Television Company, Inc.

as noted before. From each antenna, a cable leads to a master control and amplifier unit, the MC-1, shown in Fig. 6.

It is important that the cables from the antennas to this amplifier unit be as short as possible, because each foot of cable introduces additional loss and thus weakens the signal. Hence in an apartment building, the master control and amplifier unit is usually installed in a shelter on the roof, or right under the roof, as near the antennas as possible.

Following the same practice, the "PV-TV" group installed their first MC-1 master unit right on the antenna tower, as shown in Fig. 2, so that the signals from Philadelphia would be amplified right after leaving the antennas.

A word about the MC-1 unit is desirable. This unit has separate 6-tube amplifier strips for each channel, achieving two important advantages:

1. The signal is amplified tremendously, with a gain of up to 500 times.

In other words, the MC-1 is a super-booster. In addition, a new technique is now being developed to utilize a *pre-amplifier unit* between the antennas and the amplifier unit. This pre-amplifier makes it possible to utilize signals as low as 100 microvolts to achieve an output voltage from the master control and amplifier unit of 0.7 volt. This means an over-all gain of as much as 7000! Certain other new developments in amplifier design and usage are also under way, and being tested by the equipment engineers at the

"PV-TV" installation, which will further increase the efficiency of amplifier performance.

2. Because each channel amplifier strip in the MC-1 unit is tuned for that particular channel, there is good rejection of extraneous noise and interference. This means a *clean signal* as well as a *strong signal* after leaving the amplifier.

The MC-1 unit also includes a mixing circuit at the output, so that signals from all channels go out from this unit on a single cable. Hence it is pos-



Fig. 5. A view of Panther Valley from Summit Hill. In the foreground are the poles of the Pennsylvania Power & Light Co. which are used to carry the television cables into Lansford. Prior to the installation of the "community aerial," the surrounding ridges of the Blue Mountains cut off the effective reception of video signals.

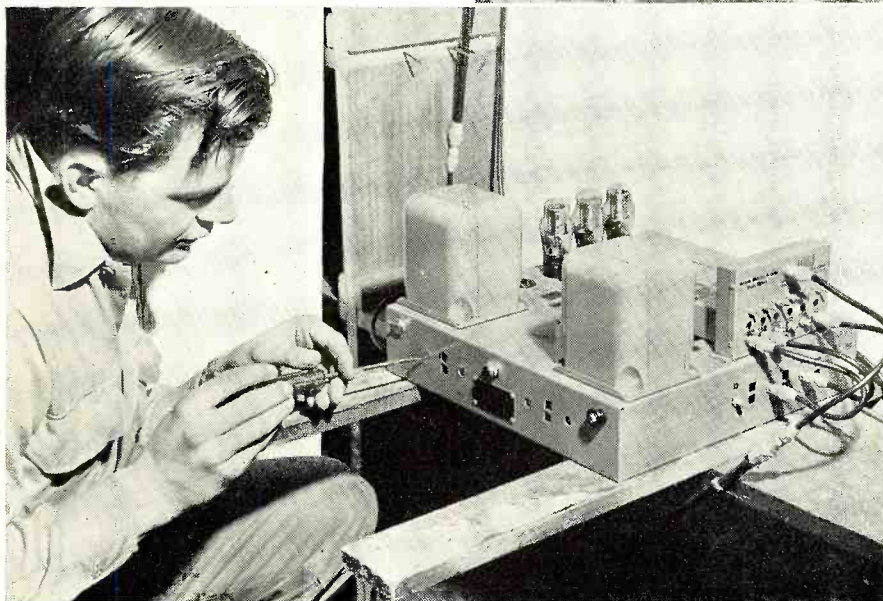

Fig. 6. A "PV-TV" technician adjusts a new MC-1 master control and amplifier unit before installation. The unit amplifies each channel separately and then mixes the amplified television signals in the output to system's distribution boxes.



Fig. 7. Lineman completes wiring of ADO-10 box during the installation. Each antenna distribution box feeds 10 connections and the units can be connected in series to feed an almost unlimited number of receivers.

sible to mix the signals from the three Philadelphia channels and send them down the mountain from Summit Hill to Lansford on a single cable, instead of three cables.

After some experimenting, "PV-TV" has found that one MC-1 unit will amplify the signals enough to "push" them through the cable for about 2000 feet between amplifier units, on the average. Where there are distribution outlets between the amplifiers, as in the town of Lansford as indicated in Fig. 4, then the length of cable between MC-1 units should not exceed about 1500 feet. However, as indicated before, new technical developments and improvements in the system are being made so rapidly that, in the near fu-

Fig. 8. Wiring an ADO-10 antenna distribution box for use in the Panther Valley "community aerial" system. Signals from Philadelphia's three television stations, seventy airline miles away, are being received in Lansford, Pa., clearly and cleanly.



ture, much longer runs of cable between amplifier units will probably be possible.

At present, the pioneers of "PV-TV" are using five MC-1 units to bring strong, clear television signals from Summit Hill into various parts of Lansford. Actually, each MC-1 provides two outlets, each with a composite or mixed signal from all the TV stations received. Thus in Lansford it is now possible to run the signal 1500 feet in two directions from a single MC-1 unit, as shown in Fig. 4.

"PV-TV" is using RG/11U coaxial cable, a standard 72-ohm cable used for many television and other electronic applications. This cable is used with standard *Jerrold* fittings and connectors throughout the community aerial system, from the tower on Summit Hill to the homes, stores and clubs in Lansford where "PV-TV" outlets are provided. Note the cable strung downhill to Lansford on power company poles, shown in Fig. 5.

One important fact should be noted. "PV-TV" binds all its RG/11U television cable to steel messenger cable to provide added strength and support. This practice of "messengering" TV cable conforms with typical telephone company practice, and is essential for a truly permanent installation. Standard telephone company equipment is used for binding the RG/11U to the steel messenger cable.

Installations of cable, MC-1 master control and amplifier units, and distribution outlets are all made by experienced line crews of the leading local coal company, the *Lehigh Navigation Coal Company*. These coal company electricians work in their spare time, and string cable on poles of the local power and telephone utilities. All work complies with safety regulations and meets the utility companies' standards.

Just as in apartment-house master

antenna systems, it is important with a "community aerial" to have soundly engineered distribution outlets to individual television sets, in addition to the right kind of antennas and amplifiers.

For instance, in Panther Valley a distribution unit called an ADO-10 is used. This unit taps off the main line from the master control and amplifier units, and feeds 10 television receivers. The advantages of using this ADO-10 unit over other methods of distribution are:

1. There is real isolation between neighboring television sets. There is *no interference* between receivers, even if the sets are placed side by side and tuned to different channels, because the ADO-10 has a separate tube (a plate-loaded pentode) to feed each receiver and *electronically decouples* it from adjoining sets.

2. You can feed any number of receivers from 1 to 10 with a single ADO-10 unit, and then continue to another ADO-10 to feed 10 more sets, and so on, until you reach a distance of about 1500 feet from the nearest MC-1 amplifier unit. Then you have to insert another amplifier unit, and "pump up" the signal again. This is shown in Fig. 4.

Fig. 7 shows a lineman from a "PV-TV" crew installing an ADO-10 unit on a pole, prior to tapping off ten leads to ten homes in Lansford.

Legal and Political Problems

The pioneers of *Panther Valley Television Company, Inc.* have had to settle a number of problems, both legal and political, which were unique because this is the first community aerial on a major scale.

First, they found that they could use poles of three utility companies serving Panther Valley, including the *Pennsylvania Power & Light Company*, the *Bell Telephone Company of Pennsylvania*, and a local independent telephone company, the *Carbon Telephone Company*. Fortunately, the power company's poles down the mountain from Summit Hill to Lansford could be used. Then in the town the poles of all three utilities proved useful for stringing television cables, and for mounting MC-1 master amplifier and control units and ADO-10 distribution boxes where needed.

However, shortly after the first installations in Lansford so much interest was aroused in neighboring communities that the utilities realized the importance of establishing formal contracts and engineering standards for their part in this development. For a few weeks, the work of "PV-TV" in connecting new subscribers for television was halted until engineering standards and rental contracts with the three utilities could be completed. Since this has been done, "PV-TV" has been able to proceed rapidly with connecting new subscribers on a clearly defined legal and technical basis, using the utilities' facilities as required.

(Continued on page 106)

MOTOR SPEED CONTROLS

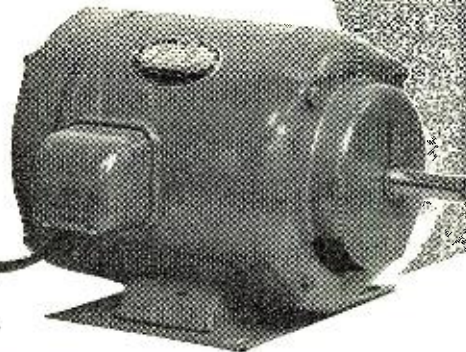
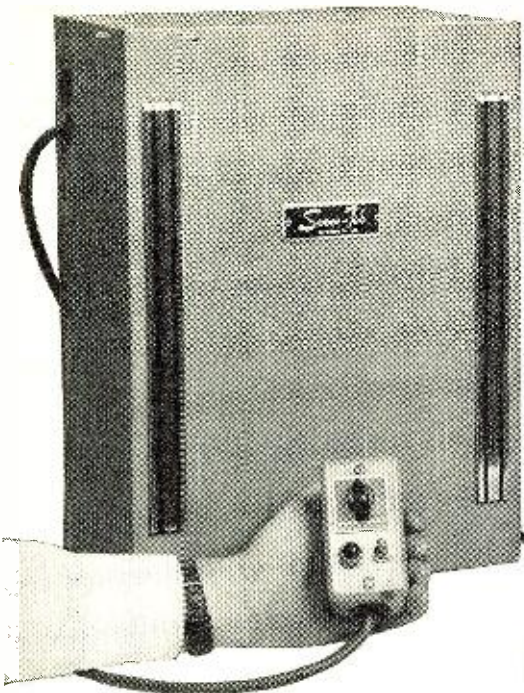

Electronic motor control developed by Servo-Tek Products Co. of Paterson, N. J. This unit provides stepless speed control of fractional horsepower motors up to 1/2 hp. rating.

By
ED BUKSTEIN

Industrial motors, controlled by electronic tubes, perform intricate production jobs automatically.

IT IS difficult to imagine the economic tragedy which would result if industry were suddenly deprived of all of its electric motors. In the electric motor, industry has found a convenient, compact, and efficient source of power. The usefulness and versatility of the electric motor is vastly increased by the electronic circuits which control its speed and torque. Electronically controlled motors are used for drawing and reeling wire with quality and uniformity of results not otherwise attainable. In multicolor printing processes, electronically controlled motors assure correct register of the various colors. In precision grinding, tensile strength testing, wind tunnel operation, and loop control, electronic control has set new standards of precision and quality. The speed of the largest motors can be varied smoothly and steplessly with a simple potentiometer. Gear changing and other time-consuming operations become unnecessary when electronic control is employed.

When speed control is desired, the shunt-wound, d.c. motor is most often used. In this type of motor, the armature and field windings are connected in parallel. The speed of this motor can be controlled by varying either the armature current or the field current. Increasing the armature current will speed up the motor, and *vice versa*. Speed control may therefore be accomplished by connecting a rheostat in series with either the armature or the

field. However, since a rectifier must be used anyway to convert the available a.c. into d.c., a special tube which serves as both rectifier and rheostat is used. This tube is the thyatron—a hot-cathode, gas-filled tube containing a control grid.

The ordinary vacuum diode rectifier conducts current whenever its plate is positive with respect to the cathode. The thyatron, however, may be made nonconductive even though its plate is positive with respect to its cathode. This is accomplished by the application of negative bias to the control grid. Moreover, the tube may be made to fire (conduct) at any desired instant during the positive alternation. In this way, the average current supplied by the rectifier, and consequently the speed of the motor, may be easily controlled by varying the thyatron bias.

Magnitude Control

One system of motor speed control is illustrated in Fig. 1. The accompanying waveforms represent the a.c. plate voltage (E_p), the control locus which shows the grid voltage required to fire the tube at any instant, and the applied grid voltage (E_g). The thyatron fires when the grid voltage becomes less than the critical value required to make the tube conduct, that is, when E_g crosses the control locus. By increasing the grid bias, the tube may be made to fire later in the positive alternation. The shaded area under the curves represents the time

during which the thyatron is conductive. Changing the bias will therefore change the average current supplied by the rectifier, and consequently the speed of the motor.

Phase Control

Another system, phase control, is shown in Fig. 2. Here, the d.c. grid bias has been replaced by an a.c. potential. As shown in the accompanying diagrams, shifting the phase of the a.c. grid voltage will cause the tube

(Continued on page 136)

Fig. 1. Magnitude control. Increasing the bias causes the tube to fire later in the cycle, decreases the average current supplied by the rectifier, and slows down the motor.

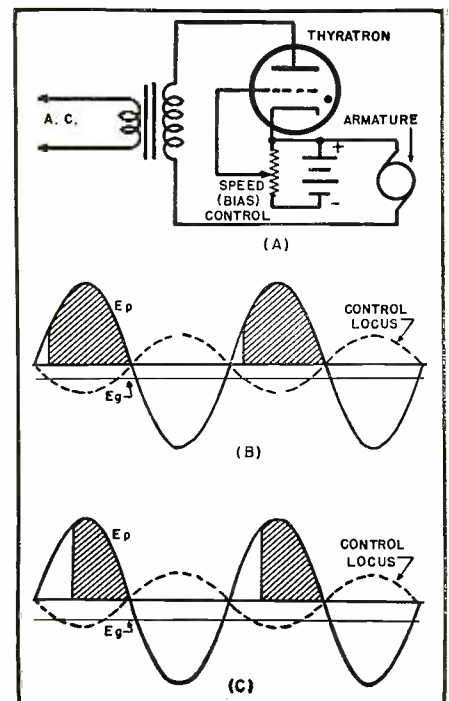

An ULTRAVIOLET PROBE



Fig. 1. Over-all view of the ultraviolet probe and its associated generator unit.

By

C. E. ATKINS

Tung-Sol Lamps Works, Inc.

Details of an electronically-energized quartz probe which requires no internal electrodes.

IN the byways of the electronic art, one of the most intriguing applications of radio frequency energy is its use to excite a gaseous discharge in a tube without internal electrodes. This principle has been most successfully exploited by Frank Furedy in the *Sun-Kraft* lamp as described by S. W. Edwards in the article "Efficient Ultra-Violet Generator," appearing in *RADIO NEWS* for November, 1943.

Dispensing with internal electrodes is especially helpful where it is desired to maintain a discharge in a slender elongated tube. Such a pencil-like device is necessary if ultraviolet energy is to be applied to the membranes of a body orifice under medical treatment by a physician. It is an effective way to destroy fungi in crevices and such out-of-the-way places as the skin between the toes in the case of "Athlete's Foot."

Ultraviolet light is most commonly produced by the ionization of mercury vapor. This is usually achieved by passing a direct or alternating current through the vapor between conducting electrodes and through associated lead-in wires. These electrodes are frequently of the type employed in neon signs. In order to transmit the ultraviolet light generated by the gas discharge, the walls of the containing vessel must be transparent to radiant energy of this wavelength. The glass used in radio tubes and most kinds of lamps fails to meet this requirement, so it is customary to use quartz or some other special material. It is dif-

ficult and costly to seal electrodes in quartz so it is nice, for this reason alone, to dispense with them. Furthermore, the electrodes wear out, thus placing a definite life limitation on a necessarily expensive structure. The internal electrodes usually produce heat, which is frequently undesirable in many applications. Of even greater

CAUTION!

The ultraviolet rays from the probe are dangerous. Every precaution should be taken to see that these rays do not reach the naked eye. While ordinary glasses will protect the eyes to some extent, goggles are recommended. With glasses, continuous viewing longer than 20 minutes is not advisable.

The ultraviolet rays reaching the skin will burn like the summer sun. The probe should not, therefore, be held directly in contact with the skin for periods longer than 1 minute in any one application.

import where this sort of applicator tube is concerned is the fact that its special purpose requires that one end of the tube be free of electrodes, wires, or any other impediment to its use. Accordingly, if internal electrodes are used, it is necessary to provide a gas-tight partition down the center of the elongated tube so that the arc will travel from one electrode to the extremity of the tube, where there is an opening in the partition and then down the other side of this wall to the second electrode. This is a cumbersome and costly arrangement.

In contrast, if no internal electrodes are needed, the quartz tube has practically limitless life, produces little or no heat, is far less costly to fabricate and it is possible to make the working end of the quartz applicator tube as tiny as necessary.

As the sketches and photographs show, the applicator tube consists of a slender quartz tube with a bulb or enlarged portion at one end where it has been sealed off. Experiments have demonstrated the desirability of this structure in order to facilitate ionization. Briefly, in a device of this kind the discharge must be established by the agitation of any free electrons or ions in the gas. When the instrument is idle de-ionization takes place and its completeness is a function of such things as available surface area contacting active gas molecules in the elongated portion of the tube. A process like this is accelerated by an unfavorable ratio of volume to surface; hence, if the quartz tube were slender throughout its length, it would be very difficult to start the discharges as experience has demonstrated. If a larger cross-section is used at one end, it is possible to obtain a more favorable ratio of volume to surface for the gas within the tube and yet the working part of the tube can remain slender.

The tube which in the present model is approximately seven inches long with a five-inch stem tapered to $\frac{1}{4}$ inch and a bulb portion two inches long and $\frac{3}{8}$ inch in diameter, is exhausted, baked out, and then filled with a mixture of rare gases (argon, helium, etc.) at a suitable low pressure—for example, 10 mm. of H_2 and a small globule of mercury which is usually so small as to be scarcely visible. It is excited by placing it in a radio

RADIO & TELEVISION NEWS

frequency field. Many experiments were performed in an endeavor to discover the best way to do this. A coil around the bulb end of the tube energized by an oscillator was tested. This did not prove satisfactory and it appeared that the gas arc useful in this case was produced by an electrostatic rather than an electromagnetic field. Insofar as the coil worked at all, it appeared to be due to the electrostatic gradient across it. A small metal band around the bulb connected through a wire to the hot side of an r.f. oscillator gave better results. However, when the tube was used as an applicator the arc which should extend to the extremity of the tube would retreat in the direction of the bulb as the probe portion was inserted in a crevice. It was found that another wire coming from the opposite side of the oscillator tank in spaced relation an inch or so away from the first wire if held alongside the quartz tube greatly enhanced the stability of the discharge. For this reason the applicator design takes the form illustrated and shown in the sketch (Fig. 2). Almost any suitable arrangement can be provided for the housing of the quartz tube which, of course, becomes the handle by which the operator applies the device. The two-wire line extending from the applicator housing to the source of radio frequency energy may be any length up to ten feet or so, although naturally more power is required for the greater lengths. In most cases five or six feet of line is sufficient. Ordinary rubber covered flexible wire can be used and the wires should be spaced an inch or two apart by means of thin insulating spacers placed along the line every few inches. These can be of bakelite or similar dielectric material. For the model illustrated regular two terminal "antenna-ground" strips were used by simply removing the terminals and threading the line through the holes that were left.

The reader may wonder why a tuned circuit was not incorporated in the applicator holder or handle so that a low impedance transmission line could be employed. This was tried many times and did not work as well as the high impedance line. In addition, such an arrangement requires that the oscillator be tuned to resonance with the circuit in the applicator handle. This of course is likely to be changed by the operator's hand due to body-capacity effects which will vary with the manner of gripping. It has been found that these effects are minimized by the configuration adopted. Of course the operator's hand does absorb some r.f. power and in practice it is best to grip the handle as lightly as possible. The arrangement shown has been found practical, although other experimenters can undoubtedly discover a host of variations upon it.

By using two concentric bakelite tubes the operator's hand is reasonably removed from the bulb of the quartz tube with its encircling metal band. As was stated, this band is connected

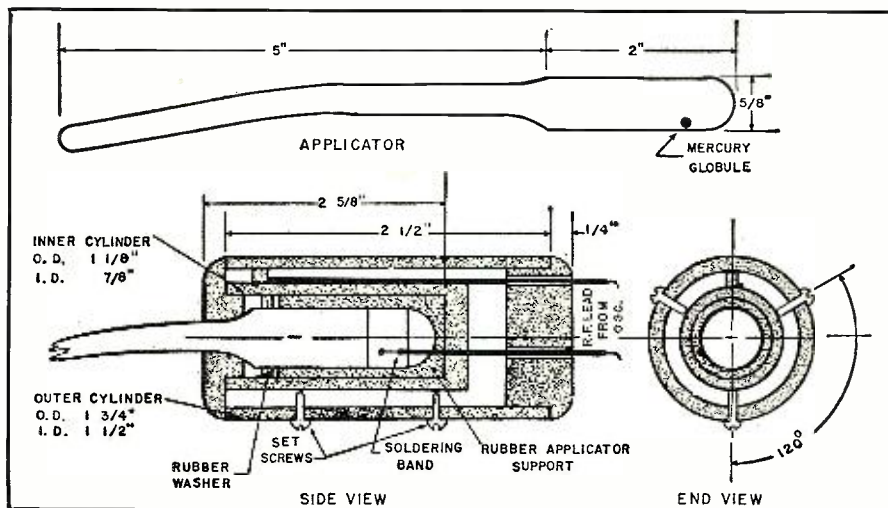

Fig. 2. Mechanical details of probe housing. This housing is used as the handle and may take any suitable form the builder finds convenient for his purposes.

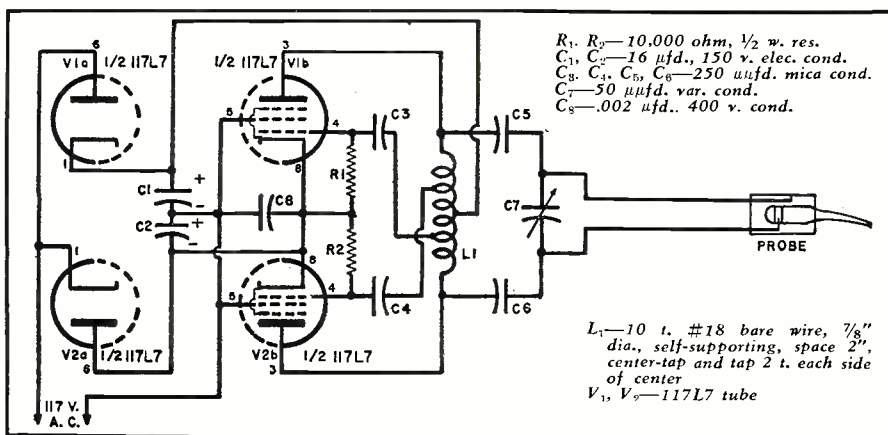

Fig. 3. Diagram of one of the author's experimental model r.f. oscillators. The unit is simpler to build and has less power than the final model shown in photographs and in Fig. 4. The quartz probe is a specially-built component and is not available on the market, however, there are some glass blowers who will build probe to order.

to one transmission line. The other line terminates just above the bulb and can be tied to the inner wall of the outer bakelite tube with a piece of fish-line or other strong thread. This can

be threaded through two small holes in the bakelite tube and then varnished over on the outside. It is best to use some such non-metallic means for se-

(Continued on page 134)

Rear view of the final model of the oscillator. Schematic diagram is shown in Fig. 4.

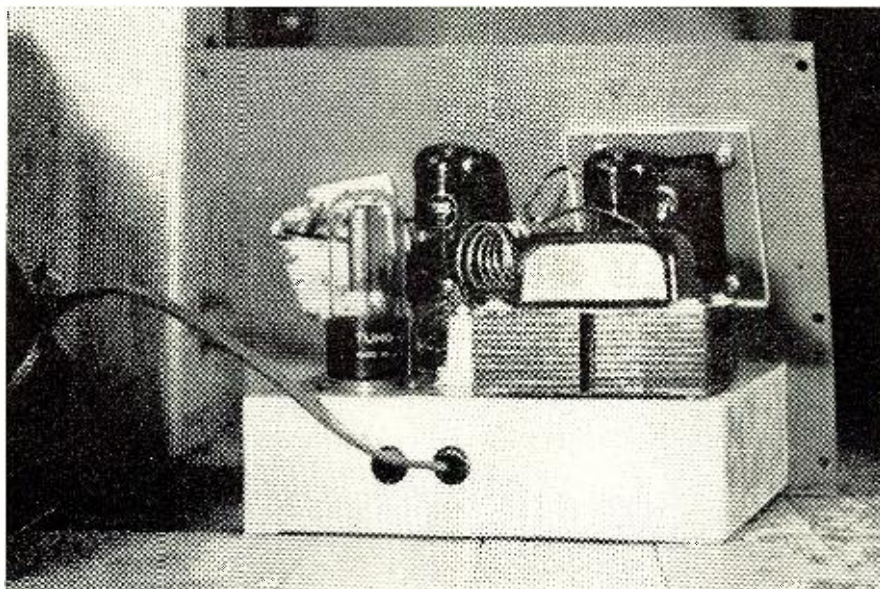

TUBE SUBSTITUTIONS In Home Receivers

By
MEYER CHERTOCK

SINCE most service technicians are already feeling the pinch of tube shortages, information on how tubes which are in fairly adequate supply can be substituted for short numbers is of more than passing interest at this time.

First of all we will consider tubes used as r.f. and i.f. amplifiers. The 78 and 6D6 may be directly interchanged, since they have similar electrical characteristics and base connections. There is a slight difference in over-all height; the 6D6 being the larger of the two. The 77 tube is the sharp cut-off version of the 78, while the 6C6 is the sharp cut-off version of the 6D6. These tubes also can be directly interchanged. Therefore, like the 78 and 6D6, the 77 and 6C6 have been interchanged directly. In some cases, substituting the 6D6, 6C6, 78, or 77 for any one of these numbers provides good results. The 6K7, 6K7G, or 6K7GT may be used in place of either the 6D6 or 78 providing an octal socket is wired in place of the 6 prong socket or an octal to 6 prong adapter is used. The 6J7, 6J7G, or 6J7GT may similarly be used in place of the 6C6 or 77. Wiring the single-ended 6SK7 or 6SJ7 introduces the added possibility of oscillation due to added coupling between the grid input circuit and the plate output circuit. The dressing and placement of leads could become rather critical.

The 6K7, 6K7G, 6K7GT, 6S7, and 6U7G can be interchanged directly providing the grid cap lead is lengthened to reach the top of the taller tubes. Grounded tube shields are usually necessary for the glass tube types. Going back still further in radio history, the 35 or 51 tube has been directly interchanged with the 24 or 24A tube in many cases. Actually the 35-51 is the remote cut-off version of the 24A. This tube provides smoother volume control or a.v.c. action than the sharp cut-off type.

In receivers employing transformers for the heater supply, the following substitutions usually will provide good reception. In the loktal family of tubes, the 7A7, 7B7, 7G7, 1232 have

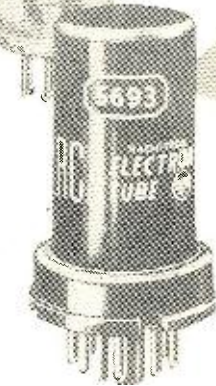

Growing tube shortages are already taxing the ingenuity of technicians. Here is data on some available alternates.

been directly interchanged by the author. The 7G7 (1232) has somewhat higher gain but substitution with the more common and lower priced 7A7 or 7B7 seemed to eliminate microphonics and impart greater stability to the receiver. Note: A seemingly intermittent loktal tube has been found to be caused by a poor socket-to-pin connection. The base pins of loktal tubes being smaller in diameter than its predecessor, the octal tube, provides this small additional source of trouble in some home receivers.

The 6SK7 and 6SS7 differ, for the most part, only in heater current requirements. Therefore they may be directly interchanged in sets having power transformers. In *Philco* receivers employing two XXL tubes, a 7A4 tube has been successfully used as a direct replacement for the XXL, which is an r.f. mixer tube. When substituted for the XXL local oscillator, no difference in performance was noted.

In portable sets good performance might be obtained by using the following interchangeable combinations:

For the r.f. or i.f. amplifier, the miniature type 1U4, 1T4, or 1L4 might be interchanged, or the octal base 1N5 and 1P5 may provide good results with a slight reduction in gain. In the audio power amplifier, the 1A5 and the 1T5 may be interchanged, or the 1C5 and the 1Q5 may be interchanged. For the pentagrid converter, adapters are available to the trade which permit the use of a 1R5 for a 1A7.

In the converter or mixer oscillator portion of receivers, substitutions are not common. The 6K8 has been used for a 6A8 with partially successful results. Extreme care must be exercised in substituting seemingly similar tubes. Specifically this recalls the situation arising when a 6SA7 was substituted for a 6SA7GT. The suppressor grid is connected differently in each of these tubes. In many cases the use of a 6SA7GT in place of a 6SA7 results in an inoperative receiver. Receivers must be tested by tuning completely from the high end of the dial to the low end of the dial and *vice versa*.

Adapters may be employed to substitute the newer 7 pin miniature tubes for their older 6 prong and octal counterparts. Replacement of the older tubes with miniature types through the use of adapters, proved successful in some cases. However other sets broke into oscillation, evidenced by either squealing, motorboating, or going completely dead after proper warm-up. This normal reaction was due in the main to the higher transconductance of the 7 pin miniature r.f. and i.f. amplifier tubes. The 6BA6 and the 6AU6 provide much more gain

(Continued on page 86)

Fig. 1. Three suggested tube adapters.

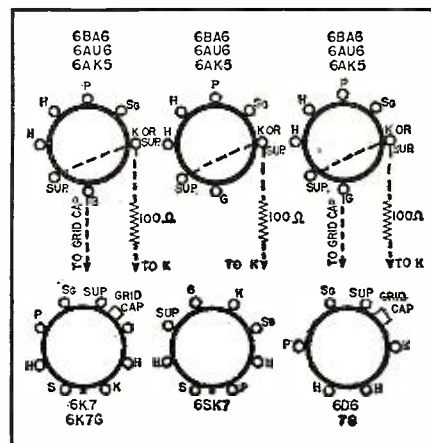

A HIGH-QUALITY AUDIO SYSTEM

Compact and well engineered—this audio system is designed primarily for home use. Included is a 20 watt wide-range amplifier and a novel control unit.

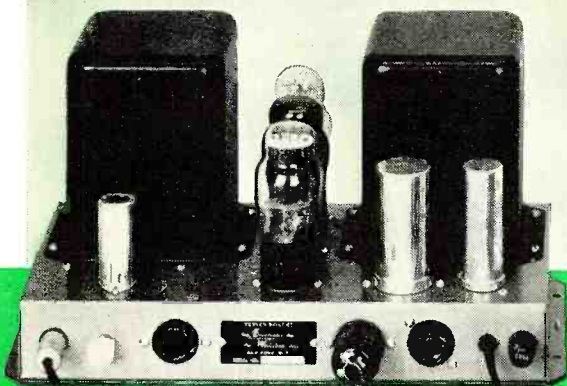

Over-all view of amplifier and remotely-operated control unit.

By
**HOWARD T. STERLING* &
ALAN SOBEL†**

IN A home music system it is usually most convenient, both physically and electrically, to separate the power amplifier from the controls and switches. Power amplifiers are, of necessity, rather large. They tend to get quite warm, and the magnetic field of the system power transformer can easily disturb sensitive low-level circuits. The controls need not be so bulky; with the requisite preamplifiers, they can be concentrated in a small control unit which can be placed wherever it is most comfortable for system operation, while the power amplifier is put somewhere out of sight in the bowels of the system, where its heat and hum fields will not be inconvenient. For these reasons, the *Electronic Workshop* A-20-5 Amplifier System is divided into two units: the A-20 Basic Amplifier, and the C-5 Control Unit.

The A-20 Basic Amplifier is rated at 20 watts with less than 1% distortion. Its frequency response is flat within ± 1 db. from 20 cycles to 20,000 cycles. Full power at rated distortion is delivered over the range of 50 cycles to 10,000 cycles—at 20 cycles and at 20,000 cycles the power capability is decreased by less than 3 db. Signal-to-hum ratio is better than 85 db., while the sensitivity is 1.5 volts for 20 watt output. All this is achieved in an amplifier only 14 inches long, 7 $\frac{3}{4}$ inches high, and 7 $\frac{1}{2}$ inches deep, including the rather large transformers.

The output tubes are 6L6GA's. Since they require only about 40 volts grid-to-grid, they are driven directly from the split-load or cathodyne phase inverter, which in turn is driven from a single triode stage. Using a 12AX7 for both these functions, the required

gain is easily obtained, with plenty of margin for the 18 db. of inverse feedback which is used. Feedback is taken from a tertiary winding on the output transformer, thus compensating for any distortion the transformer may introduce and at the same time leaving the output windings floating with respect to ground, so that an ungrounded system may be driven. The cathodyne phase inverter, because of the large amount of inverse feedback produced by the cathode load, is inherently quite linear, and the result of all the feedback is to make the amplifier quite insensitive to tube variations or line-voltage fluctuations. A further advantage of the 18 db. of feedback is a damping factor of five, which promotes distortion-free operation of the loudspeaker.

The 12AX7 driver and phase inverter has its filament power supplied from the d.c. cathode current of the 6L6's, thus eliminating any hum from this heater. In addition, up to 24 volts of d.c. at 150 milliamperes is available to heat the filaments of control-unit tubes. Because of the configuration of the 6L6 grid returns and bias resistors (the latter including the 12AX7 filament) the 6L6's act as a constant-current source of d.c., and adding cathode-circuit resistance in the form of control-unit heaters has a negligible effect on the operating point of the output tubes.

The rectifier is a 5V4, a tube which uses heater-cathode type construction. The rectifier cathode takes about the

same time to reach operating temperature as the 6L6 cathodes. Thus the high voltage does not appear across the input filter condenser until the 6L6's are ready to draw plate current. This reduces the surge voltage on the filter condensers and contributes to their longer life. Since the system is class A throughout, the poor regulation of a condenser-input filter is not important.

A shaping network is employed in the feedback loop to insure adequate transient response—it corrects for undesirable phase shifts in the region of 75 kilocycles. The transient response is clean and free from ring.

The input plug is conveniently arranged so that if more sensitivity is required, the feedback may be reduced by making the appropriate jumper connections. Reducing the feedback to 8 db. gives a sensitivity of about $\frac{1}{2}$ volt—distortion is somewhat higher than with full feedback but the frequency response is practically unchanged—or all feedback can be eliminated, giving a sensitivity of about 0.2 volt. All these changes can be made by appropriate jumper connections in the input plug, without the necessity for removing the amplifier bottom plate.

As the photographs show, all the necessary receptacles are arranged on one side of the amplifier. These include input connector, control-unit power connector, a ground binding post, power cord, amplifier output receptacle, and an a.c. outlet controlled by the amplifier power switch for operating associated equipment such as record players or tuners. Thus the amplifier

* Chief Eng., The Electronic Workshop, Inc.
† Eng., The Electronic Workshop, Inc., 351 Bleecker St., New York 14, N. Y.

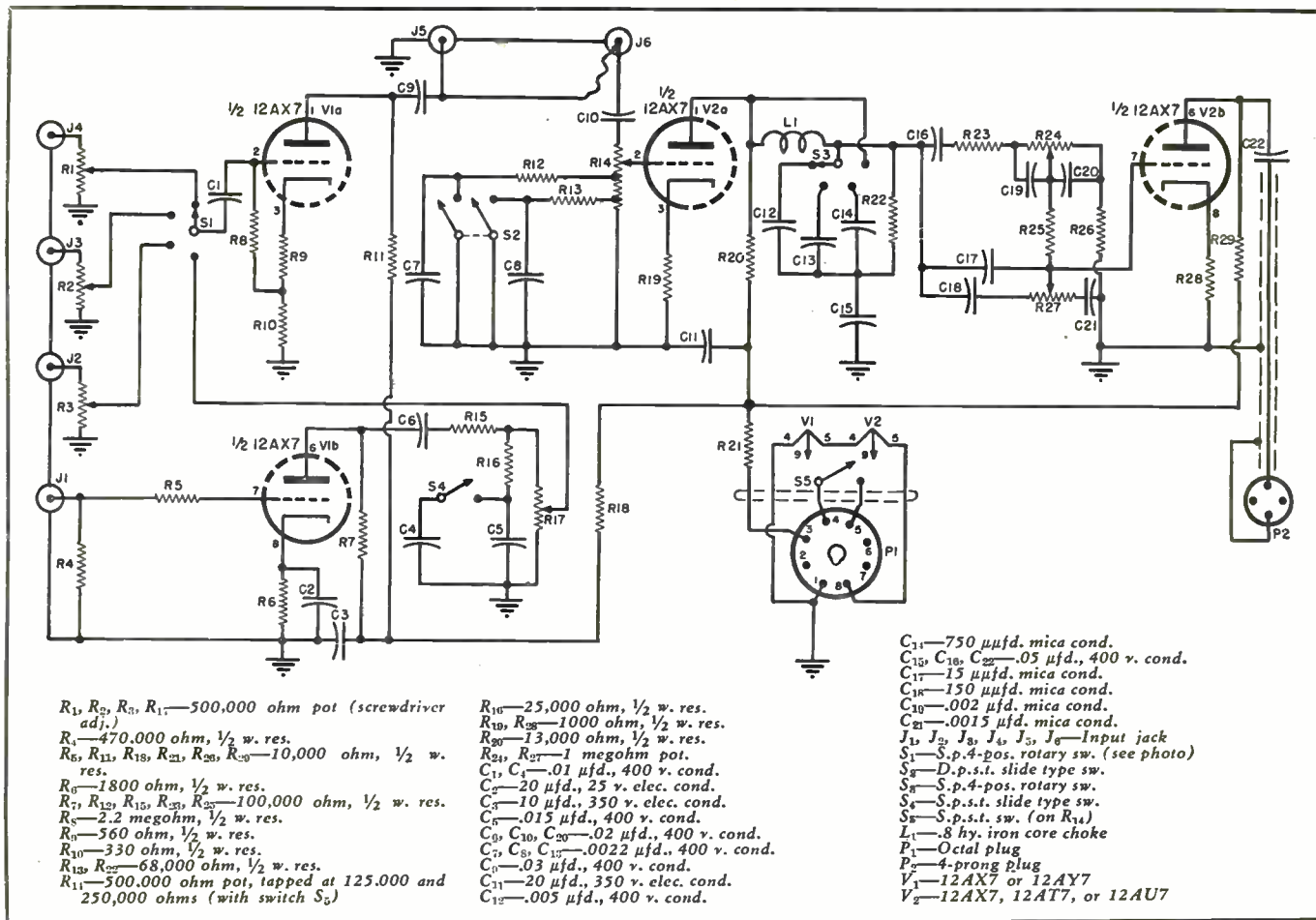

Complete circuit diagram of the Electronic Workshop C-5 remote control unit.

can be conveniently located against the wall of the cabinet in which it is to be housed.

The power rating of an amplifier is the maximum power it will deliver at a specified distortion. In a well-designed amplifier, the distortion at levels much below maximum will be completely negligible. As the illustration at the bottom of page 139 shows, the distortion in the A-20 becomes exceptionally small at a level only 6 db. down from maximum. Since the ratio of peak-to-average power in music (or speech) is quite high (on the order of 15 db.), the distortion at average level for the A-20 will certainly be inaudible. This

insures that listening fatigue will be unimportant with this amplifier.

It is important that the power amplifier be able to handle full power at all frequencies. It is true that statistical studies show that the average intensity of musical or speech sounds is lower at the ends of the audio range than at the middle, but the amplifier is designed to reproduce music, not statistics. Aside from such phenomena as organ music and percussion instruments, which require large amounts of low- and high-frequency power respectively, the use of tone controls may increase the level at the extremes of the range by as much as 20 db.

The ability of the amplifier to handle full power at the extremes of the spectrum is also important because of its effect on intermodulation. Effectively, intermodulation means the production of additional frequency components which were not in the original signal, and which may bear no simple harmonic relation to the signal frequencies. The result sounds "muddy", there is poor separation between instruments, the violins get inextricably mingled with the violas, and large groups of strings or voices sound as if they were immersed in mush. If the amplifier can be easily overloaded by high- or low-frequency components of the program, intermodulation will be much higher than the mid-frequency distortion ratings would indicate. If, as in the A-20, full power can be delivered over the entire range, then overload is quite unlikely at any frequency at any ordinary listening level, and the intermodulation distortion is low enough to be unnoticed.

The C-5 Control Unit is the other element of the A-20-5 Amplifier System. It utilizes two 12AX7's, with d.c. on the filaments to minimize hum (over-all signal-to-hum ratio, including the power amplifier, is better than 75 db.), and with considerable inverse feedback in three of the triode sections to minimize distortion and make the effects of tube aging negligible over a longer period of time than would be possible without feedback. The

Under chassis view of the commercially-built C-5 remote control unit.

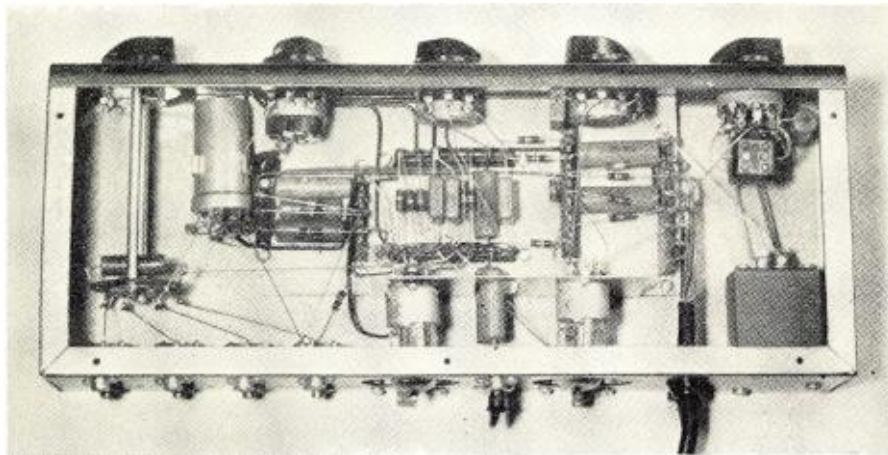

fourth section is the phonograph pre-amplifier—it is run at such a low level that amplitude distortion is no problem.

Tone controls to arbitrarily change the frequency response of the system are, of course, a necessity. Every listener has his preferences as to the way he likes his music to sound. Tone controls allow the listener to compensate for variations in microphone placement, recording characteristics, or other peculiarities of the program source. They are even useful in compensating for the acoustics of the listening room (which will be a function of, among other things, the number of people present, the number of windows open, and whether the draperies are heavy winter velvet or light summer cotton). Most important, the tone controls permit the individual user to indulge his own taste as to the quality of the reproduction he prefers. He may wish to boost the bass on an organ passage, or to listen more closely to a bit of cello counterpoint, or he can boost the treble to bring out cymbals or triangles. These are purely subjective problems, which can be met only by adequate flexibility in the system. The continuously-adjustable controls in the C-5 provide about 18 db. of bass or treble boost, and about 24 db. of attenuation at the extreme frequencies, without interaction between bass and treble controls. The tone controls are arranged to have no effect in the region around 800 cycles, so that there will be a minimum change of volume with change in tone control settings.¹ With this feature, the listener can experiment to find the setting which gives most pleasing reproduction without having the effects of the tone control setting masked by changes in the apparent loudness of the program. Maximum effectiveness of the tone controls with a minimum of juggling between tone and volume controls is thus assured.

For phonograph records, some form of treble cut-off filter to reduce noise and high-frequency distortion is desirable. Dynamic methods, such as the Scott Noise Suppressor, are quite effective when carefully used, but may add unduly to the cost and complexity of the system. The tone controls incorporated in the C-5 are not very effective for this purpose, because their slope is gradual and because the total attenuation at high frequencies is not great enough. A scratch filter should have a rapid transition between pass-band and attenuation band and a sharp slope beyond the cut-off frequency to cut off scratch cleanly and yet sacrifice as little of the music as possible. Of course, any scratch filter will sacrifice the signal along with the noise it cuts out, but this is not a case of "throwing the baby out with the bath" that it may appear to be at first glance. Reducing the scratch level makes for much pleasanter, more com-

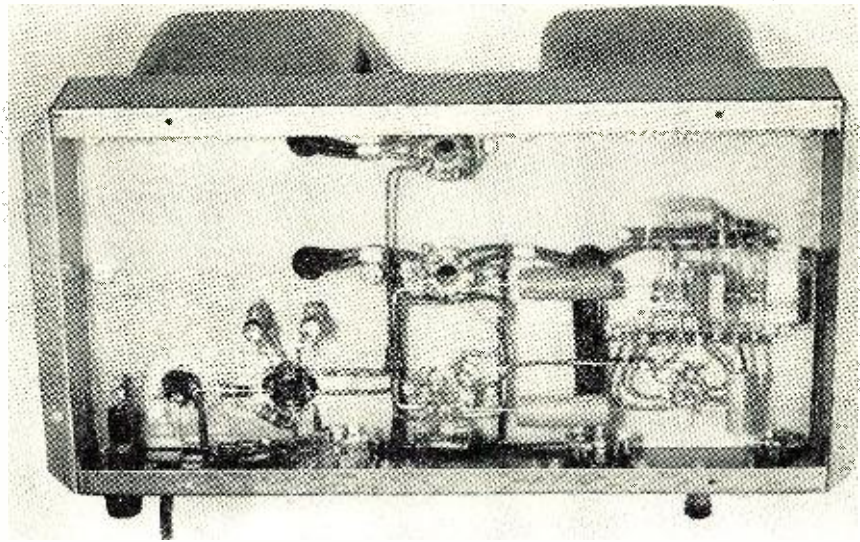

Underchassis view of the A-20 amplifier unit and its associated power supply.

fortable listening, even if this involves using less than the full (and unpleasant, under these circumstances) bandwidth of which the system is capable. In addition to scratch, high-frequency distortion, which is most severe with worn records (and worn reproducing styli), is also attenuated. Furthermore, since the noise tends to mask all but

the highest-intensity signal components at the higher frequencies, we have not really lost much of the signal available to us from a noisy record, and we have reduced an annoying form of distortion.

The high-frequency filter in the C-5 Control Unit has a slope beyond cut-off of 12 db. per octave. It is critically

Complete schematic diagram of the A-20 amplifier and necessary power supply.

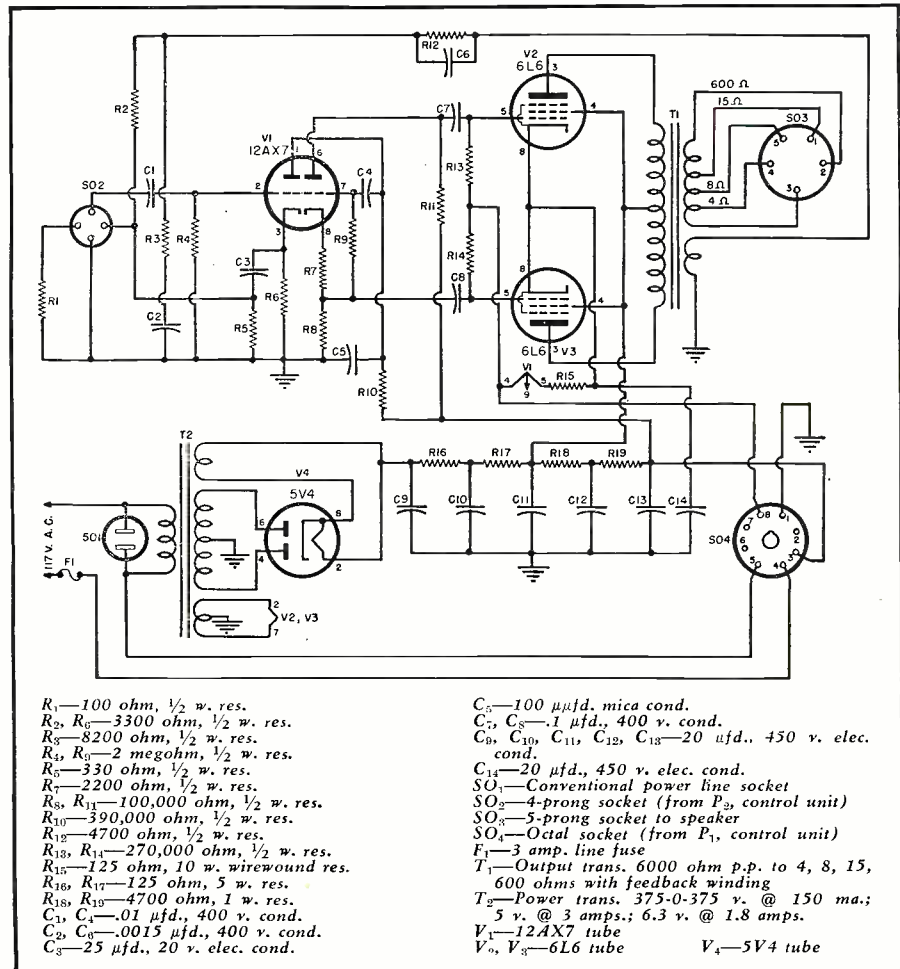

¹ Sterling, Howard T.; "Flexible Dual Control System," Audio Engineering, February, 1949.

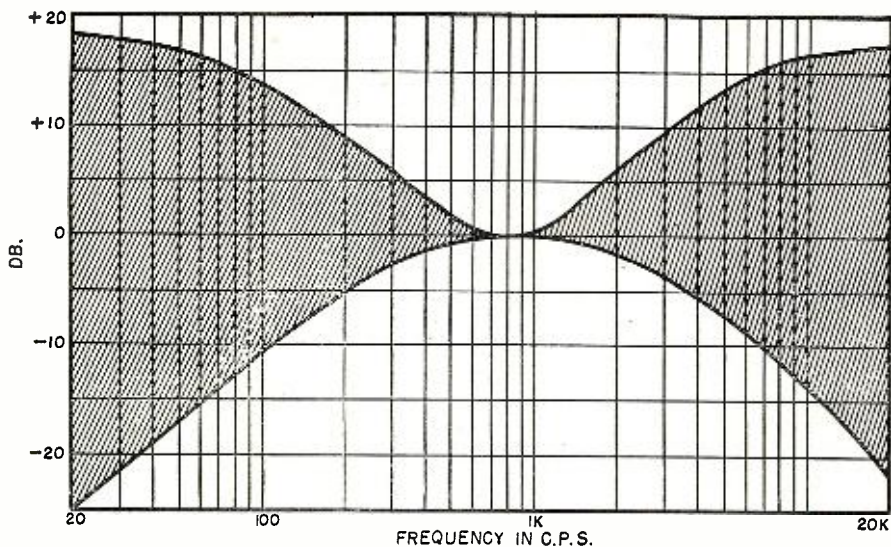

Over-all range of the bass and treble tone controls used on the C-5 unit.

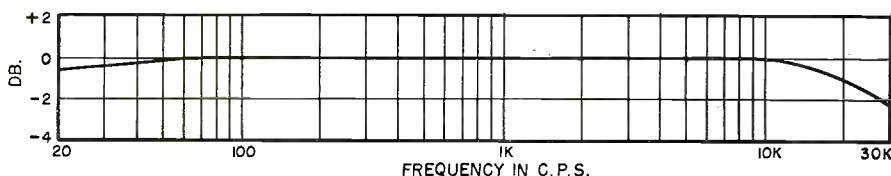

A-20 amplifier frequency response. Response is down 1 db. at 20,000 cycles.

damped in order to provide optimum transient response. No ring or overshoot is evident when the filter is in the circuit. In addition to this filter, which is operative on all input channels, a *Scott Noise Suppressor* can be connected into the system through connectors on the rear of the control unit. It, too, is effective on all input channels, so that it may be used on broadcast records as well as on those played on the home music system.

The frequency response of the ear changes with change in the volume of sound. This is the reason that reduc-

ing its volume tends to deprive music of "body" or "quality"—there is a decrease in the low-frequency response of the ear as the intensity of the sound is reduced. To minimize this uncomfortable effect, the volume control of the C-5 is a loudness control—compensated for the characteristics of the ear according to the Fletcher-Munson curves. The improvement in listening comfort over an uncompensated control is significant—the quality of the sound is unchanged as the intensity is varied. A switch on the rear of the control unit disconnects the compensa-

Loudness control characteristics (A) and treble cut-off filter characteristics (B).

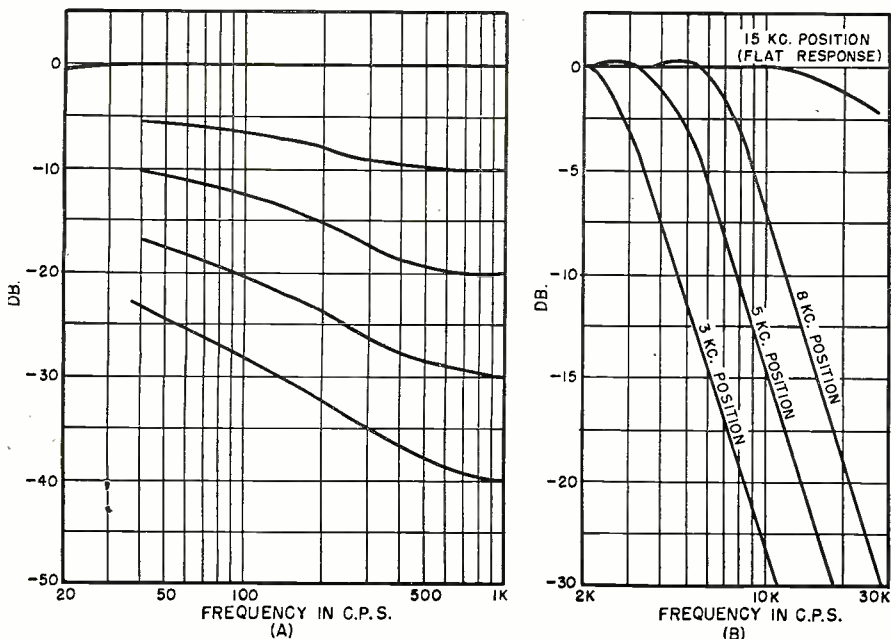

tion network, if this should be desired.

With a compensated volume control, level sets in the various input channels are not merely convenient, but essential to the proper operation of the compensation feature. The convenience of having all program sources at the same level is considerable—it is annoying to be blasted out of one's seat by a loud squawk from an overloaded loudspeaker when switching from phonograph to radio. Each of the four channels of the C-5 is, therefore, equipped with an independent level-set potentiometer. By incorporating four channels, ample provision is made for a complex system including phonograph, radio, television, and a tape or disc recorder. Furthermore, an output jack supplies about .5 volt at an impedance of 10,000 ohms for feeding a tape recorder. This output is ahead of tone and volume controls, so that the material being recorded is unaffected by the control manipulation necessary to compensate for room acoustics, conversation, etc.

The phonograph channel has a sensitivity of better than 7 millivolts—high enough for any of the available magnetic cartridges working with LP records. Performance of any cartridge is critically dependent on the impedance into which the cartridge works. For the *General Electric* RPX040 (the "variable reluctance") cartridges, the correct load resistance for 78 r.p.m. records is .5 megohm shunted by 500 micromicrofarads. This is supplied by the C-5 Control Unit (plus the cable capacitance of the usual lead from phonograph to control unit). For LP records, shunting the *G-E* cartridge with 8200 ohms gives a high frequency roll-off which is just complementary to the NAB pre-emphasis curve used in recording. When plug-in heads are used for the two types (LP and standard) of cartridges required, the 8200 ohm resistor can be soldered across the LP cartridge right in the head, thus changing the equalization automatically when changing the cartridges. If such a system is inconvenient, the treble tone control incorporated in the C-5 approximates the NAB equalization curve when turned to the extreme counter-clockwise position. (Note: The values of terminating resistance quoted here apply *only* to the *G-E* RPX040 and RPX041 cartridges.)

The optimum low-frequency turnover for phonograph equalization is 450 cycles.² With this turnover frequency and the tone controls, one can equalize within 3 db. for any of the current or past recording characteristics. However, most similar equipment uses a turnover frequency of 270 cycles, to give a more "brilliant" effect at high frequencies. To provide for comparisons with other equipment, both turnover frequencies are available, selected by a slide switch on the rear of the control unit.

The control unit is 15½ inches long,
(Continued on page 139)

² Sterling, Howard T.: "Simplified Preamplifier Design," *Audio Engineering*, November, 1949.

Low Cost Vest Pocket RADIO RECEIVER

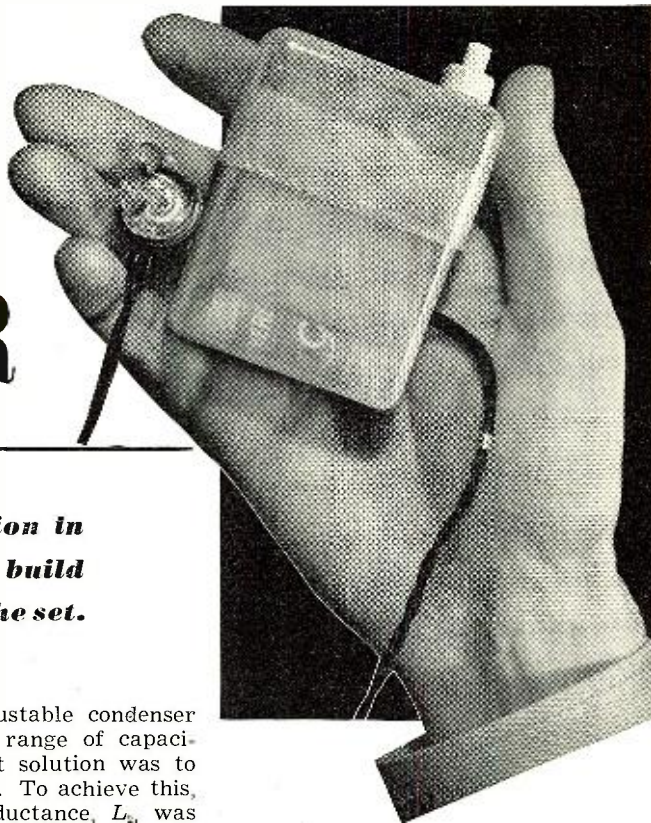

This little job, using superregeneration in the broadcast band, is inexpensive to build and operate. No antenna is used with the set.

**By
MARK A. COPPIN**

THREE major problems are involved in designing pocket receivers. They must be compact; their sensitivity must be extremely high, in order to permit operation with a small wave collector; and, for reasonably cheap operation, they should work with a low drain on the batteries.

Superregenerative receivers are an easy answer to these problems, and, if they are to be operated within a relatively short distance from a transmitter, their lack of selectivity is immaterial. There seems to be a widespread belief that superregenerative amplification is only possible at very high frequencies, but in reality it can be used in the broadcast band without losing any of its valuable characteristics, as the receiver described here will show.

This receiver can be built by anyone for about \$3.50. A single tube is used, a 958A acorn triode which can be purchased for 18 cents from any surplus store. The voltage applied to the plate is 22 volts, but reception can be obtained with only 4 volts. The plate current, from a 22½ volt "B" battery, is only about 1/5 milliampere.

The circuit is that of a conventional self-quenching superregenerative detector. Regeneration is obtained from L_1 , while the quenching frequency is provided by C_1 , periodically charging to cut-off through the filament-to-grid resistance of the tube and discharging through R_1 . In order to achieve low cost and simplicity, the set is tuned for once and for all to the station whose signals are strongest in the area where it will be operated. This, however, does not mean that no tuning control whatever is needed, as some tuning adjustment will usually be necessary after the receiver is built. The extreme compactness of the set made it impos-

sible to use an adjustable condenser with an acceptable range of capacitance, so the easiest solution was to use inductive tuning. To achieve this, the tank circuit inductance, L_2 , was made up of two midget coils, obtained from a 2.5 millihenry choke which had four such coils. They were connected in series and mounted one behind the other on the same axis so as to provide a positive mutual induction between them. The idea was to position them so as to get the correct inductance in order to have the circuit tuned to a frequency of 640 kc. However, it was found that the maximum inductance wasn't quite enough and a third midget coil was added, as can be seen in the picture. All three coils are simply glued together with fast drying cellulose glue, the third one being po-

An inexpensive, transparent plastic cigarette case is used to house the receiver. White object on the top is a push-button switch. Note the earpiece at the left.

sitioned a small distance from the two others.

The earphone used is a low impedance, magnetic, hearing aid type, together with its subminiature output transformer. The latter which can be seen on the picture is secured with a piece of Scotch tape beside the acorn tube. You might think that a hearing aid earphone would be awfully expensive. This is true of a crystal type, but the magnetic earphone is low priced. The tube is held in place by its connections, which are soldered directly to the pins because a socket for this tube came pretty close to being as big as the receiver itself.

Except for two parts, the whole receiver is mounted on a small piece of cardboard, which slips into an ordinary plastic cigarette case. The two parts are the midget switch and the feedback coil L_1 , which are mounted in the lid of the case. L_1 is a flat coil obtained from an old i.f. transformer. It is glued to the bottom of the lid, and when the lid is on the case, it faces, at a short distance, the three coils previously described. Complete regeneration control is thus achieved by merely positioning the lid on the case, and it is very easy to adjust it for best reception. The exact inductance of L_1 is quite non-critical, however, this coil should be selected with two conditions in mind: first, its inductance should be rather large as compared to that of L_2 in order to obtain a smooth regeneration control over the whole range of posi-

(Continued on page 117)

Complete circuit diagram of midget receiver.

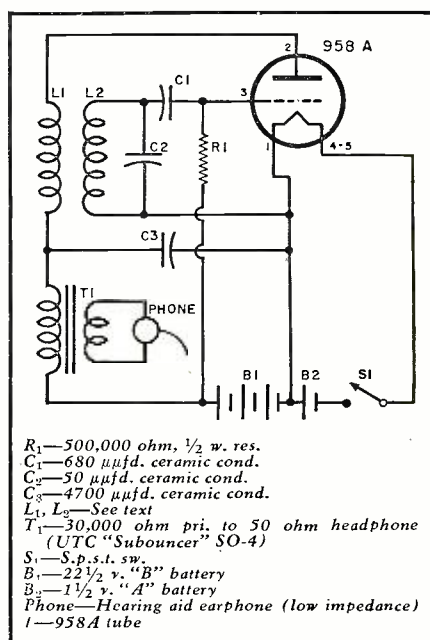



Robert Czajkowski, service technician, and Henry Gronski, supervisor of Central Television Service, Inc.'s branch on the south side of Chicago.

TV SERVICING IS BIG BUSINESS

By
CARL KORN

Chief Engr., Central Television Service, Inc.
Director, Television Communications Institute

Skilled technicians, enlightened supervision, and modern equipment spell success for this alert and progressive Chicago video service organization.

EFFICIENT and satisfactory television servicing has graduated from the "hit and miss" school into the realm of big business.

While our method of operation at *Central Television Service, Inc.* may differ from the procedures followed in other parts of the country, or even in other parts of Chicago, it is at least indicative of the many factors involved in rendering satisfactory service to our approximately 30,000 service policy holders.

To give readers an idea of the amount of detail involved in providing service for this many customers, let's follow a typical service call from the time it reaches the switchboard at *Central Television* until the "case" is closed.

If the phone call is concerned with

service it is routed immediately to the service department where girls, equipped with headsets, obtain all of the required information such as the name, address, and phone number of the customer, details on the receiver in need of repair, and the customer's complaint. This data is entered on an "out card" which is predated so that only the number of calls that can be handled per day will be scheduled. These "out cards" are turned over to another group of girls who pull the master card for the customer from the file. The master card carries a permanent record of the customer's name, address, phone number, set information, dealer's name, as well as installation data and contract expiration date. Each time a service call is made complete details are entered on this mas-

ter card, thus giving the next technician a full "case history" on the set. These master cards are also used by the company in analyzing time and material costs.

After the information on the "out card" is copied on the master card the master is sent to the "routing department" where all calls for that particular day are routed as to location and makes of sets. Routing into location groups saves travel time while division by sets saves service time. Thus specialists in repairing certain brands of receivers handle these service calls because their familiarity with the circuits cuts service time and increases customer satisfaction.

As soon as the routing department has scheduled the call, the master card is inserted in the technician's book. Each technician has two such books, one for today's calls and the other (in the office) being prepared for his next day's work. The books are designed so that he can write his information on the master card without removing it from its celluloid holder, thus minimizing damage to the company's permanent records.

Before leaving on his calls in the morning, each technician reports to his supervisor who checks his books, making sure that each card has been returned, that all of the vital information has been entered on the card, and that all cash, checks, and receipts from COD calls have been checked in to the cashier.

The new book is turned over to the technician along with all special information required to do the job. While technicians carry with them all of the replacement parts and tubes normally required, if he should need a part not in his kit he can call in to the shop where information on the part is taken down, expedited to the stockroom, and sent to the "waiting parts counter" so that the part will be ready to be delivered to the customer the following morning. If the part is not in stock it is ordered immediately upon receipt of the technician's call.

Technical information is also available to the technician for the price of a phone call. The men are trained to describe the "symptoms" quickly and accurately and the supervisor at the other end of the line provides the necessary information.

Most of our servicing is handled entirely in the customer's home with only sets requiring major replacements or having certain intermittent conditions being brought into the shop. The cost of bringing chassis into the shop is so high that condenser and resistor failures, faulty deflection yokes, high voltage transformers, and similar difficulties are handled by the technician on the spot. Sets brought into the shop are those that would be too costly to service in the field, *i.e.*, intermittents requiring all sorts of involved testing procedures.

When a set does wind up in the shop most of the tubes in the critical circuits are immediately checked on a

Simpson dynamic tube checker. When, as in most cases, the tubes test poor they are replaced to reduce the number of subsequent service calls. Since no alignment of the r.f. and i.f. sections is performed in the field, these sets end up on the service bench where a technician, equipped with a sweep generator, oscilloscope, v.t.v.m., and an r.f. signal generator, does the aligning.

For house calls the technician is equipped with a *Simpson* 20,000 ohms-per-volt v-o-m which is satisfactory for analyzing the majority of the service faults encountered.

Technicians answering our service calls are trained in company procedures in a special training class. Men chosen to attend the training school are usually those who have had at least two years' training at an approved television school and have had experience in television installation work. Our experience has been that men with practical experience prior to their association with our company are much more valuable than those who come to us fresh from school.

blems that are likely to arise during their service calls.

After the trainee has completed two or three weeks' work in the school, he is assigned to an experienced technician for further training in the field. He accompanies the older employee for a period of from one to three weeks before going out on his own but even when the trainee is finally allowed to "solo" he is carefully supervised. If he fails to repair a set satisfactorily, an experienced technician is sent to do the job and then the trainee receives a complete report on the circuit fault and information on how to handle a similar case should he encounter the same trouble at a later date.

Almost daily all technicians receive mimeographed service notes which are a compilation of manufacturers' recommended changes and significant troubleshooting hints compiled from the field experiences reported by other technicians. In this way each man benefits from the experiences of all of his co-workers and thus broadens his understanding of the job.

service, or in some cases by a personal call.

At one time we operated a conversion department where small-screen sets were adapted for large-screen tubes. The price reduction on the larger tube sets virtually wiped out the demand for this type of service and it has been discontinued except on a "custom" basis. We also found it unprofitable because of the tremendous amount of time and equipment required to move sets from the home to the shop.

The company now operates in two locations, one on the north side and one on the south side of Chicago. At present 250 persons are employed by the company, 175 of whom are technical personnel. In addition to servicing and installing television receivers the company also specializes in the installation of master antenna systems. With the volume of contracts being handled by the company and with the number of antenna systems being serviced TV servicing is truly "Big Business."
-30-

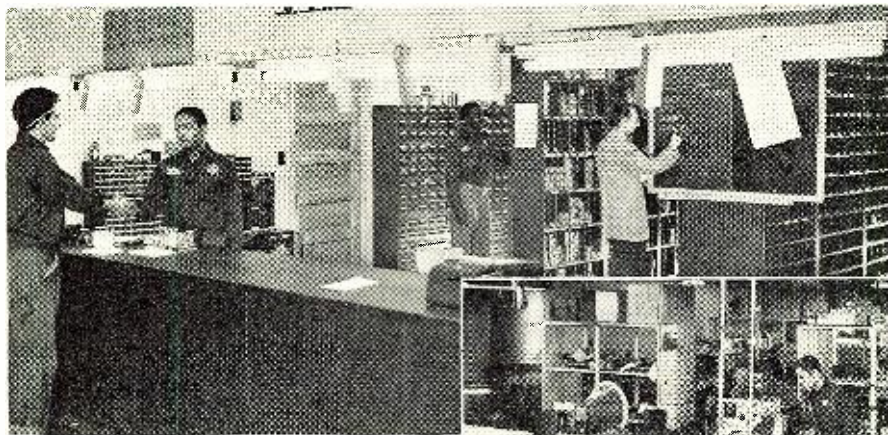

The school program consists of two weeks of work, eight hours a day, under the supervision of an instructor. About a third of the time is devoted to lectures while the balance of the program consists of practice sessions on television chassis. The company buys one or two chassis, representative of the manufacturers' latest models, and various troubles are introduced into these sets for the students to locate. In addition, dynamic demonstrators are used extensively. The circuit diagram of the set "exploded" on the demonstrator is printed alongside of the set. This technique has the dual purpose of acquainting the "practical" men with the proper way of reading a schematic and teaching the "book boys" to translate diagram symbols into actual parts.

During the training period another important feature is the "Customer Relations Course" in which technicians are trained to serve the customer as well as service the set. With the aid of an experienced psychologist and armed with an "experience file" compiled from the reports brought in by our older technicians, the trainees are taught how to handle common prob-



Each technician handles approximately eight service calls a day. This allows him sufficient time to complete each call to his and the customer's satisfaction before going on to his next assignment.

An operation of this size naturally calls for a large stock of replacement parts. This job is handled by means of an extensive inventory control system which also provides accurate information on our requirements so that parts may be ordered in quantity at substantial savings.

The job of determining just how good a job we are doing is the task of the "quality control department" which follows up each service call with a phone call, letter with prepaid postcard enclosed on which the customer is asked to note his comments on the

Central's vast stock of replacement parts requires expert inventory control of all components to insure speedy handling of the many service calls received by firm.

Intermittents and other major faults that cannot be handled by the technician in the customer's home are analyzed in this well equipped shop by specially trained technicians who are experts at this work.

Circuit analysis is simplified by combining technical skill with modern test equipment such as this TV "Genescope."



Distortion Measurements Without Tubes

By
LAWRENCE FLEMING

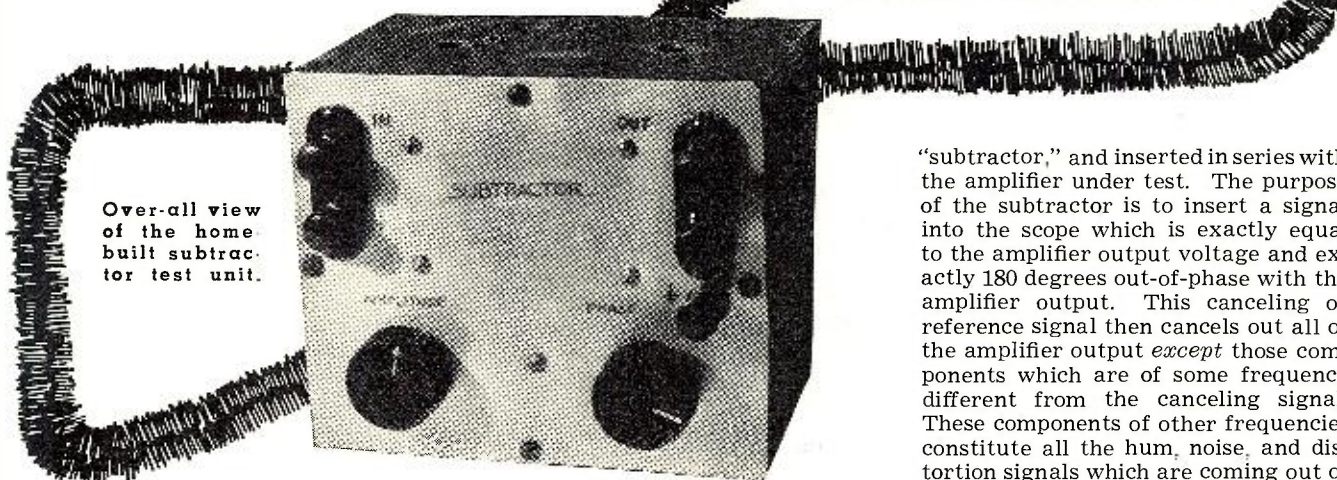

Over-all view of the home built subtractor test unit.

Construction details on a compact, tubeless test unit for checking audio distortion. It is easy-to-build and ideal for the occasional user who has an audio oscillator and scope.

"subtractor," and inserted in series with the amplifier under test. The purpose of the subtractor is to insert a signal into the scope which is exactly equal to the amplifier output voltage and exactly 180 degrees out-of-phase with the amplifier output. This canceling or reference signal then cancels out all of the amplifier output *except* those components which are of some frequency different from the canceling signal. These components of other frequencies constitute all the hum, noise, and distortion signals which are coming out of the amplifier. When the fundamental has been canceled out, it is merely necessary to measure everything that is left, and we have the magnitude of the noise and distortion.

The subtractor does not tell us what kind of distortion it is, but one can get a pretty good idea by watching the oscilloscope.

As indicated in Fig. 1, the subtractor is a simple device consisting of a volume control, an audio transformer, and a phase adjusting network. The purpose of the volume control is to set the level of the canceling voltage exactly equal to the output voltage of the amplifier under test. The function of the phase adjuster is to make the canceling voltage exactly 180 degrees out-of-phase with the amplifier output. Since neither output terminal of the subtractor is grounded, the output terminal can be inserted into the amplifier-scope circuit in either polarity. The proper polarity for approximate cancellation is picked by trial, and the final phasing to a sharp null is effected by the phase adjuster, which is arranged to give a few degrees of shift either side of mid-position in the low and middle audio band.

The transformer is for the purpose of isolation, so that the canceling signal can be added in series with the amplifier output. This is the only form of mixing that has negligible insertion loss, uses no tubes, and does not load the amplifier.

Application

It may be well to run through briefly a typical distortion measurement procedure on an audio amplifier. Suppose we are testing a phonograph amplifier that delivers 10 watts into an 8 ohm load with an input of 0.5 volt. Referring again to Fig. 1, connect an 8

HERE is a large class of distortion-measuring methods which operate on the principle of eliminating the fundamental frequency by some selective device, and measuring the magnitude of everything that is left. An elaborate instrument of this class is the *General Radio Type 1932-A Distortion and Noise Meter*. The null device in this instrument is a modified Wien Bridge, fed from a phase inverter. Other circuits which have been used for rejecting the fundamental by tuning to a null are the parallel-T RC network and the LC null circuit illustrated in Fig. 3.

Subtraction Method

Another means of eliminating the fundamental, less often used, is that of subtraction, also called the reference signal method. The idea is to invert the phase of the test signal and mix it with the output of the amplifier being measured, adjusting the level and phase so that cancellation of the fundamental is effected. All the other components of the output signal will remain. This scheme is not frequency-selective, hence does not require precise tuning nor high stability of the signal source. Instead of a tuning adjustment, we have a level or amplitude adjustment, and an additional fine adjustment for phasing. This method has been described in a form employing electronic phase inversion and electronic mixing.¹

The subtraction method can, how-

ever, be made to work very well without any tubes at all. It commends itself particularly to the occasional user and to the audio hobbyist who already has an audio oscillator and an oscilloscope, because so very little extra apparatus is required.

Block Diagram

Fig. 1 shows the arrangement in block form. An amplifier being tested is fed a signal from an oscillator in the usual way. The output of the amplifier is fed to an oscilloscope and, preferably, also a v.t.v.m. such as the *Ballantine Model 300* or a home-made substitute². If a high-gain scope or a scope preamplifier is used, the electronic voltmeter is not necessary.

The canceling or reference signal is derived from the same oscillator, fed through a unit which we may call a

Table 1. Voltages across commonly-used impedances at various levels of power.

WATTS	IMPEDANCE (OHMS)			
	4	8	15	500
.5	1.4 v.	2 v.	2.74 v.	15.9 v.
1	2	2.83	3.86	22.4
2	2.83	4	5.49	31.6
3	3.46	4.90	6.70	38.6
4	4	5.65	7.75	44.6
5	4.46	6.31	8.66	50
6	4.90	6.91	9.49	54.8
8	5.65	8	10.9	63.2
10	6.32	8.96	12.3	70.8
12	6.91	9.78	13.4	77.5
15	7.75	10.9	15	86.6
20	8.95	12.6	17.3	100

Calculated from equation
 $E = \sqrt{WR}$
Where: E = voltage, W = power (in watts),
R = impedance (in ohms)

ohm resistor R_L across the voice coil terminals of the amplifier (or a speaker can be used, to make the conditions more realistic). If we wish to measure distortion at 10 watts, the voltage across R_L will be 8.96 volts. Table 1 gives voltages corresponding to common power levels at common voice coil impedances.

The subtractor, then, will have to deliver 8.96 volts in order to provide cancellation. Therefore set the oscillator output level to something over this voltage, say about 10 volts, since the "gain" of the subtractor is about 1. Then turn down the gain control at the input of the amplifier (shown in Fig. 1 as R_1 although the amplifier will probably have one built in), until the output voltage is right, as measured by any suitable meter.

Now manipulate the volume control on the subtractor until the signal level, as indicated on the scope, hits a minimum. If the level keeps increasing, reverse the subtractor output connections. When the level is a minimum, adjust the phasing control until the fundamental has disappeared, leaving only the harmonics. It may be necessary to go back and forth between the two controls a few times, particularly at low frequencies. It will, of course, be necessary to keep increasing the scope gain as this process proceeds.

When finally only the harmonics are left, note their amplitude and divide by the total output voltage previously measured to get the distortion percentage. If for example the residuum is 200 millivolts, the distortion is $.200/8.96 = 2.3\%$.

When the amplifier output voltage is much higher than this, it is better to make the cancellation at a somewhat lower output level, say from 1 to 3 or 4 volts. To this end, the amplifier output should be attenuated by means of a potentiometer of 10,000 ohms or so, as indicated at R_2 in Fig. 1.

Subtractor Circuit

Fig. 2 shows the complete circuit of a practical subtractor that will provide cancellation of the fundamental on most good audio amplifiers over the range of about 40 to 1000 cycles. The input signal goes through potentiometer R_1 to the primary of an inter-stage-type audio transformer. The two halves of the split secondary are connected in parallel to reduce phase shift in the transformer and to permit using lower impedance circuits on the secondary side. The conventional type of connection will work almost as well, however. In the secondary circuit is a sort of phase-shifting bridge, derived from a familiar circuit. ^{3, 4} In effect it provides a zero-center phase shifter covering a phase range designed to include the degrees of shift normally found in audio sound amplifiers. At point B , the junction of R_2 and C_1 , the phase of the signal lags that of the input, and at point C it is leading, referred to one side of the secondary (point A). A potentiometer R_3 bridges points B and C and provides a continu-

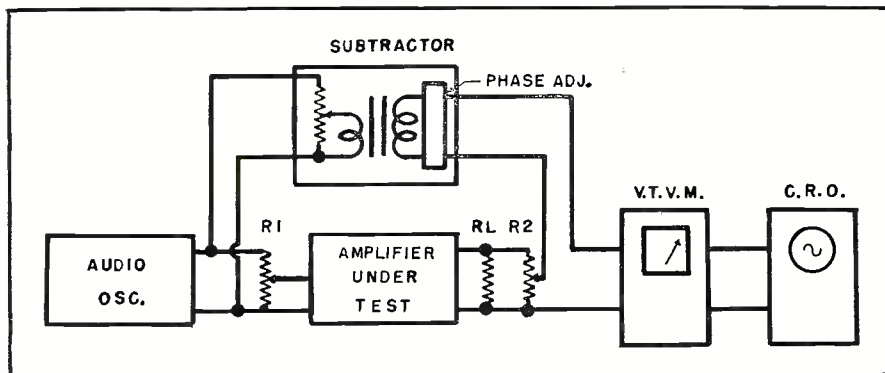

Fig. 1. Block diagram showing how the subtractor unit is wired into test setup.

ous phase adjustment. The phase at points B and C is, of course, not independent of frequency. The change in output level, however, over the range of adjustment of R_3 is less than 10 per-cent above 120 cycles and only about 30 per-cent at 50 cycles.

The phase range covered by R_3 at 60 cycles is from about 40° leading to zero; at 200 cycles from about 20° to 10° lag, and at 1000 cycles, from zero to about 30° lag. Above 1000 cycles, the increasing phase lag contributed by even a good transformer precludes further balance unless the amplifier under test has enough phase lag itself to approximately match it. 2000 or 3000 cycles is the upper limit with some amplifiers.

The reason that the bridge legs C_1 and C_2 are made unequal is a dual one: the phase range is more nearly that which is needed in practice, and the output level is much more constant with respect to the position of the arm of R_3 . A bridge in which C_1 and C_2 were each $.01 \mu\text{fd.}$ was found to cover the range of about plus 45° to minus 45° very nicely at 250 cycles, with no change in output voltage; but an octave above or below 250 cycles the level changed very drastically with the setting of the control.

Operating and Design Notes

In operation, it is merely necessary to pick the correct polarity for the output terminals by trial, then find the null by manipulation of the two controls. Above about 100 cycles the effects of the two potentiometers are generally independent of one another. At lower frequencies, where the phase control produces some level change too, there will be some interaction. The level and phase controls generally require resetting for changes in frequency, but they are not critical with respect to frequency in the same sense that a frequency-selective null circuit is.

Ideally, a device of this sort would ignore harmonics of the test oscillator. Actually it doesn't because the phasing adjustment is really correct for only one frequency at a time. Moreover, amplifiers shift the phase of the harmonics with respect to the fundamental. If distortion percentages much under 1 per-cent are to be measured, it will be necessary to use a low-pass

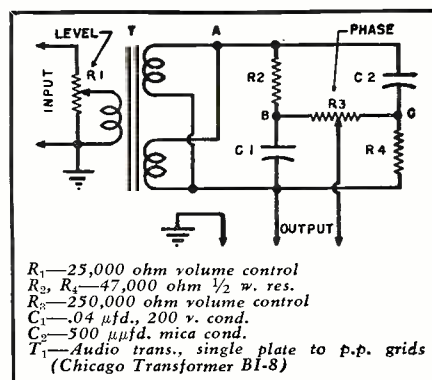

Fig. 2. Circuit diagram of subtractor.

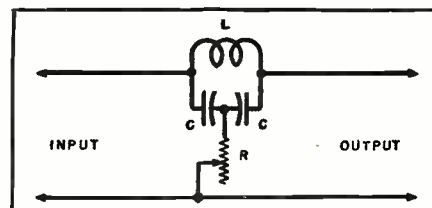
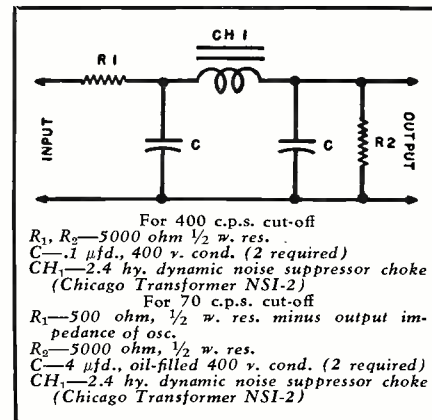

Fig. 3. LC infinite rejection circuit. For a null in transmission at resonant frequency of LC combination, R equals $2\pi fLQ$ where f equals frequency in c.p.s. and Q is the "Q" of inductor. Condensers are approximately equal and usually used between low input impedance and high output impedance but their value is not critical.

filter following the oscillator. Filter constants for 70 and 400 c.p.s. cut-off are shown in Fig. 4.

Almost any audio transformer will
(Continued on page 118)

Fig. 4. Low pass filters for reduction of the audio oscillator harmonics.



For 400 c.p.s. cut-off
 R_1, R_2 —5000 ohm $\frac{1}{2}$ w. res.
 C — $.1 \mu\text{fd.}$, 400 v. cond. (2 required)
 CH_1 —2.4 hy. dynamic noise suppressor choke
(Chicago Transformer NS1-2)
For 70 c.p.s. cut-off
 R_1 —500 ohm, $\frac{1}{2}$ w. res. minus output impedance of osc.
 R_2 —5000 ohm, $\frac{1}{2}$ w. res.
 C — $4 \mu\text{fd.}$, oil-filled 400 v. cond. (2 required)
 CH_1 —2.4 hy. dynamic noise suppressor choke
(Chicago Transformer NS1-2)

Compact 3-Band MOBILE CONVERTER

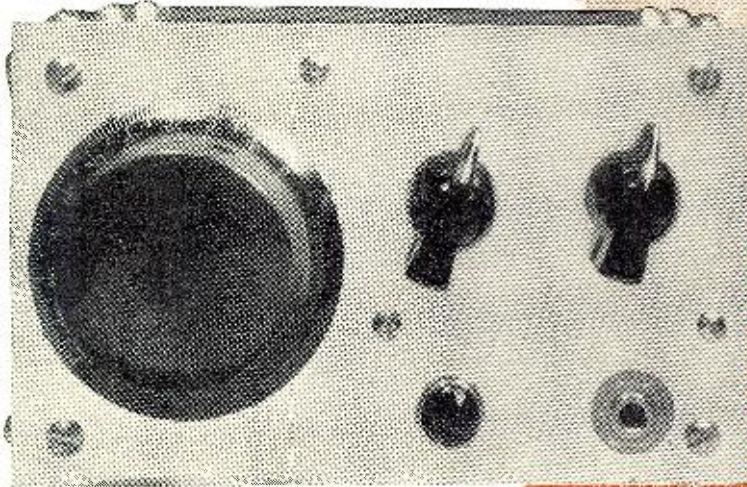

Front panel view of unit. Refer to the text for identification of the controls.

By
ROBERT LEWIS,
W8MQ

Use your car receiver—converter's 1500 kc. output permits additional use of your broadcast band car radio. Converter covers 10, 20, and 30 meter bands.

DURING the last three or four years the trend among hams toward mobile operation has been nothing less than spectacular. It has been hinted in some circles that the grand rush to hit the road has been partly motivated by the recent appearance of the Tennessee Valley Indians. Whatever the incentive, however, whether it be for emergency communication, rag chewing, or both, there's no denying that mobile ham radio is here to stay.

Obviously one cannot carry on mobile two-way communication without both a transmitter and a receiver. As this article concerns only a receiver we will dwell on this subject. Various methods, all the way from vest-pocket receivers to elaborate setups that require the services of a house trailer, have been employed by hams to cope with the receiving problem. Probably the most practical and efficient method is to use a converter with the standard car radio providing the amplification and power. Very recently a couple of multiband converters have been brought out by manufacturers, However, for the ham with more time

than money and a yen for construction, here is a home-made converter which compares favorably with the manufactured units.

A look at the circuit shows the tube lineup to be a 6AU6 r.f. amplifier, a 6BE6 converter, and a 0B2 voltage regulator. The latter is desirable due to variations in automobile battery voltage. Individual coils are provided for each band, the appropriate range being selected by a rotary wafer switch, S_1 . This switch will handle six separate circuits and has three positions. All coils are wound on $\frac{1}{2}$ -inch polystyrene rod and each coil has its own trimmer mounted on top. The output frequency can be adjusted to 1500 kilocycles or thereabouts. A standard broadcast antenna coil is used as the output transformer with the normal grid winding connected to the 6BE6 plate and the usual input winding becoming the output winding. In order to tune the mixer plate circuit to 1500 kilocycles, a small ceramic trimmer condenser is connected across the plate winding.

It might be well to mention at this point that the author's converter, de-

scribed and pictured herein, also incorporates controls for the transmitter. These include the mike jack, pilot light, and the Jones plug at the rear for connection to transmitter control cable. These items can be omitted if desired.

Turning now to the mechanical arrangement, a look at the photos will show the location of all major components. From left to right, in the front panel view are: the tuning dial, band-switch, and the converter "On-Off" switch (S_2). Below the two wafer switches are the pilot light and the mike jack. The pilot light, in this case, is connected through the transmitter remote control cable to the dynamotor primary and indicates when the high voltage is being applied to the transmitter. The tuning dial is a *National* Type A, salvaged from a BC-375 tuning unit.

Looking down into the top of the cabinet we can see on the left the planetary drive mechanism of the *National* dial, directly behind which are the 3-gang tuning condenser and the 6AU6 and 6BE6 tubes. To the right of the dial mechanism are located the bandswitch and the converter "On-Off" switch. Behind the switches are the coils and voltage regulator, with the output coil in the far right-hand corner.

The photograph of the bottom of the chassis shows the location of some of the underchassis parts plus the suggested routing for the control cable. At the rear of the chassis are mounted a rubber grommet, the standard pin-type antenna connector, and a 4-prong Jones plug. A pair of shielded wires carrying filament and plate voltage passes through the rubber grommet, plus a single shielded wire which is the outgoing antenna lead to the car radio. The pin-type receptacle receives the incoming antenna lead. If a transmitter is used, as is the case here, the Jones plug provides a means of connecting the remote control cable.

A thorough search failed to turn up a box of the desired size, therefore the complete unit was fabricated at home. The box proper is 6 inches long, $3\frac{1}{2}$ inches high, and 6 inches deep. The main deck is 6 inches square with a 1-inch lip folded down in back and a $\frac{1}{2}$ -inch lip folded up in front for attaching the panel. The chassis is, of course, mounted 1 inch from the bottom. As can be seen from the top view, the r.f. tubes and tuning condenser are mounted on a vertical chassis which is fastened to the subchassis and the front and rear panels. The vertical chassis is $2\frac{1}{2}$ inches high and 6 inches long. Both horizontal and vertical chassis require cutouts to clear the tuning dial mechanism.

Here are a few helpful hints regarding the construction of the coils. Each coil is wound on a $1\frac{1}{2}$ -inch length of $\frac{1}{2}$ -inch polystyrene rod. Each form is drilled and tapped for a 6-32 stud at each end. The bottom stud permits mounting to the chassis while the top stud allows mounting of the trimmer

condenser. The trimmers used are provided with an L-shaped bracket. The end of the bracket is cut off and a new hole drilled to center the unit on the condenser. After tapping the hole the trimmer is screwed to the coil form. It probably isn't necessary to say much about the problems inherent with working polystyrene except "take it easy." The darn stuff melts at around 200 degrees fahrenheit.

Due to a shortage of sheet aluminum, in the writer's locality at least, all sheet metal parts are made from old aluminum-base recording discs. Professional-looking cutting and bending can be done with nothing more than a pair of one-inch angle irons, a vise, a scribe, and a combination square. To make a cut, simply scribe a deep line, then clamp the piece in the vise between the angle irons and bend the sheet back and forth until it breaks. Don't work it too far at first or the metal may bend in the wrong place. To make a bend, follow the same procedure, except simply bend the sheet to the desired angle by pressing evenly along the scribed line. Don't forget that the aluminum is probably a sixteenth of an inch thick, so allow accordingly. If aluminum recording discs are used, the acetate coating can be removed by placing the record in boiling water for three or four minutes, then dunking it immediately in cold water. It should then be possible to strip the coating off in one sheet. It's not a bad idea to do all the sheet metal work before stripping. The coating protects the aluminum against scratches and fingerprints.

A word here might not be amiss regarding the wiring. The 60 cycle a.c., d.c., or shielded, low-impedance r.f. leads can be cabled if desired. However, unshielded r.f. wiring should be run as directly as possible. Bypass

(Continued on page 143)

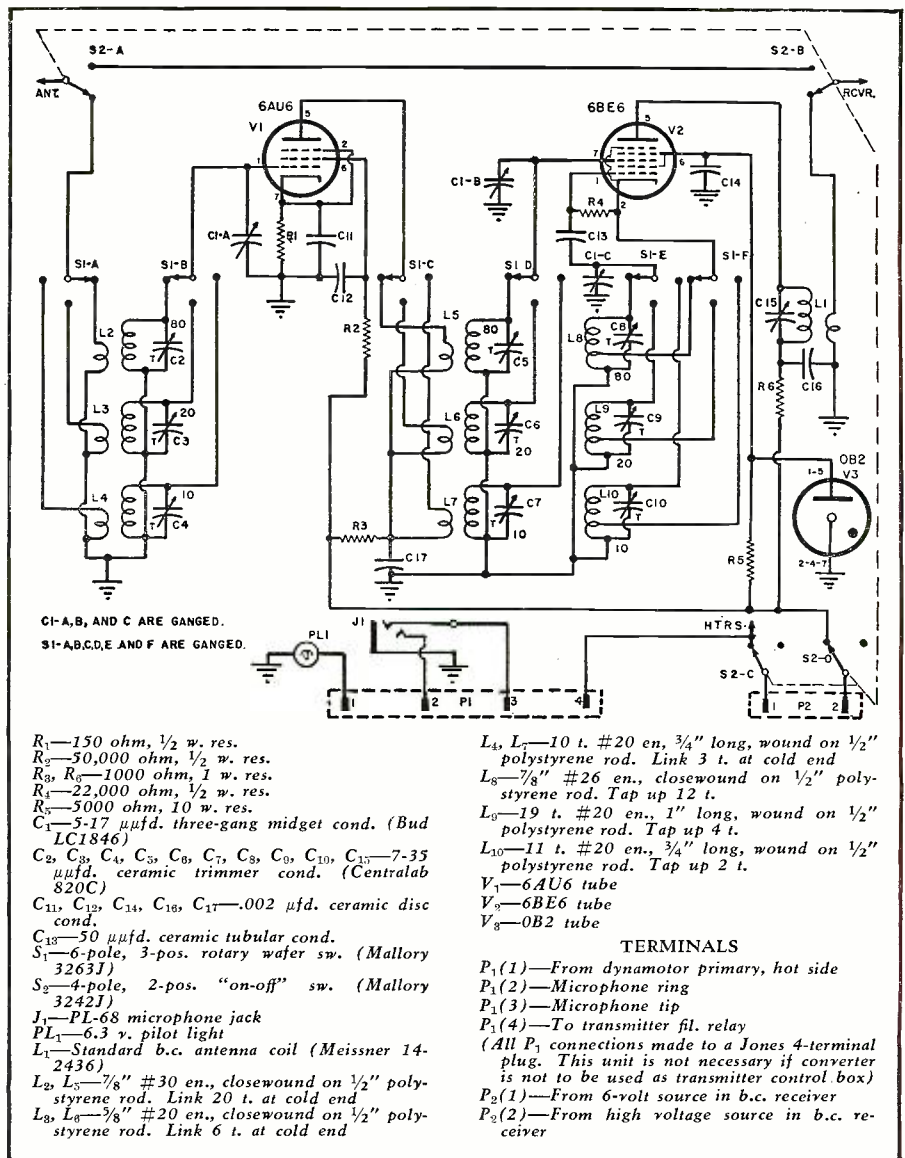

Schematic diagram of mobile converter. Power for unit is taken from the auto radio.

Top chassis view with planetary drive mechanism on left. All sheet metal parts are fabricated from recording discs.

Bottom view showing suggested routing for the control cable. Compactness of unit requires careful planning of the layout.

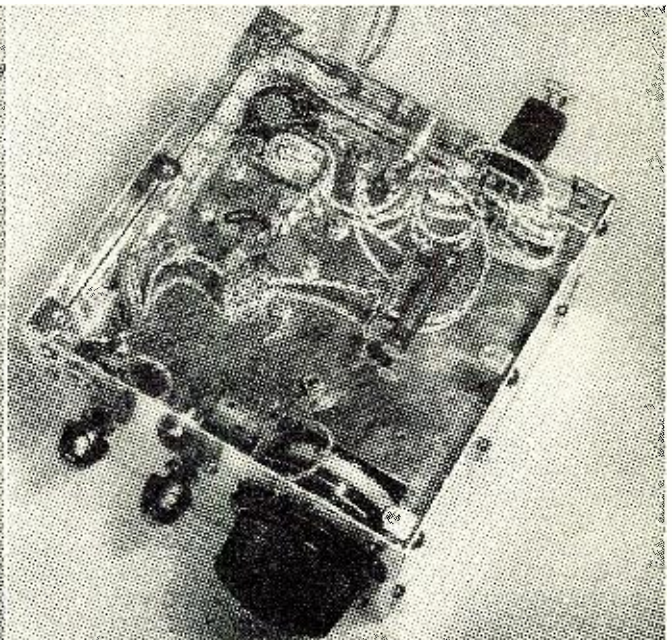
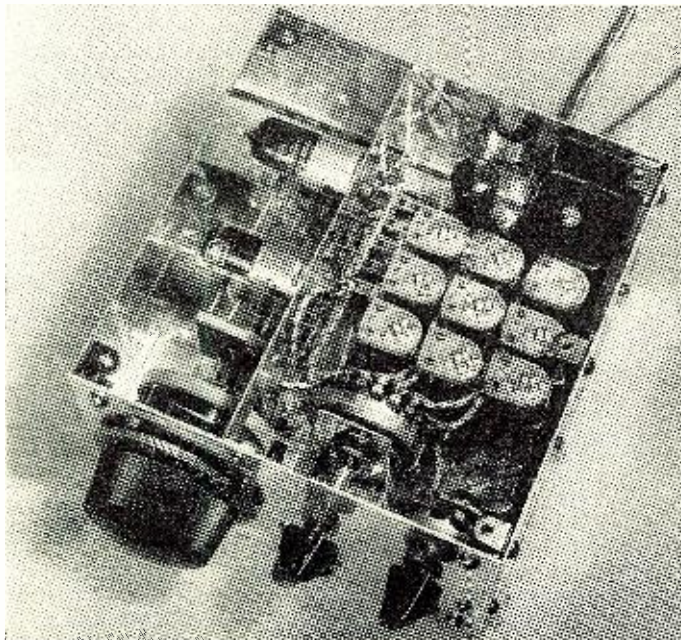

RESISTANCE DECADE APPLICATIONS

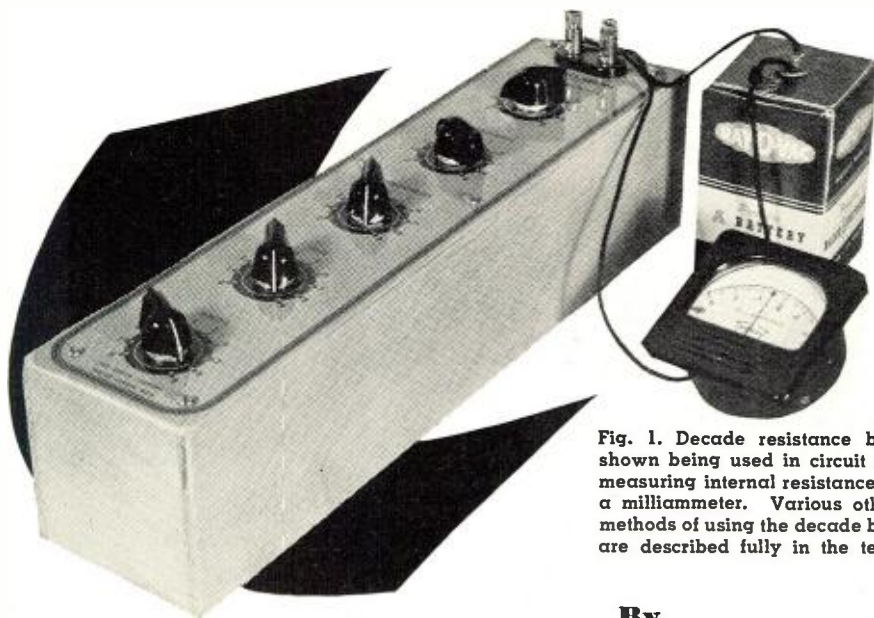

Fig. 1. Decade resistance box shown being used in circuit for measuring internal resistance of a milliammeter. Various other methods of using the decade box are described fully in the text.

By

RUFUS P. TURNER, K6AI

Tips on using a resistance decade box for electronic testing. A recently introduced kit-type box brings this device within the reach of the non-professional technician and experimenter.

AT SOME time, every experimenter discovers the usefulness of a *variable test resistor*. This discovery usually is made in the following manner. The technician needs to know what resistance value will give best circuit operation. To reach the answer quickly, he clips a volume control-type rheostat into the circuit and adjusts it for desired performance. Then he removes the rheostat, measures its resistance setting, and replaces it with a fixed resistor of the same value. This may be a troubleshooting operation or it may be a step in the development of a new piece of equipment. In both instances, the variable test resistor enables direct determination of required resistance values. It also affords quick verification of calculated values. Whichever the case may be, when the utility of the variable test resistor has been discovered, the operator generally will keep several rheostats always at hand for future use. Professionals, as well as amateurs, employ this device.

Resistance determination is speeded up by a calibrated variable resistor which has a dial that reads directly in ohms. Of the dial-calibrated variable resistors, the laboratory-type decade resistance box is the most versatile and accurate. The conventional vari-

ety of decade box can be set to any desired resistance value between 1 ohm and several thousand ohms in steps of 1 ohm. Some boxes also allow 1/10 ohm steps.

Resistance decade boxes employing precision resistors previously have been priced beyond the budgets of amateurs and experimenters. At this writing, however, the new *Heath Model RD-1 Resistance Decade* kit brings within reach of the non-professional technician all of the advantages of a precision, dial-calibrated variable test resistor at low cost. The Model RD-1 has one each of the following decades: units, tens, hundreds, thousands, and ten thousands. Each decade switch has nine positions. Thus, the Model RD-1 may be set to any resistance value between 1 and 99,999 ohms in steps which can be as low as 1 ohm each.

Typical Uses

A resistance decade has numerous laboratory and shop applications. The most representative of these are described in the following paragraphs. Other allied applications will occur to the radio and television technician.

1. *Substitution Resistor*. This term is self-explanatory. The decade box is connected into a circuit to determine the best value for a required fixed re-

sistance. Starting with the decade switches set for a total resistance somewhere near the expected correct value, the setting is varied both above and below this value while performance tests are made to determine which is the best value. In troubleshooting, the decade box may be set to the value of a burned-out or missing resistor and installed temporarily in a circuit to restore and maintain operation while other tests are made.

2. *Voltmeter Multiplier Determination*. Fig. 2A shows the circuit for determining the correct value of a multiplier resistor for a voltmeter. The decade box is connected in series with the voltage source and the milliammeter or microammeter which is to be converted into a voltmeter. The applied voltage must have the value which is to be indicated by full-scale deflection of the meter. The decade switches are set initially to their highest resistance positions. The voltage then is applied, and the resistance settings reduced until the pointer of the meter is brought exactly to full scale. At this point, the required multiplier resistance value may be read directly from the decade switch settings. For multiplier values higher than the total resistance of the decade box, several such boxes will have to be connected in series.

This system of multiplier determination may be employed with a.c. as well as d.c. instruments.

A temporary voltmeter for emergency use may be set up with the decade box, as a multiplier, in series with an available milliammeter or microammeter.

3. *Meter Shunt Determination*. The resistance decade box may be connected in parallel with a d.c. milliammeter or microammeter to determine what value shunt resistor is required to multiply the meter range a desired amount. Fig. 2B shows the test circuit. The decade box is set to a low resistance value, for example 1 ohm. The voltage delivered by the variable power supply is increased slowly and carefully until the standard current meter (ammeter, milliammeter, or microammeter) indicates the current value which is to be the full-scale deflection of the meter under test. The resistance setting of the decade box then is increased carefully to bring the deflection of the test meter exactly to full scale. The power supply voltage must be readjusted in order to hold constant the deflection of the standard meter, should this reading be disturbed by the resistance adjustments. The required shunt resistance is read as the total of the decade switch settings. In order to eliminate inaccuracies due to stray circuit resistance, the two leads from the decade box to the meter must be as short and heavy as possible. The connecting leads should not be less than No. 10 or 12 gauge.

A temporary current meter for emergency use may be set up with the decade box in parallel with a suitable milliammeter or microammeter.

RADIO & TELEVISION NEWS

4. Measurement of Meter Resistance.

The internal resistance of a 1 ma. d.c. meter or any microammeter may be measured by means of the setup shown in Fig. 2C. This arrangement is also shown in the photograph, Fig. 1. The decade box (set to its maximum total resistance) and the meter under test are connected in series with a d.c. voltage source which in most cases may be a 1½-volt dry cell. The resistance of the decade box is decreased carefully until the meter reads exactly one-half of its full-scale value. This resistance setting is recorded as R_1 . The decade resistance then is decreased further until the meter reads exactly full scale. This resistance setting is recorded as R_2 . The value of the internal resistance (R_m) of the meter may then be calculated by means of the equation: $R_m = R_1 - 2R_2$. In this test, all leads must be kept as short and heavy as possible.

5. Current Meter Calibration.

The resistance decade serves as an accurately adjusted variable resistor for current level adjustment when comparing one current meter with another. The step-by-step fine adjustment of the decade box removes the danger of "pinning" the meters which is so imminent when using a common rheostat. Fig. 2D shows the circuit. This circuit may be used in testing a.c. as well as d.c. instruments. The applied voltage must be alternating for a.c. instruments and direct for d.c. instruments.

In making the test, the decade switches first are rotated to their maximum resistance settings. The voltage is then applied to the circuit. The voltage value will depend upon the full-scale deflections of the meters, but for most milliammeters and microammeters need not be more than 1 or 2 volts. The decade resistance settings then are reduced carefully until the meter under test reads the first current value of interest (say, 1/10 of full-scale deflection of the standard meter). The correct value may then be read on the scale of the standard meter and recorded. The decade resistance next is reduced further until the meter under test reads the second current value of interest. The corresponding correct value is read from the standard meter and recorded. The procedure is repeated up to the point of full-scale deflection of one of the two meters.

The operator must be careful when making any test of this sort not to exceed the current ratings of the various decade units of the box. Ratings of the Model RD-1 are: units—500 ma., tens—150 ma., hundreds—50 ma., thousands—15 ma., and ten-thousands—5 ma. From these ratings, it readily is seen that the maximum current which can be handled safely by the box is governed by the current rating of the highest-resistance decade in use in a particular test. Thus, when the Model RD-1 is set to 45,561 ohms, the maximum current which may be passed safely through the box is 5 ma., since this is the maximum current recommended for the ten-thousands decade

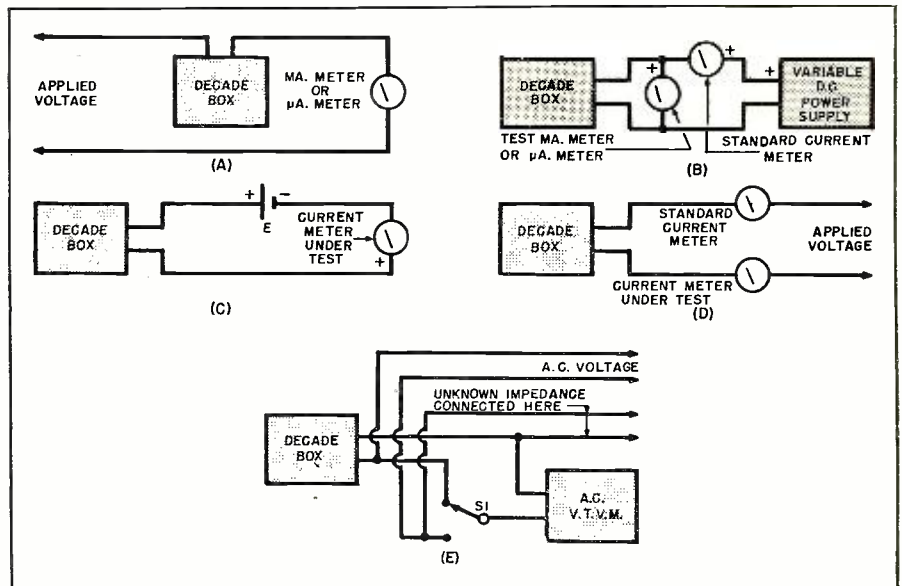

Fig. 2. Wiring arrangements for several resistance decade applications. (A) Voltmeter multiplier determination. (B) Current-meter shunt determination. (C) Checking internal resistance of meter. (D) Current-meter calibration. (E) Impedance meter circuit.

(the highest resistance decade used in setting up the 45,561 value).

6. Ohmmeter Calibration.

Since the decade box is a source of precision resistance, it may be used to standardize resistance measuring instruments. In calibrating an ohmmeter, the resistance decade box is used simply as a resistor of accurately-known value. It is set successively to various values which appear on the ohmmeter scale, and the corresponding deflection of the ohmmeter noted.

7. Bridge Calibration.

In a manner similar to the calibration of an ohmmeter, the resistance decade box may be used to standardize an a.c. or d.c. bridge. The bridge is set to one of its resistance ranges. The decade box then is adjusted to a resistance value corresponding to the value shown at the center of the bridge dial scale. The decade box next is connected to the bridge "unknown" terminals and the bridge carefully balanced. If the bridge nulls at some point other than its center-of-dial value, the dial may be loosened from its shaft and set to correspond to the decade resistance value. If the bridge under adjustment is an a.c. impedance bridge, the standardizing operation performed, in the manner

just explained, on the resistance range will calibrate the meter automatically on its capacitance and inductance ranges as well.

8. Bridge Element.

The decade box may be used as the main adjustable arm of an a.c. or d.c. bridge assembled from laboratory parts for temporary use on the bench. Close readings of the settings are afforded by the 1 ohm resistance steps. Resistance, capacitance, and inductance bridges may be built around the decade box. Circuits for these bridges may be found in the various radio handbooks.

9. Impedance Meter.

The impedance of electronic circuit components may be checked by means of the circuit shown in Fig. 2E. The unknown impedance is connected to terminals indicated. An a.c. signal voltage is applied to the "A.C. Voltage" terminals. This signal may be taken from an audio oscillator (the usual frequencies employed for impedance checking are 400 and 1000 cycles), or it can be supplied by a low-voltage filament transformer operated from the power line when 60 cycle measurements are required.

In operating the circuit, switch S_1 (Continued on page 120)

Fig. 3. Inside view of decade box. Note precision resistors mounted on switches.

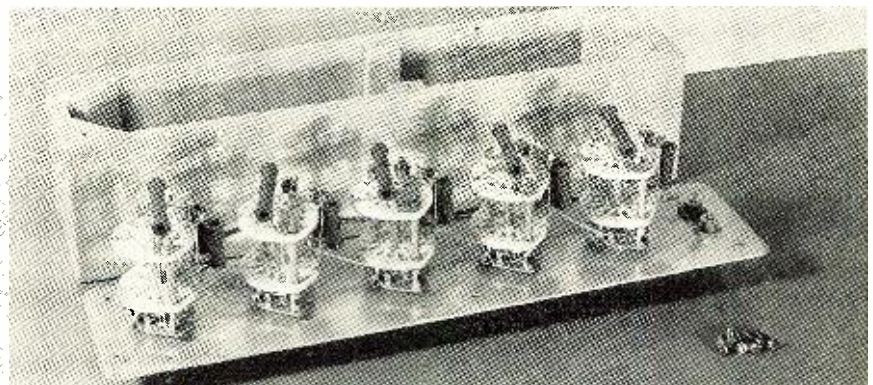



Practical SOUND ENGINEERING

By
H. M. TREMAINE, D.Sc.
College of Audio Engineering
University of Hollywood

Part 1. The first of a series of articles covering fundamental principles of good audio design. The series will include a discussion of recording and reproduction, acoustics, sound propagation, etc.

SOUND is produced when air is set into vibratory motion. This is usually the effect of some vibrating body, perhaps a string stretched between two supports. In Fig. 1A, a string is shown stretched between points X and X', and vibrating between the limits A and A'. If we consider the motion of the string toward A', it is evident that the air will be compressed in front of the string as it moves. Since air is an elastic body, the compression thus produced will tend to compress adjacent regions of air on either side of it. Thus this compression travels away from the source of the disturbance. When the string reaches its point of maximum displacement and begins to move in the opposite direction a region of rarefaction (partial vacuum) is produced. This also spreads to adjacent layers, due to elasticity, and is propagated outward following immediately behind the previously formed compression. It is important to note that these compressions and rarefactions move to adjacent areas due to the elasticity of the medium. In a perfectly inelastic substance sound waves would not be propagated.

Sound is a wave motion. There are two general classes of wave motions, transverse and longitudinal. A cork floating on a disturbed body of water will be seen to move up and down as the water waves pass by. The motion of this cork is the motion of the particles of a medium in which a transverse wave is propagated. The particle motion is transverse or at right angles

to the direction of movement of the wave itself. Light is considered to be a transverse wave.

In the transmission of sound, the particles in the medium are caused to move in the same direction as the movement of the wave. The particles move along a line drawn between the source and the ear, thus producing (or

the result of) alternate compressions and rarefactions.

Sound may be defined as an alteration of pressure, particle displacement, or particle velocity which is propagated in an elastic medium. When sound is propagated, the pressure at any point varies in accordance with the variations of sound, the particles normally located at that point undergo displacement and due to this displacement, a velocity is imparted to the particles.

Sound may also be defined as the sensation observed by the listener when this process takes place. This dual definition places us safely beyond the reach of those who would ask the old question—"If a tree falls in an area where there is no living thing to observe it, will there be sound?"

The amplitude of a motion is the interval between the rest position of the object in motion and its position of maximum displacement. In Fig. 1A, the amplitude of motion of the string is either the distance from the center line (rest position) to A or to A'. The greater the amplitude of the vibrating body, the greater the amplitude of the variations in pressure, particle displacements, and particle velocities, which combine to propagate sound. Thus, the sound wave has greater intensity.

When such a wave strikes a surface, it will tend to impart some of its energy to that surface. The wave will then be attenuated (reduced in amplitude or intensity) since it has lost energy. In order to deliver a part of its energy to a surface, the sound wave must flex or deform the surface, acting against the tendency of the object not to be flexed or deformed. Thus, when a sound wave strikes a totally immovable object, it will be totally reflected without diminution of energy content. If a sound wave strikes an object which can

Fig. 1. (A) Sound produced by air set into vibratory motion. (B and C) Instantaneous pressure, particle velocity, or particle displacement vs. time, for a sound wave.

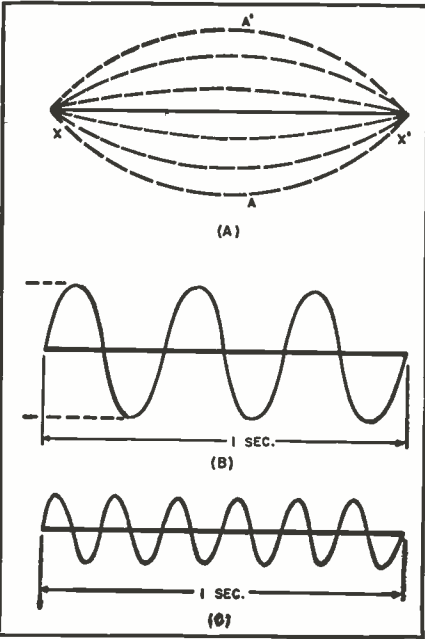

be moved by the wave, then a part of the wave energy is expended in doing work. If this object is the ear, flexing of the ear drum causes the sensation of sound. In this sense we use the term volume or loudness to denote the relative magnitude of sounds. Although loudness, as we observe it, is proportional to the intensity of the sound, it is not a simple linear relationship since the intensity must act through the mechanism of the ear and the associated sensory system to produce loudness. Loudness is that aspect of hearing which enables us to arrange sounds on a scale ranging from "soft" to "loud." Intensity is a physical quantity, not subject to different interpretations by different observers.

When a quantity varies through a set of values repetitiously, it is said to be periodic. The period for such a variation is the time required for the execution of one complete cycle of values or positions and may be measured from an instant when certain conditions prevail to the next successive instant when those exact conditions again occur. The frequency of a periodic variation is the number of complete cycles which occur in a given interval of time, usually one second. Figs. 1B and 1C may be considered plots of instantaneous pressure, particle velocity, or particle displacement versus time, for a sound wave. The amplitude is from the center line to either the positive maximum or the negative maximum. In Fig. 1B, three complete cycles are seen to occur in one second. The frequency illustrated is 3 cycles-per-second, and the period is $\frac{1}{3}$ second. In Fig. 1C, the frequency is doubled, the period is halved. Frequency and period are related by: $F = 1/T$ or $T = 1/F$ where F is frequency in cycles-per-second, and T is the period in seconds.

Our ears assign to a sound a pitch, by which the sound can be placed on a musical scale. The pitch of a sound is almost totally dependent on the frequency of the sound. Intensity has an influence on the observed pitch of a sound, however this is often neglected.

The response of the ear, in terms of frequency and intensity, can perhaps best be demonstrated by a set of curves called equal loudness contours, shown in Fig. 2. Any point on one of these curves has two coordinates, an intensity value, and a frequency value. These values are such that the ear interprets that combination to be the same loudness as all other points on that curve. It will be observed that, as frequency is reduced below 1000 cycles-per-second, the ear becomes progressively less sensitive, since greater intensity is required for the same loudness. At frequencies above 5000 cycles-per-second, a decreasing sensitivity is also noted. From the curves it can be seen that, as the intensity level is raised, the response of the ear becomes more and more uniform and the curves correspondingly more nearly flat. It is interesting to note that the average level of sounds that we hear in concert halls, theaters, or from home radios,

will probably lie between the 50 and the 80 db. curves. (The reader need not understand the meaning of db. at this point. This will be discussed later.)

These curves are used in a number of ways, two of which may be of interest at this time. In the measurement of noise, such as street traffic, factories, stenographic rooms, and so forth, we find that noise may have high, medium, and low frequency components. Since these do not affect the ear in the same way, it is considered desirable to weight the measurement in accordance with the ear characteristics so that our results will properly convey the nuisance value of the measured noise. To do this we determine the approximate intensity of the noise and then select an appropriate curve from Fig. 2, using this curve to interpret the measurement. Curves commonly used for this purpose are those marked 40 and 70 db., and are often referred to as 40 and 70 db. weighting curves. These curves illustrate why a sound system playing at a level lower than normal appears to lack both high and low frequencies. It also shows that speech, music, and sound effects should be played at an intensity level near the original sound to obtain realistic reproduction.

If recorded or transmitted music is reproduced at a level less loud than normal, the observer's ear will operate along one of the lower curves on the graph and will consequently be insensitive at the lower and the extremely high frequencies. These components of the orchestral music will thereby be attenuated and the result will not be pleasing to the discerning listener. It is for this reason that critical listeners and music lovers operate their record playing equipment and radios at a level that may seem unnecessarily loud to others. A special type volume control has been devised which alters the relative amplitudes of the various frequency components of music, so that the music may be played softly yet the

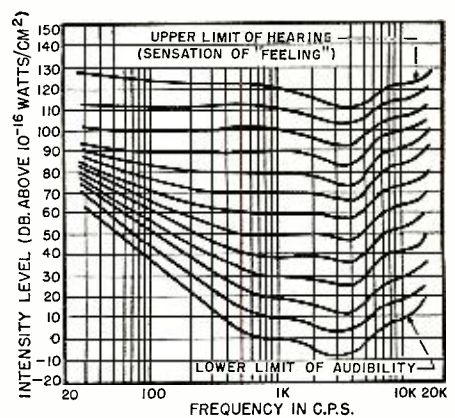

Fig. 2. An "equal loudness contour." See text for explanation on use of the graph.

lower and extremely high frequencies will be apparent to the auditor. In some instances, compensation is only effected at the lower values of frequency. This control serves to increase the relative intensity of the low frequencies above normal when the overall audio output is low. This overcomes the lack of sensitivity of the ear at low sound levels and provides a tonal balance which appears to be the same as that observed at higher loudness values.

The audio spectrum is sometimes stated as lying between 20 cycles-per-second and 20,000 cycles-per-second. This is done largely for convenience and does not imply that all must hear this range and none beyond it. An indication of the frequency range employed in various sound systems, compared to a musical scale and a piano keyboard, is shown in Fig. 3. In some cases these figures lie beyond the range of frequencies actually realized in the average system.

For high fidelity sound reproduction, the range of the sound system must be capable of reproducing frequencies up to 30,000 cycles. This will be dealt with in subsequent discussions. However, it must be remembered that before the

Fig. 3. Frequency range of various sound systems compared to musical scale.

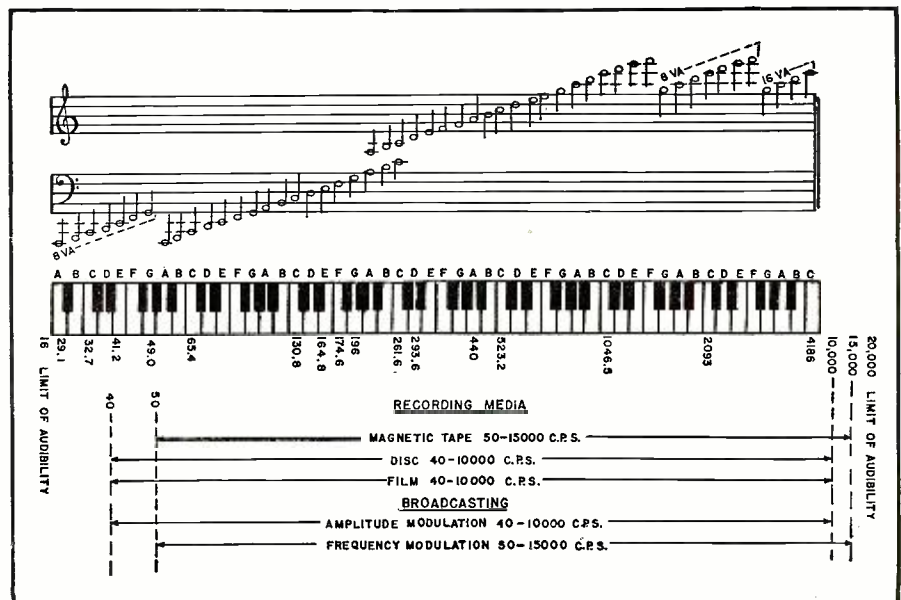

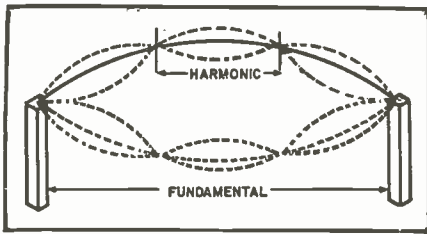

Fig. 4. String vibrating at its fundamental and simultaneously at the third harmonic.

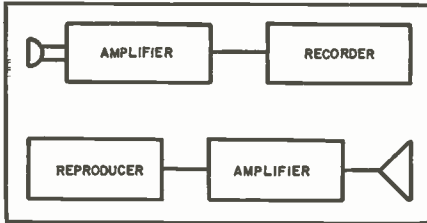

Fig. 5. Block diagram of a conventional recording-reproducing equipment setup.

Air.....	1120 ft. per sec.
Water.....	4700 ft. per sec.
Brick.....	12,000 ft. per sec.
Steel.....	16,500 ft. per sec.

Table 1. Approximate velocities of sounds traveling through various common media.

frequency range can be extended to the extremely high frequencies, the harmonic distortion of the various components making up the system must be reduced to a very small amount.

Rarely does a vibrating object (vocal chords, violin string, or saxophone reed) vibrate at one single frequency. In addition to the main frequency of vibration, called the fundamental, there are usually other frequencies produced at smaller amplitudes. These other frequencies produced are called overtones, or harmonics. We will use the term harmonic. A harmonic is a whole-number multiple of the fundamental. To achieve mathematical simplicity, the harmonics are numbered, and any specified harmonic is obtained by multiplying the fundamental by the number of the harmonic desired. The third harmonic of 100 cycles-per-second is 300 cycles-per-second. The "n" harmonic of a fundamental is "n" times the fundamental. This system imposes the requirement that the fundamental and the first harmonic be the same frequency. A sub-harmonic is obtained mathematically by dividing the fundamental by the number of the desired sub-harmonic. Few devices produce important sub-harmonics. One source, however, is the loudspeaker.

Fig. 4 shows, diagrammatically, a string vibrating at its fundamental and simultaneously at the third harmonic. The addition of the third harmonic provides a distinction to the sound of this string and would enable us to select it from a group of others which were not vibrating in exactly the same way. It is the harmonic distribution which enables us to distinguish between two musical instruments which are sounding the same fundamental. Harmonics are important to those concerned with sound reproduction be-

cause a common fault of reproducing equipment is to introduce harmonics not originally present in the signal. This is a source of distortion and causes the reproduced sound to differ from the original sound.

A severe set of requirements are imposed on sound recording and reproducing equipment. All of the frequency components of the original sound must be reproduced without alteration or omission, but no spurious components should be added if we are to obtain perfection. When we consider the variety of types of equipment involved in such a system, the magnitude of the problem becomes apparent.

Fig. 5 shows, in block form, a record-reproduce system. The sound waves actuate the mechanical elements of the microphone which, in turn, must translate these variations into a very small fluctuating voltage. This voltage is amplified and used to actuate the recorder which may be magnetic, film, or disc. In the latter two systems, the sound must be put into the form of mechanical movements again for transfer to the recording medium. The medium must store the information in such a form as to be available for reproduction. When reproduced, the sound is obtained by means of a magnetic reproducer head, a photoelectric cell, or a phonograph pickup. The output of this device is amplified and used to operate a loudspeaker where mechanical vibrations are caused to produce sound waves. We have seen that the sound energy may be translated into mechanical form, electrical form, mechanical form again, stored, obtained from the storage medium, placed into electrical form, then mechanical form, and finally back into sound energy in the air. To do all this and still preserve intelligibility, much less high quality, is a process that has required years of effort on the part of many workers.

The previous discussion neglects the acoustical problems both at the source and at the loudspeaker. To gain a perspective of these problems we must consider the behavior of sound waves in various media and under various conditions. Sound waves, like other wave motions, may be reflected, refracted, absorbed, and diffracted. These

Fig. 6. The angle of incidence is equal to angle of reflection when reflection occurs.

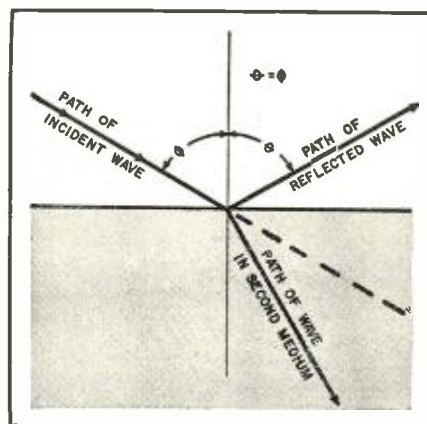

will be discussed in the order mentioned.

Reflection occurs at any surface which represents a discontinuity of medium. This may occur at a wall, or at a line of demarcation between a cold body of air and a warm one. We consider reflection to occur at the junction of two media which have different properties. The amount of energy which is reflected is the difference between the amount of impinging energy and the amount which enters the second medium. When reflection occurs, the angle of incidence is equal to the angle of reflection, as shown in Fig. 6.

In this diagram, the path of that part of the wave which enters the second medium is seen to be different from the projection of the direction of the impinging wave. This alteration of direction is called refraction, and is due to the difference between the velocity of propagation in the two media. When the velocity in the second medium is lower than the velocity in the first, the path of the ray is deviated toward the normal (perpendicular to the plane of reflection), which is the case in Fig. 6. That part of the wave which enters the second medium is said to be absorbed, since it is no longer present in the first medium.

Diffraction is the name applied to the bending of sound waves around corners and obstacles. This obviously occurs, since you can hear sounds whose source is not visible. This is sometimes explained by making use of Huygen's principle which states that any point on the surface of a sound wave can be considered to be a point source of sound, itself, which emits spherical wavelets. By applying this principle, geometrically, to a traveling wave, we can readily see how it gets around obstacles.

Sound waves, of the same frequency, whose fields overlap, may reinforce each other at points or may cancel each other at other points. Such a condition sometimes occurs due to reflection where a sound wave is "folded back on itself." Points of reinforcement will occur where a particle is subjected to force in the same direction by the two waves. Points of whole or partial cancellation will occur where a particle is subjected to two forces in the opposite direction. This is called interference.

The distance to a reflecting object can be determined if the travel time and the velocity of the wave is known for the particular medium involved. In air, the velocity of propagation of sound is approximately 1120 feet-per-second. If the time interval between the transmission of a sound pulse and the receipt of the echo is known to be, for instance, one second and the medium is air, then the distance the sound traveled is 1120 feet, and the distance (one way) to the object is 560 feet. This has important applications in underwater sound ranging, geology, and other fields. See Table 1 for velocities of sound in various media.

(To be continued)



International

SHORT-WAVE

Compiled by **KENNETH R. BOORD**

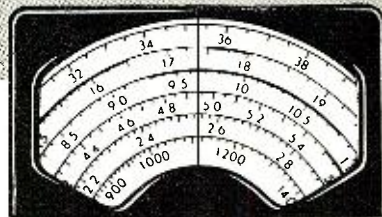

THIS month, we are privileged to dedicate the *ISW DEPARTMENT* to "United Nations Radio." Thanks go to Dorothy Lewis, Coordinator of U.S. Station Relations, "United Nations Radio," for providing the *DEPARTMENT* with this interesting data:

The basic principle for all work of the Department of Public Information of the United Nations is contained in the statement made at the 31st meeting of the General Assembly in February 1946, that "the U.N. cannot achieve the purpose for which it has been created unless the peoples of the world are fully informed of its aims and activities."

Broadcasting of United Nations activities began with the opening of the first General Assembly in London in February 1946, when the *British Broadcasting Corporation* gave excellent cooperation to visiting correspondents.

The U.N. Radio Division may be said to have come into being with the opening of the second half of the first General Assembly in October 1946 at Lake Success, New York. Studio recording facilities were provided for radio correspondents from all parts of the world to transmit dispatches, talks, and interviews back to their respective countries. Meetings were broadcast regularly in *English* and *French*. Programs were produced and released in the five official languages—*English*, *French*, *Spanish*, *Russian*, and *Chinese*. Relay facilities were provided by the U.S. State Department, the *Canadian Broadcasting Corporation*, and others.

As the number of correspondents increased, facilities and staff were expanded. Talks studios and booths at Lake Success and Flushing Meadows were set up to accommodate correspondents from 18 countries. The Radio Division considered that its most important function was to stimulate and maintain close contact with program directors of existing broadcasting stations, suggesting themes and interviews as well as supplying actual transcriptions and scripts.

(Note: Unless otherwise indicated, all time is expressed in American EST; add 5 hours for GCT. "News" refers to newscasts in the English language. In order to avoid confusion, the 24 hour clock has been used in designating the times of broadcasts. The hours from midnight until noon are shown as 0000 to 1200 while from 1 p.m. to midnight are shown as 1300 to 2400.) The symbol "V" following a listed frequency indicates "varying." The station may operate either above or below the frequency given. "A" means frequency is approximate.

At that time, the Radio Division staff consisted of 53 members representing 18 countries—United Kingdom, Norway, Chile, U.S.A., Netherlands, France, China, New Zealand, Iran, Canada, Paraguay, Brazil, Mexico, Cuba, Byelorussia, Costa Rica, Belgium, and Yugoslavia.

It became increasingly evident that broadcasting systems and stations could not be expected to take full responsibility in preparation necessary to give adequate coverage to the United Nations by radio. Therefore, plans were made to increase the number of qualified persons to staff the Radio Division. The executive staff is composed of Benjamin Cohen, assistant secretary-general, Department of Public Information; Tor Gjesdal, director, Department of Public Information; Peter Aylen, director, Radio Division; Carbs Garcia-Palacios, deputy director, Radio Division; W. Gibson Parker, chief of production, and Norman Corwin, special projects. Regional Supervisors are—Hugh Williams, European and Middle East Services; Eugenio A. Soler, Latin-American Services; Mike Peng, Trans-Pacific Services; Gerald Kean, *English* Language Services; Dorothy Lewis, U.S. Station Relations, and

Cesar Ortiz, Supervisor Reports Desk.

The work of the Radio Division of the United Nations falls roughly into two classifications: First and of primary importance, U.N. Radio provides transmission facilities, studios, and recordings for radio correspondents and newsmen who are officially accredited to the United Nations. Many of these correspondents are permanently stationed at U.N. headquarters and report the day-to-day activities. At times when the General Assembly meets, they number into the hundreds from all parts of the world. To supplement these regular broadcasts by accredited correspondents, United Nations Radio prepares various types of programs to meet the requests and needs of systems of broadcasting everywhere. Such programs are only created after close collaboration with radio executives on the receiving end. Short-wave programs usually are intended for rebroadcast.

The content of all United Nations Radio programs is designed to cover the broad activities of the U.N. General Assembly, Security Council, Trusteeship Council, the Commissions, and Agencies. A large portion of the U.N. broadcasts is devoted to news reports
(Continued on page 127)

Ambassador Mahmoud Fawzi Bey, representative of Egypt to the United Nations, broadcasts to his country from a U.N. Radio studio. From left to right are: Mr. George S. Khouri, chief of the Middle Eastern Service of the U.N. Radio Division; Ambassador Bey; Mr. Mohamed Hamid Abdul Chani, member of the Egyptian delegation; Mr. Mohamed Wagdi of the U.N. Radio news desk; Mr. A. S. Dajany (back to camera) of U.N. Radio Division; Mr. Habib I. Katibah, correspondent of "Al Ahram," a Cairo daily newspaper; and Mr. L. Keshishian, correspondent at the U.N. for the "Arab News Agency."



A Unitized

Band-Switching

TRANSMITTER

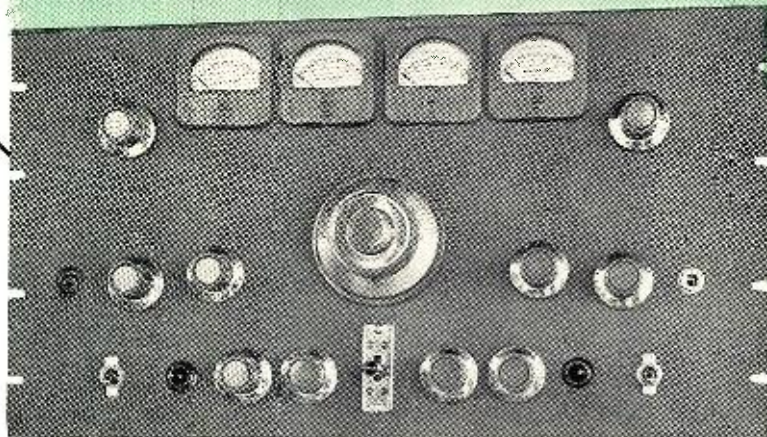

By
CARL V. HAYS,
W6RTP

Fig. 1. Front view of the 100 watt rig, showing the various controls.

Construction details on a four-band transmitter which includes all the most desirable features.

SOME time ago the author, like thousands of other hams, found that his amateur activities, if any, would have to be confined to a total space of some eight cubic feet for quite some time to come. Accordingly the usual "scattered" rig, receiver, antenna tuner, etc., went the way of all such things when space is at a premium.

It wasn't long until the bug bit unbearably, and tentative plans began to appear on scattered bits of paper. After some months of head-scratching, the compact, self-contained transmitter described herein evolved, and W6RTP was on his merry way once again.

Despite the lack of space, we wanted to sacrifice nothing in the way of desirable efficiency, ease of operation, dependability, appearance, power, better-than-average audio, etc., and the unitized plan quickly became a necessity, if the available space and the equipment requirements were to be correlated.

We felt that a 100 watt input was minimum, with v.f.o. control on four bands a "must." Next was the requirement for "no spare coil" operation, since there was no place for the unused coils. We settled, for sweet efficiency's sake, on plug-in coils for the final, leaving only three compact units to be stored. The audio system we wanted had to have adequate power, bass suppression, over-modulation control, and AB₁ operation for econ-

omy and quality. Adequate and efficient power for the rig was also a requirement. All this, plus complete station control from the rig proper at all times, instant fone/c.w. operation, efficient antenna coupling, complete metering and controls, all on a standard chassis could, we quickly found, only lead to one of the suits that zipper up the back of the planner, if gone at it in the usual way.

To make matters more interesting, there were no power tools of any kind available and the work space was the familiar kitchen table, when it wasn't in use otherwise. The reader will probably agree that all this presented quite a problem. After looking over the pictures the reader will undoubtedly agree that the "unitized" plan of assembly made possible, quite easily and neatly, what otherwise would have been at the very least a crowded mess.

Inspection of the top chassis photo will show the complete audio system (at the left) as a separate unit, quite snugly fitted to the main chassis, with the oscillator unit, shock-mounted at three points on the main chassis, next in the front center. Directly behind the v.f.o. unit is the compact, efficient 4-stage exciter unit. Power and modulator transformers are at the extreme rear, with associated rectifier and voltage control tubes at the rear right. Directly in front of the rectifier-volt-

* All parts identified by the asterisk refer to the schematic diagram of the power supply. All other parts refer to the schematic diagram of the transmitter.

age control tubes is the final tube and tank assembly.

The bottom chassis photo shows the placement, at the center rear, of the dual chokes used in the two high voltage supplies, the fourth member of these being at the extreme right forward portion of the chassis, with the heavy-duty, plug-in filters directly to the rear of this choke. Tuning controls and the control switch are at the front of the chassis, the fone/c.w. relay in the center, the power bleeders to the center left, final tube socket to the left front, and the rectifier/voltage control tube sockets, low power-supply choke, and antenna relay to the left rear. The back drop of the chassis holds (from right to left) the a.c. line recessed socket, line fuses, antenna coaxial socket, receiver "B—" control socket, receiver antenna coaxial socket, on either side of the chokes. Tie-points, fixed to the chokes, make convenient solder points for the power circuits.

The front panel photo completes the layout and shows, in the top row and from left to right: Fone/c.w. relay control switch (S_2^*); audio compression meter (M_1); final grid meter (M_1); final plate meter (M_3); antenna meter (M_2); and the variable antenna link control dial. In the second row are the microphone jack (J_3); audio gain dial (R_{30}); compression control dial (R_{23}); the v.f.o. tuning condenser dial (C_{23}); bandswitch dial (S_1); final tuning condenser dial (C_{22}); and the key jack for c.w. (J_1). In the bottom row are filament switch (S_1^*), the filament pilot light (PL_1^*); the 80 meter doubler dial (C_4); the 40 meter doubler dial (C_5); the station control switch (S_3^*); the 20 meter doubler dial (C_{14}); the 10 meter doubler dial (C_{10}); the "B+" pilot light (PL_2^*); and the "B+" neutralizing switch (S_3).

The main chassis is of heavy-gauge

RADIO & TELEVISION NEWS

steel and measures 17" x 14" x 3". The audio unit chassis measures 9" x 5" x 3"; the exciter unit chassis measures 8" x 4" x 2"; and the v.f.o. unit chassis measures 6" x 6" x 4" (a drawn aluminum box).

The front panel is grey crackled *Masonite* ($\frac{1}{4}$ "), 19" x 10 $\frac{1}{2}$ ". Meters are standard *Simpson 2"* square types, given two coats of French grey lacquer on the front faces, in order to match dials and grey crackle finish of the panel. All dials are *National*, and the over-all effect makes a very attractive front panel in the grey-and-chrome motif.

With the major components identified, we can get to the "labor of love" part of the rig, with the accent on the *labor*.

The first step, after procurement of all parts, is to lay out and drill the main chassis. Mount and wire completely the power circuits and then test. The next step is the control circuit, after which the oscillator unit box is completed. This includes a small, rigid shelf for the 6C4 and 6AG7 tubes, directly over the v.f.o. coil, which is rigidly mounted by means of brass spacers (tapped 6/32") to the front and rear sides of the v.f.o. box. The next step is the coil form and, mounted the same way, is the v.f.o. main tuning condenser, with its associated *National* dial assembly mounted to the box only. This is extremely important if really smooth v.f.o. performance is to be expected. This may be done quite easily with the aid of tapped brass spacers, thus bringing the "Velvet Vernier" dial assembly out 1 $\frac{1}{2}$ ", which allows it to protrude through a suitable hole in the front panel. A metal plate, slightly larger than the dial skirt, holds the dial marker and covers the cutout very nicely.

This system, together with live-rubber grommet mounts and flexible connections, gives complete freedom from vibration and torque transmission from the main chassis is obviated by three-point mounting only, since twists, if any, are not transmitted. Just remember that everything in the v.f.o. unit must be rigid, and the entire unit shock-mounted as described above, and your v.f.o. will "do right by you," if this circuit is copied. As an illustration, the v.f.o. dial can be struck a sharp blow (output on 10 meters) with no ill effects whatsoever. The padder and trimmer condensers are mounted on the main tuning condenser; a small hole in the side, next to the final tank assembly, allows for trimming the unit to the frequency coverage desired.

With the v.f.o. and Class A stage perking, lay out and drill the exciter unit chassis. The four 6AG7 frequency-multiplier stages are equispaced at the rear of the chassis, with the *Millen* 74001 coils offset to the front, to allow room for S_1 at the right front on the chassis drop. Power and r.f. connections are made to small L-shaped shelves affixed to the underside

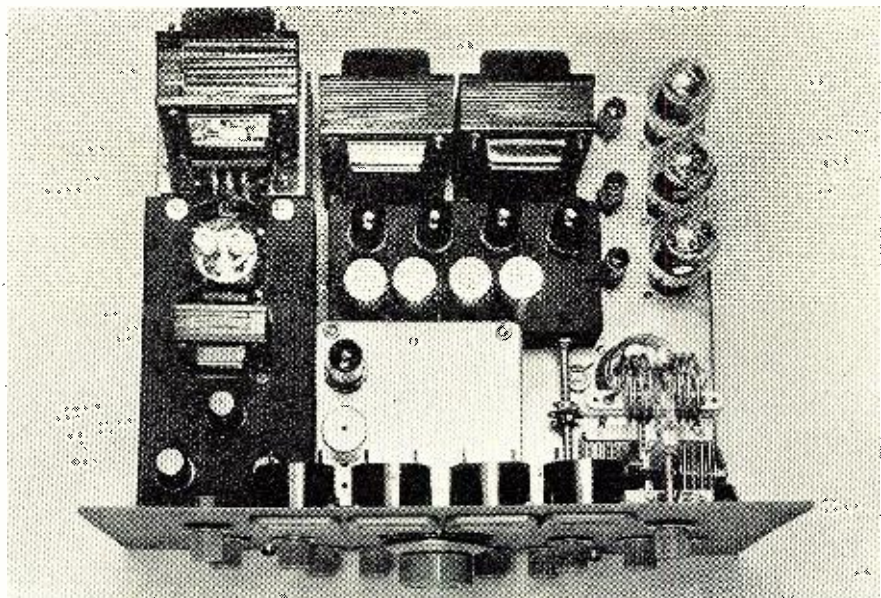

Fig. 2. Top view of the transmitter showing the unit type construction used.

of the chassis (side wall mount was used) and coincide with tube-socket cutouts in the main chassis proper, to permit plug-socket contact. Extension cables, made up and stored, not only help during the initial test, but are very handy for subsequent test and repair should the need arise. The tuning condensers associated with the 74001 coils mount vertically, shafts downward, by means of an aluminum bracket extending alongside the front chassis lip. Insulated rotor-type trimmers, of good, husky construction, are a "must" here. Laid out in this manner, coil-condenser connections butt together for efficient wiring. Well-spaced bus wires to the r.f. section of S_1 are required. These, together with the suppressor resistors in the leads proper as well as screens and plates of the 6AG7's, give smooth, bug-free amplification and frequency multipli-

cation in this unit. Incidentally, the twisted link shown in the bottom chassis photo, while OK, was replaced with the shielded 75-ohm *Amphenol* twin-lead cable running to the "Twin-ex" socket/plug combination in the course of making the inevitable changes, with gratifying results. The circuit diagram shows this addition, and this change should be incorporated.

The 829-B final stage, which is simple and standard except for the use of unity-tuned coils in the grid circuit, comes next. This scheme has been used in two previous rigs built by the author and is a simple answer to band-switching complications when only the final plate coil is to be of the conventional plug-in variety. With this system, grid drive, even on 10 meters, is such that too much grid current flows with the usual bias. Increasing the

Fig. 3. Bottom view showing the flexible shafts driving the multiplier tanks.

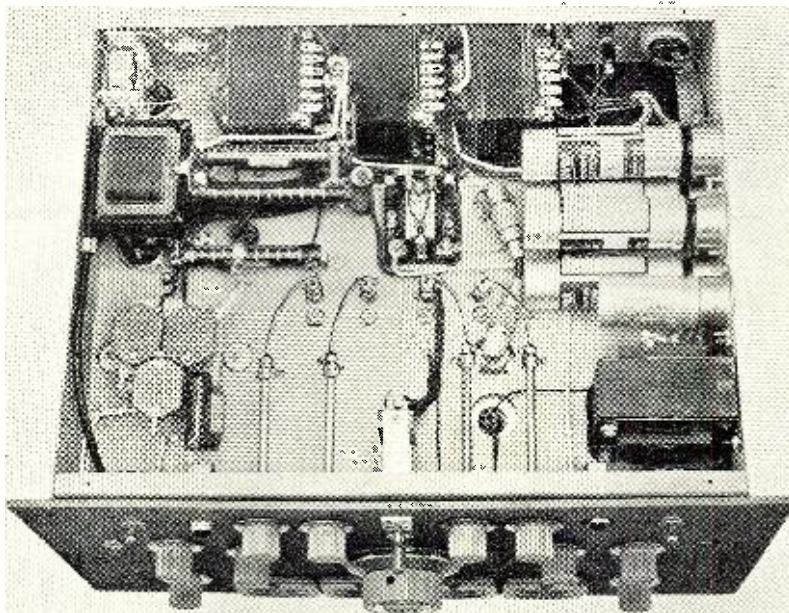

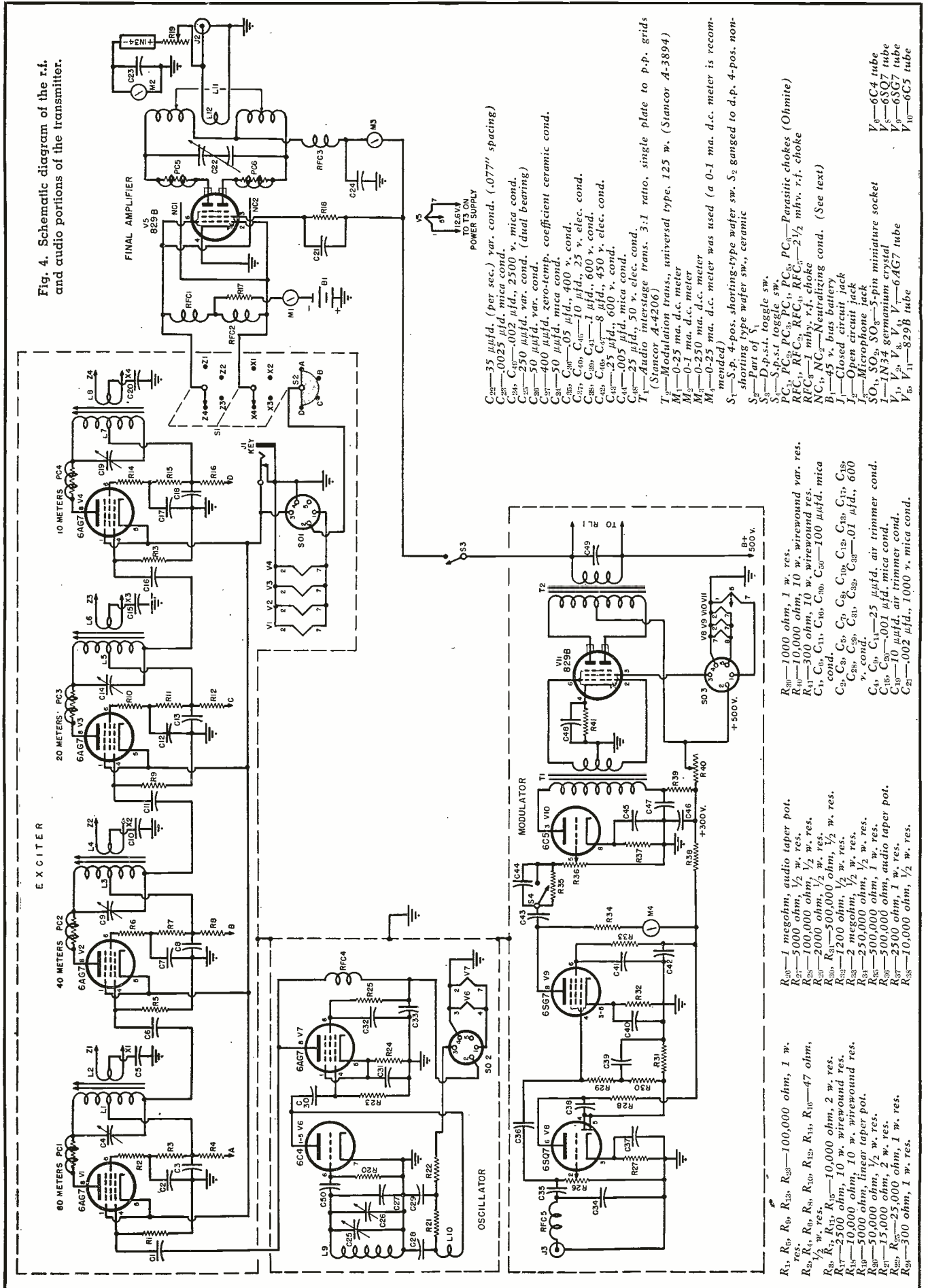

Fig. 4. Schematic diagram of the r.f. and audio portions of the transmitter.

C₃₀₅—35 μ fd. (per sec.) var. cond. (.077" spacing)

C₃₀₆—0.025 μ fd. mica cond.

C₃₀₇—250 μ fd. var. cond. (dual bearing)

C₃₀₈—50 μ fd. var. cond. (dual bearing)

C₃₀₉—400 μ fd. zero-temp. coefficient ceramic cond.

C₃₁₀—50 μ fd. mica cond.

C₃₁₁—0.05 μ fd. 400 v. cond.

C₃₁₂—C₃₁₇—10 μ fd., 25 v. elec. cond.

C₃₁₈—C₃₂₁—1 μ fd., 600 v. cond.

C₃₂₂—C₃₂₅—8 μ fd., 450 v. elec. cond.

C₃₂₆—C₃₂₉—25 μ fd., 600 v. cond.

C₃₃₀—C₃₃₃—25 μ fd. mica cond.

C₃₃₄—C₃₃₇—25 μ fd., 50 v. elec. cond.

T₁—Audio interstage trans. 3:1 ratio, single plate to p.p. grids (Stancor A-4206)

T₂—Modulation trans., universal type, 125 w. (Stancor A-3894)

M₁—0-25 ma. d.c. meter

M₂—0-1 ma. d.c. meter

M₃—0-250 ma. d.c. meter

M₄—0-25 ma. d.c. meter (recom-
mended)

S₁—S.p. 4-pos. shorting-type wafer sw. S₂ ganged to d.p. 4-pos. non-
shorting-type wafer sw., ceramic

S₃—Part of V₅

S₄—D.p.s.t. toggle sw.

S₅—S.p.s.t. toggle sw.

P.C.—P.C. 1/2 PC, 1/4 PC, 1/8 PC

P.C.₁—Parasitic chokes (Ohmite)

R.F.C.—R.F.C. 1, R.F.C. 2, R.F.C. 3—2 1/2 mfr. r.f. choke

R.F.C.—1 mfr. r.f. choke

N.C.—Neutralizing cond. (See text)

B—45 v. bias battery

I—Closed circuit jack

J₁—Microphone jack

J₂—Open circuit jack

S.O.—5-pin miniature socket

S.O.₁—5-pin miniature socket

I₁—IN34 germanium crystal

V₁, V₂, V₃, V₄, V₅—6AG7 tube

V₆, V₇, V₈, V₉, V₁₀—6C5 tube

R₃₀₁—10,000 ohm, 1 w. res.

R₃₀₂—300 ohm, 10 w. wirewound var. res.

R₃₀₃—300 ohm, 10 w. wirewound res.

C₁, C₂, C₃, C₄, C₅, C₆, C₇, C₈, C₉, C₁₀, C₁₁, C₁₂, C₁₃, C₁₄, C₁₅, C₁₆, C₁₇, C₁₈, C₁₉, C₂₀, C₂₁, C₂₂, C₂₃, C₂₄, C₂₅, C₂₆, C₂₇, C₂₈, C₂₉, C₃₀, C₃₁, C₃₂, C₃₃, C₃₄, C₃₅, C₃₆, C₃₇, C₃₈, C₃₉, C₄₀, C₄₁, C₄₂, C₄₃, C₄₄, C₄₅, C₄₆, C₄₇, C₄₈, C₄₉, C₅₀, C₅₁, C₅₂, C₅₃, C₅₄, C₅₅, C₅₆, C₅₇, C₅₈, C₅₉, C₆₀, C₆₁, C₆₂, C₆₃, C₆₄, C₆₅, C₆₆, C₆₇, C₆₈, C₆₉, C₇₀, C₇₁, C₇₂, C₇₃, C₇₄, C₇₅, C₇₆, C₇₇, C₇₈, C₇₉, C₈₀, C₈₁, C₈₂, C₈₃, C₈₄, C₈₅, C₈₆, C₈₇, C₈₈, C₈₉, C₉₀, C₉₁, C₉₂, C₉₃, C₉₄, C₉₅, C₉₆, C₉₇, C₉₈, C₉₉, C₁₀₀

R₃₀₄—1 megohm, audio taper pot.

R₃₀₅—500 ohm, 1/2 w. res.

R₃₀₆—100,000 ohm, 1/2 w. res.

R₃₀₇—200 ohm, 1/2 w. res.

R₃₀₈—100,000 ohm, 1/2 w. res.

R₃₀₉—500,000 ohm, 1/2 w. res.

R₃₁₀—1200 ohm, 1/2 w. res.

R₃₁₁—2 megohm, 1/2 w. res.

R₃₁₂—250,000 ohm, 1/2 w. res.

R₃₁₃—500,000 ohm, 1 w. res.

R₃₁₄—500,000 ohm, 1 w. res.

R₃₁₅—2500 ohm, 1 w. res.

R₃₁₆—10,000 ohm, 1/2 w. res.

R₁, R₂, R₃, R₄, R₅, R₆, R₇, R₈, R₉, R₁₀, R₁₁, R₁₂, R₁₃, R₁₄, R₁₅, R₁₆, R₁₇, R₁₈, R₁₉, R₂₀, R₂₁, R₂₂, R₂₃, R₂₄, R₂₅, R₂₆, R₂₇, R₂₈, R₂₉, R₃₀, R₃₁, R₃₂, R₃₃, R₃₄, R₃₅, R₃₆, R₃₇, R₃₈, R₃₉, R₄₀, R₄₁, R₄₂, R₄₃, R₄₄, R₄₅, R₄₆, R₄₇, R₄₈, R₄₉, R₅₀, R₅₁, R₅₂, R₅₃, R₅₄, R₅₅, R₅₆, R₅₇, R₅₈, R₅₉, R₆₀, R₆₁, R₆₂, R₆₃, R₆₄, R₆₅, R₆₆, R₆₇, R₆₈, R₆₉, R₇₀, R₇₁, R₇₂, R₇₃, R₇₄, R₇₅, R₇₆, R₇₇, R₇₈, R₇₉, R₈₀, R₈₁, R₈₂, R₈₃, R₈₄, R₈₅, R₈₆, R₈₇, R₈₈, R₈₉, R₉₀, R₉₁, R₉₂, R₉₃, R₉₄, R₉₅, R₉₆, R₉₇, R₉₈, R₉₉, R₁₀₀

68

bias to the value shown results in more linear phone operation, and doesn't hurt c.w. a bit. The neutralizing condensers, NC_1, NC_2 , are rigid lengths of #12 bare wire fed through the chassis in the now-familiar method for use with the 829-B tube. The bias battery for this stage, not employed at the time the photo was taken, fits nicely, by means of an aluminum strap, between the panel-bearing shafts to the left of the 829-B tube socket. It will be found that shorter leads and better appearance will result if both the final 829-B and modulator 829-B sockets are sub-mounted 1" on brass spacers. The right-angle center gear-drive final tank condenser (Millen 11035) is mechanically perfect for the layout and is recommended highly. A simple, rigid (if "Goldbergish") mount for the tank jack bar-and-plug is made by screwing the metal swinging-link arm support to the top of the condenser mount, where it will be found that coil and condenser connections butt together perfectly for rigid soldered connections.

Since 10 meters and, on occasion 20 meters, are "our" bands, we went for the most efficiency on the h.f. end of things, utilizing proper size vacuum-padder condensers directly on the proper coils for 40 and 80 meter operation, where they performed very well. Since the law of compensation is what it is, we can't have optimum performance everywhere, so the individual can alter this stage to fit his primary needs if lower frequency work is desired.

A final word in connection with this stage concerns the antenna meter circuit. It is one, with minor variations, which is employed in some of the best commercial v.h.f. gear, and is a simple means of securing adequate indication of antenna output at the higher frequencies. A study of the transmitter schematic diagram will show clearly its wiring and connection to the hot side of the link output coax. The shielded 2" square aluminum box holding the parts is mounted on an insulating strip affixed across the termi-

L_1	—115 t. #32 en. closewound, c.t. on Millen 74001 form
L_2	—20 t. #22 en. closewound, c.t. (center of L_1)
L_3	—36 t. #28 en. closewound, c.t. on Millen 74001 form
L_4	—10 t. #20 en. closewound, c.t. (center of L_3)
L_5	—18 t. #22 en. closewound, c.t. on Millen 74001 form
L_6	—8 t. #20 en. closewound, c.t. (center of L_5)
L_7	—12 t. #18 en. closewound, c.t. on Millen 74001 form
L_8	—5 t. #20 en. closewound, c.t. (center of L_7)
L_9	—24 t. #18 en. on grooved ceramic form, 1 1/4" diam.
L_{10}	—14 t. #20 en. closewound 1/4" below L_9 on same form
L_{11}	—Millen 44000 series coils (See text)
L_{12}	—Swinging link (part of L_{11} assembly)

Table 1. Winding data for coils used in the r.f. portion of the transmitter.

nals of M_2 , and suspended under it, next to the front panel.

The audio system is essentially a 3-stage affair, employing an 829-B as a push-pull AB₁ amplifier, a simple triode driver, and a high-gain mike (Continued on page 92)

Fig. 5. Schematic diagram of the transmitter power supply and relay switching.

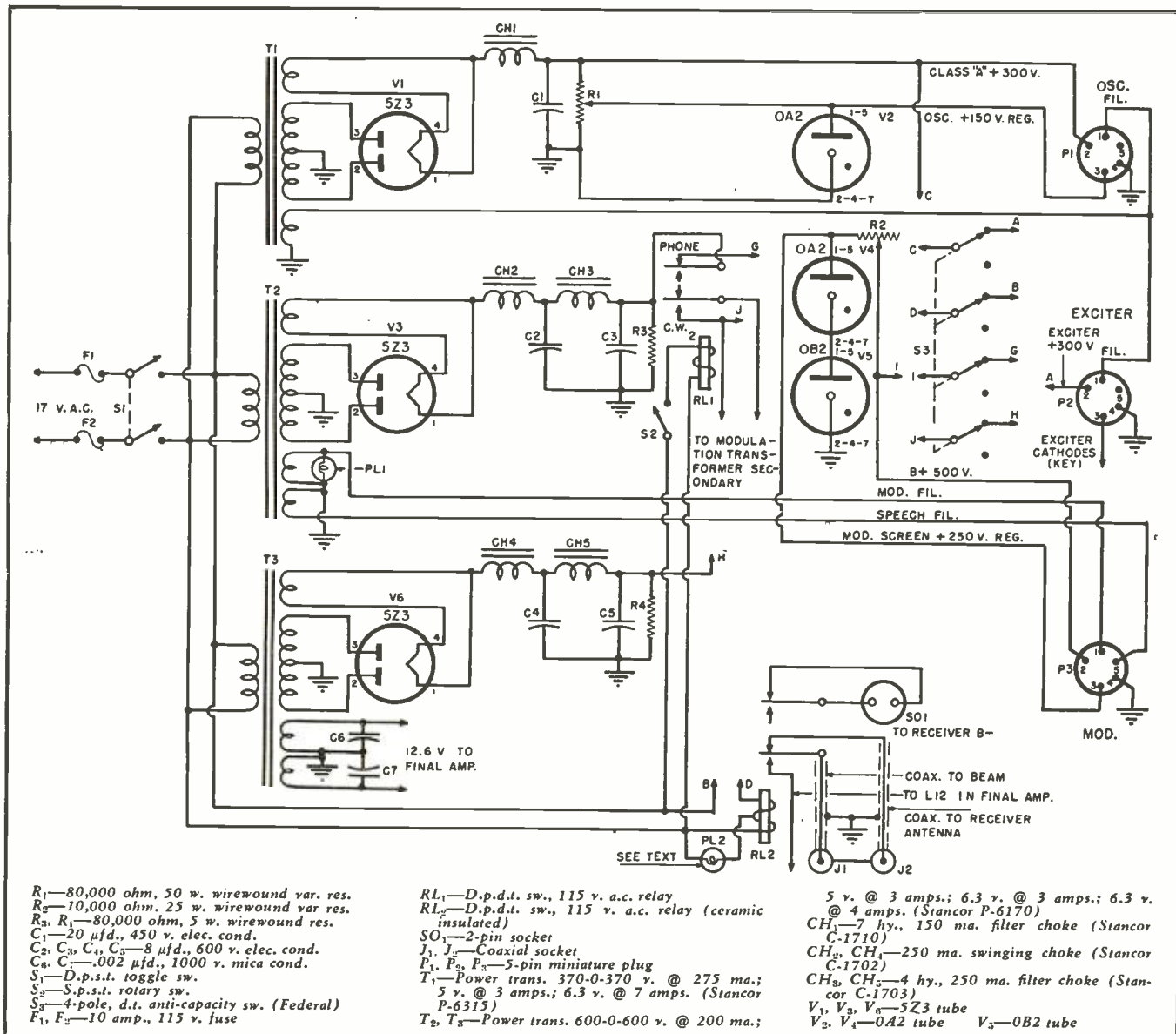

Mac's RADIO SERVICE SHOP

By JOHN T. FRYE



LOOKING FORWARD—AND BACKWARD

NOT ten minutes before a cloud of swirling snowflakes had been brushing against the front window of Mac's Radio Service Shop, but now the bright sun had suddenly popped through an opening in the ragged, wind-torn clouds and was melting the skiff of snow that had scarcely had time to settle on the sidewalk.

"Sure is a funny day," mused Barney, the apprentice technician. "Acts as though it can't decide whether to go forward into spring or backward into winter."

"That's March for you," Mac grunted as he pulled a large cardboard box from beneath the bench and began stirring around in the contents with a probing forefinger.

"Holy cow!" Barney exclaimed as he peered over Mac's shoulder. "Where did you get that bunch of tube adapters?"

"You might say I have my pessimistic foresight to thank," Mac admitted rather sheepishly. "After the war was over and tubes were plentiful, when a set came in with a burned-out substitute tube in one of these adapters, I simply replaced it with the original tube and tossed the adapter into this box. It seemed rather senseless at the time, but now I am glad I did. With the tube situation getting tighter than a seersucker suit in a rainstorm, it looks as though adapters are going to be right in style again."

"You think using an adapter is better than rewiring or replacing the socket to take a different tube?"

"Depends. In rectifier and audio sockets, and in many of the r.f. and i.f. stages of broadcast receivers, I prefer adapters because they provide a quick, inexpensive, and just-as-good a method

of tube substitution as going to the trouble of changing the socket. When it comes to changing the tubes in an FM or TV set, though, that is horse of another hue. In many stages of a television receiver, the few inches of extra wire added to the leads by the use of an adapter is sufficient to prevent the set from working at all; or, if it does work, to make a complete re-alignment necessary. In such cases, rewiring or replacing the socket to take the substitute tube is actually the best and easiest way of doing the job."

"You don't need to do any re-aligning on an AM set after using a substitute tube in an adapter?"

"I didn't say that. Usually a little touching up of the alignment is necessary, just as is often the case when you simply change from a metal to a glass tube of the same type; but this is a much simpler process than, say, completely re-aligning the stagger-tuned i.f. system of a TV set."

"Is there anything else to watch when substituting tubes?"

"You can bet your pointed little head there is! Just because the filament voltage and current is the same and the local broadcast station can be heard with the substitute tube in place is no sign the substitution job is complete. A good up-to-the minute tube manual, like this *RCA Technical Series RC-16*, should be the technician's bible when he starts juggling tubes. Every feature of the original tube and the contemplated substitute should be carefully compared. Plate impedance, grid bias, maximum grid swing—these and other ratings should be carefully considered and provision made for providing the substitute tube with the proper values when the switch is made."

"It would be better yet if we could just make the tubes last longer, wouldn't it?"

"We can make them last longer—after a fashion. For example we have been discarding noisy rectifiers like 35Z5's and 35Y4's. Now that these tubes are about as common as Stradivari violins, we shall place metal shields around such tubes and ground the shields to the chassis. In practically all cases this will completely stop the noise, and the rectifier can be used until it burns out.

"And the life of the whole string of tubes in an ac-d.c. set—and such sets are the tube-eaters—can be greatly lengthened by just inserting a 100 ohm, 10 watt resistor in series with the filament string. Most of the damage to the tubes is caused by the surge of heavy current that flows when the set is first turned on and the filaments are cold. At that time, the average total resistance of the filaments is about 100 ohms, which means that our 117 volts of line current can send more than an ampere through the filaments designed for only fifteen hundredths of an ampere. The strong magnetic fields that accompany this husky current make the little filament wires writhe like a fire hose when the pressure is first turned on, and that writhing is what breaks the filaments."

"Looks to me like putting in a 100 ohm resistor would double the resistance and halve the current. Will tubes work with only half their normal current?"

Before he answered Mac pulled his slide rule from its battered leather case.

"I said the *cold* resistance was around 100 ohms," he said. "According to the slipstick here, if 117 volts are to send the rated 150 mils through the tube filaments, their total hot resistance must be about—hm-m-m-m—about 780 ohms. That means that while our resistor will hold the cold-resistance current down to about half of the value passed without the resistor, the actual operating current will be about 87% of the normal figure, which is plenty to make the set perform satisfactorily."

"Where do you cut this resistor into the tube line?"

"I like to put it between the rectifier filament and that of the output tube. This point is ordinarily easy to reach; it allows the resistor to be mounted away from the oscillator and i.f. coils where its heat might cause trouble; and at this point it will not cause hum by lifting a sensitive filament, such as that of the second detector, above ground. I always mount the resistor above the chassis so its heat will do no harm. The leads, covered with thick-walled spaghetti, go down through a couple of $\frac{3}{16}$ " holes drilled in the chassis."

"Well, you have told me how to make tubes last longer and how to do a good job of substituting when that becomes necessary; but now if you can

(Continued on page 115)

HORIZONTAL PULLING

By
JOHN R. MEAGHER
Tube Department, Harrison, N. J.
Radio Corporation of America

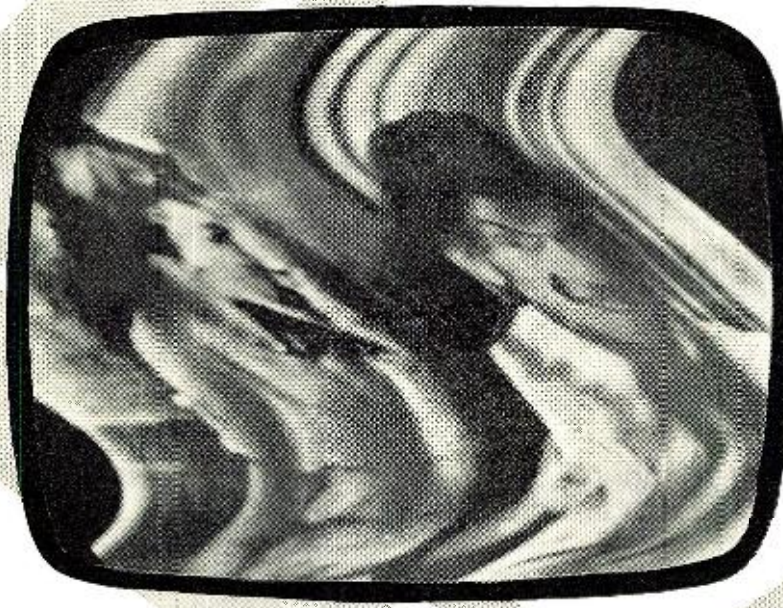

Horizontal pulling caused by heater cathode leakage in the horizontal a.f.c. circuit.

Part 1. Although horizontal pulling is a common trouble in television receivers, there is practically no information available on the subject. This article is designed to meet the need for authoritative data on its causes and remedies.

NO SIMPLIFY a rather complex story, numerous kinescope photographs are used to show the effects of horizontal pulling, as well as other visible symptoms, resulting from a variety of troubles. In many of these examples, the pulling effects are incidental. For this reason, the photographs and their explanatory captions are helpful in diagnosing other symptoms, in addition to horizontal pulling.

A Few Terms

When set owners complain of horizontal pulling, they may describe the symptoms by saying that telephone poles, doors, and windows in the TV picture appear bent, bowed over, curved, snaky, etc. Most technicians use the terms "horizontal pulling" and "horizontal bending" more or less interchangeably, usually reserving the latter for mild cases of pulling. The terms "waver" and "weaving" are generally applied in cases where the extent of pulling varies.

The writer uses the terms "raster pulling" and "picture pulling," because there is a real difference between the two effects, even though both produce the same outward symptoms in the picture. The troubles that cause raster pulling are usually entirely different from the troubles that cause picture pulling, as we shall see.

Slight Bending at Top

One of the most common types of picture pulling is a slight bending, toward the left or right, at the top of the picture. The bending can usually be varied, or even straightened out, by adjustment of the horizontal hold control or the contrast control or, in some receivers; by the a.g.c. threshold con-

trol or switch. Occasionally, the bending at the top of the picture may shift, or "flag-wave," back and forth from left to right. In cases where slight bending or flag-waving at the top of the picture is normal and common in a particular model of receiver, it is often a waste of time for the technician to check for defective components. The bending, in such cases, may be more of a design problem than a service problem.

Many technicians have wondered why the top of the picture is most susceptible to horizontal pulling (or to actual tearing in receivers without horizontal a.f.c.). One reason is that the horizontal sync action is most

Fig. 1. Two cycles of bending between top and bottom of raster or 120 cycle change in amplitude of horizontal deflection as caused by open condensers in the "B+" filter circuit. The bending is present on the raster either with or without a picture.

Fig. 2. Slight horizontal pulling, as evidenced by bending of the left and right hand sides of the box around "WFIL-TV," caused by an undesired magnetic field near the picture tube. The pulling, which is present on the raster with or without the picture, may be horizontal, vertical, or both depending on the location of the field. If the field is due to a magnetized portion of the shell of a metal-type picture tube, it may be detected by turning the tube, thus shifting direction of pulling.

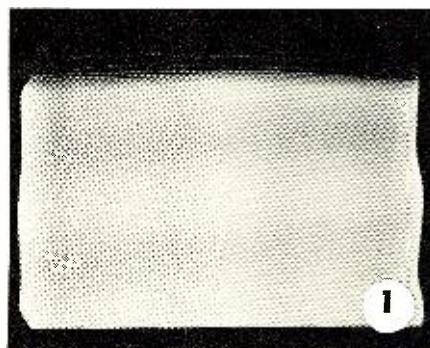

likely to be unstable immediately following the disturbance of vertical sync. The top of the picture follows after vertical sync, hence any instability of this type that may exist in the receiver will show up at the top of the picture. Another possible cause in some receivers is that the surge in the vertical oscillator, following vertical flyback, may be coupled into the horizontal sync circuit, producing a disturbance in horizontal sync phasing at the top of the picture. A simple check for the presence of this trouble is described later.

Two Types of Pulling

For troubleshooting purposes, it is helpful to recognize that there are two basic types of horizontal pulling.

1. "Raster pulling," where the pulling or bending is present on the raster, *without* a picture. Naturally, any pulling or bending on the raster is equally evident on the picture. One example of raster pulling is shown in Fig. 1. Possible causes include:

- (a) Troubles in "B" supply filtering.
- (b) Troubles in the horizontal deflection section.
- (c) Troubles in the deflecting yoke.
- (d) Undesired magnetic fields near the picture tube.

2. "Picture pulling," where the pulling or bending is present on the picture, but *not* on the raster. Examples of picture pulling are shown in all of the photos except Fig. 1. Picture pulling is a direct result of variation in horizontal sync phasing, as described later. Possible causes for picture pulling include:

- (a) Poor low-frequency response in the r.f., i.f., or video amplifiers.
- (b) Undesired limiting action in the video amplifier due to trouble in the amplifier or to excessive signal input.
- (c) 60-cycle modulation of the horizontal sync pulses, due to heater-cathode leakage in the r.f., i.f., or video

amplifiers, the sync separator, or the horizontal a.f.c. circuit.

(d) Excessive or insufficient sync signal input to the sync separator or troubles in the sync separator.

(e) Extraneous signals coupled by any means into the horizontal a.f.c. circuit.

(f) Electrical hunting action in the horizontal a.f.c. circuit.

(g) Extremely weak signals, interference, some reflection conditions, and other reasons.

It is desirable to consider the subject of raster pulling first.

Raster Pulling

Under normal conditions, all of the horizontal scanning lines in the raster have exactly the same length and the left- and right-hand edges of the raster are straight and parallel. If, however, there is any variation in the amplitude of horizontal deflection, some of the scanning lines become longer or shorter than others, resulting in the appearance of horizontal pulling or bending at the edges of the raster. One example of raster pulling is shown in Fig. 1, where 120 cycle ripple in the "B" supply, caused by open filter condensers, has produced a 120 cycle variation in the length of the scanning lines. (The vertical deflection rate in this example is 60 cycles: There are *two* cycles of bending between the top and bottom of the raster, or two cycles in 1/60th second, indicating that the variation in width is occurring at rate of 120 cycles-per-second.) *Any pulling or bending in the raster is, of course, equally evident in the TV picture.*

When the raster, without a picture, is pulled or bent, particularly at a 120 cycle rate, and is accompanied by hum in the audio, and possibly also by 120 cycle hum bars on the raster, it indicates that the trouble is in the "B" supply filter circuit. (In Fig. 1, there

is a trace of 120 cycle hum bars on the raster, which has two light, and two slightly darker, horizontal areas.)

Another reason for pulling or bending of the raster is the presence, near the picture tube, of an undesired magnetic field from a speaker, transformer, or choke. Such parts are carefully positioned in well-designed receivers to avoid this type of trouble, therefore it is seldom encountered. The technician, however, should be acquainted with the effect since it is the uncommon troubles that account for many of the headaches in television service. The direction of pulling due to an undesired magnetic field may be horizontal, vertical, or a combination of both, depending on the direction of the field. One example of a rather mild case of pulling due to a magnetic field is shown in Fig. 2.

Troubles in the deflection yoke or in the design of the yoke can cause pulling or bending of the raster.

Yoke troubles can generally be identified by the characteristic shapes that they produce in the outline of the raster. They may resemble a keystone, pillow, pincushion, or barrel. The most common symptom of yoke trouble is a keystone-shaped raster. In order to observe the shape, it may be necessary to reduce the width and the height so that all four sides of the raster are in full view on the picture tube.

As every technician knows, the scanning lines can be bent up or down or pulled sideways by incorrect adjustment of the focus coil and the beam bender.

When the pulling or bending on the raster is not caused by trouble in the "B" supply or in the deflection circuits, the following simple checks will usually enable the technician to determine whether the pulling is due to yoke trouble, or to an external magnetic field.

Remove the thumbscrew on the deflection yoke and rotate the yoke by about 90°, keeping the yoke pressed forward against the flare of the picture tube. The raster will turn as the yoke is turned. If the pulling or bending on the raster is caused by yoke trouble, the *shape* of the raster will not change when the yoke is turned. If the pulling is due to an undesired magnetic field, the shape of the raster will change when the yoke is turned.

When a portion of the shell of a metal-type picture tube has become magnetized as, for instance, by accidentally touching it with the magnet in a speaker, the resulting magnetic field may cause pulling or bending of the raster. To check for such magnetization, loosen the tube clamp slightly and rotate the picture tube by about 30°. The raster will not turn when the tube is turned, providing the yoke is kept from turning. If the direction of pulling changes when the tube is turned, it indicates that a portion of the shell is magnetized. It may be possible to use a magnetized tube without demagnetizing it by turning the tube

Fig. 3. Slight horizontal pulling at top of picture, accompanied by dark vertical bars at left, caused by open filter condensers in the "B+" feed to the horizontal deflection circuit. Horizontal blanking and sync signals are intentionally brought into view in this photo to show that there is no variation in width of raster but that there is variation in horizontal sync phasing at top of picture where it may be noted that shortstop and edge of picture are bent toward the left. Vertical hold control was adjusted to bring vertical blanking and sync into view in order to show that the horizontal bending exists only at the top of the picture. Also see Fig. 5.

Fig. 4. Example of 60 cycle horizontal pulling, accompanied by light and dark areas, caused by heater-cathode leakage in the r.f., i.f., or video amplifiers. Here and in Fig. 6 picture is moved to left in order to show that edge of raster is straight without variation in width of raster (no change in amplitude of horizontal deflection). Picture pulling is result of 60 cycle variation in horizontal sync phasing.

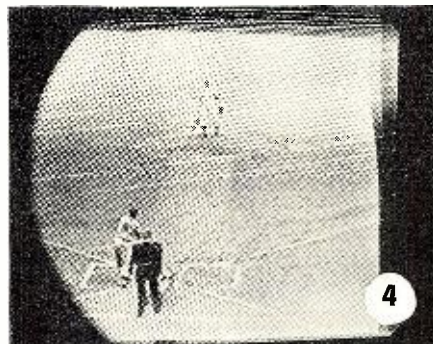
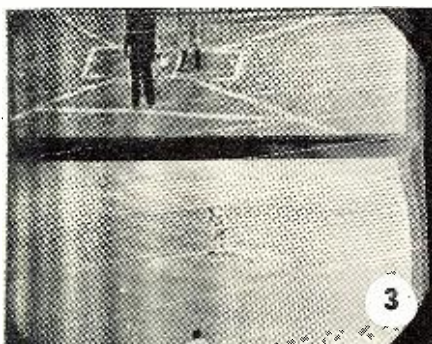

so that the magnetized portion is at the top or bottom, where it is farthest from the raster. This expedient is not possible, of course, in receivers with round masks.

To avoid high-voltage shocks, the receiver should be turned off and the high-voltage circuit discharged before any metal-type picture tube is touched.

Picture Pulling

When the cause for horizontal pulling is not immediately evident, it is a good practice to inspect the horizontal blanking and sync signals at the right-hand edge of the picture. These signals may be brought into view by moving the picture centering to the left, and by reducing the contrast and increasing the brightness to make the sync appear dark gray, as shown in Figs. 3 and 4. It may be necessary to adjust the horizontal hold control so that a sufficient portion of horizontal sync appears in view. (In some receivers, it may be necessary to adjust the a.g.c. threshold control to secure sufficient reduction in contrast, and temporarily short out a resistor in the brightness-control circuit for sufficient increase in brightness.)

By inspection of the horizontal blanking and sync signals, as in the examples shown in Figs. 3 and 5, we can immediately determine two facts:

1. The right-hand edge of the raster is not bent, but is straight. This is a positive indication that the particular pulling is not present on the raster.

2. The leading edge of horizontal sync is definitely pulled or bent with respect to the edge of the raster. Stated differently, there is a variation in the spacing (phasing) between the leading edge of horizontal sync and the edge of the raster. The spacing, or phasing, at the top portion of the picture is wider than at other portions. The trouble, therefore, is picture pulling due to variation in horizontal sync phasing.

Under normal conditions, when there is no horizontal pulling, the leading edge of horizontal sync is parallel to the edge of the raster and the edge of the raster is straight.

Regardless of any trouble in the receiver, the right-hand edge of the picture is always parallel to the leading edge of horizontal sync. The spacing between the edge of the picture and the leading edge of horizontal sync represents the "front porch" between the picture signals and the horizontal sync.

In Figs. 4 and 6, it may be seen that there is a variation in the spacing, or phasing, between the leading edge of horizontal sync and the edge of the raster. For instance, in Fig. 4, the spacing is wider at the top and bottom than at the center. In both Fig. 4 and Fig. 6, the edge of the raster is actually straight, although this fact is not clearly apparent because the particular trouble has darkened some portions of the picture. In working on a set, it is usually a simple matter to bring the entire edge of the raster into

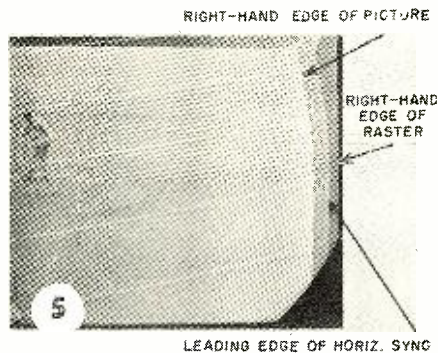

Fig. 5. Detailed section of the photo of Fig. 3. Note that the leading edge of horizontal sync, which should be parallel to the edge of raster, is not parallel (at the upper portion) thereby indicating a variation in horizontal sync phasing. Edge of raster is substantially straight, indicating pulling is not present in raster itself.

Fig. 6. Same fault as shown in Fig. 4 except that 117 volt plug has been reversed which shifts position at which the picture is bent and also the position of dark and light areas by about one-half the height of picture. Note that umpire appears to be doing a balancing act. Position of bending and of light and dark areas moves slowly or rapidly up or down when TV camera supply is not synced with receiver.

Fig. 7. Horizontal pulling caused by poor low frequency response in r.f. and i.f. amplifiers, reducing amplitude of sync signals with respect to higher frequency picture signals. The horizontal wedge, which represents low frequency signals, is faint compared with vertical wedge representing high frequency signals. Fault is poor alignment. Picture carrier is too low on the slope of the over-all response curve.

Fig. 8. Horizontal pulling caused by undesired limiting action in video amplifier which clips or reduces amplitude of sync signals making it difficult or impossible for sync separator to perform its normal function. With this type of trouble, the position and amount of pulling may vary with changes in picture content. The pulling may change from scene to scene, with motion of persons in scene, and with camera panning. Any significant reduction of sync amplitude can be detected by observing vertical sync on the tube, as shown in Fig. 9. The fault here is the incorrect setting of the a.g.c. threshold adjustment, permitting excessive signal input to video amplifier, where the limiting action reduces the amplitude of the sync signals.

view by adjusting the contrast and brightness controls.

Up to this point, we have shown how any case of horizontal pulling may be quickly and easily classified into one of the two basic types—raster pulling or picture pulling. We have also discussed simple means for localizing the troubles that cause raster pulling. We will now consider the steps that may be necessary in localizing troubles responsible for picture pulling.

The composite (picture, blanking, and sync) signal from the TV station passes through the r.f., i.f., and video amplifiers, and appears on the picture tube. With normal adjustment of contrast, the blanking and sync signals are blanked out, or blacked out, and are not visible on the picture tube. They may, however, easily be brought into sight and are then extremely useful in diagnosing certain troubles.

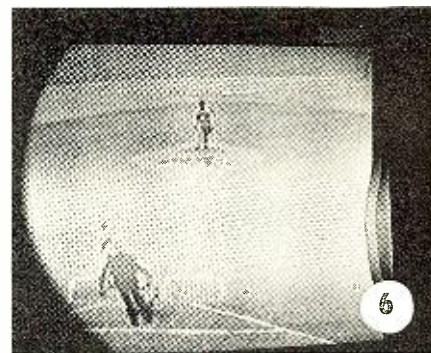

The composite signal is picked off at some point in the receiving circuits, usually in the video amplifier, and is fed into a sync separator. Under normal conditions, the sync signals are about 33% higher in voltage than the blanking signals which, in turn, are slightly higher in amplitude than the darkest picture signals. On the basis of this difference in sync amplitude, the sync separator is designed to pass the high-amplitude sync and (by limiting and clipping action) to remove the blanking and picture signals. The output of the sync separator should consist of sync pulses only with no trace of and no effect from the blanking and picture signals.

The horizontal sync pulses that are delivered from the sync separator to the horizontal a.f.c. circuit should have uniform amplitude, uniform spacing

(Continued on page 141)

Serviceing

INTERSYNC CIRCUITS

By
SOLOMON HELLER*
and
PETER ORNE

**Design, operation, and service hints on
one of the most critical of all TV circuits.**

THE intersync circuits of the TV receiver separate the vertical from the horizontal sync pulses, and permit only the desired pulses to reach the oscillator for which they are intended. That is, only the vertical pulses are permitted to enter the vertical oscillator and the horizontal pulses are kept out; only the horizontal pulses are allowed entry to the horizontal oscillator and the vertical pulses are kept out. If such a separation was not made, proper triggering of the vertical and horizontal oscillators would not be possible. The undesired pulses, differing as they do in their rate of repetition (60 cycles vs 15,750 cycles), would tend to trigger the oscillator to which they were applied at the wrong times, thus upsetting synchronization.

The simplest intersync circuits used in TV receivers are known as the *integrator* and the *differentiator*. The integrator (see Fig. 1) is an RC network with a relatively long time constant that builds up a suitable triggering charge at the grid of the vertical oscillator when vertical sync pulses are applied to its input. The primary purpose of the integrator is to prevent horizontal pulses from getting through to the vertical oscillator. The manner in which it does so will be explained shortly.

The differentiator (see Fig. 4A) is an RC network with a relatively short time constant. The pips (see Fig. 4C) produced at the output of the differentiator by the horizontal sync pulses applied to its input, trigger the horizontal oscillator at the required inter-

vals. The primary purpose of the differentiator is to attenuate the vertical sync pulses to negligible amplitudes.

The reader may, when he examines the outputs of the differentiator and integrator, wonder why such rather singular waveforms should be needed for triggering purposes. The answer is, they aren't. Waveforms of any shape could be used to trigger the sweep oscillators. Pips are, however, the natural output of the differentiator network, and are therefore employed unchanged. Similarly, the mountain-like charging curve of the integrator is the natural output of the latter circuit, and is therefore used for triggering.

We previously stated that the primary purpose of the integrator was to keep horizontal sync pulses from getting through to the vertical oscillator. Let us consider very briefly how it does so. A one-stage integrator network is assumed (See Fig. 1A).

Fig. 1. (A) Simple one-stage integrator circuit. (B) A two-stage integrator circuit. (C) A three-stage integrator circuit.

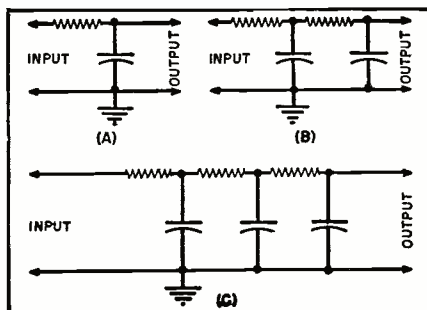

The reader will note, if he examines Fig. 2, that the horizontal and equalizing pulses cause charges of relatively slight amplitude to be developed in the integrator output. This is true because the duration of these pulses is so short, compared to the time constant of the integrator, that the latter hasn't the time to become considerably charged. Attenuation of the horizontal pulses is thus effected.

The vertical sync pulse, on the other hand, has a duration that is long with respect to the integrator's time constant. Enough time is therefore present for a large-amplitude charge to be developed in the integrator by the vertical pulse.

Let us consider how well the (one-stage) integrator attenuates the horizontal sync pulses. We can measure this attenuation by comparing the peak charge developed by the vertical pulse to the peak charge produced by a horizontal pulse.

Now, the height of the waveform developed by the vertical sync pulse is 80-point K, Fig. 2, -7 (point Z)—or 73% of the applied voltage. The horizontal pulses have an amplitude equal to approximately 4.2% of the applied voltage. The ratio of the vertical to the horizontal pulses is, therefore, 73 to 4.2, or about 17:1. This separation is not good enough to maintain satisfactory interlace. That is, the attenuation of the horizontal pulses is not great enough to prevent them from shifting the triggering peak of the integrator

* Mr. Heller is co-author, with Irving Shulman, of the new book "Television Servicing," published by McGraw-Hill Book Company, Inc., New York.

charging curve and thus causing interlace to be upset.

To further attenuate the horizontal pulses, two integrator stages may be used in cascade (see Fig. 1B). The vertical pulse will be attenuated 73% by the first branch of the circuit, and 73% by the second branch or $.73 \times .73$. Its amplitude at the output of the integrator will, therefore, be about 53% of the applied voltage. The horizontal pulses will be attenuated to 4.2% by the first branch, and 4.2 of 4.2% by the second—their amplitude at the integrator output will now be about .2%.

The ratio of the vertical to the horizontal pulses is now 255:1. With three circuits in cascade, the separation ratio becomes still better—about 4000:1. This ratio is adequate to maintain good interlace. Note that, with three circuits in cascade, the size of the vertical pulse is reduced to about 38% of the original voltage. This attenuation factor limits the number of circuits we can use in cascade. Three are generally employed in the integrator networks of TV receivers.

The differentiator network gives a large output at high frequencies, and no output at low frequencies. In this way it fulfills its purpose, which is to attenuate the vertical sync pulses to negligible amplitudes. Let us consider briefly how this process is achieved.

Now, the differentiator, due to its short time constant characteristic, responds only to *sudden* or *rapid* changes in the voltage present at its input. When the input signal is a horizontal pulse, the condenser charges and discharges in accordance with the voltage variation of the pulse. When a vertical pulse appears, the condenser will be charged by the edge of the pulse, since this represents a rapidly increasing voltage. When the long flat top section of a vertical serration arrives, however, no further change in the charge of the condenser will take place, since the condenser has already become fully charged. The differentiator will thus be insensitive to the vertical pulse, since the great bulk of the latter is made up of a flat-top signal, representing an unchanging voltage.

The differentiator does respond to the edges of the serrations in the vertical sync signal. This is as it should be, since these serrations are intended to act as horizontal sync signals, and keep the horizontal oscillator in synchronization during the vertical blanking interval.

A typical differentiator circuit used in a 1949 *Philco* TV receiver contains an 820 μfd . condenser and a 330 ohm resistor (see Fig. 4A). The time constant of the network is about .3 microseconds. The 5 microsecond horizontal sync pulse is quite long in comparison to this time constant. The resultant differentiator output is a much sharper pip than the one transmitted or the applied input signal.

Technicians should note that the output pips of the differentiator are normally equal in amplitude to the applied signal voltage (see Fig. 3).

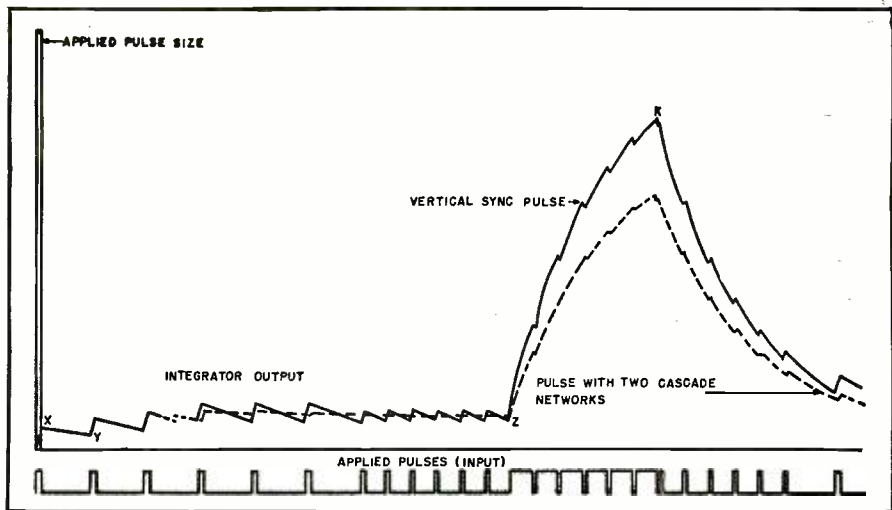

Fig. 2. Input and output of the integrators shown in Figs. 1A and 1B. See text for explanation.

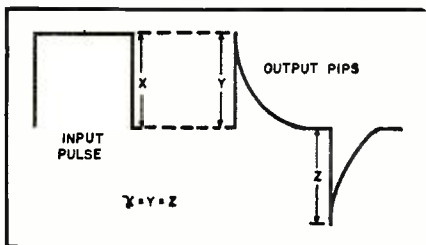

Fig. 3. The output pips of the differentiator should be equal in amplitude to the applied signal voltage of this circuit.

The first problem that confronts the technician with respect to servicing the integrator and differentiator networks, is when to look for trouble in this circuit. Trouble *may* be present in the integrator if the picture refuses to remain synchronized in the vertical direction alone. We stressed the word *may* because the source of trouble may also lie in the vertical oscillator.

Here is how a further localization of the trouble may be made. Try adjusting the vertical hold control. If the control can be adjusted to give a normal picture for an instant—even though the picture does not remain stationary, but begins rolling immediately—the vertical oscillator is functioning normally, and trouble in the integrating network is indicated. If, on the other hand, no readjustment of the vertical hold control can stop the picture vertically for an instant, a defect in the vertical oscillator or its associated circuit is indicated.

It should be remembered that the sync pulse can only control the oscillator properly, *i.e.*, initiate the retrace at the correct time, if the oscillator's free-running frequency is *slightly* lower than the frequency of the sync pulse (see Fig. 5). When the oscillator, due to some defect, cannot be brought, by manipulation of the hold control, to operate at a frequency below that of the sync pulse, synchronization will not be obtained.

In the case of the integrator, if the picture cannot be stopped vertically even for an instant, the frequency of the oscillator is too far above the cor-

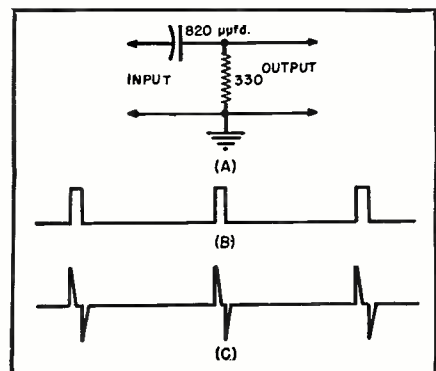
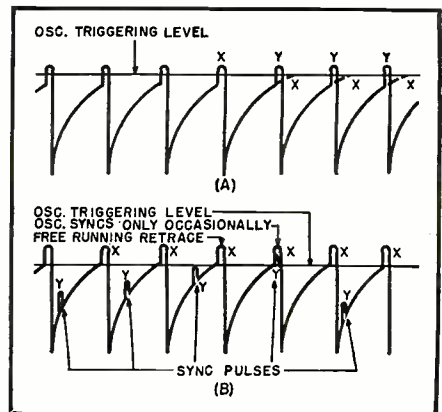

Fig. 4. (A) A typical differentiator circuit. (B) Input to the differentiator. (C) Output of the differentiator. The sharp upper and lower waveforms are referred to as "pips."

rect one, and the frequency determining components of the oscillator should be checked for defects. A point worthy of note is that the integrating network in many sets must be included in these frequency determining components

Fig. 5. (A) Effect of sync pulses on free-running oscillator when the oscillator frequency is slightly lower than the frequency of the sync pulses. Retrace which, in the absence of sync pulses, occurs at X, is begun earlier, or at Y when the pulses come in. (B) Effect of sync pulses on a free-running oscillator at a frequency higher than that of the incoming sync pulses. Sync pulses Y arrive at different times during each cycle and only occasionally synchronize the oscillator at correct time.



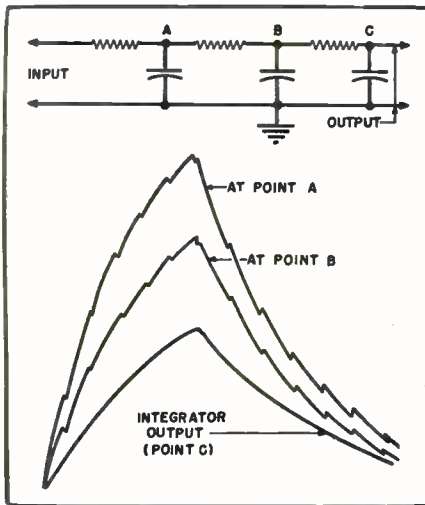

Fig. 6. Relative amplitude of the signal at different points in the integrator network.

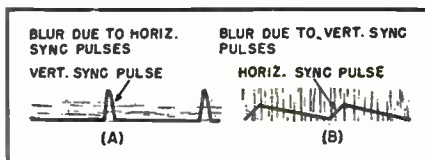

Fig. 7. Scope pattern when horizontal pulses are present in the output of the integrator when the scope is set at (A) 30 cycles, and (B) when it is set at 7.75 kc.

since it is in the oscillator grid circuit of these sets.

Troubles in the integrator may be divided into simple categories—a change in the value of a resistor, or a decrease in the capacitance of a condenser. If a resistor should increase in value, the time constant of the integrator would increase. The integrator output would correspondingly become smaller. Poor vertical holding action might result, that is, the setting of the vertical hold control might become very critical.

We previously discussed the normal reduction in the amplitude of the signal as it passed through the integrator. In each stage of a three-stage integrator (see Fig. 6) the normal output should be about 70%, or roughly $\frac{2}{3}$, of the input signal voltage. Thus the signal voltage at B should normally be $\frac{2}{3}$ of the signal voltage present at A; and the signal voltage at C should be $\frac{2}{3}$ of that present at B. This information should prove helpful when the technician is troubleshooting the integrator with an oscilloscope. If these relative signal amplitudes are not present, trouble in the affected integrator branch is indicated.

An increase in the capacitance of a condenser in the integrator network would have the same effect as an increase in the value of a resistor. Condensers, of course, do not increase in value to a large enough extent to produce such an effect. An incorrect replacement might, however, cause such a condition to occur. The wary technician will not overlook the possibility.

In some cases, a resistor may increase greatly in value, or open-circuit,

only when it has become heated during set operation to a certain temperature. A resistance check of the integrator will not locate the defect in such a case, because the integrator, when cold, may read its correct value. A scope test, however, will localize the trouble very quickly and narrow down the suspects to one condenser and one resistor. Each or both of these units can be readily replaced, and results then noted.

Condensers are more apt to become intermittent and open-circuit when the temperature around them has reached a certain level than resistors. Such an open-circuit does not have the same effect as when the condenser is entirely absent, since some capacitance remains between the pigtail that has opened, and the body of the condenser. A great reduction in the effective capacitance present does, however, result. The resultant shortening of the integrator's time constant (1) prevents the proper attenuation of the horizontal sync pulses, and (2) causes an excessively large vertical sync pulse output.

Effect No. 1 may cause premature triggering of the vertical oscillator. In extreme cases, a complete loss of vertical synchronization will occur. In less extreme instances, a loss of interlace will be noted. The loss of interlace will be due to the inability of the equalizing pulses to equalize the excessively large vertical pulses (effect No. 2), as explained in the authors' articles "Servicing TV Sync Circuits" (August and September 1950 RADIO & TELEVISION NEWS).

When horizontal pulses are present in the output of the integrator, due to one of the circuit defects just outlined, the condition will be readily revealed by a scope test. Two traces instead of the normal one will be seen on the scope screen. When the scope is set at a low frequency, the horizontal pulses will appear as a background blur (see Fig. 7A). When the scope frequency setting is advanced to maximum, the horizontal pulses will be clearly evident. The vertical pulses will now appear blurred (see Fig. 7B).

When no scope is available, resistance, bridging, and substitution tests will generally locate the defective component. An ohmmeter check will readily determine if a shorted condenser or open resistor is present or if one of the resistors has changed in value. An open condenser may be checked for by bridging the suspect unit with a new one and noting results on the picture. If no component defect is revealed by these tests, the few connections pres-

ent in the circuit should be resoldered to make sure no cold solder joint is causing the trouble. Tube pin connections to which the integrator is connected should also be checked for defects.

When the picture holds properly in the vertical direction, but does not lock in horizontally, trouble in the differentiator or horizontal oscillator is indicated. (Trouble may, in such a case, be also due to the defective operation of an a.f.c. circuit, if one is present. No differentiator is used in the latter case.)

If, during the adjustment of the horizontal hold control, the picture holds horizontally for an instant, the horizontal oscillator may be absolved from suspicion, and trouble should be sought in the differentiator. If no adjustment of the hold control will lock the picture in horizontally, the frequency determining components of the oscillator should be checked. The same resistance, condenser bridging, and resoldering tests recommended for troubleshooting the integrator can be used to locate trouble in the differentiator.

A scope will quickly indicate whether or not trouble in the differentiator is present and what is the nature of the trouble. Since there is only one condenser and one resistor in the circuit, the number of possible troubles is very small.

If the condenser open-circuits, or its capacitance decreases considerably, the sync pulse may be attenuated to an amplitude too low to produce synchronization. The reduction in amplitude will be readily apparent on the scope, provided, of course, that the technician knows (from the set manufacturer's notes or his own experience) what the amplitude of the pulse should be at that point.

If the resistor has decreased greatly in value, the same results will be noted. A resistance test will readily determine which of the two defects is present when the small amplitude of the pulse causes such a question to arise.

If an inexperienced technician has incorrectly replaced the condenser with a unit whose capacitance is too large, or if the resistor has increased considerably in value, the vertical pulse may not be sufficiently attenuated, causing poor holding in the horizontal direction, particularly near the top of the picture. An effect that will be noted in less severe cases of this trouble, i.e., instances where the increase in resistance or capacitance is not as great, is that noise will disturb the horizontal sync circuits to a greater extent than formerly.

The fastest way to recognize the type of defect just outlined is to check the width of the differentiated pulses on the scope. This width will be too great in the case cited (see Fig. 8). An ohmmeter check will readily determine whether the resistor is at fault. If it checks normal, the condenser should be replaced, and results noted.

Fig. 8. Excessive width in the base of the differentiated pulse indicates trouble in the differentiator circuit of the TV set.

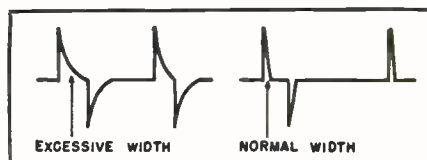

"Sure we can fill many Shoes"

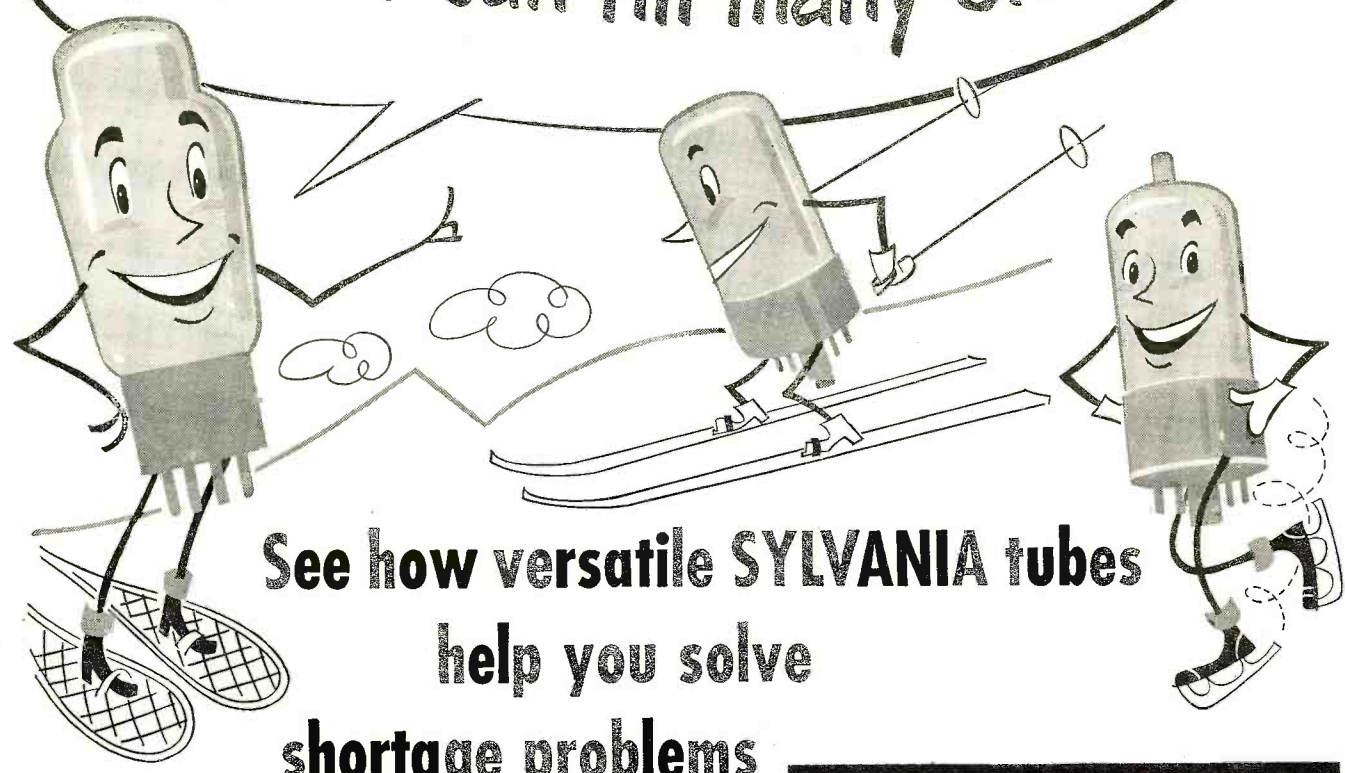

See how versatile SYLVANIA tubes help you solve shortage problems

Yes, radio tubes are still in short supply. But, Sylvania is doing its utmost to serve all its loyal customers.

Production facilities are being increased, and all Sylvania Distributors are being taken care of on the fairest possible allocation basis.

But, there's *no shortage* in ingenuity at Sylvania! Now this company offers you service dealers a great new tube substitution manual.

Here's a complete classified listing to assist service technicians and engineers in making substitutions for tube types not immediately available. This booklet includes circuit modifications and substitution directions for battery types, 150 ma. and 300 ma. types, as well as for Transformer and Auto Tube types . . . Television Tubes and Picture Tubes, too.

40 pages of valuable, up-to-the-minute information . . . FREE from Sylvania. Get your copy from your Sylvania Distributor NOW, or mail the coupon below.



This book is being given away FREE by Sylvania as a service to its good friends, the country's radio-television service dealers.



SYLVANIA ELECTRIC

Sylvania Electric Products Inc.
 Dept. R-2103, Emporium, Pa.
 Please send me new booklet "Sylvania Tube Substitution Manual."
 Name _____
 Street _____
 City _____ Zone _____ State _____

RADIO TUBES; TELEVISION PICTURE TUBES; ELECTRONIC PRODUCTS; ELECTRONIC TEST EQUIPMENT; FLUORESCENT TUBES, FIXTURES, SIGN TUBING, WIRING DEVICES; LIGHT BULBS; PHOTOLAMPS; TELEVISION SETS

March, 1951

THE NEW... IMPROVED

"STANDARD TV BOOSTER"

Model B-51



Manufactured by the leading designer and producer of TV tuners "The Standard Tuner"

INCLUDES THESE KEY FEATURES

- ★ Attractively styled
- ★ Dark brown plastic cabinet
- ★ Large two knob control
- ★ Four purpose switch
 - Off:** Signal by-passed to set
 - Set:** Filament on, signal by-passed to set
 - On:** Plate voltage applied, booster in operation
 - Tune:** Fine tuning for sharper picture or sound reception
- ★ Detent Tuning—positive channel selection
- ★ Continuous one knob tuning—no switch from high to low
- ★ Simple installation
- ★ Single tube operation
- ★ High gain, all channels
- ★ Low noise factor
- ★ Printed circuits
- ★ Iron core transformer input
- ★ 300 ohm operation
- ★ Fully shielded
- ★ Easy, simplified servicing

These and many more outstanding features are incorporated into the new B-51 "Standard Booster"

Standard COIL PRODUCTS CO. INC.
 CHICAGO • LOS ANGELES • BANGOR, MICH.

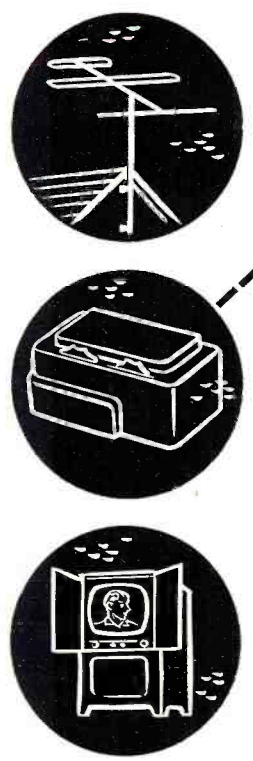

Details on a v.f.o. keying method which allows constant cathode current to flow in oscillator, key-up or key-down, without chirps or clicks.

By
ED MILLER, W7JBK

OFTENTIMES the very characteristics of a particular circuit which are usually considered a disadvantage, can be used to benefit the circuit's operation. So it is in the case of variable frequency oscillators. Changes in bias voltage or plate voltage or anything that will affect the cathode current, causes changes in the temperature of the tube elements which, in turn, varies the frequency. Many methods have been used to partially overcome these frequency changes, or chirps, when a v.f.o. is keyed directly,

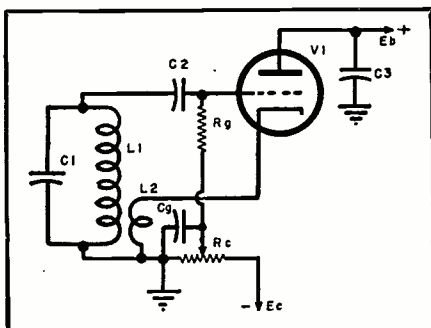

Fig. 1.

but none has been completely satisfactory. By using this characteristic of changing temperature with changing bias, a satisfactory method has been developed that eliminates chirps and clicks in a self-excited oscillator.

Consider the circuit of Fig. 1, where V_1 is an oscillator whose initial bias can be varied by the potentiometer R_c . If the cathode current of V_1 was plotted against the settings of R_c the curve of Fig. 2 would result. As the bias is decreased from cut-off the cathode current will increase, but the circuit will not be oscillating until point X is reached. At this amount of bias, oscillation takes place, causing a small amount of grid current to flow through R_p which develops a little additional bias and reduces the plate current again. Continuing the decrease of the bias voltage by R_c causes the cathode current to continue to increase and oscillation to be maintained. Note that there are two bias voltages that allow equal cathode current as shown at a and b in Fig. 2. With the greater bias of a, oscillation does not exist, while at b the circuit is oscillating. If, then, the bias was keyed between these two values, cathode current (and therefore the element temperature) would be the same key-up or key-down, but oscillation would take place only with the key down.

In Fig. 1 we considered changing

fixed grid bias, but with proper design of the regenerative circuit, changing cathode bias will accomplish the same thing. Fig. 3 is a schematic of such a circuit.

There are a few factors which must be considered in designing a circuit such as that shown in Fig. 3. Because different tubes, even of the same type, will have slightly different characteristics; the resistors R_1 and R_2 , used to adjust the two bias levels, should be variable, and for most satisfactory operation for long periods of time should be wirewound. The cathode bypass condenser C_1 should be sufficiently large for proper r.f. bypass, but not large enough to be considered as a keying filter. In that respect, with well-designed following amplifiers or multipliers a keying filter should not be necessary, because chirps are eliminated by the constant temperature of the tube elements, and clicks are prevented by the fact that the cathode current does not change key-up or key-down.

Another consideration in a circuit of this design is that if a wide range of frequency coverage is desired, the trimmer condenser C_{1A} must be large enough that the "Q" of the tuned circuit is almost the same with C_1 at maximum as at minimum. The reason this is necessary is that the settings of R_1 and R_2 are dependent upon the "Q" of the tuned circuit as well as the amount of feedback applied, the amplification factor of the tube used, the plate and screen voltages, and the value of the grid leak resistor.

The component values listed are for a 6SH7 tube and the coil enclosed in an aluminum shield should be as specified in the parts list. R_p can be replaced with an r.f. choke, but if it is, the choke should have more than 10 mhy. inductance to prevent changing load with changing frequency.

The fundamental frequency coverage of the oscillator, with the constants

Fig. 2.

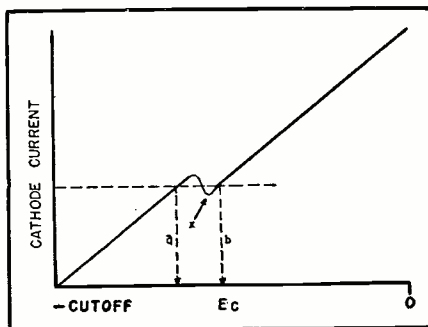

A New V.F.O. Keying Method

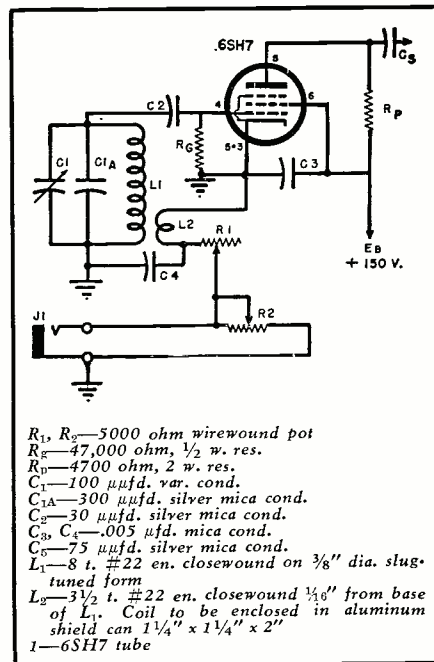

Fig. 3.

shown, is 1650 kc. to 2200 kc. The slug-tuned coil allows for moving this range to match the bands used.

To adjust, insert a 50 ma. meter in series with the plate supply to the oscillator and tune in the oscillations on a receiver with R_1 and R_2 set at minimum resistance. Now increase the resistance of R_1 and watch the meter, noting where oscillation ceases. Reduce the resistance of R_1 slightly, and increase the resistance of R_2 to where oscillations stop and increase it beyond this point to where, with key inserted in the jack, plate current is the same key-up or key-down and oscillation is present with key-down only. There is quite a wide range of adjustments that will give proper operation, and it is desirable to use settings that will allow either R_1 or R_2 to be adjusted a little either side of the final setting without changing the state of oscillation.

The wise choice for better TELEVISION PERFORMANCE

Telrex
"CONICAL-V-BEAMS"



*REGISTERED
TRADE MARK

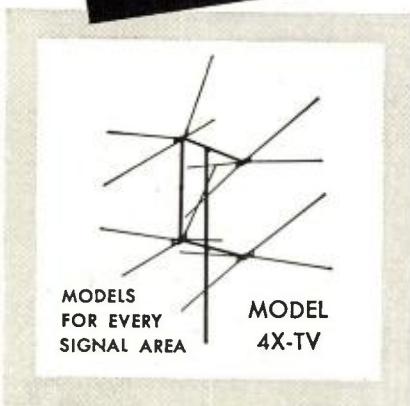

Conical-V-Beams are produced under Patent No. 2518297.

The Nation's Leader from Coast to Coast

Three basic factors contribute to the superior performance of Telrex Conical-V-Beams. Experienced engineering, exhaustive laboratory and extensive field tests and, most important, conservative factory ratings. Remember—if there's a usable TV signal, Telrex will deliver it to the receiver with picture quality that let's you—

"See the Difference"

WRITE FOR COMPLETE CATALOGS

Telrex INC.
CONICAL-V-BEAMS

AMERICA'S STANDARD OF COMPARISON
ASBURY PARK 7, N. J.

THE SKILL TO DESIGN
THE FACILITIES TO PRODUCE
THE ABILITY TO DELIVER



RADIO ENGINEERING TELEVISION ELECTRONICS

Thorough training in all phases of radio and electronics, open to high school and junior college graduates. Old established school specializing in Radio training exclusively. Modern laboratories and courses. Enrollments limited. Approved veteran training.

VALPARAISO TECHNICAL INSTITUTE
Dept. RD Valparaiso, Ind.

DO YOU WANT TO STOP TOBACCO?

Banish the craving for tobacco as thousands have with Tobacco Redeemer. Write for free booklet telling of injurious effect of tobacco and of a treatment which has relieved many men.

In Business Since 1909
300,000 Satisfied Customers
THE NEWELL COMPANY
462 Clayton Sta., St. Louis 5, Mo.

FREE BOOK

WALKIE TALKIES \$3.99 PER SET OF 2

POCKET SIZE
—Electronic
Voice Powered



No tubes, batteries, adjustments, license or permit needed! Should last for years.

Guaranteed to work anywhere up to 14 miles with extra wire. Clear tone. Swell for room to room—garage to house, etc.! Your own private, talk-listen phone. Not war surplus. Brand new. Solid Aluminum Case. Guaranteed. Two absolutely complete units with wire—READY TO USE! SEND ONLY \$3.00 deposit and pay post-man \$2.99 plus postage charges on arrival. Ideal gifts for boys—girls. Order Now! Today! THE MIDWAY COMPANY, Dept. WRT-3 KEARNEY, NEBRASKA.

Within the Industry

(Continued from page 26)

He has been associated with *General Electric* since graduating from college in 1931. He served in the Navy during World War II.

JOHN R. HOWLAND, who has been associated with the television and electronics industry since 1935, has been named to head a newly-created corporation office of product research for *Stewart-Warner Corporation* of Chicago.



Mr. Howland was a colonel in the Signal Corps during World War II and prior to the war and since that time he served as assistant to the president of *Zenith Radio Corporation*.

The new office which he fills was created to develop and encourage the development of new products.

NEDA has rescheduled its 1951 Convention and Annual Jobber Show in Cleveland to September 10-13.

Originally planned for Aug. 27-30, a conflict with *WCEMA's* Pacific Coast Show was discovered and the dates were changed to permit companies to be represented at both conventions.

The West Coast convention will be held Aug. 22-24 to allow time for exhibits to be shipped to Cleveland.

JULIUS HABER has been appointed director of advertising and sales promotion for *RCA Technical Products*.



Formerly advertising and sales promotion manager of the *RCA Tube Department*, Mr. Haber will now coordinate the advertising and sales promotional activities of all *RCA* technical products including those of the Engineering Products Department and the Tube Department. In his new capacity he will be attached to the staff of the vice-president in charge of Technical Products.

STANLEY P. LOVELL has been named to the board of directors of *Raytheon Manufacturing Company* of Waltham, Mass. He is president of *Lovell Chemical Company*. . . **DR. FERD E. WILLIAMS** has been appointed head of the Light Production Division of *General Electric Company's* Research Laboratory. Part of the duties of the division is a continuing study of phosphors used in television tubes. . . **HARRY H. ERICKSON**, formerly service manager of the Chicago Factory branch of *Admiral Corporation*, has been promoted to the post of service manager for all of the company's service branches. . .

RADIO & TELEVISION NEWS

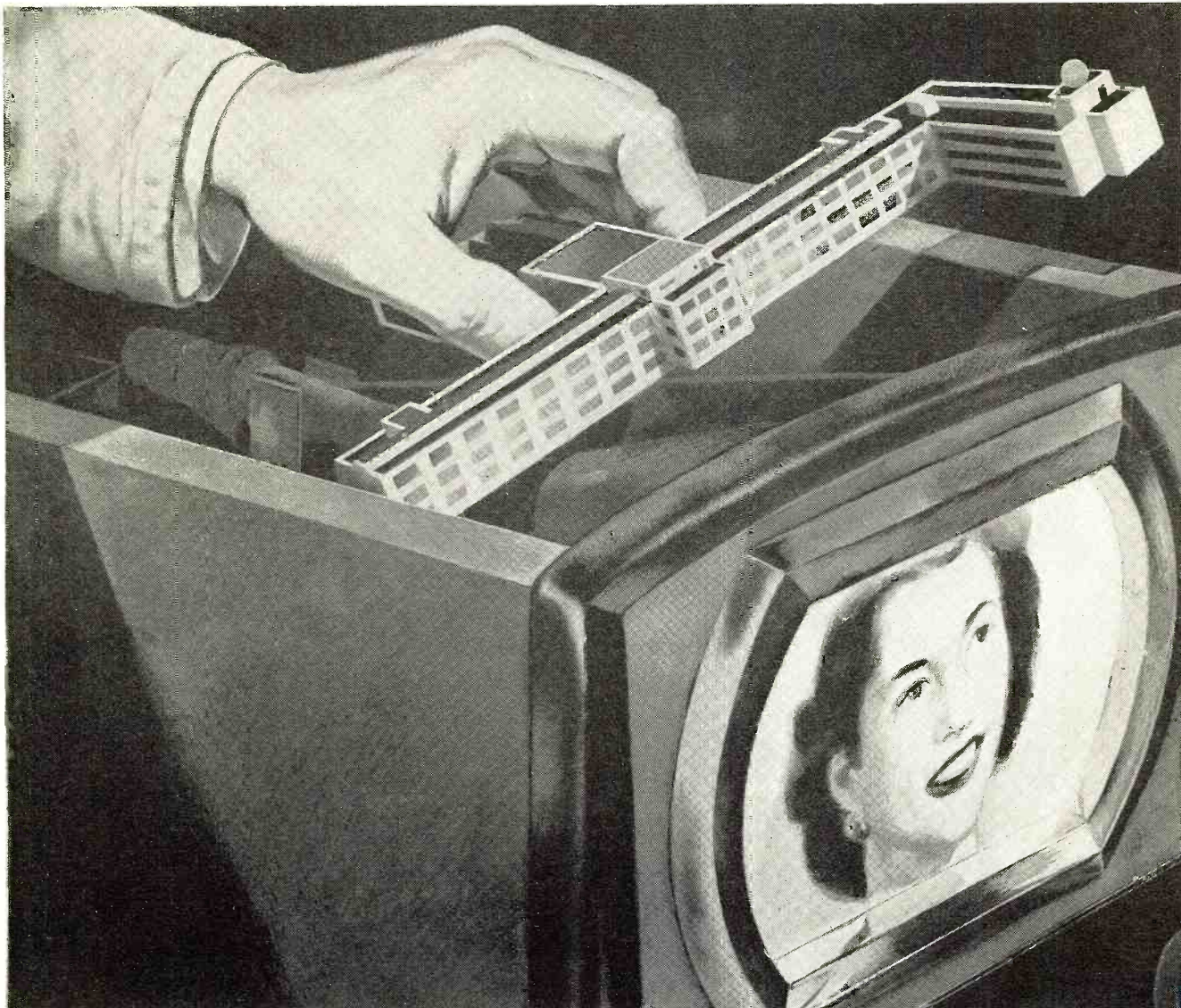

Basic research at RCA Laboratories has led to most of today's all-electronic television advances.

At the heart of every television set!

Why show RCA Laboratories *inside* your television receiver? Because almost every advance leading to all-electronic TV was pioneered by the scientists and research men of this institution.

The supersensitive image orthicon television camera was brought to its present perfection at RCA Laboratories. The kinescope, in these laboratories, became the mass-produced electron tube on the face of which you see television pictures. New sound systems, better microphones—even

the phosphors which light your TV screen—first reached practical perfection here.

Most important of all, the great bulk of these advances have been made available to the television industry. If you've ever seen a television picture, you've seen RCA Laboratories at work.

* * *

See the latest wonders of radio, television, and electronics at RCA Exhibition Hall, 36 West 49th St., N. Y. Admission is free. Radio Corporation of America, RCA Building, Radio City, New York 20, New York.

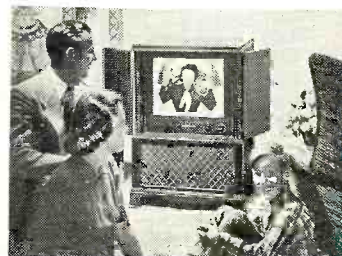

Through research from RCA Laboratories, today's RCA Victor television receivers are the finest example of electronic engineering.



RADIO CORPORATION of AMERICA

World Leader in Radio — First in Television

new **PHOTOFACT** book
shows you tested
proved ways for

"Making Money in Television Servicing"

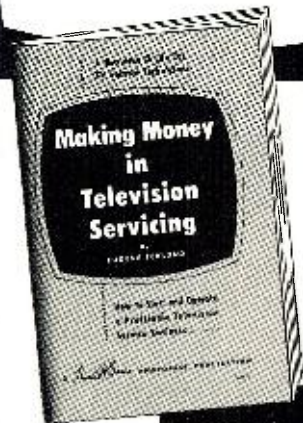

A "must" for every-
one in TV Servicing

**SHOWS YOU HOW TO
START AND OPERATE A
PROFITABLE BUSINESS**

CONTENTS:

Helpful chapters cover following subjects:

Overall Planning, Personal and Economic Considerations In Starting Business; Initial Investment; Selecting Location; Expansion; Current Finances; Budget and Control; Work Control; Overhead; Service Charges; Purchasing; Operating and Personnel Policies; Business Contacts; Contracts; Customer Relations; Collections; Advertising, etc.

If you're already in TV Servicing, this new book will help you run your business more smoothly, efficiently and profitably. If you're considering entering the field, this book will help you avoid expensive pitfalls and start you off on the right foot. Authoritatively written by Eugene Ecklund, B.E.E., former manager of the National Service Department, Allen B. DuMont Laboratories, Inc., and now a successful operator in his own TV service business. Here is sound, practical advice that's actually been tested, proved and found profitable. You'll want this valuable, inexpensive volume. Over 130 pages; 5½ x 8½; sturdy paper cover.

Only \$125

**ORDER
TODAY**

Order from your Parts
Jobber, or write direct to
HOWARD W. SAMS & CO., INC.,
2201 E. 46th St., Indianapolis 5, Ind.

My (check) (money order) for \$.....
is enclosed

Send.....copy(ies) of **MAKING
MONEY IN TELEVISION.** \$1.25 per copy.

Name.....

Address.....

City.....State.....

Emerson Radio & Phonograph Corporation has named **GERALD LIGHT** to the post of sales promotion manager . . . **FRANK MARSHALL** is the new director of manufacturers' sales for *Aerovox Corporation* and *Electrical Reactance Corporation*. **CHARLES GOLENPAUL** will continue to direct the *Aerovox* jobber sales . . . **GILBERT C. KNOBLOCK**, who has been advertising and sales promotion manager of *Standard Transformer Corporation* for several years, has been upped to the post of general sales manager of the firm . . . **ROBERT A. SEIDEL**, vice-president in charge of *RCA Victor* distribution since October 1949, has been named to the newly-created position of vice-president and special assistant to the vice-president and general manager . . . **LYNN EATON**, general sales manager for *Andrea Radio Corporation*, is the new mobilization director of the company in charge of all government contracts for the firm . . . **N. C. HENRY** has been appointed manager of TV and radio distribution for

the *Bendix Television and Broadcast Receiver Division* of *Bendix Aviation Corporation* . . . The president of *Air King Products Company, Inc.* has named **ROBERT K. ROULSTON** as his assistant . . . **GLEN L. LOGAN**, former *Packard Motor Car Company* executive, has been elected managing director of the Electric League of Los Angeles, Inc., trade association for the local electrical industry . . . *Fidelity Tube Corporation*, manufacturer of TV tubes, has named **BENJAMIN OZAROFF** president of the firm . . . **JEROME HOLLAND** has joined the engineering staff of *Oak Ridge Products*. He was formerly associated with *Du Mont* and *General Electric* . . . The new general sales manager of *Altec Service Corporation* is **L. D. NETTER, JR.** . . . **JOHN A. KUNEAU** has been appointed director of public relations of *Philco Corporation* and its subsidiaries and been named to serve on the company's management operations committee.

-30-

HAND-OR-STAND MIKE

By **ARTHUR TRAUFFER**

BY THIS simple arrangement, you can hold your microphone in your hand, or slip it onto a stand. For the stand, you can use an economical, but rugged, folding photolamp stand selling for \$3.00. These stands extend to a height of about 6 feet, and fold to a length of 4 feet.

Obtain a 5" hardwood chisel handle and saw off the tapered nipple on the tool end of the handle. Bore a hole about 2¼" deep in the bottom end of the handle. This hole should be of the correct diameter to allow the handle to slip onto the top section of your stand easily, but snugly. Obtain a 5/16" diameter carriage bolt about 2" long and saw off the head with a hacksaw. These bolts have a threaded section on the shank about 1" long. Bore a ¼" dia. hole in the tool end of the handle to a depth of about 1⅞", and thread the bolt-shank into the hole securely, allowing 7/8" of the shank to protrude from the end of the handle. Now, remove the cable-protecting spring in the end of a standard male 5/8" 27-thread microphone cord-connector, slip the connector over the bolt, and tighten the setscrew. Your handle is now ready for use. The threads on the micro-

phone cord-connector fit the threaded sockets on the bottoms of all American-made microphones. The completed handle and photolamp stand should cost about \$3.60, quite a bargain for such a handy setup!

-30-

Mechanical details of mike handle.

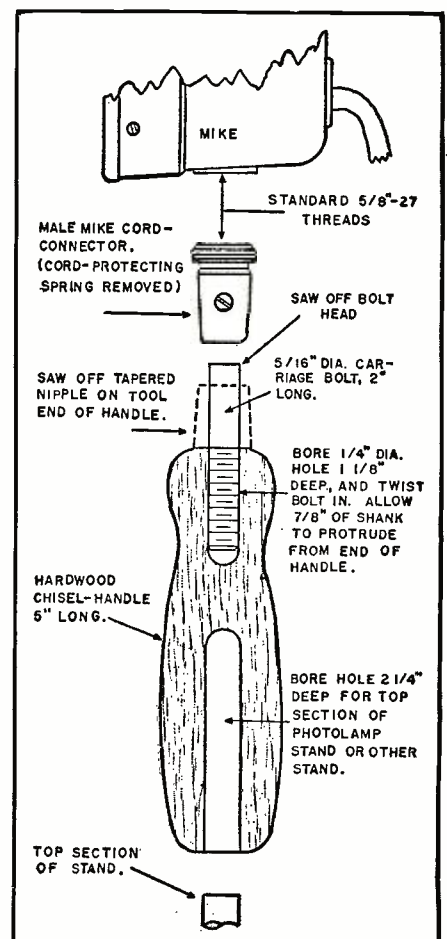

Over-all view of completed mike stand.



You GET
THE BEST IN
Heathkits

Heathkits are the Quality Line of TEST INSTRUMENT KITS



Modern STYLING KITS THAT MATCH

Heathkits are styled in the most modern manner by leading industrial stylists. They add beauty and utility to any laboratory or service bench. There is a complete line of Heathkit instruments allowing a uniformity of appearance.

An attractive service shop builds a feeling of confidence. Many organizations have standardized on Heathkits providing uniform service departments.

There is no waste space or false effort to appear large in Heathkits — space on service benches is limited and the size of Heathkit instruments is kept as small as is consistent with good engineering practice.

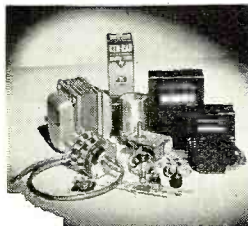

Accuracy ASSURED BY PRECISION PARTS

Wherever required, the finest quality 1% ceramic resistors are supplied. These require no aging and do not shift. No matching of common resistors is required. You find in Heathkit the same quality voltage divider resistors as in the most expensive equipment.

The transformers are designed especially for the Heathkit unit. The scope transformer has two electrostatic shields to prevent interaction of AC fields.

These transformers are built by several of the finest transformer companies in the United States.

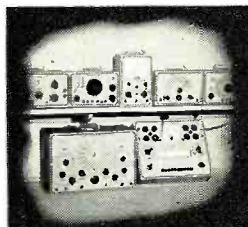

Used BY LEADING MANUFACTURERS

Leading TV and radio manufacturers use hundreds of Heathkits on the assembly lines. Heathkit scopes are used in the alignment of TV tuners. Impedance bridges are serving every day in the manufacture of transformers. Heathkit VTVM's are built into the production lines and test benches. Many manufacturers assemble Heathkits in quantity for their own use thus keeping

purchase cost down.

Famous HEATHKIT PARTS

- MALLORY FILTER CONDENSERS
- WILKOR PRECISION RESISTORS
- GRIGSBY ALLISON SWITCHES
- ALLEN-BRADLEY RESISTORS
- GENERAL ELECTRIC TUBES
- CHICAGO TRANSFORMER
- CENTRALAB CONTROLS
- SIMPSON METERS
- CINCH SOCKETS

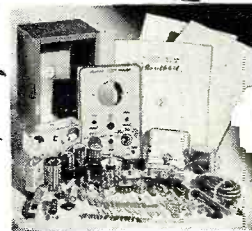

Complete KITS WITH PARTS THAT FIT...

When you receive your Heathkit, you are assured of every necessary part for the proper operation of the instrument.

Beautiful cabinets, handles, two-color panels, all tubes, test leads where they are a necessary part of the instrument, quality rubber line cords and plugs, rubber feet for each instrument, all scales and dials ready printed and calibrated. Every Heathkit is 110 V 60 Cy. power transformer operated by a husky transformer especially designed for the job. Heathkit chassis are precision punched for ease of assembly. Special engineering for simplicity of assembly is carefully considered.

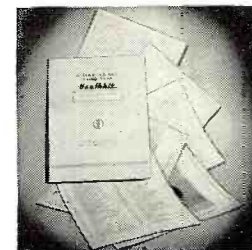

Complete INSTRUCTION MANUALS

Heathkit instruction manuals contain complete assembly data arranged in a step-by-step manner. There are pictorials of each phase of the assembly drawn by competent artists with detail allowing the actual identification of parts. Where necessary, a separate section is devoted to the use of the instrument. Actual photos are included to aid in the proper location of wiring.

Used BY LEADING UNIVERSITIES

Heathkits are found in every leading university from Massachusetts to California. Students learn much more when they actually assemble the instrument they use. Technical schools often include Heathkits in their course and these become the property of the students. High schools, too, find that the purchase of inexpensive Heathkits allows their budget to go much further and provides much more complete laboratories.

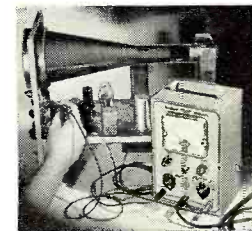

YOU SAVE BY ORDERING DIRECT FROM MANUFACTURER—USE ORDER BLANK ON LAST PAGE

EXPORT AGENT
ROCKE INTERNATIONAL CORP.
13 E. 40th ST.
NEW YORK CITY (16)
CABLE: ARLAB-N.Y.

The HEATH COMPANY

... BENTON HARBOR 15, MICHIGAN

12 Improvements IN NEW 1951

MODEL O-6

PUSH-PULL

Heathkit OSCILLOSCOPE KIT



- ★ New AC and DC push-pull amplifier.
- ★ New step attenuator frequency compensated input.
- ★ New non frequency discriminating input control.
- ★ New heavy duty power transformer has 68% less magnetic field.
- ★ New filter condenser has separate vertical and horizontal sections.
- ★ New intensity circuit gives greater brilliance.
- ★ Improved amplifiers for better response useful to 2 megacycles.
- ★ High gain amplifiers .04 Volts RMS per inch deflection.
- ★ Improved Allegheny Ludlum magnetic metal CR tube shield.
- ★ New synchronization circuit works with either positive or negative peaks of signal.
- ★ New extended range sweep circuit 15 cycles to over 100,000 cycles.
- ★ Both vertical and horizontal amplifier use push-pull pentodes for maximum gain.

Only **\$39.50**

New INEXPENSIVE MODEL S-2 ELECTRONIC SWITCH KIT

Twice as much fun with your oscilloscope — observe two traces at once — see both the input and output traces of an amplifier, and amazingly you can control the size and position of each trace separately — superimpose them for comparison or separate for observation — no connections inside scope. All operation electronic, nothing mechanical — ideal for classroom demonstrations — checking for intermittents, etc. Distortion, phase shift and other defects show up instantly. Can be used with any type or make of oscilloscope. So inexpensive you can't afford to be without one.

Has individual gain controls, positioning control and coarse and fine switching rate controls — can also be used as square wave generator over limited range. 110 Volt transformer operated comes complete with tubes, cabinet and all parts. Occupies very little space beside the scope. Better get one. You'll enjoy it immensely. Model S-2. Shipping Wt., 11 lbs.

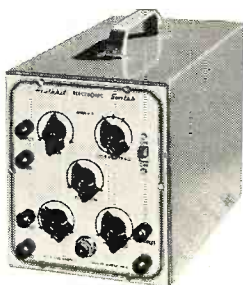

Only
\$19.50

The new 1951 Heathkit Push-Pull Oscilloscope Kit is again the best buy. No other kit offers half the features — check them.

Measure either AC or DC on this new scope — the first oscilloscope under \$100.00 with a DC amplifier.

The vertical amplifier has frequency compensated step attenuator input into a cathode follower stage. The gain control is of the non frequency discriminating type — accurate response at any setting. A push-pull pentode stage feeds the C.R. tube. New type positioning control has wide range for observing any portion of the trace.

The horizontal amplifiers are direct coupled to the C.R. tube and may be used as either AC or DC amplifiers. Separate binding posts are provided for AC or DC.

The multivibrator type sweep generator has new frequency compensation for the high range it covers; 15 cycles to cover 100,000 cycles. The new model O-6 Scope uses 10 tubes in all — several more than any other. Only Heathkit Scopes have all the features.

New husky heavy duty power transformer has 50% more laminations. It runs cool and has the lowest possible magnetic field. A complete electrostatic shield covers primary and other necessary windings and has lead brought out for proper grounding.

The new filter condenser has separate filters for the vertical and horizontal screen grids and prevents interaction between them.

An improved intensity circuit provides almost double previous brilliance and better intensity modulation.

A new synchronization circuit allows the trace to be synchronized with either the positive or negative pulse, an important feature in observing the complex pulses encountered in television servicing.

The magnetic alloy shield supplied for the C.R. tube is of new design and uses a special metal developed by Allegheny Ludlum for such applications.

The Heathkit scope cabinet is of aluminum alloy for lightness of portability.

The kit is complete, all tubes, cabinet, transformer, controls, grid screen, tube shield, etc. The instruction manual has complete step-by-step assembly and pictorials of every section. Compare it with all others and you will buy a Heathkit. Model O-6. Shipping Wt., 30 lbs.

YOU SAVE BY ORDERING DIRECT FROM MANUFACTURER — USE ORDER BLANK ON LAST PAGE

EXPORT AGENT
ROCKE INTERNATIONAL CORP.
12 E. 40th ST.
NEW YORK CITY (16)
CABLE: ARLAB-N.Y.

The **HEATH COMPANY**

... BENTON HARBOR 15, MICHIGAN

New 1951 • • MODEL V-4A

Heathkit VTVM KIT

HAS EVERY EXPENSIVE Feature

- ★ Higher AC input impedance, (greater than 1 megohm at 1000 cycles).
- ★ New AC voltmeter flat within 1 db 20 cycles to 2 megacycles (600 ohm source).
- ★ New accessory probe (extra) extends DC range to 30,000 Volts.
- ★ New high quality Simpson 200 microampere meter.
- ★ New 1/2% voltage divider resistors (finest available).
- ★ 24 Complete ranges.
- ★ Low voltage range 3 Volts full scale (1/3 of scale per volt).
- ★ Crystal probe (extra) extends RF range to 250 megacycles.
- ★ Modern push-pull electronic voltmeter on both AC and DC.
- ★ Completely transformer operated isolated from line for safety.
- ★ Largest scale available on streamline 4 1/2 inch meter.
- ★ Burn-out proof meter circuit.
- ★ Isolated probe for dynamic testing no circuit loading.
- ★ New simplified switches for easy assembly.

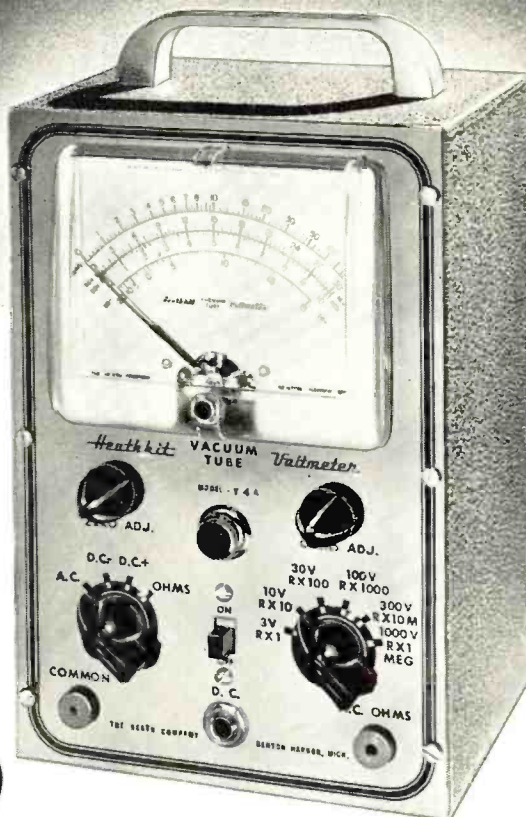

New
LOW PRICE **\$23.50**

The new Heathkit Model V-4A VTVM Kit measures to 30,000 Volts DC and 250 megacycles with accessory probes — think of it, all in one electronic instrument more useful than ever before. The AC voltmeter is so flat and extended in its response it eliminates the need for separate expensive AC VTVM's + or - db from 20 cycles to 2 megacycles. Meter has decibel ranges for direct reading. New zero center on meter scale for quick FM alignment.

There are six complete ranges for each function. Four functions give total of 24 ranges. The 3 Volt range allows 33 1/3% of the scale for reading one volt as against only 20% of the scale on 5 Volt types.

The ranges decade for quick reading.

New 1/2% ceramic precision are the most accurate commercial resistors available — you find the same make and quality in the finest laboratory equipment selling for thousands of dollars. The entire voltage divider decade uses these 1/2% resistors.

New 200 microampere 4 1/2" streamline meter with Simpson quality movement. Five times as sensitive as commonly used 1 MA meters.

Shatterproof plastic meter face for maximum protection. Both AC and DC voltmeter use push-pull electronic voltmeter circuit with burn-out proof meter circuit.

Electronic ohmmeter circuit measures resistance over the amazing range of 1/10 ohm to one billion ohms all with internal 3 Volt battery. Ohmmeter batteries mount on the chassis in snap-in mounting for easy replacement.

Voltage ranges are full scale 3 Volts, 10 Volts, 30 Volts, 100 Volts, 300 Volts, 1000 Volts. Complete decading coverage without gaps.

The DC probe is isolated for dynamic measurements. Negligible circuit loading. Gets the accurate reading without disturbing the operation of the instrument under test. Kit comes complete, cabinet, transformer, Simpson meter, test leads, complete assembly and instruction manual. Compare it with all others and you will buy a Heathkit. Model V-4A. Shipping Wt., 8 lbs. Note new low price, \$23.50



New 30,000 VOLT DC PROBE KIT

Beautiful new red and black plastic high voltage probe. Increases input resistance to 1100 megohms, reads 30,000 Volts on 300 Volt range. High input impedance for minimum loading of weak television voltages. Has large plastic insulator rings between handle and point for maximum safety. Comes complete with PL55 type plug.

No. 3366 High Voltage Probe Kit
Shipping Wt. 2 pounds.

\$550

Heathkit
RF PROBE KIT

Crystal diode probe kit extends range to 250 megacycles = 10% comes complete with all parts, crystal, cable and PL55 type plug.

No. 309 RF Probe Kit
Shipping Wt. 1 lb

\$550



YOU SAVE BY ORDERING DIRECT FROM MANUFACTURER — USE ORDER BLANK ON LAST PAGE

EXPORT AGENT
ROCKE INTERNATIONAL CORP.
13 E. 40th ST.
NEW YORK CITY (16)
CABLE: ARLAB-N.Y.

The HEATH COMPANY

... BENTON HARBOR 15, MICHIGAN

NEW Heathkit T.V. ALIGNMENT GENERATOR KIT



Shipping Wt., 16 lbs.

\$39.50

- ★ New simplified circuit for easy calibration and assembly.
- ★ New 2 band built-in marker covers 19 to 75 Mc.
- ★ New dual spider sweep motor for long life.
- ★ New blanking circuit gives base line for better alignment.
- ★ New variable oscillator gives high output fundamentals on high TV band.
- ★ New standby switch keeps instrument ready for instant use.
- ★ New 6 to 1 slow speed drive on both master oscillator and marker tuners.

The new Heathkit TV Alignment Generator incorporates the new developments required for modern TV servicing. An absorption marker circuit covering all possible IF bands and even several of the RF bands. The new blanking circuit provides a base reference line which is invaluable in establishing proper traces. The new sweep motor incorporates dual spiders in the speaker frame assuring better alignment and long life. The mounting of the speaker sweep motor has been simplified for easy alignment.

The variable master oscillator covers 140 to 230 Mc. thus giving high output fundamentals where they are most needed. Low band coverage 2 Mc. to 90 Mc.

A new step attenuator provides excellent control of output.

Planetary 6 to 1 drives on both oscillator and marker provides smooth easy control settings.

A standby position is provided making the instrument always instantly available.

Horizontal sweep voltage with phasing control is provided. No other sweep generator under \$100.00 provides all these features — comes complete with instruction manual. Model TS-2.

Heathkit CONDENSER CHECKER KIT

Only **\$19.50**

Features

- Power factor scale.
- Measures resistance.
- Measures leakage.
- Checks paper-mica-electrolytics.
- Bridge type circuit.
- Magic eye indicator.
- 110 V. transformer operated.
- All scales on panel.

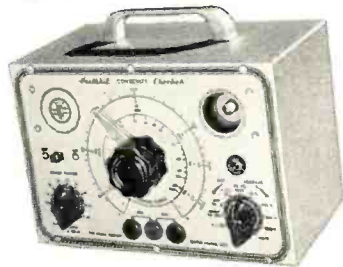

Checks all types of condensers over a range of .00001 MFD to 1,000 MFD. All on readable scales that are read direct from the panel. NO CHARTS OR MULTIPLIERS NECESSARY. A condenser checker anyone can read. A leakage test and polarizing voltage for 20 to 500 Volts provided. Measures power factor of electrolytics between 0% and 50%. 110 V. 60 cycle transformer operated complete with rectifier and magic eye tube, cabinet, calibrated panel, test leads and all other parts. Clear detailed instructions for assembly and use. Model C-2. Shipping Wt., 7 lbs.

NEW Heathkit SIGNAL TRACER AND UNIVERSAL TEST SPEAKER KIT

\$19.50

Features

- High sensitivity
- Complete set of speaker impedances
- Tests microphones and PA systems
- Tests both single and push-pull speaker circuits

The popular Heathkit Signal Tracer has now been combined with a universal test speaker at no increase in price. The same high quality tracer follows signal from antenna to speaker — locates intermittents — detects parts quicker — saves valuable service time — gives greater income per service hour. Works equally well on broadcast — FM or TV receivers. The test speaker has assortment of switching ranges to match push-pull or single output impedance. Also test microphones, pickups, PA systems — comes complete — cabinet, 110 V 60 cycle power transformer — tubes, test probe, all parts and detailed instructions for assembly and use. Model T-2. Shipping Wt., 8 lbs.



Heathkit TUBE CHECKER KIT

Features

Sockets for every modern tube — blank for new types.

Fastest method of testing tubes — saves time — makes more profit.

Rugged counter type birch cabinet.

Test your tubes the modern way — dynamically — the simplest, yet fastest and surest method — your Heathkit has a switch for each tube element and measures that element — no chance for open or shorted elements slipping by, all the advantages of the mutual conductance type without the slow cumbersome time consuming setups.

Your Heathkit Tube Checker has all the features — beautiful 3 color BAD-GOOD meter — complete selection of voltages — roller chart listing hundreds of tubes including the new 9 pin miniatures — finest quality Centralab lever switches for each element — high grade birch counter type cabinet — continuously variable line adjust control — every feature you need to sell tubes properly. The most modern type tube checker with complete protection against obsolescence. The best of parts — rugged oversize 110 V 60 cycle power transformer — finest of Mallory and Centralab switches and controls, complete set of sockets for all type tubes with blank spare for future types. Fast action brass gear driven roller chart quickly locates the settings for any type tube. Simplified switching cuts necessary testing time to minimum and saves valuable service time. Short and open element check. Simple method allows instant setup of new tube types without waiting for factory data. No matter what the arrangements of tube elements, the Heathkit flexible switching arrangement easily handles it. Order your Heathkit Tube Checker Kit today. See for yourself that Heath again saves you two-thirds and yet retains all the quality — this tube checker will pay for itself in a few weeks — better assemble it now. Complete with instructions — pictorial diagrams — all parts — cabinet — ready to wire up and operate. Model TC-1 Shipping Wt., 12 lbs.

Gear driven roller chart gives instant setup for all types.

Tests each element separately for open or short and quality.

Beautiful 3 color meter — reads good-bad and line set point.

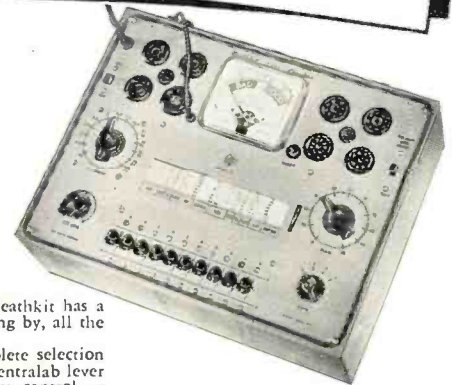

\$29.50

YOU SAVE BY ORDERING DIRECT FROM MANUFACTURER—USE ORDER BLANK ON LAST PAGE

EXPORT AGENT
ROCKE INTERNATIONAL CORP.
13 E. 40th ST.
NEW YORK CITY (16)
CABLE: ARLAB-N.Y.

The HEATH COMPANY

... BENTON HARBOR 15, MICHIGAN

NEW 1951
Heathkit

SIGNAL GENERATOR KIT

Features

- Sine wave audio modulation.
- Extended range 160 Kc. to 50 megacycles fundamentals.
- New step attenuator output.
- New miniature HF tubes.
- Transformer operated for safety.
- Calibrated harmonics to 150 megacycles.
- New external modulation switch.
- 5 to 1 vernier tuning for accurate settings.

A completely new Heathkit Signal Generator Kit. Dozens of improvements. The range on fundamentals has been extended to over 50 megacycles; makes this Heathkit ideal as a marker oscillator for T.V. New step attenuator gives controlled outputs from very low values to high output. A continuously variable control is used with each step. New miniature HF tubes are required for the high frequencies covered.

Uses 6C4 master oscillator and 6C4 sine wave audio oscillator. The set is transformer operated and a husky selenium rectifier is used in the power supply. The coils are precision wound and checked for calibration making only one adjustment necessary for all bands.

New sine wave audio oscillator provides internal modulation and is also available for external audio testing. Switch provided allows the oscillator to be modulated by an external audio oscillator for fidelity testing of receivers.

A best buy — think of all the features for less than \$20.00. The entire coil and tuning assembly are assembled on a separate turret for quick assembly — comes complete — all tubes — cabinet — test leads — every part. The instruction manual has step-by-step instructions and pictorials. It's easy and fun to build a Heathkit Model SG-6 Signal Generator. Shipping Wt., 7 lbs.



\$19.50

Heathkit SINE AND SQUARE WAVE AUDIO GENERATOR KIT

Either sine or square wave.
Stable RC bridge circuit.
Covers 20 to 20,000 cycles.
Less than 1% distortion.

Hundreds of Heathkit Audio Generators are used by speaker manufacturers—definite proof of their quality and dependability. The added feature of square wave opens up an entirely new field of amplifier testing. Uses the best of parts, 4 gang condenser, 1% calibrating resistors, metal cased filter condensers, 5 tubes, completely calibrated panel and detailed instruction manual. One of our best and most useful kits. Model G-2. Shipping Wt., 12 lbs.

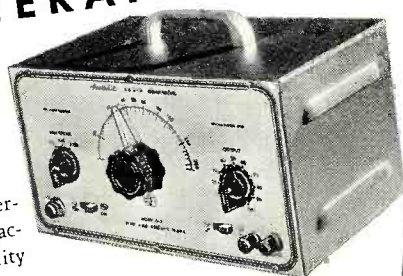

\$34.50

THE NEW *Heathkit* HANDITESTER KIT

- Beautiful streamline Bakelite case.
- AC and DC ranges to 5,000 Volts.
- 1% Precision ceramic resistors.
- Convenient thumb type adjust control.
- 400 Microampere meter movement.
- Quality Bradley AC rectifier.
- Multiplying type ohms ranges.
- All the convenient ranges 10-30-300-1,000-5,000 Volts.
- Large quality 3" built-in meter.



\$13.50

A precision portable volt-ohm-milliammeter. An ideal instrument for students, electricians, mechanics, etc. Rugged 400 ua meter movement. Twelve complete ranges, precision dividers for accuracy. Easily assembled from complete instructions and pictorial diagrams. An hour of assembly saves one-half the cost. Order today. Model M-1. Shipping Wt., 2 lbs.

NEW *Heathkit* BATTERY ELIMINATOR KIT

Features

- Provides variable DC voltage for all checks.
- Voltmeter for accurate check.
- Locates sticky vibrators-intermittents.
- Has 4000 MFD Mallory filter for ripple-free voltage.

Even the smallest shop can afford the Heathkit Battery Eliminator Kit. A few auto radio repair jobs will pay for it. It's fast for service, the voltage can be lowered to find sticky vibrators or raised to ferret out intermittents. Provides variable DC voltage 5 to 7½ Volts at 10 Amperes continuous or 15 Amperes intermittent. Also serves as storage battery charger. Ideal for all auto radio testing and demonstrating.

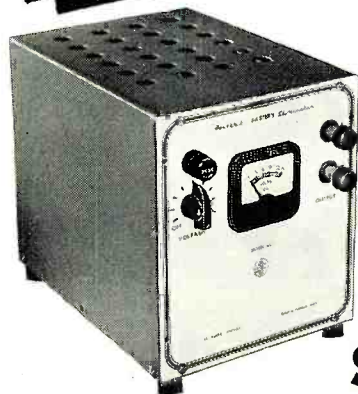

\$22.50

A well filtered rugged power supply uses heavy duty selenium rectifier, choke input filter with 4,000 MFD of electrolytic filter for clean DC. 0-15 V. voltmeter indicates output which is variable in eight steps. Easily constructed in a few hours from our instructions and diagrams — better be equipped for all types of service — it means more income. Model BE-2. Shipping Wt., 19 lbs.

YOU SAVE BY ORDERING DIRECT FROM MANUFACTURER—USE ORDER BLANK ON LAST PAGE

EXPORT AGENT
ROCKE INTERNATIONAL CORP.
13 E. 40th ST.
NEW YORK CITY (16)
CABLE: AREAB-N.Y.

The **HEATH COMPANY**

... BE TON HARBOR 15, MICHIGAN

New
**LABORATORY
INSTRUMENT KITS**



HUNDREDS OF LABORATORIES USE
Heathkit **IMPEDANCE BRIDGE** *as Standard*

Features

- Measures inductance 10 microhenries to 100 henries • Measures resistance .01 ohms to 10 megohms • Measures capacitance .00001 MFD to 100 MFD • Measures "Q" and power factor.

Measures inductance from 10 microhenries to 100 henries, capacitance from .00001 MFD to 100 MFD. Resistance from .01 ohms to 10 megohms. Dissipation factor from .001 to 1. "Q" from 1 to 1,000. Ideal for schools, laboratories, service shops, serious experimenters. An impedance bridge for everyone — the most useful instrument of all, which heretofore has been out of the price range of serious experimenters and service shops. Now at the lowest price possible. All highest quality parts. General Radio main calibrated control. General Radio 1,000 cycle hummer. Mallory ceramic switches with 60 degree indexing — 200 microamp type binding posts with standard 3/4" centers. Beautiful birch cabinet. Directly calibrated "Q" and dissipation factor scales. Ready calibrated capacity and inductance standards of Silver Mica, accurate to 1/2 of 1% and with dissipation factors of less than 30 parts in one million. Provisions on panel for external generator and detector. Measure all your unknowns the way laboratories do — with a bridge for accuracy and speed.

\$6950

Internal 6 Volt battery for resistance and hummer operations. Circuit utilizes Wheatstone, Hay and Maxwell circuits for different measurements. Supplied complete with every quality part — all calibrations completed and instruction manual for assembly and use. Deliveries are limited. Model IB-1. Shipping Wt., 15 lbs.

**NEW Heathkit LABORATORY
RESISTANCE DECADE KIT**

Features

- 1/2% Accuracy
- Birch Cabinet
- Ceramic Switches
- Covers 1 ohm to 99,999 ohms



\$1950

The new Heathkit Resistance Decade is a handy tool for laboratory, school and service shop. Ideal for test setups, calibrating instruments, bridge measurements, selecting multipliers, etc.

Uses the finest Centralab ceramic switches, 1/2% ceramic decade resistors and heavy birch cabinet matching other laboratory equipment. The range is 1 ohm to 99,999 ohms in one ohm steps.
Finest quality throughout to withstand school usage — heavy aluminum panel — laboratory type binding posts — the fine decades are extremely simple to assemble — complete kit. Model RD-1. Shipping Wt., 4 lbs.

**NEW Heathkit LABORATORY
POWER SUPPLY KIT**

Features

- Supplies 6.3 V. AC at 4.5 Amps.
- Heavy duty construction.
- Handy for schools, labs., and service shops.
- Supplies variable DC 50-300 Volts.
- Shows voltage or current on 3 1/2" meter.



\$2950

This new Heathkit Variable Power Supply Kit fills hundreds of needs — use it for experimental circuits — no need to build a separate power supply — use it for a test voltage to determine proper coefficients in unknown circuits — calibrate instruments with its variable voltage, etc. This new Heathkit supplies 50 to 300 Volts continuously variable DC together with an AC filament voltage of 6.3 Volts at 4.5 Amperes. A built-in 1 MA 3 1/2" meter has proper shunts to read 0-500 Volts and 0-200 Milliampers. The circuit uses a 5Y3 rectifier, two 1619 tubes as electronic control tubes to vary the output voltage with a single potentiometer. Case measures 7 1/8" x 13" x 7 1/8". Has instruction manual for assembly and use. Model PS-1. Shipping Wt., 18 lbs.

Heathkit **RECEIVER & TUNER KITS for AM and FM**

**TWO HIGH QUALITY Heathkit SUPERHETERODYNE
RECEIVER KITS**

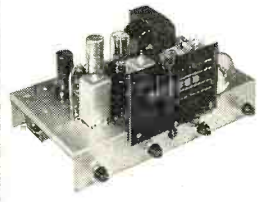

Model BR-1 Broadcast Model Kit covers 550 to 1600 Kc. Shipping Wt., 10 pounds.

\$1950

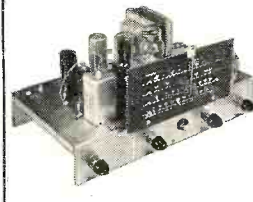

Model AR-1 3 Band Receiver Kit covers 550 Kc. to over 20 Mc. continuous. Extremely high sensitivity. Shipping Wt., 10 lbs.

\$2350

Two new Heathkits. Ideal for schools, replacement of worn out receivers, amateurs and custom installations.

Both are transformer operated quality units. The best of materials are used throughout — six inch calibrated slide rule dial — quality power and output transformers — dual iron core shielded I.F. coils — metal filter condensers and all other parts. The chassis has phono input jack — 110 Volt outlet for phono motor and there is a phono-radio switch on panel. A large metal panel simplifying installation in used console cabinets is included. Comes complete with tubes and instruction manual incorporating pictorials and step-by-step instructions (less speaker and cabinet). The three band model has simple coil turret which is assembled separately for ease of construction.

**TRUE FM FROM Heathkit
FM TUNER KIT**

\$2250



The Heathkit FM Tuner Model FM-2 was designed for best possible tonal reproduction. The circuit incorporates the most desirable FM features — true FM — ready wound and adjusted coils — 3 stages of 10.7 Mc. I.F. (including limiter).

Tube lineup: 7E5 oscillator, 6SH7 mixer, two 6SH7 I.F. stages, 6SH7 limiter, two 7C4 diodes as discriminator, 6X5 rectifier.

The instrument is transformer operated making it safe for connection to any type receiver or amplifier. The R.F. coils are ready wound — mounted on the tuning condenser and the condenser is adjusted — no R.F. coils to wind or adjust.

A calibrated six inch slide rule dial has vernier drive for easy tuning. The finest parts are provided with all tubes, punched and formed chassis, transformers, condensers and complete instruction manual. Model FM-2. Shipping Wt., 10 lbs.

EXPORT AGENT
ROCKE INTERNATIONAL CORP.
132 E. 40th St.
NEW YORK CITY (16)
CABLE: ARLAN-N.Y.

The **HEATH COMPANY**

... BE TON HARBOR 15, MICHIGAN

ENJOY MUSIC AT ITS *Finest* WITH **Heathkit AMPLIFIERS**

NEW *Heathkit* HIGH FIDELITY 20 WATT **AMPLIFIER KIT**



\$21.50

Features

- Push-pull 6L6's.
- Full 20 Watts output.
- Fully enclosed chassis.
- Provisions for reluctance pickup compensation stage.
- Cased high fidelity output transformer.
- Treble and bass boost tone controls.
- Full range of output impedances 3.2 ohms to 500 ohms.

The finest amplifier kit we have ever offered — check the features. This inexpensive amplifier compares favorably with instruments costing five times as much. Nothing has been spared to provide the best reproduction — an ideal amplifier for the new Heathkit FM Tuner listed below.

Dual tone controls for control of both treble and bass. Bass control is of the boost type for maximum listening pleasure. Optional preamplifier stage for use with G. E. reluctance pickup or microphone. Uses inverse feedback to give excellent response over entire range. Tube lineup: 6SJ7 preamplifier stage, 6J5 phase splitter stage, two 6L6's in push-pull and 5Y3 rectifier. (6SC7 as optional compensation stage).

Uses highest quality Chicago Transformer Corporation cased output transformer with taps of 3.2, 8, 15, 60 and 500 ohms to match any speaker combination. Power transformer is conservatively rated for continuous operation in sound systems. Tone control gives maximum bass boost of 6 db at 70 cycles. Amplifier has maximum gain of 75 db. Response within 3 db 20 to 20,000 cycles. Shipping Wt., 17 lbs. Complete with all parts, tubes and instruction manual.

Model A-5A Amplifier with preamplifier for G. E. cartridges or microphone **\$23.50**
12" 20 Watt Speaker, No. 326. **7.50**

Heathkit ECONOMY 6 WATT PUSH-PULL **AMPLIFIER KIT**



\$12.50

No. 304,
12-inch Speaker... **\$6.95**

This new Heathkit Amplifier was designed to give quality reproduction at a very low price. Has two preamp stages, phase inverter stage and push-pull beam power output. Comes complete with six tubes, quality output transformer (to 3-4 ohm voice coil), husky cased power transformer (to 3-4 other parts. Has tone and volume controls. Instruction manual and all flat $\pm 1\frac{1}{2}$ db from 50 to 15,000 cycles. Six watt output with response kit at new low price. Better build one. Model A-4. Shipping Wt., 7 lbs.

Heathkit RECEIVERS and TUNER CABINETS

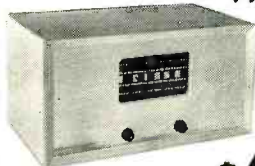

\$4.95

Order No. 350 for FM tuner

Blonde birch veneer cabinet for either the receivers or tuner. Modern styling is an asset to any room. 5" speaker fits in end of cabinet when used with receivers. Size 7 x 13½ x 8¼ inches. Shipping Wt., 5 lbs. Order No. 345 for either receiver

Metal professional type communications receiver cabinet. Finished in deep grey to fit the panel supplied with Heathkit BR-1 and AR-1 Receivers (panel shown not included with cabinet) 5" speaker mounts in end of cabinet. Gives professional appearance to Heathkit receivers. Size 7 x 14 x 7¾ inches. Shipping Wt., 6 lbs.

5" Permoflux Speaker for either cabinet for use with either Heathkit Receiver No. 320 5" Speaker... **\$2.75**



\$4.50

No. 355 Cabinet for receivers only.

ORDER BLANK

To HEATH COMPANY
BENTON HARBOR 15,
MICHIGAN

From

SHIP VIA

- Parcel Post
 Express
 Freight
 Best Way

(PLEASE PRINT)

Quantity	Item	Price	Quantity	Item	Price
	Heathkit Oscilloscope Kit — Model O-6			Heathkit VTVM Kit — Model V-4A	
	Heathkit T.V. Alignment Gen. Kit — TS-2			Heathkit R.F. Probe Kit — No. 309	
	Heathkit FM Tuner Kit — FM-2			Heathkit H.V. Probe Kit — No. 336	
	Heathkit Broadcast Receiver Kit — Model BR-1			Heathkit R.F. Signal Gen. Kit — Model SG-6	
	Heathkit Three Band Receiver Kit — Model AR-1			Heathkit Condenser Checker Kit — Model C-2	
	Heathkit Amplifier Kit — Model A-4			Heathkit Handitester Kit — Model M-1	
	Heathkit Amplifier Kit — Model A-5 (or A-5A)			Heathkit Variable Power Supply Kit — Model PS-1	
	Heathkit Tube Checker Kit — Model TC-1			Heathkit Resistance Decade Kit — Model RD-1	
	Heathkit Audio Generator Kit — Model G-2			Heathkit Impedance Bridge Kit — Model IB-1	
	Heathkit Battery Eliminator Kit — Model BE-2			Heathkit Signal Tracer Kit — Model T-2	
	Heathkit Electronic Switch Kit — Model S-2				

On Parcel Post Orders, include postage for weight shown and insurance. (We insure all shipments.)

On Express Orders, do not include transportation charges — they will be collected by the Express Agency at time of delivery.

Enclosed find Check Money Order for _____

Please ship C.O.D. Postage enclosed for _____ lbs.

EXPORT AGENT
ROCKE INTERNATIONAL CORP.
13 E. 40th ST.
NEW YORK CITY (16)
CABLE: ARLAB-N.Y.

The HEATH COMPANY

... BENTON HARBOR 15, MICHIGAN

HIGH FIDELITY

is here!

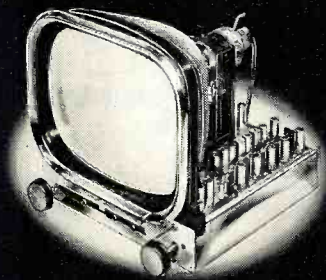

TWO BRILLIANT NEW CUSTOM CHASSIS —

Now, for the first time, you can enjoy the finest television and FM—plus high fidelity audio—all in one superbly-designed instrument! Now, at last, custom builders and electronics enthusiasts can choose the Craftsman Television which best suits their needs. SEE them! HEAR them! Above all—COMPARE them!

The RC-101

An outstanding new high fidelity custom video tuner with the same fine, big-picture quality and sensitivity as its famous predecessor, the RC-100. Features include keyed AGC and booster switch, plus new, double-shadow tuning eye for precision tuning. 20-20,000-cycle audio output permits remote hook-up with high fidelity audio and FM-AM tuners. Turret-type channel selector.

The RC-200

Here, at last, is a TV-FM-high fidelity audio receiver which, in one chassis, combines true high fidelity television and FM reception! Has all features of RC-101, plus 5-watt, push-pull high fidelity audio system and coverage of FM band. Continuous-type tuner and tuning eye permit 1-knob control of TV, FM or phono. Both chassis finished in polished chrome.

Write for information—or send 50¢ for instructions and schematics.

THE RADIO

craftsmen

INCORPORATED

Dept. R-11, 1617 S. Michigan Ave., Chicago 16, Ill.

What's New in Radio

For additional information on any of the items described herein, readers are asked to write direct to the manufacturer. By mentioning RADIO & TELEVISION NEWS, the page, and the issue number, delay will be avoided.

POWER RESISTORS

Clarostat Mfg. Co., Inc. of Dover, New Hampshire has developed a new power resistor which is specially designed for replacement applications.

The Type 330N "Greenohm" features an insulated safety knob and a convenient Edison screw base. The company reports that these units are especially effective in tropical installations or in areas where the humidity is high.

An engineering bulletin, No. 113, covering these units is available on request.

TREBLE FILTER

Berkeley Custom Electronics, 2216½ Grant Street, Berkeley 3, California is marketing a new adjustable five-range treble filter, the OA-1.

According to the company, the new unit eliminates annoying surface noise and disagreeable distortion products in the upper frequency ranges, eliminates 10 kc. whistles and other heterodyne in AM broadcasts, and allows adjustment to be made on FM to correct for

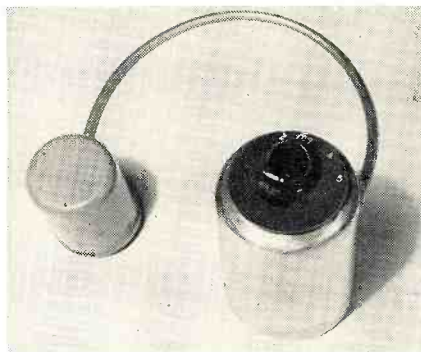

poor recordings and transcriptions as well as high range microphone distortion.

Original treble control arrangements of the equipment with which the filter is used retain full usefulness to boost or attenuate within the treble range selected. The unit operates from the outputs of typical AM-FM tuners or phono preamplifiers and into usual amplifier or tuner input circuits. No power is required. Installation is simple and in most instances soldering is unnecessary.

UNITIZED AMPLIFIERS

A new line of unitized amplifiers has recently been introduced to the trade by Modula Audio Corporation, 1546 Second Avenue, New York 23, New York.

Designed in the form of block units (modular units) which can be assembled quickly and easily to form a single piece of equipment, the new units are

suitable for all types of custom installations and specialized audio applications. Changes and additions may be easily made as needed.

All chassis are of a standardized length and of widths which are integ-

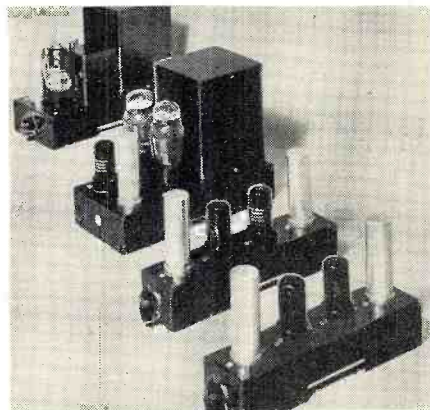

ral multiples of 2¼ inches. Small tie plates lock the units together to form a single structure for cabinet or rack mounting. Connecting terminal strips on the underside of each component are placed so that the output terminals of one unit are always directly adjacent to the input terminals of the next unit. Plate and screen supply and heater power is fed directly across, via the terminals, from the power supply through each chassis to the following unit.

Several of these units are currently available and full details may be obtained from the company.

FM COMMUNICATIONS MONITOR

A new, low-cost FM communications monitor that requires no adjustment during operation has been announced by Hewlett-Packard Company of 395 Page Mill Road, Palo Alto, California.

Designated the -hp-Model 337A-BM FM communications monitor, the new equipment is designed to be used by non-technical personnel. It provides FM emergency and communications

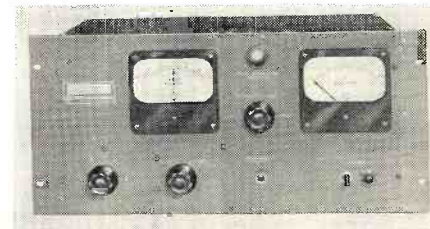

networks with a monitor. The new unit employs the same pulse-counter circuits used in the company's monitors for commercial broadcasters. This feature eliminates tuning of discrimi-

RADIO & TELEVISION NEWS



EDW. H. GUILFORD
Vice President

I can train you to pass your FCC License Exams in a minimum of time if you've had any practical radio experience—amateur, Army, Navy, radio servicing, or other. My time-proved plan can help put you, too, on the road to success.

Let me send you FREE the entire story

Just fill out the coupon and mail it. I will send you, free of charge, a copy of "How to Pass FCC License Exams," plus a sample FCC-type Exam, and the amazing new booklet, "Money-Making FCC License Information."

How to Pass FCC Commercial Radio Operator License Exams



FREE

Tells where to apply and take FCC examinations, location of examining offices, scope of knowledge required, approved way to prepare for FCC examinations, positive method of checking your knowledge before taking the examination.

Get Your FCC Ticket in a Minimum of Time

Get this Amazing Booklet FREE



TELLS HOW—

WE GUARANTEE

TO TRAIN AND COACH YOU AT HOME
IN SPARE TIME UNTIL YOU GET

YOUR FCC LICENSE

If you have had any practical experience—Amateur, Army, Navy, radio repair, or experimenting.

TELLS HOW—

Employers make

JOB OFFERS Like These

to Our Graduates Every Month

Telegram, August 9, 1950, from Chief Engineer, Broadcast Station, Pennsylvania: "Have job opening for one transmitter operator to start immediately, contact me at once."

Letter, August 12, 1950, from Dir. Radio Div. State Highway Patrol: "We have two vacancies in our radio Communication Division. Starting pay \$200; \$250 after six months' satisfactory service. Will you recommend graduates of your school? These are just a few examples of the job offers that come to our office periodically. Some licensed radioman filled each of these jobs . . . it might have been you!

HERE'S PROOF FCC LICENSES ARE OFTEN SECURED IN A FEW HOURS OF STUDY WITH OUR COACHING AT HOME IN SPARE TIME

Name and Address	License	Lessons
Lee Worthy 2210 1/2 Wilshire St., Bakersfield, Calif.	2nd Phone	16
Clifford E. Vogt Box 1016, Dania, Fla.	1st Phone	20
Francis X. Forch 38 Beucler Pl., Berginfield, N. J.	1st Phone	38
S/Sgt. Ben H. Davis 317 North Roosevelt, Lebanon, Ill.	1st Phone	28
Albert Schoell 110 West 11th St., Escondido, Calif.	2nd Phone	23

CLEVELAND INSTITUTE OF RADIO ELECTRONICS
Desk RN-27, 4900 Euclid Bldg., Cleveland 3, Ohio
(Approved for Veteran Training Under G.I. Bill)

TELLS HOW—

Our Amazingly Effective
JOB FINDING SERVICE

Helps CIRE Students Get Better Jobs

Here are a few recent examples of Job-Finding results:

GETS FIVE JOB-OFFERS FROM BROADCAST STATIONS
"Your 'Chief Engineer's Bulletin' is a grand way of obtaining employment for your graduates who have obtained their 1st class license. Since my name has been on the list I have received calls or letters from five stations in the southern states, and am now employed as Transmitting Engineer at WMMT."

Elmer Powell, Box 274, Sparta, Tenn.

GETS CIVIL SERVICE JOB
"I have obtained a position at Wright-Patterson Air Force Base, Dayton, Ohio, as Junior Electronic Equipment Repairman. The Employment Application you prepared for me had a lot to do with my landing this desirable position."

Charles E. Loomis, 4516 Genessee Ave., Dayton 6, Ohio.

GETS JOB WITH CAA
"I have had half a dozen or so offers since I mailed some fifty of the two hundred employment applications your school forwarded me. I accepted a position with the Civil Aeronautics Administration as Maintenance Technician. Thank you very much for the fine cooperation and help your organization has given me in finding a job in the radio field."

Dale E. Young, 122 Robbins St., Owosso, Mich.

Your FCC Ticket is always recognized in all radio fields as proof of your technical ability.



Get All 3 FREE

MAIL COUPON NOW

CLEVELAND INSTITUTE
OF RADIO ELECTRONICS

Desk RN-27—4900 Euclid Bldg.
Cleveland 3, Ohio

(Address to Desk No. to avoid delay)

I want to know how I can get my FCC ticket in a minimum of time. Send me your FREE booklet, "How to Pass FCC License Examinations" (does not cover exams for Amateur License), as well as a sample FCC-type exam and the amazing new booklet, "Money-Making FCC License Information."

NAME

ADDRESS

CITY..... ZONE..... STATE.....

Paste on penny postcard or send air mail.

FINEST FOR FRINGE AREA RECEPTION—1952 MODEL

30 TUBE 630 CHASSIS

LIC. UNDER
RCA PAT.

ADAPTABLE FOR COLOR

THE PERFECT
CHASSIS FOR

16"-17"-19"-20"

PICTURE TUBES

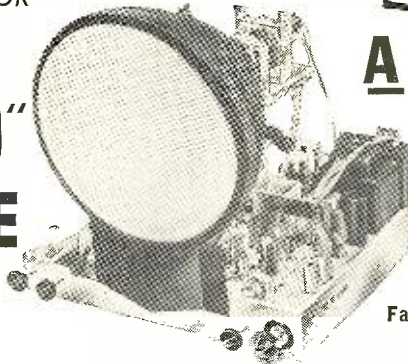

A SET

CHASSIS
MOUNTING
BRACKETS
FOR TUBE

\$495

RMA &
AIREX

Guarantee
Factory wired,
aligned &
tested.

\$159.95
Without Cathode Tube
With Hi-gain Standard
Coil Tuner and 5"x7"
Speaker

Thousands of our 16", 17", 19" & 20" sets are giving new viewing thrills to TV watchers all over the country. This extra powerful super chassis is designed to bring in sharp, clear pictures, even in fringe areas. Works in most areas on only an indoor antenna. Has Improved Keyed AGC; Full 4 Megacycle Band Width; 16 KV output; 3 stage SYNC Separator & clipper; Moulded Plastic Condensers; Uses new Mark Transformer; 5-Hour Min. Heat Run at Factory; Improved high gain front end, down to 45 microvolts; Synchro Lock; Freedom from arcing & corona leakage; Armstrong FM Sound System; Improved linearity adjustment & second horizontal linearity control. Phono connection and switch for record player on chassis.

AVAILABLE with DUMONT INPUTUNER FM RADIO & \$169.95
5"x7" SPEAKER

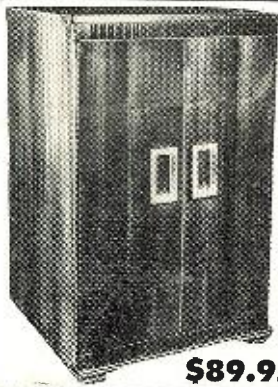

A PRICE-SMASHING VALUE IN TV CABINETS FOR THE 630 CHASSIS

Full Doors for
16"-17"-19"-
20"
Picture Tubes

Beautiful, richly finished, hand rubbed mahogany cabinets specially designed to house the 630 chassis with a 12" speaker. A perfect picture deserves a perfect cabinet. It will be a focal point of beauty in your home. 40" high x 24" x 24". All complete with brackets, mask & hardware. Above cabinets in blond—\$10 EXTRA.

\$89.95

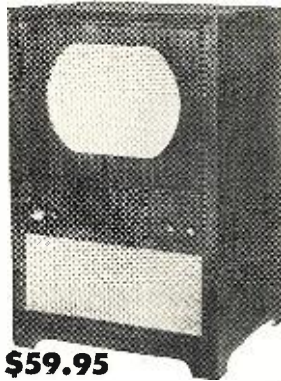

\$59.95

TV MASKS, 16"-17"—\$4.95; 19"-20"—\$7.95 | 12" RCA HI-FI SPEAKER—\$5.95

TV TUBE SCOOP
All Black, Glareless
Dumont, Sheldon, Zetka, TRL
14" rectangular \$24.95
16" rect. or round 37.95
17" rectangular 39.95
19" round metal 54.95
20" rectangular 59.95
All Tubes Fully
Guaranteed for 6 Months
Plastic ring and sleeve
for metal tubes \$4.95

REGENCY BOOSTER
MODEL DB-470
Improves
reception
in Low
Signal
Areas. All
channel
tuning,
4 knob
control.
Turns set
on and off.
\$19.87

RECORD CHANGER
SALE
WEBSTER 3-SPEED
CHANGER **\$32.95**
Plays 12 records automatically. All sizes. All speeds. 33 1/3-45-78 RPM. Permanent point needle. In original carton. Reg. \$48.00

All merchandise is brand new, factory fresh & fully guaranteed. Mail & phone orders filled upon receipt of certified check or money order for \$25 as deposit on TV chassis. 20% on other items. Balance C.O.D., F.O.B., N. Y. Prices subject to change without notice.

AIREX RADIO CORP.

171 WASHINGTON ST., N. Y. C. 7, N. Y.
Worth 2-4029; Worth 2-9578

nators and does away with the frequent adjustment of voltage levels. No i.f. calibration is required because the i.f. is low (30 kc.) and circuits are not sensitive to signal level changes.

The monitor gives continuous indication of frequency and modulation swing, and monitors by transmitter output sampling or antenna pickup. It includes a peak modulation indicator and an audio output for aural monitoring. Frequencies from 30 to 175 mc. may be monitored. The instrument is sensitive enough to monitor mobile units some distance away.

OUTPUT POWER METER

The Daven Company, 191 Central Avenue, Newark 4, New Jersey has developed and is manufacturing a new output power meter which has been designated the Type OP-962.

While designed expressly for measuring the actual power delivered by an audio signal system to a given load, they may also be used for determining the characteristic impedance of an a.c. source, the effect of load variation on a signal system, make transmission line equalization measurements, measure insertion loss in multi-channel mixer and other complex circuits, make filter and transformer measurements, and radio receiver measurements.

The new unit features a large meter, provision for the use of a calibrated external amplifier to extend the power range below .1 milliwatt, and provision

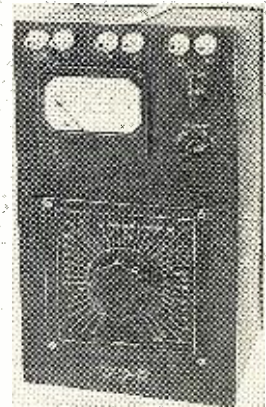

for connecting an oscilloscope in the circuit to observe the wave shape of the signal. The OP-962 covers the range from .1 milliwatt to 100 watts. It is mounted on a black engraved metal panel and is enclosed in a ventilated metal case. Binding posts are provided on the panel for input, external amplifier, and oscilloscope connections.

Complete catalogue data on the Type OP-962 is available on request.

PLATE CIRCUIT RELAYS

Potter & Brumfield, Princeton, Indiana is currently offering two new low cost plate circuit relays which have been designated the LM and LS series.

The LM series relays are of long coil construction giving a powerful magnetic circuit that with a 10,000 ohm

(Continued on page 99)

"RADIO-TELEVISION Questions and Answers"

A separate book for each element of the study-guide questions pertaining to the various classes of commercial U.S.A. radio operator licenses. You need buy only those elements required for the license you want.

Element 1: BASIC LAW (mimeographed)	45c
Element 2: BASIC THEORY & PRACTICE	90c
Element 3: RADIO TELEPHONY	90c
Element 4: ADVANCED RADIO TELEPHONY	90c

AT YOUR FAVORITE DEALER
OR DIRECT BY MAIL FROM
Editors and Engineers
LIMITED
1702 ZENWOOD ROAD, SANTA BARBARA, CALIFORNIA

Prepare Now!

RADIO ENGINEERING

B.S. DEGREE IN 27 MONTHS

Complete Radio Engineering course incl. Telev., U.H.F., and F.M. BS Degree Courses also in Mech., Civil, Elect., Chem. and Aero Eng.; Bus. Adm., Acct. Extensive campus, modern buildings, well equipped labs. Low cost. Prep courses. Personalized instruction. Heavy demand for graduates. Placement service. Founded in 1884. Prepare now for the civil and military opportunities ahead. Enter March, June, Sept., Jan. Write for Catalog.

TRI-STATE COLLEGE
1631 COLLEGE AVE. ANGOLA, INDIANA

PARTS and TUBES

TUBES—Radio and TV

OZ4 \$0.99
 OZ4G99
 1A5GT 1.08
 1A6 1.92
 1A7GT 1.20
 1B3GT 1.59

ORDER from "PREMIER"
 Your reliable source
 since 1926

SPEAKERS

Very Best Quality—NATIONAL BRANDS
 Individually Packed

10 or more each Price Each

3" \$1.14 \$1.26
 4" 1.55 1.65
 5" 1.69 1.79
 6" 2.94 3.23
 10" 4.74 5.10
 12" 5.34 6.54



5x7..... \$2.25 ea. 6x9..... \$3.25 ea.
 5" PM with 50L6 o. p. Xformer. \$1.99
SPECIAL—6" PM Speakers, big Alnico 5 magnet
 In lots of 10..... each \$1.55
 Individual..... 1.67

World's Best Indoor TV Antenna

A beautiful antenna which is the ultimate in reception, highest signal gain, nothing to adjust.

List price \$9.95 Each **\$4.78**

TV Antennas:

Twin V Antenna with 8 ft. mast..... \$6.95
 In-line Antenna..... \$8.95

All band YAGI with 8 ft. mast
 can be used in-line or hi-low **\$10.74**

WORLD'S BEST DELUXE CONICAL \$10.74
 with 8-ft. mast and heavy cast fittings.

100 ft. of twin lead with any TV antenna..... **\$1.98**

VIBRATORS

Standard small size, 2 3/8" in height (the popular small size), bright and shiny, Stock up while they last, all 4-prong Universal Vibrators. **\$1.59** each

OUTPUT TRANSFORMERS

STANDARD REPLACEMENT

For 50L6, 35L6, 50A5, 35A5, 117L7..... **74c** ea.

For 6V6, 6F6, 3Q5, 3Q4, 35A, 3V4, 41, 42, 6K6, 2A3, 45, 6L6 **79c** ea.



UNIVERSAL OUTPUT TRANSFORMERS

SPECIAL

Up to 12 watts to any speaker (while they last)..... **\$1.18**

VOLUME CONTROLS

VERY BEST BRANDS 10 or more Each Price Each
 1/2 meg. or 1 meg. or 1/10 meg. with switch—long shaft..... **52c 59c**
 2 meg. for battery sets—switch, long shaft..... **52c 59c**
 1/2 meg., 1 meg., 1/10 meg. or 2 meg., long shaft, less switch..... **24c 28c**
 1000 ohm..... 19c 23c
 5000 ohm..... 19c 23c
 1/2 meg. with 6" shaft..... 59c 71c

Special on #47, #44 and #51 **\$4.74**
100 PILOT LIGHTS...

Box of 10..... 59c

PILOT LIGHTS #40 #41 #46 \$5.88

100 Bulbs..... 65c

TV Discriminator Transformers..... ea. 83

TV Screen Filters with suction cups—best quality INDI-VIDUALLY BOXED for highest re-sale value..... 1.40 2.34

OCTAL SOCKETS 10 for 59c

7-PIN MINIATURE SOCKETS..... 10 for 59c

9-Pin Miniature Sockets..... 10 for 59c

Loctal Sockets..... 10 for 59c

1C5GT	1.32	6AB7	1.92	6K7GT	0.99	786	1.08	12SH7GT	1.32	3E25GT	0.90
1C6	1.92	6AC5GT	1.74	6K8GT	1.44	788	1.08	12SJ7GT	1.08	3Z6GT	1.59
1C7G	1.92	6AG5	1.59	6L5G	1.59	7C4	1.92	12SK7	1.08	59/44	1.59
1D5GP	2.34	6AG5	1.59	6L5G	1.59	7C4	1.92	12SK7GT	1.44		.99
1D7G	1.92	6AG7	1.92	6L6	2.12	7C6	1.08	12SL7GT	1.44		.99
1D8GT	1.92	6AH6	2.34	6L6G	2.12	7C7	1.08	12SN7GT	1.32		.99
1F4	1.59	6AK5	2.34	6L6GA	2.12	7C7	1.08	12SN7GT	1.32		.99
1F5G	1.59	6AK6	1.44	6N6G	1.44	7E6	1.32	12SQ7GT	.99	45Z5GT	1.08
1G4GT	1.59	6AL7GT	1.59	6O7	1.20	7E7	1.59	12SR7	1.32	46	1.44
1H6G	1.92	6AQ5	1.20	6Q7GT	1.08	7E7	1.59	12S7	1.44	50A5	2.34
1J5G	1.59	6AL6	1.44	6S4	1.08	7F8	1.59	12T7	1.44	50B5	1.32
1J6GT	1.92	6AN5	.99	6S7GT	1.92	7H7	1.59	14A7	1.32	50C5	1.20
1L5	1.59	6AT6	1.20	6S8GT	1.59	7I7	1.59	14B6	1.32	50C6G	1.74
1N5GT	1.20	6AU5GT	1.59	6SA7	1.20	7K7	1.59	14E6	1.32	50L6GT	.99
1P5GT	1.59	6AV6	1.20	6SA7	1.20	7L7	1.59	14E6	1.32	50L6GT	.99
1Q5GT	1.59	6AV6	1.20	6SD7GT	1.74	7Q7	1.08	14F7	1.32	50M6GT	1.32
1R5	1.20	6AX5GT	.81	6SFS	1.99	7R7	1.32	14F8	1.32	50X6	1.08
1S5	1.08	6B4G	1.92	6SFSGT	1.08	7S7	1.59	14H7	1.44	56	1.08
1T4	1.20	6B5	1.08	6S7GT	1.20	7V7	1.59	14J7	1.59	57	1.20
1T5GT	1.59	6B8GT	1.92	6S7GT	1.20	7W7	1.59	14N7	1.59	58	1.20
1U4	1.20	6BA6	1.08	6SH	1.08	7X7	1.59	14Q7	1.59	70L7GT	2.34
1U5	1.08	6BA7	1.44	6SH7GT	1.32	7Y4	1.08	14X7	1.59	71A	1.20
1V	1.32	6BC5	1.20	6SJT	1.08	7Z4	1.08	14Y4	1.44	71A	1.20
1X2A	1.59	6BC7	1.32	6SJTGT	1.08	10	1.08	18CG6G	3.60	75	.99
2A3	1.92	6BE5	1.08	6S7GT	1.20	12A	.81	19T8	1.74	76	.99
2A5	1.92	6BF5	1.32	6SL7GT	1.44	12A6	1.74	20	2.34	77	.99
2A7	1.59	6BF6	.99	6SN7GT	1.32	12A7	1.92	20	2.34	77	.99
2E5	1.59	6B8GT	1.20	6S7GT	.99	12A8GT	1.20	24A	1.32	79	1.59
3A8GT	1.59	6BJ6	1.20	6S7GT	.99	12AT6	.99	25A7GT	3.60	80	.81
3B7/1291	1.59	6BJ6	1.20	6SR7GT	1.08	12AT7	1.74	25A7GT	3.60	80	.81
3C6	1.92	6BN6	1.92	6S7GT	1.20	12AUS	1.20	25B0GGT	1.92	82	1.59
3E6	1.92	6BN6	1.92	6S7GT	1.20	12AU7	1.44	25C6G	1.74	83	1.59
3FL4	1.59	6CS2GT	.99	6T8	1.92	12AV6	.90	25D8	1.74	83	1.59
3Q4	1.32	6C6	1.20	6U8GT	1.20	12A7	1.32	25EGT	1.08	85	1.32
3Q5GT	1.44	6C6G	1.60	6U7G	1.08	12BA6	1.44	25W4GT	1.20	89V	1.32
3S4	1.20	6CD6G	1.20	6V6GT	1.08	12BA7	1.08	25Y5	1.74	89V	1.32
3V4	1.20	6D6	1.20	6V6GT	1.08	12B8	1.44	25Z8	1.20	91V	1.32
5T4	2.34	6D6G	1.92	6V7G	1.20	12B8F6	1.59	26	1.08	1177GT	1.44
5U4G	.99	6F5GT	.99	6W4GT	1.08	12B8G	1.08	25Z6GT	.90	117P7GT	2.34
5U4G	1.44	6F6GT	.99	6W6GT	1.08	12H6	1.08	30	1.20	VR150	1.50
5W4	1.92	6F6	1.92	6X5GT	.90	12J5GT	.90	31	1.59	482B	.30
5W4GT	.99	6G6G	1.59	6X5GT	.90	12K7GT	1.44	327GT	1.08	483	.30
5X4G	1.08	6H4GT	1.59	6V6G	1.44	12K7GT	1.08	33	1.92	199V	.30
5Y3GT	.75	6H6GT	.99	7A4	1.20	12S6GT	1.59	35/51	1.20	807	1.50
5Z3	1.08	6J5GT	.90	7A5	1.20	12S7	1.20	35	1.92	2050	1.75
5Z4	1.59	6J6	2.90	7A7	1.08	12SA7GT	1.20	35C5	1.20	1619	.25
6A4	1.92	6J7G	1.90	7A7	1.08	12S7	1.32	35L6GT	1.08	1622	1.75
6A7	1.92	6J8G	1.92	7A8	1.08	12SF5GT	1.20	35W4	1.08	2051	1.25
6A8	1.20	6K5GT	1.44	7B7	1.08	12S7	1.20	35Z3	1.08	7193	.18
6W4GT	1.20	6K6GT	.99	7B4	1.08	12SG7	1.20	35Z4GT	.90	VT 52	.30
6B4	1.20	6K7G	.99	7B5	1.08	12SH7	1.32				

INDIVIDUALLY BOXED—STANDARD FACTORY GUARANTEE.

TV PICTURE TUBES

10BP4 **\$10.95**

16RP4 **\$29.95**

12LP4 **\$19.95**

16TP4 **\$29.95**

14BP4 **\$22.95**

17BP4A **\$31.95**

FILTER CONDENSERS

Very best brands. Fresh stock

450 Working Volts	150 Working Volts	40-40-150 V
8-450 V..... ea. 29c	8-150 V..... ea. 23c	20-25 V..... ea. 47c
10-450 V..... ea. 35c	8-150 V..... ea. 23c	50-30-150 V..... ea. 47c
20-450 V..... ea. 47c	10-150 V..... ea. 23c	20-16-16-350 V..... ea. 47c
30-450 V..... ea. 59c	10-10-150 V..... ea. 29c	Sprague type..... ea. 47c
30-450 V w/ 20-20-25 V..... ea. 35c	10-10-10-150 V..... ea. 35c	25-25-150 V-200-10 V..... ea. 47c
10-10-450 V..... ea. 52c	15-150 V..... ea. 25c	15-15-40-20..... ea. 35c
20-20-450 V..... ea. 59c	20-150 V..... ea. 30c	150 V-25 V..... ea. 35c
10-10-10-20..... ea. 59c	30-150 V..... ea. 35c	20-20-150 V-25 V..... ea. 47c
450V-150-25 V..... ea. 59c	40-150 V..... ea. 35c	30-30-200-150 V-10 V..... ea. 47c
30-30-400 V-350 V..... ea. 47c	15-15-150 V..... ea. 35c	20-16-16-150 V..... ea. 47c
30-30-25-400 V-25 V..... ea. 47c	20-10-150 V..... ea. 35c	
	30-20-150 V..... ea. 35c	
	30-20-150 V..... ea. 47c	
	30-30-150 V..... ea. 47c	
	35-35-150 V..... ea. 47c	
	40-20-150 V..... ea. 47c	
	40-40-150 V..... ea. 47c	

BY-PASS CONDENSERS

100 Condensers assorted in package..... **\$7.14**

.001 6c
 .002 6c
 .005 6c
 .01 600 V. 8c
 .02 8c
 .05 10c
 .1 11c

.0005 7c
 .0005 7c
 .0005 7c
 500 mmf 600 V. MICA
 250 mmf 600 V. MICA
 100 mmf 50 mmf

BYPASS SPECIAL—SOLAR

In lots of 25 or more..... ea. 11c

.25 mfd. 600 V..... Less than 25 ea. 14c

400-VOLT BY-PASS CONDENSERS

.05 mfd..... ea. 7c

.2 mfd..... ea. 7c

.25 mfd..... ea. 12c

.5 mfd..... ea. 18c

BUFFER CONDENSERS

.005 mfd. 1600 WV..... ea. 18c

.008 mfd. 1600 WV..... ea. 18c

.01 mfd. 1600 WV..... ea. 18c

VARIABLE CONDENSERS

Two-gang for superhet or TRF..... ea. 53c

IF TRANSFORMERS

Standard Replacement Regular size 455 Kc..... ea. 35c

Midget 455 Kc..... ea. 47c

Midget 10.7 AM-FM..... 59c

OSCILLATOR COILS

for any 5-tube AC-DC..... 23c

HOOK-UP WIRE

100 ft..... 69c

6-FT. LINE CORDS

Good Rubber with plug 10 for..... **\$1.50**

Underwriters' Approved. 10 for..... **\$2.03**

Premier RADIO TUBE CO.

551 West Randolph St.
 Chicago 6, Illinois
 Phone: ANdover 3-1590

McGEE'S "SUPER STORE" OPERATION SAVES YOU MONEY!



024

4-PRONG VIB.

5 0Z4 TUBE & 5 VIB.
DEAL No. RN-V5 \$9.50

Here's a red hot deal for you fellows that do a lot of auto radio service. 5 standard brand metal tubes and 5 of our famous 4-prong serrated can vibrators. This vibrator is of the latest design, for long life. Standard diameter can short circuit to fit all Chrysler auto sets, also fits Motorola, etc. Our 20th Anniversary, big deal No. RN-V5. You can get 5 0Z4 metal tubes and 5 4-prong vibrators, all for \$9.50. Shipping weight 3 lbs.

MN-8	8 mfd 450 volt.....	39c
MN-16	16 mfd 450 volt.....	45c
MN-30	30 mfd 450 volt.....	59c
MN-20	20 mfd 150 volt.....	39c
MN-40	40 mfd 150 volt.....	45c
MN-220	20 mfd 150V.....	49c
MN-53	50-30 mfd 150V.....	59c
MN-42	40-20 mfd 150V.....	69c

All cond. guaranteed one year.

RED HOT SPEAKER VALUES

McGee has a tremendous stock of 100,000 speakers to fill your needs. Every speaker fully guaranteed. Order your speakers now.

- 4 inch, square.....1 oz. magnet \$1.69
- 5 inch, pincushion.....1 oz. magnet 1.79
- 6 inch, pincushion.....1.47 oz. magnet 2.79
- 4 x 6 inch.....1 oz. magnet 2.29
- 5 x 7 inch, oval.....1.47 oz. magnet 2.49
- 7 inch, pincushion 2.15 oz. magnet 3.49
- 8 inch, pincushion 2.15 oz. magnet 3.49
- 6 x 9 inch, oval.....1.5 oz. magnet 3.49

100 Molded Plastic Bypasses \$9.95

100 molded plastic tubular bypass condensers. All 600 volt. And all by the same nationally known mfr. Regular dealers get in over two and one-half times our 20th Anniversary special price. You'll chuckle when you look these over. Here's what you get: 10-.001, 10-.002, 20-.002, 10-.005 and 10-.1. Our big deal No. RN-202. 100 plastic tubulars. Shipping weight 2 lbs. Net price, \$9.95.

100 600 VOLT TUBULARS \$6.95

100 top quality 600 volt tubular by-pass condensers. Made this year by a famous condenser factory. Don't confuse these with grab-bag surplus. McGee's deals are guaranteed to please you. Here's what you get: 10-.001, 10-.002, 20-.005, 20-.01, 10-.02, 20-.05 and 10-.1 600 volt condensers. Our big deal No. RN-203. Shipping weight 2 lbs. Net price, \$6.95.

20 50 x 30 150 V. \$10.95 ELECTROLYTICS

Here's a red hot value. 20 of our XX quality replacement electrolytics. The most popular condensers in use today. Takes care of 90% of your AC-DC radio filter needs. Compact construction 1950 production. 1-year guarantee. 50-30 mfd. 150 volt, housed in a cardboard tube with common negative, has flexible leads. 20th Anniversary, big deal No. RN-204. Sale price, \$10.95.

SELENIUM RECTIFIERS

65 mil Selenium Rectifier, net.....59c each

100 mil Selenium Rectifier, net.....69c each

150 mil Selenium Rectifier, net.....79c each

200 mil Selenium Rectifier, net.....\$1.09 each

250 mil Selenium Rectifier, net.....1.19 each

350 mil Selenium Rectifier, net. 1.49 each

450 mil Selenium Rectifier, net. 1.69 each

McGee offers you the finest in Selenium rectifiers. All standard 130 volt.

1 or 4 VOLT CRYSTAL CARTRIDGES \$1.99

McGee offers you a famous make crystal cartridge. Standard size and shape, but very light weight. Will track on 3/2 oz. or more pressure. Stock A-6, one volt output, replaces Astatic L-70 etc., Net \$1.99. Stock No. A-10, 4 volt output, replaces Astatic L-72 and L-82, etc., Net \$1.99. Buy 10 assorted for \$19.00.

5-Station Intercom Master \$16.95

Model 2700 5-station intercom master, in an attractive walnut cabinet 10x5 1/2x8 1/2. Push-button for each sub and talk-listen switch and volume control. AC-DC amplifier with lots of power and full size Alnico V PM speaker. 1950 production of a famous factory. Only 300 left, weight 7 lbs. Model 2700, net, \$16.95.

10-Station Intercom Master \$24.95

Heavy duty Model 2520 10-station intercom master in a beautiful walnut cabinet. Features a 3 wire intercom system. Heavy 2.15 oz. Alnico V speaker. Push-button for each of 10 stations, talk-listen switch and all call buttons; volume control. Installs as a 3 wire system. A fortunate purchase by McGee makes a saving for you. Model 2520, weight 12 lbs. Net, \$24.95 each.

19 TUBULAR ELECTROLYTICS DEAL RN-PL19 \$7.50

19 tubular electrolytics, guaranteed for one year. All fresh stock in aluminum tubes with cardboard insulating sleeves. You must be satisfied or money back. You get: 10 8 mfd, 450 volt, 4 16 mfd, 450 volt, 3 0 mfd, 150 volt and 2 40 mfd, 150 volt condensers. Shipping weight 2 lbs. Deal #RN-PL19. Net \$7.50.

20 CONTROLS \$5.95

All have SPST switch, which may be used by pulling a small tab. red hot value. All National Union, individually boxed. 1 100,000, 1 100,000, 1 250,000, 50,000, 100,000 and 5 each 250,000, 500,000 and 1 megohm. Shipping weight 1 lb. Deal #RN-U20. Net \$5.95.

SUB-STATION FOR ABOVE INTERCOMS \$3.95

Model MG-300 molded walnut plastic sub-station with call-back switch and heavy PM speaker. 5 1/2x8 1/2x3 1/2", for wall or desk. Weight 2 lbs. Net, \$3.95 each; 5 for \$18.95. 3 wire intercom cable, plastic, \$1.95 per 100 ft.; 500 ft., \$9.50.

10 FP ELECTROLYTICS DEAL RN-10DS \$3.49

10 assorted F.P. aluminum can electrolytics. Popular twist tap mounting. Mostly multiple section banks. 100% of 50 volts. A red hot deal. Shipping weight 2 lbs. Deal #RN-10DS, Net \$3.49.

10 BOXES OF PILOT LIGHTS \$5.49

Pilot lamps, boxed 10 to a handy carton. American made. 7 boxes #47, 1 box #40, 1 box #44 and 1 box #50 volts. A total of 100 lamps. Deal #CM-51. Net \$5.49. 100 #47 imported panel lamps. Guaranteed 100 to the carton. Deal #RN-J47. Net \$4.49.

\$2.95 FOR A REG. \$7.77 PROBE

Boes signal tracer probe, with instructions, and playback for \$7.77. A heavy bakelite probe containing a 6F5GT tube. (The end of the probe is secured by three screws, may be taken apart easily.) A 5 foot lead with 3 circuit amphenol plugs and receptacle and Mueller peevie clip. Connect this probe to an amplifier and have a signal tracer. SHRP. wt. 1 lb. Net, \$2.95; 2 for \$4.95.

SUPER HEAVY DUTY 10" PM \$6.95

We made a special purchase on several hundred 20 watt, 10", 32 oz. Alnico 3 magnet PM speakers. Deep throat and easy moving cone. Ideal for all high fidelity sound systems and radio receivers. The magnet on this speaker is usually used on a 15 watt. Very efficient, good high and bass response. You'll appreciate it when you get your hands on this speaker. Attractive copper finish. 8 ohm voice coil. Stock No. 1025PS. Weight 7 lbs. Net \$6.95 each.

Order three of these and use them in a cluster of three. They will handle 60 watts audio and have more cone area than any 15" speaker. For high power, top quality P.A. work. Think this over. 3 No. 1025PS speakers for only \$19.95.

100 KNOBS Set-Screw Type \$3.95

100 bakelite set screw knobs, for radio set replacement. All fit standard 3/4" shaft. Assorted walnut, black and ivory. Enough of each style to give you matched sets. This value worth \$7.50. Shipping weight 1 lb. Deal #RN-100K. Net \$3.95. 1/2 a Deal or 50 knobs, \$2.00.

\$19.95 BUYS A NEW St. George Wire Recording Mechanism ONLY 100 TO SELL

McGee offers you a terrific saving on the St. George Series 1100. wire recording mechanism. Brand new and factory cartoned. This unit will record and playback from a standard recording wire, up to 1 hour. The wire take-up reel turns at 78 RPM and will play and record from a 78 RPM phono record. The base is punched for a phono pickup. Space required, 9x13x3 1/2". Shipped with a diagram of how to connect and also how to wire a 3 tube converter to enable the wire recorder to be used in conjunction with any radio or amplifier. St. George wire recording mechanism. Serial 1000. Shipping weight 1.5 lbs. Net price \$19.95 each. Crystal phono pickup arm and cartridge \$1.95 extra. Recording wire. 15 minute spool. Net price \$1.19. 30 minute spool. Net price \$1.79. 1 hour spool. Net price \$2.79. Crystal mic and desk stand \$4.95 extra.

BIG SALE ALUMINUM CAN ELECTROLYTICS

McGee offers you Nationally known brands of FP type electrolytic condensers at a tremendous saving. After these are gone, we don't know where we can buy any more to sell at these prices. Order a good supply now. Unconditionally guaranteed.

40-40 mfd.	25v.	FP cond. 1 x2"	\$0.19	40-40 mfd.	150v.	40-4025v.	FP cond. 1 1/2x2"	\$0.39		
250 mfd.	25v.	FP cond. 1 x2"	.25	60-40 mfd.	150v.	10 25v.	FP cond. 1 x3"	.49		
20-20 mfd.	150v.	FP cond. 1 x2"	.23	40 mfd. 300v.	50 25v.	20 200v.	FP cond. 1 1/2x3"	.59		
20-20 mfd.	150v.	25 25v.	FP cond. 1 x2"	.34	15 mfd.	400.	10-355v.	FP cond. 1 x3"	.49	
20-20 mfd.	150v.	100 25v.	FP cond. 1 x2"	.44	24 mfd.	450v.		FP cond. 1 x3"	.29	
40 mfd.	150v.	200 10v.	FP cond. 1 x2"	.29	10 mfd.	450v.		FP cond. 1 x3"	.34	
30-30 mfd.	150v.		FP cond. 1 x2"	.39	16 mfd.	450v.		FP cond. 1 x3"	.34	
40-20 mfd.	150v.		FP cond. 1 x2"	.29	20 mfd.	450v.		FP cond. 1 x3"	.39	
80 mfd.	150v.		FP cond. 1 x2 1/2"	.49	24 mfd.	450v.		FP cond. 1 x3"	.49	
50-50 mfd.	150v.	25 25v.	FP cond. 1 x2 1/2"	.29	30 mfd. 450v.	30 350v.	40 25v.	FP cond. 1 1/2x3"	.69	
80-40 mfd.	150v.		FP cond. 1 x3"	.49	20-20 mfd.	450v.		FP cond. 1 1/2x3"	.89	
80-40 mfd.	150v.	25 25v.	FP cond. 1 x3"	.59	20-20 mfd.	450v.		FP cond. 1 1/2x3"	.89	
40-40-20 mfd.	150v.		FP cond. 1 x3"	.59	32 mfd.	450v.		FP cond. 1 x3"	.39	
15-15 mfd.	150v.	1200 1 1/2v.	FP cond. 1 x2"	.29	40-15-10 mfd.	450v.	20 25v.	FP cond. 1 x3"	.59	
40-20 mfd.	150v.		FP cond. 1 x2"	.19	10-10-10 mfd.	450v.	20 25v.	FP cond. 1 x3"	.59	
40 mfd.	250v.		FP cond. 1 x2"	.19	20-20 mfd.	450v.		FP cond. 1 1/2x3"	.59	
15-15 mfd.	250v.		FP cond. 1 x2"	.29	20-20-20 mfd.	450v.		FP cond. 1 1/2x3"	1.19	
40-20 mfd.	150v.	100 15v.	FP cond. 1 x3"	.39	40-30-10 mfd.	450v.	20 25v.	FP cond. 1 1/2x3"	1.49	
30-50 mfd.	150v.	20 50v.	100 10v.	FP cond. 1 1/2x2"	.49	40-40-40 mfd.	450v.		FP cond. 1 1/2x3"	1.49

V.M. 3 SPEED Record Changers

VM Model 406 deluxe automatic record changer—plays them all—intermixes records of the same speed with a flip over crystal pickup with twin needles—a very sleek designed record changer—base size 12x14x3. Ship. weight 12 lbs. VM-406. Net \$33.21.

Buy the VM-950 changer with or without base. Choice of 30, 33, 45, 78, or 12 rpm. The VM-950 record changer is the finest in America. It automatically plays all records at all speeds and all sizes; 12 10-in., 3 3/4-in., 7 8-in., 3 1/2-in., 3 1/4-in. or 78 rpm and 12 and 10-in. records of the same speed intermixed. 12 7-in., 3 3/4-in. or 12 3 1/2-in., 4 5 rpm. Includes 3 sets of needles after the last record. Size 13 13 1/8x1 7/8x1 7/8 in. high. Offered with crystal cartridge. VP cartridge with a base. VM-950. 3 speed changer with standard output crystal cartridge and needles for 1 and 3 mil. (78 rpm, 33 1/3, 45 rpm.) Net \$29.62.

VM-950GE. 3 speed changer with the new RPX-050 magnet button, all-in-one variable reluctance cartridge with stylus. Net \$32.80.

VM-955. 3 speed changer with crystal cartridge on a base. Net \$32.00.

VM-955GE. 3 speed changer with RPX-050 VP cartridge and stylus; with base. Net \$35.19.

WIRE RECORDER CONVERTER

3 tube AC wire recorder oscillator and erase circuits for use with the St. George mechanism, or any wire recorder head. Adapts any radio or amplifier to operate a wire recorder, mike and phono inputs. self powered. Wired, with tubes and instructions. Model RW-Y. shipping weight 6 lbs. Net price, \$13.95.

DELCO VIB UNITS 69c

Delco sync vibrator unit, with buffer condensers attached. This same unit used in all sync vibrators, regardless of case size. If buffers are not needed, simply clip off. You save up to \$4.00 by replacing the unit in your old vibrator can, \$1.09 each; 10 for \$9.95.

Delco 8 point, heavy duty, non-sync replacement vibrator unit. The best non-sync unit known today. For regular and heavy duty replacement use. Small in size. Fits them all. Net 69c each, 10 for \$5.95.

GE. VR \$5.95

G.E. variable reluctance pickup arm with separate 1 and 3 mil needles for playing all records. The finest General Electric ball bearing pickup arm. UPX-004 with RPX-04 micro-groove variable reluctance cartridge and replaceable 1 mil stylus; furnished with an extra 2 mil G.E. stylus and playing 78 RPM records, at no extra charge. Total value over \$11.00. Stock No. 0042. Net price \$5.95. Shipping weight 1 lb. 10 for \$5.95. Turntable for 3 3/4, 4 5 and 78 RPM \$5.95 extra.

2-STATION INTERCOM \$16.95

Complete, top quality two station intercom system, \$14.95. With 50 feet of connecting cable. New 1951 production, housed in vacuum cleaned plastic cases. Master has push-to-talk switch on wall or desk. Conventional amplifier using 125T7, 50L6 and 35Z5 tubes. Stock No. MG-38, weight 6 lbs. Net price \$16.95. Extra sub for use in parallel with other sub as a non-selective 3 station system, \$3.95.

10" HEAVY DUTY P.M. WITH RED HOT 8.95 SPECIAL

Super heavy duty 10" 32 oz. Alnico 3 PM speaker. Features 8 ohm voice coil. Ideal for music box operators and all sound in general. A lucky purchase makes this possible. The baffle is of the slanting wall type mounting, and covered with leatherette. Stock No. MP-10. Net price \$8.95 each. In lots of 3 or more, \$6.50 each.

4-PRONG VIBRATORS \$1.29 IN ALUMINUM SERRATED CANS 10 FOR \$11.90

Latest 1951 production by a top quality manufacturer. Fully guaranteed one year. Quiet running. A result of modern vibrator engineering and research. Replaces Motorola, Chrysler and any standard 4 Prong non-sync Vibrator. McGee contracts for a tremendous quantity to take care of your 1951 needs. Stock #V-53 Standard 4 Prong Vibrator \$1.29 each, 10 for \$11.90. Offset 4 Prong for Delco, etc. \$1.29 each, 10 for \$12.90.

Quick Replacement same as Delco 5050500. Fits all Buicks, 1937 thru '47, etc. \$1.95 each, 10 for \$17.90.

Mallory 534C 7 Prong Reversible Sync. \$1.95 each, 10 for \$17.90.

MOTOROLA REMOTE CONTROLS

Genuine Motorola Controls Heads, 99c each. Pick any of these automatic control heads in factory cartons at 99c each. Automatic heads with push buttons and manual tuning for the following: 42-46 Cadillac, 42, 46, 47 Hudson, 40 Lincoln Zephyr, 42-46 Lincoln Zephyr, 40 LaSalle Cadillac, 42 Oldsmobile, 46 Buick. Packard. Shipping weight 3 lbs. each. Net 99c. 10 for \$7.95. 2A1 Universal under dash \$1.95 each.

McGEE RADIO COMPANY

Prices F.O.B. M.O. Send 25% Deposit with Order, Balance Sent C.O.D. With Parcel Post Orders, Include Postage

TELEPHONE VICTOR 9045, WRITE FOR FLYER
1422 GRAND AVE., KANSAS CITY, MISSOURI

McGEE HAS COMPLETE KITS FOR SCHOOLS AND CUSTOM BUILDERS

7-TUBE FM-AM TUNER

- ★ AC SELF POWERED
- ★ 3 GANG TUNING ★ A COMPLETE KIT

\$29.95

McGee has ready for delivery, this self powered AC, 7 tube FM and AM superhet tuner kit. Build yourself a professional looking tuner that may be connected to any audio amplifier. Receives broadcast 550 to 1650 kc and FM 88 to 108 mc. A 3 gang tuning condenser is used on both FM and AM. This extra stage of TRF makes a smoother working tuner. 2 V stages on FM and one IF stage on AM (I.F. frequency 456 and 10.7 mc). Lighted slide rule dial using these parts. Chassis is ready punched and painted. Everything furnished including tubes and diagrams. Shipping weight 12 lbs. Stock No. RAL-8, net price \$29.95.

MODEL ME6-2 \$19.95

NEW MODEL 6-TUBE, 2-BAND RADIO KIT A FULL 2-GANG SUPERHET KIT RECEIVES 550-1600 KC PLUS 6-18 M.C.

McGee's new 1951, 6 tube; AC-DC 2 band radio kit. Receives broadcast, 550 to 1600 kc and short wave, 6 to 18 mc. A straight forward superhet circuit with 2 gang tuning condenser, 456 kc I.F. transformers, etc. 5" 12M speaker illuminated slide rule dial. Everything furnished, including tubes, diagram and a photo showing view of underside of completely wired chassis. The chassis pan and dial parts are factory production. With this kit, you can build a commercial looking and factory quality 2 band radio, housed in a streamlined plastic cabinet. Size: 13 x 6 1/4 x 6 1/4". Stock No. ME6-2, shipping weight 10 lbs. Net \$19.95.

5-TUBE BROADCAST SUPERHET RADIO KIT \$12.95

Model NS-5X 5 tube AC-DC superheterodyne radio kit. Has loop antenna and 2 gang condenser, with lighted slide rule dial and attractive plastic cabinet. Receives broadcast, 550 to 1650 kc. Full size dynamic speaker, matched 456 I.F.'s, automatic volume control. This is a complete radio kit. Everything furnished, including diagram, photos and tubes: 14B6, 14Q7, 14A7, 50B5 and rectifier. Shipping weight 7 lbs. Stock No. NS-5X. Net price \$12.95.

Build Your Own \$7.95 Phono-Mike Oscillator Kit

Kit Model DE-6X. With this simple kit, you can build a 4 tube phono oscillator that also has a mike input. Will broadcast over any radio, within your home (about 75 feet) from 800 to 1500 kc. Inputs for crystal mike or crystal phono pickup. Fader control fades from mike to record. Ideal for a home P.A. system, baby listener and home entertainment. A complete kit of parts including tubes. Kit Model DE-6X. Net price, \$7.95. DE-6XWT wire and tested. Net price, \$9.95. Crystal mike and desk stand, \$4.95 extra. Concealed microphone unit, only 1" in diameter and 1/2" thick. Speaks hidden mike when ordering. Stock No. T-001. Net, \$3.95 extra.

New 16 Watt Utility Amp Kit \$16.95

Kit Model TM-16, push-pull wide-range 16 watt amplifier kit. Ideal for a high quality record player as a P. A. system or recording amplifier. Matched component parts, ready punched chassis. One control fades from phono to mike. Input compensation for G.E. variable reluctance, or crystal pickup, fully shielded. Output matches 8 ohm voice coil. 100 mil power transformer. Complete with tubes, photos and diagram. 2-7C5, 7F7 and rectifier. Variable tone control. Model TM-16. Weight 10 lbs. Net \$16.95.

3-SPEED RECORD PLAYER KIT \$13.95

Complete record player kit to build a 3 speed player. Heavy 3 speed phono motor, universal crystal pickup, all parts and tubes to build a 70L7 type amplifier in an attractive walnut case with grill for speaker cut on top. Kit model D-3378, net price \$13.95.

SELF POWERED AC Broadcast Tuner Kit, 3-Gang Tuning, Complete Kit, \$12.95

A self powered, 3 gang superhet tuner kit, with R.F. stage, when wired according to diagram will make the best possible broadcast tuner, (550 to 1650 kc) for use with any amplifier. Has a 6" lighted slide rule dial. Don't class this with ordinary tuners, this has its own transformer. The complete kit is furnished with a diagram, with tubes: 6SK7 R.F., 6SA7 converter, 6SK7 I.P., 6HG detector, 6X4 rectifier. Connect to any audio amplifier. Ideal for use with our 7X5, TM-16, or S-2020 amp. kits. Chassis size: 9 1/4 x 8 1/4 x 4 1/2" high. Shipping weight 8 lbs. Broadcast tuner kit. Model BT-38. Net price \$12.95.

8-TUBE 22 WATT Wide Range Amp. Model 7x5 Kit Only \$37.95

A complete kit, including tubes (3-7E5, 2-7F7, 2-6A3 or W.E. VT-52, plus rectifier) and photos. All triode circuit makes for minimum harmonic distortion. Inputs for radio tuner any kind of phono pickup (crystal or G.E. variable reluctance) and either crystal or dynamic mike. Output transformer matches 8 ohm voice coil. Twin electrode controls and variable tone control for either juke box quality with heavy bass response or brilliant symphonic range. The best quality amplifier kit we know how to make. Has a very wide range output. Response 18 to 20,000 CPS. 8 tube all triode amplifier kit, complete with tubes. Weight 25 lbs. Net \$37.95.

\$19.95 BUYS THIS ALL PURPOSE 18 WATT AMP KIT

High fidelity amplifier kit. Model S-2020. Has inputs for radio tuner, any phono pickup, crystal or G.E. variable reluctance as well as crystal or dynamic mike. Volume controls can be mounted on the chassis or on extension leads, as pictured. Has broadcast quality shielded 100.00 value output transformer. Matches 8 ohm speaker. A complete amplifier kit with tubes: 3-7F7, 2-7C5, plus rectifier. A fine amplifier for the home music system. Model No. S-2020, weight 16 lbs. Net \$19.95.

BUY YOUR WIDE RANGE COAXIAL SPEAKER AT McGEE

12" COAXIAL PM \$12.95

A \$32.50 retail value, 20 watt 12" coaxial PM speaker of quality with mounting of the \$300 to \$500 bracket. Hook up like any PM speaker. High fidelity filter is built on speaker. Matches 8 ohm radio or amplifier. Wide range response, 20 to 17,500 CPS. Model No. CU-14X, weight 1 1/2 lbs. Retail sale price, \$12.95, or two for \$25.00.

15" COAXIAL PM \$17.95

Only \$17.95 buys a full 15" 20 watt coaxial PM speaker, with built-in high pass filter. Hook to any 8 ohm output on radio or amplifier. Response below 17,500 CPS. Good bass response. A lucky purchase makes this price possible. Full 22 inch magnet in the woofer. 5" tweeter. Model P15-9. Weight 1 1/2 lbs. Sale price, \$17.95, or two for \$34.00.

PUSH PULL TRIODE OUTPUT TRANS. \$4.95

High fidelity push-pull 2A3 to 8 ohm voice coil transformer. Wide range response, upright mounting. Use with push-pull 2A3 or 6A3 tubes. 3,000 ohms plate to plate. No. K-04137, weight 2 1/2 lbs. Net \$4.95. High fidelity push-pull transformer to 8 ohm voice coil. Upright, shielded. Matches push-pull 6V6 or any 10,000 ohm plate to 8 ohm voice coil. Weight 2 1/2 lbs. No. K-04241. \$3.95.

HIGH FREQUENCY TWEETER 750 TO 17,500 CPS. \$10.95

1951 model high frequency speaker, designed for reproduction from 750 to above 17,500 CPS. Use with any high quality cone speaker as a woofer for putting a 2 mid condenser in series with high frequency tweeter. Has removable 8 ohm driver. Bell diameter 4 3/4", length 1 0 3/4". Model HF-5 speaker, \$10.95 each.

MAHOGANY BAFFLE \$32.95

Mahogany armchair height speaker baffle, with 12 and 15 inch speakers. 24" high, 27" wide and 16 1/2" deep. Use with 15" whether baffle is needed for 12 or 15" speaker. Beautiful matched mahogany, furniture quality finish. High quality, non-rattle construction. Baffle No. 1S-4, weight 40 lbs. Net price \$32.95.

Mahogany Armchair radio phonograph cabinet with blank panels. 24" high, 27" long and 16 1/2" wide. Will hold record changer up to 14" square; radio compartment 14" long, 9" high and 10" deep. Baffle cut for 15" speaker. Top quality furniture construction. Weight 40 lbs. Net price \$34.95.

McGee's Super High Fidelity Best Value in U.S.A. OUTPUT TRANS. \$7.95

Model A-403 High fidelity output transformer. Why pay \$20 or \$30 for an output when our A-403 is available at \$6.95? Impedance, 6600 ohms plate to plate, for 6P6L or 6V6L, 100% feedback winding, 4-8 15-250 and 00 ohm secondary. Housed in a potted case. Net weight 6 lbs. Recommended for all amplifiers up to 34 watts. Size 3 7/8 x 4 1/8 x 3 3/8". Suggested diagram furnished. Shipping weight 8 lbs. Net price A-403 \$7.95.

NEW T.V. KIT \$89.50

Sensational New AC-DC Television Kit, which is shipped with major parts mounted and ready to go. I.F. strip ready wired and pre-aligned. Only 8 hours required to finish building this nice, new T.V. Chassis. For use with picture tubes up to 14" Rectangular. A complete kit with all parts, tubes (except picture tube), and standard coil. 3 Channel, ready wired tuner. Bright cadmium. Chassis 17x14x4 1/2", 4x6" Speaker. Shipped with 10" Safety Mask (specified when ordering). Ship. wt. 30 lbs. Kit Model K-141T. Net \$89.50. 14" Raytheon Black Face Picture Tube, \$26.50 extra. 12 1/2" Neutral Face Picture Tube, \$17.95 extra.

McGEE WANTS YOUR BUSINESS

T.V. AERIALS—BOOSTERS, TUBES EVERYTHING FOR YOUR RADIO & T.V. SERVICE

PHONE—VICTOR 9045

McGee is just as close as your telephone. Don't buy until you talk with us at McGee, Victor 9045 or Victor 9091. All written inquiries promptly answered.

T.V. BOOSTER REGENCY \$19.10

Regency DE-410 television booster. A real engineered unit, small and compact. Single tuned, using 1-6J6 tube as neutralized push-pull amplifier. Dollar for dollar, your best booster buy. 54X4 43 1/2". For 110 volt AC operation. Weight 6 lbs. Net price \$19.10. Astatic AT-1 "Channel-Chief" booster. Two tuned circuits and two broad circuits on all channels. Dual controls tune sound and picture independently. 8 1/2 x 4 1/2 x 3 1/4". Weight 6 lbs. Net price \$29.10. Astatic BT-1 television booster. Continuous variable tuning on all channels; simplified single knob tuning; low noise design; uses single 6AK5 tube and selenium rectifier. For either 72 or 300 ohm input and out. Woodgrain metal cabinet. Weight 4 lbs. Net \$19.10. Picture tube masks. Molded plastic; decorative and neat looking; to dress up your TV set and for conversion. 14" rectangular, \$4.79. 16" round, \$6.45. 16" rectangular, \$6.19. 17" rectangular, \$7.49. 19" round, \$9.95. 12 1/2" round, \$4.95.

T.V. PICTURE TUBE SALE

10", \$17.95
12", \$17.95
16", \$24.95

All Guaranteed 90 Days—You Must Be Satisfied

10-inch picture tube, 10MP4. This is the latest 10" tube made. Replaces 10BP4. We made a lucky purchase and pass the savings on to you. Shipping weight 15 lbs. 10MP4, net, \$17.95 each; lots of 3, \$17.00 each.

12 1/2", 12-inch picture tube, replaces most 12" tubes and offers them at a tremendous savings. Shipping weight, 19 lbs. 12 1/2", net, \$17.95 each.

16 1/2", 16-inch picture tube, replaces most of all standard 16" round glass tubes offered at the unusually low price of \$24.95 each; lots of 3, \$22.95 each. Shipping weight 25 lbs.

16AP4 General Electric, 16" metal picture tube, wt. 25 lbs., \$34.95.

17BP4 black face 17" rectangular picture tube, wt. 25 lbs., \$29.95. 20-inch black face, rectangular picture tube, 38 lbs., \$59.95.

BUY YOUR TELEVISION MATERIAL AT McGEE

20 MATCHED VIDEO COIL KIT \$7.95

20 matched TV video and sound I.F. coils. Intended for use with the RCA circuit. You get 6 peaking coils, 4-25.75 mc picture I.F.'s, 2-21.25 mc sound I.F.'s, discriminator and converter coil and 5 filament choices. Stock No. 205-XX, weight 3 lbs. Net price, \$7.95. \$6.95 if purchased with a Sarkes-Tarzian TV tuner; all coils identified.

SARKES-TARZIAN TV TUNER \$9.95

Sarkes-Tarzian 13-channel television front end tuner. Factory-wired. Rotary switch type, popular today on many TV sets. Also good for building purposes. 6C4 oscillator, 6BH6 RF and 6AG5 mixer. Output of tuner feeds your converter coil, I.F.'s, etc. Stock No. T-3, weight 3 lbs., has converter coil built on. Our 205-XXX video coil kit, \$6.95 extra, when ordered with tuner.

BRAND NEW GENERAL INST. TELEVISION FRONT END-TUNERS Sale Price \$7.95

All completely wired, brand new and pre-aligned. 13 channel selector incorporating fixed inductance and variable capacitance. Converter output transformer is attached to be coupled direct to separate sound and video I.F.'s. 3 6J6 tubes are required. Shaft length 2 1/4". Built in fine frequency control. Original factory cost over \$20.00. Weight 4 lbs. Stock No. G1-13P, less tubes. Net price \$7.95.

T.V. FLYBACKS YOKES, ETC.

52 degree deflection yokes, for 10, 12 and 16" round tubes, \$2.95 each. 70 degree deflection yokes for 14, 16, 17 and 19" rectangular tubes, \$3.45 each.

New small horizontal output (flyback) 14000 volt, \$3.95. Philco 12 or 16" horizontal output (flyback), \$3.49. Vertical output transformer, strap mounting, \$1.95. Vertical oscillator transformer, strap mounting, \$9.95. Single magnet ion trap, 49c. Double magnet ion trap, 89c.

McGEE RADIO COMPANY

Prices F.O.B. K.C. Send 25% Deposit with Order. Balance Sent C.O.D. With Parcel Post Orders, include Postage

TELEPHONE VICTOR 9045. WRITE FOR FLYER 1422 GRAND AVE., KANSAS CITY, MISSOURI

March, 1951

85

SAVE \$ ON SUN SURPLUS AND STANDARD SPECIALS!

CRYSTALS FOR S.S.B. EXCITER

AS IN NOV. '50 QST—LO FREQ.

Also many other uses—in FT 241-A Holder—1/2" Pin SPC. Marked in 54th OR 72nd Harmonic MO Freq. Listed Below by Fundamental Frequency. Fractions Omitted.

412 435	472 492	390 401	372 381	450 530
413 434	473 493	391 402	373 382	451 531
414 435	474 494	392 403	374 383	461 538
415 436	475 495	393 404	375 384	465 537
416 437	476 496	394 405	376 385	526 538
417 438	477 497	395 406	377 386	
418 439	478 498	396 407	378 387	
419 440	479 499	397 408	379 388	
420 441	480 500	398 409	380	
421 442	481 501	399 410		
422 443	482 502	400 411		
			EACH 39c	EACH 99c
SPECIAL 200 KC XTALS				
			without Holders, 21/28 x 23/32	
423 444	483 503		EACH 79c	69c ea. 3 for \$2
424 445	484 504			
425 446	485 505			
426 447	486 506			
427 448	487 507			
428 449	488 508			
429 450	489 509			
430 451	490 510			

HAM CRYSTALS

4190 6873 7840	8735 5850 6406 6705 7506
6039 6906 7873	5305 5873 6425 6740 7540
5485 6973 7906	5677 6875 6440 6806 7578
6006 7740 7973	5706 5900 6450 7306 7640
6040 7773 8273	5740 5906 6473 7340 7673
6073 7806 8306	5750 5925 6475 7373 7706
	5760 5940 6506 7406 7806
	5773 5973 6540 7440 7840
	5775 5975 6540 7440 7840
	5806 6273 6606
	5825 6340 6640
	5840 6373 6673
	89c EACH
	10 for \$9.00

SCR-522 XTALS

5910 6610 7580
6379 6750 7810
6450 7480 7930
6470
6477
6522
6527
6537

EACH \$1.29

BC-610 XTALS

2 BANANA PLUGS—3/4" SPC.
2045 2220 2360 2557 3520
2105 2258 2390 3202 3550
2125 2260 2415 3215 3570
2145 2282 2435 3237 3580
2155 2300 2442 3250 3945
2305 2532 3222 3955
2320 2545 3510 3995

Payments must accompany order. Enclose 20c for Postage & Handling. Crystal shipped packed in cloth bags. All Shipments Guaranteed.



BENDIX 100 WATT TRANSMITTER

These can be easily converted to 20-40-80 meters. Crystal required for 10 meters. Each electronic coupled oscillator dial has 3000 divisions enabling quick precision shifting. This transmitter was constructed of the highest quality of precision parts, with laboratory precision. Four separate output tanks; one 4-position selector channel switch having seven sections which changes the ECO, IPA and output tanks simultaneously. All the controls are mounted on the front panel. The housing is cast aluminum; shields and case are sheet aluminum. Dimensions 11 x 12 x 15 inches, weighing 35 1/2 lbs. Complete, simple instruction for conversion furnished. Uses three 807, four 12SK7 tubes; one 2-inch 5 amp. R.F. meter. A complete coverage transmitter, for the new or experienced amateur. A TRUE HAM VALUE—complete with tubes

NOW ONLY 29.95 LIKE NEW 19.95 USED

NOW AVAILABLE FROM STOCK

HALLICRAFTERS—RECEIVERS

S-38B	49.50	S-53	79.95
S-40B	99.95	S-72	109.95
	SX-71	199.50	

NATIONAL RECEIVERS

NC-33	67.50	NC-183	294.00
NC-57	99.50	HRO-50	359.00

ALL PRICES SUBJECT TO CHANGE AT TIME OF SHIPMENT

TERMS: All items F. O. B., Washington, D. C. All orders \$30.00 or less, cash with order. Above \$30.00, 25 per cent with order, balance C. O. D. Foreign orders cash with orders, plus exchange rate.

SUN RADIO

OF WASHINGTON, D. C.

938 F STREET, N. W. WASH. 4. D. C.

Tube Substitutions

(Continued from page 38)

than the older 6K7, 6SK7, and 6D6 tubes. This tendency to oscillate because of higher gain was overcome by inserting a 100 ohm resistor in series with the cathode lead. This provided sufficient degeneration to counteract any feedback. Three typical adapters are illustrated in Fig. 1.

The top portion of Fig. 1 is a 7 pin miniature shielded tube socket. The bottom portion is the base of a defective tube. Leads are soldered to the miniature socket elements. A small 100 ohm resistor is soldered to the cathode. In addition, a wire is soldered to the metal frame of the miniature socket to be connected to the shield pin of the tube base below. Since there is no shield pin on 6 prong tubes, the lead from the tube shield must be grounded to the chassis with the shortest possible lead. The connections from the miniature tube socket are pulled through the corresponding element pins of the tube base below and soldered. If maximum sensitivity is desired, the i.f. transformer preceding and following the miniature tube may be repeated for maximum output on a correctly tuned weak station signal. If all the signals are strong the aerial can be removed or a short piece of wire left instead, in order to obtain a weak signal for peaking purposes. For radios with built-in loops, the radio can be tuned to weaken the signal pickup.

Several audio amplifier tubes of the older series merit consideration. Some of these tubes are the 41, 42, 43, 47, 75 and 2A6. The 41 and 42 may be interchanged directly where a single audio power amplifier is used. Substitution of one tube of a push-pull pair would unbalance the output circuit, creating distortion and accentuating hum. In addition, the octal tubes 6K6, 6F6, 6V6, or the miniature types 6AQ5, 6AR5 may be used in place of the single 41 or 42, either by replacing the 6 prong socket with an octal or miniature socket or, by using an adapter which permits the use of the octal or miniature tube in place of the 6 prong 41 or 42 tube.

The 43, which is a 6 prong tube, may be replaced with its octal type equivalent, the 25A6, with either a new socket or an adapter provided. The 25L6 will also operate in place of the 25A6 or 43. The pins of the 25L6 and 25A6 are identical.

Another method of replacing a 25 volt heater audio power amplifier is through the use of the equivalent tube with a 6 volt heater. To accomplish this a separate source of 6 volts must be supplied and the 25 volt drop across the old tube must be taken up by the addition of a 80 to 90 ohm, 10 watt resistor. The 6 volts is obtained from either a small filament transformer or a small 50L6 output transformer when it is connected to the line. The 50L6

output transformer has a turns ratio of 20 to 1. Therefore a 120 volt line will be stepped down to six volts. The 80 to 90 ohm, 10 watt resistor may be obtained by using a 250 ohm resistor line cord in place of the usual 160 ohm line cord or ballast tube.

The 47 tube, which employs a 2.5 volt filament without the usual separate cathode, has no direct counterpart. Substitution for the 47 is a little complicated. The tubes whose characteristics are somewhat similar to the 47 are the octal 6F6 and 6K6 or the prong 42 and 41. First, either a new socket or an adapter will have to be provided. Second, 6 volts must be provided for the heater as noted previously from a filament transformer or a 50L6 output transformer. The cathode of the replacement tube must be connected to the center tap of the old 2.5 volt heater in order to obtain grid bias.

The 75 tube may be replaced with either a 6Q7 or a 6SQ7, through the use of an adapter connecting the corresponding element pins together or by total replacement of the six prong socket with an octal type.

The 2A6 is a duo-diode, hi-mu triode similar to the 75 except for the fact that the heater requires 2.5 volts. The 75 tube is a direct replacement providing the 2.5 volt heater connections are removed from the 6 prong socket and a 6 volt source is substituted. Again substitutions for the 75 tube may be employed for the 2A6 if the 6 volt heater is supplied.

Going back to r.f. and i.f. amplifier tubes, it might be well to note that the old 58 employs the same socket and pin connections as the later 78 or 6D6. Similarly the 57 employs the same socket and pin connections as the 77 or 6C6. Therefore the 78 or 6D6 may be used in place of the 58 and the 77, with the 6C6 used in place of the 57 provided 6 volts is supplied in place of the old 2.5 volt heater connections.

Among the low voltage rectifiers the 5Y3, 5Z4, and 5W4 are directly interchangeable. The 80 type tube is the original 4 prong equivalent of these later octal base types. The 84 5 prong tube, the 6X5 octal base tube, and the 6X4 miniature base tube have similar electrical characteristics. Replacement of either the socket or the use of an adapter will permit substitution. Replacement of either tube, through the use of an adapter or a new socket, provides good results.

In the single triode family, the 6F5 may be replaced with a 6Q7 provided the plate connection is removed from socket pin #4 and reconnected to an empty socket pin #3. The single ended 6SF5 may be replaced by a 6SQ7 when the plate, grid and cathode are removed from socket pins 5, 3, and 2 respectively and are reconnected to socket pins 6, 2, and 3 in the same order.

In a.c.-d.c. receivers, some familiar tricks of the trade are as follows: Where the 35Z5 pilot light section opens from pins 3 to 4, a small 15 ohm wirewound resistor will provide

OUTSTANDING VALUES NOW AVAILABLE

STANDARD TYPE REPLACE- MENT PHONO CARTRIDGE

All New—All Guaranteed

Type No. 1 will replace Shure W58A
Webster N10
Astatic L70

Price—only \$1.85 ea.
Lots of 10 \$17.90

Type No. 2 will replace Shure W56A
Webster N10
Astatic L-72

Price—only \$1.99 ea.
Lots of 10 \$18.90

GT TUBE CARTONS

Sturdy—Many Uses.

Box bulk tubes, spare parts, nuts
and bolts.

\$0.79 per 100
\$4.95 per 1000

VIBRATORS

Standard Brand—Fully Guaranteed

4 Prong Standard \$1.49 each
10 for \$13.95

4 Prong Delco type . . . \$1.59 each
10 for \$14.95

5 Prong Buick type \$2.89 each
10 for \$27.50

TOP COWL MOUNT AUTO ANTENNA

3 Section, 58" Brass Ribbing. Heavy
chrome plating. Bakelite insulators with
chrome trim. Single hole mount. Com-
plete with low loss lead. \$2.19 each
Case lots of 25—\$1.98 each

SIDE COWL—2 MOUNT ANTENNA

66", 3 Section. Complete with insula-
tors. Tin shielded low loss lead.
\$1.89 each
Case lots of 25—\$1.75 each

BUFFER CONDENSERS

New Stock. All Guaranteed.

.006—1600V	} 10 for \$2.90
.005—2000V	
.01 —2000V	
100 assorted	\$25.00

NOW! LARGE 14" or 16" PICTURE FROM YOUR 10" or 12" TELEVISION SET

Servicemen: Convert customers' sets for
extra profits! 90% of all conversions
can be made by use of the RAPARCO
conversion kit.



Includes 14BP4 CR tube, 70° deflec-
tion yokes, and attractive lucite mask.
Complete, only \$34.95

STANDARD MANUFACTURE —ALL NEW—ALL GUARAN- TEED. All these parts are used constantly in repair or conversion work.

70° Deflection Yoke—includes con-
densers and resistors. . . . \$3.50 each

Flyback transformer for 12½" set
\$2.75 each

14" attractive Lucite Square Mask
\$3.95 each

16" attractive Lucite Square Mask
\$4.50 each

Single Magnet Beam Bender 39c ea.

Double Magnet Beam Bender. 75c ea.

500 MMFD 10 KV. 69c ea.

500 MMFD 20 KV. 98c ea.

Vertical Output Transformer 5½x5½.
Standard strap mounting. . . . 95c ea.

9 ft. Rubber covered TV Power
Cord. 45c ea.

6 ft. Rubber covered TV Power
Cord. 39c ea.

CONICAL TV ANTENNAS

Featuring 8 inter-changeable elements.
Hi-tensil Aluminum Alloy. Just insert
elements and lock. Universal U Bolt
\$4.25 each

Stacked conicals, including stacking
bars. \$8.00 each

CHIMNEY MOUNTS

Double Mount, including strapping and
all hardware. Galvanized steel. Heavy
Duty. Rustproof.

\$1.45 each. Case of 12 \$1.30 each

UNIVERSAL MOUNT

Can be used for a Chimney Mount or
Base Mount. Will also mount on peaked
roof.

\$1.65 each. 12 for \$1.50 each

TV ANTENNA MASTS — Heavy

Gauge Steel—Rust Proof.

5 ft. \$1.25 each. 10 ft. \$2.59 each

12 ft. TV ANTENNA MAST—Heavy

Gauge Aluminum. \$2.95 each

GUARANTEED PICTURE TUBES RECTANGULAR

16"—Replaces 16TP4—16XP4
\$28.50

17"—17BP4. \$29.95

TUBES MUST BE SHIPPED RAILWAY
EXPRESS

150W SOLDERING IRON

Underwriters Laboratories approved.
Standard ¾" Plug-In-Tip. A very good
utility iron. Comes with
stand. \$2.29 each

TV CONDENSERS

Top manufacturer.

.01 —6000V	} \$0.59 each
.005—6000V	
10 for	\$5.50

Radio Parts Company, 614 RANDOLPH ST., CHICAGO 6, ILL.

the **chicago** V.T.V.M. ELECTRONIC MULTITESTER

A versatile new Chicago Vacuum Tube Volt Meter with more ranges and greater utility—at the lowest price in the industry!

\$39⁰⁰
net



RANGES

DC VOLTS

0-5, 10, 50, 100, 500, 1000, 5000. Input impedance: 20 megohms (including 10 megohms in the DC probe)

AC VOLTS

0-5, 10, 50, 100, 500, 1000, 5000
Input impedance: 10 megohms

OHMS

0 to 1000 megohms in 6 ranges with center scale readings of 10, 100, 1000, 10K, 1Mag, 10Mag.

CAPACITANCE

50 MMF to 5000 MF in 6 ranges. Low voltage power source enables testing of electrolytic condensers.

MILLIAMPERES

DC 0-1, 10, 100, 500
(Not electronic) 50 millivolt drop.
Operates on 115 V.A.C. Dimensions: 6 3/4" Wide x 9 1/2" High x 6" Overall Depth

The big 5 1/2" meter is mounted in a handsome brown Hammerloid case slanted for easy reading.

See Your Parts Distributor or Write for Complete Information

CHICAGO INDUSTRIAL INSTRUMENT CO.

536 W. ELM ST. • CHICAGO 10, ILL.



HENRY HAS THE NEW **hallicrafters** MODEL SX-71 NOW!



This new type of receiver—the first of its kind on the market—has extra sensitivity, selectivity, and definitely superior image rejection. Continuous AM reception from 538 kc to 35 Mc, and 46 to 56 Mc. One RF, 2 conversion, and 3 IF stages. 105-125 volts AC. 11 tubes plus voltage regulator and rectifier. Only \$199.50. (R-46 matching speaker only \$19.95)

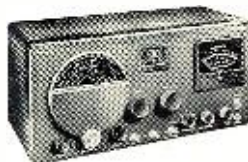

NEW DUAL-CONVERSION RECEIVER HALLICRAFTERS Model S-76

Note these features: Dual conversion (1650 Kc and 50 Kc)—more usable selectivity than the best crystal. Giant 4-in. "S" Meter—calibrated in microvolts and "S" units. Four bands 538-1580 Kc, 1720 Kc to 32 Mc. Calibrated electrical bandspread. 5 position selectivity. Sensitivity 2 microvolts or better with 5 watt output. 9 tubes plus regulator, rectifier. \$149.95.

I have a complete stock of Hallicrafters receivers and transmitters. I'll make you the best deal on a trade-in for your communications receiver. I give you prompt delivery, and 90-day FREE service. Nobody can beat Bob Henry on a trade-in, and I offer you the world's lowest credit terms. Write, wire, phone, or visit either store today for the best deal. Export orders solicited.

Bob Henry
W4ARA

Buller 2, Missouri

HENRY RADIO STORES

11240 Olympic Blvd.
LOS ANGELES 25
CALIF.

"WORLD'S LARGEST DISTRIBUTORS OF SHORT WAVE RECEIVERS"

operation, eliminating tube replacement. Similarly in the 35W4, when an open is detected between pins 4 and 6, a small 15 ohm wirewound resistor connected across these pins, will preclude tube replacement. A defective 35L6 can usually be replaced with a 50L6 lowering the effective heater voltage across each tube, yet provide good results. Similarly the 35B5 can be replaced with the 50B5, and the 35C5 can be directly replaced with the 50C5.

The 6SS7 r.f. and i.f. amplifier can be replaced with the 12SK7, again reducing the heater voltage across each tube in the series filament string, but still providing good results. The 6SK7 adapter has been used with either a 12AU6, 12BA6, or 6AK5 to replace either the 12SK7 or 6SS7. The possibilities of tube substitutions are endless and therefore numerous other combinations are possible.

—50—

INVERTED PICTURES

By JACK NAJORK, W2HNH

BASEBALL fans in the office force of a TV supply house, watching the first game of the season on a TV receiver in their service shop, were amazed to see a well-known southpaw hurler suddenly change to right-arm throwing, while the right-handed batter likewise made a quick switch to the left side of the batter's box. To top it off, the batter belted the ball and then took off for third base!

As was to be expected, this bit of devilry had been dreamed up by one of the TV technicians who had accidentally discovered that a very simple change in the receiver caused it to produce inverted (mirror image) pictures. A hidden switch, connected to the receiver in operation, enabled the technician to invert the picture at will.

This seemingly useless bit of nonsense, however, soon turned out to have some real practical value. Polio patients in iron lungs and other bed-ridden invalids who must lie flat on their backs are finding inverted pictures a real boon because they can now watch TV via a mirror without having to read title lines backwards! The mirror is placed above the patient's head at a 45 degree angle so that the screen of a set facing the head of the bed can be seen. Under these conditions, the picture will be right-side up but inverted horizontally, making it necessary for the patient to read titles backwards. By inverting the picture on the receiver, the mirror image will come out correctly and the patient is relieved of the strain of trying to read backwards.

The change necessary in the receiver to produce these horizontally inverted pictures is very simple and can be made in a few minutes. Merely reverse the two leads running to the horizontal windings on the deflection yoke! If the vertical leads are interchanged by mistake, you will have an upside down picture, so there should be no doubt about the correct leads. Reversing the horizontal leads should produce a picture right side up but "inside out".

One word of caution: Do not interchange horizontal leads with vertical leads, or you may end up with no picture at all!

—50—

RADIO & TELEVISION NEWS

Critical Shortages of Qualified Men in TELEVISION — ELECTRONICS!



Your Spare Time is Prepare Time! CREI Home Study can lead to quick promotion in essential industry or in uniform

"Technicians may soon be as scarce as certain tubes," says informed industry spokesman as growing military demands cut sharply into skilled personnel.

THE critical shortages aren't imaginary—they're serious. With demand for electronics equipment by the military increasing daily—and with qualified technicians wanted by industry to fill orders and maintain TV sets—now is certainly the time to get into the big-paying jobs in electronics. In this essential industry you're assured—if qualified—of a lifetime career at an interesting salary. If you're headed for the armed services your technical electronics ability will be rewarded quickly with supervisory work *at extra pay* in vital radar, navigation, or communications units.

CREI offers a home study program recognized by industry and the military as outstanding. *Proof:* Leading industrial firms like RCA-Victor, PAA, United Air Lines and many others have chosen CREI for technician training at company

expense; during World War II CREI trained thousands for the Army, Navy, and Coast Guard—and provided texts for thousands more.

CREI, through home study, offers practical training that starts with basic principles and goes step-by-step through the more advanced subjects of TV and its related fields. Each student is grounded thoroughly in the fundamentals required for development work in TV, guided missiles, communications, and industrial electronics. You study Optics; Pulse Techniques; Deflection Circuits; RF, IF, AF and Video Amplifiers; FM; Receiving Antennas; Power Supplies; Cathode Ray, Iconoscope, Image Orthicon and Projection Tubes; UHF Techniques, TV Test Equipment, and many other subjects. You go on to specialized fields as soon as your capabilities permit.

If you want promotion, more money, a lifetime career, send for—and study—the FREE BOOKLET offered below. The sooner you begin your training, the better off you'll be—in industry or in service. The cost is nominal, the terms easy. ACT NOW!

THE THREE BASIC CREI COURSES:

- ★ **PRACTICAL RADIO ENGINEERING**
Fundamental course in all phases of radio-electronics
- ★ **PRACTICAL TELEVISION ENGINEERING**
Specialized training for professional radiomen
- ★ **TELEVISION AND FM SERVICING**
Streamlined course for men in "top-third" of field

ALSO AVAILABLE AS RESIDENCE SCHOOL COURSES

CAPITOL RADIO ENGINEERING INSTITUTE

An Accredited Technical Institute Founded in 1927
Dept. 113C, 16th & Park Rd., N. W. Washington 10, D. C.
Branch Office: San Francisco, 760 Market St.



MAIL COUPON FOR FREE BOOKLET

CAPITOL RADIO ENGINEERING INSTITUTE

Dept. 113C, 16th & Park Road, N. W., Washington 10, D. C.

Gentlemen: Send booklet, "Your Future in the New World of Electronics," together with details of your home study training, CREI self-improvement program and outline of course. I am attaching a brief resume of my experience, education and present position.

- Check Field of Greatest Interest:
- | | |
|---|---|
| <input type="checkbox"/> Practical Television Engineering | <input type="checkbox"/> Aeronautical Radio Engineering |
| <input type="checkbox"/> Practical Radio Engineering | <input type="checkbox"/> Broadcast Radio Engineering (AM, FM, TV) |
| <input type="checkbox"/> TV, FM & Advanced AM Servicing | <input type="checkbox"/> Radio-Electronics in Industry |
- If Residence School in Wash., D. C. Preferred, Check Here

NAME AGE

ADDRESS

CITY ZONE STATE

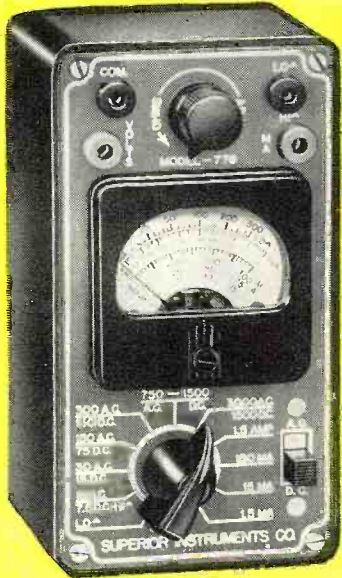

SUPERIOR'S AN ACCURATE POCKET-SIZE
new model 770 **VOLT-OHM MILLIAMMETER**

(SENSITIVITY: 1000 OHMS PER VOLT)

FEATURES

- ★ Compact-measure 3 1/8" x 5 7/8" x 2 1/4".
- ★ Uses latest design 2% accurate 1 Mil. D'Arsonval type meter.
- ★ Same zero adjustment holds for both resistance ranges. It is not necessary to readjust when switching from one resistance range to another. This is an important time-saving feature never before included in a V.O.M. in this price range.

- ★ Housed in round-cornered, molded case.
- ★ Beautiful black etched panel. Depressed letters filled with permanent white, insures long-life even with constant use.

The Model 770 comes complete with self-contained batteries, test leads and all operating instructions.

SPECIFICATIONS

- 6 A.C. VOLTAGE RANGES:
0—15/30/150/300/1500/3000 VOLTS
- 6 D.C. VOLTAGE RANGES:
0—7.5/15/75/150/750/1500 VOLTS
- 4 D.C. CURRENT RANGES:
0—1.5/15/150 MA. 0—1.5 AMPS.
- 2 RESISTANCE RANGES:
0—500 OHMS 0—1 MEGOHM

\$14⁹⁰
NET



Superior's new model 670

SUPER-METER

A COMBINATION VOLT-OHM MILLIAMMETER PLUS CAPACITY REACTANCE INDUCTANCE AND DECIBEL MEASUREMENTS

SPECIFICATIONS:

- D.C. VOLTS: 0 to 7.5/15/75/150/750/1,500/7,500 Volts
- A.C. VOLTS: 0 to 15/30/150/300/1,500/3,000 Volts
- OUTPUT VOLTS: 0 to 15/30/150/300/1,500/3,000 Volts
- D.C. CURRENT: 0 to 1.5/15/150 Ma. 0 to 1.5 Amperes
- RESISTANCE: 0 to 500/100,000 Ohms to 10 Megohms
- CAPACITY: .001 to .2 Mfd. .1 to 4 Mfd. (Quality test for electrolytics)
- REACTANCE: 700 to 27,000 Ohms 13,000 Ohms to 3 Megohms
- INDUCTANCE: 1.75 to 70 Henries 35 to 8,000 Henries
- DECIBELS: — 10 to + 18 + 10 to + 38 + 30 to + 58

ADDED FEATURE:

The Model 670 includes a special GOOD-BAD scale for checking the quality of electrolytic condensers at a test potential of 150 Volts.

The Model 670 comes housed in a rugged, crackle-finished steel cabinet complete with test leads and operating instructions. Size 5 1/2" x 7 1/2" x 3".

\$28⁴⁰
NET

Superior's new model TV-20

20,000 OHMS PER VOLT MULTI-METER and TELEVISION KILOVOLTMETER



The Model TV-20 was designed to provide all the multi-meter measurement requirements of A. M., F. M. and Television. Unlike other recent models, which are actually standard V.O.M.'s converted to test the new Television Voltages, the Model TV-20 is a completely new unit. It provides the sensitivity, ranges and accessories which are needed to service F. M. and Television in addition to A. M. Radio. The High Voltage Probe for example, with a range of 50,000 volts and designed to withstand 100,000 volts, is an integral part of the instrument with a special compartment for housing it when not in use.

SPECIFICATIONS

- 9 D. C. VOLTAGE RANGES: (At 20,000 ohms per Volt)
0-2.5/10/50/100/250/500/1,000/5,000/50,000 Volts
- 8 A. C. VOLTAGE RANGES: (At 1,000 ohms per Volt)
0-2.5/10/50/100/250/500/1,000/5,000 Volts
- 5 D. C. CURRENT RANGES
0-50 Microamperes
0.5/50/500 Milliampers
0.5 Amperes
- 4 RESISTANCE RANGES:
0-2,000/20,000 ohms 0-2/20 Megohms
- 7 D. B. RANGES: (All D. B. ranges based on
Odb = 1 Mv. into a 600 ohm line)
— 4 to + 10 db + 36 to + 50 db
+ 8 to + 22 db + 42 to + 56 db
+ 22 to + 36 db + 48 to + 62 db
+ 28 to + 42 db
- 7 OUTPUT VOLTAGE RANGES:
0 to 2.5/10/50/100/250/500/1,000 Volts

ADDED FEATURE:

The Model TV-20 includes an Ultra High Frequency Voltmeter Probe. A Silicon V. H. F. Diode together with a resistance capacity network provides a frequency range up to 1,000 MEGACYCLES. When plugged into the Model TV-20, the V. H. F. Probe converts the unit into a Negative Peak-Reading H. F. Voltmeter which will measure gain and loss in all circuits including F. M. and T. V.; check capacity and impedance; test efficiency of all oscillator circuits; measure band-width of F. M. and T. V.; etc.

The Model TV-20 operates on self-contained batteries. Comes housed in beautiful hand-rubbed oak cabinet complete with portable cover. Built-in High Voltage Probe. H. F. Probe. Test Leads and all operating instructions. Measures 4 1/2" x 10 1/4" x 11 1/2". Shipping Weight 10 lbs.

\$39⁹⁵
NET

USE CONVENIENT RUSH ORDER FORM ON OPPOSITE PAGE

GENERAL ELECTRONIC DISTRIBUTING CO. DEPT. RN-3, 98 PARK PLACE NEW YORK 7, N. Y.

Superior's New Model TV-10

TUBE TESTER



SPECIFICATIONS:

- ★ Tests all tubes including 4, 5, 6, 7, Octal, Lock-in, Peanut, Bantam, Hearing-aid, Thyatron, Miniatures, Sub-Miniatures, Novals, etc. Will also test Pilot Lights.
- ★ Tests by the well-established emission method for tube quality, directly read on the scale of the meter.
- ★ Tests for "shorts" and "Leakages" up to 5 Megohms.
- ★ Uses the new self-cleaning Lever Action Switches for individual element testing. Because all elements are numbered according to pin-number in the RMA base numbering system, the user can instantly identify which element is under test. Tubes having tapped filaments and tubes with filaments terminating in more than one pin are truly tested with the Model TV-10 as any of the pins may be placed in the neutral position when necessary.
- ★ The Model TV-10 does not use any combination type sockets. Instead individual sockets are used for each type of tube. Thus it is impossible to damage a tube by inserting it in the wrong socket.
- ★ Free-moving built-in roll chart provides complete data for all tubes.
- ★ Newly designed Line Voltage Control compensates for variation of any line voltage between 105 Volts and 130 Volts.

The Model TV-10 operates on 105-130 Volt 60 Cycles A.C. Comes housed in a beautiful hand-rubbed oak cabinet complete with portable cover.

\$39.50
NET

The New Model 200

AM and FM SIGNAL GENERATOR

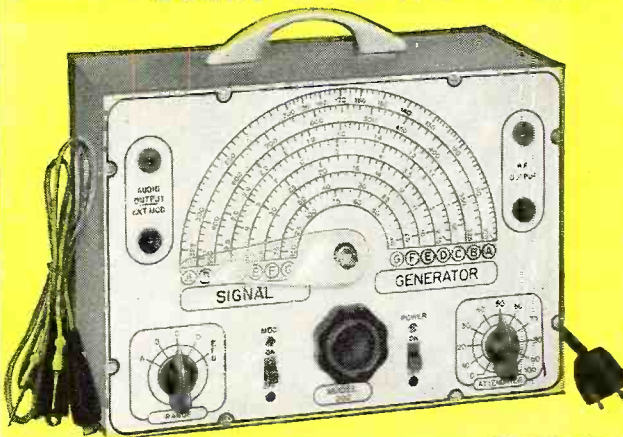

SPECIFICATIONS

- ★ **R.F. FREQUENCY RANGES:** 100 Kilocycles to 150 Megacycles.
- ★ **MODULATING FREQUENCY:** 400 Cycles. May be used for modulating the R.F. signal. Also available separately.
- ★ **ATTENUATION:** The constant impedance attenuator is isolated from the oscillating circuit by the buffer tube. Output impedance of this model is only 100 ohms. This low impedance reduces losses in the output cable.
- ★ **OSCILLATORY CIRCUIT:** Hartley oscillator with cathode follower buffer tube. Frequency stability is assured by modulating the buffer tube.
- ★ **ACCURACY:** Use of high-Q permeability tuned coils adjusted against 1/10th of 1% standards assures an accuracy of 1% on all ranges from 100 Kilocycles to 10 Megacycles and an accuracy of 2% on the higher frequencies.
- ★ **TUBES USED:** 12AU7—One section is used as oscillator and the second is modulated cathode follower. T-2 is used as modulator. 6C4 is used as rectifier.

The Model 200 operates on 110 Volts A.C. Comes complete with output cable and operating instructions.

\$21.85
NET

Superior's new model TV-30

TELEVISION SIGNAL GENERATOR

ENABLES ALIGNMENT OF TELEVISION I. F. AND FRONT ENDS WITHOUT THE USE OF AN OSCILLOSCOPE!

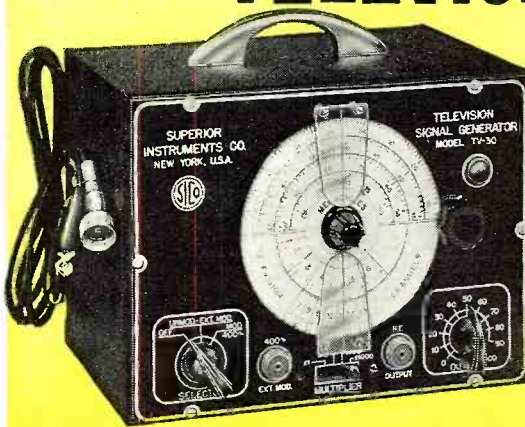

FEATURES Built-in modulator may be used to modulate the R. F. Frequency, also to localize the cause of trouble in the audio circuits of T. V. Receivers.

Double shielding of oscillatory circuit assures stability and reduces radiation to absolute minimum. Provision made for external modulation by A. F. or R. F. source to provide frequency modulation. All I. F. frequencies and 2 to 13 channel frequencies are calibrated direct in Megacycles on the Vernier dial. Markers for the Video and Audio carriers within their respective channels are also calibrated on the dial.

Linear calibrations throughout are achieved by the use of a Straight Line Frequency Variable Condenser together with a permeability trimmed coil.

Stability assured by cathode follower buffer tube and double shielding of component parts.

SPECIFICATIONS Frequency Range: 4 Bands—No switching; 18-32 Mc., 35-65 Mc., 54-98 Mc., 150-250 Mc.

Audio Modulating Frequency: 400 cycles (Sine Wave). Attenuator: 4 position, ladder type with constant impedance control for fine adjustment. Tubes Used: 6C4 as Cathode follower and modulated buffer. 6C4 as R.F. Oscillator. 6SN7 as Audio Oscillator and power rectifier.

Model TV-30 comes complete with shielded co-axial lead and all operating instructions. Measure 6" x 7" x 9". Shipping Weight 10 lbs.

\$33.95
NET

MONEY BACK GUARANTEE!!

GENERAL ELECTRONIC DISTRIBUTING CO.

DEPT. RN-3, 98 PARK PLACE, NEW YORK 7, N. Y.

GENTLEMEN: PLEASE RUSH THE MATERIAL LISTED BELOW:

Phone—REctor 2-1677

QUANTITY	MODEL	PRICE
TOTAL		

Name _____

Address _____

City _____ Zone _____ State _____

\$ _____ (Deposit Enclosed—)

(Payment in Full Enclosed) Ship Balance C.O.D.)

PRECISION ELECTRONICS PRESENTS the GROMMES CUSTOM AMPLIFIERS

Designed by Sound Engineers
for CRITICAL MUSIC LOVERS



- For those who want the best
- Response 10 to 100,000 CPS
(±0.1 DB 10 to 50,000 CPS).
- Passes square waves 20 to 10,000 CPS
- Total distortion 0.2% or less at
20 watts.
- Peak power 50 watts.
- 25 DB feedback; Damping factor-11.
200 PG List \$225.00

- Out-performs larger amplifiers.
- Response ±1 DB 20 to 20,000 CPS.
- Total distortion 1.5% or less at 10 watts.
- Peak power 20 watts.
- 10 DB feedback.

50 PG List \$73.50

Now! Available
with Pfanstiehl
pre amps.....

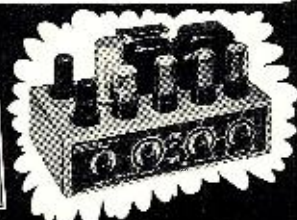

Both models feature the most advanced circuits known to electronics; 4 inputs, feedback pickup pre-amp, calibrated bass and treble controls, hum inaudible. Free technical bulletin.

PRECISION ELECTRONICS, INC.

641-43 MILWAUKEE AVENUE

CHICAGO 22, ILLINOIS

Unitized Transmitter

(Continued from page 59)

preamplifier stage. This unit chassis is next, and last, on the agenda, and should now be laid out and drilled. It will be noted that T_2 , the modulation transformer, is mounted atop the v.f.o.-exciter power transformer by means of spacers and a 4" square of 1/4" aluminum, to bring it in line with the 829-B and the audio chassis. The only other points requiring clarification are the sub-mount socket for the 6SQ7 compression-amplifier/rectifier tube, to clear the meter, M_1 , and the location of S_1 , which is on the extreme front edge of the audio unit chassis, directly below S_2 * on the front panel. See the top chassis photo.

The 6SQ7 tube is used in an old, reliable, simple a.g.c. circuit and is quite effective in preventing over-modulation while allowing a high average percentage of audio to be employed. As shown, this tube is at the front right of the audio unit chassis; directly to its left is the 6SG7 preamp stage and next to the rear is the 6C5 driver and interstage transformer, T_1 , with the modulator 829-B and the modulation transformer directly behind.

The load impedance of the 829-B in this application is figured at 10,000 ohms plate-to-plate and use of the usual ratio determination is made to match the modulator to the final Class C stage. The large transformer was chosen because of the high current (200 plus milliamperes) of the tube in this service, both as modulator and final. Audio output appears to be well over 60 watts, which (in speech frequency use) really kicks the pants off the 100 plus watts we run to the final, believe me! Power connections are made in the same manner as to the other two units.

Three points should clear up any questions about the unit since wiring is simple and straightforward. Regulated voltage to the 829-B screen is shown, and this is a necessity for good operation. The miniature voltage regulator tubes shown handle the chore nicely, and no bugs were encountered. Components S_4 , C_{43} , C_{44} , and R_{35} are used as a simple, but effective, bass suppression circuit and is recommended highly. R_{35} serves primarily to kill "click" when suppression is in or out, by means of S_4 . The last point, if the builder is a male, is to switch the connection to the primary of T_1 , observing the modulation pattern on a scope for "upward" polarization of the envelope—a common broadcast practice. It really makes a difference in audio response. Oddly enough it has no effect on female voices, so if the XYL is going to use the rig while you do the dishes let it go! The last contingency is quite possible, at that, since the transmitter definitely has eye-appeal.

The method of utilizing a 6.3 volt pilot light for the "B+" indicator re-

TUBES

Brand New • Standard Brands
MANUFACTURERS GUARANTEE!

074	\$1.95	6C4	\$1.80
1D8GT	1.25	6CB6	2.00
1AB5	2.00	6F5	1.20
1B3/8016	2.85	6J6	2.50
1B4	3.98	6K5	1.18
1F4	1.40	6K6	1.55
1G4	1.20	6K7	1.40
1H4	1.10	6L6GA	2.00
1J6	1.60	6SF7	.98
1LB4	1.50	6SJ7	1.65
1LH4	1.90	6SK7	1.80
1LNs	1.90	6SL7GT	1.40
1R4	2.40	6SN7	2.50
1S5	2.00	6X4GT	1.85
1R5	2.00	6VCGT	2.00
1S4	2.00	6X4GT	1.50
1T4	2.00	6X4	1.50
1T5	2.00	7J7	1.50
1U4	2.00	7E7	1.50
1U5	2.00	12A6	1.50
1X2A	1.00	12AT6	1.50
2A5	1.00	12AR7	1.50
2A7	1.40	12AU7	1.40
2B3	1.00	12AV7	1.00
2B7	1.25	12AV7	2.50
3ABGT	2.40	12BA6	1.80
3B7	.92	12BE6	1.80
3LF4	1.30	12BF7	1.20
3Q4	.99	12BH7	2.00
3Q5	.99	12BJ7	1.80
3S4	.99	12SK7	1.80
3V4	.99	12SL7	1.67
4U4G	1.00	12SN7	2.20
5Y3	1.35	12SQ7	1.50
6AC7	1.00	14F7	1.00
6AG2	2.65	14W7	1.90
6AC7	2.00	14CS	1.00
6AL5	3.90	25DQ6	3.20
6AK5	3.90	25DQ6	3.20
6AK5	3.90	25A5	.95
6AK5	3.90	25L6	1.05
6AL5	3.90	25L6	1.05
6AL7	3.90	25L6	1.05
6AG5	3.90	41	1.00
6AR5	3.90	50A5	1.35
6BR5	1.50	50B5	1.50
6AT6	1.50	50C5	1.50
6AU6	2.00	50C5	1.50
6AV6	1.50	50L6GT	1.85
6RA6	1.80	50L6GT	1.85
6BA7	2.40	55	1.30
6BC5	3.00	57	1.30
6BD6	3.00	58	1.00
6BE6	1.80	70L7	2.25
6BG6	2.40	80	1.10
6B16	2.00	117L7	1.50
6BL7	2.50	117Z3	1.50
6BQGT	6.00	1619	1.85
12AY7	6.00	1V2	1.00

IMMEDIATE SHIPMENT

Minimum Order \$5.00—25% Deposit, 100% Discount on Orders Over \$25.00. Shipped via Express

RADIO CITY LABORATORIES
1373 West Chicago Ave., Chicago 22, Ill.

SAVE \$\$ AT RED ARROW

SPECIAL! 300 OHM TWIN LEAD TV LINE \$3.89 per hundred ft. \$35.00 per thousand ft.

SOLDERING PASTE —8 oz. cans— U.S.N. Specifications. 51-FLB...29c ea. (10 for \$2.50)

FILTER UNIT

This unit is an excellent buy for the parts alone. Some parts are worth more than we're asking for the whole unit.

- 1-40 MFD @ 450V
- 1-1000 MFD @ 12V
- 1-.5 MFD @ 400V
- 2-.5 MFD @ 50V
- 1-.01 MFD @ 400V
- 2-20 Watt Resistors
- 2-Filter Chokes
- 3-RF Chokes
- 1DPST Toggle Switch

Miscellaneous hardware, wire, etc.
BRAND NEW, ORIGINAL PACKING.
89c ea. (10 for \$7.50)

TUBES • Brand New

• Standard Brands • Immediate Delivery
VT25A/10Y39c 162639c
3C24/24G59c 372A\$1.75

HIGH FREQUENCY BY-PASS CONDENSERS

1220 MMF.....
2400 MMF.....
4800 MMF.....
25 for 99c

DYNAMOTOR SALE!

3D77—Brand New\$8.95
PE34—Used, excellent4.95
PF73—Used, excellent4.95
DM33A—Used, excellent1.45

6 ft. line cords with molded rubber plug.....\$14.95 per hundred cords

WARD LEONARD RESISTORS

0.5 ohm— 10 watt14c
85 ohm— 10 watt14c
2500 ohm— 25 watt27c
2500 ohm— 33 watt20c
250 ohm— 50 watt, lamp base.....24c
105 ohm—100 watt, 4 taps.....48c
50 ohm Muter Resistor, 5 watt.....8c ea.
(\$6.00 per hundred)
100 ohm Muter Resistor, 10 watt.....13c ea.

MINIMUM ORDER—\$2.00. Send 25% deposit with order, balance C.O.D. Shipped F.O.B., N.Y.C. (N.Y.C. residents add 2% sales tax.)

RED ARROW SALES CO.

Dept. A, 63 East Broadway, New York 2, N. Y.
Phone—Cortlandt 7-5425

NOW-You can help protect your community by building FTB AIR-RAID ALARM UNITS

HERE is a made-to-order opportunity for radio engineers, custom equipment builders, parts jobbers, servicemen, and technicians to cooperate with local Civil Defense organizations, by building and selling air-raid alarm equipment:

Although more than 17,000 communication transmitters are being operated by police, fire, taxicab, public utilities, and other services, in addition to 700 FM broadcast stations, no standard equipment is available to transmit air-raid warnings over these existing facilities!

Only now, information has been released on simple, positive, inexpensive equipment for use with these transmitters to alert Civil Defense personnel without divulging advance alarms to those not authorized to receive them.

THE FTB SYSTEM: Known as the FTB Air-Raid Alert Alarm, this system has been developed, tested, and perfected by Frederick T. Budelman, vice president in charge of engineering for Link Radio Corporation, one of the leading manufacturers of radio communication equipment.

It employs a simple signaling device which can be attached to any communication or FM broadcast transmitter without interfering with normal operation. The alarm unit, with standard white, yellow, and red lights, can be connected to any suitable receiver without interfering with normal speaker reception.

The FTB Alarm meets the basic requirement of fail-safe operation. That is, the alarm unit immediately indicates any failure at the transmitter or receiver.

A JOB FOR YOU: Put your knowledge of radio and your skill in building equipment at the service of your community by building FTB Air-Raid Alert Alarm units. In this way, you can make an important contribution to the protection of life and property in your area, and realize a reasonable profit from your efforts. Here's how:

INEXPENSIVE, EASY TO BUILD: The FTB signaling device and the alarm

units can be built readily by anyone familiar with radio apparatus construction. No alteration of the transmitter or receivers is required. Positive operation can be obtained up to the normal range of the transmitter, generally 20 to 40 miles.

The cost of the signaling device and 50 alarm units would probably be less than the price of a single high-power siren. All the parts are standard items, readily available.

COMPLETE INFORMATION: As a public service, Mr. Budelman is making the complete information on the FTB Air-Raid Alert Alarm system available to the radio fraternity through RADIO COMMUNICATION Magazine. This data, fully illustrated with photographs and diagrams, will appear in a series of articles as follows:

FEBRUARY: How it Works. An overall description of the system, and the method of fail-safe operation.

MARCH: FTB Signaling Device. How to build and install it in any communication or FM broadcast station.

APRIL: FTB Alarm Unit. How to build and connect it to any type of receiver.

MAY: Fixed-Frequency Receiver. For the benefit of those who want to construct special receivers, the fourth article will show how to build a miniature fixed-frequency receiver to operate the FTB Alarm Unit.

This information will be supplemented with reports on actual installations for Civil Defense organizations.

YOUR PLAN OF ACTION: Get the technical information on the FTB system at once by ordering a subscription to RADIO COMMUNICATION Magazine. Then you will be prepared to work out a plan with your local Civil Defense officials for the use of FTB units. Act at once, while there is time to get under way, and while funds are still available for purchasing Civil Defense communication equipment. The February issue will be sent to you by *return mail*, so you can get started without delay. Use the coupon below.

WHY THE FTB SYSTEM IS SO IMPORTANT

A survey of equipment for air-raid warnings in public buildings, stores, hotels, and industrial plants, and for alerting the personnel of Civil Defense organizations reveals these astonishing facts:

No Radio-Operated Alarms: Although every city and practically every town has one or more radio communication system operated by police, taxicab, public utility, or other services, no radio-operated alarm devices are available or have ever been built commercially for use as air-raid warnings.

Telephones Are Too Slow: In other words, up to this time we have had no practical means for utilizing communication transmitters already on the air to broadcast alarms instantly to every person who must be alerted as soon as advance warning is received of approaching planes. The only method now available is to use the telephone, making one call after another, and skipping those who do not answer quickly. That process is so slow that bombs could fall long before *advance* warnings could be completed!

Sirens Aren't Adequate: Sirens are useful only as a general warning to the public. Even for that purpose, as was determined in the recent New Jersey tests, only a part of the people can hear them. Sirens *cannot be used* to alert Civil Defense personnel, because they must go into action *before any warning* is sounded for the public.

Time Is Very Short: Some \$300,000,000 have been set up for the purchase of communication equipment by local and state Civil Defense organizations, but radio-operated alert alarms, most needed items of all, simply aren't available for them to buy. Now, at this late date, although a design has been perfected at last, the only way the units can be obtained quickly is through the cooperation of local radio engineers and technicians.

You can help in this unusual emergency, but the situation calls for fast action. The coupon below will bring you the necessary information so that you can survey your local requirements and act quickly, while there is still time.

RADIO COMMUNICATION MAGAZINE Radio Building, Great Barrington, Mass.
Please enter my subscription to start with the February issue, so that I shall have Mr. Budelman's complete series on the FTB Air-Raid Alert Alarm. I enclose:
<input type="checkbox"/> \$3.00 for 1 year (12 issues)
<input type="checkbox"/> 6.00 for 3 years (36 issues)
YOU SAVE \$3.00
Name
Address
Foreign, add \$1.00 per year — Canada 50c

RADIO COMMUNICATION (FM-TV) Magazine

Published by Milton B. Sleeper

Radio Building Great Barrington Massachusetts

Let **MILTON S. KIVER** Help You
Prepare For **COLOR TV**
And...

**TELEVISION
SERVICING**

Easy to TRAIN AT HOME This Practical Way!

Men with the right training in Television Servicing are in big demand... pull down big pay. T.C.I. TRAINS YOU RIGHT with easy-to-follow technical training designed by servicemen, for servicemen! You learn practical, professional type Television Servicing without leaving your present job. Included are money-making extras such as set conversion, master antenna installation, COLOR TV and field servicing short cuts. You can start earning Television money after the first few lessons. You learn to test, trouble shoot and repair all types of TV sets. You learn **COLOR CONVERSION** too!

HERE'S HOW YOU GET EXPERIENCE!

You train on your own large screen RCA 630TS type television receiver, furnished as part of your course. We loan you test instruments. As an optional feature you can get two weeks of actual field experience out on service jobs and on the repair bench for Chicago's largest independent servicing organization. You learn Television Servicing by *actually doing* Television Servicing... you get the *practical* know-how you need to qualify for **BIG MONEY** in this fast-growing field! Age is no barrier. Many TCI students are over 40!

ACT NOW! Fill out and mail coupon for FREE Catalog and SAMPLE LESSON. Write TODAY!

**TELEVISION COMMUNICATIONS
INSTITUTE**
205 W. Wacker Dr., Dept. LG, Chicago 6, Ill.

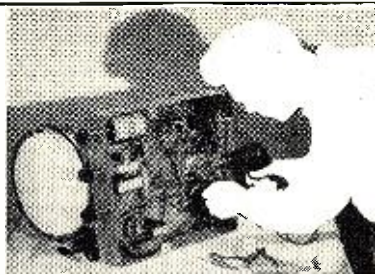

YOU GET and keep famous RCA 630 TS type Television receiver.

YOU DO actual testing, servicing, trouble shooting and repairing.

FOR THE BEGINNER
TCI offers a low-cost Pre-Television Course in Radio, especially designed to prepare you for television in just 5 to 7 weeks. Everything you need from basic radio through servicing... to Television.

MAIL NOW FOR FREE BOOKLET

MILTON S. KIVER, President
TELEVISION COMMUNICATIONS INSTITUTE
205 W. Wacker Dr., Dept. 1-G, Chicago 6, Ill.

O. K. Mr. Kiver! Rush FREE Catalog on your practical home study course in Television Servicing, including COLOR TV. Include FREE Sample Lesson. I am not obligated. Salesman will not call.

Name..... Age.....
Address.....
City..... Zone..... State.....
BEGINNERS check here for information on Pre-Tel Radio Course.

Leotone

- POWERFUL "ALNICO CHIP MAGNETS"**—irreg. shapes (100 pcs./oz.) 15c oz. lb. \$1.50
- ALNICO MAGNET**—powerful Bar, Block, Rod, etc. Kit of 10 ass'd. \$1.98
- WRITE FOR ALNICO MAGNET FLYER**
- RUBBER SHOCK MOUNTS**—8 lb., 1 1/4" 12c; 10/1.00
- TUBE CARTONS**—Plain white (prices per 100)
Min. (1" sq. x 2 3/8") 20c; 1 1/2" sq. 30c;
3 1/4" x 5 1/4" Med. (1 1/2" sq. x 4 3/8") \$1.55;
Large (2" sq. x 5")
- TU-17 TUNING UNITS** (BC-223) 2-3 Mc. New. 2.49
- SPONGE RUBBER**—3" x 3/16" Lgths to 12 ft. 10c/ft.
- WALL JACK** for PL-35 plugs, etc. 29c. 4/1.00
- AC-DC BLOWER** (Delico)-3V, 24 blade impeller. Less hsg. 5400 RPM. 27V, 1 1/2 A. 2 1/2 x 5". 3.95
- HI-FREQ. ANTENNA** (AN-74)—100-156Mc. 30"L. .89
- ANEROID THERMOMETER**—2" rhd. 100°-260°F. 1.29
- PLUG-IN COIL FORMERS**—Pin. 4 3/8" x 2 1/4" L. .19
- 1/4" SHAFT LOCKS** for std. controls. .29
- "GUNCOR" INPUTS**—30 ~ grid (1/2" x 1 1/4") .98
- WIDGET PLUG & JACK**—PL-291 (36-48) 6/1.98
- GENERATOR VOLTAGE REGULATOR** (GBO-A-18)—24 cont. adj. relay. Shock-mtd. 1.98
- 4 MFD—600V. OIL COND.**—upright, nut mtg. 1 1/2" x 4 1/2" .59
- .05 MFD—600V. OIL COND.**—1" x 1 1/2" 12c; 10/1.00
- 1/8" GLOSSY BLACK BAKELITE**—6" x 7" 45c; 6" x 8" 49c; 6" x 10" 59c; 6" x 12" pair .29
- 5" SPEAKER BAFFLE**—1/4" insonite-19c; 6/1.00
- SPST CURRENT RELAY**—N.O., 3/4" cont., 24VDC 1.29
- 2830 Mc. HF (SCR-274)**—Plug-in. 25c; 3/1.00
- RADIO HARDWARE TREASURY**—FULL POINT of Nuts, Screws, Lugs, Washers, etc. in CAN. .69
- CABINET & CHASSIS FOUNDATION**—modern plastic (Walnut or Ebony) 5 tube punched fitted chassis. Overall: 11 1/2" x 9" x 7" 1.79
- BUTTERFLY CONDENSER**—360° rot. 5-15mmf. 4 part rotor & Stator. 1" plate nut. cond. 4" x 4 1/4" x 5 1/4" 1.95

- HEARING AID BONE CONDUCTION RECEIVER**, Exc. MUSICAL CONTACT MIKE or MIN. SPKR. 1/2" x 3/4" x 1 1/2" Impedance. 5/2.49
- HEARING AID AMPLIFIER** (2 tube) MAKE A REAL VEST POCKET RADIO add simple tuner. 1 1/2" x 2 1/2" x 3" WITH SCHEMATIC FOR 2 or 3 TUBE SET. Less tubes, case. 2.49
- HEARING AID TUBES** for above amplifier. Set of 2. 2.49
- SUB-MINIATURE TUBES**—CK-503 or 505. 1.49
- P-23 HEADSETS**—5 ft. cord & PL-55 plug. 4/1.96
- RUBBER PHONE CUSHIONS**—12/1.39
- HB-7 HEADBAND**—leather; 13" cord & PL-54. .39
- HB-1 HEADBAND**—thumbscrew adj. forks 39c; 6/1.98
- HB-30 HEADBAND**—for 30 phones. 1.55; 3/1.00
- HS-30 MATCHING TRANSFORMER**—low to hi-Z .49
- DPDT TOGGLES** (C-H)—20A/125V Sprg. ret. 1.39
- DIAL DRIVE SPRINGS**—1 1/2" 25c; 100 ft. 1.98
- DIAL CORD**—nylon & linen 10 ft. 23c; 100 ft. 1.98
- ROTARY SELECTOR SWITCHES**—incl. multi-deck, multi-contact. Kit of 6 ass'd. 1.49
- SPRING ASS'TMENT**—tension, comp. 40 ass'd. 1.98
- RESISTORS**—carb. v.v.v.; ferrule-end. 25 ass'd. .79
- EXPERIMENTAL TUBES**—for Test. Research. Fil. tested. 20 ass'd; receiving tubes. 1.00
- RF. ANT. & OSC. COILS**—kit of 10 ass'd. .98
- MOUNDED BAKELITE CONDENSERS** (Micamold)—30 ass'd; .00001 to 2mf.; 20V to 500V. 1.98
- PRECISION RESISTORS**—1% to 400K ohms. 10/1.98
- WIRE-WOUND RESISTORS**—5-20W. 15 ass'd. 1.29
- Min. order \$3.00. 20% deposit req. on all COD's. Full remittance with foreign orders. Please add sufficient postage—excess refunded.

LEOTONE RADIO CO.
65 York Street
New York 7, N.Y.

OUTSTANDING - TV - VALUES

- MODEL #300**
Folded dipole complete with reflector and high frequency adapter. Covers 13 channels. All alum. construction. Less mast. Shpg. wt. 7 lbs. PRICE.....\$4.95
- MODEL #200-D**
Stacked array. Consists of 2 complete conicals and connecting bar. Very rigid construction. Covers all 13 channels. Matches 300 Ohm or 72 Ohm. Center impedance 150 Ohm. Ideal for low signal areas. An outstanding buy. Shpg. wt. 12 lbs. SENSA-TONAL. OFFER at, less mast. \$9.75
- MODEL #200-S**
Single array. Same construction as above. Shpg. wt. 7 lbs. Price, less mast.\$4.50
- MODEL #500**
All-band folded dipole antenna. Ideal for rotator use. Maximum gain on any channel. All alum. construction. Less mast. Shpg. wt. 8 lbs. Price.....\$5.25
- MODEL #Y-100**
5 element Yagi Hi-Gain beam designed specifically for fringe area use. All alum. construction. Cu to specific channels. Shpg. wt. 4 lbs. Channel #7, \$5.80; Channel #9, \$5.20; Channel #11, \$4.60; and Channel #13, \$4.00. The prices are less mast. "V" type antenna. Price \$4.25
- FULLY AUTOMATIC BOOSTER**—automatic on-off, automatic tuning, concealed installation, single or dual input, full band width on all channels, high uniform gain. 19 db on low 2-6, FM and 14 db on high 7-13. Specially priced.....\$29.95
- ANTENNA ACCESSORIES**
- CM-100 Chimney Mount.....\$ 1.50
WM-104 Wall Mount 4"..... 1.25
WM-107 Wall Mount 7"..... 1.25
U-100 "Universal" Ant. Mtg. Bkt. Offset to 8" Price 1.00 but Offset to 12"..... 3.95
U-200 Same as U-100 but Offset to 12"..... 6.95
3 1/2" 300-ohm stand-off insulators for coax cable. Per 100, \$3.00; per 500, \$12.00; per 1000, 20.00
- Best Quality 300-ohm twin lead—Send for prices.
High Quality 72-ohm Coax Cable—Send for prices.
Folded Dipole Hi-Frequency Adapters..... 1.50
Straight Dipole Hi-Frequency Adapters..... 1.50
- TERMS:** All shipments F.O.B. Newark, New Jersey. 25% deposit with orders. Balance C.O.D. Minimum order \$2.00. include ample postage.
Prices Subject to Change Without Notice
- EAST COAST ELECTRONICS**
39 George St. Dept. 3-N Newark 5, New Jersey

ferred to in the control circuit is one used several times before, and involves reworking the 115 volt a.c. coil of the antenna relay, RL₂. The winding is carefully bared, and unwound to a point (determined by ohmmeter or direct voltage measurement) that will produce approximately 6 volts. A careful solder job is done at this point, the connection fully insulated, and the wire then rewound firmly and secured by *Mystik* tape and the original glued-on paper. Connected across this tape, the "B+" pilot (6.3 volts) automatically indicates when the 'beans' are on, whenever the relay is energized. We like the system, since it allows for use of small-sized jewel indicators, but it does involve some tedium and care (both of which are cheaper than the 1" variety of light which would otherwise be necessary).

Layout and drilling of the panel was done after completion of the remainder, to avoid damage to the *Masonite*. We recommend this, using the meters, etc., separately at first.

Now that the unit is complete, we feel that the time, money, and labor were well spent, since the finished product represents what a large percentage of apartment-dwellers of the ham fraternity are looking for in the way of a transmitter. All that is necessary is a mike, key, receiver, and antenna, plus a 115 volt a.c. source, and you're on the air without fuss, muss, or "eyesore" annoyance. Operation is a pleasure—fone/c.w. operation is a question of a second; voice quality and carrying power are very good, according to reports; keying is clean; stability excellent; bandchanging involves turning one switch and plugging in one coil; no v.f.o. "birdies" when on "Receive," and frequency spotting is quick (by killing final with S₁ and modulator with S₂*, band wanted with S₁ and checking receiver). What more could a cooped-up ham ever want in the way of a rig? We're happy again!

-30-

CARBON TET GUN

CARBON tet is an excellent agent for cleaning noisy switches, controls, etc. However, most of the time it is a problem to get the carbon tet in the right spot to do the job.

A very good solution to this problem is to purchase a pump oil gun, fill it with carbon tet, aim—and fire away. A bull's-eye every time. . . . M.K.

Method for applying carbon tet to radio parts by means of a pump oil gun.

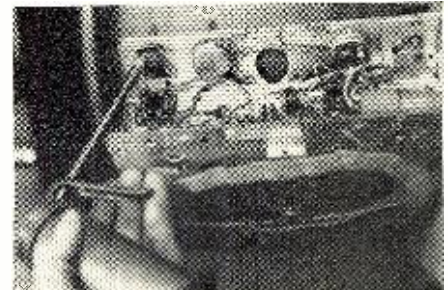

NOW MORE THAN EVER BEFORE...

YOU'LL WANT FIRST CHOICE OF TOP VALUES IN TV, RADIO & ELECTRONICS

CONCORD OFFERS OUTSTANDING BARGAINS

THE MODERN CONTROL MECHANISM

Sessions SWITCH TIMERS

Especially designed for turning radios, Television sets, Air Conditioners, & other common household appliances on and off automatically. Offers the best in timer movements. Easily installed as replacement unit in

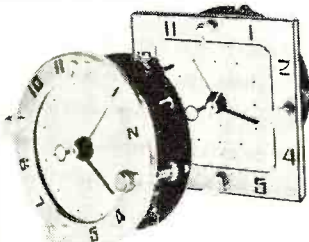

old clock-radios. All controls, including on-off, switch set, time set, and "Sleep Selector" are conveniently located on front of attractive clock face. "Wake-up" feature turns your radio on in the morning or turns on any desired program at any pre-set time within a 12 hr. period. Special safety feature turns off controlled appliance within 1-1/2 to 2 hrs. should you forget to turn it off manually. "Sleep Selector" lets you go to sleep with your radio playing and turns it off at a pre-set elapsed time up to 90 min. Has low speed, long life motor... built compactly, neat in appearance extremely quiet in operation... no buzz or whine of high speed gears. Size: 3-1/2" dia., 2" deep from clock face. Bezel finished in polished brass. Shipped complete with mounting bracket, and mounting and operating instructions. Switch rating 10 amps at 115 v. For 110 V, 60 cycles AC. UL approved. 33-25472R - Model W-31 - Shpg. wt. 3 lbs. Net. **6.50**

As above except with 3-1/2" square face and bezel. 33-25492R. Net. **6.50**

Model W-26, same as W-31 except without "Sleep Selector" and has switch rating of 15 amps at 115 volts. 33-25473R. Net. **5.50**

As above except with 3-1/2" square face and bezel. 33-25493R. Net. **5.50**

TIMER CASE



Attractively finished in rich, hand-rubbed mahogany... a perfect housing for the round bezel Sessions Switch Timer described above. Overall size: 6-1/2" W; 4-1/2" H; 2-1/4" D.

33-25494R. Net. **2.50**

6-VOLT STORAGE BATTERY

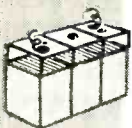

Brand new Willard Midget 6 volt storage battery. 3 amp hr. rating. Housed in sturdy transparent plastic case. Size: 3-5/8 x 1-13/16 x 2-3/8" high. Uses standard electrolytics. Limited quantity... Order now. Don't miss this good deal. 99-6510R. Ea. **2.65**

1/150 HP ELECTRIC MOTOR



Shaded pole, single phase 1/150 hp 1500 RPM motor that can be utilized to drive fan in power tube or other electronic cooling systems and for hundreds of other applications requiring a fractional horsepower motor. Has bronze bearings that assure long, dependable service; 3/16" shaft, 3-1/2" long. Complete with 4" leads & mounting brackets. For 115 volts, 60 cycles AC. 99-7100R - Shpg. Wt. 1 lb. **1.95**

SPECIAL! RECORDING TAPE



Best Recording Tape Buy on the market and only Concord can offer it at this Special Low Price! Made by a famous natl. manufacturer to Concord's strict specifications. 1200' long, 1/4" wide with uniform coating of red oxide particles on kraft paper base. Magnetic coating wound facing in.

Plastic reel included. Order yours Today before our supply is exhausted.

35-16297R - 1200' Kraft Paper Base Tape. Net. **1.49**
Lots of 12 - 1.35 ea.

As above but on stronger more efficient plastic base for more uniform output and lower noise level.

35-16296R - 1200' Plastic Base Tape. Net. **2.25**
Lots of 12 - \$1.98 ea.

FM-AM BASIC KIT



Exclusive Concord Basic FM-AM Kit. Build your own 8-tube (includes rect.) FM-AM tuner or 11-tube (includes rect.) complete chassis and save. Both include phono preamp for GE reluctance cartridges. All major basic parts supplied. You get:

- | | |
|----------------------------|------------------------|
| (1) 3 Gang FM-AM Condenser | (1) FM Dipole Antenna |
| (1) FM Antenna Coil | (1) AM Converter Coil |
| (1) FM Converter Coil | (1) AM Oscillator Coil |
| (1) FM Oscillator Coil | (2) AM IF xformer |
| (2) FM IF xformer | (1) AM Loop Antenna |
| (1) FM Ratio Detector | |

Easy-to-follow schematic diagram and a complete list of all necessary parts for finishing your tuner or chassis are also included. This way you're able to utilize parts you already own and make double savings. At this low price these kits won't last long, so order yours TODAY!

99-5075R - Shpg. wt 4-1/2 lbs. Net. **6.95**

YOU'RE ASSURED THIS THRU

CONCORD BUYER'S GUIDE

PUTS YOU FIRST IN LINE FOR

- Complete Listings of Available Merchandise
- Current Low Prices
- Prompt Expert Shipment
- Satisfaction Plus

SEND FOR YOUR
**FREE COPY
NOW!**



FILL IN AND MAIL TODAY

CONCORD RADIO CORP., Dept. RC-51
901 West Jackson Blvd., Chicago 7, Illinois

Please forward your latest Buyer's Guide

Name.....

Address.....

City..... Zone... State.....

BE FIRST TO KNOW WHAT'S NEW IN THE FIELD

CONCORD RADIO

"WHERE THE WORLD SHOPS"

Mail Order Center and Showroom

901 W. Jackson Blvd., Chicago 7, Ill.

EXPORT

For PROMPT Service on Export Orders & Inquiries
Address to CONCORD RADIO CORP., EXPORT DIVISION,
901 West Jackson Blvd., Chicago 7, Illinois.

FREE

OLSON AKRAD

Olson Radio Warehouse, Inc.

73 E. Mill St. • Akron 8, Ohio

Free—send for our latest Radio & Television Bargain Catalog.

TV INSTALLATION MEN

If you install TV Antennas, Olson wants you to take advantage of this terrific Antenna Value. High gain Stacked Conical Array with high frequency stubs. Ideal for "Fringe" Area Reception. Sturdily constructed elements are aluminum. Easily assembled.

This is a Terrific Value! Each Antenna consists of two conical bays plus a pair of matching Q bars. Less mast. Packed—3 Antennas to a carton. This gives you six bays and 3 pairs of Q bars.

Sold Only in Boxes of 3 Antennas

Stock No. AU-66 In lots of 3 each.....	\$8.66	Carton of 3.....	\$25.98
Weight 25 lbs.			

TV BOOSTER KIT RA-26

Build your own TV-FM booster. Improves reception on low-signal, "fringe" areas. 3 to 5 db gain in signal to noise ratio. All channel tuning. Complete with 6AK5 tube, pre-aligned coils, etc. Shpg. wt. 5 lbs.

Complete Kit \$9.95

Finest components in the manufacture of these gorgeously designed phonographs. Features include: 3 speed Alliance motor with heavy flocked turntable. 5 volt output tone arm with precious-tip needle, volume control, 2 tube built-in amplifier. Alnico 5 PM speaker, leatherette covered case with rounded corners, convenient carrying handle. Order early and order enough. Every phonograph 100% guaranteed. Original factory-seated cartons. Operates 115 volts AC or DC. Shpg. wt. 15 lbs.

TV COMPONENTS

Deflection Yoke for use with 10BP4, 12LP4, 16AD4 and all similar kinescopes, same RCA 201D1. WT. 2.2#.

T-84, Olson's Price, only... **\$3.59**

Deflection Yoke for use with kinescopes requiring 70 degree magnetic deflection such as Rectangular 14BP4, 14CP4, 16RP4, 16TF4, 16KP4 and round 16GP4. WT. 2.2#.

T-86, Olson's Price, only... **\$4.46**

Hi-Voltage Flyback output transformer for 10" & 12" kinescopes. Provides 2KV. Same as RCA 211T1. WT. 4.2#.

T-82, Olson's Price, only... **\$3.99**

300-Ohm Lead-in

High grade, low loss. For all TV installations. Shpg. wt. 3 lbs. W-68, 100 ft. coil. **\$4.00**

4 Drawer Steel Cabinet FREE with OLSON'S Gigantic AKRAD CONDENSER KIT

Olson's Price AS-20 **\$16.95**

You get \$45.20 (dist. worth of "Akraud" condensers plus cabinet. 8 1/2"x7 1/2"x10 1/2").

42 "Akraud" By-Pass Condensers!				27 "Akraud" Electrolytic Condensers			
Qty.	Cap.	Volts ea.	List Total	Qty.	Cap.	Volts ea.	List Total
2	.001	600	\$.25 \$50	2	10	25	\$75 \$150
2	.002	600	\$.25 \$50	2	25	25	\$.75 \$1.50
2	.005	600	\$.25 \$50	2	25	25	\$.75 \$1.50
5	.01	600	\$.30 \$1.50	5	20	150	\$.95 4.75
5	.02	600	\$.30 \$1.50	5	40	150	1.10 5.50
10	.05	600	\$.40 4.00	4	20-20	150	1.30 5.20
10	1	600	\$.45 4.50	5	8	450	\$.95 4.75
2	.005	1600	\$.55 1.10	4	16	450	1.35 5.40
2	.008	1600	\$.55 1.10				
2	.01	1600	\$.60 1.20				
							69 Total List Value \$45.20

Akraud TUBULAR ELECTROLYTIC

Olson "Akraud" Condensers are becoming more widely used by radio servicemen everywhere—and for a good reason! They're made to take hefty surges and overloads and pack a mighty wallop. They cost so little, too! Every "Akraud" condenser is backed by Olson's famous Satisfaction or Your Money Back Guarantee! Always get "Akraud." Compact size with superior characteristics. Easily mounted. Sealed aluminum inner tubes insure maximum life. Tinned copper leads. Give long, trouble-free service.

Stock No.	Cap.	W.V.	Each
C-136	10	25	\$0.25
C-137	25	25	.30
C-138	20	150	.45
C-139	40	150	.45
C-140	20-20	150	.59
C-200	50-30	150	.69
C-141	8	450	.39
C-211	8-8	450	.69
C-142	16	450	.77
C-197	20	450	.69
C-198	30	450	.79
C-199	40	450	.89



3-SPEED PHONOGRAPH Special \$19.97 RA-56

Plays 78-45-33 1/3 RPM Discs

Complete

Finest components in the manufacture of these gorgeously designed phonographs. Features include: 3 speed Alliance motor with heavy flocked turntable. 5 volt output tone arm with precious-tip needle, volume control, 2 tube built-in amplifier. Alnico 5 PM speaker, leatherette covered case with rounded corners, convenient carrying handle. Order early and order enough. Every phonograph 100% guaranteed. Original factory-seated cartons. Operates 115 volts AC or DC. Shpg. wt. 15 lbs.

ASTATIC PROFESSIONAL

Has all advantages of low pressure design. For Broadcast and Recording Studio use. Ball bearing swivel base, accurately counter balanced arm for one ounce needle pressure. Plays up to 16" discs. Astatics Model No. HP-16. Overall length 15 in. Equipped with Astatic LP-21 cartridge and precious tipped stylus. Regular list price \$25.00.

Stock No. M-72 each **\$5.95**

POWER RELAYS

Genuine Potter and Brumfield relay. Single pole, single throw. Normal position open. Finest coil, silver contacts. Wiping action assures good contact. Size 3"x1 1/4"x1 3/4". Coil operates on 115 volts AC.

X-229 Olson's Price, Only... **\$1.39**

PHONOGRAPH RECORDS

"TIME TO SLEEP." A 12", 78 RPM, unbreakable disc in album form. Features the World Famous magician Ralph Slater. Designed to put anyone to sleep. Save money. Thousands sold at \$3.75.

SHPG. wt. 3 lbs.

X-242, your cost, per album only. **\$1.29**

BATTERY ELIMINATOR MODEL P \$10.95

Converts portable battery sets to all-electric AC. Will give years of dependable, trouble-free service. Supplies 1.4 volts "A", and 90 volts "B" power for 4 to 6 tube sets.

Close Out Entire Stock CORNELL-DUBILIER CONDENSERS

Save big money during Olson's big C-D close-out sale. Over 35,000 brand new shiny electrolytic condensers will be purchased by Olson's customers. Be sure of getting your share. Order early.

Stock	Fig.	Capacity	Volts	Close-out Price
C-530	A	8	450	\$.05.59
C-510	B	15	300	.29
C-504	B	10-10-20	450-450-225	.39
C-617	B	20-10-10-10	450-450-450-450	.99
C-502	C	32	350	.39

Cornell-Dubilier Paper Filter Block

Hard to get, but Olson has these 4 MFD 400 volt tough condensers. Not Electrolytic. Dry construction throughout. Size 3 1/2"x2"x1". Reg. list price \$2.95.

C-523 Olson's Price, each... **49c**

TL-3 FAIRCHILD GRINDER \$9.98

Every service shop needs one of these handy tools made by Fairchild, famous manufacturer of precision electric grinders. Regular nationally advertised price is \$19.75. The set consists of 1-1 1/2 volt high speed, air cooled grinder, 6 assorted grinding wheels, 1 circular saw blade, 1 hardened steel reamer, 1 buffing brush, 1 abrasion stone and a natural finish wood case size 10"x5"x3". To house the grinder. Shipped in original factory sealed cartons.

AM-FM RADIO CHASSIS \$49.95

It's a beauty! Comes to you with eight tubes. Stock No. RA-52

It's new! Never offered before by any jobber! A high quality, high-fidelity radio that you will be proud to own. You'd expect to pay more but Olson made a remarkable deal with the manufacturer. When present stock gone, this set will be no more. This receiver can be used in combinations selling from \$350.00 to \$500.00. It's a perfect unit for custom building into cabinets. Two dual controls are provided for simplicity of operation. Wide vision, easy to read dial. This radio cannot be beat for quality and precision.

Any PM speaker can be used with this set. Choose one from this flyer. Set is supplied with 8 tubes—2AT7, 1-6BE6, 2-6BA6, 1-6AL5, 1-6AV6, 1-6V6GT, 1-5Y3GT, less speaker. Individually packed in factory-sealed cartons. Chassis size 13 1/8"x7 1/16"x8 7/8".

Olson's Great Bargain of the Year

GIANT COMBINATION DEAL \$10 Worth of RCA Records and Phonograph \$19.97 RA-60

Compact beautifully performing phonograph for all 78 RPM records. Amplifier employs 2 tubes, 50-L-6 and 35-Z-5. Only the finest components are used, such as Alliance Rim-Drive Motor, Astatic Phono arm with L-82 cartridge, PM speaker, full range volume control, etc. The case is decorated with colorful circus figures. Operates on 115v. AC. Weight 11 lbs.

RCA VICTOR NON-BREAKABLE RECORDS INCLUDED

Yes, with the phonograph you get approximately \$10.00 worth of RCA Victor non-breakable discs for children. Titles include "Happy the Humberg," "The 500 Hats of Bartholomew Cubbins," "Rapunzel," "Aladdin and His Lamp," etc. Discs are enclosed in beautifully illustrated colored folders giving each story so that the child can follow the recording. Quantity Limited—Offer Will Not Be Repeated.

STEEL RECORDING WIRE

For all standard wire recorders. Frequency response is excellent. Stainless steel wire.

X-165	1/2 hr. spool.....	\$1.98
X-166	1 hr. spool.....	\$2.98

RECORDING TAPE

Fine magnetic recording tape. Frequency response, 50 to 8,000 cycles at 7 1/2" per second. Uniformly coated with red oxide. Available in paper base and plastic base which is stronger. Order your recording tape from Olson. Get the best for less.

Stock No.	Size	Type	Price, ea.
X-203	1/4"x600 ft.	Paper	\$1.35
X-204	1/4"x600 ft.	Plastic	2.10
X-205	1/4"x1200 ft.	Paper	2.10
X-206	1/4"x1200 ft.	Plastic	3.30

OLSON'S GIGANTIC NEW AKRAD KIT—WITH 4-DRAWER STEEL CABINET FREE \$6.95

Reg. List Price \$18.38. AS-36, Olson's Special Price

We have a limited quantity of Olson Akraud "Super Sealed" by-pass condensers available in 4 drawer steel cabinets, size 6 1/4"x3 3/8"x8 1/2". Drawers have compartments. Condensers are designed to give long dependable service even in the tropics.

Kit Contains 42 Condensers

You get the 4 drawer steel cabinet and the following 42 Olson Akraud "Super Sealed" by-pass condensers.

Qty.	Cap.	Volts	Qty.	Cap.	Volts
10	.001	600	10	.05	600
10	.002	600	10	.1	600
2	.005	600	2	.005	1600
2	.01	600	2	.008	1600
2	.02	600	2	.01	1600

Qty.	Cap.	Volts	Qty.	Cap.	Volts
10	.001	600	10	.05	600
10	.002	600	10	.1	600
2	.005	600	2	.005	1600
2	.01	600	2	.008	1600
2	.02	600	2	.01	1600

OUTPUT TRANSFORMERS

T-87 UNIVERSAL OUTPUT TRANSFORMER—Matches any single tube to any 3.2 ohm voice coil. Primary tapped at 2,000, 7,000, 10,000 ohms. 2 inch mounting centers. List Price \$2.50.

99c

T-21	Matches single 50L6, 35L6, 35AS, 25L6 to voice coil; 2000 ohms pri., 2" mtg. ctr.....	69c
T-57	Matches single 6V6 to voice coil. 2 3/8" mtg. ctr.....	69c
T-58	Matches push-pull 6V6's to voice coil. 2 3/8" mtg. ctr.....	79c
T-59	Matches single 6F6 to voice coil. 2 3/8" mtg. ctr.....	69c
T-60	Matches push-pull 6F6's to voice coil. 2 3/8" mtg. ctr.....	79c

AM-FM RADIO CHASSIS \$49.95

It's a beauty! Comes to you with eight tubes. Stock No. RA-52

It's new! Never offered before by any jobber! A high quality, high-fidelity radio that you will be proud to own. You'd expect to pay more but Olson made a remarkable deal with the manufacturer. When present stock gone, this set will be no more. This receiver can be used in combinations selling from \$350.00 to \$500.00. It's a perfect unit for custom building into cabinets. Two dual controls are provided for simplicity of operation. Wide vision, easy to read dial. This radio cannot be beat for quality and precision.

Any PM speaker can be used with this set. Choose one from this flyer. Set is supplied with 8 tubes—2AT7, 1-6BE6, 2-6BA6, 1-6AL5, 1-6AV6, 1-6V6GT, 1-5Y3GT, less speaker. Individually packed in factory-sealed cartons. Chassis size 13 1/8"x7 1/16"x8 7/8".

BUILD 15 RADIOS At Home

WITH THE NEW IMPROVED 1951
PROGRESSIVE RADIO "EDU-KIT"

\$19.95
ONLY ...

**FREE TOOLS
WITH KIT**

ABSOLUTELY NO
KNOWLEDGE OF
RADIO
NECESSARY

NO
ADDITIONAL
PARTS
NEEDED

EXCELLENT
BACKGROUND
FOR TELEVISION

10-DAY MONEY-BACK GUARANTEE

**WHAT THE PROGRESSIVE
RADIO "EDU-KIT" OFFERS YOU**

The Progressive Radio "Edu-Kit" offers you a home study course at a rock bottom price. Our Kit is designed to train Radio Technicians, with the basic facts of Radio Theory and Construction Practice expressed simply and clearly. You will gain a knowledge of basic Radio Principles involved in Radio Reception, Radio Transmission and Audio Amplification.

You will learn how to identify Radio Symbols and Diagrams; how to build radios, using regular radio circuit schematics; how to mount various radio parts; how to wire and solder in a professional manner. You will learn how to operate Receivers, Transmitters, and Audio Amplifiers. You will learn how to service and trouble-shoot radios. In brief, you will receive a basic education in Radio exactly like the kind you would expect to receive in a Radio Course costing several hundreds of dollars.

THE KIT FOR EVERYONE

The Progressive Radio "Edu-Kit" was specifically prepared for any person who has a basic knowledge of the English language, and has the desire to learn Radio. The Kit contains the necessary parts by young and old in all parts of the world. It is not necessary that you have even the slightest background in science or radio.

The Progressive Radio "Edu-Kit" is used by many Radio Schools and Clubs in this country and abroad. It is used by the Veterans Administration for Vocational Guidance Training.

The Progressive Radio "Edu-Kit" requires no instructor. All instructions are included. All parts are individually packaged and identified by name, photograph and diagram. Every step involved in building these sets is carefully explained. You cannot make a mistake.

PROGRESSIVE TEACHING METHOD

The Progressive Radio "Edu-Kit" comes complete with instructions. These instructions are arranged in a clear, simple and progressive manner. The theory of Radio Transmission, Radio Reception and Audio Amplification is clearly explained. Every part is identified by "Doing" and diagram; you will learn the function and theory of every part used.

The Progressive Radio "Edu-Kit" uses the principle of "Learn by Doing". Therefore, you will build radios to illustrate the principles which you learn. These radios are designed in a modern manner, according to the latest principles of present-day educational practice. You begin by building a simple radio. The next set that you build is slightly more advanced. Gradually, in a progressive manner, you will find yourself constructing still more advanced radio sets, and doing work like a professional Radio Technician. Altogether you will build fifteen radios, including Receivers, Amplifiers and Transmitters.

THE PROGRESSIVE RADIO "EDU-KIT" IS COMPLETE

You will receive every part necessary to build 15 different radio sets. This includes tubes, tube sockets, variable condensers, electrolytic condensers, mica condensers, paper condensers, resistors, tie strips, coils, tubing, hardware, etc. Every part that you need is included. In addition, these parts are individually boxed, so that you can easily identify every item.

TROUBLE-SHOOTING LESSONS

Trouble-shooting and servicing lessons are included. You will be taught to recognize and repair troubles. While you are learning this practical way, you will be able to do many a repair job for your neighbors and friends, and charge fees which will far exceed the cost of the Kit. There is an opportunity for you to learn radio and have others pay for it.

FREE EXTRAS IN 1951

- ELECTRICAL AND RADIO TESTER
- ELECTRIC SOLDERING IRON
- BOOK ON TELEVISION
- RADIO TROUBLE-SHOOTING GUIDE
- MEMBERSHIP IN RADIO TELEVISION CLUB
- CONSULTATION SERVICE
- QUIZZES

The Progressive Radio "Edu-Kit" is sold with a 10-day money-back guarantee. Order your Progressive Radio "EDU-KIT" Today, or send for further information.

**PROGRESSIVE
ELECTRONICS CO.**

497 UNION AVE.
DEPT. RN-3 BROOKLYN 11, N. Y.

Technical BOOKS

"APPLICATION OF THE ELECTRONIC VALVE" by Dr. B. G. Dammers, J. Haantjes, J. Otte & H. Van Suchtelen. Published by *Philips' Industries*, Eindhoven, Holland. Distributed by *Elsevier Publishing Co.*, New York. 413 pages.

This fourth volume dealing with the use of electronic tubes in radio receivers and amplifiers is designed for engineers, technicians, and advanced students of the art.

The book is divided into five main sections, each of which is subdivided into more specific topics. The first section deals with r.f. and i.f. amplification and covers single-tuned circuits, bandpass filters, circuits for the reduction of shunt damping, r.f. amplification, and i.f. amplification. The section dealing with frequency changing has chapters on mixing, the properties of oscillator circuits, circuits for constant oscillator voltage, the design of the parallel-fed oscillator circuit, squegging oscillator, interaction between oscillator and input circuits, some results of electron transit time, and frequency drift. The third section covers the determination of the tracking curve and includes calculation of the circuit constants and corrections of the calculated tracking curve.

The section of the book dealing with the parasitic effects and distortion due to curvature of tube characteristics has data on r.f. and i.f. amplifying tubes, distortion in mixing tubes, the measurement of the parasitic phenomena, and whistles. The final section on detection gives information on detector circuits and diode detection under different circumstances.

Like the preceding volumes of this series reviewed in this magazine, this text is a scholarly treatment of the subject matter and an excellent source book for those actively engaged in design work on receivers and amplifiers. The treatment is mathematical throughout and a complete comprehension of the subject will come only with a healthy, working knowledge of mathematics.

* * *

"TV AND OTHER RECEIVING ANTENNAS" by Arnold B. Bailey. Published by *John F. Rider Publisher, Inc.*, New York. 581 pages. Price \$6.00.

This book is a happy combination of both theoretical and practical material on the subject of receiving antennas, with special attention being given to the television antenna.

Designed for television engineers, television technicians, antenna design engineers, students, teachers, hams, and broadcast station personnel, this text is a logical development of the subject matter. Treatment is straightforward and generally non-mathematical.

The author has divided his subject matter into twelve main topics cov-

ering a review of definitions and antenna terminology, the television signal and its bandwidth, problems in television reception, the electromagnetic wave, the radio path, the theory of signal interception, the center-fed zero-db. half-wave antenna, a comparison of zero-db. half-wave antennas, parasitic-element antennas, horizontally-polarized antennas, vertically-polarized antennas and special types, and the practical aspects of TV receiving antennas.

The author's tremendous grasp of his subject has not caused him to lose sight of the immediate problem of imparting this knowledge in an understandable fashion. The book should find wide audience among both beginning and advanced students of the subject.

* * *

"AUTOMATIC RECORD CHANGER SERVICE MANUAL" by Sams Staff. Published by *Howard W. Sams & Co., Inc.*, Indianapolis. Price \$3.00. Paper. Volume 3.

This third volume of record changer service data covers the years 1949 and 1950.

Included are not only the latest models of the three-speed record changers but also valuable information on wire and tape recorders. The products of over fifteen manufacturers have been included in this latest volume. Each of the items covered is completely analyzed as to operating instructions, change cycle, adjustments, troubleshooting, lubrication, and replacement parts. Photographs of the top and bottom of the unit plus an exploded view are provided on each unit.

With the upsurge in the sale of combination sets and replacement changers, service technicians will undoubtedly want to add this reference book to their service libraries.

* * *

"COYNE TELEVISION CYCLOPEDIA" by Coyne Staff. Published by *Coyne Electrical and Television-Radio School*, Chicago. 727 pages. Price \$5.95.

The format of this book is a departure from the usual method of presenting such subject matter in that the topics are presented in alphabetical order rather than in their sequence in the television circuit.

Such subjects as alignment, amplifiers, antennas, biasing, capacitance, centering and centering controls, constants, crystals, dampers and damping, deflection, detectors, filters, focusing and focusing controls, gain controls, etc., are covered in order. Whether this method of presenting the subject matter will prove more advantageous than the more conventional means is yet to be proven but on the surface it appears to offer time-saving advantages.

The material is clearly and concisely written at a fairly elementary level. The text material is well illustrated with line drawings, diagrams, and photographs.

-30-

What's New in Radio

(Continued from page 82)

winding permits adjustment to pull-in as low as 1 ma. with contact pressure sufficient to carry 5 amperes. The nominal operating power is .1 watt. The design includes an adjustable armature return spring which allows easy adjustment when installing to meet unusual or variable current or voltage conditions. The armature is equipped with an adjustable residual screw which controls the ratio between pull-in and drop-out current. The LM relays are stocked in 2500, 5000, and 10,000 ohm windings and all contact combinations up to d.p.d.t.

The LS series units are smaller and adjustments are preset at the factory for maximum sensitivity and lowest differential. They are available in s.p.d.t. only with contacts for 5 amperes and windings of 2500 and 5000 ohms. Nominal operating power is .2 watt and they are adjusted to pull-in at approximately 5 ma.

LIMITING AMPLIFIER

A new amplifier which provides an automatic means of limiting the output to a safe maximum value during broadcast transmission, recording, or reproduction of sound is now available to broadcasting stations and recording studios, according to word received from the Broadcast Equipment Sections of the RCA Engineering Products Department.

By limiting the high audio peaks which occasionally occur during AM-FM broadcasting and preventing over-modulation of the transmitter, the new RCA Type BA-6A limiting amplifier permits a substantial increase in the average modulation level and there-

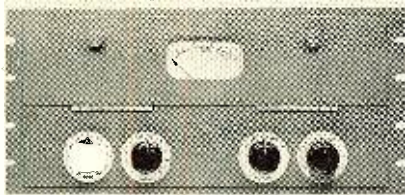

fore a greater transmitting range with the same carrier power. In recording applications the amplifier prevents overcutting of the recording disc on heavy passages of music or speech and allows a marked improvement in the signal-to-noise ratio.

Descriptive literature carrying full performance details and specifications is available from the Broadcast Equipment Section of the RCA Engineering Products Department, Camden 2, New Jersey.

TRIPLETT V-O-M

The Triplett Electrical Instrument Co. of Bluffton, Ohio has recently added a new tester to its line of service instruments.

The Model 666-RL is a compact volt-ohm-milliammeter designed to meet

March, 1951

THE GREAT NEW GHIRARDI BOOK



A. A. Ghirardi . . . the man who makes even the most complicated phases of radio-television-electronics easy to learn.

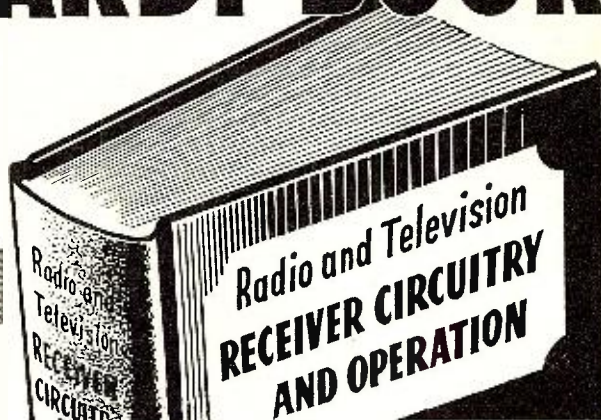

... MAKES IT EASY TO UNDERSTAND TODAY'S RADIO AND TV CIRCUITS!

Untold thousands of men now in electronics got their start from A. A. Ghirardi's world-famous "Radio Physics Course" and "Modern Radio Servicing" books. Now comes this great new book, RADIO AND TELEVISION RECEIVER OPERATION AND CIRCUITRY to fill a long felt need by getting right down to earth in helping you really understand

every detail of the design and circuit fundamentals of present day equipment. Actually, there are only a few really basic circuits in radio and TV receivers. Learn these from A to Z and even the most complicated of the countless modern circuit variations won't bother you. You'll work faster, better—and a whale of a lot more profitably!

Do You Know?

Why is a high-transconductance, low capacitance tube best for TV and FM receiver r-f amplifiers? How is a grounded-grid r-f amplifier connected? Why is this circuit so popular in TV? What is a "squelch" system? How many types of discriminators are used in FM receivers, and what are their circuits. Such are just a few of thousands of questions answered in this great book.

Here are the basic circuit and design fundamentals covered:

- Amplitude Modulation and AM Signals
- Frequency Modulation and FM Signals
- RF Amplifiers and TRF Receivers
- AM Superheterodyne Receivers
- AM Detectors and AVC Systems
- FM Receivers
- Push-Button Tuning and AFC Systems
- Audio Frequency Amplifiers
- Loudspeakers
- Radio Receiver Power Supply Systems
- Television Receivers
- Receiving Antenna Systems
- Home Recorders
- Phono Pickups & Record Players
- Automatic Record Changers
- Mechanical Construction of Receivers, etc.

... HELPS YOU HANDLE TOUGH JOBS IN HALF THE USUAL TIME

Backed with what you can learn from RADIO AND TELEVISION RECEIVER CIRCUITRY AND OPERATION, you'll find that nine out of ten difficult service jobs are tremendously simplified. Starting with a clear explanation of AM and FM processes and characteristics, it progresses to a complete understanding of ALL basic circuits, shows how they oper-

ate, teaches you to recognize them quickly. Guesswork is eliminated. Laborious testing is greatly minimized. By making it easy for you to understand each circuit and its relation to other circuits, this book helps you go right to the seat of the trouble with far less time and effort. It speeds up your work! It helps you keep abreast of new developments with less time, money and effort!

OVER 600 PAGES OF MONEY-MAKING "KNOW HOW"

Know all about the circuits you are dealing with—and watch 9 out of 10 service problems disappear! You'll know what to look for—and you'll have the "know how" that will enable you to repair troubles faster and more efficiently. In short, Ghirardi's RADIO AND TELEVISION RECEIVER CIRCUITRY AND OPERATION is the ideal book for the man who knows that the day of the "screwdriver and

pliers" service man is a thing of the past—that the way to get ahead these days is to be equipped with the real know how of the job that spells more efficient work, better jobs and bigger pay!

Send coupon today. Our 10-day Money-Back Guarantee protects you fully. If not more than satisfied, return book and your \$6 will be refunded promptly!

10 DAY MONEY-BACK GUARANTEE

Dept. RN-31, Rinehart Books, Inc.,
Technical Division, 232 Madison Ave.,
New York 16, N. Y.

Enclosed find \$6 (\$6.50 outside U.S.A.) for Ghirardi's new RADIO AND TELEVISION RECEIVER CIRCUITRY AND OPERATION book; or send C.O.D. and I will pay postman this amount plus a few cents postage. If book is not satisfactory, I will return it in 10 days and you guarantee to refund my \$6.

(Cash only outside U.S.A.—same return privilege.)

Name.....

Address.....

City, Zone, State.....

TECH-MASTER

TELEVISION

New TECH-MASTER developments!

LO-PRICED
Universal KIT

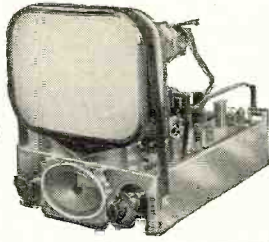

FOR TUBES UP TO 14" RECT.

First LOW-COST TV Receiver Kit completely engineered by TECH-MASTER. Features 2-knob control and small, light-weight chassis.

Model 5016
Resale Price \$89.50

Advanced
630 Type KIT

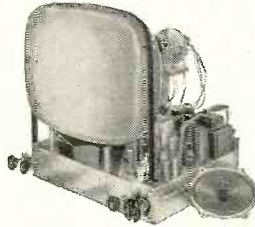

FOR ALL TUBES 12" Rd. to 20" Rect.

The greatest advance in TV Kits developed by TECH-MASTER!

Model 630D19 (DeLuxe) Principal components assembled.

Resale Price \$159.50
Model 630S19 (Standard) Unassembled.
Resale Price \$154.50

Above 3 Kits supplied with tubes, parts, speaker and pix tube mounting brackets (less Kine).
CONTACT YOUR JOBBER or write Dept. RN-3 for literature.

TECH-MASTER PRODUCTS CO.

443-445 Broadway, New York 13, N. Y.

More leading engineers and technicians have built Tech-Master for their own use than any other Television Kit.



JFD TWIN LEAD LIGHTNING ARRESTER

Protects TV Sets Against Lightning and Static Charges

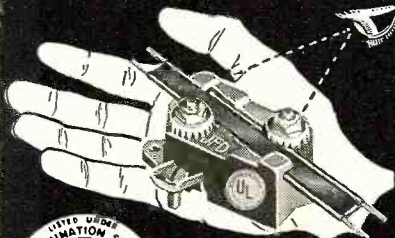

Underwriters Laboratories Approved

No. AT105
\$1.25
List



For Regular Twin Lead

SEEING IS BELIEVING!
ONLY JFD Lightning Arresters offer you these exclusive patented features...

1. Patented strain-relief Retaining Lip which prevents pulling or straining against contact points.
2. You actually see positive contact made with lead-in wire.
3. Lead-in contact remains fully visible at all times.
4. No wire stripping. No Arrester Cover to Hide Poor Contacts!

At Your Jobber or Write Direct



MANUFACTURING CO., Inc.
6105C 16th AVENUE, BROOKLYN 4, N. Y.
FIRST in Television Antennas and Accessories

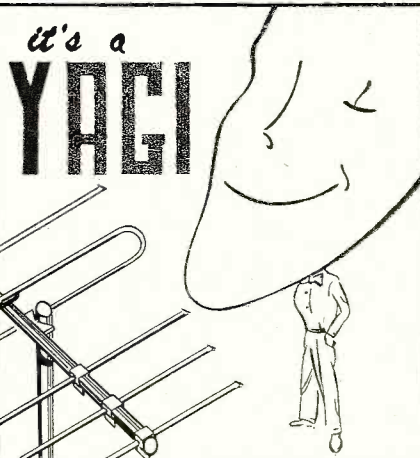

it's a
YAGI

IMMEDIATE DELIVERY

EB Series Five Element TV YAGI

MODEL 707-EB to 713-EB L.P. 7 to 13 \$8.75
Cut for any high channel

MODEL 302-EB to 306-EB L.P. 2 to 6 \$23.60
Cut for any low channel

All Elincor Yagi now furnished with transformer for matching perfectly to 300-ohm line. No stacking bars required for stacking.

Send for Literature

ELINCOR

ELECTRONIC INDICATOR CORP.

259 GREEN STREET

BROOKLYN 22, N. Y.

the need for a handy portable unit. Only one selector switch is required for all settings and the enclosed, molded switch retains contact alignment permanently.

The instrument provides a.c.-d.c. voltage ranges from 0 to 5000, 1000

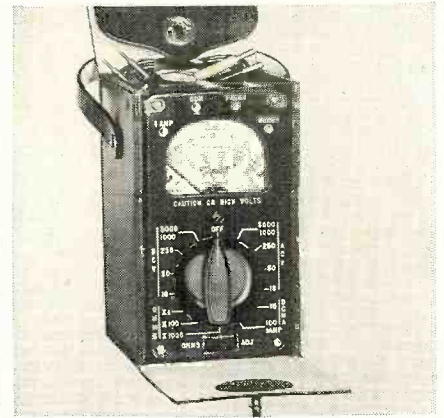

ohms per volt; direct current readings to 10 amperes; and resistance measurements of 0-3000-300,000 ohms and 3 megohms. A 3" meter is mounted flush with the panel and features black and red dial markings on a white background.

The instrument may be used in its leather case by dropping the front and top flaps. The strap handle permits hanging the tester on jobs where both hands must be free. The unit comes complete with self-contained batteries, test leads, and instructions.

NEW RECTIFIERS

The Rectifier Division of *Sarkes Tarzian, Incorporated*, 415 North College Avenue, Bloomington, Indiana is currently in production on a new "Centre-Kooled" power rectifier and an enclosed high voltage selenium rectifier.

The power rectifiers are available in 10 basic cell sizes and by employing series-parallel connections and combinations, any practical current and voltage range may be obtained. These units are applicable to battery charging, electroplating, railway signaling,

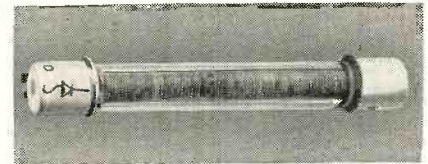

aviation, elevator control and power supply, cathodic protection uses, and wherever direct current is required or desirable.

The high voltage selenium rectifiers are available in two cell sizes with inverse voltage ratings to 5000 volts and d.c. current ratings of 5 and 25 ma. in half-wave circuits and 10 and 50 ma. in full-wave circuits.

RESONANT TUBULARS

To meet the critical i.f. bypass functions in modern receivers, *Aerovox Corporation* of New Bedford, Mass. has recently introduced a new line of resonant condensers.

RADIO & TELEVISION NEWS

Special Relays-

OVER A MILLION IN STOCK!

Whether you require large quantities of relays for production runs or single units for laboratory or amateur work, Wells can make immediate delivery and save you a substantial part of the cost.

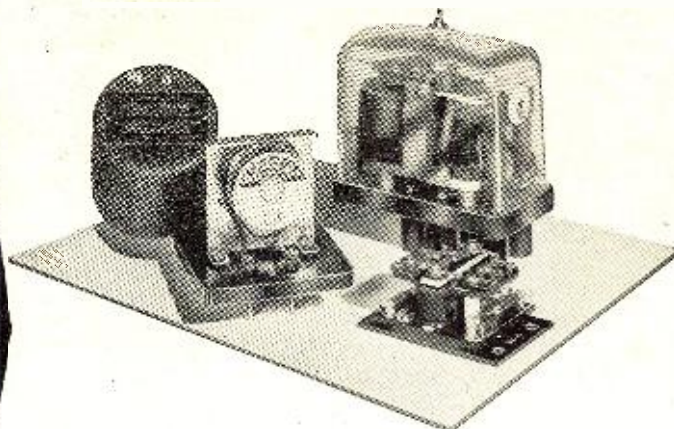

This list represents only a few types of Special Relays. We also have huge stocks of Standard D.C. Telephone Relays, Midget Relays, Contactors, Keying Relays, Rotary and Slow Acting Types as well as many others. Write or wire us about your requirements.

STOCK NO.	VOLTAGE	OHMAGE	CONTACTS	MANUFACTURER & NUMBER	PRICE
R-503	12/32 VDC.	100	3A, 2C	G.E. Ant. Keying 500W 2C6530-653A1	\$ 2.25
R-749	600 VDC.	...	Max. 28 Amps.	Allen Bradley 810 Dashpot	5.95
R-804	550 VAC.	...	1B/38 Amps.	Culter Hammer C-261173A34 Contactor	3.50
R-250	115 VAC.	...	Adj. Cir. Breaker .04-.16A	Westinghouse MN Overload	12.95
R-579	220 VAC.	...	1B	Adlake 60 Sec. Thermo Delay	6.95
R-294	27.5 VDC.	200	1B	Edison 50 Sec. Thermo Delay	4.25
R-686	115 VAC.	...	2C	Leach 1157T-5/20 Sec. ADJ. Delay	4.95
R-246	115 VAC.	...	1B	Cramer 2 Min. Adj. Time Delay	8.95
R-246A	115 VAC.	...	1A	Cramer 2 Min. Adj. Time Delay	8.95
R-611	24 VAC.	...	1A/30 Amps.	Durakool BF-63	4.25
R-283	12 VDC.	125	AC/10 Amps.	Onan Rev. Current 3H4512/R24	1.00
R-614	18/24 VDC.	60	1A/15 Amps.	Rev. Current Cutout 3H2339A/E1	3.50
R-262	200	1C	W. U. Tel. Co. 41C Single Current	3.75
R-245	12 VDC.	25	4 In. Micallex Lever95
R-527	6/12 VDC.	50/50	In Series95
R-544	12/24 VDC.	60/60	1C	227668 For Scr-274N
R-255	1A	G.E. Push Button Remote Relay	1.65
R-669	75 VAC.	400 CYC.	1B, 1A	#CR2791-R-106C8
R-660	6 VDC.	3/8" Stroke	G.E. Pressure Switch #2927B100-C2	.95
R-651	24 VDC.	100	Solenoid Valve	Clare 400	.95
R-295	12 VDC.	275	Annunciator Drop	Cannon Plunger Relay #13672	.95
R-230	5/8 VDC.	2	2A, 1C	2.50
R-813	12 VDC.	12	Wafer	Guardian Ratchet Relay	2.15
R-275	12 VDC.	750	1A, 1B, 1C	Ratchet Relay From Scr-522	4.25
R-716	24 VDC.	70	2A/5 Amps.	Guardian BK-10	2.75
R-620	6/12 VDC.	35	2C, 1A	BK-13	1.45
R-629	9/14 VDC.	40	1C/10 Amps.	Guardian BK-16	1.05
R-778	8 VDC.	4500	1C/5 Amps.	Guardian BK-17A	1.25
R-720	24 VDC.	50	2C, Ceramic	Kurman BK-24	2.10
R-500	12 VDC.	10/10	2C/6 Amps.	45A High Power	1.35
R-816	12 VDC.	10/15	2C/6 Amps.	Str. Dunn. Latch & Reset	2.85
R-811	48 VDC.	8000	1C	Guardian Latch & Reset	2.85
R-524	24 VAC/DC.	Sigma 4R	1.65
R-838	90/120 VDC.	925	2A	Edwards Alarm Bell	.95
R-839	100/125 VDC.	1200	3A	Allen Bradley-Bulletin #702
R-840	115 VDC.	1200	2A	Motor Control	4.50
R-841	115 VDC.	1200	4A	Allen Bradley-Bulletin #200E
R-842	115 VDC.	925	3A	Motor Control	4.50
R-843	115 VDC.	1200	3A	Allen Bradley-Bulletin #209 Size 1
R-844	115 VDC.	1200	3A, 1B	Motor Control W/Type "N" Thermals	5.50
R-845	220 VAC.	Intermit.	3A	Allen Bradley-Bulletin #709 Size 2
R-831	7.5/29 VDC.	6.5	1A/250A, 1000A Surge	Motor Control W/Type "N" Thermals	25.00
R-837	110 VAC.	2A/30 Amps.	Allen Bradley-Bulletin #709
R-835	24 VDC.	2800	1A Dble. Brk./10 Amps.	Motor Control W/Type "N" Thermals	5.50
R-836	220 VAC.	2A Ddle. Brk./10 Amps.	Allen Bradley-Bulletin #200
R-566	115 VAC.	(Coil only, Not a complete relay)	Motor Control	4.50
R-710	150-Ohms. Coil Only	Allen Bradley-Bulletin #202
				Motor Control	4.50
				Allen Bradley-Bulletin #704
				Motor Control	4.50
				Leach B-8	3.50
				Leach 6104	2.75
				Wheelock Signal, B1/39	1.95
				Wheelock Signal, A7/37	3.45
				Leach #6104	.75
				Guardian #38187	.50

Wide Selection of Electronic Components at WELLS

- Tubes
- Resistors
- Condensers
- Wire & Cable
- Volume Controls
- Co-ax Connectors
- Relays
- Rectifiers
- Transformers and Chokes
- Micro Switches and Toggles
- Antennas and Accessories
- Electronic Assemblies
- Dial Light Assemblies

NOTICE!

Although our offices and showrooms were recently destroyed by fire: we are conducting business as usual from our new address.

Write For New Wells Catalog

Each relay is new, individually boxed, and unconditionally guaranteed by Wells



TELEPHONE: SEeley 8-4143

833 W. CHICAGO AVE., Dept. R, CHICAGO 22, Ill.

March, 1951



In the laboratory...

In the field...

Repeated tests by leading set manufacturers prove it to be

Best!

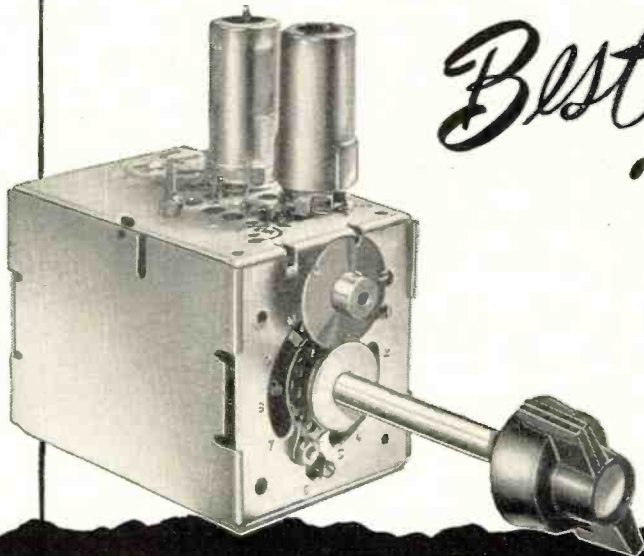

the Tarzian Tuner

Tops in overall performance
High in quality
Low-priced — offering maximum performance per dollar cost

Manufacturers are invited to:

- 1 Write for complete technical data
- 2 Request engineering service
- 3 Write for prices and availability
- 4 Inquire about latest, advanced developments

SARKES TARZIAN, INC.
 TUNER DIVISION
 Bloomington, Indiana

OTHER TARZIAN-MADE PRODUCTS



Centre-Kooled Selenium Rectifiers

Air Trimmers

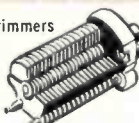

Cathode-Ray Tubes



STATIONS WTTs (5000 WATTS) AND WTTV (CHANNEL 10)
OWNED AND OPERATED BY SARKES TARZIAN IN BLOOMINGTON

These new units act as a series resonant circuit, effectively bypassing undesirable i.f. signals; improve the filtering of i.f. systems without resorting to larger condensers or improvised traps; and reduce cost as well as bulk.

Because these tubulars are wound in such a manner as to increase their inductance, by properly placing the tabs, the section inductance can be controlled so that the condenser will be resonant in the i.f. frequency band.

Designated the Type RC, the new resonant condensers are available in .05 μ fd., .1 μ fd., and .2 μ fd., 400 v. capacities.

SCOPE CALIBRATOR

Tensor Electric Development Co., Inc. of 343 Classon Ave., Brooklyn 5, N. Y. has developed an oscilloscope



calibrator which is essentially a source of continuously variable monitored voltage from .0005 volt to 100 volts r.m.s.

Known as the A-42F, the new unit enables the operator to make measurements of voltages within this range. It has the added feature of being calibrated directly in peak-to-peak volts and decibels as well as in r.m.s. volts.

The calibrator is housed in a molded bakelite case and comes complete with tubes and operating instructions.

CODE PRACTICE RECORDS

Insuline Corporation of America, 3602 35th Avenue, Long Island City 1, New York, has released a set of five double-faced phonograph records which have been especially prepared for the home study of Morse code.

The discs which contain the transcribed lessons are ten inches in diameter, of unbreakable plastic, and work



on any 78 r.p.m. player. These records which were originally made by the *Linguaphone Institute* are now produced exclusively by *Insuline*.

RADIO & TELEVISION NEWS

SERVICEMEN ARE SOLD

Yes, SOLD on RIDER MANUALS! And for good reason, too! Check for yourself... RIDER MANUALS give you ALL the information you need! COMPLETE coverage of the manufacturers' ENTIRE receiver output! ALL production runs (not just pilot models)... giving you, in this ONE course, ALL of the priceless information that you MUST have

Yes, and ALL of the data is ACCURATE, AUTHENTIC, FACTORY-AUTHORIZED! ALL of it comes direct from the service departments of the receiver manufacturers themselves, and is compiled by RIDER into these indispensable television servicing manuals... giving you, in this ONE course, ALL of the priceless information that you MUST have

...and you can see WHY

For in the **FIRST FIVE RIDER TV MANUALS**, containing 10,544 pages:

731 pages are devoted to understandable descriptions of circuit action... telling you HOW the circuit functions. NOBODY, but RIDER furnishes you with so much of this necessary information!

293 pages are on signal waveforms... so vital to any rapid trouble diagnosis in picture i.f., sound i.f., video, sync and sweep circuits. Nobody, but RIDER, offers anywhere near this amount of important data!

337 pages have factory-issued unpacking and installation instructions. Nobody, but RIDER, brings you as many of these helpful, time-saving notes!

ONLY IN RIDER TV MANUALS

NOWHERE else can you get as much... in such easy-to-find format... so very easy-to-understand... so accurate... so thorough... so complete... so efficient...

★ ★ ★ ★ ★

RESERVE YOUR COPY OF TV MANUAL No. 6

Despite severe production difficulties, this new "BIG" TV Manual is being scheduled for delivery in March. However, due to paper shortages, we can print only a limited quantity. And since the contemplated curtailment of television receiver production makes the information contained in this volume absolutely essential to servicing technicians, we suggest that you order your copy IMMEDIATELY.

NOW AVAILABLE! RIDER MANUAL Vol. XXI

Factory-authorized servicing material from 61 manufacturers... AM-FM, auto radios, record changers, disc and tape recorders... Coverage from December 1949 to October, 1950. 1648 pages plus Cumulative Index Volumes XVI through XXI!..... \$1800

John F. Rider Publisher, Inc.
480 Canal Street New York 13, N. Y.

Complete your Rider Manual Library! If any volumes are missing, order a replacement today!

The lessons are set up so that individuals or groups may learn code without a teacher. All instructions necessary to use the course are contained in a 32-page booklet which accompanies the discs.

LINEAR POT

Chicago Industrial Instrument Co., 536 W. Elm Street, Chicago 10, Illinois has recently introduced a new calibrated 0-100,000 ohm linear potentiometer designed to be used as a resistance substitute for service or laboratory work.

The new "Selectohm" provides a fast

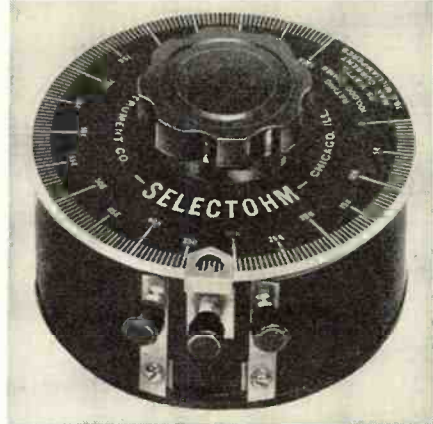

means for determining the values of blackened and burned-out resistors when it is substituted in radio, television, or other electronic circuits.

The unit, which is also useful for laboratory work, may replace the conventional decade box, or serve as a precision rheostat, shunt, or multiplier. It is rated at 25 watts.

CRYSTAL CALIBRATOR

Measurements Corporation of Boonton, New Jersey is now in production on the Model 111 crystal calibrator designed for the frequency calibration of equipment in the range of 250 kc. to 1000 mc.

A new circuit arrangement utilizes the cross modulation products of three separate oscillators operating at the fundamental frequencies of .25, 1, and 10 mc. This system extends the usable range of the harmonic frequencies.

The calibration and frequency checking of signal generators, transmitters, receivers, grid dip meters, and other equipment requiring a high degree of frequency accuracy may be performed with this unit.

CIRCLE CUTTER

Of interest to service technicians, hams, and the home constructor is the new circle cutter being released to the trade by *Precise Measurements Company*, 942 Kings Highway, Brooklyn 23, New York.

Two types of cutters are available, one with a round shank for drill presses or hand drills and the other with a square tapered shank for hand braces. The maximum hole diameter is 4" for the Model 1 and 6" for the Model 5 cutter.

BEAT THE TUBE SHORTAGE!

Receiving tubes are getting scarcer every day! This book shows you how to keep sets working... even though exact replacements are unavailable.

RECEIVING TUBE SUBSTITUTION GUIDE BOOK

BY H. A. MIDDLETON
for TV-AM-FM Receivers and Allied Equipment!



★ 2500 Radio and TV Substitutions are Listed! ★ TV Receiver Filament Wiring! ★ Heater Substitution Wiring Instructions! ★ Tube Types Classified by Functions! ★ Other Priceless Data!

Place your order today! First printing sold within 21 days! Second printing is now on press and will sell as fast! Make sure of your copy!
224 pages. 8 1/2 x 11 inches. Heavy, durable paper cover.Only \$2.40

BE EXPERT with OSCILLOSCOPES

This practical book tells you everything you should know about an oscilloscope! WHAT it is... what it can DO... and HOW to use it properly!

ENCYCLOPEDIA ON CATHODE-RAY OSCILLOSCOPES AND THEIR USES

by John F. Rider and Seymour D. Uslan

The FIRST and ONLY book that so fully and clearly describes the 'scope... its construction... its capabilities... its applications in servicing, engineering, research... with thousands of time-saving and labor-saving references, charts, waveforms, etc.

All oscilloscopes produced during the past ten years, a total of more than 70 different models, are accurately described—with specifications and wiring diagrams.

Planning to buy a 'scope? This book will help you select the type best suited to your needs! If you already own one, the book will show you how to increase your instrument's usefulness and, naturally, its value to you!

We GUARANTEE that it will SAVE and EARN many, many times its cost for you!
992 Pages • 500,000 Words • 3,000 Illustrations
8 1/2 x 11" Size • 22 Chapters • Completely Indexed
Easy to Read • Cloth BoundAnd only \$9.00

with ANTENNAS TV and OTHER RECEIVING ANTENNAS

(Theory and Practice)
by Arnold B. Bailey

Tells you... WHAT each type can do... and HOW to use it... and WHICH is best!

This is a text book on all types of receiving antennas. If you have any questions—you'll find the answers in this book! Teacher, engineer, student, service technician—all can use this text. WE GUARANTEE IT! Antenna data never before published anywhere will be found in it. And it's readable—because mathematics has been translated into charts and graphs.

Everything you hoped for... and asked for!
606 Pages... 310 IllustrationsAnd only \$6.00

10-DAY MONEY-BACK GUARANTEE—Make these books PROVE their value! Unless you agree they are the best investments you've ever made—return the books, in good condition, for refund.

RUSH THIS COUPON TODAY

JOHN F. RIDER PUBLISHER, INC.
480 Canal Street, New York 13, N. Y.

Please send me the following books on your 10-day MONEY-BACK GUARANTEE.

RECEIVING TUBE SUBSTITUTION GUIDE BOOK \$2.40
"ENCYCLOPEDIA ON CATHODE-RAY OSCILLOSCOPES AND THEIR USES" 9.00
"TV and OTHER RECEIVING ANTENNAS" 6.00

Name.....
Address.....
City..... Zone..... State.....

SAVE POSTAGE. If you enclose check or money-order WITH coupon, we will prepay postage charges. Money back if you return books within 10 days.

Check Encl. Money-Order Encl. C.O.D. 2

Service-Dealers: DO A
\$50,000
 TV BUSINESS
 ON A \$500 INVESTMENT

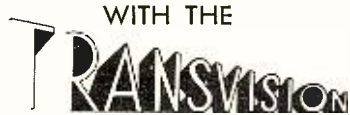

Factory Agent Plan

Why this Plan is BEST FOR YOU:

- You have NO INVENTORY PROBLEM because you work from our MILLION-DOLLAR stock.
- You get SPECIAL PRICES to enable you to undersell competition at a profit.
- You get EXCLUSIVE TERRITORY benefits.

REQUIREMENTS: You must be a Radio-TV Technician (experienced only); and you must have a presentable business place.

The TRANSVISION TV LINE is of the finest quality. Has the famous "A" chassis, housed in beautiful cabinets. 28 models. 17" or 19" Tubes.

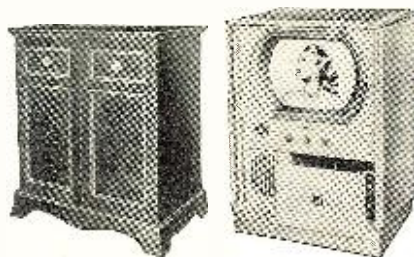
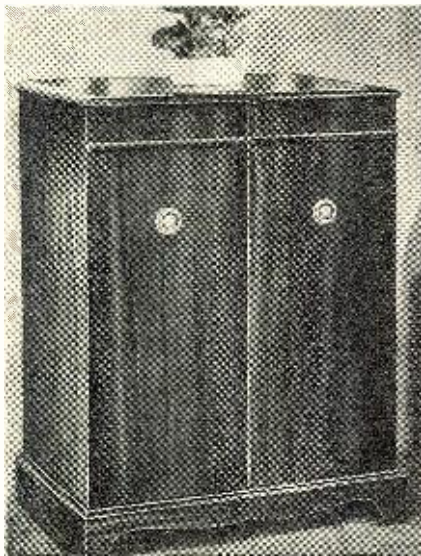

Write for Details on
 FACTORY AGENT PLAN today!

TRANSVISION, INC.

Dept. RN NEW ROCHELLE, N. Y.

Increasing Bandwidth of Older Oscilloscopes

By JAMES KAUKE

Many small-screened scopes can be given new life by the addition of a simple, easily-built circuit.

THERE are lots of old model 3-inch oscilloscopes in circulation whose usefulness for TV servicing and other modern applications is hampered by their poor high-frequency response. Chief among these are the RCA Model 155 and the Du Mont 164E, good, sturdy instruments which were designed before TV appeared on the scene. These instruments generally use type 6C6 tubes for both vertical and horizontal deflection amplifiers, each a single stage, with single-ended output. The plate load resistors are usually 100,000 ohms. Their gain begins to droop at about 50 kc., and is generally down by 50 per cent at 100 kc.

The high end can be considerably extended in these scopes by replacing the 6C6 amplifiers with 6AK5's, in the circuit shown in Fig. 1B. The gain is 56, about the same as with the original 6-prong tubes. High frequency response is something over twice as good, beginning to droop, with the gain full on, at 200 kc. Gain is down to half at 1 megacycle, down to about 20 per cent of its low-frequency value at 2 mc. This data was taken off the screen of a 3-inch cathode-ray tube deflected by the 6AK5 amplifiers shown.

The high end is brought up, relatively, by the use of a small (.002 μ fd.) cathode bypass condenser, as in the original circuit. The degeneration thus introduced at low frequencies, where the .002 μ fd. is ineffective, cuts the gain to about half the value it would have with a large bypass. Even so, the de-

flexion sensitivity in a typical case is about 0.7 volt r.m.s. input for 1 inch peak-to-peak deflection on the screen. Incidentally, the fact that one naturally reads scope deflections in peak-to-peak fashion has the effect of providing free gain, since the peak-to-peak voltage of a sine wave is 2.8 times the r.m.s. voltage.

Some thought was given to upping the gain by using bias cells for fixed bias and to using a VR105 tube for fixed screen voltage. It turns out that this is not advisable because of the variation in static characteristics of individual tubes. The regulating action of cathode and screen resistors is needed to keep the tubes near their proper operating points. The large screen bypass shown is necessary because of the comparatively low screen circuit impedance of the 6AK5. It is also needed to prevent cross-coupling between the two amplifiers at low frequencies.

Gain Control

With the gain control advanced half-way, using the 0.5 megohm potentiometer indicated, the high-frequency droop due to the shunting effect of the tube input capacitance is at its worst. Gain begins to drop at 60 kc., and is down to half at 100 kc. Even so, the 6AK5 has a slight edge over the older tube, since its input capacitance is 4 μ μ fd., compared to 5 μ μ fd. of the 6C6.

The most practical remedy for insuring maximum high-end response at

Fig. 1. (A) Cathode follower gain control system which may be added ahead of the 6AK5 amplifier shown in (B) to give maximum bandwidth at all settings of the gain control. (B) 6AK5 replacement circuit for the 6C6 and similar deflection amplifiers found in RCA Model 155 and other older scopes. Gain of 6AK5 is down 10 per cent at 250 kc.

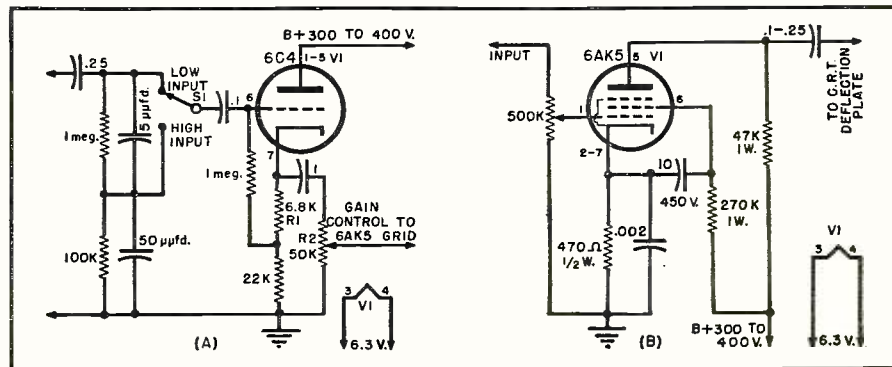

all gain settings is to add a cathode follower between the vertical input terminals and the amplifier tube input. The gain control is made a low-resistance unit, placed in the output circuit of the cathode follower. This stunt is the one used in the *Du Mont* Model 203 and many other scopes. A suitable circuit is shown in Fig. 1A.

Because of the limited signal handling capacity of cathode followers, a two-position compensated attenuator with toggle switch S_1 is needed to attenuate the input when handling signals over about 20 volts. Multi-position compensated step attenuators are equally effective and make the follower tube unnecessary, but lack the feature of continuous variation and are a bit awkward to build. Both arrangements have been described in this magazine and elsewhere.

The .1 μfd . condenser shown in Fig. 1A should be a tubular type, or have its case insulated from the chassis, because bathtub condensers have too much capacitance (about .001 μfd) between the insides and the case. In operation, the 6C4 cathode should ride at a potential of around 40 to 60 volts above ground. Adjustment may be made by varying the value of bias resistor R_1 .

The above represents about the practical limit in modifying the older 3-inch scopes for improved performance. Chassis space and power supply limitations preclude the addition of push-pull deflection or of true wideband amplifiers. Multi-stage, high-gain amplifiers offer the same objection, plus new ones of decoupling and stray feedback problems induced by the limitations in space. In spite of the size of these scopes, there is not much accessible and usable room under the chassis.

-30-

SERVICE TIP

By NICHOLAS B. COOK

THERE was no vertical sweep. First thing to suspect was the blocking oscillator. Plate voltage was OK. No grid voltage. Continuity OK on grid side of oscillator transformer. Doubtful on plate side.

Was the rest of the circuit OK? Was the trouble only in the oscillator? I tried a quick check.

On my bench I have a Telechron field coil assembly that I use for testing Telechron rotors. I plugged its line cord into an outlet and brought the field coil near to the oscillator transformer. At once the vertical sweep was restored! It was a ragged sweep, out of phase and out of sync, but it was a visual OK for the circuits following the oscillator.

Though there was voltage on the plate, the ohmmeter definitely indicated a defective primary winding in the oscillator transformer. Clearly the doctor could order a new transformer and be reasonably certain that the patient would be cured. Reports show complete and immediate recovery.

It's worth a try. Any energized 60-cycle coil will do, as long as it has a strong leakage field. When it works it's an impressive demonstration of "know-how." In any case, it's speedy and conclusive.

-30-

March, 1951

NOW

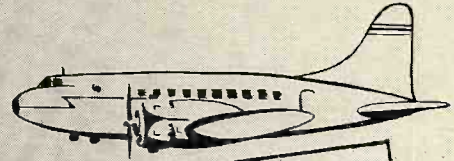

ELECTROLYTIC CAPACITORS THAT WITHSTAND WIDE EXTREMES OF TEMPERATURE



ILLINOIS CONDENSER COMPANY proudly presents a new line of capacitors that are designed to meet the most rigid JAN specifications for marine, air and other severe service applications—as well as exacting civilian requirements.

Perfect Hermetic Seal With New Terminal Cap Structure

The new hermetically sealed cap structure, with molded-in terminals, represents a milestone in capacitor development. With the new construction, electrolytic leakage, wafer deterioration and cracking, are eliminated. Immune to sudden temperature and barometric changes, and built to withstand wider temperature ranges, these capacitors are superior in field and emergency equipment, high altitude or shipboard gear.

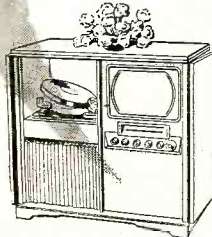

Increased Mass Production Economy

Because of greatly expanded production facilities, capacitors with the new cap structure are now available to civilian consumers for TV and other electronic applications. ILLINOIS CONDENSER COMPANY is constantly expanding in size and facilities to meet the increased demand for those who demand the best with mass production economy.



Type UMP An old favorite now completely Hermetically Sealed if desired or necessary. For use in all TV, radio and rectified DC circuits. Twist-prong mounted, available in single, dual, triple and quadruple units. Wide range of capacities in working voltages from 3 to 600 VDC. Heavily tinned soldering lugs, seamless drawn aluminum cans.



Type PE Convenient plug-in capacitors, also available with new complete hermetically sealed cap structure. Widely used during World War II and now available for civilian emergency use such as police, fire and forestry service, railroads, etc. Ideal for any stationary or portable electronic equipment where rapid replacement service is important. Type PE capacitors are top quality, hermetically sealed in seamless drawn aluminum cans. Mount in standard Octal Sockets. Available in single or multiple units in wide variety of capacity and voltage types.

Write ILLINOIS CONDENSER COMPANY for further information on these outstanding electrolytic capacitors as well as tubular, bathtub, inverted screw mounting and other types.



ILLINOIS CONDENSER CO.

Time tested - - - Quality

1616 NORTH THROOP STREET • CHICAGO 22, ILL.

The HIT of the AUDIO FAIR!

Plays 10½" Reels!



Comp etc, for
console installation with
single or dual track heads:

\$345⁰⁰

CONCERTONE

■ The professional quality tape recorder you have been waiting for! NAB standards; triodes throughout; 40-15000 cycles at 15", 40-8000 cycles at 7½". Three motors; flutter less than 0.1%; signal-to-noise better than 50 db. Three heads for simultaneous erase, record, playback. Quick change from single to dual track. Write for booklet.

FISHER RADIO CORPORATION • Distributors • 39 E. 47th St., N. Y.
MAGNETIC RECORDERS CO., 7120 MELROSE AVE., L. A. 46, CALIF.

Panther Valley

(Continued from page 34)

A second important consideration was to clear the operations of "PV-TV" with the Pennsylvania Utility Commission. Here the services of Scott, as a State assemblyman and attorney, proved invaluable. It was determined that *Panther Valley Television Company* is not a public utility but rather a service company. This precedent is highly important for others planning to establish similar community aerial programs in other areas.

Another essential precedent was set when the Federal Communications Commission was informed of the "PV-TV" operation. *The FCC decided that no license was necessary*, because the signal is merely amplified and distributed, and there is no broadcasting or transmitting involved.

Financial Organization and Growth

As noted previously, the five founders of "PV-TV" each contributed \$500 for a total of \$2500, and supplemented this capital with a loan of \$10,000.

At first, the "PV-TV" group planned a non-profit corporation, to supply television reception to the community at cost, and make their profit from the sale of television sets. But when they approached their bank for a loan, the bankers insisted on a regular corporation which would attempt to make profits, before approving the loan. All concerned are now glad that this arrangement was made.

Expenses of *Panther Valley Television Company, Inc.*, were heavy for the initial installations, of course, including relatively large outlays for the erection of the tower, purchase and installation of amplifiers, cables and distribution outlets, promotional and legal costs, and all the other expenses of starting in business. Also a considerable supply of additional material, including extra MC-1 and ADO-10 units and cable, has been purchased to take care of the many additional outlets planned in Lansford, as well as an extension of the system to the neighboring town of Coaldale.

When this was written, a total of about 100 subscribers had been connected to the "PV-TV" community aerial. Rates have been established as follows:

1. *Residential*: \$100 for the original installation, and \$25 for each additional outlet. Service charge is \$3 a month for one outlet; \$1.50 per month for each additional outlet.

2. *Commercial* (defined as any place of business): \$100 for first outlet, and \$25 for each additional outlet. Service charge is \$5 a month for one outlet; \$2.50 a month for each additional outlet.

Thus a total of about \$10,000 in connection fees has been collected, and monthly service contracts obtained from 100 subscribers. In the same period, a total of about \$15,000 has been

Believe It Or Not!

FAMOUS LICENSED R.C.A. 630TS

30 TUBES—Latest Features.

Complete with all Knobs, Dial Plate, Mounting For Picture

Tube 12" Speaker.

FREE PLASTIC MASK

16" PICTURE TUBE

\$189

17 INCH PICTURE TUBE . . \$199

20 INCH PICTURE TUBE . . \$219

RMA Guarantee on Chassis—Tube (Tax Included)

25% WITH ORDER — BALANCE C. O. D.

UPSTATE

107 DUANE AVE., SCHENECTADY, N. Y.—Tel. 4-3008

NIAGARA—ONE OF AMERICA'S GREAT ELECTRONICS STORES



NIAGARA'S "Fireman" Frank Bruce Helps To PIN PRICES DOWN!

Meet "Fireman" FRANK BRUCE, W2QDD

Professionally engaged in the art of "Grunt and Groan," (wrestling to the uninitiated), on your favorite TV station, during the evening. Serving Hams and Servicemen with a wealth of radio Know-How over Niagara's counter during the 9 A.M. to 6 P.M. "Working" hours. On your next New York visit, don't fail to drop in, at Niagara, for a congenial visit and chat with Frank on Sports or Radio. Be a "Visiting Fireman," you will be most welcome.



CONVERSION KIT

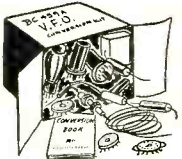

BC459A to V. F. O.
Complete kit of parts required to convert any BC457A, BC459A or ARC-5 equivalent, to a fixed or mobile, 6 volt 10 meter V. F. O. Transmitter. Kits contain—
1 Copy of Vol. 2 "Surplus Radio Conversion Manual" (worth \$2.50 alone). All 6V/ Tubes (1-807, 1-6Y6, 1-6J5), sockets, slug tuned coils, resistors, condensers, wire, etc. Absolutely complete! **ONLY \$9.95**

TUBES

NEW-BRANDED • GUARANTEED
LARGE STOCK
RECEIVING-TRANSMITTING
INDUSTRIAL
Prices on Request

TRANSFORMER BARGAINS

PLATE		
511-T1	330-0-330, 600MA	\$5.75
A-10	1025-0-1025V, 500MA	17.95
D-161913	2500V, 4MA (TV or CB)	3.95
BE9126	612-593-0-593-612V, 200MA	9.95
FILAMENT		
P-3061	2.5V-5A, 7.5V-4A	2.60
T-2	2.5V, 19A	4.95
528049	5VCT-3A, 5V.C.T.-10.5A, 6.3V.C.T.	4.50
475-T201	5V.C.T.-15A	5.95
P-47164	6.3V.-8A	2.05
P-4091	7.5 V.-5A	2.49
D-161917	6.3 V.-3A, 2.5V, 2A	2.85
POWER		
511-T2	350-0-350V-190 MA, 6.3V.-6A	2.15
475-T201	245-0-245V.-70 MA, 6.3V.-6.2A	2.25
466-T1R	110-0-110V-225 MA, 3V.-3A	1.95
PC-110	300-0-300 V. 125 MA, 6.3V.-3.8A, 5V.-3A	2.95
P-6001	325-0-325 40MA., 5V.C.T.-2A., 2.5V.C.T.-4A.	2.25
P-6009	275-0-275 70MA., 5V.-5A, 2.5V.-10.5A	3.00
T-47165	135-0-135 80MA., 5V.-3A, 5V.-3A	2.49
MODULATION		
ARC-3	807 R.F. to P.P. 6L6	2.49
900716	PPS13 R.F. to P.P. 211 (R.C.A.)	3.95
T-47171	"AB" P.P. 807 to "C" 425V-240 MA.	4.50
DRIVER		
A-4205	10,000 OHM Plate to Single Grid	.89
A-4406	P.P. 45, 2A3, etc. to P.P. 210, 801	1.95
A-4404	P.P. 6L6, 2A3 etc. to P.P. Grids	1.65
OUTPUT		
SP-10	6Y6 to 2, 4, 8 OHMS	.69
SP-12	P.P. 6Y6 to 8 OHMS	.79
T-46255	P.P. Par. 6N7 "B" to 5000 OHMS	1.49
511-T1	6Y6 to 8 or 600 OHMS	.85
11666	6Y6 to Voice Coil or 500Ω Line	1.89
INPUT		
T-47368	600 OHM C.T. to 300 OHM Mike	1.29
T-47369	"MIKE TO LINE"	1.65
T-47369	30 OHM MIKE to 600 OHM C.T. Sec.	1.65
CHOKES		
L-143	1.72 HY 3 AMPS	8.95
C-2303	100 MA.	1.10
32584	3.8 75	2.35
	4 40 MA. (AC/DC)	.25
475-CH301	4 200 MA.	1.25
10634	10 100	3.49
	10 90 Dual	2.49
2647	10 200	1.75
A-43567	12 150	1.60
RC-72	12 125	1.75
L-554	20 125	1.75

VIBRATOR POWER SUPPLY AIRCRAFT TYPE

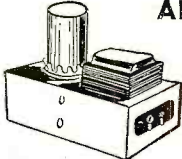

Vibrator power supply delivering 300 V. D. C. at 80 MA. Filter Built-in fully wired, tested and guaranteed new. **\$5.95**

OIL FILLED CONDENSERS

Leading Brand Names
All Brand New—Guaranteed

CAP.	D.C. VOLTS	MFG. & NO.	NET EACH
.005	15,000	GE 14F322	\$ 7.95
.005-.005-.01	10,000	GE 26FH16e2	10.50
.035	10,000	AEROVOX AXIU36	7.50
.02	15,000	GE 14F321	21.95
.01	6,000	FAST 148-806	7.50
.15	2,500	FE 26F345	1.10
.2	5,000	CEBR2784	2.98
.25	4,000	SPRAGUE P9717	3.10
.25	10,000	GE 14F192	19.50
.6	2,500	72041-503	1.25
1	440 AC	C.D. KG4010	.59
1	2,500	C.D. 482616-10	2.55
1	3,000	Capacitor A1089	2.75
1	3,600	SPRAGUE C8B3062	2.95
1	5,000	G.E. 23F49-32	3.15
1	6,000	CDT60010GA	4.35
1	12,000	GE-26F628	9.50
2	440 AC	GE 67x21	.79
2	600	CD A14109-2	.85
2	1,000	GE 23F11	1.10
2	2,000	Micamold 324-138	2.20
2	3,000	SPRAGUE 2538-16	4.50
2	5,000	SPRAGUE G-8R2784	6.50
2.5-2.5-5	600	Micamold C8B1256	1.95
4	330 AC	C.D. KG3040	.85
4	400	G.E. 25F785	.95
4	600	C.D. I8B1253-1	1.10
4	1,000	CANADIAN 10395	1.75
4	1,000	RCA 13765	1.85
6	330 AC	GE 67x7A	.89
6	44 AC	C.D. K64000	.95
6	600	SPRAGUE P9718	1.75
8	1,000	FAST 143-117	2.50
8	2,000	C.D. T3U20080G	4.95
10	400	SOLAR (DBIA)ELD	1.25
10	600	CANADIAN 10373	1.85
15	1,000	G.E. 23F19G2	3.95

Split-Stator Condensers

Popular Split Stator Variables at unbelievable low Prices! Well Built, low loss ceramic mounted with bushings at both rotor ends. Ideal for V. F. O., low powered rig and exciter units, receivers, etc. All with 1/4" Shafts.

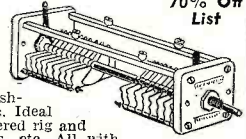

Capacity	List Price	Your Cost
15-15	\$3.80	\$1.14
20-35	3.95	1.19
27-27	4.10	1.23
35-35	4.30	1.39
75-75	4.80	1.44

70% Off List

IMPORTANT NOTICE: Minimum Order \$5. Quantity prices on request. All items in stock now—subject to prior sale—prices subject to change without notice. 20% Deposit with orders unless rated. All prices F.O.B. our N.Y.C. Warehouse.

ARC-5/R-28 (Plus \$2.50 BONUS)* Hottest 2-Meter Receiver Ever Built!

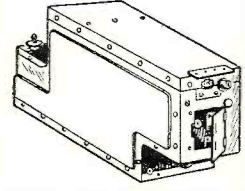

Here is the 2-meter superhet you have been looking for! Absolutely the BEST available today! Tunes from 100 to 156 Mcs. in four crystal channels. (Easily converted to continuous tuning.) Tube lineup is as follows: 717A—R.F., 717A—Mixer, 2-12SH7—1st and 2nd I.F. (6.9 Mc.), 12SL7—Det-AVC-Squelch, 12SL7—1st audio-squelch amplifier, 12A6—2nd audio, 12SH7—R.F. Osc.—4th Harmonic Gen., 717A—Trip, 12th Harmonic Gen., 717A—Dhr.—12th harmonic gen. A highly desirable superhet, made of rigidly inspected parts and contained in a louvered aluminum cabinet measuring 7 5/32" x 4 7/8" x 1 1/4". Complete with all tubes in original sealed cartons. **\$1995**

*FOR A LIMITED TIME ONLY!

With each order for ARC-5/R-28 Receivers, one copy of Vol. 2 "Surplus Radio Conversion Manual" (Regular price \$2.50) will be shipped at no additional cost! This volume contains circuit diagram and full description of above receiver, plus a wealth of additional conversion data on many other popular items of surplus equipment. ACT NOW, for YOUR \$2.50 BONUS!

RCA 50% OFF NET (Equal to 70% Off List) TELEVISION COMPONENTS TO MEET YOUR REPLACEMENT NEEDS

TELEVISION IF AND VIDEO COIL KIT—TYPE 204x2

- A kit of all the coils used in the picture if (frequency 25.75 Mc), sound if (frequency 21.25 Mc) and video circuits of a high-quality television receiver. The RCA 204X2 kit comprises:
- 1—Video Series—Peaking Coil type 203L1.....\$0.27
 - 1—Video Shunt—Peaking Coil type 203L2..... .27
 - 2—Video Series—Peaking Coils type 203L3..... .54
 - 2—Video Shunt—Peaking Coils type 203L4..... .54
 - 2—First and Second Sound IF Transformers type 201K1..... 2.64
 - 1—Converter Transformer type 202K1..... 1.32
 - 1—First Picture IF Transformer type 202K2..... 1.41
 - 1—Second Picture IF Transformer type 202K3..... 1.08
 - 1—Cathode Circuit Trap type 202K4..... 1.32
 - 1—Sound Discriminator type 203K1..... 1.65
 - 2—Third and Fourth Picture IF Transformers type 202L1..... .78
 - 1—Filament Choke 204L1..... .12
- Worth \$11.94

Our Price 50% Off **\$5.97**

Niagara Radio Supply Corp.
Dept. N-31 160 Greenwich Street, New York 6, N. Y.
Phone Digby 9. 1132-34

NIAGARA'S GUARANTEE of Satisfaction
All items ordered must meet with full approval or your money back!

LEARN

Television -Radio OR Electricity

IN THE GREAT SHOPS OF **COYNE**



TRAIN QUICKLY!
OLDEST, BEST EQUIPPED
SCHOOL of ITS KIND in U.S.
Young and Older Men

Come to the Great Shops of Coyne in Chicago. Get practical training in TELEVISION-RADIO or ELECTRICITY—vital in Defense Program. Prepare now for a better job or better service rating.

START NOW—PAY LATER

You can finance most of your tuition, pay for it later in easy monthly payments. Special plan for men of Draft Age. Part time employment service available. **GI APPROVED**

FREE BOOK Clip coupon for Big Free Illustrated Book. Indicate below, course that interests you. No salesman will call. Act NOW.

An Institution not for Profit

B. W. COOKE, Pres.
COYNE Electrical & Television-Radio School.
500 S. Paulina St., Chicago 12, Ill. Dept. 31 35H

Send FREE BOOK and full details on:

TELEVISION-RADIO ELECTRICITY

NAME

ADDRESS

CITY STATE

spent by "PV-TV" to establish their community aerial system.

"PV-TV" has surveyed the community and has established a reasonable potential of 750 subscribers at the end of six months. This will mean a revenue for installations of \$75,000 and a monthly service income of around \$2500, including residential and commercial contracts. These estimates are based on serving about one-third of the homes in Lansford, and seem conservative on the basis of the tremendous enthusiasm for television in Panther Valley.

To connect 750 subscribers will require a further outlay of about \$15,000, or a total of about \$30,000, according to estimates by officers of "PV-TV." Because the installations are being made by experienced line crews, using the best and most durable equipment, total service and maintenance expense can be expected to run well under \$1000 a month.

Obviously, even after allowing an ample sum for depreciation and to extend the "PV-TV" system further, the company will make a handsome profit.

It should be explained here that the founders of Panther Valley Television Company have already surveyed the adjoining town of Coaldale, the city limits of which are only 1/4 mile east of Lansford. With this town so close, it is planned to use the same tower on Summit Hill and merely extend the Lansford cable to serve Coaldale. This will add a potential of many hundreds of additional subscribers,

without much additional capital expense.

The "PV-TV" group has also been approached by the other towns in Panther Valley, including Tamaqua, Nesquehoning and Mauch Chunk. Plans are now being made by "PV-TV" to construct community aerial systems for these towns, using the knowledge gained from the Lansford installations in tackling the job.

Service and Maintenance

Careful arrangements have been made by "PV-TV" to handle all service and maintenance problems on a 24-hour basis, seven days a week. Practically, of course, most calls for service will come in the period from 4 p.m. to midnight.

At the company's headquarters, 132 W. Ridge St., Lansford, a crew of trained service technicians is on duty at all times. In this office is a huge enlarged street map of the town, with the locations and telephone numbers of all subscribers clearly marked on it. If a call for service comes in, the source of the trouble can be isolated in a matter of minutes by a few telephone calls to subscribers on either side of the one who complained. If the subscribers on both sides of the complaining one are getting good reception, then the complainant is told his TV set is probably at fault and to call his dealer for service.

However, when the "PV-TV" service technician goes out, he takes with him test equipment, spare units and

Get your **EICO** Test Equipment Kits directly from Federated

NEW SIGNAL GENERATOR

For FM-AM precision alignment and TV marker frequencies. Variable Tuning Condenser. Highly stable RF oscillator, range: 150 KC—102 MC with fundamentals to 34 MC. Separate audio oscillator supplies 400-cycle pure sine wave voltage. Pure RF, modulated RF or pure AF for external testing. Attractive three-color etched rub-proof panel; rugged hammertone steel case. 115 v., 60 cycle AC. 10 x 8 x 4 1/4".

Model 320-K, KIT, only \$19.95



Each EICO product is jam-packed with unbelievable value. **SAVE!** Write NOW for free newest Catalog C.

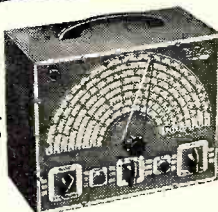

NEW 5" PUSH-PULL OSCILLOSCOPE

All-new laboratory-precision scope with all the extra sensitivity and response for precise servicing of TV, FM & AM sets. Push-pull undistorted vertical and horizontal amplifiers. Boosted sensitivity, .05 to .1 rms volts/inch. Useful to 2.5 MC. TV-type multivibrator sweep circuits, 15 cps—75 KC. 2-axis intensity modulation feature. Dual positioning controls move trace anywhere on screen. Complete with 2-6J5, 3-6SN7, 2-5Y3, 58P1 CRT. 3-color etched rubproof panel; steel case. 115 v., 60 cycle AC. 8 1/2 x 17 x 13".

Model 425-K, KIT, only \$44.95



NEW VACUUM TUBE VOLTMETER

Laboratory-precision VTVM for trigger-fast operation and lifetime service. 15 different ranges. Large 4 1/2" meter, can't-burn-out circuit. New zero center for TV & FM discriminator alignment. Electronic AC & DC ranges: 0.5, 10, 100, 500, 1000 v. (30,000 volts & 200 MC with HVP-1 & P-75 probes). Ohmmeter ranges, 2 ohms to 1000 megohms. DB scale. New stable double-triode balanced bridge circuit—extreme accuracy. 25 megohms DC input impedance. 3-color etched rubproof panel; steel case. 115 v., 60 cycle AC. 9-7/16 x 6 x 5".

Model 221-K, KIT, only \$25.95

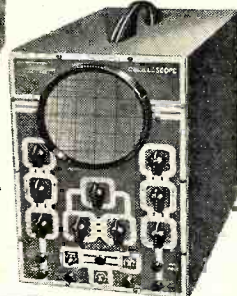

NEW BATTERY ELIMINATOR, CHARGER & BOOSTER

For all auto radio testing. Latest-type full-wave bridge circuit, 4-stack manganese copper-oxide rectifiers. Specially designed transformer, variable from 0 to 15 volts. Continuous: 5-8 v., 10 amps. Intermittent: 20 amps. 10,000 mfd filter condenser. Meter measures current and voltage output. Fused primary; automatic reset overload device for secondary. Hammertone steel case. 115 v., 60 cycle AC. 10 1/2 x 7 1/4 x 8 1/4".

Model 1040-K, KIT, only \$25.95

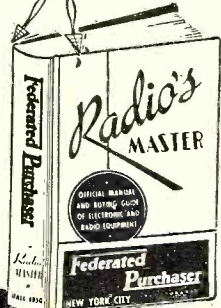

FREE WITH ORDER
RADIO'S MASTER
1200 PAGE
REFERENCE MANUAL

Federated Purchaser

INCORPORATED

66 DEY ST., NEW YORK 7, N. Y. Dlgby 9-3050

ALLENTOWN, PA. NEWARK, N. J. EASTON, PA. 701 NORTHAMPTON ST.

1715 HAMILTON ST.

114 HUDSON ST.

701 NORTHAMPTON ST.

parts, and a portable TV receiver in good condition. There have been very few calls for service to date, and most of them have been caused by failures in the subscriber's own television set.

Towns with a Community Aerial

Since the success of Panther Valley's community aerial became known, other towns in Pennsylvania have already proceeded with a similar operation.

Mahanoy City, Pa., is 15 miles west of Lansford and about 90 air miles from Philadelphia. There the antenna tower is on a hill three miles from the city, and several additional MC-1 units are used to amplify and re-amplify the signals so as to provide clear reception from all three Philadelphia stations. George Koval, a leading automobile dealer, and Emmanuel Liadrakis, a radio and appliance dealer, are two of the six principals in this operating company, known as *City Television Corporation*. Here the rates are \$125 for the first outlet, with the monthly service fee \$3.50.

Honesdale, Pa., is about 30 miles northeast of Scranton and about 80 air miles from New York, 120 miles from Philadelphia. There a system installed by a local company organized by Kenneth A. Chapman, appliance dealer, is bringing in clear reception to Honesdale residents on Channels 2, 4, and 5 from New York, Channel 3 from Philadelphia, and Channel 12 from Binghamton, N. Y.

On the West Coast, similar activity

is under way. Although "PV-TV" was the first master antenna system organized to bring in reception from several stations for a whole community, the same equipment has been used for a year by Ed Parsons of *Radio & Electronics Company* in Astoria, Oregon, nearly 100 miles southwest of station KING-TV (Channel 5) in Seattle, to bring reception from this station to Astoria, at the mouth of the Columbia River.

Bellingham, Wash., a lumber center about 75 miles north of Seattle, is another city now being served by similar equipment in a community aerial system.

Palm Springs, Cal.; Logan, Utah; Salisbury, Md.; Olean, N. Y.; Wilkes-Barre, Scranton and Pottsville, Pa., and many other cities and towns "beyond the fringe" are now being surveyed for a similar lifting of the TV veil.

New Developments

Jerrold is now developing special equipment to make the installation and operation of a community aerial system much more efficient and economical. Here are typical new developments:

1. At the antenna tower, instead of an MC-1 master control and amplifier unit, there will be a preamplifier, converter, and new amplifier and mixer unit. The *preamplifier* will make it possible to utilize much weaker signals and obtain much greater total

CUT HOLES 1/2" to 3 1/2" IN RADIO CHASSIS

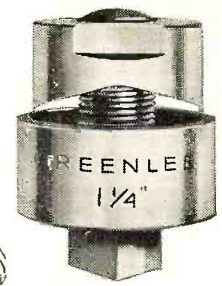

WITH A GREENLEE RADIO CHASSIS PUNCH

• Save hours of work . . . no reaming or tedious filing. Punch cuts through chassis quickly . . . makes accurate, clean holes for sockets, plugs, and other receptacles. Just turn with an ordinary wrench. There's a GREENLEE Punch in each of these sizes: 1/2"; 5/8"; 3/4"; 7/8"; 1"; 1 1/8"; 1 1/4"; 1 1/2"; 1 3/4"; 1 7/8"; 1 3/4"; 2 1/4". Write for complete facts. Also get information on Knockout Punches and Cutters for conduit and meter holes up to 3 1/2". Greenlee Tool Co. 1883 Columbia Avenue, Rockford, Illinois.



Scoops and Bargains!
Federated does the Purchasing so YOU can SAVE!

PHILCO FM and AM SIGNAL GENERATOR

A \$97.50 Laboratory Type Instrument for \$64.50!

A "MUST" FOR RADIO AND TV SERVICE MEN AND LABORATORIES. ULTRA-SENSITIVE. SIX FREQUENCY RANGE BANDS. CALIBRATION ACCURATE WITHIN ±1%. DRIFT NOT OVER 1/2 OF 1% UNDER CONTINUOUS OPERATION. RESIDUAL OUTPUT LESS THAN 5 MICROVOLTS. NO SWITCHING TROUBLES.

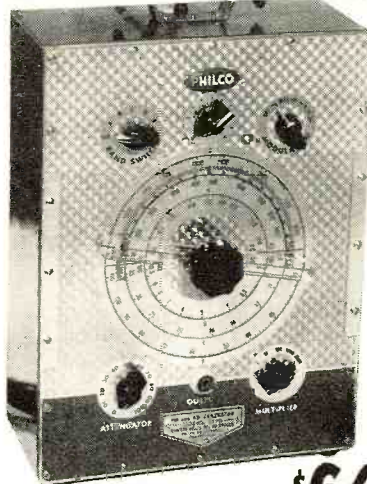

SPECIFICATIONS	
Frequency Range	100 kc. to 110 mc. (six bands)
R.F. (AM)	100 kc. to 170 mc.
R.F. (FM)	400 cycles
Audio Frequency	.6-1 volt (r.m.s.) depending upon range
R-F Output Amplitude	1 volt (r.m.s.) approximately
A-F Output Amplitude	Variable from 4 kc. to 500 kc.
Sweep Width	60 c.p.s. (fixed)
Sweep Rate	Direct reading (for AM)
Calibration	60 mc.
F.M.-Oscillator Frequency	110-120 volts. 60 cycles a.c.
Operating Voltage	25 watts
Power Consumption	6C4 (1), 7F8 (2), 6X5GT (1)
Tube Complement	

Another Bargain
DUMONT 16" ALL GLASS
16FP4 BENT-GUN C R TUBE
 Fully Guaranteed, in Factory-Sealed Carton **\$29.95** SPECIAL

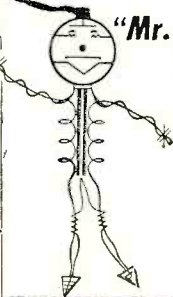

"Mr. Fed" says:

SEND YOUR ORDERS NOW!

MODEL 7170 **\$64.50**
 ONLY A LIMITED QUANTITY AVAILABLE READY FOR SHIPMENT

Federated Purchaser
 INCORPORATED

66 DEY ST., NEW YORK 7, N. Y. Dlgby 9-3050
 ALLENTOWN, PA. NEWARK, N. J. EASTON, PA.
 1115 HAMILTON ST. 114 HUDSON ST. 701 NORTHAMPTON ST.

YOU CAN STILL

Buy—

TROUBLEPROOF TELEVISION

THE 630 TV WILL WORK WHERE OTHERS FAIL!

Own the Television Set preferred by more Radio and Television Engineers than any other TV set ever made!

THE ADVANCED CLASSIC 630 TV CHASSIS

With the latest 1951 improvements the 630 TV will out-perform all other makes in every way. The new, high efficiency, 29 plus tube circuit should not be compared to the cheaply designed 24-tube sets now being sold under standard brand names.

• Greater Brilliance

Assured by the new 14-16 KV power supply.

• Flicker-Free Reception

Assured by the new Keyed AGC circuit—no fading or tearing of the picture due to airplanes, noise or other interference.

• Greater Sensitivity

Assured by the new Standard Tuner, which has a pentode RF amplifier and acts like a built-in High-Gain Television Booster on all channels! The advanced 630 chassis will operate where most other sets fail, giving good performance in fringe areas, and in noisy or weak locations.

• Larger—Clearer Pictures—for 16", 17", 19" or 20" Tubes

Assured by advanced circuits. Sufficient drive is available to easily accommodate any tube.

• Trouble-Free Performance

Assured by use of the finest materials such as quality condensers, overrated resistors, RCA designed coils and transformers, etc.

• RMA Guarantee

Free replacement of defective parts or tubes within 90-day period. Picture tube guaranteed fully for six months at no extra charge!

PRICE COMPLETE

LESS PICTURE TUBE.....NET **\$164.95**

NO ADDITIONAL TAXES TO PAY

TELEVISION PICTURE TUBES

Standard Brands

SIX-MONTH GUARANTEE

12½" (Black or White)....	\$26.50	Glass 16" Round (Black).....	\$39.50
Glass 14" Rectangular (Blk.)	\$29.50	Glass 16" Rectangular (Blk.)	\$39.50
17" Rectangular (Blk.)	\$42.50		
19" Round (Blk.)	\$69.50		
20" Rectangular (Blk.)	\$73.50		

TELEVISION CABINETS

16" or 17" Table Model Cabinet

A gorgeous table model cabinet for the average size living room. Outside dimensions 23¾" Wide x 24" High x 24" Deep. Walnut or Mahogany..... **\$44.50**

16" Economy Console Cabinet

An exceptional buy in a console cabinet made of fine veneers to house the 630 TV chassis, tube and speaker. Outside dimensions are 39" High x 24" Wide x 22¾" Deep. **\$49.50**

16" or 17" PERIOD CONSOLE

Handsomely styled for the conventional living room. Has a drop-door panel to conceal control knobs when desired. Outside Dimensions are 41" High x 26" Wide x 24" Deep. **\$64.95**

Above cabinets available for 19" or 20" tubes at \$5.00 additional.

We are now authorized Distributors for the famous Masco line of high fidelity Amplifiers, Public Address Systems, Tape Recorders, Inter-Communication Systems, etc. Write for latest Catalog.

All Merchandise Subject to Prior Sale. All Prices Subject to Change without Notice.

WRITE FOR COMPLETE CATALOG N-3

EDLIE ELECTRONICS INC.

154 Greenwich St. New York 6, New York

gain, as previously mentioned. The *converter* will convert any high-band channel (for example, Channel 10) to an unused low-band channel (say, Channel 2) and thus make possible greater gain in the amplifier and lower loss in the cable. The new *amplifier*, similar to the MC-1 unit, will provide separate channel amplifiers for each channel and assure even higher gain and better noise rejection.

2. New distribution boxes are being designed which introduce practically no attenuation of signal between amplifier and receiver, and thus the only effective losses are in the cable. This will make it possible to install, in the community served, a new distribution box beside each amplifier and then run 900 to 1000 feet of cable from this box, tapping off a much larger number of receivers. Thus the number of distribution boxes, will be greatly reduced.

3. A new isolation network has been designed for insertion in the cable at the point where you tap off for each receiver. This is a very small, efficient, and inexpensive component.

4. With this new amplifying and distribution equipment, it is possible to use RG/59U cable for practically all runs, instead of the RG/11U now used in Panther Valley. This will mean a saving in cable cost of about 60%.

5. All of the new equipment is weatherproofed and designed to operate under any climatic conditions.

UHF Television Stations?

Although the question has not yet arisen in actual experience, some people have already asked what effect the building of nearby u.h.f. television stations might have on such a community aerial system. The answer is simple. If a u.h.f. station is within receiving distance of the master antenna tower of the community aerial, and this new service is desired, then the u.h.f. signal can be received, and it can be converted to a lower, *unused* v.h.f. channel and then distributed through the standard community aerial system.

For example, suppose a new u.h.f. station were built in Scranton, Pa., and could be received by the "PV-TV" tower on Summit Hill. The Panther Valley system is already receiving Channels 3, 6, and 10. However, the new u.h.f. station's signals could be converted to the frequency of Channel 2, say, right at the tower. Then, merely by adding channel amplifier strips for Channel 2 to all the MC-1 amplifier units, the programs from the new u.h.f. station could be piped around Lansford with *no modification* of television receivers necessary!

The Potential

The potential of the community aerial is truly tremendous. Every city and town now beyond the fringe of television reception, either because of distance or intervening mountains, or both, now stands a chance of getting good TV signals from a master antenna system. For the town in a valley, there is probably a hilltop near

NOW! SPEED UP ALL SOLDERING WITH UNGAR FEATHER-LIGHT SOLDERING PENCILS WITH HI-HEAT INCREASED WATTAGE TIPS



For use with No. 776 Handle & Cord Set

Stop wrestling with big irons. New HI-HEAT TIPS in your Ungar Electric Soldering Pencil produce a really versatile tool that'll perform on a par with the big, bulky 100-150 watt irons. If you can't get immediate delivery, please be patient, for production hasn't yet caught up with demand. Ask your supplier for No. 1236 Pyramid or No. 1239 Chisel. List price, \$1.25 each.

Ungar

ELECTRIC TOOL CO., Inc.

LOS ANGELES 54, CALIFORNIA

RCA VICTOR Camden, N. J.

Requires Experienced Electronics Engineers

RCA's steady growth in the field of electronics results in attractive opportunities for electrical and mechanical engineers and physicists. Experienced engineers are finding the "right position" in the wide scope of RCA's activities. Equipment is being developed for the following applications: communications and navigational equipment for the aviation industry, mobile transmitters, microwave relay links, radar systems and components, and ultra high frequency test equipment.

These requirements represent permanent expansion in RCA Victor's Engineering Division at Camden, which will provide excellent opportunities for men of high caliber with appropriate training and experience.

If you meet these specifications, and if you are looking for a career which will open wide the door to the complete expression of your talents in the fields of electronics, write, giving full details to:

National Recruiting Division
Box 130, RCA Victor Division
Radio Corporation of America
Camden, New Jersey

enough, a hilltop where distant stations can be received as in the case of Summit Hill and its antenna tower serving Lansford. For the town out on a wide, flat prairie with no convenient hill, the most probable solution is to erect a lofty antenna tower at the edge of town nearest the TV stations to be received, which may be 80 to 100 miles away. Then the amplified signals can be "piped" around town from the base of the tower, and savings in amplifiers and cable (with no run down a mountain needed) may compensate for the added height of tower required.

By this new technique of the community aerial, it is feasible for television to reach new audiences by the million, just as television has come to Panther Valley.

-30-

Spot Radio News

(Continued from page 18)

with the gentlemen from Princeton, members have been hammering away at the virtues of the approved disc system. And featured talks have been the perfect setting for these opinions. So Coy offered in his address a few more views on the subject. He felt that . . . "color is an important improvement in television broadcasting. . . . It adds both apparent definition and realism in pictures . . . and opens whole new fields for effective broadcasting, permitting television to render life-like and exciting scenes, where color is of the essence." Then defending the Commission's stand on the CBS system, he said . . . "The field sequential system . . . produces excellent color, is relatively simple as compared to other proposed systems, and the Commission believed that sets could be produced at prices which would make it possible to have mass distribution of them reaching to most of the homes in this country." Admitting that the pinwheel idea requires alterations in present receivers, he struck out at the critics of the decision and said that . . . "any system now known requires all present sets to be rebuilt or converted to get a color picture." Declaring that this was a point . . . "obscured in the fuss which has been made about adapting present sets in order that they will continue to receive black and white pictures from all transmissions . . ." Coy pointed out that . . . "the Commission was not interested in just finding another way for people to get black and white pictures."

Voicing concern over the effect the defense efforts may have on color, Coy said that . . . "the future of our defense mobilization effort may well hold the answer to whether color television broadcasting makes a small or large beginning within the year in becoming the prevailing television of this country."

THE DELAYING EFFECT which defense movements may have on color

March, 1951

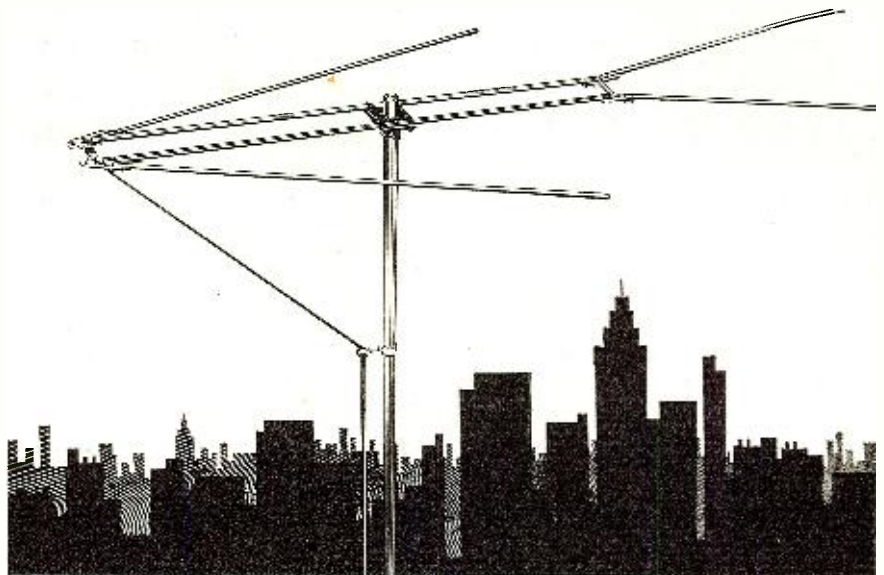

THE RUGGED WORKSHOP

DUBL - VEE TV ANTENNA

PATENT PENDING

**Stands up in Winter Storms . . .
Saves Costly Service Calls**

That well-remembered storm in late November knocked down thousands of TV antennas but only a small percentage of DUBL-VEES. Alert set owner, dealers, and installers were quick to note that it stood up through wind, ice, sleet, and snow . . . saved annoying, expensive service calls. This rugged performance was possible because the DUBL-VEE offers less wind resistance than any other popular TV antenna.

Coupled with its exceptional mechanical strength, the DUBL-VEE's high gain and sharp directivity insure clear, brilliant pictures throughout the TV spectrum with a minimum of interference. Four outstanding pictures under all conditions get the WORKSHOP DUBL-VEE.

Write for Bulletin A

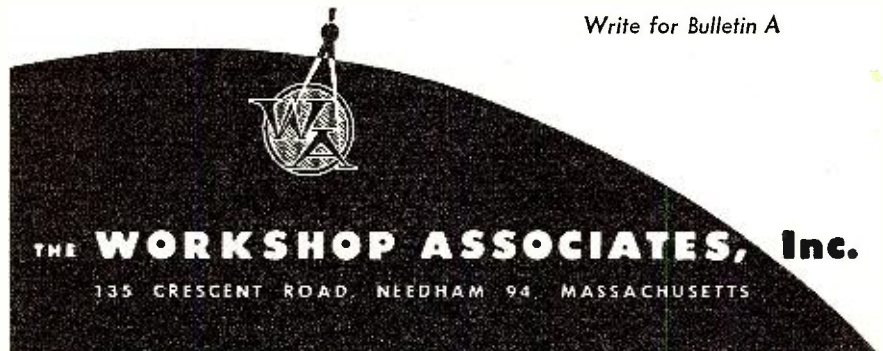

You saw it at
the Audio Fair...

**"exciting current
test"** Another in a series which
**demonstrates
PEERLESS
transformer
superiority!**

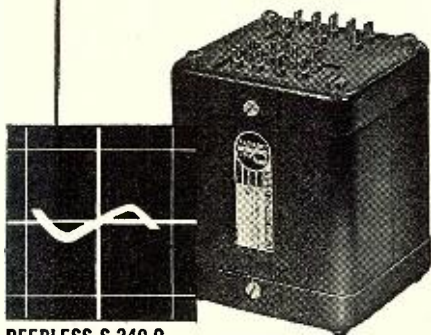

PEERLESS S-240-Q



Competitor No. 1

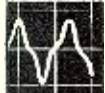

Competitor No. 2



Competitor No. 3



Competitor No. 4

Since the 1949 Audio Fair, comparative square wave tests on transformers shown all over the country have demonstrated Peerless superiority... Now Peerless emphasizes another very important property of transformers as shown by the "exciting current test."

An output transformer's ability to deliver plenty of clean, low-frequency power (the goal of every music lover) is inversely proportional to the amplitude and distortion of its exciting current.

PEERLESS superior low-frequency power handling capacity is illustrated in these comparative oscillograms.

Write for complete data.

PEERLESS
Electrical Products



Division



161 Sixth Avenue
New York 13, N.Y.

9356 Santa Monica Blvd.
Beverly Hills, Calif.

was also spotlighted in a resolution presented to NPA by a radio, television and home appliance wholesalers group, which asked that color television production be banned during the emergency.

Citing that it was not the group's intention to halt development of color, a committee spokesman said that the resolution just sought assurance that red, green, and blue sets would not be made, because they required about five times as much critical material as the standard chassis.

When CBS Prexy Frank Stanton heard about the ban request, he wired General Harrison for an explanation. The reply indicated that no definite action had been taken and that the matter would receive serious consideration. However, at this writing, in view of the series of rollbacks being ordered for practically every major metal and chemical required in a color chassis, it appeared as if the distributors' suggestion would probably go into effect automatically, for the additional materials just won't be available.

MECHANICAL COLOR, which Washington declared an advanced concept, was placed in a shell of antiquity recently by the Television Society of London, who in a memorial booklet on John L. Baird, revealed that the Scotsman had demonstrated a color scanning method in 1928. Describing the test, the magazine "Nature" said: "Delphiniums and carnations appeared in their natural colors and a basket of strawberries showed the red fruit very clearly."

Reviewing the technique used by Baird, picture-tube inventor V. K. Zworykin disclosed that a Nipkow disc flying-spot system had been employed, providing 20 to 30-line pictures. Color filters were mounted directly over three successive aperture spirals of the disc. In '39 Baird had raised the number of lines in his pictures to over a hundred; the field frequency was one hundred as compared with sixty for black and white.

Dr. Zworykin's remarks were made during an SMPTE meeting on the occasion of the presentation of the society's progress medal to him.

THE EDUCATOR AND TV hearings which it was originally assumed would be a mild event and involve the usual assortment of placid statements, rocketed into a round-the-clock affair with few dull moments. The educators put on quite a show, for they wanted to be sure that they received their share of those precious listen-and-look channels.

In one blistering report, offered by Mark C. Schinnerer, superintendent of the Cleveland public schools, the Commissioners were told that enlightenment and entertainment are not synonymous. He pointed out that if the history of radio is repeated... "then school television will never exist with any continuity unless it becomes part

and parcel of our educational scheme."

Stating that broadcasting is not a frill nor a plaything, the educator said that... "if radio and television can influence people to buy soap and toothpaste, desirable as that may be, then we in our business, the nation's most important business, the refinement of its human resources, must also use the most modern tool of communication."

The significant applications of radio and TV were described by Los Angeles' school assistant superintendent, Maurice G. Elair, who declared that the schools of L.A. now own 2117 radios and all of the new schools are wired for television and radio. In addition, he said, we have... "a radio office fully equipped for the production of radio programs, with a competent staff in attendance." Subjects transmitted include spelling, math and science in agriculture, citizenship, home-making, safety, housing, welfare, health, industrial arts, business education, general music and college preparation.

The chairman of the National Association of Educational Broadcasters, Richard B. Hull, also offered some vital data on the force of communications in teaching. Said Hull: "It is axiomatic in radio broadcasting, and by inference in television, that audiences listen for three reasons... (1) strength of signal, loudness, ability to get a station; (2) frequency of program, a program aired five times weekly is more listened to than one heard once per week, per month, or per year, and effective in that ratio; (3) the program itself... Hence it is obvious that without an outlet, a strong outlet and without numerous programs heard frequently, any educational program, any dissertation, any type of entertainment or education, no matter how intrinsically valuable or important to our society, cannot be an effective element in the complex art of mass communications."

HORSE-RACING INFORMATION BROADCASTING, has found itself, after years of debate, the target of an investigation, with a two-page questionnaire placed before every broadcaster in the country.

Disturbed by the manner in which the racing results have been described as being used in betting, the Commission decided to find out how often the racing results are put on the air and particularly what kind of information is broadcast, requesting details on such racing items as entries, scratches, probable jockeys, jockeys, weights, selections, off time, next post time, track conditions, weather conditions, time of race, mutuels, results of race, results in code, post positions, post positions in code, and running account of race. The Commission was quite concerned as to the time element, asking if the results are announced as soon as received, or delayed until the conclusion of a program and if delayed how many minutes after official off time were the results aired.

METER SPECIALS

RD 3 1/2" O-20 ua (O-100 Scale) WH.	\$5.95
SQ 3 1/2" O-200 ua DC	6.50
SQ 3 1/2" O-1 MA	3.95
SQ 2 3/4" O-9 VDC	.99
SQ 2 3/4" O-100 AMP DC with shunt	.99

WESTERN ELECTRIC 104A Two Tone Signaling Selector for mobile use. Unit contains 600 CY & 1500 CY Filter Units, Relays, etc. Used, Excellent Condition.		\$49.50
Superior Powerstat, Model 20	12.50	
Superior Powerstat, Model 116U	18.00	
Superior Powerstat, Model 216	26.00	
Superior Powerstat, Model 1126	46.00	
Superior Powerstat, Model 1156	118.00	
Superior Powerstat, Model 1256	118.00	
GH Wavemeter 738A 35-400 MC	24.50	
12 HY 160 MA CHOKES 51.25 ea., 2 for	1.98	
SOLA Constant Volt Trans 115 V 50 CY, Out. 1.5 V 250VA	39.50	
ART/13 Mod. Trans PP 811 to 813	12.95	
ART/13 Audio Driver Transformer	.99	
ART/13 Auto. Tune Dial, 52-95 VFO Dial	3.45	
Beachmaster Output Transformer, 250W	12.95	
Wagge Tube Heaters, 110 V 100 W, 2 5/16" Inside Diameter, 2 for	3.90	
IRC 50K 100W Rxd, 2.5K 100W ADJ. Fr. Counter Type Instrument Dial, 3"x3", 1/4"	1.95	
4MF 600 V Oil TC Type	3.95	
7MF 600 V Oil Cap	.90	
888 Dual MFD 600 V Oil Cap	1.95	
18P 600 V Metal Cased Oil Tub. Cap. 10/	2.50	
Aerovox Type 484 .5MF 400 V Tube Cap. 10/	2.50	
CP29AIEF504M .5MF 600 V M. Tub. Cap.	4.95	
C-D 100MF 50 VDC Electrolytic Cap.	.49	
Muter KS136B 2-3MMF Var. Cap.	.99	
Four Quadrant Phasing Capacitor, 50 P.F.	3.50	
C-H Luminous Tip Bat Handle Aircraft Toggle-SW, SPDT, 5A 125 V 10 for	1.95	
SPST As Above	.40	
3 Way Binding Post, Red or Black	.40	
100KC Precision Crystal	6.95	
1000KC xtal, \$4.95; 5 Mc xtal	4.95	
BC221 Fred. Meters, excellent	75.00	
7/8" Fluted Knobs, Brass Insert, 1/4"	1.20	
Amphenol Connector AN106-18-6P	.25	
Pilot Light Assembly, Porcelain Dimmer Type, Red, Green, Amber, White	.24	

3" METERS

0-50 ua	\$14.50	30-0-30 AMP DC	\$5.95
100-0-100 ua	8.95	0-50 AMP AC	7.95
0-50 ua GE	9.95	0-10 AMP AC	9.95
0-1 MA Scale	3.95	JBT 31-F FRMTR	5.95
0-1 MA DC	5.95		
0-5 MA SP Scale	2.95		
0-15 MA DC GE	4.50		
0-20 MA DC WH	4.50		
0-30 MA DC GE	4.50		
0-50 MA DC	4.50		
0-80 MA DC WE	4.50		
0-100 MA DC	4.50		
0-150 MA DC WH	4.50		
0-200 MA DC GE	4.50		
0-300 MA DC	4.50		
0-500 MA DC	4.50		
0-1 AMP DC WH	4.95		
0-2 AMP DC Simp	5.95		
0-30 VDC Sun.	7.95		
0-750 VDC	7.95		
0-8 VAC WES 476	4.50		
0-15 VAC GE	4.50		
-10-8 DB WS	10.95		
301	10.95		
0-150 VAC	5.95		

2" METERS

0-500 ua SP Scale	\$3.95
0-1 MA DC SUN.	3.95
0-1-2 MA 506	3.45
0-50 MA SP Scale	2.49
0-300 MA	3.95
0-20 MA SP Scale	3.50
0-50 MA SP Scale	3.50
0-300 MA DC	3.50
0-3 VDC, 1 MA	3.50
0-20 VDC	3.50
0-30 AMP DC	3.50
0-10 VAC GE	3.50
0-300 VAC	4.95
0-1 AMP RF GE	3.50
0-4 AMP RF GE	3.50
0-9 AMP RF WH	3.50

CO-AXIAL RELAYS

Allied Control Type RA, SPDT, 6 VDC, Uses Standard Co-Ax Connectors	\$5.95
Above Relay for 24 VDC	6.95
Set of 83-15P Co-Ax Connectors for above	.99
Cramer Time Delay Relay, 120 Sec 120 VAC	\$9.95
Post-From. Type Relay, 6 VAC, DPST	1.95
24 VDC Relays, 5 for	.99

CHOKES

200 HY 6MA 620 OHM, Cased	\$ 0.99
6 HY 65 MA 24 OHM	.99
10 HY 80 MA 24 OHM	2.00
7 HY 125 MA, Cased	\$1.10 ea.; 2
10 HY 150 MA 140 OHM	1.69
7 HY 200MA 100 OHM, Cased	3.49
4-16 HY 200 MA 70 OHM Swinging Ch.	2.95
3 HY 250 MA 15 OHM Herm. Seal	1.25
15 HY 250 MA 60 OHM, Cased	3.49
3-14 HY 300 MA 70 OHM Swinging Ch.	5.95
6 HY 300 MA 65 OHM, Cased	4.95
8 HY 300 MA 80 OHM, Cased	6.10
6 HY 350 MA 70 OHM, Cased	6.50
4 HY 400 MA 100 OHM, Cased	5.95
6 HY 450 MA 80 OHM, Cased	6.50
7 HY 750 MA 40 OHM, Cased	11.50

115V FILAMENT TRANSFORMERS 60 CY

2.5 VCT 10 A, 10KV Insulation	\$4.50
2.5 V @ 6 Amps, 6.5 @ 6 Amps	5.25
5 VCT 3A, 2.5 KV Insulation	2.55
3 V 20 A, 2.5 KV Insulation	6.85
6.3 V 1.2 A	6.85
6.3 V 3 Amps	2.45
6.3 V 12 Amps	3.95
6.3 V 4 Amps, 6.3 V 4 Amps	2.95
6.3 V 3.5 A, 2 x 2.5 V 3 Amps ea.	3.95
6.3 V 3A, 2.5 V 6 AMP Herm Seal	3.49
6.3 V 8 Amps	3.95
10 VCT 10 A, 2.5 KV Insulation	6.00
6.3 V 12A, 6.3 V 2 A Herm Seal	4.50

115 V POWER TRANSFORMERS 60 CY

435 VCT 145 MA, 6.3 V 3A, 5V 3A	\$ 2.49
700 VCT 90 MA, 6.3V 4A, 5V 3A	3.50
700 VCT 150 MA, 5V 3A	3.50
800 VCT 200 MA, 6.3V 4A, 5V 3A	6.50
800 VCT 300 MA, 6.3V 10.5A, 5V 6A, 5V 2A	9.50
750-600-0-600-750 225 MA	24.50
3200 VCT 450 MA	24.50
115 V, 230 V TAP, PRI. 850 VCT 280 MA -36V 7A-6.3V 3A-5V 3A, Cased	12.50

OIL CAPACITORS

7 MF 330 VAC	\$0.95	25 MF 2000 VDC	\$1.95
5 MF 600 VDC	.95	1 MF 2000 VDC	2.10
2 MF 600 VDC	.79	2 MF 2000 VDC	2.75
4 MF 600 VDC	1.00	4 MF 2000 VDC	4.50
8 MF 600 VDC	1.80	8 MF 2000 VDC	3.95
10 MF 600 VDC	2.49	5 MF 2500 VDC	1.39
2 MF 1000 VDC	.90	25 MF 3000 VDC	2.25
5 MF 1000 VDC	1.45	1 MF 3000 VDC	1.49
10 MF 1KV DC	3.25	3 MF 4000 VDC	5.95
15 MF 1KV DC	3.95	1 MF 5000 VDC	5.50
2 MF 1.5 KV DC	2.95	2 MF 6000 VDC	2.95
4 MF 1.5 KV DC	2.75	4 MF 5000 VDC	11.50
6 MF 1.5 KV DC	2.95	2 MF 6000 VDC	12.95
1 MF 2000 VDC	1.79	1 MF 7500 VDC	1.25

TERMS: 25% Deposit with order, balance C.O.D. Rated firms open account

POLY-TECH

919 Dawson St., New York 59, N. Y.
Tel. Murray Hill 6-2650

While the Commission does not have the immediate authority to discontinue either station operation or the result broadcasts, they can if they find that the reports tie in too closely with any betting ring activities and in addition represent a feature not in the public interest, advise the licensee that the continuance of the practice is a violation of their civic responsibility and thus they will not be eligible for license renewal.

With such revocation procedures looming and the threat of criminal action by Federal authorities to consider, there is little doubt that every broadcaster will cooperate in the effort to stamp out any collusion, and discontinue any broadcasts reported to be serving as a possible feed for book-making.

WASHINGTON WILL BE THE SCENE of a host of intriguing scientific meetings during the year, paying tribute to the fiftieth anniversary of the Bureau of Standards.

In the early spring the National Academy of Sciences and the Union Radio Scientifique International will honor the bureau with sessions which will feature discussions of the many developments initiated at NBS, developments which served to provide the basis of new techniques in industry.

During the year the bureau will also hold a series of symposia on special topics involving many phases of radio and TV. All meetings are expected to be open to members of industry societies and organizations. L.W.

V.W.O.A. ELECTS

WILLIAM J. MCGONIGLE of the New York Telephone Company and **William C. Simon** of Tropical Radio-United Fruit Company, were reelected president and secretary of the Veteran Wireless Operators Association at its 26th annual business meeting held recently in New York City.

The Association's membership is composed of some 300 "brass pounders", operators of ship and shore wireless stations, many of whom were active before the term "radio" replaced "wireless". **Lec de Forest**, the "Father of Radio", is honorary president of the group.

Other officers elected included: **A. J. Costigan**, Radiomarine Corp. of America, 1st vice-president; **H. L. Cornell**, Esso Shipping Co., 2nd vice-president; **R. H. Pheysey**, United Fruit Co., treasurer; and **R. J. Iverson**, New York Times-Radio, assistant secretary.

George E. Sterling, a member of the FCC, was reelected to the Association's board of directors. Serving with Mr. Sterling on the board are the following members: **George H. Clark**, Radio Corporation of America (retired); **C. D. Guthrie**, U. S. Maritime Commission (retired); **Capt. Fred Muller**, USNR (retired); **Jack R. Poppele**, vice-president and chief engineer of WOR and president of Television Broadcasters Association; and **Mr. McGonigle**, **Mr. Costigan**, and **Mr. Simon**.

G. W. Johnstone, National Association of Manufacturers, was appointed publicity chairman.

USE

KESTER

FLUX-CORE

SOLDER



FOR TV AND RADIO WORK—Kester Plastic Rosin Core Solder and Kester "Resin-Five" Core Solder. Kester Solders are made only from newly-mined grade A tin and virgin lead.

KESTER SOLDER COMPANY

4235 Wrightwood Ave.
Chicago 39
Newark, N.J. Brantford, Canada

KESTER SOLDER

SCR 522

originally designed for Aircrafts

Transmitter Receiver, for communications on frequency 100 to 156 Mcs, through 4 pre-set channels, using following tubes: (Transmitter) 2/832, 3/12A6, 1/6GG6, 2/6SS7; (Receiver) 1/12J5GT, 1/12C8, 1/9002, 3/9003, 1/12AH7GT, 3/12SG7. Complete, New, with case and rack FT244 \$119.00

Dynamotor PE94C, 28 v. input, 300 v., 150 v., 13 v. outputs; complete with filters, voltage regulator, case and shockmount base, New, \$9.90

Junction box JB29, \$7.50

Control box BC602, \$3.50

Jack boxes BC631 and/or BC629, \$1.00

Plugs, all types in use for interconnection of components of SCR522, PL (P or Q type) 164, 165, 166, 167, 169, 170, 171, 172, 173, \$0.55 ea.

Antenna mast AN-104, A or B, Steel or Copper, \$1.25

Spare parts, also available in limited quantity. All above equipment is new, and if desired, in original Manufacturer's packing, for export.

Terms: net, for delivery FOB Plattsburg, N.Y. Above prices are basic prices per unit, inquiries for quantities will be carefully considered.

NORTH AMERICAN ELECTRONICS CO.

P. O. Box 178 PLATTSBURG, N. Y.

Mac's Service Shop
(Continued from page 60)

tell me how we can get more tubes, I'll say you are a real genius," Barney challenged.

"All I can do is tell you what I am doing along that line," Mac said with a chuckle. "I am concentrating all of my ordering on one large and well-established jobber instead of shopping around for bargains as I did when tubes were plentiful. Since we are a small outfit, the only way we can make like a good customer is to concentrate all our buying in one place. I know from experience in World War II that a jobber appreciates a technician's depending upon him for all his needs; and he shows this appreciation by doing his best to take care of that technician in connection with the hard-to-get items."

"You got any fiendishly-clever schemes for making other items than tubes go further?"

"Yep, lots of 'em. For one thing, we are starting re-coning all speakers that can be re-coned instead of replacing the whole speaker as we have been doing. In the past, especially in the case of small speakers, it was actually cheaper in many cases to make the replacement because of the low price on speakers. Now, however, the cut in the use of cobalt is going to make a deep cut in speaker production. New speakers should be saved for those jobs where no repair is possible. And don't throw away any speaker that cannot be re-coned *now*. If things get tougher, a lot of things that are impractical now will become very practical."

"How's about such things as r.f. and i.f. coils, power transformers, speaker fields, deflection yokes, and focus coils?"

"The technicians who were in business during the last war and during the depression know darned well that many of these coil-type parts can be repaired if a fellow will just take the time and trouble to do it. By far the great majority of the breaks in the windings occur near the ends where they can be easily mended. The trick, of course, is to find where the wire is broken. If the coil is entirely open, our stunt of placing a high-voltage neon transformer across the ends of the coil and watching for the arc works one hundred per-cent. If the break is only partial and results in a high resistance in the winding, it can usually be made complete by passing a heavy current through it from a tapped transformer such as is used with an electric train or a tube checker. After the coil is open, the neon transformer can then be used to spot the location of the fault."

"Three hundred ohm twin-lead is rapidly becoming a collector's item. What are you going to do about that?"

"Shame on you, a ham, for asking a question like that!" Mac exclaimed.

March, 1951



CHICAGO FULL FREQUENCY OUTPUT TRANSFORMERS

.2db 30-20,000 CPS

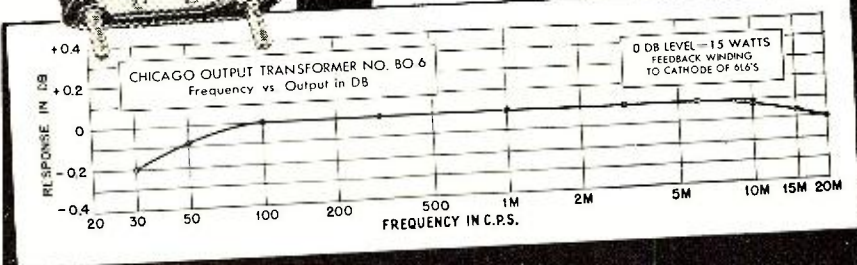

CHICAGO OUTPUT TRANSFORMER NO. BO-6
Frequency vs Output in DB

RESPONSE IN DB

FREQUENCY IN C.P.S.

0 DB LEVEL - 15 WATTS
FEEDBACK WINDING
TO CATHODE OF 6L6'S

No. BO-6. For use in high fidelity amplifiers. Couples push-pull 6L6's (7500 ohms, C-T) to 6/8 or 16/20-ohm voice coil. Center-tapped tertiary winding provides 15% inverse feedback to reduce harmonic distortion to a minimum. In drawn steel case, 4⁵/₁₆" x 3⁷/₈" x 3¹¹/₁₆", with mounting studs and convenient pin-type terminals.

No. BO-7. For matching 600 or 150-ohm line to a 6/8 or 16/20-ohm voice coil. Frequency response within plus or minus 1db. at full rated output—maximum power level, 30 watts. Mounted in compound-filled drawn steel case, 4⁵/₁₆" x 3⁷/₈" x 3¹¹/₁₆". Mounting studs and pin-type terminals same as No. BO-6 illustrated above.

There's a CHICAGO Output Transformer for Every Full Frequency Use

Cat. No.	Application	Impedance	Max. Power
BO-1	Single Plate to Line	Pri.—15,000 ohms at 0 to 10 ma d-c *Sec.—600/150 ohms CT	+20 dbm..
BO-2	P.P. Plates to Line	*Pri.—20,000 ohms CT *Sec.—600/150 ohms CT	+30 dbm..
BO-3	P.P. Plates to Line	Pri.—5,000 ohms CT *Sec.—600/150 ohms CT	+40 dbm..
†BO-4	P.P. Plates to Line	Pri.—7,500 ohms CT *Sec.—600/150 ohms CT	+43 dbm..
BO-5	P.P. Plates to Line	Pri.—10,000 ohms CT *Sec.—600/150 ohms CT; 16/8/4 ohms	+37 dbm..

†Tertiary winding provides 15% inverse feedback. *Split and balanced windings.

HIGH Q CHOKES



for Dynamic Noise Suppression Circuits

Two precision-built chokes with inductance values of .8 and 2.4 henrys respectively—accurate to within ± 5% with up to 15 ma d-c. Units have a minimum Q of 20. Remarkably compact, 1¹/₁₆" x 2³/₈" x 1¹/₁₆".

No.	Inductance
NSI-1	.8 h
NSI-2	2.4 h

Famous "Sealed in Steel" New Equipment Line

The units described above are typical of CT's New Equipment Line featuring transformer engineering that's *ahead* of the trends in circuit design. Get the full facts on the complete line now. Check the features, and you'll see why CT is called the "Engineer's Transformer." Check the prices: see how little more these advanced units cost over ordinary transformers.



Write for Complete "New Equipment" Catalog Today



CHICAGO TRANSFORMER

DIVISION OF ESSEX WIRE CORPORATION

3501 ADDISON STREET • CHICAGO 18, ILLINOIS

BLOWERS:

115 Volt 60 cycle BLOWER (pictured), approx. 100 CFM Dis. 2 3/4" intake; 2" outlet. Quiet running. Motor size: 2 1/2" x 3 1/4". NEW—not Gov't surplus. Order No. RN-520. **\$7.99**



DUAL BLOWER—Same as RN-520 above, except has blower assembly on each side of motor. Order No. RN-800. **\$12.95**
L-R #2 Blower Assembly, Plastic Housing 3"x1 1/2". Blower Wheel 2"x1 1/2"—3/4" shaft. (No Motor) **\$1.95**
L-R #2 1/2—Same as above. Housing 3 1/2"x1 1/2". **\$2.00**
L-R Blower Wheel only. 3"x2"—3/8" shaft. **\$1.00**

ANTENNAS:

LP-21 Loop Housing only. **\$2.00**
AS-27/ARN-5 Rams Horn, 110 MC. **\$2.95**
AN-104 Stub, 100-156 MC. **\$2.95**
AN-100A Whip Steel, 5 Ft. w/Base. **1.50**
AN-117A Whip Steel, 6 Ft. w/Base. **2.00**
AT-37A/AT Stub, 113-150 MC. **5.95**
AS-32/ATX-1 UHF 18-3 1/2" 3" Base. **2.50**

BC-223 TRANSMITTER

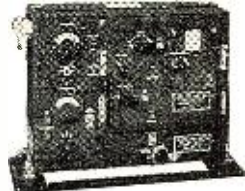

30 Watt transmitter with h Crystal or MO control on four pre-selected channels. CW, MCW cover frequency range 2000-5200 KC. by use of plug-in coils. Complete with h tubes and choice of one Tuning Unit (listed below), Less Mtg.—Prices:
USED: **\$29.95**
NEW: **\$23.50**

CABLE—Trans. to Power Supply. **\$2.00**
TUNING UNITS: TU-17—2000-3000 KC.; TU-18—3000-4500 KC.; TU-23—3500-5250 KC. **\$3.50 EACH**
SPARE TUBE KIT in metal box, f/BC-223. **\$4.95**
OPERATING MANUAL for BC-223. **\$2.50**
PE-125 POWER SUPPLY f/BC-223—12/24 Volt input; output 500 Volt 150 MA. **NEW: \$11.95**
SPARE VIBRATOR & TUBE KIT f/PE-125. **\$4.95**
SHOCK MOUNTING for PE-125. **\$1.50**

BC-375 TRANSMITTER

BC-375 Transmitter—100 Watt Voice, CW, MCW covers frequency range 200 KC. to 12 MC. by the use of Plug-in Tuning Units, as listed below. Complete, with tubes, less Tuning Units. **USED: \$18.95**
TUNING UNITS FOR BC-375 OR BC-191 TRANSMITTERS (Listed Below) **\$3.95 EA.**
TU-5—1500 to 3000 KC. TU-9 — 7700 to 10000 KC.
TU-6—3000 to 4500 KC. TU-10—10000 to 12500 KC.
TU-7—4500 to 6200 KC. TU-28 — 200 to 500 KC.
TU-8—6200 to 7700 KC. BC-306—Antenna Loading
FT-151 Shock Mounting for BC-375-191. **\$2.00**
CABLES F/BC-375-191 w/PL-64, 59, or 61 ea. end. **\$2.00 EA.**

ATD TRANSMITTER

50 Watt, 540 to 9050 KC. MO control. CW and Phone complete with tubes (4/6/403, 1/8H, 128/7, VR105), 24 V. Dynamo, Control Boxes, Spare Tubes, Parts, etc. BRAND NEW. **\$150.00**

BC-645-A TRANSCEIVER

15 Tube Transceiver, ideal for conversion to 460 MC. Citizens Band. Frequency coverage 435 to 500 MC. With conversion instructions. **\$16.95**
Price: New and Boxed BC-645-A.

COMMAND TRANSMITTERS and RECEIVERS with SCHEMATICS

	USED:	NEW:
BC-453 Receiver—190-550 KC.	\$12.95	
BC-454 Receiver—3 to 6 MC.	5.95	
BC-455 Receiver—6 to 9.1 MC.	6.95	
BC-457 Transmitter—4 to 5.3 MC.	5.95	
BC-458 Transmitter—5.3 to 7 MC.	5.95	
BC-459 Transmitter—7 to 9 MC.	14.95	\$24.95
T-20/ARC-5 Trans.—4 to 5.3 MC		8.95
T-23/ARC-5 Trans.—100 to 156 MC		29.50

RECEIVER (MOBILE-BOAT-AIRCRAFT)

BENDIX RA-10 RECEIVER—8 Tube Set covering frequency range 150 to 1100 KC. and 2000 to 10000 KC. in four bands by use of remote control unit. Set size: 18 1/2" L. x 10 1/2" W. x 8 3/4" H. Wt. 32 1/2 lbs. Comes complete with remote control unit, dynamotor, and plugs. BRAND NEW.
Order RA-10 CA f/ 12 Volt DC operation. **\$49.95**
Order RA-10 DA f/ 28 Volt DC operation.

TRANSFORMERS 110 V. 60 CYCLE PRIMARYS:

SEC.:	
24 V. 1/2 amp.	\$1.50
24 V. 4 1/2 amps.	3.95
36 V. 2 1/2 amps.	2.95

WIRE—HEAVY DUTY, RUBBER COVERED:

2/ #1620'	\$1.25
2/ #1210'	1.00
1/ #6 Shield.	15'	1.50
1/ #6 Shield.	7 1/2'	.75

115 V. 60 cycle #C78248, 3 1/2" SELSYNS:
D x 5 1/2" L. New sealed cans.

Pair. **\$10.95**

AUTOSYN TRANSMITTER

Autosyn Transmitter for I-81 or I-82 Indicator. Operates from 26 Volt 400 cycle or 12 Volt AC. Removed from new LP-21A Loops. W/calibrated dial and correction pointer.

MC-507: **\$6.95** MC-217: **\$5.95**

AUTOSYN AY54D—26 Volt 400 cycle. **\$6.75**

DIEHL AC CONTROL MOTOR

#FPE-25, 100 Volts, .44 amps 400 cycle 2 Phase output. 7 Watts, 4 Pole. Price. **\$6.95**

MOTOR ALTERNATOR

Morrill Model HA-1 Motor, 120 Volts .41 amps, one Phase 120 cycle 3600 RPM Generator 35 Volts two Phase 60 VA. Price. **\$9.75**

JOHN OSTER MOTOR

Type A-16-B—26 VDC series rev. with reduction gear approx. 100 RPM and limit contacts. Size: 3 1/2" x 1 1/8". Slotted shaft at side 1/4" x 1/8". Price **\$5.95**

ALNICO FIELD MOTOR

24 VDC 3 1/4" x 1 1/8". Shaft size: 3/8" x 1/8". 10,000 RPM Eicor No. 63662 C. Price. **\$4.75**
ALNICO FIELD MOTOR—24 VDC 3 1/8" x 2". Shaft 1/8" x 1/4" knurled. 10,000 RPM. #P-1212. Price **\$4.75**

BAND SWITCH MOTOR and switching assy. for MN26 Compass. Bendix motor #E-11500-1. 28 Volts DC. Price. **\$9.95**

GEAR TRAIN MOTOR



Ball bearing, low inertia, reversible type motor, 588 RPM. Low speed gear 14 RPM. Extra large Gear 7 1/2 RPM. Operates 26 V. 400 cycle or 12 Volt 60 cycle. Complete with Cond. and instructions. **\$2.95** only. Ea.

AERIAL WIRE:

Aerial Wire Phosphorous Bronze #16 Stranded. 200 lb. test. Weather-proof. 150 Feet on Reel RL-3 w/Clips. **\$1.50**

RG-8/U COAXIAL CABLE

(W/PL-259 Plugs, ea. end):
65 Foot length. **\$4.95**
50 Foot length. **3.95**
35 Foot length. **2.95**

WHIP ANTENNA EQUIPMENT

MAST BASES—INSULATED:

MP-48 Base (Illustrated at right) Insulated type with heavy coil spring. Requires 1 1/8" mounting hole. Weight: 11 lbs. Price. **\$4.95**
MP-132 Base (Illustrated at left) 1" heavy coil spring. 2" insulator. Overall length: 11 1/2". Weight: 2 3/4 lbs. Price. **\$3.95**
MP-22 Base—Spring action direction of bracket. 4" x 6" mounting. Price. **\$2.95**

MAST SECTIONS FOR ABOVE BASES:

Tubular steel, copper coated, painted, in 3 foot sections, screw-in type. MS-53 can be used to make any length, with MS-52-51-50-49 for taper. Price, each, for any section (Ea.) **50c**
MS-54—Larger section than MS-53. **75c**
BAG BG-56 for carrying 5 Mast Sections. **50c**

MOTORS:

6 or 12 Volt AC or DC heavy duty reversible motor, approx. 2500 RPM, 1/10th HP. Shaft size: 3/16" x 1/16". Motor size: 2 3/8" x 3". Flange mounting. NEW **\$3.95**

6 Volt AC-DC Motor—ideal for auto fans, models, etc. Shaft size: 1/4" x 3/8". Used, Tested. **\$1.50**

MODEL MOTOR 12 Volt AC-DC; 1/4" double end shaft. Motor size: 2 1/2" L x 2 1/2" W x 1 1/2" H. **\$2.50**

John Oster 12 Volt AC-DC Motor; 5000 RPM; 3/8" x 1 1/2" Dia. w/spined shaft 1/2" D x 1/2" L. Can be converted to 110 V. hand tool motor. Price. **\$2.95**

HIGH VOLTAGE POWER SUPPLY

PM Field Dynamo-motor Supply, 12 or 24 Volt DC input; 500 Volt 50 MA and 275 Volt 110 MA output. Complete with hash filters, separate fuse for each output. Contains two separate dynamotors for the above output; also on and off switch, indicator light, switching relay, receptacles, etc. Heavy gauge metal case, size: 8 3/4" x 6 1/4" x 1 1/2". Used on No. 19 Mark II Radio Set.

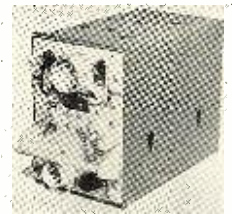

Shipping Weight: 62 lbs. Price. **\$7.95**
Metal Case and Punched Front Panel only **\$2.00**

INVERTERS:

MG-149F—Input 28 VDC 36 A.; Output 26 V. 250 VA 400 cycle or 115 V. 500 VA 400 cycle. USED—Tested: **\$19.95** NEW: **\$29.95**
MG-149H—Input 28 VDC 44 A.; Output 26 V. 250 VA 400 cycle or 115 V. 500 VA 400 cycle. USED—Tested: **\$19.95** NEW: **\$29.95**
MG-153F—Input 24 VDC; Output 115 Volt 400 cycle 3 Phase 750 VA, and 26 V. 400 cycle 1 Phase 250 VA. USED—Tested: **\$69.50** NEW: **\$110.00**

GASOLINE ENGINE GENERATOR

HOMELITE Gasoline Engine Generator—30 Volt DC 50 ampere (1500 Watts) generator driven by single cylinder, two cycle air-cooled gas engine approx. 3 HP. Rope or electric starting. From unused Govt. vehicles, reconditioned. Shipping Wt. 150 lbs. **\$59.50**
Price

GUY CABLE

Regular Aircraft Control Cable, 3/32"—7x7—49 Strands galvanized weatherproof, 920 lb. Test. Ideal for television or radio mast guying. Prices:
2 1/4c per Ft.—1000 Ft. or more: 2c per Ft.

DYNAMOTORS:

INPUT	OUTPUT:	STOCK No.	PRICE
9 V. DC	450 V. 60 MA.	DM-0450	
@ 6 V. DC	275 V. 50 MA.	W/Blower	\$3.95
12 or 24 V. DC	440 V. 200 MA. & 220 V. 100 MA.	D-104	9.95
12 V. DC	600 V. 300 MA.	BD-86	7.95
12 V. DC	330 V. 150 MA.	BD-87	5.95
12 V. DC	375 V. 150 MA.	BD-83	6.95
12 V. DC	1000 V. 300 MA.	BD-77	7.95

PERMANENT MAGNET FIELD DYNAMOTORS:

12 or 24 V. DC	275 V. 110 MA.	USA/0516	\$3.95
12 or 24 V. DC	500 V. 50 MA.	USA/0515	2.95
@ 6 V. DC	240 V. 50 MA.		

Tell Us Your Dynamo, Inverter, & Motor Needs!

SELENIUM RECTIFIER UNITS

HEAVY DUTY—30 VOLT DC OUTPUT:

115/200 V. Three Phase 400 Cycle input:
TYPE 143 w/Transformer & VR 100 amp. **\$89.50**
TYPE 3FS-5 w/Transformer, VR, & Blower 200 amp. **99.50**
TYPE 52A-11 Rectifier only. Cased 200 amp. **49.50**
TYPE A1 Rectifier only. Cased 300 amp. **59.50**
TYPE RE-60 Rectifier only. Cased 40 amp. **69.50**

3/4 RPM ANTENNA ROTATOR MOTOR

High torque, reversible motor—operates directly from 110 Volt 60 cycle by use of condenser. Light weight, quiet running, ruggedly built, positive stop, easily mounted. Normally operates from 110 Volt 400 cycle. Complete—with instructions. NEW. **\$4.95**
10 AMPD 400 Volt Cond. **\$1.00.** SPST Momentary Switch **35c.** DPDT Momentary Switch **75c.** Resistor. 100 ohm 25 Watt, **50c.** 4 Wire Cable, **5c** per ft.

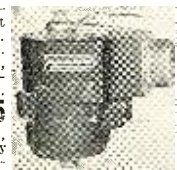

GENERATOR

3/16 HP Generator, 3450 RPM. Shaft size: 1/2" x 1 1/2". Output 240 VDC 100 MA and 12.5 VDC 4 amps. Model G-102. Price **\$14.95**

CONTROL BOXES:

C-87/ART-13 f/ART-13 Transmitter **\$9.50**
MR-9 f/RA-10 12 Volt Receiver **\$14.50**
MN-52-H f/Azimuth Control **\$1.95**
BC-602 f/SCR-522 **2.00**
BC-732 f/BC-733. **2.00**

MISCELLANEOUS:

BC-347 Amplifier w/Tube. **\$ 2.95**
BC-709 Amplifier w/Tubes. **4.95**
PAE-1 Portable Amplifying System with charger **39.95**

Address DEPT. RN • Minimum Order \$2.00
Prices F.O.B., Lima • 25% Deposit on C.O.D. Orders

FAIR RADIO SALES

132 SOUTH MAIN ST.
LIMA, OHIO

"Hams were building and using open-wire lines long before they heard of twin-lead. If the worse comes to the worse, the technician will simply have to obtain some copper wire by unwinding an old coil or transformer, boil some dowel-rod in paraffin for spacing material, and build open lines. He may have to use a 600-ohm line and employ impedance matching transformers at the receiver and the antenna, and the open line may not look so neat as twin lead, but I am willing to bet it will work just as well—at least in rainy weather! At any rate, he is not going to allow a good TV set and a good antenna both to stand idle simply because he does not have a manufactured product to tie the two together.

"And along that same line, I have been talking with Bill Garr who runs that motor-rewinding shop on Fifth Street, and he feels certain he can take care of just about any troubles that show up in the antenna-rotating

motors. I figure some of these have been up just about long enough to start needing a little overhauling, and I want to be prepared to handle this situation when it develops."

"By golly," Barney exclaimed, "when I was in school I read one time that the only thing we learn from history was that we learn nothing from history, but that certainly does not apply to a technician. Here you are looking away ahead to servicing troubles that are bound to come during this emergency, and, at the same time, looking backward to your experiences during the depression and during World War II for help in meeting those problems. A crystal ball ought to be standard equipment on every service bench!"

"If the situation gets much rougher I may consider adding that little item. Come to think of it, housed in a matching cabinet it might not look too bad," mused Mac.

-50-

Vest Pocket Radio (Continued from page 43)

tioning of the lid; second, the coil should be flat enough to avoid reducing the range of positioning of the lid. There is no external antenna, but the reception level depends more or less on the orientation of the receiver, particularly since there is a sharp null of reception when the set is oriented in one definite direction. This seems to indicate that the tank circuit coil acts as a loop antenna. One advantage of such a small wave collector is that it is also a very poor wave radiator. This superregenerative device will not cause any noise in neighboring sets, unless it is held less than two feet from an ordinary receiver. The "B" voltage supply is a 22½ volt hearing aid battery, while a small flashlight battery is used to provide filament current. When used intermittently, this latter battery will last five hours. It is difficult to figure out an accurate life expectancy for the high voltage supply. A hearing aid normally draws from 1.5 to 2 milliamperes which is from 7

to 10 times more current than this receiver requires. The useful life of the battery depends on its electromotive force at the time the level of reception becomes too low for adequate reception.

The reception level will not be high with only a one-fifth milliamperere plate current, but it is high enough to provide a very clear reception in areas relatively free from noises. As for the range of reception, this naturally depends on the power of the station to which the set is tuned. Mine gives good reception of KFI all over Los Angeles County.

The values of R_1 and C_1 are selected for a high quenching frequency. However, only the discharge time of C_1 depends on these values alone. Its charging time depends on the filament-to-grid resistance of the tube and on the amount of regeneration. There is no difficulty in finding a position of the lid for which the amount of regeneration is such that the quenching frequency is practically ultrasonic and therefore almost inaudible. The listener's body capacitance, which can be so troublesome in regenerative receivers, has no effect on this set.

-50-

View of vest pocket receiver showing how components are assembled for compactness.



March, 1951

USE PHOTOFAC

the world's best Radio-TV service data—it pays for itself every working day



Try PHOTOFAC!

FREE We'll send you any Photofact Folder listed in the Photofact Cumulative Index

WE'LL PROVE YOU'LL SAVE TIME and EARN MORE WITH PHOTOFAC

NOW—learn for yourself—at our expense—how PHOTOFAC makes your Radio and TV work quicker, easier, more profitable! Examine an actual PHOTOFAC Folder. Use it. You'll learn first-hand why over 35,000 successful service technicians use PHOTOFAC daily. You'll learn that no other service gives you PHOTOFAC'S completeness, accuracy, uniformity, and lowest cost. PHOTOFAC is the only radio and TV service data prepared from laboratory analysis of the actual equipment. Know the facts—get your FREE Folder now. Examine, use, compare—learn why no modern service shop can afford to be without PHOTOFAC!

WRITE FOR FREE INDEX

PAY AS YOU EARN! Ask your distributor about this amazing plan. Only \$18.39 puts the entire profit-boosting Photofact library in your shop now!

NOTE: Our FREE Folder offer is limited to Service Technicians only. Attach coupon below to your letterhead and mention your jobber's name. If you have no letterhead, send coupon to your jobber. Experimenters and others may obtain the Photofact Folder by remitting amount shown below.

HOWARD W. SAMS & CO., INC.
2201 E. 46th St., Indianapolis 5, Ind.

- Send FREE Photofact Cumulative Index
 Send Full Easy-Pay Details

I am a Service Technician:

- Send FREE Folder for set model.....

I am an Experimenter: Enclosed \$.....

- Send Folder for set model.....
TV-\$1.00. Record Changer or Comm. Receiver-75c. AM/FM-50c

Name.....

Address.....

City.....Zone...State.....

117

You Can't Beat Wholesale Radio for Quality and Price

Lowest Price Conical Array

CAN BE STACKED FOR FRINGE AREAS HAS 8 INTERCHANGEABLE ELEMENTS SNYDER MODEL XA-44—LESS MAST



\$495

Complete TV-FM band. Hi-tensile 3/8" aluminum alloy elements. Includes mast clamp for use with poles up to 1 1/2". Can be used with any type lead-in 72 to 300 ohms.

Hi-Gain For Fringe Areas! Snyder Double V TV ARRAY



\$495

Easiest installed hi-gain array. Four hi-tensile 3/8" Aluminum Alloy elements. Two 1/2" Aluminum Alloy cross arms. Completely preassembled. AR-55.

UNBEATABLE TV RECEPTION BEST FOR THE FRINGE AREAS

Snyder Lazy XX TV ANTENNA

Complete with three 3/2 ft. masts & adj. mounting base

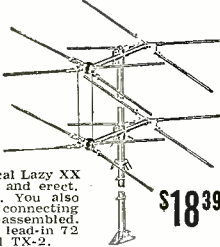

\$1839

Extremely hi-gain. Superior construction. Designed to withstand all weather conditions. Easily stacked double conical Lazy XX type. Just unfold, tighten and erect. All TV channels and FM. You also get guy wire rings, and connecting stubs. Completely pre-assembled. Can be used with any type lead-in 72 to 300 ohms. Order model TX-2.

Snyder HI-LO INLINE ARRAY

Hi and lo dipoles with reflector. Complete with cross arm, hi band extension arm and mounting bracket. Less mast. AR-29.



\$495

\$695 SNYDER HI-LO ANTENNA with Mast Sections Model TV 21

We don't believe you'll find a finer antenna anywhere near this low price. Two folded dipoles (High and Low) with reflectors. Complete with two 3 1/2 ft. mast sections, guy ring. Ready for easy, quick installation. MODEL AR-21 Exactly same as TV-21. Less Mast and guy ring. **\$4.95**

TV ANTENNA ACCESSORIES

- STEEL EXTENSION POLES. Weather treated.
 - 10 ft. long, 1 1/4" di. \$2.19
 - 5 ft. long, 1 1/4" di. Crimped end. 1.35
 - 3 1/2 ft. long, 1 1/4" di. Crimped end. 1.19
- ANTENNA SWIVEL BASE. Aluminum Fits 1 1/4" O.D. mast section.45
- GUYWIRE. 6 strand No. 20. Per 50 ft.39
- CHIMNEY MOUNT BRACKETS. Complete with strap. 1.59
- 3" 300 OHM STAND OFF INSULATORS Wood screw-in type (4c ea.) per 100. 2.95
- SNAP ON TWIN LEAD INSULATORS Fit 1 1/4" masts. Each.06
- JFD LIGHTNING ARRESTORS (AT-102). 1.35
- JFD LIGHTNING ARRESTOR (AT-105) Connects to baseboard.75
- TIE RODS for double V type antenna. Pr.85
- TIE RODS for conical type antenna. Pr.85
- TIE RODS for inline type antenna (TR-29). Pr.85
- 10" MAST COUPLINGS for 1 1/4" masts.90
- 8" MAST COUPLINGS for 1 1/4" masts.45
- 4B STACKING ASSEMBLY. 4 rods and a center tie point. For stacking 2 double XX arrays. 1.95
- PEAK ROOF MOUNTS for all type antenna installations. Fits wall, flat roof, any angle peaked roof. For masts 3/4" to 1 1/2". 2.69
- HEAVY DUTY MAST BRACKETS WB-2 Adjustable up to 18" from wall. For masts 1" to 1 1/2" di. Pr. 3.75
- STANDARD TV FRONT END. Overall Shaft Length 3 15/32" **\$29.95**

Write for Free "FYI" Bulletin Address Orders to Dept. R-N-3 or Call Mulberry 2134

WHOLESALE RADIO PARTS CO., Inc.
311 W. Baltimore St.
BALTIMORE 1, MD.

Distortion Measurement
(Continued from page 47)

work in this application. A good-sized broadcast-quality unit (Chicago Transformer No. BI-8) was used in the unit illustrated because it has a lot less phase shift, particularly at the higher frequencies, than a silicon steel core transformer, and there is a possibility that a poor transformer may introduce core distortion at low frequencies. The general effect of using a transformer of restricted bandwidth is to reduce the range of frequencies over which the unit will measure distortion. Oddly though, in one case a strap-mounted replacement-type transformer was found to permit adjustment to a null, when testing a certain amplifier, up to 10 kc., where a broadcast-type unit would allow balance up to only 2 kc. This was because the particular amplifier under test had more phase shift on the high end than the bridge components R_2 and C_2 could provide. The poor transformer contributed the extra phase lag required to match that of the amplifier. Nevertheless, it seems better to get the phase adjustment from the components designed for that purpose rather than incidentally from another component.

Extra phase shift for a particular occasion can, of course, be added ex-

Fig. 5. (A) Single reactance bridge phase shifter. Maximum shift approaches 180 degrees. Output voltage is constant at half of input voltage when R_A and R_B are equal. Center-tapped transformer or phase inverter can be substituted for R_A and R_B . (B) Double reactance bridge phase shifter. Maximum shift approaches 180 degrees. Output voltage is equal to input voltage as long as R_1 equals R_2 and C_1 equals C_2 .

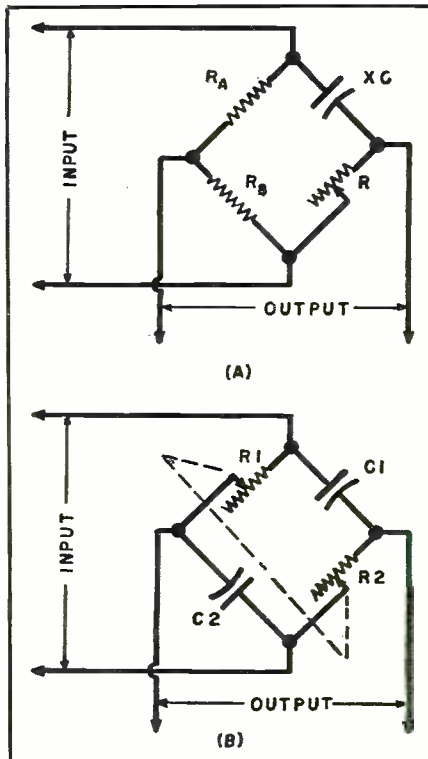

PHOTOCON SALES

Mail Order Address: 1060-2 N. Allen Ave. Pasadena 7, Calif. SYcamore 4-7156 RYan 1-8271
Retail Sales Store: 1240 East Colorado St. Pasadena 1, Calif. SYcamore 6-7217

March Specials

- Write for Our Latest Sales Bulletins
- HS-23 Hi Imp. Headset with plug and ear cushions—NEW \$2.45
 - HS-38 Headset, Low Imp., less headband—NEW 1.75
 - TELETYPE PAPER—8 1/2" wide by 3 1/2" diameter—White—Single. 50c per roll
 - Weston Tachometer Generator, Model 724, Type C—GOOD USED \$12.95
 - Weston Electrical Tachometer, Model 545, for use with 724 Generator. Speed 0-2000 R.P.M. Ratio 2:1—NEW. 14.50
 - We have thousands of Tubes, High Voltage Oil Capacitors, Mica Capacitors, Transformers, and Miscellaneous Items. Please send us your requirements.
 - PL-8 Range Finder—NEW \$ 1.95
 - .25 mfd. 20,000 V.V.D.C. Oil Capacitor NEW—each 29.95
 - APN-1 Altimeter Indicator basic movement 0-1 ma. 5 ma. shunt 270° dial. An excellent movement for constructing your own meters—BRAND NEW 1.95

- PLUGS**
- PLQ-171, PL-172, PLQ-60, PLQ-63, PL-147, PL-148, PL-151, PL-152, PL-153, PL-154, PL-156, PLQ-103. Plugs for ARC-1, ARC-3, ARC-5, BC-375, SCR-522, BC-348, GP-6, GP-7, LM Frequency Meters and many others.
 - IE-19A Test Set for SCR-522 complete with manual—NEW \$325.00
 - LM Frequency Meter with cal. book, crystal, tubes—EXCELLENT 79.50
 - BC-221 Frequency Meter with calibration book, crystal, tubes—EXCELLENT. 79.50
 - BC-348, ATC, T47/ART-13, T47A/ART-13, MN26C, BC-342, BC-312, BC-224, RT18/ARC-1, R5/ARN7, SCR-522, SCR-625, BC-375, BC-222, BC-684, BC-461, RA10, and many others. Prices on request.
 - We will buy new or clean used ARC-1, ARC-3, ART-13, BC-348 original condition or converted to 115V. A.C., BC-312, BC-342, Test Equipment, etc. All letters will be answered promptly. Please list equipment, condition, and lowest price.
 - TERMS: Prices f.o.b. Pasadena, Cal. 25% on all C.O.D. orders. Californians add 3% Sales Tax.

1951 TELEVISION CYCLOPEDIA
A "MUST" FOR EVERY RADIO-TV MAN!

Have hundreds of time-saving, money-making TV facts at your finger-tips . . . 750 fact-packed pages cover every phase of Television! Over 450 illustrations, charts and diagrams! All complete, easy-to-understand . . . all in alphabetical order and cross-indexed for quick reference. It's yours for 7 days' Free Trial!

Helps you get ahead faster in TV
The New 1951 Coyne Television CYCLOPEDIA tells you **why** things happen . . . **how** to handle any TV problem . . . and does it quickly! Covers alignment, amplifiers, antennas, frequencies . . . UHF and COLOR TV . . . converters and adapters . . . television television traps and every other TV fact. Includes a complete explanation of what Test Patterns are . . . **how** to use them to adjust TV sets . . . with dozens of actual Test Patterns. Mathematics is limited to easy, grade-school arithmetic. Formulas are simplified. Everything explained in detail. **SEND NO MONEY!** Just mail coupon for this book. Have TV Cyclopedias for 7 days. Then send either \$5.95 plus postage or return book and owe nothing. Act now!

MAIL THIS COUPON TODAY!

Educational Book Publishing Division
COYNE ELECTRICAL & TELEVISION-RADIO SCHOOL
500 S. Paulina St., Dept. 31-RT, Chicago 12, Ill.

Send me the 1951 Coyne Television Cyclopedias for 7 days' FREE Trial per your offer.

Name Age
Address
City Zone State
Where Employed
() Check here if you are enclosing \$5.95. We pay postage. 7-day Money-Back Guarantee.

ternally when needed by means of simple RC circuits.

More flexibility in this respect can be obtained at the expense of extra complication by using two bridges of the type shown in Fig. 5—one for leading angles, and another for lag, with a switch to select between them.^{3, 4} A study of the more scholarly texts on communication networks could well lead to a better phase-shifter for this sort of amplification.

Potentiometers R_1 and R_2 (Fig. 2) can be ordinary volume controls. When distortion percentages under 0.5 to 1 per-cent are being measured, the null becomes very critical with respect to the setting of the level control, and a large wirewound unit in this position might make manipulation easier. Still better would be a step attenuator in conjunction with a potentiometer for the fine adjustment between steps.

Since the subtractor output must be at least equal to the output voltage of the amplifier under test, padding at the output terminals of the amplifier is sometimes required, as previously indicated.

Circuit Impedances

The choice of values for the components was partly based on source and output impedance considerations. It was felt that an interstage-type transformer would be less likely to introduce spurious harmonics and phase shift at low frequencies than a line-to-line transformer, even though the unit is working out of the rather low impedance of the audio oscillator. This is based on the theory that distortion measurement at low frequencies is usually of more interest than at high. On the secondary side, the impedance at the output terminals should be as low as practicable compared to the usual 0.5 megohm input impedance of scopes and electronic voltmeters. Hence the impedance, on the average, of the phase-shifting bridge was made as low as possible without loading the transformer secondary too much. The potentiometer R_3 (Fig. 2) needs to have a resistance a few times higher than the average impedance across which it is connected. The impedance looking into the output terminals varies roughly from a few thousand to around 85,000 ohms, depending on the frequency and on the position of the control. This implies an error of 13 per-cent maximum, if no allowance for it is made at the time of the measurement. The writer does not feel that errors of this order are serious in measuring percentage distortion. However, it is easy to adjust the controls to compensate for it. After the null or minimum is found (null for the fundamental, minimum for the total), turn the level control on the subtractor back to zero and note the value of the indicated output voltage from the amplifier. This value will be the true level to which the distortion voltage will be referred, with the loss in the subtractor impedance already taken into account.

“When did you last change your Phono-Cartridge?”

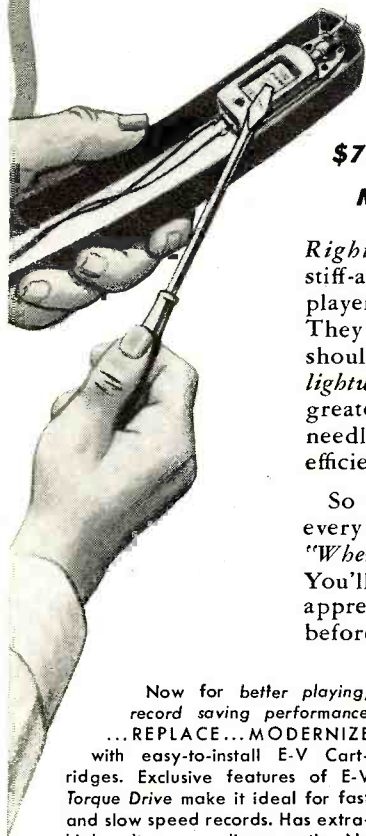

That's your \$70 (Million) question, Mr. Service-Dealer!

Right now . . . 10,000,000 old style, heavy, stiff-acting phono-cartridges in existing record players are *obsolete*. They limit reproduction. They rapidly wear out valuable records. They should be replaced immediately with *modern, lightweight, compliant* cartridges that guarantee greater record enjoyment, longer record and needle life. Current cartridges that operate inefficiently should be replaced, too.

So check the cartridge on every job . . . ask every record player owner this simple question: “When did you last change your phono-cartridge?” You'll render a service your customers will appreciate—you'll sell replacements like never before—you'll make more money!

Now for better playing, record saving performance . . . REPLACE . . . MODERNIZE with easy-to-install E-V Cartridges. Exclusive features of E-V Torque Drive make it ideal for fast and slow speed records. Has extra-high voltage-compliance ratio. No bearings or bushings to deteriorate. Simplified design permits maximum replacements with fewer models. Single and dual needle types. Used today in original equipment of many leading manufacturers.

Make the Finger-Tip Compliance Test



Modern, compliant needle system



Old style, stiff-acting needle system

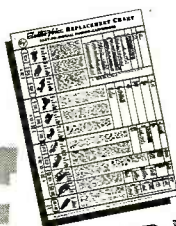

FREE!

REPLACEMENT CHART

Large, Complete Replacement Chart. Gives handy cross-reference and valuable data. Tells when to replace a phono-cartridge. Ask your E-V Distributor or send for it now.

Electro-Voice

410 CARROLL STREET • BUCHANAN, MICHIGAN

Export: 13 East 40th St., New York 16, N.Y., U.S.A. Cables: Arlab

Electro-Voice, Inc.
410 Carroll St., Buchanan, Michigan

Send FREE Cartridge Replacement Chart

Name

Address

City Zone State

Not a kit, but a complete chassis assembled and checked by professional experts

14 reasons why our **RCA type 630** chassis is your best TV buy!

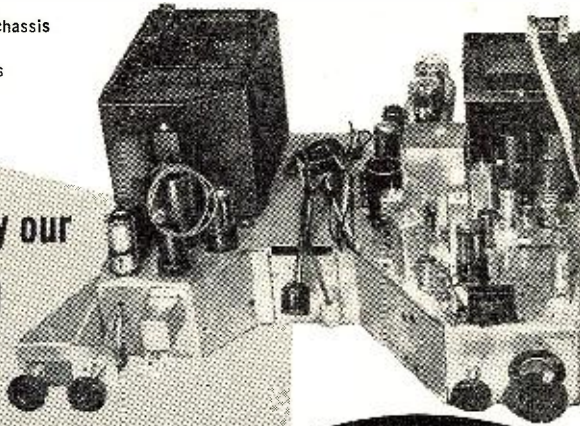

Contact us immediately for low price of this unbelievable buy!

manufactured by

TRAD TELEVISION CORP.

Tradtel sold by **DISTRIBUTORS, INC.**

a division of TRAD TELEVISION CORP.

Dept. N-3, 1001 First Avenue Asbury Park, New Jersey
Asbury Park 2-7447. In New York, WOrth 4-1197

1. 30 tubes—27 tubes, 3 rectifiers
2. AFC horizontal hold, featuring Syncrolok
3. High voltage doubler circuit
4. Maximum brilliance with any picture size up to 19"
5. Co-channel sound, featuring good limiting for maximum noise immunity
6. Keyed ACC (using extra 6AU6 tubes), minimizes airplane flutter, keeps picture level constant and uniform when switching from channel to channel
7. Overall band width four m. c. for maximum definition and picture crispness
8. Original 630 sync chain for maximum picture stability
9. Molded condensers throughout
10. Full complement of electrolytics as specified in original design
11. Focus coil and yoke assembly with removable plugs for easy servicing
12. Top quality video amplification assuring good contrast range for full "blacks and white"
13. Same chassis used in highest-priced sets and custom installations
14. Complete with mounting hardware ready for installation

The whole subtractor is well adapted to building into a small black box, ready for instant use, and free of such complications as power cords, tubes, pilot lamps, and fuses.

REFERENCES

- ¹ Wolfe, Michael; "A Simple Distortion Analyzer." RADIO & TELEVISION NEWS, November, 1949.
- ² Fleming, Lawrence; "An Electronic A. C. Voltmeter." RADIO & TELEVISION NEWS, February, 1951.
- ³ Everest, F. Alton; "Phase Shifting up to 360 Degrees." Electronics, November, 1941.
- ⁴ Lafferty, R. E.; "Phase Shifter Nomograph." Electronics, May, 1946.

-30-

Resistance Decade

(Continued from page 51)

is thrown alternately from one position to the other while the decade box is adjusted. In the upper position of the switch, the v.t. voltmeter indicates the voltage drop across the unknown impedance; in the lower switch position, the meter shows the drop across the decade resistance. When the decade resistance has been adjusted to equal the unknown impedance value, there is no change in voltmeter reading as the switch is thrown back and forth between its upper and lower positions. At this point, the unknown impedance value (in ohms) is read directly from the dials of the decade box.

This circuit allows measurement of any impedance value (in steps of 1 ohm) from 1 ohm to 99,999 ohms. When checking low impedance values, the applied signal voltage must be kept low (of the order of a few millivolts r.m.s.) in order to restrict current through the decade box to a safe value. (See current limits listed under *Current Meter Calibration*.) Under these conditions, the v.t. voltmeter must be capable of indicating low voltage levels. If the instrument available will not respond to potentials of a few millivolts, an audio amplifier may be connected ahead of it to increase meter sensitivity.

-30-

"HAVE YOU HEARD THE SOUND OF QUALITY?"



**FOR THE "GOLDEN EAR"
CROWD
THE STRAIN-SENSITIVE
PHONOGRAPH PICKUP**

Here's why this truly faithful reproducer appeals to people gifted with the "Golden Ear" . . . why the STRAIN-SENSITIVE PICKUP developed by the PFANSTIEHL CHEMICAL COMPANY brings out the brilliance of great voices and orchestras . . . the latent music on your records that other pickups leave untouched.

- The STRAIN-SENSITIVE PICKUP is an amplitude transducer with a CONSTANT RESISTANCE of about 250,000 ohms.
- Signal output is at a practically CONSTANT IMPEDANCE LEVEL.
- Excellent Transient Response.
- NO DISTORTION, phase shift or evidence of intermodulation is audible.
- LINEAR RESPONSE, free from peaks or resonances.

Cartridges are available for both standard and micro-groove, and can be had with Famous PFANSTIEHL M47B Precious Metal Alloy or diamond tipped styli.

A special preamplifier is necessary to provide the correct D.C. voltage for the pickup element and to provide the first stages of signal gain. Four styles are ready, or, if you prefer, you can build your own from the circuit in the literature.

Ask your radio supply man, or write today for complete FREE INFORMATION.

**P FANSTIEHL
CHEMICAL COMPANY**

101 Lake View Avenue, Waukegan, Illinois

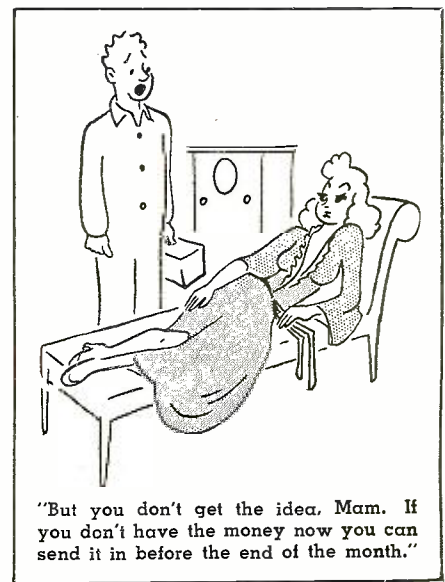

"But you don't get the idea, Mam. If you don't have the money now you can send it in before the end of the month."

NEWCOMB SOUND IS BETTER

- Manufacturers of public address, mobile, phonograph, musical instrument and wired music amplifiers • Portable systems • Portable phonographs and radios • Transcription players • Rack and panel equipment.
- Write today! Circle items of interest and indicate whether you are a Dealer, Parts Jobber or Sound Specialist.

NEWCOMB AUDIO PRODUCTS CO.
DEPT. F, 6824 LEXINGTON AVE.
HOLLYWOOD 38, CALIFORNIA

1000 KC crystal BT cut. \$3.95
 3" scope shield. 1.29
 2 speed dial drive for 1/4" shaft ratios 5:1 1 to 1 .39
 ATC 100 mmfd air trimmer screwdriver shaft.29
 Sigma Sens. Relay 8000 ohms 1.98
 Centralab 850 S 50MMF 5KV BUTTTON COND. 3.49
 500 watt 12.5 ohm power rheostat. 3.49



50 mmfd 5 KV vacuum condenser. \$1.49
 6v. 12v vibrator any type.98
 Rotary switch Mvalex, 2 deck SP3T.39
 1 mfd 5000v oil condenser. 2.98
 2 mfd 3000v oil condenser. 3.25
 3 mfd 4000v oil condenser. 3.95
 24 mfd 1500v DC 3KV flash. Excellent for speed lamp 3.95

TUBES!! BRAND NEW! STANDARD BRANDS! NO SECONDS! COMPARE! TUBES!!

0A3/VR75 \$1.69	8C23 \$46 9.95	904A \$69.50	809 \$ 2.45	8012 \$ 5 3.95	0A2	6SN7GT	12SJ7
0B3/VR90 1.29	8C24 246 2.95	904B .69	810 .95	8013 .2.95	0A4G	6S07	12SL7
0C3/VR105 1.49	8C30 2.95	904C .49	811 2.95	8014 2.95	0B2	6S57	12SW7
0D3/VR150 1.29	8C31/CIB 3.45	904D .19	812 2.95	8015 1.45	0Z4	6ST7	12SQ7
1B22 3.45	8C45 1.75	904E .85	812H 8.95	8016 1.45	01A	6SU7GT	12SR7
1B23 12.50	8CP1 2.25	904F 5.95	813 2.95	8001 2.25	1A3	6SU7GT	12S7
1B24 6.95	8CP1-S1 2.95	904G 3.95	814 3.95	8002 1.45	1A4P	6T7	14A4
1B26 2.45	8DP1 6.95	904H 21.50	816 1.19	8004 1.45	1A6	6T8	14A7
1B29 2.75	8DP1-S2A 8.95	904I 21.50	826 1.98	8005 2.35	1A7GT	6T9	14B6
1B32 2.25	8E2 3.95	904J 27.50	827 2.95	8006 2.25	1A8	6U6GT	14F7
1B36 2.95	8E2A 1.45	904K 27.50	828 12.95	8007 1.45	1B3/8016	6U7	14F8
1B38 32.50	8E2B 14.95	904L 27.50	829 12.95	8008 1.95	1B4	6V6	14J7
1N1 Xtal 1.25	8EP1 5.95	904M 27.50	829B 14.95	8009 1.95	1B4	6V6GT	14J7
1N1A Xtal 2.25	8EP1 3.95	904N 27.50	830B 2.95	8010 1.95	1B4/25S	6V6GT	14N7
1N1B Xtal 3.25	8EP1 4.75	904O 27.50	831 5.95	8011 1.49	1B7GT	6V7	14R7
1N2 Xtal 1.35	4-5E7A 3.95	904P 27.50	832A 8.95	8012 1.49	1C6	6W4	14R7
1N2A Xtal 1.35	4-5E7B 3.95	904Q 27.50	833A 37.50	8013 2.95	1C7	6W5	14R7
1N2B Xtal 3.25	4-5E7C 3.95	904R 27.50	834 2.95	8014 2.25	1D5GT	6X5	15A4
1N23 Xtal 4.95	4-5E7D 3.95	904S 27.50	835 2.95	8015 2.25	1D7G	6X5GT	15A4
1N24 1.69	4B22/EI5B 9.95	904T 24.50	837 1.69	8016 2.25	1D8GT	6X5GT	15A4
1N3 1.40	4B22/EI3C 7.95	904U 24.50	838 2.95	8017 2.25	1E5GT	6Z5	15A4
1N3A 1.40	4B22/GCP 8.95	904V 24.50	841 2.95	8018 2.25	1F7G	6Z5GT	15A4
1N3B 1.40	4B22/GCP 8.95	904W 24.50	844 3.95	8019 2.25	1F4	6Z5GT	15A4
1P2 1.79	4B22/GCP 8.95	904X 24.50	845 3.95	8020 2.25	1F5	6Z5GT	15A4
1P36 2.95	4B22 4.95	904Y 24.50	852 2.95	8021 2.25	1G6	6Z5GT	15A4
1P41 8.95	CV92 49.50	904Z 24.50	861 2.95	8022 2.25	1G6	6Z5GT	15A4
2AP5 6.95	4C35 29.50	904AA 24.50	864 1.39	8023 2.25	1G6GT	6Z5GT	15A4
2C21/RK33 .69	4D22 12.95	904AB 24.50	866A 1.39	8024 2.25	1G6GT	6Z5GT	15A4
9C22 7.193 4.95	4D32 14.95	904AC 24.50	866B 1.39	8025 2.25	1G6GT	6Z5GT	15A4
2C26A .49	4E27 2.75	904AD 24.50	866JR 1.29	8026 2.25	1G6GT	6Z5GT	15A4
2C27 24.50	5AP1 3.69	904AE 24.50	872A 2.49	8027 2.25	1G6GT	6Z5GT	15A4
2C34/RK34 .69	5AP4 3.69	904AF 24.50	874 2.49	8028 2.25	1G6GT	6Z5GT	15A4
2C39 24.50	5BP4 5.95	904AG 24.50	876 2.49	8029 2.25	1G6GT	6Z5GT	15A4
2C40 4.95	5BP4 5.95	904AH 24.50	884 1.49	8030 2.25	1G6GT	6Z5GT	15A4
2C43 14.95	5CP1 4.95	904AI 24.50	885 1.49	8031 2.25	1G6GT	6Z5GT	15A4
2C44 2.45	5CP1 4.95	904AJ 24.50	885 1.49	8032 2.25	1G6GT	6Z5GT	15A4
2C46 7.50	5CP1 4.95	904AK 24.50	905 3.59	8033 2.25	1G6GT	6Z5GT	15A4
2C51 5.75	5C22 24.50	904AL 24.50	908 7.95	8034 2.25	1G6GT	6Z5GT	15A4
2E22 1.95	5D21 24.50	904AM 24.50	919 2.79	8035 2.25	1G6GT	6Z5GT	15A4
2E24 4.89	5D21 24.50	904AN 24.50	922 1.95	8036 2.25	1G6GT	6Z5GT	15A4
2E26 2.95	5D21 24.50	904AO 24.50	927 1.59	8037 2.25	1G6GT	6Z5GT	15A4
2E30 2.29	5GP1 4.95	904AP 24.50	930 1.05	8038 2.25	1G6GT	6Z5GT	15A4
2F21A 9.95	5JP4 24.45	904AQ 24.50	954 .39	8039 2.25	1G6GT	6Z5GT	15A4
2F22 2.95	5JP4 24.45	904AR 24.50	955 .45	8040 2.25	1G6GT	6Z5GT	15A4
2F27 29.50	5J29 12.95	904AS 24.50	956 .45	8041 2.25	1G6GT	6Z5GT	15A4
2G30 39.50	5J29 12.95	904AT 24.50	957 .45	8042 2.25	1G6GT	6Z5GT	15A4
2J27 29.50	5J29 12.95	904AU 24.50	958 .45	8043 2.25	1G6GT	6Z5GT	15A4
2J31 39.50	5J29 12.95	904AV 24.50	959 .45	8044 2.25	1G6GT	6Z5GT	15A4
2J32 39.50	5J29 12.95	904AW 24.50	960 .45	8045 2.25	1G6GT	6Z5GT	15A4
2J33 39.50	5J29 12.95	904AX 24.50	961 .45	8046 2.25	1G6GT	6Z5GT	15A4
2J34 39.50	5J29 12.95	904AY 24.50	962 .45	8047 2.25	1G6GT	6Z5GT	15A4
2J35 39.50	5J29 12.95	904AZ 24.50	963 .45	8048 2.25	1G6GT	6Z5GT	15A4
2J36 39.50	5J29 12.95	904BA 24.50	964 .45	8049 2.25	1G6GT	6Z5GT	15A4
2J37 39.50	5J29 12.95	904BB 24.50	965 .45	8050 2.25	1G6GT	6Z5GT	15A4
2J38 39.50	5J29 12.95	904BC 24.50	966 .45	8051 .65	1G6GT	6Z5GT	15A4
2J39 39.50	5J29 12.95	904BD 24.50	967 .45	8052 5.95	1G6GT	6Z5GT	15A4
2J40 39.50	5J29 12.95	904BE 24.50	968 .45	8053 1.75	1G6GT	6Z5GT	15A4
2J41 39.50	5J29 12.95	904BF 24.50	969 .45	8054 1.75	1G6GT	6Z5GT	15A4
2J42 39.50	5J29 12.95	904BG 24.50	970 .45	8055 1.75	1G6GT	6Z5GT	15A4
2J43 39.50	5J29 12.95	904BH 24.50	971 .45	8056 1.75	1G6GT	6Z5GT	15A4
2J44 39.50	5J29 12.95	904BI 24.50	972 .45	8057 1.75	1G6GT	6Z5GT	15A4
2J45 39.50	5J29 12.95	904BJ 24.50	973 .45	8058 1.75	1G6GT	6Z5GT	15A4
2J46 39.50	5J29 12.95	904BK 24.50	974 .45	8059 1.75	1G6GT	6Z5GT	15A4
2J47 39.50	5J29 12.95	904BL 24.50	975 .45	8060 1.75	1G6GT	6Z5GT	15A4
2J48 39.50	5J29 12.95	904BM 24.50	976 .45	8061 1.75	1G6GT	6Z5GT	15A4
2J49 39.50	5J29 12.95	904BN 24.50	977 .45	8062 1.75	1G6GT	6Z5GT	15A4
2J50 39.50	5J29 12.95	904BO 24.50	978 .45	8063 1.75	1G6GT	6Z5GT	15A4
2J51 39.50	5J29 12.95	904BP 24.50	979 .45	8064 1.75	1G6GT	6Z5GT	15A4
2J52 39.50	5J29 12.95	904BQ 24.50	980 .45	8065 1.75	1G6GT	6Z5GT	15A4
2J53 39.50	5J29 12.95	904BR 24.50	981 .45	8066 1.75	1G6GT	6Z5GT	15A4
2J54 39.50	5J29 12.95	904BS 24.50	982 .45	8067 1.75	1G6GT	6Z5GT	15A4
2J55 39.50	5J29 12.95	904BT 24.50	983 .45	8068 1.75	1G6GT	6Z5GT	15A4
2J56 39.50	5J29 12.95	904BU 24.50	984 .45	8069 1.75	1G6GT	6Z5GT	15A4
2J57 39.50	5J29 12.95	904BV 24.50	985 .45	8070 1.75	1G6GT	6Z5GT	15A4
2J58 39.50	5J29 12.95	904BW 24.50	986 .45	8071 1.75	1G6GT	6Z5GT	15A4
2J59 39.50	5J29 12.95	904BX 24.50	987 .45	8072 1.75	1G6GT	6Z5GT	15A4
2J60 39.50	5J29 12.95	904BY 24.50	988 .45	8073 1.75	1G6GT	6Z5GT	15A4
2J61 39.50	5J29 12.95	904BZ 24.50	989 .45	8074 1.75	1G6GT	6Z5GT	15A4
2J62 39.50	5J29 12.95	904CA 24.50	990 .45	8075 1.75	1G6GT	6Z5GT	15A4
2J63 39.50	5J29 12.95	904CB 24.50	991 .45	8076 1.75	1G6GT	6Z5GT	15A4
2J64 39.50	5J29 12.95	904CC 24.50	992 .45	8077 1.75	1G6GT	6Z5GT	15A4
2J65 39.50	5J29 12.95	904CD 24.50	993 .45	8078 1.75	1G6GT	6Z5GT	15A4
2J66 39.50	5J29 12.95	904CE 24.50	994 .45	8079 1.75	1G6GT	6Z5GT	15A4
2J67 39.50	5J29 12.95	904CF 24.50	995 .45	8080 1.75	1G6GT	6Z5GT	15A4
2J68 39.50	5J29 12.95	904CG 24.50	996 .45	8081 1.75	1G6GT	6Z5GT	15A4
2J69 39.50	5J29 12.95	904CH 24.50	997 .45	8082 1.75	1G6GT	6Z5GT	15A4
2J70 39.50	5J29 12.95	904CI 24.50	998 .45	8083 1.75	1G6GT	6Z5GT	15A4
2J71 39.50	5J29 12.95	904CJ 24.50	999 .45	8084 1.75	1G6GT	6Z5GT	15A4
2J72 39.50	5J29 12.95	904CK 24.50	1000 .45	8085 1.75	1G6GT	6Z5GT	15A4
2J73 39.50	5J29 12.95	904CL 24.50	1001 .45	8086 1.75	1G6GT	6Z5GT	15A4
2J74 39.50	5J29 12.95	904CM 24.50	1002 .45	8087 1.75	1G6GT	6Z5GT	15A4
2J75 39.50	5J29 12.95	904CN 24.50	1003 .45	8088 1.75	1G6GT	6Z5GT	15A4
2J76 39.50	5J29 12.95	904CO 24.50	1004 .45	8089 1.75	1G6GT	6Z5GT	15A4
2J77 39.50	5J29 12.95	904CP 24.50	1005 .45	8090 1.75	1G6GT	6Z5GT	15A4
2J78 39.50	5J29 12.95	904CQ 24.50	1006 .45	8091 1.75	1G6GT	6Z5GT	15A4
2J79 39.50	5J29 12.95	904CR 24.50	1007 .45	8092 1.75	1G6GT	6Z5GT	15A4
2J80 39.50	5J29 12.95	904CS 24.50	1008 .45	8093 1.75	1G6GT	6Z5GT	15A4
2J81 39.50	5J29 12.95	904CT 24.50	1009 .45	8094 1.75	1G6GT	6Z5GT	15A4
2J82 39.50	5J29 12.95	904CU 24.50	1010 .45	8095 1.75	1G6GT	6Z5GT	15A4
2J83 39.50	5J29 12.95	904CV 24.50	1011 .45	8096 1.75	1G6GT	6Z5GT	15A4
2J84 39.50	5J29 12.95	904CW 24.50	1012 .45	8097 1.75	1G6GT	6Z5GT	15A4
2J85 39.50	5J29 12.95	904CX 24.50	1013 .45	8098 1.75	1G6GT	6Z5GT	15A4
2J86 39.50	5J29 12.95	904CY 24.50	1014 .45	8099 1.75	1G6GT	6Z5GT	15A4
2J87 39.50	5J29 12.95	904CZ 24.50	1015 .45	8100 1.75	1G6GT	6Z5GT	15A4
2J88 39.50	5J29 12.95	904DA 24.50	1016 .45	8101 1.75	1G6GT	6Z5GT	

Timely Values — Speedy Service



ACORN

SUPREME MODEL 542 MULTIMETER



SCALE

- 4 DC MIL ranges 0/0.3/6/30/150
 - 4 DC VOLT ranges 0/6/150/300/1500
 - 4 OHM ranges 0/2000/20000/200000/2 meg
 - 4 AC VOLT ranges 0/6/30/150/600
 - 4 OUTPUT ranges 0/6/30/150/600
 - 4 DECIBEL ranges -6/+10, +8/+24/, +22/ +38, +34/+50
- Bakelite moulded case..... **\$18.95**



TRIPLETT MILLIAMMETER

Model 327A—3" square
0 to 3 mils DC..... **\$4.95**

FOUNDATION KIT SPECIALS!

• BATTERY CHARGER FOUNDATION KIT

12 AMPS: Consists of 15v-12 amp transformer; full wave bridge selenium rectifier; fuse post; fuse; toggle switch. Delivers 10v DC @ 10 amps. (less chassis, wire). **ALL FOR \$12.95**

• HI-FIDELITY 6V6 PHONO-FM AMPLIFIER KIT

Consists of Power transformer; filter choke; output transformer; resistors; condensers; sockets; hardware; switches. Uses inverse feed-back tone control. Frequency range 60—12000 cycles. (Less tubes, chassis, wire). **ALL FOR \$11.95**



UTC CASED TRANSFORMER

Pri. 115v. 50-60 cy. Sec. #1: 600v. c.t. @ 150 mils; #2: 6.3v. @ 4 amps; #3: 5v. @ 3 amps. **\$3.95**

PHILCO TRANSFORMER

Pri. 115 v. 50-60 cy. Sec. #1: 650 v. c.t. @ 150 mils; #2: 6.3 v. @ 4.5 amps; #3: 6.3 v. @ .3 amps; #4: 5v. @ 3 amps. Half shell mount. **\$3.95**

POWER TRANSFORMERS

(RCA Part No. 941580-1) Pri. 115 v. 50/60 cy. Sec. #1 750 v. c.t. @ 225 mils. #2 6.3 v. @ 8 amps. #3 6.3 v. @ 1.2 amps. #4 5 v. @ 3 amps. Mtg. centers 3 1/2" x 4". Wt. 12 lbs. **\$6.97**

(RCA Part No. 941582-1) Pri. 115 v. 50/60 cy. Sec. #1 760 v. c.t. @ 160 mils. #2 6.3 v. @ 4 amps. #3 6.3 v. @ 1.2 amps. #4 5 v. @ 3 amps. Mtg. center 3 1/2" x 2 3/4". Wt. 8 1/2 lbs. **\$3.95**



THORDARSON POWER TRANSFORMER

Pri. 115 v. 50-60 cy. Sec. #1: 600 v. c.t. @ 100 mils; #2: 6.3 v. @ 3.5 amps; #3: 5 v. @ 3 amps. Half shell mount. **\$2.95**

KENYON MULTIPLE-FILAMENT TRANS.

Input 105-110-115 v. 50-60 cy. Sec. #1: 11v. c.t. @ 10 amps; #2: 7 v. @ 1 amp; #3: 7 v. @ 1 amp..... **\$5.95**

STEP-DOWN TRANSFORMERS

Pri. 115 v. 50-60 cy. Sec. 15 v. @ 12 amps. Perfect for battery charger use or Model Railroadng. **\$4.95**

Pri. 115 v. 50-60 cy. Sec. 10 v. @ 12 amps..... **\$4.95**



TERMS: 20% cash with order. balance C.O.D. unless rated. All prices F.O.B. our warehouse in N. Y. C. Minimum order \$5. NOTE: Due to conditions beyond our control, prices are subject to change.

Phone WOrth 4-3270

ACORN ELECTRONICS CORP.
76 Vesey St., Dept. N-3, New York 7, N.Y.

NEW TV PRODUCTS on the Market.....

DOUBLE MAST STANDOFF

Technical Appliance Corporation of Sherburne, New York is now merchandising a double lead mast standoff insulator which has been specially designed for TV installations where it is desirable to have two leads from the antenna to the receiver.

These units keep the leads far enough apart to eliminate coupling between the lines. The standoffs are made to withstand time and weather yet can be easily assembled to the mast. Available for either ribbon-type or RG transmission line, the standoff is made with two length steel tapes, one for masts 1 to 2" o.d. and the other for masts up to 5" o.d. High grade molded polyethylene gives excellent non-inductive support.

"MULTIBOOSTER"

Industrial Television, Inc. of 359 Lexington Avenue, Clifton, New Jersey has announced the addition of a new TV amplifier to its line.

Tradenamed the "Multibooster", the new unit is a broadband TV antenna amplifier designed specifically for use with multiple installations. It



may be employed in a wide variety of applications with existing and new antenna installations. Where receiver radiation is a problem, the company recommends the use of this unit in conjunction with its "Autobooster."

The circuit is similar to that of the "Autobooster" with the addition of certain features needed for multiple antenna system applications. Separate low and high band gain controls are provided. The unit is designed for continuous and unattended operation.

Data sheets and circuit specification are available from the company on request. Write direct to R. J. Harrington, sales manager of the firm.

17" RECTANGULAR TUBE

A new, 17" metal-shell rectangular picture tube for television receivers has been developed by the Tube Department of Radio Corporation of America, Harrison, New Jersey.

The new tube, the first metal-shell

rectangular picture tube to be made available commercially, is designated as the 17CP4. It has a picture area 14 5/8" x 11" with slightly curved sides and rounded corners.

Use of the metal shell not only makes practical a construction which



weighs less than a similar all-glass tube, but also makes practical the use of a higher-quality face plate, according to the company.

Employing magnetic focus and magnetic deflection, the 17CP4 features an improved design of funnel-to-neck section which facilitates centering of the yoke on the neck and, in combination with better centering of the beam inside the neck, contributes to the good uniformity of focus over the entire picture area. The diagonal deflection angle is 70 degrees and the horizontal deflection angle is 66 degrees.

Other features include a short-over-all length and an ion-trap gun which requires only a single-field external magnet. A technical bulletin on the 17CP4 is available from the company.

RECTIFIER CARTRIDGES

International Rectifier Corporation, 6809 South Victoria Avenue, Los Angeles 43, California has developed a line of high voltage selenium rectifier cartridges with ratings up to 25,000 volts per cartridge and current ratings up to 75 ma.

These cartridges utilize five different selenium cell sizes varying from



1/8" in diameter up to 1" in diameter with corresponding current ratings varying from 1.5 ma. up to 75 ma. They are designed to meet rigid humidity, altitude, vibration, and shock specifications and they can be operated over the temperature range of -55 degrees C to 100 degrees C.

RADIO & TELEVISION NEWS

The units are available in phenolic tubings with either pigtail or ferrule type terminals and in metallic hermetically sealed assemblies with pig-tail leads.

For information and literature on these new selenium rectifier cart-ridges for television, cathode-ray oscilloscope, bias supply, etc. applications, write direct to the company.

DECORATIVE ANTENNA

J. H. Rasmussen & Company of 1454 Merchandise Mart, Chicago 54, Illinois has brought out a new indoor television antenna, the "Decor-Antenna."

The unit consists of a flower pot base with the extended rods seated in turning sockets for easy orientation. The new design of the antenna provides for solid connections and eliminates picture flutter on the TV screen.



It is not necessary to turn the base of the antenna, instead the rods can be turned in their sockets at the sides. The rods are easily removable by simply pulling them from their sockets.

The flower pot is made of electrical insulating porcelain and is not conductive. Available in two shades of green, two shades of yellow, black, and maroon, the antenna retails in the moderate price class.

"PERFECTION" ELIMINATOR

Perfection Electric Company, 2635 South Wabash Avenue, Chicago, Illinois has recently introduced a new device for the elimination of vertical bars on television picture tubes caused by Barkhausen oscillation in the horizontal sweep output tube.

Designed to be used with such tubes as the 25BQ6, 6BQ6, 6EV5, 25EV5, 6AU5, 25AU5, etc., the eliminator is slipped over the tube. The unit is then moved up or down or turned to the right or left until the dark vertical bars disappear from the picture.

The company reports the device is particularly helpful in weak signal and fringe areas where the Barkhausen effect is especially bothersome.

TV MASK

The Cathode-Ray Tube Division of the Allen B. Du Mont Laboratories, Inc., 750 Bloomfield Ave., Clifton, New Jersey has announced a specially designed TV mask for simplifying the replacement of the Types 12JP4 and 12RP4 with the Type 12QP4A kinescope.

March, 1951

**Money-maker with A Fast Pay-Off . . .
Keeps Income Up When Sets Get Scarce**

Mail Coupon
for
NEW Bulletin



1. Fixed pole provides mount adaptable to all antenna rotors.

2. Top plate provides guy holes for easy guying.

3. New straight TXT eliminates bending under heavy stack load.

Scarce sets aren't making scarce sales for dealers who push Teletowers! They're selling improved reception to present set-owners . . . and collecting a quick pay-off. Penn Teletowers and Thriftowers . . . advertised hard and merchandised hard . . . are now No. 1. on the "Hit Parade" of consumer tower acceptance.

NEW, cost-cutting engineering improvements are now incorporated in Teletowers. You're not up-to-date on your tower engineering until you've read Penn's new, free bulletin. Mail coupon or write today!

Penn Boiler & Burner Mfg. Corp.—Dept. N-1
Lancaster, Pa.

Please send me free bulletin describing structural improvements in Teletowers and Thriftowers.

Name

Address

Canadian representative: J. R. McVITY & CO.,
53 Dalewood Road, Toronto, Ontario, Canada.

PENN Teletowers
Thriftowers

PENN BOILER & BURNER MFG. CORP.
LANCASTER, PA.

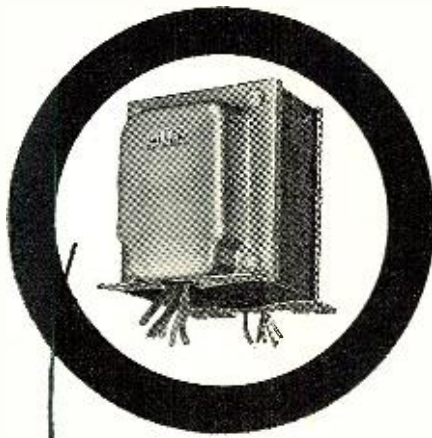

Here is a group of
TRIAD Transformers
Especially Designed for
REGULATED POWER SUPPLIES

In the design of regulated power supplies, plate voltages, 100 volts or more in excess of those required for normal power supplies, are needed. In addition, the tube filaments are operated at differing potentials, requiring several separate filament windings.

The following new plate and multi-filament transformers, used in connection with standard higher voltage plate transformers and chokes now available, will permit design of a wide range of regulated supplies.

POWER TRANSFORMERS

Type No.	Pri. Volts	Sec. Volts	Fil. No. 1	Fil. No. 2	Fil. No. 3	Fil. No. 4
R-26A	115	880-720V. C.T. @ 200 Ma.	6.3V. C.T. @ 8A.	6.3V. @ 3A.	6.3V. @ 1A.	5V. @ 3A.
R-28A	115	1250V. C.T. @ 300 Ma.	6.3V. C.T. @ 8A.	6.3V. @ 3A.	6.3V. @ 3A.	5V. @ 6A.

FILAMENT TRANSFORMERS

Type No.	Pri. Volts	Fil. No. 1	Fil. No. 2	Fil. No. 3	Fil. No. 4	Fil. No. 5
F-34A	115	6.3V. C.T. @ 1.75A.	6.3V. @ 1.75A.	6.3V. @ 1.75A.	6.3V. @ 1.75A.	6.3V.
F-36A	115	6.3V. C.T. @ 3.5A.	6.3V. @ 3.5A.	6.3V. @ 3.5A.	6.3V. @ 3.5A.	6.3V. @ 3.5A.
F-38A	115	6.3V. C.T. @ 5A.	6.3V. @ 5A.	6.3V. @ 1A.	5V. C.T. @ 2A.	5V. @ 4A.

These and other Triad Transformers are described in

Catalog TR-51, just off the press. Write for your copy today.



2254 Sepulveda Blvd.
Los Angeles 64, Calif.



The new mask will adapt the Type 12QP4A to early *Du Mont* "Telesets" and most receivers of other manufacture which employ either the 12JP4 or the 12RP4. Popularity of the Type 12QP4A as a replacement for these

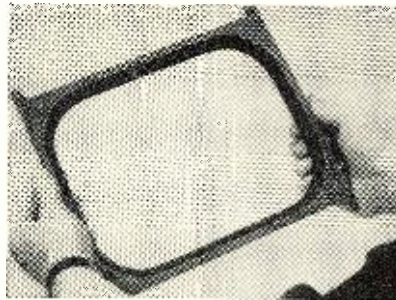

other tubes is based on its close similarity to the older types, plus the feature of a flatter face and a gray filter face plate.

The greater radius of face curvature of the Type 12QP4A, which is the biggest consideration in replacing the older types, is compensated by the mask making the replacement simple and direct. When replacing the two aforementioned tubes an ion-trap magnet must be added.

TV PICTURE TUBES

National Union Radio Corporation of Orange, New Jersey has developed a new series of television picture tubes which permits the saving of over two pounds of copper in each TV set by utilizing electrostatic focus in place of electromagnetic focus.

This new line of tubes, available in the popular 14, 17, and 20 inch rectangular designs, can be used in place of the same sizes employing electromagnetic focusing.

Electrostatic focusing is achieved through the use of a new electron gun having a focusing electrode. This electrode, operating at approximately 20 per-cent of the anode potential, is de-

signed to operate with essentially zero current. The focusing potential is easily obtained from a conventional flyback type power supply employing a low cost rectifier operated from the primary of the horizontal deflection amplifier transformers. Variations in centering due to external conditions is readily compensated by the use of electrical centering in the deflection yokes.

5-ELEMENT YAGI

The JFD Manufacturing Co., Inc. of 6101 Sixteenth Avenue, Brooklyn 4, New York has developed a new line of 5-element yagi television antennas for high gain reception in fringe and remote areas.

A high impedance driven element assures a terminal impedance which is a true match for 300 ohm transmission lines. The 5-element beam, employing triple directors, is custom-cut to suit exact channel wavelength.

The antenna is designed in such a way that the elements swing into position and then wing nuts are tightened. The antenna is constructed of heavy-wall, corrosion-resistant aircraft aluminum with a 1" o.d. collector element and crossarm.

The high front-to-back ratio rejects co-channel interference. A special jumper harness is available for stacking bays where conditions warrant this construction. Models are available for all low and high band channels.

NEW MODEL BOOSTER

The engineering department of *I.D.E.A.*, 55 N. New Jersey Street, Indianapolis 4, Indiana has redesigned the company's "Regency" TV signal booster to allow for the current shortage of certain scarce metals.

The new model, known as the DB 410, is similar in appearance to the earlier units. It measures 4½x5½x3¾

Quite a few American G.I.'s will undoubtedly recognize this thriving radio shop as *S.O.S. Radio Ltd.* of 283 Queen Street, Auckland, New Zealand, for many of our troops in New Zealand paid the company a visit. *J. R. Eckford*, the company's director, reports that dollar import restrictions prevent the purchase of U. S. goods at the present time.



#630 SUPER DELUXE 31-TUBE (20" RECTANGULAR PICTURE TUBE) TV CHASSIS

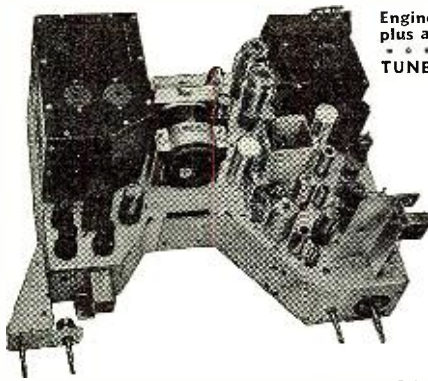

Engineered in strict adherence to the genuine RCA #630, plus added features . . . LARGER POWER TRANSFORMER . . . VOLTAGE DOUBLER . . . AGC . . . STANDARD TUNER.

OPERATES ALL 20", 17", 16" RECTANGULAR PICTURE TUBES

COMPLETE, ready to PLUG IN AND PLAY. Including 8" speaker, knobs and hardware, (less CRT) **\$187.97**
(With 12" speaker \$3.98 extra)

RECTANGULAR PICTURE TUBES

20" — #20DP4A	\$74.89
17" — 17RP4A	46.78
16" — 16RP4A	39.63

KNOWN MFR. . . LICENSED BY RCA

CUSTOM-BUILT TV CABINETS FOR #630 CHASSIS (16" TO 20")

4 leading styles in genuine mahogany or walnut. (Blonde 10% extra). WINDSOR and NEW YORKER when open look like STREAMLINER. Ready cut for easy, perfect assembly (at same prices) for 16", 17" or 20" rectangular or 16" or 19" round picture tube. Complete with hardware, supports and safety glass. Also supplied with blank panel to fit any make TV set.

THE NEW YORKER
A Deluxe Cabinet
With a Piano Finish.

THE STREAMLINER
Center Drop Panel
Conceals Tuning Knobs.

THE WINDSOR
Hand Tooled Leather
in Green, Red or Brown.

THE VOGUE
Most Popular
Table Model.



16" — H-24", W-24", D-24"
17" — H-24", W-24", D-24"
20" — H-27", W-24", D-24"

\$47.45



H-42", W-26", D-24"

\$96.87

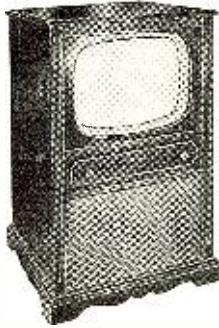

H-42", W-26", D-25"

\$74.98

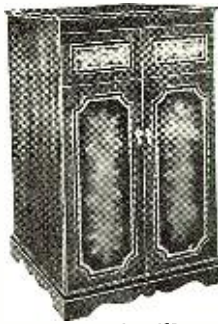

H-42", W-26", D-25"

\$129.74

#630 SUPER DELUXE 31-TUBE TV KIT (operates 20", 17", 16" CRT's) UNASSEMBLED, complete with tubes incl. instructions (less wire and CRT) **\$166.49**

You can purchase this kit less any tubes or parts (that you may already have) a liberal allowance will be deducted.

#630 TV PARTS . . . TOP QUALITY . . . LOW PRICES

RCA FRONT END TUNER, compl. w/tubes.	\$22.49
STANDARD TURRET TUNER, com. w/tubes.	22.49
ESCUTCHEON PLATE, for either tuner.	.69
COMPLETE SET OF KNOBS, incl. decals.	1.34
COMPLETE SET OF KNOBS, (Gold)	2.49
POWER TRANSFORMER, 295ma.	201T6 . . . 9.97
VERTICAL OUTPUT TRANS.	204T2 . . . 2.69
VERTICAL BLOCKING TRANS.	208T2 . . . 1.32
HORIZONTAL OUTPUT TRANS.	211T1 . . . 2.47
HORIZONTAL OUTPUT TRANS.	211T3 . . . 2.98
HORIZONTAL OUTPUT TRANS.	211T5 . . . 3.98
FOCUS COIL, 247 ohms.	202D1 . . . 2.29
FOCUS COIL, 470 ohms.	202D2 . . . 3.42
DEFLECTION YOKE, 60°	201D1 . . . 2.97
DEFLECTION YOKE, 70°	206D1 . . . 3.98
SOUND DISCRIMINATOR TRANS.	203K1 . . . 1.12
1st PIX I.F. TRANSFORMER.	202K2 . . . 1.08
2nd PIX I.F. TRANSFORMER.	202K3 . . . 1.08
1st & 2nd SOUND I.F. TRANS. (2)	201K1 ea. . . 1.02
HORIZONTAL DISCRIM. TRANS.	208T8 . . . 1.49
FILTER CHOKE, 62 ohms	. . . 1.47
CATHODE TRAP COIL.	202K4 . . . 1.08
WIDTH CONTROL COIL.	201R144
WIDTH CONTROL COIL.	201R448
WIDTH CONTROL COIL, keyed AGC.79
HORIZONTAL LINEARITY COIL.	201R339
HORIZONTAL LINEARITY COIL.	201R549
3rd & 4th PIX COILS, (2)	202L1 ea. . . .39
FILAMENT CHOKES, (5)	204L1 ea. . . .09
VIDEO PEAKING COIL.	203L118
VIDEO PEAKING COIL.	203L218
VIDEO PEAKING COILS, (2)	203L4 ea. . . .18
VIDEO PEAKING COILS, (2)	203L4 ea. . . .18
ION TRAP BEAM BENDER, (single)	203D179

ION TRAP BEAM BENDER, (double)	203D3 . . . \$.98
AUDIO OUTPUT TRANSFORMER (6K6)69
HV RECTIFIER SOCKET ASSEMBLY, single.79
HV RECTIFIER SOCKET ASSEMBLY, double	. . . 1.37
PUNCHED CHASSIS PAN, cadmium plated.	. . . 4.87
630-KIT, screws, nuts, rivets, washers.	. . . 1.69
HI VOLTAGE CAGE ASSEMBLY, complete.	. . . 3.73
HI VOLTAGE DIVIDER SHIELD & COVER, "	. . . 1.79
VOLTAGE DIVIDER COND. SUB-CHASSIS.94
ELECTROLYTIC COND. SUB-CHASSIS.19
SOUND DISCRIMINATOR SHIELD.57
TUBE CRADLE BRACKET.29
DEFLECTION YOKE MOUNTING HOOD.59
DEFLECTION YOKE MOUNTING HOOD.49
FOCUS COIL BRACKETS.	. . . per set .39
CATHODE TRAP COIL SHIELD.44
CHASSIS MOUNTING BRACKETS, set of 459
BRIGHTNESS & HOLD CONTROL BRACKET.16
WIDTH CONTROL BRACKET.17
TUNER SHAFT BRACKET.08
CORONA TERMINALS, set of 209
CORONA RING22
TUBE SHIELD & CLIP	. . . 2 sets .39
CATHODE RAY TUBE SOCKET, 18" leads.39
HV KINESCOPE LEAD, with clip.29
TV 6' LINE CORD, with both plugs.17
INTERLOCK SAFETY CONNECTOR (input).48
AMPHENOL CONNECTOR PLUGS, set.	. . . 2.49
OVAL PM SPEAKER, 5"x7"	. . . 6.94
12" PM SPEAKER, heavy alnico #5 magnet.	. . . 1.88
PLASTIC SLEEVE, for insulating 16AP4.	. . . 1.88
PLASTIC SLEEVE, for insulating 16GP4.	. . . 1.97
PLASTIC RING, for insulating rim 16" CRT.	. . . 1.96
PLASTIC SLEEVE, for insulating 19" CRT.	. . . 2.08
PLASTIC RING, for insulating rim 19" CRT.	. . . 2.08

PARTS #630 COMPLETE SETS

VIDEO AND I.F. KIT, 19 items.	\$7.84
MICA CONDENSER KIT, 11 condensers.	1.38
ELECTROLYTIC CONDENSER KIT, 6 cond.	7.37
TUBULAR CONDENSER KIT, 37 cond.	4.28
CERAMIC CONDENSER KIT, 28 cond.	3.37
CARBON RESISTOR KIT, 107 resistors.	6.98
WIREWOUND RESISTOR KIT, 4 resistors.	2.31
OCTAL WAFER SOCKET KIT, 13 sockets.	.72
MIN. WAFER SOCKET KIT, 10 sockets.	.63
MIN. MOLDED SOCKET KIT, 2 sockets.	.22
TERMINAL STRIP KIT, 18 terminal strips.	.59
COMPLETE SET OF GOLD KNOBS.	2.49
BRACKET AND SHIELD KIT, 18 items.	8.63
TERMINAL STRIP KIT, 18 strips.	.59
VARIABLE CONTROL KIT, 9 controls.	5.83
16"—CRT MOUNTING BRACKET KIT.	2.98
UNIVERSAL CRT MOUNTING BRACKET KIT.	6.97

VARIABLE CONTROLS

PICTURE & SOUND, 10K ohms 1 meg. & switch	1.14
VERTICAL & HORIZ., 50K ohms 1 meg.	1.04
BRIGHTNESS CONTROL, 50K ohms.	.44
HORIZ. CENTERING, wirewound, 20 ohms.	.57
HEIGHT CONTROL, 2.5 megohm.	.48
VERTICAL LINEARITY, 5000 ohms.	.44
VERTICAL CENTERING, wirewound, 20 ohms.	.96
FOCUS CONTROL, wirewound, 1500 ohms.	.98
HORIZONTAL DRIVE, 20K ohms.	.44

ELECTROLYTIC CONDENSERS—85° C

40/10/80MFD — 450/450/150 VOLTS.	1.37
40/40/10MFD — 450/450/450 VOLTS.	1.49
80/50MFD — 450/50 VOLTS.	1.49
40/10/10MFD — 450/450/350 VOLTS.	1.37
20/80MFD — 450/350 VOLTS.	1.49
250/1000MFD — 10/6 VOLTS.	.98

TUBULAR CONDENSERS—85° C

.002 — 600V	.09	.005 — 400V (3)	ea. .07
.0025 — 600V (2)	ea. .09	.01 — 400V (5)	ea. .09
.004 — 600V	.11	.015 — 400V (2)	ea. .11
.005 — 600V	.11	.05 — 400V (5)	ea. .12
.01 — 600V (2)	ea. .12	.1 — 400V (2)	ea. .14
.05 — 600V (6)	ea. .15	.001 — 1000V	ea. .14
.1 — 600V	.17	.004 — 1000V (2)	ea. .14
.25 — 400V (2)	ea. .21	.035 — 1000V	ea. .18
		.05 — 1000V	.18

H.V. FILTER CONDENSERS (Cartwheels)

10KV — 500 MMFD	.48
15KV — 500 MMFD	.67
20KV — 500 MMFD	.79

MICA CONDENSERS—85° C Operation

270 MMFD — 500 W.V. (7)	ea. .12
390 MMFD — 500 W.V.	.12
470 MMFD — 500 W.V.	.12
680 MMFD — 500 W.V.	.16
4700 MMFD — 500 W.V.	.29

WIREWOUND RESISTORS

5000 ohms, 5 watts.	.22
VOLTAGE DIVIDER, 1360/250 ohms.	.74
VOLTAGE DIVIDER, 5300/2-500 ohms.	.89
VOLTAGE DIVIDER, 6750/12/93 ohms.	.72

#630 TV TUBES—STANDARD MAKES

6J6 R.F. Amplifier	1.97
6J6 R.F. Oscillator	1.97
6J6 Converter	1.97
6BA6 (2) . . . 1st and 2nd Sound I.F.	ea. 1.08
6AU6 3rd Sound I.F.	1.69
6AL5 Sound Discriminator	1.69
6AT6 1st A.F. Amplifier	1.08
6K6GT Audio Output	1.08
6AG5 (4) . . . 1st, 2nd, 3rd, 4th Pix I.F.	ea. 1.74
6AL5 Pix. Det. & DC restorer.	1.69
6AU6 1st Video Amplifier	1.69
6K6GT 2nd Video Amplifier	1.08
6SK7 1st Sync. Amplifier	.98
6SH7 Sync. Separator	1.69
6SN7 2nd Sync. Amp & Hor. Dis.	1.62
6J5 Vert. sweep osc. dis.	.87
6K6GT Vertical sweep output.	1.08
6AL5 Hor. Sync. Discriminator	1.69
6K6GT Hor. Sweep Oscillator	1.08
6AC7 Hor. Sweep Osc. Control.	2.29
6BG6G Horizontal Sweep Output.	2.89
5V4G Reaction scanning	1.87
1B3/8016 . . . High Voltage Rectifier	1.94
5U4G (2) . . . Power Supply Rectifier	ea. 1.08

STANDARD GUARANTEED PICTURE TUBES

19AP4A—Round Metal Black.	64.74
16DP4A—Round Glass Black.	39.63
14LP4—Rectangular Black	31.38
12LP4A—Round Black	28.72
10BP4—Round	22.46
20DP4A, 17RP4A, 16RP4A—Black (See above left)	

BROOKS RADIO & TV CORP., 84 Vesey St., Dept. B, New York 7, N.Y. TELEPHONE **COrtlandt 7-2359**

INVENTORY SALE ALL PRICES CUT TO BONE

Don't Buy Tubes until you get our prices. Quantities Limited. Prices Subject to Change Without Notice. Low Prices.

TELEVISION TUBES

6CD6—\$2.75, 6BG6—\$1.95, 6CB6—\$1.75,
6S4—\$1.40, 6AK5—\$1.90, 6AQ5—\$1.75,
6BA7—\$2.00, 12AT7—\$2.25, 6BQ6—\$2.50,
6AU6—\$1.75

All Other Types at Vast Reductions

Westinghouse Cuprox Rectifier 0.64 Amp. 28
Volts. Reg. \$11.00 ea. Special... \$1.95
TUBE SALE—#247-55-27-85-31-56-57. No
Mixed Ass't. 6 Each Type... 2.25

12 BRAND NEW 10" PHONO RECORDS—Ass't.
Jazz—Pop—Hillbilly—Polkas. Please specify... \$1.79
3 Ft. 5 Wire Shielded Cable with Amphenol Con-
nection... 8 for \$1.00
7 Wire Shielded Cable, 24 in. with Octal Plug...
6 for \$1.00

TRANSMITTING PLATE TRANSFORMERS

A Pair of Signal Corps transformers connected in se-
ries to 110-125 Volts, AC, will deliver approximately
750 to 800 Volts, DC, 200 mls. when connected to a
rectifier tube and filter condenser. Cost Uncle Sam
\$25.00—our price per pair, \$2.98. Shipping weight
33 lbs.

Signal Corps Phones—2 M. Ohms (8 M. Ohms
Imp.)... \$1.00
2 Ft. Ext. Cord (and Plug)... 40c

OIL FILLED FILTER CONDENSERS

1—MFD—1000 working volts... 6/99c; 12/\$1.75
2 MFD—1000 V. Upright bottom lug... .89c

TOBE TUBULAR ELECTROLYTICS

20-20 MFD. 150 V. 49c 30-30 MFD. 150 V. 57c
40-40 MFD. 150 V. 59c

Low-Loss Short Wave Lock Type Air Trimmer Variable Condensers

3 Pl.—12-15 Mmfd. .12c
7 Pl.—25-30 Mmfd. .15c
8 Pl.—30-35 Mmfd. .16c
14 Pl.—56 Mmfd. .24c
27 Pl.—100-110 Mmfd 35c SWITCH... 15c

3 GANG T.R.F.
VARIABLE CON-
DENSERS
.000365 Con. 65c

D.P.D.T. SLIDE
TOGGLE
SWITCH... 15c



4 PR. WAFER SOCKETS—\$1.49 per C. each... 3c
5-6 PRONG WAFER SOCKETS... \$2.50 per C
100 ASST. SOCKETS... \$2.50 per C
1,000 OHM WIRE WOUND POTENTIOMETER... 15c
30 HY-FILTER CHOKE SHIELDED... 3 for \$1.25
UNSHIELDED... 3 for 1.00
2,000 ohm Wire Wound Rheostats... \$1. per doz.
CARTER WIRE WOUND C.T. VARIABLE 20 OHM
RESISTORS... 95c per doz.
GEN. ELEC. WESTINGHOUSE, etc. 60 CYCLE WATT
HOUR METERS, slightly used, perfect condition,
same as used in your home. 110-125 volts.
5 Amps. \$2.95; 10 Amps... \$3.95

PIEZO CRYSTAL HOLDERS.
12 for \$1.00—\$6.00 per hundred—\$50.00 per 1,000

RCA Band Switches—
3 gang, 3 pos. 3 band. 30c 6 gang, 4 pos. 4-5 band. 40c

Trimmer-Padder Ass't.—all isolantite—singles, duals,
triples—100 asst. pieces... \$2.25

Philco push button Rotary Switch Double Pole... 35c

ATTENTION: Prospectors, Explorers for Hidden Treasures!
Construct a U.S. Army Type of Metallic Mine Detector
Amplifier. Amplifier unit only (less tubes and bat-
teries) with cables, headphone cord, and jack. Army
wiring diagram. Type AN/PRS-1... \$1.95

RCA Ass't Mica By-Pass Cond. .001, .0025,
100 for... 95c
8 or 9 Gang Push Button Switch... 49c

DRILLED CHASSIS FOR 5-6 tubes 5"x10"x1 1/2". 25c
PHONE JACKS—OPEN & CLOSED AUTO... 18c
NATIONAL 450 VOLT 450 VOLT C.A.T. FILTER
CONDENSER... 25c
ERY SPEAKER VOL. CONTROL—60 OHMS... 15c
SALE—PHONO RECORD ALBUMS—12"—3 comp. 15c;
10"—3 comp.—15c; 4 comp. 20c; 12 comp.—69c

IRC—300 Watt—300,000 OHM Wire Wound Res. 95c

6 Prong Amphenol Sockets... \$4.00 per C

AMERTRAN FILAMENT TRANSFORMER—6.3 V. 1
Amp. Encased Isolantite Terminal Posts... \$1.50

AMERTRAN XMITTING AUDIO XFORMER—For Class
B or Modulator. Pri. 600/1600—Sec. 550 @
160 MA. Cost \$75.00... SPECIAL \$2.49

AMERTRAN AUDIO OUTPUT XFORMER—Pri. 10,000
@ 15 MA; Sec. 300, 6-1 Ratio... \$1.49

AMERTRAN MIXER AUDIO XFORMER—Pri. 600-10-
000 Ohms... \$1.00

156-1 RATIO VERNIER DIALS—4 in., 3/8 in. Hub. 35c

LINE VOLTAGE NOISE ELIMINATOR—Plugs in Be-
tween Radio and Elec. Socket... 35c

12 in. MAGNAVOX SPEAKER, 2500 Ohms... \$2.95

HEARING AID CORDS—Assortment of 12 for... \$1.00

BY-PASS COND. ASST.—25 Cans, Bake.. Paper,
etc... \$1.00

MINIMUM ORDER \$2.00—NO C.O.D.
SHIPMENTS—PLEASE INCLUDE POSTAGE

NEWARK
SURPLUS MATERIALS CO.

Dept. MA

324 Plane Street NEWARK 1, N. J.

inches and is operated by means of a single tuning knob.

The Model DB 410 has contra-wound bifilar coils with a push-pull triode to give a balanced circuit. Internal impedance, matching an input

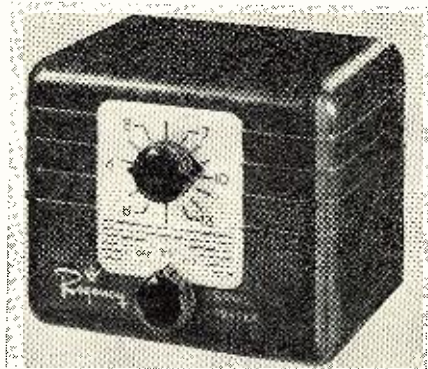

and output, accommodates either 300 ohm parallel line or 73 ohm coaxial cable. The wide bandwidth assures satisfactory video-audio reception on all 12 channels. —30—

"FRIENDSHIP AWARD"

The Sandia Base Radio Club, Sandia Base, Albuquerque, New Mexico has recently established a "Friendship Award," originally designed to help Albuquerque amateurs get better acquainted but now expanded in scope to include all hams.

The idea was originated by A. David Middleton, W5CA, and W. Arnold Finchum, W5FO while the certificate was designed by John R. Halliday, W5PIZ.

The rules governing the award are as follows: 1. The club will issue an award certificate to any licensed amateur presenting proof of two-way contact with 25 different amateur stations licensed within the Albuquerque area. Endorsements will be made for multiples of 25 confirmed contacts. The awards will be numbered in the order of their presentation.

2. Any amateur is eligible for the award. Contacts with any Albuquerque area station are valid. Awards will be made only after complying with the provisions as set forth under Rule 7.

3. Work any Albuquerque area station and obtain written verification of the contact.

4. Any amateur station licensed and operating within a radius of 25 airline miles from downtown Albuquerque shall be considered to be in the "Albuquerque area."

5. Contacts may be made on any amateur band. Cross-band and cross-emission contacts are valid.

6. Only contacts made after June 12, 1950 are valid for purposes of determining eligibility for the award.

7. Written confirmation (in the form of cards, letters, or QSL's) showing date, time, band, and station contacted should be forwarded, together with first class return postage, to: Secretary, Sandia Base Radio Club, Sandia Base Branch Post Office, Albuquerque, N.M.

8. Awards will be made for contacts made after June 12, 1950 and until further notice.

The club emphasizes that this is not a contest and the award is given for achievement.

At the present time there are approximately 85 stations operating in the area, most of them on 10 meter phone. —30—

For Clearer,
Sharper
Pictures...

For
Easier,
Faster
Installations

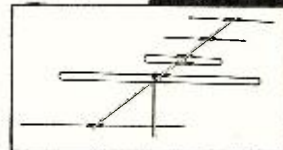

PHOENIX
Speed
TENNAS...
Speed
MOUNTS...
and HARDWARE

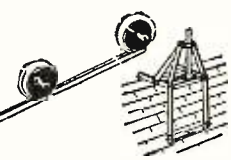

PHOENIX ELECTRONICS
INC.
LAWRENCE, MASS.

Use ERIE
DISC and PLATE
CERAMICONS®
... as dependable replace-
ments for molded mica and
paper tubular capacitors



STYLE 811



STYLE 812

Simplify servicing—Guarantee customer satisfaction by replacing micas and papers with dependable ERIE DISC and PLATE CERAMICONS. Small in size—they are easier to install. Easy to identify—look for the RED BODY disc and plate capacitors—they are ERIE CERAMICONS.

If your distributor cannot supply you, write us for information. New catalog on request.

Electronics Division
ERIE RESISTOR CORP., ERIE, PA.
LONDON, ENGLAND • TORONTO, CANADA

RADIO & TELEVISION NEWS

International Short-Wave
(Continued from page 55)

ing. These news bulletins are, of course, entirely objective. With the searchlight of 58 nations trained upon U.N. newscasts, they must adhere closely to fact and not indulge in editorializing or propaganda.

Listeners in many parts of the world were able to follow the debates of the 1950 General Assembly as they took place in the council chambers at United Nations headquarters. Through the cooperation of major world broadcasting organizations—the *Voice of America*, the *British Broadcasting Corporation*, and *Radiodiffusion Française*—the principal meetings of the Assembly were broadcast in the five official languages. Listeners in Europe and the Middle East heard the meetings in *English* and French broadcast directly from New York, and in Russian relayed from Paris. Listeners in Latin America heard the meetings in Spanish broadcast directly from New York, and those in the Trans-Pacific Area heard the meetings in Chinese relayed from Singapore. In addition, in the New York area, the meetings were broadcast in *English* by the municipal station of New York City, WNYC, and throughout the continental United States over stations of the *Continental FM Network*.

Programs other than news are designed to describe various phases of United Nations work in all parts of the world as it relates to the everyday lives of its two billion individual members. These programs reach all age levels, women, college students, and so on, for example, and contain material about health, social welfare, education, pilot projects, labor, displaced persons, youth, and many other topics.

Each week, some 20-25 hours are devoted to live broadcasts of regular meetings. Approximately 100 hours of broadcasting originate weekly at Lake Success except when the General Assembly is in session at which time the output increases materially. This figure does not reflect the countless hours of rebroadcasting by national systems, networks, local stations, nor the use of recorded meetings and interviews, nor utilization of radio scripts.

Here is a partial list of United Nations special programs—"United Nations Today"; "U.N. News"; "Memo From Lake Success"; "U.N. Story"; "U.N. Album"; "U.N. Report"; "United or Not," and "Spotlight on the U.N." Most of these are carried on medium-wave throughout the United States and/or Canada, and some are carried abroad on either medium- or short-wave, or by both.

(NOTE: At the time this was written, the United Nations was in the process of moving its headquarters from Lake Success to its new "home" on New York City's East Side, and

Valuable guides for television technicians

Just published!

MOVIES FOR TV

This complete, practical book gives you all the information you need to choose the best equipment, operate it most efficiently, and make the most effective use of movies on TV programs. It explains the operation of all leading makes of cameras, projectors, sound and kinescope recording equipment, different types of lenses, etc., giving the advantages, disadvantages, and relative costs of each. It shows what may go wrong and how to avoid trouble, what type of picture is good on television and what is not, how to light movies for best TV reception, how to insure good shots on location, combine live scenes with movies, produce special effects, titles, newsreels, different types of commercials, and much else that will be of utmost practical aid to station personnel and program planners. *By J. H. Batison.*



A practical how-to-do-it guide for technician and program director alike.

CHECK THE ONES THAT CAN HELP YOU MOST AND SEE THEM ON APPROVAL

TELEVISION & FM ANTENNA GUIDE

This excellent handbook will save you much testing and readjusting and insure the best reception from any antenna system. It gives you the characteristics, dimensions, advantages and disadvantages of all VHF and UHF antennas and allied equipment, including heretofore unpublished information on new types recently tested by the authors. It tells how to determine the right type of antenna for a specific location, locate space loops, determine signal strength, etc.; how to mount various types of antennas on different kinds of roofs or window sills; how to minimize noise and avoid standing waves in transmission lines, and all other installation procedures. Handy tables give comparative data, and there is full, clear instruction in all fundamental antenna principles. *By Noll & Mandl.*



How to get the most out of the antenna system at any location.

Outstandingly helpful references

TELEVISION FOR RADIOMEN

The outstanding book on television for servicemen. Explains in clear, non-mathematical terms the operating principles and function of every part and circuit in today's TV receivers, and the chief principles of transmission. Complete, practical instruction in installation and alignment procedures, testing equipment and how to use it, adjustment, and trouble-shooting. *By E. M. Noll.*



RADIO & TELEVISION MATHEMATICS

This unique handbook of 721 problems and solutions shows you what formulas to use, what numerical values to substitute, and each step in solving any problem you are likely to encounter in radio, television, or industrial electronics. Conveniently arranged and fully indexed for quick reference. *By Bernhard Fischer.*



USE THIS COUPON

to get FREE examination copies. If you're not fully satisfied, you may return them without further charge.

The Macmillan Company, 60 Fifth Avenue, New York 11

- Movies for TV \$4.25
- Television & FM Antenna Guide. \$5.50
- Television for Radiomen \$7.00
- Radio & Television Mathematics \$6.00

Please send me the books checked. I will either remit in full or return the books in 10 days.

Signed
Address N



Music—sweet music to his ears!

And why not? A satisfied customer has telephoned—yes, actually telephoned—to thank this service-dealer for the swell repair job on his TV sets.

Your customers may not take the trouble very often to do this, but you can bet your last dime that a *dissatisfied* customer will lose no time in telling you what he thinks. This means call-backs on which you lose time, money, and reputation.

The trick, of course, is to eliminate call-backs. Unfortunately, you can't eliminate them *all*. But, you can keep them to a minimum by using only parts on which you can stake your reputation.

Look at any tube marked TUNG-SOL. There is the same tube—the same performance standards—the same dependability which eight out of ten leading set manufacturers use for initial equipment. All TUNG-SOL tubes are made to meet their requirements. So, when you make replacements with TUNG-SOL tubes, you're putting back into the set the same high quality with which it left the factory.

This TUNG-SOL "one standard" policy safeguards your service work, your prestige and your profit.

Tell your distributor's salesman you'd rather have TUNG-SOL tubes.

TUNG-SOL LAMP WORKS INC., NEWARK 4, N.J.
Sales Offices: Atlanta, Chicago, Dallas, Denver, Detroit, Los Angeles, Newark



ONE STANDARD—*The best that can be made*
For Initial Equipment and Replacement

the press section was still at Lake Success.—KRB)

Incidentally, General Assembly meetings are televised over U.S. national networks. "U.N. Stamp Club," a half-hour philatelic program, slanted to the teenager, in which stamps are used to teach about the United Nations and its specialized agencies, is carried over WNBT, Channel 4, on Sundays at 1245-1315.

The *Canadian Broadcasting Corporation* cooperates with U.N. Radio and initiates its own United Nations material, on both its national networks and on its International Short-Wave Services. The *BBC*, serving both the peoples of the United Kingdom and a world-wide audience of *English-speaking* listeners, as well as listeners in many other languages, has covered U.N. developments from the inception of the organization. Australia and New Zealand use much U.N. material, both from transmissions and recordings. South Africa currently uses some U.N. material weekly and further expansion is expected. The Philippines takes not only U.N. broadcasts in Tagalog, but also material from transmissions and transcriptions in *English*. Likewise, a certain percentage of material has been taken by the *English Service of the Egyptian State Broadcasting System*, in *English* as well as in Arabic. All India Radio, the Pakistan Broadcasting Service, and *English-speaking* stations such as Hong Kong, Trinidad, Jamaica, Malaya, Mauritius, Malta, Northern and Southern Rhodesia, all carry U.N. material sent out from headquarters by transcription or in script form. During 1948-49, there was marked increase in coverage by U.S. stations and networks.

The 1950-51 pilot projects—known as Communications Campaigns—are being set up in 35 key U.S. and Canadian cities for the purpose of publicizing U.N. Radio programs. Committees are made up of local representatives of organizations with accredited observers at United Nations and local World Affairs Councils and chapters of the American and Canadian Associations for the United Nations.

A Radio Reports Desk is charged with the preparation of all news broadcasts which later are used by the language sections. It employs seven persons and functions 18 hours a day to bring to the various international programs the latest news about U.N. from all parts of the world. A weekly summary is released to members of the National Association of Radio News Directors.

A record library is maintained which contains some 25,000 recordings of meetings, interviews, and music. All major meetings of U.N. are recorded. It is estimated that 45,000 words are recorded every day. There were, throughout member countries, thousands of meetings held in 1950. The recordings cover a wide range of subjects—from the General Assembly or

Trusteeship Council, for example, to impressions of the U.N. spoken in Ibo, a language of Nigeria, by a group of visiting Nigerian students.

Laymen, members of non-governmental organizations who have regular time on radio stations, are provided with material for broadcast from United Nations Radio. Frequently, U.N. committees, commissions, and agencies include radio directors on their staffs. Close cooperation is maintained between U.N. Radio and such offices, resulting upon occasion in jointly-produced programs and increased promotion.

Periodically, schedules of all broadcasts of United Nations Radio are printed and released in quantity to broadcasters and to the public. In addition, booklets about United Nations Radio are published by various sections for release to listeners, titled "*U.N. Calling the Peoples of the World.*"

The Radio Division is eager to establish contact with as many listeners as possible and gladly will acknowledge all communications. Letters from all parts of the globe already have brought valuable information about the reception of United Nations broadcasts. All correspondents reporting on U.N. broadcasts will receive *on request* a United Nations Radio verification card and a copy of the Charter.

Correspondence or requests for copies of schedules should be addressed to United Nations Radio, New York City, New York, U.S.A., or to the Director of the nearest U.N. Information Center. These Centers are located in Belgrade, Buenos Aires, Cairo, Copenhagen, Geneva, London, Mexico City, Monrovia (Liberia), Moscow, New Delhi, Paris, Prague, Rio de Janeiro, Shanghai, Sydney (Australia), Teheran, Warsaw, and Washington, D.C.

Schedule of world radio coverage of General Assembly meetings, when in session, are listed—*To Europe and Middle East* (in *English* and *French*)—1030-1300, WRCA, 21.610, WABC, 15.130; 1500-1600, WRCA, 21.610; 1500-1745, WABC, 15.130; 1515-2200, WRCA, 11.770; 1615-2200, WRCA, 9.615. *To Europe* (in *Russian*)—RDF relay from Paris, 1030-1300, 17.765; by this time, also may relay afternoon (*EST*) meetings. *To Latin America* (in *Spanish*)—1030-1300, WLWO, 21.690, WLWO, 15.200; 1500-1800, WLWO, 21.690, WLWO, 15.230. *To Trans-Pacific Area* (in *Chinese*)—BBC relay from Singapore, 0100-0400, 15.300, 11.880.

Such is the story of United Nations Radio. Our best wishes go to United Nations Radio for continued success, with full appreciation that its effects can go far in helping to achieve better world understanding and mutual goodwill.

* * *

Handbook Available

"World Radio Handbook" (1950-51 Edition) is available for \$1.25; "How to Listen to the World" (explained by experienced world listeners), for 30c;

RADIO & TELEVISION NEWS

FLASH! Stupendous! Gigantic! Colossal! BARGAINS in RADIO EQUIPMENT



AUDIO AMPLIFIER Push-Pull triode amplifiers having 2 of the valuable and scarce ounce type hypersil core audio transformers that sell for over \$10.00 each. Neat aluminum case, fully enclosed. Perfect for intercom systems, phono, mike, or signal tracer amplifier for testing radio. A \$25.00 bargain at only \$3.40 each.

FREE

GET A RIDER PERPETUAL TROUBLESHOOTER'S MANUAL FREE plus a copy of the latest Radio Handbook with any order for 3 Rider Manuals at regular price. 5 books for the price of 3.

We will also send you one FREE RIDER TEXTBOOK plus a current Radio Handbook with any order for 3 Rider's Textbooks.



A BETTER RAT TRAP (Or From Blind Mice to Electric Eyes)

We offer a limited quantity of sensitive photo-cell amplifiers, complete with tubes, including the photo-cell. These were part of an ingenious rat trap manufactured by the Kryptor Optical Company of Rochester, N. Y. for use in flour and feed mills, etc., all over the world, for killing rats. This was done when the rodents interrupted a light beam, setting off a mechanism which electrocuted them. These amplifiers are useful for traffic counting, checking units in a production line, for opening garage doors, for burglar alarms, for smoke detectors on chimneys or fire alarms, for turning on street lights at dusk, and many other applications. Super Special, completely wired—\$12.50. Kit Form—\$8.50.



Universal 4 lead broadcast band oscillator coil (can be converted to 3 lead type by addition of jumper). Ten for \$1.00.

TOROIDAL COIL FILTERS

Are the Answer to Any Network Problem

- SHARP CUT-OFF
- LOW INSERTION LOSS
- HIGH STABILITY
- 1000 CYCLE AUDIO FILTERS
- "Q"-55 AT 1000 CY.; 150 AT 3000 CY.
- COMPACT
- HUM PROOF
- HIGHEST "Q"

Navy PDE901 .1 low pass audio filters that are the exact electrical and physical equivalent of commercial audio filters selling for \$35.00 wholesale. Far superior to surplus Radio Range Filters now being offered. Twice as selective as Q-fixer section of 274N, which has previously provided the highest standard of interference elimination. With diagram \$2.00.

P.M. SPEAKERS

Latest type PM Speaker in a fully-enclosed metal cabinet. Speaker and case match communication receivers, in addition make perfect intercom remote stations. \$4.50. Including output transformer \$4.95.



Musical Instrument or Contact Microphones

Assembly complete with two Microphones, On-Off Switch, Amplifying Transformer, Batteries, Battery Case and Connector to attach to any radio; AC, DC, or battery portable. Tremendous amplification up to the full volume output of the radio or sound system used. Perfect for watch or clock repair diagnosis, diesel engine injector adjustment, gasoline engine trouble shooting, or for use on any musical instrument with dance band or orchestra. Worth \$30.00. Your cost \$4.95.

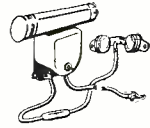

SUPER HEAVY DUTY HIGH FIDELITY UNIVERSAL OUTPUT TRANSFORMER

by famous manufacturer
Flat within 1 D.B. to 20,000 cycles. Handles up to 125 watts without distortion • Hermetically sealed with 2500 volt insulation and porcelain standoff terminals • 6 1/2" high and 14 lbs. net weight • 18 voice coil impedances available, plus 500 ohm line • \$80.00 value for only \$20.00.

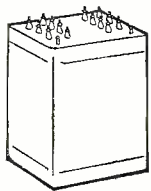

COAXIAL SPEAKERS

Latest Model Co-Axial Speaker—Woofers-Tweeter design. Response 40 to 17,500 cps. New efficient speakers represent the result of years of research. Low and high pass filter built-in. Only 2 wires to connect. 8 ohms impedance. Only \$12.50 each or \$24.00 for 2.



HEAT GUN

Red plastic, streamlined pistol grip heat gun. Blasts 160° hot air at 20 cu. ft. per minute. Big rugged vacuum cleaner type AC-DC motor that also blows cold air. Use to clean radio chassis, heat capacitors, dry ignitions, quick-dry paint, thaw out radiators or water pipes, etc. Guaranteed or money refunded if returned, prepaid, in 3 days. \$12.95.

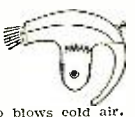

WINDOW ANTENNA

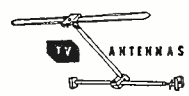

Highest quality telescoping folded dipole antenna with all the features usually expected in such an antenna, including use as a dipole and reflector, and in addition a mounting bracket provided so that the antenna can be installed in any window in two minutes or less. Any slight loss in gain because of the reduction from rooftop height is more than compensated by ability to orient antenna instantly by opening window and adjusting for maximum signal strength. Mounting bar can be installed horizontally or vertically in window frame or even between attic rafters, whichever is most convenient. Your cost, \$7.00. With high frequency attachment for channels 7 to 13, \$9.00. Either type 10% less in dozen lots.



3-Gang Broadcast Band Tuner. Was \$3.50. Now \$1.50.

WE CAN MAKE IMMEDIATE DELIVERY ON THE FOLLOWING TUBE TYPES IN REASONABLE QUANTITIES.

2A5\$1.10	6C6\$1.20	6SF5\$0.90	76\$0.89
2X21.50	6D699	6SK780	7789
5V41.44	6F71.73	6SQ775	7880
5Y375	6J590	10 or 210 1.25	8069
5Z31.08	6K699	12A7690	8490
6AC7 ...1.74	6K799	12SL7 ...1.40	851.05
6AJ5 ...2.34	6L61.60	2680	117L7 ...2.34
6AK5 ...2.34	6R71.59	2780	9GP7-9"
6AK6 ...1.44	6SA799	32L7 ...1.50	scope or
6B71.50	6SC7 ...1.20	501.25	picture
6C480	6SD7 ...1.40	5685	tube .. \$7.95

MIKE Jr. 60c LAPEL MIKES

(Specify whether carbon or magnetic) 93c

Many of the above are JAN tubes. Manufacturer's quantities on some of the above. No price reduction while present shortage lasts. We will buy all types of tubes and pay top dollar.

Super Special Tower and Antenna Bargain

The Best Antenna and the Best Tower!



Most extremely light but strong!!! Chrome Molybdenum alloy steel. Made for use in car, plane air frames. Enormous load carrying capacity — no comparison with ordinary steels. We will not ship more than 12 masts to any dealer, as the quantity available is limited and no more steel of this quality is available, even at many times this price. All tower hardware, except guy wire, is furnished including large mast base adjustable to any angle. Base suitable for mounting on sloping roofs or on a concrete block set on ground. Total price for 30 ft. tower—with double stack antenna as shown \$35.00.

Drillmaster Electric Drill



Pistol Grip electric drill, ideal for hobbyists. Complete with sander, buffer, grinding wheels, etc.\$9.95

New 18-Watt Utility Amplifier Kit

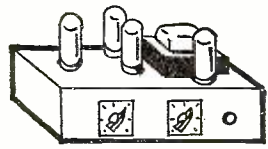

Kit Model SA, high quality wide range 18-watt public address amplifier. Matched component parts. 3-stage, high-gain circuit with push-pull 7C5 output tubes. Dual inputs for mike, phono or radio tuner. Fully shielded. Universal output to match any speakers used. Fully variable tone control on output. Complete with all parts and tubes. Super Special, \$16.95.

PHONO SCRATCH ELIMINATOR

Consists of 2 condensers and powdered iron core choke connected in filter network. Same as used in most jukeboxes. Connects instantly between pick-up and amplifier\$2.00

Bandswitching Tuning Turret

4 bands above 100 Mc. #14 silver plated coil wire. Tuning condensers, driving motor diagram included. Only \$2.95.

HURRY

Get your 2 gang midget superhet tuning condensers with 1/4" shaft and trimmers. Reg. \$1.25 each, now \$5 for \$2.00.

All sales final and no returns unless otherwise specified in ad of item. Right reserved to change prices and specifications at any time. Cable address BUFRAD

BUFFALO RADIO SUPPLY, 219-221 Genesee St., Dept. RN-3 BUFFALO 3, N.Y.

both for \$1.50; prices include postage. Send orders direct to Ben E. Wilbur, 32 Whittlesey Ave., East Orange, New Jersey. These publications (in *English*) are compiled by O. Lund Johansen, Copenhagen, Denmark.

* * *

The "Berne List"

I have just received word via air-mail from International Telecommunication Union, Geneva, Switzerland, that the next (16th) Edition of the List of Frequencies (commonly known as the "Berne List") will be published in June of this year. It will contain assignments since the 15th Edition (published 1947, reprinted 1950, and in supplements), plus assignments received to March 1951.

* * *

This Month's Schedules

Albania—Radio Tirana, 7.853, still has news 1515. (Pearce, England)

Andorra—Radio Andorra, approximately 5.990, noted from around 1755 to 1935 sign-off with anthem; fair signal, but after 1830 has bad QRM from HCJB, Quito, Ecuador; announcements in Spanish are by man, in French by woman. (Bellington, N. Y.)

Argentina—LRA, 9.69, Buenos Aires, concludes first part of *English* transmission at 2100 directed to East Coast; is off briefly and returns in a few minutes to transmit the second part of the *English* release to West Coast until 2300. (Russell, Calif.) SIRA, 15.290, noted in *English* to 1230 and later; very weak in Texas. (Stark)

Australia—VLQ3, 9.660, Brisbane, noted with news 0400. (Russell, Calif.) VLI3, 9.500, Sydney, is good around 0200-0300 sign-off; VLI2, 6.090, noted 0330-0700, news 0400; VLM, 4.917, Brisbane, comes in some mornings well around 0600-0815, news 0700. (Saylor, Va.) Perth, Western Australia, heard on approximately 4.890 around 0830-0900 relaying 6WF. (Dary, Kans.)

Austria—"Sender Innsbruck," 6.000, noted daily 0200 after call in German, with relay from Paris of "Le Journal Parle" (news in French); lasts to around 0218 when resumes in German. (Pearce, England)

Azores—Ponta Delgada, 11.090, heard 1500-1600. (Harris, Mass.)

Belgian Congo—Leopoldville now changes from its 9.767 frequency to new 9.800 at 1830 where it is heard to around 0015 sign-off. (Bellington, N. Y., others) Was measured on 9.80052 at 2030 recently by Oskay, N. J. DX-ers throughout the U. S. report the new 9.800 channel suffers severe CWQRM most of the time.

OTM is noted still opening 0000 on 6.285. (Bellington, N. Y.) OTM2, 9.40, Leopoldville, heard 1620-1635; mostly in French. (Patterson, Ga.) Heard on a Sunday signing off 1805. (Bellington, N. Y.)

Brazil—Summer Time in Brazil is scheduled to terminate March 31. Calls of *Radio Record*, Sao Paulo, are PRB21, 6.055; PRB22, 9.505, and PRB23, 15.135. (Serrano, Brazil)

PRL7, 9.72, Rio de Janeiro, noted with *English* announcement 2030 recently.

Burma—Radio Rangoon, 6.035, still has news 1000, fair signal but some QRM. (Balbi, Calif.)

Cape Verde Islands—CR4AA, measured 5.8925V, Praia, noted signing off 1653 after playing "A Portuguesa." At times is as low as 5.8854. (Oskay, N. J.)

Ceylon—Commercial Service of Radio Ceylon verified from G.P.O. Box 574, Torrington Square, Colombo, Ceylon. (Pearce, England)

The 9.52 outlet noted early evenings to around 2030 or 2045 sign-off. (Russell, Calif.; Stark, Texas) Uses 4-note interval signal; has popular music with *English* announcements.

Cushen, N. Z., lists this complete current schedule for *Radio Ceylon*—Series 1 transmitters—No. 1, 100 kw., 1730-2030, 21.620; 2045-0230, 15.120; 0325-0900, 17.730, and 0900-1205, 15.120; No. 2, 7.5 kw., 2330-0130 daily except Sat. when opens 0000 and closes 0200 (Sun. *EST*), 21.620, and 0325-1205, 21.620; No. 3, 7.5 kw., 2045-0230, 9.520; 0630-1130, 11.975; No. 4, 7.5 kw., 0630-1130, 7.190. Series 2 transmitters—No. 1, 250 w., 2130-2230, 0000-0330, 0530-1200, 6.075; No. 2, 250 w., 2045-0230, 0630-1130, 3.395; No. 3, 250 w., 2130-2230, 0000-0330, 0530-1200, 4.900.

China—Nanking, 9.733, noted in Britain parallel with Peking, 10.260, at 1800 with all-Chinese broadcast; poor level. (Catch) I have not heard

(Continued on page 148)

Manufacturers • Distributors • Radio Service Companies

**Standard Manufacturer
Bulk Pack
New In Date
GUARANTEED**



RADIO and TV TUBES

● AVAILABLE FOR IMMEDIATE DELIVERY

1B3GT	6AL5	6BA6	6SL7GT	12AU7	807
1X2A	6AH6	6BQ6	6SN7GT	12AV7	813
5U4G	6AU6	6K6	6V6GT	211	VR150

● MANY OTHER TYPES AVAILABLE ●

Write, Wire or Call for Special Quotations • Subject to Prior Sale

ELECTRONIC EXPEDITERS

6411 North Oakley Avenue
Sheldrake 3-1827 • CHICAGO 45, ILLINOIS

shortages

COPPER!

MANGANESE!

ALUMINUM!

COBALT!

STEEL!

PAPER NEXT?

PLAY SAFE!

Reserve your copies of RADIO & TELEVISION NEWS.
The order card facing this page assures you
of staying in line for every important
development in crucial months ahead!

**Act now! Make sure
you don't miss a
single vital issue!**

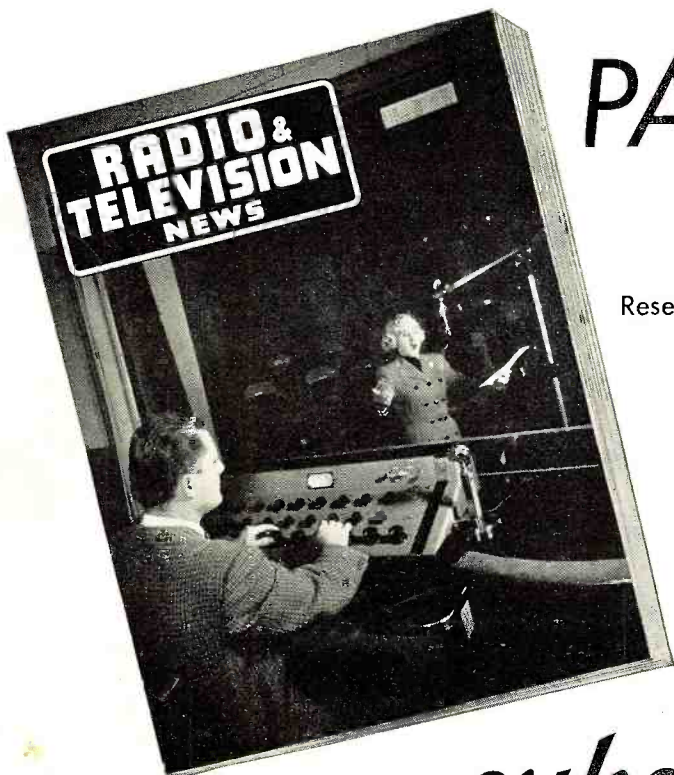

subscribe today!

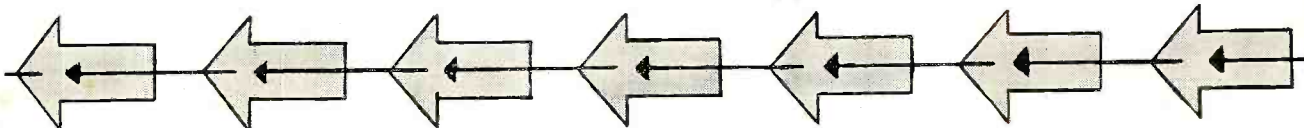

ZIFF-DAVIS PUBLISHING COMPANY • 185 N. WABASH AVENUE • CHICAGO 1, ILLINOIS
Publishers also of: RADIO-ELECTRONIC ENGINEERING Edition of RADIO & TELEVISION NEWS * POPULAR PHOTOGRAPHY
* PHOTOGRAPHY ANNUAL 1951 Edition * MASTERPIECES * FLYING * MODERN BRIDE * FICTION GROUP
ZIFF-DAVIS COMICS.

Use the **HANDBOOKS**
the **EXPERTS USE**



GET AHEAD FASTER IN RADIO TELEVISION ELECTRONICS

The Library set assists you in every operation in radio, television and electronics. Gives you the fundamentals, complete ground work, understanding of all types of radio, television, electronic gear and their circuits, including theory of operation.

Shows you expert methods of planning, building, installing, operating, testing, adjusting, and servicing. The know-how of radio, television and electronics presented in plain language and simple terms with easy to understand pictures and working diagrams.

You get 1800 pages of basic knowledge, methods and data of radio, television, electronics completely illustrated with over 2000 pictures, drawings, codes, charts and graphs.

Written by the Boyce-Roche experts who make electronic manuals for the U. S. Signal Corps.

SPECIAL OFFER—Save one dollar. Send for the **RADIO & TELEVISION LIBRARY SET** and get **THE RADIO & ELECTRONICS HANDBOOK** and **The VIDEO HANDBOOK** in handsome slip case as shown above for.....\$10.90

RADIO & ELECTRONICS HANDBOOK provides instruction and reference on fundamentals, parts, tubes, circuit elements, receivers, transmitters, amplifier systems, power supplies, antennas, meters, test equipment, and accessories, with complete Data Section.....\$5.95

VIDEO HANDBOOK teaches television and provides complete handbook reference on all phases with full sections on principles of television, receivers, antennas, test equipment, servicing, pattern interpretation, transmitters, show production and more.....\$5.95

SEND NO MONEY

10 DAY FREE EXAMINATION COUPON!
(Good only while special Library Set offer lasts)

BOYCE ROCHE BOOK CO.
CALDWELL 23, NEW JERSEY

Send () Library Set @ \$10.90
() Radio & Electronics Handbook @ \$5.95
() Video Handbook @ \$5.95

In ten days I will send you price plus postage or I will return book(s) postpaid. (Offer good only in U. S.)

Name.....

Address.....

City, Zone, State.....

Employed By.....

Save Postage. We pay postage if you enclose full price(s) now. Money back on same return privilege.

Manufacturers' Literature

Readers are asked to write directly to the manufacturer for the literature. By mentioning **RADIO & TELEVISION NEWS**, the issue and page, and enclosing the proper amount, when indicated, delay will be prevented.

HI-FI EQUIPMENT

Hudson Radio & Television Corp. of 212 Fulton Street, New York 7, New York has just announced the availability of a 36-page catalogue devoted to high fidelity sound, television, and radio equipment.

The catalogue contains complete descriptions of all the standard brand components required to assemble a high fidelity sound system for the home or professional use. It includes an explanation of high fidelity, data on how to evaluate the performance of the various components, an explanation of terminology, installation instructions, etc.

One of the unique features of the catalogue is an extensive listing of "packaged" high fidelity systems, consisting of carefully matched components in various price ranges.

Copies of the catalogue are free on request to those writing direct to the company.

TEST EQUIPMENT

The Hickok Electrical Instrument Co. of Cleveland 8, Ohio has issued a one-page data sheet covering three instruments in its line.

Data is given on the company's long scale meters, the Model 640 oscillograph for electronic and industrial laboratory applications, and on the dynamic mutual conductance tube testers put out by the firm.

Specialized booklets on each of these units are described and readers may send for these booklets for information other than that included on this data sheet.

PARTS DIRECTORY

A new "Service Parts Directory for *RCA Victor TV Receivers*" which is designed to speed and facilitate the selection of proper replacement parts for the company's receivers manufactured from 1946 through June 1950 has been announced by the Tube Department of *Radio Corporation of America*.

Designed for the television service dealer or technician, the new 80-page directory contains schematic diagrams and parts list for 56 *RCA Victor* receiver models. The pages, 11 by 17 inches in size, are arranged so that the parts list for any particular model faces the corresponding schematic.

The parts list for each model is divided into two sections. The first section covers all service parts which are identified on the schematic by symbol numbers and gives the *RCA* stock numbers for those which are available through the company's distributors.

The second section gives the *RCA* stock numbers for other parts which are not identified on the schematic by symbol number but are available through the distributors.

The new directory, Form SP-1008, may be obtained from *RCA* tube and parts distributors.

"ADASHAFT" CATALOGUE

Centralab Division of Globe-Union, Inc., 900 E. Keefe Avenue, Milwaukee 1, Wisconsin has issued a new reference aid for service technicians.

The "Adashaft Chart" shows the varied shaft and switch cover combinations used for replacement controls. The chart enables the service engineer to select the type and size shaft and switch cover needed for the individual replacement job.

The chart is printed on card stock, covered with a special coating to make it durable. It can be tacked to the wall above or near the service bench.

Requests for copies of the chart should be sent direct to the company.

ARMCO STEEL FOLDER

Armco Steel Corporation of Middletown, Ohio has just published a new folder giving technical data on its paper-thin stainless steel.

Entitled "Paper-Thin Stainless Steel for Light Vital Parts," the new booklet shows where stainless steel, .010 to .001" thick, has been used and outlines its manufacturing advantages.

Complete information is given on how the metal is supplied, along with typical mechanical properties. Of special importance is the description of the company's 17-7 PH thin-gauge strip, which has tensile strength comparable to the best high carbon spring steel.

Copies of the folder are obtainable from the company direct.

TUBE SUBSTITUTIONS

Sylvania Electric Products Inc. performed a much needed service for the industry when it recently released a 40-page booklet on tube substitutions for radio and television.

The manual is arranged in nine sections providing informative text and charts on general tube classifications, circuit modifications in which additional resistors are needed, substitute battery type tubes, substitute 150 ma. tube types, substitute 300 ma. tube types, substitute transformer and auto tube types, substitute TV receiving type tubes, substitute TV picture tubes, and frequently needed change-over diagrams.

Tubes classified in the manual in-

RADIO & TELEVISION NEWS

clude remote cut-off r.f. amplifiers, sharp cut-off r.f. amplifiers, converters, diode detectors, diode-pentodes, diode triode detector-amplifiers, indicators, multi-purpose tubes, duo-triodes, power amplifiers, general purpose rectifiers including voltage doublers, high voltage rectifiers for TV, gas triode and tetrode relays, horizontal TV scanners, vertical TV scanners, high voltage single and duo-triode oscillators, etc.

Copies of this manual may be secured at no charge to those writing to the Advertising Department of the company in Emporium, Pa.

NEEDLE REPLACEMENTS

M. A. Miller Manufacturing Company of 1163 East 43rd Street, Chicago, Illinois is currently offering a copy of its new replacement needle cross reference guide to technicians and others engaged in phono work.

This new simple and convenient guide consists of three easily-read pages with the required data given in tabular form. The material includes the company's replacement number, the manufacturer's name and number, the tip material, radius, and list price. Information on competitors' products is also included to provide as complete a guide as possible.

Manufacturers whose instruments are listed include *Astatic, Webster-Chicago, Webster-Electric, Shure, Electro-Voice, Columbia, Seeburg, RCA, Philco, and Magnavox*. Replacement needle data is given on *Miller, Jensen, Duotone, Recoton, and Walco* units.

AUDIO AMPLIFIER

A data sheet giving complete performance data and other specifications on three of the company's audio amplifiers is now available from *Brook Electronics, Inc.* of 34 DeHart Place, Elizabeth, New Jersey.

This two-color flyer covers the company's Model 12A3, a 10 watt remote control unit; the Model 12A, a 10 watt basic amplifier without controls; and the Model 12A2, a preamplifier and basic amplifier combined on one chassis.

Technicians specializing in custom work and audio enthusiasts will undoubtedly want a copy of this data sheet for their files.

ANTENNA BULLETIN

Andrew Corporation, 363 East 75th St., Chicago 19 is currently offering copies of a new bulletin, No. 38-C, describing the company's folded unipole antenna.

This data sheet carries information on power handling capacity, impedance matching, frequency range, radiation pattern, mechanical features, specifications, and transmission line requirements.

RCA BOOKLET

The Tube Department of *Radio Corporation of America*, Harrison, New Jersey has just issued a revised and enlarged edition of its widely-used booklet entitled "Phototubes, Cathode-Ray, and Special Tubes."

March, 1951

CHECK THESE MONEY-SAVING SURPLUS "BUYS"!

Hundreds Already Sold! Still a Few

WESTON AIRCRAFT METERS

1 Milliampere Zero Center **\$1.95** Ea.

What a buy! FB for field strength meters, grid-dip or tuning meters, beam antenna indicators, vacuum tube volt indicators. Brand new.



DU-1 MANUAL DIRECTION FINDERS

Tunes to broadcast, lighthouse and beacon bands—easy to convert for use on marine bands. True bearing immediately. For use with any loop input receiver. Complete with 2 tube pre-amplifier. Used, good condition.

1000's sold at twice this low price! **\$14.95**

80 METER EXCITER OR 75 METER PHONE RIG

Completely Converted and Ready for Use! These are BC457's converted and retracted to 3-4 Mcps. Dial reads 3.5 to 4 mcs. Complete, ready to add the power supply. Easily a \$25 value. Only a few left! **\$9.95**



READY FOR USE WITH MODULATOR. F.B. for Mobile and Home Station Use. **\$10.95**

POWER SUPPLY KITS for the above transmitter. Complete, nothing else to buy or assemble. Chassis, transformer, sockets, tube, etc. **\$14.95**

10 METER RECEIVER—A BC 454 3-6 MC converted to cover the entire 10 meter band. All brand new, converted by expert technicians at a fraction of the cost. Complete with tuning knob. Just add the power supply and it's the hottest 10 meter receiver you've ever used. Volume control and head phone jack on front panel. **\$16.95**

TRANSFORMER VALUES!

Filament transformers for hi-voltage rectifiers. PRI. 115V 3.75/60 cycle. Sec. 5 V. C/P @ 10 amps. 35 KV R.M.S. Test 12 KV D.C. operating. Uses \$7.24 tubes or others. New **\$9.95**

STANCOR P-4086 FILAMENT TRANSFORMER. Secondary 110-125 volts CT 14 amps. Cased. Heavy duty. 10 KV insulation. **\$3.95**

THERMADOR J-29 FILAMENT TRANSFORMER. Secondary 5 V CT 150 amps. 10 KV insulation. Cased, heavy duty. **\$3.95**

March only! **\$3.95**

SCOPE TRANSFORMERS

THORADSON T17. HERCULES. 115 V. R32. Primary 115 60 cycles primary. V. 60 cycles. Sec. 1800 V. secondary output 2300 V. 2 1/2 Shielded. **\$3.95**

March only! **\$3.95**

THERMADOR SPECIAL TRANSFORMERS

Build for Gov't lab use. All hermetically sealed with glass terminals.

- CS5727. 900, 700 V CT at 150 Ma. 3 filament windings: 6.3-5A, 6.3-5A, 5-4A. Shpg. wt. 20 lbs. **\$3.50**
- CS5728. 860 V 650 CT at 100 ma. 3 filament windings: 6.3-4A, 6.3-4A, 5-2A. Shpg. wt. 14 lbs. **\$3.25**

STANCOR ISOLATION & STEP-DOWN TRANSFORMER

No. P-5065. Primary 220-250 volts. 50-60 cycle. Secondary 110-125 volts, 250-300 watts.

THORADSON T18V22 LINE VOLTAGE REGULATOR. 95, 105, 125 V to 15 V 60 cycle. Complete with cord and plug. 250 VA.

THERMADOR CS 10535 ISOLATION TRANSFORMER. 105, 115, 125 V to 115 V cy-cycles. Complete with cord and plug. 250 VA.

YOUR CHOICE **\$6.69** Ea. BRAND NEW

MARK IX AIRCRAFT COMPASS

White They Last! **\$9.95**

Orig. Gov't cost, approx. \$75. Great for planes, boats, autos. Illuminated with 12 one 2 1/2 V bulbs, but can be changed to cheap 6 V auto bulb without modification. Accurate. Reading-in-alcohol dial reads directly from the front.

EQUIPMENT WANTED!

Need all types aircraft, radio, radar, test equipment. TOP PRICES FOR ARC-1's, R5A/ARN7's, BC-348's, ART-13's. Try us first and be pleasantly surprised!

GRID DIP METER KITS

Sensational Value at **\$7.95** Postpaid in U.S.A.

Selling like hotcakes for home stations, TV technicians, experimenters. Tells you where your equipment is in the radio spectrum. 935 OSTS. Range approx. 3P to 170 mcps. Also ideal for Phone or CW monitor. Harmonic indicator, absorption wavemeter, measures tuned circuits, antennas, etc. FB for TVI checking. Power requirements 6.3 filament, 150 V DC. Easily obtained from your receiver, etc. Complete with instructions on Calibrating Coils, etc.



BEAM MOTORS

With Complete Operating Instructions For Use on 110 V, 60 Cycles

\$3.95 Postpaid in U.S.A.

A wonderful value at this low price. Great little highly geared motors for Television serials and Ham Stations. A 1947 value in 1951! Compare this price anywhere!



SCOPE TRANSFORMERS

THORADSON T17. HERCULES. 115 V. R32. Primary 115 60 cycles primary. V. 60 cycles. Sec. 1800 V. secondary output 2300 V. 2 1/2 Shielded. **\$3.95**

March only! **\$3.95**



Special! CONTACT MIKE ASSEMBLY

A 100-and-1 **\$3.95** Postpaid in U.S.A.

The complete assembly consists of 2 microphones, on-off switch, amplifying transformer, batteries, battery case and connector to attach to any radio. AC, DC or battery portable. Tremendous amplification up to the full volume output of radio or sound system used. FB for watch or clock repair, diesel engine injector adjustment, gas engine diagnosis, or theatrical or musical use.

LOW PRICES ON SCARCE TUBES!

Many May Be Available For Last Time

RK-65	.. \$19.50	5BP7	.. \$.98	8AP1	.. \$8.95
Similar to 4-250		5BP1	.. \$2.50	3BP1	.. 7.95
5CP1	.. 3.95	5BP5	.. \$2.50	3BP5	.. 3.50
5CP5A	.. 3.95	5LP1	.. \$10.50	5BP1	.. 3.50
5CP11	.. 3.95	5LP7	.. \$1.50	4E27	.. 9.95
24C	.. .98	53A Eimac	2.95		

ARR-1 RECEIVERS

Complete with 4 RCA 954 Acorn Tubes (Reg. \$5.65 ea.), Schematic Diagrams and Complete Conversion Information

\$4.95 Postpaid in U.S.A.

Compare this value! Includes the Receiver, 4 tubes, schematic diagrams and a reprint of "A 220 MC CONVERTER FROM THE SUPPLIES R-1 ARR-1" by Leroy W. May, Jrs. (WSAJG), an article from RADIO & TV NEWS, Jan. 1949 issue. Ideal for 50, 144, 220 MC Converters or Preselctors. Also TV boosters. FB for hopping up the SCR-522 Receiver on 2 meters.



TS323/U FREQUENCY METER CASES

Don't miss out on this unusual value—only a few left! See QST, October 1950 issue for construction article regarding these sturdy, useful cases. Brand new **\$3.95** Ea.

\$3.95 Ea.

A Completely Staffed FOREIGN DEPT.

Prompt and efficient service to all Export Inquiries and Orders. Correspondence in all languages. Write "Attn. Foreign Dept. ALVARADIO."

ORDER DIRECT FROM THIS AD!

Prompt, speedy shipment. Cash with order. Minimum order \$3.00. Order deposit on C.O.D. truck shipments by collect. Calif. buyers please add state sales tax. All prep. subject to change. All merchandise subject to prior sale.

ALVARADIO SUPPLY CO.

DEPT. A-11, 341 S. VERMONT, LOS ANGELES 5, CALIF., DuNKirk 8-2211



Hams! Get yer rigs in shape now for possible civilian defense work. Here are some bargains to help you do the job.

TBY WALKIE-TALKIE: VHF Transceiver. 28-80 mc., 4 bands. Voice or MCW, crystal calibration on 130 channels. Unlimited receiving. Approx. 5 W. transmitting. In carrying trunk, complete with vibropack, headset, mike, spare tubes and canvas carrying case. In excel. cond. The whole deal. \$47.50

SCR-610 10-METER FM TRANSCEIVER: Freq. 27-38.9 mc. Compact, semi-portable, for 6, 12, or 24 V. THIS IS IDEAL UNIT FOR CIVIL DEFENSE, fire depts., police, forestry. Comes with power supply, handset, antenna, built-in speaker. ONLY. \$37.50

PE-103 DYNAMOTOR: 6 or 12 V. Input, 500 V. output, with filter base and cords. EXCELLENT FOR RUBBER WORK. Brand new. \$24.95

RUBBER BALLOONS: Get ready to ride the March winds. These expand to 4 ft. Ideal for antennas & signaling. New in cans. Each. \$1.95

BOAT OWNERS, HEAR THIS! HEAR THIS! COLUMBIAN MARINE TRANSMITTER: Kill your transmitter trouble once and for all! Check these outstanding features: 12 or 24 V. optional, 120 W. output rated at 100% modulation, 4-channels, Xtal control on your freq. WILL MATCH ANY ANTENNA! FCC approval guaranteed. Dimensions - 19 1/4 x 16 1/2 x 7 3/4 inches. COMPLETE with dynamotor, cords, mike, tubes, pre-tuned and ready to go. We got it cheap, so we're sellin' it cheap! ONLY. \$249.00

APN-4 INDICATOR: Makes swell foundation for scope. Comes with 5" tube and shield. Put tubes in rack, ideal PPI marine radar. Complete, less tubes and crystal. Excel. cond. New Low Price. \$9.95

1D-59/APA11 COMBINATION TEST OSCILLOSCOPE & PULSE ANALYZER: Gives pulse duration, PR control, 2-8 kc. Sweep freq. range 100-1000 cps. Pulse duration 1-170 microseconds. Has 3BP1 tube, sine wave osc., servo sweep generator, trigger amp., video amp., sweep fine control, trigger gate, video sync. control, sensitivity control, 400 cyc. power supply can be removed with snap-slide fasteners and external power supply made to use same plug assembly. Complete less 2-45N7 tubes. ONLY. \$59.95

ARC-4 VHF TRANSCEIVER: 140-144 mc. Xtal controlled. Xmitr has 832 in final. Modulated by 61.6's. 10 W. output. Has 13-tube receiver. Excel. cond., less dynamotor. Ideal for CAP. \$25.50

RADAR CONTROL BOX: 110 V. latch-type relay. Has a raft of uses. Operates radio, coffee pot, toaster, etc. remotely. \$2.75

GE RELUCTANCE PICK-UP: Only. \$2.50

MICA CAPACITOR: Sangamo type G-1, .0051 mfd @ 4,000 peak v. New in box. ONLY. \$4.95

BC-683 RECEIVER: Freq. 27-39 mc., push-button or manual tuning. FM 300 kc. wide. Easily changed to AM. THIS IS THE FINEST RECEIVER OF ITS TYPE AVAILABLE. Complete with all tubes and dynamotor. Excel. cond. ONLY. \$39.95

14 ASSORTED GOLD BAND RESISTORS: New on card, 20-50,000 ohms. 1/2 and 1/4 watt. \$86 per card.

TS-15 APN SIGNAL GENERATOR: Used with radio-aircraft altimeter for checking and aligning scale. Complete. Excel. cond. \$39.95

MN-26C RECEIVER: Freq. 150-1500 kc. 28 V. with control box, flex. cables, azimuth indicator, loop, and loop cable. Extra hot for aircraft or marine use. Most parts brand new. THIS IS HOT! Only. \$34.95

FIXED WIRE WOUND RESISTORS: 10 watts 25 M ohm, 50 M ohm, 75 M ohm, 100 M ohm. 29c ea. NEW!

ARC-5 OR 274-N TRANSMITTERS COMPLETE
 2-1-3 mcs. Excel. for ship use. \$12.95
 4-5-3 mcs. Used, excel. cond. 3.95
 5-3-7 mcs. Used, excel. cond. Less Xtal. 4.50
 7-9-1 mcs. Used, excel. cond. Less Xtal. 10.95

ARC-5 OR 274-N RECEIVERS
 3-6 mcs., excel. cond. \$ 4.95
 6-9-1 mcs., good cond. 6.95
 100-550 kcs., excel. cond. 12.50
 Command Receiver, 28 V. 7.25
 Command Knobs for Receiver, Ea.69
 MDT/ARC-5 Plate Modulator, Less dyn. 7.95

274N ANTENNA RELAY BOX
 Contains RF meter plus 50 mmfd H. V. vacuum cond. and relay. New in carton. 2.95

SIGNAL LAMP
 Pistol grip. 12 V. 6.6 amp. Use it on your car, or even on yer boat, launch or yacht—you plutocrat! NEW in original box. Only. \$2.50

METERS! THE BEST BUYS IN THE BOOK!
 0-3 VDC 2 in. round, Simpson. \$2.49
 0-15 VAC 3 in. round, Weston or Roller-Smith. 3.29
 0-50 amp. AC 2 in. square, Triplet. 2.99
 0-25 MADC 2 in. round, Weston. 4.50
 0-50 MADC 2 in. square, Simpson. 2.99
 0-1 amp RF 2 in. round, G.E. 2.99
 0-2 amp RF 2 in. round, Thermocouple type. 2.99
 0-9 amp RF 2 in. round, Westinghouse. 2.99
CONTROL UNIT C-58/APT-1 complete with 0-1 mil movement with 0-200 scale. Box contains 2 toggle switches, control knobs, panel light, etc., all for only. 4.50

TUBES! BEST BUYS! LOOK 'EM OVER!
 6AG7 \$2.25 388A \$1.50
 6AC7 2.50 11H4 1.25
 6SN7 1.95 6J5 1.45
 12AT6 1.50 6K6 1.85
 832A 7.50 6AF6 1.25
 3B24 3.75 7EG 1.05

CHEST SETS
TD-1-A: Has F1 carbon capsule in mike, on-off switch, approx. 8 ft. of cord and plug. Excel. for mobile work or home xmtr. New, boxed. \$2.95
GP-7 NAVY TRANSMITTER: 100 W. master osc. type. Covers any freq. from 350-8050 kc. by using proper plug in tuning unit. Type 803 P.A. and built-in 115 V. 400 cyc. power supply using a pair of 1616 receivers. NEW IN ORIGINAL BOX! COMES WITH 7 EXTRA TUNING UNITS AND CONTROL BOX. SPECIAL! \$39.95.

HAMS! HIGHEST PRICES PAID FOR CLEAN EQUIPMENT • TELL US WHAT U HAVE

COLUMBIA ELECTRONIC SALES
 522 South San Pedro Street
 LOS ANGELES 13, CALIFORNIA

Designed for users in industrial, broadcast, experimental, and similar fields, the new booklet provides detailed technical data on more than 150 RCA electron tubes including single-unit, twin-unit, and multiplier phototubes, CR tubes, TV camera tubes, TV monoscopes, low-microphonic tubes, u.h.f. tubes, and other types for special applications.

Technical information, which is arranged in tabular form, includes descriptions, ratings, operating conditions, dimensions, base and envelope connection diagrams, and applications. Many representative types are illustrated. Additional data includes spectral sensitivity curves for all phototubes and information about the characteristics of cathode-ray fluorescent screens.

The booklet, which has been designated CRPS-102-A, is available from RCA tube distributors.

-30-

Ultraviolet Probe

(Continued from page 37)

curing this end of the transmission line to avoid the possibility of r.f. burns to the operator's hand. The bulb of the quartz tube is cushioned in rubber and a large rubber band can be used as a gasket between the bulge of the bulb and the plug which holds the quartz tube inside the inner bakelite tube housing. This use of rubber permits a bit of flexibility which is desirable. Unfortunately, ultraviolet rays cause the rubber to deteriorate and the gasket must be replaced periodically if the unit sees much service. Usually, however, the device is used only a few minutes at a time.

An arc discharge of this kind gives off predominantly rays of the resonance line of mercury, 2537 Angstrom units. This is considered a very effective germicidal and fungicidal ray. At a distance of a few inches from the tube the intensity of the ultraviolet radiation varies from a few hundred to several thousand or more microwatts per square centimeter, depending upon the radio frequency power

applied. Since in most applications it is possible to use the applicator in direct contact with the surface to be treated, the radiation may be very powerful indeed, and great care must be exercised in its use.

Almost any fairly high radio frequency may be used. Frequencies in the band between 27.16 mc. and 27.43 mc. assigned by the FCC to non-communication services are quite satisfactory. A few watts of power is generally enough in most cases. Fig. 3 shows a circuit which can be fabricated into a small package which still puts out considerable power. No power transformer is required. Two 117L7GT's are employed. Their pentode sections are connected as a push-pull Hartley oscillator while the rectifier sections are connected as a voltage doubler. This makes it possible to apply four times the r.f. voltage to the high impedance line that would be the case with the typical straight oscillator and rectifier arrangement. By using the pentodes in push-pull, the r.f. voltage is approximately doubled with a given "B" supply voltage and of course use of the doubler makes this greater too. Blocking condensers C₅ and C₆ are used to keep the d.c. plate supply voltage off of the transmission line. The small trimmer condenser, C₇, is for frequency adjustment. This circuit is not recommended for continuous duty service because the tubes are severely taxed, but for intermittent duty it has proven eminently satisfactory.

The more powerful generator illustrated in the photographs has the circuit of Fig. 4. This is like Fig. 3 in most respects except that a transformer type high voltage power supply is used and two 6V6GT's in push-pull are employed. Also there is an intensity control which varies the r.f. power developed by the oscillator by regulating the screen voltage of the oscillator tubes.

REFERENCES

- Furedy, Frank; U.S. Patent No. 2,300,916
- Atkins, C. E.; U.S. Patent No. 2,439,787
- Atkins, C. E.; U.S. Patent No. 2,447,304
- James, R. F.; U.S. Patent No. 2,258,765
- Floyd, Oscar; U.S. Patent No. 2,326,773

-30-

Fig. 4. Schematic diagram of final unit. Instrument operates in 27.16-27.43 mc. band.

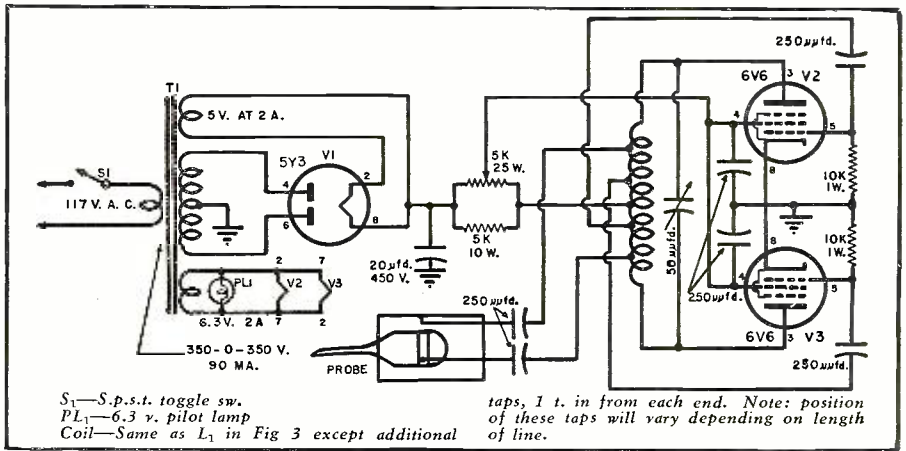

S₁—S.p.s.t. toggle sw.
 PL₁—6.3 v. pilot lamp
 Coil—Same as L₁ in Fig 3 except additional

taps, 1 t. in from each end. Note: position of these taps will vary depending on length of line.

SAVE

THAT GOOD LOOKING OLD CONSOLE—
REPLACE YOUR OBSOLETE RADIO

with a modern, easily installed

ESPEY AM/FM CHASSIS

and your favorite console is "right-up-to-date"

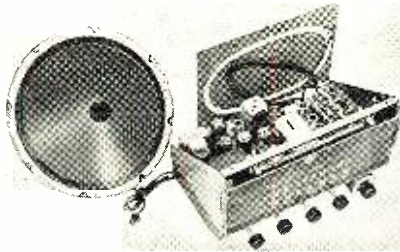

Rated an excellent instrument by America's foremost electronic engineers. Fully licensed under RCA and Hazeltine patents. The photo shows the Espey Model 511-B, supplied ready to play. Equipped with tubes, antenna, speaker, and all necessary hardware for mounting.

NEW FEATURES—Improved Frequency modulation circuit, drift compensated • 12 tubes plus rectifier, electronic tuning eye and pre-amplifier pick-up tubes • 4 dual purpose tubes • High quality AM-FM reception • Push-pull beam power audio output 10 watts • Switch for easy changing to crystal or variable reluctance pick-ups • Multi-tap audio output transformer supplying 4—8—500 ohms.

Makers of fine radios since 1928.

Write for literature RN for complete specifications on Model 511-B and others.

ESPEY TEL. TRafalgar 9-7000
MANUFACTURING COMPANY, INC.
528 EAST 72nd STREET, NEW YORK 21, N. Y.

High score every time with "Safe Centers!"



In Basketball there's no better assurance of victory than a lengthy lad jumping center . . . and there is nothing that scores higher in radio, TV and other electronic circuits than SELETRON miniature rectifiers with "Safe Center" plates.

When you specify SELETRON Selenium Rectifiers you eliminate arc-over danger, short circuits and heating at the center contact point. Assembly pressure, or pressure applied in mounting the rectifier cannot affect its performance—a SELETRON feature accomplished by deactivating the area of the plate under the contact washer.

The millions of SELETRON Selenium Rectifiers in satisfactory service as original equipment in the products of leading manufacturers are millions of reasons why you can specify SELETRON and be safe!

Look for Howard W. Sam's Red Book Supplement listing SELETRON replacements . . . and write for Bulletin No. TN-5



RP RADIO RECEPTOR COMPANY, INC. RP
SELETRON DIVISION
Since 1922 in Radio and Electronics
Factories: 84 North 5th St., Brooklyn 11, N. Y. • Sales Department: 254 West 49th St., New York 11, N. Y.



WALSCO

—in any
climate,
anywhere . . .

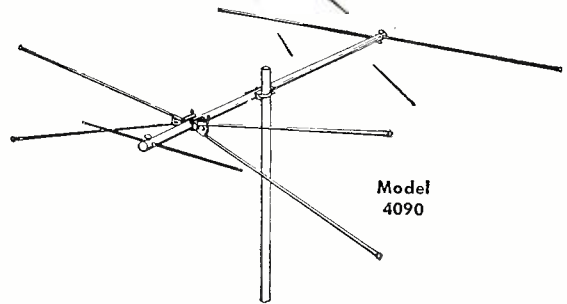

Model 4090

INSTALL IT and FORGET IT

new WALSCO SIGNAL-KING

No fear of costly "call backs" that eat up a dealer or installer's profit. In any climate, anywhere . . . the new WALSCO Signal King antenna provides sharper, clearer response over entire TV spectrum. Rugged aluminum alloy construction for elements, cross-arm and mast. Corrosion resistant. All steel parts are cadmium plated to AN specifications.

NOTHING LIKE IT ANYWHERE . . .

- High gain on all channels—no weak spots. Excellent for fringe areas.
- Entirely new insulator guaranteed unbreakable under all operating conditions. Outstanding and lasting dielectric properties.
- Marine type aluminum alloy elements, reinforced and closed ends.
- Assemble in a jiffy (less than 2 minutes).

Write for Information Bulletin No. 51-N

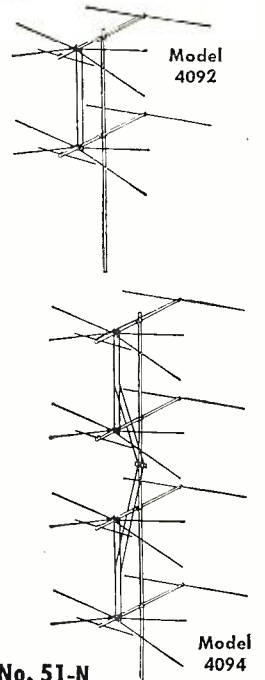

Model 4092

Model 4094

WALTER L. SCHOTT CO. Beverly Hills, Calif. • Chicago 6, Ill.

FOR FINE SPEAKERS
World's Finest
 Reproducer Cabinet
 by **Jensen**



These new Customode Imperial Reproducer Cabinets combine fine acoustic performance with beautiful modern styling and new features for convenience. Speaker is easily, quickly installed or removed from the front. Adjustable Base Reflex port. Optional protective grille assembly furnished. Positive anchor nut attachment of speaker to baffle — no wood screws. Fine mahogany veneer, Blonde or Cordovan finish. Ask for data sheet 161.

Jensen
 MANUFACTURING CO.
 Division of The Moler Company
 6601 SO. LARAMIE, CHICAGO 38

Motor Control
 (Continued from page 35)

to fire later in the positive alternation. The tube fires when the grid voltage (E_g) crosses the control locus. The shaded area again indicates conduction time of the thyatron, which in turn is a measure of the average current supplied by the rectifier. The motor speed is thus controlled by shifting the phase of the a.c. grid voltage. A commonly used phase shifting bridge is shown in Fig. 2.

The direction of a shunt-wound motor may be reversed by reversing either the armature or the field current. Fig. 3 shows the diagram of a speed control circuit including a reversing control. V_1 and V_2 are used in a full-wave, phase controlled rectifier circuit to supply armature current. Control R_1 , which shifts the phase of the grid voltage, varies the speed of the motor. V_3 and V_4 are rectifiers which supply field current. Only one of these tubes is in the circuit at a time, depending upon the position of the switch (S_1). Since V_3 and V_4 are connected "back-to-back," the direction of current through the field windings and consequently the direction of the motor, depends upon which tube is switched into the circuit.

Constant Speed

In some applications, precision grinding and tensile strength testing for instance, it is desired to hold the speed of the motor constant regardless of changes of load. When constant speed is required, the feedback system shown in Fig. 4 is employed. A small

Fig. 2. Phase control. The variable resistor in the phase shifting bridge determines point at which the thyatron fires.

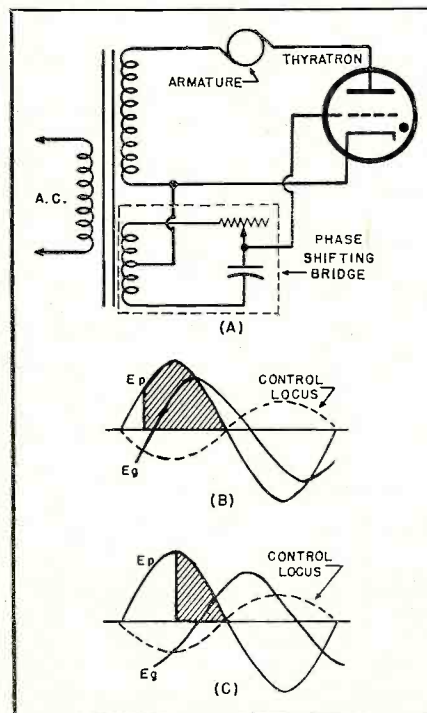

YOU'RE THERE WITH A
PREMAX 75

MOBILE ANTENNA
Center-Loaded Type

A mobile Antenna that'll give you high gain and enable you to work distant stations. This center-loaded Antenna gives 4.5 d.b. optimum with a 2.5 db. over the band average improvement. This adds to the 6 db. basic gain over a straight whip. Each to change bands quickly for 10, 15, 20 and 40 meters. Net price less mount \$9.30. Also available for 2374 CAP, 3105 Airport, 2-3 mc. Marins—plus any spot frequency on request.

PREMAX PRODUCTS
 DIVISION CHISHOLM-RYDER CO., INC.
 5105 HIGHLAND AV., NIAGARA FALLS, N. Y.

The New
GONSET FM
COMMUNICATIONS
TUNER

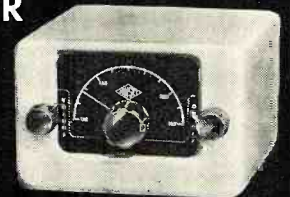

PROVIDES A SENSITIVE RECEIVER
 FOR 2 WAY FM RADIO-TELEPHONE
 COMMUNICATIONS

- Excellent for mobile or fixed operation
- Used with your auto or fixed radio
- Receives police, fire, taxi, etc.
- Compact (5 1/4" x 3 1/2" x 5 1/4")
- High sensitivity
- 5 tubes

\$59.50 net

Models available
 30-40 MC
 40-50 MC
 88-108 MC
 152-162 MC



see your distributor or write direct

GONSET CO., BURBANK, CALIF.

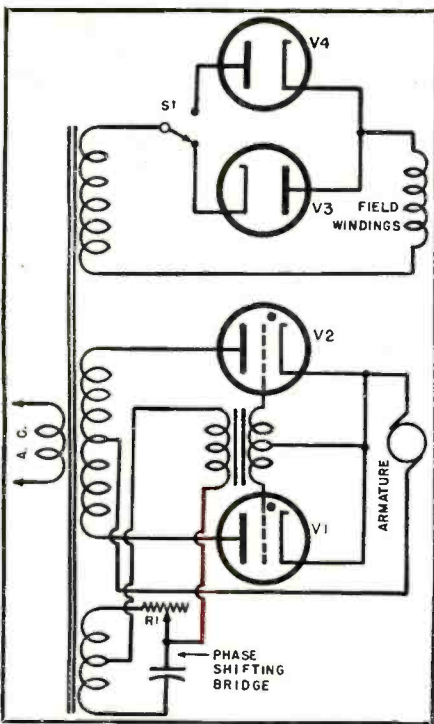

Fig. 3. Speed control circuit. R₁ shifts phase of grid voltage supplied to rectifiers V₁ and V₂ and thus serves as speed control. Switch S₁ is reversing control.

d.c. generator is coupled to the motor whose speed is to be held constant. The output of this generator is fed back to the control grids of the thyatron rectifiers. The result is a magnitude controlled rectifier whose grid bias depends upon the speed of the motor. If the motor tends to slow down, the d.c. output of the generator will be decreased. The decreased bias of the thyatrons will cause these tubes to conduct for a greater portion of the positive alternations. The resulting increase of armature current will increase the motor speed to its original value. If the motor tends to speed, the thyatrons receive a greater bias from the generator. The increased bias reduces the conduction time per cycle of the thyatrons, and the motor slows down to its original speed. This arrangement is capable of holding the motor speed constant to within one-half of one per-cent, from no load to full load.

Edge Alignment and Register Control

After the necessary processing, strips

Fig. 4. Constant speed. Bias voltage on thyatron increases when motor tends to speed and decreases when motor tends to slow down thus equalizing the speed.

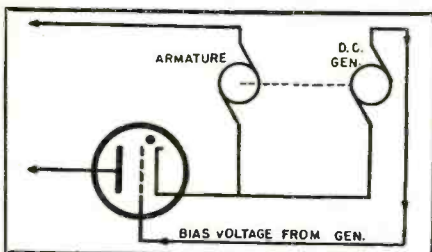

NEW for '51
Automatic Radio
CUSTOM-BUILT
AUTO RADIOS

RECORD SMASHING VALUES!

1949, 1950 and 1951
CHEVROLET RADIOS

1949, 1950 and 1951
PLYMOUTH-DODGE RADIOS

1949, 1950 and 1951
FORD AUTO RADIOS

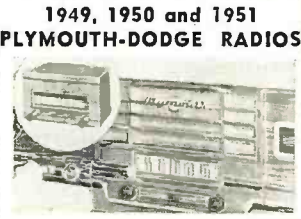

List Price..... \$59.95

CUSTOM-BUILT RADIO

1948-49-50 HUDSON
1951 HENRY J
1949-50-51 STUDEBAKER
List Price..... \$59.95
UNIVERSAL MOUNT
M-90..... \$49.95

List Price..... \$59.95

**ATTRACTIVE DISCOUNTS
TO DEALERS**

List Price..... \$59.95

Each auto radio is specifically designed to fit all 1949 and 1950 cars shown above and all incorporate the same outstanding features. . . Six-tube superheterodyne. Six-volt storage battery operation. Two dual-purpose tubes. Eight-tube performance. Installation in a few minutes. Three-gang tuning condenser and tuned R.F. stage for extreme sensitivity. Permanent magnet dynamic speaker with Powerful Alnico #5 magnet. Low battery drain. Weight 10 lbs.

SPECIAL

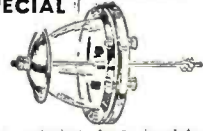

Navy entering tube insulator. Porcelain flanged bowl with brass rod and fittings and aluminum shield. Dimensions: 4 3/8" high, 6 3/16" O. D. at base. . . \$3.95
New Spare Bowl..... .50

CAPACITORS

UPRIGHT MOUNT	PA.	TEN.		
2X.3 MFD	400 VDC	\$.35 \$.30		
5 MFD	500 VDC	.40 .35		
1 MFD	500 VDC	.40 .35		
2X.05 MFD	600 VDC	.40 .35		
25 MFD	600 VDC	.40 .35		
2X.1 MFD	600 VDC	.45 .40		
1 MFD	600 VDC	.45 .40		
40 MFD	600 VDC	.45 .40		
4 MFD	50 VDC	.45 \$.35		
4 MFD	100 VDC	.55 .50		
2X.1 MFD	400 VDC	.50 .45		
3X.1 MFD	400 VDC	.40 .35		
2 MFD	400 VDC	.55 .50		
.05 MFD	600 VDC	.35 .30		
.25 MFD	600 VDC	.40 .35		
.5 MFD	600 VDC	.40 .35		
1 MFD	600 VDC	.40 .35		
1 MFD	1000 VDC	.55 .50		
2 MFD	600 VDC	.45 .40		
4 MFD	600 VDC	1.15 1.10		
8 MFD	600 VDC	1.60 1.55		
15 MFD	600 VDC	2.25 2.20		
1.8 MFD	600 VDC	2.25 2.20		
.5 MFD	1000 VDC	.95 .90		
2 MFD	1000 VDC	1.65 1.60		
1 MFD	2000 VDC	2.90 2.85		
.25 MFD	3000 VDC	2.85 2.80		
.5 MFD	3000 VDC	2.95 2.90		
1 MFD	7500 VDC	7.50 7.05		
1 MFD	7500 VDC	12.50 12.00		
1 MFD	12000 VDC	14.95 14.50		
.0008 MFD	15000 VDC	12.50 12.05		
.045 MFD	16000 VDC	12.95 12.50		
PAPER				
8-8 MFD	600 VDC	\$2.25 \$2.15		
Tobe Filtermats				
3NS MFD	600 VDC	\$2.55 \$2.40		
8-8 MFD	600 VDC	2.00 1.90		
160-160 MFD	150 VDC	5.00 4.25		
ELECTROLYTICS				
2500 MFD	3 VDC	\$.40 \$.35		
500 MFD	12 VDC	.90 .85		
25 MFD	25 VDC	.40 .35		
50 MFD	25 VDC	.60 .55		
1000 MFD	25 VDC	1.25 1.15		
150 MFD	50 VDC	.50 .45		
TRANSFORMERS				
PRIMARYS 115V 60CY				
9V @ 750 MA.	6.3V @ 3.0A. \$3.25		
5V @ 6A.	240V CT. 3.25		
6.6V @ 0.6A.	2000V Ins.	2.60V @ 1.75A.	2700V Ins. 2.75
6.4V @ 10A.	4.3 @ 0.6A 3.45		
660-430V @ 0.8A	CT.	5.0/2.5 @ .8A CT. 3.25	
350-0-350 @ 150 MA.	5V @ .8A.	6.3V @ .4A CT. 4.25	
SPECIALS				
80-86 KC Crystal with Holder \$2.50			
CD-501A Cord Connects IC-634 1.95			
Transceiver to GN-45 Gen. 2.50			
Radio with Redington Gen. 2.50			
Gibson Girl Box Kite 2.25			
17-217-848 Variable Condenser 2.25			
33-440 Mmf Variable Condenser79			
7-100 Mmf Variable Condenser79			
24-750 Mmf Tapered Rotor90			
Plates90			
American Blower and Motor90			
G.E. 1 1/2 HP 115V. 1 Phase90			
60 Cy 1725 RPM.90			
Brand New 24.95			

CHECK THESE VALUES

BC-705 Intermittent Amplifier, ideal for aircraft-booster telephone. New \$ 4.00
MN-26V Radio Compass Receiver, 150-325 KC. 325-695 KC. 3.4-7.0 MGS. 28 volt Bends. Brand new 44.50
RA-10DR Receiver, Beau-Brass, New 39.95
BC-733D Receiver, new, less dynamotor 14.95
Used w/dynamotor 6.95
BC-324 Receiver, n e w, less mtr. 100.00
BC-412 5" Radar Oscilloscope 59.95
RS/ARN-7 Radio Compass Receiver, w/ Lube s, used, excel. cond. 39.95
BC-433G Radio Compass Receiver, used, excel. cond. w/tubes 39.95

TUBES

2C34..... \$0.85	1G29..... \$0.30
2X2/879..... .90	2051..... .95
3C24..... 2.20	7193..... .50
70Y/1203A..... .85	8011..... 2.40
10C1..... .45	3006..... .50
6X4..... .65	6X4..... .65
15R..... .85	CEQ-2..... 1.40
317/44..... .65	CK-70..... 4.25
45 Spec..... 1.40	GH-72..... 1.40
203A..... 5.95	E1148..... .30
218..... 10.00	HY-615..... .40
702B..... 1.40	RT-72..... 3.00
W1-531..... 4.95	RR-73..... .75
702B..... 2.50	VT-137A..... 21.00
45 Spec..... 1.40	VT-58..... 21.00
801A..... .55	3BP1..... 3.45
803..... 4.45	3BP4..... 5.95
804..... 4.95	3BP7..... 1.35
805..... 5.50	1J6G..... .95
806..... .45	3A4..... .60
809..... 23.95	6X4..... .65
CK1005..... .85	6S17..... 1.45
CK1007..... 1.20	33..... .65
1G29..... .95	

RELAYS

6 VDC DPST Contacts 6A Coil \$0.65
12 VDC DPST Allied Control Box 1.25
110 VDC 3 PBT 8 Amp 1.75
24 VDC Solenoid. Operates 2 Switchettes80
40 MFD DPST-SFDT 1000 Ohm 3.65
110 VAC DPST 1 Amp Contacts Strth's Dum CNA 3.65
110 VAC DPST 25 Amp Contacts Ward Leonard 3.95
115 VAC DPST Strth's Dum CNA-2997 3.65
230 VDC DPST Strth's Dum CNA122 4.50

Ceramic Rotary Switches

Pole Position	Section	Shaft	Price
2	3	7/8"	\$0.50
2	4	1"	.50
2	8	2 1/2"	.55
4	10	3 1/4"	.50
4	12	2 1/4"	.55
2	8	2 3/8"	2.50
Flash Over			
2 Pole 2 Circuit G Cant40
W/knob40
DPST Toggle Switch 3A 250V35

TRANSMITTING MICA

.065 MFD	1800 VDC \$ 0.65
.080 MFD	2000 VDC65
.095 MFD	2000 VDC65
.02 MFD	3000 VDC 1.20
.040 MFD	3500 VDC 1.15
.0025 MFD	2500 VDC 2.60
.00175 MFD	5000 VDC 2.75
.002 MFD	5000 VDC 3.50
.001 MFD	6000 VDC 3.50
.002 MFD	5000 VDC 7.50
.0002 MFD	6000 VDC 9.50
.0012 MFD	20,000 VDC 32.50

VALUES

De-Ion Line Starter DPST \$6.95
115V 60 Cy 15A West. New \$6.95
Genuine Upright Desk Telephone and Ringing Box 4.95
1 Micro Second Delay Line 15 KVA 400 Cy 50 Ohm 24.95
CD-1-23 Conductor Cable90

TERMS: Minimum order \$5.00—Mail orders promptly filled—All prices F.O.B. Boston, Mass. Send M.O. or check. Shipping charges sent C.O.D. 25% deposit required with all C.O.D. orders.

Prices Subject to Change without Notice
SEND FOR OUR CATALOGUE
Inquiries from Dealers, Schools and Industrial Firms Invited

COMET ELECTRONIC SALES CO.

22 Washington St. • BEacon 2-7863 • Brighton 35, Mass.

RCP INSTRUMENT KITS

Easy-to-Build

MORE THAN 150,000 RCP INSTRUMENTS
IN USE TODAY—PROVE THEIR SUPERIORITY

NOW!

You can get in kit form the best professional test equipment! Made by Radio City Products, one of the outstanding manufacturers of test instruments for 18 years. You get kits that are complete with all necessary parts and easy-to-follow assembly instructions. There is nothing else to buy! Yes, an RCP kit provides an enjoyable few hours in instruction and construction plus a finished test instrument at a tremendous saving!



MODEL 345K SUPER VACUUM TUBE VOLTMETER

Features long scale 4 1/2" meter in burn-out proof meter circuit—electronic balanced bridge type push-pull circuit—negligible current drawn due to high input impedance of 25 megohms—Isolation Probe—center of ohm scale 10 ohms—5 ohmmeter ranges reading from 2 ohms to 1 billion ohms (1000 megohms). 20 voltage ranges 0-1000 volts including AC and DC—Complete D.B. meter. Discriminator alignment scale with zero center permitting operation in both directions. Operates on 105-130 volts, 50-70 cycles—Extra heavy panel, case and chassis. Size 10"x6"x5". Weight 3 1/4 lbs. Shipping weight 11 lbs. **\$25⁹⁵**
MODEL 345K KIT COMPLETE.....

MODEL 322AK TUBE TESTER KIT

Fully engineered to test all recently developed tubes and television types. Has provisions for checking individual sections of multi-purpose tubes as well as miniature and subminiature receiving tubes. Jack for head-phone noise test to check noisy swinging or high resistance internal tube connections. Neon lamp for rapid short and leakage tests between elements. **\$27⁹⁵**
KIT MODEL 322 AK, only.....

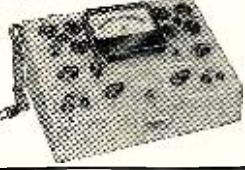

MODEL 447BK MULTI-TESTER KIT

3" square D'Arsonval meter, DC Voltmeter: 0-5-50-250-2500 Volts at 100 Ohm per Volt. AC Voltmeter: 0-10-100-500-1000 Volts. Output Voltmeter: 0-10-100-500-1000 Volts. DC Milliammeter: 0-1-10-1000 MA. DC Ammeter: 0-1-10 Amperes. Ohmmeter: 0-10,000 Ohms—1 Megohm—10 Megohms Ext. Decibel Meter: -8 to +55 decibels. Complete with batteries. **\$13⁹⁵**
Available at Your Distributor.
Insist on RCP Instruments. Write for Catalog RN-3

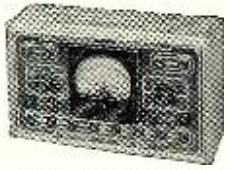

RADIO CITY PRODUCTS CO., INC.

152 WEST 25th ST — NEW YORK 1, N. Y.



FREE! Just For Examining **COYNE'S** New 5-Volume Set **APPLIED PRACTICAL RADIO-TELEVISION**

Get this Book of TV, P.I.C., TUBE PATTERNS, TERN'S, WAVE FORMS, FILE. Gives you dozens of actual TV Test Patterns and wave forms—tells how to use them to shoot trouble and repair TV sets quicker... easier. Money-making short cuts that help you get ahead in Television. It's yours FREE!

Complete Practical... Up-to-Date!
This book is our gift to you for examining Coyne's brand new 5-volume set APPLIED PRACTICAL RADIO-TELEVISION. Here is the most completely up-to-date set of reference books in America! 1500 easy-to-understand pages; 1000 illustrations. Covers all phases of radio and television. Tells you how to install, service trouble shoot, align all types of radio and television sets. "Break-down" photos help you understand quicker.

Sensational Free Book Offer
Send No Money!
Mail coupon now to get this great new 5 volume set and the FREE Book of Picture Patterns. Use the set 7 days. If you keep the set, pay just \$3.00 after 7 days and \$9.00 a month until \$16.50 plus postage is paid. (Cash price \$15.00.) If not 100% satisfied with set send it back and owe us nothing. EITHER WAY THE BOOK ON TV PICTURE PATTERNS IS YOURS FREE. Coupon is just a request to see set and get Free book of picture patterns. This offer is limited. ACT NOW!

FREE ON 7 DAYS TRIAL

STAY ON THE AIR WHEN POWER FAILS...with an ONAN Electric Plant



AUTOMATIC START & STOP

Model 10EL, 10KW A.C.

When storms, floods, or fires interrupt electricity and force you off the air, you lose listeners and income. Guard against loss, assure vital public service during emergencies by installing an Onan Electric Plant. Onan Standby Electric plants serve many network and private stations. Automatic models to 35,000 watts.

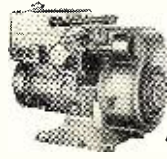

PORTABLE ELECTRIC PLANTS FOR MOBILE RADIO USES
Supply A.C. power for broadcasting at scene of events. Can be carried by hand or in trunk of car. Weigh as little as 80 pounds. A.C. models 350 to 35,000 watts.

Write for **FREE Folder**



D. W. ONAN & SONS INC.
4812 Royalston Avenue
Minneapolis 5, Minnesota

of fabric, steel, and other materials are wound on reels. It is desirable, of course, that the resulting coil of material have smooth ends, that is, each layer should be directly over the one below it. A phototube "watches" the edges of the material as it winds up on the reel. If the material tends to move either right or left, the phototube circuit controls a motor which moves the entire reel in the required direction to assure edge alignment.

Register control is another application in which a phototube controls a motor. Package labels, for instance, are first printed on a continuous roll and then cut into individual labels. A series of small marks on the roll is scanned by a phototube to assure that the blade cuts between the labels and not through them. If the roll is advanced too far or too little in relation to the cutting blade, the phototube supplies this information to a motor. The motor then moves either the roll or the blade into correct cutting position. —50—

NEW CBS COLORSET

THE Columbia Broadcasting System recently unveiled a new direct-view color television receiver which measures only 34 inches by 27 inches and features a 17 inch rectangular tube.

No magnifying lens is used with this new set and the receiver employs a color drum which rotates around the axis of the tube, replacing the whirling disc in front of the tube face as was the case with earlier models.

According to Dr. Peter C. Goldmark, vice-president in charge of Engineering Research and Development for CBS, this same system can also be employed with a 20 inch tube.

The compactness of this new receiver has been achieved by placing the receiving tube inside the filter drum, the diameter of which is only slightly larger than the length of the tube, and whose width is approximately the tube's width.

The color drum was originally developed by Dr. Goldmark and his CBS laboratory associates in 1941 and was recently perfected. —50—

Over-all view of CBS' recently-introduced colorset which uses a revolving drum.



RADIO & TELEVISION NEWS

Audio System

(Continued from page 42)

3 1/4 inches high, and 6 1/2 inches deep, including the knobs, and is finished in brown hammer with gold lettering. Decorative mahogany end blocks complete the unit for table-top or similar mounting; for mounting in a cabinet, they are removable, reducing the length by 1 1/2 inches. All cables and controls which can be dealt with once and then forgotten are located on the rear of the control unit. These include input and output cables, level-set potentiometers, phono turnover switch, and compensation cut-out switch. The front panel carries only volume and tone controls, selector switch (which shorts out the unused channels to minimize annoying feed-through), and cut-off switch. The latter has four positions; "wide open," "8 kc. cut-off," "5 kc. cut-off," and "3 kc. cut-off" (for very worn records).

A simpler version of this control unit, supplied as part of the S-20 System, is also available. Using only one 12AX7, and reduced feedback in the A-20 Basic Amplifier, its tone controls have somewhat less range and the flexibility is not quite as great. A recorder output jack is included, although a Noise Suppressor cannot be connected as conveniently as in the C-5 Control Unit. The sharp cut-off filter is connected only on the phonograph (where it is needed most)—the inductance of the magnetic cartridge is used as the filter inductance. Signal-to-hum ratio and frequency response are similar to the A-20-5 System; appearance is identical.

-50-

Harmonic distortion as a function of power output for A-20 amplifier. Measurements were made at 1000 cycles. The curves at 50 and 10,000 cycles are of the same shape but with somewhat higher distortion.

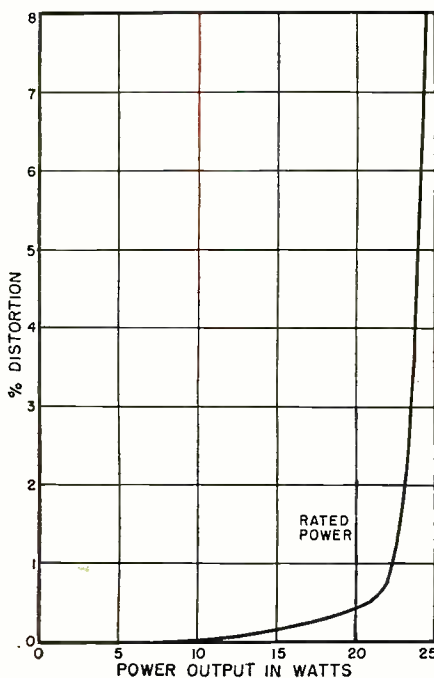

March, 1951

Real values on hard-to-obtain items

"S" METER . . . An outstanding buy!



Here is a beautiful instrument exactly suited for use as an "S" meter. Illuminated face, (supplied with miniature lamp) with a full-scale reading of 5 ma, a standard value for most "S" meter circuits. Diameter across face is 2 3/8", black bakelite case, reverse-set pointer. New, surplus . . . limited quantity. Only . . . \$1.95 ea.

836 hi-vacuum rectifiers. 2 for . . . \$1.50

TRANSFORMERS-CHOKES:

2.5V, 10A. 10KV insulation. Suitable for 866, 836, etc. Reduced to \$3.39 ea.

10H, 200 ma choke. Hermetically-sealed steel case. Also has hum-bucking tap. A beautiful item only \$1.98.

10H, 50 ma choke. Strap mounting. Handy for dozens of applications. Reg. 98c, reduced to 65c. Charger or fl. trans. Pri. 110V, 60 cycle. Secondary, 9-10-11-12-13 volts @ 1.2 A. Fully cased. A buy at \$1.49.

Vibrator transformer. 6V inp. Secondary 345-0-345 @ 150 ma. Also has bias winding. Fully cased. Bargain at \$1.49 ea.

Power transformer. 780V. CT @ 200 ma. 2.5V at 8a. 5V at 8a. 6.3V at 6A. Pri. 115V, 60cy. AC. Has electrostatic shield. Upright mount. Shipping weight 11 lbs. Only \$4.95.

Power transf. Pri. 115V, AC, 60 cy. Sec. 520-0-520 @ 200 ma. . . . \$5.25 ea.

Power transf. Pri. 115V, 60 cy. AC. Sec. 310-0-310 at 50 ma. Cased, upright mount. . . . \$1.95 ea.

Output transf. 50L6 to voice coil. . . . 79c ea.

Choke, 6 henry, 200 ma. Strap mtg. . . . \$1.95 ea.

HS-16 phones. Used, with headband and 6' cord. A hot buy at . . . 98c

RCA Hand Mike. Hi-grade, single button. Bronze colored w/cord and plug. NEW. Were \$1.98, now reduced to 98c ea.

TELEPHONE EQUIPMENT:

EES9 Repeaters (see previous ads). Only a few left. NEW! Regularly \$9.95 ea. . . . now \$6.95 ea.

T5-10 Sound powered handsets. A limited quantity only. BRAND NEW! . . . \$25.95 pair

Handset hanger. Beautiful cast aluminum shell finished in black wrinkle. Takes all makes and models. An extremely useful, well-made item only \$1.95 ea.

STORAGE BATTERIES:

2 volt. Willard. Dry packed. Very special at \$1.19 ea.

36 volt storage bat. Consists of 18, 2V units in sturdy case. Here is really a bargain! Only \$17.95.

RECEIVERS:

SCR-522 Receiver. Used, good condition. With tubes \$14.85 ea.

LOW FREQUENCY CRYSTALS

Precise units in holders. Ideal for oscillators as markers, BFO, etc. Can also be used as resonators for crystal filters. 450, 453.70, 457.4, 464.81, 466.66, 468.51, Freq. in KC. These are an excellent buy at only. . . . 89c ea.

CRYSTAL SETS FOR SSSB FILTERS

Three crystals, 450, 451.85, 453.7 kc. See QST, Nov. 1950, page 11. Set of three. . . . \$2.60 set.

SPECIAL PLUGS & CONNECTORS

RS-ARNS. Two special plugs. . . . \$1.00 set

PL-Q103 for BC-343—new. . . . 75c ea.

PL-58 fits into EE-8 telephones and many switchboards—new . . . 30c ea.

PL-106 fits RM-14 telephones and others—new . . . 45c ea.

8 pr. Female. Fits SCR-284 equip. . . . 35c ea.

CONDENSER TESTER

• One of our best sellers! Useful, versatile laboratory item, in kit form. Simple, and easy to build in less than an hour. Checks condenser leakage and continuity up to 8 megs. Will test any paper, electrolytic, mica or oil capacitor from 50 mmf. to 50 mfd. Self-contained power supply and neon bulb indicator with socket and bezel. Drilled metal cabinet. Complete instructions and diagrams included with each kit. Only \$4.85.



THE WELL-KNOWN "Q5'er"!

Special purchase on this outstanding unit. Frequency range 190 to 550 kc. 85 kc I.F. Complete with full tube complement.

Used, good condition. . . . only \$10.95 ea.

New . . . only \$12.95 ea.

R-23-ARC/5. Identical receiver to above except has switch to change from antenna to direction finding loop. Makes a wonderful L.F. direction finder. With tubes.

Used, good condition. . . . only \$10.95 ea.

New . . . only \$12.95 ea.

GRAIN-OF-WHEAT LAMPS

The smallest of the small. Overall, 5/8", diam. 3/16". Operates on 3 volts. Wonderful for receivers, models, etc. . . . only \$.15 ea.

12 for \$1.50

DOUBLE-POTS

Carbon, small size, two-gang. Made by A-B. One section, 12,000 ohms, one section 22,000 ohms. A buy at. . . . \$.50 ea.

15 OHM RHEOSTATS

Rated at 25 watts. Ohmite Type "H". . . . Only \$.50 ea.

SCOPE COMBO OFFER

The makings for an excellent scope. Includes: 1-5NP1 C-R tube, transformer for hi-voltage and fl. for 2X2 rectifier, circuit diagram, only \$7.95

FL-8 Filters, New . . . only 98c ea.

ULTRA-VIOLET LIGHT SOURCE

FOR TELEVISION AND C/R TUBE EXAMINATION

O-R now presents . . . new . . . an 8-watt, ultra-violet, "black-light" source! Here is a highly effective and time saving device for checking burn spots and other defects in phosphors of C/R tubes. C/R tube face fluoresces when exposed to this special black-light to give visual indication of condition of phosphor. Reflected light from C/R tube face is negligible and tube does not have to be in operation. An invaluable device for TV service shops, schools, laboratories. Also used in medical, chemical, foods, stamps, criminology . . . a thousand uses.

In kit form including Sylvania 8 watt, black-light tube, ballast, starter, mounting panel, tube clips, reflector line cord/plug, hardware, instructions. Simple shadow box for outer housing is easily made.

Complete kit (less outer housing) . . . only \$4.95

NEW! PORTABLE GEIGER COUNTER

A small light-weight unit (2 pounds), with a sensitivity that compares favorably with instruments many times its purchase price. Rugged and dependable and intended for professional use. Batteries used provide long life and low replacement cost. Each Geiger counter comes complete ready for use with instructions and radio-active ore sample for comparison tests. . . . \$35.00

TU-10 B TUNING UNITS

The best of the BC-375 tuning units. Has three, transmitting type variables, H.V. micas, RF chokes, Velvet Vernier tuning dials, worm-gear reduction. Really a wonderful source of excellent components . . . only \$1.75 ea.

VACUUM TUBE SPECIALS

8012 . . . UHF triode . . . \$1.50 ea.

WE-717A 1.00 ea.

WE-316A . . . Trans. doorknob 75c ea.

WE-388A . . . Large doorknob 1.00 ea.

815 . . . twin-beam tet. 2.50 ea.

6L6 . . . metal 2.25 ea.

6L6G 1.95 ea.

6L6GA 1.95 ea.

1636 . . . VHF converter. 1.00 ea.

LOOK! NO HANDS!

This mike leaves both hands free for mobile QSO's. Fastens to operator by simple snap strap. Western Electric button assures best quality obtainable from any carbon mike. Adjustable. Double action sw. operates push-to-talk or holds on. BRAND NEW only \$1.75 ea. POSTPAID in U.S.A. and CANADA.

MINIMUM ORDER \$2.00. ALL ITEMS SUBJECT TO PRIOR SALE.

ALL PRICES SUBJECT TO CHANGE WITHOUT NOTICE.

20% DEPOSIT MUST ACCOMPANY ALL ORDERS, BALANCE C.O.D.

OFFENBACH & REIMUS CO.

372 ELLIS ST.

SAN FRANCISCO, CALIF.

PHONE ORway 3-8551

Insist on
VEE-D-X

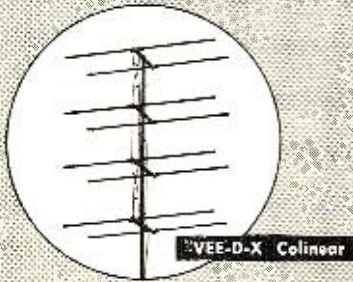

VEE-D-X Colinear

THE WORLD'S



VEE-D-X Stacked Yagi

MOST POWERFUL



VEE-D-X Yagi

T V ANTENNAS

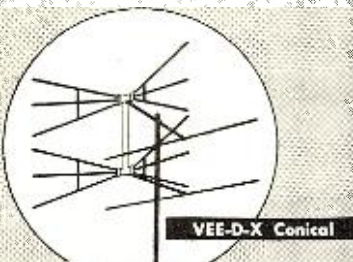

VEE-D-X Conical

LaPOINTE-PLASCOMOLD CORP. 10
WINDSOR LOCKS, CONN.

Please send me new 1951 catalog of VEE-D-X antennas and accessories.

NAME.....
STREET.....
CITY.....ZONE.....STATE.....

MARS

**Station
of the Month**

MARS BEAMS WEEKLY BROADCASTS

MARS—Army Headquarters station, WAR, located at the Pentagon Building, Washington, D. C., broadcasts a weekly message each Tuesday at 0100Z and at 0400Z. (This is Monday at 8 p.m. and 11 p.m., Eastern Standard Time; Monday at 7 p.m. and 10 p.m., Central Standard Time; Monday at 6 p.m. and 9 p.m., Mountain Standard Time; and Monday at 5 p.m. and 8 p.m., Pacific Standard Time.)

Simultaneous broadcasts are made on frequencies 3497.5 kc., 6997.5 kc., 14,405 kc., and 20,994 kc. Each message is sent three times, once at 10 words per minute, once at 15 words per minute, and once at a higher rate of speed—usually 20 words per minute.

Designed especially to transmit quasi-official traffic and training information to MARS members, the broadcast offers an excellent opportunity for all amateurs to build up their code proficiency.

WHEN you are an airman, thousands of miles from home, performing military service at an island base clear across the Pacific Ocean from your homeland, it is sometimes difficult to avoid an occasional pang of homesickness. Morale is no longer just a word; it is a way of life. Mail call is a highlight of the day's activity, and a radiogram assumes the proportions of a major event.

And the Military Amateur Radio System sees to it that there are a lot of major events for the boys at Andersen Air Force Base. The outstanding job of morale-building which the Andersen Air Force Base amateur club has done earns for Station AI4AF/KG6FAA the title of MARS Station of the Month, according to Captain Charles C. Mack, Chief of MARS-Air Force.

Andersen is located on the Island of

Guam, the strategic importance of which was recently indicated when Guam based planes were actively engaged in combat missions in support of the Republic of Korea.

AI4AF is the club station for the AFB Amateur Radio Club. Officer in Charge of the organization is Second Lieutenant Clement R. Coggins of Milwaukee, an amateur for 16 years, and AI4AF custodian.

President of the club is Master Sergeant Henry L. Kent of Columbus, Georgia, a radio mechanic. Captain Herbert B. Berk of New York City is vice-president and Master Sergeant Lomax G. Sawyer, a Tarheel from Aydelett, North Carolina, is chief operator.

KG6FAA is a key link in the Far East amateur relay network. The boys had all available operators working like mad to handle all the personal message and greeting traffic which

Present at the first meeting of the MARS Club, Andersen Air Force Base, Guam, were: First row—Sgt. G. F. Wagner; 2nd. Lt. C. R. Coggins, W4MXU; 1st. Lt. F. R. Williams, W6ULE; Corp. D. J. Endrizal; Corp. J. E. Micala. Second row—PFC. G. H. McNally; S/Sgt. J. Wilson; Sgt. H. G. Wiechman; PFC. C. B. Pollard. Third row—Capt. H. B. Berk; PFC. R. G. Wright; T/Sgt. J. T. Murphy, W0AST; M/Sgt. L. G. Sawyer, W4OWS; S/Sgt. D. G. McGwinn, W0BCL; M/Sgt. H. L. Kent, W4OBK; Corp. A. J. Nilges.



poured in for the Christmas and New Year season. The W6's and the KH6's have learned that traffic for delivery in Guam, or for relay to Philippines and Japan is always accepted and expedited by Andersen Air Force Base.

-50-

Horizontal Pulling
(Continued from page 63)

(phasing), and uniform duration. (The horizontal sync pulses that occur during the vertical equalizing and sync interval have different duration but normally this difference is wiped out through differentiating action.)

Any trouble in the r.f., i.f., or video amplifier that acts to reduce the amplitude of sync, bringing it closer to the blanking and picture level, will make it difficult or impossible for the sync separator to function properly and may result in horizontal picture pulling or complete loss of sync.

In this connection, there are two principal troubles to watch for in the r.f., i.f., and video amplifiers:

1. *Poor low-frequency response.* The sync pulses represent relatively low-frequency signals. Inadequate low-frequency response in the r.f., i.f., or video amplifiers can reduce the amplitude of sync in comparison with the higher-frequency picture signals. The usual reason for poor low-frequency response in the r.f. and i.f. amplifiers is incorrect alignment with the picture carrier too low on the slope of the response curve. An example of picture pulling caused by incorrect alignment is shown in Fig. 7.

The usual reasons for poor low-frequency response in the video amplifier are:

(a) The resistance of a load resistor may have dropped appreciably below the specified value, due possibly to over-heating resulting from a short in a tube.

(b) A coupling condenser may have

Fig. 9. In this example, sync signals are completely wiped out or reduced to blanking level by undesired limiting action in video amplifier. Trouble is caused by low plate voltage on 2nd video tube. Same condition can result from excessive signal input to video amplifier, or incorrect bias and other troubles in video amplifier. There is horizontal pulling at top and bottom of picture and sync is extremely unstable. With complete absence of sync, vertical and horizontal oscillators may tend to sync on leading edge of blanking signal.



**SCR-27N
COMMAND and ARC-5
EQUIPMENT**

	USED	NEW
BC-453-190 to 550 KC	\$12.95	
BC-454-3 to 6 MC	6.95	
BC-455-6 to 9 MC	6.95	
R-23-ARC 5-190-550 KC		\$21.95
RECEIVERS		
BC-457-1 to 5.3 MC	5.95	
BC-458-5.3 to 7 MC	5.95	8.95
BC-606-3 to 4 MC	14.95	24.95
T-19-ARC 5-3 to 4 MC		24.95
BC-459-7 to 9.1 MC	12.95	24.95
T-22-ARC 5-7 to 9.1 MC	12.95	24.95
ADDITIONAL EQUIPMENT		
BC-458 Modulator	2.25	3.25
BC-450 Control Box (3 Receiver)		1.95
BC-451 Control Box (Transmitter)		.89
BC-442 Relay Unit (ANT)	1.95	2.95
Plugs: PL-147, 148, 151, 152, 153, 154, 156—EACH		.75
Flexible Shafting with gear to fit Receiver		1.69
3 Receiver Rack	2.25	
2 Transmitter Rack	1.69	

BEACON RECEIVER BC-1206-C
Manufactured by Satchell-Carlson
Frequency Range—195 KC to 420 KC, 1F Frequency—135 KC Receiver Sensitivity—3 Microvolts for 10 Milliwatts output. Output Impedance—200 Ohms and 4000 Ohms to be selected internally. Power Output—230 Milliwatts, Volume Control—RF Gain Control, Power Supply—24-28 Volts Aeroplane Battery. Current—.75 Amperes.
\$7.95
BRAND NEW—ONLY

BC-223 TRANSMITTER
A 30 watt Transmitter, ideal for ship-to-shore or Ham Rig. Crystal or MO control on four pre-selected channels. 2000 to 5250 KC. Use of 3 plug-in coils, five tubes: 2-801 and 3-46, and TU 17-18-25 tuning units.
TRANSMITTER \$25.95
TUBES 3.75
TUNING UNITS 2.25 ea.
PE-125 VIBRATOR POWER SUPPLY FOR BC-223 \$18.95

BC-746 TUNING UNIT
Plug-in transmitter tuning unit from Army Walkie-Talkie. Contains antenna and tank coils, tuning condenser, transmitting and receiving crystals. Ideal transmitter foundation.
\$1.29
ONLY

PRE-AMPLIFIER MODEL K-1
The K-1 is used to amplify output level for microphones and phonographs. Operates on 24-28 VDC, can be converted to 110 AC. Comes complete with PL 55 plug and 2 foot 119-B cord, 2 terminal blocks and instruction book.
BRAND NEW SPECIAL **\$3.95**

MINIMUM ORDER \$2.00
Immediate Delivery—Send 25% deposit on C.O.D. orders. All shipments F.O.B., N.Y.C. (N.Y.C. residents add sales tax to your remittance.)

LOOK! PLATT'S PULLING 'EM OUT OF HIS HAT FOR EASTER!

Just check PLATT'S BARGAIN PRICES and see for yourself. So why not make it a point RIGHT NOW to order by mail or stop in at PLATT'S BIG RETAIL STORE at 489 BROOME ST., N. Y. C.

TURBO AMPLIFIER
4 tube Amplifier used by U.S. Air Force. 115 V. input at 400 cye. Without tubes—BRAND NEW \$1.49

HEADSETS
HS-33 low impedance with cord and plug, used, fine condition \$1.59
HS-23 high impedance, BRAND NEW with ear pads 3.25
HS-33 low impedance, BRAND NEW with ear pads, cord and PL54 plug 3.50
TH-37A—1200 ohms with dual plugs 2.95
HS-16 high impedance with cord and pin plugs, BRAND NEW 1.95
HS-30 with ear plugs, low impedance, used, good condition 1.29

Control Box BC-434-A Used with Radio Com- p a s s receiver R5-A R N - 7, Be a d i x ADF Equipment Only **\$1.95**
Control Box BC-648-A Excellent condition. Made by Westing-house. Terrific value! Only **\$3.29**

BC-461 CONTROL BOX
Used for RL-42 Ant. Reel. Has Veeder-Root control with "0" reset adjustment and multi-switch to control RL-42 which is reversible. ONLY **95c**

BC-1255 MONITOR
A battery-operated receiver, 75-150 MC range. Used as monitor in operation and calibration of radio transmitters. BRAND NEW **\$14.95**

Mallory NF1-7 RADIO NOISE FILTER
Can be adapted for many uses 89c

ARMY TEST UNIT 1-236
Meter is contained in a metal box 5 1/2" long x 3 3/4" wide x 3 1/4" deep. Comes complete with test leads and instruction book. Can be used for testing between AC & DC measuring resistances of circuits, checking fuses, and testing capacitors. ONLY **\$7.95**

RADIO RECEIVER BC-1023-A and MOUNTING FT-161
UIHF aircraft receiver with frequency range from 62 to 80 MCS for receiving 75 MC marker beacon signals BRAND NEW! **\$7.95**

SPECIAL!! A BUNDLE OF KITS
Unfortunately space does not allow us to list all the individual parts of these sensational kits, but take Platt's word—they're value-packed!
1 Kit of 25 assorted metal and plastic ESCUTCHEON PLATES \$2.49
1 Kit of 25 assorted DIAL FACES, finished in various stages and used on present high priced broadcast receivers. (Can be used with above kit) 2.79
1 Kit of 100 assorted RADIO KNOBS—push-on, screw-on, pointer-type, long neck 3.89
1 Kit of 12 assorted SWITCHES—many uses: TV, electrical, circuit breakers, wafers, etc. 3.49
1 Kit of 25 assorted COILS AND CHOKES—IFs, antenna, broadcast and short wave 1.79

PLATT ELECTRONICS CORP.
DEPT. A, 489 BROOME ST., NEW YORK 13, N. Y.
PHONES: RE 2-8177 and WO 4-2915



ENTER RADIO-TV NOW thru this Proven Plan

As a young man with a career to build, you may today be interested primarily in training for Radio — and perhaps for TV. But — *who knows* . . . you may some day have both the desire and opportunity to climb further and become an Electrical Engineer! Here, then, is a world-renowned educational plan that permits you to use your Radio training as a major stepping-stone to an even greater career.

IN 12 MONTHS BECOME A RADIO TECHNICIAN

Train here for radio shop operator or serviceman, mobile receivers and all types of transmitters, and for supervision of service personnel. You may then advance immediately, or at any future date, into courses described below.

IN 6 ADDITIONAL MONTHS you become a Radio-Television Technician

An additional 6-months course gives you intensive TV Technician's training — under the *personal guidance* so necessary in this expanding field.

ALSO...YOUR RADIO COURSE IS FULL CREDIT TOWARD THE B.S. DEGREE IN ELECTRICAL ENGINEERING

The Radio course, while complete in itself, is *one-third* of the college program (major in Electronics). Further — you are guided scientifically toward specialization beyond basic engineering training.

Military, practical or prior academic training evaluated for advanced credit. Preparatory courses available. Over 1500 enrolled. Terms open April, July, October, January.

MILWAUKEE SCHOOL of ENGINEERING

Technical Institute • College of Electrical Engineering

FREE—Write for "Occupational Guidance Manual" and 1951 Catalog.

MILWAUKEE SCHOOL OF ENGINEERING
Dept. RN-351, N. Broadway
Milwaukee, Wis.

Without obligation, mail Occupational Guidance Manual on:

- Radio-TV Electrical Power Welding
 Heating, Refrigeration, Air Conditioning
Also send 1951 Catalog for Electrical Engineering, B.S. degree in Electric Power Electronics

Name.....Age.....

Address.....

City.....Zone...State.....

Check if World War II Veteran

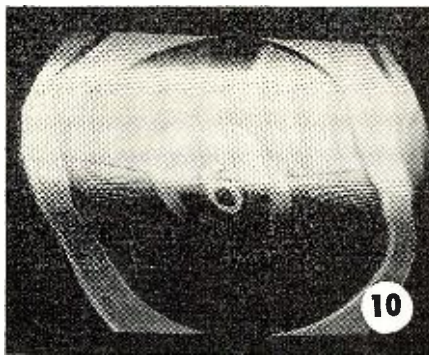

Fig. 10. Horizontal pulling, accompanied by darkening of half of picture, caused by heater-cathode leakage (60 cycles) in the r.f., i.f., or video amplifiers. There is no variation in width of raster. Pulling in picture is result of 60 cycle variation in horizontal sync phasing. This illustration is not covered in the text.

opened or may have decreased radically in capacitance value.

2. *Undesired limiting action in the video amplifier* can seriously reduce the sync amplitude. The usual reasons for undesired limiting in the video amplifier are:

(a) Excessive amplitude of signal input to the video amplifier, resulting from trouble in the a.g.c. circuit, or incorrect adjustment of the a.g.c. threshold control, as shown in the illustration, Fig. 8.

(b) Incorrect plate, screen, or bias voltages due to circuit, components or tube trouble in the video amplifier or in the power supply. An example of limiting and horizontal pulling caused by low plate voltage on a video amplifier is shown in Fig. 9.

(c) Defective or worn-out tubes in the video amplifier.

Instructions on making a visual check on relative amplitude of sync, the checks for localizing the cause of picture pulling, picture pulling due to external interference, microphonic pulling, and troubleshooting procedures will be discussed next month. Next month's issue will conclude this series.

(To be continued)

OLD TIMER'S NITE

THE Delaware Valley Radio Association will sponsor its 7th annual Old Timer's Nite Round-up and Banquet on Saturday, April 21st. The affair will be held in the Grand Ballroom of the Stacy-Trent Hotel, West State and Wilcox Streets in downtown Trenton, New Jersey. A turkey dinner will be served promptly at 6:30.

Guest speakers will include radio personalities and W2ZI's famous collection of old time wireless gear will be on display. A prize will be given to the holders of the oldest commercial and ham tickets in the crowd. A special award will be presented to the "Grand OM" whose radio and wireless experiences date back to "pioneer" times.

Tickets for the affair are \$5.00 per person when purchased in advance from Ed. G. Raser, W2ZI, general chairman, 315 Beechwood Avenue, Trenton 8, New Jersey. The tariff will be \$6.00 at the door. As usual, the affair will be stag.

-30-

BUILD YOUR OWN 5 TUBE SUPERHET RADIO

**\$295
ONLY**

We furnish all but the components

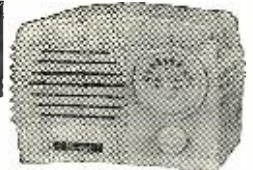

• A Beautiful Plastic (Buterine) Cabinet • A Copper Plated Chassis—Stamped for Mounting Parts • A Name Plate • A Calibrated Tuning Dial • A Volume Control Knob • A Stamped Jute Back • 3 Rubber Grommets • 4 Sheet Metal Screws—For Chassis and Back Mounting • 5 Miniature Tube Sockets, All yours to get you started on your own radio. \$1.00 deposit with C.O.D. orders. You pay postage. Send only \$2.95 and we will pay postage.

FOUNDATION KIT FOR THE NEW 1951 "MELROSE PAGODA"

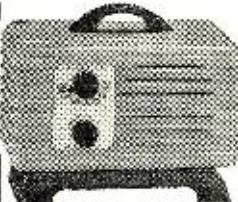

**\$395
ONLY**

Less Components
• A Beautiful Plastic (Styrene) Cabinet (Your choice in 5 pastel colors) • A "Cadmium" Plated Chassis to Match. (Stamped for Mounting various style and size parts) • Metal Dial Plate (Etched in black numerals) •

Pointer Knob and Matching Switch Knob • Fiber Back and 4 Fasteners • Strain Roller Bushing for Line Cord • Black Plastic Handle and 2 Screws for Mounting • Black Chinese Pagoda Base and 2 Fasteners • Cadmium Plated Bracket for Variable Condenser Mounting • 5 Miniature Wafer Sockets and Rivets. This is not a discontinued model—but our latest 5 tube table model radio. Modern in design and color styling. Just out on the Market.

Check your choice of color: White Ivory Green Canary Yellow Chinese Red

FREE Mounting of the following if desired, please check: Drill Cabinet—mount handle & Pagoda Base Spot Weld Var. Cond. Bracket Rivet Wafer Sockets to Chassis

THE LORMEL PRODUCTS, Inc.

10408 Superior Ave. Dept. RT Cleveland 6, Ohio

POWER!

Your ad in the Classified Section of RADIO & TELEVISION NEWS is read by the largest audience in the field—monthly circulation—over 200,000.

QUALITY CARBON RESISTORS

1/2 Watts ± 10%				
47Ω	470Ω	10KΩ	68KΩ	1 Meg.
100Ω	560Ω	22KΩ	.10 Meg.	3.3 Meg.
150Ω	1000Ω	27KΩ	.15 Meg.	4.7 Meg.
220Ω	2700Ω	33KΩ	.33 Meg.	
330Ω	4700Ω	47KΩ	.47 Meg.	\$5 per 100

25% Deposit. Balance C.O.D.
Satisfaction or Money Back Guaranteed.
Write for prices on speakers and tubes.

AUDIOTRON CORP. 1640—18th Street Santa Monica, Calif.

ANOTHER OUTSTANDING JOBBER

RADIO PRODUCTS SALES COMPANY

1237—16th Street
Denver 2, Colorado



\$25.95

HAS THE
SENSATIONAL NEW
TEICO 221-K
VTVM KIT
IN STOCK!

RADIO & TELEVISION NEWS

Mobile Converter (Continued from page 49)

condensers should be connected directly from the appropriate socket pin to one of the bolts holding the socket in the chassis. All other grounds from the same tube should be grounded to the same lug. All parts should be fastened securely because of the vibration encountered in mobile operation, and all holes in the chassis should be lined with rubber grommets.

With construction completed and assuming that the wiring is correct, the next step is to align the converter. With plate and filament voltages being supplied by a receiver, and with the output of the converter connected to the antenna post of the receiver, set the receiver dial to about 1500 kc. Then adjust C_{15} for maximum noise, or for maximum signal if a signal generator is available. During alignment of the r.f. section the oscillator trimmers should be adjusted first. On the 80 and 20-meter bands set the oscillator frequency 1500 kc. to the high side, while the low side should be used for the 10-meter band. After setting the oscillator frequencies, adjust the r.f. and mixer trimmers for maximum signal.

Under normal conditions this converter will deliver strong signals from a simple whip antenna, with even better results if the antenna is tuned to the operating frequency.

Before connecting the converter to your car radio it will be necessary to install a socket in the receiver to provide plate and filament voltages. It is desirable to take these voltages from points in the car radio that are well filtered to prevent vibrator hash. Bypassing the leads with mica condensers at the point where the output socket is mounted will help remove any remaining hash. Chances are, too, that a noise clipper will be required if ignition noise is to be eliminated, especially on 10 and 20 meters. On 75 meters ignition noise is no problem, but instead we are plagued with other types of interference from power lines, etc., for which no cure has as yet been suggested.

-30-

DOCKET 9295 ADOPTED

On January 31, 1951, the FCC finally adopted Docket 9295 which deals with several changes in rules and regulations applying to amateur operation.

Probably the portion of greatest importance is the provision for the Novice and Technician classes of licenses which will allow operation of a restricted nature with a simple operator's examination.

Details of the revised document, as finally adopted, are not available at the present time but the docket takes effect on July 1, 1951.

SAVE UP TO 95% SENSATIONAL SURPLUS VALUES!

EXPORT INQUIRIES INVITED!

We carry an unusually large stock of Airline Equipment, Test Equipment, Radar Sets, etc. Write for our low prices and complete information. We furnish immediate answers to all inquiries! Write today!

BC-906 ABSORPTION-TYPE FREQ. METER

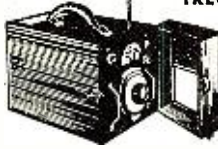

Freq. range 150-225 Mc. Uses 0-500 DC Microammeter for indicator. In black crackle carrying case with handle. $12\frac{1}{2} \times 8\frac{3}{4} \times 6\frac{1}{2}$ ". Net 18 lbs. With tubes and calibration chart. New... **\$14.95**

ATTN: AIRLINE OPERATORS

- | | |
|------------------------------|----------------------|
| APN-9 with MG-149F or PE-206 | TS-19 |
| T-47A/ART-13 | BC-611 |
| DY 11 | O-17/ART-13 LFO Unit |
| DY 12 | O-16/ART-13 LFO Unit |
| DY 17 | SCR-509 |
| RC-103 | PP-39/TRC-2 |
| R 89B/ARN-5 | AT-49/APR-4 |
| TA-2124 | BC-929 |
| ARC-1, 10 or 20 Channel | BC-800 |
| SCR-522C | APN-2 |
| SCR-269 ADF Systems | SO-7 Parts |
| 1-96 VHF Test Sets | RC-79A |
| SCR-718 | ARG-13A APG-134 |
| BC-976 | CP-11/APG-15 |
| AN ARN-8 | R-5/ARN-7 |
| APS-15 | R-5A/ARN-7 |
| APS-13 | MT-283/ART-13 |
| APS-4 | MT-284/ART-13 |
| APS-6 | T-30 Microphone |
| SCR-717 | APH-1 Altimeter |
| SCR-729 | BC-221 AK |
| TBS | LM Freq. Meter |
| HS-33 | RTA-1B |
| TS-226A | TA-12 |
| IE-56A | ARC-4 Complete |
| ARC-4 | SCR-274N |
| SCR-274 N | BC-1023 |
| ARC-5 VHF Set | BC-357 |
| AN/ARN-5 | BC-348-L New |
| TS-23/APN-1 | Plus many others |

SPECIALS FOR MARCH ONLY!

- APS-13 ANTENNAS. Tunes to 460 megs. Brand new. 89c Regularly \$1.50 each, now...
- JENSEN ELECTRO-DYNAMIC SPEAKERS. 12-inch hi-fidelity, 8-ohm voice coil, 2500 ohm field. Regularly \$12.50. Brand new... **\$9.95**
- JENSEN ELECTRO-DYNAMIC SPEAKERS. 10-inch hi-fidelity, 8-ohm voice coil, 2500 ohm field. Regularly \$6.95. Brand new... **\$4.95**
- OHMITE TAP SWITCHES. 100 amps, 2 gang, 4-position. Approx. 5" diameter, 6" long. Regular \$10.00 value, now... **\$6.95**
- OIL CONDENSOR, 20 mfd. 600 volts. Reg. \$3.50... **\$2.95**

BC-1072 RADAR TRANSMITTER

Frequency range 157 to 187 megacycles. Comes complete with all tubes, 1 1/2 amp GR Variac. Operates on 110V AC 60 cycles and contains 3 1/2" meter to measure up to 5 K.V. **\$18.95**

TRIPLETT 1183-SC COMBINATION TUBE & MULTI-TESTER.

Checks tubes, AF output, measures AC, DC volts, direct current, resistance, cap. Can be used as free-point tester for measurements at tube sockets while radio is on, without removing chassis. 0-10/50/250/500/1000 AC, DC volts, Ohms/volt; 10,000 DC. 2000 A.C. DC MA 0-1, 10/50/250. Ohms: 0-500, 15,000, 0-15 or 15 megs. Used good cond. Part of 1-56C test set. $14\frac{1}{2} \times 7\frac{1}{2} \times 4\frac{1}{2}$ ". Weights 5.2 lbs. **\$49.50**

MODULATION TRANSFORMER. 50 watts, matches 807's to 2000 ohm RF load. Brand new... **\$3.49**

SCR-522 Used, complete with tubes... **\$49.50**

BC-434A RADIO COMPASS CONTROL BOX. Complete with 5 Millimeter New... **\$2.95**

RS-32 CARBON MICROPHONE. Made by MAGNOVOX. Comes complete with push-to-transmit switch, cord and PL68 plus... **\$4.95**

CD-307 EARPHONE EXTENSION CORDS. Used with HS-33 and HS-23 Head Sets. Brand new... **69c**

GENERAL ELECTRIC VOLT METER 0 to 150 Volts, AC, 60 cycles. 3 1/2" diameter. Brand new. Specially priced at just... **\$4.95**

ARC-4 VHF TRANSCEIVER. 140 to 144 Megs. Comes complete with tubes, dynamotors and crystals... **\$24.95**

BENDIX TA-12 TRANSMITTER

A terrific buy at this low price. Used, good condition... **\$29.50**

BC-929 RADAR SCOPE

Complete with all tubes including 3BP1 Scope Tube and many other parts. Ideal for experimental Oscillograph set-ups... **\$14.95**

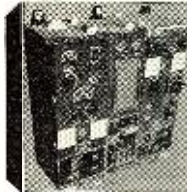

GO-9 XMITTER. Frequency range 3-18 MC and 300-600 KC. Band switching 100 w output. Brand new in original mfg. crates. Comes complete with tubes and spare parts kit. Comes in three units: high and low frequency xmitter and rectifier. Dimensions: 14" deep x 27" long x 2 3/4" high. Net wt. 137 lbs. Shpg. wt. approx. 250 lbs. Finished in black crackle, shock mounted. Has 7 meters for indicating plate and grid current, also antenna current. Operates 110V 800 cycles. Single phase and 24V DC. Contains 2-803 tubes, 1-807, 1-801, 2-837, 1-523, 2-1616. Comes with maintenance manual and test data... **\$72.50**

EXPORT QUANTITIES AVAILABLE. Write for complete information.

SURPLUS RADIO CONVERSION MANUAL NO. 2 containing conversion information for GO-9 to 10 meters and 110V 60 cycles. Contains 18 other popular conversions and complete information... **\$2.50**

274-N AND ARC-5 EQUIPMENT RECEIVERS

3-6 MC. Used. Originally \$30, NOW... **\$5.95**

6-9-1 MC. Used... **\$7.95**

TRANSMITTERS

T-22 ARC-5, 7-9 Megs. Used... **\$10.95**

T-23/ARC-5 100-156 Megs. 4 channel Xtal, used... **\$25.00**

MD7-ARC5 Modulator Plate and Screen for T23ARC5, with Dynamotor... **\$15.00**

T-21 ARC-5.3-7 MC. New. Orig. \$40. Now... **\$8.95**

4-5.3 MC. Used. Orig. \$30.00. Now... **\$5.95**

2-1.3 MC. LN. Orig. \$40. Now... **\$16.95**

BC-924 FM XMITTER. Frequency range 27-39 MC. 35 Watts output. 4-channels, tunable throughout entire range. Complete with tubes and dynamotor. Specially priced at just... **\$19.95**

THE BOTTOM OF THE BARREL IN OUR SUPPLY OF

PORTABLE F.M. XMITTERS & RCVRs!

These operate on 6V DC, 34 MC varied either direction depending xtals, xmttr and Rcvr has aluminum case with antenna relay. Xmttr uses 1073,125 KC crystal in osc. stage followed by 4 doubles and 1 fin. amp. all using HY 65 tubes. Mike amp. and Fre. Mod. use 1C7G tubes. Xmttr stages have metering jacks. Rcvr is superhet. Xtal cont. local osc at 8060 KC. Power Supply on chassis using Carter 6V gen. output 450V @ 250 Ma 6V vibrator power supply for receiver. All ma tubes incl. heating. Included is control box, hand set, 8" speaker and extra microphone. **\$45.00** Used, complete set priced at only...

IMPORTANT

NO ORDER LESS THAN \$5.00. Send 30% deposit on cost of item or full amount to save C.O.D. charges. Do not send shipping costs. It will be C.O.D. only. Shipments sent via Railway Express unless other instructions given. Merchandise subject to prior sale. Prices subject to change at any time.

NEW STANDARD BRAND CHOKES

SWINGING CHOKES							
HY	BRAND	MILS	OHMS	PRICE	VOLTAGE	CASE	WT.
8-40	Stancor	175	100	2.75	3KV	Closed	3.5
8-30	Stancor	200	80	3.25	3KV	Closed	4.5
5-25	UTC	200	100	4.95	2KV	Closed	5
5-25	UTC	300	90	9.95	5KV	Closed	18
8-25	Stancor	300	80	5.95	5KV	Open	8 1/2
5-25	Stancor	300	80	4.95	3KV	Open	4
5-25	UTC	500	60	12.95	7KV	Closed	28
8-40	UTC	1 amp	50	39.95	10KV	Closed	58
SMOOTHING CHOKES							
HY	BRAND	MILS	OHMS	PRICE	VOLTAGE	CASE	WT.
5	GTC	500	600	4.95	2KV	Closed	4
7	Stancor	150	200	1.25	2KV	Open	2
10	UTC	500	60	12.95	7KV	Closed	28
12	Stancor	300	80	5.95	5KV	Closed	9
12	Thordarson	375	105	3.95	5KV	Closed	8
12	Thordarson	400	400	6.95	2KV	Closed	15
15	Stancor	200	120	2.95	3KV	Open	4.5 lbs.
20	Stancor	300	80	4.95	3KV	Closed	9 lbs.
20	UTC	300	90	4.50	4KV	Closed	10 lbs.
20	UTC	400	85	5.95	5KV	Closed	14 lbs.
SMOOTHING CHOKES WITH HUM BUCKING TAP							
HY	BRAND	MILS	OHMS	PRICE	VOLTAGE	CASE	WT.
20 Series	UTC	1A	50	39.50	10K	Closed	80
5 Parallel	UTC	2A	12.5				
16 Series	UTC	175	95	5.95	2.5K	Closed	15
4 Parallel	UTC	350	24				
26 Series	UTC	200	112	6.95	3.5K	Closed	15
6.25 Parallel	UTC	400	28				

BC-223 TRANSMITTER. Complete with 2 to 3 megs. tuning unit... **\$35.00**

LAVOIE 105 SM VHF FREQ. METER. Tunes from 375-725 MC 1%. Brand new. Complete with calibration chart... **\$67.50**

VARIAC, GR. 0-130 volts, AC 60 cycles, 5 amps. 7 1/2 A intermittent. Brand new and specially priced at just... **\$17.50**

BC-347 INTERPHONE AMPLIFIER. Contains 6F8 **\$1.49**
Dual Triode and matching transformer. Brand new...

TBY VIBROPACK for TBY Transceiver. Supplies all voltages. Operates on a 10 volt source. Brand new. Save at this low price... **\$12.50**

VACUUM CONDENSERS. 50 MMFD 5 amps, 5 KV... **\$1.25**

BC-611 HANDIE-TALKIE. Part of SCR-536. Frequency 3.5-6 MC. Attention Construction men, Builders, surveyors. Perfect for short distance communication. Weighs only 5 1/2 lbs., hand-held like a hand set. Pre-set to your frequency. Push-button controlled. Transmitter and receiver in same case 1 5/8" x 3 3/8" x 5 3/8" sturdy aluminum case. Comes complete with tubes, crystals, one set batteries. Extra batteries available. Models B, C, D, E, F, available. PRICE ON REQUEST!

VAC RADIO & ELECTRONICS SUPPLY
DEPT. R-19, 2033-37 W. VENICE BLVD., LOS ANGELES 6, CALIFORNIA

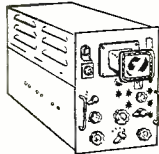

Aeronauticals, Attention!

R-65/APN-9

Brand New in Original Packing
First like these in 4 years!
Price quotation on request.

BC-347-C INTERPHONE AMPLIFIER

Brand new, with 6F8C.....\$2.50

Excellent Used, with 6F8C.....1.29

MN-26-S FOR A.D.F. See our ad, page 125, in
January Radio and Television News.

DYNAMOTORS AND INVERTERS

(Quantity buyers, write for discount.)

FOR AN/ARC-1: DY-9/ARC-1 (27 v) or DY-10/ARC-4x
(27 or 13.5 v). Output 360 v, 135 ma, cont. 90
310 v, 355 ma, int. Guaranteed condition...\$12.50

FOR T47/ART-13 or ATC: DY-12/ART-13, rotary
machine only, no filter-relay base. 27 v in, two
outputs: 1150 v, 350 ma; plus 400 v, 400 ma.
Brand New.....\$7.95

FOR BC-375: PE-73, 28 v in, output 1000 v, 850 ma.
Brand new.....\$5.95

FOR A.D.F., 750 VA Inverter MG-149-F: Input 24 v,
outputs 115 v, 500 VA, 400 cy; plus 26 v, 250 VA,
400 cy. Excellent used.....\$7.95

115 VA to 500 VA Inverters. We have an assortment
of inverters suitable for A.D.F., much lighter than
MG-149. Have voltage regulation. Repairable...\$12.50

FOR RADAR: PE-218 Inverter, 25-28.5 v in. Output
115 v, 13 amp (1.5 KVA), 400 cy.....\$17.50

Out of original packing.....12.50

FOR MARINE RADIOMEN G.L. "MARINER" TRANSMITTER

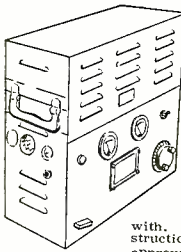

180 w input, 120 w to
antenna, 90% modulated, 4
channel xtal cont. 12 or 24
v input with dynamotor, con-
necting cord, xtals, tubes,
mike, all aligned and ready
to operate. (Specify volt-
age and freq. when ordering.)
Contains break-in relay for
receiver in addition to ant.
switching relay. Dimensions:
8 1/4" deep, 17 1/4" wide,
19 1/2" high. Tubes included:
493 speech amp, two 211
mod., 12J5 osc., 1625 IPA,
two 814 parallel PA. We
add over \$150 worth of
skilled engineering and parts
to equipment which cost
\$1.85 over \$1200 to start
with. How can you lose? With in-
structions. FCC license \$275.00
approval guaranteed...\$275.00

MARINE FREQ. COMMAND RECEIVER NAVY ARA
(SCR-27 AN) 1.5 to 3 MC spread over entire dial.
Very hot! Modified, entirely self contained. (Less
speaker.) New! 12V.....\$32.50 24V.....\$27.50

G.L. "MARINER" RECEIVER

Long wave, broadcast, marine
and short wave reception. A beautiful
conversion of finest Navy surplus!
All controls, vernier
tuning, BFO ON-OFF and AVC
MVC on entirely new front panel.
Coaxial type antenna fittings
furnished. Tagged wires out of
rear to battery to power a DU-1
loop, and to kill B+ with xmt
break-in relay. 12 or 24 v. Dcs.
Only 15 1/2" long, 5" wide, 6 3/4"
high, and self-contained; no
plugs needed. 115 v tubes, neon voltage limiters,
and dynamotor. Requires an external speaker. Align-
ment instructions and schematic furnished.
Specify voltage.....\$69.50

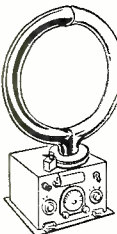
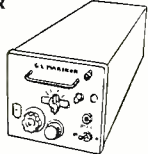

3-SECOND MANUAL DIRECTION FINDER

DU-1, 12 or 24 v. Goes ahead of
the G.L. "Mariner" ARA, or any
other receiver. We convert it to the
Marine band. Still retains lower
half of broadcast band, and all the
lighthouse and beacon band. 2-tube
bearing circuit, no 180° ambiguity.
Gives true bearing in 3 seconds!
Schematic and complete instructions
furnished. BRAND NEW, specify
voltage.....\$32.50

20-WATT TRANSMITTER

BC-223 TRANSMITTER.

15 to 25 w output, 4
chan xtal control. To
modify for FCC ap-
proval, just remove a
few knobs and put one
metal screw into panel
to keep channel selector
switch from being
turned to MO position.
WE CHECK THEM OUT!
With tubes, 12 v dynamo-
tor PE-55, connecting
cable, 4 marine
freq. xtals, mike, and
schematic. Don't forget to
specify
xtal freqs...\$89.50

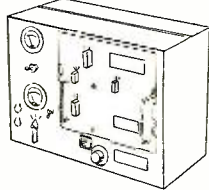

NAVY WATERPROOF BULKHEAD SPEAKER with uni-
versal matching transformer, cord and phone, plug \$9.95

FOR EVERYONE!

6 V STORAGE BATTERY. New! Consists of three Willard
2 v, 20 amp. hr. spill-proof batteries, dry
charged, and Battery Box CH-201 with plastic windows
to see built-in hydrometer balls.
A neat little set-up!.....\$4.95

3-DIGIT resettable Veeder-Root counter with 90°
bevel-gear drive, pilot lamp assembly, wiper
switch, case. NEW.....79c

See our ads in Radio and TV News, Jan., page 125,
Feb., page 144. Bargains galore!

WANTED!

Your Spare Surplus Equipment and Tubes, Dynamotors,
Recvrs., Xmtfrs., Equipment. Send List; stating
condition and rock bottom price.

G.L. ELECTRONICS

905 S. Vermont Ave., Los Angeles 6, Calif.
All Prices F.O.B. Los Angeles,
Calif. Buyers Add Sales Tax.



CHAPTER NEWS

Augusta-Camp Gordon

THE chapter's third annual elec-
tions took place at Camp Gordon
on December 13th. Heading the
slate of officers as president is Major
Norman J. Kinley who served as chapter
secretary during the chapter's first
year of existence. The other new offi-
cers are: 1st vice-president—Charles
M. Eberhart; 2nd vice-president—Lt.
Col. Randolph V. Fite; secretary-treas-
urer—Maj. Walter J. Hewitt. Col.
Robert A. Willard and Hugh A. Flem-
ing were chosen to represent the chapter
on the national council of the asso-
ciation.

The following were elected to the
board of directors: Thomas M. Baker,
Lt. Col. Phillip Rose, Raymond E.
Chandler, Lt. Col. William V. Norton,
Henry A. Wright, Cpl. Richard A.
Long, J. A. Harp, Lt. Col. Robert W.
Harnett, Walter S. Williams, and Mar-
ion S. Symms.

Prior to the election, Capt. John A.
Ritner of Headquarters, Signal Corps
Training Center, Camp Gordon, pre-
sented an interesting discussion of the
local MARS station and the Camp Gor-
don Radio Club.

Boston

The December 21st meeting of the
Boston Chapter was devoted to an au-
thoritative discussion of the communi-
cations phases of the civil defense pro-
gram, with Professor William H. Rad-
ford, Associate Professor of Electrical
Communications at the Massachusetts
Institute of Technology and presently
Communications Consultant for the
Massachusetts State Director of Civil
Defense, as guest speaker. Professor
Radford's talk on "Communications for
Civil Defense" was most interesting
and timely and was followed by a
lively question and answer period.

Chapter President T. F. Halloran of
the *General Communication Company*
opened the meeting by introducing
various guests, which included Lt. Col.
John Leidenheimer of the Office of the
Chief Signal Officer, and representa-
tives of civilian defense organizations
from Cambridge, Newton, Wellesley
and Needham, Mass., and representa-
tives of the Massachusetts State Po-
lice. He also introduced Lt. Comdr.
James E. Teague, Assistant Electron-
ics Officer, Boston Navy Yard, who had
recently joined the chapter. Contin-
uing the drive for increased member-
ship, Admiral Halloran suggested that
everyone present adopt the slogan
"Every member bring in a member."

Capt. A. R. Taylor, USN, chairman
of the chapter's communications com-

This Association is a patriotic non-profit
organization, with chapters in most of
the larger cities, dedicated to developing
and maintaining efficient personnel, com-
missioned, enlisted, civilian, for the sup-
ply (including design and development),
installation, maintenance, and operation
of communications and electronic equip-
ment for Army, Navy, and Air Force and
their supporting civilian activities. It pub-
lishes a magazine "SIGNALS" at its na-
tional headquarters in Washington. Every
American interested in any way in com-
munications is eligible and invited to
join. Dues are \$5.00 per year. Application
should be submitted to the secretary at
1624 Eye St., N. W., Washington 6, D. C.,
who will furnish details upon request.

mittee, reported substantial progress
in the committee's work with civilian
defense organizations. Offers of assist-
ance in this work have been addressed
to the civilian defense authorities in
the States of Rhode Island and New
Hampshire. The chapter's services had
been offered to the State of Massachu-
setts early in the fall. A resolution was
adopted unanimously that the Boston
Chapter continue its efforts to assist
in the establishment of communication
facilities for civil defense.

Decatur

The election and installation of new
officers took place at the chapter's De-
cember 7th meeting at the Decatur
Signal Depot. The new slate is: presi-
dent—Robert J. Bangert; 1st vice-
president—Lt. Col. J. N. Nahas; 2nd
vice-president—Capt. T. A. Mulcahy;
secretary-treasurer—Willard Hay-
ward; directors—Robert McMurtrey,
Maj. A. W. Hazuda, David Richardson,
W. R. Winn and George V. Miller.

A copy of the speech given by Major
General S. B. Akin, Chief Signal Of-
ficer, before the Washington Chapter's
meeting in October was read to the
members by Chapter Secretary Ed-
ward C. Whitcomb. The speech was
extremely well received and at its
close some discussion was held re-
garding new equipment, with special
interest being evidenced in the capa-
bilities of the new Signal Corps wire.

A movie, made for the British Army
and subsequently shown to the Ameri-
can troops, called "Fighting in the
Streets," concluded the evening's pro-
gram.

New York

Civil defense was given top billing
on the program of New York's Decem-
ber 13th meeting with Robert R. Bur-
ton, Director, Civil Defense Commu-
nications of the National Security Re-
sources Board, as the principal
speaker. Mr. Burton told of his experi-
ences while attending international

radio conferences as a representative of the State Department "Voice of America." He outlined many of the problems confronting civil defense and stressed the important role that communications will play in each community's civil defense organization.

A demonstration of the "Alert Radio Signaling System" was given by Comdr. Arthur F. Van Dyck of RCA's engineering staff. He showed that a simple device employing a "tuned reed" could be connected to any broadcast receiver to permit civil defense officials to receive air raid alerts or other warnings. An inaudible warning tone signal would be transmitted by the local broadcast station and would cause a lamp to light and a bell to ring in the device associated with the broadcast receiver. An actual demonstration of this alert system was given through the facilities of station WNBC.

The chapter's annual elections for the year 1951 were held, with the following result: president—Rear Admiral Ellery W. Stone, president of *American Radio & Cable Corp.*; vice-presidents—Col. Theodore L. Bartlett of *RCA*; Herbert J. Schroll, *New York Telephone Co.*; Col. Hobart R. Yeager, USAF, Mitchell Field; treasurer—Maj. Theodore W. Pope, *Bell Labs*; secretary—Lt. Col. David Talley, *IT&T Corp.* The board of directors are: Vice Admiral W. S. Anderson, *International Automatic Electric Co.*; George W. Bailey, *IRE*; Brig. Gen. C. O. Bickelhaupt, *AT&T*; Commodore J. B. Dow, *Hazeltine Electronics Co.*; Lt. Col. W. L. Hallahan, *Laird & Co.*; Col. W. H. Harrington, *AT&T*; Maj. Gen. Harry C. Ingles, *RCA Communications*; Fred R. Lack, *Western Electric*; Brig. Gen. A. W. Marriner, *IT&T*; Col. T. H. Mitchell, *RCA Communications*; Rear Adm. S. F. Patten, *Allen B. DuMont Labs*; Col. Van Ness Philip, *AUS (Ret.)*; Maj. W. H. Rivers, *Eastman Kodak*; Lt. Col. E. R. Shute, *Western Union*; Col. Morton Sultzer, *Bell Labs*; Brig. Gen. S. M. Thomas, *RCA Communications*.

Rochester

The United States is way ahead in the field of military photography, Edward K. Kaprelian, chief of the Army Signal Corps photographic section, Fort Monmouth, said while addressing the organizational meeting of the Rochester Chapter on December 13th. He described a few of the photographic and optical devices being developed at the Signal Corps engineering laboratory to sharpen America's military eyes, and related some of the achievements of the Rochester photographic industry in recent developments.

Mr. Kaprelian showed on a screen a picture of a crude 120-inch German camera used in World War II for photographing the coast of England, then in contrast a compact extension camera made by *Eastman Kodak Company* which he said far exceeded the effectiveness of the earlier one. A 70 mm. combat camera made by *Graflex* he declared is slated to replace all other

STANCOR High Fidelity OUTPUT TRANSFORMERS

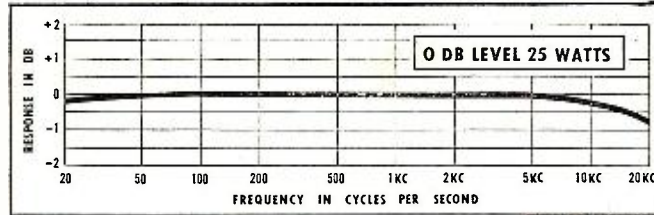

Curve represents an average response of the ten transformers in this series. Units used for this test were drawn at random from current Stancor stock.

±1 db FROM 20 TO 20,000 cps

Premium Quality at Low Cost

Stancor has taken advantage of the most advanced design and manufacturing practices to bring you a series of output transformers combining outstanding audio response with very moderate cost.

Extensively interleaved "trifilar" windings, extremely tight coupling, and careful electrical balance result in audio fidelity to please the most critical specialist. An inexpensive, but thoroughly practical, type of mounting is used since elaborate shielding is not required at the audio output power level.

Listed part numbers have a maximum power level rating of 50 watts and provide a wide selection of impedances for popular amplifier applications.

PART NO.	PRI. IMP. (P-P) IN OHMS	SEC. IMP. IN OHMS*	MAX. PRI. D. C. PER HALF	NET PRICE
A-8050	1500	8, 16	200 ma	\$10.86
A-8051	2500	8, 16	150 ma	10.86
A-8052	3000	8, 16	175 ma	10.86
A-8053	5000	8, 16	150 ma	10.86
A-8054	9000	8, 16	100 ma	10.86
A-8060	1500	500	200 ma	10.86
A-8061	2500	500	150 ma	10.86
A-8062	3000	500	175 ma	10.86
A-8063	5000	500	150 ma	10.86
A-8064	9000	500	100 ma	10.86

For complete specifications and prices of more than 450 stock part numbers, including other high fidelity transformers, see the current Stancor catalog. Ask your distributor for a copy or write direct.



STANDARD TRANSFORMER CORPORATION 3584 ELSTON AVENUE, CHICAGO 18, ILLINOIS

EASY TO LEARN CODE

It is easy to learn or increase speed with an Instructograph Code Teacher. Affords the quickest and most practical method yet developed. For beginners or advanced students. Available tapes from beginner's alphabet to typical messages on all subjects. Speed range 5 to 40 WPM. Always ready—no QRM.

ENDORSED BY THOUSANDS!

The Instructograph Code Teacher literally takes the place of an operator-instructor and enables anyone to learn and master code without further assistance. Thousands of successful operators have "acquired the code" with the Instructograph System. Write today for convenient rental and purchase plans.

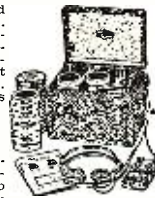

INSTRUCTOGRAPH COMPANY

4711 SHERIDAN ROAD, CHICAGO 40, ILLINOIS

SURPLUS RADIO CONVERSION MANUAL

IN TWO VOLUMES

This set of reference data has become standard for the most commonly used items of surplus electronic equipment. All conversions have been proven by testing on several units; each yields a useful item of equipment. For list of items covered, write us.

\$2.50 FOR EITHER VOLUME

By mail, \$2.60 postpaid.

AT YOUR FAVORITE DEALER
OR DIRECT BY MAIL FROM
Editors and Engineers
LIMITED
1202 KENWOOD ROAD, SANTA BARBARA, CALIFORNIA



.0005V-100 VOLT OSCILLOSCOPE CALIBRATOR

Indispensable for measurement of pulse amplitude, noise, hum, and other low level voltages as well as voltages up to 100 volts.

Connected between any signal and an oscilloscope, this instrument will measure the amplitude of the entire or any portion of the signal.

\$24.95

COMPLETE WITH TUBE
AND INSTRUCTIONS

SPECIFICATIONS

- ★ .0005V — 100 VOLTS RMS
- ★ CALIBRATED DIRECTLY IN PEAK TO PEAK, RMS, AND DB
- ★ 35 MMFD Input Capacity
- ★ Infinite shunt resistance

TENSOR

ELECTRIC DEVELOPMENT
CO., INC.
343 CLASSON AVENUE
BROOKLYN 5, N. Y.

STERLING 9-4805

Tensor Electric Development Co., Inc.
Dept. A, 343 Classon Ave., Brooklyn 5, N. Y.

Please send.....Oscilloscope calibrators to

Name.....

Address.....

Terms: Rated Firms Net 30 days.
Others — 25% with order, bal. C.O.D.

LET US PUT THIS
Magnificent NEW 1951
MIDWEST
TELEVISION

RADIO
PHONO
CONSOLE
in Your
Home on
30 DAYS
TRIAL

FACTORY
TO YOU

EASY
TERMS

MAMMOTH 19 1/2-Inch PICTURE TUBE
AM-FM Radio and 3-Speed Phonograph

Be your own judge! See and hear Midwest Television in your own home. Then decide whether to keep it or have your money refunded. Low Factory Prices.

Also Available on 30 DAYS TRIAL!
The Sensational New 5-Band
World-ranging 1951 Model
MIDWEST RADIOS

SEND THIS COUPON ON 1c POST CARD FOR NEW 1951 FREE 4 COLOR MIDWEST CATALOG

MIDWEST RADIO & TELEVISION CORP.
Dept. 37-K, 909 Broadway, Cincinnati 2, Ohio

NAME _____
ADDRESS _____
CITY _____ ZONE _____ STATE _____

TESCO

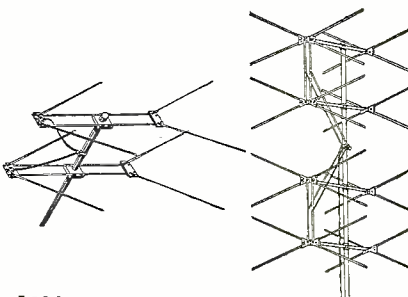

1236—
SINGLE BAY.....\$4.58

1237—
DOUBLE BAY\$9.15

No. 1231
\$20.85

- 1230—Double Bay Conical.....\$9.56
- 1215—Swift Rig Folded Hi Folded Low... 5.37
- 1814—Economy Chimney Mount...Dozen Lots 1.32
- 1302 to 1306—Five El. Yagi any Lo Channel 13.62
- 1307 to 1313—Five El. Yagi any Hi Channel 5.45
- 1219—Swift Rig Folded Hi Straight Low... 4.92
- 2113—DeLuxe Indoor Antenna..... 2.48
- 1860—Chimney Mount..... Dozen Lots 1.54
- 1905—3 1/2" Mast Snap-On Standoff, per 100 4.00
- 1873—3 1/2" Mast Standoff Insulator, per 100 6.50
- 1872—4" Nail-In Insulator, Lots of 250... .025
- 1870—3 1/2" Wood Screw-Eye Insulator
- Lots of 250025
- 1229—Single Bay Conical..... 4.58
- 1231—Four Bay Conical..... 20.85

Send for quantity prices and complete list



TELEVISION SUPPLY CO.
Box 213 Gracie Square Station
New York, N. Y.

frontline cameras. He also showed a medical camera made by *Graflex* which he characterized as outstanding in this field. Lenses manufactured by *Wollensak Optical Company* surpass in quality those formerly made in Germany, he said, and added that *Ilex* shutters are highly important for military use. Mr. Kaprelian emphasized the value of xerography research at the *Haloid Company* for particular needs of the armed forces, and also paid tribute to lens research at the Hawk-Eye plant of *Eastman Kodak*.

The University of Rochester, stated Mr. Kaprelian, is doing research on variable focus lenses, and *Kodak* on the recovery and reuse of photographic compounds, regarded as highly important under combat conditions.

The speaker also showed pictures of batteryless flash-holders, electronic shutter holders, special sound projectors, a 2000-watt lamp operating without electricity, a field photographic processing machine that operates at the rate of 45 feet per minute, and an electric camera requiring no film.

Mr. Kaprelian emphasized that the Korean war has re-established the vast importance of photo-reconnaissance work. "Without photography it would have been impossible to move anywhere in Korea," he said.

AFCA Executive Secretary George Dixon emphasized the objectives of the association and formally launched the new AFCA unit by presenting the charter of the new Rochester Chapter to Joseph C. Wilson, president of the *Haloid Company*, who is acting president of the chapter.

Among those attending the meeting at the Chamber of Commerce were representatives from *Eastman Kodak*, *Bausch & Lomb*, *Stromberg-Carlson*, *Graflex*, *Haloid*, *Wollensak*, and *Ilex Optical* companies.

Sacramento

A description of "Electrical Power and Communications in the Korean Picture" was presented to the Sacramento Chapter meeting on December 12th by George A. Fleming, Chief, Power and Resources Development Division, U. S. Bureau of Reclamation, Sacramento. Mr. Fleming illustrated his talk most effectively with color film and slides which he had taken on a recent trip to Korea where he was making a survey of power and communication facilities. Mr. Fleming left Korea in June, just one week before the outbreak of hostilities.

The meeting was opened by Chapter President Paul Carrington with a word of welcome for the members and guests. He then presented an outline of the part to be played by the chapter in the Sacramento Disaster Relief Plan. Major X. W. Godfrey was appointed chairman of the committee to cooperate with the communications committee of the Disaster Relief Council.

San Francisco

The aeronautical communications functions of an international airline

company were described by D. E. Axe, Superintendent of Communications, Pacific Alaska Division, *Pan American Airways*, before a meeting of the chapter on November 16th.

Mr. Axe, who has traveled extensively for his company, related some of the many interesting experiences and problems with which he has been confronted in establishing the extensive world-wide communications system necessary for the successful operation of *Pan American Airways*. Of special interest were his reports of the operation of the radio telephone networks which have replaced radio telegraph for *Pan American*. The lively question and answer period which followed was indicative of the interest aroused by the speaker's excellent talk.

A Signal Corps film showing combat scenes of the Korean action concluded the evening's program.

Seattle

The election of new officers for the ensuing year was the main item of business at the December 13th meeting held in the Seattle Chamber of Commerce building. The following slate was chosen: president—Marshall B. James, *Northwestern Agencies, Inc.*; 1st vice-president—Frank D. Keyser, *Pan American Radio*; secretary—Merrill R. Stiles, Alaska Communications System; treasurer—Joe E. Gregory, re-elected for a second term. Chapter directors are: Col. Fred P. Andrews, Lt. Col. Clarence D. Lawrence, Phil Duryea, and John F. Rozanski.

It was announced that Major William F. Devin of Seattle has appointed retiring Chapter President Clarence D. Lawrence chairman of the communications committee of the Seattle Civil Defense Commission. Col. Lawrence has been active in the civil defense program in Seattle since its inception.

—30—

CONDENSER LEAKAGE

By KEN MAXWELL

USING an ordinary voltohmmeter it is possible to check the coupling condensers in an audio amplifier without resorting to a soldering iron. To do this the tube following the condenser is used as a vacuum tube voltmeter with the aid of the voltohmmeter as an indicator.

First measure the voltage across the cathode bias resistor. While looking at the meter, short the grid to ground. If the reading changes, the grid was not at ground potential. The voltmeter reading is proportional to the plate current. A leakage through the coupling condenser will make the grid positive with respect to ground and increase the plate current and consequently make the cathode voltage increase. Even small changes in cathode voltage should be investigated since leakage increases with age.

Leakage may occur inside the tube and this possibility should be checked by testing or replacing the tube.

—30—

March, 1951

ARROW "The Home of Values!"

BC-604 Transmitter FM 20-28 MC

11 and 15 meters. Can be operated on 10 meters—10 channel push button crystal. With all tubes and meter but less dynamotor. Excellent Condition. \$19.95
Crystals—Set of 80..... 19.95

BC 603

Receiver—Good. Used..... \$24.95
Complete SCR-503 Installation available—price and information upon request.

TUBESPECIALS!

211..... \$0.39
307A..... 4.95
703A..... 1.89
723A/B..... 12.95
724B..... 1.89
803..... 2.89
805..... 3.29
807..... 1.89
813..... 6.95
832A..... 7.95
837..... 1.19
860..... 4.95
5D21..... 9.95

RT7/APN1 TRANSCEIVER UNIT—

Used as an altimeter, it may be converted for signaling control circuits, etc.
Complete with 14 tubes and dynamotor they are in good used condition at \$6.95 the amazingly low price of.....



COMMAND (SCR 274 N) EQUIPMENT

	Used	New
BC-454.....	\$ 5.95	
BC-455.....	7.95	\$ 9.95
BC-456.....		2.95
BC-457.....	5.95	
BC-458.....	5.95	8.95
BC-695.....	14.95	24.95
BC-450—3 Receiver Remote Control	.89	1.95
BC-442.....		2.95
3 Receiver Rack.....	1.95	
2 Transmitter Rack.....	1.50	

Flap Pitch Motor

24 VDC. will operate on AC—3300 or 11,000 R.P.M. Complete with gear box and limit switches, each \$2.95

SURPRISE PACKAGE

20 lbs. Ass't radio parts. A \$25.00 value for only \$1.95

MN 26 Y Compass Receiver, twelve stage superhet covering frequencies of 150 to 325 KC; 325 to 695 KC; and 3400 to 7000 KC in three bands. These units are brand new but with Dynamotor, Band switch motor and tubes removed. Schematic furnished. While they last..... each \$4.95

1D6/APN4 Scope unit complete with 5CP1 cathode ray tube and shield and all parts except smaller tubes and crystal. Used..... \$9.95 ea.

COMPASS RECEIVER MN-26

Remote control commercial type navigational receiver. Indicates direction of any desired transmitting station. 3 bands—frequency range: 150 Kc to 1500 Kc; has 12—6-V. type tubes.
Brand New..... \$39.95
Accessories for Above:
Loop MN-20..... \$ 9.95
MN-26 Control Box..... 10.00
MN-52 Loop Control Unit..... 4.45
Loop Transmission Cable—168" long..... 9.95
MC-124 Flexible Shaft..... 2.45
IN-4D Left-right Indicator..... 9.95
Set of 3 plugs..... 4.60

AS-138/ARN—10 inch streamline loop as used with direction finding receivers. Fixed position, it is ideal for planes, boats, auto-mobles. New \$1.95

MONTHLY SPECIAL!

2-Meter Transmitter Scoop!

The famous AN ARC-5 VHF Transmitter (T-23/ARC-5), brand new 100-156 mc. Furnished with complete schematic, 4 Xtal-controlled channels selected by 3 motor-driven turrets. Motor can be spun by hand for manual band switching or driven by low-power rectifier power pack. Tube line-up is 2—1625 and 2—832A. Don't pass this up at ONLY \$24.95

BC 620—Receiver-Transmitter—2 crystal channels—20 to 27.8 MC FM—13 tubes. Metered, Plate and Filament..... Used \$9.95

PE 97 or PE 117 or PE 120 Power Supply for above 6-12 volt vibrator type. Used less tubes, vib. & con..... \$2.95
Used, complete..... 6.95
FT 250 Mount for both BC 620 and PE 97 New 1.50

All shipments FOB warehouse. 20% Deposit required on all orders. Minimum order accepted—\$5.00. Illinois residents, please add regular sales tax to your remittance.

A SWEET OSCILLOSCOPE DEAL

ASB-7 Radar Indicator Unit: For conversion to test scope or for use as modulation monitor. Has standard test-scope CR tube, H Cent, V Cent, Brill, Foc, Gain, and range selection switch. External power source was used. Tubes: 4—6AC7, 3—6H6, 1—5BF1. Condition: used, excellent. LOOK AT THIS PRICE: only..... \$14.95

MISCELLANEOUS SPECIALS!

	Used	New
RA 10 DA Receiver.....	\$17.50	\$24.95
RT7/APN1 Transceiver.....	6.95	9.95
APN 1 Complete.....		24.50
BC 347 Interphone Amplifier.....		2.95
I-70 Tuning Meter.....		.89
BC 442 Less Condenser.....	1.49	1.95
APS 13 UHF Antenna, Pair.....		.98
FL 8 Filter.....		2.95
I-97 Bias Meter.....	3.95	4.95
RL 42 Antenna Gearbox Motor and Reel.....	4.95	7.50
TS 10—Sound powered phones.....		6.50

BC 1066 B—150 to 225 MC Portable Receiver adaptable to many amateur uses. In Canvas Carrying Bag. Used..... \$5.95

One Tube Interphone Amplifier—Small compact aluminum case fully enclosed. 2 1/4" x 3 3/4" x 5 3/4" Less Tube..... 79c

BC 709 Battery operated lightweight interphone amplifier. Complete with tube and shock mount, but less battery..... New \$3.95

40 Amps Circuit Breaker..... New 59c
220 M.A. Circuit Breaker..... New 59c

Collins VFO Dial—5 calibrated ham bands from 3.2 Mc to 32 Mc; complete with pointer, gears, logging dial and flywheel. Scales 6" on 8" plate..... New each 95c

C-18—Antenna coil assembly slug tuned used in BC 603 receiver. Frequency range 20-27.9 Mc. fully shielded..... New. 10 for \$1.95

I82 F—Five Inch 360 degree compass indicator and Selsyn receiver..... New \$4.95

A-81-2 Transmitter selsyn for I82 indicator... \$2.45 (Both I82F & Trans. Selsyn for \$7.00)

RC 100—Complete or components parts available—Price upon request.

ARROW SALES, Inc.

Dept. N
1712-14 S. Michigan Ave., Chicago 16, Ill.
PHONE: Harrison 7-9374



WE HAVE LARGE QUANTITIES OF RADIO TUBES

TYPE	TYPE	TYPE	TYPE	TYPE	TYPE	TYPE	TYPE	TYPE
1LN5	6AB7	6B8G	6J5	6SG7	12A6	803	813	
IR5	6AC7	6C4	6J5GT	6SH7	12SK7	805	866A	
IS4	6AL5	6CSGT	6K6GT	6SK7	12SR7	807	9005	
IT4	6B8	6C6	6K7GT	7Q7	42	808		

Packed in Original Cartons
Substantial Discounts on Large Orders
Prices on Request

All tubes are brand new standard brands. This offer subject to change without notice and prior sale. Terms: 25% deposit with order, balance C.O.D. \$25.00 minimum order.

MANUFACTURERS: Interested in EXPORT? CONTACT: MICHEL LEVIT

METROPOLITAN OVERSEAS SUPPLY CORPORATION

MANUFACTURERS AND DISTRIBUTORS OF ELECTRONIC PRODUCTS

1133 BROADWAY, NEW YORK 10, N. Y. CHELSEA 3-1105

Good

THE PERFORMANCE — PROVED LINE

Don Good Products are acknowledged performance products—precisely engineered for their job—and with a wealth of experience behind their building. They do what they're "planned" to do. That's why you'll be pleased with them.

NEW, GOOD HI-PASS TELEVISION FILTER*



ELIMINATES or GREATLY REDUCES INTERFERENCE which may be picked up by I.F. Amplifier or TV Receiver. Effectively eliminates interference arising from strong, local low-frequency fields: Amateur Radio Stations, Diathermy Equipment, X-Ray, Industrial Induction Heaters, Household Appliances, Neon Lights, etc. . . . Pre-tuned at factory. No adjustments required. Easily installed at antenna terminals. In low-loss Polystyrene case. . . . TWO MODELS: No. 300—for 300 Ohm Line. . . . No. 72—for 72 Ohm Line. . . .

CORRECTLY PRICED at \$3.95 LIST

NEW, GOOD VARIABLE TELETRAPS*

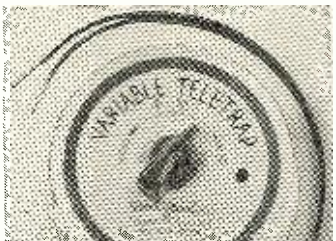

NO. R-301 FM—88 MC to 110 MC. Wonderfully effective for eliminating interference from FM Stations within its tuning range.
NO. R-302 DA. 26 MC to 32 MC. Without an equal for effectively eliminating interference from DIATHERMY and AMATEUR signals within its tuning range.
Both above for quick, simple installation at TV Receiver Antenna Terminals.

CORRECTLY PRICED at \$3.95 LIST

INVESTIGATE *GOODLINE AIRLEAD ELIMINATES 80% OF FEEDLINE DIELECTRIC LOSSES. . . . It's the *AIRLEAD of the FUTURE. Standard close wire spacing and standard nominal 300 Ohm impedance eliminates losses through re-radiation. . . . Also effectively eliminates WET WEATHER LOSSES, too. . . . **FIND OUT ABOUT THIS MOST EFFECTIVE OF ALL LEADLINES. . . . WRITE FOR SPECIAL LITERATURE** giving full information: Features, Specifications, Wire Lengths, etc.

* Patent Pending. * Trade Mark. U.S. & Foreign Patents Pending.

Don Good, INC.

EXCLUSIVE LICENSEE AND
SOLE MANUFACTURER

1014 Fair Oaks Ave. • South Pasadena, Calif.

International Short-Wave

(Continued from page 130)

Peking on 10.260, 11.685, or 15.054V lately; however, should still have *English* news 0835.

Colombia—HJEX, 6.054, Cali, noted with native music evenings. (Russell, Calif.)

Costa Rica—Radio *El Mundo*, 6.153, San Jose, heard to around 2310 or 2315 sign-off; fades in late. (Stark, Texas)

Denmark—OZF, 9.52, Copenhagen, still has *English* to North America 2200-2230 sign-off. (Russell, Calif.)

Dominican Republic—HI2T, 9.730, Ciudad Trujillo, noted 2240 with music; off 2300. (Russell, Calif.) HI2L, measured 3.2528 recently; varies; previous measurement was 3.2438; announced in Spanish at 1830. (Oskay, N. J.)

Dutch New Guinea—The Biak transmitter on 4.895 has been moved to Hollandia where it broadcasts daily 0445-0700 on 15.400 with 500 watts; QRA is De Radio-Omroep Nieuw Guinea te Hollandia, Hollandia, New Guinea. (Radio Sweden)

Ecuador—HCJB, Quito, "The Voice of the Andes," is currently conducting an "Advance Program" to provide additional funds with which it is hoped to be able to increase power to 100 kw. (highest-powered transmitter of HCJB at present is 10 kw.) and to acquire new, enlarged grounds which will allow for higher-gain antennas. (Wadhams, Calif.) The 12.455 channel has strong signal in South Africa at 2300. (Hannaford)

HC1PM, 5.726, Quito, heard with native news 1830-1845, *English* program 1845-2000. (Sutton, Ohio)

Egypt—SUX, 7.8606, Cairo, recently was noted at 1800, which is beyond normal operating schedule; on that

particular Sunday did not sign off until 1830. (Oskay, N. J.) Heard in Bermuda at 1520 with Arabic program. (Arnold)

El Salvador—YSR, 6.2655, San Salvador, noted with dance music 0230; also heard around 2000. (Russell, Calif.) YSUA, 6.255, San Salvador, noted 2150-2205, another day at 1822-1830; all-Spanish; strong signal in Georgia. (Patterson)

French Camerouns — FIA6, 9.150, Douala, noted with recordings 1430-1515 sign-off. (Sutton, Ohio)

French Equatorial Africa — Radio *Brazzaville*, 15.595, heard with news for Middle East and Europe 0515-0530; announced as parallel in 31-m. band. (Pearce, England) The 25-m. outlet recently was measured 11.9705 at 2015 and on another occasion at 1910; previous check showed it to be on 11.972. (Oskay, N. J.)

French Indo-China—Station heard on 6.165 with news 0830 may be "Voice of Vietnam." (Stark, Texas) Saigon, 11.830, noted with news 0500 and signing off 0515. (Pearce, England; Balbi, Calif.)

Direct from Jean Pipon, head of the *English* Department, Radio France *Asie* ("Voice of France in the Far East"), 86, Rue Mac-Mahon, Saigon, South Vietnam, Indo-China, I have received this message—"Re our 31-m. outlet, we do list it as 9.524 and that is exactly what it should be. However, the use of this frequency, which is *new* to us, being only at the test stage, no quartz control has been installed so far and the autoscillator with which it is fitted is—like all autoscillators—subject to variation. This explains that we are heard, in the 31-m. band, on rather irregular frequencies." Listed newscasts in French for 1715-1730, 9.524, to Europe; 1815-1845, 9.524, 6.116, to South East Asia; 1915-1930, 9.524, 6.116, to South East

Broadcasting "United Nations Radio Newsreel." Director Everett Ball and Engineer George Rateau are in control room while Oscar Rose and Michael Haywood man the mike.



Asia; 2115-2130, 11.780, to India; 2345-2400, 9.524, to South East Asia; 0700-0735, 9.524, to South East Asia, and 1015-1030, 11.780, 9.524 (relay from Paris). Newscasts in *English* were listed for 1730-1800, 9.524, to Europe; 1930-2000, 9.524, to South East Asia; 0500-0515, 11.830, to Australia-New Zealand, and 0900-0915, 11.780, to India. And in Chinese—Mandarin—1845-1900, 9.524, to South East Asia; 2245-2300, 9.524, to South East Asia, and 0400-0415, 9.524, to South East Asia; in Cantonese, 2245-2300, 6.116, to South East Asia; 0415-0430, 6.116, to South East Asia; 0745-0800, 6.116, to South East Asia. Also listed *English* talks and music at 0420-0500, 11.830, for Australia-New Zealand.

French Morocco — *Radio Maroc*, 6.005, noted 1740 with music, at 1800 with chimes followed by "Le Journal de Morocaine" (news in French), and signing off 1805 with "La Marseillaise." Also noted signing on 0200 and with news in Arabic 0300, off 0330. (Pearce, England)

Germany—*Radio Free Europe*, 6.130, signs on with bells 1020; gives calls in Bulgarian, Hungarian, Roumanian, Czech, Polish at 1023 before beginning program at 1030. (Pearce, England) Hamburg, 7.29, heard with weak signal 0100. (Brown, Conn.)

Greece—Current schedule received from *Radio Athens*, "The Voice of Greece," is 2000-2100, 9.607 directed to U.S.A. (*English* and Greek); 0000-0230, 6.177 (Greek); 0430-0830, 9.607 (Greek); 1000-1200, 6.177 (Greek); 1230-1400, 7.300 (Balkan languages); 1430-1445, 9.607 (*English*); 1445-1500, 9.607 (French); 1530-1700, 6.177 (Greek). (Maurice, N. Y.)

Larissa, 6.745, is coming in well 0045-0200 sign-off; some QRN. (Saylor, Va.)

Sutton, Ohio, reports *Radio Macedonia*, 7.950, with talks in Greek and music 0000-0100.

Guatemala—Guatemala City, 6.2925, noted with orchestral music 0100. (Russell, Calif.) This may be the station noted by Bellington, N. Y., on approximately 6.285 at 0015 when man announced as "Radio Internacional."

TGNA, 9.660 (at times seems high as 9.670), Guatemala City, has Mail Bag session (*English*) Wednesdays 2230-2245; other nights signs off 2230. (Bellington, N. Y.) Roberts, Texas, says this one has started to issue QSL cards instead of (former) letter-verification and that DX-ers who have already received letter-verifications should write again to TGNA for a QSL card.

Haiti—4VRW, 9.8385, Port-au-Prince, noted 1900 with classical music, French announcements. (Russell, Calif.) 4V2S varies in frequency, recently was measured 5.9554 at 1835 when had musical program; previous measurement was 5.9514. (Oskey, N. J.) 4VEH noted signing on 1900 on approximately 9.727 with strong signal. (Bellington, N. Y.) This *new* channel varies; measured 9.751V at 1757, and 9.7463 at 0700. (Oskey, N. J.)

Holland—Hilversum noted on 11.73

March, 1951



WANTED!

Yes, the revolutionary new TRIO TV Yagi — the only yagi that provides 10 DB gain on each of two channels — is America's most wanted antenna in weak signal areas.

This lightweight, compact array, which gives metropolitan quality TV reception in fringe areas, is available for channels 4 and 5 in the low band, and channels 7 and 9 in the high band.

OUTSTANDING FEATURES

- Provides gain on both channel 4 and 5 (or 7 and 9). Equal to any two conventional 4-element yagis!
- One bay replaces bulky stacked array!
- One lead replaces old-style 2-lead systems!
- Less weight-per-gain than any other TV antenna!
- Greatly reduced installation costs for complete TV coverage!
- Can be stacked for additional gain.

HOW IT WORKS

Antenna consists of 4 elements whose function is different on the two channels. In Model 445, the elements, on Channel 4, act as reflector, dipole, director, director, in that order. On Channel 5, the same elements act as reflector, reflector, dipole and director. Careful design insures proper impedance match with standard 300 ohm lead.

Eliminates Co-Channel Interference • Venetian Blind Effect . . . When Used With Trio "Controlled Pattern" System

This unique, "Controlled Pattern" system uses 2 bays, off-set stacked and tuned with the remarkable TRIO "Phasitron". High gain and front to back ratio of the new single or stacked yagi eliminates most co-channel interference.

When the TV receiver is located in the center of several TV stations operating on the same channel, co-channel interference CAN BE COMPLETELY eliminated with the use of the "Controlled Pattern" system.

When other antennas fail, try TRIO — America's MOST WANTED TV Antenna!

- Model 445 • Single bay Yagi for Channels 4 and 5.
- Model 445-2 • Conventional 2 bay stacked array for Channels 4 and 5.
- Model 479 • Single bay Yagi for Channels 7 and 9.
- Model 479-2 • Conventional 2 bay stacked array for Channels 7 and 9.
- Model 645 • "Controlled Pattern" System for Channels 4 and 5, and Model 679 for Channels 7 and 9.

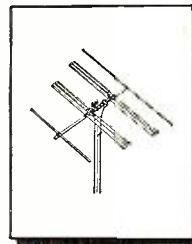

Single 4-element yagi with dual purpose elements. Provides high gain on two channels.



Two of the new TRIO yagis may be stacked to get up to 12 DB forward gain.

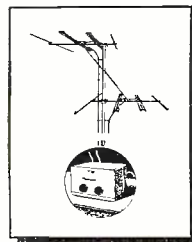

The "Controlled Pattern" System—eliminates "Venetian-Blind effect" when caused by co-channel interference.

- TELEVISION TUBES
- All types of HARD-TO-GET receiving tubes available
- BEST PRICES - STANDARD BRANDS
- SCIENTIFIC TUBE CO.
- 3029 Webster Ave. New York 67, N. Y.

COUPON-OF-THE MONTH

TUBES—STD. BRAND 5Y3 CT.	3 for \$0.99
TUBES—STD. BRAND 3Z25 or 35W4	2 for .99
VOL. CONTROLS—STD. BR. .5 Meg. W. SW	3 for .99
CONDENSERS—40-40 Mfd. 150V.	2 for .99
CONDENSERS—40-20 Mfd. 150V. EP.	2 for .99
LOOP ANTENNA—HI GAIN (3"X8")	3 for .99
SAPPHIRE PHONO NEEDLES (list \$2.50)	2 for .99
OSC. COILS 455 KC (for 12SA7)	4 for .99
BY PASS COND. KIT—18 Ass'd.	.99
DIAL CORD KIT—100 Ft. Ass'd. & 6 Springs	.99
GRILLE CLOTH—6 Ass'd. 6"X6" & 10 Knobs	.99
● COMBINATION KIT—All above items—Only	10.00

WITH THIS COUPON—ORDER AT ONCE
Write for Monthly Coupons and Bulletin
RADIO DISTRIBUTING CO., Pasadena 18, Cal.

No Experience Needed To
**PRINT YOUR OWN
POST CARDS**

The GEM STENCIL DUPLICATOR saves money... gets results quickly! Hundreds of uses for every type of business and organization. We ship the GEM complete with all supplies, Guide Board for accurate printing and 60-page Book of Ideas at the special low price of only **\$8.50** (a \$15.00 value)

FREE TRIAL OFFER

Use the GEM FREE at our expense! SEND NO MONEY. Write and complete GEM outfit will be sent you postpaid. After ten days, send us only **\$8.50** or return the GEM. You must be satisfied! WRITE TODAY.

BOND EQUIPMENT CO. Dept. 52
6633 Enright • St. Louis 5, Mo.

Our
21st Year



VIBRATORS!

By every test

ATR

is Best!

**ATR
AUTO RADIO
VIBRATORS**

have Ceramic Stack Spacers



Free



A COMPLETE LINE OF VIBRATORS . . .

Designed for Use in Standard Vibrator-Operated Auto Radio Receivers. Built with Precision Construction, featuring Ceramic Stack Spacers for Longer Lasting Life. Backed by more than 19 years of experience in Vibrator Design, Development, and Manufacturing.

**ATR PIONEERED IN THE
VIBRATOR FIELD.**

**NEW MODELS NEW DESIGNS
NEW LITERATURE**

"A" Battery Eliminator, DC-AC Inverters
Auto Radio Vibrators

See your jobber or write factory

ATR

AMERICAN TELEVISION & RADIO CO.
Quality Products Since 1931
SAINT PAUL 1, MINNESOTA-U. S. A.

and 15.22 with service in *English* to India at 1100. (Russell, Calif.)

Honduras—HRN, 5.884, noted 1900 with CWQRM. HROW, 6.020, "*Radio Montserat*," Tegucigalpa, noted around 2115 in Spanish. (Patterson, Ga.)

India—VUM2, Madras, sent letter-*verie*, photo, schedules by airmail. Schedules were listed 2030-2145, 7.260, 6.085; 0130-0200, 9.590; 0200-0415 weekdays, 0230-0430 Sats., 0230-0630 Suns., 7.260, 9.590; 0530-0630, 7.260, 9.590; 0630-1200 daily, 6.085, 4.920. VUB2, 4.840, Bombay, heard around 1115 to 1200 or 1230 sign-off.

Israel—Tel-Aviv, 9.0108, still noted in French 1615-1700, then *English* to 1745 closedown. (Maurice, N. Y.; Harris, Mass.)

Italy—Rome, 21.500, heard with news 0600 followed by songs (these in Italian); is beamed to Far East; excellent level in England. (Catch) A station heard afternoons (*EST*) on approximately 3.960 is definitely Rome (harmonic?); seems to relay Home Service in parallel with 6.245. (Peddle, Newfoundland)

Jamaica—At the time this was written *Radio Jamaica* was still using 3.360 (instead of former 4.950) evenings to 2300 closedown.

Japan—JKI4, 11.80, noted 2000 with news, at 2115 with news at dictation speed. (Don Baker, Calif.) JKI3, 6.175, and JKL, 4.860, sign on 0300. (Balbi, Calif.) Present AFRS schedule is 1600-0300 over JK14, 11.800 and JKL2, 9.605; from 0300 on JKI3, 6.175, and JKL, 4.860. (Cushen, N. Z.)

JKJ, 7.284, noted 0135 with talk in Japanese; JKH, 7.2578, heard 0120 with man in native talk, also heard around 0900-0930. (Russell, Calif.)

Kashmir—*Radio Kashmir*, 4.860, Srinagar, noted from around 1000; Indian music with vocals; AIR news relay 1030-1045; generally has woman announcer; Indian music from 1045; fades out soon after 1100, but probably closes down 1140. (Pearce, England)

Kenya Colony—The Forces Broadcasting Service, McKinnon Road, is scheduled now on 7.180 daily at 2200-0000, 0430-0630, 0900-1400 weekdays; 0000-1400 Sundays. (Radio Australia)

Korea—At the time this was compiled, Balbi, Calif., was hearing a station with weak level around 0600-0700 on 4.400, probably Pyongyang. Watch for former HLKA, 7.933, Seoul, and/or the 2.510 Seoul outlet around 0500-0700 or later.

Lebanon—Beirut, 8.036, noted with *English* program daily 1000-1100. (Pearce, England)

Liberia—The Liberian Broadcasting Company, Monrovia, radiates on 6.025, starting with *English* 0300. (DX-AREN, Sweden)

Madagascar—*Radio Tananarive*, 9.515, has strong signal in South Africa at 2300. (Hannaford)

Malaya—*Radio Malaya*, 6.025, Kuala Lumpur, noted 0530 with chimes, followed by program schedule. (Balbi, Calif.) Should have news 0630.

Malta—FBS, Middle East, at close around 0200 on 6.015 and 7.220 says

MORE THAN
50,000 TV SETS
MONTHLY

rightly rely on

JSC 300 ohm TELEVISION TRANSMISSION WIRE

J S C

TWIN LEAD

300 ohm

Television

Transmission

Wire

TV manufacturer, installation engineer, TV sponsor and televiewer all form an inseparable chain, securely linked by the world's finest television transmission wire. J S C is justly proud of its important role in the development and progress of television. Rigid adherence to the principle of "quality before quantity" will pave the way to greater accomplishments for J S C! Write for Descriptive Pamphlet.

Jersey Specialty Co.
LITTLE FALLS NEW JERSEY
All Phones: Little Falls 4-0784, 1404, 1405

Specialized Service Men

CRYSTALS FOR LESS! If you are servicing aircraft, marine, police, mobile or industrial radio you may be entitled to our SPECIAL DISCOUNT on highest quality quartz control units. Write for full details . . . it will mean money to you!

RADIO SPECIALTY MFG CO. Dept. RT
2023 S.E. Sixth Ave. Portland 14, Oregon

**5U4G's
WHILE THEY LAST**

\$1.60 Post Paid

BELLE MEAD ELECTRONICS

Belle Mead, N. J. Phone: Belle Mead 8J2

COAXIAL CABLE CONNECTORS

83-1AP . . . \$.30	83-1SP . . . \$.45	83-168 . . . \$.15
83-1P . . . 1.30	83-1SPN . . . 50	83-185 . . . 15
83-1R09	83-1T . . . 1.30	UG-27/U . . . 63
83-1J80	83-22AP . . . 1.10	UG-58/U . . . 63
83-1R40	83-22R48	UG-85/U . . . 88

Others in stock. Write for prices.

AN CONNECTORS—IMMEDIATE SERVICE

Phone! Wire! Write! Your Needs.

1N34 CRYSTAL 79c

VERNIER DIAL or DRUM (from BC-221)

DIAL—2 5/8" dia. 0-100 in 360°. Black with silver marks. Has thumblock. **DRUM**—0-50 in 180°. Black with silver marks either 85c

SELSVN 2J1G1—Brand New—400 Cyc. \$2.25

SOUND POWERED Handsets—Including 6 ft. cord with each \$17.60 pr.

THROAT MIKE (MT 81-A), 2 mikes in leather zipper case with 56" cord & PL68—Brand New 59c

CARBON MIKE T-17, slightly used—Guaranteed—Has 5 ft. cord and PL68 89c

GEAR ASST.—100 small sizes. Mostly stainless steel or brass. Experimenters' dream! Only \$6.50

Minimum Order, \$3.00—All Orders F.O.B. Philadelphia

RELIANCE Merchandizing Co.
2221 Arch Street Philadelphia 3, Pa.
Telephone: Rittenhouse 6-4927

RADIO & TELEVISION NEWS

will re-open 0430 on 7.220, 11.895, and 3.305; heard at 1300 on 3.305 with news relay from BBC, parallel 7.220, 6.015. (Pearce, England) Bluman, Israel, says Malta's third transmitter has been carrying out tests on channels of 15.125, 11.710, 7.270, 6.140, 4.965, and 3.305. (Radio Australia) Noted on 7.270 at 1515, good level. (Dary, Kans.) Heard on 11.895 signing off 1100, then on 7.220. (Baines, Nova Scotia)

Mauritius—V3USE, 15.060V, noted 1050 with songs; heard erratically to 1230 when closes with "God Save the King." (Pearce, England) Is good level in South Africa around 1015-1045. (Hannaford) Heard recently in New Jersey around 1030. (Oskay)

Mozambique—Lourenco Marques, 11.764, noted recently 1100-1200 with musical request program in *English*; extended schedule? (Don Baker, Calif.) CR7BG, 15.191, Lourenco Marques, is heard daily with good signal from around 1130. (Arnold, Bermuda) Signs off 1500. Recently was measured 15.1857V by Oskay, N. J., whose previous measurement was 15.1916.

New Caledonia—Radio Noumea, 6.035, noted signing on with "La Marseillaise" at 0200, followed by French announcement; strong signal in Calif. (Don Baker)

Nicaragua—YNDG, approximately 7.648, heard with announcement in *English* at 2100.

Norway—Oslo is now using both LLM, 15.175, and LKV, 15.170. Complete schedules are available from Short-Wave Division, Radio Norway, Oslo, Norway. (Radio Sweden)

Pakistan—Present schedule for *Radio Pakistan*, Karachi, is listed 2105-2330, 9.445; 2105-2300, 15.335; 2235-2300, 9.755; 0110-0330, 17.770; 0130-0330, 11.885; 0700-0830, 11.885; 0700-0720 and 0730-0830, 17.770; 0830-0945, 15.250; 1000-1130, 7.096; 1100-1330, 11.885; news at 2105, 0110, 0210, 0700, 1015, 1230; local and sports news at 0825 on 11.885 *only*, programs in *English* may be heard at 0300 daily, a request program being transmitted at that hour on Saturdays. (Radio Australia) Still noted on 7.140 with news 0700. (Maurice, N. Y.) At times is heard parallel on approximately 11.570, 11.845.

Peru—OAX4V, 5.908, Lima, noted 2100 with audience participation program; heavy CWQRM occasionally. OAX4Z, 5.898, Lima, noted 2050 with American popular music. (Russell, Calif.) OAX4W, 9.3953, Lima, measured here recently at 1850; previous measurement was 9.3903; announces as "Radio America." (Oskay, N. J.)

Philippines—DZH2, 9.64922 (relaying DZRH, 650 kc.), noted around 1030 with American popular recordings. (Russell, Calif.)

DZH5, 9.690, Manila, has news 0515; schedule is 0500-0900; is under *new* ownership now and has *new* slogan of "The Voice of Catholic Philippines;" relays DZST, 860 kc. DUH2, 6.170, Manila, "The People's Station," operates 1600-1100; is 1 kw.; relays m.w. DZFM; other outlets are 9.620 and

March, 1951

SELENIUM RECTIFIERS and ASSOCIATED COMPONENTS

SINGLE PHASE Full Wave Bridge

Input: 0-18 VAC		Output: 0-12 VDC	
Type No.	Current	Price	
B1-250	250 Ma.	\$.98	
B1-1	1.0 Amp.	2.49	
B1-1N5	1.5 Amp.	2.95	
B1-3N5	3.5 Amp.	4.50	
B1-5	5.0 Amp.	5.95	
B1-10	10.0 Amp.	9.95	
B1-20	20.0 Amp.	15.95	
B1-30	30.0 Amp.	24.95	
B1-40	40.0 Amp.	27.95	
B1-50	50.0 Amp.	32.95	

Input: 0-36 VAC		Output: 0-26 VDC	
Type No.	Current	Price	
B2-150	150 Ma.	\$.98	
B2-250	250 Ma.	1.25	
B2-300	300 Ma.	1.50	
B2-2	2.0 Amp.	4.95	
B2-3X5	3.5 Amp.	6.95	
B2-5	5.0 Amp.	9.95	
B2-10	10.0 Amp.	15.95	
B2-20	20.0 Amp.	27.95	
B2-30	30.0 Amp.	36.95	
B2-40	40.0 Amp.	44.95	

Input: 0-115 VAC		Output: 0-90 VDC	
Type No.	Current	Price	
B6-250	250 Ma.	\$ 2.95	
B6-600	600 Ma.	5.95	
B6-750	750 Ma.	6.95	
B6-1X5	1.5 Amp.	10.95	
B6-3X5	3.5 Amp.	18.95	
B6-5	5.0 Amp.	24.95	
B6-10	10.0 Amp.	36.95	
B6-15	15.0 Amp.	44.95	

Full Wave Center Tap

Input: 10-0-10 VAC		Output: 0-8 VDC	
Type No.	Current	Price	
C1-10	10.0 Amp.	\$ 6.95	
C1-20	20.0 Amp.	10.95	
C1-30	30.0 Amp.	14.95	
C1-40	40.0 Amp.	17.95	
C1-50	50.0 Amp.	20.95	

THREE PHASE

Full Wave Bridge

Input: 0-234 VAC		Output: 0-250 VDC	
Type No.	Current	Price	
3B13-1	1.0 Amp.	\$ 22.00	
3B13-2	2.0 Amp.	32.00	
3B13-4	4.0 Amp.	56.00	
3B13-6	6.0 Amp.	81.50	
3B13-10	10.0 Amp.	105.00	
3B13-15	15.0 Amp.	120.00	

Powerstats



Smooth, efficient voltage control 0 to 135V output from 115V. AC line. Type 20 3 Amps. \$12.50 Type 116 U

(Illustrated) for panel mtg. 7.5 Amps. \$18.00 Type 1126 15 Amps. \$46.00 Type 1156 45 Amps. \$118.00 Also available for 230 volt input. Write for descriptive literature.

71-3 WARREN ST., NEW YORK 7, N. Y. PHONE: BEekman 3-7385-6

POWER SUPPLIES

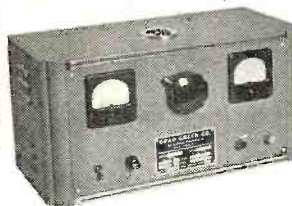

GENERAL PURPOSE low voltage DC power supplies, with variable outputs. Rugged—Dependable—Precision Control.

- ✓ Long life FULL WAVE SELENIUM RECTIFIERS
- ✓ Output voltage continuously adjustable from zero to maximum
- ✓ 3" Voltmeter and Ammeter—2% accuracy
- ✓ Stepless control
- ✓ Instant Power—no warm-up period
- ✓ Dimensions: 8 3/4" x 16 1/2" x 8"
- ✓ Assembled and Ready to Operate
- ✓ For 115 VAC 60 cycles

Write for descriptive bulletin GPA Model Voltage Current
GPA810 0-8 VDC 10 Amps.
GPA1210 0-12 VDC 10 Amps.
GPA2810 0-28 VDC 10 Amps.

RECTIFIER CAPACITORS

CF-1	1000 MFD	15 VDC	\$.98
CF-2	2000 MFD	15 VDC	1.69
CF-7	3000 MFD	35 VDC	3.25
CF-19	500 MFD	50 VDC	1.95
CF-16	2000 MFD	50 VDC	3.25
CF-21	1200 MFD	90 VDC	3.25
CF-10	500 MFD	200 VDC	3.25

Mounting clamps for above capacitors. 15c ea.

RECTIFIER TRANSFORMERS

All Primaries 115 VAC 50/60 Cycles

Type No.	Volts	Amps.	Shpd. wt.	Price
TNF36-2	36	2	6 lbs.	\$ 4.95
TNF36-5	36	5	8 lbs.	6.50
TNF36-10	36	10	12 lbs.	9.95
XFC18-50	18VCT	50	17 lbs.	18.95
TNF36-20	36	20	25 lbs.	17.95
XFC18-14	18VCT	14	10 lbs.	6.95
XFC18-50	18VCT	50	17 lbs.	18.95

All TNF Types are Tapped to Deliver 32, 34, 36 Volts. XFC Type is Tapped to Deliver 16, 17, 18 Volts Center-tapped.

RECTIFIER CHOKES

Type No.	Hy.	Amps.	DC Res.	Price
HYX6	.055	600MA.	2.0	\$ 1.50
HY5A	.028	5	.20	5.25
HY10A	.014	10	.04	9.95
HY20A	.007	20	.02	13.95

ATTENTION MANUFACTURERS

We are in a position to furnish Selenium Rectifiers, in quantity, to specifications. Excellent delivery, prompt quotations.

All prices FOB our N. Y. C. warehouse. Send M.O. or check. ONLY shipping charges sent COD. Rated concerns send P.O., Terms Net 10 days.

Opad-Green COMPANY

RADIO ENGINEERING 27 MONTHS DEGREE IN 27 MONTHS

Radio engineering is a big field. There's room for you in it—if you're good. Get first-class training at Indiana Tech. Intensive specialized course, including strong basis in mathematics and electrical engineering, advanced radio theory and design, television. Modern laboratory. Low tuition. Also 27-month courses in Aeronautical, Chemical, Civil, Electrical and Mechanical Engineering. Approved for G.I.'s. Enter March, June, September, December. You can earn part of your expenses right here in Fort Wayne while you are studying.

INDIANA TECHNICAL COLLEGE

931 E. Washington Blvd., Fort Wayne 2, Indiana
Please send me free information on B.S. Engineering Degree in 27 months as checked.

- Radio-Television Aeronautical
 Civil Mechanical Electrical

Name _____
Address _____

SENSATIONAL NEW BOOK

ELEMENTS of SINGLE and DUAL TRACK MAGNETIC TAPE RECORDING and 1001 APPLICATIONS

by A. C. Shaney

INFORMATIVE! INSTRUCTIVE! INTERESTING!

ONLY \$1.00 POSTPAID

The book that brings you up-to-date on tape recording. Complete history, theory, design and uses. 144 pages of FACTS!

Order today. Remit with order, please. Booklet mailed same day.

AMPLIFIER CORP. of AMERICA
398-2 Broadway, New York 13, N. Y.



Special Offer On This Complete RADIO ENGINEERING LIBRARY

New, Up-To-Date Edition of Famous Library Covers Whole Field of Radio Engineering. Places Latest Facts, Standards, Data, Practice, and Theory At Your Fingertips.

THE five big volumes of the new edition of the Radio Engineering Library now include the very latest facts, standards, data, and practice. This Library will help solve hundreds of problems for designers, researchers, engineers, and students in any field based on radio.

Written by leading radio engineers, these books cover circuit phenomena, networks, tube theory, vacuum tubes, amplification, measurements, etc.—give specialized treatment of all fields of practical design and application. They provide you with a complete and dependable encyclopedia of facts.

5 Volumes • 3872 Pages • 2770 Illustrations

- Eastman's FUNDAMENTALS OF VACUUM TUBES, 3rd Edition.
- Terman's RADIO ENGINEERING, 3rd Edition.
- Everitt's COMMUNICATION ENGINEERING, 2nd Edition.
- Hund's HIGH FREQUENCY MEASUREMENTS, 2nd Edition.
- Henney's RADIO ENGINEERING HANDBOOK, 4th Edition.

SEND NO MONEY

Special Low Price • Easy Terms

On this special offer you get this Library for \$34.50, instead of \$39.00. You save \$4.50 and may pay on easy terms. Mail coupon below to examine the Library FREE for 10 days. No obligation. These books are recognized as standard works; you are bound to need them. So take advantage of this special money saving offer. *Mail coupon at once!* McGraw-Hill Book Co., Dept. RTN-3, 327 W. 41st Street, New York City.

**McGraw-Hill Book Co., Dept. RTN-3,
327 West 41st St., New York 18, N. Y.**

Send for 10 days' FREE trial, the RADIO ENGINEERING LIBRARY. If not satisfied I will return books. Otherwise I will send \$4.50, plus delivery charges, then; and \$5 a month for 6 months. (Reg. price \$39.00; you save \$4.50.)

Name.....

Home Address..... RTN-3

City & State.....

WE'LL PAY DELIVERY CHARGES if you enclose \$4.50 first payment WITH coupon. Same return privilege for full refund.

11.840, both now inactive. DZV2, Mindanao Broadcasting System, Davao City, is the correct call of this station operating on 3.950. (Cushen, N. Z.)

Far East Broadcasting Co., 15,300, Manila, signs on 1800 with religious program; has severe QRN, some CWQRM. (Russell, Calif.)

Poland—Warsaw, 9.57, heard signing off 0830 after program in Russian. (Radio Sweden) *English* for U.S.A. still opens on 6.115 daily at 1930, 2300, 0030. (Bellington, N. Y., others)

Portugal—Lisbon has been noted widely on approximately 11.980 lately, parallel 11.027, afternoons (EST) to closedown 1800.

Is definitely using 6.360 lately. (Bellington, N. Y.) The 19-m. channel was measured recently as 15.3865V at 0710; previous measurement was 15.3792. (Oskay, N. J.)

Portuguese Guinea—CQM7, 6.993, Bissau, is again in use; appears to have replaced CQM4, 5.8392; the 6.993 channel noted 1650 with American recordings. (Oskay, N. J.) Schedule is 1630-1800.

Roumania—Radio Bucharest heard lately with news 1400 on 9.252, 6.210; announces daily *English* period for 1400 in the 32-, 25-, 48-, and 50-m. bands. (Pearce, England) The 9.252 channel noted in N. Y. at 1430 in French. (Maurice)

South Africa—Don Baker, Calif., recently heard for one day only, SABC with news 1200 on approximately 11.927; asked for reports and may have been a test transmission.

Southern Rhodesia—Airmail verie from Salisbury asked for further reports; said the 6.018 channel was out of service for a while for modification, and that is using 3.320 local "evenings" and 7.280 local "daytime." (Pearce, England)

Spain—Radio Falange de Alicante heard recently near 8.130 with recordings at 1400, another day at 1500 with varied recordings and at 1545 with a relay from Radio Nacional, Madrid. Radio Mediterraneo de Valencia, 7.037, noted Tuesdays and Fridays with *English* Lesson 1445-1500. (Pearce, England) By this time, Radio Nacional de Espana, Malaga, 7.022, should have programs in *English* at 1600, at least on some days. (Radio Sweden)

Syria—Sutton, Ohio, says Damascus, 9.525, is partly readable during news period 1530-1540; is better after 1545.

Tahiti—Radio Tahiti, 12.080, Paapeete, is seldom heard in its daily 2300-2345 schedule, but the 6.982 outlet is heard at fair level daily. (Balbi, Calif.)

Taiwan—BED9, Taipei, was recently measured at 0645 on 7.132; frequency varies, previous measurement was 7.1338. (Oskay, N. J.) Still noted with *English* 0630, French 0645. (Maurice, N. Y.) The 11.725 channel noted 2345 with *English* broadcast. (Don Baker, Calif.) Still has *English* daily 2300-2400 on 15.235, 11.725; continues in Chinese after 0000. (Russell, Calif.) Transmission ends 0100.

Tangier—Pan American Radio,

FREE! LATEST ISSUE OF "TV SERVICE NEWS"

Yours For 3¢ Postage

Now! Get your FREE copy of TV SERVICE NEWS—have latest TV data at your finger tips!

This valuable bulletin gives you practical time- and money-saving TV servicing short-cuts, up-to-minute service techniques, facts on TV circuits and systems. Plus many other helpful details. Easy to read. Illustrated. Latest issue is yours FREE!

ACT NOW! Get FREE Copy. Mail name, address and 3¢ stamp for postage. Offer limited. WRITE TODAY!

TELEVISION COMMUNICATIONS INSTITUTE
205 W. Wacker Dr. Dept. 100 Chicago 6, Ill.

TELEVISION

PREPARE FOR A GOOD JOB!
BROADCAST ENGINEER
COMMERCIAL OPERATOR (CODE)
RADIO SERVICEMAN

Television Servicing

(Approved for Veterans)
SEND FOR FREE LITERATURE
BALTIMORE TECHNICAL INSTITUTE
1425 EUTAW PLACE, BALT. 17, MD.

4-CHANNEL E.C.O.

Channel 1 1050-1700 KC | Channel 3 3000-4800 KC
Channel 2 2000-3400 KC | Channel 4 4370-7000 KC
Unit is the front end of the TA-12D aircraft transmitter add an 807 intermediate power amplifier and 2 807 for power amplifier you have a 50 watt transmitter, each channel is complete with 12SK7 tube is a complete oscillator with variable condensers, etc., each channel shielded all mounted on one chassis ready to add voltage.
BRAND NEW ORIGINAL BENDIX PACK, \$9.95 EACH
McCONNELL'S 3834 Germantown Ave.
Phila., Penna. RA 5-6033

SCHEMATICS—CONVERSIONS FOR SURPLUS GEAR

NEW LIST! MANY ADDITIONS!

Send stamped, self addressed envelope for List B. Add 25¢ for chart explaining AN nomenclature.

R. E. GOODHEART 345 1/2 N. PALM DRIVE
BEVERLY HILLS, CALIF.

SHOOT TV TROUBLE FAST!

With H. G. CISIN'S RAPID "TV TROUBLE SHOOTING METHOD"

EARN more money! Locate television troubles by this quick, entirely new method. Rapid checks enable you to locate all faults in record breaking time regardless of make or model! 160 Picture, Raster, Sound trouble symptoms. Over 100 Rapid Checks including over-all alignment checks, 20 illustrations: simplified step-by-step directions!

H. G. CISIN, well-known to radio men as a recognized electronic engineer, inventor, technical author and educator, has trained thousands of television technicians, many of them now owning their own prosperous TV service organizations. The results of his years of experience are embodied in this remarkable TV TROUBLE SHOOTING METHOD.

INCREASE your earning power with the most valuable aid to TV servicing ever written! SEND YOUR NAME AND ADDRESS TODAY WITH ONLY \$1.00 FOR YOUR POSTPAID COPY.

RUSH COUPON NOW!

H. G. CISIN, CONSULTING ENGINEER, Dept. RN
200 Clinton Street, Brooklyn 2, N. Y.

Enclosed is \$..... for which please rush copies (postpaid) of your TV TROUBLE SHOOTING METHOD.

Name.....

Address.....

City..... Zone..... State.....

RADIO & TELEVISION NEWS



"United Nations Calling the Peoples of the World." A bilingual French and English U.N. radio commentator broadcasts from radio booth in Security Council Chamber as radio reporter at left takes notes for news bulletin and radio engineer (right) monitors transmission. This direct broadcast is only one of U.N. Radio services.

15.048, is still testing; noted to 0835. (Radio Sweden)

Trans-Jordan—The Hashemite Broadcasting Service, Ramallah, has *English* at 1000-1100 over 7.058. (DX-AREN, Sweden)

Turkey—TAP, 9.465, Ankara, has news 1445. TAV, 17.840, and TAQ, 15.195, noted signing on in *English* for Turkish Forces in Korea at around 0515, followed by news and music in Turkish; TAV appears to leave the air around 0600 but TAQ continues to 0700 when signs off with *English* announcement. (Pearce, England)

Radio Ankara lists calls and frequencies as TAN, 6.000; TAM, 7.240; TAP, 9.465; TAK, 11.760; TAQ, 15.195, and TAD, 17.720, for its 25 kw. transmitter. Lists TAS, 7.285; TAT, 9.515; TAO, 11.880; TAU, 15.160; TAV, 17.840, and TAX, 21.660, for its new 100 kw. transmitter. (N. Z. DX Times)

USA—U. S. Coast Guard Station NMJ, 2.638, Point Higgins, Alaska, carries voice transmissions daily 0100 and 1300; officer-in-charge, B. Dallinger, is eager to hear from *distant* short-wave listeners who hear these broadcasts. (Radio Sweden)

USI—YDF, 6.045, Djakarta, noted in England with time signal (pips) and call at 1830, followed by news in Indonesian; excellent level; this seems to be outside normal overseas schedule. (Catch) YDE, 11.77, announces in *English* 1000, then has musical program with *English* announcements. (Stark, Texas)

Radio Sweden reports that Djakarta now has *English* at 0600-0700, 1000-1100, and 1400-1500 on 4.910, 11.770, 15.150.

USSR—*Khabarovsk*, 5.940, noted 0310 with native music. (Russell, Calif.) Home Service on 5.010 is heard from 0100 onwards, good signal in Calif.; Petropavlosk, 6.075, signs on 0300 in Russian, and has Chinese 0545-0615; a Soviet station is heard irregularly on 6.080 in Chinese, signs on 0500, very strong signal. (Balbi) The 6.020 outlet noted 1553 with *English*. (Os-kay, N. J.)

Vatican—HVJ, approximately 9.64, noted 1000-1010 with news; signal strength varies from day to day. (Don Baker, Calif.) Heard signing on at

March, 1951

MORE *New* FE TURES IN CHELSEA'S BETTER-THAN-EVER C-4 CHASSIS

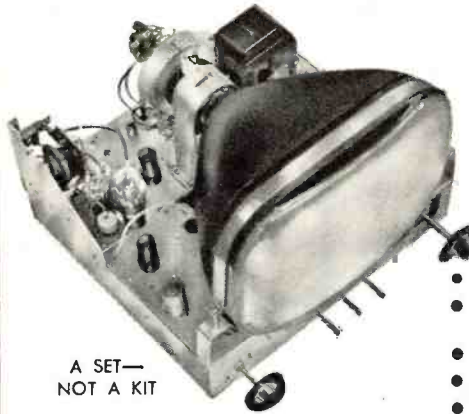

A SET—
NOT A KIT

Our engineers continually strive to improve our famous C-4 Chassis . . . more and more new features each month find their way into the construction of this quality-controlled 1951 chassis . . . now at the peak of operational perfection, yet still priced incredibly low.

FOR
17" —C4-11— **\$124⁹⁵**

round or
rect. tube

plus Fed.
Excise Tax

FOR
20" —C4-13— **\$134⁹⁵**

round tube

plus Fed.
Excise Tax

ALSO AVAILABLE—630 TYPE CHASSIS

New NOISE LIMITER
Circuit added to brilliant
all-station performance

**JUST PLUG IT IN—
AND IT WORKS!**

- Factory-engineered, aligned and tested
- Completely wired, superpowered, noise-limiter circuit
- Improved AFC . . . Keyed AGC
- Improved Single-Knob control
- 13K Anode Voltage
- Front End down to 45 microvolts
- Phono-Jack Switch
- Excellent reception—even on indoor antenna in most areas
- Long range reception—even in fringe areas

**FULL RMA Guarantee
FREE Chelsea Warranty**

Because of conditions due to the national emergency, we recommend that you place your orders immediately . . . don't delay a single day!

**GUARANTEED FACTORY-FRESH
PICTURE TUBES** in sealed cartons:
(Plus Fed. Excise Tax)

16"— round,	\$36 ⁹⁵	17"— rectangular,	\$39 ⁹⁵
16"— rectangular,	\$38 ⁹⁵	19" round, 20" rect.,	\$64 ⁹⁵

Write Dept. 351 for latest literature and prices—AND COMPARE!

Phone and mail orders filled on receipt of certified check or money order for \$25 as deposit—balance C.O.D., F.O.B., N. Y. All offerings subject to prior sale.

Prices and models subject to change without notice.

The House of Bargains

CHELSEA TELEVISION CENTER, INC.

Office and Showroom: 130 West 42nd Street, near Broadway
New York 18, N. Y. LOngacre 5-2254-5-6

LEARN DAY and EVENING CLASSES
TELEVISION
ELECTRONICS-RADIO
Modern Laboratory
Instruction in

- SERVICING
- BROADCAST OPERATING
- ELECTRONIC and TV ENGINEERING

G.I. APPROVED

WRITE FOR CATALOG
ELECTRONICS INSTITUTE, Inc.
21 HENRY, DETROIT 1, MICH.

YOU NEED 'EM—WE GOT 'EM!

TUBES

CURRENT MARKET PRICES

Send us your requirements
Write: Dept. R, 3201 S. LaCienega Blvd.
Los Angeles 34, California

SPELLMAN HIGH VOLTAGE POWER SUPPLIES

4½ KV POWER SUPPLY

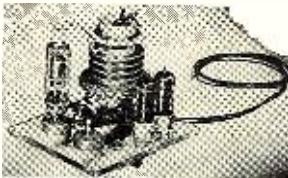

This new compact, well-built unit will supply voltages up to 7.5 KV at 1 milliamperere. Negative or positive output optional.

- Case dimensions: 5½" x 4½" x 5".
- Input voltages: 250 Volts DC.
- Input current: 50 milliamperes.

15 to 30 KV REGULATED POWER SUPPLY

A 12-tube 30 KV unit with a variable 4 to 6 KV voltage tap for focus voltages for the 5WP11 transcriber kinescope, 5WP15 Flying Spot cathode ray tube, 5TP4 projection kinescope and the 5RP11 tubes. A compact unit ideal for use with film recording or projection systems where it is imperative to keep picture size constant with changing beam current. HV variable through knob on front panel.

- Input voltage: 110 Volts AC.
- Output voltage: 15 to 30 KV.
- Regulation of .1% at 1 milliamperere.

COMPLETE LINE OF HIGH VOLTAGE RF STEP-UP COILS. Send for folder with HV diagrams up to 90 KV.

20-40 KV RF POWER SUPPLY

For TV and Experimental Work

Dimensions—
Length 14½", Width 11½", Height 12½"

The voltage is variable from 20 KV to 40 KV through a control on the front panel. The high voltage unit includes a focus control and voltage tap variable from 4 KV to 6 KV for use with 5TP4 Projection Kinescope Tube. Input 115 volts AC—60 cycles. Utilizes 6 tubes.



VARIABLE 0-30 KV DC RF POWER SUPPLY

Positive or negative outputs. Polarity reversible from front panel. Dimensions: Length 14½", width 11½", height 12½".

VARIABLE 5-20 KV REGULATED DC HIGH VOLTAGE POWER SUPPLY

Regulations better than .1% at 1 milliamperere. Ripple voltages less than 5 V peak to peak. Dimensions: Length 14½", width 11½", height 12½".

PERTINENT FACTS AVAILABLE IN FOLDER

SPELLMAN TELEVISION CO. INC.

3029 Webster Ave., Bronx 67, N. Y.
Kingsbridge 7-0306

1315 with *English* on 11.74. (Harris, Mass.)

Venezuela—YVMG, 4.810, Maracaibo, noted 0045 and later with native dance music. YVKB, 4.879, Caracas, heard in Spanish 1915; YVPA, 4.860, Vera Cruz, logged with Spanish program 1925, through heavy CWQRM. YVMS, 4.851, Barquisimeto, noted 1945; YVQI, 3.450, Barcelona, heard 0035 with native program, badly QRM'd by airlines traffic. (Russell, Calif.)

Yugoslavia—Radio Belgrade, 6.100, noted 2300-2400. (Saylor, Va.)

* * *

Last Minute Tips

Bluman, Israel, says the station reported widely earlier as *Radio A.E.F.*, is a Home Service transmission from Brazzaville, French Equatorial Africa; consists of music only and is on the air daily 1200-1500 on 17.838, 9.970, 6.025. At that time, *Radio Brazzaville* normally transmits its own program on 11.970, 9.440, 7.000. The 17.838 outlet has been heard by Balbi, Calif., 1300-1500 sign-off, weak to fair; and the 9.970 channel has been noted at the same time in Connecticut by Boice.

By this time, *Radio Quitandinha*, Petropolis, Brazil, should be on regular schedule; when this was compiled, it was still testing on 5.045 with 5 kw. under the call-sign ZYP23 at 1500-2100; plans to identify in *English* as well as in Portuguese (this is on request of the ISW DEPARTMENT monitor who reports this item—KRB), probably also in other languages; reports may be sent in Portuguese, *English*, French, Spanish, Italian, or German, and an *IRC* should be enclosed; QRA is Radio Quitandinha, Ed. Brasilia, Av. Rio Branco 311, Rio de Janeiro, Brazil, where offices are located. (Serrano, Brazil) This one has been heard by Oskay, N. J., identifying in Portuguese at 1800, and to after 1900.

Hannaford, South Africa, flashes that *Radio Algerie*, Algiers, has been noted on a new channel of approximately 9.950 around 1300 (when has news in French) to 1345 or later.

Balbi, Calif., reports a Manchurian outlet on 7.100 heard at 0400; has had improved signal lately.

A Spanish-speaking station on 2.760, heard evenings as late as 0100 when has native dance music, has been identified as a harmonic of XEAC, 690 kc., at Tijuana, Baja California (Lower California), Mexico. (Russell, Calif.)

Cushen, N. Z., flashes that *Radio Republic Indonesia* (Home Service) now has 38 short-wave stations in operation and that many changes have been made recently. He lists major changes as—YDG2, Suarkarta, 100 w., is on 2.310; 2.320, YDL2, Padang, Sumatra, 300 w., new station; 2.350, YDW, Pontianak, Borneo, 300 w., new frequency for better coverage of northern Sumatra, programs are relayed mainly from Djakarta; 2.467, YDI3, Souabaya, 300 w., moved here from 7.295; 3.270, YDM, Bukittingi, Sumatra, new frequency, 300 w.; 3.230, YDP2, Medan, moved here from 7.360, relays Second Regional Program; 3.380, YDO, Band-



WORLD'S RADIO TUBES

(Radio Tube Wade Mecum)
The only book of its kind in the world. 18 languages with more than 15,000 tubes listed. The most complete set of tube data in existence. Many carefully prepared charts. Tube characteristic data of U.S., British, French, Czech, German, Swiss, Australian, Italian, Russian, Japanese, Scandinavian and all other available types... all in one book!

\$3.00 PER-COPY - By mail, \$3.20 in U.S.; foreign, \$3.35.

AT YOUR FAVORITE DEALER
OR DIRECT BY MAIL FROM
Editors and Engineers
LIMITED
1102 KENWOOD ROAD, SANTA BARBARA, CALIFORNIA

GREYLOCK TUBES

MORE THAN 400 TYPES LISTED

We're STILL DELIVERING
Better Than 90%!

Complete stocks of Standard Brand Lines, including
AMPERITE—Micro-phones
EICO—Instrument Kits
X-CELITE—Tools
EBY—Parts
WALSCO—Chemicals & Tools
HOWARD SAMS—Photo-facts
TV Antennas & Accessories.
Write TODAY for our Complete Catalog Dept. N-2

GREYLOCK ELECTRONICS SUPPLY CO.

115 Liberty Street New York 6, N. Y.

NOW! AT Hy-Grade! the SKY-HIGHEST VALUE in Television Today!

World Famous Quality

630

TV CHASSIS

only

\$169.95

All Taxes less CRT Included

Hard-to-Get! Virgin Polyethylene

300-ohm TV WIRE!

IMMEDIATE DELIVERY!

Write for price and quantity quotations—NOW!

For SKY-HY VALUES at rock-bottom costs—it's HY-GRADE!



Yes, you can believe your eyes! Here's the exact duplicate of the incomparable RCA 630TS Circuit—television's unmatched standard for super-sensitivity and stability—now with all the newest features of trigger-fast Keyed AGC, Voltage Doubler, Standard Tuner, molded condensers, plus the finest quality components, Yoke, Focus Coil, Mounting Brackets, plus 30 tubes. Supplies 13 to 14KV under load for full brilliance and width for all rectangular and round 12½, 14, 16, 17, 19 and 20" tubes.

At only \$169.95 this is the TV super-value you can't afford to miss! Order several NOW! Immediate Delivery! 25% deposit with order, balance C.O.D., f.o.b., Brooklyn, N. Y.

National Distributors of Electronic Parts and Equipment

Hy-Grade Electronics, inc.

1509 EAST NEW YORK AVE., BROOKLYN 12, N. Y.

jermason, Borneo, new station, 300 w.; Ambon has been closed down but will re-open on a new channel (yet unknown) soon; 3.390, YDA, Bandoeng, has line connection with Djakarta now and is a member of a small regional network covering Indonesia (others in chain include YDB2, 7.270, beamed on Sumatra; YDE, 11.770, on East Indonesia; YDD, 2.600, on Djakarta); 3.500, YDI6, Kediri, Java, has this call assigned, 300 w.; YDG3, Madiun, Java, using 100 w. on 4.160; 4.840, YDI4, Denpasar, on the famous Isle of Bali, moved there from Sourabaya, power is still 300 w.; YDD2, 4.865, Djakarta, closed down December 1 and frequency will be used by another station while YDD2 is scheduled to open on a new (yet unknown) channel; 4.950, YDP, Medan, Sumatra, new frequency, 1 kw.; YDJ2, 7.100, Jogjakarta, will be key to new Home Network, power 1 kw., with other stations in that city being YDJ, 5.060, YDJ3, 2.450; YDL, Padang, moved to 7.240 from 3.270, but frequency is only temporary, power 300 w.; YDQ3, Makassar, Celebes, moved to 7.295 from 11.080 as latter channel was outside the broadcast band.

Cushen also reports DZB2, 3.320, 300 w., is a pre-tuned frequency of Far East Broadcasting Co., P. O. Box 2041, Manila, used for community receivers in outlying areas; by this time may have increased power to 1 kw., and may have added projected new zepp antenna; operates 0500-0900.

Press Time Flashes

TGNA, missionary station in Guatemala City, has been testing on 9.668 and if tests there are satisfactory it will ask for reassignment to that channel from 9.660; its 11.85 channel should be on the air by this time. (Russell, Calif.)

At press time, Hannaford, South Africa, flashed this message he had just received from the South African Broadcasting Corporation—"The SABC's extra-territorial service carries the Afrikaans program on Sundays, Mondays, Wednesdays, and Fridays, and the English program on Tuesdays, Thursdays, and Saturdays at 0330-1045 on 17.75 or 15.23, and 1100-1505 on 11.93 or 9.87. On Mondays to Fridays there is a break at 0700-0900. As this is an experimental service, we cannot say which frequency will be in use at any time."

Radio Herakleion, 6.480, Crete, has been heard faintly in England around 1330. (Patrick)

The 7.133 and 11.735 outlets of Taipei, Taiwan, now sign on daily 0430 (former Sunday sign-on was 0530). Radio France Asie, Saigon, is now noted on 6.108, often is covered by Kure, Japan, also by a Brazilian station after 0400; also noted lately on 9.535 (claimed 9.524), often covered by KRHO (9.53), Honolulu, after 0400. (Balbi, Calif.)

ZOY, 4.915, Accra, Gold Coast, puts in a good signal in England around 1245 with news, then musical interlude

March, 1951

SEE LEO FIRST FOR

hallicrafters!

I can SAVE you money... Liberal Trade-ins



ONLY \$99⁹⁵

HALLICRAFTERS S-77 RECEIVER

Improved AC-DC version of the famous S-40 B. One r-f, two i-f stages. Temperature compensated. Series type noise limiter. Mico-set iron core i-f coils. Separate electrical bandsread. Improved cabinet construction. Built-in PM speaker. 7 tubes plus rectifier.

LOW DOWN PAYMENT

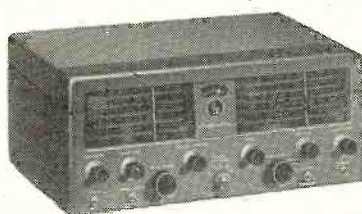

ONLY \$199⁵⁰

HALLICRAFTERS SX-71 RECEIVER

Double Conversion sharp selectivity, plus built-in NBFM at moderate cost. 11 tubes plus voltage regulator and rectifier.

LOW DOWN PAYMENT

Hallicrafter S-38B Receiver \$49.50

WRITE FOR DETAILED SPECIFICATION EQUIPMENT SHEETS

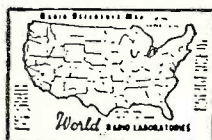

RADIO REFERENCE MAP
CU ON 10-20 & 75 METERS
Just right for your control room walls. Approximately 28" x 36". Contains time zones, amateur zones, monitoring stations. Mail coupon today and... **25c**

FREE

Send for the 1951 complete WRL Catalog containing everything new in radio and television. Deal with the "World's Most Personalized Radio Supply House."



Trade for a new Hallicrafter Receiver. I'll allow you more for your present equipment. WRL buys more equipment... WRL sells more equipment... WRL means faster turnover, greater savings for you! We finance our own paper—no red tape!
LOW DOWN PAYMENTS
NAME YOUR TERMS
PERSONALIZED SERVICE

PHONE 7795

WRITE—WIRE



WORLD RADIO LABORATORIES
744 West Broadway
Council Bluffs, Iowa

R-3

Please send me:

- Radio Map SX-71 Info
 New Catalog S-77 Info
 List of Guaranteed Used Equipment

Name

Address

City..... State.....

RCA 630 TV CABINETS
FULL CONSOLES \$49.95
AVAILABLE TO FIT MOST SETS
In Mahogany—Walnut—Blonde
Full Doors Slightly Higher
JACK CANTOR, 74 Cortlandt St., NYC

ANOTHER OUTSTANDING JOBBER
RADIO SUPPLY of MUNCIE, Inc.



305 North Madison St.
Muncie, Indiana

HAS THE
SENSATIONAL NEW
EICO 221-K
VTVM KIT
IN STOCK!

\$25.95

U. S. SURPLUS!!

STILL AVAILABLE!!

- VOLTOHM METERS! 5000 Ohms per Volt Pocket Multimeter... \$13.25
 - 3" Square meter—well known brand—24 Ranges—Ohms, Volts AC, Volts DC, Millamps, Db. Fully guaranteed & reconditioned... \$1.25
 - 6BQ6 & 6BQ6 Substitute—Brand new Navy Surplus Tube—only \$1.95
 - KILOWATT-HOUR METER—C.E. Demand Totalizer—has Telechron Synchronous 1 RPM Motor; gears, clutches—120 Volts, 60 Cycles—Less case... \$32.45
 - FAS High Fidelity Cross-Over Network—for above unit... \$8.95
 - FAS High Fidelity Bass Speaker Air Coupler Encloser Kit—Shipped in knockdown form—with speaker opening not cut out—to match any size speaker... \$32.45
- Order at once! First Come—First Served
All material fully guaranteed to be as advertised

FM ELECTRONICS CO.
92 East End Avenue New York 28, N. Y.

Still Available at HARVEY'S

WILLIAMSON HR-15 AMPLIFIER

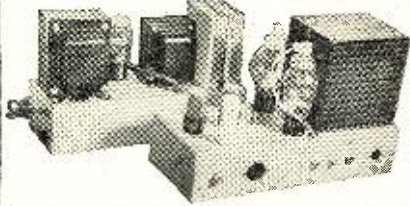

The famous Williamson HR-15 amplifier circuit . . . now available with the original Partridge transformers built to Williamson's specifications. Build this kit in 3 hours or less, and enjoy sound of a quality you never heard before. The HR-15 is a 2-Chassis power amplifier for use with tuners or other front ends having own volume and tone controls. All American triodes, 2-6SN76GT, 2-807, or 6BG6G in PP output, 5V4G rectifier. Response ± 5 db, 10-100,000 cycles. Output impedances 1.7 to 109 ohms in 8 steps. Absolute gain 70.8 db. 20 db. of feedback around 4 stages and the output transformers. Kit is Complete with Tubes, Punched Chassis, Pre-wired Resistor Board, Sockets, Genuine Partridge Output Transformer, and All Necessary Parts. \$75.00

PARTRIDGE OUTPUT TRANSFORMER, as used in above Kit, available separately \$22.50

KOLLSMAN Remote Reading THERMOMETER



There are thousands of applications for this BRAND NEW (Aircraft Surplus) unit. Complete with 12 ft. of tubing in woven copper sleeve. Black Face, Illuminated Dial. Temperature Range from -40° to $+120^{\circ}$ F. At a fraction of initial cost \$ 4.95



TECHMASTER

America's Finest TV Chassis

Made by Techmaster Products Co. 630 circuit RCA licensed. For all size Kinescopes, Full-rated high voltage . . . improved AGC . . . advanced turret 12-channel tuner . . . molded tubular condensers . . . perfect linearity . . . four tube split sound circuit . . . full 4 Mc bandwidth . . . hi-fidelity FM TV sound.

Will accommodate all tubes, glass or metal—round or rectangular—from 10" to 20" size \$189.50

Same Chassis with Turret or Dumont Tuner and Push-Pull Audio. \$199.50

Above Prices are Complete with 12" Speaker and all tubes, less Kine.

16" Round Tube \$39.35
17" Rectangular Tube \$39.35
19" Round or 20" Rectangular Tube \$66.25

RCA 201-EI (KRK-2) FRONT END TV TUNER — as used in the RCA 630 chassis. Brand new, and complete with tubes \$ 18.50

CONVERT TO LARGER TV TUBE SIZES with these two essentials which can accommodate the larger sizes from 14" through 20"

G.E. #77J1—High Voltage Transformer, 14,000 volts output. TODD #70W85—70" Yoke. Specially Priced. Both for only \$ 10.95

Prices Subject To Change Without Notice

Telephone: LUxemburg 2-1500

HARVEY'S
RADIO COMPANY INC.
103 West 43rd St., New York 18, N. Y.

to 1300 when signs with "God Save the King." (Patrick)

OTC2, Leopoldville, Belgian Congo, is now scheduled 1100-1815 on 9.767; 1830-0100 on 9.800. (Kroll, N. Y.) Wednesday DX sessions are at 1410-1425 and 2210-2225. (Garcia, N. J.)

ZFY, approximately 5.980, Georgetown, British Guiana, noted 1815. (Hoffman, N. Y.)

At the time this was compiled, Pyongyang, Korea, 4.400, had not been heard for some time. (Balbi, Calif.)

HRA, Tegucigalpa, Honduras, is now using both 5.920 and 9.029 around 2005. (Ferguson, N. C.; Stark, Texas)

Radio Jamaica, Kingston, is now scheduled on 4.95 at 0630-0900; on 3.360 at 1600-2300. (Kroll, N. Y.)

At press time, I received a flash from Serrano, Brazil, that *Radio Quitandinha*, ZYP23, 5.045, Petropolis, State of Rio de Janeiro, had begun regular schedule of 0500-0900, 1500-2100; usually identifies in *English*, German, Italian, French, and Spanish—as well as in Portuguese—around 1900; wants reports, IRC should be enclosed. Serrano reports a *new* Brazilian as Bauru Radio Clube at Bauru, State of Sao Paulo, ZYR31, 3.275, 1 kw., closes down 2000.

The International Programs of ZYN7, Ceara Radio Club, Fortaleza, Brazil, have ceased but ZYN7 officials have asked Staples, England, to get the signatures of 100 or more persons who desire that the programs be reinstated. (Radio Sweden)

YDL, 7.240, Indonesia, noted 0600; is temporary transmitter; Dutch program. Location is Pedang, Sumatra. (Sanderson, Australia)

4VEH, Cap-Haitien, Haiti, now runs to around 1830 on 9.745, then moves to 9.730; announces *English* for Sundays at 0730 and 2030; noted in *English* weekdays to 1830. (Gerran, N. Y.; Stark, Texas)

Current schedules for SIRA, Buenos Aires, are 9.455, *English* 1600-1700, 2100-0100; 9.69, Spanish 1000-1100, French 1100-1200, Italian 1200-1300, Swedish 1300-1400, *English* 1400-1700, German 1700-1800, Spanish 1800-1900, *English* 1900-2400; 11.88, Portuguese 0800-1300, French 1300-1430, *English* 1430-1600, French 1600-1700, Portuguese 1700-2230; 15.29, Spanish 1215-1545, 2100-0100. (Serrano, Brazil)

Cushen, N. Z., flashes that YDF, Djakarta, Indonesia, is now using 7.220, parallel YDC, 15.150, to Europe in *English* 1400-1500 daily. Also, that CR4AA, 5.895, Praia, is operating 1530-1700. And that the "N. Z. Radio DX Times" reports DZI2, Manila, Philippines, Bolinao Broadcasting System, heard on 9.550 after 1000 at fair strength, signs off 1008, has QRM from Makassar, Celebes, Indonesia, to 1000; DXV2, Mindanao Broadcasting System, Davao, is noted on *new* channel of 7.280 to sign-off 0900 but with severe interference from Pt. Moresby, British New Guinea.

Sanderson, Australia, flashes that Thailand has been heard on 18.85 at 0545 with news and weather report.

SCARCE TV PARTS!

Lots of Hard-to-Find Items

- Famous Telekit TV Kits from \$49.50 up, complete with all parts, wire and instruction book.
- Scarce TV Tubes
- Resistors
- Condensers
- Chokes and Coils
- Transformers
- TV Cabinets, Antennas, Boosters
- Hundreds of others!

We are balancing out our inventory! Write or wire us about your needs.

ELECTRO-TECHNICAL INDUSTRIES
1432 N. Broad St. Philadelphia 21, Pa.

TWIN-TRAXTM TAPE RECORDERS



...give you more

MORE MODELS

the most complete variety of recorders for professional, semi-professional and experimenter use.

MORE FEATURES

for better quality, smoother performance and easier operation.

MORE VALUE

because our direct sales policy saves you dealer markups.

Send today for our catalog 5109 which lists complete technical specifications and performance ratings for all recorder models and accessories. *Trademark Reg.

AMPLIFIER CORP. OF AMERICA

398 Broadway New York 13, N. Y.

CODE SENDING SPEED
RECEIVING SPEED

Free Book

HIGH SPEED

WITHOUT NERVOUS TENSION

REVEALING BOOK shows how "crack" operators develop high speed and proficiency. Learn code for Amateur or Commercial Radiotelegraph License, or improve your sending and receiving with the Candler System which develops radiotelegraph experts and code champions.

CANDLER SYSTEM Box 928, Dept. 2-C, Denver, Colorado

ANOTHER OUTSTANDING JOBBER

RADELCO, INC.

246 West First Street Mount Vernon, N. Y.



\$44.95

HAS THE SENSATIONAL NEW IGO 425-K 5" SCOPE KIT IN STOCK!

RADIO & TELEVISION NEWS

Peddle, Newfoundland, flashes — Scutari, 8.170, Albania, is heard 1445-1515; Tel Aviv, Israel, calls New York mornings on 17.645; station on 3.940 at 1215-1345 sign-off and 2200-2315 may be EPP, Teheran, Iran, listed 4.040.

Rome's "Third Program" is radiated over approximately 3.970, 5.980, 6.240, and 6.260 daily around 1500-1700. (*WRH Bulletin*) The 3.970 outlet is heard by Peddle, Newfoundland.

Copenhagen's program for Latin America, Tue.-Thur.-Sat. at 1900-2000, is now radiated from OZF, 9.52 (*WRH Bulletin*)

Hopper, Va., reports TAS, 7.285, is still a good signal in *English* daily 1600-1700.

JJY, Kemigawa, Tokyo, Japan, operates on 4.000 and 8.000 with 2 kw.; schedule is 2400 hours a day on 4.000; and 2100-1100 U.T. (may mean 1600-0600 EST?) on 8.000; offers various services including radio propagation disturbance warning signals ("W's" or "U's"); QRA is Standard Frequency Section, Engineering and Monitoring Division, Radio Regulatory Commission, Minato-ku Aoyama, Tokyo, Japan. (Boase, Calif.)

Radio Athens, 6.175, noted opening 0000. (Fargo, Ga.; Bellington, N. Y.)

Warsaw, Poland, has moved from 6.115 to 9.57 for the *English*-Polish periods to North America, opening daily in *English* at 1930, 2300, and 0030; also mentions *English* for 0430. (Bellington, N. Y.) Asks for reports to English Program Director, English Transmissions Department, Aleja Stalina 12, Warsaw, Poland. (Donaldson, D. C.)

Finally, Bellington, N. Y., sends these last-minute tips: ZAA, 7.852, Tirana, Albania, sent schedule for newscasts as 1230 Serbo-Croat; 1245 Albanian; 1300 Greek; 1315 Italian; 1330 Russian; 1345 French; 1400 Roumanian; 1415 Turkish; 1430 Serbo-Croat; 1500 Bulgarian; 1515 *English*; 1530 news in Albanian and musical program for Albanians abroad, and 1615 end of transmission. Lisbon has been noted lately on 11.955 and 11.04 around 1600. Prague seems to use 9.55 and 11.84 to North America with *English* starting at 1900, 2100, and 2230; also noted with *English* at 1715-1730 on 9.504, 6.170. A station noted in Arabic on 7.090 from 2346 fade-in to fade-out around 0040 is believed to be Baghdad, Iraq; news in Arabic shortly after 0000; much chanting.

Ferguson, N. C., reports announced Santiago, Chile, on 11.581 at 2315-2331 sign-off; asked for reports to P.O. Box 2626, Santiago, Chile; heard early as 1805. Also heard by Bellington, N. Y.

* * *

Acknowledgment

Despite over-all poor reception conditions—reportedly the worst in many years—in most parts of the world, DX-ers have kept this *Department* well supplied with reports. Many thanks, fellows, and keep them coming to Kenneth R. Boord, 948 Stewartstown Road, Morgantown, West Virginia, U.S.A. KRB

March, 1951

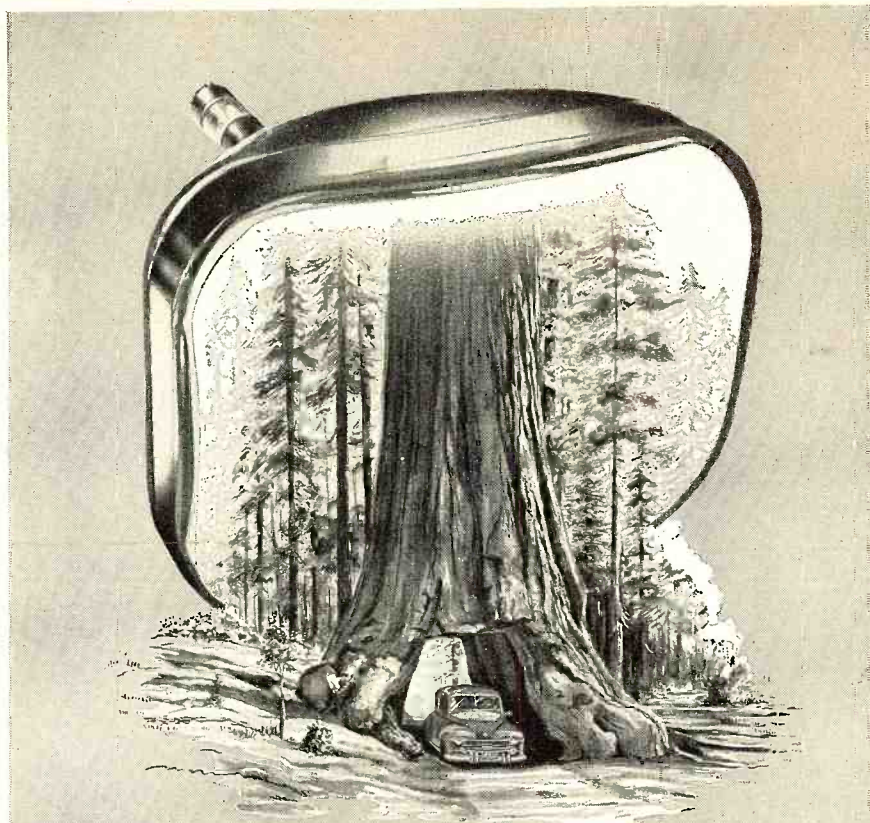

Thomas Tubes mean

LONG LIFE

No one can say exactly how long it has taken Nature to perfect the California redwoods' secret of longer life. But we of Thomas can say that a great amount of time and effort have been spent in increasing the service life of our product.

This time and effort, as a part of our research program, have led to the use of new materials, new design improvements, new construction methods which are continuing to give the Thomas tube an ever-longer "lease on life."

You can always depend on more service, more performance from a Thomas picture tube because, "It's built that way!"



THOMAS ELECTRONICS, Inc.

118 Ninth Street

Passaic, New Jersey



Get
**EMERGENCY BAND
CALLS At Home!**

• Many fans spend hundreds of happy hours listening to city and state police calls on their Polic-Alarm radios. . . . Polic-Alarm Model PR-31 is a quality radio which will give years of trouble-free service on the 30-50 mc. band. Can be used on either AC or DC current of 115 volts.

Besides police calls, the 30-50 mc. band also is used by fire departments, ambulances, border patrol, forestry, maritime, railroads, bus lines, and other services. Enjoy the thrill of listening to these vital messages **\$44.95** at home. Model PR-31 (illustrated)

Polic-Alarm Model PR-8 is available for 152-162 mc. band reception. **\$44.95** Price, complete.

POLIC-ALARM

RADIO APPARATUS CORPORATION

DEPT. RN-3, 310 FOUNTAIN SQUARE THEATRE BLDG., INDIANAPOLIS 3, INDIANA

SERVICE-MEN!

REEVES Soundcraft Laboratories afford you the best in television picture tubes at prices consistent with such quality. When replacement requirements dictate the need for high efficiency and fidelity, Reeves products are the answer. Experienced servicemen have found that they always result in satisfied customers — and a profitable service operation.



Soundcraft rectangular neutral-density filter tubes are available in 16", 17" and 20" sizes. You can use and recommend them with assurance because they are backed by the greater integrity and experience of the Reeves name, a foremost manufacturer in the electronics and recording field throughout the country for twenty years.

REEVES
Soundcraft
CORP.



TWENTY YEARS OF LEADERSHIP IN SOUND ELECTRONICS
10 EAST 52nd STREET, NEW YORK 22, N. Y.
EXPORT—REEVES EQUIPMENT CORPORATION
10 EAST 52nd STREET, NEW YORK 22, N. Y.

RADIO-TV Service Industry News

AS REPORTED BY THE
TELEVISION TECHNICIANS LECTURE BUREAU

ONE of the most heartening developments in the Radio-Television service industry in a long, long time occurred recently in Philadelphia. A television service contractor filed a petition in voluntary bankruptcy. He was a member of the Television Contractors Association of Philadelphia. He had approximately 800 unexpired service contracts to fulfill.

The Television Contractors Association immediately put into action a standby plan that had previously been developed to take care of just such an emergency. The Association assumed the service responsibility for all of the unexpired contracts on the failed member's books.

This unusual action, unprecedented in the television industry, was given signal attention in the news columns of the Philadelphia papers. And the organization was highly praised by manufacturers, distributors, and dealers for their foresight in preparing for such a contingency.

Following on the heels of the failure of the large *Supreme Television* service company in Philadelphia which left hundreds of service contract owners holding the bag for the money they had spent for "service insurance" on their sets, this development served to bring into sharp focus the economic value of a strong, local service association.

Normally trade associations are viewed as groups of individuals who have banded together in the hope of "getting something extra" for themselves. But this action provided concrete proof that the public itself has most to gain from an association of businessmen working together toward the common goal of higher technical and business operating standards in their field of work.

It is obvious that TCA members will gain a great deal of prestige, goodwill, and new business from this development. Owners of television receivers are deeply interested in reliable service and this action of the Association

Part of the audience of more than 800 who turned out to hear Edward M. Noll lecture on color television in Philadelphia. Sponsored by Albert Steinberg & Company, well-known Philadelphia parts distributor, the attendance represented one of the largest audiences ever to gather for a service meeting in the "City of Brotherly Love."



will encourage more and more of them to turn to TCA members for their television service.

Failures Hurt Everyone

Because the annual service contract has not been a major factor in the service business outside of the metropolitan areas, service shop operators in the smaller cities have been inclined to brush off the fast-moving developments in the TV contract business as the break-up of a mushroom service industry that was spawned by the fear of television service costs in the early days of the business.

And a distorted picture of what is happening is gotten from the news stories that play up the spectacular failures like *Supreme* of Philadelphia and *Prudential* of New Jersey. The inference gathered from reading these news accounts is that it is only the big fellows who are cracking up. But this is not true. The big outfits get the publicity when they fold up because of the amount of the customer money that is involved while at the same time hundreds of smaller operators "fold up their tents like the Arabs and as silently steal away" into failure.

The failures—and successes—of service businesses, big and little, in both radio and television affect every man who is engaged in the business regardless of where his business may be located. Local failures will affect him more directly, of course, but many failures scattered across the country may stimulate outside forces into actions that may affect his business adversely regardless of where it may be located.

Agencies like *Dun & Bradstreet* accurately chart the failures occurring in every type of business and their graphs show a continuing picture of the types of businesses that are getting more—or less dangerous financially as reflected in the failures. Bankers and other fiscal agencies follow these trends closely. If the radio and television service business shows a continuing sharp upward climb in failures it gets tougher and tougher for men operating service businesses to borrow money. And it has a chain reaction. A radio parts distributor may need to borrow money on his accounts receivable. If a high percentage of these accounts are with radio-TV service businesses and the failure curve in these businesses is climbing, the distributor probably will have a hard time borrowing the money. The banker will probably advise him to reduce his accounts receivable drastically.

The far-reaching effects of customer dissatisfaction with and complaints about television service was indicated by a resolution recently introduced in the U.S. House of Representatives calling for a Federal investigation of service companies and practices.

Small Operators Targets

While most of the news accounts have put their fingers on the TV serv-

March, 1951

PRICES ARE DOWN HERE NO INFLATION!!!



MODEL GO-9 TRANSMITTER

All brand New. 100 Watts CW, or MCW, emission. Operates from 110 V., 300 Cycle, easily converted to 60 Cycle operation. Low frequency range 300 KC. to 600 KC. High frequency 3,000 KC. to 18,000 KC. using an E.C.O. We furnish complete conversion data with each transmitter. Complete with \$59.95 schematics. \$59.95

G.P.7 TUNING UNITS

6 Ranges: A-330-800 KC. B-500-1500 KC. C-1500-3000 KC. D-3000-4535 KC. E-4535-6500 KC. F-6200-9050 KC. Also contains Capacitors, Resistors, Varner Diodes and many other parts. A REAL BUY while they last. Each unit range \$4.95



MINE DETECTOR, AN/PRS-1

Easy to operate, easy to carry. Can be used for detecting ore deposits, both metallic and non-metallic. Now being used extensively by Miners, Prospectors, Beachcombers, and Explorers. These sets are brand new and come complete with Detector head with antenna; Reflector meter and housing and exploring rod; a bag for carrying equipment while operating and a wooden case for storing or transporting unit when not in use. These units contain Tubes, and instruction books. Shipping weight is 125 lbs. Weight when operating unit is 22 lbs. All New—Complete with Batteries and ready to operate Set \$29.95
SCR-625 MINE DETECTOR. Set \$59.50
Complete with batteries. \$59.50

COMMAND RECEIVERS

3 MC to 6 MC. \$6.95 ea.
6 to 9 Meg. 6.95 ea.
1.5 to 3 Meg. 14.95 ea.
All used but complete and in good condition.

COMMAND TRANSMITTERS

3 to 4 MCS \$8.95 ea. 5.3 to 7 Meg. \$4.95 ea.
7 to 9 Meg. \$4.95 ea.
Complete with Tubes and Crystals, excellent condition.

METERS

Westinghouse—G.E. Weston

MILLIAMPERE D.C.	KILOVOLT D.C.
3"-0 to 100. . . \$3.95 Ea.	3"-0 to 400 DC. \$3.95 Ea.
3"-0 to 100. . . 3.95 Ea.	3"-0 to 500 DC. 3.95 Ea.
3"-0 to 200. . . 3.95 Ea.	3"-0 to 1.5 . . . 3.95 Ea.
3"-0 to 250. . . 3.95 Ea.	3"-0 to 4 . . . 3.95 Ea.
3"-0 to 500. . . 3.95 Ea.	3"-0 to 20 . . . 3.95 Ea.
3"-0 to 750. . . 3.95 Ea.	(All are 1 Ma. full scale, require external multiplier.)

VOLT METERS

3"-0 to 8 AC. \$2.95 Ea.
3"-0 to 15 AC. 2.95 Ea.
3"-0 to 30 DC. 3.95 Ea.
3"-0 to 150 DC. 3.95 Ea.

TIME HOUR METERS

99999.9 Hrs.
10-12 Volts, 60 Cycle 3 Inch \$6.95 Ea.



3" TRIUMPH OSCILLOGRAPH

Complete Test Scope, with built-in Wobbulator, so as to be used on TV or FM servicing. Operates from 110 Volt, 60 Cy. A.C. Limited Supply. All these units have been carefully checked and are in excellent condition. \$34.95 Ea.
A Real Buy. SPECIAL

BC-605 INTER-PHONE AMPS.

(See conversion of this Unit on Page 140 in April issue—Radio-Tel. News). Ideal for Inter-Com; Office to office; airplane inter-com, etc.; Complete with Tubes, Diagram and Case. Easily converted. \$3.95 ea.

RU-16 RECEIVERS

190 KC-12 Meg. in separate coils. All Brand New. \$5.95 ea.
16 PLUG-IN COILS FOR RECEIVERS
16 Separate Frequency Ranges from 195 to 12500 KC. We will send coil closest to your requirements. Excellent condition. \$1.50 ea.
RU-19 Control Box for Receiver \$1.00 ea.

2 VOLT WET CELL RADIO BATTERY

NEW, Uncharged (Appr. wt. 4 lbs.)
TYPE 20-2 \$1.45
Complete set of three with Box and Connections to make a 6 volt 20 Amp. Hr. Battery Uncharged (Approx. wt. 15 lbs.) Set \$5.95

ARMY FIELD TELEPHONES

Type EE-8—Talk as far as 17 miles, wonderful 2-way communication at a very low cost, ideal for homes, farms, factories, etc., up to 6 phones can be used on one line. Each phone complete with Finger, Mag-neto, Batteries, etc. Used, but good as new. \$16.95 pair
360 Foot Roll Wire for above. \$1.95 roll

MG-149F INVERTER

Input 24 Volt DC 36 Amps, 110 V. 400 Cy. AC. 500 V.A. Output at 90% P.F. Used, excellent condition \$9.95 ea.

PROP PITCH MOTORS

For your Beam Antenna:
20 Volt to 32 Volt, A.C. or D.C. 1/2 H.P. Motor;
114 RPM Gear Reduction,
7000 to 1.
ALL BRAND NEW. \$13.95 ea.

MIDGET SELSYNS

AY type operates from 6-12 Volts 60 Cycle. Use as both transmitter and receiver. These compact little units draw almost no current and work fine at all remote positions indicating applications. OD 2 1/2 x 2 1/2". All New (Appr. wt. 1 lb.) Each \$1.50

BEACON RECEIVER BC-357

FREQUENCY RANGE 30 to 80 Meg. Operates from 24 Volts D.C. With Tubes. \$3.95

GENERAL TEST EQUIPMENT

38 Argyle Buffalo 22, N. Y.

ARMY HAND SIRENS

All New, with canvas cover carrying strap. Can be heard for many miles. Ideal for Civil Defense, Camps, etc. A bargain at. . . \$9.95

FRANKLIN TECHNICAL INSTITUTE

46 Berkeley Street Boston 16, Mass.

APPLIANCES, INC.

9220 Church Ave., Brooklyn, N. Y.

STANDARD SURPLUS 1230 Market St., San Francisco 3, Cal. Telephone HEMlock 1-3106

Advance with ELECTRONICITY

You need firm grasp of fundamentals to keep pace with these complex, fast-growing fields. In thorough 2-year course learn electricity, electronics, physics, mathematics, drafting, etc. Employers want Franklin graduates. Coed. G.I. approved. Day, evening, 43rd year. Write for Catalog.

FRANKLIN TECHNICAL INSTITUTE
46 Berkeley Street Boston 16, Mass.

PEN-OSCIL-LITE

Extremely convenient test oscillator for all radio servicing: alignment • Small as a pen • Self powered • Range from 700 cycles audio to over 600 megacycles u.h.f. • Output from zero to 125 v. • Low in cost • Used by Signal Corps • Write for information.

GENERAL TEST EQUIPMENT
38 Argyle Buffalo 22, N. Y.

SPECIAL LOW PRICES ON PICTURE TUBE and 630 CHASSIS

Lic. by RCA

Chassis Features:—
Molded Condensers
Voltage Tripler
Keyed AGC, etc.

Send Card For Details

ELECTRONIC APPLIANCES, INC.
9220 Church Ave.,
Brooklyn, N. Y.

TRIPLEX WAVE MASTER

YOUR BEST ANTENNA BUY!
PROVEN UNDER ACTUAL TESTS!

- ✓ GHOST FREE RECEPTION
ALL CHANNELS
- ✓ TRIPLE DIRECTORS
- ✓ NO BOOSTER REQUIRED
- ✓ MATCHES ANY OHM WIRE
75—150—300
- ✓ USERS REPORT UP TO 300-
MILE RECEPTION

... Approximate Weight—7 Lbs.

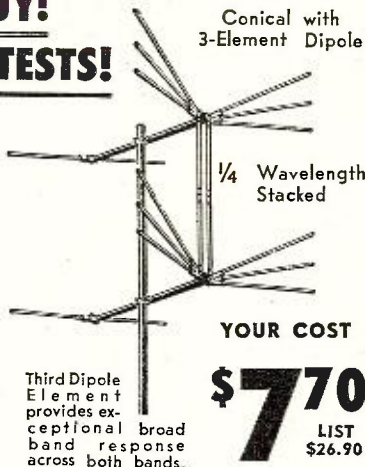

YOUR COST

\$770
LIST \$26.90

SENSATIONAL NEW TRIPLEX TV ANTENNA KIT

Includes: Triplex antenna, 10-ft. mast, 100-ft. guy wire, 60-ft. 300 ohm lead, guy ring, mast insulators, house insulators, peak mounting base, guy hooks.
Nothing else to buy!

All For **\$12.95**

20% DEPOSIT ON ALL C.O.D. ORDERS

SOLD DIRECT! WRITE . . . WIRE . . . CALL FAIRFAX 9171

RAY MANUFACTURING CO.

441 SUMMIT ST. -- TOLEDO, OHIO

REK-O-KUT presents a New

Continuously Variable-Speed Turntable of Broadcast Quality

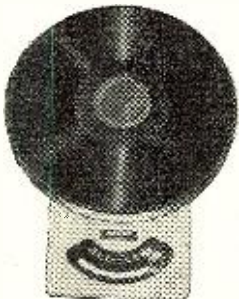

Plays at any speed from 25 to 100 R. P. M., without "wow!"

Speed can be varied while in operation to produce sound effects.

Now for the first time . . . a continuously variable turntable of Broadcast Quality at a popular price. Ideal for record collectors, musicians, singers, disc jockeys, broadcast stations, music schools, dance studios, skating rinks, gymnasiums, etc. Plays through amplifier, radio, TV set or phonograph. Operates on 50 or 60 cycles.

Model CV5-12 (illustrated)
 Chassis, motor and turntable . . . \$84.95 net.
Model CV5-12P, mounted in portable case with 16" dual stylus pickup . . . \$124.95 net.

3-Speed 12" Transcription Turntable

Recommended by outstanding music critics. Induction-type motor designed for smooth, quiet, vibration-free operation. 3 speeds, 78, 45 and 33 1/3.

Model LP-743 . . . \$54.95 net.

Write for Illustrated Catalog of REK-O-KUT Line of Hi-Fidelity Recording Instruments, Phonographs, Transcription Tables, Accessories.

REK-O-KUT CO.

38-05 QUEENS BLVD., LONG ISLAND I., N. Y.

the "High Quality" AUDIO AMPLIFIER



For the Critical Music Lover

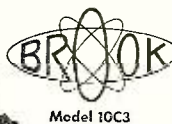

Model 10C3

- Handsome appearance
- ALL TRIODES for the utmost in naturalness.
- Exclusive Brook circuits & transformers.
- Listening fatigue reduced to a minimum.
- Inputs compensated for any type of phono-pickup, TV, FM & AM receiver.

Write for Technical Bulletin, detailed Distortion Analysis & booklet "Better Listening"

Brook Electronics, Inc., Dept. RC-1

• • • 34 DeHart Place, Elizabeth, New Jersey



R. J. Mahler, industrial consultant for CBS, was swamped by technicians when he offered to display "inner workings" of color wheel.

ice contractors by far the bulk of the user complaints have been against small operators—usually one-man affairs—and COD service. Owners of service contracts handled by reliable independents are the most satisfied TV set users. This is clearly shown by the high percentage of them who renew their contracts year after year.

Committees composed of representatives of dealer and distributor organizations working with the Better Business Bureaus are trying to find a satisfactory solution to television service practices in many cities. A rising volume of customer complaints in cities like St. Louis, Milwaukee, and New York has brought on a detailed study of the television service situation in each of those areas.

This problem would find a natural solution if more cities had effective TV service associations like TCA in Philadelphia, TISA in Chicago, the Association of Television Service Dealers in Los Angeles, and the handful of other TV service organizations that have been formed. But there are far too few of them.

Individual service operators can do little or nothing to improve the situation. It requires the studied, concerted action of an organized group. In cities where effective service organizations do not exist the decisions about what is to be done to control retail service practices will be made by men who are not intimately familiar with the needs and problems of an independent service business. This is not good.

It appears as if there are only about seven television installation and service associations now operating. These are located in Philadelphia, Chicago, New York, Washington, Boston, Los Angeles, and Omaha. Out of these seven organizations only TISA of Chicago and TCA of Philadelphia have been successful in building local and national acceptance and recognition.

The national recognition accorded both TISA and TCA is due largely to the fact that their executive officers are able to devote enough time to the problems of their organizations as a whole and to carry through the details of the programs which these groups set up for stimulating better technical and business practices in the TV service business. Also they realize that you gain nothing by "hiding your light under a bushel" so they keep their members, the industry, and the press

fully informed on what they are doing.

The latest tabulation of radio service organizations shows that only about sixty associations are now active. With the exception of PRSMA in Philadelphia, none of these associations have any regular or consistent plan for keeping the industry and the press informed about their programs or their association activities.

Organizers of radio service groups have always been unrealistic in appraising what must be done in building a cooperative association that will be successful. They theorize that low dues will bring in a lot of members so they make the dues a mere pittance. Then they unload the presidency on a busy service shop operator whose business keeps him humping all the time, and expect this busy man to handle all of the details of an aggressive association program. It never works out successfully.

Plans Being Studied

One of the plans that is receiving serious consideration is based on a "service insurance fund" that is built up in an account in a local bank with the payment of one dollar per receiver collected by the set distributors for each TV set they sell. This fund would be administered by a committee representative of the various industry elements involved in the sale and servicing of television receivers in the area where the plan was operating.

The purpose of the fund would be to assure qualified television service operators that their service contract commitments would be fulfilled if they went broke. When the fund reached what was considered an adequate size the excess would be pro-rated among participating service operators or used for a consumer educational advertising program.

To participate in the program a service operator would have to furnish the committee with adequate proof of the soundness of his business and continuing reports to show that it was being managed properly. These probably would be in the form of regular CPA audits of his books and business.

Such a plan would probably solve the problem of user protection on service contracts when a contractor's business failed. But it would have to be expanded to protect the set owner on COD service. It would have to provide for some means of "policing" the service business in its area to discourage inefficient and "gyp" technicians who are always easing into the business and causing trouble. However, the longer such a plan was in operation and properly publicized the less likelihood there would be of service gyps slipping in and victimizing users. TV set owners would come to depend on service operators who are participants in the plan and would look with suspicion on one who was not.

Perhaps one of these days we will have an independent "rating" bureau in this service industry that will "approve" qualified shops on a plan simi-

SIGMA SENSITIVE RELAY

S.P.D.T. adjustable from 700 Microamps to 1.5 MA, 8000 ohm coil...\$2.29 ea.

PANEL METERS

GE-General Electric
W-Westinghouse
W-Weston
S-Sun
SQ-Square Case

2" Meters

0-5 MA, S, SQ...\$2.95
0-5 MA, GE...2.45
0-20 MA, S...1.95
0-25 MA, SU...1.95
0-50 MA, SU, SQ...1.95
0-1 AMP RF, GE...2.95
0-2 AMP RF, S, SQ...2.95
0-4 AMP RF, GE...2.95
0-250 MA, A, C...3.50
0-30 AMP DC, GE...2.50

3" Meters

75-0-75 UA, S, SQ...\$8.95
0-2 MA, GE, SQ...3.50
0-5 MA, GE, SQ...3.95
0-10 MA, GE, SQ...3.95
0-20 MA, WH...3.95
0-50 MA, S...3.95
0-30 MA, GE, SQ...3.95
0-5 VAC, GE, SQ...3.95
0-10 VAC, GE, SQ...3.95
0-15 VOLT AC, GE...3.95
0-30 VOLT DC, DA...2.75

OIL CONDENSERS

1.75 mfd 400 vdc \$0.39
6 mfd 600 vdc .95
8/8 mfd 600 vdc 1.79
10 mfd 600 vdc 1.95
4 mfd 1000 vdc 1.69
6 mfd 1500 vdc 3.50
2 mfd 2000 vdc 2.50
10 mfd 2500 vdc 4.95
2 mfd 4000 vdc 4.90
1 mfd 5000 vdc 4.50
1/1 mfd 7000 vdc 2.95
.1 7500 vdc 1.25
2 mfd 6000 vdc 9.95
2 mfd 6000 vdc 12.95
.65 mfd 12500 vdc 12.95
1 mfd 15 KVDC 24.50

PIGTAIL MICAS

MMF: 5, 20, 50, 60, 100,
250, 300, 400, 500, 1000,
800, 1000, 2000, 3000,
4000, 5000, 6000,
10000\$0.09 ea.

Ceramics

MMF: 3, 8, 20, 22, 120,
500\$0.05 ea.

Silver Mica Capacitors

MMF: 10, 50, 60, 340,
750, 1780, 1000, 50.12 ea.

CHOKE BARGAINS

6 H, 400 MA, C \$3.95
5 H, 250 MA, C 1.25
5 H, 170 MA, C 1.25
6 H, 50 MA, C .39
16 H, 80 MA, C .39
8 H, 175 MA, C 1.25

PEAK ELECTRONICS COMPANY

188 Washington St., New York 7, N. Y.
Phone COrtland 7-6443, 7-6486

POWER TRANSFORMER BARGAIN

740 Volts CT @ 185
MA 6.3V @ 4A, 5
Volts @ 3A 0.9V, 60
cy. pr. Half shell
mount\$3.49 ea.

RAYTHEON SWINGING CHOKE

2 to 12 Henrys, 1 Amp to 100 MA, 15 Ohms DC fully
cased. High voltage insulation, ceramic insulators. Very
conservatively rated. Weight 60 Lbs.\$16.95 ea.

HIGH WATTAGE ANTENNA RELAY

110/220 volt 60 cycle Solenoid,
D.P.D.T. Heavy duty paralleled
contacts rated 5000 Volts @ 15
Amps. Sturdy Construction. 160
lanite insulation\$18.50
As above but DPST.....12.50
As above but SPDT.....12.50

BAKELITE CASED MICAS

MFD	VDC	Price	MFD	VDC	Price	MFD	VDC	Price
.001	600	\$.18	.024	1500	\$.55	.00045	5 KV	\$1.10
.002	600	.24	.033	1500	.75	.001	5 KV	1.60
.01	600	.26	.02	2 KV	.90	.0015	5 KV	1.60
.02	600	.26	.005	2500	.55	.003	5 KV	1.90
.027	600	.26	.002	2500	.45	.005	5 KV	2.50
.01	1 KV	.45	.005	3 KV	1.00	.0003	8 KV	2.50
.002	1200	.35	.0001	5 KV	.70	.0005	8 KV	2.90

WIRE WOUND RESISTORS

5 watt ohms: 25-50-200-2500\$.09 ea.
10 watt ohms: 25-40-84-400-1325-2K-4K15 ea.
20 watt ohms: 50-70-100-300-750-1K-1.5K20 ea.
2.5K-2.7K-5K-16K-20K22 ea.
30 watt ohms: 100-250-5300-18K22 ea.
100 watt ohms: 100-3750-1500-2K, 10K, 20K, 25K,
50K, 75K\$0.59

GUARDIAN LATCHING RELAY

SPDT, 110 V 60 cy Coil, 15 Amp Contacts\$1.95

ADJUSTABLE SLIDER RESISTORS

20 Watt: 1, 5, 50, 300 ohms25
50 Watt: 10, 50 Ohms35
100 Watt: 100, 150, 200 Ohms39
100 Watt: 20, 50, 75, 100, 500 Ohms49

MISCELLANEOUS BARGAINS

25 ohm 675 watt Rheostat\$2.95
50 meg 35 watt Resistor95
250 mmf Midget Var. Ceramic Ins69
15 mmf Midget Var. Ceramic Ins39
4PT Levtr Switch Mossman89
Ceramic RF Switch SP 11 Pos89
4PDT Relay, 4500 Ohm DC Coil15 for .99
.02 600V Tubular12 for .99
.05 600V Oil Tubular4 for .69
10K, 15K Pots59
50 Watt Sockets w/shell29
300 Ohm 50 W. Rheostat29
16 mfd 450 V. Electrolytic29
5-20 mmf Ceramic Variable29
1-7 mmf Ceramic Variable29
SPST Push Button Switch29
5x5 MFD 400 VDC29
1x1x1 MFD 1200 VDC29
100 mmf Air Paddle APC 10049
50 mmf Air Paddle APC 5039
Fil Transf. 2 1/2 CT, 40 AMPS, 110V CY6.95

POWER TRANSFORMERS

Fully Cased, Pri. 110 Volts 60 cy.
110 volts CT 60 MA, 220 volts CT 30 MA,
6.3V, 18A, 6.3V, 1.25V, 5V2A, 5V2A4.95 ea.
700 volts CT @ 125 MA, 6.3V2A, 5V.3A2.99
940 Volts CT 425 MA, 65V BIAS7.95



PANEL METER KIT

Here's what you get:
• 2" Sq. bakelite cased meter, Gov't. Surplus
• Scales for all the following ranges: 0-50 ma, 0-100 ma, 0-200 ma, 0-500 ma.
• Pre-calculated shunt sizes for all ranges.
• Complete instructions.
• Only \$2.50 ea.; 3 for \$6.75

Meter Multipliers

1 Meg. 1/5 of 1% Cage Enclosed 1 KV...\$2.95
2 Meg. 1/2 of 1% Tubular 2 KV\$2.95
4 Meg. 1/2 of 1% Tubular 4 KV\$3.95

Weston Portable AC VOLTMETER

Model 433, 0-150 Volts AC, 25 to 2400 cycles, 3/4%, mirrored hand calibrated scale, Bakelite case with leather handle\$27.50



HIGH CURRENT MICAS

Tolerance 5%.
CAP Amps. KV Price
TYPE G1
MFD 1 Mic DC Each
.00024 4 6 \$3.95
TYPE G2
.0006 10 20 \$15.50
.0008 12 20 16.50
TYPE G5
.0001 35 \$32.50
.00015 10 35 37.50
.0005 20 35 42.00
TYPE G4
.08 40 \$27.50
.02 40 9 29.50

1% W. W. Resistors
Ohms: 2K, 5K, 8500,
50K\$.25 ea.

Non-Inductive Resistors

Ohms: 250, 500, 12,500
100 watts\$0.75



EVERY RADIOMAN

Can Use These

SERVICE HINTS!

Valuable Manual Yours—FREE!



SEND COUPON OR PENNY POSTCARD FOR YOUR FREE COPY TODAY!

FEILER ENGINEERING CO., Dept. 3H1
1601 S. Federal St., Chicago 16, Illinois
Please RUSH my FREE copy of "How to Simplify Radio Repairs."

Name

Address

City

State

EASY TO LEARN IN YOUR HOME...

ELECTRONICS RADIO and TELEVISION



GET YOUR F.C.C. LICENSE

Step ahead with Central training! ●●●

- Broadcast Engineers (AM-FM-TV)
- Manufacturing Technicians
- Radio-Television Serviceman
- Emergency Radio Operators
- Airlines Radio Operators
- Public Address Servicemen

ALL essential jobs in a NEW, RICH field of OPPORTUNITY. Free placement service has put our graduates in top positions from coast to coast. Plan your professional career now, by sending for FREE LITERATURE.

CENTRAL RADIO and TELEVISION SCHOOLS, Inc.
Dept. E-3, 1644 Wyandotte, Kansas City, Mo.

I want complete information on how I can succeed in Radio, Television and Electronics. This does not obligate me in any way.

Name

Address

City

Zone

State

Lowest prices!



BEAM INDICATOR
1-82F Compass Indicator.
0-360°-5 in. dial. 26 v 400
cy. 8-12 v. 60 cy. Ideal
position indicator. Brand
new.

Price \$3.95 each

C-1 AUTOPILOT VERTICAL GYROS

May be used to conduct many interesting and amusing experiments. Operates from 24 V. DC or may be operated for short periods on 110 V. AC. Gyro will run for approx. 15 minutes after actuating. Size—approx. 8" x 8 1/2" x 8 1/2". Less Amphenol Connector.



Special

\$4.95



C-1 AUTOPILOT AMPLIFIERS

Three channel servo amplifier consisting of many valuable electronic parts including 6 relays, 7 tubes.
With Tubes.....\$8.95
Less Tubes.....\$5.95

METERS

J.B.T. Frequency Meter Type 30F 48-62 cycles 100-150 volt.....\$ 9.95
G.E. Type DW volts-amp meter 0-30 vdc 0-60 amps d.c.....\$ 4.95
S Meters—Weston Model 606 range 2.5 ma. movement.....\$ 3.50

DYNAMOTORS

G.E. Type D-101 input 27 vdc @ 1.5a output 285 vdc @ .060a.....\$ 4.95
Weston Electric DM36D 28 vdc @ 1.4a output 220 vdc @ .081a.....\$ 5.50
Pioneer Gen E Meter input 12 vdc @ 9.4a output 275 @ 110a 300 vdc @ .050a.....\$11.95
Dunmore PE94C input 28 vdc @ 10.5a output 300 vdc @ .260a 150 vdc @ .010 and 14.5 vdc @ 5.0a.....\$16.50

AIRCRAFT INSTRUMENTS

Turn & Bank Indicators Pioneer 1719-1AF-AI.....\$10.25
Altimeters Kollsman 371803-0-40,000 ft.....\$ 7.95
Air Speed Indicator Pioneer 1403-1N-B1 0-300 m.p.h.....\$ 6.95
Climb Indicator—Pioneer 1636-6H-B1.....\$10.95

RELAYS

Cutler-Hammer Type 6041H30B 12 vdc 50 amp contacts.....\$ 2.95
6 1/2 vdc DPST low voltage contacts flange mount.....49c
G.M. Lab. 12942 6-12 vdc make one break one heavy contacts.....69c
G.M. Lab. 12849 6-12 vdc DPST heavy contacts.....69c
Clare A 15764 150 ohm coil telephone type break three make two.....95c
Clare A 7409 3300 ohm coil telephone type SPST.....\$ 1.19

SWITCHES

Arrow H & H DPST 450 v. @ 3 amp 110 v. 10 amp.....69c
Arrow H & H DPDT 450 v. @ 3 amp 110 v. 10 amp.....69c
Push Button SPST enclosed metal housing flange mount.....19c
Push Button DPDT momentary.....59c

CAPACITORS

5000 Volt Mica.....each \$ 1.10
.0005 .0004 .002 .001 .004.....98c
.0115 @ 3000 volts.....89c
.015 @ 2000 volts.....89c
.0075 @ 1500 volts.....85c

OIL CAPACITORS

2 mfd @ 600 vdc.....44c .5 mfd @ 400.....29c
1.15 mf @ 400 v.....39c 2x.05 mfd @ 400.....24c
25 mf @ 2500 v.....95c 2x.1 @ 5000.....\$1.00

TUBES

6SN7...\$1.88 7N7...\$1.49 CIB...\$3.75
7F7...89c 7Y4...89c

TERMS: 20% cash with order—balance C.O.D. Orders accompanied by payment in full must include sufficient postage, otherwise shipment will be made via Railway Express collect. Minimum order \$2.00.

Electro Devices

INCORPORATED
247 BROADWAY PATERSON, N.J.

lar to that of the American Automobile Association for garages and auto repair shops.

Custom Business Neglected

One of the best business opportunities open to capable service operators and one which has been sorely neglected by almost everybody in the industry, is the custom-installation of various audio, television, phonograph, and radio units.

Recently one of the editors of this department was asked to determine the equipment to buy for a custom installation in a new home. Investigation revealed that three separate and complete "home entertainment units" were to be installed in special cabinets in this home! The owner had one radio receiver and one TV receiver that were to be used. The chassis units that had to be purchased included two television receivers (one 16" and one 19"), a record changer, an AM-FM assembly, and sundry smaller items.

The architect on this job said he had about a dozen homes to build during 1951 and every one of the owners would be interested in complete radio-audio-television custom installations designed right into the home! He said he had not pushed the matter with these home builders because he did not know anything about electronic equipment nor high fidelity sound requirements and he was not acquainted with anyone who was.

If you are looking for some "plus" business get in touch with the architects who are handling the twenty thousand dollar and up homes that are being built in your town. The chances are excellent that you will be able to pick up some very good contracts for the custom installation of "home electronic entertainment" systems.

Color TV a "Hot" Subject

In the heat of the Fall political campaign "The New Yorker" magazine made the sage observation that the only two subjects on which politicians would not take a stand were the "use of the atom bomb and color television."

It is still anyone's guess about when we will have commercial color TV and which system will eventually emerge as the standard for the industry.

However, the serious student of television circuits and servicing will gain a great deal by studying the circuitry involved in all of the systems proposed. Many millions of dollars have been spent on color television research. There has evolved from some of these studies and experiments several circuits and systems that will eventually be adopted for use with monochrome to produce clearer, better pictures, for instance, the "crispening circuit" developed by CBS. The high field rate required by the CBS system (144 as compared to the present 60) brings about a loss in horizontal resolution. To compensate for this loss CBS engineers developed the "crispening circuit" which gives a decided improvement in the apparent resolution of the

COMPLETE DELUXE

T-V ANTENNA KIT WITH 45' TWIN LEAD



Ten bar conical or flying arrow type—30 ft. of guy wire—8 ft. mast—base and guy ring—standoff insulators and roof hooks included with complete instruction sheets. Add 5c ft. for additional lead-in if needed.

7.95

NOTHING ELSE TO BUY
20% Deposit on C.O.D. orders. Include postage.
Shipping weight 7 lbs.

THE WEST'S LEADING
T-V ANTENNA MAIL ORDER HOUSE

Davis TELEVISION SUPPLY CO.

3047 W. OLYMPIC BLVD. - LOS ANGELES 6, CALIF.

Olson Radio Warehouse

2020 EUCLID AVENUE
CLEVELAND, OHIO

CARRIES THE ENTIRE LINE OF

EICO KITS

and factory-wired Instruments



425-K
5" SCOPE
KIT
\$44.95



221-K
VTVM
KIT
\$25.95



625-K
TUBE
TESTER
KIT
\$34.95



HVP-1
HIGH VOLTAGE
PROBE (wired)
\$6.95

Write us about your TV needs!

SERVICEMEN—DEALERS—JOBBERS

RESISTORS

1/4—1/2—1—2 WATT

Good Sizes—Mixed \$35.00 per M
25% Dep. with Order—Bal. C.O.D.

Write—Phone—Wire

LEONARD ASHBACH ENTERPRISES

743 N. La Salle St.
Chicago 10, Ill.
Phone: WHitehall 4-0077

RADIO and TELEVISIO

Over 30 years N.E. Radio Training Center. Train for all types FCC operators' licenses. Also Radio and Television servicing. FM-AM broadcasting transmitters at school. Send for Catalog M.

MASS. RADIO SCHOOL

271 Huntington Avenue Boston 15, Massachusetts
Lic. by Comm. Mass. Dept. Educ.

picture. This circuit can be usefully employed in our present monochrome system to improve small area contrast.

The pulse sampling system used by RCA in its color television system is another development that holds promise for improving our present black-and-white pictures. Philco has been conducting experiments with this system and it is reported that they have been able to produce a monochrome picture with a comparative 7 mc. resolution from transmissions over the present 6 mc. channel. This is about double the best resolution we are able to accomplish with the best of our present circuits.

Substitution Manual Timely

If you haven't received a copy of *Sylvania's* new tube substitution manual be sure to get one from your *Sylvania* distributor right away. And take good care of your manuals and replacement guides as well as all of your other reference material. Paper is getting tighter and tighter and if our experience of the last war is repeated you will find manuals hard to get. So "baby" all of those that you get now.

Notice to Service Associations

The editors of this department are compiling a new directory of radio service organizations and television installation, contract, and service associations.

If your organization is active please send us the names and addresses of your present officers, when your association was formed, and an outline of the various programs that your group is now carrying out. This would include membership training programs, employee training programs, cooperative activities with other industry elements, etc.

-30-

SHORTED CR TUBES

By RAYMOND E. WERNER, W8QGI

AT LEAST one of the ways that a picture tube may fail is through a short between the cathode and heater. The symptoms are loss of focus, loss of contrast, and failure of the brightness control to function. If the tube is a thirty or fifty dollar item in your budget, it may be painful to discard it when nothing else seems wrong.

The remedy is quite simple and considerably less expensive than the cost of any size picture tube. Merely isolate the filament circuit of the picture tube from the common supply and install a separate filament transformer for the picture tube. It is important that the filament winding of this transformer be insulated from ground, so resist the urge to tie the center tap to the chassis.

You have now effectively eliminated the cathode from the circuit and have a filament which is maintained above ground by the internal short to the cathode and thus performs the same function.

You may be pleasantly surprised by the performance of the set after this modification. In addition to the money saved, your set may furnish you with a considerably better picture; mine did.

-30-

March, 1951

TELECHROME

FLYING SPOT PICTURE GENERATOR

Model 300-A

NEW!

Used in TV stations, development laboratories, schools, factories, service organizations and wherever a reliable, easily changed video picture source is required



Supplied with driven sweep
10" monitor
\$96500
Complete



- Resolution greater than 500 lines
- Supplied with standard RMA 3x4" test pattern
- Slide Holder for positive or negative transparencies
- Excellent picture tonal rendition
- Supplies pictures without driving pulses from a sync. generator
- Low and high impedance outputs, black positive or negative polarities

Complete with all tubes, self-contained high and low voltage regulated power supplies, sweep and video circuits, in rack width metal cabinet.

LIMITED PRODUCTION ON ABOVE MODELS

Write today for catalog of our color equipment line.

TELECHROME
INCORPORATED
88 Merrick Rd, Amityville, L.I., N.Y.

630 TV CHASSIS SPECIAL

1951 Improved De Luxe RCA licensed 630 Chassis complete with 30 tubes. Not a kit, but a factory wired, engineered, tested and aligned TV Chassis. Just plug it in and it works.

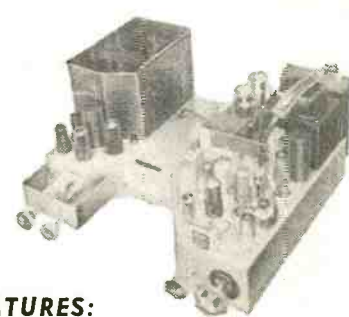

IMPORTANT FEATURES:

- Newly developed keyed automatic gain control
- Improved Automatic frequency control (synclock)
- Voltage doubler produces 14KV for maximum brilliance
- Wide angle deflection yoke will spread any 14", 16", 17", 19" or 20" picture tube
- Large cartwheel focus coil for razor sharp focusing
- Armstrong FM high quality sound using Standard coil selector
- Moulded condensers
- 12" R.C.A. Speaker

Perfect Chassis for any size and shape picture tube—complete with knobs, escutcheon plate and hardware

\$17950 (less CRT plus Federal Tax)

14" Glare Proof Tube (Rect.)	\$29.50
16" Glare Proof Tube (Rect.)	41.50
17" Glare Proof Tube (Rect.)	46.50
19" Glare Proof Tube (Round)	71.50
20" Glare Proof Tube (Rect.)	74.50

(Plus Fed. Tax)

TERMS:
25% Deposit with order — Balance C.O.D., F.O.B. Brooklyn, N. Y.

Standard RMA Warranty

RCA LICENSED T-20 CHASSIS

- 20 Tube Chassis
- Standard Coil Front-end
- 12" R.C.A. Speaker
- FM high quality sound (not intercarrier)
- Phono jack and switch

For all size picture tubes to 20" — **\$13950** (less CRT plus Fed. Tax)

DEALERS:
Special Quantity Prices!

WIRE, PHONE, WRITE or Come in TODAY!

J & H TELEVISION CO.
1845 Pitkin Ave. (near Sackman St.), Brooklyn 12, N. Y.
PHONE: HYacinth 8-5932

Prices and Models Subject to Change Without Notice

QUAM FOCALIZER UNIT*

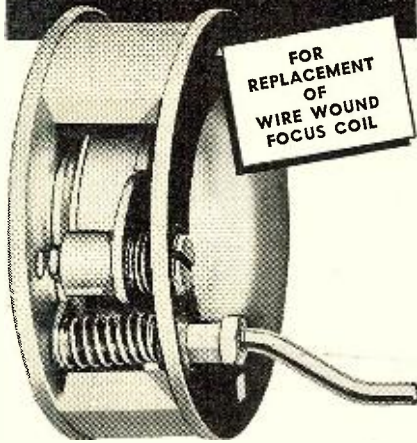

**PROVIDE SHARPER FOCUS OF TELEVISION IMAGE!
UNAFFECTED BY TEMPERATURE AND VOLTAGE FLUCTUATIONS!**

Simple to Install
NO WIRING NEEDED

Now, wire wound focusing coils are easily replaced on television sets being repaired or rebuilt for larger tubes with the QUAM Alnico V Permanent Magnet Focalizer* unit that is being used as original equipment in many leading sets.

Easy to install, the Quam Focalizer* unit provides a sharper image that is unaffected by voltage and temperature fluctuations.

A slight turn of the adjusting screw brings the tube in focus—the centering handle centers the image on the screen. 2 Kits are available, one for anode voltages up to 12 K.V., and one for anode voltages of 12 K.V. and over. Complete kits include aluminum supporting bracket, mounting screws and centering handle.

List Prices—QF1 Kit, 12 K.V. or less....\$4.75
QF2 Kit, 12 K.V. or over..... 5.95

There's a growing demand among servicemen for Quam Focalizer* Kits!

QUAM-NICHOLS COMPANY

522 E. 33rd Place Chicago 16, Ill.

Makers of Quam Adjust-A-Cone Speakers.

*TRADE MARK



RADIO and TELEVISION

Thorough Training in All Technical Phases

APPROVED FOR VETERANS

WEEKLY RATES

DAYS—EVENINGS

FREE PLACEMENT SERVICE FOR GRADUATES

For Free Catalog write Dept. RN-51
RCA INSTITUTES, INC.

A Service of Radio Corporation of America
350 West 4th St., New York 14, N. Y.

ON-THE-SPOT BATTERY RECORDER

WALKIE-RECORDALL 8 lb. miniature BATTERY RECORDER-PLAYBACK

Continuous, permanent, accurate, indexed recording at only 5¢ per hr. Instantaneous, permanent playback. Picks up sound up to 60 ft. Records conferences, lectures, dictation, 2-way phone & sales talks; while walking, riding or flying. Records in closed briefcase with "hidden mike"! Write for Detailed Literature.

MILES REPRODUCER CO., INC.

912 BROADWAY Dep't RN-4 NEW YORK 3, N. Y.

THE AL-VISER

7 DIRECT MAIL ADVERTISING

By
IRVING SETTEL

SOMEONE once asked a direct mail specialist to explain the uses of this type of promotion. His answer was quick and very apt. "Direct Mail," he said, "can be used in the following ways: as a pathfinder; as an introduction; as a personal salesman; as a customer reminder; as a goodwill builder; as a sales increaser; as a stimulant for active customers; as an effective tonic for inactive customers; as a reviver for almost dead customers. Direct mail is the most versatile of all advertising media."

Direct mail is not only versatile, it is also the most flexible within its own field. It lends itself to many forms of salesmanship where "others fear to tread." For example, it has been used successfully for missionary work preceding visits of salesmen; it has been used as a follow-up of salesmen; it lends itself to the emphasizing of special sales where the advertiser desires to control circulation. Most important, direct mail actually gets into the homes.

As a radio and television merchant there are a number of types of direct mail pieces which are suitable for your use. Let us consider the most practical of these and what they can do in terms of sales.

Letters

The most commonly used direct mail form is the letter. It is highly effective because it simulates the personal message which people are accustomed to receive every day. This type of promotion may be typed individually or reproduced by machine. The following points are important to remember:

1. Compared to most mailing pieces, letters are inexpensive. The use of modern mechanical devices such as the multigraph or the mimeograph machines have made inexpensive quantity runs possible. Of course, individually typed letters are most effective. But this method is expensive in both time and money. The multigraph machine, closest to the original typing, is used to simulate the individual letter. This can duplicate the "color" of your own typewriter ribbon. Fill-in salutations make the message appear personal.

2. A letter is usually read more carefully than a planned circular.

3. To be effective, the letter should be short, well written and to the point. It should employ all the rules of effective advertising.

4. The letter has been used successfully to promote single items of merchandise, the institution, to solicit new business, to promote collections, etc. Many radio and television merchants use a standard form letter to express congratulations to people on lists of marriages, births, and graduations, taken from the local paper. Such a direct mail piece creates goodwill among potential customers.

First Class Mail Cards

This type of promotion consists of either an unfolded piece of cardboard with a message or a government penny postcard. The government card has been used extensively by retailers throughout the country with excellent results. Some businesses frown upon this method of advertising; nevertheless, it has proven its worth. A postcard is more apt to be read than any other type of direct mail piece. It requires only a glance to read the message. No opening of envelopes complicates matters. If the message is short and effective, the reader will respond. It is excellent for announcing sales, selling single items, making special offers, etc. It can be written by hand or printed in one or more colors. The cost of mailing is always one cent and preparation can be done equally inexpensively. For its cost, certainly no other type of promotion can compare with the government postcard. It is possible, too, to obtain return postcards from the post office. These come attached to the regular postcards and the cost of the complete double-postcard is only two cents. It has the advantage of bringing to the customer a return card already addressed and ready to mail with the postage already paid. When it is necessary for the customer to fill out the coupon, this form has proven to be highly successful.

Leaflet

A leaflet is a single small-sized sheet, printed on one or both sides. These have been used effectively as package inserts, letter stuffers, etc. It is also used as a supplement to a letter and usually carries more details about the product.

Folder

A folder is a leaflet containing one or more folds. It is sometimes of heavy

RADIO & TELEVISION NEWS

STAR SPECIAL!

HIGH-GAIN CONICAL ANTENNA \$545

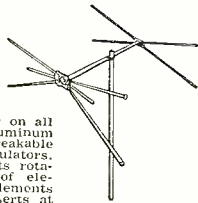

High gain and directivity on all channels. Top-quality aluminum construction with 1/4" unbreakable molded polystyrene insulators. Square cross bar prevents rotation and misalignment of elements and reflectors. Elements reinforced with steel inserts at at one end, other end crimped. One man quick assembly! U-bolt for mast has tooth-grip to prevent slipping. Shipped less mast. Greatest conical value ever offered. Use stacked conical for deep fringe areas and for exceptional directivity; permits separate adjustment of high and low channels.

A-547 Single Conical Antenna \$5.45 each
 With 75-ft. of 300-ohm lead. . \$7.70 each
 \$6.95 each in lots of 10

A-548 Stacked Conical Antenna . . . \$11.95 each
 \$10.75 each in lots of 10

A-548-75 With 75-ft. of 300-ohm lead. . \$14.20 each
 \$12.95 each in lots of 10

STAR VEE-BEAM \$545



Pre-assembled Vee-Beam for easy installation. High gain and excellent directional characteristics on all channels. Shipped less mast. An unbeatable buy at our low price.

Meets most installation requirements. Order now!

A-1128 Star Vee-Beam \$5.45 each
 \$4.95 each in lots of 10

A-1128-75 With 75-ft. of 300-ohm lead. \$7.70 each
 \$6.95 each in lots of 10

A-1129 Stacked Vee-Beam \$11.95 each
 \$10.75 each in lots of 10

A-1129-75 With 75-ft. of 300-ohm lead. \$14.20 each
 \$12.95 each in lots of 10

Aluminum Mast Sections

5-ft. aluminum mast. Will resist rust and out-last any ordinary mast section. Sold only with antennas in this ad.

A-549 \$1.03 each
 93c ea. in lots of 10

COMPLETE STOCKS All Standard Brands

Just off the press BIG BARGAIN BULLETIN



ELECTRONIC DISTRIBUTORS, INC.

Dept. RN 2-7736 S. Halsted, Chicago 20, Ill.

Just Published!

TELEVISION SERVICING

by Walter H. Buchsbaum



340 pages 170 illustrations



Symptoms of defective operation easily recognized, quickly corrected by illustrations, diagrams and how-to-do-it facts in this new book.

Get this brand new, complete handbook for sure-fire working knowledge of TV installation, maintenance and troubleshooting. Tells you step-by-step procedures for audio IF alignment, video IF alignment, aligning RF amplifiers, mixers, oscillators, etc. All possible defects classified for ready reference, thoroughly analyzed to show what is wrong and why . . . and what to do to correct the defect. No mathematical knowledge needed! Practical, authoritative, up-to-the-minute, the perfect handbook for set owners, trainees, and repairmen.

USE IT 10 DAYS FREE

Coupon below brings you "Television Servicing" on FREE trial for 10 days, without obligation. Mail it NOW.

PRENTICE-HALL, Inc., Dept. M-RN-351
 70 Fifth Ave., New York 11, N. Y.

Send me, for 10 DAYS' FREE TRIAL, "Television Servicing." I will return it in ten days and pay nothing—or keep it and send \$1.35 down (plus postage) and \$2 monthly for 2 months.

NAME
 ADDRESS
 CITY ZONE . . . STATE

SAVE! Send \$5.35 with this coupon, and we'll pay postage and packing.

March, 1951

ier stock and contains better art work. The size makes it possible to present a complete sales story. The folds are carefully planned to permit the reader to follow the copy without difficulty.

Broadside

The broadside is a large folder, usually 19 by 25 inches or larger. It has proven effective for special sales, for certain smashing effects, etc. Its size lends itself to interesting and complete stories. When folded, it should be small enough to be mailed. Radio and television retailers have used broadsides to good advantage for Christmas, for special promotions, etc.

Booklets

A booklet is a leaflet of several pages. It is used when a great deal of space is necessary to make a presentation. It often provides detailed information about products with pictures, prices, and descriptions. Because of its increased cost in printing, paper, and mailing, an advertiser usually invests more money in the art work and presentation.

Catalogues

A catalogue is an enlarged booklet containing a complete list of articles available at a particular firm with prices and descriptions and usually pictures of the articles. The catalogue will tell, in detail, the story of the radio and television sets being offered. Because of its expense, it is not issued more than once or twice a year. Regularity, however, is an important part of the campaign. A customer will look forward to the catalogue and generally keeps it for future reference.

Figuring Costs

In planning a direct mail piece, the cost will determine your actions. The entire campaign will be based upon how much money you have to spend. Approximate figures must be determined in advance. The following procedure may be followed in your preparation:

1. Get your production costs from your printer, engraver, etc. With a very rough layout, these specialists can give you a good figure with which you can work.

2. Your first mailing will be considered a test mailing. Here, you will discover your mailing costs, the probable returns for future mailings and other answers to individual problems.

3. Determine your cost per order. This can be arrived at in a simple manner. For example, assume that you have a list of 10,000 and the folder will cost you \$50 per thousand including printing, mailing, etc. (or a total of \$500). Assume, too, that you receive 50 orders. Your cost per order, then, would be 500 divided by 50 or \$10. Your future campaigns should be gauged upon these results. Always keep in mind that you must try to increase your sales and lower your unit cost. A return of 3 per-cent on a mailing is considered excellent for prod-

FREE TO TV SERVICEMEN

THE LAST WORD IN TV 'TENNA INSTALLATIONS



TV TENNA TIPS
PRICE 50c

BRAND NEW AUTHORITYATIVE INFORMATIVE

Simplifies

TV-ANTENNA INSTALLATIONS

A fact-filled, pocket size reference manual edited by outstanding authorities. Packed with vital information on all types of antennas, Helpful Hints, Do's and Don'ts, Dimension Guide, Channel Frequencies, Proper Feed Methods and many other subjects.

LIMITED QUANTITY

PUBLICATION PRICE 50c. AVAILABLE WITHOUT OBLIGATION IF YOU WRITE IMMEDIATELY.

FREE!

MAIL THIS COUPON TODAY

SNYDER MFG. CO., Dept. K
 22nd & Ontario Sts., Phila. 40, Pa.

Please send free copy of TV 'TENNA TIPS

Name
 Address
 City Zone . . . State

VARIETY

COVERS THE WORLD
IN TELEVISION · RADIO ·
INDUSTRIAL · TEST
EQUIPMENT & SUPPLIES



DU MONT SERIES T3A FOUR-SECTION IMPUNETER*

INTERCHANGEABLE with
existing TV tuners for
superlative TV plus
FM reception.

New "high" in performance; new "low" in cost—
with FM band reception as a bonus value! Mechanically and electrically interchangeable with most switch-type TV tuners. Embodies Mallory-Ware three-section inductor* plus antenna tuning. Startling sensitivity and selectivity. Velvety-smooth, continuous tuning.

* More gain than that of previous Inputuners—
2:1 on high channels. Low noise figure.

* Input impedance, 300 ohms. Inclusion of sound
trap, optional. Choice of either 21.25 or 21.75
mcs sound center I.F.

* Continuous tuning in four turns. Skip mechanism
eliminates area between end of FM band and
Channel 7.

Price **\$25.50** plus postage

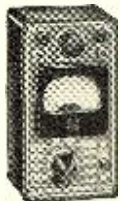

SUPERIOR'S POCKET SIZE VOLT-OHM MILLIAM- METER NEW MODEL 770 (SENSITIVITY: 1000 OHMS PER VOLT)

6 A.C. VOLTAGE RANGES:
0—15/30/150/300/1500
/3000 VOLTS

6 D.C. VOLTAGE RANGES:
0—7.5/15/75/150/750/
1500 VOLTS

4 D.C. CURRENT RANGES: 0—1.5/15/150 MA.
0—1.5 AMPS.

2 RESISTANCE RANGES: 0—500 OHMS 0—1
MEGOHM

* Compact—measure 3 1/8" x 5 7/8" x 2 1/4".

* Uses latest design 2% accurate 1 Mil. D'Arsonval type meter.

* Same zero adjustment holds for both resistance
ranges. It is not necessary to readjust when
switching from one resistance range to another.
This is an important time-saving feature never
before included in a V.O.M. in this price range.

* The Model 770 comes complete with self-contained
batteries, test leads and all operating
instructions.

Price **\$14.90** plus postage

20% Deposit with Order
Required, Balance C.O.D.

To Be Sure, Call on Variety First for Everything
You Need.

VARIETY ELECTRIC CO.
INC.
601 BROAD ST., NEWARK 2, N. J.
New Address After April 1, 1951
468-470 BROAD ST., NEWARK 2, N. J.

RADIO COURSES

- RADIO OPERATING • CODE
- RADIO SERVICING • ELECTRONICS
- F.M. TELEVISION
- PREPARATION FOR CIVILIAN,
MARITIME, ARMY AND NAVY LI-
CENSE REQUIREMENTS.

Write for Catalog T.S.

YMCA

TRADE & TECH. 229 W. 66 St., N. Y. 23
SCHOOL (Indicott 2-8117)

ANOTHER OUTSTANDING JOBBER SUPPLIES, INC.

1013-15 Jefferson Ave.
Toledo, Ohio



\$44.95

HAS THE
SENSATIONAL NEW
TEICO
425-K 5"
SCOPE KIT
IN STOCK!

ucts costing under \$10. Usually no more than 2 per-cent can be expected.

4. For future mailings, use past sales as a measure to determine your appropriation. The money you spend will affect the size and type of mailing piece you use. As you increase the returns, you should attempt to add to the effectiveness of your piece. The more you have to spend, the greater the opportunity to offer your public your merchandise in the most effective presentation.

-50-

DETENT REPAIR

By HENRY G. LOEWY

I BELIEVE that I have a solution to a rather tough television service problem which might be of interest to other technicians. Most of us are called upon to repair TV tuners. The switches on most tuners break and the detents have to be replaced. Some of these detents are easy to obtain, others are specially made and can only be secured from the manufacturer. This usually takes a lot of time and the customer cannot always understand the reason for the delay.

I have found that these detents can be easily repaired. The result will usually outlast three new units. This time-saving procedure means more business because customers appreciate the faster and better service.

Simply remove the detent from the switch assembly. The most common defect is that the small steel ball falls out because the spring tension fails. Simply replacing the spring will solve the problem. Any jeweler will be able to give or sell you a broken clock spring. One about 1/2 inch will do.

First of all knock out the pin holding the metal part of the detent to the fiber. The spring can then be removed. Now cut an equal length from the half-inch clock spring. Mark corresponding holes on the new spring. To make these holes in the new spring use a miniature grindstone, one of the type made for hand engravers will answer the purpose.

Instead of putting in another steel ball, simply insert a small round-head machine screw and reassemble. Now, even if the spring loses its tension, the machine screw will not fall out. I have used this technique many times and it hasn't failed yet.

-30-



Classified

Rate 50c per word. Minimum 10 words

RADIO ENGINEERING

RADIO Engineering Broadcasting, Aviation and Police Radio, Servicing, Marine Operating and Electronics taught thoroughly. Expenses low. Write for catalog. Valparaiso Technical Institute, Dept. N, Valparaiso, Ind.

SALE

RADIO and Television Tubes. We have all numbers. They're all new at good discounts. Write us for your needs. Immediate response. Beacon Stores, Inc., Anderson Ave., Grantwood, N. J.

HOTTEST surplus list in the country. Electronics-Hydraulics, Aircraft-Gadgets. Dick Rose, Everett, Wash.

RADIO Diagrams 50c; Record Changers, Recorders 60c; Television Diagrams with service data \$1.00 up. State Manufacturer and model number. Kramer's Radio Service, Dept. RX, 36 Columbus Ave., New York 23, N. Y.

COLOSSAL bargain in radio parts, over 150 assorted radio parts including resistors, condensers, controls, coils, etc. All new, \$75.00 value, guaranteed satisfaction or money refunded, postpaid in U. S. A., \$2.50. Write for catalog. Buyers Syndicate, 30 N. Taylor St., Springfield 3, Mass.

HARD-To-Get-Tubes, all numbers, any quantity, priced right. Write your specific needs. Immediate reply. Sperry Servo-amplifier including four useful tubes, used, \$3.98. C-D DYR Dykanol, 1mf/1000wv, 3 for \$1. Tube specials: \$07, \$1.49; \$68, \$2.25; \$84, \$1.25; 931RCA, \$3.98. Add postage. Free list, no dealers. Tubes, surplus bought. Cash waiting. Send list and prices. Betz, 73 Caroline Ave., Yonkers 5, N. Y.

53 OHM Coax; 300 ohm twin; prices reasonable. Inquire: Harry H. Van Dick, Little Falls, N. J.

STEEL Tubing. Welded 1" O.D. new 16 to 20 ga. wall; 5 and 10 foot lengths. Ideal for Television masts. 14c per foot, f.o.b. Toledo. Ace Steel & Wire Co., 416 Woodland, Toledo 2, Ohio.

300 OHM wire \$35 per thousand. Tubes available. Write requirements. Post Electric, Farnhurst, Del.

HIGHEST Bidder, Scott Philharmonic Radio, excellent condition. R. C. Chadwick, Aiden Park Manor, Philadelphia 44, Pa.

THREE BC-683 receivers: 27-39 mc. Converted AC. Best offer. Ditzel, 859 Wellington, Chicago.

WANTED

GRAIN of Wheat Lamps, 323, 322, 328, etc. Radar Magnets, any shape, size, condition. Blan, 64 Dey St., New York.

AN/APR-4, other "APR-", "ARR-", "TS-", "TE-", ARC-1, ARC-3, everything surplus. Special tubes, Tech. Manuals, Lab. quality Test Equipment, etc. Describe, price in first letter. Littell, Farhills, Box 26, Dayton 9, Ohio.

RA-34 Rectifiers; TCS sets, parts; PE-104; PE-103; BC-654 (SCI-284). Arrow Appliance, 525 Union, Lynn, Mass.

HELP WANTED

OPENING for experienced or qualified television technicians. 1032 W. Peachtree St., Atlanta, Ga.

PATENT ATTORNEYS

LANCASTER Allwine & Rommel Registered Patent Attorneys. Patent practice before U.S. Patent office. Validity and infringement investigations and opinions. Booklet and form "Evidence of Conception" forwarded upon request. Suite 414, 815 15th St., N.W. Washington 5, D.C.

HERMAN Lewis Gordon, Registered Patent Attorney. Patent Investigations and Opinions. Warner Building, Washington, D. C.

CORRESPONDENCE COURSE

USED Correspondence Courses and Books sold and rented. Money back guarantee. Catalog free. (Courses bought.) Lee Mountain, Pisgah, Ala.

AMATEUR Radio Licenses. Home study theory course. Preparation for FCC examinations. Low cost. Personal coaching. Federal Electronics Institute, 45 E. Putnam, Dept. D, Greenwich, Conn.

USED Correspondence Courses and Educational Books bought, sold, rented, catalog free. Educational Exchange, Summerville, Ga.

RADIO & TELEVISION NEWS

MISCELLANEOUS

ELECTRONIC Research. Equipment designed or built to specifications. Inventors, experimenters, inquiries invited. E. A. K. Research Laboratory, Box 62, Tarrytown, N. Y.

SPEAKERS repaired at wholesale prices, guaranteed work. Amprite Speaker Service, 70 Vesey St., New York 7, N. Y.

WANT latest Riders Radio Television Manuals. Clem Ripberger, Adrian, Minn.

PHONOGRAPH Records cheap. Catalogue free. Paramount, CG-313 E. Market, Wilkes-Barre, Pa.

DETECTIVES. Make Secret Investigations. Write, Wagoner, Z-125 W. 86th, N. Y.

INCREASING WIDTH

By M. KALASHIAN, WINXT

MANY times a set will come in for repairs because the picture does not fill the mask by about one-half inch. The customer complains of a black vertical line on either or both sides of the picture.

Replacing the horizontal output tube, damper tube, horizontal oscillator tube will not always give the required half inch. Adjusting the drive and width controls or increasing voltages is useless. The set is just getting old, it hasn't the extra push for a little more.

Most of the older sets use the popular RCA horizontal output transformer (or an exact duplicate by another manufacturer) and that extra width can be obtained by placing a condenser across the lower half of the damper winding. This tends to produce a little more sweep by lowering the high voltage to the picture tube. This will dim the picture slightly but this is hardly noticeable and can easily be compensated for by advancing the brilliance control.

With the RCA transformers a mica condenser of 220 micromicrofarads and at least 600 volts d.c. (and preferably 1000 volts d.c.) will produce about a half inch greater width. The larger the value of capacitance used the greater the width, but with corresponding reduction in brilliance. The same trick can be used with transformers of other manufacture by experimenting around with different values of condensers. On the RCA transformer the condenser should be placed across terminals 4 and 5.

Completely removing the width coil from the circuit will provide a small amount of additional width—this working better on some sets than others. Make sure that removing the width coil does not interfere with the rest of the circuit (such as breaking a d.c. path to some other circuit). In a majority of the sets you will not need to worry about this because the width coil is merely connected to the upper half of the damper winding on the horizontal output transformer.

PHOTO CREDITS

PAGE	CREDIT
31	Julian Krupa
32, 33, 34	Philco Corporation
35	Servo-Tek Products Co.
38	Radio Corporation of America
38	Raytheon Manufacturing Company
39, 40, 41	The Electronic Workshop, Inc.
44, 45	Black Box Photo & Colotype Studio, Inc.
52	University of Hollywood
61, 62, 63, 141, 142	John R. Meagher
55, 148, 153	United Nations Radio
64 (left)	Zenith Radio Corporation
64 (center)	Bendix Radio Division
64 (right)	General Electric Company
124	S.O.S. Radio Ltd.
138	Columbia Broadcasting System
140	MARS
158, 160	Paul Wendel

March, 1951

EFFICIENCY IS THE KEYNOTE!

NEW DRIVE FOR PRODUCTION EFFICIENCY MEANS NEW DEMAND FOR INTER-COM SYSTEMS!



The model HU-15V is a medium sized speaker suitable for all paging and talk-back applications. All ATLAS paging speakers are designed to offer a maximum sensitivity in talk-back systems. The weather proof universal line matching transformers are easily attached to any model. Designed for constant impedance, constant voltage systems and 50 Ohm lines. The model HU-24V is an oversized speaker having the obvious advantage of a longer air column length. Suitable for music as well as speech in industrial applications.

Model TP-15V . . . TP-24V

The TP type speakers are available in two sizes. These dual two-way speakers produce two speaker results from a single location for long corridors, hallways, etc.

All ATLAS speakers are priced Right! COMPARE! But remember, we make no compromise with quality.

Don't miss your best new business opportunity in years. Write us TODAY for full details.

ATLAS Sound Corp.
1446 39th Street, Brooklyn 18, N. Y.
in Canada: Atlas Radio Corp., Ltd., Toronto, Ont.

Profitable Careers in Radio TELEVISION ELECTRONICS

CREI RESIDENCE SCHOOL

trains you for vital industry —qualifies you for better jobs in the armed services.

- Your success in this highly technical field depends on how much you know and how well you apply it. Whether you want a career in the electronics industry, where critical shortages of trained men exist, or plan to enter military service, CREI Residence School training is your key to a better job at higher pay.

Recognized as outstanding by engineers, educators, the Armed Services, and important firms like RCA-Victor, Bendix, and United Air Lines (whose technicians have received CREI training at company expense) your course can be completed in approx. 20 months.

ILLUSTRATED CATALOG FREE

Send for the new descriptive catalog, with survey of opportunities, and details of course and school. New classes start twice a month. Act now!

VETERANS: Training available under G.I. Bill, July 25, 1951 is deadline for most veterans. Don't delay!

CAPITOL RADIO ENGINEERING INSTITUTE
An Accredited Technical Institute Founded in 1927
Dept. 133C, 16th & Park Rd., N. W., Wash. 10, D. C.

Please send FREE Residence School Catalog 133C

Name _____

Street _____

City _____ Zone _____ State _____

Veteran Non-Veteran Age _____

Send details about Home Study Courses.

music lovers

Unless you hear recorded music recreated by a fine record playing system, you cannot enjoy the realism, the beauty, the concert hall quality inherent in modern recordings.

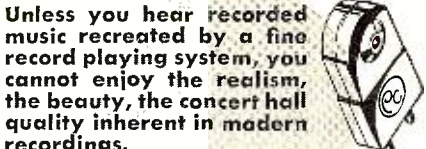

PICKERING Audio Components are the choice of leading audio engineers, lovers of fine music, record critics and specialists who design and build the better music systems.

PICKERING Pickups, Preamplifiers, Compensators, Arms and Speakers are available through leading jobbers and distributors everywhere; detailed literature will be sent upon request.



PICKERING & CO., Inc.
Oceanside, L. I., N. Y.
Address Department C.

RADAR, COMMUNICATIONS AND SONAR TECHNICIANS

W-A-N-T-E-D For Overseas Assignments

Technical Qualifications:

1. At least 3 years practical experience in installation and maintenance.
2. Navy veterans ETM 1/c or higher.
3. Army veterans TECH/SGT or higher.

Personal Qualifications:

1. Age, over 22—must pass physical examination.
2. Ability to assume responsibility.
3. Must stand thorough character investigation.
4. Willing to go overseas for 1 year.

Base pay, Bonus, Living Allowance, Vacation add-up to \$7,000.00 per year. Permanent connection with company possible.

Apply by Writing to

**D-4, P.O. Box 3575,
Philadelphia 22, Pa.**

Men qualified in RADAR, COMMUNICATIONS or SONAR give complete history. Interview will be arranged for successful applicants.

LEARN CODE WITHOUT MEMORIZING!

Now it's easy to send and receive 18 words per minute! Jobs available for men with code only. Also, preferential ratings in the Armed Forces frequently given. Or, prepare for F.C.C. Code requirements with Photosound's 36 records. SEVENTY-TWO sides that take you GRADUALLY and SURELY from basic International Morse Code Alphabet to a speed of up to 18 words per minute. An entirely new concept in teaching code—avoids the loss of speed which occurs with ordinary methods when the student has to slow down to mentally translate "dah-dits" into letters. You learn the WHOLE letter as ONE SOUND as it is at NORMAL SPEED. No memorizing code tables! Just like having a private instructor in your own room. Don't confuse Photosound's GUARANTEED course with the ordinary set of a few "code records" which leave impossible-to-overcome gaps in the learning process. With Photosound you learn in SEVENTY-TWO gradual, easy, SURE stages. Tested and proven on hundreds of students. Sold with a MONEYBACK GUARANTEE. Tests graded free. Certificate of Code proficiency issued after completion of 13 or 16 W.P.M. tests. Instructions for constructing your own inexpensive code oscillator included. Album 1, Sides 1-24, teaches Alphabet and Punctuation; Album 2, Sides 25-48, speed of 4-10 words per minute; Album 3, Sides 49-72, 11-18 W.P.M. Separate Albums, \$10 ea. Complete set of 3, \$26.95. MONEYBACK GUARANTEE. Mail Coupon Today.

SEND NO MONEY

Electronic Technical Institute, Dept. RN-551
759 W. Venice Blvd., Los Angeles 15, Calif.
Please send Album(s) 1 () 2 () 3 () 1,2,3 () for which I agree to pay the postman.

Name.....
Address.....
City..... State..... Troop.....

INDEX OF

Advertisers

MARCH
1951

While every precaution is taken to insure accuracy, we cannot guarantee against the possibility of an occasional change or omission in the preparation of this index.

ADVERTISER	PAGE	ADVERTISER	PAGE
Acorn Electronics Corporation	122	Mass. Radio School	162
Airex Radio Corp.	82	Metropolitan Overseas Supply Corp.	147
Allied Radio Corporation	9	Midway Company, The	70
Altec Lansing Corporation	112	Midwest Radio & Television Corporation	143
Alvaradio Supply Co.	133	Miles Reproducer Company, Inc.	164
American Phenolic Corporation	26	Milwaukee School of Engineering	142
American Television & Radio Co.	150	McConnell's	152
Amplifier Corporation of America	151, 156	McGee Radio Company	84, 85
Arrow Sales, Incorporated	147	McGraw-Hill Book Co., Inc.	152
Ashbach Enterprises, Leonard	162	MacMillan Company	127
Ashe Radio Company, Walter	14	National Radio Institute	3
Atlas Sound Corporation	167	National Schools	11
Audiotron Corp.	142	Newark Surplus Materials Co.	126
Baltimore Technical Institute	152	Newcomb Audio Products	120
Belden Manufacturing Company	19	Newlex Electronics, Inc.	126
Bell Telephone Laboratories	28	Newell Company, The	70
Belle Mead Electronics	150	Niagra Radio Supply Corporation	107
Belmont Radio Corp.	6	North American Electronics Limited	114
Bond Equipment Company	149	Offenbach & Reimus Company	139
Boyce-Roche Book Company	132	Olson Radio Warehouse, Inc.	96, 97
Brooks Electronics, Incorporated	160	Onan & Sons, Inc., D. W.	138
Brooks Radio & Television Corp.	125	Opad-Green Company	151
Buffalo Radio Supply	129	Peak Electronics Company	161
Candler System	156	Penn Boiler & Burner Mfg. Corp.	123
Cantor, Jack	155	Pfanstiel Chemical Company	120
Capitol Radio Engineering Institute	89, 167	Phoenix Electronics, Inc.	126
Centralab, Division of Globe-Union, Inc.	22, 23	Photocon Sales	118
Central Radio & Television Schools, Inc.	161	Pickering Company, Inc.	167
Chelsea Television Center	153	Platt Electronics Corporation	141
Chicago Industrial Instrument Company	88	Poly-Tech	114
Chicago Transformer Company	115	Precision Electronics, Inc.	92
Cisin, H. G.	152	Premax Products	136
Cleveland Institute of Radio Electronics	81	Premier Radio Tube Co.	83
Columbia Electronic Sales	134	Prentice-Hall, Inc.	165
Comet Electronic Sales Company	137	Progressive Electronics Company	98
Communications Equipment Company	113	Pyramid Electric Company	24
Concord Radio Corporation	95	Quam-Nichols Company	164
Coyne Electrical & Television-Radio School	108, 118, 138	R C A Institutes, Inc.	164
Davis Television Supply	162	Radio Apparatus Corp.	157
De Forest-Sanabria Corporation	7	Radio City Laboratories	92
DeForest's Training, Inc.	5	Radio City Products Co., Inc.	138
Du Mont Laboratories, Allen B.	Third Cover	Radio Corporation of America	Second Cover, 71, 110
East Coast Electronics	94	Radio Craftsmen, Inc., The	80
Editors & Engineers, Ltd.	82, 145, 154	Radio Distributing Company	149
Eddie Electronics, Inc.	110	Radio Ham Shack, Inc.	121
Electro-Devices, Incorporated	162	Radio Parts Company	87
Electro-Technical Industries	156	Radio Receptor Co., Inc.	135
Electro Voice, Inc.	119	Radio Specialty Mfg. Co.	150
Electronic Appliances, Inc.	159	Rauland Corporation	29
Electronic Expeditors, Inc.	130	Ray Manufacturing Company	160
Electronic Indicator Corporation	100	Raytheon Manufacturing Company	15
Electronic Technical Institute	168	Red Arrow Sales	92
Electronic Instrument Company, Inc.	30, 142, 155, 156, 162, 166	Reeves Soundcraft Corporation	158
Electronics Institute, Inc.	153	Rek-O-Kut Company, Inc.	160
Erie Resistor Corporation	126	Reliance Merchandizing Company	150
Espey Manufacturing Company, Inc.	135	Rider, Publisher, Inc., John F.	103
F. M. Electronics Company	155	Rinehart Books, Inc.	99
FM-TV Magazine	93	Sams & Company, Inc., Howard W.	72, 117
Fair Radio Sales	116	Sarkes-Tarzi, Inc.	10, 102
Federated Purchaser, Incorporated	108, 109	Schott Company, Walter L.	135
Feller Engineering Company	161	Scientific Tube Company	149
Fisher Radio Corp.	106	Simpson Electric Company	25
Franklin Technical Institute	159	Snyder Manufacturing Company	165
G. L. Electronics	144	Spellman Television Company, Inc.	154
General Electric Company	13, 17	Sprague Products Company	16
General Electronic Distributing Co.	90, 91	Standard Coil Products Co.	68
General Test Equipment	159	Standard Surplus	159
Gonsel Company	136	Standard Transformer Corporation	145
Good, Inc., Don	148	Star Electronics Distr., Inc.	165
Goodheart, R. E.	152	Sun Radio of Washington, D. C.	86
Greenlee Tool Company	109	Supreme Publications	27
Greylock Electronic Supply Co.	154	Sylvania Electric Products, Inc.	67
Harvey Radio Company	156	Tab	169, 170
Heath Company, The	73 thru 79	Tech-Master Products Company	100
Henry Radio Stores	88	Telechrome, Inc.	163
Hy-Grade Electronics, Inc.	154	Television Communications Institute	94, 152
Hytron Radio & Electronics Corp.	20	Television Supply Company	146
Illinois Condenser Company	105	Telrex, Incorporated	70
Indiana Technical College	151	Tensor	146
Instructograph Company	145	Thomas Electronics, Inc.	157
J & H Television Co.	163	Trad Television Corporation	120
J.F.D. Manufacturing Co., Inc.	100	Transvision, Incorporated	104
Jackson Electrical Instrument Co.	18	Triad Transformer Manufacturing Co.	124
Jensen Manufacturing Company	136	Trio Manufacturing Company	149
Jersey Specialty Company	150	Triplett Electrical Instrument	12
Kester Solder	114	Tri-State College	82
La-Pointe Plascomold Corporation	140	Tunk-Sol	128
Leotone Radio Company	94	Ungar Electric Tool Company, Inc.	110
Littelfuse, Incorporated	21	Upstate Distributors	106
Lornel Products Company, The	142	V & H Radio & Electronics Supply	143
Mallory & Company, P. R.	Fourth Cover	Variety Electric Company, Inc.	166
		Valparaiso Tech, Institute	70
		Weller Electric Corp.	8
		Wells Sales, Inc.	101
		Wholesale Radio Parts, Inc.	118
		Workshop Associates, Inc., The	111
		World Radio Laboratories, Inc.	155
		YMCA Trade & Tech. School	166

PRECISION RESISTORS—

Over 2 1/2 Million in Stock

"TAB"—Specialists in Precision Resistors

No Mfrs Choice—We Ship Types in Stock

0.116	271	1200	3100	14550	90000
0.425	275	1223	3163	14600	91000
0.425	280	1250	3259	15000	93000
0.607	286	1300	3360	15500	95000
0.7	289	1300	3333	15500	100000
1.03	299	1350	3384	16800	110000
1.5	302	1375	3450	17000	115000
1.75	310	1400	3509	17500	116667
2.5	311.5	1488	3700	17977	120000
3.5	320	1493	3730	18000	120000
3.83	325	1500	3760	18300	135000
4	330	1510	4000	18380	140000
4.35	340	1510	4030	18500	141000
5	345	1600	4200	19000	145000
5.025	360	1640	4220	19000	147000
6.25	366.6	1646	4280	19500	150000
1.5	370	1650	4300	19000	155000
7	375	1670	4314	20441	160000
7.8	380	1680	4440	20500	165000
12	385	1700	4450	20500	170000
8	390	1712	4500	21500	167000
10.38	400	1740	4720	22000	169200
12	410	1750	4750	22000	170000
12	414.3	1800	4850	22990	180000
13.52	418.8	1818	4885	23000	180600
14.2	425	1820	4900	23000	181000
14.25	426.9	1865	5000	23225	186600
14.5	427	1892	5100	23400	190000
15	440	1900	5150	23500	190000
16	450	1895	5235	24000	200000
17	452	1896	5270	24600	201000
17.5	460	1900	5300	24600	201000
19.2	470	1898	5500	25200	210000
20	475	1899	5500	25400	215000
20	475	1913	5600	25400	215000
23	480	1901	5770	26000	225000
24	487	1902	5910	26500	229000
25	500	1905	6000	26500	230000
26	520	1904	6000	27000	235000
28	525	1905	6125	27500	238000
31.5	550	1907	6200	28000	240000
37	575	1908	6300	28500	250000
48	580	1909	6495	29000	265000
49	584	1911	6500	29000	265000
50	600	1911	6840	29990	270000
51.78	612	1912	6990	30000	275000
55	625	1913	7100	31000	280000
56.7	633	1914	7320	31500	300000
60	640	1915	7500	32000	307500
62	645	1916	7600	32000	310000
68	645	1917	7717	35000	314000
74	649	1918	7900	37000	316000
75	650	1919	8000	37000	316000
80	657	1922	7950	38500	330000
81.4	665	1924	8000	39000	335000
88	668	1925	8100	39500	340000
89.8	670	1960	8250	40000	353500
95	673	1980	8500	42000	375000
100	675	1980	8700	42000	375000
101	680	2045	8770	45000	400000
105	681	2080	9000	47500	402000
105.7	684	2087	9100	47500	402000
107	689	2141	9445	48000	422000
120	697	2142	9500	48660	425000
121.2	698	2143	9500	48660	425000
125	700	2150	9600	49000	450000
130	711	2160	9900	52000	478000
132	713	2180	9900	55000	500000
147.5	740	2187	10300	55000	500000
150	750	2195	10430	57065	521000
160	800	2200	10500	58333	525000
165	800	2200	10500	58333	525000
170	850	2300	10900	61430	550000
175	854	2400	10926	62000	570000
175	859	2400	10926	62000	570000
182	900	2463	11140	65000	600000
182.4	910	2485	11500	66600	620000
200	919	2500	12000	67500	654000
209.4	946	2550	12000	67500	654000
216	975	2625	12500	68000	660000
225	1000	2625	13000	72000	700000
220.4	1030	2625	13000	72000	700000
225	1056	2635	13100	73500	750000
225	1056	2635	13100	73500	750000
235	1067	2710	13550	80000	800000
240	1100	2850	13600	82000	813000
245	1145	2850	14000	85000	850000
245.4	1150	2870	14250	85000	900000
250	1155	2900	14400	87500	930000
260	1162	3000	14500	88000	950000
Any size Above, Each \$5; Ten for \$32.50					

1.	1.57	2.25	3.673	6.	8.02
1.1	1.579	2.5	3.75	6.5	8.5
1.2	1.65	2.75	4.0	7.0	9.0
1.25	1.75	2.75	4.0	7.0	9.5
1.3	1.8	2.8	4.23	7	10
1.35	1.85	2.8	4.5	7.5	10.5
1.39	1.9	2.85	4.5	7.62	12
1.4	2.11	3.3	5	7.74	12.83
1.5	2.2	3.5	5.5	8	13.85

Any Size Above, Each 70c; Ten for \$6.49

Vacuum Precision Resistors

Megohms—.12/.25/.6/.75/.83/.99/1.1/1.5/2/3/3.75/1/2% Accy. Ea. \$1; 10/57.50

CIRCULAR SILICE RULE

12" Equiv.—2 1/4" Radius PRINT STAYS ON, Laminated, Divided, Logs, Dec Equiv., Case98c

PARALLEL RULES, 6" Lg Mfr BRUNING39c

PAPER CONDENSER BUYS!

WVDC Mid	Each 100 for	WVDC Mid	Each 100 for
150	.04	250	.04
200	.07	300	.07
250	.12	400	.12
300	.16	500	.16
400	.22	600	.22
500	.28	700	.28
600	.35	800	.35
700	.42	900	.42
800	.50	1000	.50
900	.58	1100	.58
1000	.66	1200	.66
1100	.74	1300	.74
1200	.82	1400	.82
1300	.90	1500	.90
1400	.98	1600	.98
1500	1.06	1700	1.06
1600	1.14	1800	1.14
1700	1.22	1900	1.22
1800	1.30	2000	1.30
1900	1.38	2100	1.38
2000	1.46	2200	1.46
2100	1.54	2300	1.54
2200	1.62	2400	1.62
2300	1.70	2500	1.70
2400	1.78	2600	1.78
2500	1.86	2700	1.86
2600	1.94	2800	1.94
2700	2.02	2900	2.02
2800	2.10	3000	2.10
2900	2.18	3100	2.18
3000	2.26	3200	2.26
3100	2.34	3300	2.34
3200	2.42	3400	2.42
3300	2.50	3500	2.50
3400	2.58	3600	2.58
3500	2.66	3700	2.66
3600	2.74	3800	2.74
3700	2.82	3900	2.82
3800	2.90	4000	2.90
3900	2.98	4100	2.98
4000	3.06	4200	3.06
4100	3.14	4300	3.14
4200	3.22	4400	3.22
4300	3.30	4500	3.30
4400	3.38	4600	3.38
4500	3.46	4700	3.46
4600	3.54	4800	3.54
4700	3.62	4900	3.62
4800	3.70	5000	3.70
4900	3.78	5100	3.78
5000	3.86	5200	3.86
5100	3.94	5300	3.94
5200	4.02	5400	4.02
5300	4.10	5500	4.10
5400	4.18	5600	4.18
5500	4.26	5700	4.26
5600	4.34	5800	4.34
5700	4.42	5900	4.42
5800	4.50	6000	4.50
5900	4.58	6100	4.58
6000	4.66	6200	4.66
6100	4.74	6300	4.74
6200	4.82	6400	4.82
6300	4.90	6500	4.90
6400	4.98	6600	4.98
6500	5.06	6700	5.06
6600	5.14	6800	5.14
6700	5.22	6900	5.22
6800	5.30	7000	5.30
6900	5.38	7100	5.38
7000	5.46	7200	5.46
7100	5.54	7300	5.54
7200	5.62	7400	5.62
7300	5.70	7500	5.70
7400	5.78	7600	5.78
7500	5.86	7700	5.86
7600	5.94	7800	5.94
7700	6.02	7900	6.02
7800	6.10	8000	6.10
7900	6.18	8100	6.18
8000	6.26	8200	6.26
8100	6.34	8300	6.34
8200	6.42	8400	6.42
8300	6.50	8500	6.50
8400	6.58	8600	6.58
8500	6.66	8700	6.66
8600	6.74	8800	6.74
8700	6.82	8900	6.82
8800	6.90	9000	6.90
8900	6.98	9100	6.98
9000	7.06	9200	7.06
9100	7.14	9300	7.14
9200	7.22	9400	7.22
9300	7.30	9500	7.30
9400	7.38	9600	7.38
9500	7.46	9700	7.46
9600	7.54	9800	7.54
9700	7.62	9900	7.62
9800	7.70	10000	7.70
9900	7.78	10100	7.78
10000	7.86	10200	7.86
10100	7.94	10300	7.94
10200	8.02	10400	8.02
10300	8.10	10500	8.10
10400	8.18	10600	8.18
10500	8.26	10700	8.26
10600	8.34	10800	8.34
10700	8.42	10900	8.42
10800	8.50	11000	8.50
10900	8.58	11100	8.58
11000	8.66	11200	8.66
11100	8.74	11300	8.74
11200	8.82	11400	8.82
11300	8.90	11500	8.90
11400	8.98	11600	8.98
11500	9.06	11700	9.06
11600	9.14	11800	9.14
11700	9.22	11900	9.22
11800	9.30	12000	9.30
11900	9.38	12100	9.38
12000	9.46	12200	9.46
12100	9.54	12300	9.54
12200	9.62	12400	9.62
12300	9.70	12500	9.70
12400	9.78	12600	9.78
12500	9.86	12700	9.86
12600	9.94	12800	9.94
12700	10.02	12900	10.02
12800	10.10	13000	10.10
12900	10.18	13100	10.18
13000	10.26	13200	10.26
13100	10.34	13300	10.34
13200	10.42		

WILLIAMSON'S

THAT'S A BUY

"WILLIAMSON'S" 10W HI-FI KIT

10cyc to 20Kc with Ease! Internationally Famous, To 1M for Experimenters. Incl Pwr Supply, RCA Chassis, Less Pre-Amp & Output Xfmr. **\$29.95**

Wmson Pre-Amp Kit & Tone Boost Amplifier. **\$34.95**

"Wmson" 12 Amp Booklet. **\$1.95**

Super-Wide Range Hi-Fi Kit: 20 cyc to 20 Kc. 100W. Max Harmonic Distortion 1 1/2% @ Full Output; 0.5% 3W output. Preamp-Tone Control. RCA chassis. Less output Xfmr. **\$34.95**

5E Var Reluc Cartridge, REV 050. **9.45**

5E Var Reluc Cart. R4040 of 041. **\$1.69**

5E Spkr 1201D. **19.95**

Hi-Fi Output Xfmr. 30W P66L6/2A3/6AS6 Pri 4000 ohms. Sec 5 taps 21k to 250 ohms. **\$5.98**

SENSATIONAL 10" Hi-Fi Spkr Ideal 6Watt Home-Speck 10W Peak. Concentric Separately Driven Tweeter—30 to 16000cps. **\$16.98**

DYNAMIC SPEAKER BUY!

5" Dyn Comp. w/Exp. Nmr. 2500 ohm Field. 1/2" Dyn. From Equip. Like-New Tested. Gtd. **98c; 12/50**

"G-1" CONS. SPEED PHONO MOTOR Model C-33RPM. Fully Equipped. **\$12.95**

110VAC/60Cyc S9 List. Only. **\$2.69**

"G-1" Gov. Contrb Phono Motor 33RPM. Speed Adjustable. Hyd. 2 1/2" Dia. **\$4.69**

Buy SPECIAL. 110VAC/60Cyc. **\$4.69**

Gov. Wts. for "G-1" Motors. **2 for 39c; 6/51**

BUZZER TYPE FOGHORN

USN, New, Adjustable, Intense Low Pitch. Ideal P.A. System. Photocell, Burglar Alarm, Boats, Cars, Buses, Trucks, Oper 6-24 vacdc. 5 1/4" Diam. 1 1/2 lbs. **\$1.49**

HOLTZER-CABOT BELL! High Efficiency Type Perm Magnet 2 7/8" Diam. 115Volts AC/DC Only. **98c; 6 for \$4.98**

0A2	\$1.69	2E22	1.12	
0A2	VR75	2E25A	4.50	
0A4G	1.33	2E25A	4.50	
0B2	1.70	HY65	5.15	
0B3	VR90	2E25	4.50	
0C3	VR105	2E30	2.25	
0D2	VR150	2E30	10.69	
0E4	2.10	2J21	2.10	
0E4	2.86	2J26	28.50	
0E4	4.90	2J27	28.50	
0E4	6.16	2J30	39.50	
0E4	6.16	2J38	64.50	
1A4	1.07	2J32	39.50	
1A4P	.98	2J32	39.50	
1A5GT	.98	2J33	18.45	
1A6	1.26	2J38	19.99	
1A7GT	1.06	2J36	95.00	
1A8	1.80	2J37	12.75	
1B3	8016*	2E25	4.50	
1B4	.98	2J39	38.50	
1B5	255	2J40	33.50	
1B7GT	.98	2J43	38.50	
1B8	2J49	39.45		
1B21	471A	2.85	2J49	39.45
1B22	3.49	2J50	22.00	
1B23	2.65	2J58	12.00	
1B24	3.49	2J56	24.50	
1B26	3.69	2J62	49.45	
1B27	4.90	2J62	49.98	
1B29	2.65	2K25		
1B32	532A	1.71	7Z3AB	39.98
1B36	10.00	2K28	36.98	
1B37	10.00	2K28	36.98	
1B38	34.00	2K39	89.50	
1B40	4.90	2V30	1.29	
1B41	4.90	2V32	1.29	
1B42	7.95	2X2	89	
1B46	3.69	2X2A	1.49	
1B5	4.90	2X2	1.49	
1B54	79.95	3A5	1.25	
1B56	40.95	3AR6T	1.90	
1B59	64.95	3B2	2.29	
1B60	64.95	3B5	.98	
1C5GT	1.09	3B7	1291	
1C6	1.09	3B7	.69	
1C7G	.98	3B25	4.60	
1D5GT	.98	3B26	3.95	
1D6	.98	3B27	3.95	
1E5GT	.98	3C3	1.60	
1E7G	.98	3C3	1.60	
1F5G	.98	3C4	1.60	
1F6	.98	3C4	1.60	
1F7G	.98	3C4	1.60	
1G4GT	.98	3E2A	17.49	
1G5G	.98	3F4	1.33	
1G6GT	1.98	3F4	1.33	
1H4G	.98	3Q5GT	1.15	
1H5G	.98	3S4	.99	
1H6G	.98	3S4	.99	
1J5G	1.20	4B27	4.98	
1J6G	.98	4B32	11.69	
1L4	1.33	4C36	15.98	
1L6	1.33	4D32	19.49	
1L7	1.33	4E7	257	
1L8	1.33	4J37	95.00	
1L9	1.33	4J42	700	
1L15	.98	4J47	260.00	
1L16	.98	4K21	1.33	
1L17	.98	4K22	59.95	
1L18	.98	4K23	59.95	
1L19	.98	4K24	59.95	
1L20	.98	4K25	59.95	
1L21	.98	4K26	59.95	
1L22	.98	4K27	59.95	
1L23	.98	4K28	59.95	
1L24	.98	4K29	59.95	
1L25	.98	4K30	59.95	
1L26	.98	4K31	59.95	
1L27	.98	4K32	59.95	
1L28	.98	4K33	59.95	
1L29	.98	4K34	59.95	
1L30	.98	4K35	59.95	
1L31	.98	4K36	59.95	
1L32	.98	4K37	59.95	
1L33	.98	4K38	59.95	
1L34	.98	4K39	59.95	
1L35	.98	4K40	59.95	
1L36	.98	4K41	59.95	
1L37	.98	4K42	59.95	
1L38	.98	4K43	59.95	
1L39	.98	4K44	59.95	
1L40	.98	4K45	59.95	
1L41	.98	4K46	59.95	
1L42	.98	4K47	59.95	
1L43	.98	4K48	59.95	
1L44	.98	4K49	59.95	
1L45	.98	4K50	59.95	
1L46	.98	4K51	59.95	
1L47	.98	4K52	59.95	
1L48	.98	4K53	59.95	
1L49	.98	4K54	59.95	
1L50	.98	4K55	59.95	
1L51	.98	4K56	59.95	
1L52	.98	4K57	59.95	
1L53	.98	4K58	59.95	
1L54	.98	4K59	59.95	
1L55	.98	4K60	59.95	
1L56	.98	4K61	59.95	
1L57	.98	4K62	59.95	
1L58	.98	4K63	59.95	
1L59	.98	4K64	59.95	
1L60	.98	4K65	59.95	
1L61	.98	4K66	59.95	
1L62	.98	4K67	59.95	
1L63	.98	4K68	59.95	
1L64	.98	4K69	59.95	
1L65	.98	4K70	59.95	
1L66	.98	4K71	59.95	
1L67	.98	4K72	59.95	
1L68	.98	4K73	59.95	
1L69	.98	4K74	59.95	
1L70	.98	4K75	59.95	
1L71	.98	4K76	59.95	
1L72	.98	4K77	59.95	
1L73	.98	4K78	59.95	
1L74	.98	4K79	59.95	
1L75	.98	4K80	59.95	
1L76	.98	4K81	59.95	
1L77	.98	4K82	59.95	
1L78	.98	4K83	59.95	
1L79	.98	4K84	59.95	
1L80	.98	4K85	59.95	
1L81	.98	4K86	59.95	
1L82	.98	4K87	59.95	
1L83	.98	4K88	59.95	
1L84	.98	4K89	59.95	
1L85	.98	4K90	59.95	
1L86	.98	4K91	59.95	
1L87	.98	4K92	59.95	
1L88	.98	4K93	59.95	
1L89	.98	4K94	59.95	
1L90	.98	4K95	59.95	
1L91	.98	4K96	59.95	
1L92	.98	4K97	59.95	
1L93	.98	4K98	59.95	
1L94	.98	4K99	59.95	
1L95	.98	4K100	59.95	
1L96	.98	4K101	59.95	
1L97	.98	4K102	59.95	
1L98	.98	4K103	59.95	
1L99	.98	4K104	59.95	
1L100	.98	4K105	59.95	
1L101	.98	4K106	59.95	
1L102	.98	4K107	59.95	
1L103	.98	4K108	59.95	
1L104	.98	4K109	59.95	
1L105	.98	4K110	59.95	
1L106	.98	4K111	59.95	
1L107	.98	4K112	59.95	
1L108	.98	4K113	59.95	
1L109	.98	4K114	59.95	
1L110	.98	4K115	59.95	
1L111	.98	4K116	59.95	
1L112	.98	4K117	59.95	
1L113	.98	4K118	59.95	
1L114	.98	4K119	59.95	
1L115	.98	4K120	59.95	
1L116	.98	4K121	59.95	
1L117	.98	4K122	59.95	
1L118	.98	4K123	59.95	
1L119	.98	4K124	59.95	
1L120	.98	4K125	59.95	
1L121	.98	4K126	59.95	
1L122	.98	4K127	59.95	
1L123	.98	4K128	59.95	
1L124	.98	4K129	59.95	
1L125	.98	4K130	59.95	
1L126	.98	4K131	59.95	
1L127	.98	4K132	59.95	
1L128	.98	4K133	59.95	
1L129	.98	4K134	59.95	
1L130	.98	4K135	59.95	
1L131	.98	4K136	59.95	
1L132	.98	4K137	59.95	
1L133	.98	4K138	59.95	
1L134	.98	4K139	59.95	
1L135	.98	4K140	59.95	
1L136	.98	4K141	59.95	
1L137	.98	4K142	59.95	
1L138	.98	4K143	59.95	
1L139	.98	4K144	59.95	
1L140	.98	4K145	59.95	
1L141	.98	4K146	59.95	
1L142	.98	4K147	59.95	
1L143	.98	4K148	59.95	
1L144	.98	4K149	59.95	
1L145	.98	4K150	59.95	
1L146	.98	4K151	59.95	
1L147	.98	4K152	59.95	
1L148	.98	4K153	59.95	
1L149	.98	4K154	59.95	
1L150	.98	4K155	59.95	
1L151	.98	4K156	59.95	
1L152	.98	4K157	59.95	
1L153	.98	4K158	59.95	
1L154	.98	4K159	59.95	
1L155	.98	4K160	59.95	
1L156	.98	4K161	59.95	
1L157	.98	4K162	59.95	
1L158	.98	4K163	59.95	
1L159	.98	4K164	59.95	
1L160	.98	4K165	59.95	
1L161	.98	4K166	59.95	
1L162	.98	4K167	59.95	
1L163	.98	4K168	59.95	
1L164	.98	4K169	59.95	
1L165	.98	4K170	59.95	
1L166	.98	4K171	59.95	
1L167	.98	4K172	59.95	
1L168	.98	4K173	59.95	
1L169	.98	4K174	59.95	
1L170	.98	4K175	59.95	
1L171	.98	4K176	59.95	
1L172	.98	4K177	59.95	
1L173	.98	4K178	59.95	
1L174	.98	4K179	59.95	
1L175	.98	4K180	59.95	
1L176	.98	4K181	59.95	
1L177	.98	4K182	59.95	
1L178	.98	4K183	59.95	
1L179	.98	4K184	59.95	
1L180	.98	4K185	59.95	
1L181	.98	4K186	59.95	
1L182	.98	4K187	59.95	
1L183	.98	4K188	59.95	
1L184	.98	4K189	59.95	
1L185	.98	4K190	59.95	
1L186	.98	4K191	59.95	
1L187	.98	4K192	59.95	
1L188	.98	4K193	59.95	
1L189	.98	4K194	59.95	
1L190	.98	4K195	59.95	
1L191	.98	4K196	59.95	
1L192	.98	4K197	59.95	
1L193	.98	4K198	59.95	
1L194	.98	4K199	59.95	
1L195	.98	4K200	59.95	
1L196	.98	4K201	59.95	
1L197	.98	4K202	59.95	
1L198	.98	4K203	59.95	
1L199	.98	4K204	59.95	
1L200	.98	4K205	59.95	
1L201	.98	4K206	59.95	
1L202	.98	4K207	59.95	
1L203	.98	4K208	59.95	
1L204	.98	4K209	59.95	
1L205	.98	4K210	59.95	
1L206	.98	4K211	59.95	
1L207	.98	4K212	59.95	
1L208	.98	4K213	59.95	
1L209	.98	4K214	59.95	
1L210	.98	4K215	59.95	
1L211	.98	4K216	59.95	
1L212	.98	4K217	59.95	
1L213	.98	4K218	59.95	
1L214	.98	4K219	59.95	
1L215	.98	4K220	59.95	
1L216	.98	4K221	59.95	
1L217	.98	4K222	59.95	
1L218	.98	4K223	59.95	
1L219	.98	4K224	59.95	
1L220	.98	4K225	59.95	
1L221	.98	4K226	59.95	
1L222	.98	4K227	59.95	
1L223	.98	4K228	59.95	
1L224	.98	4K229	59.95	
1L225	.98	4K230	59.95	
1L				

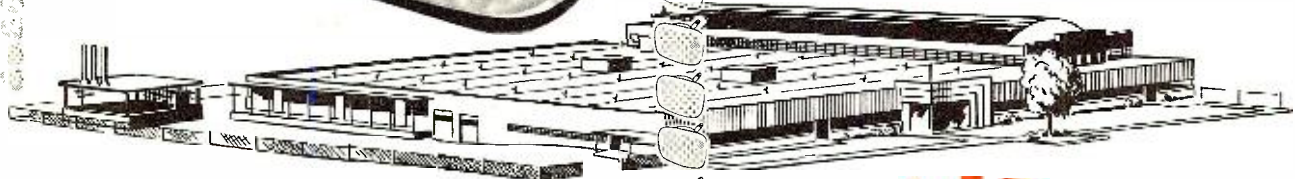

uniform

Yes, UNIFORM! There's no such thing as a "better tube" or a "poorer tube" when you insist on Du Mont Teletrons. Advanced engineering, precise mechanization second to none, and the most rigid quality control account for *uniformly dependable performance* that has made the Du Mont label symbolic of the finest in TV tubes. Best of all, with a productive capacity in excess of one million BIG picture tubes a year, the giant Du Mont Allwood plant meets *quantity* as well as *quality* requirements. Literature on request.

DU MONT

*Teletrons**

*TRADE-MARK

FIRST WITH THE FINEST IN TV
ALLEN B. DU MONT LABORATORIES, INC.
Cathode-ray Tube Division, Clifton, N. J.

Don't let comebacks pick your pocket!



A recent survey among hundreds of servicemen reveals that more of them prefer Mallory Vibrators than all other brands combined. Why? To avoid the problem of costly comebacks! Their solution is . . .

Make Sure! Make it Mallory!

Performance, quality, sound design . . . those are the reasons why servicemen say they prefer Mallory Vibrators. They help cut down on comebacks, permit more time for profitable work.

Mallory led the first commercial vibrator development and today supplies more original equipment vibrators than all other makes combined . . . has always stayed in close touch with *your* field service needs. Mallory gives you a better vibrator, available in a complete line, meeting required specifications. And Mallory Vibrators cost no more.

Don't just order vibrators! Don't take chances with comebacks! Make it Mallory . . . and make sure of positive starting, quiet operation and long life!

Depend on your Mallory Distributor for precision quality at competitive prices.



P. R. MALLORY & CO. Inc.

MALLORY

CAPACITORS • CONTROLS • VIBRATORS • SWITCHES • RESISTORS
• RECTIFIERS • VIBRAPACK* POWER SUPPLIES • FILTERS
TR Reg. U. S. Pat. Off.

APPROVED PRECISION PRODUCTS

P. R. MALLORY & CO., Inc., INDIANAPOLIS 6, INDIANA