

DECEMBER
1950

RADIO-ELECTRONIC
ENGINEERING
EDITION

RADIO & TELEVISION NEWS

MILITARY
COMMUNICATIONS

ON LAND

IN THE AIR

ON SEA

Now... the new RC-16

RCA RECEIVING TUBE MANUAL

- ✓ Up-to-the-minute
- ✓ Over 300 pages
- ✓ Latest TV tube data
- ✓ Over 460 tube types
- ✓ "Lie-flat" binding
- ✓ Expanded circuit section



... you should have these other "RCA firsts" in authoritative technical literature



Receiving Tubes for AM, FM, and Television Broadcast Bulletin 1275-E. Characteristics and base diagrams on over 450 RCA receiving types. 24 pages. Price 10 cents.

New RCA Triple Pindex At your fingertips ... any 3 base diagrams out of over 600 receiving tubes and kinescopes. Price 75 cents.



Months of planning and preparation went into the new RC-16 Receiving Tube Manual to produce what is unquestionably the most complete and authoritative reference guide to receiving-type tubes ever published.

Patterned after the famous RC-15 — of which over 600,000 copies were sold — and retaining its proven features, the new and larger RC-16 contains over 300 pages of detailed information on more than 460 RCA receiving tubes and kinescopes.

Features include—

... tube and circuit theory with formulas and examples for calculating power output, load resistance, and distortion for several classes of amplifiers—plus new information on cathode follower design.

... new information on kinescope installation and handling.

... a classification chart which groups types having similar characteristics and the same filament or heater voltages. Also shows miniature types and their GT equivalents.

... expanded circuit section including many new audio amplifier and receiver designs.

... design data and charts for resistance-coupled amplifiers.



A textbook in itself, the new RC-16 is the most valuable day-to-day tube reference guide in the field ... yet it costs only 50 cents! **Get your copy today from your local RCA Tube Distributor.**

RCA Television Pict-O-Guides For quick and accurate TV trouble shooting by picture analysis. (See your RCA Tube Distributor for details.)

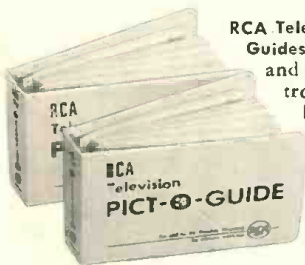

For quick action—

-----Mail this coupon to your **RCA TUBE DISTRIBUTOR** *-----

Mr. RCA Tube Distributor:
Please rush me RCA Technical Literature checked below for which remittance is enclosed—

Name _____

Address _____

City _____ Zone _____ State _____

- RC-16 RCA Receiving Tube Manual (50 cents) Receiving Tubes for AM, FM, and TV (10 cents)
- RCA Triple Pindex, New Edition (75 cents) Tell me how I can obtain Volume I Volume II of the RCA Pict-O-Guide.



**RADIO CORPORATION
of AMERICA**

ELECTRON TUBES HARRISON, N. J.

*If you do not know your RCA Tube Distributor, orders may be sent to RCA, Commercial Engineering, Section L52U, Harrison, N. J.

I Will Train You at Home for Good Jobs in RADIO and TELEVISION



**VETERANS
HURRY!**

TO GET THIS VALUABLE TRAINING UNDER G. I. BILL.
TIME IS RUNNING OUT. MAIL COUPON NOW!

**I Send You Many
KITS OF RADIO PARTS
for Practical Experience**

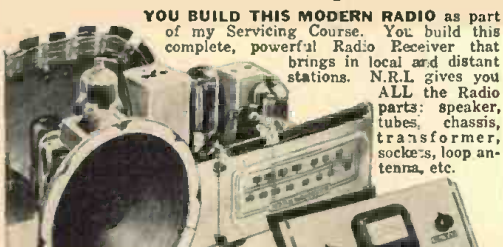

YOU BUILD THIS MODERN RADIO as part of my Servicing Course. You build this complete, powerful Radio Receiver that brings in local and distant stations. N.R.I. gives you ALL the Radio parts: speaker, tubes, chassis, transformer, sockets, loop antenna, etc.

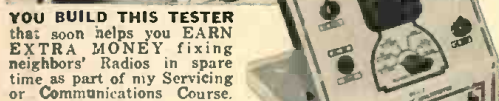

YOU BUILD THIS TESTER that soon helps you EARN EXTRA MONEY fixing neighbors' Radios in spare time as part of my Servicing or Communications Course.



YOU BUILD THIS TRANSMITTER. I send you all the parts to build Transmitter shown below as part of my new Communications Course. Conduct actual procedure of Broadcast Operators, learn how to actually put a station on the air



YOU BUILD THIS WAVE-METER in my Communications Course with parts I send. Use it to determine frequency of operation, make other tests on transmitter currents.

**America's Fast Growing Industry
Offers You GOOD PAY-SUCCESS**

Do you want good pay, a job with a bright future and security? Would you like to have a profitable shop or store of your own? If so, find out how you can realize your ambition in the fast growing, prosperous RADIO-TELEVISION industry. Even without Television, the industry is bigger than ever before. 80 million home and auto Radios, 2,700 Broadcasting Stations, expanding use of Aviation and Police Radio, Micro-Wave Relay, Two-Way Radio for buses, taxis, etc., are making opportunities for Servicing and Communications Technicians and FCC-Licensed Operators.

Television is Today's Good Job Maker

Look at these facts. In 1946 only 6,000 TV sets were sold. In 1950 almost 5,000,000. By 1954, 20,000,000 TV sets will be in use, according to estimates. 100 TV Stations are operating in 35 states. Authorities predict there will be 1,000 TV Stations. This rapid growth means new jobs, more jobs, good pay for qualified men all over the U. S. and Canada.

Many Make \$10 A Week Extra in Spare Time

Keep your job. I train you at home in your spare time. Hundreds I've trained are successful RADIO-TELEVISION TECHNICIANS. Most had no previous Radio experience; many no more than grammar school education. You learn Radio-Television principles from well-illustrated lessons. You get PRACTICAL EXPERIENCE with kits—build valuable multimeter for conducting tests; also practice servicing Radios or operating transmitters—experiment with circuits common to Radio and Television. You keep all equipment. Many students make \$5, \$10 a week extra fixing neighbors' Radios in spare time. The day you enroll I start sending you SPECIAL BOOKLETS to teach you how. Multimeter you build helps do it.

Get Actual Lesson and Book FREE

Send now for my FREE DOUBLE OFFER. You get actual Servicing lesson to show you how to learn at home. Also my 64-page book, "How to Be a Success in Radio-Television." Read what my graduates are doing, earning; see equipment you practice with at home. Send coupon in envelope or paste on postal. J. E. SMITH, President, Department ONR, National Radio Institute, Washington 9, D. C.

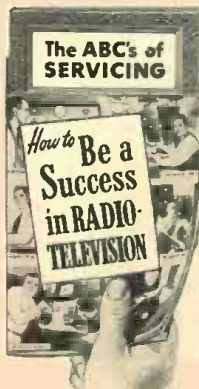

I TRAINED THESE MEN

\$10 to \$15 Week Spare Time

"Four months after enrolling for N.R.I. course, was able to service Radios . . . averaged \$10 to \$15 a week in spare time. Now have full time Radio and Television business."—W. M. B. WEYDE, Brooklyn, N. Y.

Video Engineer with NBC

"I am a video engineer employed by NBC. My duties here at Station WNBW have to do with Television control work. Glad I am in this fast growing Television field."—W. D. DEEM, Arlington, Va.

Makes Money with Own Shop

"Am doing Radio servicing full time in my own shop. Make more money than I ever made before. I owe my success to N.R.I."—C. STATH, Fort Madison, Ia.

Over \$40 Month Spare Time

"When I enrolled, had no idea it would be so easy to learn. Have equipped my shop out of spare time earnings. Clearing about \$40 to \$60 a month."—J. D. KNIGHT, Denison, Texas.

Good for Both—FREE

MR. J. E. SMITH, President, Dept. ONR
National Radio Institute, Washington 9, D. C.

Mail me Sample Lesson and 64-page book about How to Win Success in Radio-Television. Both FREE. (No salesman will call. Please write plainly.)

NAME.....AGE.....
ADDRESS.....
CITY.....ZONE.....STATE.....
 CHECK IF VETERAN APPROVED UNDER G. I. BILL

Editor
OLIVER READ, D.Sc., D.Litt., W9ETI

Managing Editor
WM. A. STOCKLIN, B.S.

Technical Editor
H. S. RENNE, M.S.

Associate Editor
RAY FRANK, W9JU

Contributing Editor
R. HERTZBERG, W2DJJ

Television Consultant
MILTON S. KIVER

Short-Wave Editor
KENNETH R. BOORD

Editorial Assistants
I. M. CARROLL
E. V. HITZEL
P. B. HOEFER

Staff Artist
R. S. KUPJACK

Advertising Manager
L. L. OSTEN

Midwest Adv. Manager
JOHN A. RONAN, JR.

Art Director
HERMAN R. BOLLIN



COVER PHOTO: Communications in our military services on land, sea, and in the air. See pages 36, 38, 47, 50, and 63 for an authoritative review of these communications systems. (Montage of Official U.S. Army, Navy, and Air Force Kodachromes)

Chairman of the Board and Publisher
WILLIAM B. ZIFF

President
B. G. DAVIS

Secretary-Treasurer
ARTHUR T. PULLEN

Vice-Presidents
MICHAEL H. FROELICH
Dir. Eastern Div.

H. J. MORGANROTH
Production Director

LYNN PHILLIPS, Jr.
Advertising Director

H. G. STRONG
Circulation Director

BRANCH OFFICES
NEW YORK (17)

366 Madison Ave., Murray Hill 7-8080

LOS ANGELES (14)
815 S. Hill St., TUCKER 9213
Manager, WILLIAM L. PINNEY

First in
radio-television-electronics

Average Paid Circulation over 200,000

Radio News Trademark Reg. U.S. Pat. Office No. 521506 • Television News Trademark Reg. U.S. Pat. Office No. 517468
Radio & Television News Trademark Reg. U.S. Pat. Office No. 517025

RADIO & TELEVISION NEWS

CONTENTS

DECEMBER, 1950

Survey of Television Antennas.....	Alan Smolen	31
Clever Idea Promotes Dealers' Sales.....		35
Planning Integrated Signal Communications.....	Brig. Gen. Wesley T. Guest, USA	36
Engineering the Integrated Communications System.....	Col. Edwin R. Petzing	38
A TV Contrast Generator and Gamma Checker.....	J. R. Popkin-Clurman, W2LNP	40
New Audio Developments.....	Jack Simon	43
Mac's Radio Service Shop.....	John T. Frye	46
Naval Communications.....	Rear Admiral John R. Redman, USN	47
Technical Aspects of Naval Communications.....	Capt. J. A. Morrison, USN	50
Building the "Williamson" Amplifier.....	Herbert I. Keroes	52
Extending Multimeter Utility.....	Rufus P. Turner, K6AI	55
Video Amplifier Frequency Response.....	Walter H. Buchsbaum	56
Compact 100-Watt AM-NBFM Transmitter.....	H. H. Patterson, W5DAH and A. D. Middleton, W5CA	59
Why, Strategic Air Communications.....	Major Gen. F. L. Ankenbrandt	63
Duo-Band Ham Antenna.....	C. L. Buchanan, W3DZZ	66
The Ad-Viser (Part 4).....	Irving Settler	74
Radio-TV Service Industry News.....		128
Radio & Television News Index (Vols. 43-44).....		160

DEPARTMENTS

For the Record.....	The Editor	8	What's New in Radio.....	84
Spot Radio News.....		16	MARS.....	90
Within the Industry.....		26	Technical Books.....	137
Short-Wave.....	K. R. Boord	54	AFCA News.....	138



COPYRIGHT 1950
ZIFF-DAVIS PUBLISHING COMPANY
185 North Wabash Ave., Chicago 1, Ill.
VOLUME 44 • NUMBER 6



Member
Audit Bureau of
Circulations

RADIO & TELEVISION NEWS is published monthly by the Ziff-Davis Publishing Company at 185 N. Wabash Ave., Chicago 1, Ill. Entered as second-class matter July 21, 1948, at the Post Office, Chicago, Ill., under the act of March 3, 1879. Entered as second-class matter at the Post Office Department, Ottawa, Canada. **SUBSCRIPTION RATES:** in U. S., Canada, Mexico, South and Central America and U. S. Possessions, \$4.00 for twelve issues; in British Empire \$5.00; all other foreign countries, \$5.00 for twelve issues. **RADIO-ELECTRONIC ENGINEERING EDITION SUBSCRIPTION RATES:** in U. S., Canada, Mexico, South and Central America and U. S. Possessions, \$6.00 for twelve issues; in British Empire \$7.00; all other foreign countries, \$7.00 for twelve issues. Subscribers should allow at least two weeks for change of address. All communications about subscriptions should be addressed to the Director of Circulation, 185 N. Wabash Ave., Chicago 1, Ill. **CONTRIBUTIONS:** Contributors are advised to retain a copy of their manuscripts and illustrations. Contributions must be accompanied by return postage and they will be handled with reasonable care, but this magazine assumes no responsibility for their safety. Any copy accepted is subject to whatever adaptations and revisions are necessary to meet the requirements of this publication. Payment covers all author's, contributor's and contestant's rights, title, and interest in and to the material accepted and will be made at our current rates upon acceptance. All photos and drawings will be considered as part of the material purchased.

RADIO & TELEVISION NEWS

Want To Double Your Pay?



How To Pass **FCC** COMMERCIAL RADIO OPERATOR **LICENSE** EXAMINATIONS

GET THIS AMAZING NEW BOOKLET FREE!

TELLS HOW—

WE GUARANTEE

TO TRAIN AND COACH YOU AT HOME
IN SPARE TIME UNTIL YOU GET

YOUR FCC LICENSE

If you have had any practical experience—amateur, Army,
Navy, radio repair, or experimenting

TELLS HOW—

Employers make

JOB OFFERS Like These To Our Graduates Every Month

Telegram, August 9, 1950, from Chief Engineer, Broadcast Station, Pennsylvania, "Have job opening for one transmitter operator to start immediately, contact me at once."

Letter, August 12, 1950, from Dir. Radio Div. State Highway Patrol, "We have two vacancies in our Radio Communication Division. Starting pay \$200; \$250 after six months' satisfactory service. Will you recommend graduate of your school?"

These are just a few examples of the job offers that come to our office periodically. Some licensed radioman filled each of these jobs . . . it might have been you!

**HERE'S PROOF FCC LICENSES ARE OFTEN
SECURED IN A FEW HOURS OF STUDY with OUR
Coaching AT HOME in Spare Time.**

Name and Address	License	Lessons
Lee Worthly, 2210 1/2 Wilshire St., Bakersfield, Cal...	2nd Phone	16
Clifford E. Vogt, Box 1016, Dania, Fla.	1st Phone	20
Francis X. Foerch, 38 Beucler Pl., Berginfield, N. J.	1st Phone	38
S/Sgt. Ben H. Davis, 317 North Roosevelt, Lebanon, Ill.	1st Phone	28
Albert Schoell, 110 West 11th St., Escondido, Cal.	2nd Phone	23

CLEVELAND INSTITUTE OF RADIO ELECTRONICS
Desk RN-24, 4900 Euclid Bldg., Cleveland 3, Ohio
Approved for Veteran Training Under G.I. Bill

December, 1950

TELLS HOW—

Our Amazingly Effective

JOB-FINDING SERVICE

Gets Better Jobs for Graduates

Here are a few recent examples of Job-Finding results:

GETS FIVE JOB-OFFERS FROM BROADCAST STATIONS

"Your 'Chief Engineer's Bulletin' is a grand way of obtaining employment for your graduates who have obtained their 1st class license. Since my name has been on the list I have received calls or letters from five stations in the southern states, and am now employed as Transmitting Engineer at WMMT."

Elmer Powell, Box 274, Sparta, Tenn.

GETS CIVIL SERVICE JOB

"I have obtained a position at Wright-Patterson Air Force Base, Dayton, Ohio, as Junior Electronic Equipment Repairman. The Employment Application you prepared for me had a lot to do with my landing this desirable position."

Charles E. Loomis, 4516 Genessee Ave., Dayton 6, Ohio.

GETS JOB WITH CAA

"I have had half a dozen or so offers since I mailed some fifty of the two hundred employment applications your school forwarded me. I accepted a position with the Civil Aeronautics Administration as Maintenance Technician. Thank you very much for the fine cooperation and help your organization has given me in finding a job in the radio field."

Dale E. Young, 122 Robbins St., Owosso, Mich.

GETS JOB IN BROADCASTING

"I have accepted a position with KWAD. I secured this position through the help of your Job-Finding Service and I had at least six other offers. I am sincerely under obligation to you."

Fred W. Kincaid, Box 241, Wadena, Minn.

Your FCC Ticket is always recognized in all radio fields as proof of your technical ability.

**OURS IS THE ONLY
HOME STUDY
COURSE WHICH
SUPPLIES FCC-
TYPE EXAMINA-
TIONS WITH ALL
LESSONS AND
FINAL TESTS.**

Get All 3 FREE

MAIL COUPON NOW

Cleveland Institute of Radio Electronics
Desk RN-24, 4900 Euclid Bldg., Cleveland 3, Ohio
(Address to Desk No. to avoid delay)

Approved for Veteran Training Under G.I. Bill.

I want to know how I can get my FCC ticket in a minimum of time. Send me your FREE booklet, "How to Pass FCC License Examinations" (does not cover exams for Amateur License), as well as a sample FCC-type exam and the valuable new booklet, "Money-Making FCC License Information."

NAME

ADDRESS

CITYZONE.....STATE.....

Veterans check for enrollment information under G.I. Bill.



THE **NEW HOME** OF

PYRAMID CAPACITORS

will be in full operation by FEBRUARY 1, 1951

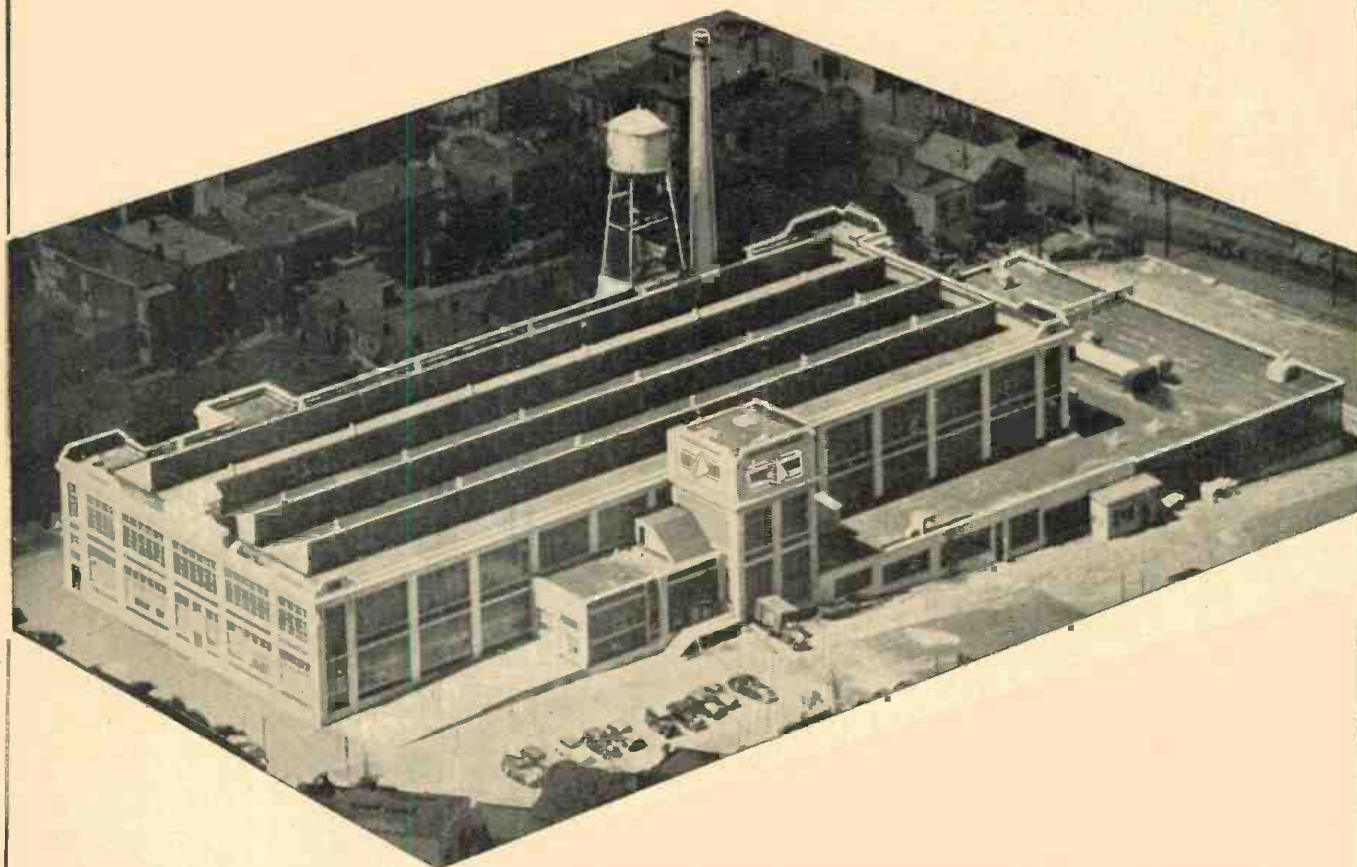

LOCATION 1445 HUDSON BOULEVARD, NORTH BERGEN, N. J.

SIZE 137,000 SQUARE FEET

PRODUCTS ELECTROLYTIC CAPACITORS
PAPER CAPACITORS
RF INTERFERENCE FILTERS

Your inquiries are invited

PYRAMID ELECTRIC COMPANY



**NOW . . . GET EVERYTHING YOU
NEED TO LEARN AND MASTER**

TELEVISION

RADIO-ELECTRONICS

...AT HOME!

Use **REAL** commercial-type equipment to get practical experience

Your future deserves and needs every advantage you can give it! That's why you owe it to yourself to find out about one of the most **COMPLETE**, practical and effective ways now available to prepare **AT HOME** for America's billion dollar opportunity field of **TELEVISION-RADIO-ELECTRONICS**. See how you may get and keep the same type of basic training equipment used in one of the nation's finest training laboratories . . . how you may get real **STARTING HELP** toward a good job or your own business in Television-Radio-Electronics. Mail the coupon today for complete facts — including 89 ways to earn money in this thrilling, newer field.



**Here's the
REAL THING!**

**SET UP YOUR OWN
HOME LABORATORY**

ABOVE: Build and keep a real 16 INCH commercial TV receiver. Optional after completing regular training at slight additional cost.

D.T.I., ALONE, INCLUDES BOTH MOVIES and HOME LABORATORY — in addition to easy-to-read lessons, you get the use of **HOME MOVIES** — an outstanding training advantage — plus 16 big shipments of Electronic parts. Perform over 300 fascinating experiments for practical experience. Build and keep real commercial-type test equipment shown at left.

**Get BOTH of these
information packed
publications FREE!**

MODERN LABORATORIES

If you prefer, get all your preparation in our new Chicago Training Laboratories—one of the finest of its kind. Ample instructors, modern equipment. Write for details!

MILITARY SERVICE!

If you're subject to military service, the information we have for you should prove doubly interesting. Mail coupon today.



Oscilloscope

R-F Signal Generator

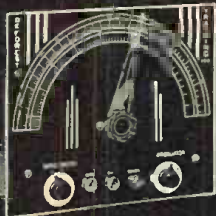

6-Tube Radio



Multimeter



**HOME
MOVIES**

De FOREST'S TRAINING, INC.
CHICAGO 14, ILLINOIS
A De VRY INSTITUTION

ACT NOW! MAIL COUPON TODAY!

DeFOREST'S TRAINING, INC., Dept. RN-G-12
2533 N. Ashland Ave., Chicago 14, Ill.

Without obligation, I would like your late News-Bulletin showing 89 ways to earn money in Television-Radio-Electronics . . . and how I may prepare to get started in this thrilling field.

Name..... Age.....
Street..... Apt.....
City..... Zone..... State.....

Specially Designed

for TV

Technicians

New OVER/UNDER

WELLER SOLDERING GUN

For ticklish TV soldering, there's no tool like the new 135-watt Weller Gun. Dual spotlights eliminate shadows. Precision balance assures accurate soldering. Long length reaches deep into chassis. 5-second heating saves time and current. Your Weller Gun pays for itself in a few months.



Check This Exclusive Combination of Features

- **5-SECOND HEATING**—No waiting. Saves power.
- **OVER/UNDER DESIGN**—Tube construction gives bracing action to tip, and improves visibility.
- **DUAL SOLDERLITE**—Prefocused spotlights completely eliminate shadows—let you see clearly.
- **LONGER REACH**—Slides easily into the most complicated set-up. Reaches tight corners.
- **COMPACT DESIGN**—Streamlined and precision balanced for delicate "pin-point" soldering.
- **TRIGGER-SWITCH CONTROL**—Adjusts heat to the job. No need to unplug gun between jobs.
- **DUAL HEAT**—Single heat 100 watts; dual heat 100/135 watts; 120 volts, 60 cycles. Handles all light-duty soldering.
- **SOLDERING GUIDE**. Get your new copy of "Soldering Tips"—revised, up-to-date and fully illustrated 20-page booklet of practical soldering suggestions. Price 10c at your distributor, or order direct.

WELLER

ELECTRIC CORP.

810 Packer Street, Easton, Pa.



For the RECORD.

BY THE EDITOR

WE REPEAT—WHY THE RUSH FOR COLOR TELEVISION?

AFTER talking to many industrial leaders, especially manufacturers of television sets, it becomes quite apparent that the television industry thinks of the FCC as a group of Federal "eager beavers" in their endorsement of the CBS color television system.

It is generally known that the much touted ballyhoo for a compatible television system, suddenly switched to one which is completely incompatible and highly impractical. The result—more confusion and dilemma to the Industry, and particularly to the public.

In an editorial (February, 1950 "For The Record") titled, "Why The Rush For Color Television?" we took issue with those seeking to literally force a color television system on the public. We were not ready for color television then, and we are not ready now, some ten months later.

May we again ask, "Why The Rush For Color Television?" Don't we have enough headaches now in attempting to maintain nearly 10,000,000 monochrome receivers now in service?

Dealers and servicemen are already feeling the impact, not only of the FCC's color decision, but the attendant publicity which implies that color service will soon be available on full schedule. Such publicity creates doubt in the minds of the public as to the advisability of purchasing a present black and white television set. At best it would be many months, perhaps even years, until any color system would receive any favor from the advertiser. Millions of dollars are spent annually on television programming and there is nothing whatsoever in the FCC's color decision that indicates that monochrome telecasting service will be discontinued at any time in the future. It is generally believed that color television programs, when they do become available, will be a supplementary service. The acceptance of color will depend entirely upon the type and quality such programs will provide. At this moment, however, the public is not ready to be sold on an incompatible device.

Must we chop receiver cabinets and make other major alterations, including the masking of large television picture tubes into smaller ones, so a clumsy motor and scanner can be slid into place? Must we constantly tell Junior not to fool with the various gadgets that stick out for all to tinker with?

With the present limit to 10—12½" size for the CBS system, there will be

required a high speed revolving color disk, placed in front of the picture tube, rotating at 1440 r.p.m. The disk for a 10" tube is about 24" in diameter and 28" for a 12½" tube. The trend has been toward larger picture tubes. Therefore, to adapt a 16" set for CBS color would require a disk of about 36". That's like turning a round card table in front of a screen.

Must servicemen be emissaries in the home of John Q Public in an attempt to convince him that the FCC just couldn't wait for some practical method for color television that, according to most engineers, can be fully developed within a reasonably short time? Is it not reasonable to assume that within a short length of time there will be developed an acceptable compatible television system, employing new developments and making use of those already under test?

We have talked to many television set users and without exception, they have stated that their present black and white sets are perfectly satisfactory and that they saw no point in converting to color in the near future. Some ask, why don't they (the FCC) give the manufacturers more time to perfect a compatible system? Didn't the Motion Picture Industry eliminate flicker from early technicolor?, etc.

These United States are blessed with the finest electronic technicians in all the world. Is it not probable that this "brain power" will develop a real honest-to-goodness compatible television system for the public? Developments in recent months have definitely shown real progress in the dot-simultaneous system, the tri-color tube and others, to the point where it is quite probable that the entire goal in achieving a flicker-free compatible color television system may be almost at arms reach.

This feeling is shared by the vast majority in the television industry who know what can be perfected to give the public what it really wants, and not what the FCC and CBS want it to have.

It now appears that the CBS system (except for superior color rendition) is so impractical that it may die out when the public learns all the facts. Time will tell. In the meantime—we're stuck with second best and we'll have to make the best of it and prepare for things to come by studying conversion techniques (now in preparation) and to carry the hope that competition will ultimately force a compatible color system. . . . O.R.

RADIO & TELEVISION NEWS

There's Only ONE COMPLETE CATALOG for EVERYTHING IN RADIO, TELEVISION & INDUSTRIAL ELECTRONICS

IT'S YOUR **FREE**
ALLIED 212-PAGE
 VALUE-PACKED CATALOG!

Send For It Today!



HERE'S the only *complete* Buying Guide to TV, Radio and Industrial Electronics—packed with the world's largest selections of quality equipment at lowest, money-saving prices. See the latest in TV, AM and FM receivers; radio-phonos; new Sound Systems and P.A. equipment; high-fidelity custom sound components; recorders and accessories; full selections of newest Amateur receivers and station gear; test instruments; builders' kits; huge listings of parts, tubes, tools, books—the world's *most complete stocks* of quality equipment.

ALLIED gives you *every* buying advantage: speedy delivery, expert personal help, lowest prices, assured satisfaction, liberal time payment terms. Get the 1951 ALLIED Catalog. Keep it handy—it will save you time and money. Send today for your **FREE** copy!

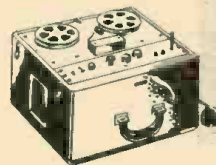
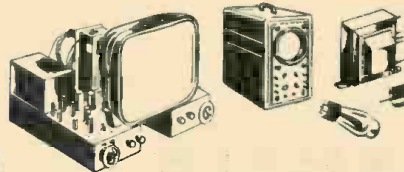

WORLD'S LARGEST STOCKS

- Radio Parts Unlimited
- Test Instruments—All Makes
- Television & Home Radios
- P.A. and Hi-Fi Equipment
- Amateur Station Gear
- Supplies for Industry

QUICK, EXPERT SERVICE

ALLIED IS YOUR TELEVISION HEADQUARTERS



To keep up with TV, depend on ALLIED! Count on us for the latest releases and largest stocks of picture tubes, component parts, antennas and accessories—plus the latest in TV tuners and kits. If it's anything in TV—we have it in stock! So remember—for TV—it's ALLIED First!



ALLIED RADIO

THE WORLD'S LARGEST RADIO SUPPLY HOUSE

Everything in Electronics

WRITE TODAY FOR RADIO'S
 LEADING BUYING GUIDE

FREE

ALLIED RADIO CORP.
 833 W. Jackson Blvd., Dept. 1-M-0
 Chicago 7, Illinois

Send **FREE** 212-page 1951 ALLIED Catalog.

Name.....

Address.....

City..... Zone..... State.....

Announcing **CENTRALAB'S**

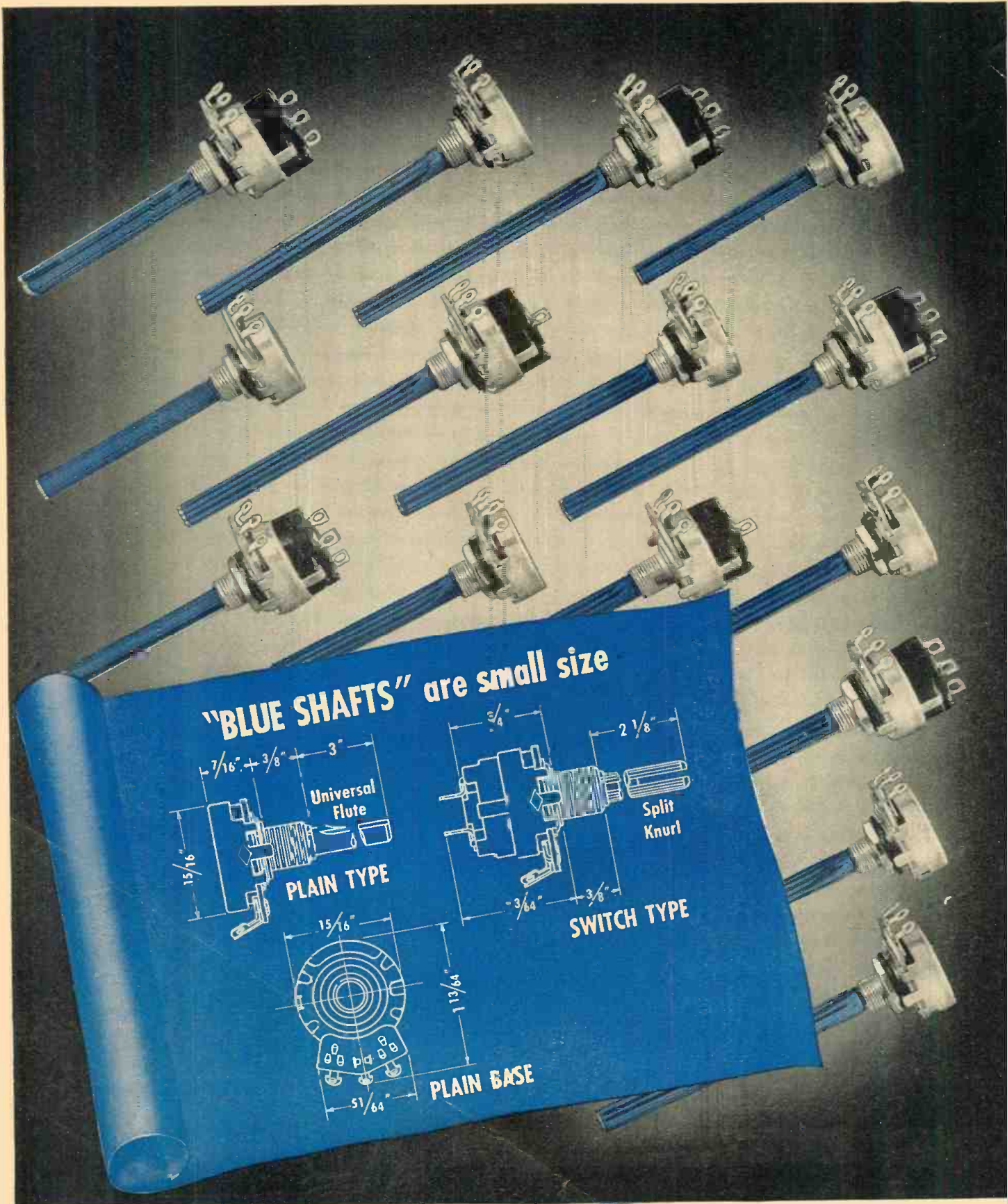

NEW Blue Shaft **CONTROLS**

Centralab now offers service engineers...today's finest replacement controls . . . quickest for servicing . . . at today's most favorable prices

8 Reasons why "Blue Shafts" are better

1. Blue Shaft controls are complete, ready-to-use units — factory assembled and tested including switches. No time lost fussing with assembly — smooth action guaranteed.
2. Blue Shaft Controls are *small size* — only 15/16" diameter — meet any modern service requirement.
3. Shafts — Standard Model B — 3" long — universal fluted — full length mill. Model BSK — 2 1/8" long with split knurl.
4. Switches — positive throw in both "on" and "off" positions. Terminals — surfaces elevated to eliminate danger of shorting to cover legs . . . 1/8" hole diameter for quick wiring . . . hot tin dipped for easy soldering.
5. Contact Spring gives you double wiping contacts on both resistor and center terminal ring . . . to insure noiseless operation.
6. Blue Shaft resistors are made of special resistance material bonded to high quality phenolic for smooth operation, low noise level, outstanding humidity characteristics.
7. Insulator's high dielectric strength permits breakdown test at 1000 volts R. M. S. *Dust and dirt can't get in.*
8. Blue Shaft Controls are produced and *guaranteed* by Centralab — the company that *introduced* carbon-type controls to the radio industry 25 years ago!

"Blue Shafts" offer complete range of all values

Service engineers! Centralab's new Blue Shaft controls are an exclusive *service item* and are available in a complete line of plain and switch types. Resistance ranges from 500 ohms to 10 megohms in a wide variety of tapers and tapped units suitable for any circuit.

Blue Shaft Controls are available packaged singly, in handy plastic boxes containing 12 — and in a special metal cabinet containing 22 controls—*No extra charge for the cabinet.* Ask your nearest Centralab distributor for complete details on all Blue Shaft controls.

Check These **LOW PRICES** on Popular Size Controls!

Cat. No.	Ohms Max. Resistance	Taper	Circuit Location	List Price
B-60	500,000	C-2 (audio)	Volume or Tone	\$1.00
B-60-S*	500,000	C-2 (audio)	Volume or Tone	\$1.50
B-70	1 megohm	C-2 (audio)	Volume or Tone	\$1.00
B-70-S*	1 megohm	C-2 (audio)	Volume or Tone	\$1.50

*Switch Type

Get More Information . . . You can get complete information on the entire Blue Shaft line of replacement controls from Centralab's new Bulletin No. 42-106. Ask your jobber or write direct.

Centralab®

CENTRALAB DIVISION OF GLOBE-UNION INC., 910 East Keefe Avenue, Milwaukee 1, Wisconsin

Please send me Blue Shaft Control Bulletin No. 42-106 Include new Centralab Catalog No. 27

Name.....

Company Name.....

Address.....

City.....Zone.....State.....

Please!

Your Distributor's Name.....

Address.....

City.....Zone.....State.....

Eye witness reports from a fiery furnace!

A new television development which
adds to industry's efficiency

No. 11 in a series outlining
high points in television history

*Photograph and painting
from the RCA collection*



Compact industrial television system—developed at RCA Laboratories—lets us see the unseeable in safety!

● Something's wrong in a big blast furnace, and it is too hot for engineers to approach in safety. But now, with the Vidicon camera of an RCA Industrial Television System focused on the flames, the furnace can be studied closely and carefully on a television receiver.

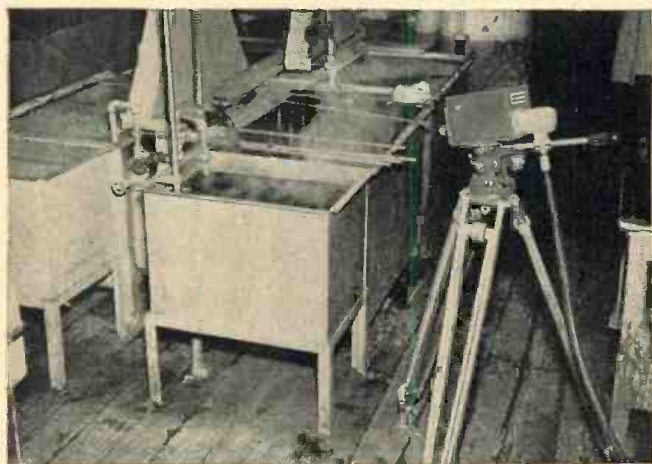

Here's RCA's Vidicon system at work beside a steaming vat. Note how the compact television camera is getting a safe "close-up" of the action.

One of the great advantages of this system—other than its contributions to industrial safety—is its ability to save both time and money. No longer need engineers "shut-down" machines or processes to observe them. Normal operations can continue without waste, while the Vidicon System gathers information.

Key to the success of Vidicon is a tiny television camera—small enough to hold in one hand—and inexpensive. The camera's "eye" is the sensitive Vidicon tube developed by scientists at RCA Laboratories. The only other equipment needed is the Vidicon camera's suitcase-size portable control cabinet, which operates on ordinary household current, and any television receiver—on which to view the pictures.

Adaptable to many uses, RCA's Vidicon camera could be lowered under water to watch divers at work—or stand watch on atomic piles, secure from radiation. And this RCA Industrial Television System can also be arranged for 3-dimensional pictures . . . real as life!



Radio Corporation of America

WORLD LEADER IN RADIO—FIRST IN TELEVISION

RADIO & TELEVISION NEWS

FOY ELECTRIC COMPANY, INC.

305 SOUTH MINT STREET TELEPHONE 3-4834

CHARLOTTE 6. N. C.



August 21, 1950

Hytron Radio & Electronics Corp.,
Salem, Mass.

Dear Sirs:

It is with great pleasure that I write you at this time to compliment you on the superior performance of the Hytron 16RP4 cathode ray picture tube.

I have just purchased one of the NEW _____ 16" table model television sets, model _____, for my own personal use. I was not pleased with the brown spot which is often found in the rectangular tubes so I replaced this new _____ picture tube with one of Hytron's. The result? Amazing! Actually clearer and sharper pictures, more brilliance and no brown spot.

We are authorized service for about 11 different makes of TV sets and _____ is one of the factories we serve. From now on we shall insist upon Hytron for all picture tube replacements.

Yours truly,

J. A. Gupton, Jr.
Service Dept. Manager

WHY MR. GUPTON PREFERS

HYTRON RECTANGULARS...

Thanks to Mr. Gupton. His unsolicited appreciation naturally warms our heart. More important, he gives all service-dealers an excellent reason for picking Hytron rectangulars.

Does he choose Hytron: Because the rectangular is Hytron's baby . . . the original leader? Because Hytron's picture-tube plant is the most modern in the country? Because nine out of ten leading TV set makers choose Hytron? Because more and more service-dealers show equal shrewdness?

He has an even better reason: experience. His own experience proves Hytron better. Hytron rectangulars give him amazingly clearer, sharper, more brilliant pictures. They'll do the same for you. Demand original Hytron rectangulars. Prove by your own tests that Hytron is also *your* best choice.

16RP4 Rectangular

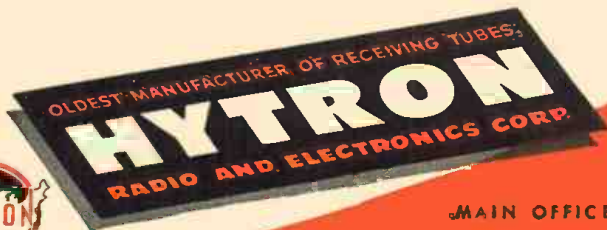

MAIN OFFICE: SALEM, MASSACHUSETTS



NOW READY! A Sensational New Line Of 1951 MIDWEST TELEVISION

**CONSOLES and
COMPLETE CHASSIS**

Featuring the NEW MAMMOTH

19½-Inch

BLACK PICTURE TUBE

At Low Factory Prices

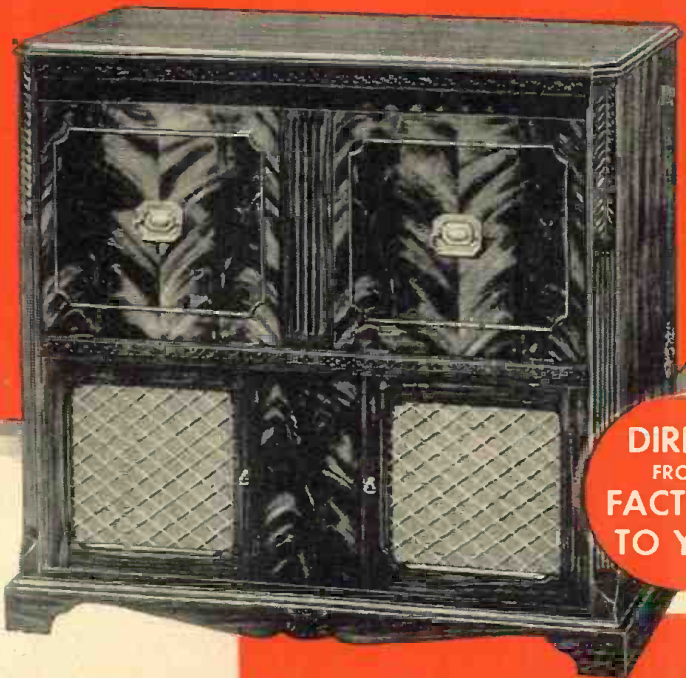

**DIRECT
FROM
FACTORY
TO YOU**



"VIDEO GRAND"
19½" Television-Radio-Phonograph Console

Never before have you seen such tremendously BIG clear pictures, such luxurious cabinets, such sensationally low Factory Prices as Midwest offers in its 31st Anniversary Line of 19½" and 16½" TV Consoles, TV - Radio - Phono Combinations, and complete TV Chassis.



"CONSTELLATION"
19½" Television Console

Check these features: Mammoth 19½-Inch Picture Tube (225 sq. in. image); Synchronized sound and picture; Simplified One-Knob Tuning; Big 12" Panasonic Speaker; Video-Sonic Tuning; and scores of other features.

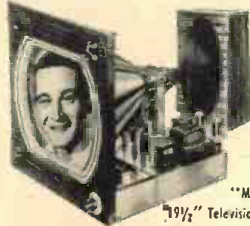

"MIDWEST"
19½" Television Chassis and Speaker

Factory Authorized Service Available in Television Areas

Plus Powerful New 1951 World-Ranging 5-Band
MIDWEST SERIES 16 **RADIOS**
In Beautiful Consoles and Complete Chassis



An entirely new line featuring the powerful Series 16 AM-FM Five-Band Radio Chassis and the magnificent Symphony Grand Radio-Phonograph with 3-Speed Automatic Intermix Record Player.

**EASY
TERMS**

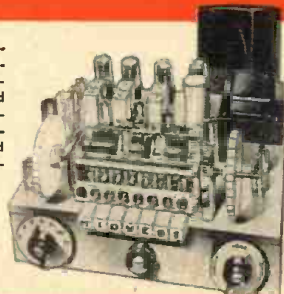

MIDWEST RADIO & TELEVISION CORP.
DEPT. 37-E, 909 BROADWAY, CINCINNATI 2, OHIO

**LET US PUT THIS
Luxurious NEW 1951
MIDWEST "VIDEO GRAND"
19½-Inch TELEVISION**

with AM-FM RADIO and 3-Speed
Automatic Intermix Phonograph

In Your Own Home on

30 DAYS MONEY
BACK TRIAL

You Must Be Satisfied or Your
MONEY BACK

SEND COUPON TODAY
For This NEW 1951 4-Color

FREE MIDWEST
RADIO-
TELEVISION
CATALOG



WRITE IN NAME AND ADDRESS (PLEASE
PRINT) ON COUPON OR 1c POSTCARD

MIDWEST RADIO & TELEVISION CORP.
Dept. 37-E, 909 BROADWAY • CINCINNATI 2, OHIO

Please send me your new FREE 1951 Catalog.

NAME _____
ADDRESS _____
CITY _____ ZONE _____ STATE _____

OHMITE

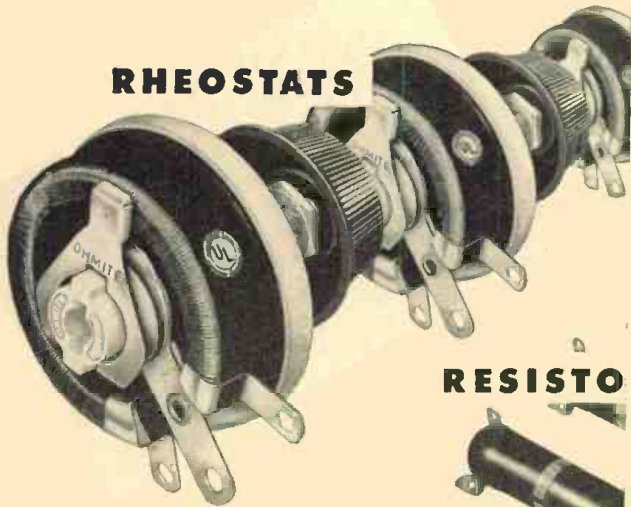

RHEOSTATS

RESISTORS

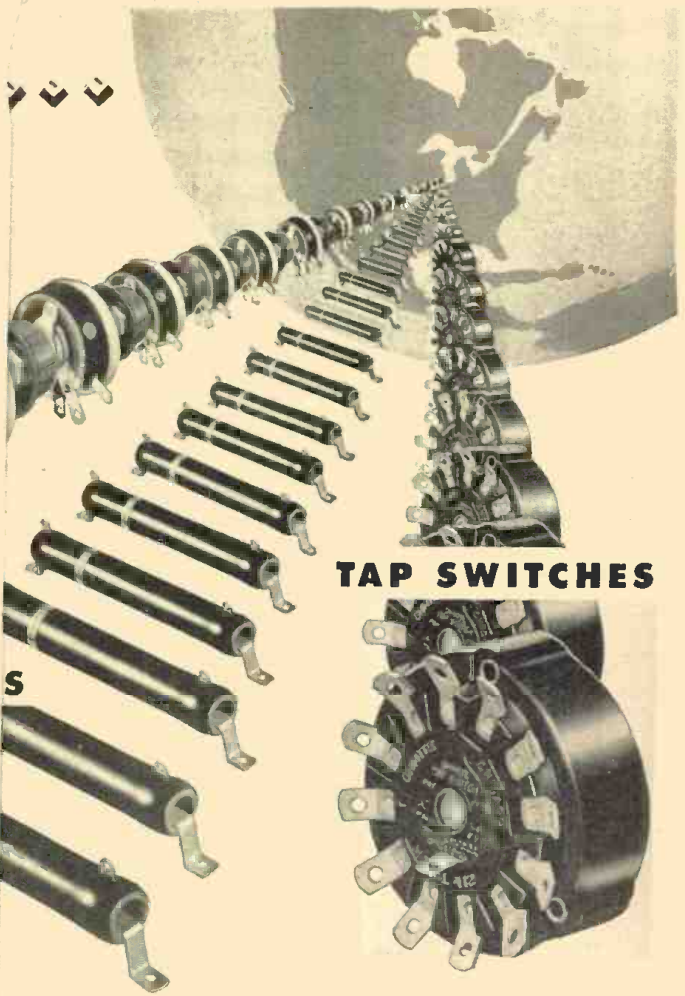
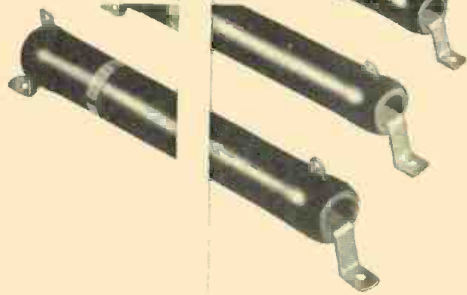

TAP SWITCHES

World Renowned for Dependability

To thousands of equipment manufacturers the world over—the name OHMITE has become synonymous with *QUALITY*. These manufacturers have put OHMITE resistance products through the most rigid of all tests—performance in the field—and these superior units have provided consistently dependable performance and long life under the most difficult operating conditions.

“Be Right with OHMITE” is more than just a slogan to these users. They know that when they specify OHMITE, they get the finest resistance equipment available—anywhere!

Write
for stock
catalog



OHMITE MFG. CO.
4885 Flournoy St.
Chicago 44, Ill.



Be Right with

OHMITE

Reg. U. S. Pat. Off.

RHEOSTATS

RESISTORS

TAP SWITCHES

December, 1950

Terrific FOR TELE-CIRCUITS!

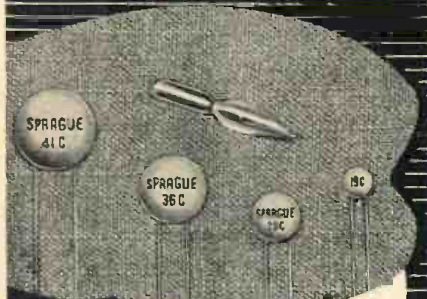

Cera-mite[★] CAPACITORS

ARE
THE *First* COMPLETE
DISC CERAMIC LINE

DEVELOPED especially for the television industry, Sprague Cera-mite Capacitors fill the bill for the alert service technician!

Temperature-compensating, general-use, and high-K bypass types fit every type of circuit application. The low self-inductance feature of the flat plate with uni-directional lead design gives better high frequency performance than the older tubular ceramics which they replace. And they're ideal as mica capacitor replacements, too!

Tiny and dependable, every Cera-mite is rated at 1000 volts test, 500 wvdc, and for operation at 185°F.

Cera-mites are clearly stamped with capacitance—no confusing color coding.

Stock up at your Sprague distributor without delay!

Write for Cera-mite Bulletin

★Trademark

SPRAGUE PRODUCTS COMPANY

DIVISION OF THE SPRAGUE ELECTRIC COMPANY

ST., NORTH ADAMS, MASS.

Spot Radio News

★ Presenting latest information on the Radio Industry.

By RADIO & TELEVISION NEWS'
WASHINGTON EDITOR

COLORCASTING, riddled with conflicting theories for over a decade, shelved quite emphatically by the D.C. ether policemen a few years ago, now appears to have found a legal haven with the warm approval of the lawmakers of the land, at least some of them. With the issuance of that second report by the Commission has come the news that the whirling shaft or Goldmark's pinwheel, as it has been dubbed by some, will be the official medium for huecasting, news which rocked most of industry and caused many to predict that the disks will speed to an early demise.

Indications that field sequential would win, at least the first phase of the color war, appeared in many sections of the first report. The bracket-standard time table was the most significant rough spot, for the sixty-day limit was immediately conceded by many as an impossible deadline date. The mechanical switch requirement was another stumbling block, practically all in industry stating that they didn't even know how to include the 405-525 line provision in an effective way in so short a time. In addition, there were the statements declaring that unless the proponents could produce equipment that would unqualifiedly meet the Commission's criteria, all bets were off and *CBS* would be declared the winner for the time being. After reviewing the criticism heaped on the other two systems, citing that neither method appeared to be capable of rapidly overcoming their innate defects, the consensus was that in the short time allotted little could be done to alter the legislators' opinions.

The second report reaccented the majority views of the airwave judiciary. For instance, there appeared the statement that in the opinion of the Commission . . . "the *CBS* system squarely meets the test of adaptability and convertibility. . . . It is the *CTI* and the *RCA* systems that fail to meet the test, for neither *CTI* nor *RCA* demonstrated a practical converter and hence failed to meet the test of convertibility." Describing the basis under which the new standards were being adopted, the Commission said that the new rules being promulgated were the result of . . . "expert calculations based on the characteristics of the present standards and the

evidence concerning the *CBS* field-sequential color system. It is clearly within the province of the rule-making proceedings, as prescribed by the Administrative Procedure Act, to adopt such standards without the necessity for further proceedings."

As in the first report, contrary remarks appeared throughout many paragraphs which attempted to explain the Commission's reasoning behind the conclusions reached. For instance, in a review of the problem of horizontal interlace, it was pointed out that the record shows quite clearly that if this technique is successfully developed for the *CBS* system, and it can be added at a later date, horizontal resolution would be increased and provide an appropriate picture improvement. However, said the Commissioners, if it had been possible to adopt bracket standards now (which it couldn't because of the reluctance of industry to go along) the Commission could . . . "determine whether to increase vertical resolution as well as horizontal resolution. . . . Since receivers without brackets could not be adjusted to a different line rate, our inability to adopt brackets at this time probably means that as a practical matter, when and if horizontal interlace is adopted for the color system, the improvement may be confined to horizontal resolution." Thus any suggestions for improvement of vertical resolution may be bypassed.

The problem of long-persistence phosphors, cited as means of providing better and brighter pictures with no objectionable flicker, may have to be overlooked now too, because of the immediate adoption of the *CBS* setup. In the words of the FCC: "Had it been possible to adopt brackets now, then if developments in the field of long-persistence phosphors turned out to be sufficiently impressive, the Commission could consider lowering the field rate and increasing the resolution without objectionable flicker."

Ripping into those who were requesting new hearings because of improvements in color systems, the second report declared that in the Commission's opinion . . . "a new television system is not entitled to a new hearing or reopening simply on the basis of a paper presentation." Citing that in the radio field many theoretical systems exist and that it's a long step from a description to a successful

RADIO & TELEVISION NEWS

BOOST

your sales with the NEW

ALLIANCE BOOSTER*

Tenna-Scope, like Tenna-Rotor will be backed by national TV advertising that sells! No other booster will have equal acceptance!

For Tenna-Scope is superior in design for ease of operation and performance. One control for all channels! Automatic switch turns booster on with set. Superbly styled plastic control case blends with all furniture. Exceptional high-channel reception and uniformity of picture and sound! Price \$29.95.

Actual size 6 1/4" x 5 1/4" x 5"



2 perfect companions:
***TENNA-SCOPE**
TENNA-ROTOR

Actual size 6 1/4" x 5 1/4" x 5"



New Deluxe Model HIR Tenna-Rotor

New Automatic Tenna-Rotor—Model HIR—just set the pointer—antenna then turns to that point and stops. North—East—South—West. Direction indicator dial shows exact position at all times. May be marked for present or new channels. Guaranteed for one year. Uses special "Zip" feature, 4-conductor cable for fast installation. Advertised in all major TV areas.

Just set it—and forget it!

Alliance Manufacturing Co.
Alliance, Ohio

Export Department: 401 Broadway, New York, N. Y., U. S. A.

alliance
TENNA · SCOPE

December, 1950

Hold That PRICE LINE with Teletower and Tenna-Mast



Mail Coupon for FREE Price Lists and Bulletin

PENN BOILER and BURNER MFG. CORP.
Dept. N-3 Lancaster, Pa.

Please send me free retailers price lists on both Teletower and Tenna-Mast Hardware as well as a free Teletower Bulletin.

Name

Company

Address

Canadian Representative
J. R. McVITY & COMPANY
53 Dalewood Road, Toronto, Ontario, Canada

The dealer in your area who features PENN towers and television hardware will have a big edge in the months ahead. He'll hold his prices without reducing his profit — because he's selling the production-line "line". Only Penn has dared to go "all out" in applying mass production technique to the making of top-quality towers with lowered costs as a direct result.

BE that lucky dealer who'll gain sales through price-appeal . . . construction-appeal . . . eye-appeal. Get the prices! Get the facts about Tenna-Mast hardware that's popular as a bosomy blonde at a TV convention . . . about the towers that weigh less than two pounds per foot . . . feature exclusive automatic pilot hole alignment that permits safe, easy 2-man erection without use of rigging hoists . . . provide sectional construction that eases inventory and storage problems. Mail that coupon today.



Pole-Base Mount
PM-1



Pole-Base Mount
PMB-3



Guy Ring &
Collar Sets



PENN Teletowers & Lifting Towers

PENN BOILER & BURNER MFG. CORP.
LANCASTER, PA.

operation, the Federal experts added: "There can be no assurance that a system is going to work until the apparatus has been built and tested."

The denial of an appeal for a test by RCA a few days before the second report was issued, presaged the stern beliefs the Commission had on reopenings. In denying this petition, the ether guardians rebuked the dot-sequential proponent, declaring that the . . . "state of television is such that new ideas and new inventions are matters of weekly, even daily occurrence . . . the question of approving a color television system which will best serve the interests of the American people is one which has been before the Commission for almost ten years . . . in all proceedings such as the instant one a point is reached which calls for administrative finality . . . and in the sound discretion of the Commission a delay in reaching a determination with respect to the adoption of standards for a color television service . . . would not be conducive to the orderly and expeditious dispatch of the Commission's business and would not best serve the ends of justice."

Notwithstanding the Commission's sharp rejoinder, RCA announced that they were not only going ahead with their color research, but would hold a series of demonstrations in Washington, during which the latest improvements in compatible all-electronic high definition color would be shown. In a telegram to all licensees, RCA said: "At this demonstration we will supply you with information about our latest simplified circuits, the converter and the tri-color tube. We shall continue to give you further demonstrations periodically so that you may see the successive steps in our progress. . . . By June 30, 1951, we will show that the laboratory apparatus which heretofore has been demonstrated has been brought to fruition in a commercial, fully-compatible all-electronic system . . . available for immediate adoption of final standards."

Blunt addresses by FCC headman Wayne Coy before advertising and engineering groups, days before the CBS edict was issued, also served as a forecast of how the color-wind blew in Washington. Discussing the demonstrations, Coy said that during all of the tests the dot and line-sequential proponents had . . . "trained operators who worked assiduously before each demonstration to make sure that the equipment was adjusted in tip-top shape and who hovered over the equipment . . . continuously making adjustments to insure optimum performance. . . . Despite all of these efforts . . . the proponents were unable to maintain accurate registration and color control. . . . You can imagine what the situation would be like in the ordinary home where children or untrained adults had to operate such receivers. . . . The conclusion seems to be inescapable that CTI and RCA

(Continued on page 109)

DECEMBER, 1950

**RADIO &
TELEVISION
NEWS**

RADIO-ELECTRONIC

Engineering

TELEVISION

RADAR

ELECTRONICS

RESEARCH

COMMUNICATION

MAINTENANCE

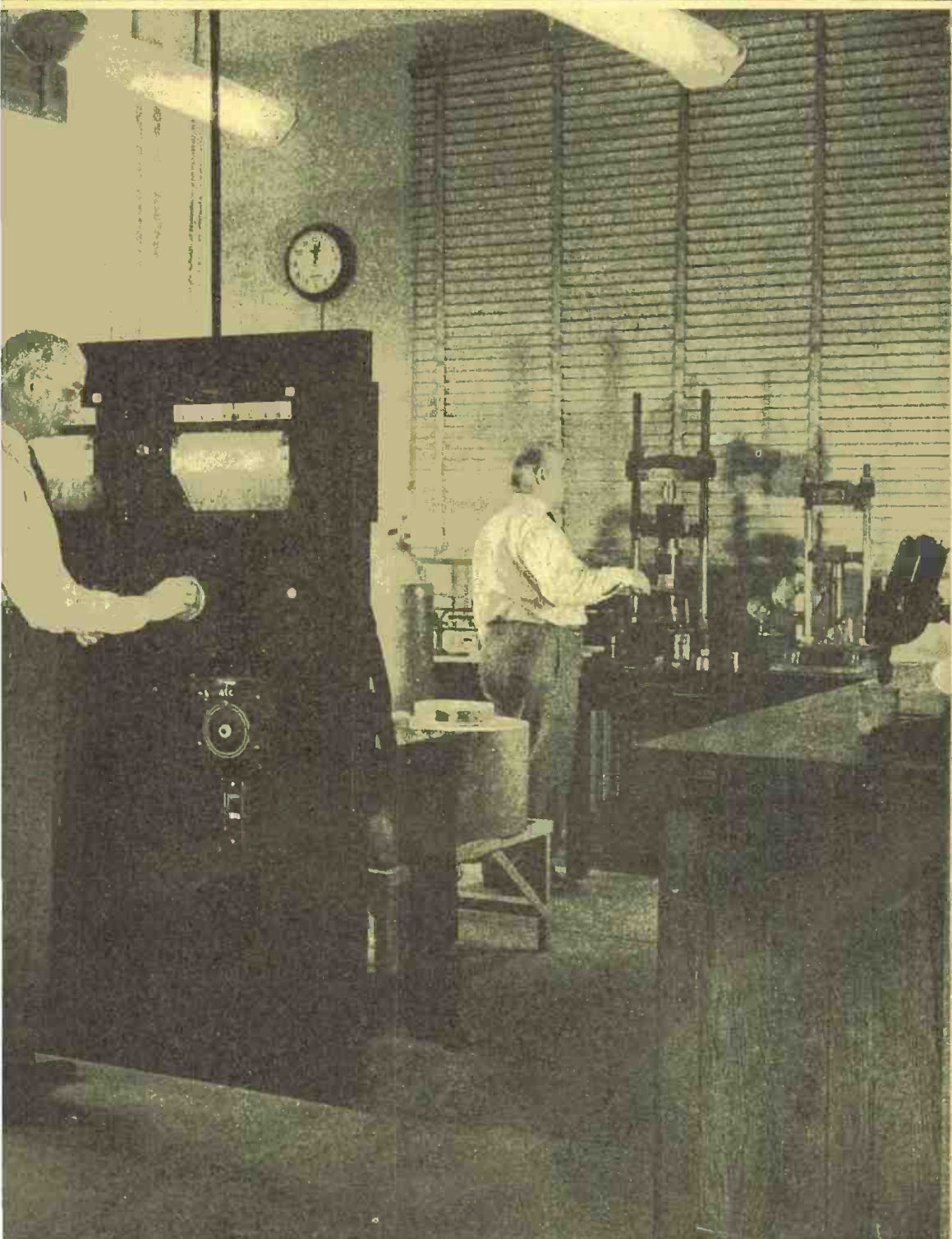

RADIO-ELECTRONIC

Engineering

Trade Mark Registered U.S. Patent Office No. 432907

ELECTRONICS • COMMUNICATIONS • TELEVISION • RESEARCH • MAINTENANCE

DECEMBER, 1950

ELECTRODES FOR H.F. HEATING	R. A. Whiteman	3A
POTTED ELECTRONIC CIRCUITS	Harold E. Bryan	6A
3-PROBE METHOD OF IMPEDANCE MEASUREMENT	Edwin N. Phillips	9A
MINIATURIZATION OF ELECTRONIC EQUIPMENT	Sam Milbourne	10A
ELECTRONIC D.C. MILLIVOLT CHOPPER	Alvin B. Kaufman	12A
MICROWAVE MEASUREMENTS (PART 1)	J. Racker	15A

DEPARTMENTS

NEWS BRIEFS	22A	PERSONALS	26A
NEW PRODUCTS	24A	TECHNICAL BOOKS	28A
1950 INDEX	30A		



RADIO-ELECTRONIC ENGINEERING is published each month as a special edition in a limited number of copies of RADIO & TELEVISION NEWS, by the Ziff-Davis Publishing Company, 185 N. Wabash Avenue, Chicago 1, Illinois.

VOLUME 15, NUMBER 6, Copyright, 1950, Ziff-Davis Publishing Company

COVER PHOTO—Courtesy of National Bureau of Standards

General view of the laboratory where high-dielectric ceramic capacitors under development at the National Bureau of Standards are produced. Batches of systematically varied compositions are processed into capacitor plates of 0.003 to 0.006 inch thickness, and the performance properties then studied.



ELECTRODES for H.F. HEATING

By **B. A. WHITEMAN**

Consulting Engineer, Chicago

A discussion of the performance of electrodes as a component part of h.f. dielectric heating equipment.

THE h. f. heating of dielectric material has reached new production heights in recent years. With this increase in production there has been a parallel increase in the diversity of applications and also design problems. These applications include the heating of plastics, melting frozen foods, deinfestation of pharmaceutical products, and the gluing of wood. The design and application problems range from the d.c. power supply through the power-oscillator circuit to the final arrangement of the electrodes. This article will deal specifically with the performance of the electrodes as a component part of the h.f. dielectric-heating equipment. The effectiveness of the electrodes naturally depends upon their shape as well as the shape and dielectric properties of the material being heated.

A statement of certain fundamental high-frequency properties of dielectrics is of value at this time in order to emphasize the important design parameters which must be considered. These fundamental relations depend upon the theory that nonmetallic solid materials have few free electrons and the effect of the electric field on the dielectric molecules becomes very important. In accordance with this theory, the electric field causes a definite displacement of the electrons within the atoms and also a displacement of the atoms within the molecules. These displacements have translational as well as rotational components and are most important in the range of frequencies used for radio-frequency heating. As the electric field components of the molecules are rotated to line up with the electric field, a displacement of charge within the mate-

Fig. 1. Conveyor belt arrangement for dielectric heating showing electrodes and transmission line through side of cabinet.

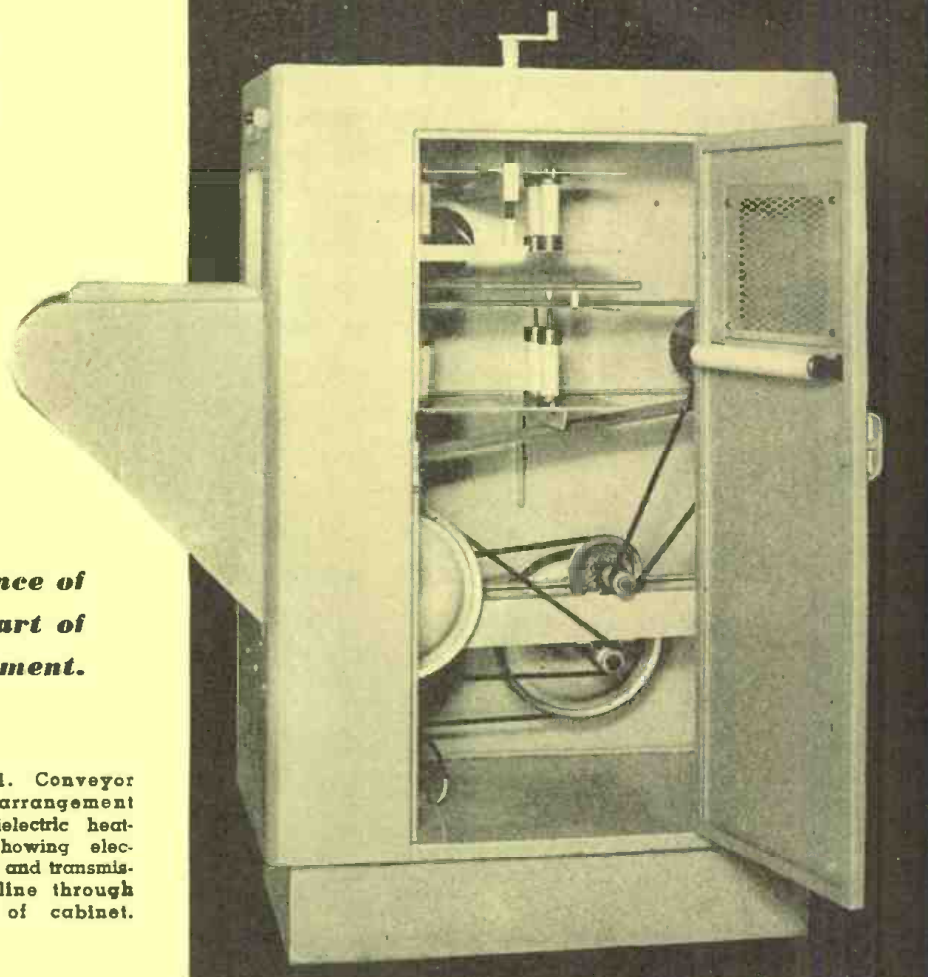

rial takes place. As a result of this effect, the displacement current in the circuit is greater due to the presence of the dielectric material than that occurring due to free space. The ratio of the former to the latter displacement current for a given electric-field intensity is defined as the dielectric constant of the material.

Since the changes in the molecular configuration impart kinetic energy to the thermal motion and are due to the applied electric field, an equivalent displacement current must flow into the material in phase with the voltage impressed on the material.

If the power loss in watts for each cubic inch of the dielectric is P and the electric field intensity in volts per inch is E , then by definition the ratio of the power P to E^2 is the effective conductivity σ . The numerical value of σ is generally a very involved function of the frequency and is not a constant.

For materials that have a very small conductivity, the algebraic relation for σ is:

$$\sigma = 2 \pi f \epsilon p \dots \dots \dots (1)$$

where ϵ is the dielectric constant at the operating frequency f and p the power factor of the dielectric material. By equating the right member of Eq.

(1) to the ratio of P to E^2 and solving for the power dissipated in a cubic inch, the result becomes:

$$P = 2 \pi f \epsilon E^2 p \dots \dots \dots (2)$$

Although this equation is a simple relation between the power dissipated and the fundamental parameters of the dielectric circuit, it clearly indicates the dependency of the power dissipation upon the power factor, frequency, dielectric constant, and the electric field intensity. It is possible to make the frequency f as well as the dielectric constant ϵ independent of the electrode shape. It is, however, impossible to make the electric field intensity throughout the dielectric material independent of the electrode shape. In order to have a uniform distribution of power density, it is necessary to have a uniform electric field intensity, which can be achieved in practice by properly arranging the electrodes.

The objective in dielectric heating is to first develop a sufficient power density for the required heating time interval and then the problems which follow must be solved as secondary items. Thus, it may seem advisable at first to have the equipment operate on one of the lower frequency channels in order to obtain a uniform potential across

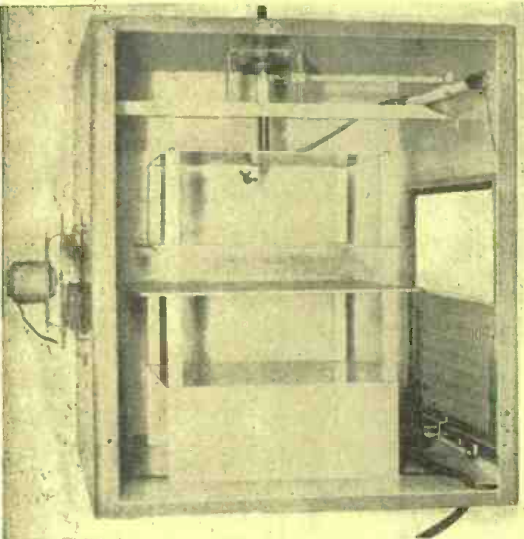

Fig. 2. Adjustable height work oven for heating dielectric materials.

the surface of the electrodes. This would be accomplished by having the wavelength large compared with the size of the electrode. However, with this condition, the voltage will be uniform on the electrodes but the electric field intensity E will be high and flash-over as well as internal sparking within the dielectric material will exist. This means that a higher frequency f must be used and the field intensity E will then be within a numerical value which does not produce dielectric breakdown. In some applications the electrodes will then be large compared with the wavelength and means of compensating for the variation in voltage along the electrode must be included in the design of the electrodes.

This undesirable effect is very well exemplified in large electrodes used in the high-frequency wood-gluing process. It is quite common in this industry to glue sheets of wood from 10 to 20 feet and sometimes longer and use frequencies in the region of 37 megacycles. With the average dielectric constant of the wood and glue equal to ϵ , the wave-

length of the voltage wave on the long electrodes is given by the formula:

$$\lambda = \frac{984}{f\sqrt{\epsilon}} \dots \dots \dots (3)$$

where λ is the wavelength measured in feet and f is the frequency in megacycles. The voltage wave will have a maximum at the open end of the electrode and a minimum at a quarter wavelength from the open end. If the wavelength of the voltage wave is very much greater than the length of the electrode, it is possible that the ratio of the maximum voltage to the minimum is greater than 0.9. To accomplish this desirable voltage distribution, however, the frequency would be entirely too low and the power concentration for a permissible operating voltage would be insufficient for a reasonably short gluing cycle. This condition can be improved somewhat by feeding the voltage to the center of the electrode plates with each half of the press considered separately, thereby enabling the frequency to be twice that where the voltage is applied at one end. If it is physically permissible, it is advisable to introduce auxiliary tuning of the long electrodes by using small inductances spaced along the electrodes. These inductances should be connected in parallel across the electrodes and tune the capacitance of the press to parallel resonance. To accomplish this, each inductor should have n times the total inductance required to tune the loaded electrodes. This is expressed by:

$$L = \frac{n 10^6}{4 \pi^2 f^2 C} \dots \dots \dots (4)$$

where n is the number of equally spaced inductors, f is the frequency in megacycles, C is the capacitance of the loaded electrodes in micromicrofarads and L is the inductance of each coil in microhenrys. At resonance the load will present a resistive impedance of:

$$Z = \frac{2 \pi f L}{\tan \theta} \dots \dots \dots (5)$$

where $\tan \theta$ is the ratio of effective

resistance to the capacitive reactance of the dielectric load.

The distance between the tuning inductors in feet is given by:

$$d = \frac{5.48}{f\sqrt{\epsilon}} \cos^{-1} \frac{E_1}{E_2} \dots \dots \dots (6)$$

where the ratio of E_1 to E_2 is the ratio of the minimum voltage to the maximum voltage on the electrodes and is generally made greater than 0.9.

As a typical example to illustrate this method of using special electrodes for high-frequency heating, consider the following set of conditions:

- $f = 37$ megacycles
- $\epsilon = 2.5$
- $\tan \theta = .05$
- $l = 20$ feet
- $E_1/E_2 = 0.9$
- $C = 1000$ micromicrofarads

$$d = \frac{5.48}{37\sqrt{2.5}} \cos^{-1} 0.9 = 2.44 \text{ feet}$$

is the spacing of the inductors. In an application very similar to this example, 7 tuning inductors were used in order to provide a fairly uniform voltage along the electrodes. The inductance of each coil was:

$$L = \frac{7 \cdot 10^6}{4\pi^2 \cdot 32^2 \cdot 1000} = .130 \text{ microhenrys}$$

and the impedance of the dielectric load:

$$Z = \frac{2\pi \cdot 37 \cdot .130}{7 \cdot .05} = 86 \text{ ohms}$$

This example illustrates the application of a special electrode for high-frequency heating where the geometrical length of the electrode is very much greater than $\frac{1}{4}$ of an electrical wavelength.

In applications where the electrodes are short compared with the quarter wavelength, problems of voltage variation do not exist. Compensation by tuning is, therefore, not necessary and the only adjustment necessary is that of varying the distance between electrodes. This condition exists when heating plastic preforms and is illustrated in Fig. 2. In the case of heating plastic preforms it is usually necessary to supply an air movement parallel to the electrodes. The air movement is provided by the fan and removes water vapor and volatile chemicals, thereby preventing them from condensing on the upper electrode.

If instead of having the electrode long, it is short compared with $\frac{1}{4}$ of the electrical wavelength, then the voltage applied to the electrodes will be uniform. The electrodes under these circumstances may be considered to be equipotential surfaces and the electric field intensity will be substantially uniform within the dielectric if the dielectric has a special shape. In general, any piece of dielectric will require electrodes of a special shape in order to obtain a uniform electric field intensity within the given dielectric.

Fig. 3. Curved and flat electrodes used in dielectric heating equipment.

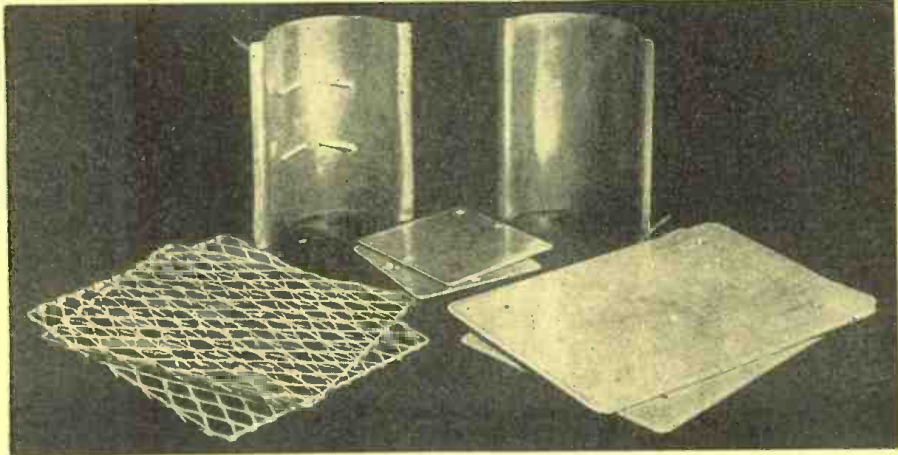

A general solution of this type of problem may be easily expressed but not always easily evaluated. For the general solution, refer to Fig. 4 where the electrodes are above and below the x -axis and the electric field is parallel to the y -axis within the dielectric. Let the potential within the dielectric be:

$$V_i = f_i(\rho_i, \theta) \quad (7)$$

and must satisfy the relation $\delta V_i / \delta y = \text{a constant}$ to insure that the field intensity within the dielectric is a constant. With a uniform field within the dielectric, the equation of the potential external to the dielectric is:

$$V_o = f_o(\rho_o, \theta) \quad (8)$$

and the potential at an external point through which the electrode must pass:

$$V_o' = f_o'(\rho_o, \theta) \quad (9)$$

To find the equation of the equipotential surface with a potential equal to V_o' , set V_o in Eq. (8) equal to the constant potential of Eq. (9) as follows:

$$V_o = V_o' = f_o(\rho_o, \theta) = f_o'(\rho_o, \theta) \quad (10)$$

and solve for ρ_o in terms of the angle θ and the constant ρ_o . Then the equipotential surface can be expressed as:

$$\rho_o = F(\theta) \quad (11)$$

A metallic electrode which is constructed so that it satisfies Eq. (11) will be coincident with the equipotential surface and thereby produce the desired electric field. This mathematical approach is generally cumbersome and can be replaced by one which is not as accurate but easier to apply. By referring to Eqs. (7), (8) and (9) and rewriting them for rectangular coordinates they become:

$$V_i = g_i(x, y) \quad (12)$$

$$V_o = g_o(x, y) \quad (13)$$

Then since the voltage across the electrodes is a constant for any one application, this voltage is:

$$V_i = \int \vec{E}_i \cdot d\vec{y} + \int \vec{E}_o \cdot d\vec{y} \quad (14)$$

$$V_i = E_i(s + a\epsilon) \quad (15)$$

where s is the thickness of the dielectric and a is the distance of a flow line through the air gap between the dielectric and the electrodes. Since the total applied voltage V_i and the internal electric field intensity are constants, then $(s + a\epsilon)$ must be a constant for small values of a .

It is readily observed that the position of the electrodes can be located point by point using Eq. (15). This method not only applies to dielectrics with flat surfaces but to surfaces of any shape even though it is understood that the numerical value of a must be small compared with s . In general, the shape of the electrode surface will not be a plane but will resemble such surfaces as shown in Fig. 3.

In many applications, it is not necessary or advisable to attempt to form the electrodes to conform with an equipotential surface providing an alternate solution to the problem is available. In many heating procedures, moving the object to be heated has long been standard practice. This same procedure may and is being used to advantage when dealing with the high-frequency heating of dielectric material. If the dielectric material is moved or passed between electrodes of the required shape the higher intensity electric fields will shift from one region of the dielectric to another. Such a change or shift will enable the heat generated within the dielectric to conduct from the hotter to the cooler portions, thereby producing a more uniform heating of the material. The procedure is very well applied in the *SIECO* dielectric belt oven shown in Fig. 1. The oven is loaded from the long end which projects to the left of the photograph. The dielectric material moves on a traveling belt of specially treated fabric. The speed of travel through the oven is adjustable over a wide range and the vertical spacing between the upper and lower electrodes is also adjustable from $\frac{1}{2}$ inch to approximately 6 inches. The electrodes generally extend 18 inches along the belt and are slightly wider than the belt. These electrodes are used under an applied voltage of 8000 volts at 27 megacycles. This belt driven system is constructed to be used with a *SIECO* dielectric heating unit with the aid of a transmission line connection. This type of connection is shown in Fig. 5. The oven is equipped with a stop button both at the loading end and at the exit end so that in the event of a mechanical fouling of the dielectric material, or for any other reason, the operator can then shut off the entire machine including its radio frequency

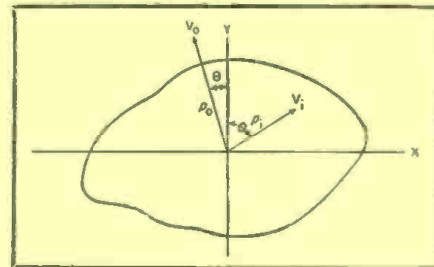

Fig. 4. A section of dielectric symmetrical about the z -axis with internal and external potentials indicated.

power by one simple stop button operation. The fluorescent lamp located and visible inside the door is grounded at the near end and at the far end is equipped with a 4-inch long antenna which picks up sufficient radio-frequency power from the adjacent heating electrode to operate the fluorescent tube and to give a soft uniform light of good intensity indicating normal operation of the oven. Also visible in the photograph is a safety interlock switch so that if the door is opened the entire equipment is disconnected from the power line. This equipment provides an excellent method of production-line handling as well as a method of obtaining uniform heating of dielectric materials. It has been used for protective deinfestation of pharmaceutical and plastic products.

This analysis has indicated the various conditions which must be considered when selecting electrodes for high-frequency heating of dielectric material. The primary requisite in this work is that of uniform heating of the dielectric in order to avoid "hot spots."

The author wishes to thank *Sherman Industrial Electronics Company* of Belleville, N. J. for the accompanying photographs and other helpful information.



Fig. 5. 27 mc. oscillator showing transmission line connection to adjacent electrode enclosure.

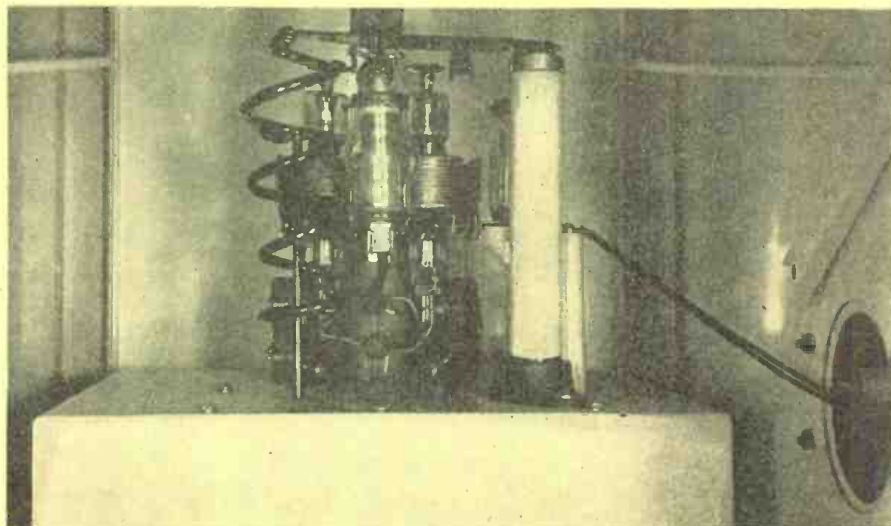

Potted Electronic Circuits

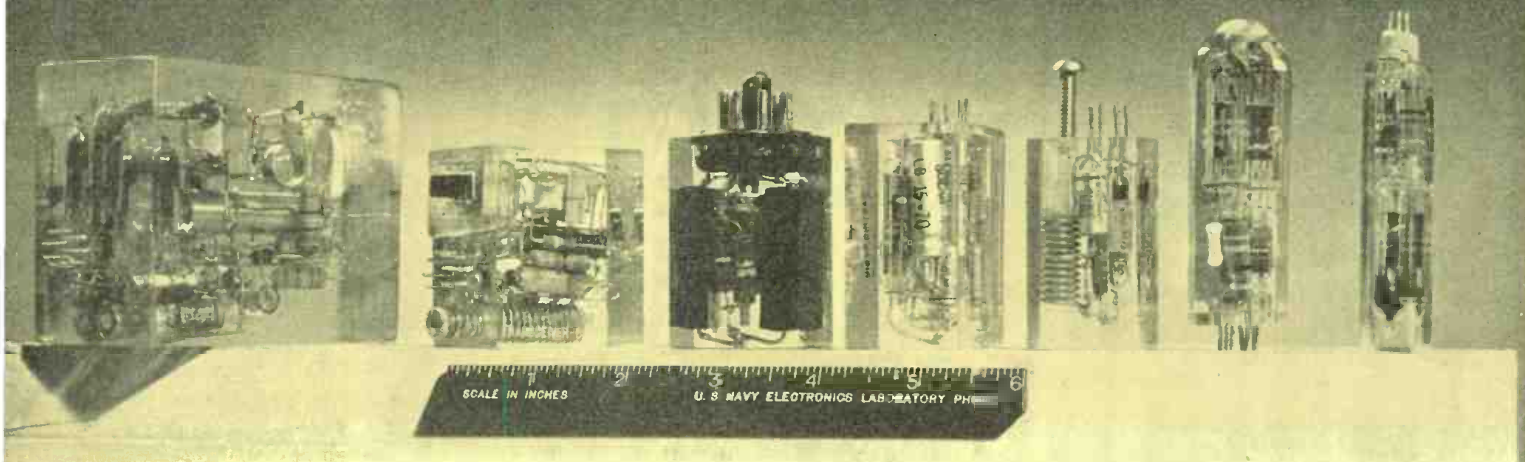

Miscellaneous units cast in NEL casting resin.

By **HAROLD E. BRYAN**

Casting or potting materials protect electronic circuits from effects of humidity, fungus, shock, and vibration.

IT USED to be standard practice to construct electronic equipment for the Naval forces in a most rugged and substantial manner, in order that it might continue to operate and withstand the rigors of the service. This worked fine, and the equipment did indeed stand up in Naval shipboard operation. However, with the coming of the late war the electronics art progressed very rapidly. Ships no longer are able to carry all the electronic equipment considered desirable, or even in some cases essential, if it is built in the usual rugged and massive manner.

Attention has therefore been directed to the miniaturization and subminiaturization of the many electronic devices required by modern Naval warfare. The advent of miniature and sub-miniature electron tubes, as well as the production of smaller and smaller components such as resistors and capacitors, has made the reduction in size not only desirable but possible.

This reduction in size of components and complete units has, nevertheless, not been achieved without new complications. True miniaturization of a circuit requires the elimination of the

common chassis as it is usually known, since such a base occupies considerable space by itself. Making the components more or less self-supporting, or using very small flat sub-chassis where required for support, can in itself save a very substantial amount of volume.

Other problems which must be met in the new designs are those involving damage from such things as high humidity, fungus growths, and mechanical damage from handling and shock and vibration. It has been stated that in certain areas during the last war as much as 60% of the electronic equipment was useless as received, due primarily to the effects of humidity and fungus. This is a very high casualty rate for equipment that has not even been used!

Attempts have been made to meet the attacks of humidity and fungus by means of hermetic sealing. This would seem to be ideal, since all moisture and other effects would be excluded from the start, and it would not be impossible to repair the units, given the necessary facilities. However, most such attempts have met with failure. It appears almost impossible to obtain a true seal, very small pin-holes invariably appearing in the solder joints sometimes after several cycles of expansion and contraction due to temperature changes.

The use of casting or potting materials has been put forward in an attempt to overcome these difficulties;

Top view of a complete receiver encased in NEL casting resin.



when embedded in the plastic, the electronic components are thoroughly protected from the effects of humidity and fungus. Considerable protection is, of course, also provided from mechanical damage due to handling; and the effects of vibration in particular are reduced because of the damping produced by the plastic surrounding the components.

There are other problems which appear, however, when potted circuits are used. For one thing, it is obviously impossible to repair a defective unit in most cases. This increases the maintenance problem, when it is considered in the conventional light. However, modern electronic equipment is becoming so complex that it is very difficult to obtain qualified Naval personnel for maintenance. It is desirable therefore to increase the ease of repair of the equipment itself. This may be done by designing units in small subassemblies which plug into the main assembly. In this way, when defects appear they may be remedied in service rapidly and effectively by replacing the defective subassembly. Admittedly this is expensive in that it throws away good as well as defective components; but it reduces the training necessary for the service personnel to a considerable extent and makes unnecessary the carrying of large quantities of spare parts, each individually protected from the elements. Instead, a relatively small volume of replacement subassemblies is carried.

One other effect is of importance in miniaturized circuits. Usually there is just as much power dissipated in the small units as in the equivalent large ones, but there is less surface area to carry away the resultant heat. Operating temperatures are therefore in general much higher than for the larger units, making things difficult for the components involved. Fortunately new and better components are being produced all the time, and it is possible to reduce the temperatures to at least some extent by proper thermal design.

Early in the studies of potted electronic circuits at the Navy Electronics Laboratory it was found that there were no entirely suitable casting materials then available. All which could be obtained had some faults, either electrically or mechanically. The casting resin developed by the National Bureau of Standards, commonly known as NBS Resin, while excellent from the electrical standpoint was unsatisfactory mechanically. Electrically it was equivalent to polystyrene, very good indeed; but it was also otherwise similar to polystyrene, being soft, flowing at a low temperature, and fairly difficult to machine. In addition, it was expensive and the ingredients difficult to obtain.

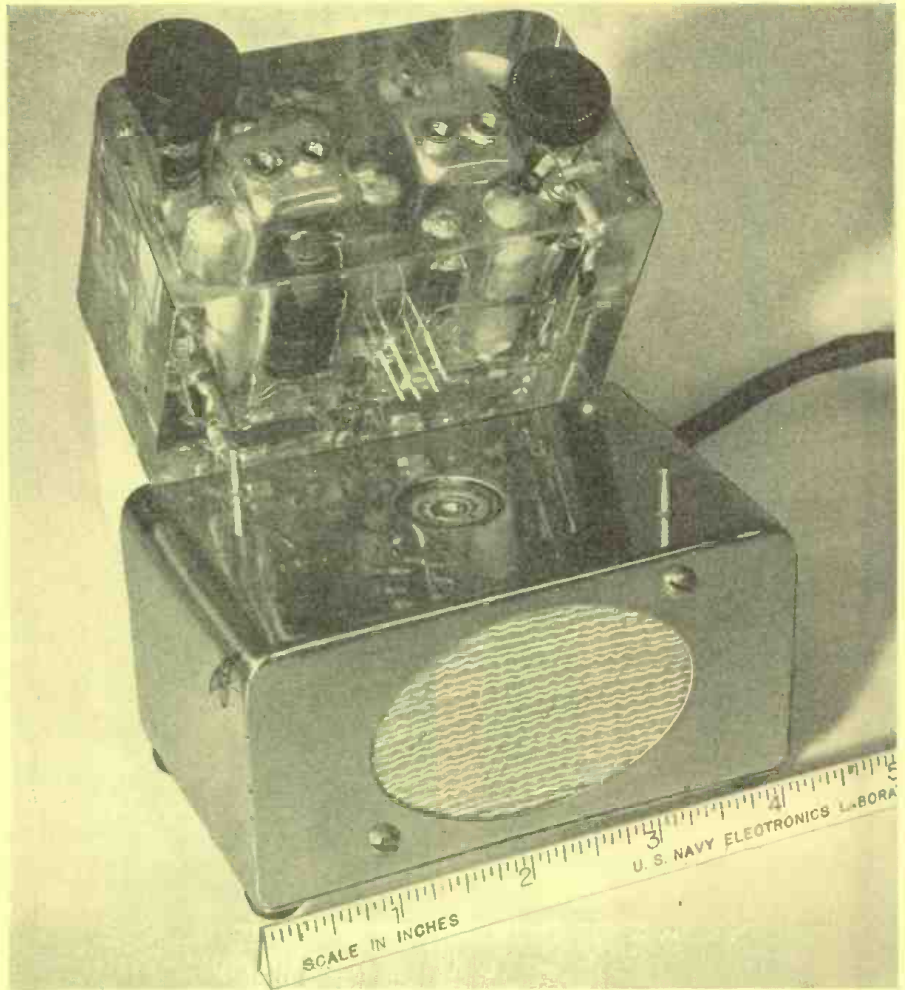

Another view of the six tube receiver shown on P. 6A, complete with power supply and speaker. Note size of fly on speaker case.

Typical cylindrical plug-in assemblies encased in NEL casting resin. An octal tube is included to indicate size of the castings.

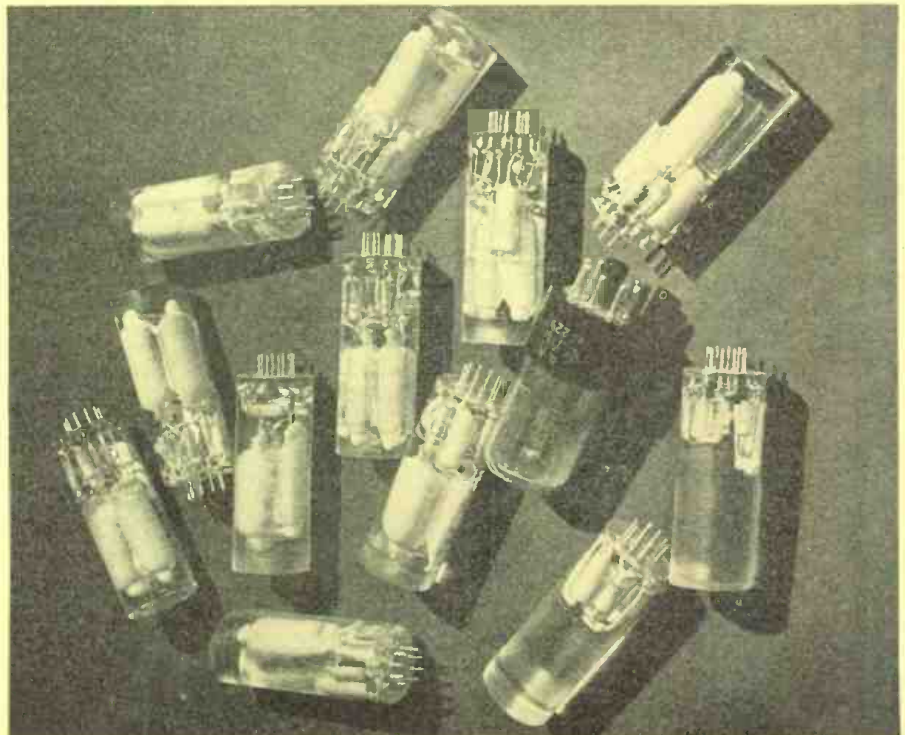

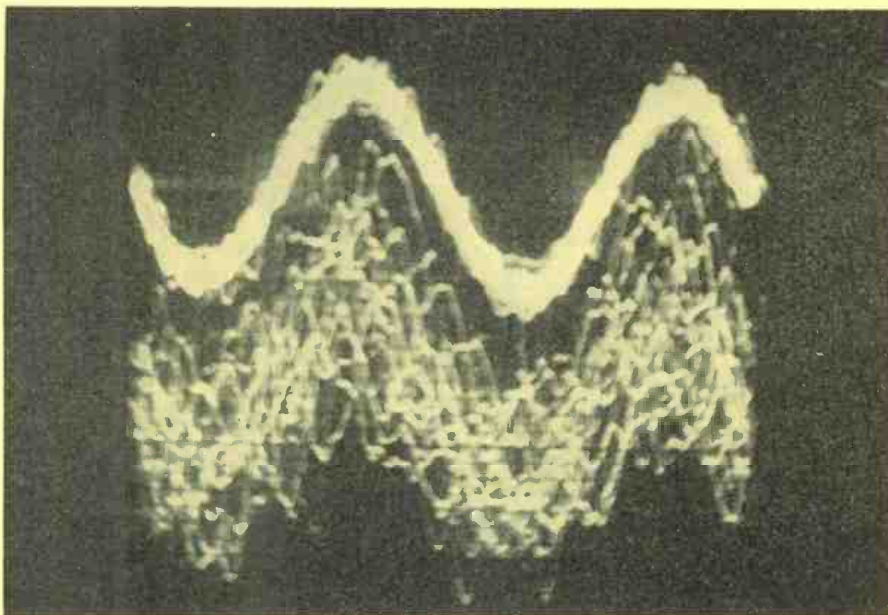

Comparison between two identical amplifiers mounted on vibration table. Top oscilloscope curve shows output of potted unit; bottom, conventional subminiature chassis construction.

Other materials available at that time were usually good, or at least fairly good, mechanically but poor electrically. These no doubt would be suitable for many low frequency applications encountered, but it was felt that something which could be applied to both high and low frequency units was desirable.

The material currently in use at the Navy Electronics Laboratory, designated NEL-177 Casting Resin, while not ideal, is at least usable at frequencies as high as 100 megacycles and has fair mechanical and heat-resisting properties. Dielectric constant and power factor are of the order of 3.0 and 2% respectively at 10 megacycles, and do not depart from these values appreciably at other frequencies. When properly cured, surface temperatures as high as 100 degrees Centigrade can be withstood satisfactorily, and internal temperatures of the order of 200 to 250 degrees are not excessive. Surface checking tends to take place at higher temperatures, and if the internal temperature is too high the material changes in color from almost water-white with a slight amber tint to a dark brown in a relatively short time. When operated at elevated temperatures the color normally changes slightly, gradually darkening.

While the ingredients used in NEL-177 are cheap and readily available, they must be pure and fresh if satisfactory results are to be obtained. The base stock in particular deteriorates with time even when stored under refrigeration and eventually will become unusable for electronic applications. Considerable variation in properties, particularly mechanical, will be experienced with its deterioration. In addition,

the manufacture of the base ingredient is not controlled to as fine a point as might be desired. There are therefore small changes from one batch to another which in some cases result in appreciable changes in properties. Fortunately these do not appear to be reflected to any great extent in the electrical properties.

There is nothing at all difficult about the formulation of the material which makes trained personnel necessary. Anyone who can read and weigh out the ingredients accurately can do it. Also there are no critical temperatures or processes involved in the casting and curing of the resin.

Mold requirements are easily met, since the material is poured in the form of a liquid over the circuit to be cast. This makes it possible to make unusual shapes without difficulty. The main requirement of course is that the molds be made of some material that does not react with or adhere to the casting resin. This restricts the choice to a relatively small field, but no difficulty is experienced in finding suitable materials. In some cases lucite has been used. There is no reaction between the lucite and the resin, but the mold must be machined from the casting if it is desirable to remove it. Since lucite is readily formed to shape this is not a great disadvantage, especially if there is no point in removing the form. Polystyrene cannot be used in the same manner, because it is seriously affected by the casting resin. Certain acetates perform satisfactorily as forms, since they neither adhere to nor are attacked in any way by the resin; and they are very flexible in application.

The principal disadvantage of plastic molds is that they are usually either

destroyed or otherwise made unsuitable for further use. A type of mold which can be used over and over, which has been found very useful at NEL, consists of chromium-plated metal. The metal is of course not destroyed in removing the casting, and the chromium plating produces a smooth mirror-like surface. Since the plastic does not adhere to the chromium surface if it is clean, the casting is easily removed after curing. This type of mold has been used extensively for manufacturing cylindrical plug-in sub-assemblies, the only machining required on the finished casting being the cutting of the unit to the required length.

Although cured in the mold, there is a certain effect on the surface of the castings, apparently caused by the oxygen of the air. This has been overcome by curing the plastic in such materials as pure linseed or cottonseed oil or glycerine. The resulting surface then has the same properties as the interior of the casting. This is accomplished by removing the casting from the mold after it is sufficiently gelled and completing the curing immersed in the oil.

The change from a liquid to a solid in these resins is due to a chemical process known as polymerization. During this process a certain amount of heat is generated, and this must be controlled if satisfactory castings are to be obtained. If too much heat is generated, the polymerization will take place too rapidly and the resulting casting will in all probability contain large cracks or fissures. If too little heat is produced curing will take too long for practical application. The control of the amount of heat generated is accomplished at NEL in part by refrigeration. After the unit has been poured, it is held at a low temperature for as long as is required for the plastic to thoroughly gel. This is usually five to six hours, but depends upon the size of the casting involved. After the casting has gelled sufficiently it is removed from the refrigerator, taken out of its mold and placed in an oven for several hours, at which time the cure is essentially complete. It is possible to allow the cure to take place at room temperature but considerably more time will be required—unless of course it is summer and room temperature is up around 100 degrees Fahrenheit. In this case no oven is needed since the room is one anyway. In any case, carrying on this latter cure at elevated temperature is best done with the casting immersed in oil as described above. No excessive temperatures are involved in such a process, so no damage is done to components.

The plastic materials generally used as casting resins all shrink from five
(Continued on page 27A)

3-PROBE METHOD of IMPEDANCE MEASUREMENT

By **EDWIN N. PHILLIPS**

Research Div., Collins Radio Co.

Derivation of a chart for determining impedance from voltage readings at three fixed probes spaced $\frac{1}{8}$ wavelength apart.

WELL-KNOWN methods of impedance measurement at high frequencies include the use of a slotted coaxial line and the use of directional couplers. Another method involves the use of three voltage probes which are spaced an eighth wavelength apart. On occasion, this method can be of considerable utility: when the frequency is low (with a corresponding long wavelength), or when measurement at a fixed frequency is being performed, this latter method is more easily set up and interpreted than the first two methods.

One difficulty which, possibly, may have inhibited the wider use of this method stems from the fact that the loci of constant voltage-ratios are circular only on a rectilinear map. The chart presented herewith eliminates this difficulty, since these loci are transformed onto a closed chart.

It will be recalled that the voltage at any point x units distant from the load on a lossless line is given by:

$$E_x = E_R \cos\left(\frac{x}{\lambda} 360^\circ\right) + jI_R Z_0 \sin\left(\frac{x}{\lambda} 360^\circ\right) = E_R \left\{ \cos\left(\frac{x}{\lambda} 360^\circ\right) + j \frac{Z_0}{Z_R} \sin\left(\frac{x}{\lambda} 360^\circ\right) \right\} \text{ volts} \quad (1)$$

where λ is the wavelength (the free-space wavelength for principal mode, the guide-wavelength for guided modes) and E_R is the voltage across the load. If, now, a probe at the load reads E_1 , a probe located an eighth wavelength down the line reads E_2 , and a probe located a quarter wavelength from the load reads E_3 , then these voltages are given by:

$$E_1 = E_R \quad (2)$$

$$E_2 = \frac{E_R}{\sqrt{2}} \left(1 + j \frac{Z_0}{Z_R} \right) \quad (3)$$

$$E_3 = j \frac{Z_0}{Z_R} E_R \quad (4)$$

From these three quantities, two ratios can be formed:

(Continued on page 31A)

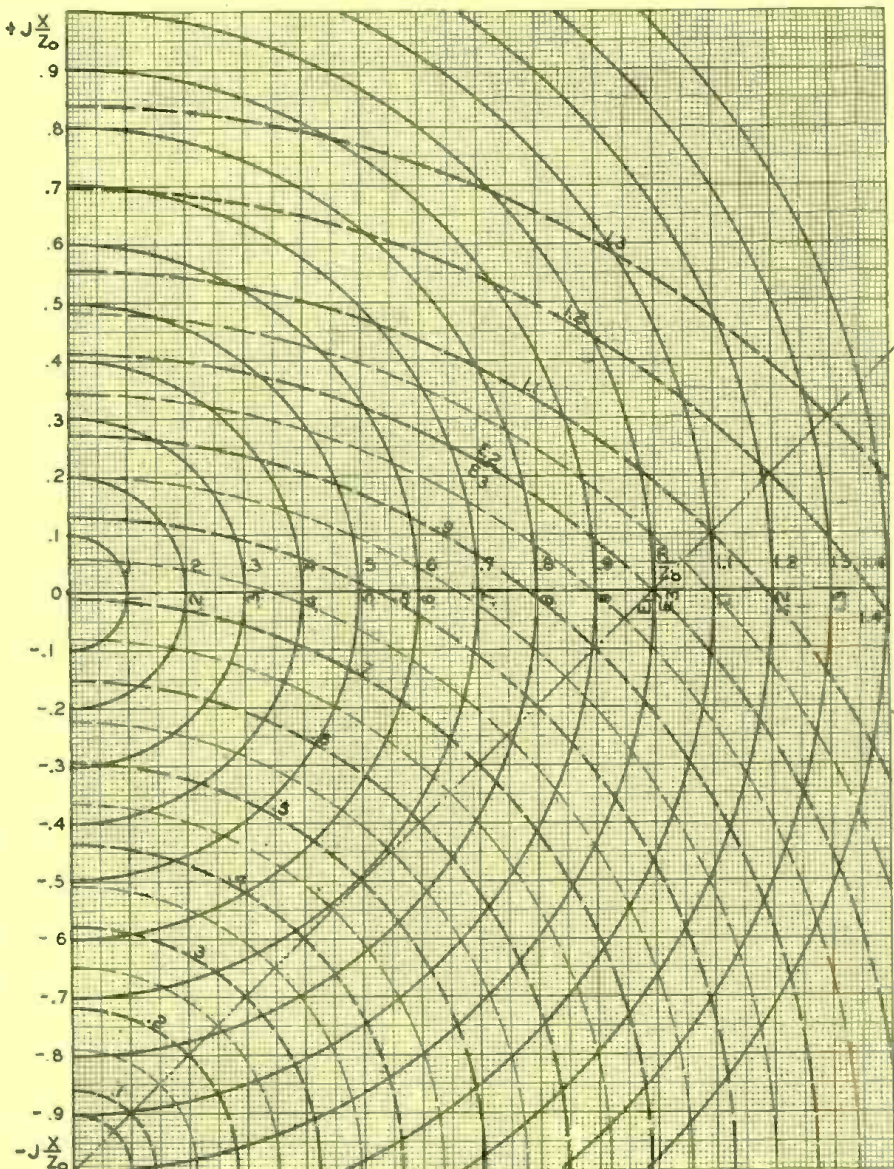

Rectilinear map for use with 3-probe method of impedance measurement.

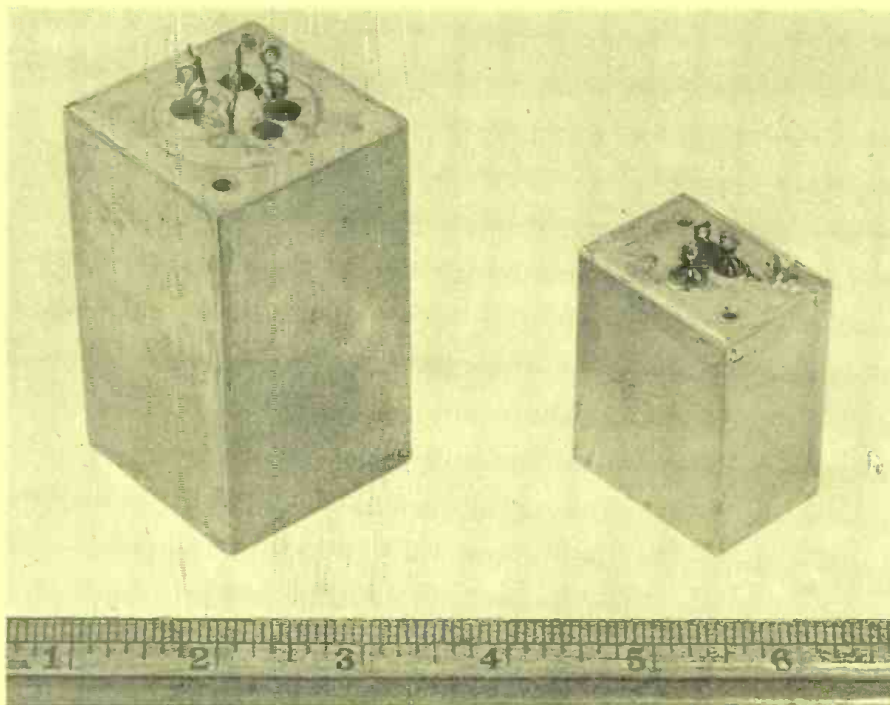
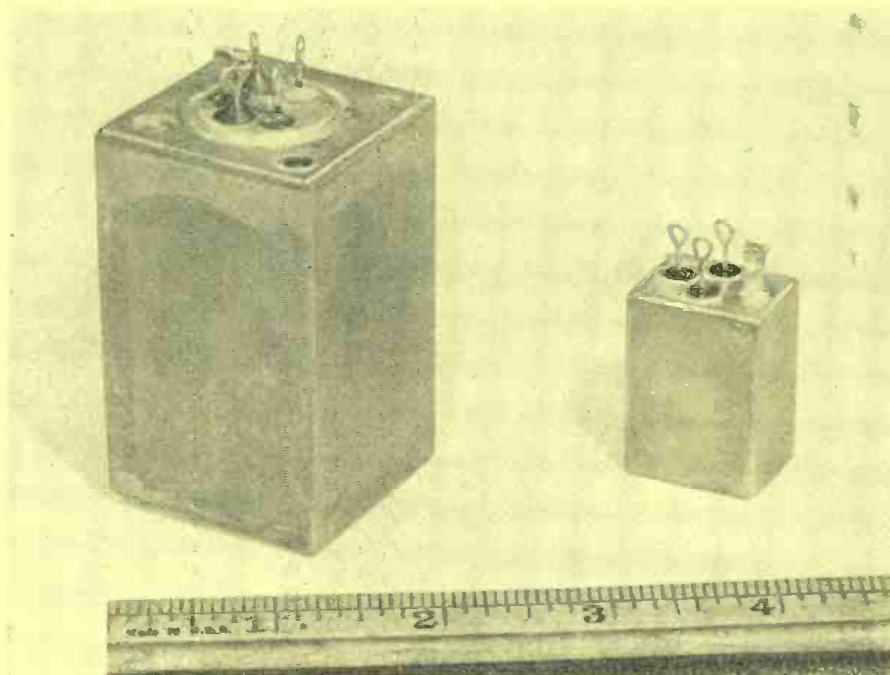

Fig. 1. Comparison between typical 400-cycle 14 VA transformer and miniaturized version, which supplies 33 VA, weighs $\frac{1}{4}$ as much, and takes up 68% less volume.

MINIATURIZATION of Electronic Equipment

By **SAM MILBOURNE**, Eng. Dept.
Eclipse-Pioneer Div., Bendix Aviation Corp.

Fig. 2. Conventional excitation transformer (left) compared with miniaturized version, which occupies $\frac{1}{9}$ the space and weighs $\frac{1}{10}$ as much.



Smaller components and improvements in design reduce size and weight.

A PRACTICAL, if somewhat whimsical, definition of equipment miniaturization is that it is the design process wherein the size and weight are progressively decreased while the use is progressively increased until the resulting equipment takes up no space, weighs nothing but does everything.

Miniaturization of electronic circuits and components—for both military and non-military use—is demanding the greater interest and attention of design engineers. Rapid strides have been made in lightness and compactness—particularly in modern airborne electronic equipment. Fig. 3 illustrates a recently developed plug-in assembly which is part of a complete airborne equipment. Fig. 4 shows the underside. The chassis or “card” is of plated aluminum and measures 5" x 12" x 2 $\frac{3}{4}$ " over-all. The complete assembly weighs only one pound thirteen ounces! The assembly comprises five two-stage push-pull output amplifiers with a total of fifteen tubes. Small parts such as resistors and condensers are connected between glass-bead through-type terminals which are soldered into the card. Besides the fifteen tubes, the card carries 5 output transformers, 30 resistors, 32 condensers and two plugs—a total of 84 components!

Improvements in non-military electronic equipment are often the outgrowth of previous military equipment improvement. Present television progress can be traced in no small measure to military radar developments. Thus, it can be expected that future non-military miniaturization will be greatly aided by developments in military equipment miniaturization.

It should be remembered that the requirements for military electronic equipment are much more rigid than those for non-military use. Military airborne electronic equipment design is pointed toward a maximum of accuracy, dependability and ruggedness. Extremes of temperature, humidity and barometric pressure as well as resistance to fungus, salt-water, chemicals, vibration, etc., all add their problems. Any miniaturization must be accomplished without serious sacrifice of the above.

Specifically, the general requirements for military airborne electronic equipment can be stated in terms of “Maximum” and “Minimum” as:

Maximum

1. Operational life.
2. Safety in use and in the event of equipment failure.

3. Ambient temperature range.
4. External pressure (altitude) range.
5. Resistance to water immersion and salt spray.
6. Ability to withstand shock and vibration.
7. Resistance to chemicals.
8. Resistance to fungus.
9. Ease of service with minimum technical knowledge.
10. Electrical and mechanical efficiency.
11. Dissipation of developed heat.
12. Use.

Minimum

1. Size.
2. Weight.
3. Lost space.
4. Internal heat rise compatible with minimum size.
5. Number and types of power supplies.
6. Number and types of parts.
7. Size and weight of individual parts.

Although there may be other requirements in certain applications, the above breakdown presents the designer with his major problems.

Now, how can equipment be made smaller and lighter?

To accomplish this, our first approach was to eliminate the unnecessary in circuits and parts. The design was pared to an absolute minimum of parts. Every resistor and condenser having no real purpose was eliminated. Resistance-condenser coupling between stages was used in place of transformer coupling where possible. Autotransformers and tuned chokes were utilized where practical. One master power supply was designed in place of several smaller ones.

Next, we attacked the problem of reducing the size and weight of component parts, starting with the largest and heaviest parts and working down to the last nut and screw. The success of such a program was positive. A twenty per-cent reduction in the final weight of the complete system under the weight requirements of the development specification was accomplished. It can be stated that in terms of previously designed comparable equipment this represents more than a fifty per-cent reduction in weight.

Transformers and chokes (power and audio) exhibit the greatest weight density per cubic inch of all electronic parts. Previous design experience indicated an average weight of one ounce per VA (approximate) for hermetically-sealed transformers and chokes. This type of airborne transformer is designed with ordinary silicone steel "E-I" laminations, potted in compound and housed in copper or brass cans.

To illustrate what can be done to reduce size and weight in this direction, Fig. 1 shows a typical 400-cycle excitation (power) transformer operating from 115 volts and supplying 14 VA.

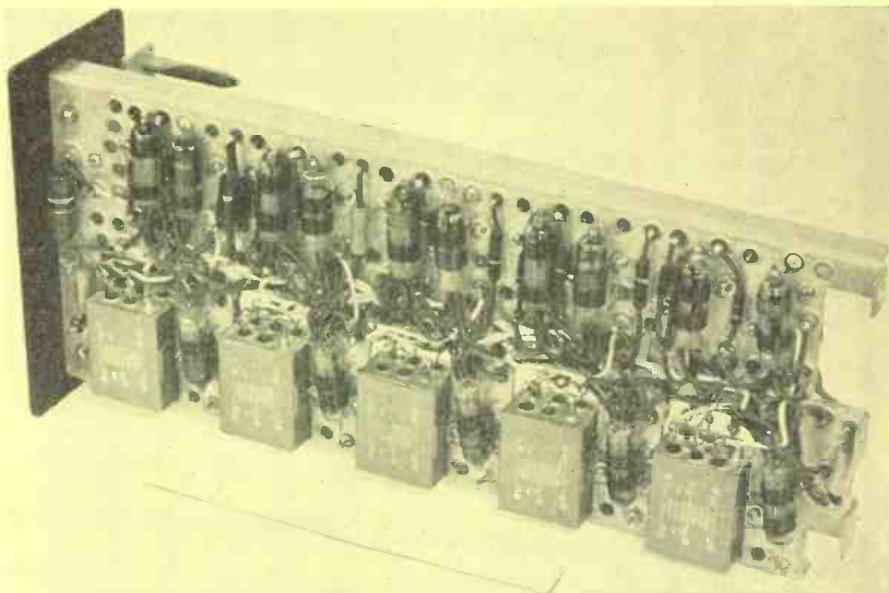

Fig. 3. A plug-in assembly using miniature tubes and parts.

This transformer measures 3" x 1 3/4" x 1 3/4" over-all and weighs 12 ounces. Also shown is the resulting comparable miniaturized version. Supplying over twice the VA (33 VA), it measures 1 7/8" x 1 9/16" x 1 3/8" over-all, takes up 68% less volume and weighs but 3 oz.!

Acknowledgment by the electronic engineer must be made, not only to the mechanical engineer, but to the chemical engineer. It is through the use of new products and new processes that space and weight reductions can be accomplished. The best results can be achieved by a welding of the knowledge and efforts of these men.

Specifically, how was this size and weight reduction accomplished in the above mentioned transformer?

It was felt that sometimes unreasonable safety factors crept into the

design of airborne transformers, particularly when the design passed through several hands—each adding a bit to the over-all safety factor. It was also felt that too little attention was sometimes paid to absolute limits of safe operation. Too many "rules of thumb" seemed to be used. Too little attention seemed to be paid to the requirements of each specific design.

In the design of this transformer, we first studied the core. A toroidally oriented-silicone prefabricated core was finally chosen because a 15% to 30% weight reduction was indicated over standard "E-I" laminations—without altering transformer characteristics or increasing core losses. More rigid control of magnetic characteristics, faster assembly and no high temperature de-

(Continued on page 28A)

Fig. 4. Bottom view of assembly shown in Fig. 3. Five driver amplifiers are included—a total of 15 tubes, 5 output transformers, 30 resistors and 32 condensers.

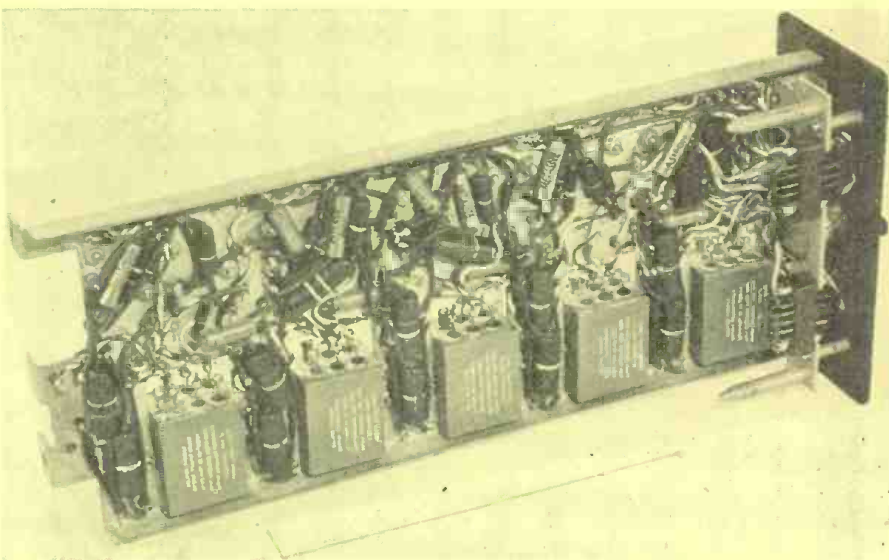

By ALVIN B. KAUFMAN

This useful device converts very small d.c. voltages to a.c. so they can be more readily amplified and measured.

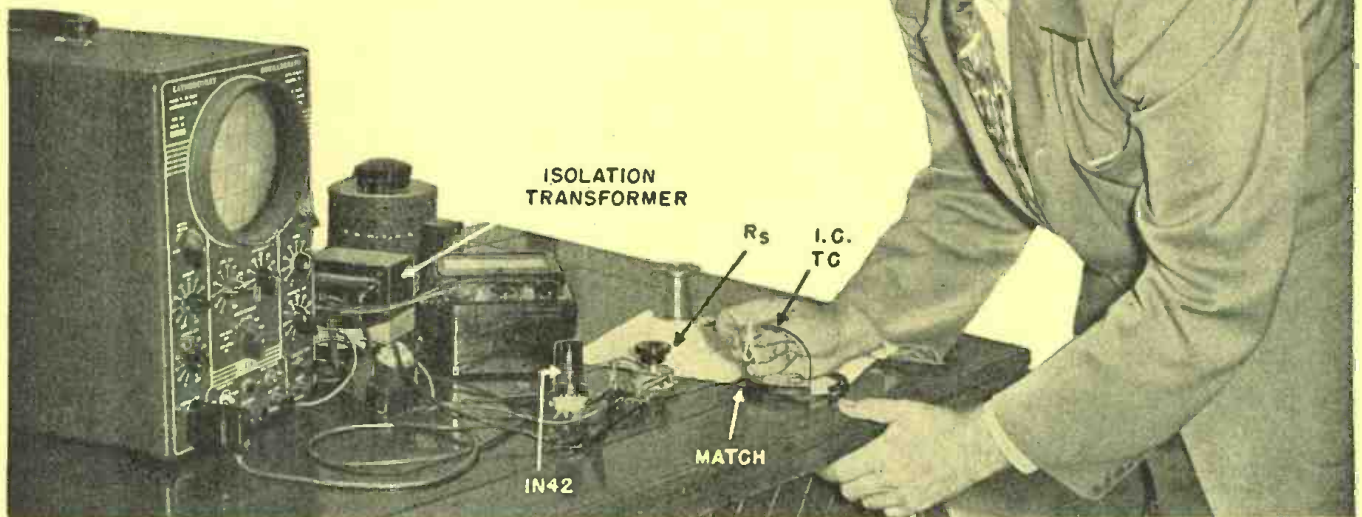

Experimental setup for testing the chopper with an iron-constantan thermocouple.

Electronic D.C. Millivolt Chopper

THE amplification of small d.c. potentials is an old problem. That this problem is of much importance may be seen by examining the literature on methods of d.c. amplification.

Application of d.c. amplification systems has been made for strain gauge signals, thermoelectric potentials, electrometer output potentials and in medical, industrial, and experimental fields.

Amplification systems are generally of one of the following types:

1. Mechanical-electrical chopper (vibrator) and a.c. amplifier.
2. D.c. Amplifier.
3. D.c. Modulating R.F. Carrier System.¹
4. Magnetic Amplifier.
5. Electronic Chopper (Bridge Type); a) Neon, b) Resistive, c) Tube, d) Varistor.

Most of these types have been discussed quite liberally in engineering literature and there is little need of recapitulation of their problems of drift, complexities and general unsatisfactoriness.

The "Electronic Chopper" discussed herein is not presented as a cure-all, but a substantial simplification of the d.c. amplification problem as applicable to many laboratory and industrial problems.

The very use of the word chopper signifies the use of an associated a.c. amplifier and detector. As the chopper may be referenced to the amplifier output voltage, a "phase sensitive system" or a conventional carrier detection system may be employed. Unlike the mechanical chopper system of a vibrator or carbon button hummer, the bridge modulator, to be described, may be operated at frequencies as high as five or six megacycles allowing full dynamic recording of d.c. potential variations up to signal intelligence of 600 kilocycles. This feature also allows simplified filtering of the rectified a.c. or carrier signal to produce smooth d.c. output, where required. Of course industrial line frequencies of 60 cycles, or aircraft frequencies of 400 cycles may be used to operate the "chopper" and regulate its frequency of operation.

The electronic chopper utilizes two

basic principles. The first is that if a signal is applied to the grid of an amplifier tube through a series resistance and the grid is intermittently shorted to the cathode, the d.c. potential on the grid will vary from zero to its full value. This is roughly the action of the electronic chopper. The electronic chopper does not create a dead short from grid to ground, but does effectively create a varying resistance, which in combination with the series resistance causes voltage divider action and a variation of the d.c. potential impressed on the tube grid. The method of impressing this varying resistance between grid and cathode is the second basic innovation. It is well known that a bridge with four equal legs will have zero voltage difference between its conjugate output terminals. Therefore a bridge circuit is used. Its "output" terminals are connected between grid and ground and a.c. (the carrier frequency) applied to the source terminals. The bridge output terminals must not develop any output voltage, but must vary in resistive value at the carrier frequency rate. The bridge elements,

then, are the major consideration.

The bridge modulator may consist of any of a number of entirely different elements, operating technically different, but producing the same end result to varying degrees. Four basic types with several modifications will be discussed.

The resistive bridge modulator consists of four equal resistive legs of fine wire with a high coefficient of thermal resistance change. With each half-cycle of carrier current applied to the bridge, all four legs heat up and increase in resistance. Thus the modulator output is at twice carrier frequency. This modulator is limited by the thermal characteristics of the wire, and the heating and cooling resistive changes of all four legs. The resistance change available without burning out the wire is the major limitation of output, while the dynamic resistance tracking of all four legs on their heating and cooling cycle regulates the undesirable output of bridge carrier voltage and this regulates in turn the value of the lowest possible d.c. signal that may be amplified. If all four legs do not remain equal in value, then the bridge supply will cause an output voltage to appear on the grid of the tube without a d.c. input signal and this consequently regulates the signal-to-carrier (or noise) ratio, as indicated. It is this ratio which limits the value of the d.c. potential which may be amplified. These factors limit the use of the resistance bridge modulator and it is not too satisfactory, but may be improved with research.

The neon bridge modulator has a much better resistive output variation, possessing as it does a variation between almost zero and infinity ohms. With no potential (or carrier) applied to its bridge, the neon lamps are unlit and at the low d.c. signal potential applied to them will not ionize and therefore present a high impedance to the tube grid. As each half-cycle of carrier is applied to the bridge the neon bulbs ionize (or light) and form a low impedance path from grid to cathode. Any resistive unbalance between neon lamps is balanced out by the slide wire potentiometer forming the other half of the bridge. On the non-conducting portion of the carrier cycle, the bridge is balanced capacitively by the padders. It is apparent that this modulator also puts out a frequency twice the carrier frequency.

The neon modulator works quite well and its limitations are due mainly to the dynamic resistance characteristics of the neon lamps, firing point and inverse resistance characteristics. The lowest d.c. potential which may be amplified satisfactorily because of these limitations is approximately 50 milli-

volts, varying with the modulator components and associated equipment. Another variation of the neon modulator is the replacement of the neon bulbs with vacuum tube diodes. The system faces similar problems of capacity balance and matching of dynamic characteristics, along with not too satisfactory a variation in impedance and Edison effects causing performance not to be any more satisfactory than the neon modulator.

Possibly the best bridge modulator is that used in telephone and radio work as described by Terman, "non-linear rectifiers" in his Handbook of Radio Engineering. This modulator is commercially described as a "Bridge Modulator", "Copper Oxide Modulator", and under varying other synonyms. Here four non-linear rectifiers consisting either of copper oxide, selenium, or germanium are wired together identical to that circuit used in a full wave bridge instrument rectifier. However the lead away connections employed are entirely different. A.c. or the carrier is applied to what would normally be the plus and minus output connections, and what would be the input a.c. connections are tied grid to cathode.

As with the three other modulators the dynamic and static resistance characteristics of the four non-linear rectifiers which form the four legs of the bridge, limit the useful input signal level. The theory of operation is

simple. The forward resistance of such rectifiers is very high at extremely low current, dropping off to a low value at full current rating. The d.c. signal potential is insufficient to cause appreciable current flow and therefore the bridge is effectively an open circuit. With application of the carrier signal, full current flows through the rectifiers on the conducting half of the cycle and the bridge output resistance (grid to cathode) falls to a low value. As the bridge only conducts every other half cycle, the amplifier will effectively produce the same output frequency as the carrier supply. Of course there is a certain shunting effect from the impedance of the carrier exciting transformer, particularly with the full bridge circuit, which may be limited however by the addition of a series resistor of high value in one of the carrier exciting leads. The carrier series resistor should be five to ten times higher than the value of the series grid limiting resistor.

For high efficiency the signal-to-carrier voltage ratio should be ten or higher. Actual values will depend on the dynamic characteristics of the rectifiers used and the d.c. signal potential. A carrier current value should be selected that gives best signal to noise (or carrier) output.

The interelectrode capacity of such rectifiers is usually insignificant at carrier frequencies up to several thou-

Fig. 1. Circuit diagrams of several versions of the d.c. millivolt chopper.

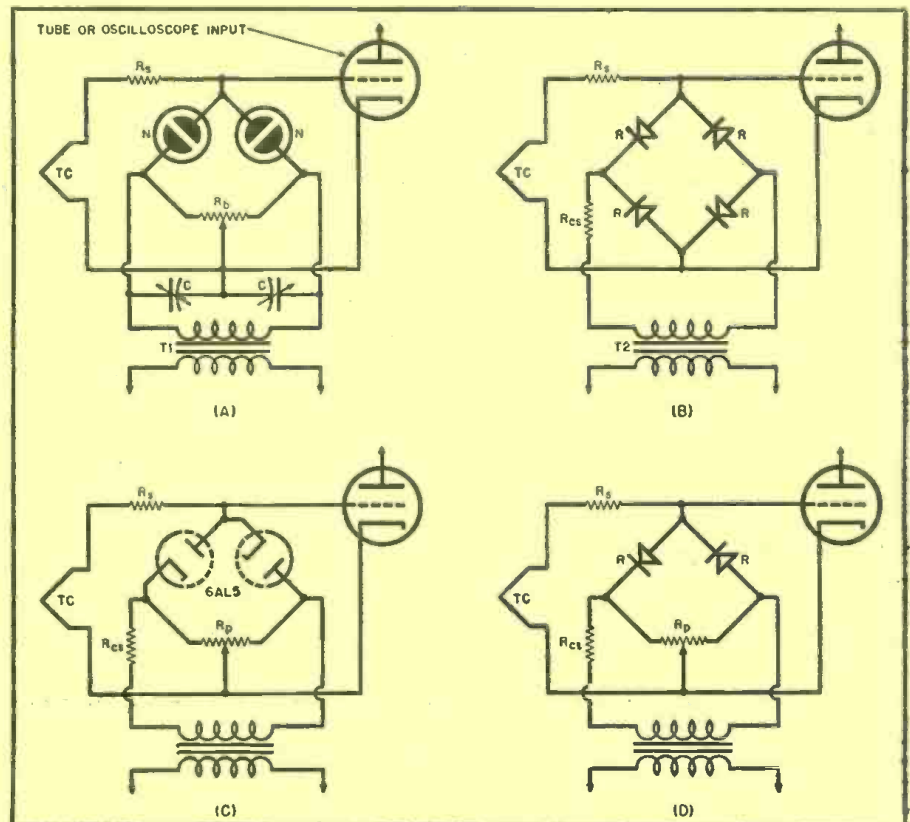

sand cycles, balancing possibly being required at five or six megacycles. Load impedances are generally of little importance except at the higher frequencies where the shunting effect of the rectifier capacities may become appreciable.

The inverse resistance characteristics of the rectifiers if dissimilar may cause an undesirable output on the non-conducting half of the carrier cycle. As indicated before, static matching is not sufficient; the dynamic, static, and inverse resistance characteristics must be the same.

Tests were conducted by the author using a *Conant* instrument rectifier Model 160 B and a *Sylvania* Varistor type 1N42. The instrument rectifier was not intended for this service. The *Sylvania Electric Company* Varistor, consisting of four matched germanium diodes, is specifically designed, among other uses, for use as a bridge modulator.

Considering the *Conant* instrument rectifier first, wired exactly as Fig. 1B, good readable signals from 10 millivolts d.c. could be observed on an oscilloscope with its gain adjusted for fairly straight line output with no d.c. input signal. Smaller signals could not be read above the noise (unbalance carrier) level. The observed signal was, of course, at carrier frequency. 60 cycle carrier was used. This rectifier is rated at 5 volts r.m.s. input, maximum current 5 milliamperes. Possibly twice this rated current could be run on the half duty cycle as used in this configuration, if necessary. The series grid limiting resistor finally selected was 300 ohms, but was not critical. The carrier supply across the bridge was 3.3 r.m.s. volts, supplied through a half-watt 10,000 ohm carrier resistor. The millivolt source was an iron-constantan thermocouple of low resistance.

A number of factors must be considered; the impedance of the d.c. signal source, the correct value of the grid

or series limiting resistor, optimum impedance matching, and the optimum carrier voltage. Some of these questions may be answered quantitatively while others must be qualitative, depending largely upon components and amplification equipment.

The impedance of the d.c. signal source should preferably be small in comparison with the input impedance of the amplifier with its modulator and series limiting resistor, or excessive shunting of the signal source impedance will occur with a corresponding reduction of the d.c. signal potential. The input impedance of the modulator and amplifier should be its highest possible value, i.e., with the modulator not conducting, when used for calculations. In the conducting state we are trying to reduce the signal as much as possible and the shunting is not serious.

The series limiting resistor value may best be determined empirically, approximations being made by formula. Part of this problem hinges on the fact that in determining by test the forward or inverse impedances of these rectifiers, the analyzer current must be of the same value as the operating carrier current or erroneous data will be secured. Also, this operating carrier current in itself will depend somewhat on the value of d.c. signal and the value of the series limiting resistor. As much carrier current should be used as will allow substantial dynamic tracking of all four rectifiers, generally less than one-half rated current of the rectifier. This must be determined empirically with an oscilloscope. The carrier current should be adjusted to the value where maximum change of output signal occurs for a given d.c. input signal. This may in some cases result in a background level or signal which may be balanced out in the detector or output circuit.

If the bridge modulator effectively changed resistance between infinity and zero ohms, then no series resistance would be necessary, except to prevent loading of the signal supply source or excessive bridge current for high values of d.c. signal potentials. In practice this optimum condition does not exist. The fact that the modulator does not open to infinity ohms is the main problem in determining the series limiting value. With a very low impedance signal source, if no limiting resistor were used, the d.c. signal could not be attenuated sufficiently because the modulator resistance does not go to zero ohms. Thus to reiterate, to prevent loading or reaction on the signal source and limiting by the action of the modulator a series limiting resistor is generally necessary. Optimum series resistance value for low values of d.c. input potentials is approxi-

mately: $R_{series} = R_{nc} - R_c$ of the bridge, where R_{nc} and R_c are respectively the nonconducting and conducting grid-to-cathode impedance of the bridge. R_c depends upon the carrier voltage and consequential rectifier currents. This series resistance may vary widely in value with variations of d.c. input signal and input impedance. High values of d.c. input potential require the use of a higher series grid resistor than normal to maintain the ratio between carrier and signal currents.

Where intermittent loading of the signal source, at carrier frequency, is permissible it is often possible to secure much higher output by eliminating the series limiting resistor. This depends, however, on three factors: the input impedance, the d.c. input level, and the characteristics of the particular modulator used. This is satisfactory only where: $R_{source} > R_c$ modulator.

A half-bridge modulator may also be used quite effectively, in which case only two rectifiers are used and these need not have identical static resistance values, as this may be balanced out by the potentiometer forming the other half of the bridge. Dynamic slope characteristics must still be close. Under these conditions, although possessing less available change in resistance than with the full bridge, it is sometimes possible to use more of the resistance change available because of decreased matching problems and thus secure higher outputs for a given d.c. input signal. The potentiometer forming the other half of the bridge should have a resistance of: $R_p \approx R_c + R_c$ where R_c is the conducting resistance of the rectifiers at the rated carrier current. Optimally, the potentiometer should be of as low a value as consistent with reasonable carrier current through its half of the bridge.

The *Sylvania* Varistor bridge modulator (shown in photograph) performed excellently and is to be preferred over the other units because of its availability as matched units, making hunting for individual matched components unnecessary. This would be especially important for commercial equipment.

As with the other circuits, the millivolt d.c. supply consisted of an iron-constantan thermocouple with about five ohms lead resistance. This supply was chosen as a convenient standard signal source for comparison of chopper efficiency. The thermocouple (about 28 gauge wire) was heated to cherry red with a match, supplying about 40-50 mv. peak. R_s was empirically determined optimum at 500 to 1000 ohms when R_c was 10,000 ohms. With 60 cycles as the carrier, optimum carrier voltage was 6-10 volts r.m.s. across the

(Continued on page 29A)

Fig. 2. Simplified schematic diagram of an automatic potentiometer.

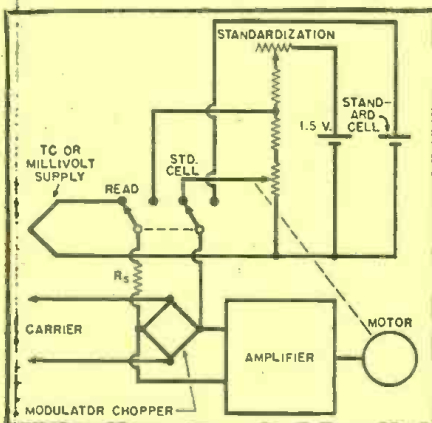

By
J. RACKER

Federal Telecommunication Labs.

THE design principles described in the previous articles in this series provide the engineer with the basic approach to a given microwave problem. Once this approach is established the details of design, i.e., configuration, size, and position of the various elements, will be determined primarily on an empirical trial and error basis. This procedure is employed in many other fields, but it is particularly necessary in microwave techniques because of the mathematical complexity of even relatively simple circuit calculations. For example, a cavity filter is desired between antenna and mixer in a receiver. The exact position of the input and output probes must be determined to effect proper matching between antenna and filter, and filter and mixer. The mathematical solution to this problem involves very complex computations and is completely impractical, while it is a relatively simple matter to adjust probes for maximum power output and minimum standing-wave ratio.

Several years ago the measuring equipment necessary to effect such a trial and error procedure was not readily available and the engineer frequently had to design and build these instruments himself. Sometimes this was the most difficult part of the project. Today, due to the expanded use of microwave systems, a wide selection of commercial equipment is on the market. In this article, the author will be primarily concerned with the theory of operation and practical application of these units.

Not only are the techniques themselves different, but the electrical characteristics of interest in the microwave region are, in several instances, not the same as those of interest at longer wavelengths. For example, we are more concerned with the electric field than in potential difference; in fact, voltages are difficult to define in most microwave elements other than coaxial lines. For this reason, the output of an oscillator or signal generator is specified in terms of power delivered to a load matched to the transmission line rather than in terms of available voltage across a given impedance. Similarly, instead of inductance or capacitance, measurements are usually made of the normalized impedance of unknown loads.

In previous articles^{1,2} it was shown that when a transmission line was terminated in an impedance equal to the line characteristic impedance, no



Power meter for measuring standard wave ratios on slotted line. The r.f. is modulated at 1000 cycles and is detected, amplified, and measured by this instrument.

MICROWAVE MEASUREMENTS

Part I. Equipment and techniques for measuring impedance and power at microwave frequencies.

reflections from the load occurred. If the load impedance was not equal to the line characteristic impedance, part of the energy would be reflected back down the line and standing waves would be developed. The magnitude of these standing waves would be proportional to the impedance mismatch ratio. The position of the maxima and minima

along the line would be a function of the phase difference between the two impedances. Thus it is seen that knowing the impedance of the line, the standing-wave ratio, and position of the maxima and minima points, it would be possible to determine the impedance of a given load.

The impedance Z_n is known as the normalized impedance and is equal to the actual impedance, Z , divided by the characteristic impedance of the line, Z_0 . For most transmission line matching applications (particularly in wave guides) the normalized impedance is a more useful parameter than the actual impedance. The normalized impedance of the load is related to the reflection coefficient, K , by the following expression:

$$Z_n = \frac{1 + K}{1 - K} \dots \dots \dots (1)$$

The reflection coefficient, K , may be a complex number having both magnitude

Fig. 1. Equivalent circuit for probe in (A) block diagram form and (B) schematically with probe represented by $G_p + jB_p$.

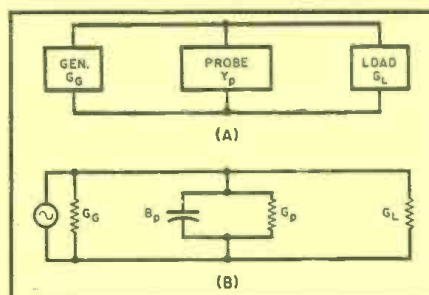

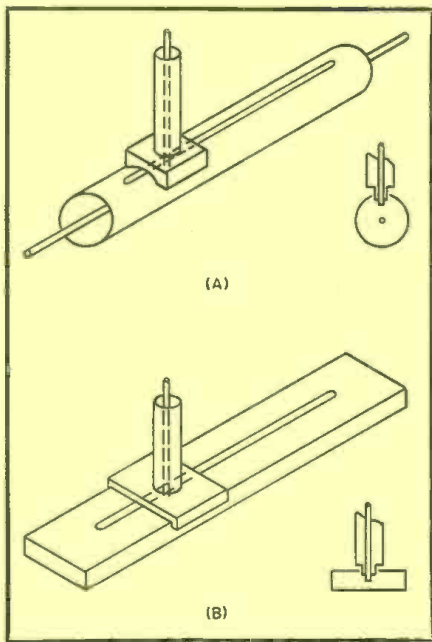

Fig. 2. Slotted line with probe for (A) coaxial and (B) wave guide line.

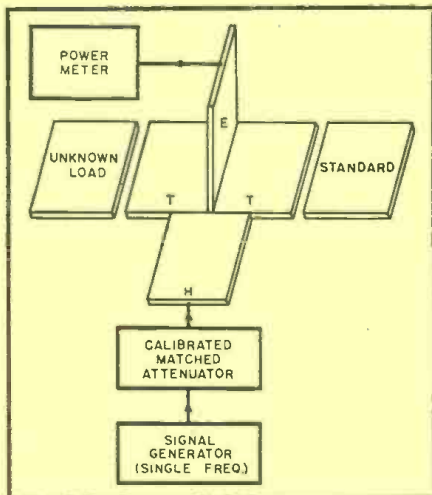

Fig. 3. Single frequency "magic T" impedance measuring bridge.

and phase components. The magnitude of K can be determined empirically by measuring the standing-wave ratio

(power) and using the following equation:

$$|K| = \frac{\sqrt{\rho} - 1}{\sqrt{\rho} + 1} \dots \dots \dots (2)$$

The phase of K is determined by the minima on the line, being equal to zero at these points. (Maxima points correspond to a phase angle of 90°). Knowing the phase at any one point, N , it is possible to determine the phase at point, M , by the following expression:

$$K_N = K_M e^{j2\beta x} \dots \dots \dots (3)$$

where x , the distance between the two points, will be positive when M is nearer to the generator, and negative when N is nearer to the generator. β is equal to $2\pi/\lambda$, where λ is the signal wavelength in the transmission line.

Standing waves are measured through the use of slotted lines which consist of a section of transmission line into which a small probe is introduced through the slot. Fig. 2 shows two types of slotted lines, i.e., coaxial and wave guide. The probe extracts a small fraction of the power flowing through the line and this power is measured in an external circuit. (The external circuit will be described later in this article when power measurements will be discussed).

By moving the probe along the slot, the standing waves can be determined. In order to minimize distortion of the field configuration, the slot should run parallel to the lines of surface current. In coaxial lines, due to symmetry the slot can be placed anywhere parallel to the axis, but in the $TE_{1,0}$ wave guide the slot should be placed at the center of each of the broad sides. It is very important to maintain the width and depth of the slot constant and its direction parallel to the axis. If the probe insertion varies by as much as 0.001 inch as the carriage is moved along the slot an error of several per-cent in the measured value of standing-wave ratio may be introduced. This imposes very close mechanical tolerances in the construction of the line.

Assuming proper construction and reflection-free matching between line and load, there are two factors that may require consideration in the evaluation of the results. One is the standing wave introduced by the slot and the other is the standing waves caused by the presence of the probe. It can be shown that the characteristic impedance of a coaxial line varies due to the insertion of the slot by approximately:⁸

$$\frac{\Delta Z_0}{Z_0} = \frac{1}{4\pi^2} \frac{w^2}{D^2 d^2} \dots \dots \dots (4)$$

where ΔZ_0 is the change in original characteristic impedance, w is the slot width, and D and d are the radii of the outer and inner conductors. The reflection coefficient K will therefore be equal to:

$$K = \frac{\Delta Z_0}{2Z_0} \dots \dots \dots (5)$$

For very precise work this effect may be troublesome. It may be avoided by compensating for the change in impedance caused by the slot by increasing the diameter of the inner conductor.

In a wave guide the impedance due to the presence of a slot is approximately equal to:⁸

$$Z_s = Z_0 \left(1 + \frac{w^2 \lambda_g^2}{8\pi b a^2} \right) \dots \dots (6)$$

where Z_0 is original guide impedance.

The presence of the slot also affects the propagation constant of the wave guide, and increases the guide wavelength by the same factor as the impedance. This factor is not too important, however, since (as will be indicated later) it is recommended that the wavelength of the guide be determined by actual measurement.

Probe Effects

An ideal probe would be one whose presence in no way altered the field within the transmission line and which, nevertheless, provided an indication of the intensity of the electric field within the line. This ideal is not attainable, of course, and usually some compromise between probe sensitivity and mismatch effects must be made.

For most practical applications where the probe dimension parallel to the slot is small compared to a wavelength, the probe can be represented as a shunt admittance across the line as shown in Fig. 1A and B. The impedances shown in this diagram are normalized so that $Y = 1$ represents an admittance equal to $1/Z_0$.

Assuming that the generator is matched to the line and that B_p can be made to be equal to zero by tuning it out (both assumptions are valid for most applications) then $G_L = 1$, the ratio between standing-wave ratios with and without probe can be given by:

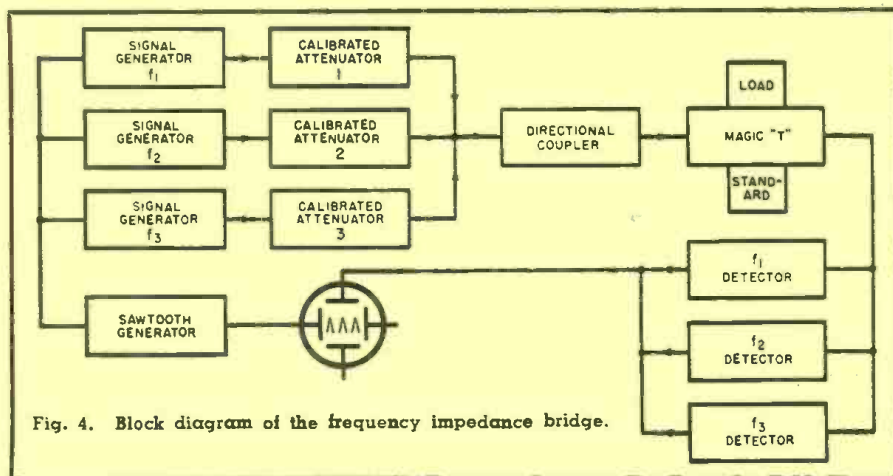

Fig. 4. Block diagram of the frequency impedance bridge.

SYLVANIA TV Picture Tubes are natural-born leaders because . . . they come from a leading family



Radio Tubes . . . 25 years' experience in building high quality tubes for every radio and television need.

Electronics . . . wide experience in designing radar and electronic equipment for war-time and post-war commercial use.

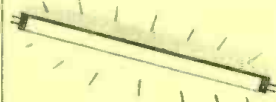

Phosphors . . . production of white and colored phosphors for the "Finest in Fluorescent Lighting."

Lighting . . . half a century of research and manufacture of incandescent and fluorescent lamps to meet longest life and highest vision standards.

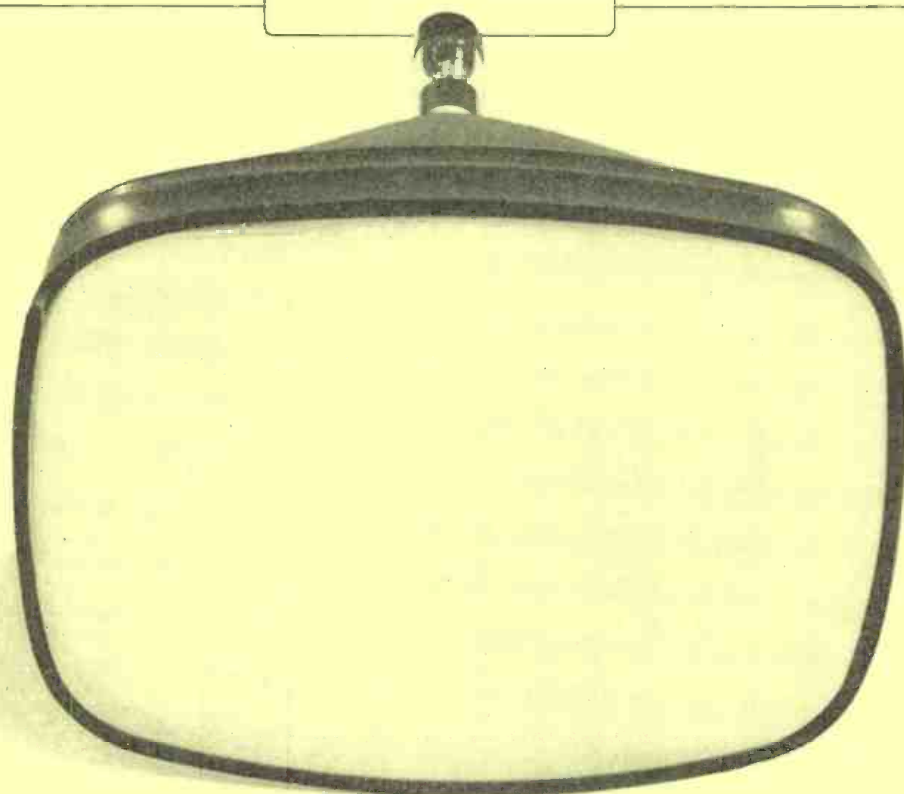

This unique combination of experience naturally fits Sylvania for top position in the TV Picture Tube field.

Maintaining this leadership is a continuing program of research and engineering. A Sylvania engineer, for example, invented the famous "Ion Trap," now licensed to numerous other picture tube makers.

Sylvania achievements in fluorescent powders, tungsten wire, and precision parts are some of the other reasons which lie behind the consistent color, greater clar-

ity, and longer life of all Sylvania TV Picture Tubes.

Backing up each Sylvania advance is a rigid system of quality control . . . of checking and rechecking every step of every process . . . so that TV set owners everywhere will continue to look to Sylvania for the finest performance possible. New booklet gives information concerning the complete line of Sylvania Picture Tubes. Write for your copy today. Address Sylvania Electric Products Inc., Dept. R-2312, Emporium, Pa.

SYLVANIA ELECTRIC

TELEVISION PICTURE TUBES; RADIO TUBES; ELECTRONIC PRODUCTS; ELECTRONIC TEST EQUIPMENT; FLUORESCENT TUBES, FIXTURES, SIGN TUBING; WIRING DEVICES; LIGHT BULBS; PHOTOLAMPS; TELEVISION SETS

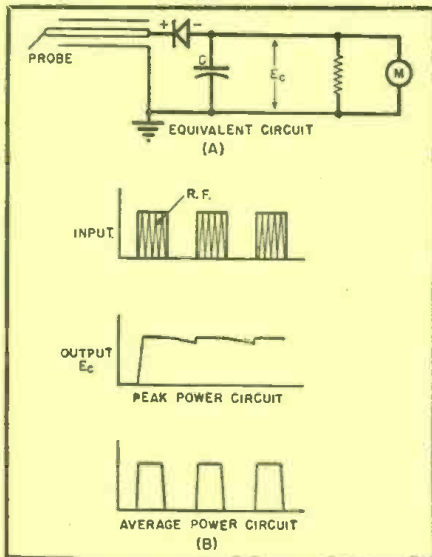

Fig. 5. Crystal detector power meter.

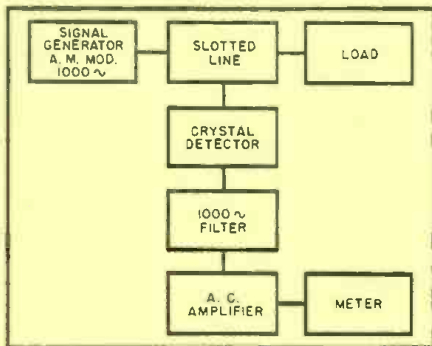

Fig. 6. Power meter (with slotted line) employing 1000 cycle modulation of r.f. to effect sensitivity.

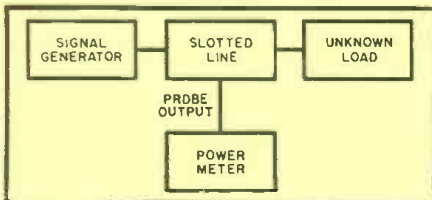
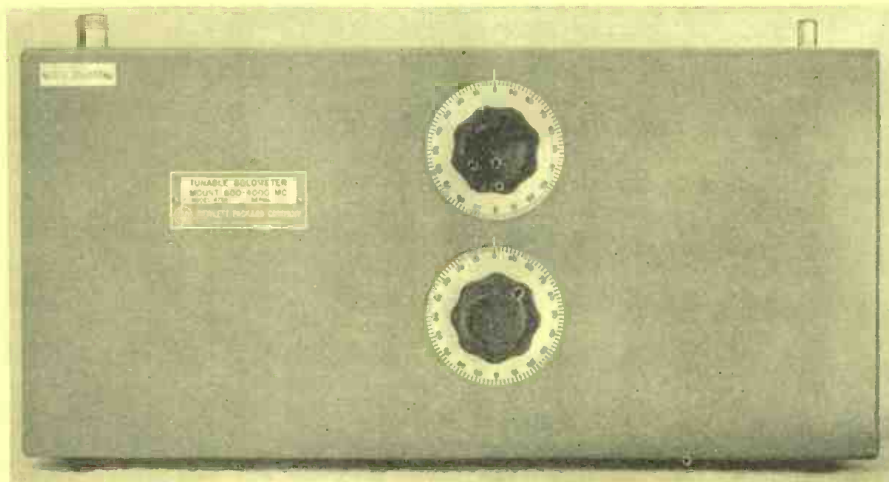

Fig. 7. Block diagram of typical impedance measuring setup.

Tunable bolometer mount used for measuring power at microwave frequencies.



$$\frac{P_s}{P} = \frac{1 + P + G_p}{1 + P + PG_p} \dots \dots \dots (7)$$

The quantity G_p determines the amount of power extracted by the probe, and is called the coupling coefficient of the probe. As previously indicated, every standing-wave measurement poses the problem of compromise between a very small coupling coefficient necessitating relatively elaborate external equipment to obtain sensitivity, or extracting more power by increasing G_p and thereby encountering a larger discrepancy between measured and true readings.

Fig. 7 shows a typical impedance measuring test setup using a slotted line. To determine the impedance of the load it is necessary to measure the standing-wave ratio and distance from the first minimum to the load impedance. Equations (1) and (2) are then used to calculate the load impedance. It should be noted that Eq. (2) is expressed in terms of power standing-wave ratio. In some instruments voltage standing-wave ratios, ρ_v , are measured, in which case the substitution $\rho = \rho_v^2$ should be made in Eq. (2).

The determination of the distance from load to first minimum may be complicated by the fact that for some loads, such as antennas, it is not apparent exactly where the load starts. In these cases it is necessary to calibrate the slotted line in terms of distance from the desired load. The following procedure is used to effect this calibration: the signal generator is first set to a frequency at which the load acts as an open or short circuit. Antennas, for example, have a finite bandwidth beyond which they act as short circuits. With the load presenting a short, the first minimum will occur exactly one-half wavelength away from the load, with the second minimum the same distance ($\lambda/2$) from the first one. By measuring the

distance between second and first minima, the load starting point becomes known and the line can be calibrated in terms of distance from this point.

"Magic T" Impedance Measuring Bridge

Slotted lines are used extensively for impedance measurements; however, they do have the disadvantage of being time consuming. In some applications it is desirable to determine the reflection coefficient instantaneously. For these applications a device, somewhat equivalent to the Wheatstone bridge, using a "magic T" wave guide, shown in Fig. 3, is employed. The magic T, as previously described, has the property of dividing the power fed into the H-arm equally between the two test arms if these arms are properly terminated in reflectionless loads. If these arms are not properly terminated, some of the energy reflected from the load will go into the E-plane arm.

For impedance measurements, one test arm is terminated in a standard load which represents a reflectionless match over the desired band. The load of unknown impedance is placed across the other test arm. A signal at the desired frequency is applied to the H-plane arm. If this load does not match the test arm at this frequency, some power will be reflected into the E-plane arm. The magnitude of this power is proportional to the square of the reflection coefficient, K . Hence, a detector placed in the E-plane arm can be calibrated in terms of voltage or power standing-wave ratios. It should be noted that the phase of the unknown impedance cannot be measured by this method. However, in many applications, only the value of the reflection coefficient is of interest since the power lost due to mismatch is a function of this parameter only.²

The simplest type of magic T device is the single frequency bridge shown in Fig. 3. In this equipment impedance measurements can be made at one frequency only for a given setting of the instrument. To determine the impedance characteristics over the desired band, the frequency must be varied and individual readings noted at each point.

It is possible to measure the reflection coefficient over a band of frequencies instantaneously by feeding several radio frequency signals simultaneously, as shown in Fig. 4, through proper attenuators into the H-plane arm of the magic T. The output of the E-plane arm is fed to an oscilloscope through appropriate frequency selection, amplifying, and detecting apparatus. The radio frequency signals are so spaced in time that they will appear in proper time sequence on the scope. Hence, the scope

EL-MENCO CM-15 CAPACITOR



THIS GEM-SIZED UNIT DOES A

GIGANTIC JOB

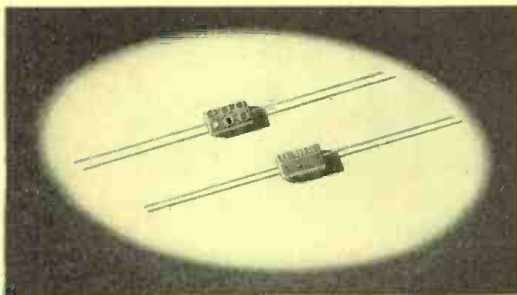

CM-15 MINIATURE CAPACITOR

Actual Size 9/32" x 1/2" x 3/16"
 For Television, Radio and other Electronic Applications.
 2 to 420 mmf. cap. at 500v DCw.
 2 to 525 mmf. cap. at 300v DCw.
 Temp. Co-efficient ± 50 parts per million per degree C for most capacity values.
 6-dot color coded.

Each tiny El-Menco CM-15 capacitor performs at maximum efficiency regardless of climate or critical operating conditions. Before leaving the factory, it is tested for dielectric strength at *double* working voltage—for insulation resistance and capacity value. Every gem-sized El-Menco capacitor meets and beats the strictest Army-Navy standards. That's why *you* can always depend on this tiny condenser to give gigantic performance in your product.

A COMPLETE LINE OF CAPACITORS TO MEET EVERY REQUIREMENT

THE ELECTRO MOTIVE MFG. CO., Inc.
 WILLIMANTIC CONNECTICUT

Write on your firm letterhead for Catalog and Samples.



MOLDED MICA **El-Menco** MICA TRIMMER CAPACITORS

FOREIGN RADIO AND ELECTRONIC MANUFACTURERS COMMUNICATE DIRECT WITH OUR EXPORT DEPT. AT WILLIMANTIC, CONN. FOR INFORMATION.

ARCO ELECTRONICS, INC. 103 Lafayette St., New York, N. Y.—Sole Agent for Jobbers and Distributors in U.S. and Canada

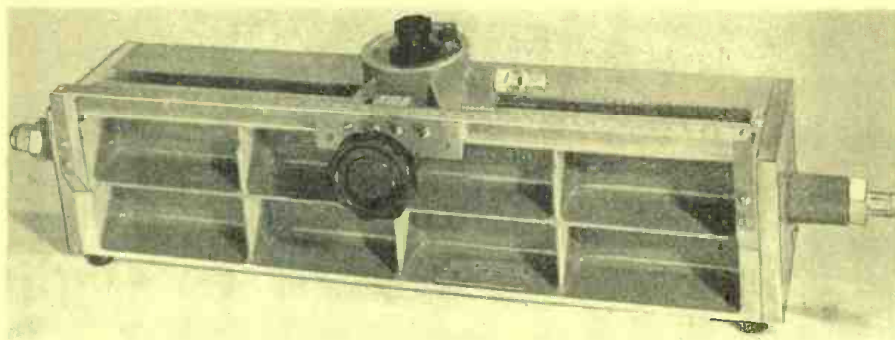

Typical slotted line used for microwave impedance measurements.

peak of the pulse, while an average current design would have a series of pulses at the condenser output. This type of power indicator is calibrated with a signal generator whose power output can be varied and is matched into the crystal detector.

Sufficient power must be extracted from the device under measurement to actuate the meter over an appreciable portion of its range. This is a serious disadvantage of this method since, in the slotted line for example, the more power absorbed by the probe, the greater the error in standing-wave ratio measured. As a consequence, the circuit shown in Fig. 5 is used only to provide a relative indication of power output in a microwave transmitter (thereby indicating proper operation) or in some standing-wave equipment which is not required to be very accurate.

The sensitivity of this method can be increased and the SWR error decreased by modulating the microwave signal and employing an a.c. amplifier following the crystal detector, as shown in Fig. 6, tuned to the modulating frequency. The amplitude of the modulating signal obtained at the crystal detector output will be proportional to the amount of r.f. power pickup. By providing sufficient amplification it is possible to effect a highly sensitive and accurate measurement of power with a very small probe G_p .

Calorimeters

Another method of measuring power involves conversion of microwave energy into thermal (caloric) energy and measuring the latter. This can be done by feeding the microwave power into a water load matched to the output of the generator. The temperature rise of the water will be a function of the power absorbed and thereby provides an indication of output power.

A typical coaxial line calorimeter that employs this principle is shown in Fig. 8. This instrument consists of a coaxial line into which r.f. power is fed at its input and is terminated into a water load. The water is contained within a section of the coaxial line with inlet and outlet connections permitting a continuous flow of water throughout this section of line. The temperature of the inlet and outlet streams is measured as well as the rate of flow, and from this data it is possible to calculate the absorbed power.

Due to the high dielectric constant of water, a mismatch is produced at the junction of the air- and water-filled sections. This mismatch can be eliminated through the use of a dielectric transformer placed between the two sections. This transformer, which also

(Continued on page 26A)

will display these signals as a series of pips, the magnitude of each pip being proportional to the reflection coefficient at the frequency involved. Thus the

bandwidth response will be noted instantaneously.

Power Measurement

Power measurement, rather than voltage, is of much greater interest at microwave frequencies. There are two basic approaches to the measurement of power. In one case the power is measured directly at microwaves, while in the other the microwave energy is modulated by a low frequency signal and measurement is actually made of the modulation, after the microwave energy is detected and bypassed. This latter method is particularly useful in standing-wave measurements where it is possible to apply any convenient signal to the slotted line. Of course, in checking the output of microwave equipment where convenient modulation cannot be applied, microwave energy must be measured directly.

Microwave power is measured by one of three equipment methods, namely, crystal detectors in which power is measured directly; calorimeters in which power is converted to thermal energy and this energy measured; and bolometers in which power variation is converted, via thermal energy, into a varying resistance, and this variation is measured.

The crystal detector, shown in Fig. 5, is the simplest and least accurate method of measurement. The r.f. power is rectified by the crystal and used to charge up condenser C which also acts as an r.f. bypass. Two designs are possible, one for peak power measurement and the other for average power measurement. For peak power measurement the RC constant of the circuit is such that the condenser will charge to the peak of the applied voltage and will discharge only slightly during the remainder of the cycle as shown in Fig. 5B. For average power measurements the RC constant is made such that the video or modulation voltage will appear across C . This output is then fed to a meter which measures average voltage. For example, if the r.f. is pulsed at 1000 times per second, the peak power design will provide an essentially constant output equal to the

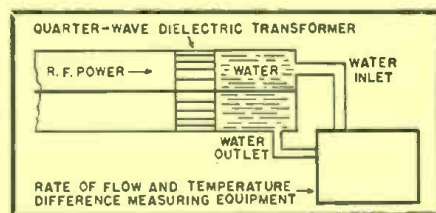

Fig. 8. Coaxial line calorimeter.

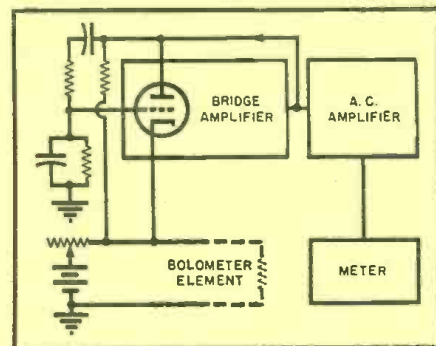
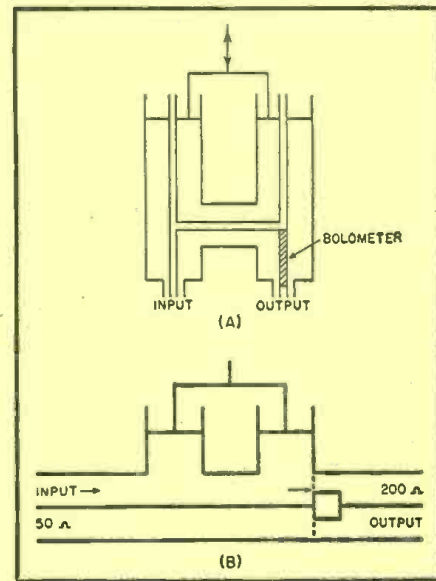

Fig. 9. Basic circuit of a self-balancing bridge power meter.

Fig. 10. Cross-section (A) and equivalent schematic (B) of a tunable bolometer mount.





Time and Cost Saving Features

ON WHICH CLUTCH HEAD CHALLENGES COMPARISON WITH ANY AND ALL OTHER SCREWS

1. **What Other Screw** equals the high visibility of the CLUTCH HEAD recess to check out the slow-down of hesitation . . . even with "green" operators?
2. **What Other Screw** frees the line from burred and chewed-up heads with automatic straight driving . . . with Center Pivot entry that prevents driver canting?
3. **What Other Screw** has a non-tapered driving engagement (without dangerous "ride-out" as set up by tapered driving) to eliminate the hazard of skid damage? . . . and the need for fatiguing end pressure?
4. **What Other Screw** provides a simple Lock-On which unites screw and bit as a unit to hurdle "fumble spots" by permitting one-handed reaching and driving from any angle?
5. **What Other Driver** can begin to approach the durability record of the rugged Type "A" Bit . . . 214,000 screws driven non-stop?
6. **What Other Assembly Bit** can be repeatedly reconditioned on the spot by a 60-second application of the end surface to a grinding wheel . . . for unmatched tool economy.
7. **What Other Modern Screw** has a recess basically designed for operation with a common screwdriver . . . for the simplification of field service adjustments?

TYPE "A"
ASSEMBLY BIT



COMMON
SCREWDRIVER



According to users of CLUTCH HEAD Screws, you may confidently expect these time- and cost-saving features to deliver assembly production increases ranging from 15% to 50%.



The New CLUTCH HEAD Brochure details and illustrates the exclusive advantages of America's Most Modern Screw. Your copy will come to you by mail on request . . . mentioning the types and sizes of screws in which you are interested.



UNITED SCREW AND BOLT CORPORATION

CLEVELAND 2

CHICAGO 8

NEW YORK 7

Laboratory Standards

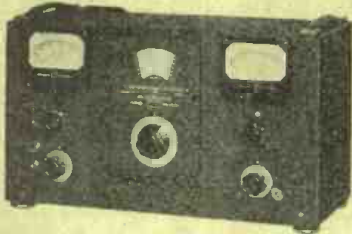

STANDARD SIGNAL GENERATOR

Frequency range: 75 kc. to 30 mc. Output 0.1 microvolt to 2.2 volts. MODEL 65B



STANDARD SIGNAL GENERATOR

Frequency range: 2 mc. to 400 mc. Output 0.1 microvolt to 0.1 volt. MODEL 80

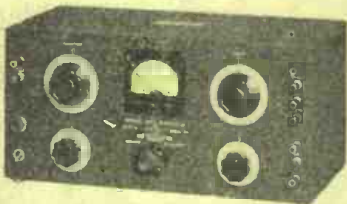

SQUARE WAVE GENERATOR

5 to 100,000 cycles. Recommended for AM, FM and television testing. MODEL 71



MODEL 59

MEGACYCLE METER

MANUFACTURERS OF
Standard Signal Generators
Pulse Generators
FM Signal Generators
Square Wave Generators
Vacuum Tube Voltmeters
UHF Radio Noise & Field Strength Meters
Capacity Bridges
Megohm Meters
Phase Sequence Indicators
Television and FM Test Equipment

A versatile grid-dip oscillator covering the frequency range of 2.2 mc. to 400 mc.

CIRCULARS ON REQUEST

MEASUREMENTS CORPORATION
BOONTON NEW JERSEY



AUDIO SYMPOSIUM

One of the main features of the IRE West Coast Convention held recently in Long Beach, California, was an Audio



Symposium led by John Hilliard, Chief Engineer, *Altec Lansing Corp.*, which featured a discussion of contemporary problems in television audio.

Bryan Cole (seated at right) of KFI-TV illustrated the principal problems in television audio such as: microphone placement, acoustics of sets and studio, reduction of noise in studio, etc. Dr. J. G. Frayne (left), Chief Engineer of *Westrix Corp.*, led the discussion on magnetic recording and stated that magnetic recording in the movie industry is here to stay.

Fred Albin, Supervisor of Video Recording of *ABC*, headed the discussion on sound on film problems, and E. B. Harrison of *Altec Lansing Corp.*, discussed the engineering specifications for high fidelity audio transformers.

TO BUILD ELECTROSTATIC ACCELERATOR

Northwestern University recently announced that it will build a 4½ million volt electrostatic accelerator for nuclear research. Dr. Russell A. Fisher, acting chairman of the Physics Department, said construction of the 28-ton atom smashing equipment will begin shortly, but it will be at least two years before the work is completed.

The instrument, a Van de Graaf type ion accelerator, will be installed in a structure to be built just south of the Northwestern Technological Institute. The lower part of the building probably will be underground so that the earth will serve as a shield for protection against the powerful rays produced by the generator. Additional protection will be provided by concrete

walls and ceiling at least two feet thick.

The apparatus will be designed and constructed under supervision of Dr. Edward N. Strait, Jr., assistant professor in the Physics Department, who formerly worked with Professor R. J. Van de Graaf at MIT, and Dr. James H. Roberts, another nuclear physicist and assistant professor of physics. Consulting with them will be Dr. Paul E. Klopsteg, Director of Research in the N.U. Tech. Institute.

CALIBRATION SERVICE

A calibration service for field-intensity meters at all radio frequencies of broadcast and commercial importance up to 300 megacycles is now offered by

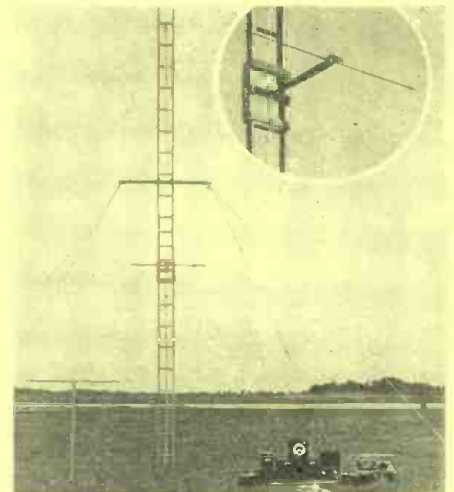

the National Bureau of Standards.

Of special interest are the new standards and methods which have been developed at the Bureau for calibrating field-intensity meters in the v.h.f. region from 30 to 300 megacycles. Two distinct experimental methods are used in the Bureau's field-intensity standardization work: the standard-antenna method for frequencies greater than 30 megacycles, and the standard-field method for lower frequencies.

In calibrating a commercial v.h.f. field-intensity meter by the standard-antenna method, the field strength at some arbitrary distance from a special v.h.f. transmitter is determined by a standard receiving antenna employing a crystal voltmeter. The antenna of the commercial set is substituted at the same position. The field strength, height of the antenna above ground, and the

meter readings obtained with the two antennas enable one to compute the antenna coefficient that must be applied to the commercial instrument to relate field intensity to its meter readings.

H.F. MEASUREMENTS CONFERENCE

The second High Frequency Measurements Conference sponsored jointly by the American Institute of Electrical Engineers, the Institute of Radio Engineers, and the National Bureau of Standards will be held in Washington, D. C. on January 10 to 12 in celebration of the semicentennial of NBS.

The Conference will be a forum at which leading engineers will exchange information on progress made since the previous Conference held in 1949. The Conference program will include about 25 technical papers, an evening demonstration, a luncheon, and conducted inspection tours of selected institutions.

The technical sessions will be held in the auditorium of the Department of the Interior. Conference Headquarters will be at the Hotel Statler. The Conference is under the general direction of Prof. Ernst Weber of the Microwave Research Institute of the Polytechnic Institute of Brooklyn. Dr. Harold Lyons of NBS is Chairman of the Local Arrangements Committee, and Dr. Frank Gaffney of the *Polytechnic Research and Development Company* is Chairman of the Technical Program Committee.

METEOROLOGICAL BATTERY

A battery capable of powering meteorological equipment such as radio-sonde to heights of 30 miles into the stratosphere has been developed by the Signal Corps Engineering Laboratories at Fort Monmouth, N. J. According to Signal Corps engineers, this battery is the result of years of work to find a compact, lightweight battery that could meet the desired standards of easy activation, long storage life, good low temperature operation, low weight, low cost, and high service.

GERMANIUM PHOTOCELLS

George D. O'Neill, head of the Solid State Section of *Sylvania Electric Products Inc.*, presented a paper at the recent National Electronics Conference in Chicago describing a device consisting of a tiny piece of germanium placed in contact with a pointed wire for use as a light-actuated valve to control the flow of an electric current.

Such a device, called a germanium photocell, is smaller in diameter than a match stick and less than $\frac{1}{2}$ " long, requiring only a single pair of connecting wires.

According to Mr. O'Neill, germanium
(Continued on page 31A)

PRODUCTIMETER "SPECIALS" for Radar and Electronic Applications

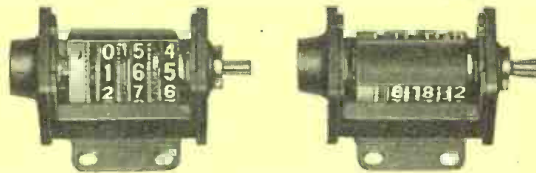

Companion shutter counters used as dual direction indicators. One counter adds while the other subtracts. Shutter blanks out counter which is on negative side of 000.



"Y" 2-figure Rotary Counter used in navigating instruments.



High-speed, non-reset "Y" type counter for building into radar instruments.



Special Model "Y" with window at rear designed for use in radar equipment.

These are a few of the "specials" developed by Durant for Radar and Electronic applications. When one of the many standard Productimeters is not the exact answer to a problem, Durant engineers modify, combine, or develop entirely new counters to meet the particular requirements of the job.



DURANT MFG. COMPANY
1919 N. Buffum St. 119 Orange St.
Milwaukee 1, Wis. Providence 3, R. I.
Representatives in Principal Cities

PRODUCTIMETERS
SINCE 1879
Speedometers OF INDUSTRY

Coil Insurance FOR FAMOUS PRODUCTS

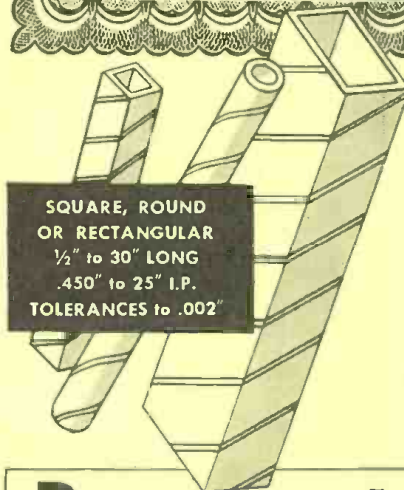

SQUARE, ROUND
OR RECTANGULAR
 $\frac{1}{2}$ " to 30" LONG
.450" to 25" I.P.
TOLERANCES to .002"

PARAMOUNT Spiral Wound PAPER TUBES
Protect Coil Accuracy and Stability
in Countless Applications

Years of specialized "know-how" easily enable PARAMOUNT to provide exactly the shape and size tubes you need for coil forms and other uses. *Hi-Dielectric. Hi-Strength.* Kraft, Fish Paper, Red Rope or any combination wound on automatic machines. Wide range of stock arbors. Special tubes made to your specifications or engineered for you.

NEW! Moisture-Resistant Shellac-Bond Kraft Paper Tubing. Heated shellac forms a bond which prevents delaminating under moisture conditions.

Paramount PAPER TUBE CORP.

613 LAFAYETTE ST., FORT WAYNE, IND.

Manufacturers of Paper Tubing for the Electrical Industry

WRITE
ON COMPANY
LETTERHEAD FOR
STOCK ARBOR
LIST OF OVER
1000 SIZES

NEW PRODUCTS

PRESSURE MEASURING SYSTEM

Elimination of the tubing connections in the new flush-mounted pressure cells announced by *Sierra Electronic Corp.*,

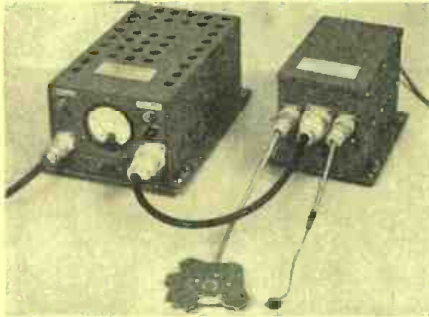

1110 County Rd., San Carlos, California, eliminates phase and amplitude errors arising from flexible-tube connection of pressure cells used in dynamic measurement. Cells mount directly in the surfaces upon which the measured

pressures impinge.

Several styles are offered to fit various applications, including wedge-shaped types small enough to be used within $\frac{1}{2}$ " of an airfoil trailing edge. Units are listed with these sensitivities: 0 to ± 2.5 psi, 0 to ± 5 psi, and 0 to ± 10 psi.

SCALER

The *Atomic Instrument Co.*, 84 Massachusetts Ave., Boston 39, Mass., is now in production on its new 1010 Scaler, described as the first of a series of "building block" units.

While the standard Model 1010 is furnished optionally with a scale-of-100 or scale-of-256, added scaling assemblies to make either a scale-of-1000 or a scale-of-4096 may be specified. Other custom modifications include: scaling factor selector switch (10-100 or 4-16-64-256); precision calibrated 50 to 100

volt discriminator on front panel; electrical reset register; omission of manual reset register; omission of regulated high voltage power supply; etc.

A complete description of the 1010 Scaler may be obtained by writing the company.

OSCILLOGRAPH

Consolidated Engineering Corp., 620 No. Lake Ave., Pasadena 4, California, is now offering a small, low-cost recording oscillograph. Designated Type 5-116, the instrument is similar to the larger oscillographs manufactured by *Consolidated* but over-all dimensions have been appreciably reduced, and its weight cut by a factor of almost 50 per-cent.

A new record transport system, recently adopted by *Consolidated* for their standard recording oscillographs, is also included in the 5-116. In this system neither sprocket teeth nor a pressure roller is required to provide positive record engagement, thus removing the major sources of record-drive malfunction, and at the same time reducing the power required to drive the recording



medium. Source of power for the record transport system is an exceptionally powerful governor-controlled motor directly connected through gearing to the record drive roll in the magazine.

The 5-116 is available in 9- or 14-trace block capacity for either 24-28 volt d. c. or 115-volt, 60-cycle a. c. drive.

TRANSMISSION MEASURING SET

A transmission measuring set which eliminates lengthy calculations and intricate setups for checking audio gain or loss, measurement of matching and bridging devices, complex circuit readings, and mismatch loss and frequency



response has been announced by the *RCA Engineering Products Department*.

CABINETS • CHASSIS • PANELS • RACKS

Planning ELECTRONIC EQUIPMENT?
Investigate the ECONOMIES
of PAR-METAL HOUSINGS!

We manufacture Metal Housings for every purpose — from a small receiver to a deluxe broadcast transmitter. And the cost is low!

Because we specialize in the Electronics field, Par-Metal Products excel in functional streamlined design, rugged construction, beautiful finish, and economy.

Remember, Par-Metal equipment is made by electronic specialists, not just a sheet metal shop.

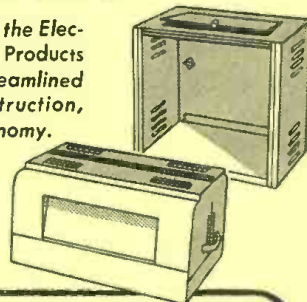

PAR-METAL

PRODUCTS CORPORATION

32-62 — 49th ST., LONG ISLAND CITY 3, N. Y.

Export Dept.: Rocke International Corp.

13 East 40 Street, New York 16, N. Y.



WRITE FOR CATALOG!

The new equipment, RCA Type BI-11A, consists of a volume indicator meter, input and output attenuators, impedance matching system, and jacks for convenient connection. A meter multiplier, geared to the load-impedance shaft, provides an automatic correction for changes in load impedance. Convenient switches facilitate connection of the volume indicator to the input of the attenuator system, or to jacks for external connection. An output impedance switch allows matching to 600, 250, 150, 16, 8, or 4-ohm circuits.

Illustrated literature and specifications on the equipment are available on written request to the Broadcast Equipment Section of RCA in Camden, New Jersey.

SURVEY METER

Nuclear Instrument and Chemical Corp., 229 W. Erie St., Chicago, Illinois, now has available a survey meter for checking all types of radiation found in clinics, hospitals, and laboratories.

Model 2581 is a battery powered, non-discriminating rate meter, and is an



improved version of the wartime "Zeuto." The detecting ionization chamber is covered with a rubber hydrochloride film on the underside of the instrument and is capable of detecting 25 k.e.v. beta particles and 2 m.e.v. alpha particles as well as gamma and x-radiation. This film is easily replaced and is protected by a removable wire grille.

The operating life of Model 2581 is at least 200 hours, and the batteries may be easily replaced by a minor disassembling of the instrument.

DISTORTION AND NOISE METER

The Daven Company of Newark, New Jersey, announces the availability of its Type 35-A Distortion and Noise Meter with two amplifier gain controls provided; one an accurate step type covering the range +40 to -60 in steps of 10 db., the other a continuously variable control covering the range ± 10 db.

The indicating meter covers the range

0 to -15 db., the range of 35-A is +40 to -60 db. full scale meter reading or +40 to -75 db. utilizing the meter scale. The range of noise and distortion



that can be measured depends upon the level of the source being investigated. At a level of -15 dbm. the limit is 60 db. below or 0.1% distortion. A pair of

output jacks is provided for connecting an external scope in place of the output meter.

MASS SPECTROMETER TUBE

Available from the General Electric Company, Schenectady, N. Y., is an ion resonance mass spectrometer tube to aid scientists in the analysis of chemical compounds, especially gases. High-precision measurements can be made by the new tube in a number of special analysis problems.

In the ion resonance tube, when in operation, electrons from the filament
(Continued on page 29A)

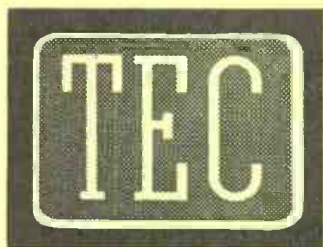

Electronic BLACKBOARD

External Screen: 8' x 10' or larger. Integral Screen: 18" x 25" for smaller groups. 5RPA tube, brightness 130 f.c., 20 KV acceleration. B & L f/1.9 coated lens.

Y-AXIS: a-c gain 1 mv rms/in.; d-c gain 2.5 v/in. Response $\pm 10\%$ 2 cps, $\pm 10\%$ 750 kc, -3 db 825 kc. Input 2 megohms, 30 μ f. Attenuator 1, 10, 100X.

X-AXIS: a-c gain 60 mv rms/in. Also Z-axis input.

SWEEP CIRCUITS: Recurrent: 1 cps to 50 kc, auto. retrace blanking. Driven: 20 μ s to 10⁶ μ s, auto. brightening.

INTERNAL SIGNAL CALIBRATOR • INPUT: 105-130 v, 50/60 cps, 600 watts. SIZE: 33" L x 26" W x 66" H—350 lbs.

Med. Gain Wide-Band Units available on special order.

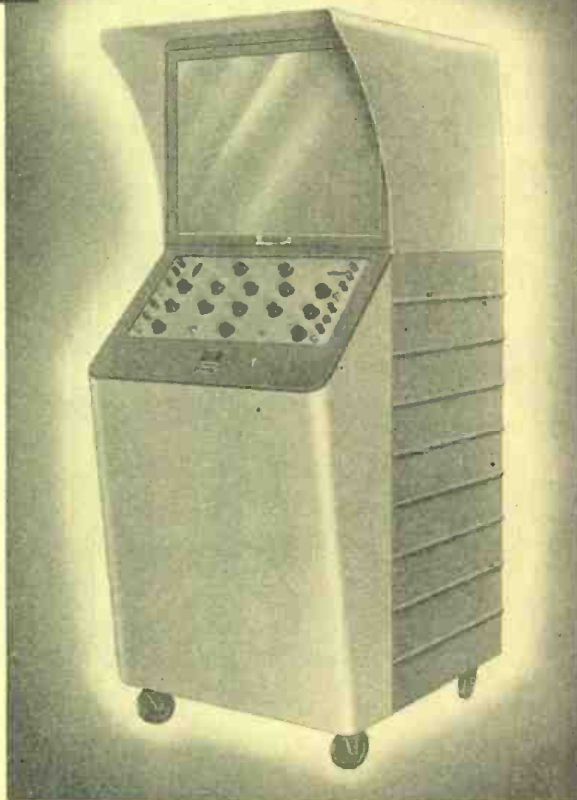

Here's the exact duplicate of the TEC Projection Oscilloscope developed for the U. S. Navy for mass electronics training. Makes waveforms brilliantly clear to groups as large as 750 persons! No more students hunching round a tiny image! No more mistaking what you mean!

WRITE
FOR
CATALOG
SHEET RE-B



TELEVISION EQUIPMENT CORP.
238 WILLIAM ST., NEW YORK 7, N. Y.
IN CANADA THE AHEARN & SOPER CO. LTD. OTTAWA

Personals



C. A. HAINES, formerly general manager of the Photo-flash Division of *Sylvania Electric Products Inc.*, is now general manager of operations for the Radio Tube Div. and the Television Picture Tube Div. Mr. Haines joined the factory engineering staff of *Sylvania* in 1929 and served as superintendent of their Salem radio tube plant and as general manufacturing manager of proximity fuse tube operations during World War II.



JOHN H. HOWARD, a consultant in the field of electronic control systems, has joined the staff of the Research Division of the *Burroughs Adding Machine Company* in Philadelphia. Following service with the U.S. Navy, Mr. Howard was appointed Director of Development at *Engineering Research Associates* and was later associated with the *Sperry Gyroscope Company*. He is a member of the AIEE and the Institute of Radio Engineers.



DR. R. G. E. HUTTER, head of the electronics research section of the Physics Laboratory, *Sylvania Electric Products Inc.*, has been appointed adjunct professor at the Brooklyn Polytechnic Institute where he will conduct classes in electron tube theory and electron optics. Dr. Hutter, a native of Berlin, Germany, served several years as a research physicist in the *Telefunken* transmitter laboratories and has been associated with *Sylvania* since 1944.



PHILIPS B. PATTON has been named Manager of the Sales Engineering Department of *Lenkurt Electric Co., Inc.*, San Carlos, California. Before joining the company as field engineer, Mr. Patton was chief of FCC's Radio Telephone-Telegraph Section, Common Carrier branch; flight radio officer with *Pan American World Airways*; a field engineer and technical coordinator with *Farnsworth Mobile Radio*; and was associated with *Western Union Telegraph Co.*



BENJAMIN SAMPSON has been appointed General Sales Manager of the *K. H. Huppert Company*, Chicago. Mr. Sampson was formerly District Sales Manager of the Stewart Div. of the *Sunbeam Corp.*, and recently Manager of the Industrial Furnace and Oven Div. of the *Claud S. Gordon Company*. Plans are under way to expand the Industrial Furnace Div. to meet the demand of their special applications on industrial furnaces, ovens, and ceramic kilns.



DR. LAURISTON S. TAYLOR, Chief of the Radiation Physics Laboratory of the National Bureau of Standards, delivered the Sylvanus Thompson Memorial Lecture before the meeting of the British Institute of Radiology recently. The first American scientist to receive this honor since the lectures were begun in 1916, Dr. Taylor is an internationally known authority on x-rays and has contributed extensively to scientific journals in the field of radiology.

Microwave Measurements

(Continued from page 20A)

acts to keep water within its section, has an effective length of a quarter of a wavelength and a dielectric constant such that it acts as a quarter-wave transformer. It should be noted that in this setup matching is effected at one frequency only, with no provision for tuning to other frequencies.

Water calorimeters are useful only for measuring fairly large powers. Their operation is sluggish and heat losses are such as to prohibit their use for power smaller than a few watts. For larger powers, however, water loads may serve as very reliable power standards.

For the measurement of radio-frequency power in the range from 1 microwatt to several milliwatts, bolometer type instruments are usually used. The bolometer employs the characteristics of some conductors whose resistance varies as a function of power absorbed. This variation in resistance can be measured by bridge circuits and indicates the magnitude of power flow.

Bolometer elements, such as the thermistor, are manufactured by a number of companies and are usually contained within glass enclosures. As in other instruments described in this article an important problem in this equipment is effecting a match between generator and bolometer element. Matching at one frequency is relatively simple, but over a range of frequencies becomes more complex.

Fig. 10 shows a tunable mount which matches a 50-ohm line to a 200-ohm bolometer from 1000 to 4000 megacycles. This circuit uses a double stub tuner and employs the bolometer as the center conductor of the output connector. The r.f. power is fed across the input and the output operates into a bridge circuit.

Many types of bridge circuits can be used to determine bolometer resistance. It should be noted that if the bolometer element is allowed to vary in resistance appreciably, due to the absorption of r.f. power, the match between generator and this element may be affected. A circuit which overcomes this problem is shown in simplified block diagram form in Fig. 9. This circuit consists of a self-balancing bridge, with a bolometer as one of its arms, and a audio voltmeter. A high-gain amplifier is connected across the bridge as a detector and the output of this amplifier is fed back as a driving source for the bridge. This circuit will oscillate to maintain the bridge balanced and the design is such that bridge balance occurs when bolometer resistance is 200 ohms. The amplitude of oscillation is, therefore,

such as to obtain a 200-ohm bolometer resistance. The frequency of the oscillator is determined by the bridge circuit and is a convenient audio frequency.

When r.f. power is applied through the bolometer element its resistance tends to increase and, to maintain bridge balance, the amplitude of the oscillator decreases so that the power flowing through this element remains the same. The reduction of audio power is equal to r.f. power, and hence an audio voltmeter (zero set for r.f. power) can be calibrated in terms of r.f. power. It should be noted that in this system the bolometer element has a 200 ohm impedance at all times and hence the proper matching is assured. An accuracy within 5 per-cent can be effected with this circuit.

BIBLIOGRAPHY

1. Racker, J., "Microwave Techniques", RADIO-ELECTRONIC ENGINEERING, February, 1950.
 2. Racker, J., "Microwave Transmission Lines", RADIO-ELECTRONIC ENGINEERING, March, 1950.
 3. Racker, J., "Microwave Components", RADIO-ELECTRONIC ENGINEERING, April, 1950.
 4. Racker, J., "Microwave Transmitters", RADIO-ELECTRONIC ENGINEERING, May-June, 1950.
 5. Racker, J., "Microwave Receivers", RADIO-ELECTRONIC ENGINEERING, July-August, 1950.
 6. Racker, J., "Microwave Antennas", RADIO-ELECTRONIC ENGINEERING, Sept., 1950.
 7. Racker, J., "Microwave Propagation and Site Planning", RADIO-ELECTRONIC ENGINEERING, Nov., 1950.
 8. Montgomery, C. G., "Techniques of Microwave Measurements", McGraw-Hill Book Company, 1947, pp. 478 to 496.
 9. Gaffney, F. J., "Microwave Measurements and Test Equipments", Proc. IRE, Oct., 1946.
- (To be continued)

Potted Circuits

(Continued from page 8A)

to eight per-cent in the setting process. However, the great bulk of this shrinkage takes place at an early gel stage, when the material is still quite soft, and no undue pressures are therefore exerted on the components embedded.

On the other hand, these materials have a greater coefficient of thermal expansion than most of the metals and glass usually enclosed in them. No difficulty is experienced at higher than normal temperature operation from this effect. When low temperature operation is to be experienced—temperatures below about minus 30 degrees Centigrade—special treatment of the circuit to be embedded is required. Equipment has been successfully operated at temperatures as low as minus 85 degrees C.

Silicone plastics, such as *Dow-Corning Silastic 181*, remain flexible at extreme temperatures and make suitable cushions when placed between the circuit and the plastic which surrounds it. The Silastic is dispersed in a solvent so that the circuit to be protected can be dipped in it. Several dips are required, with treatment in an oven after each dip to drive off the volatile material and vulcanize the Silastic.

Unless the Silastic is vulcanized, trouble may be experienced. Under the heat of operation of the tubes embedded

in the plastic, it will undergo the vulcanization process, liberating certain materials. This results in the development of a pressure within the casting which may result in fissures.

The photographs accompanying this article show some of the applications to which the casting resin has been put at the Navy Electronics Laboratory. A large number of cylindrical sub-assemblies one inch in diameter and two to two and one-half inches long have been made. These contain single stages or at most two stages, such as multivibrators, oscillators, amplifiers, modulators, etc., as complete units.

It will be noted that no chassis as such has been used in any of these units. Leads are necessarily short and as a result the circuits are normally sufficiently self-supporting to get them embedded in the plastic before something happens. Most of those illustrated use a seven or a nine pin miniature base in order to plug into the corresponding socket. However, any type of connection means may be used which is desirable for the application in mind. Circuits are wired in a jig which holds the plug pins in position and the components built up by point-to-point wiring.

Also illustrated is a superheterodyne receiver containing six tubes and cast as a unit. This particular receiver covers the standard broadcast band and was built as a "propaganda" unit to prove to some skeptics that the things would continue to operate after being potted. It is not intended as a representative design, either electrically or mechanically, for military applications. It has, nevertheless, created considerable interest. The speaker and power supply are enclosed in the base into which the receiver plugs. The power supply uses a selenium rectifier which is also potted for protection.

The formulation and processing of NEL-177 Casting Resin are fully covered by a patent disclosure in the name of Mr. Edward Rolle, NEL chemist, who is chiefly responsible for the development of the materials and processes involved. The details of these may be obtained for use by firms legitimately involved in production for Government use which requires the use of such compounds.

Others who contributed to the program are: Messrs. J. C. McAdam, A. T. Steinkamp and J. R. Potthoff, who did the bulk of the circuit work; Mr. R. J. Violette, who developed the molds and did a large amount of the actual casting; Mr. A. H. Attebery, whose assistance in selection and procurement of suitable components was extremely valuable; and last but not least, Mr. E. B. Robinson, whose foresight started the whole program. ~@~

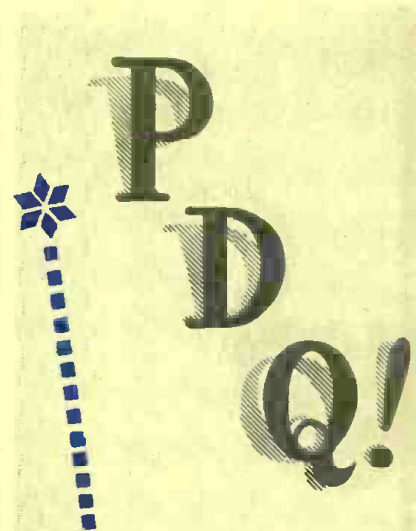

Shown:
Bliley type TCO-1
Crystal Oven with
Bliley type BHS
crystal



PRECISION...

DEVELOPMENT... QUALITY!

When the end use is military...
Bliley crystals are combat veterans.
Military specifications demand precision... development... quality.
These factors are basic with Bliley—the top choice for 20 years.

Bliley
CRYSTALS

BLILEY ELECTRIC COMPANY
UNION STATION BUILDING
ERIE, PENNSYLVANIA

TECHNICAL BOOKS

"SURVEY OF MODERN ELECTRONICS" by Paul G. Andres, Associate Prof. Electrical Engineering, Illinois Institute of Technology. Published by *John Wiley & Sons, Inc.*, 440 Fourth Ave., New York 16, N. Y. 522 pages. \$5.75.

This is a textbook for a short course in electronics based on lectures and classroom notes from a course given to mechanical, chemical, and industrial engineering students to familiarize them with the basic principles of construction, operation, and application of electron tubes.

It explains the fundamentals of electronics and provides a summary of applications. The material is treated in a descriptive manner rather than mathematical, and the description of nearly every tube is followed by one or more practical applications. Final chapters review applications of electronics in instrumentation, communication, control, and heating, and offer practice in reading circuit diagrams.

General references in the appendix and specific references and problems at the end of each chapter are given for additional study. Data, circuits, and illustrations are also included.

"ANTENNAS" by John D. Kraus, Prof. Electrical Engineering, The Ohio State University. Published by *The McGraw-Hill Book Co.*, 330 West 42nd St., New York 18, N. Y. 553 pages. \$8.00.

Here is a clear, systematic treatment of basic antenna theory and its applications to a great number of antenna systems, compiled from lectures given in recent years by the author in a course on antennas at Ohio State.

The text presents a unified treatment of antennas from the electromagnetic theory point of view with stress upon those aspects which are of engineering importance. The principles given are basic and are applied to antennas for all frequency ranges. Some of the material is published here for the first time, particularly portions of the treatment on point sources and on helical antennas. Recent advances in the field are described, and problem sets are included at the end of each chapter. The rationalized mks system is employed and a complete table of units in this system is included in the Appendix.

Although primarily written to serve as a textbook, it is hoped that practicing engineers and scientists will find it a valuable reference book.

Miniaturization

(Continued from page 11A)

terioration were also promised.

Next, the general problem of insulation was considered. The hotter a transformer is run, the smaller can be its size. However, the usual organic material used to insulate wire, and the insulating tapes used for start, interlayer and finish wraps, will carbonize if they are pushed beyond their safe high temperature limits.

Thus, an inorganic insulated wire and an inorganic paper for the insulating tape were chosen. The former is a wire coated with a ceramic material. The latter is composed of asbestos with a binder, and is available in sheet or tape form, in a variety of widths, and in thicknesses down to 0.003". Its ability to withstand heat without disintegration is unusual. A few thousandths of asbestos paper is sufficient to stop the passage of the direct flame of a blow torch. Finally, as an impregnant, a silicone varnish was picked for its inorganic composition and relative ease of production use.

It was found that interlayer insulation in many instances was unnecessary. Where possible, random winding was used—that is—machine-winding without interlayer insulation. This meant, of course, that the potential between the two adjacent layers was the difference between the potential of the first turn of the first layer and the last turn of the next layer. This potential is usually a matter of only a few volts and, if the coil is properly impregnated, sufficient insulation appears to exist. Inter-winding insulation of asbestos paper was always provided.

When impregnation was first considered, a material was sought which would act as impregnant, seal and outer shell. However, no such material was found which could qualify, as available impregnants were not true hermetic seals. Furthermore, it was calculated that if a dipped seal was used, the weight of the seal would be greater than the weight of a conventional brass can.

The use of a silicone varnish as an impregnant consists of first driving off the moisture in the coil and then subjecting it to a series of impregnation and bake cycles. The impregnant fills in the spaces between the wires, seals the coil and allows maximum heat transfer.

Military requirements usually call for hermetically sealed transformers and chokes. As previously stated, this is normally done by using a solder-sealed brass or copper can in which the transformer is mounted and held in place by an impregnant fill or compound commonly known as "gunk".

Our survey started with the knowledge that the specific gravity of copper is 8.91 as compared with 2.7 for aluminum. Heretofore, aluminum could not be used for cans because of the difficulty of solder-sealing. Iron or zinc with 7.85 and 7.1 specific gravities respectively showed little weight advantage. Magnesium, with a 1.8 specific gravity, could not be obtained in comparable wall thicknesses. It appeared that aluminum was the desired material if some process could be evolved for solder-sealing it.

Aluminum-plating techniques were developed whereby the fabricated can parts could be plated with copper or nickel. This resulted in a can which could be soldered readily, yet gave a 70% reduction in weight.

Early in the development of the plated aluminum, some discussion arose over the possibility of electrolysis developing between the base aluminum and the copper plating (due to their removed position in the electromotive series). However, extended tests indicate that, when the developed plating process is followed, this condition is not existent in practice. Plated strips of aluminum have been subjected to 500 hours of salt-spray without deleterious effects.

The use of a compound or "gunk," which anchors the transformer in the can and conducts heat from the transformer to the can, has been the standard practice for some years. However, the weight of the compound often approached the weight of the transformer and can. By using an alternative method, we accomplished the same result at a saving in weight and cost.

This we did by mounting the transformer with special aluminum braces, evacuating the can, re-filling the can with a non-explosive, non-inflammable gas and sealing off the can against leakage.

For transformer terminals, the small glass bead type was used. They withstand applied voltages and exhibit no leakage between can and terminal stem so long as the glass bead does not become cracked in assembly.

As a final illustration of what has been done in transformer miniaturization with newer materials and techniques, Fig. 5 illustrates a 400-cycle 115-volt excitation transformer which delivers 4.2 watts at 24.25 volts into a resistive load with an efficiency of 73.9%. It can deliver 7.06 watts into a resistive load with an efficiency of 62%. Yet, this hermetically-sealed transformer measures 1 1/4" x 3/4" x 1/2" and weighs only *one ounce!* Compare this with a previous comparable design which occupies approximately 900% more space and weighs approximately 10 times as much.

The use of subminiature tubes (as shown in the assembly illustrated in Fig. 1) allows the designer to utilize better the space available. Newer and more compact condensers save much additional weight and space. The failure of electrolytic condensers to hold capacity at low ambient temperatures (such as -55 degrees C.) results in the forced use of paper and mica types. Thus, a 30% to 50% saving in weight and size of paper condensers used in a power supply filter circuit can mean an appreciable saving in total size and weight of the complete electronic system.

The Scotch saying, "Many a mickle makes a muckle" aptly describes the process of miniaturization. A fraction of an ounce saved and multiplied many times means pounds saved in the final electronic equipment. However, this process can not be accomplished overnight. It is a slow, painstaking inching forward requiring the best of laboratory equipment and personnel working as a team to advance the cause of science and to provide our military with the very best in operational equipment—modern as tomorrow.

Millivolt Chopper

(Continued from page 14A)

modulator, while the supply was approximately 12-25 volts. A *Sylvania* 1N42 Varistor was employed as the modulator. The carrier voltage was supplied through an isolation transformer so as to not introduce capacitively unbalanced line frequency signals into the oscilloscope.

The output of the electronic chopper may be connected into an oscilloscope or amplifier. In the typical circuits illustrated, input into a schematic tube is shown. Tube biasing was not shown, as this may depend on a number of variables. No biasing at all may be required with a high mu tube with low plate potential; while fixed bias, where bias is required, will give higher gain than cathode bias due to elimination of negative regeneration from the cathode circuit. The total amplifier gain required will depend on the operating conditions of input signal available and output signal required.

The amplified d.c. signal may be read or indicated four ways. Visual observation of an oscilloscope, a.c. output of the amplifier measured, or the a.c. output rectified into d.c., any residual (or hash) signal balanced out and the differential read on a d.c. meter. The fourth method and possibly one of the best is the use of an automatic potentiometer circuit. Here the amplified signal is used to turn a potentiometer arm and balance out the d.c. input signal. The potentiometer arm position is

then read in terms of d.c. input (the voltage across the potentiometer is standardized) and any amplifier or chopper gain variation affects the accuracy of reading only to a small percentage of the total accuracy.

The *Dumont* 274 oscilloscope used by the author in these experiments was not a standard instrument. Its gain had been increased by the addition of a cascade 6J7 and it compared in gain with the *Dumont* 208B and other higher priced instruments. With full gain and some unbalance carrier appearing on the screen, the output signal level was sufficient to cause about a one- to two-inch variation in trace. The chopper efficiency was not established, but was 50% or lower; therefore the input signal did not exceed 25 millivolts.

REFERENCES

1. *Freedman, Samuel*, "D. C. Amplifier of Improved Stability". *RADIO-ELECTRONIC ENGINEERING*, April, 1950.

New Products

(Continued from page 25A)

are accelerated and form ions which are in turn accelerated in a space where crossed magnetic and r. f. electric fields are maintained. In these crossed fields, ions describe spiral paths. Those ions with the proper mass to resonate with the crossed fields will gain energy and describe larger and larger orbits until they reach the collector and are measured.

Approximately 150 volts d.c. and r.f. voltages of about 1 volt at frequencies up to 5 megacycles are employed. The filament utilizes 5 amperes at 15 watts.

NOISE GENERATORS

A series of random noise generators designed to produce a known output noise in the frequency range of 2600 to



12,400 mc. has been announced by *The Kay Electric Co.*, Maple Ave., Pine Brook, N. J.

Designated Microwave Mega-Nodes, they are a group of five separate noise sources, each utilizing a standard commercial fluorescent lamp in a JAN size wave guide, each mounted on a hardwood stand. A separate cabinet houses the power supply for the noise sources.

The following wave guide sizes are available: RG48/U, RG49/U, RG50/U, RG51/U, and RG52/U. Noise output is 15.84 db. above thermal noise at a wave guide temperature of 32° C.

Here are a couple of **GOOD LEADS**

—another advantage of using

PRECISION Coil BOBBINS

The lug-type terminal leads you can specify for the flanges of Precision Coil Bobbins allow faster, more trouble-free connecting than open-wire leads. Entire bobbin is impregnated to meet Underwriters' standards. We can give you flanges with leads (as above), with slots, holes, or plain—and all types can be furnished flat, recessed, or embossed—to fit any mounting. Tube ends swaged to lock flanges in place. Spiral-wound cores, heat-treated under compression, provide greater strength with less weight. Insulation strips are unnecessary—permitting closer winding, more compact coils.

Let us help you with bobbins designed to fit YOUR particular product!

Any shape, any size . . . round, square, rectangular . . . in dielectric Kraft, Fish Paper, Cellulose Acetate, or combinations. Let us make up a free sample for you NOW!

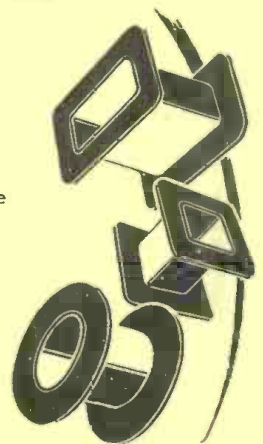

PRECISION PAPER TUBE CO.

Also Mfr's of Precision Di-formed Paper Tubes
2063 W. CHARLESTON ST., CHICAGO 47, ILL.
Plant #2, 79 Chapel St., Hartford, Conn.

Radio-Electronic Engineering-1950

Index to Volumes 14 & 15

ANTENNAS	
Automatic Antenna Pattern Recorder (Gerwin).....	14 Jan.
Automatic Antenna Pattern Recorder (Freedman).....	10 June
Microwave Antennas (Racker)...	15A Oct.
AUDIO	
An Improved Audio Amplifier (Fritze & Goodell).....	7A Nov.
Custom Sound Installation (Shapiro)	3 May
Design of Acoustic Systems by Electromechanical Analogies (Part I) (Fidelman).....	15 July
Design of Acoustic Systems by Electromechanical Analogies (Part II) (Fidelman).....	12A Aug.
Graphical Determination of Non-linear Distortion (Chatterjee & Felt).....	10A Nov.
Measurement of Studio and Room Acoustics (Part I) (Fidelman)...	16 Jan.
Measurement of Studio and Room Acoustics (Part II) (Fidelman)...	14 Feb.
Synthetic Reverberation (Fidelman)	3A Nov.
BOOK REVIEW	
Acoustic Measurements (Beranek)	28 Jan.
Acoustical Designing In Architecture (Knudsen & Harris).....	28 May
Advances In Electronics (Marton)	28 May
An Index of Nomograms (Adams)	29A Aug.
Antennas (Kraus).....	28A Dec.
Communication Circuit Fundamentals (Smith).....	28 Apr.
Dissociation Energies (Gaydon)...	29A Oct.
Electrical Communication (Albert)	30A Nov.
Electrical Engineers Handbook (Vol. I) (Pender & Del Mar)...	28 Jan.
Electromagnetic Theory (Heaviside)	29A Oct.
Electron-Tube Circuits (Seely)...	28 Apr.
Electronic Engineering Master Index, The.....	28A Sept.
Electronic Principles and Applications (Wright).....	28 June
Electronics Manual for Radio Engineers (Zeluff & Markus).....	26 Feb.
Frequency Modulated Radar (Luck)	26 Feb.
Fundamentals of Radio-Valve Technique (Deketh).....	26 Feb.
Ocean Electronic Navigational Aids (U. S. Coast Guard).....	28A Sept.
Pulses and Transients In Communication Circuits (Cherry)...	28 June
Questions and Answers In Television Engineering (Rabinoff & Wolbrecht).....	28 July
Radar Systems and Components (Bell Telephone Labs).....	26 Feb.
Radio Engineering Handbook (4th Edition) (Henney).....	30A Nov.
Radio-Frequency Heating Equipment (Langton).....	29 Mar.
Short-Wave Radio and the Ionosphere (Bennington).....	28 July
Survey of Modern Electronics (Andres).....	28A Dec.
Terrestrial Radio Waves (Bremmer)	29 Mar.
Transient Performance of Electric Power Systems (Rudenberg)....	29A Aug.
FM	
FM In the Power Industry (Ohlinger)	3 June
MEASUREMENTS	
Microwave Measurements (Part I) (Racker).....	15A Dec.

3-Probe Method of Impedance Measurement (Phillips).....	9A Dec.
---	---------

MICROWAVES

400 Mc. Performance of Type 5840 Pentode (Ritchey).....	6A Aug.
Helical Coils as Transmission Lines and Radiators (Freedman)	6 July
Microwave Antennas (Racker)....	15A Oct.
Microwave Components (Racker)	7 Apr.
Microwave Directional Couplers (Freedman).....	11 Feb.
Microwave Measurements (Part I) (Racker).....	15A Dec.
Microwave Propagation and Site Planning (Racker).....	16A Nov.
Microwave Receivers (Part I) (Racker).....	3 July
Microwave Receivers (Part II) (Racker).....	15A Aug.
Microwave Standing Wave Detectors (Freedman).....	3 Mar.
Microwave Techniques (Racker)...	3 Feb.
Microwave Transmission Lines (Racker).....	14 Mar.
Microwave Transmitters (Part I) (Racker).....	6 May
Microwave Transmitters (Part II) (Racker).....	13 June
Surface Wave Transmission Line (Goubau).....	10 May
V.H.F. Tank Design (Parker).....	8 Jan.

MISCELLANEOUS

Crystal Oscillator Plates for H.F. Use.....	7 Feb.
Design Features of A New Photocell (Crow & Rideout).....	8 Feb.
Electron-Optical Mapping in A Magnetron.....	22A Aug.
Electronic Fluorescence Detector-Comparator (Weeks).....	10A Oct.
Electronically Driven Ripple-Tank (Schooley).....	6 June
Forced Air Cooling for Electronic Equipment (Parker).....	12 Apr.
Loading Quartz Crystals.....	9 June
Magnetic Powder Clutch Servo (Wald).....	12A Sept.
Miniaturization of Electronic Equipment (Milbourne).....	10A Dec.
Nonmagnetic Mass Spectrometer	15A Nov.
Oscillographic Strain Gauge Recording (Kaufman).....	15A Sept.
Potted Electronic Circuits (Bryan)...	6A Dec.
Power Line Carrier (Alchuk)....	3A Aug.
P.T.A. (Phase to Amplitude) Modulation.....	20 July
Radio Navigation Equipment (Part I) (Griffin).....	3A Sept.
Radio Navigation Equipment (Part II) (Griffin).....	11A Oct.
Strain Gauge Link (Kaufman)....	7 Mar.
Strain Gauge Load Rings (Kaufman).....	9A Aug.
Stress and Strain Determination (Kaufman).....	11A Nov.
The Auto-Semby Technique.....	11A Sept.

NOMOGRAPHS

Characteristic Impedance of Lines	32 Apr.
Circular Wave Guide Attenuation.....	32 July

Circular Wave Guide Cut-Off Frequency.....	32 June
Length of Transmission Line.....	32 Feb.
Off-Resonance Phase Shift (Young)	32A Sept.
Off-Resonance Response-Large Deviation (Young).....	32A Oct.
Off-Resonance Response-Small Deviation (Young).....	32A Nov.
Sending End Impedance of Uniform Line.....	32 Jan.
Square Wave Guide Attenuation.	32A Aug.
TE ₀₁ Waves in Rectangular Wave Guides.....	32 Mar.
Quarter-Wave Matching Section..	32 May

R.F. HEATING

Electrodes for H.F. Heating (Whiteman).....	3A Dec.
Work-Coils for H.F. Heating (Whiteman).....	3A Oct.

SPECIAL CIRCUITS

A Compact Geiger Counter (Ives)	10 July
A New R-C Oscillator Circuit (Crothers).....	12 May
An Amplifier for Magnetic Oscillographs (Tirk).....	7A Oct.
Bridge-Balanced D.C. Amplifier (Korn & Korn).....	12 Jan.
Crystal Savers (Bryan).....	12 Mar.
Curve Generator for Electron Tubes.....	9 July
D.C. Amplifier of Improved Stability (Freedman).....	10 Apr.
Electronic D.C. Millivolt Chopper (Kaufman).....	12A Dec.
Fluid Velocity Measurement and Control (Bennett).....	10 Feb.
Frequency Dividers (Bryan).....	7 June
High Impedance D.C. Voltmeters (Kaufman).....	7 Jan.
Improved R.F. Capacitometer (Travis & Wilson).....	12 July
Klystron Power Supply and Square Wave Modulator (Freedman).....	3 Jan.
Magnetic Flux Comparator (Kaufman).....	20 Mar.
Multiple Channel Cathode-Ray Instrumentation (VanScoyoc & Warnke).....	3 Apr.
The Monoformer (Munster).....	8A Oct.
Variable Pulse Width Voltage Calibrator (Baer).....	8A Sept.

TV

Wide-Band Chain Amplifier for TV (Tyminski).....	14 Apr.
TV Impulse Interference Generator (Fogarty).....	6A Sept.
U.H.F. TV Converter Design (Simopoulos).....	10 Mar.
U.H.F. TV for Areas Not Served by V.H.F. TV (Popkin-Clurman)...	14A Sept.
Video Amplifier Design (Moses)...	15 May

TUBES

Curve Generator for Electron Tubes.....	9 July
Rugged Electron Tube Development.....	10 Jan.



PHOTO CREDITS

Pages	Credit
3A, 4A, 5A.....	Sherman Industrial Electronics Co.
6A, 7A, 8A..	U. S. Navy Electronics Lab.
15A, 18A, 20A.	Hewlett-Packard Co.

News Briefs

(Continued from page 23A)

photocells are of three types: the photo-resistance cell, able to produce electric signals at least as great as 25 volts when a light shining on the cell is interrupted or modulated; the photoconductance cell, having a large current response for operating a relay directly in applications such as alarms and door openers; and the photovoltaic cell, similar to a tiny battery but having the peculiar property of supplying a voltage in proportion to the amount of light shining on the germanium.



3-Probe Method

(Continued from page 9A)

$$\frac{E_1}{E_2} = -j \frac{Z_R}{Z_0}; \frac{E_2}{E_3} = \frac{1}{\sqrt{2}} \left(1 - j \frac{Z_R}{Z_0} \right) \quad (5)$$

Substituting for Z_R/Z_0 its value $(R/Z_0) + j(X/Z_0)$, these are:

$$\frac{R}{Z_0} + j \frac{X}{Z_0} = j \frac{E_1}{E_2} \quad (6)$$

$$\frac{R}{Z_0} + j \left(\frac{X}{Z_0} + 1 \right) = j \sqrt{2} \frac{E_2}{E_3} \quad (7)$$

It is seen that these two equations, when the moduli are squared,

$$\left(\frac{R}{Z_0} \right)^2 + \left(\frac{X}{Z_0} \right)^2 = \left(\frac{E_1}{E_2} \right)^2 \quad (8)$$

$$\left(\frac{R}{Z_0} \right)^2 + \left(\frac{X}{Z_0} - [-1] \right)^2 = \left(\sqrt{2} \frac{E_2}{E_3} \right)^2 \quad (9)$$

define two circle families; a family of circles centered at (0, 0) with radii of E_1/E_2 , and a family of circles centered at (0, -1) with radii of $\sqrt{2}(E_2/E_3)$. These are plotted in Fig. 1. The intersection of any two of these circles defines normalized impedance uniquely, and additionally, if so desired, the voltage standing-wave ratio.

For practical use, however, a chart in a form other than this is to be preferred. The present map extends to infinity in three directions. These infinite boundaries can be collapsed into a single point if the coordinates are distorted according to the bilinear transformation:

$$\frac{W}{Z_0} = \frac{1 + Z/Z_0}{1 - Z/Z_0} \quad (10)$$

This particular complex-plane transformation can be employed to produce either the Smith Chart ("Transmission Line Calculator," *Electronics*, January 1939; "An Improved Transmission Line Calculator," *Electronics*, January 1944, both written by Phillip H. Smith) or the Carter Chart ("Charts For Transmission-Line Measurements and Computation" by P. S. Carter, *RCA Review*, January 1939).

At the outset, the circle family defined by:

$$\left(\frac{R}{Z_0} \right)^2 + \left(\frac{X}{Z_0} \right)^2 = \left(\frac{E_1}{E_2} \right)^2$$

$$\text{or } \left| \frac{Z_R}{Z_0} \right| = \left| \frac{E_1}{E_2} \right| \quad (11)$$

is seen to be identical with the modulus of the Carter Chart, Z_R/Z_0 , and so it can be transformed into the new W/Z_0 by:

$$\left(\frac{R}{Z_0} - \frac{(E_1/E_2)^2 + 1}{(E_1/E_2)^2 - 1} \right)^2 + \left(\frac{X}{Z_0} \right)^2 = \left(\frac{2 E_1/E_2}{(E_1/E_2)^2 - 1} \right)^2 \quad (12)$$

It is difficult to so treat the other circle family. However, since these circles can easily be drawn graphically in the original Z/Z_0 , and since the coordinates are transformed conformally in the Smith Chart, a point-for-point plot enables this latter family to be carried over to the new W/Z_0 plane. These circle families are shown on P. 32A.

Aside from the drafting error in the construction of this map, P. 32A, an additional inaccuracy lies in the fact that, in some regions of this map, the intersecting circles are not orthogonal. Thus, in these regions, it is difficult to obtain a clear-cut "fix." As examples of this, it will be noted that the voltage ratios of .8 and .5 for E_1/E_2 and E_2/E_3 , respectively, intersect nearly at right angles, and, so, a definite value of impedance can be obtained if this chart is used as an overlay for either the Smith- or the Carter-Chart, with which charts this one has a one-to-one interior correspondence. On the other hand, ratios of 1.3 and 1.6 for E_1/E_2 and E_2/E_3 , respectively, intersect at such an acute angle that any chosen impedance value would be rather doubtful. This fault of interpretation is not caused by the transformation, since the transformation is conformal, but lies, rather, in the setup of the original chart, Fig. 1.

However, this new map has several advantages. In common with both the Smith- and Carter-Charts, the entire right-hand half of the infinite plane is contained within the bounding circle, which contains all impedance values within the range $(0 < R/Z_0 < \infty)$, $(-\infty < X/Z_0 < \infty)$. Again, in common with these charts, the circles of constant VSWR are concentric with the center of the chart. In this connection, the arm shown in the figure may be pivoted at the center, or a circle family in contrasting color may be drawn using the chart center and a radius equal to E_1/E_2 , equal to 1.1, 1.2, 1.3, 1.4, Thus, ratios of 1.4 and .7 for E_1/E_2 and E_2/E_3 , respectively, indicate a VSWR of 2.6.



ZOPHAR



WAXES COMPOUNDS and EMULSIONS

FOR
INSULATING and WATERPROOFING
of ELECTRICAL and
RADIO COMPONENTS

Also for
CONTAINERS and PAPER
IMPREGNATION

FUNGUS RESISTANT WAXES

ZOPHAR WAXES and COMPOUNDS
Meet all army and navy
specifications if required

Inquiries Invited

ZOPHAR MILLS, INC.

FOUNDED 1846

122-26th ST., BROOKLYN, N. Y.

HAVE YOU A JOB FOR A TRAINED TECHNICIAN?

We have a number of alert young men who have completed intensive training in Radio and Television Repairing. They learned their trades thoroughly by working on actual equipment under personal, expert supervision.

If you need a trained man, we invite you to write for an outline of our course, and for a prospectus of the graduate. No fees, of course. Address:

Placement Manager, Dept. P-106-12
COMMERCIAL TRADES INSTITUTE
1400 Greenleaf Chicago 26

WANTED

ENGINEER — to head up Electronics Department. Must be able to attract as well as execute business in this field. Experience and good standing with Government customers essential. Excellent growth opportunity. Write Chief Engineer, Kellett Aircraft Corp., Central Airport, Camden, N. J.

SPEND YOUR \$\$\$ SECURITY!

How you spend what you make is more important than how much you make! How you manage income; control household, personal expenses; organize spending and saving determines degree of your financial peace of mind. The "KWIK-GLANCE" simplified method of keeping track of income and outgo has happily solved money problems for 100,000 users. A year's service in one volume, \$1.25 complete. Write for FREE descriptive folder. **NAV PUBLISHING COMPANY**
537-C 56. DEARBORN CHICAGO 5, ILL.

When answering Advertisements Please mention
R.E.E. section of
RADIO & TELEVISION NEWS

3-PROBE IMPEDANCE MEASUREMENT CHART

A chart for determining load impedance from voltage readings taken from three fixed probes spaced $\frac{1}{8}$ wavelength apart.

(See page 9A)

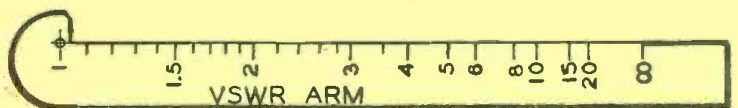
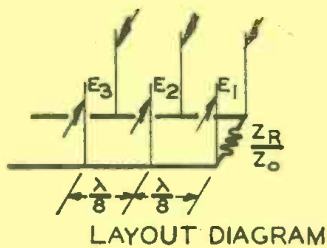
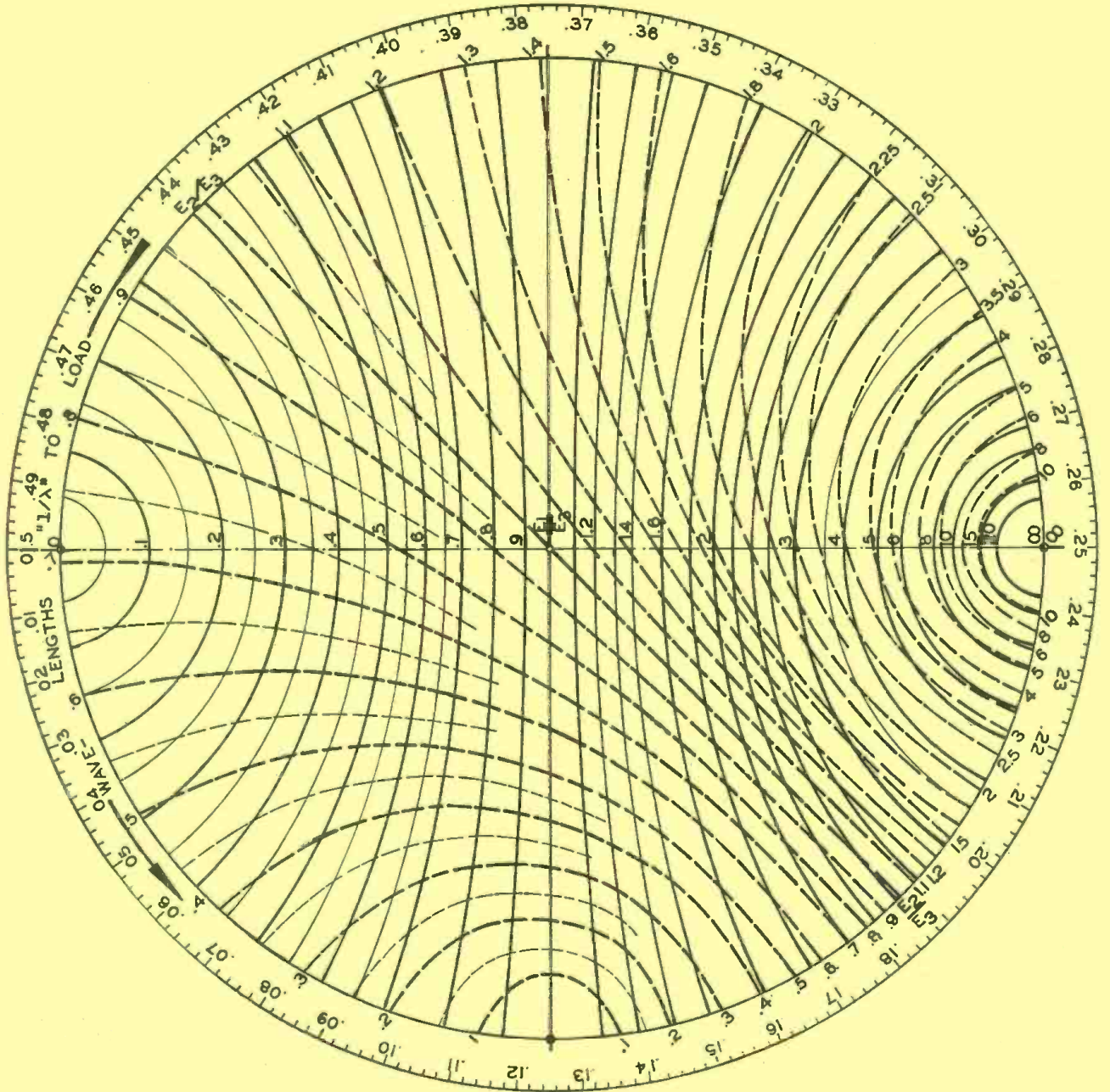



Train at Home in Spare Time for **RADIO** and **TELEVISION**

**I Send You
18 BIG
KITS
OF RADIO-
TELEVISION
EQUIPMENT**



**My Famous Training System Prepares
You in Double-Quick Time for a Good
Job or Your Own Profitable Radio-
Television Business**

Radio-Television is now America's greatest opportunity field. Trained men are needed to fill good jobs and handle profitable Radio-Television Service work. I have trained hundreds of men for success in Radio-Television—and I stand ready to Train you too, even if you have no previous experience. My training is 100% practical—designed to give you the knowledge and experience you need to make money in Radio-Television in the shortest possible time. I Train you with up-to-the-second revised lessons—PLUS many big kits of Radio-Television equipment. You actually do over 300 demonstrations, experiments and construction projects. In addition, you build a powerful 6-tube 2-band radio, a multi-range test meter and a complete Television receiver! All equipment is **YOURS TO KEEP.**

EASY TO MAKE EXTRA MONEY WHILE YOU LEARN

You do all your training with me **AT HOME** in spare hours. Keep right on with your present job and income while learning—and earn extra cash besides! The day you enroll I begin sending you plans and ideas for doing profitable spare-time radio-TV work. Many of my Sprayberry students pay for their entire training this way! You get priceless experience and many plans for making extra money. You build all your own radio-TV Test Equipment from parts I send you—nothing else to buy. Just one more reason why I believe I offer the ambitious man the biggest value in top notch Radio-TV Training available anywhere in America today.

Be Ready for Top-Paying Radio-Television Jobs

Radio-Television is growing with amazing speed. More than 2000 Radio broadcasting stations PLUS an additional 102 Television stations are now on the air. Radio sets and TV receivers are being made and sold in record-breaking numbers. If you enjoy working with your hands . . . if you like to do interesting and varied work . . . if you really want to make good money and work in an industry that has a future . . . **YOU BELONG IN RADIO-TELEVISION.** But you **MUST** have good Training to "cash in" . . . the kind of Training that starts you out with basic fundamentals and carries you right through every circuit and problem of Radio-Television Servicing and Repair. In a word . . . that's Sprayberry Training . . . the course backed by more than 20 years of association with the Radio-Television industry!

FREE 3 BIG RADIO-TELEVISION BOOKS

I want you to have ALL the facts about my complete system of Radio-Television Training! Act now! Rush the coupon for my three big Radio-Television books: "How to Make Money in Radio-Television," PLUS my new Illustrated Television Bulletin PLUS an actual sample Sprayberry Lesson—all FREE with my compliments. No obligation and no salesman will call on you. Send the coupon in an envelope or paste on back of post card. I will rush all three books at once!

Sprayberry Academy of Radio, Dept. 25-R
111 North Canal St., Chicago 6, Ill.

**Mail
Coupon
Today!**
**NO OBLIGATION
No Salesman
Will Call**

**SPRAYBERRY ACADEMY OF RADIO, Dept. 25-R
111 North Canal St., Chicago 6, Ill.**

Please rush to me all information on your Radio-Television Training Plan. I understand this does not obligate me and that no salesman will call upon me.

Name..... Age.....
Address.....
City..... Zone..... State.....

Please Check Below About Your Experience
 Are You Experienced? No Experience

**VETERANS: My
Radio Training is
Approved for Vet-
erans.**

**IF YOU ARE EXPERIENCED
in Radio I'll qualify you for
Television in 4 to 8 weeks.
Rush coupon.**

Testing for sound lost between telephone receiver and ear. Many subjects were used in these tests.

How to compensate for a curl . . . and add to your telephone value



Bell scientists know that the telephone is not used under ideal laboratory conditions. There is never a perfect seal between receiver and user's ear. A curl may get in the way, or the hand relax a trifle. And ears come in many shapes and sizes. So some sound escapes.

Now, sound costs money. To deliver more of it to your ear means bigger wires, more amplifiers. So Bell Laboratories engineers, intent on a thrifty telephone plant, must know how much sound reaches the ear, how much leaks away. They mounted a narrow "sampling tube" on an ordinary

handset. The tube extended through the receiver cap into the ear canal. As sounds of many frequencies were sent through the receiver, the tube picked up a portion, and sent it through a condenser microphone to an amplifier. That sampling showed what the ear received.

As a result, Bell scientists can compensate in advance for sound losses—build receivers that give *enough* sound, yet with no waste. That makes telephone listening always easy and pleasant.

It's another example of the way Bell Telephone Laboratories work to keep your telephone service one of today's biggest bargains.



Automatic recorder plots sound pressures developed in the ear canal at different frequencies.

BELL TELEPHONE LABORATORIES



Working continually to keep your telephone service big in value and low in cost.

hallicrafters

"The Radio Man's Radio"



commands the world's airwaves!

In every price range, Hallicrafters offers precision instruments—to serve you better, and giving you more value for your investment than any other set.



Model SX-62 World's finest receiver for the all-wave listener. Outperforms any broadcast receiver on any frequency—continuous coverage from 540 kc to 109 Mc in six bands. Crystal calibration oscillator built in. Six position selectivity with crystal filter. Two stages r-f, three stages i-f amplification. 10-watt push-pull high fidelity output. Phonograph jack. 14 tubes plus regulator and rectifier.....\$289.50

Model SX-71 Value-packed with features specifically asked for by the Hams. Extra sensitivity, selectivity, and stability; double super-heterodyne, plus built-in Narrow Band FM. One r-f, two conversion, and three i-f stages. Range 538 kc to 35 Mc, 46-55 Mc. Extra wide dials for Main and Bondspread Tuning. Sensitivity, Volume, BFO Pitch, Selectivity, and Crystal Phasing controls; AVC, BFO, Rec./Standby, ANL, Tone, and Phono-Rec. switches. Phonograph input jack. 500, 3.2-ohm output.....\$199.50

Model S-77 New version of an old favorite. Temperature compensated oscillator; tuned r-f stage, two i-f stages for better selectivity. Covers 540 kc to 43 Mc in four bands. Sensitivity, volume, three-position Tone, BFO Pitch, controls; AVC, BFO, Rec./Standby, and Noise Limiter Switches. Built-in PM speaker. External power, remote control connections. 7 tubes plus rect. S-77.....\$99.95

Model S-388 Pulls in broadcast stations in weak signal areas where ordinary sets fail. Also offers world-wide reception for the short-wave listener and the new amofeur. Covers Broadcast Band and three short-wave bands 540 kc to 32 Mc. Separate Fine Tuning control. BFO, Rec./Standby, Speaker/Phones switches. Built-in PM speaker. Four tubes plus rectifier. For 115 V. AC or DC.....\$49.50

WORLD'S LEADING MANUFACTURER OF PRECISION RADIO AND TELEVISION • CHICAGO 24, ILLINOIS

We want you to know that every effort is being made to keep our Distributors supplied. If the model you select is temporarily out of stock, please be patient—you'll find that a Precision HALLICRAFTERS is worth waiting for!

HEADQUARTERS

THRU THE YEARS



Back in 1922 the first National communications receiver was offered to the public. Model SW-3 was among their first great units, the mention of which may evoke some nostalgia in the old timers of the radio fraternity. Ever since, National has always been in the vanguard with every great receiver development and today their place as undisputed leader in the field of communications equipment is acknowledged by all. The name National on a receiver means the finest in performance, the utmost in value.

Radio Wire Television was proud to offer the first National equipment to its public back in 1922, and its pride has increased many fold since then. R.W.T., where delivery, price and quality of service on National receivers have matched the superb performance of these products, has come to be regarded as National headquarters by radio men everywhere. For the greatest possible satisfaction in your National communications receiver, buy yours from Radio Wire Television.

Lafayette

Radio Wire Television Inc.

NEW YORK 13, N. Y.
100 SIXTH AVENUE

BOSTON 10, MASS.
110 FEDERAL ST.

NEWARK 2, N. J.
24 CENTRAL AVE.

BRONX 58, N. Y.
542 E. FORDHAM RD.



FREE
NEW BOOK!
HOT-OFF-PRESS
LATEST BUYS!

RADIO WIRE TELEVISION (Lafayette Radio)
100 Sixth Avenue, N. Y., Dept. RL-50

Enclosed \$..... (Include shipping charge, excess will be refunded). Rush me National Model.....

Please rush FREE Buying Guide 950F.

Name.....

Address.....

City..... Zone..... State.....



Model NC-33 \$67.50



Model NC-125 \$149.50



Model NC-183 \$279.00

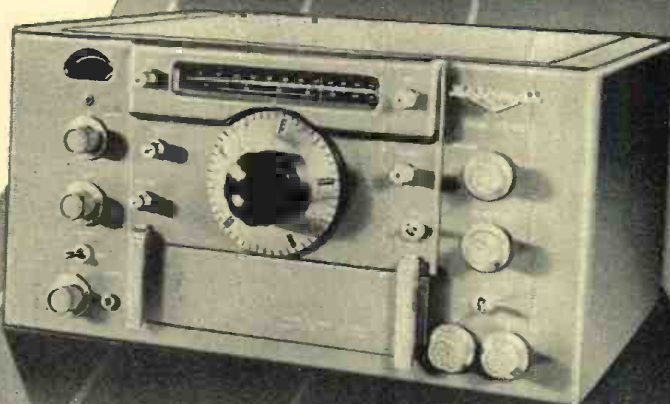

Model HRO-50T \$359.00

1950 1940 1930 1922

NEW... **EICO**

Instruments and KITS

Over 50,000 SERVICEMEN must be right!

give you Laboratory Precision at Lowest Cost!



NEW 5" PUSH-PULL OSCILLOSCOPE

All-new laboratory-precision scope with all the extra sensitivity and response for precise servicing of TV, FM & AM sets. Push-pull undistorted vertical and horizontal amplifiers. Boosted sensitivity, .05 to .1 rms volts/inch. Useful to 2.5 MC. TV-type multivibrator sweep circuits, 15 cps-75 KC. Z-axis intensity modulation feature. Dual positioning controls move trace anywhere on screen. Complete with 2-6J5, 3-6SN7, 2-5Y3, 5B1 CRT. 3-color etched rubproof panel; steel case. 115 v., 60 cycle AC. 8 1/2 x 17 x 13".

Model 425-K, KIT, only \$39.95
Model 425, factory wired, \$49.95

NEW VACUUM TUBE VOLTMETER

Laboratory-precision VTVM for trigger-fast operation and lifetime service. 15 different ranges. Large 4 1/2" meter, can't-burn-out circuit. New zero center for TV & FM discriminator alignment. Electronic AC & DC ranges: 0-5, 10, 100, 500, 1000 v. (30,000 volts & 200 MC with HVP-1 & P-75 probes). Ohmmeter ranges, .2 ohms to 1000 meg. DB scale. New stable double-triode balanced bridge circuit—extreme accuracy. 26 meg. DC input impedance. 3-color etched rubproof panel; steel case. 115 v., 60 cycle AC. 9-7/16 x 6 x 5".

Model 221-K, KIT, only \$23.95
Model 221, factory wired, \$49.95



NEW TUBE TESTER

Brand new professional tube tester and merchandiser EICO Service-Engineered for unbeatable value! Large 4 1/2" full-vision meter. Tests conventional and TV tubes including 9-pin miniatures. New lever-action switches—tests every tube element. Illuminated "Speed Roll-Chart." 2-grid caps. Short and open-element tests. Spare socket for new tubes. Protective overload bulb. Electronic rectifier. 3-color etched panel; rugged steel case. 115 v., 60 cycle AC. 12 1/2 x 9 1/2 x 4 1/2".

Model 625-K, KIT, only \$29.95
Model 625, factory wired, \$44.95



NEW SIGNAL GENERATOR

For FM-AM precision alignment and TV marker frequencies. Vernier Tuning Condenser. Highly stable RF oscillator, range: 150 KC-102 MC with fundamentals to 34 MC. Separate audio oscillator supplies 600 cycle pure sine wave voltage. Pure RF, modulated RF or pure AF for external testing. Attractive three color etched rub-proof panel; rugged hampered steel case. 115 v., 60 cycle AC. 10 x 8 x 4 1/2".

Model 320-K, KIT, only \$19.95
Model 320, factory wired, \$29.95

NEW BATTERY ELIMINATOR, CHARGER & BOOSTER

For all auto radio testing. Latest-type full-wave bridge circuit, 4-stack manganese copper-oxide rectifiers. Specially designed transformer, variable from 0 to 15 volts. Continuous: 5.8 v., 10 amps. Intermittent: 20 amps. 10,000 mfd filter condenser. Meter measures current and voltage output. Fused primary; automatic reset overload device for secondary. Hampered steel case. 115 v., 60 cycle AC. 10 1/2 x 7 1/2 x 8 1/2".

Model 1040-K, KIT, only \$22.95
Model 1040, factory wired, \$29.95



NEW DELUXE SIGNAL GENERATOR

A laboratory-precision generator EICO Service-Engineered with 1% accuracy. Extremely stable. Frequency 95 KC-150 MC in 7 calibrated ranges. Illuminated hairline vernier tuning. VR stabilized line supply. 400-cycle pure sine wave with less than 5% distortion. Tube complement: 6X5, 7F7, 6C4, VR-150. 3-color etched panel; rugged steel case. 115 v., 60 cycle AC. 12 x 13 x 7".

Model 315-K, KIT, only \$39.95
Model 315, factory wired, \$59.95

NEW SWEEP GENERATOR

Covers all TV-FM alignment frequencies, 500 KC-228 MC. Vernier-driven dial; center of each of 13 TV channels marked on front panel. Sweepwidth variable 0-30 MC with mechanical inductive sweep—permits gain comparison of adjacent RF TV channels. Crystal marker oscillator, variable amplitude. Provides for injection of external marker. Phasing control. Complete with HF Subsets 6X5GT, 12AU7 (dual-triode), 2-6C4. Lens crystal. 10 x 8 x 6 1/2". 5 MC Crystal, ea. \$3.95.

Model 360-K, KIT, only \$29.95
Model 360, factory wired, \$49.95



VOLT-OHM-MILLIAMMETER

Packet-size VOM cram-packed with value! 22 different ranges. 3" D'Arsonval movement. Ring-type shunts. Germanium crystal rectifier. Ranges—DC: 0-5, 50, 250, 500, 2500 v. AC & Output: 0-10, 100, 500, 1000 v. DC Ma: 0-1, 10, 100. DC Amp: 0-1, 10. Ohm: 0-500, 100,000: 0-1 Meg. DB: -8 to +55. 3-color etched panel; rugged hardwood case. 8 x 4 1/2 x 3".

Model 511-K, KIT, only \$14.95
Model 511, factory wired, \$17.95



MULTI-SIGNAL TRACER

Highest gain and flexibility in low-cost field. Audibly traces all IF, RF, Video and Audio from ANT to SPKR or CRT without switching. Response well over 200 MC. Integral test speaker. Provision for visual tracing with VTVM. Complete with 6J7, 6K6, 6X5. Germanium crystal diode. 3-color etched panel; rugged steel case. 115 v., 60 cycle AC. 10 x 8 x 4 1/2".

Model 145-K, KIT, only \$18.95
Model 145, factory wired, \$28.95

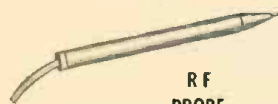
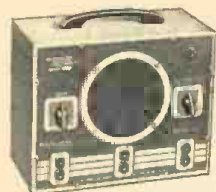

RF
PROBE

Sensitive Germanium crystal probe for signal tracing and measurements to over 200 MC. Extends range of VTVMs and scopes.

P-75K KIT, for VTVM;
P-76K for Scope; ea. \$3.75

P-75 or P-76, factory wired, ea. \$7.50

Due to unsettled conditions, prices are subject to change without notice.



HIGH
VOLTAGE PROBE

New professional EICO-engineered HV probe carefully designed and insulated for extra safety and versatility. Extends range of VTVMs and voltmeters up to 30,000 v. Lucite head. Large flash-guards. Multi-layer protected handle. Complete with interchangeable ceramic Multiplier to match your instrument.

HVP-1 (wired) only \$6.95

EICO SUPER-SIMPLIFIED INSTRUCTIONS

Easy-to-follow step-by-step EICO pictorial and schematic instructions—most explicit and comprehensive in electronics!—supplied with each Kit. Anyone can build the EICO Kits!

ELECTRONIC INSTRUMENT CO., Inc.
276 NEWPORT STREET, BROOKLYN 12, N. Y.

© 1950, Electronic Instrument Co., Inc., Brooklyn, N. Y.

the exclusive EICO Make-Good GUARANTEE

Each EICO Kit and Instrument is doubly guaranteed, by EICO and your jobber, to contain only selected quality components. EICO guarantees to replace any component which might become defective in normal use if returned to the factory transportation charges pre-paid within 90 days of purchase. EICO guarantees all Kits assembled according to EICO's simplified instructions will operate as specified thereon. EICO guarantees service and calibration of every EICO Kit and Instrument at the nominal charge as stated in the instructions.

Be sure to look at the EICO line before you buy any higher-priced equipment! Each EICO product is jam-packed with unbelievable value. YOU be the judge—compare EICO at your local jobber today, and SAVE! Write NOW for free newest Catalog R.

Prices 5% higher on West Coast

GET YOUR NEW Hallicrafters

COMMUNICATION RECEIVER HERE and



Save Money With a "Surprise" Trade-In Allowance on Your Used Test and Communication Equipment



HALLICRAFTERS SX-71

Shpg. wt. 33 lbs. . . . Only **\$199⁵⁰**

Slash the above price by trading in your used test or communication equipment. What do you have to trade?

ALL PRICES F.O.B. ST. LOUIS

FREE! New 164-Page Catalog. The "treasure chest" of values! Send for your copy today.



For super dooper savings on Hallicrafters Receivers get a Walter Ashe "SURPRISE" Trade-In offer on your used (factory-built) Test Instruments or Communication Equipment. Walter will give you an extra-liberal allowance that will put the Hallicrafters model of your choice within easy reach! So don't delay! Get your trade-in deal working today. Wire, write, phone or use the handy coupon below.



HALLICRAFTERS S-40B

Buy it at a substantial saving with a Walter Ashe "Surprise" Trade-In deal.

Shpg. Wt. 32 lbs. Only **\$99⁹⁵**



Hallicrafters S-38B

For amazing savings apply our "Surprise" trade-in allowance against this price.

Shpg. wt. 14 lbs. Only **\$49⁵⁰**



Hallicrafters S-72

Shpg. wt. 16 lbs. Price Only

\$109⁹⁵

(less battery)

Buy it for less by applying our liberal Trade-In Allowance against the purchase price.

**ATTENTION:
Prospective Novices!**

The Hallicrafters Receivers available at Walter Ashe represent the best values obtainable at the lowest possible cost consistent with high quality. From the models available you can choose just the one that meets your requirements as the ideal receiver to get you started in the proposed Novice Class of Licensee in Amateur Radio. Write for free Hallicrafters Catalog.

PHONE: Chestnut 1125

**Walter Ashe
RADIO CO.**
THE HOUSE OF "SURPRISE" TRADE-INS
1125 PINE ST. • ST. LOUIS 1, MO.

Walter Ashe Radio Co.
1125 Pine St., St. Louis 1, Mo. RN-50-12

O. K. Walter, Rush "Surprise" Trade-in offer on my
.....
(describe used equipment)

for.....
(show make and model No. of new equipment desired)

Rush Free Copy of your new 164-page Catalog.

NAME.....

ADDRESS.....

CITY.....Zone.....STATE.....

**SEND
FOR YOUR
COPY
TODAY!**

RADIO & TELEVISION NEWS

Now--

BIG-TIME CONSUMER ADVERTISING BOOSTS YOUR SALES OF G-E TUBES!



Full-page, eye-catching ads like this appear regularly in

LIFE

THE SATURDAY EVENING
POST

HERE'S a tube "first" that will put you first in volume, profits, and neighborhood prestige. Feature G-E tubes on your shelves; display them prominently on your counter. Your G-E tube distributor (better phone him, it's quicker) gladly will help you tie in with this national advertising. Or wire or write Electronics Department, General Electric Company, Schenectady 5, New York.

The Secret of TV's Brightest Picture Tube!

LONG-LASTING TUBES
for Radio-Television

FINEST ANY SET CAN HAVE!

Do you remember when television was a dim, dark-room pastime... when the screen was dim, the picture was dim, the picture was dim, the picture was dim... (The text is partially obscured and difficult to read in the original image.)

This basic contribution to picture enjoyment is typical of the research that helps make G-E tubes for television and radio as fine as any set can have. For long life and superb performance, specify G-E tubes. Installed by dependable servicemen everywhere.

General Electric Company, Radio Division, Schenectady 5, New York

You can put your confidence in...

GENERAL ELECTRIC

You can put your confidence in...

GENERAL ELECTRIC

new!



ACTUAL
SIZE

PYRAMID TINY TYPE 85LPT TUBULAR PAPER CAPACITORS

Fit anywhere!

Suitable for
85°C. operation!

CAPACITANCE RANGE:
.0001 TO .5 MFD.

VOLTAGE RANGE:
200 TO 600 V., INCLUSIVE

Sturdily built in phenolic-impregnated tubes. Ends are plastic-sealed.

WRITE FOR COMPLETE LITERATURE
Representatives and Distributors
Throughout the U.S.A. and Canada



PYRAMID

PYRAMID ELECTRIC COMPANY

155 Oxford Street
Paterson, N. J., U.S.A.

TELEGRAMS: WUX Paterson, N. J.
CABLE ADDRESS: Pyramidusa

Within the INDUSTRY

P. B. REED, a veteran of more than 20 years in the electronic equipment and servicing fields, has been named head of the *RCA Service Company's* new Government Service Division.



Mr. Reed, who was formerly a representative of the *RCA Victor Division* in Washington, D. C., has been given the title of vice-president in charge of the Government Service Division for the *RCA Service Company*. The new division will undertake an expansion program involving technical personnel and facilities to keep pace with increased requirements of the military services. Included in the expansion program are elaborate and centralized repair facilities and a technical publications section.

He has been associated with *RCA* since 1930 and has held various posts with the company.

CORNELL-DUBILIER ELECTRIC CORPORATION and its subsidiary, the **RADI-ART CORPORATION**, has purchased the **U. S. DEVICES CORP.** of South Plainfield, New Jersey. The new owners will continue the manufacture and merchandising of the "Tele-Rotor" line . . . **R. M. KARET ASSOCIATES, INC.** has changed its corporate name to **JKM INCORPORATED**. The new name is formed from the initials of the principals, Oden Jester, Bob Karet, and John Margolin . . . John C. Merman, operator of an engineering firm and a TV service firm in Philadelphia, and four other television service contractors in the Philadelphia area have recently formed an electronics manufacturing firm under the name of **ELECTRONIC CONTRACTORS, INC.** General offices of the new company are at 1508 Sansom Street in Philadelphia.

JEROME J. KAHN, president of the 1951 Radio Parts Distributors Show, has named a fifteen-man manufacturer-distributor advisory committee to consult with and advise the Show management and committees making preparations for the annual all-industry sponsored Show to be held in Chicago next May.

Herbert C. Clough of *Belden Mfg. Co.* was named chairman of the committee. Serving with him are: W. O. Schoning, *Lukko Sales*; W. D. Jenkins, *Radio Supply Co.*; L. W. Hatry, *Hatry & Young*; W. A. Wilson, *Hughes-Peters, Inc.*; George Barbey, *George D. Barbey Co.*; Lew Bonn, *Lew Bonn Co.*; H. L. Dalis, *H. L. Dalis Co.*; Sam

Poncher, *Newark Electric Co.*; Charles Golenpaul, *Aerovox Corp.*; Milton Deutschmann, *Radio Shack Corp.*; Walter W. Jablon, *Espey Mfg. Co.*; John Stern, *Radio Electric Service Co.*; Les Thayer, *Belden Mfg. Co.*; and Robert C. Sprague, *Sprague Electric Co.*

Last year's recommendations by a similar committee resulted in a highly successful program for the Show and it is anticipated that the new committee will be called upon shortly to make similar recommendations for the 1951 session.

ROBERT PAXTON, manager of manufacturing policy for the *General Electric Company*, has been elected a vice-president of the company by the board of directors . . . **SEYMOUR D. NEWMAN** has been appointed national sales manager of *Ansley Radio and Television, Inc.* . . . **LYNN C. HOLMES**, who has been associate director of research at *Stromberg-Carlson Company* since April 1950, has been named director of research for the company, succeeding **BENJAMIN OLNEY** who retired recently . . . **MARIO A. GARDNER** has been promoted to the post of vice-president in charge of purchases for *Air King Products Company, Inc.* . . . **TYRELL G. ROGERS** has been appointed executive assistant to **LEONARD F. CRAMER**, executive vice-president and director of the *Allen B. Du Mont Laboratories, Inc.* . . . *Olin Industries, Inc.* recently named **ROBERT H. EVANS** as executive assistant to the president and the executive committee . . . The newly-created post of vice-president in charge of engineering for *Starrett Television Corp.* is being filled by **EDMOND SHERMAN**, until recently chief engineer for the firm . . . **CAPTAIN STEADMAN TELLER, USN**, has been appointed Navy Secretary of the Research and Development Board, Department of Defense, succeeding **REAR ADMIRAL ARLEIGH A. BURKE** who has been recalled to sea duty in the Far Eastern theater of operations.

CLARENCE E. LINDSTROM who has been associated with *Philco Corporation* for 18 years, has been named western sales manager of the company with headquarters in San Francisco.



He replaces Cliff S. Bettinger who recently retired after 19 years in the post. Mr. Lindstrom joined the company in 1932 and served as controller of *Philco Distributors*,

RADIO & TELEVISION NEWS



take it from EXPERTS

renew
with **N.U.**
premium quality tubes

PAT REID SAYS:

Salesmanager, United Radio Supply, Inc.
Portland and Eugene, Oregon

"Our 379 servicemen and dealers tell us N. U. tubes are best, because their own experience has proved N. U. tubes are reliable, uniform, and above all are properly designed for interchangeability. What's more, costly call-backs are minimized by N. U.'s proven quality control. That's why we've featured N. U. tubes for 15 years. They mean good business for all of us.

- RADIO AND TELEVISION RECEIVING TUBES
- VIDEOTRON TELEVISION PICTURE TUBES
- PANEL LAMPS
- TRANSMITTING AND SPECIAL PURPOSE TUBES



NATIONAL UNION RADIO CORP.

Main Office: 350 Scotland Rd., Orange, N. J.

Research Division: Orange, N. J. • Plants: Newark, N. J. — Hatboro, Pa.

CHICAGO

Preferred Transformers geared to **TODAY'S** **ELECTRONIC CIRCUITS**

Designed to Meet The Requirements
of Today's Most-Used Tube Types

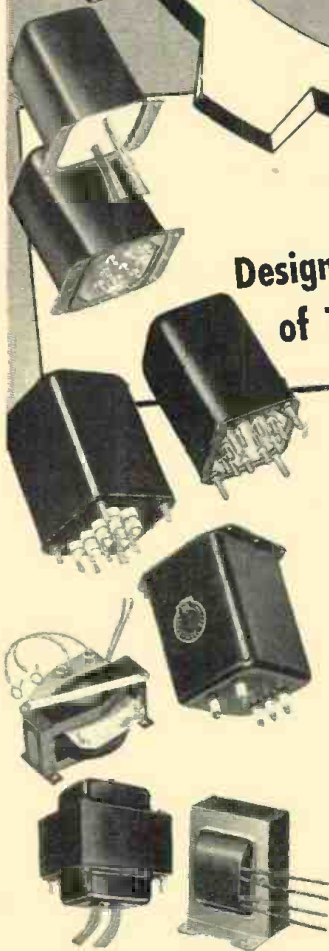

1. Power Transformers. Famous, advanced-design, Sealed-in-Steel construction. Exactly suited to specific requirements—one range of ratings expressly designed for capacitor input, another for reactor input.

2. Full Frequency Audio Transformers. For optimum performance—high-fidelity $\pm 1/2$ db from 30 to 15,000 cps. Other ranges available: Public Address— $\pm 1/2$ db, 50-10,000 cps; Communications— $\pm 1/2$ db, 200-3,500 cps.

3. JAN-T-27 Transformers. Now available for quick shipment from stock. Hermetically-sealed units which meet all requirements of Grade I, JAN-T-27 specifications for Class A operation. Full range of Power, Audio and Reactor units available.

4. Driver and Modulation Units. For Amateur and commercial speech transmitters. Matched sets of drivers, modulation transformers and reactors provide frequency response ± 1 db over entire range from 30-15,000 cycles.

5. Television Transformers. A complete catalog line in a range of designs that are the exact duplicates of units used in leading TV sets. Built by CHICAGO—the largest single manufacturer of original equipment TV transformers.

WRITE FOR FREE CATALOGS

You'll want these two important Catalogs—the New Equipment Line listing Sealed-in-Steel and JAN-T-27 units, and the Replacement Line showing a complete range of Radio, TV and Vibrator transformer replacements. Send for these valuable FREE catalogs today—or get them from your distributor.



CHICAGO TRANSFORMER

DIVISION OF ESSEX WIRE CORPORATION

3501 ADDISON STREET • CHICAGO 18, ILLINOIS



Inc. of Chicago for several years before becoming sales manager of this branch of the company's wholesale organization. During the war he was active in special work connected with the company's large-scale production of radar and ordnance.

J. B. SHIMER has been appointed to the newly-created post of Factories Manager of the Industrial and Electronic Division plants of American Structural Products Company.



The increased demand for the company's Kimble all-glass rectangular television bulbs has been cited as the reason for creating the new post. Mr. Shimer, who recently served as plant manager for the company's Columbus, Ohio facility now assumes supervision over the Columbus and Toledo factories as well as certain forming operations at the Chicago Heights plant. For the present he will continue to make his headquarters in Columbus, Ohio.

Mr. Shimer has been associated with Owens-Illinois Glass Company, the parent company, since 1946 when he joined the Libbey Glass Division as manager of Factory A. Prior to that he was connected with other firms in the production of electronic equipment.

THE LAPOINTE-PLASCOMOLD CORPORATION, manufacturers of "Vee-D-X" television antennas and accessories, has recently purchased a new plant in Windsor Locks, Conn. The increased size of the new factory will permit the company to double its present production . . . THE TECHNICAL MATERIAL CORPORATION'S new mailing address is P. O. Box 142, Mamaroneck, New York . . . TELEFEX has moved its office and laboratory facilities to 5746 Sunset Boulevard in Hollywood, California . . . AMERICAN ELECTRONEERING CORP., Los Angeles manufacturer of test equipment, has moved to new and larger quarters at 5025 West Jefferson Boulevard in that city . . . TELEVISION TECHNICIANS INC. is now occupying new quarters at 516 South Cicero Avenue, Chicago 44, Illinois . . . SONOTONE CORPORATION is currently producing miniature electron vacuum tubes for radio and television receivers in its new Elmsford, New York plant . . . The RCA Victor Division of RADIO CORPORATION OF AMERICA is establishing a new plant in Cincinnati, Ohio for the manufacture of miniature-type electron receiving tubes. The plant is expected to be in production by the autumn of 1951 . . . A new plant for the production of plastic and plastic-metal components for the radio, television, and lighting industries is now under construction at Warren, Pa. for the Parts Division of SYLVANIA
(Continued on page 152)

RADIO & TELEVISION NEWS

Raytheon Backs its Products with a COMPLETE FIELD SERVICE PROGRAM!

WE AIN'T TELLIN' YOU NOTHIN' when we say that the major headache of the television business today is installation and service of TV sets.

But we *are* telling you something when we say that Raytheon backs its television dealers and servicemen with a *complete field service program!*

Seven factory-paid service representatives are in the field 12 months of the year, making scheduled calls in every TV community. These service experts call regularly on distributor service departments and, in conjunction with them, schedule regular servicemen's educational meetings.

At these meetings, they explain new techniques and simplified methods of servicing... they franchise Raytheon service agents and supply them with the

latest bulletin releases from the factory on new servicing techniques.

In addition to all this, the factory maintains a regular direct-by-mail program going to distributors for their franchised Raytheon service agents only, keeping them completely informed at all times.

THE NET RESULT is a complete, detailed, organized service program designed to simplify the problems of distributors, dealers and servicemen... to provide workable information on installation, service and maintenance of Raytheon TV receivers... and to save them time and money through a thorough understanding of Raytheon products.

For full details, contact your Raytheon field representative or write Service Manager, Belmont Radio Corp., 5921 West Dickens Ave., Chicago 39, Ill.

BELMONT RADIO CORPORATION • 5921 W. Dickens Avenue, Chicago 39, Ill.
Subsidiary of RAYTHEON MFG. CO.



Dependably Built

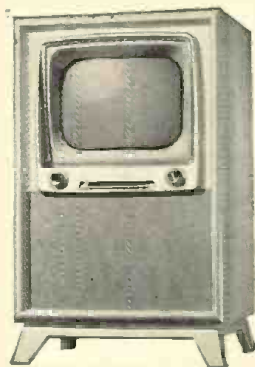

THE MAYFAIR—Model 1715

for Dependable Performance

List prices range from \$259.95 to \$625.00



**These famous names in
the sky...have a famous
friend in SYLVANIA**

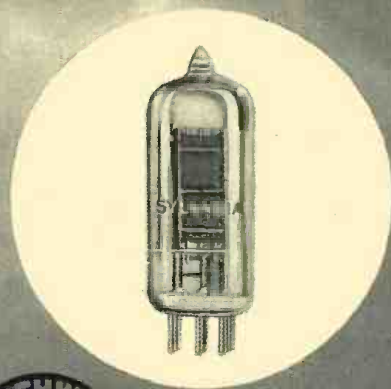

Wherever these famous airliners fly, a trusted group of friendly guides goes with them, in the form of Sylvania Radio Tubes.

For, the dependability, long life, and splendid performance of Sylvania Tubes have won them top preference with radio and electronics engineers throughout this country, as well as abroad.

Sylvania's ruggedized tubes are typical examples of the alert engineering which is responsible for the

increasing demand for all Sylvania quality products.

What is your problem?

Let Sylvania radio research and advanced engineering work for you. If you have problems—as widely varied as the designing of more compact sets, and the overcoming of shock and vibration—put them up to Sylvania. Address your letters to Radio Tube Division, Dept. R-1212, Emporium, Pa.

SYLVANIA  ELECTRIC

RADIO TUBES; TELEVISION PICTURE TUBES; ELECTRONIC PRODUCTS; ELECTRONIC TEST EQUIPMENT; FLUORESCENT LAMPS. FIXTURES. SIGN TUBING. WIRING DEVICES; LIGHT BULBS; PHOTOLAMPS; TELEVISION SETS

SURVEY OF TELEVISION ANTENNAS

Do you know which type of antenna is best suited for your particular installation? Here are the facts.

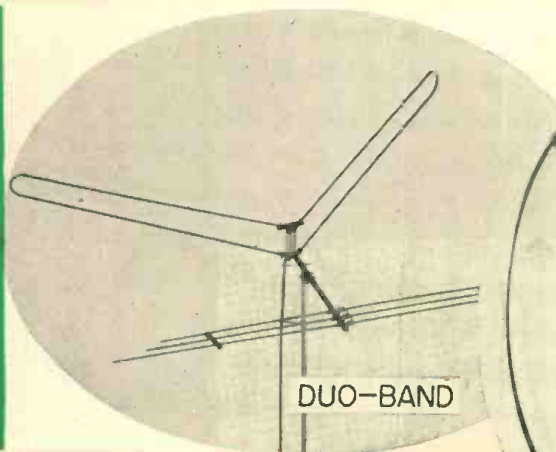

DUO-BAND

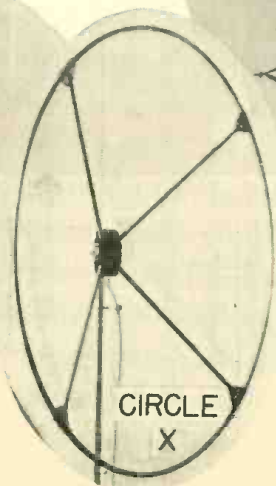

CIRCLE X

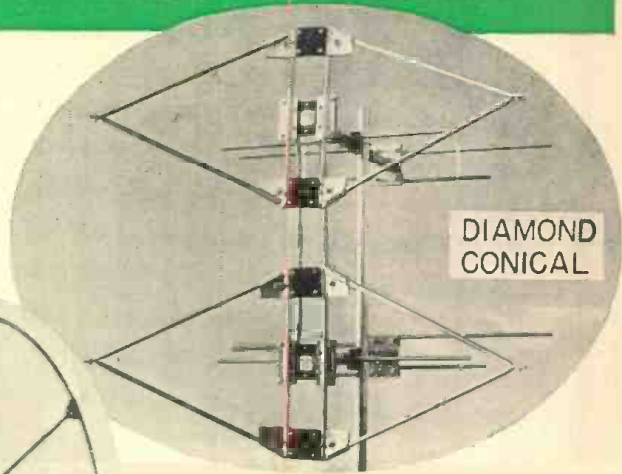

DIAMOND CONICAL

By
ALAN SMOLEN

THE picture obtained on a television screen can never be better than that allowed by the signal supplied at the antenna and, as most technicians know, given a strong, noise- and ghost-free signal any set can be adjusted to provide good reception. Unfortunately, many manufacturers' claims to the contrary, there is no single type of antenna that provides the best signal for all or even a large majority of locations and channels. Every installation has its individual requirements and the antenna chosen should be the type that best meets these requirements. For this reason there are scores of antenna types now available on the market and each one can be considered the "best" for a given set of installation conditions. It is the purpose of this article to review the characteristics of the most popular antennas and indicate where and why they should be employed.

One of the most common descriptions of an antenna today is that it is "high gain." It is extremely important that the installer understand what this term "high gain" means because in some locations it may result in a very strong signal while in others it may provide a weak signal or none at all. The reason for this can be understood by briefly reviewing the

significance of the radiation patterns.

Two typical radiation patterns are shown in Fig. 1. The radiation pattern indicates the relative signal strength that can be expected from a given direction. In both patterns shown in Fig. 1 maximum signal is obtained in the A direction or 0 degrees. At an angle of 15 degrees however the antenna of Fig. 1A picks up about 95 per-cent of the maximum

signal while that of Fig. 1B picks up about 62 per-cent. At an angle of 30 degrees the percentages would be 85 for 1A and 0 for 1B. The beamwidth of these patterns is defined as the angle between half power directions as shown in Fig. 1.

In order to determine the power gain of an antenna as a function of direction the "nominal" gain given by the manufacturer (usually in db.) must be reduced by the percentage factor indicated on the radiation pattern converted to db. Table 1 is a percentage-to-db. conversion chart. Note the inclusion of voltage ratios for conversion from power to voltage and vice versa. Thus the gain of an antenna in a direction corresponding to 85 per-cent maximum signal on the radiation pattern would be equal to the nominal gain (in db.) minus approximately 0.7 db.

The smaller the beamwidth angle

Fig. 1. (A) Radiation pattern of folded dipole with reflector, and (B) pattern of a yagi.

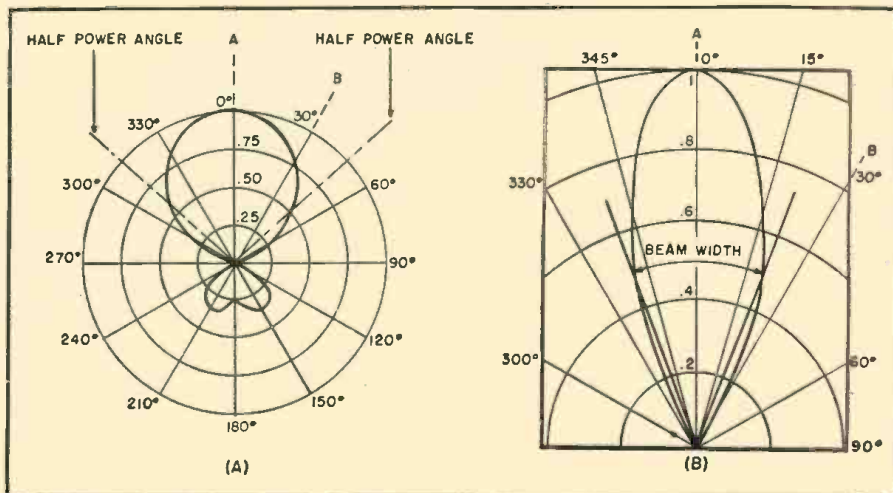

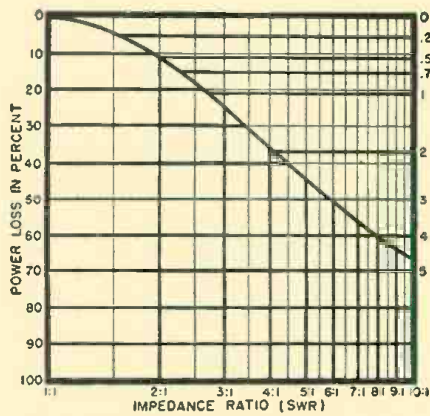

Fig. 2. Power loss which occurs due to mismatch from antenna to receiver. Note that impedance ratio is equal to the v.s.w.r.

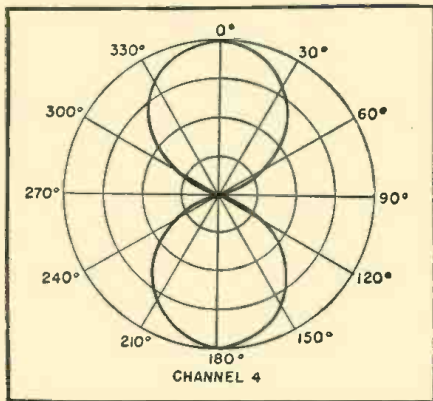

Fig. 3. Typical bidirectional radiation pattern (folded dipole without a reflector).

(sharper radiation pattern) the higher the gain of the antenna. The pattern shown in Fig. 1A (folded dipole with reflector) corresponds to a power gain of 2.5 db. (with respect to a dipole), while the gain of the antenna whose pattern is shown in Fig. 1B (yagi) is about 9 db. If the transmitter is located in direction A the yagi would pick up 6.5 db. more signal than the folded dipole. However, if the signal originates at point B, the dipole will pick up a signal equivalent to a gain of 1.8 db. (2.5 - 0.7) while the yagi will not pick up any signal at all. This illustrates a very important point, i.e.,

that a high gain antenna is "high gain" for a given direction only and may be "low gain" for other directions.

Assume that these two antennas are available at an installation where there is only one broadcast transmitter operating from direction A. If the installation is in a very strong signal area with no ghosts or interfering signals, the author would be inclined to choose the dipole, provided an adequate signal can be obtained with its use. The high gain antenna, because of its directivity, has the disadvantage that it must be secured very firmly. Otherwise a strong wind will turn the antenna thereby losing the signal completely. The direction of the dipole, on the other hand, is not very critical and a simple mechanical installation is possible. Furthermore, should a transmitter be placed in direction B in the future it may not be necessary to erect another antenna to cover this station.

The high gain antenna would be used in weak signal areas and in areas where a ghost or interfering signal exists in the null points of the yagi pattern, such as point B. In this latter case it is obvious that the yagi would not pick up the ghost or interfering signal at all, while the dipole would. This principle of using the radiation pattern of an antenna to minimize ghosts and interfering signals is overlooked by many installers, though it can prove to be very effective.

In areas where there are a number of transmitting stations the same general considerations would prevail over a wider area. Other factors, such as favoring weak stations over strong signal ones, must be introduced and frequently some compromise must be made between maximum signal strength, presence of ghosts in picture, and number of stations received.

At multi-station installations it is desirable to employ one antenna to cover all channels. In such an installation it is important to investigate the effect of different frequencies on the radiation pattern, power gain, and mismatch losses—particularly when high and low band frequencies are in-

cluded. For some antennas the radiation pattern for the low frequency band is completely different than the pattern for the high frequency band and may even vary from channel to channel.

The variation of power gain and impedance mismatch with frequency are usually considered separately though some manufacturers include mismatch effects in their published data on power gain. In this latter case, however, a statement to the effect that gain is measured into a 300 ohm impedance is prominently indicated. Unless this statement appears, the power gain-versus-frequency curves given assume that the antenna is suitably matched. Gain may also be expressed in terms of voltages. Use Table 1 to convert voltage gain to power gain and vice versa.

The losses due to mismatch between antenna and receiver must be subtracted from the calculated antenna power gain to determine the over-all system gain. It is well known that for maximum power transfer the impedance of the antenna must be equal to the receiver input impedance—usually 300 ohms. When the impedances are not the same, some power is lost. Fig. 2 plots the power loss in percentage and db. for various impedance mismatch ratios (also expressed as v.s.w.r.—voltage standing wave ratio). As in the case of power gain, the antenna impedance—and hence mismatch losses—will vary with frequency and therefore must be checked. Throughout this article proper matching between lead-in and receiver will be assumed.

With these facts in mind it is possible to intelligently analyze the published characteristics of television antennas and indicate their application. In this article we are concerned with antennas readily available on the market. Antennas will be discussed in accordance with the following application categories; strong signal areas, medium signal areas, and weak signal areas. It should be noted that the line of demarcation between these classifications is not very rigid and weak signal antennas can frequently find application in medium signal areas and vice versa.

Strong Signal Areas

Strong signal areas are defined as those areas where the power gain of the antenna is not a very important factor and where serious ghosts or interference are not encountered. In these cases the most inexpensive antenna which also results in a relatively simple, non-critical installation should be employed. Antennas which fall into this category are; (A) dipole, (B) dipole with reflector, (C) folded dipole, (D) folded dipole with reflector, and (E) high and low band folded dipole and reflector. A typical radiation pattern is shown in Fig. 3.

(A) Dipole. The simplest and most inexpensive antenna is a dipole cut to a particular frequency. The imped-

Table 1. Conversion table. Power or voltage ratios may be converted to db. and vice versa.

LOSS		DB.	GAIN	
Power Ratio	Voltage Ratio		Power Ratio	Voltage Ratio
1.000	1.000	0	1.000	1.000
.977	.988	.1	1.023	1.011
.955	.977	.2	1.047	1.023
.891	.944	.5	1.122	1.059
.794	.891	1.0	1.259	1.122
.631	.794	2.0	1.585	1.259
.501	.708	3.0	1.995	1.413
.398	.631	4.0	2.512	1.585
.316	.562	5.0	3.162	1.778
.215	.501	6.0	3.981	1.995
.199	.447	7.0	5.012	2.239
.158	.398	8.0	6.310	2.512
.126	.355	9.0	7.943	2.818
.1	.316	10.0	10.000	3.162
.01	.100	20.0	100.0	10.0
.001	.0316	30.0	1000.0	31.62

ance of a dipole is 72 ohms and, as such, matches the few 72 ohm receivers manufactured. The response curve (gain-versus-frequency) of this antenna is quite sharp providing maximum gain at the specified frequency, and falling rapidly at different frequencies.

When this antenna is used to feed a 300 ohm receiver, the gain of the antenna is offset by the 4:1 mismatch. Fortunately, the impedance of the antenna increases off resonance so that the loss in gain is balanced by a decrease in mismatch loss. The result is an over-all system gain that does not vary radically over either the low or high frequency band. Hence the dipole is a narrow-band antenna when used to feed a 72 ohm receiver and broadband antenna for 300 ohm receivers. It should be noted that this applies over the high or low band but not over both bands simultaneously with one antenna.

The radiation pattern of this antenna is very broad. The antenna is bidirectional and will receive signals equally well from 0 and 180 degrees. This will be advantageous if there are stations in both directions and undesirable if a ghost originates from one of these points.

(B) *Dipole and reflector.* The back lobe of the dipole radiation pattern can be reduced through the use of a reflector. The reflector will also reduce the impedance of the dipole. This results in an increased mismatch so that even though the reflector increases the antenna gain, the over-all system gain may not be increased.

(C) *Folded dipole.* The folded dipole is, in effect, two dipoles in parallel, thereby increasing the effective cross-section of the antenna. The impedance of this antenna is approximately 300 ohms and it provides a good match for 300 ohm receivers. The gain of this antenna is slightly greater than that of the dipole because of the improved matching obtained. The impedance of this antenna does not vary to an appreciable degree over either the high or low band. Its radiation pattern is virtually the same as that of the dipole.

(D) *Folded dipole with reflector.* A reflector can be added to the folded dipole to obtain greater power gain and reduce the back lobe to 50 percent of its value without a reflector. This antenna is sometimes used in medium signal areas because it does provide a power gain of approximately 3 db.

(E) *High and low band folded dipole (and reflector when necessary).* Both the dipole and folded dipole can be used over either the high or low bands but not over both with one antenna. When it is necessary to cover both bands two individual antennas connected together must be used. The most important factor in these antennas is the necessity for isolating the low band unit from the high band antenna. The feed system between the two antennas is also very important

Antenna Type	Av. Power Gain (in db.)	Front-to-Back Ratio (approx.)	Av. V.S. W.R.	Beam Width (in deg.)	Impedance	Broad-band	Remarks
A. STRONG SIGNAL AREAS							
Dipole	0	1:1		90	72	No	
Dipole	-1	1:1	3	90	300	No	Broadband only when mismatched to 300 ohm line
Folded Dipole	-0.5	1:1	2.5	90	300	Lo or Hi band	
Folded Dipole (with reflector)	2.5	2:1	3.5	90	300	Lo or Hi band	
Folded Dipoles (with reflectors low and high band)	Lo 3 Hi 4	4:1	3.5	Lo 90 Hi 80	300	Yes	High band directivity affected by orientation of low band antenna
B. MEDIUM SIGNAL AREAS							
2-Bay Low Band Folded Dipoles (with reflectors)	6	2:1	2	80	300	Lo band	
2-Bay High Band Folded Dipoles (with reflectors)	6	3.5:1	1.5	80	300	Hi band	
2-Bay Low and High Band Folded Dipoles (with reflectors)	Lo 6 Hi 9.5	Lo 2:1 Hi 3.5:1	2	Lo 80 Hi 100	300	Yes	
Winged Dipole	Lo 4 Hi 5	5:1		Lo 60 Hi 40	300	Yes	Wings available for conversion of standard dipole
Reversible Beam	4	15:1		70	300	Yes	Beam may be reversed by switch
Duo-Band	3	5:1		Lo 80 Hi 40	72 or 300	Yes	
In-Line	Lo 2 Hi 4	6:1		Lo 90 Hi 70	300	Yes	
2-Bay In-Line	Lo 3 Hi 6	6:1		Lo 80 Hi 40	300	Yes	
Conical (with conical reflector)	Lo 1.5 Hi 5.5	4:1	1.5	Lo 90 Hi 50	300	Yes	
2-Bay Conical (with reflector)	7.5	4:1		Lo 50 Hi 35	300	Yes	
2-Bay Diamond Conical	3	5:1	1.5	Lo 80 Hi 40	300	Yes	Good mechanical construction. Beamwidth 65° on Channel 13
Circle-X	3	Lo 1:1 Hi 2:1		Lo 120 Hi 80	Approx. 150	Yes	78' in diam.
C. WEAK SIGNAL AREAS							
4-Bay Conical	10			Lo 45 Hi 30	150	Yes	Excellent when all stations are in one direction
Twin-Driven Yagi	9	20:1		30	300	No	One channel or two adjacent channels only
Square Corner Reflector	9	100:1		25	300	No	Cut for single high-band channels only

Table 2. Characteristics of some of the most popular types of television antennas.

and it should not be changed from the manufacturers' specifications.

By the addition of reflectors on both folded dipoles an antenna with greater gain is obtained which may be used in medium signal areas. Most antennas of this type permit individual siting of the two antennas. However, the orientation of the two antennas is not completely independent. The low frequency antenna pattern is not seriously affected by the orientation of the high band dipole, but the high frequency pattern may be shifted by as much as 90 degrees because of the position of the low band unit.

One way to reduce this possible shift in the high frequency lobe is to em-

ploy two transmission lines, one for each antenna. By using a double-pole, double-throw switch mounted on the receiver, the appropriate antenna can be selected for the channel desired. A better method of avoiding this shift is to use two masts, separated by several feet, to minimize interaction.

Medium Signal Areas

In this category fall antennas which have power gains of better than 3 db. but whose radiation patterns are not so sharp as to exclude large areas. These antennas are generally of the "all channel" type and are employed where many channels are to be received over a relatively wide angle

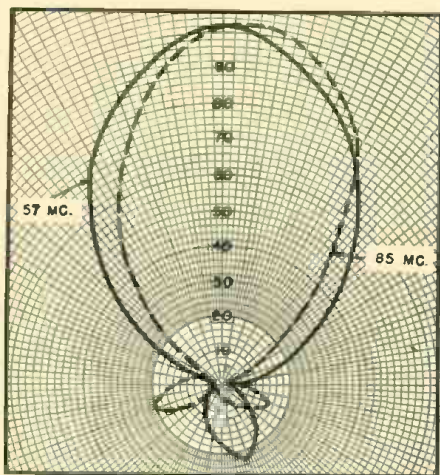

Fig. 4. Power gain patterns, at Channels 2 and 6, of a two-bay diamond array.

(45 degrees). The antennas to be described are; (A) winged dipole, (B) reversible beam antenna, (C) duo-band antenna, (D) in-line antenna, (E) conical antenna, (F) diamond conical antenna, and (G) Circle-X antenna. A typical radiation pattern is shown in Fig. 4.

(A) *Winged Dipole*. The winged dipole acts as a conventional dipole and reflector at low band frequencies. Over the high band, a single lobe is obtained by the use of wings attached to the driven element. These wings act as a wave trap and make the driven element a half wave dipole on the high band. A high frequency reflector is added in order to increase the gain and obtain a unidirectional pattern.

(B) *Reversible Beam Antenna*. There are installations where it is desirable to receive stations that are located in opposite directions, i.e., 0 and 180 degrees. If the antenna is allowed to pick up signal from both directions simultaneously there may be co-channel interference. Thus, an antenna is required which is unidirectional but whose direction can be switched in opposite directions. In this way it will be possible to pick up stations in both directions without co-channel interference.

The reversible beam antenna shown in Fig. 5 acts in this manner. The two antennas in the horizontal plane are connected together by a transmission line one-half wavelength long. This transmission line is joined at the center by the receiver lead-in. The two dipoles in the vertical plane are similarly connected together with a second receiver lead-in. The two lead-ins must be of the same length and are connected to a diplexer in the receiver. The diplexer connects the transmission lines together so that the voltages from the two antennas add for maximum gain.

This antenna is highly unidirectional with front-to-back signal ratios ranging from 5:1 to 20:1 with a gain of approximately 4 db. over the entire band. The direction of reception can be varied by 180 degrees by making

the horizontal lead-in one-quarter wave longer than the dipole lead-in. This quarter wave line is inserted in or out of the horizontal line by a switch. In this way it is possible to get good reception from either of two directions by flipping a switch. This antenna has proved very useful in locations between Philadelphia and New York and between Philadelphia and Baltimore-Washington.

(C) *Duo-band Antenna*. The duo-band antenna is another all-channel unit that utilizes two principles to achieve directivity and broadband characteristics. The first is the use of a folded dipole which is a broadband antenna. However, the low frequency folded dipole will have a multi-lobe pattern at the high frequencies, which is not desirable because lobes are off center. To focus the multi-lobe pattern, the folded dipole is tilted forward. This also results in a single forward lobe for the high frequency stations. To obtain directivity and a good front-to-back ratio, a series of three reflectors is used. This is necessary because a single reflector is effective only over a narrow band of frequencies. Use of three reflectors extends the effectiveness over a wider range.

(D) *In-Line Antenna*. This antenna consists of a high and low band folded dipole in line with a single low frequency reflector. On the low band the antenna makes use of the conventional folded dipole and reflector. On the high band, the low frequency folded dipole acts as a reflector for the high frequency dipole over the high band. Thus a unidirectional pattern is obtained over the entire TV band.

(E) *Conical Antenna*. The X elements of a conical antenna represent the corner lines of an actual cone. The true conical antenna has a very broadband characteristic impedance but it is not practical because it would be very heavy, have high wind resistance and, as such, involves an expensive installation. By proper choice of angle between elements and

forward angle, a good approximation of the true conical can be obtained.

A single conical antenna without reflector has a front-to-back ratio of approximately 2:1. If a conical reflector is used, the gain and front-to-back ratio is increased. These effects will be more pronounced at the higher frequencies. This type of antenna would lend itself to applications where more gain or sharper pattern is required at the high band. Stacking of a conical antenna will further increase the gain over the entire band. This also sharpens the pattern. This antenna is not suitable where all stations are not in one general direction unless an antenna rotator is used.

(F) *Diamond Conical*. Another form of conical antenna is known as the diamond antenna. The mechanical structure of this antenna is somewhat superior to other types because its weight is concentrated at the center where it is supported. There are no free ends that will vibrate and possibly fracture.

It is interesting to note that the radiation pattern of this antenna broadens at the high end of the band. This pattern might prove helpful in an area like New York where all stations originate from a relatively small angle except for the highest channels.

(G) *Circle-X*. This antenna is a recent addition to the variety now available commercially. The antenna may be visualized as a conical antenna with its ends joined and tilted forward. It is made of 1½ inch tubing which aids in attaining broadband characteristics. The *Circle-X* has a gain of approximately 3 db. over the entire band.

Weak or Fringe Areas

It is always possible to increase the gain of any of the antennas described by stacking them. However, stacked arrays are very cumbersome and can introduce undesirable effects unless proper spacing is obtained. In weak signal or fringe areas it is desirable to use high gain antennas with relatively simple structures. These antennas are characterized by the fact that they are generally effective for one channel only, and an individual antenna may be required for each channel. These antennas are very often used as an adjunct to an all-channel antenna to pick up the one channel that the all-channel unit is incapable of receiving properly. Two antennas will be discussed in this category; the (A) yagi antenna; and (B) the square corner reflector.

(A) *Yagi Antenna*. Two types of yagis are available. One, a single driven element, consists of a folded dipole with one reflector and two directors. The second type, twin driven, consists of a folded dipole with director and a folded dipole with reflector. The units are connected so that the two voltages combine to give higher

(Continued on page 169)

Fig. 5. A typical reversible beam antenna.

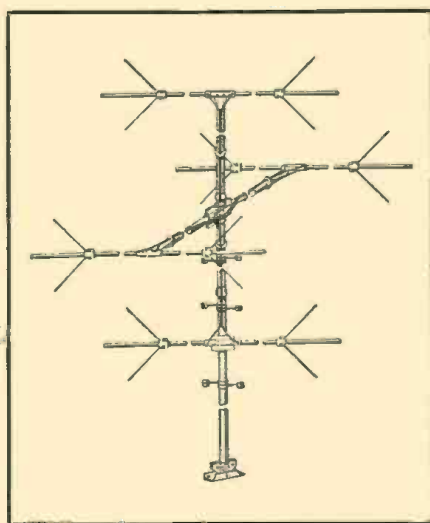

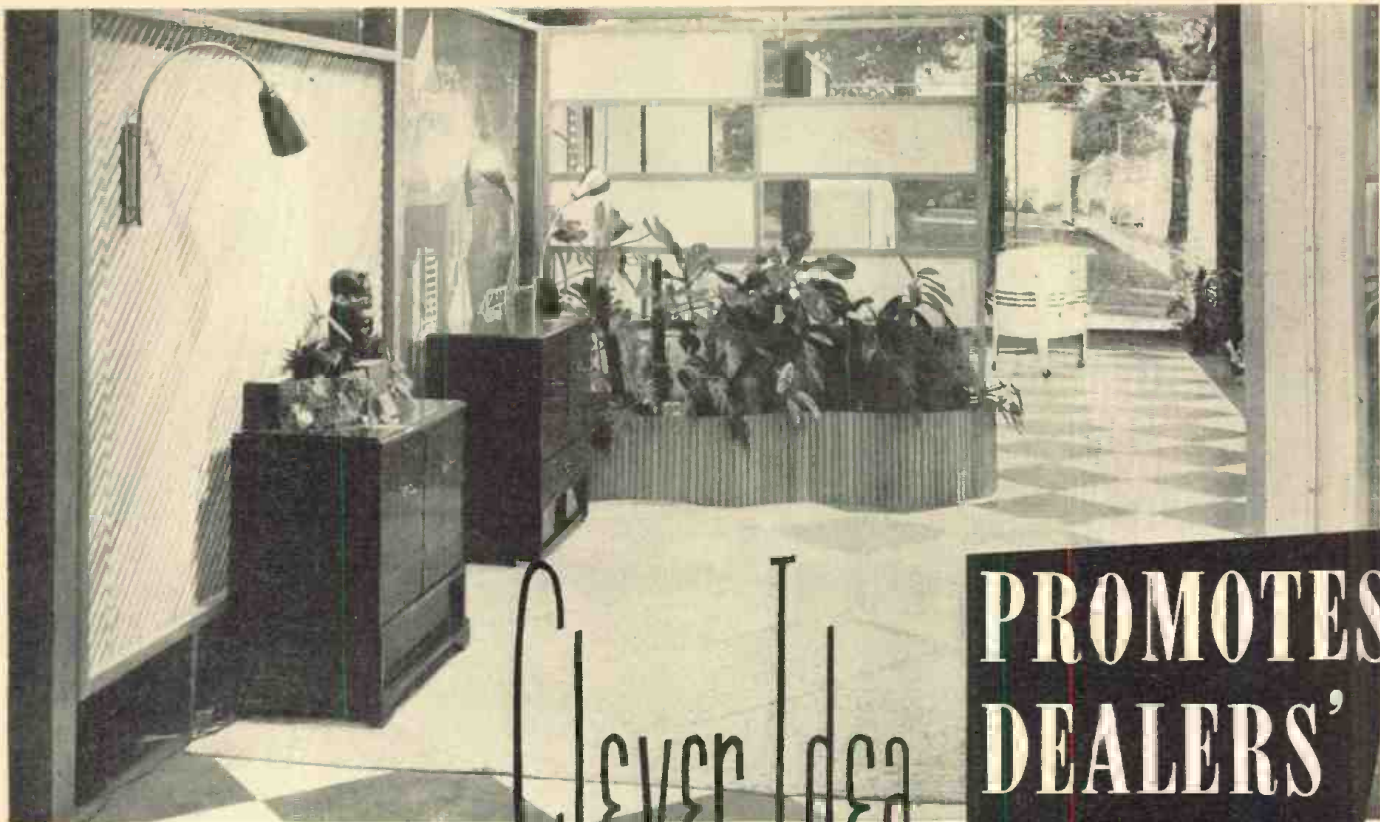

Clever Idea

**PROMOTES
DEALERS'
SALES**

How one progressive Memphis distributor uses his ultra-modern facilities to promote retail sales.

WHEN *Shobe, Inc.* of Memphis, Tenn. recently opened the doors of its new and ultra-modern headquarters a new page was written in the story of distributor-dealer relations.

While many distributors might feel that since their contact with the buying public is very slight it isn't necessary to provide elaborate showrooms, *Shobe's* expresses a different philosophy.

The interior of this new super-appliance mart features a series of ultra-modern movable partitions which

can be easily shifted to provide 52 different arrangements for attractive displays.

One of the outstanding features of this new showroom is the fact that it is used, in effect, as dealers' showrooms. *Shobe's* has put into effect a system whereby each week an outstanding dealer is selected as the "dealer of the week."

This dealer is then invited to furnish his own sales personnel to work the *Shobe* displays and make sales there to all visitors to the wholesaler. The chosen dealer is also featured in

the *Shobe* advertising that week, including mentions on the local *Philco* TV show.

This cooperation between the distributor and the dealers has proven to be extremely popular since it gives the dealers an opportunity to show a complete line of merchandise under very favorable selling conditions. Furthermore, it is an ideal arrangement for both dealer and distributor in terms of sales training, because it gives the *Shobe* salesmen a chance to help the dealer to develop the best possible selling techniques.

-50-

Part of the display area at *Shobe's*. Note how movable partitions and drapes are used to divide room into selling areas.



A well-stocked parts department is one reason why this distributor has increased his sales 1700% in the past 5 years.





**By BRIG. GEN.
WESLEY T. GUEST, USA**
Chief, Signal Plans & Operations Div.
Office of the Chief Signal Officer

Born in Silver Creek, N. Y. in 1900. Entered Regular Army in 1921. Received MS in communications engineering from Yale in 1929. Commander of Aircraft Radio Repair section (San Antonio) in 1937. Became chief of Communication Liaison Div. in Office of Chief Signal Officer in 1939 and in 1942 was named assistant director of the Plans and Operations Div. He went overseas in 1942 as director of Communications Div., of Communications Zone Hq. in European Theater. Returned to U. S. in 1944 to become chief of Plans and Operations Div. Named director of that division in the Southwest Pacific Theater in 1945. He became chief of the Army Communications Service Division in the office of Chief Signal Officer in 1947.

PLANNING INTEGRATED SIGNAL COMMUNICATIONS

A Signal Corps achievement—planning and operating an earth-girdling electronic communications network geared to the speed and mobility of modern warfare.

COMMUNICATIONS, the means of coordinating the fighting team, are, in fact, an indispensable element in creating a team from separate and often widely dispersed forces. No amount of force can be effective in repelling an enemy unless there are brains and nerves to direct it. Communications are the nerves of fighting power.

Communications do not just grow; they are planned. In the Army, the planning is the responsibility of the Signal Corps. That planning is largely guided by a concept which we call "integrated communications." The planning, engineering, and operation involve the development of equipment that will fill the tactical requirements of the integrated communications system.

It is well to remember that as technical developments have made warfare more complex, communications have

grown more complex to keep pace. When the Signal Corps was created during the Civil War as the only branch of its kind in a modern army, wig-wag flags were quite new and modern and the magnetic telegraph was just appearing. Today, military communications are geared to the speed of light by earth-girdling electronic systems.

That is the extent to which communications can be integrated. Integration is required by the speed and mobility of modern war. Delay can be fatal. The relaying of information takes time and causes delay, unless it is accomplished swiftly through the integrated system.

This thinking, it may be noted in passing, closely parallels that of the major civil communications systems. In private affairs it is necessary for efficient service. In military affairs it is a vital necessity for survival.

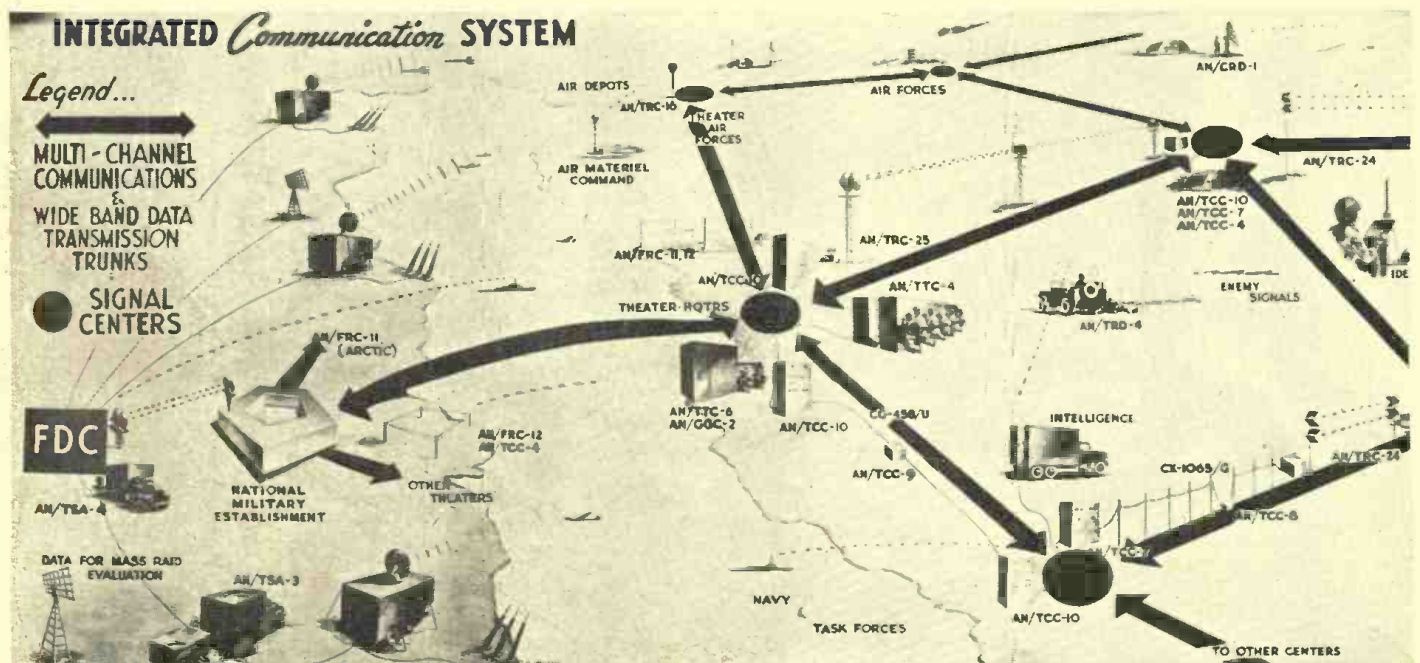

In each of the last two wars, the Signal Corps was confronted with an emergency situation in the development, procurement, distribution, installation, operation, and maintenance of a military communication system. In the First World War, the situation was relatively simple. There was only one theater of operations and that in a friendly country where communications had been established by both the British and French Forces after several years of military operations. The American Forces engaged in the First World War were relatively small compared with those of the Allies and, consequently, the organizational structure was relatively simple. In that war, Air Force communications were negligible, radar was not employed, communications for amphibious and airborne landings were not required, and major reliance was on wire and cable.

The problem during the Second World War was far more serious than it was in the first. Not one theater of operations had to be served, but many. The increased geographical coverage and the accelerated speed at which operations unfolded created difficulties never before experienced by any signal organization, either commercial or military. The need for a *system* concept—for integration—became immediately apparent.

Let us consider the organizational aspects of the Signal Corps System Concept. We feel that the best type of organization for a communications system is one that is established on a *commodity basis*. By that we mean one organization that is responsible for all aspects of the "commodity of communications," including research and development, training, procurement and distribution of signal supplies, and plans and operations—all under the control and direction of one man, the Chief Signal Officer. This is true of the Signal Corps today, and administration of the Army's farflung communications activities is centered in the Office of the Chief Signal Officer.

The reason the Chief Signal Officer must have his finger on all activities of the Corps is that those activities are closely interrelated. For instance, training must be geared to delivery of equipment, both the newly developed equipment and the old. Likewise, research and development are closely related to procurement.

Signal Corps personnel install, operate, and maintain communications from the Department of the Army to the Theater of Operations; and from the Theater Headquarters down to the regiments. Regiments and lower units to which no organic Signal Corps personnel are assigned, are responsible for their own communications, for tactical reasons that will be explored presently. However, the Signal Corps is responsible for providing signal equipment

and supplies for use between and within all tactical and service echelons. Thus, it may be said that the Signal Corps exercises supervision over signal communications literally from the Pentagon to the foxhole.

This over-all system may be considered to be composed of three networks: the *global network*, the *theater network*, and the *tactical network*.

The *global network* is used for establishing communications circuits:

1. Between the Pentagon and the Theaters of Operations, occupation zones, bases, etc.;
2. Within the Theater where wire or radio relay circuits are not feasible, as in the case of a large ocean area;
3. Within the Theaters as the first established circuits, until supplemented by wire (Continued on page 113)

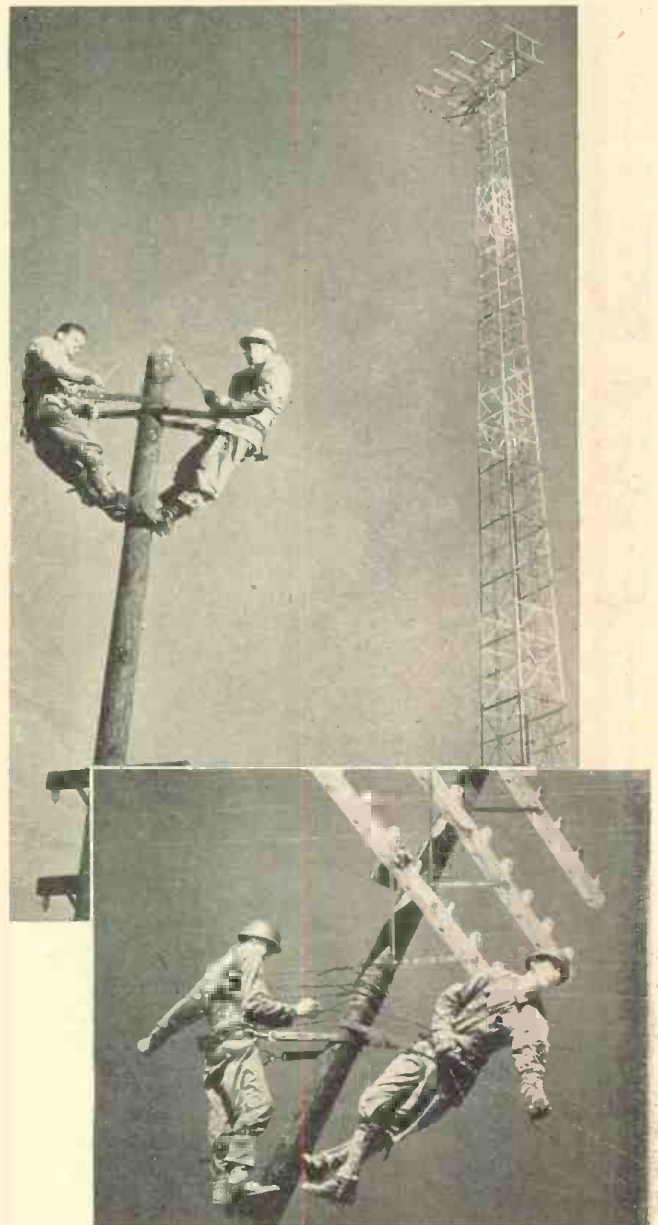

The Signal Corps is responsible for maintaining many different types of communications both in war and peace. In the top photograph Corpsmen are shown at their job of keeping transmission lines and antenna towers in good condition. The antenna is a beam, 250 feet high and supports five two-element v.h.f. antennas. By means of these antennas, this station transmits signals from all over the world to the Signal Center in the Pentagon. In the bottom photograph, another aspect of Signal Corps communications is shown as Corpsmen adjust military telephone wires.

The over-all concept of the integrated communication system.

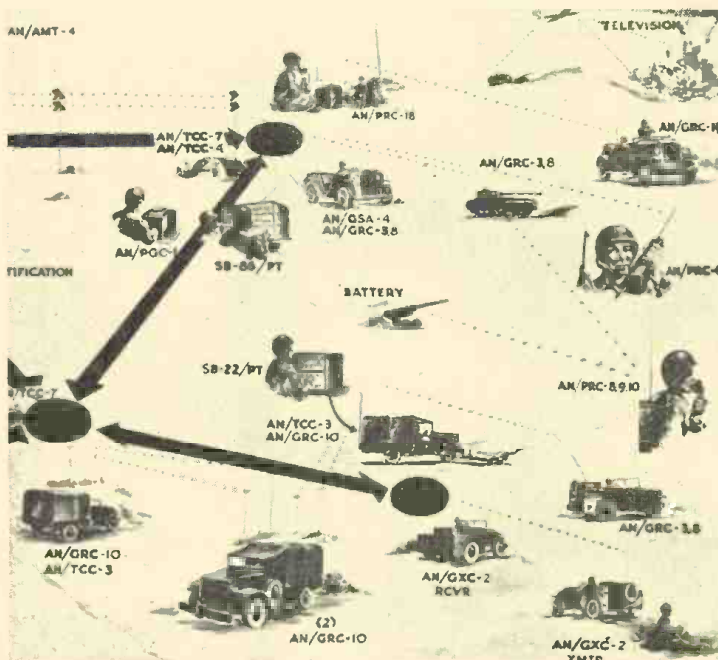

ENGINEERING THE INTEGRATED COMMUNICATIONS SYSTEM

By **Col. EDWIN R. PETZING**

Chief, Engineering & Technical Div.
Office of the Chief Signal Officer



Born in Illinois in 1896. Attended University of Illinois 1914-17. Entered Officers' training in 1917. Went overseas in 1918 and from 1919 to the outbreak of second World War attended various Army training schools and held diversified commands. Served as Signal Officer for 9th Army Corps in Panama at beginning of World War II and subsequently saw service in the Caribbean Defense Command and in the China-Burma-India theater. He served as signal officer for the 6th Army in 1946-47. He became Chief of the Engineering and Technical Division in the Office of Chief Signal Officer in September 1947, a post he still holds.

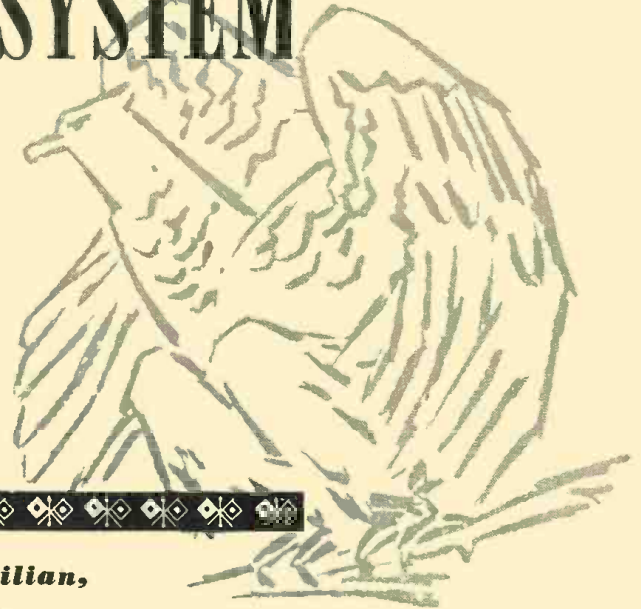

**Top-flight engineers, military and civilian,
work as a team to produce the world's finest
communications equipment for our Armed Forces.**

THE integrated communications system planning discussed on page 36 of this issue resulted, shortly after World War II, in concrete requirements for the individual items of equipment necessary to form the global, theater, and combat communications networks.

To bring the integrated concept into being, the Signal Corps established at its Signal Corps Engineering Laboratories in Fort Monmouth, New Jersey, a major program of research and development designed to furnish the fighting forces with the best and most efficient military communications equipment in the world, integrated into a system providing the maximum speed and flexibility needed for future warfare. System-wise, the development plans have taken into consideration the increasing complexity of warfare; the increasing need for inter-arm and inter-service communications; and the wider bands needed for larger numbers of communications channels or for newer forms of communications.

Equipment-wise, the plans have emphasized the requirement that all communications equipment for our modern army be light, rugged, and operable in hot, cold, dry, or rainy weather. Logistics-wise, due consideration has been given to engineering for mass production, maximum use of common components and subassemblies, and application of the "building block" principle.

Successful accomplishment of a plan as ambitious as that outlined above would require many times the facilities and manpower available to the Signal Corps in its own laboratories. But, by means of contracts with industry and educational institutions, the best communications brains and the best facilities in the country have been obtained to aid the Signal Corps in translating the many equipment requirements into the tangible hardware needed to form the system.

Military development in peacetime must, of necessity, be geared to limited budgets and limited manpower and, consequently, is spread out over a considerable time period. However, emphasis on communications developments has resulted in many equipments of the integrated system being completed and placed in production. Most of the remainder are advanced to a point where production will be started this fiscal year.

The chart shown on page 36 illustrates the general concept of the integrated communications system and depicts the general use of the various types of equipment in the system. The following discussion of the individual equipments will cover the main developments in radio and wire

illustrated on the chart.

One of the main communications requirements of lower

Army Communications Center in Pentagon, shows patchboard and coordinating and receiving consoles. Teletype loop jacks are provided at patchboard to connect spare receiving equipment to incoming circuits in case of trouble. Board is also used with associated printer equipment (left) in order to communicate directly with distant station to correct discrepancies in messages. Console in foreground is used as a coordinating point between traffic terminating section and radio control section (not shown). Console's operator decides whether a circuit is operable or requires action by some other section to correct troubles. Receiving consoles in background are where messages are received in tape form and, if necessary, are transferred to relaying equipment for further transmission.



RADIO & TELEVISION NEWS

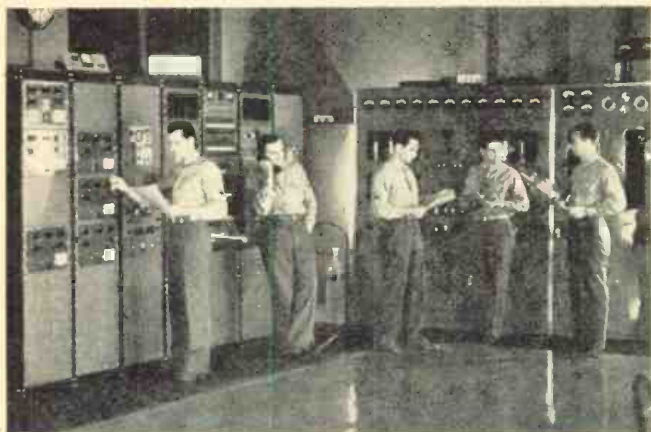

Main control board in the transmitter room of the Army Communications Center. In the foreground at left are shown the 72" racks which are equipped with Press Wireless radio teletype shifters. These units are used as exciters to each transmitter and the output is fed through a coaxial antenna system to the oscillator of the transmitter. Center foreground is the main control panel which is the nerve center between the transmitting station and message center. The 15 kw. transmitter used for transmissions on overseas circuits is in right front.

echelon combat commanders has long been a series of hand-held, back-pack, and vehicular radios designed to give efficient command communications and at the same time provide channels for use between Infantry, Armor, and Artillery. World War II equipment was not adequate for the job; handie-talkie sets were amplitude modulated; walkie-talkies were FM, and vehicular sets using FM were provided only for Armor and Artillery.

The postwar sets, on which development has now been completed and production started, provide many advantages. For example, the handie-talkie, a 1- to 3-mile set, is now FM and can communicate with other appropriate sets in the group. While it is about the same size as its AM predecessor, it represents significant progress in miniaturization in that a 14-tube FM circuit has been packaged in the same space formerly required for a 5-tube AM set. The walkie-talkie, a 3- to 5-mile set, has been designed in three frequency bands to match the bands of the vehicular sets of the Armor, Artillery, and Infantry with overlaps to allow communication between them. While power output has been slightly increased, size and weight have been reduced by one-half. Particularly important to the man in the front line is the 50 per-cent reduction in thickness which makes the set much less conspicuous when carried on the back. The vehicular sets, composed of three basic assemblies to cover separate frequency bands with overlaps, provide 10- to 20-mile FM

voice communications for the Infantry, Armor, and Artillery. In addition to the basic transceiver, a separate short range transceiver is provided which will communicate with the handie-talkie, one of the walkie-talkies, one of the basic transceivers and all of the other short range transceivers in this vehicular group. To obtain added range and flexibility, provisions are included for retransmission from the basic transceiver to the short range transceiver and *vice versa*. In addition, where 20- to 40-mile FM voice ranges are needed, a back-to-back type relay set is provided. It is interesting to note that the use of crystal saver sets in the vehicular series has resulted in a requirement of 11 to 21 crystals per set *versus* a comparable requirement of 80 to 120 in the World War II series.

Radio Relay

Experience with the limited number of equipments available toward the end of the past war indicated that radio relay was a most promising means of communications as a substitute for and augmentation of wire systems, and that it was ideal for radio-wire integration. In general, World War II equipment was not used below division headquarters level and when used in rear areas did not provide an adequate number of channels per set. Consequently, the development program has been directed toward providing three types of relay systems: forward area, intermediate area, and rear area.

With three relays, ranges up to 50 miles are possible on the forward area relay system. The transmission accommodates a relatively broadband signal and, with carrier equipment discussed later in this article, will give four voice channels, each of which can, in turn, provide up to eight teleprinter channels. Since use down to regimental level is contemplated, (Continued on page 143)

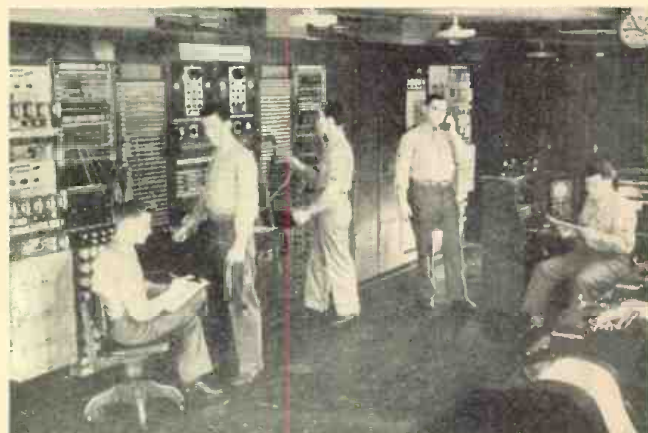

Since the transmitter and receiver sites are widely separated, a centralized control point is used. All radio circuits are coordinated and associated and the transmitted and received signals carried through the radio control switchboard to the terminating equipment used in sending and receiving the message traffic. The radio control operators carry out their coordinating work with distant stations both overseas and domestic by voice or teletype printers.

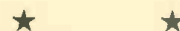

Radio control panels where all signals can be checked, switched, and measured. The panel on the left is for radio frequency patching, sometimes called switching. The next two panels are "audio" patching panels and the emergency two-way PM communications position to the Communications Center. The trick chief's duties are monitoring and keeping all circuits and two-way communications normal before reception at the center.



A TV Contrast Generator And GAMMA CHECKER

By

J. R. POPKIN-CLURMAN,

W2LNP

Hazeltine Electronics Corp.
Little Neck, N. Y.

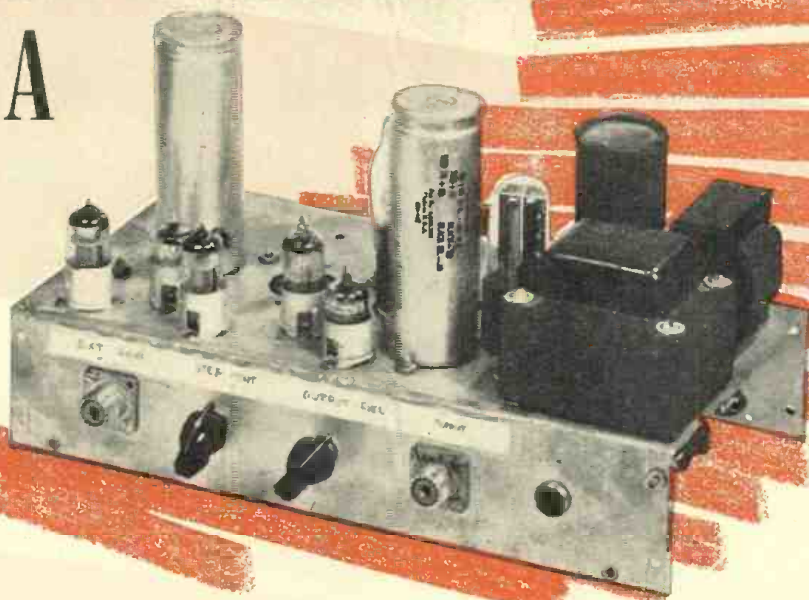

A new TV test instrument. It produces a series of uniformly graded steps in contrast range for determining gamma of a TV system.

Over-all view of test instrument. It can also be used to check linearity and the slope of the amplitude response of the video amplifiers.

IN TELEVISION systems, like photographic systems, the range of intensity between the light and dark portions of the picture plays an important part in its realistic viewing. The extent of this range from highlights to shadows is called the "contrast." Middle tones or shades in this range give the viewer a significant amount of information and make the difference between a photograph and a line drawing or a silhouette. Nuances of light and shadow often can contribute resolution to a picture by suggestion. In coarse detail areas of a picture, a contrast range of as much as 50:1 can be obtained in a television picture, while in fine-detail portions this contrast range is often not greater than 2:1. Evidence of the latter condition is apparent when looking at a standard television resolution chart on a receiver having inadequate bandwidth. The resolution of the wedges tapers off into a uniform gray as the resolving limits of the system are reached.

If a television system or a receiver is incorrectly adjusted so that the picture shows blanching in the light grays and deepening of the dark grays, the resulting picture is said to be too "contrasty." On the other hand, if a picture looks washed out, such as would be caused by a high general level of brightness with a small amount of contrast, the picture is said to be "flat." The correspondence of original tones to their reproduction contrast range is called "gamma." A picture which has the highlights relatively brighter and the dim regions relatively darker than the original is

said to have a gamma greater than 1 and has more contrast than the original scene. This is typical in the motion picture industry where the tendency is to accentuate the highlights and depress the shadows. This is why some motion pictures reproduce so poorly when sent over a television system. Pictures having a gamma less than 1 generally result with the use of present cameras and amplifiers in television systems. Since a television system should be designed to have a gamma of unity, it is generally necessary to put a gamma corrector somewhere in the television system.

Even if a television system had a unity gamma up to the picture tube, it would still be necessary to install a gamma corrector. This is because of the non-linearity of the picture tube, which requires more voltage for changes in brightness at low levels than for the same changes at high levels. Also, many pictures may be improved by compressing the ratios in the white and expanding them in the dark regions.

The generator about to be described provides a means for observing the

gamma of a television system by furnishing a series of uniformly graded steps in contrast range. The number of these steps may be varied. This electrically generated staircase is highly accurate, with uniform steps, so that the equipment may be used to check linearity and the slope of the amplitude response of video amplifiers. By the use of a simple suitable modulator and carrier source, the generator may be employed to measure the overall r.f., i.f., and video responses of a TV system.

Description of Circuit

A block diagram of the instrument is shown in Fig. 1. Essentially what is done is to make pulses, have these pulses charge a condenser, and then transfer this charge to another condenser. The voltage on the second condenser is periodically discharged while the pulses continue to charge the small condenser which, in turn, recharges the larger unit. Referring to the schematic in Fig. 2, the 884 or 6D4 tube, V_1 , is the pulse generator, which is adjusted to run at approximately 420 cycles. The bias and plate voltages of V_1 and the values of R_b , R_1 and C_1 determine the frequency. At the plate of V_1 , a 420-cycle saw-tooth exists, but is not used. Instead, the pulses at the cathode caused by the breakdown of the gas tube charge condenser C_1 . This charge is transferred by means of the 6AL5 bucket counter circuit to C_2 . The bucket circuit consists of a double-diode tube, one diode of which allows a positive pulse to pass and then cuts off as soon as the charging pulse falls. In order not to

Fig. 1. Block diagram of test instrument.

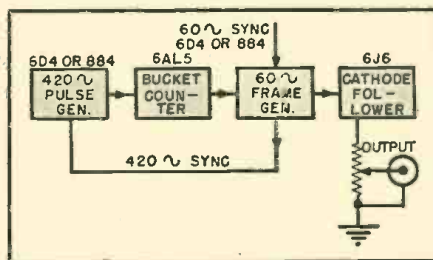

keep C_1 charged indefinitely, the other diode of the 6AL5 is connected to reset or restore the voltage level initially appearing across C_1 . Unless some means were used to prevent C_1 from charging up to the amplitude of the original pulse, (at which time the sequence of events outlined previously would stop), a gas tube V_2 is connected across C_1 to discharge it periodically. This discharge of C_1 is conveniently arranged to be at the field rate, which in television systems is 60 cycles.

At the same time, a small pulse derived from the cathode of V_2 is fed by C_2 back to the grid circuit of V_1 so that the 420-cycle staircase rate may be maintained. The output across C_4 is then fed through C_5 to V_4 , a cathode follower and isolating tube which allows the staircase voltage to be used without disturbing the generator making the staircase. Should an opposite-polarity staircase wave be desired, 2000 to 3000 ohms may be inserted in the plate circuit of the cathode follower and the output taken from the joined plates. This resistor would be inserted between the bypass condenser C_7 and the plates of the tubes. In addition to the positive power supply, there is a negative regulated supply derived from a separate rectifier and regulator tube.

The staircase output delivered at J_1 is shown in Fig. 3.

The voltage obtained at the output of the filter circuit is practically the open circuit voltage, due to the low current drain of this unit.

It was not necessary to use a transformer of 70 ma. rating, but this was the smallest stock size with the required high voltage winding.

Adjustments

The use of an oscilloscope is especially helpful in setting up the generator initially. (If none is available, a television set may be used as a final check.) With a scope, the following is the sequence of adjustments. The vertical plates of the scope are connected to the cathode of V_1 . The scope horizontal sweep is synchronized to 60 cycles, and the bias on the grid of V_1 and the frequency control in the plate of V_1 are adjusted until approximately 7 pulses appear on the scope. The input connections of the scope are then connected to the grid of V_4 and the 60-cycle sync is adjusted so that V_2 conducts every 60th of a second. It may be necessary to adjust the bias on V_2 for this to happen. It might be that instead of 7 fixed steps appearing on the staircase, the stairs are jittery and tend to slide back and forth, or the stairs tend to be moving up or down like an escalator. The motion of the stairs may be stopped by readjusting the bias and frequency controls of V_1 . If there is a tilt in the bottom two steps of the staircase, the 60-cycle sync that is injected in V_2 should be reduced and the bias of V_2 and V_1 , together with the frequency control of V_1 , should be readjusted until there is no evidence

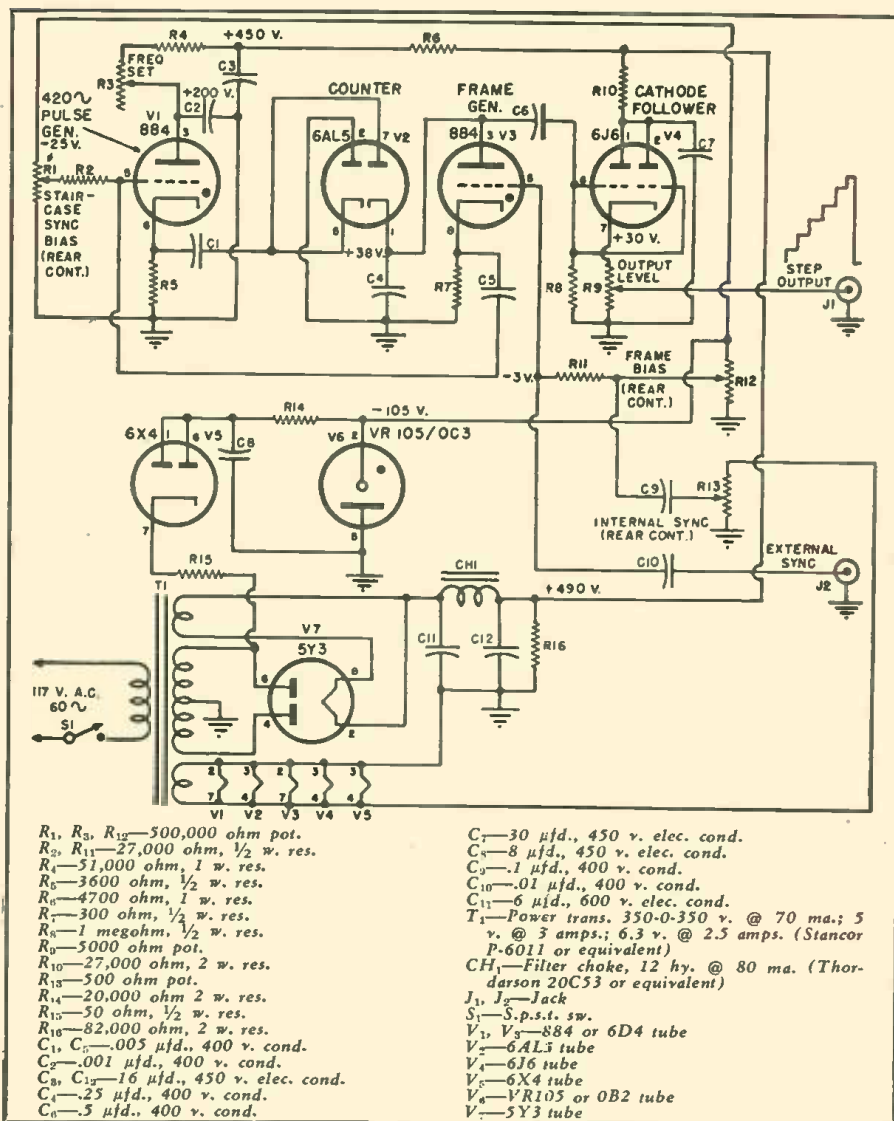

Fig. 2. Schematic diagram of gamma checker. If an oscilloscope is not available any TV set can be used to make final adjustments on this test instrument.

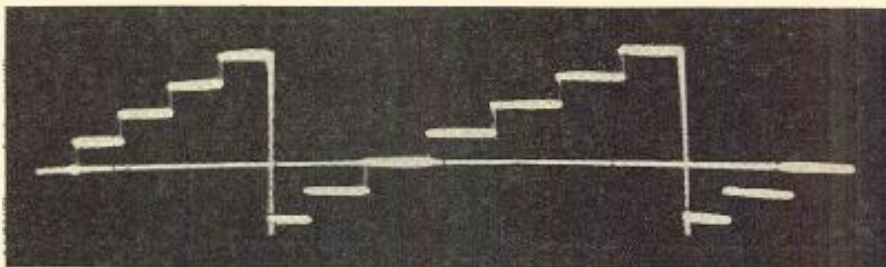
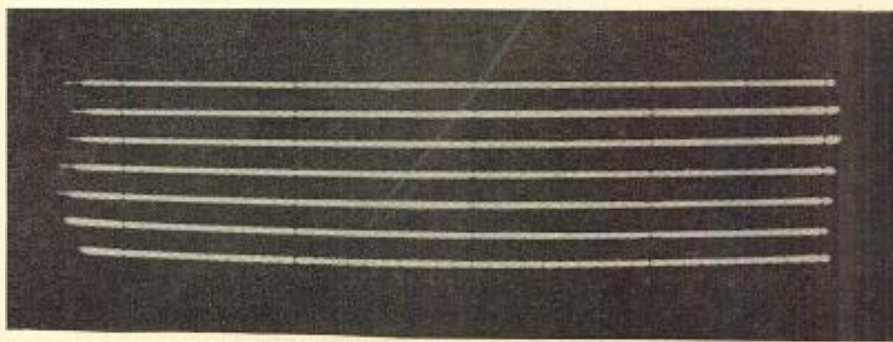

Fig. 3. Staircase output delivered at terminal J_1 , shown in the schematic diagram.

Fig. 4. Scope pattern obtained when checking generator for both amplitude linearity and tilt in the stairs. This is the desired pattern. See text for the explanation.



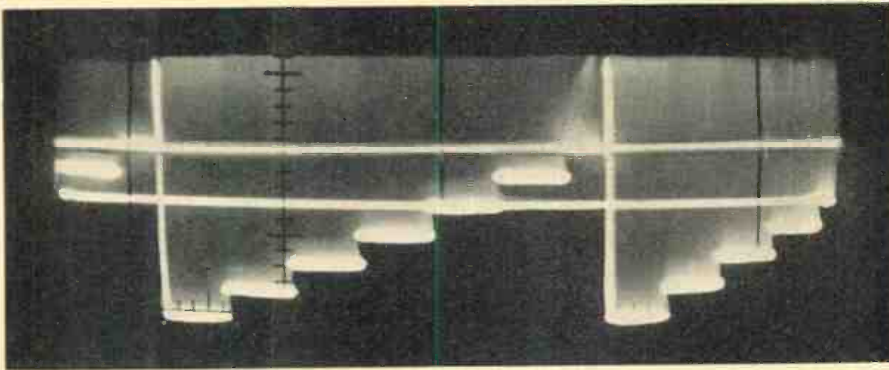

Fig. 5. The oscilloscope pattern obtained when non-standard blanking is used.

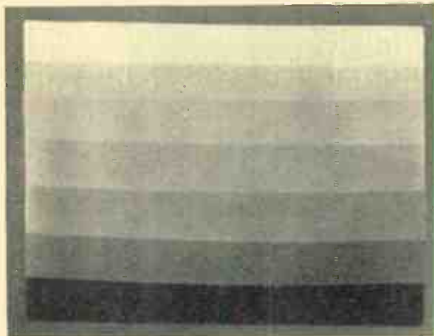

Fig. 6. Kinescope picture of Fig. 5.

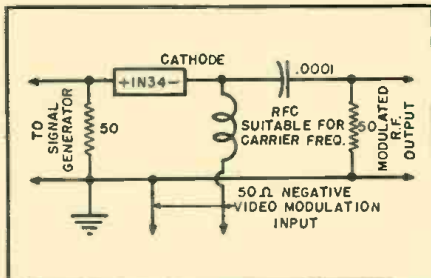

Fig. 7. Diagram of a simple modulator. The output of this modulator can be used to check over-all receiver response.

of any tilt in the first few steps. Generally, the smaller the 60-cycle sync voltage, the more uniform the steps. Of course, 60-cycle sync derived from the separated sync from an RTMA standard picture may be used for external synchronization of V_2 by application at J_1 . In this case the internal 60-cycle injection is reduced to zero at R_{13} . An easy way of checking the staircase signal generator for both amplitude linearity and tilt in the stairs is by connecting the scope to the output of the generator and running the horizontal sweep of the scope 10 to 20 times faster than 60 cycles. This will result in the picture shown in Fig. 4. Any non-linearity in the steps will show up as an unevenness in the spacing between lines. Any tilt in the stairs will show up as a widening of the lines.

Uses

The staircase waveform produced by this generator may be fed into the video amplifier of a television set and should produce a picture similar to that shown in Fig. 3 when viewed with an oscilloscope. A scope applied stage-by-stage in turn along a video amplifier would show whether the responses

of the stages are linear. Crowding of the stairs at the bottom or the top would indicate that the video amplifier is either being overloaded or operating on an improper portion of its curve of grid voltage versus plate current. Whether or not the blacks or whites will be compressed depends upon whether the video stage in question is poled black-positive or black-negative. Any tilt in the staircase waveform as observed on the oscilloscope indicates poor low-frequency response. By connecting either the composite blanking output from a standard television generator or the combined horizontal and vertical sync pulses obtained from a television set, blanking may be added to the basic staircase signal. This may be obtained by separating the grids of the cathode follower and feeding one of the grids the composite blanking voltage. The oscilloscope picture with the non-standard blanking used will then appear as shown in Fig. 5 and the kinescope picture as in Fig. 6. The apparent white edge at each grey tone is an optical illusion. The pictured steps may be checked for tilt by masking each step from its neighbor with a piece of paper. Of course blanking is not necessary, but the return traces of the horizontal and vertical lines will otherwise be seen.

This composite staircase signal with blanking is useful in checking automatic black level and the action of d.c. restorers, which are supposed to restore at the black level. Proper operation of the d.c. restorer or automatic black level circuits will be indicated by the black level remaining unchanged as varying levels of the signals shown in Fig. 5 are fed into the system. If it is desired, this signal may be fed into the simple modulator shown in Fig. 7. The output of the modulator may be used for checking the over-all response of a receiver.

As mentioned earlier, motion pictures do not always reproduce well on a television receiver. Using the gamma checker, video amplifiers may be adjusted for non-linear amplitude output by either using diodes, crystals, or several pentode amplifiers in parallel, each tube having different grid voltage-plate current characteristics. It is possible to have a sharp cut-off tube amplify by itself, then a medium cut-off tube is added to it, and then finally a remote cut-off tube is added to the other two tubes. The output of such a gamma corrector amplifier, when fed by the gamma checker, will show larger steps in the staircase at either end or in the middle. By manipulating the controls, any desired result can be obtained; control over the over-all gamma curve of the television system at the receiving end makes it possible to optimize the television picture reproduction for any given set of conditions.

It is easily seen that this relatively simple and inexpensive generator may also be quite useful for checking the performance of other portions of a television system.

Fig. 8. Under chassis view of the completed television gamma test instrument.

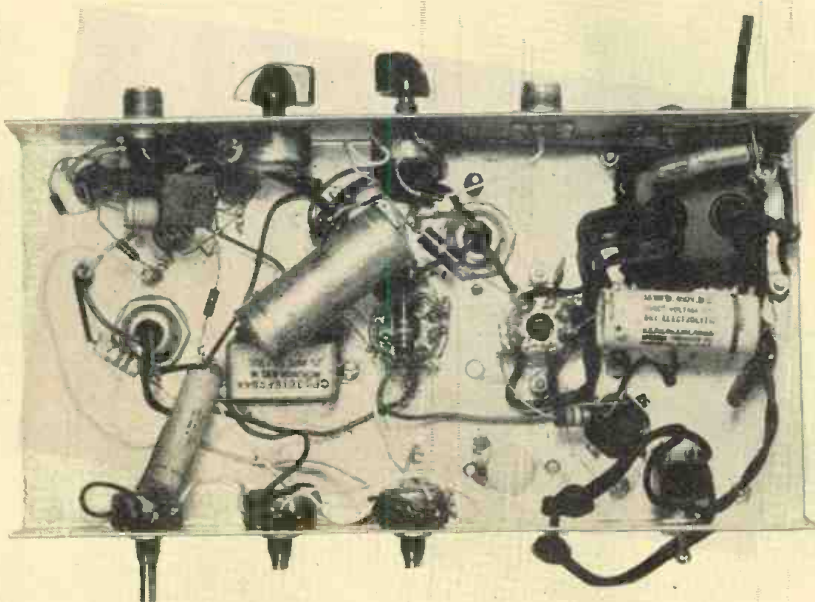

New AUDIO DEVELOPMENTS

By
JACK SIMON

Manager, Sound Studio, Terminal Radio Corp.



Three new speaker types. Each speaker has its own individual sound and the final selection of any one should be based on comparative listening tests.

A discussion of some of the latest improvements in styli, pickups, equalizers, preamps, amplifiers, etc.

OBSCURED by the widespread interest in television, the many developments recently effected in the audio art have been all but lost in the shuffle. In fact, because of the paucity of publicity on this subject, many otherwise well-informed men are of the opinion that there is "nothing new in audio." Nothing can be farther from the truth for, during the past year, the quality of sound reproduction has been increased to such a degree as to delight even the most discriminating.

This fact can best be illustrated by recalling a recent experience. A well-known symphony orchestra conductor came into the *Terminal* sound studio to replace a pickup arm for a very expensive set that he had purchased several years ago. To demonstrate the operation of the pickup arm I "piped" one of his records through our best amplifying and loudspeaker system.

The conductor was completely carried away by the recording to the extent of actually "conducting" an imaginary orchestra towards its end. He attributed his reaction to the fact that the quality of the sound was far better than any he had previously heard. Of course he was tremendously interested in "how I did it" and the explanation I gave him parallels, to some degree, the ensuing article.

The most important advance in audio is entirely intangible and extremely hard to explain. It seems that in addition to developing equipment which must meet rigid frequency response and distortion characteristics, a "plus" factor must be introduced into the design which recognizes that the human ear is the final judge of the "quality" of reproduction.

At the present time, we do not know exactly what this "plus" factor is. Many theories have been advanced and a considerable amount of research is presently being conducted to track it down. This much is known—two units may seem to have exactly the same electrical characteristics and yet one will sound better than the other.

In essence this is analogous to two piano players. One plays every note exactly as it should be played and his music is flat, while the other may ac-

tually strike a wrong chord occasionally, and yet his music has "feeling" and consequently greatness.

The biggest improvement made in audio within the past few years is in the introduction of "feeling" into the sound equipment. This improvement can be traced to the work of a number of engineers who are also topflight musicians. These men did not check the operation of their equipment on the oscilloscope alone. Instead, after obtaining the best possible oscillogram, they proceeded to pass the unit through its most severe test—their own ears. Final adjustments were made on the basis of best sound.

Because final adjustments were made to suit an individual ear, some systems will sound better than others to certain people. Each human ear has its likes and dislikes and consequently "bass" and "treble" controls are provided in better amplifiers to permit the listener to alter the audio until it sounds most pleasing to his ear. For this reason, "high quality" audio is, in the last analysis, primarily a function of the listener's music appreciation.

Of course there are also tangible improvements. It should be remembered that any audio system is no better than its weakest elements. There is no point in designing an amplifier of outstanding characteristics unless you have the record, pickup unit, and speaker that will match these characteristics. The impetus for the present intensified activity in audio is the development of the long playing record which, partly because of competitive necessity, is of far better quality. Starting with better records, it was then necessary to improve the audio reproduction systems to derive the full benefit of the higher quality. Fig. 1 is the block diagram of the units employed in an audio system. We shall

Fig. 1. Block diagram of the essential components in a high-fidelity sound system.

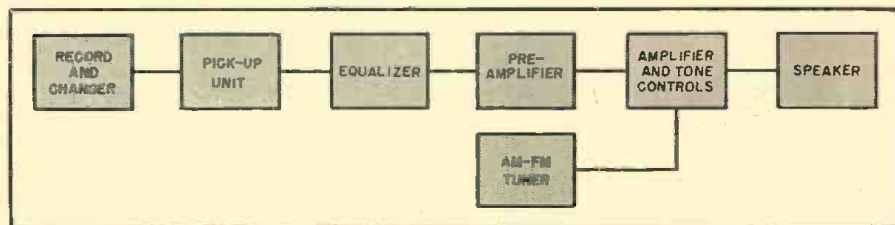

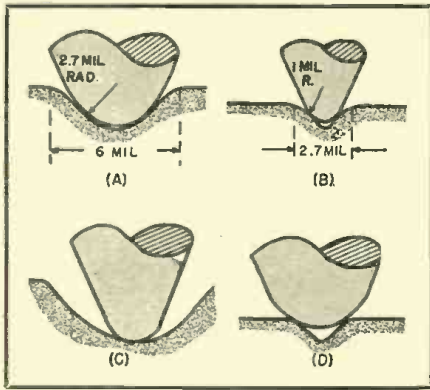

Fig. 2. (A) 78 r.p.m. groove, 2.7 mil radius stylus. (B) Microgroove, 1 mil radius stylus. (C) 1 mil stylus in a 78 r.p.m. groove. (D) A 2.7 mil radius stylus in microgroove.

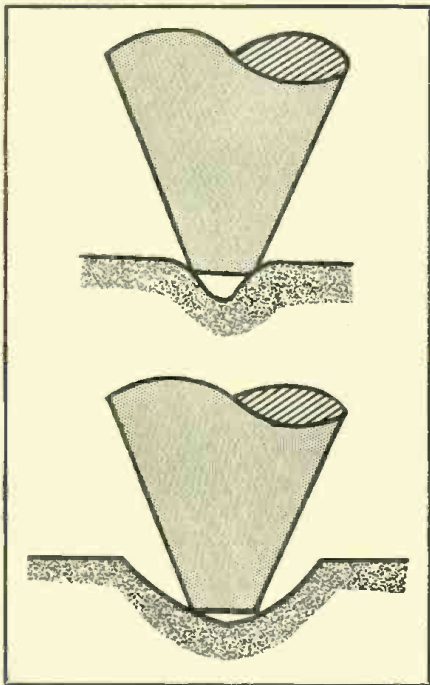

Fig. 3. Compromise stylus shape as it appears when resting in a microgroove (top) and a 78 r.p.m. groove (bottom).

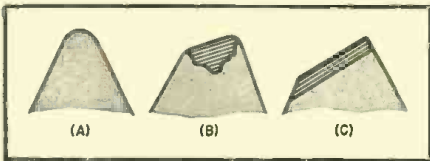
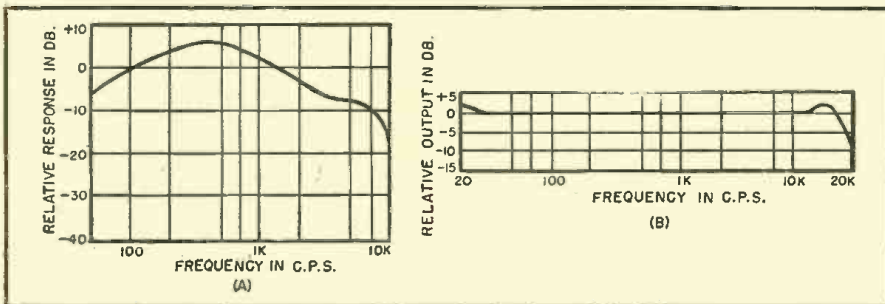

Fig. 4. Diagrams showing typical stylus wear. (A) A new stylus. (B) After 100 playings. (C) After being used 1000 times.

Fig. 5. (A) Typical crystal cartridge response curve. (B) Magnetic cartridge response.



consider the improvements effected in each of these units individually.

Pickup Unit

The pickup unit is comprised of three elements, i.e., the stylus (or needle) that contacts the record, the cartridge or crystal that converts the mechanical modulation to electrical energy, and the supporting pickup arm. Each one of these elements must meet rigid requirements.

The importance of the stylus in the audio system is often overlooked. To fully understand the functioning of this unit, a brief review of the relationship between phonograph grooves and needles is necessary. Fig. 2A shows a cross-section of a conventional 78 r.p.m. record into which a 2.7 mil tip radius needle is inserted. Fig. 2B shows a cross-section of a typical microgroove, or long playing, record with a 1 mil tip radius. In this case it can be noted that the tip radius must be considerably smaller to fit into the smaller groove. In each case the needle is made so that it is supported by the sidewalls, rather than the bottom of the groove, since in this manner it has a positive engagement with the groove and can be driven laterally without loss in motion. Under these conditions good reproduction is possible.

Consider what would happen if (a) a 1 mil stylus is used for 78 r.p.m. records, and (b) if a 2.7 mil needle is used for LP records. In this first case, as shown in Fig. 2C, the needle is not properly supported and cannot be driven laterally in a positive manner. When playing a modulated groove such a needle will "skate" from one sidewall to the other resulting in distortion and a characteristic swishing type of surface noise. When the needle is too big, 2.7 mil in microgroove, it hits the top of the sidewalls, as shown in Fig. 2D, and cannot follow the modulation accurately—again resulting in distortion.

A compromise stylus, shown in Fig. 3, has very recently been placed on the market. This stylus eliminates the necessity of using two different radii styli for conventional and LP records. With this stylus the effects mentioned above are minimized for either type record, as seen graphically in Fig. 3, but for high fidelity systems it is recommended that individual needles be used for each type of record.

From the above it is evident that the shape and size of the stylus is of utmost importance, particularly where

the audio system must meet the requirements of highly appreciative ears. Consequently, a great deal of research and development has been expended during the past year in determining the optimum stylus dimensions for each type of record, and it is likely that improvements will continue to be effected in the future.

Another important characteristic of interest is the durability of the stylus. It should be noted that when a stylus touches the record groove only a small part of the surface area is in contact with the groove walls and the pressure per square inch may amount to several tons! Under this pressure the styli tend to wear, rapidly at first and then, as the contact area increases and pressure per square inch decreases, wear continues at a slower rate. This effect, shown in Fig. 4, changes the stylus shape and hence introduces distortion in the system.

Frictional pressure not only affects the needle itself, but similarly cuts into the record so that it is modified and its quality deteriorated. Until recently it was believed that the use of a soft stylus material saves the record. However, it has been shown that softer material loads the record grooves with abrasive particles and hence modifies the groove characteristics. It is generally true that a stylus that wears poorly will, in time, affect the life of the record.

This problem has been particularly aggravated by the appearance of the microgroove because the narrower the groove the greater the frictional problem. For this reason a lighter vertical force is used though sufficient vertical force must be maintained to assure proper tracking. A light vertical weight is also required for best reproduction characteristics. However, despite the lighter vertical force, the stylus wear is far more rapid on microgroove than on standard groove. A rough estimate is about three times faster.

It is important to note that this deterioration of quality due to stylus wear occurs very gradually and therefore the listener does not readily notice the change. It is frequently not until the record is virtually ruined that the effect is noticed.

The degree of stylus wear is, of course, primarily a function of the type of material used. Steel wears very rapidly and is very rarely employed in high fidelity systems. Diamond styli have appeared recently and are by far the most durable and expensive type. Between these two extreme types, there are several materials, such as sapphire and osmium, which result in a fairly durable stylus at lower cost. The music lover who has collected a large number of records and plays them often will probably want to protect his investment by using a diamond stylus.

Cartridge

There are two basic types of cartridges; namely the crystal and mag-

netic cartridge. The crystal, because of its relatively low cost and high output, has been widely used for many years. However, as indicated by the typical response curve given in Fig. 5A, this cartridge has a poor and very non-uniform response characteristic. A poor response can sometimes be corrected by means of an equalizer, but it is extremely difficult to compensate for a non-uniform characteristic.

Magnetic cartridges, as indicated in Fig. 5B, are characterized by a much better and more uniform response but, until recently, were very expensive. The constant demand for better quality has led to the development of several magnetic cartridges which combine good electrical properties with reasonable cost. Consequently today most high quality audio systems use magnetic cartridges. Because the output of the magnetic cartridge is relatively low, a preamplifier is required when they are used. The preamplifier used should either be made by the manufacturer of the cartridge or his recommended circuits employed.

For the discriminating listener, one cartridge should be used for LP records with separate cartridge for standard records. In this way, records are played under optimum conditions. In this case, as with the stylus, attempts are being made to develop a single compromise cartridge for both type records. However, these cartridges, while satisfactory for many listeners, will at best be only a compromise.

Pickup Arm

Again, for optimum results the pickup arm must be carefully designed to assure the right vertical force for the stylus. Several new arms are available that provide adjustment for counter-balancing for different cartridges, a tracking adjustment, and a leveling adjustment. These arms are amazing in their ability to maintain tracking even when the record is at angles as high as 60°.

These features may seem like gilding the lily but when quality results are expected attention must be paid to minute details, for it is in these details that the difference between good reproduction and truly high fidelity reproduction exists, and the ear can readily detect the difference.

Equalizers

With the advent of wide frequency range and uniform characteristic cartridges, true equalization became a practical reality. Equalizers are designed to compensate for the non-linear characteristics of the record and pickup unit. Previously the non-uniformity of the crystal cartridge made it impractical to effect compensation for the pickup unit and hence only partial equalization was possible.

To fully understand the need for equalizers it is necessary to briefly review the properties of records. Two methods of cutting lateral recordings are available; namely constant amplitude and constant velocity. In con-

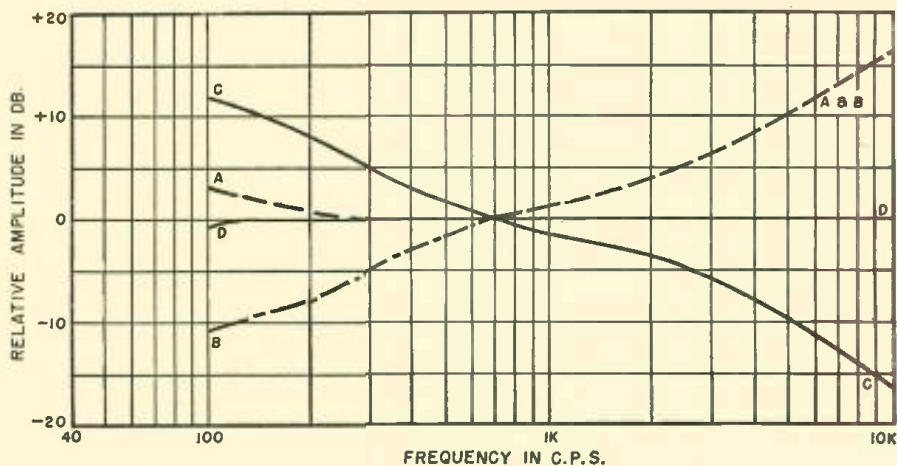

Fig. 6. (A) Recording characteristic. (B) Characteristics when played by a magnetic cartridge. (C) Equalizer characteristic. (D) Over-all characteristic (A + B + C).

stant amplitude recordings, the lateral displacement of the cutting stylus remains constant at all frequencies for a given input voltage but the lineal velocity varies with frequency. In the constant velocity method, the lineal velocity of the cutting head is constant for all frequencies for a given input voltage but the amplitude changes.

Consequently in the constant velocity cuttings the amplitude increases at low frequencies and may cut into an adjacent groove, while in the constant amplitude recording the lineal velocity becomes so high at high frequencies that it is difficult to cut and impossible for the playback needle to track. As a compromise the recording companies use constant amplitude at low frequencies and constant velocity at high frequencies. In this manner they are able to use each system to advantage. The point of change from constant amplitude to constant velocity is called the crossover frequency and is usually 500 cycles in domestic recordings.

Since the recording companies employ both methods of cutting on a record neither a crystal pickup (which is amplitude sensitive) or a magnetic pickup (which is velocity sensitive) will produce a flat characteristic. Thus, an equalizer is necessary to compensate for loss in pickup gain. Furthermore, since different recording companies produce records with different

response characteristics, modern equalizers have different circuits to cover records made by different companies.

When a magnetic cartridge is used it is not only possible to compensate for the record characteristics but also for the pickup unit. Furthermore, the frequency range of the equalizer has been extended to well beyond 10 kc. to take full advantage of the wider frequency range available.

An example of the equalizer action is shown in Fig. 6. In this figure a typical recording characteristic of a long playing record (A) is shown. Note the low frequency boost, the 500 cycle crossover, and the high frequency boost. The low frequency boost is provided to reduce the effects of hum and turntable rumble, while the high frequency boost is designed to minimize surface and stylus noise.

Fig. 6B shows the response characteristics of the LP record when picked up by a magnetic cartridge. As indicated by this curve, the low frequencies would be at a lower amplitude than they should be, while the high frequencies are over accentuated. Fig. 6C illustrates the equalizer curve that should be used with the recording. The output of the equalizer would then be the flat response shown in Fig. 6D.

Some manufacturers combine the
(Continued on page 118)

The new Pickering pickup arm designed to assure proper stylus pressure and tracking.

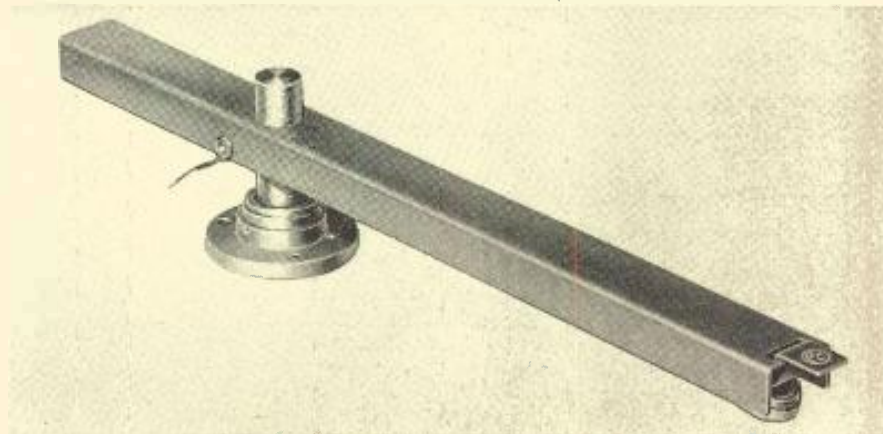

Mac's RADIO SERVICE SHOP

By JOHN T. FRYE

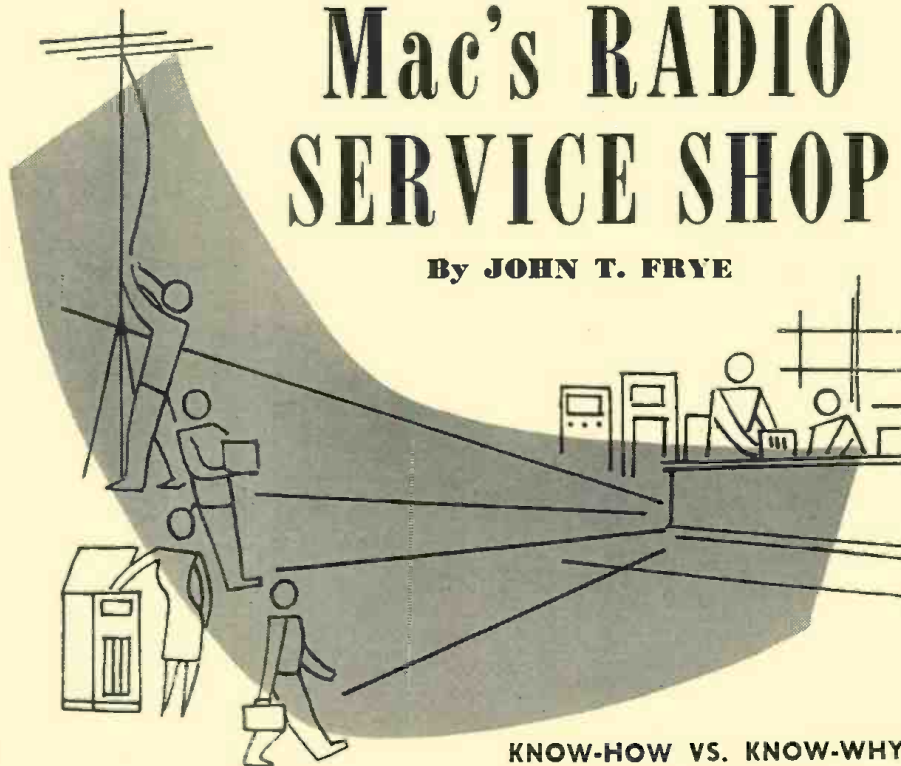

KNOW-HOW VS. KNOW-WHY

CHRISTMAS was still three weeks away, but the day itself was strictly off a Christmas card. A heavy snowfall the night before had given all the roofs a richly overstuffed look that was still further enhanced by glittering icicle fringes along the eaves. The brilliant sunshine cast purple shadows on the spotless snow.

All was warm and cozy inside Mac's Radio Service Shop. At the front of the store Miss Perkins was busy arranging, rearranging, and rearranging—after the immemorial way of women—the various small radios, toasters, mixers, electric razors, etc., that Mac always displayed on his shelves for the Christmas trade. In the service shop proper Mac and his assistant, Barney, were—after the immemorial way of men—loafing under the pretext that they deserved and needed a “break” from the hard work they had been doing.

“Whew!” Barney said as he sprawled at full length on the service bench. “I think we have repaired every radio in the county during these past two weeks, and I *know* that we have checked every TV set in town. If the people are not able to see and hear Santa, it is not our fault. Everyone certainly intends to make this an electronic Christmas.”

“Which is quite all right with us,” Mac said complacently. “Not to change the subject, though, what were you doing to John Reddinger's portable radio? All he complained about was low volume, but it looked to me as though you were giving it a major overhaul.”

“I was changing one of the tubes so it would have more gain,” Barney explained. “The dumb bunnies who designed that set must not have known

their stuff. I don't see how it could have had much pep with the tube line-up they used. I yanked out a socket and put in another that let me use a tube with a higher amplification factor.”

“And how is it now?” Mac asked with suspicious casualness.

“Well, to tell the truth, I was rather disappointed,” Barney said. “I am sure it is better, but it still is no ball of fire.”

“As I recall,” Mac said with a frown, “that set always had excellent volume. Let's have a look at it.”

Barney swung his long legs off the bench and slid the little chassis over to Mac. The owner of the shop prodded around inside it for a few minutes with a plastic rod, and suddenly the volume increased several times.

“Well I'll be darned!” Barney exclaimed. “What did you do then?”

“Just moved a coupling condenser so that the lead that was making a poor contact with the foil made a better contact,” Mac replied. “Before, the condenser was acting like a condenser in series with a high resistance. What fooled you was the fact that it was not entirely open-circuited. They'll do that sometimes, and about the only change will be a big reduction in volume and a loss of bass response.”

“Guess I had better change that tube back, huh?”

“Yes, I guess you had; and while you are doing it, let's have a little chat about gilding the lily.”

“I'm a sucker for asking, but what do you mean?”

“I mean that I want you to think a long time before deciding to ‘improve’ on a radio or TV set. Changing the circuit should always be a last resort instead of a form of first aid.”

“You are suggesting that perhaps the fellows who design these sets are maybe not so stupid after all?”

“That's the general idea,” Mac said with a wry grin. “Most of those fellows have had many years of engineering schooling plus many more years of practical experience. Their designs are checked and rechecked by other radio engineers and production men before the assembly lines are started. Even after that the ‘pilot run’ shows up other defects, and many other improvements are made after production starts.

“Remember, too, that the fellow who sold the set must have liked it when he got it from the jobber, and the owner must have been pleased with its performance when he bought it. In view of all this, it seems a pretty far-fetched assumption to decide that the set was *never* any good just because it is not working so hot when we get our hands on it. It would seem only logical to try and restore the set to its original working condition before deciding that the circuit needs revamping.”

“It is possible you have something there,” Barney cautiously offered.

“Of course,” Mac said, “if you are really a hot-shot service technician and feel obligated to prove it, you cannot be bothered with simply repairing a set. That is purely kid stuff. The thing to do is to tear it all apart and then put it back together again according to your own pet ideas. It may not work so well as before, but that does not matter. The important thing is that you have demonstrated your ability to take 'em apart and put 'em back together again.”

“Okay, okay! Lay off the heavy sarcasm,” Barney pleaded. “From now on I promise never to so much as replace a No. 44 pilot lamp with a No. 47 even in a transformer set. But aren't there some instances where changes are warranted?”

“Yes, there are a few such cases,” Mac agreed. “During the war we were forced to make many circuit changes simply because we could not get the proper replacement parts; and it seems very likely that we shall be doing some of that again. Some shortages are already beginning to crop up as a result of the increase in military requirements, and more will probably follow.

“Then, too, there are cases where a set has to be altered so that it can be used in a manner or in a location different from what the manufacturer intended. A good example is the way in which we narrow the i.f. bandwidth of TV sets in this ultra-fringe area in order to get more gain. Strictly speaking, this does not ‘improve’ the receiver at all. It simply allows us to exchange picture detail, which we could not take advantage of, for much-more-important-to-us picture-stability and contrast. The manufacturer's alignment is the best for the signal level for which the set was designed, but our alignment is best for the

(Continued on page 142)

RADIO & TELEVISION NEWS

NAVAL COMMUNICATIONS

By REAR ADMIRAL JOHN R. REDMAN, USN

Director, Naval Communications

Born Reno, Nev. in 1898. Graduated from U. S. Naval Academy in 1918. Promoted to Lieutenant (jg) during World War I, advanced to rank of Captain in 1942, became a Rear Admiral in 1944. He took a post graduate course in radio engineering at Annapolis and subsequently served in various communications posts in many different theaters. From October 1942 until March 1945 he served as communications officer and assistant chief of staff for communications on the staff of Fleet Admiral Chester W. Nimitz. He commanded the USS Massachusetts until 1946 after which he assumed command of the Naval Receiving Station at Treasure Island. He became Deputy Commander and Chief of Staff to the Commander Western Sea Frontier in 1947 and later served as Deputy Commander Western Sea Frontier and Deputy Commander Pacific Reserve Fleet. In July 1949 he reported to the Chief of Naval Operations for duty as Director, Naval Communications, a post that he continues to hold at the present. He has been decorated 9 times.



Fifty years ago Marconi installed the first wireless equipment on Navy ships. Today, utilizing all forms of communications, naval forces, whether on land, sea, or in the air, are united as a single fighting unit.

ON A GRAY morning in 1803, Commodore Edward Preble set sail with a "task force" of wooden ships to instill respect for the infant United States in the pirates of the Barbary Coast. Preble's communications consisted of a strip of bunting, a megaphone, and a bull voice. Naval Communications have come a long way since those pioneer days.

Early progress was primarily in the extension and perfection of visual communications systems. By 1875, the Navy was experimenting with electricity for signaling. There was much excitement the following year when signals were read at a distance of 6 miles by means of an electromagnetic device. The flash lamp, perfected in 1878, permitted signals to be read at the unheard-of distance of nearly 17 miles! Communicators of the day hailed the event with enthusiasm. But it was the advent of "wireless" that gave Naval Communications its real impetus.

With the Nineteenth Century approaching its close, Guglielmo Marconi startled the world by his experiments with wireless. He was invited to experiment under Navy supervision. As early as 1900 the young inventor and his assistants were installing the "Marconi device" aboard several vessels. In 1901 the Navy made its first wireless installation on a battleship. A year later the first Naval wireless test stations on shore were established at Annapolis, Maryland and Washington, D. C. During 1903, five different systems of wireless were under test in the United States. By the end of that year, the Navy's tests had progressed to the extent that seven ships and five shore stations were fully equipped with wireless apparatus and operators were furnished for service use. Wireless had shed its swaddling clothes and was growing rapidly.

The Navy now demanded that the new equipment be installed on all its fighting ships. Meanwhile, developments ashore kept pace with those at sea. Six experimental stations were built. A special training school was established at the Brooklyn Navy Yard. Wireless—or radio, as it came to be called—was in the Navy to stay. From then on, advance followed advance, keeping pace with technological progress, lessons learned from operational experience, and the needs of the Navy.

The present-day Naval Communication Service would stagger the imagination of communicators of the early 1900's. All known forms of communication are employed. Today's naval vessels are floating communications centers

—from the tiny torpedo boat with as few as seven radio circuits to the mighty carrier with more than a hundred. The extensive, yet flexible circuits of the Naval Communication Service keep the fleet units of a seven-seas Navy in constant communication with each other and with the Naval Shore Establishment. Through careful planning, an organization has been built up that can get in touch with any ship in the fleet almost instantly. With the facilities now available, a ship out of sight is never a ship out of mind. No longer does the control of communications by shore stations extend only as far as the eye can see through a telescope. Today, distance does not limit communications, for messages can be sent around the world.

The Naval Communication Service (NCS) has three watchwords—"Reliability, Security, and Speed." The performance of each element of the myriad services and devices which make up the over-all NCS is weighed in terms of those three factors. As the name implies, Naval Communications is a "Service." Its mission is to provide

A Navy radioman operates teletype equipment. These units are now being used extensively by the Navy. A private network of such teletype stations links far-flung stations and ships.



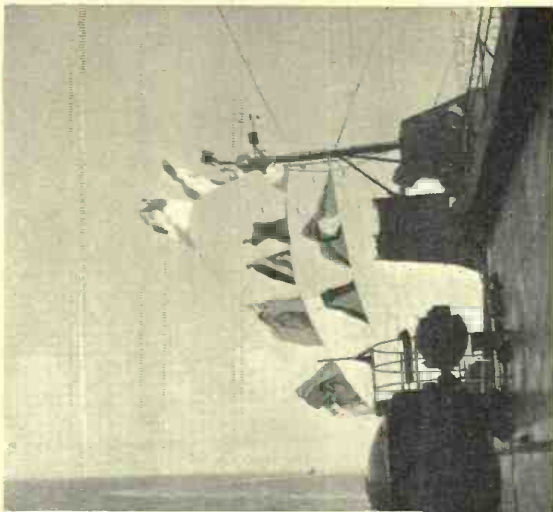

Visual signals are still widely used in the Navy. (Top) Flag-hoist signals for maneuvering and (Bottom) semaphore signals.

and maintain reliable and secure communications, based on war requirements, adequate to meet the needs of the Operating Forces, the Navy Department, and the Naval Shore Establishment, primarily to serve command and secondarily to facilitate administration.

In considering command, a parallel is found in the game of football. The quarterback on a football team is, in effect, the "officer in command." When he directs a play, he is exercising a function of command, and each signal he calls is a command communication. The information he passes on is the most important his team can receive, for it determines just which course of action will be taken against the opposition. Naval Command, playing a role similar to that of the quarterback, controls the movements of the operating forces. Command cannot function smoothly without reliable and rapid means of sending and receiving information—and no Naval operation can be successful without the smooth functioning of Command. Thus it is that the first duty of the Naval Communication Service is to serve Command.

All Navy dispatches do not relate directly to combat, even in wartime. Most communications deal with activities that support the fleet. It is a big task to equip and train all the personnel in the Navy and to provide for them such vital needs as ammunition, transportation, food, clothing, hospitals, and supply depots. In moving the countless messages that must be handled to carry on the work of supporting the fighting forces, Naval Communications facilitates Administration.

To maintain the objectives of "Reliability, Security, and Speed," flexibility is a necessity. In the development of Naval Communications, it has been found that no one method of passing information can adequately serve all purposes at all times. Scientific progress has added immeasurably to the effectiveness of communications, but it has not eliminated the utility, under certain conditions, of some of the earliest methods of signaling. The systems of communications employed today in Naval Communications embrace many new, some old, methods. They run the gamut from hand semaphore to the advanced radiotele-

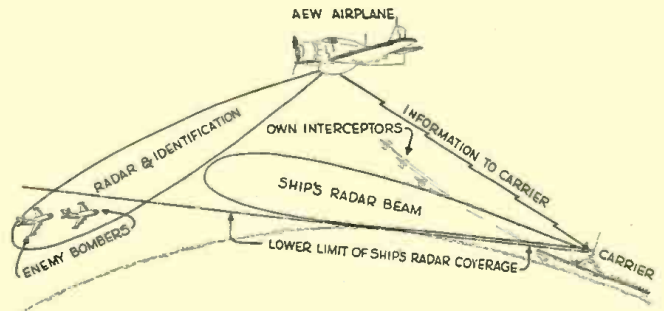

Diagram of how a plane, carrying "airborne early warning" radar equipment, is used to relay this information over the horizon.

type, and include visual communications, sound, wire systems, radiotelegraph, radiotelephone, facsimile—radio-photo, television, and even messengers.

Messenger communication, as the name implies, provides delivery by hand from the communication office of the originator to that of the addressee. The courier who carried news of victory from Marathon to Athens was a forerunner of today's messenger. When other methods, especially radio channels, are overloaded, messengers do much to relieve the congestion. Like messenger service, mail is an important alternate method for easing the transmission load on wire and radio circuits. It should be noted that the Navy Postal Service is an integral part of the Naval Communication Service. Naval Communications has responsibility for the establishment and operation of Navy post offices, both afloat and ashore.

Visual Communications

The transmission of intelligence by visual methods is ancient in origin. Yet, today visual communication still holds its own along with more modern systems. The three principal types of visual signaling—flaghoist, semaphore, and flashing light—meet the rigid demands of good naval communications.

Flaghoist signaling, because it can be used to reach a complete group of ships rapidly and simultaneously, is about the most efficient type of visual short-range communications. Almost all flaghoists are coded signals. To communicate by flaghoist, the originator selects the combination of flags that will convey his particular message. The flags are then attached to the halyard which carries them to a yardarm to form a display—a complete flaghoist message. The receiving station reads the meaning and takes appropriate action. More than 60 flags and pennants

WAVES in mock-up control tower during familiarization course which is given at the "Airman School"



RADIO & TELEVISION NEWS

A Navy signalman uses one of the Service's signal searchlights to maintain communications during "radio silence."

A different form of searchlight which utilizes an infrared filter and a specially-designed infrared viewer.



go into action at one time or another. It is an inspiring sight, to any observer, to see a large convoy of ships traveling in close formation, maneuvering in unison to displays of multi-colored flags.

Semaphore is another fast, short-range form of signaling. It requires the most simple equipment of standard visual methods, just two flags attached to staffs. Being restricted to short-distance communication, Semaphore is more secure than either radio or light, since there is less chance of interception.

The third principal visual signaling method is flashing light. It is a visual telegraphic system using International Morse Code, the same code used by radiotelegraph operators. The signalman sends and receives dot-and-dash characters as short or long flashes of light. There are two systems of flashing light, directional and non-directional. In directional signaling, the light is aimed at the ship or station to which the message is being sent. Searchlights, blinker tube, or a multi-purpose signal lamp are used for this purpose. Non-directional signaling is accomplished by yardarm blinkers. These are (Continued on page 120)

Radar, magnetic airborne detection, and sono-buoy listening devices make up the electronic "nerve center" of anti-submarine blimp.

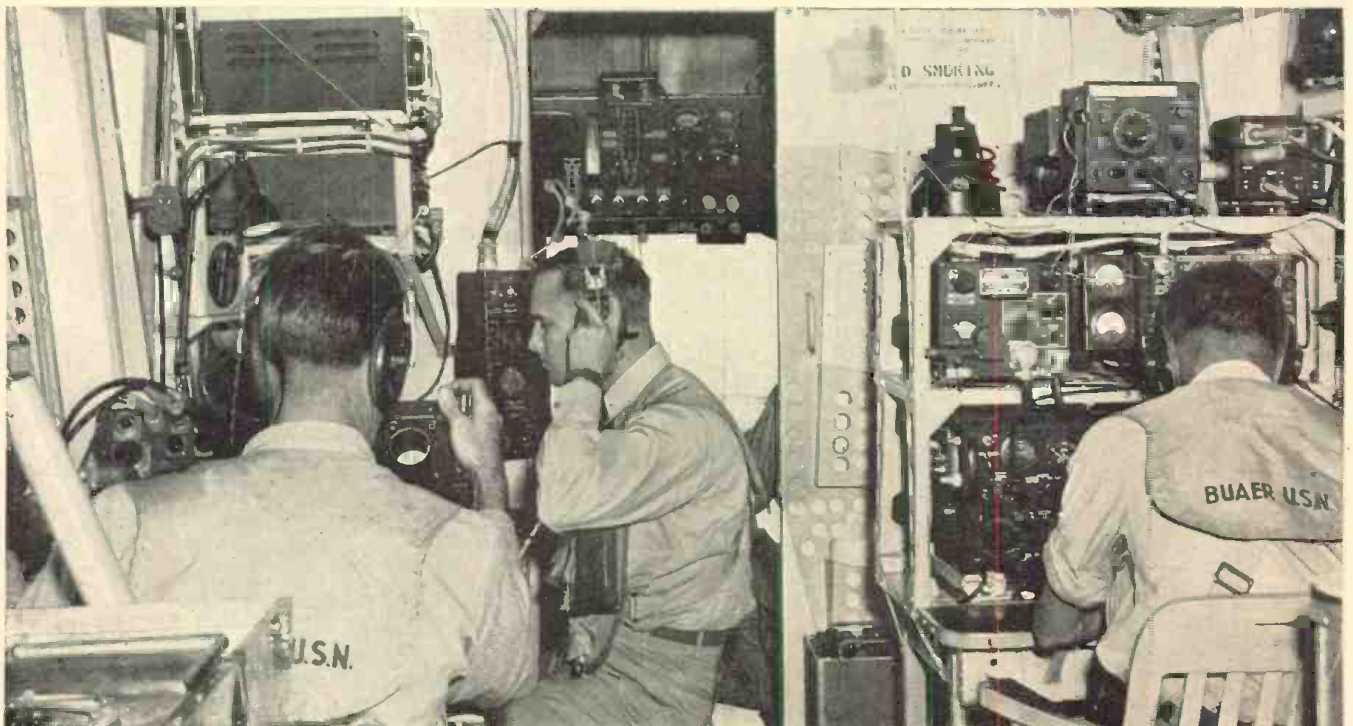

TECHNICAL ASPECTS OF NAVAL COMMUNICATIONS



By **CAPTAIN J. A. MORRISON, USN**

Head, Equipment Engineering Section
Division of Naval Communications

A "behind-the-scenes" review of the problems involved in coordinating the U. S. Navy's vast research, procurement, and installation programs.

Graduated U. S. Naval Academy in 1926, completed post-graduate course in electronic engineering in 1935. Officer-in-Charge of U. S. Navy Radio Materiel School at Anacostia, D. C. from 1938-49. During war served as Communication Officer attached to British Combined Operations Staff, attached to Allied Forces' Headquarters (North African Campaign), served on USS Yorktown, and became Communication Officer, U. S. Naval Forces (Europe). Except for two years in San Juan, Puerto Rico, he has headed the Equipment Engineering Section of the Division of Naval Communications since 1945.

THE Naval Communication Service is provided for by the Navy Communication System (shore stations) and shipboard radio facilities. The shipboard facilities provide communication channels between ships, fleet, and task force commanders. Ship-shore and air-ground circuits are part of the entire service. The primary, major, and minor relay stations of the Naval Communication System employing wire and radio systems both automatic and manual, handle the Navy's point-to-point traffic and fleet broadcasts. To maintain this service, both shore station and ship require the very latest and most modern type of communication equipment.

To accomplish progressive improvement in fleet communications, the Office of Chief of Naval Operations' staff includes trained electronic officers who are thoroughly familiar with ship and shore communication systems. These officers hold membership in various Joint and Combined Electronic groups, Electronic Committees of the Na-

tional Research and Development Board, the Munitions Board, the International Telegraph Union, and many other civil and military electronic organizations. Careful attention is paid to system-wise engineering to insure that communications can be maintained with the U. S. Army and the Air Force units, certain foreign military and commercial systems, as well as with domestic U. S. commercial systems.

Technical reports from the civil and military research laboratories are carefully reviewed in order that new methods or techniques that have military application may be considered and adopted, if improvement to naval communications is indicated.

As technological advances in design of new weapons are made, either by unfriendly nations or by the United States, tactics or counter tactics are developed in our operational planning sections to take advantage of, or overcome them.

This ever-changing struggle presents naval communi-

Interior of an operating building at U. S. Naval Radio Station, Mare Island, California in 1904. Note "dated" equipment.

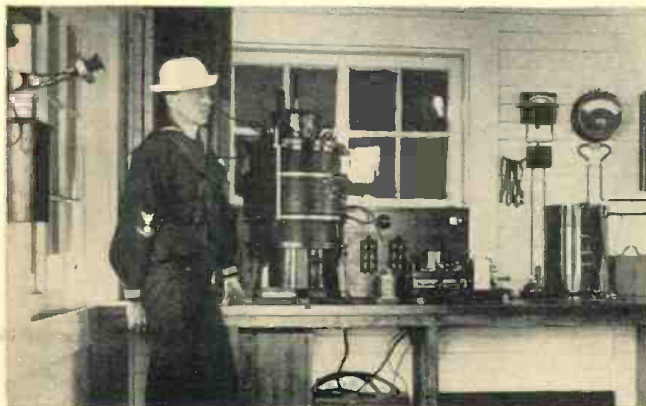

Monitoring equipment, installed at Navy Radio in Washington, D. C., makes a record of all transmissions over the system.



RADIO & TELEVISION NEWS

cation equipment and system engineers with the task of not only satisfying current requirements, but at the same time solving the problem of arranging research, development, procurement, and installation programs to insure that equipment and systems, sometimes of comparative radically changed characteristics, will be available should war come suddenly. As far as the Navy is concerned, when it is realized that from writing the specifications to the completion of the installation in all ships of the fleet of just one piece of communication equipment, may take as long as four years, even under wartime production schedules, the job of keeping fleet communication systems fitted with equipment of advanced design can be appreciated.

To insure that the best equipment available is purchased, a considerably complicated process must be followed. A government purchase involving the taxpayers' money must be justified as thoroughly as practicable, and all manufacturers must, under the law, be given opportunity to obtain the contract. The primary requisite for a justification is known as an operational requirement.

This protective helmet for pilots is literally "wired for sound." It contains a built-in headset and an adjustable microphone unit.



Navy communication and radar training on board an R4D electronics flying classroom.



A television camera peers into the cockpit of a mock-up Navy bomber as the "pilot" and "co-pilot" demonstrate a simplified control system. By means of microwave or coaxial cable relays the demonstration can be witnessed by personnel at remote naval stations or units of the fleet. The Navy is experimenting with mass training by television at Sands Point, Long Island.

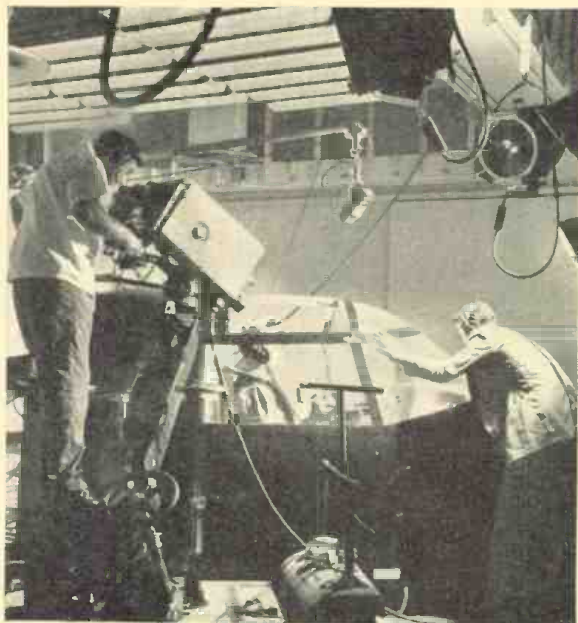

Operational requirements originate in the Office of the Chief of Naval Operations, and are based upon fleet doctrine, fleet tactics, and ship developments. Since shore stations exist fundamentally to support the fleet, an operational requirement for shore communication equipment generally stems from a fleet requirement.

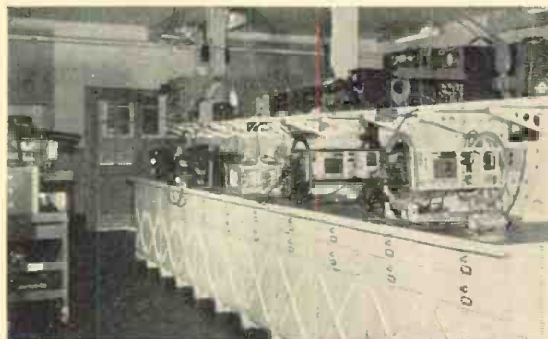

A Navy workshop setup for testing and repairing aviation communication and other electronic equipment.

These operational requirements are studied in the Naval Communication Division of the Navy Department, and from these studies are determined the allowances of equipments per ship and shore station that will fulfill them. The equipments required are listed by frequency range, distance coverage necessary, and the type of emission desired. In the case of ships, the requirements are listed in a Tentative Type Allowance, one being prepared for each type of Navy ship. The Bureau of Ships proceeds to fill this allowance with equipment available. If the equipment available will not meet the specified requirement, or cannot be economically modified, then new equipment must be developed and procured.

The first step in the development of new equipment is to write a set of military characteristics. These characteristics are written in broad terms to cover fully the operational requirement. After the preparation in the Office of the Chief of Naval Operations, the characteristics are submitted to the Joint Communications Electronics Committee of the Joint Chiefs of Staff, which is composed of representatives of the Army, Navy, and Air Force. The characteristics are studied for possible joint interest, and yield information as to whether equipment already exists, or is planned, that will fill the requirements. Technical and operational sections of the three Services study the characteristics and determine whether or not there is a joint interest in the proposed development.

After approval of the Joint Committee, the characteristics are forwarded to the Bureau of Ships. As the next step, the Bureau of Ships, using the military characteristics as a guide, writes a set of technical specifications. Here, in the interest of (Continued on page 94)

Building the "WILLIAMSON" AMPLIFIER

By **HERBERT I. KEROES**
Acro Products Co.



Fig. 1. Two views of the audio amplifier. The power supply is built on the same chassis as the amplifier.

**High quality performance is obtained
from this American version of a British design.**

THE Williamson amplifier circuit* originated in England by D. T. N. Williamson has attracted world-wide attention from high fidelity enthusiasts because of the almost perfect quality of the reproduced output. There are many features in the amplifier that make it an attractive construction project for the builder. The circuit is simple, free from critical adjustments, and may be built economically of top quality parts at a cost of less than \$50. Within its power rating of 10 watts at less than 1% intermodulation, the amplifier proves to be ideal for home and small auditorium installations.

The performance of the amplifier, based on listening tests, can best be described as containing the elusive "presence effect," a quality inherent in low distortion equipment with the flat frequency response and low phase shift that enables speech and musical transients to be correctly reproduced. The bass response is solid and free from harmonic distortion. Highs are clean and crisp with none of the shrillness so often experienced with other amplifiers.

Since a number of the components specified in the original amplifier are of English manufacture, considerable

effort was made to choose substitute parts that would permit the same high degree of performance attributed to its prototype.

The circuit diagram of the amplifier is shown in Fig. 2. The circuit contains four resistance-coupled stages and is operated with 20 decibels of voltage feedback taken from the secondary of the output transformer and carried around the complete amplifier. Medium mu triode tubes are used throughout and are biased to operate with minimum distortion. A noteworthy feature of the amplifier lies in the selection of the type of output tube. This is a power tetrode which is connected in the circuit to function as a medium mu power triode. The driving voltage required is much smaller than that taken by the more conventional 2A3 or 6B4 type of output tube, and the driver operates with considerably lower distortion.

The first two stages of the amplifier are somewhat unusual. The first stage, which is a voltage amplifier, is directly coupled to the second, a cathodyne inverter. This method of coupling is made possible by the high operating potential on the inverter

cathode. The two stages are self balancing and bias themselves to a low distortion operating point.

The heart of the amplifier is the output transformer. This device must provide response that extends well beyond the limits of the audio band in order to limit phase shift to the requisite degree in the feedback circuit. It is the degree of success with which this is achieved that makes for fidelity in musical transient reproduction. The original specifications of the output transformer call for response which is down not more than 3 db. at 3 c.p.s. and at 60 kc. An American counterpart, the Acrosound TO-290, faithfully copies the performance of the original and is used in the circuit here described.

The type 7N7 tube has been selected for use in the voltage amplifier stages because of its shielded construction, low internal capacity, and symmetrical base layout that permits direct point-to-point wiring. The output tubes are the type 807, the characteristics of which are similar to the KT-66 British type used in the original. The plate resistance, however, is about 20% greater for the 807, and this requires a corresponding increase in the plate-to-plate match of the output transformer in order to obtain the same low figures of distortion in the output. The plate-to-plate impedance of the transformer is, therefore, 12,000 ohms instead of the 10,000 ohms specified for the original. Another excel-

* Wireless World: April, May 1947, August 1949.

lent output tube which may be used is the *Western Electric* type 350A. This tube has greater power capabilities than the 807 and will provide up to 25% more output.

One deviation has been permitted in the circuit and is based on the operating characteristics of the 807. An electrolytic condenser has been added across the cathode biasing resistor arrangement of the output stage and has been found to be of material advantage in further reducing distortion at high output levels.

Construction

The amplifier is constructed on a single 10 x 14 x 3 inch chassis. Considerable care has been taken in the layout to permit direct point-to-point wiring in all signal circuits and to avoid extraneous couplings which may introduce instability into the feedback loop. In the construction of the amplifier a ground bus is not used since no improvement will be effected through its use provided several precautions are observed. Ground returns should be made closely adjacent to the stage affected. This may be easily done by using sockets with ground lugs projecting from the mounting ring. It is also desirable, but not essential, to solder one mounting tab of each electrolytic condenser to the mounting plate and one point on the plate to the chassis. The filaments are wired by running a separate two-conductor pair to each stage. The filaments do not necessarily have to be twisted. It is desirable that they be cabled or taped compactly together. The filament wiring is grounded at one point only; at the first stage, as indicated.

After the amplifier is wired and checked, it may be turned on and connected to a speaker load. If any motorboating is experienced the two plate leads connected to the output transformer should be interchanged. The plate currents may then be balanced, after which no further adjustments will be required. The amplifier will be driven to full output by about two volts r.m.s. Although a volume control has been included on the amplifier chassis to permit setting the level when the unit is used with a variety of inputs, for most installations it will not be required, and may be replaced by a resistor of equivalent value. A power take-off plug has been provided to facilitate external control from a separate preamplifier chassis.

A suggested preamplifier circuit is shown in Fig. 3. It incorporates tone controls and compensating controls for the various recording characteristics and is designed for use with reluctance cartridge input. Crystal cartridges can, however, be operated into the tuner input channel. Constructional details are not given and are (Continued on page 76)

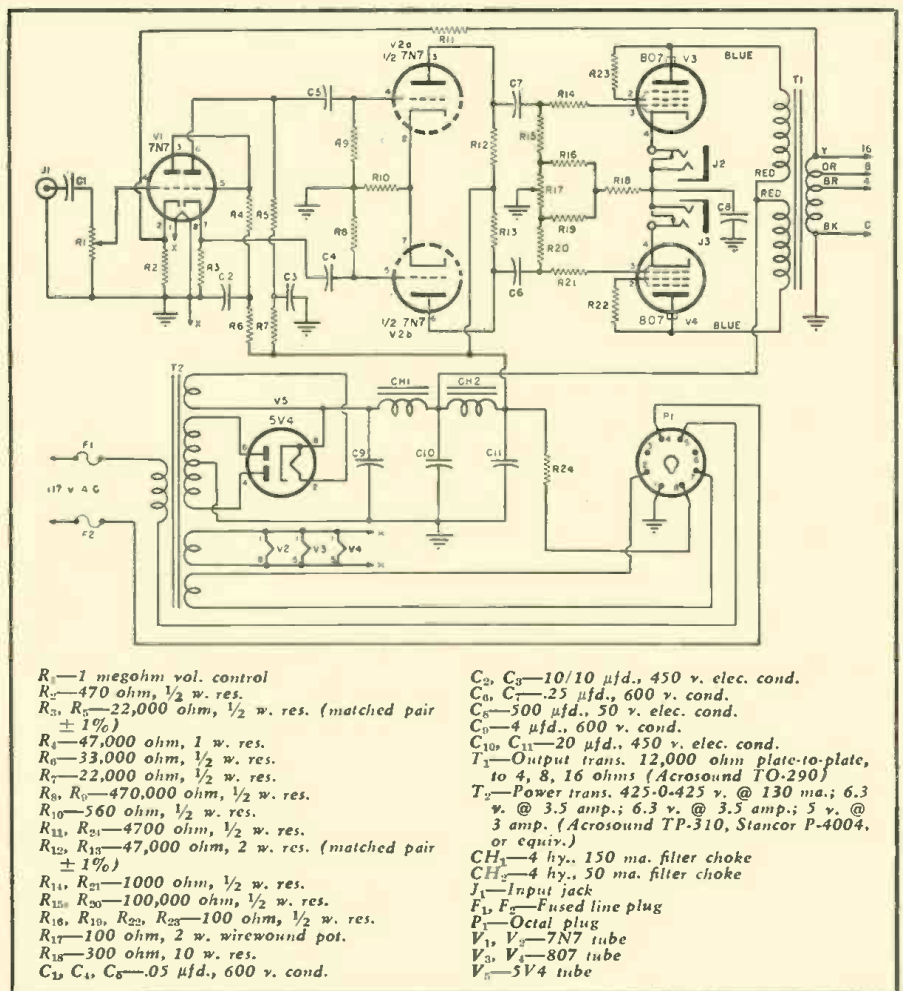
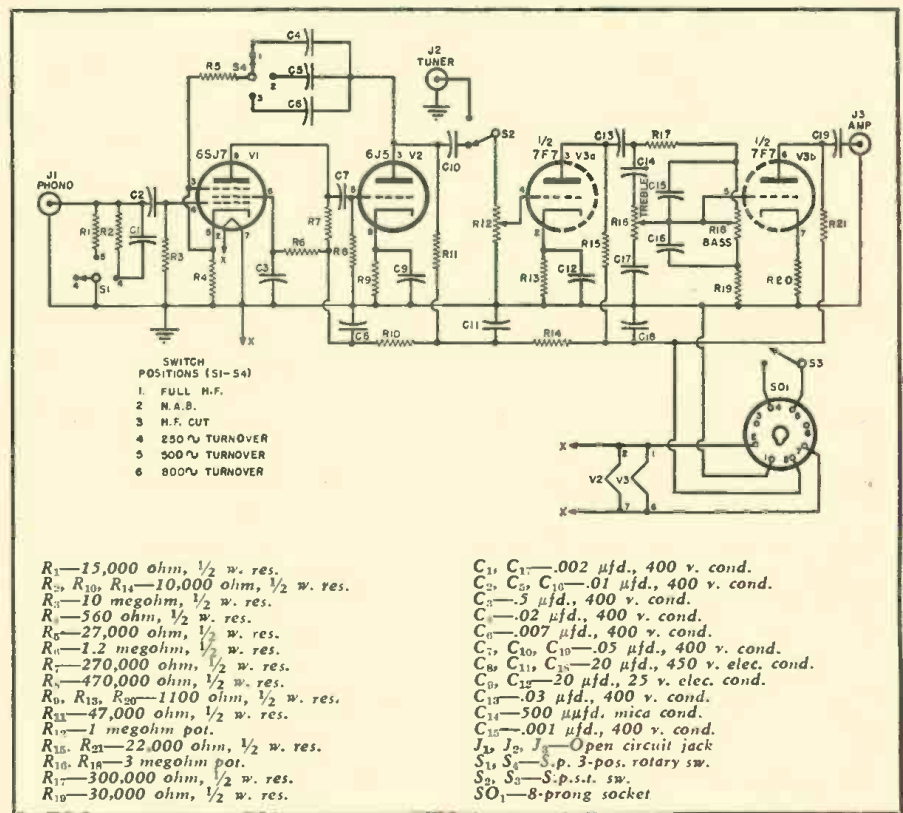

Fig. 2. Complete circuit diagram of the American version of the "Williamson" amplifier.

Fig. 3. Suggested preamplifier incorporating tone controls and equalizing networks.





International SHORT-WAVE

Compiled by **KENNETH R. BOORD**

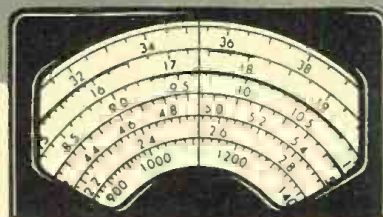

WE ARE pleased this month to dedicate the *ISW DEPARTMENT* to radio in Denmark. Direct from Paul Berg, chief of the press department, The Danish State Radio, Copenhagen, comes this interesting information:

The first radio broadcast in Denmark was made October 29, 1922. It was an experiment in which a ship's installation was used as a transmitter while the receiving apparatus was placed in a lecture hall in Copenhagen. In 1923, a transmitter was built for broadcasting. At the same time, a military transmitter was used for broadcasting purposes. The programs of these two stations were organized by two competitive listeners' organizations. Money for artists' fees and for administration was provided by private contributions. But both listeners and the State claimed a more satisfactory organization of the broadcasts.

In March 1925, Parliament agreed that as an experiment the Telegraph Administration should handle the broadcasts for a year. So on April 1, 1925, the State took over broadcasting. A Radio Council—composed of 38 members—was appointed to supervise broadcasting during the year's experiment and an annual fee was imposed on listeners amounting to 10 Kr. for a crystal receiving set and 15 Kr. for a tube receiving set. On March 31, 1926, listeners numbered 28,140. On March 13, 1926, Parliament adopted an Act of Broadcasting which set forth that the Broadcasting Service should remain a State function.

For 15 years, the Danish State Radio was controlled by the Ministry of

Public Works, but on August 8, 1940, it was placed under the Ministry of Education—except for its technical service.

The Radio Council now consists of 16 members, 11 of whom are appointed by the Minister of Education; two direct; one member must be a radio technical expert, upon nomination by the Minister of Public Works; one upon nomination by the Association of Newspaper Editors; one upon nomination by the Association of Journalists, and six upon nomination by the Listeners' Associations; the remaining five members are appointed by the five great political parties of the country as their representatives. From these members, the Minister appoints the president and vice-president of the Radio Council; the vice-president is a technical radio expert.

The Radio Council is responsible to the Minister of Education for the management of the Danish State Radio and of the Radio Fund (license fees) in accordance with a budget approved by the Minister. It lays down the general principles of the radio programs and is responsible for their being of a versatile, cultural, and educational nature. *Advertising by radio is strictly forbidden.*

Stations currently listed are Kalundborg, 245 kc., 60 kw.; Kalundborg, 1061 kc., 5 kw.; Copenhagen, 1430 kc., 30 kw.; Copenhagen, 1484 kc., 2 kw.; s.w. transmitter using OZU, 7.260, OZF, 9.520, and OZH, 15.165, 50 kw.; FM transmitters on 42.0 (800 watts) and 93.1 (1 kw.), respectively.

Official languages are Danish, Faroese, and Greenlandic. Purpose of in-

ternational broadcasts from Copenhagen are "to maintain contacts with 10,000 Danish sailors on board ships all over the world and with Danes living abroad."

International broadcasts are directed to Europe, Iceland, North America, Far East, Australia, and New Zealand. Languages used include Danish, Spanish, and *English*. Programs consist of news, talks, and features about life in Denmark, reports, Danish instrumental music and songs. Program time is 7 hours and 20 minutes daily—including 4 hours and 50 minutes relayed from Copenhagen-Kalundborg (Home Service).

Current schedules are daily 1245-1730 on 7.260 with omnidirectional antenna (relay of Home Service); daily *except* Sunday 2100-2230 on 9.520 to North America (2100-2200 in Danish; 2200-2230 in *English*, with DX session "Denmark Calling World Listeners," compiled by O-Lund Johansen, publisher of "World Radio Handbook," on Monday around 2225); Sunday *only* 2100-2200 on 9.520 to North America; Monday, Wednesday, Friday at 1900-2000 on 15.165 to South America (in Danish *except* a half-hour program in Spanish each Friday); Tuesday, Thursday, Saturday at 0500-0600 on 15.165 to the Far East, Australia, and New Zealand (in Danish with the *exception* of a Mailbag Program in *English* called "Everybody's Program"—including the DX session which is on the air *only every two weeks on Tuesday*—and a five-minute news bulletin in *English* which concludes *each* transmission).

(In addition is OZI, 5.942, 1 kw., located at Godthaab, Greenland; transmissions from Godthaab are *not* international, but are intended solely for listeners in Greenland; broadcasts are made in Danish and Greenlandic daily at 1630-1745.)

New services planned include transmissions for the Faroe Islands in Faroese and for Greenland in Danish and Greenlandic.

Approximately 8000 letters have been received from listeners abroad since July 1948; promotion of inter-
(Continued on page 114)

(Note: Unless otherwise indicated, all time is expressed in American EST; add 5 hours for GCT. "News" refers to newscasts in the English language. In order to avoid confusion, the 24 hour clock has been used in designating the times of broadcasts. The hours from midnight until noon are shown as 0000 to 1200 while from 1 p.m. to midnight are shown as 1300 to 2400.)
The symbol "V" following a listed frequency indicates "varying." The station may operate either above or below the frequency given.

This modern building is Radio House, Copenhagen. From these studios international broadcasts are made to Europe, North and South America, Far East, Australia and New Zealand.



Extending MULTIMETER UTILITY

By
RUFUS P. TURNER, K6AI

Use your V-O-M for extra duties. It can be adapted to tests that normally would be beyond the original limits of the unit.

THE service technician or experimenter who can afford only a few instruments wants to do as many things as possible with his limited equipment. Often, there are functions which may be performed in addition to the normal specified ranges of an instrument. This is true especially of the a.c.-d.c. multimeter.

This article explains several useful applications of the multimeter not ordinarily covered in the instruction literature accompanying this type of meter. In checking these applications, the author based his studies on the popular *Simpson Model 260*. This meter has had wide circulation in the electronic field. However, the same principles may be applied to other multimeters having similar characteristics. The additional jobs which can be done by means of the schemes outlined in the following paragraphs will increase the utility of the already versatile multimeter several-fold.

Multiplying Ohmmeter Range

Fig. 2A shows a circuit arrangement for multiplying the highest-resistance range of the meter by 10. With this scheme, the 20 megohm range of the Model 260 was extended to 200 megohms.

An external 90-volt battery (which can be two of the small-sized 45-volt batteries in series) is used with a 1 megohm scale-adjusting potentiometer (R_1) and 1 megohm safety resistor (R_2).

The circuit is set up for operation in the following manner: (1) Set the Model 260 to its Rx10,000 resistance range. (2) Touch the test prods together and "zero" the meter by means of the "Zero Ohms" knob of the instrument. Do not disturb this adjust-

ment afterward. (3) Connect the meter in the circuit shown in Fig. 2A. (4) Temporarily short-circuit the test leads and reset the meter to zero ohms by means of potentiometer R_1 . (5) Connect the unknown resistance to the test leads and read its value by adding one cipher to the resistance value indicated on the Rx10,000 scale of the meter. Thus, 100,000 ohms deflection is read as 1 megohm.

Checking A.C. Amperes

In some forms of experimental work, it may be desirable to measure low a.c. ampere values. Few multimeters are equipped to make these measurements directly.

Fig. 2B shows how the multimeter can be converted simply into an a.c. ammeter. The multimeter is set to "A. C. Volts" and connected in parallel with a 1 ohm shunt resistor.

Fig. 2. (A) Circuit for checking high resistance. (B) A.C. ammeter circuit.

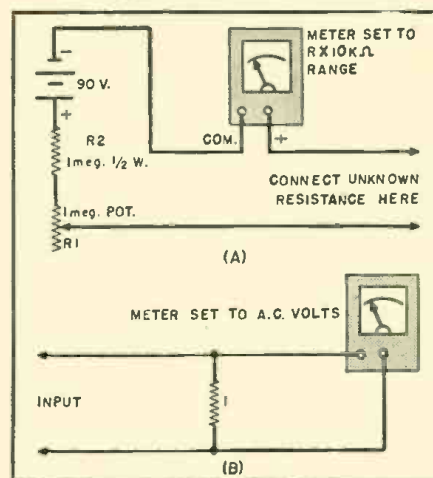

Fig. 1. The Simpson Model 260 multimeter used by the author in compiling data on meter extension.

Current values are read directly on the a.c. voltage scales. Thus, the 10 volt scale indicates directly 0-10 a.c. amp.

A 100 watt wirewound resistor will allow the 2½ and 10 volt a.c. scales of the meter to be used for 2½ and 10 a.c. amperes respectively. In order to read higher currents, it is best to reduce the size of the shunt resistor and use the 2½ volt range. For example, if a 0.1 ohm, 100 watt shunt were used, actual current would be the voltage reading on the 2½ volt scale multiplied by 10. Such a shunt could be used to give a 25 ampere range.

D. C. Kv. Measurement

A 5000 volt d.c. range is provided in the Model 260 and in several similar multimeters. However, higher voltages than this value must be checked in television receivers and in some industrial electronic equipment.

For this purpose, external safety-type high-voltage probes now are obtainable to extend the d.c. voltmeter range to several kilovolts. Thus, a *Simpson 25 kv.* probe currently is available, the *Sylvania Type 220 Series* probes extend the meter range to 10 and 30 kv., and the *I.C.A. Type 6167* probe adapts the meter to 15 kv. measurements.

For use with the 5000 volt d.c. range of a 20,000 ohms-per-volt meter, a 10 kilovolt probe must have a resistance of 100 megohms. A 30 kv. probe must have a resistance of 500 megohms.

D. C. Millivoltmeter

The 100 microampere d.c. range of the multimeter also provides an ex-

(Continued on page 134)

VIDEO AMPLIFIER FREQUENCY RESPONSE

By WALTER H. BUCHSBAUM*

A review of the factors affecting video amplifier performance and hints on troubleshooting methods.

MOST television and service technicians are aware of the influence of the video i.f. response curve on picture detail. If the i.f. bandwidth is close to 4 mc. the vertical lines can be seen clearly all the way to the center of the test pattern. Less bandwidth results in blurring of these lines before they reach the center. Experienced technicians can often align receivers just by looking at the test pattern and concentrating on the vertical lines.

While the importance of proper i.f. alignment cannot be underestimated, it is not the only step necessary to assure high quality pictures. Often the vertical lines are distinguishable down to the center and the i.f. curve appears to be perfect, but on closer inspection it is found that the contrast in the vertical wedge is much poorer than in the horizontal wedge. The picture seems to lack life and gives a dull, flat impression. This is a typical indication of poor video amplifier response.

By designing the time constant of coupling condensers and grid resistors properly the loss of the low frequencies can be minimized and this portion of the response curve is rarely troublesome.

To obtain good amplification at the higher video frequencies, special video peaking coils are used almost universally. It is the combination and design of these coils that determines the video response curve and the amount of "snap" or contrast between the lines of the vertical wedge in the test pattern. Although the circuit may be designed to give a proper response curve, a defect can occur in the compensating network. Many small screen receivers have rather poor response curves and when such a set is converted for use with a big screen tube, the loss of high frequency components becomes quite apparent. For these and many other reasons it is important that the technician understand the problems involved and is able to check the frequency response of the video amplifier section.

H. F. Compensating Networks

The frequency response of any amplifier is limited by the shunt capaci-

ties of the circuit. The output capacity of the last stage, plus the input capacity of the following stage, plus the stray wiring capacity are combined and their effect is that of a condenser shunted across the output of the amplifier. Four different methods of overcoming this effect are available and in most receivers all of them are employed.

(a) *Video load resistors:* One obvious way to reduce the divergence in amplification between low and high frequency components is to use a low value plate load resistor.

Using low value of plate load resistors does not increase or peak the high frequencies, it merely brings the lower frequency signals closer to the level of the highs. Reducing the load resistor also reduces the gain of the tube.

(b) *RC networks:* A resistor in the cathode of an amplifier will cause degeneration and a loss in output signal. If the resistor is shunted with a small condenser, a different impedance will result at different frequencies. At low frequencies the shunting effect of the condenser is negligible, but at the higher frequencies the effect of the condenser will be considerably increased.

Often the contrast control consists of an unbypassed potentiometer in the cathode of the video amplifier as shown in Fig. 4. To improve the high frequency response on strong stations a small value condenser is shunted across the control, so that when some degeneration is present, the high frequencies will receive more amplification than the lower ones. It should be understood that the RC network does not actually increase the gain at the high frequencies, but reduces the amplification at the lows.

(c) *Shunt peaking coils:* One of the methods which actually boosts the high frequencies, without affecting the lows, employs an inductance to compensate for the capacity which otherwise reduces the highs. In Fig. 1A a small coil, L , is inserted in series with the plate load resistor. Its inductance, together with the combined capacity, forms a resonant circuit, tuned to the highest desired video frequency. At the resonant frequency the LC network represents a high impedance, limited only by the plate load resistor, R_L , which is part of the tuned circuit. The grid resistor, R_g , is a high resistance and hardly affects the tuned circuit. In this manner an actual peak can be obtained on the video response curve. Most television receivers use shunt peaking with small coils, often wound on a $\frac{1}{2}$ watt resistor and ranging from about 150 to 400 microhenrys.

(d) *Series peaking coils:* In addition to shunt peaking a coil is often inserted in series with the coupling condenser or, if a direct connection is made to the picture tube, in series with the lead to this tube. Such an arrangement is shown in Fig. 1B. The effect of this series coil is to split the total capacity into two parts, the output capacity of the tube and the input and wiring capacity. Only the output capacity shunts the load resistor, R_L , and can affect the gain at high frequency signals. This permits the use of a larger load resistance and therefore more amplification. When the se-

Fig. 1. (A) Diagram illustrating shunt peaking; (B) series peaking in TV sets.

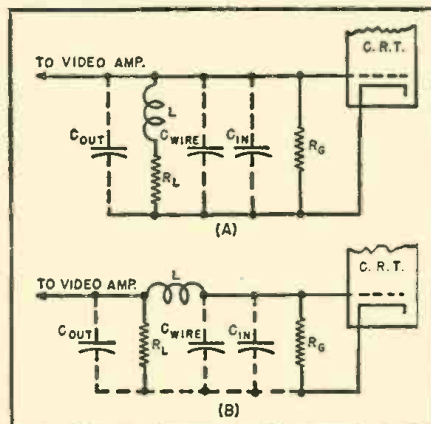

* Author of the recently published book "Television Servicing, Principles and Practice" (Prentice-Hall).

ries peaking coil forms a tuned circuit with the output and wiring capacity resonant at the high frequency end, an actual peak can result on the response curve.

Desirable Response Curves

From a theoretical point of view the response curve of the video amplifier should be absolutely flat to 4 mc. and then drop sharply to zero at 4.5 mc. This is shown as curve A in Fig. 2. The drop at 4.5 mc. is due to the composition of the television signal. The picture and sound carriers are 4.5 mc. apart. In intercarrier type circuits the 2nd detector produces a 4.5 mc. beat from these two carriers which is then used as the second sound i.f. signal. It is removed from the video amplifier before it can reach the picture tube. In receivers using split i.f. sections it can happen that on strong signals enough sound carrier reaches the second detector to produce a substantial 4.5 mc. signal. If the 4.5 mc. beat gets to the picture tube it causes a fine grain interference. This appears as if a fine wire mesh were placed over the screen. To avoid this it is desirable to have very little amplification at 4.5 mc. and in some receivers a special trap is used in the video stages to keep this interference from the picture tube.

To obtain a curve like A in Fig. 2 would be quite complicated and certainly not economical. The more gradual slope of curve B is satisfactory for all practical purposes and can be achieved in most well-designed, high-priced receivers. The curve shown as C in Fig. 2 is what should be found in the average television receiver.

If the high frequency video signals are boosted considerably, the image appears to be crisper, clearer and is said to have more "snap." Actual tests conducted by the author showed that a picture resulting from a curve like B in Fig. 2 was considered dull and lifeless compared to one resulting from curve C. To obtain such a curve some coils are peaked at 3.1 and others at 3.5 mc. This results in a fairly broad peak. To further broaden it and to prevent regeneration some of the peaking coils are wound on damping resistors ranging from 22,000 to 47,000 ohms.

In determining the frequency response curve of the video amplifier it would obviously be advantageous if a visual method could be employed. Since the video frequencies range from about 60 cycles to 4 mc., the sweep generator must furnish a signal varying over at least 5 mc. at a fixed rate. In addition, since no detector is present at the output of the video amplifier, a detector stage must obviously be added.

Fig. 3 shows a suggested crystal diode circuit which can be mounted on a terminal board and clipped into the television receiver when needed. While a 1N34 diode is shown, a 1N56 or similar unit can be used, or else a vacuum tube could be employed. One

advantage of the circuit shown in Fig. 3 is that it has very little capacitive loading and therefore will not affect the response curve greatly. The resistors should be of the non-inductive, carbon type and C_1 should be a 600 volt mica condenser. Some oscilloscopes have a special diode probe in which case the circuit given here is not needed.

Direct Sweep Method

The circuit in Fig. 4 is typical of the single stage video amplifier found in many inexpensive television receivers. The contrast control is part of the cathode resistor and an RC peaking network is employed in the cathode. Both series and shunt peaking are used and a relatively low plate load resistor helps to further improve the frequency response. To obtain the response curve of the amplifier the output of the generator is connected to the free end of the coupling condenser. The connection to the diode load resistor is broken to avoid the high frequency losses due to the 10 μ fd. diode load bypass condenser. The crystal detector probe is connected directly to the grid of the picture tube. The detected signal is then brought to the vertical input terminals on the oscilloscope. The horizontal scope terminals are connected to the generator sync terminals.

In order to tell what frequency the peaks are, a marker signal must be used. Any signal generator furnishing an unmodulated signal from about 1 to 5 mc. will be satisfactory. The output of this marker generator is connected directly across the sweep generator output. A small wiggle or "birdie" will appear on the response curve, indicating the location of the marker frequency.

Another method of marking video response curves is by means of a calibrated wavetrap. Commercially available units like the *Millen, McMurdo-Silver* and *General Radio* absorption type wavemeters are ideal for this

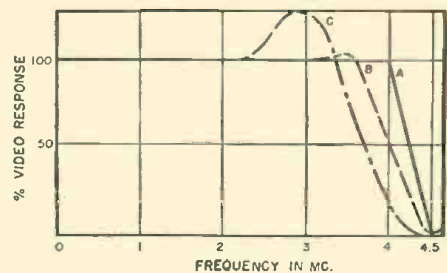

Fig. 2. Graph of theoretical video response.

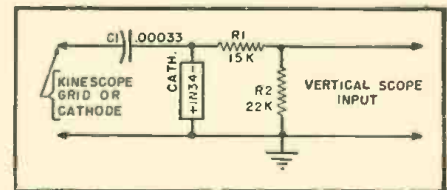

Fig. 3. Crystal diode probe circuit.

purpose. To insure sufficient pick-up, a three-turn loop of ordinary hook-up wire is slipped over the trap coil and connected in series with the "hot" side of the sweep generator output cable. By adjusting the wavetrap condenser the desired frequency is obtained. On the response curve the effect of the trap will be a slight dip as shown in Fig. 6D.

The main advantage of the direct method of sweeping is its simplicity and the relatively few adjustments required. But since not all sweep generators can be used with this method an alternative system can be employed.

Beat Frequency Sweep Method

The output of the sweep generator used for aligning the video i.f. amplifiers usually ranges from 20 to 30 mc. If the generator is set for this i.f. range and connected into the receiver before the second detector, a regular signal generator can be used, together with the sweep unit, to produce a 0.5 mc. signal in the video amplifier. With the connections as shown in Fig. 5 the second detector acts like a mixer for

Fig. 4. Test setup for the direct video sweep method of checking video amplifiers.

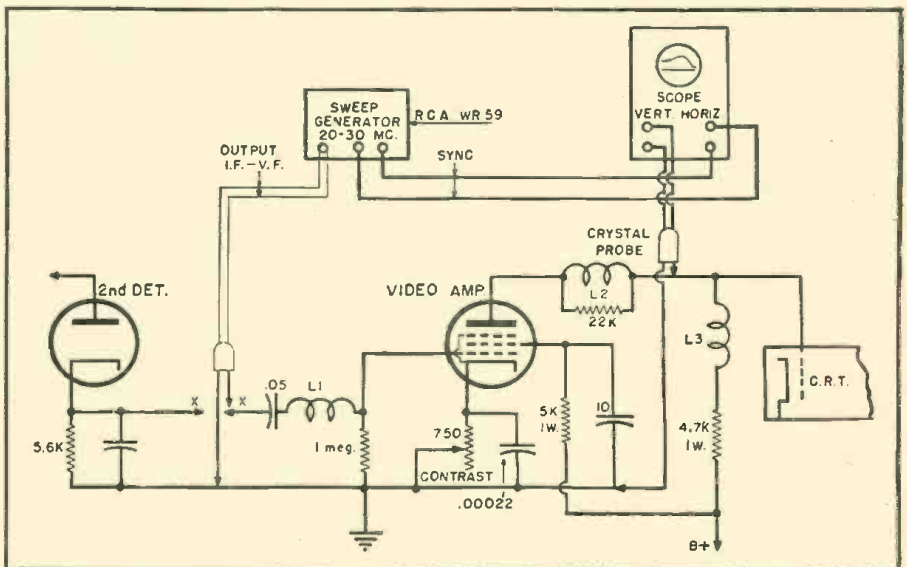

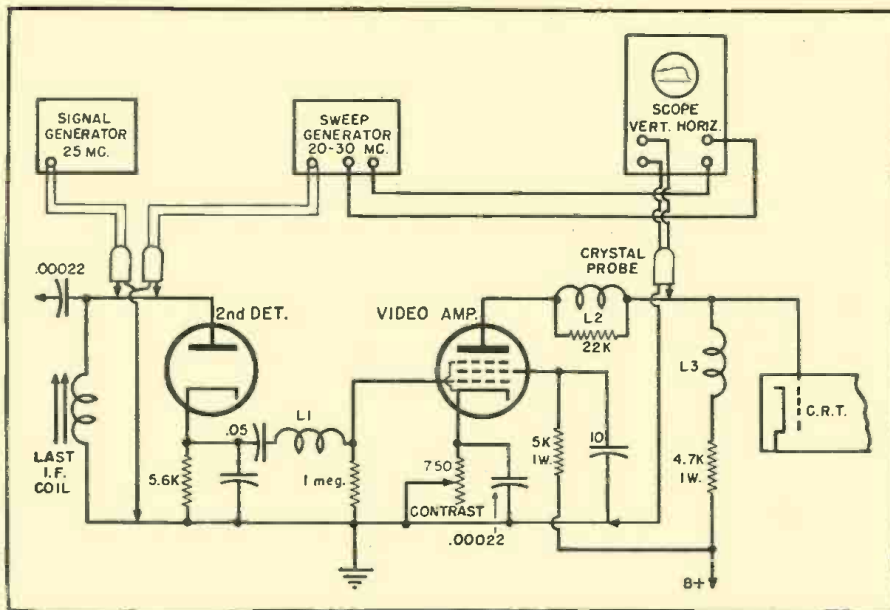

Fig. 5. Setup for checking video amplifier performance by the i.f. beat method.

the fixed frequency of the signal generator and the varying frequencies of the sweep generator.

For example, at one instant the sweep frequency may be 25 mc. and the fixed generator frequency is also 25 mc. This results in a zero beat. In the next instant the sweep signal may be 100 cycles above or below the fixed frequency, producing a 100 cycle signal in the video amplifier. When the difference frequency reaches maximum, the end of the sweep is reached and the return trace on the scope begins. If the fixed signal is not in the exact center of the sweep range, the video response curve will not be symmetrical. Should it be desired to sweep a 7 mc. curve, the fixed frequency generator can be set for either 27 or 23 mc. and the result will be a curve where the short end represents the 3 mc. sweep and the long end the 7 mc. portion. In any event, the location of the fixed signal is clearly visible on the curve as described later.

The advantage of using the beat frequency method is twofold. First, it permits the use of any i.f. sweep generator and the requirements for the fixed frequency generator are not very exacting. Secondly the true response

curve is obtained, including the effect of the second detector. If the 10 μ fd. diode load bypass condenser in Fig. 5 were shorted or of the wrong value this effect would not become apparent in the direct sweep method.

Marking the response curve is accomplished in the same manner as before. A signal generator set at the desired video frequency is connected through a small condenser across the detector load resistor. When an absorption type wavemeter is used it will be necessary to connect the pickup loop in series with the .05 μ fd. coupling condenser.

The connection of the crystal detector probe and the oscilloscope terminals is identical to that for the direct sweep.

Interpreting Curves

Using either direct or beat sweep method the first response curve on the oscilloscope screen usually requires some adjustment before it can be used for interpretation. Fig. 6A was taken with direct sweep from an RCA WR-59 with no blanking and no phasing adjustment. Actually, four curves are visible, each similar to the other. By adjusting the phasing and turning on

the blanking, the curve shown in Fig. 6B results. This represents a range of about 10 mc. with a zero frequency point in the center. Since we are interested only in a single response curve the horizontal gain of the scope is increased and the horizontal centering adjusted until the curve shown in Fig. 6C is obtained. The zero point is still visible at the left, but now only the actual response curve appears on the scope and is ready for closer examination.

When the beat method is used for sweeping the video amplifier the adjustments and their results are the same as those outlined above. The only difference may be that the curves in Fig. 6A and B may be non-symmetrical because the fixed signal is not at the center frequency of the sweep. This can be corrected by adjusting the fixed frequency generator until the zero beat appears centered.

The curve in Fig. 6C shows a very pronounced peak, small bump, and then a drop to near zero level. In Fig. 6D an absorption wavemeter was used to give the small pip shown near the peak. When the frequency was checked it turned out to be 3 mc. Interpreting the response curve of this particular video amplifier, it becomes apparent that the peak occurs slightly below 3 mc., but is rather sharp and the drop from the peak to zero level contains a bump at about 3.1 mc. This indicates that some peaking coils are resonant at 3.1 mc. and one below that, with a higher "Q." A simple resistance check revealed that the 22,000 ohm resistor shunting L_2 in Fig. 5 had opened up, causing this coil to peak very sharply.

As was mentioned earlier, some television receivers use a special trap to prevent the 4.5 mc. beat signal from interfering with the picture. The response curve of such a receiver is shown in Fig. 6E, but the trap is shorted out. Instead, two absorption type frequency meters were used to indicate the 3 mc. and the 4.5 mc. points on the curve. When the trap was activated and tuned to coincide with the 4.5 mc. dip from the wavemeter the curve shown in Fig. 6F was obtained. To show the effect of the RC network in the cathode of the video amplifier a change in contrast control setting was made between Fig. 6E and F. In the former the control was set for maximum contrast, i.e., the cathode was grounded. In Fig. 6F some resistance was inserted and the effect of the peaking condenser became quite pronounced. The lower frequencies are attenuated from what they were in Fig. 6E but the 3 mc. peak remains substantially the same.

A simple way of checking the effectiveness of each peaking coil is to short it out temporarily and observe the change in waveform.

Video Amplifier Defects

The most frequent defect is total loss of the picture. In this case the first step is to check the wiring thor-

Fig. 6. Oscilloscope patterns obtained with the direct and the beat sweep methods of checking video amplifier frequency response. See text for explanation of patterns.

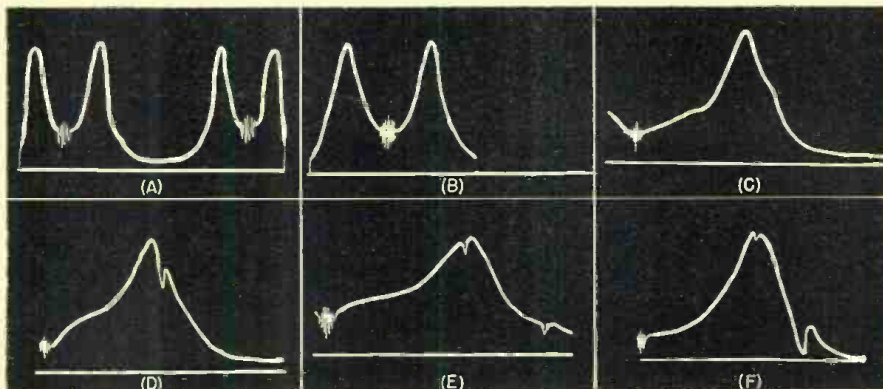

COMPACT 100-WATT AM-NBFM TRANSMITTER

By
H. H. PATTERSON,
W5DAH
and
A. D. MIDDELTON,
W5CA

TWO requirements were fulfilled in the design and construction of this transmitter. The first—*versatility*; with operation on c.w. and phone, NBFM or AM with output on all bands from 10 through 80 meters, and up to 100 watts input, depending on the power supply.

The second—*compactness*; wherein the complete transmitter is built on a single 13" x 17" x 4" chassis and a standard 10½" relay rack panel. The band-changing system involves a set of small plug-in coils and the final plate tank coils. The usual assortment of screen-dropping resistors and bypass condensers in the multiplying stages was eliminated with no sacrifice in efficiency. Direct-coupled cathode-follower drivers are used in the AM audio section to eliminate parts and to obtain the low impedance source necessary to drive the 815 modulator grids into class AB.

The NBFM circuit, one developed by F. M. Link, is used in a number of military and commercial units. Its adaptation to amateur use has proven unusually successful. As incorporated in this transmitter this system enables changes from AM to NBFM with the flip of one d.p.d.t. toggle switch.

Not the least of the advantages of the NBFM is that it has enabled W5DAH to operate in an apartment house without first walking up and down the hall to see if anyone is using his "all band" a.c.-d.c. receiver.

The diagram of this phase modulator is shown in Fig. 2 along with the vector diagram. Considerable cathode degeneration is employed. This cuts down the amplification of the tube until the amount of signal reaching the plate by the amplifying action of the tube is about the same magnitude as that appearing on the plate by coupling through the grid-to-plate capacitance and C_2 . The resultant is designated as V_{out} . The vector resulting from tube action is denoted V_{tube} and that one designated as V_{cap} is the result of grid-to-plate capacity plus C_2 . A variation in grid potential caused by the audio voltage results in a change of G_m of the tube and causes the V_{tube} vector to vary in length. This causes the resultant vector, V_{out} ,

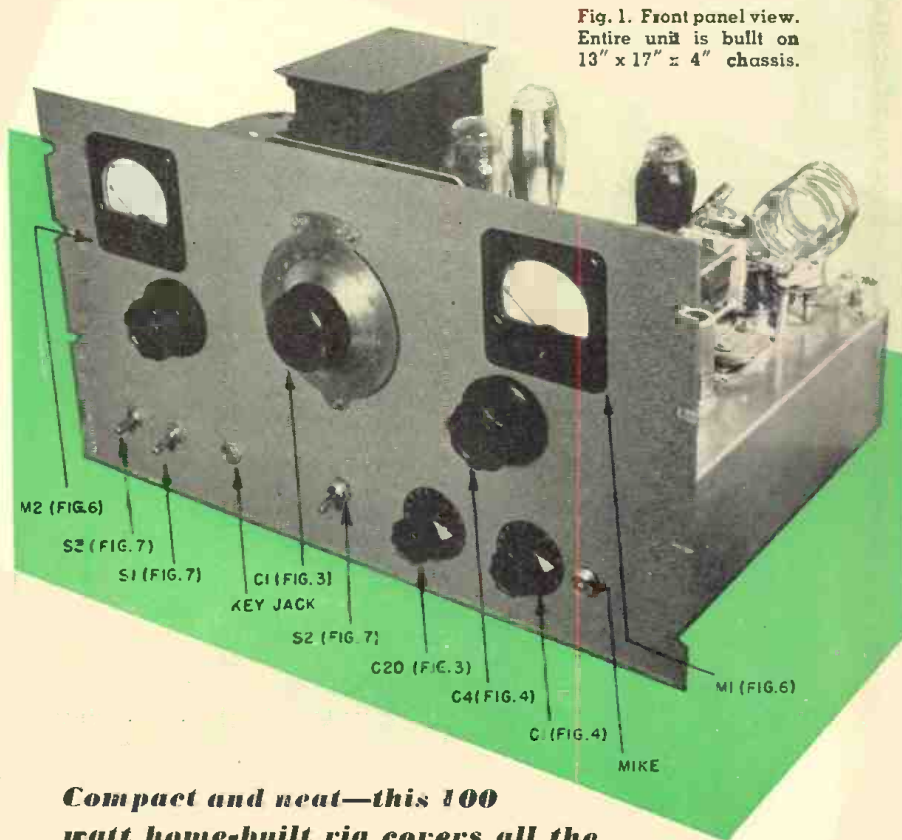

Fig. 1. Front panel view. Entire unit is built on 13" x 17" x 4" chassis.

Compact and neat—this 100 watt home-built rig covers all the amateur bands from 10 through 80 meters.

to swing back and forth in-phase producing phase modulation. The series resistance R and the capacitance C_1 constitute a filter to attenuate the highs. The correct selection of these values washes out the high frequency

emphasis of phase modulation and the result is NBFM that is pleasing to hear. The circuit should be used at low level r.f. since the developing of grid bias by a strong r.f. input signal will keep the small voltage caused by the audio from having the desired effect on the G_m of the tube. Also, no power gain is available due to the large unbypassed cathode resistor.

Fig. 2. (A) Circuit diagram of phase modulator system. (B) The vector analysis.

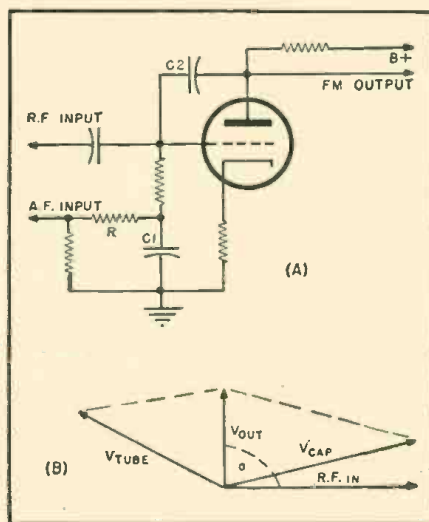

The R.F. Section

The *Clapp* oscillator was chosen because of the stability that can be obtained without undue effort. One difficulty that may be experienced, however, is that of failure of the circuit to oscillate throughout the desired range. This may result because the capacitance in use in the series resonant circuit is of too low a value to provide sufficient coupling for sustained oscillations. This condenser should not be much larger than this minimum value since a large value represents an excessive amount of coupling which decreases the isolation of the tuned circuit from the tube. This would result in a circuit less immune to capacitance changes in the tube due to heating. The oscillator

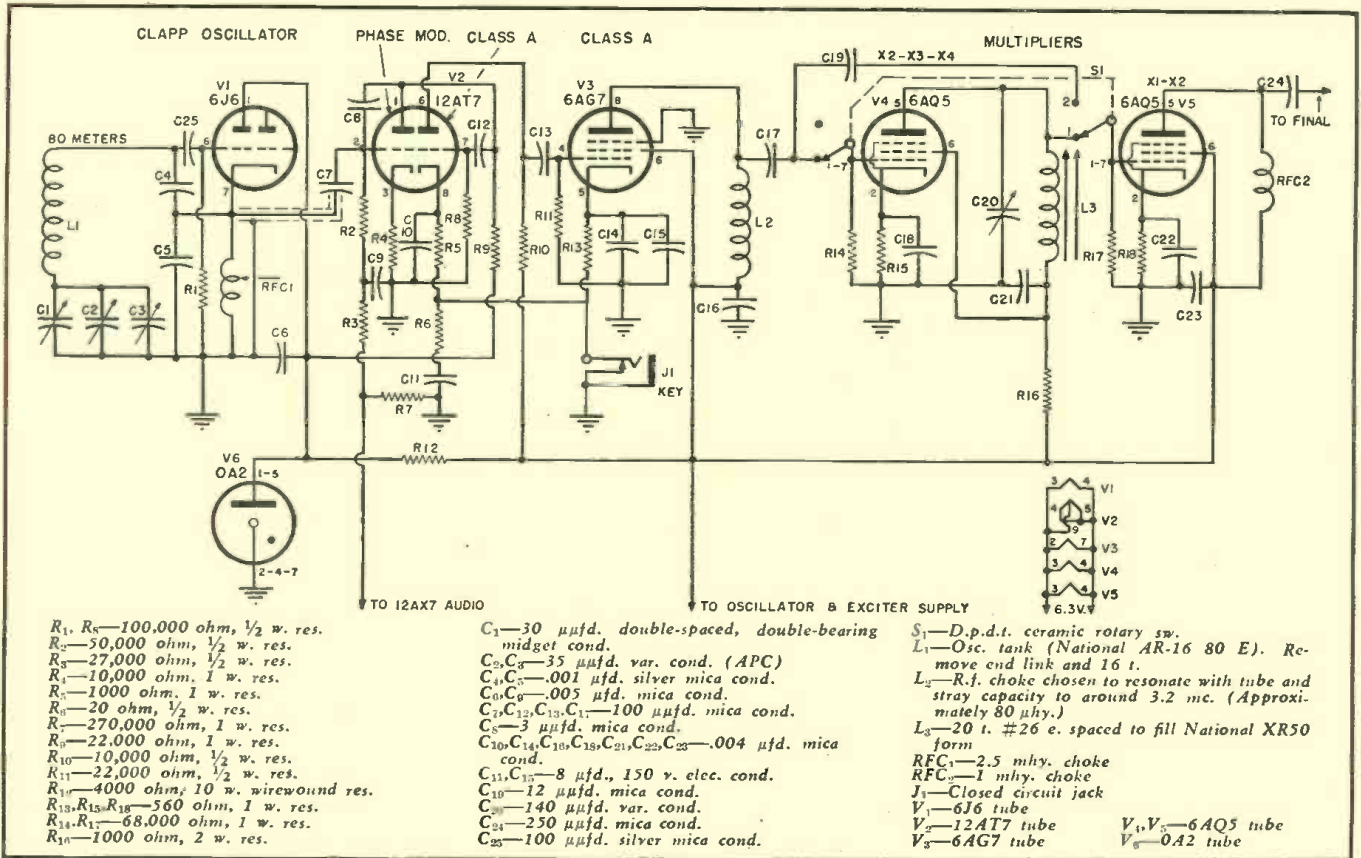
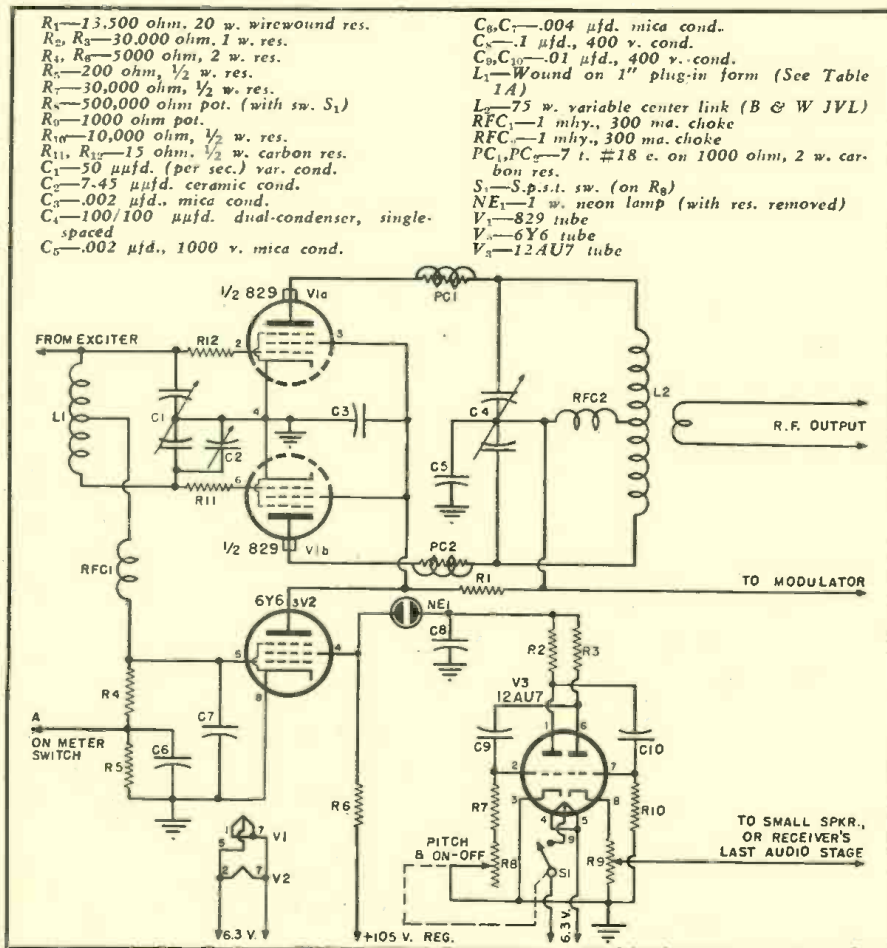

Fig. 3. Schematic diagram and complete parts lists covering the r.f. section of the AM-NBFM transmitter.

Fig. 4. Complete schematic diagram of the c.w. monitor incorporated in the transmitter.



shield can is attached only to the front panel. This avoids deformation of the box and consequent frequency shift that would result from a movement of the front panel if the can were tied both to front panel and chassis.

Following the oscillator (Fig. 3) is the phase modulator followed by the Class A isolation stage. A broad-banded 6AG7 provides the necessary power increase to drive the 6AQ5. The 80-microhenry choke in the plate circuit of the 6AG7 (see L_2 in Fig. 3) was chosen to resonate with the tube and wiring capacitance at a frequency of approximately 3.2 mc.

After the 6AG7 stage is the first 6AQ5 multiplier stage. Its function is to multiply the v.f.o. frequency by 2, 3, or 4. Any of these may be selected by means of C_{20} (Fig. 3), controlled from the front panel. When quadrupling to 10 meters the condenser is practically all out. The result is a broad-banded stage that requires very little retuning when moving from 28.5 to 29.7. The use of a slug-tuned inductance allows setting the inductance of the circuit to the correct value for operation with the single 140 μ fd. variable without excessive coil pruning. This stage is followed by a second 6AQ5 used as a driver, either doubling or straight through. The circuit arrangement utilizes the 829 grid tank as a plate impedance and thus gains in simplicity and ease of band changing.

Condenser C_2 (Fig. 4) should not be overlooked since it balances the side

of the 829 grid tank opposite the plate capacitance of the 6AQ5 and tends to equalize the drive on the 829 grids.

The two parasitic suppressors in the plates of the 829 (Fig. 4) are good insurance and should not be left out. A 6Y6 is used to lower the screen voltage on the final when keying the excitation for c.w. The voltage on the screen of the 6Y6 follows the keying and is also used to operate the 12AU7 multivibrator for a keying monitor. The monitor output will operate a small speaker or may be fed into the last audio stage of the receiver.

C.W. Click Elimination

Condensers C_{11} and C_{15} (Fig. 3) form a click-eliminating circuit that proved effective. However, since overdriving any final amplifier will produce clicks, it is recommended that the drive to the final should be limited to the required value to provide full output.

829 On Low Frequencies

A word of caution about low-voltage, high-current tubes on the lower bands. If it is found that the maximum output does not correspond to the minimum dip in plate current it is an indication that the "Q" of the tank is low. Additional capacitance is indicated and this should be added equally across the two halves of the

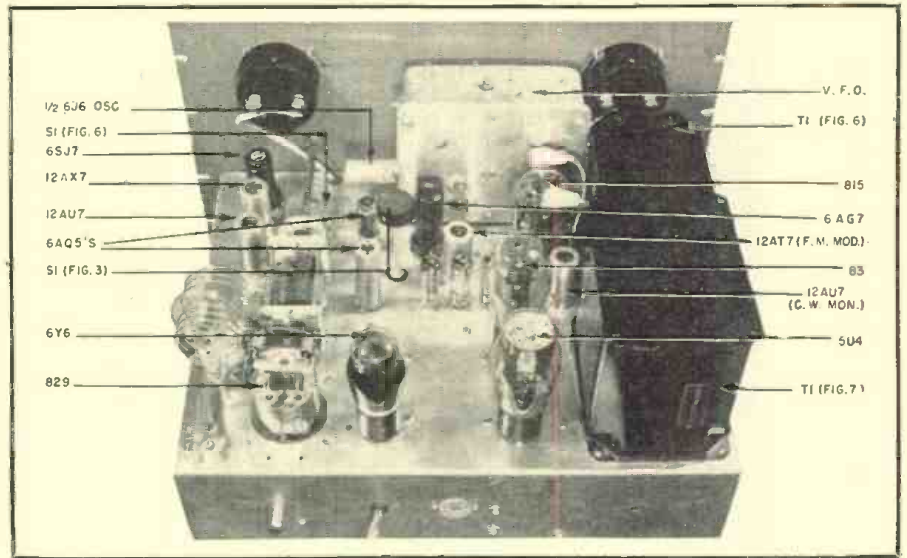

Fig. 5. Top chassis view of the compact AM-NBFM transmitter. The physical arrangement permits enclosing the transmitter in a single table-mounted cabinet. Controls are easily accessible.

final tank condenser. Do not add it in a lump across the tank coil unless you wish to increase the power in your harmonics.

Additional capacitance in the final tank will be necessary on 80 meters. The procedure is to add capacitance and prune the coil to restore reso-

nance until maximum output occurs at the dip. A 75-watt lamp forms a convenient load and helps to locate the maximum output.

From the photographs it will be noted that shielding has been held to a minimum. This was by necessity rather than desire since the rig was

Fig. 6. Complete schematic and related parts list for the audio systems and meter switch connections.

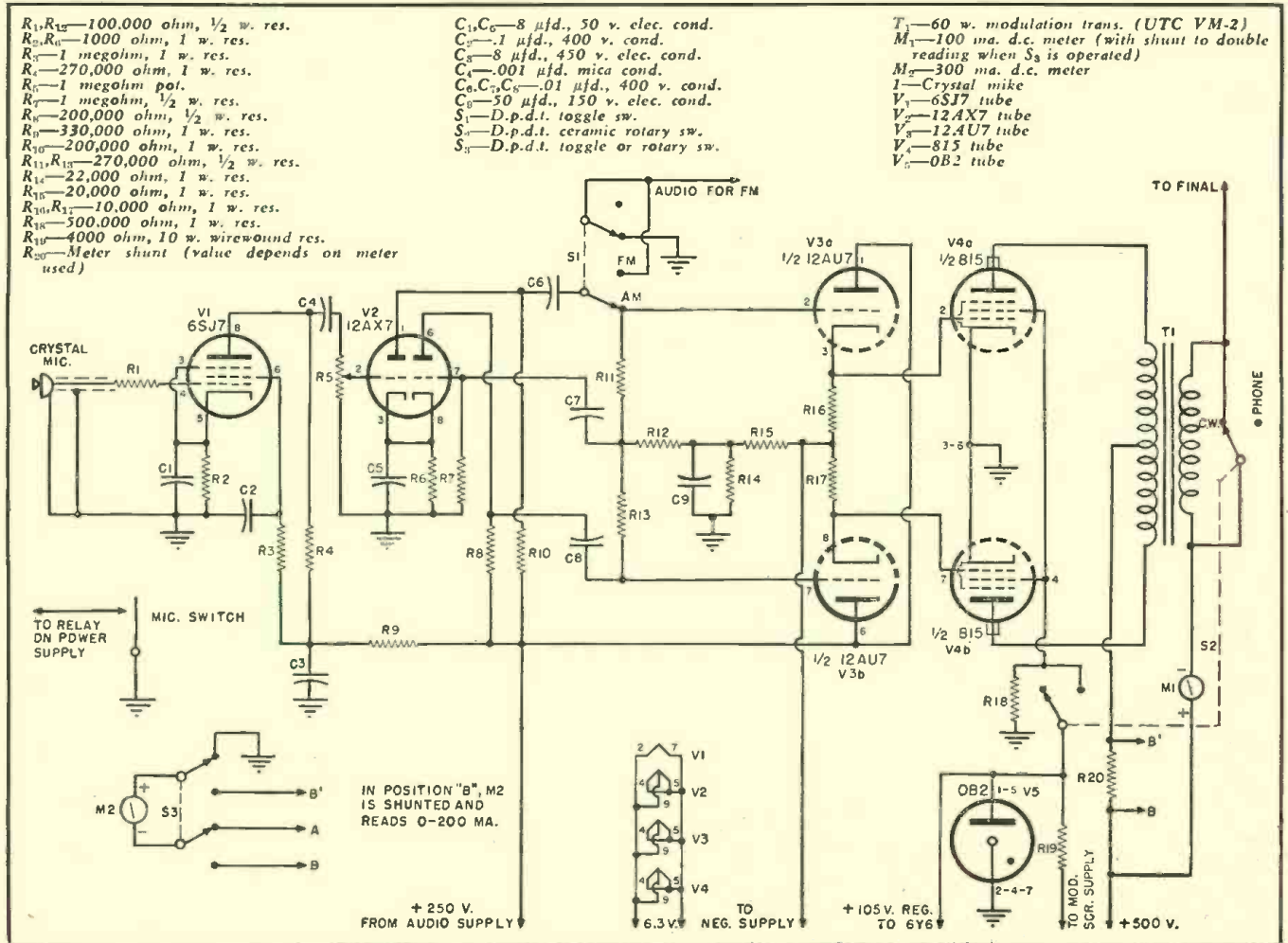

(PART A)			
829 GRID COIL DATA			
80 m.	60 t. #26 e., closewound, two 30-t. halves, 1/8" apart, 1" form		
40 m.	22 t. #24 e., closewound, 1" form		
20 m.	10 t. #24 e., closewound, two 5-t. halves, 3/16" apart, 1" form		
15 m.	6 t. #24 e., closewound, two 3-t. halves, 3/16" apart, 1" form		
10 m.	6 t. #24 e., spaced to 5/8", 1" form		
(PART B)			
80 METER 829 PLATE COIL			
B & W BVL. Short out turns and add capacity until plate meter's dips and power output agree. Then remove undesired turns.			
(PART B)			
FREQUENCY MODULATION DATA			
OUTPUT	1ST 6AQ5	2ND 6AQ5	SW. S ₁ (FIG. 3)
80 m.	out	straight through	Position 2
40 m.	out	doubles	Position 2
20 m.	doubles	doubles	Position 1
15 m.	triples	doubles	Position 1
10 m.	quadruples	doubles	Position 1

Table 1. Specifications of coil assemblies along with details of NBFM operation.

built in an apartment without shop facilities. The final grid coil is below chassis for isolation, reducing shielding problems. It can be changed through a hole in the chassis.

The Audio Section

The audio section requires little comment except for one or two features. The 100,000 ohm resistor in the grid of the 6SJ7 (Fig. 6) is a good precaution in a compact transmitter as it insures against r.f. pickup and

resultant feedback. The 12AX7 tube is a twin-triode similar to the 6SL7 and the 12AU7 is similar to the 6SN7. The negative voltage to which the cathode resistors of the driver stage are returned is adjusted to give the correct bias voltage to the grids of the 815. It will be noted that the screens of the 815 are regulated. This may seem an unnecessary refinement but a well-regulated screen supply is necessary on this and similar beam power tubes when running class AB₂ and the

0B2 is a natural for the job. Only with a well-regulated screen can the maximum peak output be obtained.

Switches

S₁ (Fig. 7) is the power switch. S₂ (Fig. 7) is the send-receive switch and, when closed, makes available 115 volts a.c. on the octal socket at the rear for use in operating the antenna changeover relay and receiver silencing relay. S₃ (Fig. 7) is the calibration switch and is used for beating the v.f.o. with a received signal. S₄ (Fig. 3) is used to bypass the first multiplier for operation on 80 and 40 meters. S₅ (Fig. 6) changes from AM to NBFM phone operation. S₆ (Fig. 6) removes the screen voltage from the 815 and shorts the modulation transformer during c.w. operation. S₇ (Fig. 6) is the meter switch. S₈ (Fig. 4) is the "on-off" switch on the c.w. monitor pitch control.

Power Supplies

The power supplies (Fig. 7) are conventional except perhaps the lack of equalizing resistors across the two series electrolytics in the filter. This, it is realized, is a controversial point and this is being tried as an experiment. (Do not try leaving them out if you are using paper condensers.) The condensers should be the same capacitance and of the same type and brand.

Fig. 7. Schematic diagram of the power supplies used in the AM-NBFM transmitter.

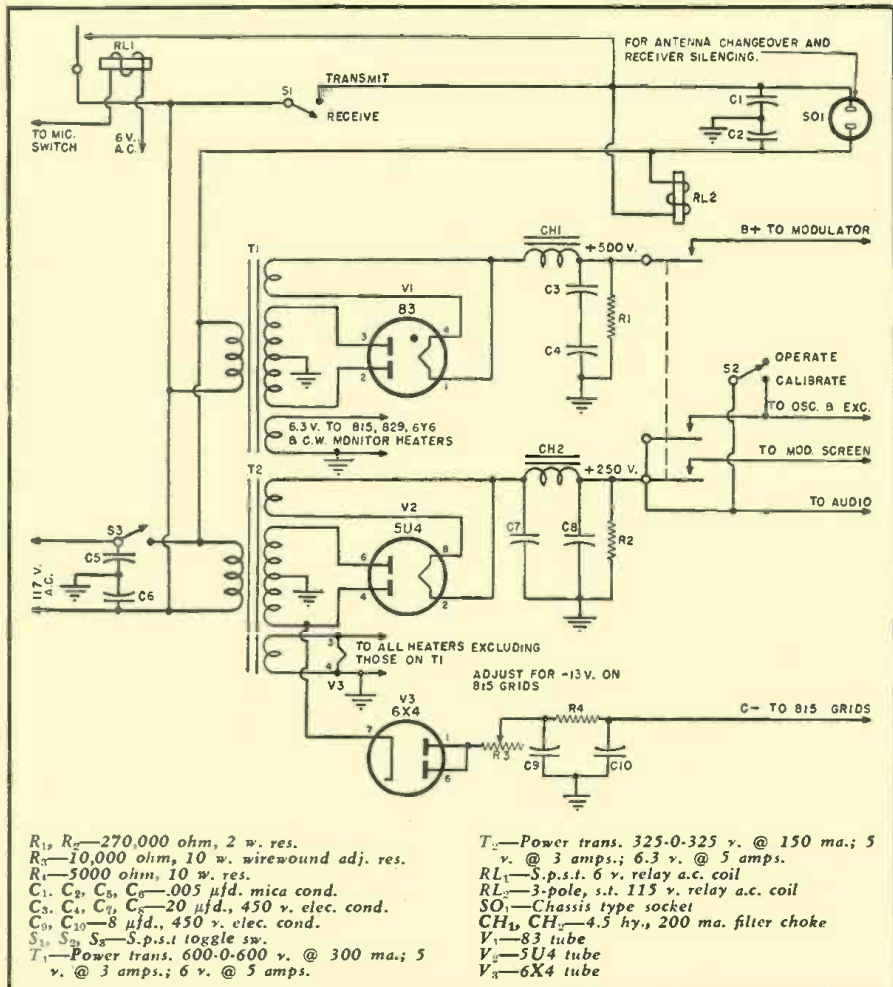

Firing Up the Rig

When firing up this or any new transmitter for the first time it is important to make a careful check for spurious oscillations of any frequency. A quick way to check the final is to apply enough fixed bias (300 ohms in the 829 cathode will do the trick here) to hold the plate current within ratings, remove the excitation and if no r.f. is observed you have been lucky. Turning plate and grid condensers through their ranges should produce no grid current. A neon bulb held near the tank while grid and plate condensers are rotated through their entire range will give a quick indication of oscillation. A wavemeter will then serve to determine the frequency of any r.f. present. If the spurious frequency is near the operating frequency more isolation between input and output circuit (and possibly, neutralization) is indicated. If the frequency is in the v.h.f. region parasitic suppressors of the type shown in this circuit are indicated.

Low frequency parasitics should also be suspected and they can usually be detected as spurious carriers near the operating frequency. Identical r.f. chokes in plate and grid circuits sometimes cause these as well as a parasitic oscillation of the modulator stage.

The final check should be made with a receiver with input shunted to produce about an S-9 signal. More signal than this may cause the receiver to generate spurious responses in itself.

It is necessary to use a calibrated
(Continued on page 108)

WHY, STRATEGIC AIR COMMUNICATIONS

By MAJOR GEN. F. L. ANKENBRANDT

Director of Communications, Headquarters, U. S. Air Force

Graduated from the U. S. Military Academy in 1926 and commissioned second lieutenant of Signal Corps. Attended Sheffield Scientific School at Yale University receiving his MS in 1927. In June of that year reported to Fort Monmouth where he served in various capacities until he entered the company officers' course of the Signal School in September 1928, which he completed a year later. He subsequently served as an instructor in chemistry and electricity at West Point where he remained for five years except for a short period of study at Columbia University. He held various commands during the war and in 1945 returned to the United States to become air communications officer at Air Force Headquarters in Washington. He served in other capacities and received his present post in 1947.

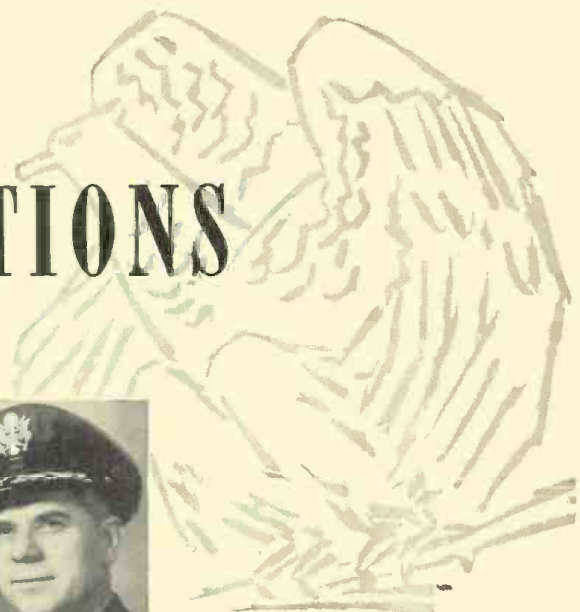

From take-off to "bombs away"—at the flip of a switch—our giant global air armadas are in constant contact with their headquarters.

IN THE few years since the end of World War II the development of an aerial concept of strategic national defense has presented the public with a new family of terms—terms that inspire visions of a shrinking globe and suggest the elimination of boundaries previously thought insuperable. The sonic barrier has been penetrated and supersonic speeds have been attained. We have devised aerial tankers for in-flight refueling. We have indirectly brought every spot on the globe within range of USAF strategic bombers. Concepts of tactics and strategy have necessarily been revised to ensure that new capabilities are exploited to the utmost.

Central to the concept and to the revision of our strategy is the super-bomber—the inter-continental land-based bomber that can deliver its bomb-load from a base in this country to an enemy-held target anywhere in the world. This bomber can pulverize an industrial target; it can support our Army; it can eliminate the source of an attack directed against our Navy. It is a weapon new to the history of warfare, and unique in its application. The bomb-load it carries spreads destruction beyond the capacity of any other weapon. Its range is unrestricted. It introduces problems previously unknown to military strategists and tacticians. But the principles directing its use are as old as warfare itself, because they are the principles of command and control. And command and control mean communications.

It makes little difference to the commander of a strategic air force where his command post is located as long as he is in communication with the aircraft he dispatches. The world, to him, is an onion and the vast distances that face a land or sea commander are just so many hours—or minutes—in span. He can dispatch aircraft from a number of points in the world to far-distant targets with almost push-button ease—but when the aircraft are out of sight of their bases, does he still have the command and control that was exercised in making them airborne?

If he has good ground-air radio communications, his command is extended directly to the aircraft in flight and

he can redirect it to alternate targets or recall it to its base at will. However, if the communication link to aircraft in flight cannot be established or maintained, his command ends the instant the aircraft becomes airborne and the aircraft is committed irrevocably to the destruction of the target, regardless of sudden political changes that may make recall or diversion a matter of grim urgency.

On paper, the problem of keeping the strategic air commander in touch with his pilots is simple. To illustrate, take a number of fixed points and draw a number of radial lines in all directions at random. Draw another family of lines across the radials at random to indicate the possible flight paths of aircraft. The radials now are communication circuits. Let's take a closer look at them.

Applying scale to our drawing, we find that the circuits are from a few hundred to a few thousand miles in length. We consult the frequency prediction charts furnished by the Central Radio Propagation Laboratories and make a series of calculations. The optimum working frequencies will vary from about five to twenty megacycles depending upon which circuit is selected, the time of day, and the distance from the station. We select a frequency from the five, eight, twelve, eighteen, and twenty megacycle bands and send them out to the half-dozen or so ground stations associated with the relay stations of the main point-to-point communications axis.

Now that our frequency problems seem to be taken care of, let's pause a moment and examine the ground plant. Making a tremendous arc around the globe somewhere between thirty and sixty degrees north are a number of ground terminal stations that form the main line. The circuits have a maximum capacity of 300,000 groups a day, and associated with each radioteletype tape-relay facility is a high powered ground-air station capable of transmitting simultaneously on three of the five selected frequencies. Modern, professionally engineered, and capable, the lash-up seems foolproof enough and we turn with confidence to an examination of the airborne terminal.

We walk along the ramp to an actual terminal, admiring the sleek aerodynamic shape that looms higher against the sky as we approach, our eyes search for the familiar fixed-wire antenna and the fairlead with its trailing antenna weight tucked tightly in the cup. But our eyes search in vain. A closer inspection reveals no sign of insulators or sky-wires.

A non-commissioned officer steps down a ladder from the bomber and looks quizzically in our direction. "Ser-

geant," we ask, "where are the antennas?" The sergeant gives us that look reserved for mere laymen and points at the wing that seems to reach the vanishing point as we scan the trailing edge for the hitherto invisible antenna array. "I'm afraid that you'll have to point it out" we say in embarrassment, and the sergeant signals us to follow. We walk in his wake to the tip of the wings. "That's the insulator for the wing cap," he says with a pitying look.

"And that's the antenna?"

"There's one just like it at the other end."

"Mind if we go inside and look at the radio operator's position?"

"It's all right I guess; anything special you want to see?"

"Yes," we reply as the radio operator sergeant leads the way into the cavernous interior, "everything."

The sergeant sits down at a table and moves a headset to one side. At the back of the table is a panel with a collection of unidentifiable knobs and firmly attached to the table is the usual radiotelegraph key. "Well" he says with a wave of his hand, "this is it."

"But where is the transmitter and receiver?"

The crew chief says "In the wing though all you can see is a tank that looks more like it holds gas or oil or something. Doesn't look like a radio set. Anyhow, it works, wherever it is."

We smile a little to ourselves as the sergeant goes on to explain that the radio set and all of its immediate complexities have been removed from the radio room and stored in some remote portion of the aircraft. The maintenance section is responsible for keeping it a serviceable set, but even so, the radio operator still has his hands full handling his briefing folder (containing frequencies, propagation data, schedules, and call signs) and the plain business of getting a message through.

"I hear a rumor," the sergeant tells us. "that the long hairs have cooked up a 'black-box' that will put me out of business one of these days. Some gadget that prints the message on a roll of paper—something simple enough for the co-pilot to operate."

"I wouldn't worry, sergeant," we assure him, "we can make 'black-boxes' do everything but use common-sense. That's where the human element comes in."

"Right," says the sergeant; "black-boxes" can work out problems that would take me weeks, but when a channel's jammed or the frequency predictions don't work out just right the 'black-box' just quits. A sharp radio operator won't quit until he's got the message through."

We leave the aircraft trying to absorb the effect of this airborne terminal station on the probabilities of maintain-

Interior view of the Ground Controlled Approach equipment.



Skilled technicians repair the USAF's electronic equipment.

ing the chain of command between the Strategic Command and this bomber once it becomes a striking force. The efficiency of this airborne terminal is certainly far below that of the ground-air station with its high-power, its high-gain directive antenna arrays, its diversity reception, and its surface-level operating conditions. The airborne radio operator, encumbered with clothing and protective devices against the cold and low pressures of the sub-stratosphere (in case cabin pressures are lost) certainly cannot be expected to come up with the same degree of performance that another operator, sitting at the control console of the ground-air station, can. Furthermore, the airborne sergeant can't entirely free himself from certain anxieties over the hours that he is airborne. The fatigue of his unrelieved attention to his job mounts at a faster rate than that of the ground operator who can say: "Hey, Joe, take my position for a minute, I wanna run over and getta cuppa coffee."

We can't escape the fact that the airborne operators of our strategic bomber force loom up as the single element in the whole chain that must come through with perfect performance against heavy odds. But now that we are acquainted with the problem and the mechanisms involved, let's look at the conditions that the airborne sergeant will have to surmount before he can assure us that the command line is intact.

Because of the distances involved, he must use frequencies from the congested—and somewhat irresponsible—high frequency band. The properties of the band permit us to make an educated guess as to what frequencies will be the most suitable for a given path at various times of day and night. However, when we consult the "Berne Book" to see what other countries may be using our choice of frequencies, and monitor the channel for a first-hand survey of users, the call signs we hear somehow or other don't coincide with Berne listings. The conviction dawns on us that at some other point in space, where we have no monitoring stations the interference pattern may be substantially different.

A glance at the world map and its present political divisions is proof enough that large land masses of the world under a single political philosophy can only be controlled by high-powered ground point-to-point radio communications circuits. Industrial developments require high-traffic-capacity communications, and when that nation is at war the civil and military communications requirements will exhaust almost every communications channel in the high frequency band. Even though certain countries may not subscribe to international agreements, in peacetime, at least, they must operate their circuits on a "live-and-let-live" basis or there will be hopeless confusion.

Not only are the big powers a source of congestion. A host of smaller nations have been urged to develop, and the United States has provided them with high-frequency radio communications and broadcasting equipment, and we have seen to it that they have frequencies for its use. Furthermore, the vast quantity of radio frequencies required for the United States military forces in all parts of the world will further burden the capacity of the high frequency band in providing usable channels.

As a mitigating factor to the apparently hopeless situation, a further study of the radio propagation charts shows that if a number of stations throughout the world are transmitting simultaneously on the same frequency (which they certainly are) they will not necessarily be all heard at a given point at the same time. Short-wave listeners and radio amateurs can verify this phenomenon. It is not at all unusual to hear a radio amateur say: "That's funny—last night at this time the Aussies were booming in, now all I can pick up is South American stations." These anomalies of the high-frequency band are in our favor, though one can be certain that some interference can be anticipated. Our ability to work through that interference will depend upon the personal skill of the airborne operator and the quality of the receiving equipment he operates.

If he can get his own signal just a few hundred cycles away from the interference (depending upon its modulation or bandwidth) he can slice away the signal completely. Except for outright jamming, he has a good chance of getting a message out of the hash that meets his ear when he switches to a new channel and listens out for his call sign.

Let us now follow through on a mission and see how well the system works.

Let us imagine that unannounced aggression has committed us to war and a message from the Joint Chiefs of Staff arrives, directing that proper measures be taken by the Strategic Air Force commander in carrying out an effort to insure our defense and end the aggression. Simultaneously, from a number of vastly separated points bombers must take to the air and fly to targets in the enemy's heartland and on his perimeter. The first bomb release is four hours away.

At this instant a flash message is delivered to the com-

Exterior view of the Ground Controlled Approach equipment.



December, 1950

mander. A country in alliance with the aggressor has broken its ties with the enemy power in the face of potential bombing attacks, and all targets within its borders must be immediately deleted from the current list of priorities. On the situation map is a steadily lengthening line reaching from the base from which our counter attacking planes were launched to the industrial capital of the now unshackled country. Slicing through the sub-stratosphere, and closing in rapidly upon this country that has sued for peace, is an aircraft capable of indescribable harm unless it is diverted or recalled.

A diversion message with "FLASH" precedence is placed on the main communications axis and addressed to the aircraft. The message is converted to perforated tape and is transmitted outward along the main line from tape-relay station to tape-relay station, branching off to a ground-air facility at key points where it is passed to the operator on duty.

A ground operator takes the message from the hands of the supervisor. When he sees the precedence, the paper suddenly feels hot to the touch. He clips it in front of his position and hurriedly consults the frequency plan that was transmitted with the mission order a few minutes



The plotting board at the USAF Radar Approach Control center.

earlier and presses a lever on the intercom. "Hey, Joe—Charlie—get this!—put transmitters four, five, and seven on the antenna that covers zone 'B.' This is it!"

He dials the three transmitters in on frequencies that for the next two hours the airborne operator will be guarding in succession, and starts transmitting the call-sign followed by the message. He repeats, and repeats again. When transmission has been completed the ground operator logs the message and listens out. In a minute or so he will be able to hear another ground operator repeating the transmission from a point a little further along the axis of communications.

On the mission, in the aircraft, the airborne operator is keeping an eye on the clock for frequency changes in accordance with his briefing chart. As he makes his first shift at the appointed time, he hears his call sign deep down in the "hash." He rapidly shifts back to his previous frequency and can barely make out his signal in the noise. He shifts up again to the previous channel and turns his receiver to "sharp" reception. He fishes around a moment then hears his call-sign coming in loud and clear.

He copies the message the first time over and waits for the repeat to verify the text and the authentication. He consults his code book. No, (Continued on page 154)

65

Duo-Band Ham Antenna

By
C. L. BUCHANAN,
W3DZZ

Over-all view of the "Multi-Max" beam. The author has contacted 98 countries with it.

Covers both 10- and 20-meter bands. In one year, using a 100-watt transmitter, 98 countries have been worked.

ONE of the most serious objections to the use of parasitic arrays has been the fact that this type of antenna is essentially a one-band affair. In spite of this limitation its obvious advantages have caused its wide acceptance by the amateur. Many attempts have been made to overcome this limitation, some with considerable success.

The antenna system described herein uses a principle of operation which eliminates the necessity for mechanical switches or "black boxes." In addition, this antenna system can be designed to operate on any number of bands which need not be harmonically related.

The frequency sensitive circuit used to control the element lengths in this design is the familiar parallel resonant circuit. Such "traps" have been used extensively by amateurs in preventing BCI, and their use in series with an antenna has been suggested by Terman for multi-band reception.

The theory of operation of the "Multi-Max" is simplicity itself at the design center frequency. At other frequencies the operation is much more difficult to predict.

The familiar dipole (see Fig. 1A) is the old standby and its performance is taken as the standard of antenna comparison.

If the insulators at the ends of the dipole of Fig. 1A are replaced

by high "Q" parallel circuits of L and C which are resonant at the resonant frequency of the dipole as in Fig. 1B, the operation of the dipole will be unimpaired at the resonant frequency. The reason for this is apparent from Fig. 6. We see that at F_r the parallel circuit presents a very high impedance. The value of this impedance is QX_L or QX_C . If the "Q" is high and X_L or X_C is high the circuit will work very well as an insulator at F_r . If, however, the dipole is excited at a frequency other than F_r , the parallel circuit becomes reactive as shown in Fig. 6, and the value of the impedance is reduced. Fig. 7A shows the equivalent circuit of the antenna above resonance and Fig. 7B shows that below resonance. A practical dipole for 10 and 20 meter operation is shown in Fig. 7C.

At 29 mc. this antenna operates as an ordinary dipole with the "traps" serving as insulators. Over the limits of the 10-meter band no detrimental effects were observed. When excited

Fig. 1. (A) A standard dipole antenna. (B) A two-band dipole for ham band operation.

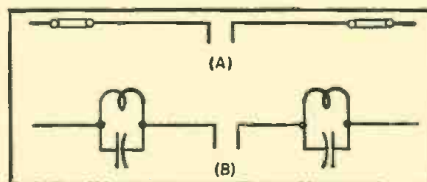

at 20 meters the impedance of the traps is quite low and is inductive. The lengths of antenna beyond the traps is adjusted to cause the antenna to resonate at this frequency. As seen from the dimensions, the total length of the antenna is considerably shorter than normal due to the series inductance of the traps. The center impedance of this antenna is not appreciably different than that of an ordinary dipole.

If ordinary condensers were used in the trap circuits, a weather-proof enclosure and a strong mechanical support would be required. It is also necessary that the voltage rating of the condenser be very high since with any appreciable power the voltage at the end of a dipole antenna is quite high. These requirements were met by constructing the high frequency section of the antenna of large dural tubing and the low frequency extensions of small tubing with an insulating bushing between them. The inductor is connected across the bushing by metal clamps. The resonant frequency of the trap is adjusted by moving one of these clamps, causing the coil to lengthen or shorten. The mechanical construction of a practical trap for 10 meter operation is shown in Fig. 2.

The capacitance across the bushing is approximately 25 μfd . and the "Q" of the trap at 30 megacycles is over 300. The effective resistance of the coil at resonance is, therefore, several megohms and the insulation is sufficient for operation at several thousand volts. The coil consists of 5 turns of $\frac{1}{8}$ inch copper tubing approximately 3 inches in diameter and 3 inches long, mounted concentric with the element as shown. The polystyrene bushing is extended beyond the large size tubing to provide a long surface leakage path. When assembled, a generous coating of silicone compound was used to protect the surface of the plastic against crazing, and to prevent the entrance of moisture into the spaces between the tubing and the bushing. The end of the large tubing was slit with a hack saw so that when the inductance clamp is tightened the bushing is securely held in the end of the tubing. The small tubing was pressed into the bushing which had been reamed to exact dimension. The dipole shown in Fig. 7C used the traps shown in Fig. 2. This dipole was tested on both 10 and 20 meters and compared on each band with a dipole cut for that band. No measurable difference could be found.

Having developed the technique of

RADIO & TELEVISION NEWS

working with multi-frequency dipoles, a parasitic array was built to test the operation of such dipoles as parasitically-excited elements. Since the previous antenna used for 10 meter operation at W3DZZ was a four-element, wide-spaced parasitic array, it was decided to make the new antenna a four-element array too. Since, however, the element spacing on 20 meters would be electrically only half as great as that on 10 meters, it was decided to use only three elements on 20 meters. Previous experimental results have shown that little additional gain is obtained by using two directors spaced at one-tenth wavelength intervals over a single director spaced two-tenths from the driven element. The spacing decided upon was: Reflector spaced .3 wavelength from the antenna, one director spaced .2 wavelength from the antenna while the second director is placed .2 wavelength from the first director on 10 meters. On 20 meters this spacing becomes .15 wavelength from reflector to antenna and .2 wavelength from antenna to the director. The calculated impedance of such an array is about 15 ohms on each band.

The boom for the array was constructed of two 12-foot lengths of 2 1/4 inch dural tubing spliced together by a 20-inch length of the same material. A 3/8 inch slit was cut from this piece which allowed it to be collapsed sufficiently to be forced into the ends of the 12-foot sections. If the width of the slot is accurately maintained a very strong splice can be obtained. The forward director and the reflector were mounted by cutting a hole through each end of the boom and inserting the element into the boom. A bolt through the joint securely holds the element in place. The hole through the boom must be accurately made to hold the element at right angles to the boom. In order to preserve the strength of the boom, the driven element and the first director were mounted by means of machined collars constructed as shown in Fig. 3. The element is held in place by "U" bolts.

Each of the elements is made of four sizes of tubing as shown in Fig. 4 except, of course, the 10 meter first director, which consists of a 12-foot section of 7/8 inch diameter dural tubing with 3/4 inch inserts in each end. When completely assembled the antenna weighs only 37 pounds.

Tuning the Beam

Tuning and adjusting the beam was done in three steps as follows:

1. Adjust the 10 meter array with no traps or extensions.
2. Adjust the traps.
3. Adjust the 20 meter array.

For tuning purposes the beam was set up on a 20-foot "A" frame mast with a hinged arrangement so all adjustment could be made from the ground. Such an arrangement allows tuning the antenna at a considerable height and still affords the safety of working on the ground all of the time.

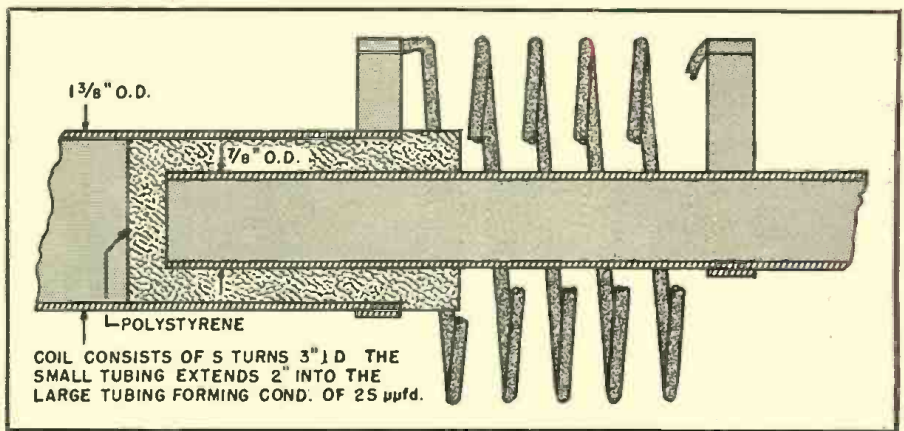

Fig. 2. Practical trap circuit for antenna applications. The length of the coil is adjusted to resonate the trap to the center of the ten meter amateur band.

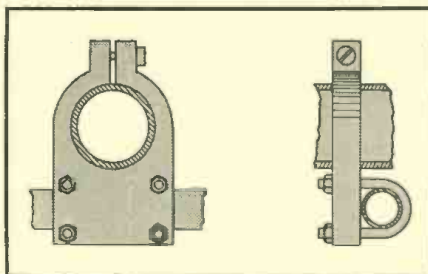

Fig. 3. Mechanical details of element clamp.

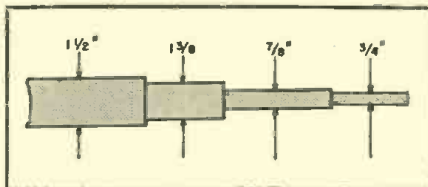

Fig. 4. Construction details of elements. All of the tubings used have .049" walls.

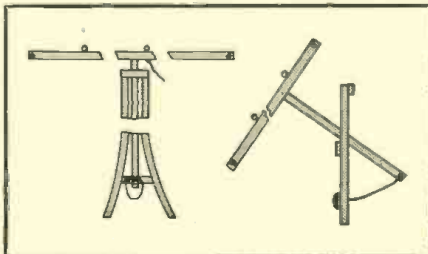

Fig. 5. Details of the temporary support which is used to facilitate the tuning.

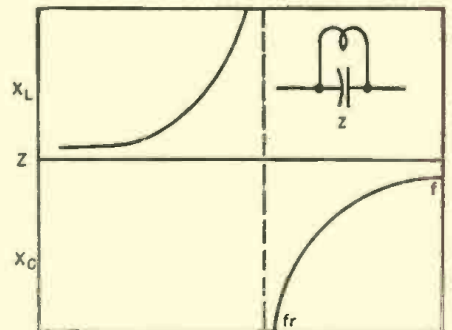

Fig. 6. Impedance of parallel tuned trap.

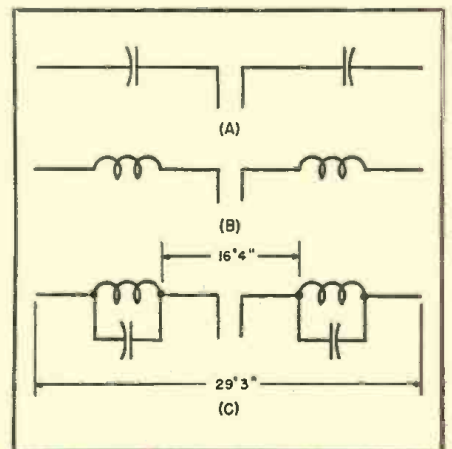
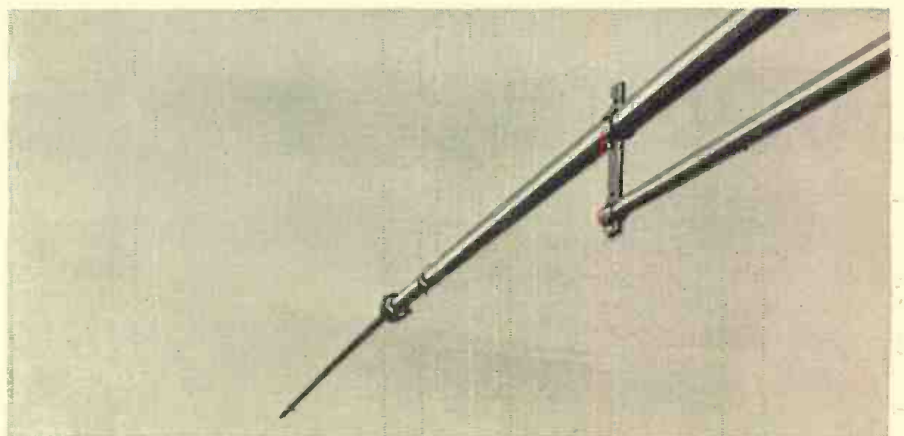

Fig. 7. Equivalent circuit (A) above resonance, and (B) that below resonance. (C) A practical ten and twenty meter dipole.

Close-up view of the "T" match section of the antenna. Loading coil is also visible.



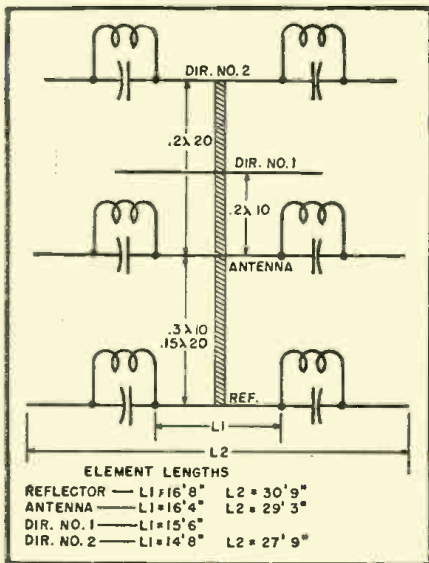

Fig. 8. Details of the "Multi-Max" beam.

A rough idea of the construction can be gleaned from Fig. 5. The hinge should be located just below the center of gravity of the antenna and the pipe mast combined, in order that the antenna will be entirely stable in the lowered position. The antenna can be lowered by merely swinging the bottom of the mast away from the "A" frame with a tie rope to keep it from swinging out farther than necessary.

The actual adjustment of the element lengths is greatly facilitated if a set of tuning gadgets such as those shown in Fig. 9 are used.

The sliding joints must work smoothly so the springs can force the element extensions back out after having been drawn in. The control line may be brought over suitable pulleys to end in a loop. A board should be secured to the pipe mast near the bottom and a series of nails or pegs driven in at about 1-inch intervals. The loop in the control line can then be hooked over the proper peg. The tuning procedure is to pull the control line down until the tuning indicator used shows that the point of maximum gain (or attenuation) has been passed, and then release the line slowly and repeat until the exact point is found. Other variations of this idea will no doubt suggest themselves to the reader. If necessary, the control line can be fastened directly to the end sections of the elements without the spring and clamps. The tuning system then will work in only one direction, but if the indicator is watched carefully, one

or two trials will permit an accurate determination of the proper length.

The beam was set up without the traps or 20 meter extensions. A test dipole was set up about four wavelengths away from the antenna and at the same height. A crystal diode was inserted in the center of this dipole with an r.f. choke from each side of the crystal to the end of a 75 ohm transmission line. The transmission line extended from the test dipole to a point near the beam where it terminated in a d.c. meter. Any low range d.c. meter can be used for this purpose, but some means will be required for shunting the meter when testing for forward gain since otherwise the range of the meter will be inadequate. Better still, one of the meters from the antenna switching unit of the command sets can be used. These meters are calibrated to read r.f. current with an external thermocouple. It is interesting to note that the scale on this instrument is linear. With the thermocouple removed the meter becomes a logarithmic d.c. ammeter with a full scale current of 6 ma. Used in a test setup as described the meter will read approximately linear in db. with a scale factor of around 3 depending on the characteristics of the line and the dipole and crystal used. The scale factor is easily checked by making two readings at different power levels. The 30 db. range is ideal for such tests.

The beam was fed through a length of 75 ohm twin lead "T" matched to the driven element. No special precautions were taken to get a correct match, but rather to get sufficient power into the antenna. With the antenna pointed toward the test dipole the elements were adjusted one at a time for maximum reading on the logarithmic meter. After all the elements had been adjusted, they were rechecked twice to eliminate errors caused by retuning the second element after the first one had been set, etc. It is suggested that the first director be adjusted first since it is the more critical as far as forward gain is concerned. After this procedure was completed, the beam was reversed to point directly away from the test dipole. Each element was then readjusted for minimum back radiation. The length of each element was carefully noted during these adjustments and it was found that there was very little difference in the adjustment for maximum forward gain and that for minimum backward radiation. Slight changes in the reflector length had very little effect on the forward gain but had a consider-

able effect on the backward radiation. The front-to-back ratio of the array at 29 mc. was almost 30 db.

The 10 meter section of the antenna was now finished and ready for the assembly of the traps and extensions. The traps were tuned by assembling them on short pieces of tubing and adjusting the length of the coil until the resonance point, as measured by a grid dip meter, was exactly 29 mc. In the process each coil was numbered and its length noted when the trap was resonant at 28.9 mc., 29.0 mc., and 29.1 mc. When this process was completed for each trap, all the traps were assembled on the 20 meter extensions. With the beam still energized on 10 meters, the 20 meter extensions with their associated traps tuned to 29.0 mc. were added, one at a time, to the adjusted 10 meter beam. Surprisingly enough the addition of these traps and extensions had no noticeable effect on either the forward or backward radiation, or on the loading of the beam.

The beam was now energized on 20 meters and the tuning procedure repeated in the same manner as for the 10 meter section. The front-to-back ratio on 20 meters was higher than that for 10 meters, probably due to the closer reflector spacing. The length of the elements at 20 meters was considerably shorter than normal due to the series inductance of the traps at this frequency. The antenna was again excited on 10 meters and no change in the beam patterns or gain was noted. The final dimensions are shown in Fig. 8 with the "finished product" shown in the photograph.

During the adjustment the SWR on the feedline was not known since no attempt had been made to adjust the match. A plot was now made of SWR vs "T" match length for each band. The two curves crossed each other at a SWR of 1.4:1 with a length of 106 inches. This was not considered too high for use and it eliminated the necessity of constructing a complicated matching network. The patterns were rechecked on both bands to make sure that the "T" match adjustment had not upset the adjustment of the beam. No such effect was observed.

When adjusting a "T" match, the matching section should be made of telescoping tubing in order to prevent any of the tubing from extending beyond the clamps. If this is not done the reactance of the short length of tubing beyond the clamps will be reflected back into the system. If at the end of the adjustment, these lengths are cut off, the SWR will change.

General Details

The appearance of the antenna is more conventional than might be expected. The traps are hardly visible from a distance and the element sag is no worse than in a regular 20 meter beam.

Operation of the antenna at frequencies between the two "fundamental" frequencies is of interest. If, for example, the excitation frequency is

(Continued on page 73)

Fig. 9. Mechanical details covering the device used for tuning the antenna elements.

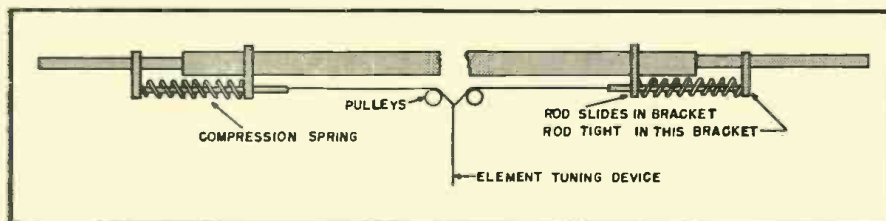

4 Pages of TEST EQUIPMENT at prices every serviceman can afford!

MONEY BACK?

Every single unit described on this and the following pages is offered on a strict "money-back-if-not-satisfied-basis." No if's—no but's—no maybe's. Simply send your order for any

unit or units you select and try them out for 10 days. If not completely satisfied—return for refund in full. No explanation necessary. You are sole judge.

GUARANTEE?

Every instrument sold by us is covered by a one-year guarantee. Guarantee registration card is included with shipment.

KITS?

We have discontinued advertising TEST EQUIPMENT in Kit form. The units offered on these 4 pages are completed instruments, NOT KITS! Every model is factory-wired, calibrated and ready to operate.

TUBE TESTERS

Important Note: The two models described below include slip-on portable hinged covers. This is a very desirable feature in Tube Testers because the multiple switches used on such units indicate properly only when clean. The slip-on covers insure long life because the front panel, including all switches, is fully protected when the instrument is not in actual use.

THE NEW MODEL 247



Check octals, loctals, bantam jr., peanuts, television miniatures, magic eye, hearing aids, thyratrons, the new type H.F. miniatures, etc.

Features:

★ A newly designed element selector switch reduces the possibility of obsolescence to an absolute minimum.

★ When checking Diode, Triode and Pentode sections of multi-purpose tubes, sections can be tested individually. A special isolating circuit allows each

section to be tested as if it were in a separate envelope.

★ The Model 247 provides a supersensitive method of checking for shorts and leakages up to 5 Megohms between any and all of the terminals.

★ One of the most important improvements, we believe, is the fact that the 4-position fast-action snap switches are all numbered in exact accordance with the standard R.M.A. numbering system. Thus, if the element terminating in pin No. 7 of a tube is under test, button No. 7 is used for that test.

Model 247 comes complete with new speed-read chart. Comes housed in handsome hand-rubbed oak cabinet sloped for bench use. A slip-on portable hinged cover is indicated for outside use. Size: 10 3/4" x 8 3/4" x 5 3/4".

\$29⁹⁰
NET

SUPERIOR'S NEW MODEL TV-10



★ Tests all tubes including 4, 5, 6, 7, Octal, Lock-in, Peanut, Bantam, Hearing-Aid, Thyratron, Miniatures, Sub-Miniatures, Novals, etc. Will also test Pilot Lights.

★ Tests by the well-established emission method for tube quality, directly read on the scale of the meter.

★ Tests for "shorts" and "leakages" up to 5 Megohms.

★ Uses the new self-cleaning Lever Action Switches for individual element testing. Because all elements are numbered according to pin-number in the RMA base number

the user can instantly identify which element is under test. Tubes having tapped filaments and tubes with filaments terminating in more than one pin are truly tested with the Model TV-10 as any of the pins may be placed in the neutral position when necessary.

★ The TV-10 does not use any combination type sockets. Instead individual sockets are used for each type of tube. Thus it is impossible to damage a tube by inserting it in the wrong socket.

★ Newly designed Line Voltage Control compensates for variation of any line voltage between 105 Volts and 130 Volts.

★ Free-moving built-in roll chart with complete data on all tubes.

The Model TV-10 operates on 105-130 Volt 60 Cycles A.C. Comes housed in a beautiful hand-rubbed oak cabinet complete with portable cover.

\$39⁵⁰
NET

TO ORDER—TURN TO PAGE 72 FOR RUSH ORDER FORM

GENERAL ELECTRONIC DISTRIBUTING CO.

DEPT. RN-12, 98 PARK PLACE

NEW YORK 7, N. Y.

1

BUY WITH CONFIDENCE!!

WE KNOW THE PRICE IS UNBELIEVABLY LOW...

But that's not all! In addition, this finely engineered instrument provides a degree of accuracy never before attained in a unit selling for even double this price. Furthermore—in designing this unit, we took advantage of every recent improvement in components. For example, by using slug-tuned coils, we are able to efficiently adjust each instrument for

perfect accuracy. This feature will also enable you to recalibrate the model 200 periodically without having to return it to the factory. The use of a Noval tube (the 12AU7) with its extremely low inter-electrode capacity enabled us to reach a higher frequency range than was heretofore possible in a unit of this type.

THE NEW MODEL 200

AM and FM

SIGNAL GENERATOR



SPECIFICATIONS

- ★ **R.F. FREQUENCY RANGES:** 100 Kilocycles to 150 Megacycles.
- ★ **MODULATING FREQUENCY:** 400 Cycles. May be used for modulating the R. F. signal. Also available separately.
- ★ **ATTENUATION:** The constant impedance attenuator is isolated from the oscillating circuit by the buffer tube. Output impedance of this model is only 100 ohms. This low impedance reduces losses in the output cable.
- ★ **OSCILLATORY CIRCUIT:** Hartley oscillator with cathode follower buffer tube. Frequency stability is assured by modulating the buffer tube.
- ★ **ACCURACY:** Use of high-Q permeability, tuned coils adjusted against 1/10th of 1% standards assures an accuracy of 1% on all ranges from 100 Kilocycles to 10 Megacycles and an accuracy of 2% on the higher frequencies.
- ★ **TUBES USED:** 12AU7—One section is used as oscillator and the second is modulated cathode follower. T-2 is used as modulator. 6C4 is used as rectifier.

The Model 200 operates on 110 Volts A.C. Comes complete with output cable and operating instructions.

\$ **18**⁸⁵
NET

2

TO ORDER—TURN TO PAGE 72 FOR RUSH ORDER FORM

GENERAL ELECTRONIC DISTRIBUTING CO.

DEPT. RN-12, 98 PARK PLACE, NEW YORK 7, N. Y.

MONEY BACK GUARANTEE!!



SUPERIOR'S new model 770 AN ACCURATE POCKET-SIZE VOLT-OHM MILLIAMMETER

(SENSITIVITY: 1000 OHMS PER VOLT)

FEATURES

- ★ Compact-measure 3 1/8" x 5 7/8" x 2 1/4".
- ★ Uses latest design 2% accurate 1 Mil. D'Arsonval type meter.
- ★ Same zero adjustment holds for both resistance ranges. It is not necessary to readjust when switching from one resistance range to another. This is an important time-saving feature never before included in a V.O.M. in this price range.

★ Housed in round-cornered, molded case.

★ Beautiful black etched panel. Depressed letters filled with permanent white, insures long-life even with constant use.

The Model 770 comes complete with self-contained batteries, test leads and all operating instructions.

SPECIFICATIONS

- | | |
|--|---|
| 6 A.C. VOLTAGE RANGES:
0—15/30/150/300/1500/3000 VOLTS | 4 D.C. CURRENT RANGES:
0—1.5/15/150 MA. 0—1.5 AMPS. |
| 6 D.C. VOLTAGE RANGES:
0—7.5/15/75/150/750/1500 VOLTS | 2 RESISTANCE RANGES:
0—500 OHMS 0—1 MEGOHM |

\$14⁹⁰
NET



SUPERIOR'S new model 670 SUPER-METER A COMBINATION VOLT-OHM MILLIAMMETER PLUS CAPACITY REACTANCE INDUCTANCE AND DECIBEL MEASUREMENTS

SPECIFICATIONS:

- D.C. VOLTS:** 0 to 7.5/15/75/150/750/1,500/7,500 Volts
- A.C. VOLTS:** 0 to 15/30/150/300/1,500/3,000 Volts
- OUTPUT VOLTS:** 0 to 15/30/150/300/1,500/3,000 Volts
- D.C. CURRENT:** 0 to 1.5/15/150 Ma. 0 to 1.5 Amperes
- RESISTANCE:** 0 to 500/100,000 Ohms 0 to 10 Megohms
- CAPACITY:** .001 to .2 Mfd. .1 to 4 Mfd. (Quality test for electrolytics)
- REACTANCE:** 700 to 27,000 Ohms 13,000 Ohms to 3 Megohms

INDUCTANCE: 1.75 to 70 Henries 35 to 8,000 Henries

DECIBELS: -10 to +18 +10 to +38 +30 to +58

ADDED FEATURE:

The Model 670 includes a special GOOD-BAD scale for checking the quality of electrolytic condensers at a test potential of 150 Volts.

The Model 670 comes housed in a rugged, crackle-finished steel cabinet complete with test leads and operating instructions. Size 5 1/2" x 7 1/2" x 3".

\$28⁴⁰
NET

SUPERIOR'S
new model TV-20

20,000 OHMS PER VOLT MULTI-METER and TELEVISION KILOVOLT METER

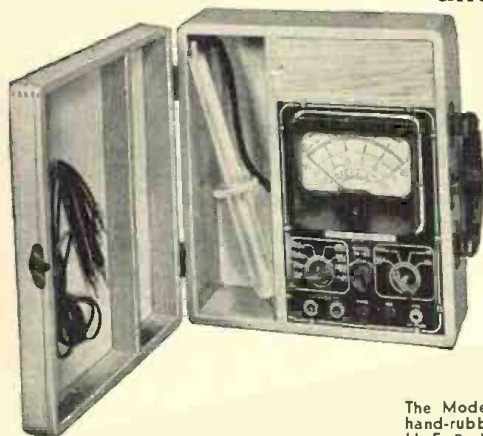

SPECIFICATIONS

- 9 D. C. VOLTAGE RANGES: (At 20,000 ohms per Volt)
0-2.5/10/50/100/250/500/1,000/5,000/50,000 Volts
- 8 A. C. VOLTAGE RANGES: (At 1,000 ohms per Volt)
0-2.5/10/50/100/250/500/1,000/5,000 Volts
- 5 D. C. CURRENT RANGES
0-50 Microamperes
0-5/50/500 Milliampers
0-5 Amperes
- 4 RESISTANCE RANGES:
0-2,000/20,000 ohms 0-2/20 Megohms
- 7 D. B. RANGES: (All D. B. ranges based on
Odb = 1 Mv. into a 600 ohm line)
- 4 to +10 db + 36 to +50 db
+ 8 to +22 db + 42 to +56 db
+ 22 to +36 db + 48 to +62 db
+ 28 to +42 db
- 7 OUTPUT VOLTAGE RANGES:
0 to 2.5/10/50/100/250/500/1,000 Volts

ADDED FEATURE:

The Model TV-20 includes an Ultra High Frequency Voltmeter Probe. A Silicon V. H. F. Diode together with a resistance capacity network provides a frequency range up to 1,000 MEGACYCLES. When plugged into the Model TV-20, the V. H. F. Probe converts the unit into a Negative Peak-Reading H. F. Voltmeter which will measure gain and loss in all circuits including F. M. and T. V.; check capacity and impedance; test efficiency of all oscillator circuits; measure band-width of F. M. and T. V.; etc.

\$39⁹⁵
NET

The Model TV-20 operates on self-contained batteries. Comes housed in beautiful hand-rubbed oak cabinet complete with portable cover. Built-in High Voltage Probe, H. F. Probe. Test Leads and all operating instructions. Measures 4 1/2" x 10 1/4" x 11 1/2". Shipping Weight 10 lbs.

TO ORDER—TURN TO PAGE 72 FOR RUSH ORDER FORM

GENERAL ELECTRONIC DISTRIBUTING CO.

98 PARK PLACE

DEPT. RN-12

NEW YORK 7, N. Y.

3

Superior's model CA-12



SIGNAL TRACER

THE WELL KNOWN MODEL CA-12 IS THE ONLY SIGNAL TRACER IN THE LOW PRICE RANGE INCLUDING BOTH METER AND SPEAKER!!!

SPECIFICATIONS

- ★ Comparative Intensity of the signal is read directly on the meter—quality of the signal is heard in the speaker.
- ★ Simple to Operate—only one connecting cable—no tuning controls.
- ★ Highly Sensitive—uses an improved vacuum-tube voltmeter circuit.
- ★ Tube and Resistor Capacity Network are built into the detector probe.
- ★ Built-in High Gain Amplifier—Alnico V Speaker.
- ★ Completely Portable—weighs 8 pounds—measures 5 1/2" x 6 1/2" x 9".

MODEL CA-12 COMES COMPLETE WITH ALL LEADS AND OPERATING INSTRUCTIONS

\$29⁹⁵
NET

Superior's new model TV-30

TELEVISION SIGNAL GENERATOR

ENABLES ALIGNMENT OF TELEVISION I. F. AND FRONT ENDS WITHOUT THE USE OF AN OSCILLOSCOPE!

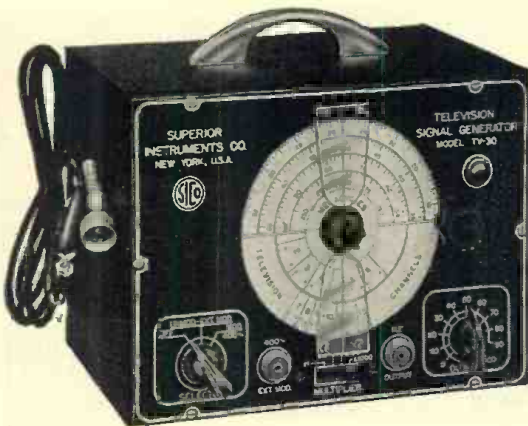

FEATURES Built-in modulator may be used to modulate the R. F. Frequency, also to localize the cause of trouble in the audio circuits of T. V. Receivers.

Double shielding of oscillatory circuit assures stability and reduces radiation to absolute minimum. Provision made for external modulation by A. F. or R. F. source to provide frequency modulation. All I. F. frequencies and 2 to 13 channel frequencies are calibrated direct in Megacycles on the Vernier dial. Markers for the Video and Audio carriers within their respective channels are also calibrated on the dial.

Linear calibrations throughout are achieved by the use of a Straight Line Frequency Variable Condenser together with a permeability trimmed coil.

Stability assured by cathode follower buffer tube and double shielding of component parts.

SPECIFICATIONS Frequency Range: 4 Bands—No switching; 18-32 Mc., 35-65 Mc., 54-98 Mc., 150-250 Mc.

Audio Modulating Frequency: 400 cycles (Sine Wave). Attenuator: 4 position, ladder type with constant impedance control for fine adjustment. Tubes Used: 6C4 as Cathode follower and modulated buffer. 6C4 as R.F. Oscillator. 6SN7 as Audio Oscillator and power rectifier.

Model TV-30 comes complete with shielded co-axial lead and all operating instructions. Measure 6" x 7" x 9". Shipping Weight 10 lbs.

\$29⁹⁵
NET

RUSH ORDER FORM

CUT OUT AND MAIL TODAY!

GENERAL ELECTRONIC DISTRIBUTING CO.

DEPT. RN-12, 98 PARK PLACE, NEW YORK 7, N. Y.

GENTLEMEN:

PLEASE RUSH THE MATERIAL LISTED BELOW:

QUANTITY	MODEL	PRICE

TOTAL

\$..... (Payment in Full Enclosed)

\$..... (Deposit Enclosed—Ship Balance C.O.D.)

SHIP TO:

Name

Address

City Zone State



Duo-Band Antenna

(Continued from page 68)

decreased starting at 29 mc. the dipole proper becomes too short. At the same time, however, the trap impedance is reduced and begins to be inductive. At some lower frequency the inductance of the trap and the reactance of the 20 meter extension offset the foreshortening of the dipole and the system again becomes resonant. By proper choice of the element size and the LC ratio of the traps, the frequency of this resonance can be caused to fall in the 11 meter band. The antenna described here works well in this band although the front-to-back ratio suffers appreciably. To correct the front-to-back ratio on this band without spoiling it on the other bands would probably require the use of different LC ratios in the various elements. It would probably help also if the first director was made a two-band element like the others. This, of course, would immediately make the problem of matching more difficult.

The circuits of Fig. 7 indicate that this type of antenna has certain broad-band characteristics. In practice the antenna has worked well over the entire 10 and 20 meter phone bands and no other check on this factor has been made.

Since the antenna was intended to radiate on 10 meters, it was feared that radiation on this band when working in the 20 meter band might be excessive. Strangely enough, this has not been found to be true. The explanation apparently is that harmonics are generally coupled into the antenna system capacitively. In this antenna system the feedline is a low impedance to the second harmonic as well as the fundamental, and therefore the energy getting into the antenna through these stray capacitances is less than with the normal 20 meter antenna where the feedline impedance is high at the second harmonic.

Operation

The antenna was mounted on a 40 foot windmill tower and fed through 120 feet of 75 ohm twin-lead. No antenna tuner was used and no difficulty was experienced in loading it on either band when link-coupled to the final amplifier. The transmitter was the old 100 watt standard—push-pull 807's.

The antenna was put into operation a few days before the DX contest in March, 1949. In eight hours of operation on 10 meter phone (during the contest), 47 contacts were made with 17 countries. After the contest was over operation on 20 meters was tried. The results were equally good on this band. In approximately one year of operation 98 countries have been contacted, mostly on 20 meter phone.

It should be understood that this antenna is no better on either band than a similar single-band beam designed, constructed, and adjusted, with equal care.

-30-

December, 1950

ASTATIC IS FIRST IN PERFORMANCE FIRST IN CABINET STYLING

Booster Model BT-1

List Price \$32.50

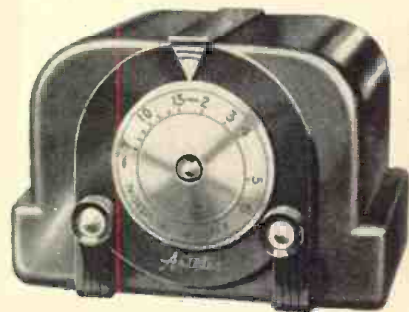

Booster Model BT-2

List Price \$34.95

Compare:
the ability to
improve reception
of these two NEW
ASTATIC TV and FM
BOOSTERS with ANY
others

Note these Quality Features

- 1 Mallory Inductuner for continuous variable tuning.
- 2 High gain, very uniform on both high and low channels.
- 3 Simplified controls—single tuning knob with continuous tuning through both TV and FM bands.
- 4 Band width adequate over entire range.
- 5 Low noise design and construction.
- 6 No shock hazard to user.
- 7 Off-on switch for easily cutting in and out of circuit.
- 8 Selenium rectifier.
- 9 Single 6AK5 Tube.
- 10 Provide for either 72 ohm or 300 ohm impedance input and output.
- 11 Model BT-2 has handsome, dark brown plastic cabinet.
- 12 Model BT-1 has metal cabinet in rich mahogany woodgrain finish.
- 13 Large dial face is easy to see in tuning.
- 14 Model BT-2 has recessed pilot light to show when booster is on.

• Yes, forget their low cost,

and make your own comparison of these new Astatic Boosters with others at any price! You'll be amazed at the difference . . . the higher gain and greater reduction of interference and distortion . . . provided by the Astatic BT-1 and BT-2. Astatic engineering leadership has given these new units an unequaled ability to improve both TV and FM reception. But, the final proof is in your own results. Why not put them to the test and see why these new low-cost models are taking the field by storm?

THE
Astatic
CORPORATION
CONNEAUT, OHIO
IN CANADA: CANADIAN ASTATIC LTD., TORONTO, ONTARIO

Here it is again!
**SUN RADIO'S ANNUAL
 WAREHOUSE INVENTORY
 CLEARANCE SALE!**

CRYSTALS Low Freq.

FT-241 A holder 1/2" pin spacing, for ham and general use, Xtal controlled Signal Generators, marked in army Mc harmonic frequencies—Directions for deriving fundamental frequencies enclosed. Listed below by fundamental frequency, fractions omitted.

412	426	442	475	493	504	516	372	381	390	401
413	427	443	477	494	506	518	374	383	391	402
414	429	444	479	495	507	519	375	384	392	403
415	431	445	481	496	508	522	376	386	393	404
416	433	446	483	497	509		377	387	394	405
418	434	447	484	498	511		379	388	395	408
419	435	448	485	503	515		380		396	409
420	436	462	487						397	411
422	437	458	488						400	
423	438	472	490						each	
424	440	473	491						each	
425	441	474	492	10 for \$4.50					each	

450	465.277	530.555	536.111	Special 200 kc Xtals without holders 21-32"x 23-32"
452.777	526.388	531.944	537.500	
461.111	529.166	533.333	538.888	59¢ each
464.815				3 for.....\$2.00

HAM CRYSTALS

FT-243 holders 1/2" pin spacing, for ham and experimental use. Fractions omitted.

4190	6140	7773	3735	5873	6450	7340	7640
5030	6173	7806	5305	5875	6473	7373	7673
5485	6206	7840	5677	5900	6475	7406	7706
6006	6773	7873	5706	5906	6506	7440	7806
6040	6840	7906	5740	5925	6540	7473	8340
6073	6873	7973	5760	5940	6573	7506	
6075	6906	8273	5760	5973	6606	7540	
6100	6973	8306	5773	5975	6640	7573	
6106	7740		5775	6273	6673		
	each		5806	6340	6706	each	
	49¢		5825	6373	6740	99¢	
	10 for \$4.50		5840	6425	6806		
			5850	6440	7306	10 for \$4.50	

**SCR-522
 XTALS**

5910	6610	7580
6370	7350	7810
6450	7480	7930
6470		
6407.9		
6522.9		
6547.9		

BC-610 XTALS

2 banana plugs 3/4" spc.

2045	2260	2415	3215	3570
2106	2282	2435	3237	3580
2125	2300	2442	3250	3945
2145	2305	2532	3322	3955
2155	2320	2545	3510	3995
2220	2360	2557	3520	each
2258	2390	3202	3550	1.29

Payments must accompany order. Enclose 30c for postage and handling. Minimum order \$2.00 plus postage. Crystals shipped packed in cloth bags inasmuch as they are shock mounted. All shipments guaranteed.

**BENDIX 100 WATT
 TRANSMITTER**



One switch used to change 10-20-40-80 meter bands.

FOUR SEPARATE ELECTRONIC COUPLED OSCILLATORS: these can be easily converted to 20-40-80 meters. Crystal required for 10 meters. Each electronic coupled oscillator dial has 3000 divisions enabling quick precision shifting. This transmitter was constructed of the highest quality of precision parts, with laboratory precision. Four separate output tanks; one 4-position selector channel switch having seven sections which changes the ECO, IPA and output tanks simultaneously. All the controls are mounted on the front panel. The housing is cast aluminum; shields and case are sheet aluminum. Dimensions: 11 x 12 x 15 inches, weighing 35 1/2 lbs. Complete, simple instructions for conversion furnished. Uses three 807, four 12SK7 tubes, one 2-inch 5-amp. R.F. meter. A complete coverage transmitter, for the new or experienced amateur.

A TRUE HAM VALUE complete with tubes was \$49.95

NOW ONLY \$29.95 LIKE NEW \$19.95 USED

High Voltage Triplet DC, Volt-meters—125 Ohms per Volt—With External Multiplier—Brand New!

Volts	2"	Price	3"	Price
600		\$2.95		\$3.95
1000		3.49		4.49
1500		3.49		4.49
2000				4.49

BC-746 Tuning Units, contains antenna, oscillator coils, 140 mmf midjet tuning condenser, double crystal socket, less xtals.....\$3.39
 With 2 crystals.....\$5.99

TERMS: All items F. O. B., Washington, D. C. All orders \$30.00 or less, cash with order. Above \$30.00, 25 per cent with order, balance C.O.D. Foreign orders cash with orders, plus exchange rate.

SUN RADIO
 OF WASHINGTON, D. C.
 938 F STREET, N. W. WASH. 4. D. C.

THE AD-VISER

4

ADVERTISING COPY MUST SELL THE PRODUCT

By
IRVING SETTEL

COPY refers to the reading matter of an advertisement. Its purpose is to stimulate sales by attracting the reader's attention and maintaining his interest in the advertised product. An effective piece of copy will sell merchandise. There is no other measurement.

Many radio and television merchants insist on writing their own copy for newspaper advertisements and direct mail pieces. Even when advertising departments are maintained, supervision may be desirable or necessary. Consequently, a few of the more important rules of effective copy writing will not be amiss.

Important Rules

1. *Address your copy to the reader.* The ultimate consumer is the most important critic of the advertisement. If he reads the copy, he may or may not act upon its suggestions. Remember that he is human. He possesses emotions, opinions, and preferences. Adjust your copy appeal to his wants and desires. Talk in terms of what you believe your potential customer wants to get out of the product. Instead of saying, "We have the lowest prices in town," say, "Here's a place that's easy on your pocketbook." Tell the reader how he will benefit from the purchase. Don't talk in terms of your needs because the reader is interested only in satisfying his own.

2. *Know the claims and advantages of your competitor's products.* Always watch your competitor's advertisements. If you feel that he is outselling you, change your copy accordingly. Always compare and improve your own copy content and ideas.

3. *Make your copy "clear, simple, and specific."* Modern readers are always in a hurry. The reading life of an average newspaper is about 15 minutes. Readers will not waste time reading unnecessary material. They prefer, instead, to get the message quickly and clearly. A good copy writer gives a reader what he wants. Clever phrases and catchwords are all right, if they do not detract from the thought. This does not mean that you should "write down" to what you believe to be the level of public intelli-

gence. Never assume that the reader is stupid. It does mean, however, that you should write plainly.

Types of Copy

Institutional Copy. Institutional copy is designed to create goodwill for the radio and television retailer. It usually describes the store's policies, ideals, payment plans, etc., in order to build prestige. It is not aimed at immediate sales but instead at long range attitudes. Because of this, it is used infrequently, usually on holidays such as Easter or Christmas.

Promotional Copy. This type of copy is aimed at immediate sales. In this case, an advertiser will attempt to bring a customer into his place to make a purchase. This type of copy, of course, makes up the bulk of current advertising.

It is also called "selling copy" and it may talk about the advantages of the radios and television sets, prices, benefits derived from their use, etc. Copy in a promotional ad can either make or break a sale. Either it will create the desire to buy or it will be a dud. Consequently, great care must be taken in the writing of promotional copy.

Writing the Copy

You do not have to be a great writer to turn out effective copy. If you follow a few basic rules, and write as you would make a sales talk, you can bring customers into your place of business with the magic of words. Here are the rules:

Watch your grammar. Correct grammar and spelling are essential. Mistakes are seen immediately by the reader and the sales message may be lost.

Choose simple words which are pleasant to read. Do not waste the reader's time or patience. Tell what your products are, what they will do, how they will benefit the reader. Don't try to be too clever with words or trick phrases, with a play on words. Remember that the most effective advertising copy written is clear down-to-earth language.

Make your copy as short as possible. Always remember that a reader is instinctively in a hurry. Save him time by writing your message in the fewest possible words.

Write in terms of the reader's needs. Remember that an advertisement is

YOUR OPPORTUNITY IS HERE NOW! LEARN

TELEVISION

RIGHT AT HOME!

By the new method of

TRANSPONDENCE

training on film and tape recordings

Now the De Forest-Sanabria Corporation—a division of the world's largest television training school—brings class-room instruction to you right in your own home! You actually hear your instructor's recorded voice. At the same time you watch "blackboard" size projected pictures, diagrams and illustrations. It's the quick, easy way to equip yourself for the big earnings in television—today!

LOOK . . . You get the tape recorder and projector right at the start of your course!



HEAR your instructor

It's even better than the classroom, because you can repeat the instructor's lectures until they're thoroughly understood.

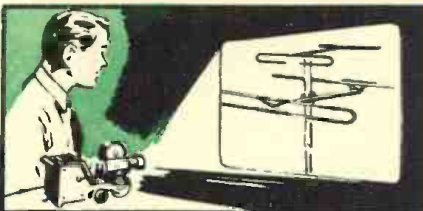

SEE 2000 illustrations

You learn quicker when you see diagrams and illustrations in black-board size.

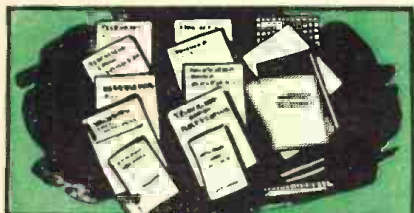

READ from reference library

You receive complete books, pamphlets and manuals to supplement your instructor's lessons.



ASK your questions on tape

Tell your instructor about anything that puzzles you and get his answers back pronto.



BE A SUCCESS . . . ACT NOW!

Millions of television set owners are demanding qualified television technicians to service their sets. There is a tremendous shortage of such qualified men today and will be for many years to come. Get in on the ground floor of this booming industry and be prepared to accept a steady, big pay job for life. We can qualify you quickly, easily, surely—and help get you a job when you complete your course. Send for illustrated booklet that gives the complete details.

The De Forest-Sanabria Corp.

An affiliate of American Television, Inc.

5050 North Broadway, Chicago 40, Illinois

MAIL COUPON TODAY!

De Forest-Sanabria Corporation **FREE BOOK**
Dept. RN-12
5050 Broadway, Chicago 40, Ill. **TELLS HOW**

Dear Sirs:

Please send me copy of your free illustrated booklet which describes the new TRANSPONDENCE method of learning television at home under the direction of Dr. Lee de Forest and U. A. Sanabria.

NAME _____ AGE _____

ADDRESS _____

CITY _____ STATE _____

(Mail in envelope or paste on a postcard.)



604B DUPLEX



8" 400B



8" 755A*



12" 600B



12" 728B*



15" 603B



Two-way 757A*

ALTEC

for every speaker need ...

Regardless of restrictions or special requirements an ALTEC speaker can do the job better ... ALTEC speakers have many "exclusive" design features, resulting in a superior product ... with smoother extended frequency response ... higher efficiency ... finer full-range tonal qualities ... greater listening pleasure ... more ruggedness and trouble-free operation. Investigate further why ALTEC speakers are chosen on direct listening comparison ... write for complete technical information.

9356 Santa Monica Blvd.,
Beverly Hills, Calif.

161 Sixth Avenue,
New York 13, New York

ALTEC

LANSING CORPORATION

* Distributed by Graybar — formerly manufactured by Western Electric Co. Inc.

often forced upon a reader's attention. Therefore, you must portray in your copy an understanding of the reader's needs and desires. Suggest that the person buy the radio or television set, not because your store is selling them, but because they will benefit the user.

Many ads use illustrations of various types to expand and amplify the copy or reading material. Since there are several effective ways of displaying your merchandise in your advertisements we will discuss these different techniques in some detail in next month's article.

-30-

"Williamson" Amplifier

(Continued from page 53)

left to the discretion of the builder. Care should be taken in the wiring to ground the filament line adjacent to pin No. 7 on the 6SJ7 stage. This tube is biased by a combination of cathode and grid leak bias; an arrangement that minimizes tube noise.

Performance

The distortion-free characteristics of the amplifier are immediately apparent upon the first playing. The lack of false bass response and bass transient hangover is also striking, and can be attributed to the exceptionally low output impedance of the amplifier which is in the neighborhood of three-tenths of an ohm on the sixteen ohm tap. The damping factor seen by the speaker is, therefore, about 48, and results in a real improvement in the transient characteristics of the speaker.

The curves taken of intermodulation, shown in Fig. 4, reveal the low distortion content of the output. It is clearly seen that the 10 watt rating of the amplifier is a conservative one, since for any condition of measurement the intermodulation is less than 1%. It might also be mentioned that these curves were taken at a lower-than-normal plate supply voltage of 400 volts on the 807 output tubes. For

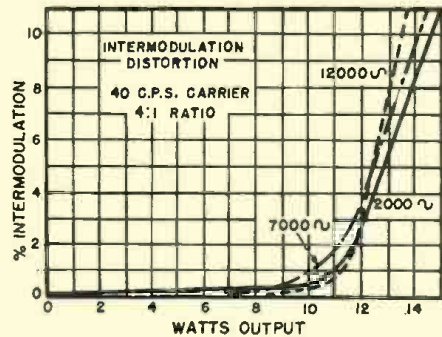

Fig. 4. Intermodulation distortion.

the normal plate supply voltage of 425 volts, about 15% more output or 11.5 watts can be expected for the same amount of intermodulation distortion.

The excellent transient characteristics of the amplifier can be deduced from the frequency response curve shown in Fig. 5. The response is shown for a 100 milliwatt output level and under the conditions both with and without feedback. The influence of the output transformer can easily be judged from these curves. Without feedback the response is down 3 db. at 55 kc. and at 12 c.p.s. It should be noted that this response is that of the complete amplifier and includes the normal roll-off in gain of the individual stages as caused by the tube input capacities and the effect of the stage coupling condensers. With feedback the curve is flat to 75 kc. and lacks the usual resonant rise associated with feedback amplifiers at the high frequency end of the band; a condition that causes ringing and a dissipation of power at unwanted frequencies. The response at maximum output power taken with distortion limited to 2% is also noteworthy and indicates the undistorted response to be down only 3 db. at 8 c.p.s. and at 50 kc.

It is the excellence of these results and the uniformity with which they may be achieved that is largely responsible for the growing popularity of the Williamson amplifier.

-30-

Fig. 5. Frequency response characteristics of the audio amplifier.

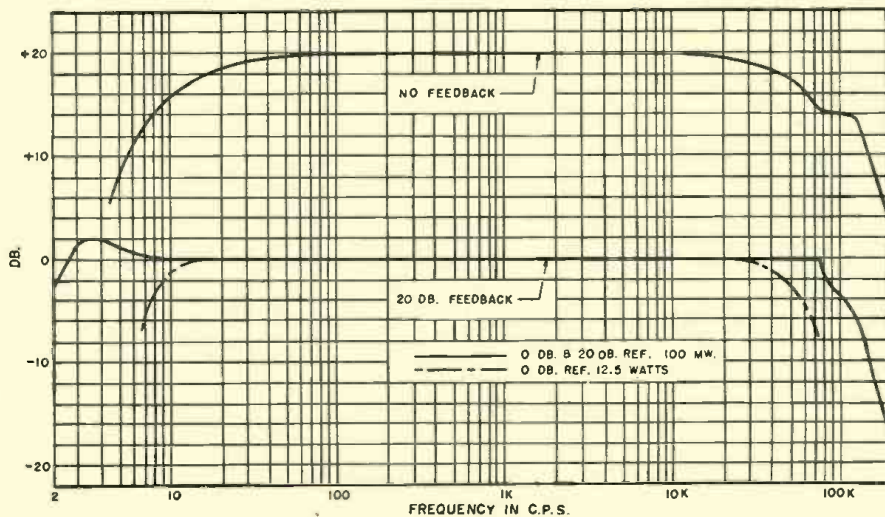

You GET
THE BEST IN
Heathkits

Heathkits are the Quality Line of TEST INSTRUMENT KITS



Modern STYLING KITS THAT MATCH

Heathkits are styled in the most modern manner by leading industrial stylists. They add beauty and utility to any laboratory or service bench. There is a complete line of Heathkit instruments allowing a uniformity of appearance.

An attractive service shop builds a feeling of confidence. Many organizations have standardized on Heathkits providing uniform service departments.

There is no waste space or false effort to appear large in Heathkits — space on service benches is limited and the size of Heathkit instruments is kept as small as is consistent with good engineering practice.



Accuracy ASSURED BY PRECISION PARTS

Wherever required, the finest quality 1% ceramic resistors are supplied. These require no aging and do not shift. No matching of common resistors is required. You find in Heathkit the same quality voltage divider resistors as in the most expensive equipment.

The transformers are designed especially for the Heathkit unit. The scope transformer has two electrostatic shields to prevent interaction of AC fields.

These transformers are built by several of the finest transformer companies in the United States.

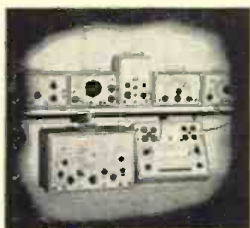

Used BY LEADING MANUFACTURERS

Leading TV and radio manufacturers use hundreds of Heathkits on the assembly lines. Heathkit scopes are used in the alignment of TV tuners. Impedance bridges are serving every day in the manufacture of transformers. Heathkit VTVM's are built into the production lines and test benches. Many manufacturers assemble Heathkits in quantity for their own use thus keeping purchase cost down.

Famous HEATHKIT PARTS

- MALLORY FILTER CONDENSERS
- WILKOR PRECISION RESISTORS
- GRIGSBY ALLISON SWITCHES
- ALLEN-BRADLEY RESISTORS
- GENERAL ELECTRIC TUBES
- CHICAGO TRANSFORMER
- CENTRALAB CONTROLS
- SIMPSON METERS
- CINCH SOCKETS



Complete KITS WITH PARTS THAT FIT...

When you receive your Heathkit, you are assured of every necessary part for the proper operation of the instrument.

Beautiful cabinets, handles, two-color panels, all tubes, test leads where they are a necessary part of the instrument, quality rubber line cords and plugs, rubber feet for each instrument, all scales and dials ready printed and calibrated. Every Heathkit is 110 V 60 Cy. power transformer operated by a husky transformer especially designed for the job. Heathkit chassis are precision punched for ease of assembly. Special engineering for simplicity of assembly is carefully considered.

Complete INSTRUCTION MANUALS

Heathkit instruction manuals contain complete assembly data arranged in a step-by-step manner. There are pictorials of each phase of the assembly drawn by competent artists with detail allowing the actual identification of parts. Where necessary, a separate section is devoted to the use of the instrument. Actual photos are included to aid in the proper location of wiring.



Used BY LEADING UNIVERSITIES

Heathkits are found in every leading university from Massachusetts to California. Students learn much more when they actually assemble the instrument they use. Technical schools often include Heathkits in their course and these become the property of the students. High schools, too, find that the purchase of inexpensive Heathkits allows their budget to go much further and provides much more complete laboratories.



YOU SAVE BY ORDERING DIRECT FROM MANUFACTURER—USE ORDER BLANK ON LAST PAGE

REPORT AGENT
ROCKE INTERNATIONAL CORP.
10 E. 40th ST.
NEW YORK CITY 16
CABLE: ARIAS-N.Y.

The HEATH COMPANY

... BENTON HARBOR 15, MICHIGAN

12 Improvements IN NEW 1951

MODEL O-6

PUSH-PULL

Heathkit OSCILLOSCOPE KIT



Only **\$39.50**

- ★ New AC and DC push-pull amplifier.
- ★ New step attenuator frequency compensated input.
- ★ New non frequency discriminating input control.
- ★ New heavy duty power transformer has 68% less magnetic field.
- ★ New filter condenser has separate vertical and horizontal sections.
- ★ New intensity circuit gives greater brilliance.
- ★ Improved amplifiers for better response useful to 2 megacycles.
- ★ High gain amplifiers .04 Volts RMS per inch deflection.
- ★ Improved Allegheny Ludlum magnetic metal CR tube shield.
- ★ New synchronization circuit works with either positive or negative peaks of signal.
- ★ New extended range sweep circuit 15 cycles to over 100,000 cycles.
- ★ Both vertical and horizontal amplifier use push-pull pentodes for maximum gain.

New INEXPENSIVE MODEL S-2 ELECTRONIC SWITCH KIT

Twice as much fun with your oscilloscope — observe two traces at once — see both the input and output traces of an amplifier, and amazingly you can control the size and position of each trace separately — superimpose them for comparison or separate for observation — no connections inside scope. All operation electronic, nothing mechanical — ideal for classroom demonstrations — checking for intermittents, etc. Distortion, phase shift and other defects show up instantly. Can be used with any type or make of oscilloscope. So inexpensive you can't afford to be without one.

Has individual gain controls, positioning control and coarse and fine switching rate controls — can also be used as square wave generator over limited range. 110 Volt transformer operated comes complete with tubes, cabinet and all parts. Occupies very little space beside the scope. Better get one. You'll enjoy it immensely. Model S-2. Shipping Wt., 11 lbs.

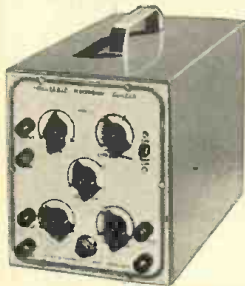

Only **\$19.50**

The new 1951 Heathkit Push-Pull Oscilloscope Kit is again the best buy. No other kit offers half the features — check them. Measure either AC or DC on this new scope — the first oscilloscope under \$100.00 with a DC amplifier.

The vertical amplifier has frequency compensated step attenuator input into a cathode follower stage. The gain control is of the non frequency discriminating type — accurate response at any setting. A push-pull pentode stage feeds the C.R. tube. New type positioning control has wide range for observing any portion of the trace.

The horizontal amplifiers are direct coupled to the C.R. tube and may be used as either AC or DC amplifiers. Separate binding posts are provided for AC or DC.

The multivibrator type sweep generator has new frequency compensation for the high range it covers; 15 cycles to cover 100,000 cycles. The new model O-6 Scope uses 10 tubes in all — several more than any other. Only Heathkit Scopes have all the features.

New husky heavy duty power transformer has 50% more laminations. It runs cool and has the lowest possible magnetic field. A complete electrostatic shield covers primary and other necessary windings and has lead brought out for proper grounding.

The new filter condenser has separate filters for the vertical and horizontal screen grids and prevents interaction between them.

An improved intensity circuit provides almost double previous brilliance and better intensity modulation.

A new synchronization circuit allows the trace to be synchronized with either the positive or negative pulse, an important feature in observing the complex pulses encountered in television servicing.

The magnetic alloy shield supplied for the C.R. tube is of new design and uses a special metal developed by Allegheny Ludlum for such applications.

The Heathkit scope cabinet is of aluminum alloy for lightness of portability.

The kit is complete, all tubes, cabinet, transformer, controls, grid screen, tube shield, etc. The instruction manual has complete step-by-step assembly and pictorials of every section. Compare it with all others and you will buy a Heathkit. Model O-6. Shipping Wt., 30 lbs.

YOU SAVE BY ORDERING DIRECT FROM MANUFACTURER — USE ORDER BLANK ON LAST PAGE

EXPORT AGENT
ROCKE INTERNATIONAL CORP.
13 E. 40th ST.
NEW YORK CITY (16)
CABLE: ARLAB-N.Y.

The **HEATH COMPANY**

... BENTON HARBOR 15, MICHIGAN

New 1951 • • MODEL V-4A

Heathkit VTVM KIT

HAS EVERY EXPENSIVE Feature

- ★ Higher AC input impedance, (greater than 1 megohm at 1000 cycles).
- ★ New AC voltmeter flat within 1 db 20 cycles to 2 megacycles (500 ohm source).
- ★ New accessory probe (extra) extends DC range to 30,000 Volts.
- ★ New high quality Simpson 200 microampere meter.
- ★ New 1/2% voltage divider resistors (finest available).
- ★ 24 Complete ranges.
- ★ Low voltage range 3 Volts full scale (1/3 of scale per volt).
- ★ Crystal probe (extra) extends RF range to 250 megacycles.
- ★ Modern push-pull electronic voltmeter on both AC and DC.
- ★ Completely transformer operated isolated from line for safety.
- ★ Largest scale available on streamline 4 1/2 inch meter.
- ★ Burn-out proof meter circuit.
- ★ Isolated probe for dynamic testing no circuit loading.
- ★ New simplified switches for easy assembly

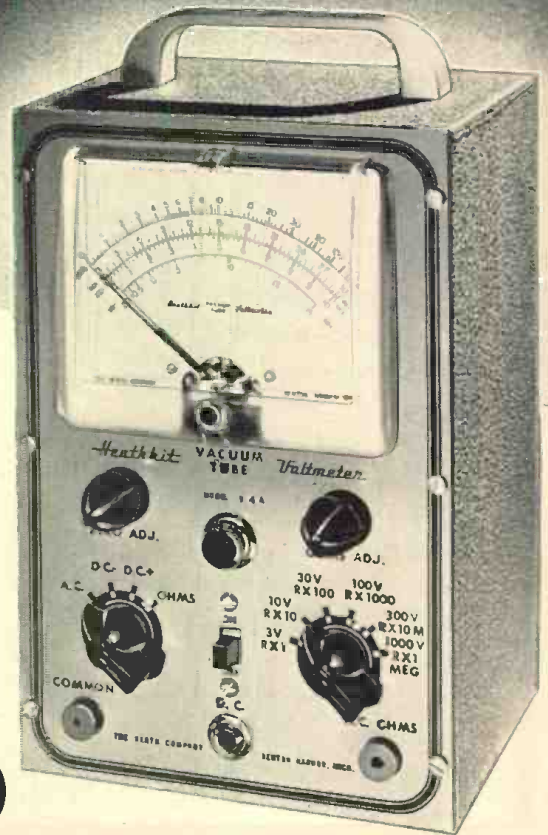

New
LOW PRICE **\$23.50**

The new Heathkit Model V-4A VTVM Kit measures to 30,000 Volts DC and 250 megacycles with accessory probes — think of it, all in one electronic instrument more useful than ever before. The AC voltmeter is so flat and extended in its response it eliminates the need for separate expensive AC VTVM's. + or - db from 20 cycles to 2 megacycles. Meter has decibel ranges for direct reading. New zero center on meter scale for quick FM alignment.

There are six complete ranges for each function. Four functions give total of 24 ranges. The 3 Volt range allows 33 1/3% of the scale for reading one volt as against only 20% of the scale on 5 Volt types.

The ranges decade for quick reading.

New 1/2% ceramic precision are the most accurate commercial resistors available — you find the same make and quality in the finest laboratory equipment selling for thousands of dollars. The entire voltage divider decade uses these 1/2% resistors.

New 200 microampere 4 1/2" streamline meter with Simpson quality movement Five times as sensitive as commonly used 1 MA meters.

Shatterproof plastic meter face for maximum protection. Both AC and DC voltmeter use push-pull electronic voltmeter circuit with burn-out proof meter circuit.

Electronic ohmmeter circuit measures resistance over the amazing range of 1/10 ohm to one billion ohms all with internal 3 Volt battery. Ohmmeter batteries mount on the chassis in snap-in mounting for easy replacement.

Voltage ranges are full scale 3 Volts, 10 Volts, 30 Volts, 100 Volts, 300 Volts, 1000 Volts. Complete decading coverage without gaps.

The DC probe is isolated for dynamic measurements. Negligible circuit loading. Gets the accurate reading without disturbing the operation of the instrument under test. Kit comes complete, cabinet, transformer, Simpson meter, test leads, complete assembly and instruction manual. Compare it with all others and you will buy a Heathkit, Model V-4A. Shipping Wt., 8 lbs. Note new low price, \$23.50



**New 30,000 VOLT DC
PROBE KIT**

Beautiful new red and black plastic high voltage probe. Increases input resistance to 1100 megohms, reads 30,000 Volts on 300 Volt range. High input impedance for minimum loading of weak television voltages. Has large plastic insulator rings between handle and point for maximum safety. Comes complete with PL55 type plug.

No. 3366 High Voltage Probe Kit.
Shipping Wt., 2 pounds.

\$550

Heathkit

RF PROBE KIT

Crystal diode probe kit extends range to 250 megacycles — 10% comes complete with all parts, crystal, cable and PL55 type plug.

No. 309 RF Probe Kit.
Shipping Wt., 1 lb.

\$550



YOU SAVE BY ORDERING DIRECT FROM MANUFACTURER — USE ORDER BLANK ON LAST PAGE

EXPORT AGENT
ROCKE INTERNATIONAL CORP.
13 E. 40th ST.
NEW YORK CITY (16)
CABLE: ARLAB, N.Y.

The **HEATH COMPANY**

... BENTON HARBOR 15, MICHIGAN

NEW Heathkit T.V. ALIGNMENT GENERATOR KIT



Shipping Wt., 16 lbs.

\$395.00

- ★ New simplified circuit for easy calibration and assembly.
- ★ New 2 band built-in marker covers 19 to 75 Mc.
- ★ New dual spider sweep motor for long life.
- ★ New blanking circuit gives base line for better alignment.
- ★ New variable oscillator gives high output fundamentals on high TV band.
- ★ New standby switch keeps instrument ready for instant use.
- ★ New 6 to 1 slow speed drive on both master oscillator and marker tuners.

The new Heathkit TV Alignment Generator incorporates the new developments required for modern TV servicing. An absorption marker circuit covering all possible IF bands and even several of the RF bands. The new blanking circuit provides a base reference line which is invaluable in establishing proper traces. The new sweep motor incorporates dual spiders in the speaker frame assuring better alignment and long life. The mounting of the speaker sweep motor has been simplified for easy alignment.

The variable master oscillator covers 140 to 230 Mc. thus giving high output fundamentals where they are most needed. Low band coverage 2 Mc. to 90 Mc.

A new step attenuator provides excellent control of output.

Planetary 6 to 1 drives on both oscillator and marker provides smooth easy control settings.

A standby position is provided making the instrument always instantly available.

Horizontal sweep voltage with phasing control is provided. No other sweep generator under \$100.00 provides all these features — comes complete with instruction manual. Model TS-2.

Heathkit CONDENSER CHECKER KIT

Only **\$19.50**

Features

- Power factor scale.
- Measures resistance.
- Measures leakage.
- Checks paper-mica-electrolytics.
- Bridge type circuit.
- Magic eye indicator.
- 110 V. transformer operated.
- All scales on panel.

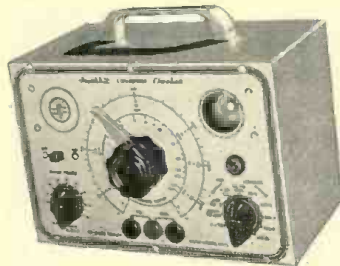

Checks all types of condensers over a range of .00001 MFD to 1,000 MFD. All on readable scales that are read direct from the panel. NO CHARTS OR MULTIPLIERS NECESSARY. A condenser checker anyone can read. A leakage test and polarizing voltage for 20 to 500 Volts provided. Measures power factor of electrolytics between 0% and 50%. 110 V. 60 cycle transformer operated complete with rectifier and magic eye tube, cabinet, calibrated panel, test leads and all other parts. Clear detailed instructions for assembly and use. Model C-2. Shipping Wt., 7 lbs.

NEW Heathkit SIGNAL TRACER AND UNIVERSAL TEST SPEAKER KIT

\$19.50

Features

- High sensitivity
- Complete set of speaker impedances
- Tests microphones and PA systems
- Tests both single and push-pull speaker circuits

The popular Heathkit Signal Tracer has now been combined with a universal test speaker at no increase in price. The same high quality tracer follows signal from antenna to speaker — locates intermitments — defective parts quicker — saves valuable service time — gives greater income per service hour. Works equally well on broadcast — FM or TV receivers. The test speaker has assortment of switching ranges to match — push-pull or single output impedance. Also test microphones, power transformer — tubes, test probe, all parts and detailed instructions for assembly and use. Model T-2. Shipping Wt., 8 lbs.



Heathkit TUBE CHECKER KIT

Features

- Sockets for every modern tube — blank for new types.
- Fastest method of testing tubes — saves time — makes more profit.
- Rugged counter type birch cabinet.
- Gear driven roller chart gives instant setup for all types.
- Tests each element separately for open or short and quality.
- Beautiful 3 color meter — reads good-bad and line set point.

Test your tubes the modern way — dynamically — the simplest, yet fastest and surest method — your Heathkit has a switch for each tube element and measures that element — no chance for open or shorted elements slipping by, all the advantages of the mutual conductance type without the slow cumbersome time consuming setups.

Your Heathkit Tube Checker has all the features — beautiful 3 color BAD-GOOD meter — complete selection of voltages — roller chart listing hundreds of tubes including the new 9 pin miniatures — finest quality Centralab lever switches for each element — high grade birch counter type cabinet — continuously variable line adjust control — every feature you need to sell tubes properly. The most modern type tube checker with complete protection against obsolescence. The best of parts — rugged oversize 110 V 60 cycle power transformer — finest of Mallory and Centralab switches and controls, complete set of sockets for all type tubes with blank spare for future types. Fast action brass gear driven roller chart quickly locates the settings for any type tube. Simplified switching cuts necessary testing time to minimum and saves valuable service time. Short and open element check. Simple method allows instant setup of new tube types without waiting for factory data. No matter what the arrangements of tube elements, the Heathkit flexible switching arrangement easily handles it. Order your Heathkit Tube Checker Kit today. See for yourself that Heath again saves you two-thirds and yet retains all the quality — this tube checker will pay for itself in a few weeks — better assemble it now. Complete with instructions — pictorial diagrams — all parts — cabinet — ready to wire up and operate. Model TC-1 Shipping Wt., 12 lbs.

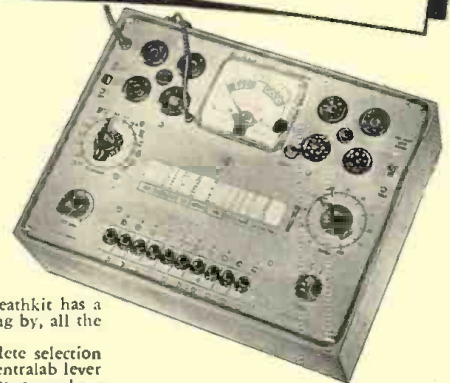

\$295.00

YOU SAVE BY ORDERING DIRECT FROM MANUFACTURER — USE ORDER BLANK ON LAST PAGE

EXPORT AGENT
ROCKE INTERNATIONAL CORP.
13 E. 40th ST.
NEW YORK CITY (16)
CABLE: ARLAB-N.Y.

The **HEATH COMPANY**

... BENTON HARBOR 15, MICHIGAN

RADIO & TELEVISION NEWS

NEW 1951
Heathkit

SIGNAL GENERATOR KIT

Features

- Sine wave audio modulation.
- Extended range 160 Kc. to 50 megacycles fundamentals.
- New step attenuator output.
- New miniature HF tubes.
- Transformer operated for safety.
- Calibrated harmonics to 150 megacycles.
- New external modulation switch.
- 5 to 1 vernier tuning for accurate settings.

A completely new Heathkit Signal Generator Kit. Dozens of improvements. The range on fundamentals has been extended to over 50 megacycles; makes this Heathkit ideal as a marker oscillator for T.V. New step attenuator gives controlled outputs from very low values to high output. A continuously variable control is used with each step. New miniature HF tubes are required for the high frequencies covered.

Uses 6C4 master oscillator and 6C4 sine wave audio oscillator. The set is transformer operated and a husky selenium rectifier is used in the power supply. The coils are precision wound and checked for calibration making only one adjustment necessary for all bands.

New sine wave audio oscillator provides internal modulation and is also available for external audio testing. Switch provided allows the oscillator to be modulated by an external audio oscillator for fidelity testing of receivers.

A best buy — think of all the features for less than \$20.00. The entire coil and tuning assembly are assembled on a separate turret for quick assembly — comes complete — all tubes — cabinet — test leads — every part. The instruction manual has step-by-step instructions and pictorials. It's easy and fun to build a Heathkit Model SG-6 Signal Generator. Shipping Wt., 7 lbs.



\$19.50

Heathkit SINE AND SQUARE WAVE AUDIO GENERATOR KIT

Either sine or square wave.
Stable RC bridge circuit.
Covers 20 to 20,000 cycles.
Less than 1% distortion.

Hundreds of Heathkit Audio Generators are used by speaker manufacturers—definite proof of their quality and dependability. The added feature of square wave opens up an entirely new field of amplifier testing. Uses the best of parts, 4 gang condenser, 1% calibrating resistors, metal cased filter condensers, 5 tubes, completely calibrated panel and detailed instruction manual. One of our best and most useful kits. Model G-2. Shipping Wt., 12 lbs.



\$34.50

THE NEW Heathkit HANDITESTER KIT

- Beautiful streamline Bakelite case.
- AC and DC ranges to 5,000 Volts.
- 1% Precision ceramic resistors.
- Convenient thumb type adjust control.
- 400 Microampere meter movement.
- Quality Bradley AC rectifier.
- Multiplying type ohms ranges.
- All the convenient ranges 10-30-300-1,000-5,000 Volts.
- Large quality 3" built-in meter.



\$13.50

A precision portable volt-ohm-milliammeter. An ideal instrument for students, radio service, experimenters, hobbyists, electricians, mechanics, etc. Rugged 400 ua meter movement. Twelve complete ranges, precision dividers for accuracy. Easily assembled from complete instructions and pictorial diagrams. An hour of assembly saves one-half the cost. Order today. Model M-1. Shipping Wt., 2 lbs.

NEW Heathkit BATTERY ELIMINATOR KIT

Features

- Provides variable DC voltage for all checks.
- Locates sticky vibrators-intermittents.
- Voltmeter for accurate check.
- Has 4000 MFD Mallory filter for ripple-free voltage.

Even the smallest shop can afford the Heathkit Battery Eliminator Kit. A few auto radio repair jobs will pay for it. It's fast for service, the voltage can be lowered to find sticky vibrators or raised to ferret out intermittents. Provides variable DC voltage 5 to 7½ Volts at 10 Amperes continuous or 15 Amperes intermittent. Also serves as storage battery charger. Ideal for all auto radio testing and demonstrating.



\$22.50

A well filtered rugged power supply uses heavy duty selenium rectifier, choke input filter with 4,000 MFD of electrolytic filter for clean DC. 0-15 V. voltmeter indicates output which is variable in eight steps. Easily constructed in a few hours from our instructions and diagrams — better be equipped for all types of service — it means more income. Model BE-2. Shipping Wt., 19 lbs.

YOU SAVE BY ORDERING DIRECT FROM MANUFACTURER—USE ORDER BLANK ON LAST PAGE

EXPORT AGENT
POCKE INTERNATIONAL CORP.
13 E. 40th ST.
NEW YORK CITY (16)
CABLE: ASLAB-N.Y.

The **HEATH COMPANY**

... BENTON HARBOR 15, MICHIGAN

**New
LABORATORY
INSTRUMENT KITS**



HUNDREDS OF LABORATORIES USE

Heathkit IMPEDANCE BRIDGE as Standard

Features

- Measures inductance 10 microhenries to 100 henries • Measures resistance .01 ohms to 10 megohms • Measures capacitance .00001 MFD to 100 MFD • Measures "Q" and power factor.

Measures inductance from 10 microhenries to 100 henries, capacitance from .00001 MFD to 100 MFD. Resistance from .01 ohms to 10 megohms. Dissipation factor from .001 to 1. "Q" from 1 to 1,000. Ideal for schools, laboratories, service shops, serious experimenters. An impedance bridge for everyone — the most useful instrument of all, which heretofore has been out of the price range of serious experimenters and service shops. Now at the lowest price possible. All highest quality parts. General Radio main calibrated control. General Radio 1,000 cycle hummer. Mallory ceramic switches with 60 degree indexing — 200 microamp type binding posts with standard 3/4" centers. Beautiful birch cabinet. Directly calibrated "Q" and dissipation factor scales. Ready calibrated capacity and inductance standards of Silver Mica, accurate to 1/2 of 1% and with dissipation factors of less than 30 parts in one million. Provisions on panel for external generator and detector. Measure all your unknowns the way laboratories do — with a bridge for accuracy and speed.

\$69.50

Internal 6 Volt battery for resistance and hummer operations. Circuit utilizes Wheatstone, Hay and Maxwell circuits for different measurements. Supplied complete with every quality part — all calibrations completed and instruction manual for assembly and use. Deliveries are limited. Model IB-1. Shipping Wt., 15 lbs.

**NEW Heathkit LABORATORY
RESISTANCE DECADE KIT**



- 1/2% Accuracy
- Birch Cabinet
- Ceramic Switches
- Covers 1 ohm to 99,999 ohms

The new Heathkit Resistance Decade is a handy tool for laboratory, school and service shop. Ideal for test setups, calibrating instruments, bridge measurements, selecting multipliers, etc.

\$19.50

Uses the finest Centralab ceramic switches, 1/2% ceramic decade resistors and heavy birch cabinet matching other laboratory equipment. The range is 1 ohm to 99,999 ohms in one ohm steps.

Finest quality throughout to withstand school usage — heavy aluminum panel — laboratory type binding posts — the fine decades are extremely simple to assemble — complete kit. Model RD-1. Shipping Wt., 4 lbs.

**NEW Heathkit LABORATORY
POWER SUPPLY KIT**

Features

- Supplies 6.3 V. AC at 4.5 Amps.
- Heavy duty construction.
- Handy for schools, labs., and service shops.
- Supplies variable DC 50-300 Volts.
- Shows voltage or current on 3 1/2" meter.



This new Heathkit Variable Power Supply Kit fills hundreds of needs — use it for experimental circuits — no need to build a separate power supply — use it for a test voltage to determine proper coefficients in unknown circuits — calibrate instruments with its variable voltage, etc. This new Heathkit supplies 50 to 300 Volts continuously variable DC together with an AC filament voltage of 6.3 Volts at 4.5 Amperes. A built-in 1 MA 3 1/2" meter has proper shunts to read 0-500 Volts and 0-200 Milliampers. The circuit uses a 5Y3 rectifier, two 1619 tubes as electronic control tubes to vary the output voltage with a single potentiometer. Case measures 7 1/8" x 13" x 7 1/8". Has instruction manual for assembly and use. Model PS-1. Shipping Wt., 18 lbs.

\$29.50

Heathkit RECEIVER & TUNER KITS for AM and FM

**TWO HIGH QUALITY Heathkit SUPERHETERODYNE
RECEIVER KITS**



Model BR-1 Broadcast Model Kit covers 550 to 1600 Kc. Shipping Wt., 10 pounds.

\$19.50

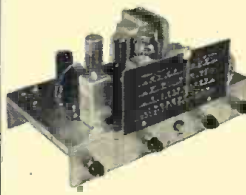

Model AR-1 3 Band Receiver Kit covers 550 Kc. to over 20 Mc. continuous. Extremely high sensitivity. Shipping Wt., 10 lbs.

\$23.50

Two new Heathkits. Ideal for schools, replacement of worn out receivers, amateurs and custom installations.

Both are transformer operated quality units. The best of materials are used throughout — six inch calibrated slide rule dial — quality power and output transformers — dual iron core shielded I.F. coils — metal filter condensers and all other parts. The chassis has phono input jack — 110 Volt outlet for phono motor and there is a phono-radio switch on panel. A large metal panel simplifying installation in used console cabinets is included. Comes complete with tubes and instruction manual incorporating pictorials and step-by-step instructions (less speaker and cabinet). The three band model has simple coil turret which is assembled separately for ease of construction.

**TRUE FM FROM Heathkit
FM TUNER KIT**

\$22.50

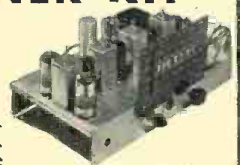

The Heathkit FM Tuner Model FM-2 was designed for best possible tonal reproduction. The circuit incorporates the most desirable FM features — true FM — ready wound and adjusted coils — 3 stages of 10.7 Mc. I.F. (including limiter).

Tube lineup: 7E5 oscillator, 6SH7 mixer, two 6SH7 I.F. stages, 6SH7 limiter, two 7C4 diodes as discriminator, 6X5 rectifier.

The instrument is transformer operated making it safe for connection to any type receiver or amplifier. The R.F. coils are ready wound — mounted on the tuning condenser and the condenser is adjusted — no R.F. coils to wind or adjust.

A calibrated six inch slide rule dial has vernier drive for easy tuning. The finest parts are provided with all tubes, punched and formed chassis, transformers, condensers and complete instruction manual. Model FM-2. Shipping Wt., 10 lbs.

EXPORT AGENT
POCKE INTERNATIONAL CORP.
13 E. 40th ST.
NEW YORK CITY (16)
CABLE: ARLAB-N.Y.

The HEATH COMPANY

... BENTON HARBOR 15, MICHIGAN

ENJOY MUSIC AT ITS *Finest* WITH *Heathkit* AMPLIFIERS

NEW *Heathkit* HIGH FIDELITY 20 WATT AMPLIFIER KIT



\$21.50

Features

- Push-pull 6L6's.
- Full 20 Watts output.
- Fully enclosed chassis.
- Provisions for reluctance pickup compensation stage.
- Cased high fidelity output transformer.
- Treble and bass boost tone controls.
- Full range of output impedances 3.2 ohms to 500 ohms.

The finest amplifier kit we have ever offered — check the features. This inexpensive amplifier compares favorably with instruments costing five times as much. Nothing has been spared to provide the best reproduction — an ideal amplifier for the new Heathkit FM Tuner listed below.

Dual tone controls for control of both treble and bass. Bass control is of the boost type for maximum listening pleasure. Optional preamplifier stage for use with G. E. reluctance pickup or microphone. Uses inverse feedback to give excellent response over entire range. Tube lineup: 6SJ7 preamplifier stage, 6J5 phase splitter stage, two 6L6's in push-pull and 5Y3 rectifier. (6SC7 as optional compensation stage).

Uses highest quality Chicago Transformer Corporation cased output transformer with taps of 3.2, 8, 15, 60 and 500 ohms to match any speaker combination. Power transformer is conservatively rated for continuous operation in sound systems. Tone control gives maximum bass boost of 6 db at 70 cycles. Amplifier has maximum gain of 75 db. Response within 3 db 20 to 20,000 cycles. Shipping Wt., 17 lbs. Complete with all parts, tubes and instruction manual.

Model A-5A Amplifier with preamplifier for G. E. cartridges or microphone **\$23.50**
12" 20 Watt Speaker, No. 326..... **7.50**

Heathkit ECONOMY 6 WATT PUSH-PULL AMPLIFIER KIT



\$12.50

No. 304,
12-inch Speaker... **\$6.95**

This new Heathkit Amplifier was designed to give quality reproduction at a very low price. Has two preamp stages, phase inverter stage and push-pull beam power output. Comes complete with six tubes, quality output transformer (to 3-4 ohm voice coil), husky cased power transformer and all other parts. Has tone and volume controls. Instruction manual flat $\pm 1\frac{1}{2}$ db from 50 to 15,000 cycles. A quality amplifier kit at new low price. Better build one. Model A-4. Shipping Wt., 7 lbs.

Heathkit RECEIVERS and TUNER CABINETS



\$4.95

Order No. 350 for FM tuner

Blonde birch veneer cabinet for either the receivers or tuner. Modern styling is an asset to any room. 5" speaker fits in end of cabinet when used with receivers. Size 7 x 13½ x 8¼ inches. Shipping Wt., 5 lbs. Order No. 345 for either receiver

Metal professional type communications receiver cabinet. Finished in deep grey to fit the panel supplied with Heathkit BR-1 and AR-1 Receivers (panel shown not included with cabinet). 5" speaker mounts in end of cabinet. Gives professional appearance to Heathkit receivers. Size 7 x 14 x 7¾ inches. Shipping Wt., 6 lbs.

5" Permoflux Speaker for either cabinet for use with either Heathkit Receiver No. 320 5" Speaker..... **\$2.75**



\$4.50

No. 335 Cabinet for receivers only.

ORDER BLANK

7a HEATH COMPANY
BENTON HARBOR 15,
MICHIGAN

From _____

SHIP VIA

- Parcel Post
 Express
 Freight
 Best Way

(PLEASE PRINT)

Quantity	Item	Price	Quantity	Item	Price
	Heathkit Oscilloscope Kit — Model O-6			Heathkit VTVM Kit — Model V-4A	
	Heathkit T.V. Alignment Gen. Kit — TS-2			Heathkit R.F. Probe Kit — No. 309	
	Heathkit FM Tuner Kit — FM-2			Heathkit H.V. Probe Kit — No. 336	
	Heathkit Broadcast Receiver Kit — Model BR-1			Heathkit R.F. Signal Gen. Kit — Model SG-6	
	Heathkit Three Band Receiver Kit — Model AR-1			Heathkit Condenser Checker Kit — Model C-2	
	Heathkit Amplifier Kit — Model A-4			Heathkit Handitester Kit — Model M-1	
	Heathkit Amplifier Kit — Model A-5 (or A-5A)			Heathkit Variable Power Supply Kit — Model PS-1	
	Heathkit Tube Checker Kit — Model TC-1			Heathkit Resistance Decade Kit — Model RD-1	
	Heathkit Audio Generator Kit — Model G-2			Heathkit Impedance Bridge Kit — Model IB-1	
	Heathkit Battery Eliminator Kit — Model BE-2			Heathkit Signal Tracer Kit — Model T-2	
	Heathkit Electronic Switch Kit — Model S-2				

On Parcel Post Orders, include postage for weight shown and insurance. (We insure all shipments.)

On Express Orders, do not include transportation charges — they will be collected by the Express Agency at time of delivery.

Enclosed find Check Money Order for _____

Please ship C.O.D. Postage enclosed for _____ lbs.

EXPORT AGENT
ROCKE INTERNATIONAL CORP.
13 E. 40th ST.
NEW YORK CITY (16)
CABLE: ARLAB-NY

The HEATH COMPANY

... BENTON HARBOR 15, MICHIGAN

FEDERATED

IS AHEAD WITH THE NEWEST
ELECTRONIC EQUIPMENT
For OFFICES, LABORATORIES,
SCHOOLS, INSTITUTIONS

READY
FOR
SHIPMENT
NOW



WORNER ELECTRONIC RECEPTIONIST

Photoelectric Unit rings a chime when mirrored light beam is broken. Insures privacy when installed in doorway. Guards hidden entrances. Can be used to operate 6V. relay for other mechanisms. Operates on 110V. 60 Cy. A.C.

MODEL 61: UNIT, MIRROR AND CHIME \$21.50
Size 10 1/4 x 6 1/2 x 2 3/4.....

MODEL 61A: Includes shield to avoid direct light interference..... \$24.00



SOUNDMIRROR BY BRUSH

Automatic Ribbon Recorder, complete with microphone, in carrying case. Ideal for Educational use. Simple and economical to operate. Ribbon tape used is the easiest of all recording materials. 30 minutes recording time. For 110V. 60 Cy. A.C. current.

MODEL BK 414..... \$199.50

OTHER MODELS AVAILABLE WITH RECORDING TIME UP TO 60 MINUTES. SEND FOR FOLDER.

SOUND EQUIPMENT THE FINEST PRECISION-BUILT UNITS AT LOWEST PRICES

A. D. C. AMPLIFIER

Power output 8 watts. Gain 70 db. Push-pull circuit with low distortion. Separate base and treble control. A quality product for home or small auditorium use.

MODEL 71F..... \$44.70

PREAMPLIFIER MODEL 10A..... \$7.50

MEISSNER F.M. TUNER

Precision built. Covers new band 88 to 108 MC. Full-scale fidelity. Equipped with phone switch for record player. Simple connection to AM tuner and amplifier.

MODEL 8C, LESS CABINET..... \$39.56

G. E. SPEAKER

A fine 12-inch P.M. 25-watt Speaker with response from 50 to 13,000 CPS. Resonance 70 Cycles. Voice Coil impedance 8 Ohms.

MODEL 51201D, LESS CABINET..... \$17.50

SEND FOR COMPLETE LITERATURE ON ALL THIS EQUIPMENT. MANY OTHER FAMOUS MAKES AND MODELS IN STOCK, BUT ORDER NOW.

Federated Purchaser
INCORPORATED

66 DEY ST., NEW YORK 7, N. Y.
DIGNV 9-3050

NEWARK, N. J. EASTON, PA.
114 Hudson St. 701 Northampton St.
ALLENTOWN, PA., 1115 Hamilton St.

What's New in Radio

For additional information on any of the items described herein, readers are asked to write direct to the manufacturer. By mentioning RADIO & TELEVISION NEWS, the page, and the issue number, delay will be avoided.

SELENIUM RECTIFIER

Precision Rectifier Corporation of 131 Boerum Street, Brooklyn 6, New York, has developed a new type of selenium rectifier which is currently on the market.

Tradenamed "Plastisel," these rectifiers resemble paper condensers in

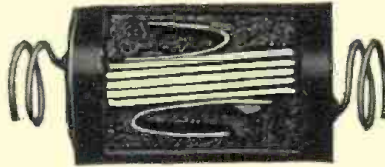

appearance and may be installed quickly and easily as no mounting holes are required. The units are completely sealed but run comparatively cool up to their rated capacities.

Production is under way on 40, 65, and 100 ma. models. The manufacture of units up to 500 ma. is expected to begin shortly.

Manufacturers, jobbers, and dealers can obtain complete literature and specifications by writing direct to the company.

BASE CONNECTOR

Alden Products Company, 117 North Main, Brockton, Massachusetts, has designed a new octal base connector with a fully-insulated, built-in resistor for use with a 6AL7-GT electron ray tuning indicator tube.

Ready for immediate connection, the 208FERC with a fully-insulated 3300 ohm resistor built in the molding and complete with leads, enables television manufacturers to incorporate the tuning indicator tube in the set



design and thus obtain precision tuning for optimum audio quality at a minimum effort and cost.

Available in production quantities, the new connector can be supplied with either 5 or 6 leads of any length specified.

RCA LINE AMPLIFIER

Of particular interest to those connected with custom sound installations is the versatile plug-in line amplifier with self-contained power supply recently introduced by the Sound Prod-

ucts Section of the RCA Engineering Products Department, Camden, New Jersey.

The new line amplifier, the RCA Type MI-12160, can be used as a master mixer for up to four preamplifiers, a booster amplifier for supplying zero level to a telephone line, a line amplifier capable of operating from a telephone line, a driver amplifier supplying voltage for up to 500 power amplifiers, a monitor amplifier supplying two watts of audio power to a speaker, or a bridging amplifier for bridging a low impedance line.

The unit, which is designed for shelf mounting, will provide good frequency response from 30 to 15,000 cycles with low distortion, according to the company. It features inverse feedback control and voltage-regulated power supply and has a rated power output

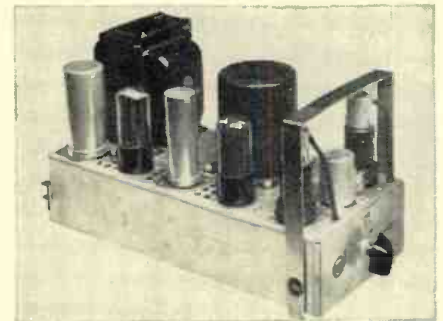

of up to two watts. An interstage gain control with positions 0-10 is mounted on the front apron of the chassis for easy operation. The self-contained power supply consists of a power transformer, a high vacuum full-wave rectifier tube, and a low hum output filter.

CONSOLETTA RECORDER

The "Magnemaster Consolette," a popularly-priced tape recorder designed specifically for professional and broadcast use, has been added to the "Twin-Trax" recorder line by Amplifier Corp. of America, 398-2 Broadway, New York 13, N. Y.

The new recorder may be operated at 15" per second with a frequency response of 50 to 15,000 cycles, or at 7 1/2" per second with a frequency response of 50 to 10,000 cycles ± 2 db. After the reel has been run through, the instrument instantaneously and automatically changes direction of tape travel and plays an equal length of time in the opposite direction. This feature provides 30 minutes of playing time at the 15" speed and 60 minutes at the 7 1/2" speed, using standard 7" diameter, 1200 foot reels of tape.

RADIO & TELEVISION NEWS

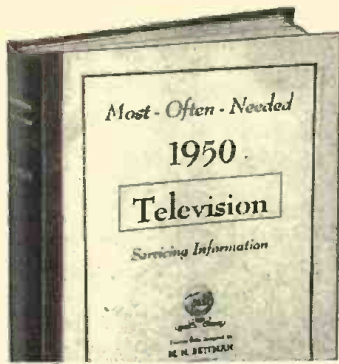

New 1950 Television Manual

This newest giant volume of the series covers 1950 factory data on all popular television sets of all makes. There are circuit explanations, 144 pages of alignment procedure, test patterns, response curves, pages of waveforms, voltage charts, service hints, and ten mammoth 11x15" blueprints. Manual \$3.50, style binding. Price postpaid, only... \$3.50

1949 T-V Manual. Similar to the volume listed above. Has 160 extra-large pages, plus 9 double-spread slant blueprints. To order see coupon below, only... \$3.50

1948 T-V Manual. Earlier volume has material on all popular T-V sets of this period. Large size: 8 1/2 x 11". Remarkable value. \$3.50 including 8 fold-out blueprints, only... \$3.50

1947 FM and T-V Manual. Covers all needed FM and television sets including popular R.C.A. 430TS. Data on 192 \$2.50 pages. Only... \$2.50

New SUPREME TELEVISION Manuals

INCLUDES ALL POPULAR SETS

All you need to service any television set are the four SUPREME TV manuals described at left. Every popular television set, from the early 1947 models to the very latest 1950 receivers, are here. Covered in great detail making adjustment and servicing really easy. Manuals have data on circuits, alignment, test patterns, response curves, service hints, voltage charts, waveforms, factory recommended changes, and many mammoth 11 x 15-inch blueprints. These manuals will give you the practical know-how of a TV expert and will repay for themselves with time saved on a single TV job.

AMAZING BARGAIN OFFER

The television series manuals are the most remarkable values offered by Supreme Publications in their 17 years of business. These TV manuals at only \$3 and \$2 each are amazing bargains and defy competition. There is nothing else like them. Each manual is a virtual treatise on practical television repairs. By normal standards, each such large manual packed as it is with practical facts, hundreds of illustrations, diagrams, charts, photographs, and expensive extra-large blueprints, should sell for \$10—but as SUPREME special values they are priced at \$3 and \$2 each. Only a publisher who sold over one million TV and radio manuals can offer such bargains based on tremendous volume-sales.

FIND—FIX ALL T-V FAULTS

Use these timely television manuals as your guide to quick fault finding and repair of any television set. Eliminates guesswork—tells you just where to look and what to do. Cuts hour-wasting jobs to pleasant moments. Use test patterns for quick adjustment, or look up probable cause of trouble in the pages of hints after simply observing fault in video picture. No equipment needed with these tests. Or use your voltmeter and compare values with many voltage charts included. With an oscilloscope you can get waveforms similar to hundreds illustrated using test points suggested and in a flash locate what used-to-be a hard-to-find fault. Order at our risk for a 10-day trial. Use coupon at bottom of page.

YOURS TO USE ON TRIAL

Decide to have in your shop all four Television Manuals as described in the first column at the left. Or try the new 1950 TV manual to see what an amazing bargain you get for only \$3. Order on no-risk trial by using coupon at bottom of page.

RADIO COURSE

AMAZING BARGAIN IN HOME-TRAINING

Here is your practical home-study course at a give-away price. The 22 lessons cover all topics just like other correspondence radio courses selling for over \$150.00. Our amazing offer permits you to obtain the course complete for only \$2.50, nothing else to pay. Course covers fundamentals, modern circuits, practical radio repairs. Includes hundreds of diagrams, thousands of repair hints, many trouble-shooting short-cuts.



COVERS EVERY TOPIC OF RADIO SERVICING



"You should get more money for your course. The first week I studied it, I made \$10.00 repairing sets. I built my own test outfit from details given in this course. I have repaired 100 radios to date. Signed: Robert C. Hammel, 120 W. 13th, Davenport, Iowa.

The easy-to-follow lessons of this home-study course will show you quickly how to repair all types of radio sets. There are lessons on how to open a shop and operate a successful radio business. Every lesson is well illustrated, interesting to read, really easy to understand and apply. No special previous knowledge is needed. The early lessons explain important principles. Other lessons cover test equipment, trouble-shooting, circuit tracing, television, and every important topic of radio servicing.



PRACTICAL ON-THE-JOB MATERIAL

Learn new speed-tricks of radio fault-finding, case histories, servicing short-cuts, extra profit ideas. Included are many large lessons on the use of regular test equipment, explanation of signal tracing, use of oscilloscope, transmitters, P.A., television, recorders, etc. Let this information save for you enough time on a single job to pay the full price of \$2.50, for the complete course of these money-making lessons.

EASY TO UNDERSTAND AND APPLY

The practical lessons of this course-manual are easy to follow and apply to actual radio jobs. Hundreds of radio and television facts that puzzled you will be quickly cleared up. You will find yourself doing radio repairs in minutes instead of hours—quickly finding faults or making adjustments. Every new radio development of importance and thousands of time-saving facts are packed into this giant-sized complete course-book.

SATISFACTION GUARANTEED

Use the NO-RISK coupon at right to order the complete COURSE for 10-day examination in your own home. Look over the material, read a few lessons, use this aid to fix several radios. Only then decide to keep the lessons at the bargain price of \$2.50 (full cost), or return the material for a cash refund. Act today, while the price is still only **\$2.50**



"I am very satisfied with the course. When I was at the twelfth lesson I started repairing radios. It took me two months to master your course." From a letter written by Roger Lantzolis, 1879 Poupard, Montreal, Canada.

SUPREME RADIO MANUALS



New 1950 Radio Diagrams

Now you can benefit and save money with Supreme amazing scope of 1950. This one giant volume has all the service data you need on all recent radio sets. Here you have clearly-printed large schematics, needed alignment data, parts lists, voltage values, and information on stage gain, location of trimmers, and dial stringing illustrations. This is the help you need to find tough faults in a jiffy. The new 1950 radio manual is a worthy companion to the 9 previous volumes used to an advantage by over 128,000 shrewd radio men.

BIGGEST BARGAIN IN SERVICE DATA

Wise servicemen know that Supreme Publications manuals have all the material needed at the lowest prices. For the remarkable bargain price (only \$2 for most volumes) you are assured of having on hand needed diagrams and all other essential repair facts on almost all sets you will ever service. Every popular radio of all makes, from old-timers to new 1950 sets is covered. Select manuals wanted, see list below, and rush no-risk order coupon.

SUPREME RADIO MANUALS for PREVIOUS YEARS



1949 1948 1947 1946 1942 1941 1940 1939 1926-1938
SUPREME Most-Often Needed RADIO DIAGRAMS Each Manual only \$2. (1949 is \$2.50); 192 pages of diagrams, alignment data, voltage values, parts lists, and service hints; large size, 8 1/2" x 11". To order, see coupon below. **RADIO Diagrams 240 Pages Price \$2.50**

NO-RISK TRIAL ORDER COUPON

SUPREME PUBLICATIONS, 3727 W. 13 St., Chicago 23, ILL.

Send on trial manuals checked below and at right. You guarantee complete satisfaction.

- 1950 Television Manual, \$3. 1949 TV, \$3.
- 1948 TV, \$3. 1947 TV & FM, only \$2.
- Radio Servicing Course, complete, \$2.50
- I am enclosing \$..... Send postpaid.
- Send C.O.D. I am enclosing \$... deposit.

- Radio Diagram Manuals**
- New 1950 Manual, \$2.50
 - 1949 Radio Manual, \$2.50
 - 1948
 - 1947
 - 1946
 - 1942
 - 1941
 - 1940
 - 1939
 - 1926-1938 Manual, \$2.50
- PRICED AT ONLY \$2 EACH**

Name:
 Address:

Supreme Publications

Sold by All Leading Radio Jobbers

December, 1950

Real values on hard-to-obtain items

TRANSFORMERS-CHOKES:

2.5V, 10A. 10KV insulation. Suitable for 866, 836, etc. Reduced to \$2.79 ea.
 5H. 400ma chokes. Fully shielded, drawn steel case. Made by Chicago Transf. Reg. \$4.95, reduced to \$2.95 ea.
 10H, 200 ma choke. Hermetically-sealed steel case. Also has hum-bucking tap. A beautiful item only \$1.98.
 10H. 60 ma choke. Strap mounting. Handy for dozens of applications. Reg. 98c, reduced to 65c.
 Charger or fil. trans. Pri. 110V, 60 cycle. Secondary, 9-10-11-12-13 volts @ 1.2 A. Fully cased. A buy at \$1.49.
 Vibrator transformer. 6V imp. Secondary 345-0-345 @ 150 ma. Also has bias winding. Fully cased. Bargain at \$1.49 ea.
 Power transformer. 780V, CT @ 200 ma. 2.5V at 8a. 5V at 8a. 6.3V at 6A. Pri. 115V, 60cy. AC. Has electrostatic shield. Upright mount. Shipping weight 11 lbs. Only \$4.95.
 Fil. transf. 24V at .6 amp. Open frame type, \$1.95 ea.
 5V, 25A transf. Cased, upright mtg. A buy at \$3.95 ea.

MICROPHONES:

Aircraft-type, push-to-talk mlke. Button on top. NEW. A real buy! Were \$1.15 ea. now reduced to 59c.
 RCA Hand Mlke. Hi-grade, single button. Bronze colored w/cord and plug. NEW. Were \$1.98 now reduced to 98c ea.

TELEPHONE EQUIPMENT:

EE89 Repeaters (see previous ads). Only a few left. NEW! Regularly \$9.95 ea. now \$6.95 ea.
 TS-10 Sound powered handsets. A limited quantity only. BRAND NEW! \$25.95 pair
 Handset hanger. Beautiful cast aluminum shell finished in black wrinkle. Takes all makes and models. An extremely useful, well-made item only \$1.95 ea.

EE-8 FIELD TELEPHONES

Used, workable \$10.95 pair
 Used, good \$12.95 pair
 All units tested before shipment.

STORAGE BATTERIES:

2 volt, Willard. Dry packed. Very special at \$1.19 ea.
 36 volt storage bat. Consists of 18, 2V units in sturdy case. Here is really a bargain! Only \$17.95.

RECEIVERS:

SCR-522 Receiver. Used, good condition. With tubes \$14.85 ea.
 R89/ARN 5A RECEIVERS. See March Radio-Electronics for converting to FM set. Brand new, orig. boxes. Now only \$10.95 ea.

LOW FREQUENCY CRYSTALS

Precise units in holders. Ideal for oscillators as markers, BFO, etc. Can also be used as resonators for crystal filters. 453.70, 457.4, 464.81, 468.66, 468.51, 450. Freq. in KC. These are an excellent buy at only .89c ea.

SPECIAL PLUGS & CONNECTORS

For PE-103, male and female (male fits PE-103), new .85c set
 R8-ARN8. Two special plugs. \$1.00 set
 PL-Q103 for BC-348—new .75c ea.
 SCR-522 meter plug, U-13/U. .25c ea.
 PL-58 fits into EE-8 telephones and many switchboards—new .30c ea.
 PL-106 fits RM-14 telephones and others—new .45c ea.
 8 pr. Female. Fits SCR-284 equip. .35c ea.

HS-30 Phones. NEW in boxes. Only \$1.29
 HS-16 phones. Used, with headband and 6' cord. A hot buy at .98c

BC-454 RECEIVERS

Frequency range, 3 to 6 mcs. Good condition. An astonishing low close-out price.
 Less tubes \$3.95 ea.

Power Supply for Any 274-N Receiver



Here it is—at last! Just plug it into the rear of your 274-N RECEIVER and you're done! Complete kit, and black metal case, with ALL parts and diagrams. Simple and easy to build in a jiffy. Delivers 24 volts plus B voltage. No wiring changes to be made. Designed especially for the 274-N receiver. All necessary parts for conversion of rest of receiver also included. ONLY \$7.95. TUNING KNOB for 274-N Receiver. 59c ea.

ULTRA-VIOLET LIGHT SOURCE FOR TELEVISION AND C/R TUBE EXAMINATION

O-R now presents . . . new . . . an 8-watt, ultra-violet, "black-light" source! Here is a highly effective and time saving device for checking burn spots and other defects in phosphors of C/R tubes. C/R tube face fluoresces when exposed to this special black-light to give visual indication of condition of phosphor. Reflected light from C/R tube face is negligible and tube does not have to be in operation. An invaluable device for TV service shops, schools, laboratories. Also used in medical, chemical, foods, stamps, criminology . . . a thousand uses.
 In kit form including Sylvania 8 watt, black-light tube, ballast, starter, mounting panel, tube clips, reflector, line cord/plug, hardware, instructions. Simple shadow box for outer housing is easily made.
 Complete kit (less outer housing) . . . only \$4.95
 Also . . . complete "black-light" equipment for any industrial or experimental application. Inquiries invited.



signal to be made of the tape for quality control.

Complete technical specifications on the new recorder are available from the company upon request.

TU-10 B TUNING UNITS

One of the most desirable tuning units for the BC-375E. Has three excellent variable condensers. Limited quantity. Only \$1.75 ea.

AN-GSC-T1 CODE TRAINING SET

Complete with 10 keys. Consists of a variable pitch audio oscillator powered by universal power supply. DC, 6-12-24-115V. AC, 115-230V. Voltage selectable by switch. Has loudspeaker and volume control. Contained in carrying case 17 x 10 1/4 x 13". Ideal for code training groups, clubs, schools, etc. NEW original boxes. Were \$49.50, now \$16.95 ea.

TM-11-437 Manual. Completely describes above equipment. Circuit diagrams, parts list, etc. \$1.00 ea.

SCOPE COMBO OFFER

The makings for an excellent scope. Includes: 1-5NP1 C-R tube, transformer for hi-voltage and fil. for 2X2 rectifier, circuit diagram, only \$7.95

FL-8 Filters, New only 98c ea.

EICO KITS in stock

Write for Circular

UHF WHIP ANTENNA

Four sections—extends to 24", closes to 8". Has 8/32 tapped hole in bottom for mounting. Ball on top 90c ea.

TWELVE FOOT, HEAVY-DUTY WHIP

Actually 12'8" in length. Composed of four, sturdy sections which plug-in and screw together. Consists of sections MS-50, 51, 52, 55. BRAND NEW! A handsome buy on a highly desirable mobile antenna. Only \$1.50 complete.

AN-75-D WHIP ANTENNA

A great buy for you mobile men. 7'3" collapsible to 14". Has 9 sections—corrosion-proof brass. Sturdy bakelite mount with jiffy wing-nut fastener. These sold formerly at \$2.50 ea.
 Final clearance price. 98c ea.

SMALL PRECISION LATHE—110-V. AC

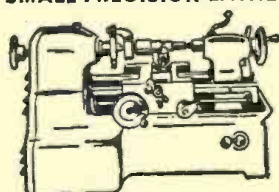

Now with Larger Motor \$44.50

A small lathe for radio shops, jewelers, laboratories, dentists, hobby-crafters, model makers, machine shops, schools, etc. Automatic Feed. Work capacity 3" between centers. Swing over bed 2". Constructed of steel and cast iron. Accurately machined and finished. Fan-Cooled Motor mounted inside the base. Complete with 1 1/4" face plate, 2 lathe centers, tool post and rocker, one lathe dog, one tool-bit and test rod.

COMPLETE ACCESSORY KIT

including 4-jaw chuck, drill chuck, center counter-sink drill, 2 tool-bits, 2 lathe dogs, 1 face plate with 8 drilled and tapped holes, 4 collets, 1 collet chuck, 1 Allen wrench \$24.50

"TRU-SONIC" MICROPHONE

Stephens Manufacturing Corporation of Culver City, California, has recently introduced a group of three microphone systems for swivel, stand, and lapel applications.

Each of the new systems employs a head of extremely small size. The company claims that the new "True-Sonic" models are essentially non-directional throughout the entire audio range. In addition, the company states that it is the only microphone currently on the market that makes use of a condenser type diaphragm in a circuit which does not require vacuum tube circuits mounted adjacent to the head.

With these new systems, all auxiliary equipment can be used up to 400 feet away from the head, connected only by a small standard single conductor microphone cable which carries no high currents and voltages to feed critical low level circuits.

A booklet containing complete specifications on these new units is avail-



able from the company. When writing, ask for Bulletin M-1 and address the company at 8538 Warner Drive in Culver City.

NEWCOMB PHONOGRAPH

The newest addition to the Newcomb Audio Products Co. line of audio (Continued on page 103)

MINIMUM ORDER \$2.00. ALL ITEMS SUBJECT TO PRIOR SALE.

ALL PRICES SUBJECT TO CHANGE WITHOUT NOTICE.

20% DEPOSIT MUST ACCOMPANY ALL ORDERS, BALANCE C.O.D.

OFFENBACH & REIMUS CO.

372 ELLIS ST.

SAN FRANCISCO, CALIF.

PHONE ORdway 3-8551

THE ONLY WAY...

The current world situation is causing continuous fluctuations in the availability of many standard items of TV, Radio and Electronic Equipment. Concord feels that its customers should be informed of these changes as they occur. Therefore, in an effort to serve you better, Concord will, during this period, issue periodically, large up-to-the-minute Buying Guides - jam-packed with the goods you need and want, at the prices you want to pay. You can't afford to miss a single issue....

Put Your Name On Concord's Mailing List TODAY!

BE ASSURED OF...

- Complete Listings of Available Merchandise First
- Best Buys - Quality Products - Lowest Prices
- Free Expert Technical Advisory Service
- Prompt Efficient Service on All Orders

CONCORD RADIO CORP. Dept. RM-50
901 W. Jackson Blvd., Chicago 7, Illinois

- Please forward your very latest Buying Guide.
- Enclosed \$ (Include Shpg. charge - Any excess will be refunded.) Rush me the following equipment.

Name

Address

City Zone State

CHECK THESE MONEY-SAVING SPECIALS!

LOOK AT THIS!

12" CO-AXIAL HI-FI SPEAKER

SPECIAL! 12.95



Concord 12" Wide Range Coaxial PM Speaker, designed to give finest in natural reproduction for high-fidelity audio systems and radios. 12" woofer has heavy duty 31 ounce Alnico 3 magnet for reproducing lower musical register down to 40 cycles. Coaxially suspended tweeter has especially designed cone for higher register of musical and vocal sound...will respond up to 17,500 cps. High pass filter is attached and combined impedance can be hooked to any 8 ohm output transformer. Rated at 20 watts.

22-19362R - Shpg. Wt. 10 lbs.

12.95

TOPS IN QUALITY - DEPENDABILITY



CONCORD'S NEW
CON-CAPS

Your assurance of high quality and long life dependability - Concord's New CON-CAP condensers. Feature seamless extruded aluminum shell with outer glazed cardboard insulating tube, and easy-to-manage tinned copper leads; hermetically sealed construction. Lowest price anywhere! Fully guaranteed.

No.	Capacity mfd	Working Volts DC	Size	Lots 10 ea.	Single ea.
5-682R	20	150	11/16 x 1-1/4	29¢	37¢
5-684R	40	150	13/16 x 1-3/4	35¢	43¢
5-690R	20 + 20	150	15/16 x 1-7/8	47¢	55¢
5-691R	40 + 40	150	15/16 x 2-1/4	59¢	67¢
5-692R	50 + 30	150	15/16 x 2-1/4	59¢	67¢
5-685R	8	450	13/16 x 1-3/4	29¢	37¢
5-686R	16	450	3/4 x 2-1/4	47¢	55¢
5-687R	20	450	1-1/16 x 2-1/4	59¢	67¢
5-689R	40	450	1-1/16 x 2-1/4	72¢	82¢
5-696R	8 + 8	450	1-1/16 x 2-1/4	59¢	67¢

GILBERT DRILL SET

One of the greatest money saving values yet offered...A Gilbert Drill Set...Complete with 1/4" electric drill and 20 attachments. Drill has Universal 110 volt, AC-DC motor - 1400 RPM no load speed...steel hobbled gears; 1/4" chuck; 16 to 1 gear reduction and toggle switch. Some of 20 attachments include...wood and metal drills, buffer, mounted grinding wheel, screw-driver, and burr...plus many more. Used for grinding, drilling, sharpening, mixing, shaping, sanding, burring, polishing and waxing. Complete set packed in metal chest 13-1/8 x 3-1/4 x 7-1/8".



18-15767R - Shpg. Wt. 8 lbs. 15.95

18-15796R - Drill above only \$9.25

EXCLUSIVE... DIAMOND STYLUS CARTRIDGE

Another Concord Exclusive! A Variable Reluctance Cartridge with a Genuine Diamond Stylus for standard 78 RPM records. Drastically reduced in price, this cartridge formerly sold for \$21.00. Now only at Concord can you get it for less than half the original net price...a 50% saving. Frequency response limited only by record itself. Extremely low needle talk and scratch. Unaffected by varying temperature and humidity conditions. Requires 3/4 oz. to 1-1/4 oz. pressure for optimum tracking. May be used with most standard tone arms. Can also be used with Garrard changers (old and new), and Webster changers (excepting those that use plug-in heads). Pre-amp required between pick-up and input. Size: 1-21/32 x 3/4 x 9/16". Mounting center 1/2 in.

99-8015R - List Price: \$35.00. Your Net Price 9.95

COMBINATION JIG SAW-SANDER-FILER

A combination Jig Saw-Sander-Filer with built-in 110-volt AC motor...all for an amazingly low price. Powerful 3,000 RPM motor has self-aligning oilite bearings and heavy fly wheel. Saw cuts to center of 16" circle. May be rotated to any position to cut longer lengths. Saw strokes: 3,000 3/16-in. strokes per minute. Saw arm may be removed and saber blades used for larger pieces. 6 x 8" table tilts and rotates to cut at any angle. Sanding table tilts through 45°. For filing, merely remove the saw blade and arm and use 1/4" dia. standard filing machine files. Made of lightweight cast aluminum. Size: 13-1/2 x 8-1/2 x 8-1/2". With 6' cord and plug.

18-15738R - Shpg. Wt. 6 lbs. 11.25

CONCORD RADIO

Mail Order Center and Showroom

901 W. Jackson Blvd., Chicago 7, Ill.
Branch Showroom: 265 Peachtree St., Atlanta 3, Ga.

EXPORT

For PROMPT Service on Export Orders & Inquiries Address to CONCORD RADIO CORP., EXPORT DIVISION, 901 West Jackson Blvd., Chicago 7, Illinois.

McGEE'S 20TH ANNIVERSARY "BIG DEALS" SAVE YOU BUCKS—ORDER NOW!

100 MOLDED PLASTIC BY-PASSES \$9.49

100 molded plastic tubular by-pass condensers. All 600 volt. And all by the same nationally known mfg. Regular dealers net is over two and one half times our 20th Anniversary sale price. You'll chuckle when you look these over. Here's what you get: 10—.001, 10—.002, 20—.005, 20—.01, 20—.02, 10—.05 and 10—.1. Our big deal No. RN-202. 100 plastic tubulars. Shipping weight 2 lbs. Net price \$9.49.

100 TOP QUALITY 600 VOLT TUBULARS \$6.49

100 top quality 600 volt tubular by-pass condensers. Made this year by a famous condenser factory. Don't confuse these with grab bag surplus. McGee's deals are guaranteed to please you. Here's what you get: 10—.001, 10—.002, 20—.005, 20—.01, 10—.02, 20—.05 and 10—.1 600 volt condensers. Our big deal No. RN-203. Shipping weight 2 lbs. Net price \$6.49.

20 50x30 MFD. 150 VOLT \$9.75

Here's a red hot value. 20 of our XX quality replacement electrolytics. The most popular condensers in use today. Takes care of 90% of your AC-DC radio filter needs. Compact construction 1950 production. 1 year guarantee. 50-30 mfd. 150 volt. housed in a cardboard tube with common negative, has long flexible leads. 20th Anniversary, big deal No. RN-204. Sale price \$9.75.

10 SELENIUM RECTIFIERS \$5.95

Be Prepared for Rectifier Shortages
10 top quality selenium rectifiers. Guaranteed 2nd to none. Latest compact construction. All standard 130 volt. Use these for your AC-DC sets when tubes are hard to get. 5-65 mfd and 5-100 mfd selenium rectifiers. McGee's big deal No. RN-211. Shipping weight 2 lbs. Net price \$5.95.

5 OZ4 TUBES 5-4-PRONG VIBRATORS ALL FOR \$8.49

Here's a red hot deal for you fellows that do a lot of auto radio service. 5 standard brand metal OZ4 tubes and 5 of our famous 5-4-prong vibrators. This vibrator is of the latest design, for long life. Standard diameter can, short enough to fit into one hole, also fits Motorola, etc. Our 20th Anniversary, big deal No. RN-110. You can get 5 OZ4 metal tubes and 5 4-prong vibrators, all for \$8.49. Shipping weight 3 lbs.

SERVICEMAN SPECIAL 5 5-INCH P.M. SPKRS. 5 50x30 150 VOLT COND. 5 4-PRONG VIBRATORS \$24.95

Here is a real value for the radio repair man. All these parts listed are fast moving items. Fully guaranteed. Tubes are standard brand. The 5" PM speakers have 1 oz. magnet. The by-passes are all 1950 production. This deal is sold as a deal only and not broken up. A McGee 20th Anniversary special, deal No. RN-245. Net price \$24.95.

10 MOTOROLA REMOTE CONTROL HEADS \$7.95

Genuine Motorola Control Heads, 99c each. Pick any of these automatic control heads in factory cartons at 99c each. Automatic heads with push buttons and manual tuning for the following: 42-46 Cadillac, 42, 48, 47 Hudson, 40 Lincoln Zephyr, 42-46 Lincoln Zephyr, 40 LaSalle, Cadillac, 42 Oldsmobile, 41, 46, 47 Packard. Shipping weight 3 lbs. each. Net 99c. 10 for \$7.95. 2A1 Push button and manual universal under dash mounting head; fits all cars and trucks. Net \$1.95 each.

CHOICE OF 4" or 5" P.M. SPEAKERS SALE PRICE \$1.29

McGee's fine quality line of replacement PM speakers. All Alnico V magnets and standard 3.2 ohm voice coils. McGee has a tremendous stock of 100,000 speakers to fill your order. Every speaker is fully guaranteed. Order your speakers now.
4 inch, square.....1 oz. magnet \$1.29
5 inch, pin cushion...1 oz. magnet 1.29
6 inch, pin cushion 1.47 oz. magnet 1.79
4 x 6 inch, oval...1 oz. magnet 1.69
5 x 7 inch, oval...1.47 oz. magnet 2.49
7 inch, pin cushion 2.15 oz. magnet 2.95
8 inch, pin cushion 2.15 oz. magnet 3.29
6 x 9 inch, oval...2.15 oz. magnet 2.95

1 or 4 VOLT CRYSTAL CARTRIDGES \$1.99

McGee offers you a famous make crystal cartridge. Standard and 4-prong, but very light weight. Will track on 3/4 oz. or more pressure. Stock A-6, one volt output, replaces Astatic L-70 etc. Net \$1.99. Stock No. A-10, 4 volt output, replaces Astatic L-72 and L-82, etc. Net \$1.99. Buy 10 assorted for \$19.00.

100 KNOBS Set-Screw Type \$3.95

100 bakelite set screw knobs, for radio set replacement. All fit standard 1/4" shaft. Assorted walnut, black and ivory. Enough of each style to give you matched sets. This value worth \$7.50. Shipping weight 2 lbs. Deal No. RN-10K, 100 knobs. Net \$3.95. or DE 1/2 a Deal or 50 knobs. \$2.00.

65 Mil Selenium Rectifier..... 59c
75 Mil Selenium Rectifier..... 69c
100 Mil Selenium Rectifier..... 69c
150 Mil Selenium Rectifier..... 79c
200 Mil Selenium Rectifier..... \$1.09
250 Mil Selenium Rectifier..... 1.19

McGee's XX quality selenium rectifiers. Small size, compact construction. All 1950 production, by a No. 1 factory. Not surplus, but uniform quality. Fully guaranteed. 130 volt RMS rated.

\$2.95 FOR A REG. \$7.77 PROBE

Boes signal tracer probe, with instructions. Made to sell to you for \$7.77. A heavy bakelite probe containing a SP50T tube. (The end of the probe is secured by three screws and may be taken apart easily.) A 5 foot lead with 3 circuit amphenol plugs and a Mueller peewee clip. Connect this probe to any AC amplifier and have a signal tracer. Shpg. wt. 1 lb. Net. \$2.95; 2 for \$4.95.

UNIVERSAL OUTPUT TRANS. DEAL RN-UP6 \$5.29

Any push-pull or single plate to any voice coil. Popular strap mounting, the same as you use every day. You get 4-5 watt, 1-8 watt, 1-15 watt transformers. Shipping weight 4 lbs. Deal #RN-UP6, Net \$5.29.

20TH ANNIVERSARY INTERCOM SALE! \$25,000 WORTH OF INTERCOMS AT SCOOP PRICES 5-STATION INTERCOM MASTER

5 station intercom master station, in an attractive walnut cabinet. 10x5 1/2 x 6" 5 pushbuttons, you can call any one or more substations. Talk-listen switch has a silent position. Volume control on front panel for easy access. The amplifier is of the conventional AC-DC design, with plenty of power. Equipments with a full size Alnico V PM speaker. This intercom master is new 1950 production by a well known factory. Made to sell at a much higher price. Only 300 to sell at this special purchase price of \$14.95 each. 5 station intercom master No. 2700. Weight 7 lbs. Net price \$14.95.

SCOOP PRICES ON ELECTROLYTICS

Save on these. One year guarantee. All single condensers are in sealed metal tubes with paper insulating and electric banks in cardboard tubes with long flexible leads. Not surplus, but the best.

115 PHONO NEEDLES \$4.95

2 \$3.50 Lind Duotone Ruby needles, with handy record brush, 3 \$2.50 Lind Duotone Sapphire needles in plastic case and 4 packages of 25 cheap needles. 115 phono needles, Deal #RN-P12, Net \$4.95.

10-STATION A.C. MASTER STATION \$24.95

Powerful—6V6 Output Tube
Walnut Vernier Cabinet
Push Button Selector
Sub Stations \$3.95 Each

HALLIGRAFTERS S-78 AM-FM CHASSIS WITH 12" COAXIAL PM \$89.95

Sensational new Halligrafters, 10 tube, plus rectifier. Model S-78 AM-FM chassis, for custom installation. A complete radio chassis with its own power supply and push-pull high fidelity audio system. Chassis size, 12 1/2 x 7 3/4" high and 1 1/2" deep. Output transformer matches 3.2 ohm speaker and 500 ohm. Receives FM, 88 to 108 mc and standard broadcast. Automatic frequency control (AFC) on FM holds receiver in perfect tune. A set used in radios of the \$300 class. Frequency response, 50 to 8,000 CPS. Bass boost tone control and phono input. Why buy an ordinary chassis, when you can buy a Halligrafter? Complete with dial escutcheon, knobs and tubes. Buy your S-78 Halligrafter chassis with a wide range speaker. S-78 Halligrafter chassis, complete. Net price \$79.95. S-78 chassis with \$32.50 list 12" coaxial PM speaker, both for \$89.95. S-78 chassis with \$60.00 list 15" coaxial PM speaker, both for \$84.95. See automatic record changers listed elsewhere in this ad. One tube pre-amplifier for S-78; adapts chassis for use with the G.E. variable reluctance pickup or crystal mike \$5.69. Net \$3.65. Crystal mike and desk stand, \$4.95 extra.

19 TUBULAR ELECTROLYTICS DEAL RN-PL19 \$5.95

19 tubular electrolytics, guaranteed for one year. All fresh stock in aluminum tubes with paper insulating and electric banks. Must be satisfied or money back. You get 10 8 mfd. 450 volt, 4 16 mfd. 450 volt, 3 20 mfd. 150 volt and 2 40 mfd. 150 volt condensers. Shipping weight 2 lbs. Deal #RN-PL19, Net \$5.95.

22 AC LINE CORDS \$4.95

20 6 ft. AC cords, with G.E. unbreakable molded caps. 10 brown and 10 ivory, plus 2 ICA universal resistance AC-DC cord sets. Shipping weight 8 lbs. Deal #GE-22, Net \$4.95.

20 CONTROLS \$5.95

All have SP5T switch, for continuous service. A powerful AC transformer type with 80 rectifier, 6V6 output and GS37 driver. 5" speaker with 2.15 oz. Alnico V magnet. Housed in a walnut cabinet 14" long, 6 1/2" deep and 7 1/2" high. Designed to install a 3 wire system to 10 push button station selector on front, with separate all station call switch. Talk-listen switch has silent position. Made to sell for a much higher price. McGee made a fortunate purchase and passes the bargain on to you. Shipping weight 12 lbs. Stock No. 2520. Net \$24.95 each.

10 FP ELECTROLYTICS DEAL RN-10DS \$3.49

10 assorted F.P. aluminum can electrolytics. Popular twist tap mounting. Mostly multiple section banks. 150, 350 and 450 volts. 2 lbs. Deal #RN-10DS, Net \$3.49.

10 BOXES OF PILOT LIGHTS \$5.49

Pilot lamps, boxed 10 to a handy carton. American made. 7 boxes #47, 1 box #40, 1 box #44 and 1 box #46. A total of 100 lamps. Deal #GM-5. Net \$5.49. 100 x 47 imported panel lamps. Guaranteed, 100 to the carton. Deal #RN-47, Net \$4.49.

\$19.95 BUYS A NEW St. George Wire Recording Mechanism ONLY 200 TO SELL

McGee offers you at a terrific saving the St. George Series 1100. wire recorder mechanism. Brand new and factory cartoned. This unit will record and playback from a standard recording wire, up to 1 hour. The wire take-up reel turns at 78 RPM and will play and record from a 78 RPM phono record. The base is punched for a phono pickup. Space required, 8x13x12". Shipped with a diagram of how to connect and also how to wire a 3 tube converter to enable the wire recorder to be used in conjunction with any radio or amplifier. St. George wire recorder mechanism, Series 1100. Shipping weight: 13 lbs. Net price \$19.95 each. Crystal phono pickup arm and cartridge \$1.95 extra. Recording wire: 15 minute spool. Net price \$1.95. 30 minute spool. Net price \$1.79. 1 hour spool. Net price \$2.79. Crystal mike and desk stand \$4.95 extra.

WIRE RECORDER CONVERTER

3 tube AC wire recorder oscillator and erase circuits for use with the above St. George mechanism, or any wire recorder head. Adapts any radio or amplifier to operate a wire recorder, mike and phono inputs, self powered. Wired with tubes and instructions. Model RW-1 shipping weight 6 lbs. Net price, \$12.95.

RECORD PLAYER SALE 78 R.P.M. RECORD PLAYER \$11.95

Self-Contained Amplifier and Speaker. Here is a red hot value. A complete self-contained 78 rpm record player with its own amplifier built into the chassis. Extra heavy duty 78 rpm phono motor. The amp and speaker are concealed under the attractive plastic base. This is a complete built-up player and has better tone and more power than you would expect for the price of its size. Only 100 to sell. Stock No. E-100P. Sale price, \$11.95.

G.E. RECORD PLAYER ATTACHMENTS SALE PRICE \$6.95

General Elec. 78 RPM Record Player. Ready to attach to an radio or amplifier. Heavy duty motor and standard crystal phono pick-up. Shipping weight 8 lbs. (No pre-amp necessary.) 78 RPM Model. Stock No. GE-78. \$6.95. 33 1/3 RPM Model. Stock No. GE-93 has Webster crystal pick-up with needle. Net \$6.95. Buy 3 for \$19.50.

McGEE ANNOUNCES NEW 1951 MODEL 8 TUBE ALL PURPOSE AMPLIFIER KIT

- 22 WATTS POWER OUTPUT
- PUSH PULL TRIODES
- RESPONSE 18 TO 20,000 CPS
- TWIN ELECTRONIC TONE CONTROLS
- WHY PAY \$100.00 FOR AN AMP—WIRE YOUR OWN
- NEW TONE RANGE SWITCH
- TUNER-MIKE-PHONO INPUTS
- FINEST VALUE IN AMERICA
- TUBES AND ALL PARTS FURNISHED

This is a complete kit. Everything furnished, including tubes and diagram. Designed in our own audio lab. to produce music and voice, with full wide range fidelity. Just the way you like to hear it, whatever your own personal taste. Response 20 to 20,000 CPS. A new volume selector switch gives the tone controls two ranges. In the low position the amp sounds like a big juke box, in the high position the highs, as well as the bass, is boosted to the brilliance of a symphony orchestra. A variable needle scratch filter is built in. Separate bass and treble boost controls circulate, using separate tubes. Inputs for mike and phono pickup, G.E. variable reluctance or standard crystal cartridge. (No pre-amp is required). The high fidelity output matches any PM speaker up to 12 ohms. This amp kit uses all triodes. No odd or even harmonics are introduced within the amp. Power output, 22 watts. Complete with all parts and tubes: 3-7E5, 2-7F7, 2 triodes in push-pull, either 6A3 or Western Electric VT-52, 5V4. This is the finest music lovers' amp kit that we have ever designed. Use with a radio tuner (buy our kit Model BT-38, broadcast tuner, \$11.95, or a record player). Controls may be mounted on the chassis or extension leads, so that the amplifier can be used in any available space. Stock No. 7X5 Amplifier Kit. Shipping weight 25 lbs. Net \$29.95. Custom wired and tested, \$12.50 extra. Why not order a 12", or 15" coaxial or 3 of our 10" PM speakers, with this kit?



8-TUBE
MODEL 7X5
AMP
KIT \$29.95

NEW 1951 MODEL 15" "COAXIAL" PM SPEAKER

20TH ANNIVERSARY SALE PRICE

\$17.95

McGee's new 1951 Model 15" coaxial PM speaker is here! And at a price everyone can afford, \$17.95. This speaker is ideal for all types of radio and audio amplifier use. It may be connected to any ohm output transformer. The 15" woofer has a 32 oz. Alnico 3 magnet and the coaxially suspended 7" speaker has its own magnet and voice coil. A true coaxially built speaker. The high pass filter prevents low frequency notes from reaching the tweeter. The response of this 15" coaxial is from below 20 CPS to above 17,500 CPS. It is the best speaker value in the U.S. today. We buy these by the carload and pass our savings on to you. If you have or are building one of our high fidelity amplifier kits, this speaker is the one you should have. It is a tremendous value. Why pay more than McGee's price, for a 15" coaxial PM speaker? Stock No. P15-9. Shipping weight 14 lbs. 20th Anniversary sale price \$17.95 each. 2 for \$34.00.

Model P15-9

ins on to you. If you have or are building one of our high fidelity amplifier kits, this speaker is the one you should have. It is a tremendous value. Why pay more than McGee's price, for a 15" coaxial PM speaker? Stock No. P15-9. Shipping weight 14 lbs. 20th Anniversary sale price \$17.95 each. 2 for \$34.00.

NEW 12-INCH COAXIAL P.M. SPEAKER \$12.95

McGee announces our new 1951 model 12-inch coaxial speaker, designed for the critical music listener; for use with high fidelity audio systems and radios. This new model reproduces all music and voice with a natural quality. It is improved over our last model in that the 12" woofer now has a heavy duty 31 oz. Alnico 3 magnet. This reproduces the lower musical register down to 10 cycles. The coaxially suspended tweeter has a specially designed cone for the higher register of music and voice. It will respond up to 17,500 CPS. The high pass filter is attached and combined impedance will hook up to any 8 ohm output transformer. It will connect in any ordinary speaker only two wires to connect. Why pay \$20 to \$40 for a speaker? McGee has them made to their own specifications, by the thousands and passes the savings on to you. We have sold over 10,000 coaxial speakers. Why pay more than McGee's price, for a 12" coaxial speaker with wide range coaxial PM speaker, Model CU-4X1. Net price, \$12.95. 2 for \$25.00. Shipping weight 10 lbs.

SARKES-TARZAIN

13-CHANNEL T.V. FRONT END

WITH TUBES AND DIAGRAM \$7.95

This popular Sarkes-Tarzain television front end is widely used today. The 13 channel rotary switch type with individually tuned coils. Price includes a schematic diagram and 3 tubes, 6C1 osc. 6B10 IF and 6AG5 mixer. Regular factory cost is twice our price. Each tuner and its own tube sockets are wired, ready to hook up to a video and sound IF strip. May be used with either intercarrier or separate sound IF circuitry. Built-in fine frequency control. Ship. weight 3 lbs. Sarkes-Tarzain Type 2 TV tuner with tubes net. \$7.95
Combination detuner, Sarkes-Tarzain TV tuner and 205-XX video coil kit both for. \$14.95
Sarkes-Tarzain Type 3—Same as Type 2 only has Input IF coil built-on. Tube \$9.95
Sarkes-Tarzain Type 3 tuner and 205-XX coil kit both for. \$16.95

TELEVISION VIDEO COIL KIT—

20 MATCHED COILS FOR PICTURE AND SEPARATE SOUND I.F. \$7.95

Order with a Sarkes-Tarzain Front End for \$14.95

20 matched TV coils; video and sound I.F. McGee Scoop price \$7.95. Television video coil kit, for TV sets up to 16", using separate sound and picture circuitry. Consists of 20 coils for use in the nationally famous 30 tube and 22 tube set. All coils are of the finest construction, furnished to you, just like they go to a TV set maker. Each coil is identified. These are not made by RCA, but by a top quality coil company, especially for McGee. If you are going to use the RCA circuit, you can use this set of coils.
Coil kit has 1-180 uh, 1-250 uh, 2-120 uh, 2-93 uh speaking coils, 4 picture IF coils for 25.75 mc, cathode trap 2 sound IF, 21.2 mc discriminator, 1 converter and 5 filament chokes. Stock No. 205-XX. SHIPPING weight 3 lbs. McGee's price \$7.95.

Regular \$25.00 Television Magnifier

SALE PRICE FOR 7-10-12 INCH TUBES \$7.95
Stock No. HA-22 12 x 17 in. tele.

Stock No. HA-22 vision magnifier. Made of crystal-clear plastic and oil-filled. Magnifies your present 7-, 10-, or 12-inch television picture up to four times. We offer you these new factory cartoned magnifiers; you provide your own means of mounting to your set. Edge of magnifier may be drilled and hung on your set with cord. This lens is a \$25.00 value. McGee offers them to you for only \$7.95. Shipped by express only. Ship. wt. 22 lbs.

REG. \$20.58 MASCO T.V. BOOSTER FOR \$13.39

Masco TMB-13X. 13 channel television booster. A regular \$20.58 dealers' net item, on sale at McGee for only \$13.39.
Housed in an attractive walnut cabinet, 5 1/2 x 5 x 5 1/2". Self powered, operates on 110 volts AC. Priced complete with 2-6AK5 tubes. These boosters are brand new and factory cartoned. Shipping weight 6 lbs. McGee's sale price only \$13.39 each. \$25.00 for \$25.00. The price is good only as long as our supply lasts.

Picture TUBES

16" 16JP4 \$19.95
12 1/2" 12LP4 \$17.95
Number one quality television picture tubes. Guaranteed by us; unconditionally for 90 days. Best quality, with neutral or white face. Factory design changes made this value possible. Why pay more than McGee's price? Only 500 left to sell, 1000 already sold. No more will be available, when these are gone. 16" tube, weight 25 lbs. 12 1/2" tube, weight 10 lbs. Order now, these 12 and 16" tubes will replace most of the glass tubes types. 12KP4, 12" T.V. AERIALS WITH 300 OHM LINE

201-XI, all hand content, as picture, less mast. Individually cartoned with 50 feet of good standard quality 300 ohm twin lead. Net price, \$7.95 each; 10 for \$69.95
402-XI, all hand, stacked content, less mast. Individually cartoned with 50 feet of good standard quality 300 ohm twin lead. Net price, \$12.45 each; 10 for \$114.95.

SUPER HEAVY DUTY 10" PM \$4.95

We made a special purchase on several hundred 20 watt, 10", 32 oz. Alnico 3 magnet PM speakers. Deep throat and easy moving cone. Ideal for all high fidelity sound systems and radio replacement. The magnet on this speaker is usually used on a 15" size. Very efficient, good high and bass response. You'll appreciate it when you get your hands on this speaker. Attractive copper finish. 8 ohm voice coil. Stock No. 1025PS. Weight 7 lbs. Net price \$4.95 each.

Order three of these and use them in a cluster of three. They will take 60 watts of audio and have more cone area than any 15" speaker. For high power, top quality work. Think this over. 3 No. 1025PS speakers for only \$13.95.

NEW 1950 MODEL 5-TUBE SUPERHET RADIO KIT

MODEL P15-9
NS-5X \$11.95

McGee's new 1950 Model 5 tube AC-DC superheterodyne radio kit. Has loop antenna and 2 gang condenser, with lighted slide rule dial and attractive plastic cabinet. Receives broadcast, 550 to 1650 kc. Full size dynamic speaker, matched 400 I.F.'s, automatic volume control. This is a complete radio kit. Everything furnished, including diagram, chokes and tubes: 14B7, 14Q7, 14A7, 50B5 and 3Z5Z. Shipping weight 7 lbs. Stock No. NS-5X. Net price, \$11.95.

COMPLETE 5-TUBE A.C. SELF POWERED BROADCAST TUNER KIT

USE WITH ANY AMPLIFIER \$11.95

A self powered, 3 gang superhet tuner kit, with R.F. stage. When wired according to our diagram will make the best possible broadcast tuner (550 to 1650kc), for use with any amplifier. Has a lighted slide rule dial. Don't class this with ordinary tuners, this has its own transformer. The complete kit is furnished with a diagram and photo, with tubes: 6SK7, R.F. 6SA7, converter, 6AR7, I.F., 6H6 detector, 6X4 rectifier. Connect to any audio amplifier. Ideal for use with our TG-5 Amp Kit. Chassis size: 6 1/2 x 8 1/2 x 4 1/2 high. Shipping weight 8 lbs. Broadcast tuner kit, Model BT-38. Net price, \$11.95.

HALLICRAFTER 16" T.V. Chassis Complete \$14.995

COMPLETE WITH PICTURE TUBES, FULL DESCRIPTION ON REQUEST
A complete television receiver chassis made by a manufacturer whose name you will recognize. Not a kit, but a 16" TV set with all tubes, 8" speaker and 19" picture tube. Has 19 tubes, plus three rectifiers. Supplied with wood frame for wall or cabinet mounting. Size 19" x 22" x 10" deep. Price was \$259.00. Now at McGee for \$149.95. Stock No. 520EX. Shipping weight 80 lbs.

1950 MODEL TAPE RECORDER \$79.95

Our brand new 1950 model portable tape recorder. Response, 60 to 8,000 CPS. With this you make and play-back top quality tape recordings. Tape speed, 7 1/2 in. per second. New mechanism records 1 hour on 1200 ft. reel of tape. Fast rewind. Record 30 minutes, turn spool over and record second 30 minutes on 1200 ft. reel. AC transformer type amplifier with 8" speaker. Inputs for mike and radio. External speaker jack. Price includes 30 minute reel of tape and mike. Hinged lid is removable. Case is attractive leatherette covered. Size 10x13x14". Shipping weight 29 lbs. Stock No. PIT-3. Net price \$79.95.

RADIO AND RECORD PLAYER \$14.95

For your children's room. Buy this superhet radio and record player. Here is what you get: A full 5 tube superheterodyne radio, with all wired and tested. Walnut cabinet, 78 RPM phono motor and crystal pickup. All you do, when you receive your set, is drill mounting holes in your wall. We are offering you this radio-phonograph at the price of an ordinary record player. Shipping weight 15 lbs. Stock No. JR-78. Net price, \$14.95. 5 tube. AUT-JO. Same radio chassis and cabinet as above, but furnished with a 78 RPM automatic record changer. Shipping weight 25 lbs. Net price, \$24.95.

RECORD PLAYER \$9.95

Complete record player kit, for 78 RPM records. All parts and tubes included. Diagram for building a 70L7 type amplifier. Attractive ready cut walnut base (speaker cut-out on top). Balancing phono motor and Astatic pickup with permanent needle. Shipping weight 10 lbs. Model No. MD-78. Net price \$9.95.
Three-speed model No. D-3378, same as above, only has 3 speed motor and 50 weight crystal pick up arm with Universal 3-speed needle. Net price \$13.95.

3-SPEED RECORD PLAYER KIT \$16.95

New 3-speed portable record player kit, housed in the attractive Capitol portable case. Has 33 1/2, 78 and 45 RPM phono motor and Dual Purpose pick-up arm, with needles. Alnico 3 PM speaker a n d complete kit of parts and tubes to build AC-DC type amplifier, with separate tone and volume controls. Kit Model 348-K, complete with wiring instructions. Weight 16 lbs.

78 R.P.M. CHANGER \$7.95

SALE CHOICE \$7.95
We have a few hundred brand new 78 RPM record changers to close out and then there will be no more. All have standard crystal cartridges. Include postage for 12 lbs. Take your pick at \$7.95 each. Stewart-Warner, General Instrument, or Detroit.

V.M. 3 SPEED Record Changers

VM Model 406 deluxe 3 speed automatic record changer—plays them all—Intermixes records of the same speed—equipped with a flip over crystal pickup with twin needles—a very sleek designed record changer—base size 1 1/2 x 1 3/4. Ship. weight 12 lbs. VM-406. Net \$33.27
Buy the VM-950 changer with or without base. Choice of G.E. VR or crystal cartridge. We include postage for 12 lbs. This is the finest in America. It automatically plays all records all speeds and all sizes; 42-10-in., 33 1/2, or 78 rpm and 12 and 10-in. records of the same speed. Intermixes, 12 7-in., 33 1/2 or 7-in., 45 rpm. Automatically shuts off after the last record. Size 13 1/2 x 11 1/2 x 7 1/4 in. high. Offered with crystal cartridge, G.E. VR cartridge, or either with a base. VM-950, 3 speed changer with standard output crystal cartridge and needles for 1 and 3 mil. (78 rpm, 33 1/2, 45 rpm.) Net \$28.35
VM-950GE, 3 speed changer with the new RPX-050 magic button, all-in-one variable reluctance cartridge with stylus. Net \$31.27
VM-955, 3 speed changer with crystal cartridge on a base. Net \$24.53
VM-955GE, 3 speed changer with RPX-050 VR cartridge and stylus; with base. Net \$35.59

McGEE RADIO COMPANY Prices F.O.B. K.C. Send 25¢ deposit with Order, Balance Sent C.O.D. With Parcel Post Orders, Include Postage TELEPHONE VICTOR 9045. WRITE FOR FLYER 1422 GRAND AVE., KANSAS CITY, MISSOURI

NEW!

**RECTANGULAR
BLACK TUBE**

16in. TELEKIT

**PRICES
BEGIN AT 49.95
LESS TUBES**

**JOBBER: WRITE FOR CONFIDENTIAL
PRICE INFORMATION**

16 BR Telekit

\$79.95 Less
Tubes

Console Cabinet shown

\$39.95

You can build this fine 16 in. rectangular black tube TV set. All you need is pliers, screw driver, and soldering iron. It's easy to assemble; no previous knowledge of TV is required. The tuning unit and hi-voltage supply are factory wired and tested for you. A big 54 page illustrated instruction book guides you through easy assembly. Satisfactory results are **GUARANTEED** by Factory Service Plan and Warranty. Write today for complete information.



12-B Telekit

\$69.95

8-B Telekit
\$49.95

Both Less Tubes

Exciting new low prices on Telekits—let you have a fine 8½ or 12½ inch set for a price far lower than comparable commercial sets. Over 35,000 Telekits have been successfully assembled by following the big illustrated Telekit instruction book. No previous knowledge of TV is required. Satisfactory results are **GUARANTEED** under the Telekit Factory Service Plan. Write for full information.



12 Channel Tuner

\$12.95

Pre-built, factory aligned. Stage of R.F. amplification. Telekit 12 channel tuner equips any TV set with video I.F. of 25.75 to 26.1 Mc and sound I.F. of 21.25 to 22 Mc. Not a kit. Complete with tubes. Only 4 wires to connect.



Telekit Booster

\$12.95

Brings in TV signals bright and clear. Especially helpful in fringe areas. For use with any TV set. **NOT A KIT**. Completely assembled with tubes.



TELEKIT

ELECTRO-TECHNICAL INDUSTRIES

1432 N. BROAD ST. DEPT. R. PHILADELPHIA 21 PA.

MARS

**Station
of the Month**

MARS BEAMS WEEKLY BROADCASTS

MARS—Army Headquarters station, WAR, located at the Pentagon Building, Washington, D. C., broadcasts a weekly message each Tuesday at 0100Z and at 0400Z. (This is Monday at 8 p.m. and 11 p.m., Eastern Standard Time; Monday at 7 p.m. and 10 p.m., Central Standard Time; Monday at 6 p.m. and 9 p.m., Mountain Standard Time; and Monday at 5 p.m. and 8 p.m., Pacific Standard Time.)

Simultaneous broadcasts are made on frequencies 3497.5 kc., 6997.5 kc., 14,405 kc., and 20,994 kc. Each message is sent three times, once at 10 words per minute, once at 15 words per minute, and once at a higher rate of speed—usually 20 words per minute.

Designed especially to transmit quasi-official traffic and training information to MARS members, the broadcast offers an excellent opportunity to all amateurs in building up their code proficiency.

THE old days of pioneering in the Southwest are about over.

And typical of the new era is a yearling MARS station at Fort Sill, Oklahoma. A5WAH/K5WAH, which made its initial contact at 0825 on 14 November 1949, has been named MARS Station of the Month by Captain E. L. Nielsen, Chief, MARS-Army, for its over-all excellence of operation, and for the good work in integrating amateur and military radio operations. Lt. Col. Robert W. Jackson (A5FCP/W5FCP) is station trustee.

No story of the Fort Sill amateur shack would be complete without the names of Captain George B. Cummings (A5MOA/W5MOA) the first trustee for A5WAH, and Sgt. Cecil C. Cash (A5PML/W5PML), the station's Chief Operator who did most of the construction work and equipment layout. The transmitter equipment consists of a *Hallicrafters* HT19, operated at approximately 200 watts input; a BC-610 on 20 meters; a BC-610 on 80 meters, both operated at 500 watts input and an RC 52 on 40 and 80 which runs at about 600 watts input. Receivers are a *National* NC 173, a *National* HRO, a *National* NC 100 and two *Hammarlund* "Super-Pro's."

When you stop drooling, let's take a look at the antenna equipment. There's a three-element beam on 10

and 20, located about 35 feet above the ground. Center-fed doublets are strung 40 to 90 feet above ground for 20, 40, and 80 meter work.

That's a "potful" of equipment—but the station does a "potful" of operating. Hardly had the station paint dried when A5WAH was appointed net control station for the Oklahoma State MARS net. The station served in this capacity until August, 1950 when the press of other military duties was too heavy.

K5WAH is a member of the OLZ (Oklahoma Traffic Net), which has about 30 members and meets daily except Sunday. K5WAH was instrumental in organizing the Armed Forces Net, and served as net control, with an average membership of 21 stations, meeting the 1300 hour daily schedule. In April and May, before the summer slump and the international situation slowed the boys down a bit, K5WAH made BPL in April with 650 points and in May with 717 points, with an average monthly traffic of 200 messages.

K5WAH operates all bands from 160 through 10 meters, averages 15 contacts a day. Because of personnel shortage the station is now on the air 0800-2200 on Mondays, 1200-1700 Tuesdays and Thursdays, 1200-2200 Wednesdays and Fridays.

Col. C. H. Hatch (A5QVE), Fourth Army Signal Officer, and Lt. Col. R. W. Jackson (A5FCP), Fort Sill Post Signal Officer, look on as Sgt. C. C. Cash (A5PML) operates A5WAH.



Critical Shortages of Qualified Men in TELEVISION — ELECTRONICS!



Your Spare Time is Prepare Time! CREI Home Study can lead to quick promotion in essential industry or in uniform

"Technicians may soon be as scarce as certain tubes," says informed industry spokesman as growing military demands cut sharply into skilled personnel.

THE critical shortages aren't imaginary—they're serious. With demand for electronics equipment by the military increasing daily—and with qualified technicians wanted by industry to fill orders and maintain TV sets—now is certainly the time to get into the big-paying jobs in electronics. In this essential industry you're assured—if qualified—of a lifetime career at ever-increasing salary. If you're headed for the armed services your technical electronics ability will be immediately rewarded with supervisory work at extra pay in vital radar, navigation, or communications units.

CREI offers a home study program recognized by industry and the military as outstanding. *Proof:* Leading industrial firms like RCA-Victor, PAA, United Air Lines and many others have chosen CREI for technician training at company

expense; during World War II CREI trained thousands for the Army, Navy, and Coast Guard—and provided texts for thousands more.

CREI, through home study, offers practical training that starts with basic principles and goes step-by-step through the more advanced subjects of TV and its related fields. Each student is grounded thoroughly in the fundamentals required for development work in TV, guided missiles, communications, and industrial electronics. You study Optics; Pulse Techniques; Deflection Circuits; RF, IF, AF and Video Amplifiers; FM; Receiving Antennas; Power Supplies; Cathode Ray, Iconoscope, Image Orthicon and Projection Tubes; UHF Techniques, TV Test Equipment, and many other subjects. You go on to specialized fields as soon as your capabilities permit.

If you want promotion, more money, a lifetime career, send for—and study—the FREE BOOKLET offered below. The sooner you begin your training, the better off you'll be—in industry or in service. The cost is nominal, the terms easy. ACT NOW!

THE THREE BASIC CREI COURSES:

- ★ PRACTICAL RADIO ENGINEERING
Fundamental course in all phases of radio-electronics
- ★ PRACTICAL TELEVISION ENGINEERING
Specialized training for professional radiomen
- ★ TELEVISION AND FM SERVICING
Streamlined course for men in "top-third" of field

ALSO AVAILABLE AS RESIDENCE SCHOOL COURSES

CAPITOL RADIO ENGINEERING INSTITUTE

An Accredited Technical Institute Founded in 1927
Dept. 1112B, 16th & Park Rd., N. W., Washington 10, D. C.
Branch Office: San Francisco, 760 Market St.



MAIL COUPON FOR FREE BOOKLET

CAPITOL RADIO ENGINEERING INSTITUTE

Dept. 1112B, 16th & Park Road, N. W., Washington 10, D. C.

Gentlemen: Send booklet, "Your Future in the New World of Electronics," together with details of your home study training, CREI self-improvement program and outline of course. I am attaching a brief resume of my experience, education and present position.

- Check Field of Greatest Interest:
- | | |
|---|---|
| <input type="checkbox"/> Practical Television Engineering | <input type="checkbox"/> Aeronautical Radio Engineering |
| <input type="checkbox"/> Practical Radio Engineering | <input type="checkbox"/> Broadcast Radio Engineering (AM, FM, TV) |
| <input type="checkbox"/> TV, FM & Advanced AM Servicing | <input type="checkbox"/> Radio-Electronics in Industry |
- If Residence School Preferred, Check Here

NAME _____ AGE _____

ADDRESS _____

CITY _____ ZONE _____ STATE _____

OLSON

AKRAD



IT'S DIFFERENT—IT'S AMAZING—IT'S GREAT
IT'S NEW! **The OLSON LOUDMOUTH**

Olson Radio Warehouse, Inc.
73 E. Mill St. • Akron 8, Ohio

RA-43 Complete with tubes and Electro-Voice Microphone. OLSON'S Special Price, only.....

\$34.99

EACH

8,000 cps. Power gain 10DB. Tubes 6X4 and 6X5GT. Hum level 60DB below output level of 8 watts. Power consumption 30 watts at 117 volts, 80 cycles. Dimensions, 13 1/2 x 8 1/2 x 13 1/2" high. Genuine leather carrying handle, beautiful two tone grey and blue carrying case with sloping control panel. Completely assembled ready to operate. Shpg. wt. 15 lbs.



ONLY AT OLSON'S

FP COND. KIT
AS-24.
\$3.98

Assortment of 15 popular FP condensers, double and triple sections. Capacities from 10 mfd to 50 mfd; from 25 to 450 volts. Shpg. wt. 3 lbs.

MATCHED PAIR AM-FM CONDENSERS
69¢ Pair

Beautifully built 3-gang. Build a tuner or AM-FM set. AM sections are 365 MMFD; FM is 15 MMFD per section. Can be operated by push-buttons. Top Shaft 3/8" dia. Condenser 3" x 1 1/2" x 1 1/2" Shpg. wt. 3 lbs. X-201. Only at OLSON'S.

X-158 22c
H & H TOGGLE SWITCH
Single pole, single throw, 6 amps, 125 V. Regular 60c.

BATTERY CHARGER
4 Amps
\$7.50 RA-55

Highly efficient storage battery charger. Automatically decreases charging rate as battery becomes charged. Housed in sturdy steel case with 117 volt AC cord, plug and battery leads with heavy-duty clips.

3-SPEED PHONOGRAPH
Plays 78—45—33 1/2 RPM Discs
Special
\$19.97
RA-56

30 WATT AMPLIFIER
• Factory Built
• Latest Design
Olson's Price less tubes. **\$34.95**
RA-23

A real commercial amplifier which looks good and performs well. Not a kit. Gain, mikes, phono 80DB. Has dual tone controls, one for bass and the other for treble tone. Output impedances 8, 15 and 500 ohms. Input for two mikes and one crystal pickup. Shpg. wt. 20 lbs. Tubes required. 3-6SQ7, 1-6SC7, 2-6L6G, 1-6V4G.

GE RECORDER—PLAYBACK
Stock No. RA-53, complete with 2 tubes and 2 discs **\$17.95**

A real recorder for children. Discs can be erased and used over. Made by GE and known as the "Play-talk." Records and plays back instantaneously. Each disc plays 2 minutes. Equipped with magnetic disc recorder and playback head, 2 tube amplifier, phono motor, combination microphone and speaker, and erasing device. Factory sealed cartons. Underwriters Lab. approved. Shpg. wt. 15 lbs. Regular Price \$39.95.
Note: This is a fine item for children and will satisfy them. It is not a high-fidelity recorder intended for commercial use.

JENSEN PM SPEAKERS
Olson's Big Bargain Value
Genuine Jensen PM speakers for PA or radio use. Come and coil assembly permanently aligned. Heavy Alnico V magnets. Order Early.
Stock No. S-12, 12 Watts, 12" Dia. Shpg. Wt. 7 lbs. **\$7.95** Net

UNIVERSAL OUTPUT TRANSFORMER
Matches any single tube to any 3.2 ohm voice coil. Primary tapped at 2,000, 7,000, 10,000 ohms. 2-inch mounting centers. List price \$25.50.
T-87, Olson's price... **99c**

TV BOOSTER KIT
RA-26 Complete
\$9.95
Build your own TV-FM booster. Improves reception in a low-signal, "fringe" areas, 3 to 5 db gain in signal to noise ratio. All channel tuning. Complete with 6AK5 tube, pre-aligned coils, etc. Shpg. wt. 5 lbs.

OLSON'S GIGANTIC NEW AKRAD KIT—WITH 4-DRAWER STEEL CABINET FREE
Reg. List Price \$18.38.
AS-36, Olson's Price only... **\$6.95**

We have a limited quantity of Olson Akrad "Super Sealed" by-pass condensers available in 4 drawer steel cabinets, size 6 1/2 x 5 3/4 x 8 1/2". Drawers have compartments. Condensers are designed to give long dependable service even in the tropics.

Kit Contains 42 Condensers
You get the 4 drawer steel cabinet and the following 42 Olson Akrad "Super Sealed" By-pass condensers.

Qty.	Cap.	Volts	Qty.	Cap.	Volts
2	.001	600	10	.05	600
2	.002	600	10	.1	600
2	.005	600	2	1.005	1600
5	.01	600	2	.008	1600
5	.02	600	2	.01	1600

FREE—SEND FOR OUR LATEST RADIO AND TELEVISION BARGAIN CATALOG

NEW DESIGN World's Fastest Automatic Changer for RCA 45 R.P.M. Records
RA-45 **\$8.95** Each

Price Slashed by OLSON
Developed by RCA. Plays one hour and 40 minutes with one turnover of the discs. No posts, clamps, to harm records. Discs slide easily down large spindle. Crystal cartridge has flat response from 50-10,000 cycles. Needle pressure is only 6 grams. Has built-in precious tipped 1 mil needle. Size 6 1/2 x 7 1/2" height overall. 6 3/4" requires 5/16" above and 3/4" below base plate. For 105-125 volts AC. Shpg. wt. 8 lbs. Factory sealed cartons. **SPECIAL AT OLSON'S.**

FAIRCHILD GRINDER
TL-3 **\$9.98** each

Every service shop needs one of these handy tools made by Fairchild, famous manufacturer of precision electric grinders. Regular nationally advertised price is \$19.75. The set consists of 1-115 volt high speed, air cooled grinder, 6 assorted grinding wheels, 1 circular saw blade, 1 hardened steel reamer, 1 buffing brush, 1 abrasion stone and a natural finish wood case size 10 1/2" x 3" to house the grinder and all the tools. Shipped in original factory sealed cartons.

ASTATIC MICROPHONE
Universal high output crystal for public address, home recording and communications. Equipped with handle and desk base, 7 ft. shielded cable. A beauty, too, for this price. Shpg. wt. 5 lbs. **\$5.95** M-67, each.

PANEL LAMPS
Westinghouse, GE, and Tung-Sol halogen panel lamps, 100 of a type to the box.
Stock No. Type No. Price
X-161 47 **\$5.19**
X-174 44

WHIZ WIRE STRIPPER
Strips off insulation clean and fast. Takes wire up to 1/4" diameter. Has 4 hole blade. Automatic grip releases after stripping. No tool box complete without this handy tool.
TL-1... **\$2.95**

KIT OF THREE VARIABLE CONDENSERS
A \$3.50 value. Perfect for the experimenter. Brand new stock. Quantity limited. Olson's Price **\$1.29**
Get a kit containing 3 assorted variable condensers. Popular values, 2-gang and 3-gang. Some have trimmers, vernier drives, AM and FM styles. X-226, Carton of 3 ass't.

Build a Receiver Set of Basic Components
Price for Kit of 5 AS-38 parts... **\$1.89**
With this kit you can build an AC-DC set or a portable. You get these five parts:

Parts	List Price	Reg.
Loop	\$0.95	
R. F. Coil	1.10	
Input I. F. Transformer (456 KC)	1.60	
Output P. Transformer (456 KC)	1.60	
Oscillator Coil	.75	
Set Price of Set	6.00	

Use any 365 mfd variable for tuning. Covers 335-5450 KC.

Famous Olson Trumpets and Drivers
Completely all weather. Made by Famous Manufacturer. 10 Watt Paging Speaker. An outdoor or indoor all weather paging speaker. Capable of continuous 10 watt output. You get the complete unit consisting of an Alnico 5 driver unit (8 ohms) and a spun metal exponential horn with swivel bracket. Bell diameter is 7". Regular list price \$26.00. Packed in original factory sealed cartons. Shpg. wt. 4 lbs. **\$11.95** Special each

Trumpet and 25 Watt Driver Unit
The most popular combination on the market. This driver and trumpet is perfect for outdoor (all weather) use on sound trucks, churches, parties, etc. Fully guaranteed by Olson and the famous manufacturer. All Weather Trumpet: 10" diameter bell, equivalent to a 3 1/2" exponential trumpet. Made of aluminum castings and spinings. Can be used with driver listed here or any other standard driver. Factory sealed cartons. Shpg. wt. 15 lbs. Regular list price \$29.00. S-152, special each... **\$13.50**

Driver Unit: 25 watts, 15 ohms for use with trumpet offered here or will fit any standard trumpet from Olson with confidence. Factory sealed cartons. Shpg. wt. 6 lbs. Regular list price \$25.00. S-151 and S-152, special, each... **\$12.50**

SPECIAL COMBINATION OFFER
Olson will supply you with a 25 watt Driver Unit S-151 and an all weather trumpet S-152 at the special price of both for **\$23.95**

CRYSTAL MIKE
Nationally famous make. Used in many tape, wire and disc recorders. Adaptable on P. A. systems, amplifiers, etc.
M-71... **\$3.99**

4 Drawer Steel Cabinet FREE with OLSON'S Gigantic AKRAD CONDENSER KIT
Olson's Price **\$16.95** RA-520
You get 4 \$45.20 worth of "Akraud" condensers plus cabinet, 8 1/2" x 5 3/4" x 10 1/2".

Qty.	Cap.	Volts	List Price	Total
2	.001	600	\$25.50	\$50.00
2	.002	600	25.50	50.00
2	.005	600	25.50	50.00
5	.01	600	30.150	150.75
5	.02	600	30.150	150.75
10	.05	600	40.400	404.00
10	1	600	45.450	454.50
2	.005	1600	55.110	110.22
2	.008	1600	55.110	110.22
2	.01	1600	60.120	120.24

69 Total List Value \$455.20

GE RPX-040
Variable Reluctance Cartridge Stylus
Regular price is \$9.95 on GE Phonograph with removable 3 mil stylus for 78 RPM discs. Stylus pressure 3/4 oz. **\$3.49** XC-45 only

ZENITH MICRO-ADAPTER
RA-54 **\$4.95** SPECIAL ONLY
Now you can play the new 33 1/2 and 45 RPM discs and old single speed 78 RPM changers. This clever unit is slipped over the arm of the changer and by setting the lever on the Micro-Adapter, the speed can be selected. Equipped with tone arm, crystal cartridge, permanent stylus and instructions. For use on all Zenith 600's equipped Record Changers.

27 "Akraud" Electrolytic Condensers

Qty.	Cap.	Volts	ea.	Total
2	10	25	\$5	\$10.00
2	25	25	\$5	10.00
5	20	150	95	475.00
5	40	150	110	550.00
4	20	150	130	520.00
5	40	150	95	475.00
4	16	450	135	540.00

Shop by Mail & Save at

ACORN



BATTERY CHARGER

Pri. 115v. AC delivers 6v. DC @ 3 amps. Can be used as trickle charger for auto batteries. Portable strobe units and a 6v DC supply..... **\$5.95**

THERMO-COUPLE RF METER

0-750 milliamps calibrated 0-10. Each division on scale 75 mil. 2 1/2" meter Type DW 52, made by G.E..... **\$2.95**



T-17B CARBON MIKE

Single button carbon with press-to-talk switch. 5 ft. rubber cord and PL 68 plug. Used, but in perfect condition. All tested..... **\$1.39**

VIBRATOR TRANSFORMER

Pri. 6v. Sec. 600v. c.t. @ 100 mls. Made by Chicago Transformer. Upright mount. Mt. dim. 2" x 2 1/4". H 3" x D 2 3/4" x W 2 3/4"..... **\$1.99**

U.T.C. LOW VOLTAGE TRANSFORMERS

Pri. 115v. 50-50 cy. Sec. 120v. 50-60 cy. @ 6 amps. Upright mount.....	Pri. 220v. 50-60 cy. Sec. 230v. @ 8 amps. Upright mount.....
\$2.79	\$3.49

LOW VOLTAGE TRANSFORMER

Pri. 115v. or 230v. At 115v. input, Sec. No. 1: 24v. @ 5 amps; No. 2: 24v. @ 5 amps. At 230v. input, Sec. No. 1: 48v. @ 3 amps; No. 2: 48v. @ 3 amps..... **\$4.49**



ISOLATION TRANSFORMER

Pri. 115v. 50-60 cy. Sec. No. 1: 125v. @ 90 mls. Sec. No. 2: 135v. @ 90 mls. Sec. No. 3: 6.3v. @ 1.5 amps. Upright mount..... **\$1.95**

THORDARSON FILAMENT TRANSFORMER

Pri. 110v. 50 to 60 cy. 32.5 v.a. Sec. 5v. 6.5 amps 35.5 k.v. insulation. Open frame. 30 lbs. H 9" x W 7 3/4" x D 7". Mounting centres 7" x 3 3/4"..... **\$7.95**

POWER TRANSFORMER

Pri. 115v-50-60 cy. Sec.: No. 1-600v. c.t. @ 120 mls. No. 2-6.3v. @ 4 amps. No. 3-5v. @ 3 amps. Upright mount..... **\$2.95**

LOW VOLTAGE TRANSFORMER

Pri. 115v. 50-60 cy. Sec. 15v. 12 amps. 180 v.a. Open frame mounting..... **\$3.95**

MAGNAVOX 12" SPEAKER

Alnico V magnet. 6-8 ohm v.c. 12 watt output. Excellent frequency range..... **\$5.95**

2" SPEAKER

Self-contained transformer; nylon parchment cone. Excellent for tweeter—can be used as mike. Originally made for Handie-talkie..... **\$2.29**

10" QUAM-NICHOLS

EXTENDED RANGE: Alnico V 6.8 oz. magnet. 13 w. output. 3.2 ohm v.c. Lists at \$14. OUR PRICE **\$4.39**

APC AIR TRIMMERS

(All Screwdriver)



Each	60 MMFD 30c
15 MMFD. 20c	75 MMFD 40c
25 MMFD. 25c	100 MMFD 40c
50 MMFD. 25c	140 MMFD 50c

NOTE: Due to conditions beyond our control, prices are subject to change.

TERMS: 20% cash with order. Balance C.O.D. All prices F.O.B. our Warehouse in New York City. Minimum order \$2.50.

Phone WOrth 4-3270

ACORN ELECTRONICS CORP.

76 Vesey St. Dept. N-12 New York 7, N. Y.

Technical Aspects of Naval Communications

(Continued from page 51)

economy, before a contract is placed, coordination to prevent undesirable duplication of effort is achieved. A proposed Research and Development project is forwarded to the Electronic Committee of the Research and Development Board for consideration. This committee comprises representatives of the three Services, as well as civilian members eminent in the electronics field. After similar development projects are scrutinized, and if no undesirable duplication is apparent, the Research and Development Board approves the project.

The specifications are then submitted to manufacturers for contract bids by the Bureau of Ships, and after the bid has been awarded, the research and development stage follows, under the close supervision of Navy engineers. The acceptance tests follow the development, and finally the service evaluation tests are conducted aboard a station or ship before the equipment is approved and purchased. In the case of shipboard equipment, the service tests are performed by the Commander, Operational Development Force who has available to him highly qualified technical personnel and various types of ships and aircraft for which the equipment is intended. The service evaluation tests consist of actually using the equipment under conditions which duplicate its ultimate employment, with naval personnel operating and maintaining it to make absolutely sure that it will fulfill the operational requirement, and meet the rigid physical standards imposed by the specifications. The foregoing procedure, while it is admittedly slow, assists greatly in providing for the U. S. Navy reliable, rugged, and compact communication equipment, as economically as possible, and with the least impact possible on research and manufacturing agencies. The communication equipment for the U. S. Navy falls generally into two groups: (1) shore, and (2) ship.

Shore Station Equipment

Shore station communication equipment must possess all of the features of reliability, long life, stability, and low maintenance, the same as shipboard equipment. Certain features, such as ruggedness, small size, and weight are not so important. Shore stations exist to provide long distance communications in large volumes; hence, the equipment is large and powerful, and no limits are placed upon the size of the radiating system required for the job. Transmitters in the order of 500 kw. to 1000 kw. are used, together with huge amounts of terminal equipment for single sideband and electronic multiplexing. Very low frequency transmitters give the fleet world wide broadcast coverage. Transmitting, receiving, and control stations are separated by several

miles, and thus must be linked together with landline or v.h.f. control links. Recent developments indicate a trend toward PTM (pulse time modulation) for replacement of the very-high frequency links. PTM offers more flexibility and more channels for the Navy's operational requirements.

Shipboard Equipment

Shipboard installations are restricted in size and weight, depending upon the type of vessel involved. Practically, this means that on some ships when a piece of equipment of any sort is placed in a ship the weight added must be compensated for; either by removing an equal weight, or if the equipment is installed above the water line, an equal weight must be inserted near the keel to preserve the stability. Similarly, space being at a premium in war vessels, consideration must be given the size of the equipment in order that other essential material may also be accommodated. This explains why those portions of Naval military characteristics and technical specifications which have to do with size and weight are most rigid and severe.

In addition to the size and weight factors, because of the extreme ranges of temperature, exposure to salt water spray, deterioration due to humidity and the wear and tear of a ship at sea to which the equipment is subjected, the problem of providing adequate equipment to meet the numerous operational needs is not an easy one.

The limited space above decks, for which requirements for guns, radars, signal searchlights, and other special electronic devices compete with increased numbers of communication antennas to meet expanding circuit requirements, all of which specify omnidirectional coverage, has placed increasing demands upon Navy Engineers for efficient antenna systems. Such research is a continuing project within the Navy, and of late years, considerable emphasis has been accorded it. Recently developed common antenna working systems show promise of producing some gratifying results.

In general, shipboard equipment is growing smaller, more compact, more stable, lighter, automatic, and rugged. It is hoped that miniaturization of components will reduce further their size and weight. On the other hand, the effort to meet the ever growing operational requirements and at the same time reduce the size and weight has introduced, in some cases, more complicated and complex equipment. This is a serious problem in view of the present shortage of Navy Electronic Technician Mates. Therefore, specifications are beginning to emphasize packaging of components for quick replacement to enable disabled equipment to remain on the air. The repair of the particular circuit can be accomplished at a later time. As a result of a standardization program, it is planned to replace the various

RADIO & TELEVISION NEWS

NEW COMPLETELY REVISED SECOND EDITION

THE RADIO & ELECTRONICS HANDBOOK

By WILLIAM F. BOYCE, PUBLISHER
JOSEPH J. ROCHE, EDITOR
AND
20 QUALIFIED EXPERTS & LEADERS
IN THE ELECTRONICS FIELD WHO HAVE
CONTRIBUTED TO THIS WORK
MAKES PRODUCTION BETTER, FASTER, EASIER

Improved!
Enlarged!



Plan every operation in radio and electronics with the *Radio & Electronics Handbook*—THE ONLY RADIO HANDBOOK OF ITS KIND. Use it every day on the board, at the bench, in the field!

Use this famous, newly-improved "radio bible" for engineering, construction, troubleshooting, testing, designing, layout . . . any and every operation in radio and electronics!

900 PAGES . . . 18 SECTIONS, EACH A COMPLETE COVERAGE OF ONE RADIO SUBJECT.

Practical engineers and skilled editors worked five years to gather and digest this great storehouse of radio principles and operation . . . statistics . . . newest developments in electronics . . . fundamentals, theory and know-how. Everything is worked out clearly, readably, with every possible detail. The same Boyce-Roche Staff, creators of electronics manuals for the U. S. Signal Corps, have made the *Radio & Electronics Handbook* a priceless book for general reference, and most of all for practical on-the-job help.

Use this valuable book **ABSOLUTELY FREE** for 10 days! Send the coupon now.

HANDSOMELY BOUND IN DURABLE FABRIKOID WITH ALUMINUM STAMPING . . . 18 SECTIONS . . . 900 PAGES . . . COMPLETELY ILLUSTRATED . . . \$5.95

ALSO DON'T MISS

THE VIDEO HANDBOOK

The Complete Television Manual

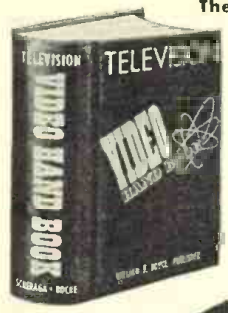

By MORTON G. SCHERAGA, *Television Research Consultant*, Allan B. Du Mont Labs., and JOSEPH J. ROCHE, former Editor, *Radio & Television Maintenance*.

More than 900 pages. More than 500 illustrations. Complete with data, diagrams, circuits, photos and time-saving, money-saving know-how! For technicians, students and engineers. Same durable, handsome Fabrikoid binding as the RADIO AND ELECTRONICS HANDBOOK. . . . \$5.95

SPECIAL OFFER—SAVE \$1.00

on this practical, handsome RADIO & TELEVISION LIBRARY SET



Covers Radio, Electronics and Video—A Gold Mine of Information—Including
RADIO & ELECTRONICS HANDBOOK and VIDEO HANDBOOK

Both in a handsome slip case for ready reference.

\$10.90 for the set

We are confident that these books will fill your every expectation and therefore offer to send them to you on approval—Mail this coupon today.

BOYCE-ROCHE BOOK CO.
PRINCETON 25, N. J.

HERE'S WHAT YOU GET IN THE NEW SECOND EDITION OF THE RADIO AND ELECTRONICS HANDBOOK (6 NEW SECTIONS)

1. FUNDAMENTALS OF RADIO & ELECTRONICS
2. VACUUM TUBE THEORY
3. RESISTORS
4. CAPACITORS
5. TRANSFORMERS & CHOKES
6. SWITCHES & DRY RECTIFIERS
7. BASIC CIRCUITS
 - VACUUM TUBE RECTIFIERS
 - R. F. AMPLIFIERS
 - AUDIO AMPLIFIERS
 - OSCILLATORS
 - DETECTORS & CONVERTERS
 - FILTERS
8. AM RECEIVERS & TRANSMITTERS
9. FREQUENCY MODULATION
10. TELEVISION
11. SOUND SYSTEMS—SELECTION, INSTALLATION & OPERATION
12. RECORDING
13. POWER SUPPLIES
14. ANTENNAS & TRANSMISSION LINES
15. METERS & TEST EQUIPMENT
16. TESTING, MEASURING AND ALIGNING
17. RADIO AND ELECTRONIC DATA SECTION INCLUDING 100 PAGES OF TABLES, CODES, CHARTS, GRAPHS, NOMOGRAPHS, FORMULAS AND STANDARDS
18. VACUUM TUBE CHART AND PIN INDEX INCLUDING RECEIVING TUBES, TRANSMITTING TUBES, RECTIFIER TUBES, CATHODE RAY TUBES AND REGULATOR TUBES.

----- 10-DAY FREE EXAMINATION COUPON -----

BOYCE-ROCHE BOOK CO.
Princeton 25, New Jersey

For my ten-day approval use, send

{ } RADIO & ELECTRONICS HANDBOOK @ \$5.95
{ } VIDEO HANDBOOK @ \$5.95
{ } BOTH THE ABOVE IN LIBRARY SET @ \$10.90

I will send you total price of \$ _____ plus postage or I will return book(s) postpaid.
(Offer good only in U. S.)

MAIL TODAY

Name _____
Address _____
City _____ Zone _____ State _____
Employed By _____

SAVE POSTAGE! We pay postage if you enclose purchase price. Money back with same return privilege. Enclosed please find \$ _____

Double Your Profits!

Sell A

Jensen needle
on Every Service Call



First Choice of:

- Servicemen
- Phono Manufacturers
- Record Collectors

FREE: Jensen's *All-New*
Replacement Needle Chart
... 89 different needles
shown in actual size. Get
one from your jobber today.

Jensen makes a needle
to fit any record player.

Jensen
INDUSTRIES, INC.
336 S. Wood St., Chicago 12, Ill.

The Meissner 9-1091-C AM-FM Tuner

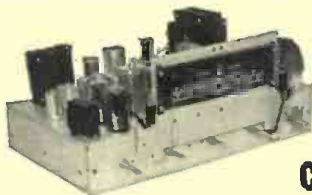

**THE IDEAL COMPONENT
FOR CUSTOM INSTALLATIONS**

COMBINES FIDELITY WITH STABILITY

Servicemen and others interested in custom installations will be quick to appreciate the many top features of the MEISSNER 9-1091-C AM-FM Tuner.

Here is real quality—precision workmanship—outstanding design, all combined to give you the very highest fidelity reception and at remarkably low price.

Frequency response—sensitivity both are phenomenal! Compare the specifications below and your choice will be the MEISSNER 9-1091-C Tuner.

MEISSNER is designing a high fidelity amplifier for this tuner. Watch for the release announcement.

**See The 9-1091-C Tuner At Your Jobber
Or Write For New Meissner Catalog**

Features

- Frequency Response flat with plus or minus 2 db 30 to 15,000 cycles
- Bass Control provides 10 db boost at 40 cycles
- Treble suppression of 12 db at 8,000 cycles
- Input Jack for Crystal or high level magnetic type phono pickup
- Sensitivity less than 10 microvolts
- "Broad" or "sharp" selectivity for AM
- Hum level 60 db below full output
- Output 11 volts high imp. terminals, 2 volts on 500 ohm terminals
- 300 ohm FM antenna input. FM antenna and line act as efficient AM antenna

MEISSNER

MEISSNER MANUFACTURING DIVISION
Maguire Industries, Inc., Mt. Carmel, Illinois

models of transmitters and receivers installed aboard our ships with an all-purpose series of transmitters and receivers. This modernization will assist to some extent in reducing the maintenance and spare parts provisions and stowage problems. The latter is one which has long plagued the logisticians. With numerous different types of equipments installed in ships, the provision and stowage of sufficient spare parts for self-sufficient operations presents many space and weight compensation problems. By standardization of equipments, components, and revising stowage methods aboard ships, a reduction of perhaps 50% in cubeage and weight per ship is anticipated.

In the development of any new equipment, the Naval Communication Service is guided largely by programs of systems-wise engineering. At the present time, there are three such programs that might be listed. They are: (1) ultra-high frequency conversion, (2) teletype, and (3) radiophotofacsimile.

The ultra-high frequency band was chosen because of the possibility of obtaining more channels to provide for our tactical requirements. It is an all-purpose band and will be used by all three military services on air-to-air, air-to-ground, and ground-to-ground circuits. Considerable difficulty has been experienced in developing equipment in this band, mainly because of frequency stability considerations; however, the demanding specifications have brought about successful research on new circuits, new techniques, and new automatic control devices and considerable progress has been made. For instance, the perfection of techniques to realize narrower channel bandwidths has produced nearly double the communication channels than was hoped for originally. Since this equipment must be installed aboard all types of ships and craft, as well as planes, attainment of small size and weight are being emphasized. This u.h.f. system will ultimately replace the very-high frequency system now in use.

Increasing traffic loads and high speed targets have resulted in more and more emphasis being placed upon the use of automatic equipment. The manual c.w. circuit is considered the "horse and buggy" type of communications and, like the horse and buggy, is highly reliable, but very slow. The teletypewriter program is an effort to shift naval communications from the manual method to the machine method, and has been successfully accomplished in the Navy Communication System (shore stations). A partial shift has been made in the fleet in that ship-shore teleprinter circuits exist for the use of those ships equipped with radio teletype equipment. It is hoped that the fleet broadcasts may soon be made by this method. Radio teletype equipment aboard ship is up against the same old problem of weight and space. Hence, new equipment is being developed that is

RADIO & TELEVISION NEWS

TECH-MASTER

TELEVISION

NEW DeLuxe KITS 630 TYPE

with keyed AGC

FOR PICTURE TUBES FROM 10" ROUND TO 20" RECTANGULAR

TECH-MASTER KITS are acknowledged by the radio industry as the finest for quality and performance. Avoid the danger of buying untested brands . . . insist on TECH-MASTER . . . indisputably the finest of them all. All components are factory mounted. Easy to follow instructions assure perfect performance in comparatively short time.



TECH-MASTER TV ACCESSORY KITS



Booster



"Hi-Sweep" VOLT-AGE MULTIPLIER.



KEYED A. G. C. CIRCUIT for 630 Type chassis.

Contact your nearest jobber or write Dept. RN for literature on complete TECH-MASTER line of Kits.

TECH-MASTER PRODUCTS CO.

443-445 Broadway, New York 13, N. Y.

More leading engineers and technicians have built Tech-Master for their own use than any other Television Kit.



Whether you're in the Armed Services or in Industry ELECTRONICS TRAINING PAYS OFF WITH INTERESTING JOBS AND HIGHER EARNINGS

CREI Residence School training offers quick promotion in uniform as well as profitable civilian careers

IN or out of the armed services, the best jobs go to the men with technical training. If you are prepared with electronics training, you're fortified for the future, whether you're headed for a berth in the armed services or a career in essential industry. Because of the critical shortages that exist today in the electronics industry, the qualified technicians and engineers can practically choose their own futures. Because of the dependence of modern armies, navies, and air forces upon electronics—for radar, communications, and navigation—the man with even limited knowledge of electronics gets ahead quickly in uniform. In case you're called to active duty before completion of your CREI course, you'll still be way ahead, for the armed services will choose you for further electronics training in place of the completely un-trained man.

At CREI you'll work with the latest equipment—over 120,000 square feet of modern class rooms, TV and radio broadcasting studios, transmitters, control rooms, and experimental labs. Here you're grounded in the fundamentals required for work in guided missiles, TV, and all the other important fields of communications and electronics. CREI's experience in training thousands of men for the Army, Navy and Coast Guard in World War II, coupled with pioneering background in technical education and close industry connections, assure you of the best in technical preparation. To insure your training ACT RIGHT NOW. Send today for free Residence School catalog.

FOR FREE CATALOG, MAIL COUPON NOW!

CREI—16th & Park Rd., Washington 10, D. C.
Please send free Residence School Catalog.

Name.....

Street.....

City..... Zone..... State.....

Veteran..... Non-Veteran..... Age.....

Send details about Home Study Courses 1312 B

APPROVED FOR VETERANS — New classes start twice a month. High level home study training also available for professional radio men.

CAPITOL RADIO ENGINEERING INSTITUTE

16th Street and Park Road
Dept. 1312B, Wash. 10, D. C.

smaller, lighter, and more compact—a distinct advance.

In line with the trend toward automatics, the radiophoto-facsimile program is the latest additional service to be provided by the Naval Communication Service. The operational requirement for the transmission of maps, charts, and official documents has spurred on the development of radiophoto-facsimile equipment. Future developments indicate strongly that this equipment will become an integral part of shore station and shipboard installations.

Considerable thought has been given to multiplexing equipment for increasing the capacity of the existing communication circuits. The limited frequency spectrum available has encouraged this development.

Looking into the future, more and more attention will be paid to data transmission systems. In this atomic energy age, faster and faster methods of communications will be necessary to support military operation. Furthermore, with the U. S. Armed Services working as a team with allied forces, coordinated communications are a must. All equipment developments must continue to be done along joint specifications so that the Services can work easily into each others' systems. Military characteristics will insist that equipment be developed for joint use, that it be reliable, small and compact as possible with miniaturized components, stable, easily serviced, rugged, and easy to operate and that certain features be automatic. In this manner the U. S. Navy will continue to obtain the best equipment for war purposes that money can buy.

—30—

FOREIGN SET OWNERSHIP

ACCORDING to the most recently released data from the U. S. Department of Commerce, the Postmaster General of the Australian Post Office has asked for bids on equipment for a television station to be built in Sydney. Although bids were submitted two years ago, recent technical developments in both the United States and Britain make it advisable to secure up-to-date information.

The display of FM radios at the Dusseldorf (Germany) Radio Fair was reported to have attracted considerable public interest. Price reductions on these receivers proved to be somewhat of a stimulus as was the displaying of special FM converters which are now available for AM receivers.

The Netherlands is planning to provide television service to the public by means of six transmitters, the first of which will be put into operation early next year in Lopik. The Lopik transmitter is expected to serve 4 million people in The Hague, Amsterdam, and Rotterdam areas. Transmission will be on the 625 line standard.

Licensed television receivers in the United Kingdom totaled 382,348 on May 31, 1950. 109,852 sets were located in London. On January 31, 1950, the number of licensed receivers was 280,092 of which 85,991 were located in London.

—30—

RADIO & TELEVISION NEWS

Special Relays-

OVER A MILLION IN STOCK!

Whether you require large quantities of relays for production runs or single units for laboratory or amateur work, Wells can make immediate delivery and save you a substantial part of the cost.

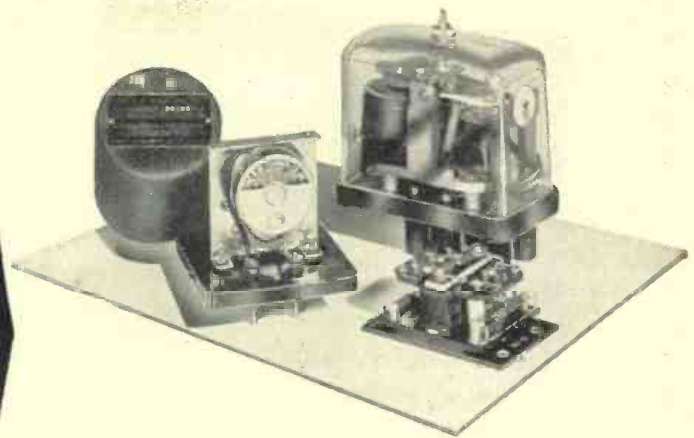

This list represents only a few types of Special Relays. We also have huge stocks of Standard D.C. Telephone Relays, Midget Relays, Contactors, Keying Relays, Rotary and Slow Acting Types as well as many others. Write or wire us about your requirements.

STOCK NO.	VOLTAGE	OHMAGE	CONTACTS	MANUFACTURER & NUMBER	PRICE
R-503	12/32 VDC.	100	3A, 2C	G.E. Ant. Keying 500W 2C6530-653ARI	\$ 2.25
R-749	600 VDC.	Max. 28 Amps.	Allen Bradley 810 Dashpot	5.95
R-804	550 VAC.	1B/38 Amps.	Culter Hammer C-261173A34 Contactor	3.50
R-250	115 VAC.	Adj. Cir. Breaker .04-.16A	Westinghouse MN Overload	12.95
R-579	220 VAC.	1B	Adlake 60 Sec. Thermo Delay	6.95
R-294	27.5 VDC.	200	1B	Edison 50 Sec. Thermo Delay	4.25
R-686	115 VAC.	2C	Leach 1157T-5/20 Sec. ADJ. Delay	4.95
R-246	115 VAC.	1B	Cramer 2 Min. Adj. Time Delay	8.95
R-246A	115 VAC.	1A	Cramer 2 Min. Adj. Time Delay	8.95
R-611	24 VAC.	1A/30 Amps.	Durakool BF-63	4.25
R-283	12 VDC.	125	AC 10 Amps.	Onan Rev. Current 3H4512/R24	1.00
R-614	18/24 VDC.	60	1A/15 Amps.	Rev. Current Cutout 3H2339A/E1	3.50
R-262	200	1C	W. U. Tel. Co. 41C Single Current	3.75
R-245	12 VDC.	25	4 In. Micalex Lever95
R-527	6/12 VDC.	50/50	In Series	227668 For Scr-274N	.95
R-544	12/24 VDC.	60/60	1C	G.E. Push Button Remote Relay	1.65
R-255	1A	#CR2791-R-106CB	.95
R-669	75 VAC.	400 CYC.	1B, 1A	G.E. Pressure Switch #2927B100-C2	.95
R-660	6 VDC.	3/8" Stroke	Clare 400	.95
R-651	24 VDC.	100	Solenoid Valve	Cannon Plunger Relay #13672	2.50
R-295	12 VDC.	275	Annuncitar Drop	2.15
R-230	5/8 VDC.	2	2A, 1C	Guardian Ratchet Relay	2.15
R-813	12 VDC.	12	Wafer	Ratchet Relay From Scr-522	4.25
R-275	12 VDC.	750	1A, 1B, 1C	Guardian BK-10	2.75
R-716	24 VDC.	70	2A/5 Amps.	BK-13	1.45
R-620	6/12 VDC.	35	2C, 1A	Guardian BK-16	1.05
R-629	9/14 VDC.	40	1C/10 Amps.	Guardian BK-17A	1.25
R-778	8 VDC.	4500	1C/5 Amps.	Kurman BK-24	2.10
R-720	24 VDC.	50	2C, Ceramic	45A High Power	1.35
R-500	12 VDC.	10/10	2C/6 Amps.	Str. Dunn. Latch & Reset	2.85
R-816	12 VDC.	10/15	2C/6 Amps.	Guardian Latch & Reset	2.85
R-811	48 VDC.	8000	1C	Sigma 4R	1.65
R-524	24 VAC/DC.	Edwards Alarm Bell	.95
R-838	90/120 VDC.	925	2A	Allen Bradley-Bulletin #702	4.50
R-839	100/125 VDC.	1200	3A	Motor Control	4.50
R-840	115 VDC.	1200	2A	Allen Bradley-Bulletin #200E	4.50
R-841	115 VDC.	1200	4A	Motor Control	4.50
R-842	115 VDC.	925	3A	Allen Bradley-Bulletin #209 Size 1	5.50
R-843	115 VDC.	1200	3A	Motor Control W/Type "N" Thermals	25.00
R-844	115 VDC.	1200	3A, 1B	Allen Bradley-Bulletin #709 Size 2	5.50
R-845	220 VAC.	Intermit.	3A	Motor Control W/Type "N" Thermals	4.50
R-837	7.5/29 VDC.	6.5	1A/250A, 1000A Surge	Allen Bradley-Bulletin #709	4.50
R-831	110 VAC.	2A/30 Amps.	Motor Control W/Type "N" Thermals	4.50
R-835	24 VDC.	2800	1A Dble. Brk./10 Amps.	Allen Bradley-Bulletin #200	4.50
R-836	220 VAC.	2A Ddle. Brk./10 Amps.	Motor Control	4.50
R-566	115 VAC.	(Coil only, Not a complete relay)	Allen Bradley-Bulletin #704	4.50
R-710	150-Ohms. Coil Only	Motor Control	4.50

Wide Selection of Electronic Components at WELLS

- Tubes
- Resistors
- Condensers
- Wire & Cable
- Volume Controls
- Co-ax Connectors
- Relays
- Rectifiers
- Transformers and Chokes
- Micro Switches and Toggles
- Antennas and Accessories
- Electronic Assemblies
- Dial Light Assemblies

Write For New Wells Catalog



320 N. LA SALLE ST., DEPT. R CHICAGO 10, ILL.

Each relay is new, individually boxed, and unconditionally guaranteed by Wells
World's Largest Display of Radio and Electronic Components
9,000 Square Feet of Display All On One Floor



SANTA PLATT RIDES AGAIN

SPECIAL CHRISTMAS BONUS

5% AUTOMATIC CREDIT AGAINST ALL \$10 ORDERS

Here's proof positive that Platt's doing everything in his power to give you what you want, when you want it, and at the prices you want to pay! Platt's policy is not to hold back merchandise to wait for higher prices. And to prove it, Platt's giving his regular Christmas Bonus. Yes, with every \$10 order you place, simply deduct \$1 as Platt's present. (On \$20 purchases you get back \$2, etc.) This special offer is good for December ONLY—SO HURRY!—place your orders NOW!

Visit Platt's Big Retail Store at 489 Broome St., New York City

★★★★★★★★★★★★★★★★★★★★



SPECIAL!! A BUNDLE OF CHRISTMAS KITS

Unfortunately space does not allow us to list all the individual parts of these sensational kits, but take Platt's word—they're value-packed!

1 Kit of 25 assorted metal and plastic ESCUTCHEON PLATES \$2.49

1 Kit of 25 assorted DIAL FACES, finished in various stages and used on present high priced broadcast receivers. (Can be used with above kit) 2.79

1 Kit of 100 assorted RADIO KNOBS—push-on, screw-on, pointer-type, long neck 3.89

1 Kit of 12 assorted SWITCHES—many uses: TV, electrical, circuit breakers, wafers, etc. 3.49

1 Kit of 25 assorted COILS and CHOKES—1F's, antenna, broadcast and short wave 1.79

RESISTORS

Wire Wound

14 ohms—30 watt.....19c	Flat 8.3 ohm w.w. resistor.....15c
500 ohms—25 watt.....29c	
5000 ohms—100 watt.....79c	
5 tap Resistor, 750x23x23x750x3000 ohms—200 watt bleeder.....89c	



SCR-27N COMMAND and ARC 5 EQUIPMENT



	USED	NEW
BC-453—190 to 550 KC.....	\$12.95	5.95
BC-454—3 to 6 MC.....	6.95	10.95
HC-455—6 to 9 MC.....	6.95	10.95
R-23—ARC 5—190-550 KC.....	21.95	

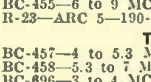

	USED	NEW
BC-457—4 to 5.3 MC.....	5.95	8.95
BC-458—5.3 to 7 MC.....	5.95	8.95
BC-459—7 to 9 MC.....	14.95	24.95
T-19—ARC 5—3 to 4 MC.....	14.95	24.95
HC-459—7 to 9 MC.....	12.95	24.95
T-22—ARC 5—7 to 9.1 MC.....	12.95	24.95

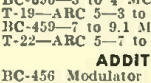

	USED	NEW
BC-456 Modulator.....	2.25	3.25
BC-450 Control Box (3 Receiver).....	.98	1.95
BC-451 Control Box (Transmitter).....	.89	1.49
BC-442 Relay Unit (ANT).....	1.95	2.95
Plugs: PL-147, 148, 151, 152, 153, 154, 156.....	EACH	.75
Flexible Shafting with gear to fit Receivers.....		1.69
3 Receiver Rack.....	2.25	
2 Transmitter Rack.....	1.69	



DYNAMOTORS

	USED	NEW
DM-33A—Input 28V, output 540 VDC, 250 mills.....	\$1.95	2.95
DM-32A—Input 28V, output 250 VDC, .06 amps.....	1.95	
DM-34—Input 12V or 14V at 2.8 amps, output 220 V at 80 MA.....	8.95	
DM-25A—12 V, input 2.3 amps, 250V output at 50 MA, ideal for use on command receivers for mobile use.....	4.95	
DA-1A—Input 28 VDC at 1.6 amps, output 230 VDC at 1 amp.....	6.95	
DY-12—for ART-12 Power Supply, 12V, 9.4 amps, 1 output 275V @ 110 MA, 2-500V @ 50 MA.....	6.95	
DV-53A—24V input, 220 VDC, output at 80 MA.....	2.95	
PE-125 Vibrator Power Supply, 12 or 24 VDC designed for BC-223 Transmitter, output 400V at 200 MA, 8V at 4.5 amps.....	17.95	
PE-103A Dynamotor with power unit, ideal for mobile use, input 6V at 21A, output 500V 1.6A or 12V at 11A, output 600V 1.6A, used with SCR-284.....	24.95	
BD-86—Input 14V 2.2 amps, output 600V 3 amps, with fuse and Cond. Box on Mount.....	7.95	

DYNAMOTORS (Cont'd)

	USED	NEW
DM-36 Dynamotor, input 24V to 28V 1.4A, output 220V at .08 amps. Complete with mounting base and Jones Plug.....	2.95	
PE-94—input 28V, output 14.5V at 4.9 amps, 150V at 10 MA, 300 V at 200 MA, used with SCR-5.....	5.95	9.95
MF-28BA—A dynamotor power supply unit, input 25 to 28V 14.8 amps DC, output 340V 450 MA DC, with a transmitter modulation section using 1-6N7 1-6F6 and a pair of 807 tubes in push-pull. Also includes modulation transformer. Used for Bendix TA-12.....		45.00

Multitester Foundation BIAS METER 1-97A

Contains a zero center 3 1/2" round Marlon voltmeter calibrated 0-100 volts each side. Movement is one mill each side of center. The unit is mounted in a steel box 7"x5"x4" and contains 3 contact push buttons, line cord dual 100 MFD at 200 V DC condenser, a potentiometer 6 RC 1% wire wound non-inductive resistors, one 400 ohm two 2500 ohm, one 5000 ohm, one 10,000 ohm, one 15,000 ohm. Excellent for building a zero center multitester with ranges of 1, 10, 100. COMPLETE BRAND NEW \$5.95

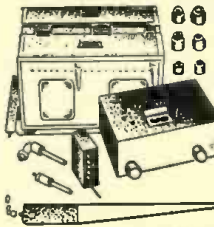

RECONDITIONED SCR-522

With New Components Very High Frequency TRANSMITTER-RECEIVER 100-156MC, 4 Channels, Crystal Controlled, Modulated Voice, Electrically Tested. Complete as shown Only \$84.50

BRAND NEW—\$92.50 SCR-522C—Complete as above—Brand New....\$129.50

BEACON RECEIVER BC-1206-C

Manufactured by Satchell-Carlson

Frequency Range—195 KC to 420 KC, IF Frequency—135 KC, Receiver Sensitivity—3 Microvolts for 10 Milliwatts output. Output Impedance—300 Ohms and 4000 Ohms to be selected internally. Power Output—250 Milliwatts. Volume Control—RF Gain Control. Power Supply—24-28 Volts Aeroplane Battery. Current—7.5 Amperes. BRAND NEW—ONLY \$795

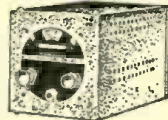

Mallory NF1-7 RADIO NOISE FILTER

Can be adapted for many uses.....89c



ARMY TEST UNIT 1-236

Meter is contained in a metal box 5 1/2" long x 3 1/4" wide x 3 1/4" deep. Comes complete with test leads and instruction book. Can be used for testing between AC & DC measuring resistances of circuits, checking fuses, and testing capacitors. ONLY \$7.95

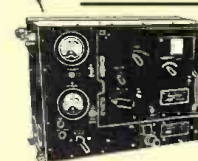

BC-223 TRANSMITTER

A 30 watt Transmitter, ideal for ship-to-shore or Ham Rig. Crystal or MO control on four pre-selected channels, 2000 to 5250 KC. Use of 3 plug-in coils, five tubes: 2-801 and 3-46, and TU 17-18-25 tuning units. TRANSMITTER.....\$25.95 TUBES.....3.75 TUNING UNITS.....2.25 ea.

PE-125 VIBRATOR POWER SUPPLY FOR BC-223.....\$18.95

20 POUNDS OF ASSORTED RADIO PARTS

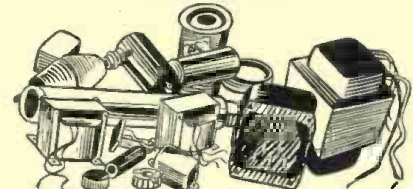

Transformers, Chokes, Wire, Condensers, Knobs, Sockets, Switches, Dynamotor. ONLY \$3.39

MINIMUM ORDER \$2.00 Immediate Delivery—Send 25% deposit on C.O.D. orders. All shipments F.O.B. N.Y.C. (N.Y.C. residents add sales tax to your remittance.)

100 ASSORTED RESISTORS

Non-Insulated, various ohmages and wattages. SPECIAL \$1.97

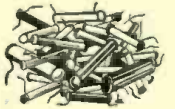

HEADSETS

HS-33 low impedance with cord and plug, used, fine condition.....	\$0.79
HS-23 high impedance, BRAND NEW with ear pads.....	2.75
HS-33 low impedance, BRAND NEW with ear pads, cord and PL54 plug.....	2.75
TH-37A—1200 ohms with dual plugs.....	2.95
HS-16 high impedance with cord and pin plugs, BRAND NEW.....	1.95
HS-30 with ear plugs, low impedance, used, good condition.....	.89



FIELD TELEPHONES

Army surplus, completely reconditioned and electrically tested, using 2 flashlight cells and a pair of interconnecting wires. GUARANTEED—like new. ONLY \$10.95

TURBO AMPLIFIER

4 tube Amplifier used by U.S. Air Force. 115 V, input at 400 cyc. With tubes—BRAND NEW.....\$3.95 Without tubes—BRAND NEW.....1.49

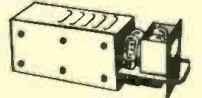

PRE-AMPLIFIER MODEL K-1

The K-1 is used to amplify output level for microphones and phonographs. Operates on 24-28 VDC, can be converted to 110 AC. Comes complete with PL 55 plug and 2 foot 119-B cord, 2 terminal blocks and instruction book. BRAND NEW.....SPECIAL \$3.95

BC-746 TUNING UNIT

Plug-in transmitter tuning unit from Army Walkie-Talkie. Contains antenna and tank coils, tuning condenser, transmitting and receiving crystals. Ideal transmitter foundation. ONLY \$1.29

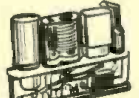

BATHTUB CONDENSERS

5-.5 MFD—100 VDC (Top Terminals).....	9c
20 MFD—350 VDC (Side Terminals).....	39c
2 MFD—400 WV—600 Peak V (Side Terminals).....	29c
25 MFD—400 WVDC (Side Terminals).....	19c
5 MFD—100 VDC—2.8 MFD—400 VDC (Side Terminals).....	29c
2x1 MFD—600 VDC (Bottom Terminals).....	39c
2x1 MFD—600 VDC (Side Terminals).....	39c
1 MFD—600 VDC (Side Terminals).....	29c

FILTER CONDENSERS

15x15 MFD—450x350 V.....	59c
8x8x20 MFD—300x300x150 V.....	59c
10x50 MFD—450x25 V.....	39c
1000 MFD—15 V.....	33c
3000 MFD—3 V.....	48c
2000 MFD—15 V.....	37c

OIL FILLED CONDENSERS

32 MFD—450 VDC Mounted on Metal Plate.....	\$0.79
.5 MFD—750 VDC—400 VAC.....	.49
8x8x8 MFD—500 VDC.....	.59
1 MFD—3000 VDC, Round Can.....	.95
1 MFD—1000 VDC, Rect. Can.....	.69
1 MFD—600 VDC, Rect. Can.....	.49
2 MFD—600 VDC, Rect. Can.....	.69
2 MFD—600 VDC, Round Can.....	.69
.25 MFD—3500 VDC, Rect. Can.....	1.29
.25 MFD—6000 VDC, Rect. Can, G.E.....	1.79
15 MFD—660 VAC—G.E., Large.....	1.29
2 MFD—4000 VDC, G.E., Large.....	4.39
30 MFD—90 V, 3 Phase, G.E., Large, 60 Cycles.....	1.39
1.25 MFD—220 VAC, Western Electric Motor Cond.....	.29

PLATT ELECTRONICS CORP.

DEPT. A, 489 BROOME ST., NEW YORK 13, N. Y. PHONES: RE 2-8177 and WO 4-2915

TWO FULL PAGES OF HARD-TO-FIND MERCHANDISE AT LOW, LOW PRICES!

TRANSMITTING MICA CONDENSERS



.00075 MFD—5000 V.79c
.0015 MFD—5000 V.89c
.09 MFD—1500 V.79c

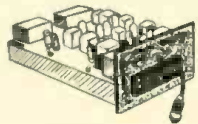

BC-620 RECEIVER-TRANSMITTER

2 crystal channels—20 to 27.8 MC. 6M1-13 tubes. Metered. Plate and Filament.

NEW \$24.95

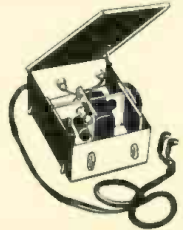

PE-97 POWER SUPPLY for BC-620

6 or 12 V vibrator type. NEW—less tubes, vibrator.

\$3.95

TUBES—Brand New Standard Brands. Immediate Delivery

5BP4	\$2.75	807	\$1.65
3CP159	85549
10Y39	128H749
7929	4A110	2.50
80169	000449

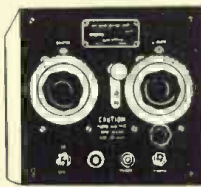

BC-1066 RADIO RECEIVER

Requires radio frequency signals for checking frequency and operation of other radio equipment. Coverage is obtained by 2 bands, 1 and G. Battery operated. New \$8.95 with tubes.

BC-433 RADIO COMPASS RECEIVER

15 tubes, frequency range 200-1750 KC. 3 bands. EXCELLENT CONDITION. \$29.95



Control Box BC-434-A

Used with Radio Compass receiver R5-ARN-7. Bendix ADF Equipment. Only \$1.95

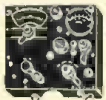

Control Box BC-648-A

Brand New. Includes 2 meters—0.5 milli-ampers and 0-40 Volts. Made by Westinghouse. Excellent Value! Only \$3.29

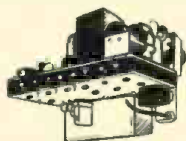

CHRISTMAS SPECIAL! APN-2 COMPLETE AIRBORNE NAVIGATIONAL RADIO UNIT

Consists of transmitter, receiver and power supply. Frequency range of receiver: 214 and 234 MC. Maximum operating range: 100 miles. Power requirement: 115 VAC—400 cye. Contains a considerable amount of excellent parts.

ONLY \$6.95 less tubes

MINE DETECTOR SET—SCR-625

A portable device capable of detecting all types of metals. Hundreds of uses: Agricultural, mining, etc. NOW ONLY \$79.95



RADIO RECEIVER BC-1023-A and MOUNTING FT-161

UHF aircraft receiver with frequency range from 62 to 80 MCS for receiving 75 MC marker beacon signals. BRAND NEW! \$7.95



MN-26 INSTALLATION

MN-26C Receiver—Remote control commercial type navigational. Indicates direction of any desired transmitting station. 3 bands—frequency range: 150 KC to 1500 KC; has 12-6 V type tubes, BRAND NEW (Original Cost \$600.00) \$22.95

MN-26C Receiver, used, excellent condition. \$15.95
MN-26Y Receiver. Frequency to 7 MC. New. \$22.95



TYPE MN-20E ROTATABLE LOOP UNIT

8" diameter, used with MN-26 Compass and RA 10DB. Manufactured by Bendix. A TERRIFIC BUY! ONLY \$11.95

BC-221 FREQUENCY METER

This is a Christmas Special! QUANTITY IS LIMITED—so first come, first served. They are just like new, with original calibration charts. Range 125-20,000 KC with crystal check points in all ranges. Complete with crystal and tubes.



ONLY \$69.50

WOOD CASES for 221 FREQUENCY METERS

Brand New \$3.95 Used \$2.25



BC-461 CONTROL BOX

Used for RL-42 Ant. Reel. Has Veeder-Root counter with "0" reset adjustment and multi-switch to control RL-42 which is reversible. ONLY 95c



FL-8 RADIO FILTER

Can be converted for use with many types of transmitters and receivers. Complete write-up in May, 1950, Issue of CQ Magazine. EXCELLENT CONDITION \$1.29

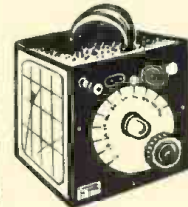

BC-1255 MONITOR

A battery-operated receiver, 75-150 MC range. Used as monitor in operation and calibration of radio transmitters. BRAND NEW. \$14.95

CONVERSION KIT E-3E

Contains one 20 ft. roll co-ax cable 1/8-8U. 2 rolls containing 75 ft. of aero glass-covered wire and assorted screws, nuts, switch plates, crummers, clips, etc. \$2.39

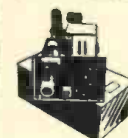

T9/APQ-2 RADAR TRANSMITTER

80/115 V 400-260-26 VDC. Designed primarily for aircraft operation. Exceptional value. NEW \$42.50

MINIMUM ORDER \$2.00 Immediate Delivery—Send 25% deposit on C.O.D. orders. All shipments F.O.B., N.Y.C. (N.Y.C. residents add sales tax to your remittance.)

MICROPHONES

T-24-G, 200 ohms, single button, 8 ft. rubber cord with PL-106 Plug and JK 38 Jack. BRAND NEW \$1.95



T-17-R, Hand-held carbon microphone for use in voice communication. Effectively covers the audio frequency range from 300 to 2600 CPS, 200 ohms, with press-to-talk switch, 5 ft. rubber cord and plug. NEW \$3.95

T-30 Microphone suitable for aircraft use. Responds to frequencies in the range of 400 CPS to 2000 CPS. Complete with cord and plug. Original Packing. NEW \$1.29

T-30-C Hand Carbon Microphone, 24 ft. cord, 3 contact amphenol plug. \$2.95

T-44C Magnetic type mike with cord, plug and jack. Brand New \$1.69

GN-45 HAND GENERATOR

6 Volts, 3 Amps
500 Volts, 0.14 Amp



Used with Signal Corps Radio Set SCR-284. Has many applications. Brand New, Original Packing. ONLY \$17.95

CORDS AND PLUGS

CD 508A Cord Assembly with SW 14-U Switch and 2 cord attachments with JK 48 Jack and PL 68 Plug. Value—\$5.00. Our Special Low Price. Brand New \$1.59



CD 307A with PL 55 and JK. New \$1.79

JK 26 Jack with cord, good condition \$1.2c
JK 26 Jack only—Brand New \$1.5c
PL 55 Plug—NEW \$3.5c
PL 68 Plug—NEW \$2.0c
Jones plus 8 contact male and female \$2.5c
PL-Q-59 \$4.9c
PL-P-60 \$4.9c
PL-Q-61 \$4.9c
PL-Q-62 \$4.9c
PL-Q-77 \$6.9c
PL-Q-171 \$8.9c
PL-153-A \$6.9c
PL-172 \$8.9c

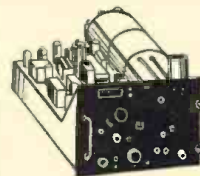

T-85/APT-5 UHF TRANSMITTER

Frequency range 300-1500 MC. 20 watts output, band width 2.5-3 MC. Complete with 8 tubes and 110 V 60 cye. transformer. Calibrated in centimeters. New in original box with operating Instruction Manual. \$79.50

APN/1 RADIO ALTIMETERS

Christmas comes but once a year and so does a bargain like this. A complete NEW 14 tube Radio Altimeter. Contains 420 MC Transmitter and Receiver, Power Supply, Range Switches, Two Antennas, Meter Indicator, All Plugs and Instruction Manual. This unit makes an excellent amateur station as it is right in the band. BRAND NEW—ONLY \$24.95



LAST MINUTE CHRISTMAS SPECIALS!

BC-348 Receiver—Excellent Condition \$129.50
BC-224 Receiver—Excellent Condition 99.50
BC-610 Radio Transmitter—Needs Repairs. 375.00
BC-614 Speech Amplifier—Used with Hallcrafters BC-610 Transmitter. 135.00
ARC-3 Transmitter—Brand New. 325.00
R5/ARN7 ComPass Receiver, complete, like new 125.00
PE-75 Gasoline Driven Power Unit, 2500 watts, Excellent Condition 169.00
SCR-284 Spare Parts Kit. 39.95
DYNAMOTOR with base for ART-13. 49.95

PLATT ELECTRONICS CORP.

DEPT. A, 489 BROOME ST., NEW YORK 13, N. Y.
PHONES: RE 2-8177 and WO 4-2915



BEST WISHES and

BEST VALUES from NIAGARA

ONE OF AMERICA'S GREAT ELECTRONICS STORES

TRANSMITTER-RECEIVER

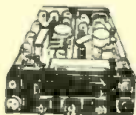

Navy Model ABA-1-BC-645
450 MC-15 TUBES,
Brand New

Can be easily converted for phone, or CW 2-way communication. Covering the following bands: 420-450 MC ham Band, 450-460 MC for fixed or mobile, 460-470 MC for citizens, 470-500 MC television experimental. Size 10 1/2 x 13 1/2 x 4 3/4. Contains 15 tubes: 4-7F7, 4-7H7, 2-7E6, 2-6F6, 2-955, 1-WE-316A door knob. Price, NEW and Boxed. Reduced to **\$15.95**

TALK UP TO 10 MILES WITHOUT BATTERIES

R.C.A. SOUND POWER PHONES

RCA No. M1-2475 Navy Type "Q." You can actually hold two-way conversations over wired circuits up to TEN MILES with these Sound Power phones. Any number of these units may be paralleled on same line without loss of power. Ample volume—excellent tone quality—rubber cushioned earphones, mouthpiece microphone attached. Massive construction, multiple adjustments, 22-ft. rubber cord, push-to-talk switch, navy waterproof plug. Ideal for TV antenna installations, fieldtests, hunting, mining, games, etc. Cat. No. N-300. Your cost, each unit, comprising 1 pair headphones, microphone, cord and plug as illustrated **\$9.95**
Same as above with mile on chest plate. Type "O" RCA M1-2454B... **4.95**



274N and ARC-5 XMTRS and RECEIVERS

2.1-3	MC. Xmtr.	\$14.95
3-4	MC. Xmtr.	19.95
4.5-8	MC. Xmtr.	12.95
5.3-7	MC. Xmtr.	12.95
7-9.1	MC. Xmtr.	24.95
190-550	KC. Revr.	14.95
550-2000	KC. Revr.	24.95
3-6	MC. Revr.	7.95
6-9.1	MC. Revr.	7.95
100-156	MC. Revr.	19.95

SPECIAL

1500 Volt—300 MA
Power
Supply Kit

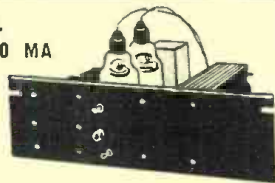

Complete with punched chassis, 19 1/2" rack panel, tubes, choke, transformers, hardware, etc. **WHAT A BUY! \$24.95**

TRANSFORMER BARGAINS!

Plate

750-0-750—300 MA.	\$ 7.50
1025-0-1025—500 MA.	17.95
2500 V.—4 MA.	3.95

Filament

2.5V-5A, 7.5V-4A	\$2.60
2.5V-10A cased	4.95
5 V.C.T.-3A	1.35
5V-10A	1.85
5 V.C.T.-10.5A	2.15
5 V.C.T.-15A	5.95
6.3V-3A	1.29
6.3 V.C.T.-3.5A	1.49
Three 6.3 V.C.T.-4A each	1.80
6.3 V.C.T.-6A	1.85
6.4V-8A	2.05
7.5V-5A	2.49

Power

40-0-40—250 MA.—5V-3A	\$1.25
55-0-55—250 MA.—5 V.C.T.-3A, 5 V.C.T.-3A	1.35
175-0-175—150 MA.—6.3V-6A	2.15
275-0-275—70 MA.—5V-5A, 2.5V-10.5A	3.00
325-0-325—40 MA.—5 V.C.T.-2A, 2.5 V.C.T.-4A	2.25
325-0-325—70 MA.—6.3V-1.2A, 5V-3A	2.95
350-0-350—70 MA.—5V-3A, 6.3V-3A	3.05
350-0-350—100 MA.—6.3V-6A, 6.3V-2A	3.25

Modulation

807 to P.P. 6L6	\$2.49
P.P. 807 to single 6L6, 4D32 (2400 ohms)	3.49
From 200,500 ohms to 5, 6, 7, 8, 9, 10K ohms at 150 MA.	4.49

Driver Xfms.

200, 10,000 ohm P. to single G.	\$.79
10,000 ohm P. to single G.	.89
P.P. 45, 2A3, etc. to P.P. 210, 801, etc.	1.95
P.P. 6L6, 2A3, etc. to P.P. grids.	1.65

Output

P.P. par. 2A3, 45, etc. "AB" to 4, 8, 15, 500 ohms	\$1.89
6V6 to 2, 4, 8 ohms	.69
P.P. par 6N7 Class "B" to 8000 ohms	1.49

Input

600 ohm C.T. to 300 ohm mike	\$1.49
------------------------------	--------

Mike to Line

From and to 50, 125, 200, 330, 500 Ohms	\$2.49
30 ohm mike to 600 ohm C.T. Bal. line	1.65

Chokes

.875 HY.	2.5 Amps	\$8.95
2.5 HY.	4 Amps.	8.95
2.5 HY.	130 MA.	1.10
4 HY.	40 MA.	.25
8 HY.	200 MA.	2.35
10 HY.	180 MA.	3.49
40 HY.	90 MA.	
10 HY.	200 MA.	2.49
12 HY.	150 MA.	1.75
15 HY.	125 MA.	1.60
15 HY.	200 MA.	2.65
20 HY.	125 MA.	1.75

BLOWERS



THREE TYPES ALL 110V. A.C. 60 CYCLE MOTORS. ALL BRAND NEW

TYPE A—Single section (illustrated above) approximately 100 Cubic Ft. Per Minute. 2 1/2" intake, 2" outlet. 3200 R.P.M. 25 cycle motor measures 6" x 6 1/2" SPECIAL **\$9.95**
TYPE B—DUAL BLOWER—100 C.F.M. Per Section. Mounted side by side with 60 cycle motor in center. Otherwise same as TYPE "A." SPECIAL **\$14.95**
TYPE C—Single section (not illustrated). Somewhat smaller than TYPE "A." Approximately 50 C.F.M. 60 cy. VERY SPECIAL **\$6.95**

New Low Price Niagara Famous High Pass Filter



Banish Interference with Niagara's High Pass Filter! Positive protection against interference from amateur transmitters, diathermy, and all other devices generating radio frequency interference below 40 MCS. Designed for 300 ohm lead-in. No loss in brightness or clarity. **\$2.50**
Wired and tested. Postpaid if entire amount is included with order.

LOW PASS FILTER

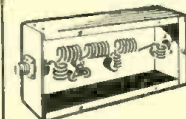

Don't be blamed for TVI! Tests have proven that Niagara's low pass filter attenuates all frequencies above 40 MC. May be used on all bands from 10 to 160 meters. Will easily handle a full kw. Matches 52-72 ohm line. Plus 25c shipping charges **\$4.99** in U. S. A.

5 WATT AUDIO AMPLIFIER

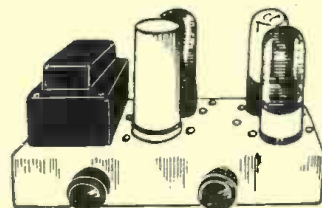

Complete with speaker and 3 tubes. Hi-impedance output for XTAL mike or Phono-Pickup. Volume and tone controls. 5 W. amplif. with 5" speaker **\$8.95**
Same as above with 8" speaker **9.95**

IMPORTANT NOTICE: Minimum Order \$5. Quantity prices on request. All items in stock now—subject to prior sale—prices subject to change without notice. 20% Deposit with orders unless rated. All prices F.O.B. our N.Y.C. Warehouse.

Niagara Radio Supply Corp. Phone Dlgby 9. 1132-3-4
Dept. N-120 160 Greenwich Street, New York 6, N. Y.

What's New in Radio

(Continued from page 86)

equipment is the Model RC-12, three-speed portable phonograph with record changer.

The new unit plays all records, 33 1/2, 45, and 78 r.p.m. in diameters up to 12". The 5-watt, full a.c. amplifier incorporates an inverse tone feedback circuit and an effective tone control. The set uses a 6" x 9" Alnico V PM speaker and a featherweight crystal pickup combined with a unique amplifier design to produce a rich tonal quality. The carrying case is of plywood construction covered with a washable fabricoid material. The unit weighs



just 31 1/2 pounds and carries the Underwriters' seal.

Additional details on the Model RC-12 are available from the company at 6824 Lexington Ave., Hollywood 38, California.

INTERMODULATION METER

Measurements Corporation of Boonton, New Jersey has recently developed a compact, completely self-contained intermodulation meter which it is offering to the trade as the Model 31.

The new unit consists of two prin-

cipal sections, a test signal generator and an analyzer. A built-in supply provides power for both units. The generator section produces two sinusoidal voltages, one on a low frequency and the other a high frequency which



are mixed in a 4:1 voltage ratio and applied to the apparatus under test.

The signal from the equipment being tested is then received by the analyzer section of the Model 31 to be filtered, amplified, demodulated, and metered. The meter is direct-reading in percentage of intermodulation and input volts.

The instrument is useful for evaluating the performance of audio systems, for the correct adjustment and maintenance of AM and FM receivers and transmitters, for checking linearity of film and disc recordings and reproductions, for checking phono pickups and recording styli, for adjusting bias in tape recordings, for quality control of all audio components and equipment, and for many other applications.

The Model 31 is 8"x19"x9" and may be mounted in a standard 19" relay rack.

LINE VOLTAGE REGULATOR

Clarostat Mfg. Co., Inc. of Dover, New Hampshire is now offering an automatic line voltage regulator for steadier television pictures irrespective of line voltage fluctuations.

Major Edwin H. Armstrong, George E. Burghard, Paul F. Godley, and Ernest V. Amy, shown below, were the recipients of an Armstrong Medallion and special citation at Greenwich, Conn. on Saturday, October 21, when a memorial was officially dedicated to Amateur Radio Station 1BCG. This station, located a few hundred yards from the site of the monument shown, was the first to transmit shortwave signals to Europe. Three other operators of 1BCG also were awarded medallions and citations but were not present at the ceremonies. Minton Cronkhite, John F. Grinan, and Walker P. Inman.



TUBES

in STOCK
IMMEDIATE DELIVERY
AT AMAZINGLY LOW PRICES

ORDERS FOR TUBES IN THIS LISTING

will be honored at these prices if post-marked no later than January 1st, 1951. SEND IN YOUR ORDER TODAY!

RECEIVING TUBES

0A2	\$1.75	6F5	\$0.98	12SH7	\$0.95
0A4G/VR75	1.20	6F6	.80	12SL7	.48
0A4G	.30	6F7	.84	12SK7	1.25
0B2	1.74	6F8	1.25	12SL7	.58
0B3/VR90	1.30	6G6	.88	12SN7	.98
0C3/VR105	1.30	6G8	.88	12SQ7	1.10
0D3/VR150	.75	6J5	.65	12SR7	.65
0Y4	.88	6J7	.98	12Z3	.78
1A3	.60	6J8	1.28	12X3	.98
1A4P	1.08	6K5	.96	14A7	.68
1A5GT	.48	6K6	.98	14A7	.88
1A6	.78	6K7	.65	14B6	.68
1A7GT	.80	6K8	.78	14B8	.88
1B4	1.18	6L5	1.06	14C5	.88
1B5/25S	.94	6G7	2.10	14C7	.88
1B7	1.06	6L7	.78	14E6	.72
1C5	.66	6N6	1.56	14E7	.88
1C7	.88	6N7	.98	14F7	.68
1D5	.96	6P5	.98	14F8	.98
1D7	.88	6C5	1.06	14H7	.75
1D8	.88	6C7	.74	14J7	1.06
1E5	1.38	6R7	.78	14N7	.88
1E7	1.56	6S7	.88	14Q7	.56
1F4	.74	6S8	1.06	14R7	.66
1F5	.74	6SA7	.98	14S7	1.06
1F6	1.56	6SB7	.88	14W7	1.06
1F7	1.56	6SC7	.98	14X4	.98
1G4	.64	6SD7	.88	14X7	1.06
1G6	.68	6SF5	.89	19	.39
1H4	.68	6SF7	.58	22	.95
1H5	.90	6SG7	.98	24	.66
1I6	.86	6SH7	.65	25A6	1.06
1J6	.88	6S7	.80	25AC6	1.16
1L4	.65	6SK7	1.20	25B6	1.25
1LA4	1.25	6SL7	1.20	25V5	1.16
1LA6	1.25	6S07	.98	25Z5	.98
1LB4	1.25	6SR7	.98	25Z6	.98
1LC5	1.25	6SS7	.98	26	.40
1LC6	1.25	6ST7	.88	27	.46
1LD5	.90	6SV7	.80	28D7	.75
1LE3	1.25	6T7	1.20	35	.56
1LG5	.88	6U5/65	.98	31	.86
1LH4	.64	6U6	.72	32	.96
1LN5	.88	6U7	.54	32L7	.96
1NSGT	.95	6V6	1.59	33	.68
1P5GT	.66	6W7	.88	34	.68
1R4	.58	6X4	.75	35	.51
1R5	1.20	6X5	.75	35A5	.89
1S4	.95	6Y6	1.25	35B5	.98
1S5	.85	6Y7	.88	35C5	.98
1T4	.98	6Z7	1.14	35L6	1.25
1T5	.78	6Z5	.68	35Y4	.89
1V4	.98	7A4/XXL	.58	35Z3	.48
1V5	.89	7A5	.72	35Z4	.75
1V	.68	7A6	.66	35Z5	1.25
2A3	1.25	7A7	.56	36	.39
2A4	1.95	7A8	.98	37	.35
2A5	.68	7A07	1.06	38	.35
2A6	.78	7A7	.39	44	.75
2A7	.88	7AC7	.98	47	.75
2B7	.88	7AH7	.88	42	.75
2V3	.98	7B4	.56	43	.48
2X2	.68	7B5	.72	45	.75
2X2A	.95	7B6	.58	45Z3	.75
3A4	.55	7B7	.58	45Z5	.75
3A5	.98	7B8	.72	45Z6	.75
3A8	1.98	7C1/1203A	.36	47	.75
3B7	.34	7C5	.98	48	3.95
3D6	.34	7C6	.72	49	.88
3L4	1.28	7C7	.78	50	1.25
3Q4	.90	7E5	.66	50A5	1.25
3Q5	1.10	7E6	.58	50B5	1.50
3S4	.98	7E7	.68	50C5	1.50
3V4	.80	7F7	.98	50L6	1.50
5R4GY	1.50	7F8	1.06	50Y6	.90
5T4	.95	7G7	1.06	53	.86
5W4	.79	7H7	.75	56	.43
5X4	.58	7J7	1.06	57	.27
5Y4	.75	7K7	1.06	58	.48
5Z3	.98	7L7	.68	59	.88
5Z4	1.29	7N7	.98	70L7	1.98
6A3	1.28	7Q7	.58	71A	.66
6A6	.88	7R7	.68	75	.98
6A7	.68	7S7	1.06	76	.38
6A8	.98	7V7	1.25	77	.42
6A8S	.88	7W7	.88	78	.44
6A8T	.98	7X7/XFM	.88	79	.88
6ACS	1.16	7Y4	.56	81	1.28
6AD6	.88	7Z4	.56	82	.86
6AD7	1.28	10	.69	83	1.35
6AF6	.78	12A	.56	83V	1.60
6AJ5	.78	12A6	.39	84	.90
6AL7	1.06	12A7	.97	85	1.10
6A07	.88	12A8	.58	89	.72
6A5S	.80	12AH7	1.30	89Y	.38
6AS7	4.98	12AL5	.80	117L/M7	1.56
6B4G	.59	12C8	.48	117K7	1.74
6B5	1.56	12F5	.57	117P7	1.26
6B6	.78	12H6	.35	117Z3	.75
6B7	.88	12J5	.35	117Z4	1.16
6B8	.88	12J7	.80	117Z6	1.20
6C5	.55	12K7	.53	9001	1.50
6C6	.56	12K8	.58	9002	1.50
6C7	1.28	12Q7	.48	9003	1.50
6C8	.68	12SA7	1.25	9004	.35
6D6	.60	12SC7	.98	9005	1.90
6D8	.57	12SF5	.56	9006	.35
6E5	1.10	12SF7	.56	1273	1.25
6E6	1.06	12SG7	.56	1280	1.25

MINIMUM ORDER \$5. F. D. B. our N.Y.C. Warehouse.

Nagara Radio Supply Corp. Phone Dgby 9, 1132-3-4
Dpt. N-120 160 Greenwich Street, New York 6, N.Y.

Get set for

ACTION!



If you're a RECEIVER MANUFACTURER
your set is ready to deliver, with a Thomas tube.

If you're a TELEVISION SERVICEMAN
you're prepared to send those use-worn receivers back into the game fresh and rarin' to go, with a Thomas tube.

If you're a JOBBER OR DISTRIBUTOR
you're stocked to meet servicemen's increasingly heavy demands for the fastest-moving tube in the game, with Thomas tubes.

For, business-wise and performance-wise, "Action" in television picture tubes demands Thomas — the strongest tube in anybody's line-up!

THOMAS ELECTRONICS, Inc.

118 Ninth Street

Passaic, New Jersey



This new accessory is said to provide improved reception in rural districts or areas habitually experiencing line voltage fluctuations. With male and female Edison connections at either end, it plugs in between the TV set's attachment plug and the outlet.

Two models are available. The TV-A is rated at 300 watts and is designed for sets consuming from 200 to 300 watts. The TV-B is rated at 375 watts and is for sets using from 300 to 375 watts.

TRANSCRIPTION PLAYERS

Califone Corporation of 1041 N. Sycamore Ave., Hollywood, California, has recently announced the availability of its new transcription player models.



The 1951 line features the company's exclusive method of "Varipole" speed tuning which permits a gradual adjustment of turntable speed from 25% below normal to 10% above.

The entire line features lightweight portability, and three-speed playing of recordings or transcriptions up to 16" in diameter. For complete details on these units, write direct to the company.

TAPE RECORDING HEAD

A tape recording head engineered for mass production has been introduced by Shure Brothers, Inc. of 225 W. Huron Street, Chicago, Illinois.

Known as the Model TR5, the new head combines the functions of record, playback, and erase in a single unit. A special feature is the use of a deep-



drawn mu-metal shield for optimum hum reduction.

The TR5 has a unique design that insures production control of gap dimension and alignment. The tape head is also designed for ease in assembly to equipment.

The record and playback coil im-

RADIO & TELEVISION NEWS



**RADIO ENGINEERING
TELEVISION
ELECTRONICS**

Thorough training in all phases of radio and electronics, open to high school and junior college graduates. Old established school specializing in Radio training exclusively. Modern laboratories and courses. Enrollments limited. Approved veteran training.
VALPARAISO TECHNICAL INSTITUTE
Dept. ED Valparaiso, Ind.

PEN-OSC-LITE

Extremely convenient test oscillator for all radio servicing; alignment • Small as a pen • Self powered • Range from 700 cycles audio to over 600 megacycles u.h.f. • Output from zero to 125 v. • Low in cost • Used by Signal Corps • Write for information.

GENERAL TEST EQUIPMENT
38 Argyle Buffalo 22, N. Y.

**ANOTHER OUTSTANDING JOBBER
STANDARD Radio Parts Co.**

1244 STATE STREET
Racine, Wisconsin



\$39.95

HAS THE
SENSATIONAL NEW
425-K 5"
TEGO SCOPE KIT
IN STOCK!

ARROW has the VALUES!

MISCELLANEOUS SPECIALS!

	Used	New
ASB 7 Indicator Scope	12.95	
MN 26 C	17.50	24.95
RA 10 DA Receiver	17.50	24.95
RT7/APN1 Transceiver	6.95	9.95
APN 1 Complete		24.50
BC 347 Interphone Amplifier		2.95
I-70 Tuning Meter		.89
BC 461 Veeeder Root Counter		.59
BC 442 Less Condenser	1.49	1.95
APS 13 UHF Antenna, Pair		.98
FL 8 Filter		2.95
I-97 Bias Meter	3.95	4.95
RM 29 Remote Telephone Control	7.95	9.95
RL 42 Antenna Gearbox Motor and Reel	4.95	7.50
TS 10—Sound powered phones	6.50	
BC 1066 B—150 to 225 MC Portable Receiver adaptable to many amateur uses. In Canvas Carrying Bag. Used		\$5.95
Tuning Units for BC 375—Presently most numbers are available in excellent condition with case at		\$2.95 ea.
BC 306—Antenna Tuning Unit for BC 375. Excellent condition.		\$1.50 ea.

One Tube Interphone Amplifier—Small compact aluminum case fully enclosed. 2 1/4" x 3 3/4" x 5 3/4". Less Tube .79c

96Q1 Complete Autotune assembly with motor and frame as used in ARC-1 Transmitter. New \$35.00
 BC 709 Battery operated lightweight interphone amplifier. Complete with tube and shock mount, but less battery. New \$3.95
 SCR 183 Complete. New \$49.50
 220 MA Circuit Breaker. New \$5.95
 Collins VFO Dial—5 calibrated ham bands from 3.2 Mc to 32 Mc; complete with pointer, gears, logging dial and flywheel. Scale 6" on 8" plate. New each .95
 C-18—Antenna coil assembly slug tuned used in BC 603 receiver. Frequency range 20-27.9 Mc—fully shielded. New. 10 for \$1.95
 I 82 F—Five Inch 360 degree compass indicator and Selsyn receiver. New \$4.95
 A-81-2 Transmitter selsyn for I82 indicator. \$2.45 (Both I82F & Trans. Selsyn for \$7.00)
 MC 385A—Headset Adapter. New \$4.95

Information and Prices on Request
 BC 639 Receiver with RA 42 Rectifier
 RTA 1B Transceiver
 TA 2J24 Transmitter and MP 10G Power Pack
 SCR 269 Compass Installation
 R 5/ARN 7 Compass Installation
 MN 26 Compass Installation
 I. L. S. Installation (R 89-BC733)
 AN APRI Receiver and Tuning Units
 ASB7 Complete Radar Installation

RT7/APN1 TRANSCEIVER UNIT—

Used as an altimeter, it may be converted for signaling control circuits, etc. Complete with 14 tubes and dynamotor they are in good used condition at the amazingly low price of **\$6.95**



Portable VHF Communication Unit

Two-way radio telephone equipment designed for operation between 152 and 162 megacycles FM. Adaptable for many uses, a complete unit including the rechargeable storage battery weighs but fifteen pounds, and is housed in a sturdy case 11 1/2" x 9" x 4 1/4", provided with shoulder straps.

This brand new set of big name manufacture comes complete with battery, battery tray, **\$89.50** and headset but less crystal. Battery charger is extra at **\$19.95**

Mobile VHF Communication Unit

Adaptable for many mobile uses, this is a compact unit 3 1/2" x 8" x 1 5/8", operating on 152 to 162 megacycles FM. It is six-volt powered direct from storage battery, and is complete with the tone filter and crystal; headset, control box, antenna and installation kit. **\$129.50**
 Brand new, ready to go.
 Extra 18" stub type antennae are available. \$2.95

HEADSETS—MIKES

HS-30 Hi Imp. Headsets	New	\$1.50
	Used	.79
T-24 Hi Imp. Carbon Mike	New	1.19
T-30 Throat Mike	New	.98
T-45 (or Navy) Lip Mike	New	.98

RADIO EQUIPMENT RC 100 B

This equipment made by General Electric, was designed for ground use as an identification of friendly aircraft.

CABINET CH-118 is of the Standard 19 inch rack type structural steel frame with runner angles for each of the units. A full length access door with safety interlocks forms the rear of the cabinet. **\$34.95**

TRANSMITTER BC-769 is designed to transmit RF pulsed signals at 470 megacycles with the use of the two type 15E Tubes operating in push-pull with resonant grid, plate and filament lines. **\$19.95**

KEYING UNIT BC-770 furnishes the pulse of the transmitter. **\$14.95**

RECEIVER BC-768 was used to detect the 493.5 megacycle reply pulses from the interrogated station and to sufficiently amplify these signals for oscilloscope observation. **\$19.95**

RECTIFIER RA-52 produces the high voltage. An O-15 kilowatt DC Meter is connected across the output of the filter to measure the voltage fed to transmitter BC-769, while an O-20 milliammeter is connected to the ground return to measure the average current drawn. **\$74.50**

AIR COMPRESSOR M-349 together with 12 feet of 1/4 inch soft copper tubing and necessary hardware is used to fill and maintain transmission lines with dry air under pressure. Operation is direct from 110 VAC 60 cycles. **\$42.50**

OVEN M-348 is furnished for removal of moisture from the dehydrating cylinders of the compressor. It too operates from 110 VAC 60 cycles. **\$29.50**

FREQUENCY METER BC-771 is used for frequency checking and for tuning operations on Radio Transmitter BC-769 and Radio Receiver BC-768. It is a separate unit mechanically and has its own power supply, which requires a 110 to 120 Volt, 50 to 60 cycle source. **\$49.50**

TECHNICAL MANUAL TM11-1113B covering entire equipment. **\$ 5.00**

COMPLETE UNITS are available at amazing low price... WRITE TODAY!

TUBE SPECIALS!

211	\$0.39	803	\$2.89	832A	\$7.95
307A	5.50	805	3.29	837	1.19
703A	1.89	807	1.89	841	.49
723A, B	12.95	813	6.95	860	4.95
724B	1.89	832	2.95	864	.24

RC 150 EQUIPMENT

Receiver BC 1161 A. New **\$29.95**
 Transmitter BC 1160 A. New **29.95**
 Control unit BC 1162 A
 New but less tubes **14.95**
 Signal Generator I 198 A. New **24.95**

COMMAND (SCR 274 N) EQUIPMENT

	Used	New
BC-453	\$12.95	
BC-454	5.95	
BC-455	7.95	\$9.95
BC-456		2.95
BC-457	5.95	
BC-458	5.95	8.95
BC-696	14.95	24.95
BC-450—3 Receiver Remote Control	.89	1.95
BC-442		2.95
3 Receiver Rack	1.95	
2 Transmitter Rack	1.50	
Complete Command set as removed from aircraft—3 receivers—2 transmitters—Relay unit—control boxes—mounting racks—plugs—modulator and dynamotors—crated Set.		\$34.50

SURPRISE PACKAGE

20 lbs. Ass't radio parts. A \$25.00 value for only **\$1.95**

AS-138/ARN—10 inch streamline loop as used with direction finding receivers. Fixed position, it is ideal for planes, boats, auto mobiles. New **\$1.95**

1D6/APN4 Scope unit complete with 5CP1 cathode ray tube and shield and all parts except smaller tubes and crystal. Used **\$9.95 ea.**

MONTHLY SPECIAL FLAP PITCH MOTOR

24 VDC. will operate on AC—3300 or 11,000 R.P.M. Complete with gear box and limit switches. ea. **\$2.49**

ARROW SALES, Inc.

Dept. N

1712-14 S. Michigan Ave., Chicago 16, Ill.

PHONE: HARRISON 7-9374

CONDENSERS

	Each
1 mfd. 6000 VDC. OIL FILLED	\$1.98
.00025 mfd. 25000 VDC. OIL FILLED	2.95
1 mfd. 600 VDC. OIL FILLED	.24
	5 for 1.00
50 mmfd.—5KV—5 Amp. Vacuum Cond.	1.19

IS-185 Weston Voltmeter Model 433—0 to 150 VAC 25 to 2400 cycles. **\$24.95**

BC-604 Transmitter FM 20-28 MC

11 and 15 meters. Can be operated on 10 meters—10 channel push button crystal. With all tubes and meter but less dynamotor. Excellent Condition. **\$19.95**

Crystals—**19.95**
 Set of 80.

BC 603 **\$24.95**
 Receiver—Good. Used.

Complete **SCR-508** Installation available—price and information upon request.

BC 620

Receiver-Transmitter—2 crystal channels—20 to 27.8 MC FM—13 tubes. Metered. Plate and Filament. Used **\$9.95**

PE 97 or PE 117 or PE 120 Power Supply for above 6-12 volt vibrator type.

Used less tubes, vib. & con. **\$2.95**

Used, complete. **\$6.95**

FT 250 Mount for both BC 620 and PE 97 New **\$1.50**

BC 223

Brand new Transmitter with all three tuning units, two tuning unit cases, spare tube carrying case, shock mount and brace; but less tubes **\$29.95** at new low price of **\$3.95**

Set of 5 tubes **\$3.95**

Tuning units are available separately at. Ea. **\$2.50**

PE 125—12-volt Vibrator Pack. New **\$12.95**

Used **\$8.95**

BC 906—Frequency Meter

Range 150-225 MC with modification possible for lower frequencies of TV, etc. Contains 0-500 DC microammeter and uses Battery pack of 1.5 V and 45 VDC. Like New—Less Batteries. **\$10.95**

HERMETICALLY SEALED CHOKES

10 H.	100 M.A.	59c
59 H.	100 M.A.	95c
3.7 H.	145 M.A.	59c
10 H.	20 M.A.	39c

All shipments FOB warehouse. 20% Deposit required on all orders. Minimum order accepted—\$5.00. Illinois residents, please add regular sales tax to your remittance.



HENRY HAS THE NEW Hallicrafters MODEL SX-71 NOW!



This new type of receiver—the first of its kind on the market—has extra sensitivity, selectivity, and definitely superior image rejection. Continuous AM reception from 538 kc to 35 Mc, and 46 to 56 Mc. One RF, 2 conversion, and 3 IF stages. 105-125 volts AC. 11 tubes plus voltage regulator and rectifier. Only \$199.50. (R-46 matching speaker only \$19.95)



LOW-COST HALLICRAFTERS MODEL S-77

Temperature compensated oscillator; tuned r-f stage, two i-f stages for better selectivity. Covers 540 kc to 43 Mc in four bands. Sensitivity, volume, three-position Tone, BFO Pitch, controls; AVC, BFO, Rec./Standby, and Noise Limiter switches. Built-in PM speaker. Gray steel cabinet, 18 1/2" wide, 9" high, 9 1/2" deep. Piano hinge top. External power, remote control connections. 7 tubes plus rect. This is AC/DC version of popular S-40B. For 115 V. AC/DC. \$99.95

I have a complete stock of Hallicrafters receivers and transmitters. I'll make you the best deal on a trade-in for your communications receiver. I give you prompt delivery and 90-day FREE service. Nobody can beat Bob Henry on a trade-in, and I offer you the world's lowest credit terms. Write, wire, phone, or visit either store today for the best deal. Export orders solicited.

Bob Henry
W6ARA

HENRY RADIO STORES
11240 Olympic Blvd.
LOS ANGELES 75 CALIF.
Butler 2, Missouri
"WORLD'S LARGEST DISTRIBUTORS OF SHORT WAVE RECEIVERS"

RED ARROW CHRISTMAS BARGAINS

During Christmas and every month RED ARROW offers you top-notch values. If you don't see what you want listed, please write. We specialize in Ceramicons, Resistors and Condensers. (Manufacturers: ask for our quantity prices.)

SPECIAL!

- 300 ohm Twin Lead TV Line, 100 ft. \$2.69
- 3 Conductor Flat Wire—Used for Rotor Antenna 3c per ft.
- 4 Conductor Flat Wire—Used for Rotor Antenna 4c per ft.
- 5 Conductor Flat Wire—Used for Rotor Antenna 5c per ft.



WARD LEONARD RESISTORS

- 5 ohm—10 watt 14c
- 85 ohm—10 watt 14c
- 2500 ohm—25 watt 17c
- 2500 ohm—33 watt 20c
- 250 ohm—50 watt lamp base 24c
- 105 ohm—100 watt, 4 taps 48c
- 50 ohm Muter Resistor 8c ea. (\$6.00 per hundred)

TUBES	TUBES	TUBES
Immediate Shipment. Brand New		
6U7 37c	102B 29c	
872 \$1.29	10Y 29c	
97A 49c	7CP1 \$2.75	
801 29c		

PLUGS

- PL55 29c
- PL54 13c
- CD 302A—Extension Cord with PL55 and JK26 59c

3 GANG TRF VARIABLE CONDENSER
365 per section with push buttons. 89c ea. (10 for \$7.25)

FILTER UNIT

This unit is an excellent buy for the parts alone. Some parts are worth more than we're asking for the whole unit.

- 1—40 MF @ 450V
- 1—1800 MF @ 12V
- 1—.5 MF @ 400V
- 2—.5 MF @ 50V
- 1—.01 MF @ 400V
- 2—20 watt Resistors
- 3—Filter Chokes
- 2—RF Chokes
- 1DPST Toggle Switch
- Miscellaneous hardware, wire, etc.



BRAND NEW. ORIGINAL PACKING. 89c ea. (10 for \$7.50)

SPECIAL! 10 MF @ 250 V. PP Type Condenser 19c each. (\$15 per hundred)

MINIMUM ORDER—\$2.00. Send 25% deposit with order. Balance C.O.D. Shipped F.O.B., N.Y.C. N.Y.C. residents add 2% sales tax.)



CONDENSER SALE!

- BATH TUBS**
 - 20 VDC @ 350 14c each
 - 2 x .25 MFD @ 600 VDC (\$12.50 per hundred)
 - .5 x .5 MFD @ 100 VDC per hundred)
 - 3 x .1 MFD @ 400 VDC 59c ea.
- G.E. Oil Condenser—2-1-1-12 MU F 600 VDC

CERAMICONS

2.5 MMFD, 5 MMFD, 4 MMFD, 2 MMFD, 8 MMFD, 24 MMFD, 25 MMFD, 26 MMFD, 47 MMFD, 38 MMFD, 300 MMFD, 180 MMFD, 75 MMFD, 750 MMFD. All these Ceramicons are priced at only \$3.80 per hundred (\$35.00 per thousand) This listing is just a few of our many ceramicons. Please write for prices on those that you do not see here.

PAPER

- .05 @ 200 V 4c ea. (\$3.50 per hundred)
- .02 @ 300 V 10 for 97c (\$7.25 per hundred)
- .05 @ 100 V 10 for 35c (\$3.00 per hundred)
- .0002 @ 600 V 10 for 92c (\$7.00 per hundred)
- 1 MFD @ 200 V (CD) 25c ea. (\$22.00 per hundred)
- .25 @ 300 V, molded paper 4c ea. (\$3.50 per hundred)

RCA MICAS

- 470 MMFD, 1200 MMFD, 1500 MMFD 6c ea. (\$50.00 per thousand)

TRANSMITTING MICAS

- .001 @ 600 VDC 33c ea.
- .0005 @ 2500 VDC 35c ea.
- 50 MMFD @ 3000 VDC, 72 MMFD @ 5000 VDC, 100 MMFD @ 5000 VDC, 250 MMFD @ 5000 VDC, 1100 MMFD @ 5000 VDC, 250 MMFD @ 2000 VDC, 250 MMFD @ 2000 VDC 39c each

BARGAINS GALORE!

- Slide Switch, 2 position 18c
- Screw Driver Start Control, 100,000 ohm 15c
- Rotary Snap Switch, used for tone controls 9c
- Band Switch, multiple deck, 2 position, 3" shaft 29c
- Kit of 25 Knobs 59c
- Heavy Duty Line Cord, rubber plug, 3 ft. 7c
- Kit of 10 Trimmers, single, dual and triple sections 29c
- Soldering Paste, 8 oz. cans 9c
- Sleeving, various colors and sizes, 3 ft. lengths, 10 for 25c (100 for \$2.00)
- 6 ft. Line Cord, molded rubber plugs, U.L. approved, sold in quantities of 100 only \$13.75

PORTABLE TELEPHONE

EE-8
Completely reconditioned with handset, generator, bell, etc. Tested and Guaranteed. \$9.95 ea.

pedance is 1650 ohms at 1000 c.p.s. while the erase coil impedance is 1000 ohms at 40 kc. The output level of the unit is 5 db. above 1 millivolt at 1000 c.p.s. at a tape speed of 3.75" per second. The over-all dimensions are .685" maximum height, 1.240" wide, and 1.031" deep.

NEW COMBINATION

Voice and Vision, Inc., 314 N. Michigan Avenue, Chicago 1, Illinois is now offering a custom AM-FM-phono com-



bination as one of the instruments in its "Professional Series."

The duo-chassis design has separate high-fidelity amplifier, 17 tubes including two rectifiers, and a 3-gang tuning condenser. An automatic frequency control eliminates station drift. Input channels for television are provided. There are continuously variable separate bass and treble controls, easily adjustable to reproduce sound from 20-20,000 c.p.s. undistorted. Flywheel tuning assures simple station adjustment.

This new set will be available in a variety of custom cabinets.

For complete details on the new "Professional Series," write for the company's new brochure.

BOLOMETER BRIDGE

General Radio Company of 275 Massachusetts Avenue, Cambridge 39, Massachusetts has designed a new bolometer bridge which provides maximum flexibility of application.

The new Type 1651-A can be easily adapted to a variety of power measurement problems. It can be used, not

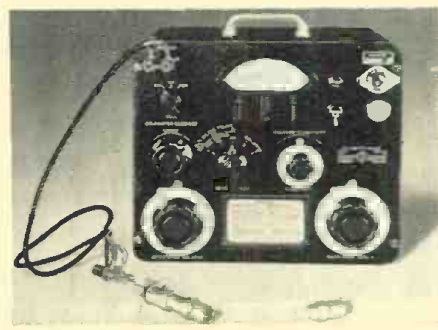

only with the General Radio bolometers, but also with those of other manufacture which have resistances between 25 ohms and 400 ohms. Measurements can be made either by a direct reading or a substitution method. The current range is 0 to

RED ARROW SALES

Dept. A 63 East Broadway, N.Y.
Phone COrtlandt 7-5425

1000 KC crystal BT cut.....\$3.95
 3" scope shield.....1.29
 2 speed dial drive for 1/4" shaft ratios 5:1 1 to 1 .39
 A7C 100 mfd air trimmer screwdriver shaft......29
 —10 +5 Weston modulation meter Weston 301. 8.95
 J37 key......69
 500 watt 12.5 ohm power rheostat..... 3.49



50 mfd 5 KV vacuum condenser.....\$1.49
 2v. 6v. 12v vibrators any type......98
 Rotary switch Myalex. 2 deck SP3T......39
 1 mfd 5000v oil condenser..... 2.98
 2 mfd 3000v oil condenser..... 3.25
 3 mfd 4000v oil condenser..... 3.95
 24 mfd 1500v DC 3KV flash. Excellent for speed lamp..... 3.95

TUBES!! BRAND NEW! STANDARD BRANDS! NO SECONDS! COMPARE! TUBES!!

0A3/VR75	51.29	3C31/C1B	53.49	217C	56.75	811	52.49	8014	524.50	0A2		6SN7GT		12S47	
0B3/VR90	1.29	3C45	12.75	227A/5C27	2.49	812B	6.90	8020	5.89	0A4G		6SN7GT		12S47	
0C3/VR105	1.05	3CP1	3.39	240C	2.95	813	8.95	8025	5.95	0B2		6SN7GT		12S47	
0D3/VR150	.89	3CP1-S1	2.25	250R	5.95	815	2.25	9001	.85	0Z4		6SN7GT		12S47	
1B22	2.95	3DP1	3.10	250TH	18.95	816	1.19	9002	.65	01A		6SN7GT		12S47	
1B23	8.75	3DP1-S2A	4.75	274A	5.50	817	1.99	9003	.85	1A3		6SN7GT		12S47	
1B24	2.95	3D21A	1.98	274B	1.95	826	1.95	9004	.45	1A4P		6SN7GT		12S47	
1B27	24.50	3E17	12.95	276A	6.95	829	12.75	9005	2.35	1A3GT		6SN7GT		12S47	
1B28	4.95	3F17	1.65	293A	2.98	830B	7.45	9006	2.95	1A6		6SN7GT		12S47	
1B32	1.79	3GP1	4.75	294A	3.95	830B	12.95	9007	2.95	1A6GT		6SN7GT		12S47	
1B36	24.95	3HP7	9.95	294B	3.95	830B	12.95	9008	2.95	1A6GT		6SN7GT		12S47	
1B38	12.95	3HP7	14.21	304H	3.65	830B	4.95	9009	2.95	1A6GT		6SN7GT		12S47	
1N21A Xtal	.79	4-125A	26.95	304TH	2.95	830B	7.95	9010	2.95	1A6GT		6SN7GT		12S47	
1N21A Xtal	1.85	4-250A	29.95	304TH	2.95	830B	7.95	9011	2.95	1A6GT		6SN7GT		12S47	
1N21B Xtal	1.75	5AT7	3.49	307A/RK75	6.95	830B	7.95	9012	2.95	1A6GT		6SN7GT		12S47	
1N22 Xtal	1.25	4B22/EL5B	9.95	310A	6.95	830B	7.95	9013	2.95	1A6GT		6SN7GT		12S47	
1N23A Xtal	1.75	4B24/EL3C	5.95	310A	6.95	830B	7.95	9014	2.95	1A6GT		6SN7GT		12S47	
1N23B Xtal	3.95	4H26/2000	4.95	316A	6.95	830B	7.95	9015	2.95	1A6GT		6SN7GT		12S47	
1N27	1.69	4B28	2.95	325A/B	24.50	830B	7.95	9016	2.95	1A6GT		6SN7GT		12S47	
1N34	1.95	4B32	9.95	327A/5C37	2.49	830B	7.95	9017	2.95	1A6GT		6SN7GT		12S47	
1N34A	.85	4C27/CV02		328A	12.95	830B	7.95	9018	2.95	1A6GT		6SN7GT		12S47	
1P23	3.49	4C35	49.50	350A	2.65	830B	7.95	9019	2.95	1A6GT		6SN7GT		12S47	
1P24	1.25	4D22	.95	350B	1.75	830B	7.95	9020	2.95	1A6GT		6SN7GT		12S47	
1P36	2.69	4D22	.95	371A	.59	830B	7.95	9021	2.95	1A6GT		6SN7GT		12S47	
1S21	3.79	4D32	12.95	371B	.65	830B	7.95	9022	2.95	1A6GT		6SN7GT		12S47	
2AP1	4.95	4E27/257B		388A	1.75	830B	7.95	9023	2.95	1A6GT		6SN7GT		12S47	
2C21/RK33	.35	5AP1	3.69	394A	3.95	830B	7.95	9024	2.95	1A6GT		6SN7GT		12S47	
2C22/7103	1.3	5AP4	3.69	417A	8.95	830B	7.95	9025	2.95	1A6GT		6SN7GT		12S47	
2C26	1.25	5AT7	3.49	434A	2.95	830B	7.95	9026	2.95	1A6GT		6SN7GT		12S47	
2C34/RK34	.39	5BP4	2.39	446A	1.25	830B	7.95	9027	2.95	1A6GT		6SN7GT		12S47	
2C39	24.50	5CP1	2.95	446B	1.79	830B	7.95	9028	2.95	1A6GT		6SN7GT		12S47	
2C40	1.25	5CT7	3.49	450H	3.50	830B	7.95	9029	2.95	1A6GT		6SN7GT		12S47	
2C43	14.95	5C22	49.55	450TL	44.50	830B	7.95	9030	2.95	1A6GT		6SN7GT		12S47	
2C44	1.49	5D21	24.50	527	9.75	830B	7.95	9031	2.95	1A6GT		6SN7GT		12S47	
2C46	1.25	5E17	1.19	530	2.95	830B	7.95	9032	2.95	1A6GT		6SN7GT		12S47	
2C51	5.75	5GP1	4.95	562	9.75	830B	7.95	9033	2.95	1A6GT		6SN7GT		12S47	
2D21	1.25	5JP1	24.45	575A	11.95	830B	7.95	9034	2.95	1A6GT		6SN7GT		12S47	
2E22	1.25	5K2	2.95	588A	1.75	830B	7.95	9035	2.95	1A6GT		6SN7GT		12S47	
2E24	4.69	5JP4	24.45	702A	2.69	830B	7.95	9036	2.95	1A6GT		6SN7GT		12S47	
2E26	3.69	5J23	12.95	703A	2.39	830B	7.95	9037	2.95	1A6GT		6SN7GT		12S47	
2E30	2.9	5J29	12.95	703B	1.05	830B	7.95	9038	2.95	1A6GT		6SN7GT		12S47	
2E32	1.25	5K2	2.95	705A	.89	830B	7.95	9039	2.95	1A6GT		6SN7GT		12S47	
2J22	9.95	5LP1	11.95	708BY	24.95	830B	7.95	9040	2.95	1A6GT		6SN7GT		12S47	
2J28	16.50	5NP1	27.50	708CY	16.95	830B	7.95	9041	2.95	1A6GT		6SN7GT		12S47	
2J27	1.95	5P4	2.49	708FY	42.50	830B	7.95	9042	2.95	1A6GT		6SN7GT		12S47	
2J30	39.50	6P4	5.79	708G	3.95	830B	7.95	9043	2.95	1A6GT		6SN7GT		12S47	
2J31	8.49	6J4	4.95	707B	14.95	830B	7.95	9044	2.95	1A6GT		6SN7GT		12S47	
2J32	1.25	6P7	4.95	709A	3.95	830B	7.95	9045	2.95	1A6GT		6SN7GT		12S47	
2J33	39.50	6GP7	8.95	709A	3.95	830B	7.95	9046	2.95	1A6GT		6SN7GT		12S47	
2J34	39.50	6JP1	5.95	710A/8011	.85	830B	7.95	9047	2.95	1A6GT		6SN7GT		12S47	
2J36	19.75	6P4	17.95	715B	1.69	830B	7.95	9048	2.95	1A6GT		6SN7GT		12S47	
2J37	12.75	6P7	3.49	714AY	3.52	830B	7.95	9049	2.95	1A6GT		6SN7GT		12S47	
2J38	9.95	6HP4	17.95	715A	6.49	830B	7.95	9050	2.95	1A6GT		6SN7GT		12S47	
2J39	19.75	6P4	17.95	715B	1.69	830B	7.95	9051	2.95	1A6GT		6SN7GT		12S47	
2J40	24.50	10	.25	715C	24.50	830B	7.95	9052	2.95	1A6GT		6SN7GT		12S47	
2J46	49.50	12DP7	12.25	717A	.69	830B	7.95	9053	2.95	1A6GT		6SN7GT		12S47	
2J48	1.25	12CP7	12.75	721A	2.95	830B	7.95	9054	2.95	1A6GT		6SN7GT		12S47	
2J49	39.50	3HP7	2.95	722A	2.95	830B	7.95	9055	2.95	1A6GT		6SN7GT		12S47	
2J50	22.50	121P4	22.50	723A	6.75	830B	7.95	9056	2.95	1A6GT		6SN7GT		12S47	
2J54B	22.95	15E	1.19	724A/B	12.95	830B	7.95	9057	2.95	1A6GT		6SN7GT		12S47	
2J55	39.50	5P4	4.95	724B	2.95	830B	7.95	9058	2.95	1A6GT		6SN7GT		12S47	
2J61	49.50	16AP4	42.50	725A	6.45	830B	7.95	9059	2.95	1A6GT		6SN7GT		12S47	
2J62	49.50	18CP4	42.50	726A	4.95	830B	7.95	9060	2.95	1A6GT		6SN7GT		12S47	
2K25	1.95	7P4	1.20	726B	1.69	830B	7.95	9061	2.95	1A6GT		6SN7GT		12S47	
2K28	24.95	29D4	.45	726C	49.50	830B	7.95	9062	2.95	1A6GT		6SN7GT		12S47	
2K29	24.50	28D7	.39	730A	8.95	830B	7.95	9063	2.95	1A6GT		6SN7GT		12S47	
3AP1	1.95	30 SPEC.	3.9	730B	8.95	830B	7.95	9064	2.95	1A6GT		6SN7GT		12S47	
3B22/EL1C	2.39	33T6	4.95	750TL	79.50	830B	7.95	9065	2.95	1A6GT		6SN7GT		12S47	
3B23/RK22	4.85	45 SPEC.	.25	801A	24.95	830B	7.95	9066	2.95	1A6GT		6SN7GT		12S47	
3B24	2.95	5P4	2.95	801A	24.95	830B	7.95	9067	2.95	1A6GT		6SN7GT		12S47	
3B24W	2.89	75T1	5.95	802	4.10	830B	7.95	9068	2.95	1A6GT		6SN7GT		12S47	
3B25	4.65	100R	.89	803	3.10	830B	7.95	9069	2.95	1A6GT		6SN7GT		12S47	
3B26	3.95	100TH	8.95	804	9.95	830B	7.95	9070	2.95	1A6GT		6SN7GT		12S47	
3B27	1.95	121A	8.95	805	3.49	830B	7.95	9071	2.95	1A6GT		6SN7GT		12S47	
3B28	7.95	203A	5.95	806	29.95	830B	7.95	9072	2.95	1A6GT		6SN7GT		12S47	
3BP1	2.59	204A	49.50	807	1.98	830B	7.95	9073	2.95	1A6GT		6SN7GT		12S47	
3C22	59.50	211	.39	808	1.95	830B	7.95	9074	2.95	1A6GT		6SN7GT		12S47	
3C23	6.89	212E	49.50	809	2.95	830B	7.95	9075	2.95	1A6GT		6SN7GT		12S47	
3C24/24G	.89	215A	.19	810	9.95	830B	7.95	9076	2.95	1A6GT		6SN7GT		12S47	

AGE, TUBES WILL BE SHIPPED AT PREVAILING PRICES.

811	52.49	8014	524.50	0A2		624		6SN7GT		12S47	
812B	6.90	8020	5.89	0A4G		6A3		6SN7GT		12S47	
813	8.95	9001	.85	0Z4		6A8		6SN7GT		12S47	
814	2.25	9002	.65	01A		6A7		6SN7GT		12S47	
815	2.25	9003	.85	1A3		6AB7		6SN7GT		12S47	
816	1.19	9004	.45	1A4P		6AC5GT		6SN7GT		12S47	
817	1.99	9005	2.35	1A3GT		6AC7		6SN7GT		12S47	
818	7.45	9006	2.95	1A6		6AD7G		6SN7GT		12S47	
819	12.95	9007	2.95	1A6GT		6AF6G		6SN7GT		12S47	
820	4.95	9008	2.95	1A6GT		6AG7		6SN7GT		12S47	
821	7.95	9009	2.95	1A6GT		6AG7		6SN7GT		12S47	
822	7.95	9010	2.95	1A6GT		6AK5		6SN7GT			



"A" BATTERY ELIMINATORS

Makes it easy to DEMONSTRATE AND TEST D.C. APPARATUS FROM A.C. LINES



for DEMONSTRATING AND TESTING AUTO RADIOS

New Models . . . Designed for testing D. C. Electrical Apparatus on Regular A. C. Lines. Equipped with Full-Wave Dry Disc Type Rectifier, Assuring Noise-less, Interference-Free Operation and Extreme Long Life and Reliability.

NEW MODELS NEW DESIGNS
NEW LITERATURE

"A" Battery Eliminator, DC-AC Inverters
Auto Radio Vibrators



See your jobber or write factory

AMERICAN TELEVISION & RADIO CO.
Quality Products Since 1931
SAINT PAUL 1, MINNESOTA-U. S. A.

100 ma. and the power range is 0 to 500 mw. The bridge operates from the 60 cycle power line.

Matching transformers and other accessory equipment can be assembled from the company's Type 874 coaxial elements so that the purchase of specialized tuning and matching assemblies is not required.

TV MAST BASE

A new type of television mast base has been recently introduced by the *Gamble Machine Works* of Carpentersville, Illinois.

The "E-Z set tele base" is fabricated of a new lightweight alloy, *Almag-35*. The base can be installed on any type of roof and its rigid construction is said to eliminate vibration and the danger of collapse and roof leakage. The unit can be installed directly over the peak, throwing the weight of the installation at the point of greatest strength.

One of the unique features of the new base is the hinged socket arrangement on the top which permits the in-

stallation of the completed antenna and mast unit in a horizontal position in the base, which has previously been affixed to the roof. With the antenna and mast seated in the base socket the hinged arrangement permits raising

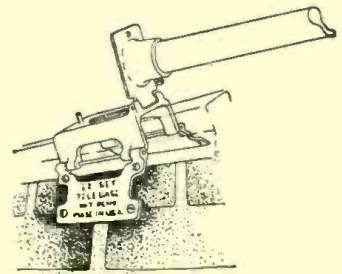

the entire unit and then locking it into position with a simple bolt. The antenna can be lowered for repairs at any time without disturbing the permanent installation of the unit proper.

Complete information on the new mast base is available from the company.

-50-

AM-NBFM Transmitter

(Continued from page 62)

wavemeter for the initial tuning of this transmitter. With the wavemeter set to the desired frequency and held near L_2 (Fig. 3) (bearing in mind that the second 6AG5 doubles) C_{20} (Fig. 3) is rotated until an indication is noted. The setting of C_{20} (Fig. 3) is noted and is returned to this reading whenever operation is desired in this band. Proceeding to L_1 (Fig. 4) the same method establishes the setting of C_1 (Fig. 4). With these settings logged it is a simple matter to change the two coils and go from band to band. S_1 (Fig. 3) is thrown *only* for operation on 80 and 40 and on these bands the first 6AG5 is then out of the circuit.

On phone the reports have shown that the NBFM circuit provides exceptional clarity on practically all popular types of amateur receivers where either slope detection or discriminators were being used. AM operation is excellent with good communications quality being obtained.

On c.w., this transmitter accounted for a large portion of the contacts made by W5MPZ/5 during the 1949 Field Day when it was operated continuously on 14 mc. c.w. Such operation speaks for itself.

Simplicity of band changing, combined with the ease of operation, the phone systems, and the c.w. monitor make this transmitter a versatile, efficient unit that has more than held its own against the "Sunday Kilowatt" and the multi-element boys.

-50-

Fig. 8. Under chassis view. Careful chassis layout will reduce construction difficulties.

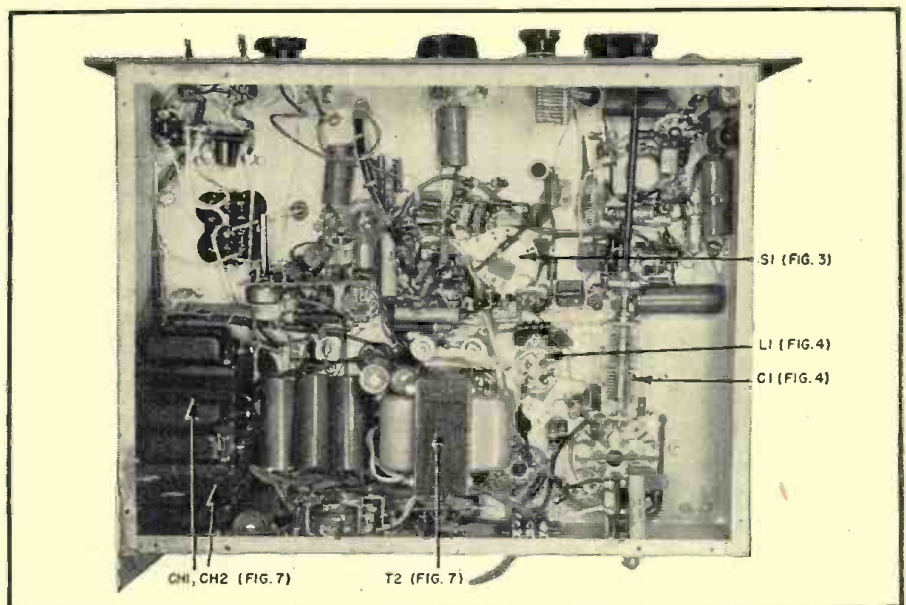

Spot Radio News
(Continued from page 18)

devoted so much of their efforts to the compatibility part of their systems that they never succeeded in producing satisfactory color."

As cited previously all of the Commissioners did not agree that the mechanical system should be the chosen one. And when the second report was released, continued evidence of revolt within the ranks appeared, with seething dissenting opinions from the pens of Commissioners George Sterling and Frieda Henneck. Declared Madame Commissioner: "In the light of the progress made in the development since the start of the proceeding, I think it essential to defer the final decision in this matter until June 30, 1951. . . . It is of vital importance to the future of television that we make every effort to gain the time necessary for further experimentation leading to the perfection of a compatible color television system. . . . It is important to repeat the conviction, expressed in my separate views in the first report, that there is a moral obligation on this Commission to insure that a reasonable amount of valuable programming service will continue to be rendered to present set owners, both day and night, for a transitional period; e.g., three to five years, without the necessity for making any expenditure to change their sets."

Sterling, also quite critical of his fellow Commissioners, pointed out that a cooling-off period of at least two days should have been provided after the bracket deadline, so the industry could have thrashed out its differences and perhaps come up with a series of helpful answers. The shortsighted action, closing the door on future developments, will in his opinion, seriously impede color progress. He felt, also, that the decision now to insist on chassis changes, when industry is becoming more and more involved in emergency activities and shortages are beginning to mount, was a faulty one which could raise havoc. He particularly struck out at the views that the public would accept smaller screens, when the trend was toward larger and larger picture tubes. Such thinking, he implied, was inconsistent with the bigger tube programs, regardless of the attractiveness of colored reproduction.

In Sterling's report there were references to the bags of mail from industry, the bulk of which carried angry denunciations of the wheel ruling. In a letter from one manufacturer, the FCC was told that the program, if carried out . . . "will cause irreparable injury to broadcasters, manufacturers, and present set owners." Another set maker said that the increased list price, required by the addition of the switch and other components, is . . . "a severe penalty for the public to pay . . . for a feature

Right: Mort Farr's modern, well equipped establishment in Upper Merion, Pennsylvania.

Below: Service dealers in the Philadelphia area get dependable personalized attention from Raytheon tube distributors. Pictured: Al Mumpells of Almo, checking an order with Mort Farr (right).



RAYTHEON MANUFACTURING COMPANY
Receiving Tube Division
Newton, Mass., Chicago, Ill., Atlanta, Ga., Los Angeles, Calif.
RADIO AND TELEVISION RECEIVING TUBES, CATHODE RAY TUBES, SPECIAL PURPOSE TUBES, SUBMINIATURE TUBES, MICROWAVE TUBES

"OUR SERVICE BUSINESS HAS INCREASED CONSIDERABLY, DUE TO THE INFLUENCE OF THE RAYTHEON BONDED DEALER PROGRAM" . . . says *Mort Farr*



Customer confidence is the key to volume service business. The RAYTHEON Bonded ELECTRONIC TECHNICIAN PROGRAM provides this vital asset for MORT FARR, just as it does for thousands of other dealers who have adopted this exclusive Raytheon business builder. Raytheon Radio and Television Tubes help, too, because Raytheons are Right . . . for Sound and Sight! Every time a worn out tube is replaced with a Raytheon, the service dealer gains another satisfied customer.

What the Raytheon Bonded Program does for Mort Farr it can do for you! Ask your RAYTHEON distributor how you can become a Bonded ELECTRONIC TECHNICIAN . . . how you can get your Television and Radio service backed by the bond that creates customer confidence in you and your work. If you qualify, it's yours at no cost to you—the Bonded Program is Raytheon's investment in your future.



NOW! At Hy-Grade! the SKY-HIGHEST VALUE in Television Today!

World Famous Quality
630
TV CHASSIS
only
\$159.00 less CRT

Yes, you can believe your eyes! Here's the exact duplicate of the incomparable RCA 63CTS Circuit—television's unmatched standard for super-sensitivity and stability—now with all the newest features of trigger fast Keyed AGC, Voltage Doubler, Standard Tuner, molded condensers, plus the finest quality components, Yoke, Focus Coil, Mounting Brackets, plus 30 tubes. Supplies 13 to 14KV under load for full brilliance and width for all rectangular and round 12 1/2, 16 and 19" tubes. At only \$159.00 this is the TV super-value you can't afford to miss! Order several NOW! Immediate Delivery! 25% deposit with order, balance C.O.D., f.o.b., Brooklyn, N.Y.

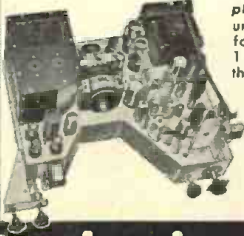

for SKY-HY VALUES at rock-bottom costs—it's HY-GRADE!

Hy-Grade Electronics, inc.
1509 EAST NEW YORK AVE., BROOKLYN 12, N. Y. National Distributors of Electronic Parts and Equipment

Beat the Tube Shortage!

This Sensational New RIDER Book Shows You HOW to Do It!

RECEIVING TUBE SUBSTITUTION GUIDE BOOK

by H. A. Middleton

For AM-FM-TV Receivers and Allied Equipment!

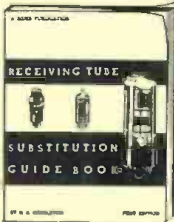

URGENT! Receiving tubes are very scarce . . . and will get scarcer. There is a wide scramble for every type of tube, and you can't always get what you need. What can you do when you can't find a tube replacement? How can you get a set working again? How can you substitute one tube for another?

HERE!

HERE Are The Answers To All Tube Problems!

- 2500 Radio And TV Tube Substitutions Are Listed!
- TV Receiver Filament Wiring!
- Heater Substitution Wiring Instructions!
- Tube Types Classified By Functions!
- And A Wealth Of Other Priceless Data!

Here the serviceman will find 2500 radio and TV tube types systematically listed in numerical sequence with accompanying wiring instructions for making the substitutions. There are views of original and substitute tube sockets, and clear explanations for whatever changes may be necessary. In this, one of the most important servicing books ever published, and certainly a most timely one right now, the serviceman will find the way to turn out jobs that would otherwise remain on the shelf because of lack of proper tubes.

EXTRA! EXTRA! In addition to tube information . . . this sensational book contains material on Cathode-Ray Tube Characteristics, Complete Tube Characteristics Chart, Ballast Tube Data, Pilot Light Information, Resistors—Capacitors—Transformer Color Codes, Transformer Substitution, Fixed Condenser Substitution, and Converting Farm Radio for Electrified Operation.

208 Pages in Heavy Durable Paper Cover. 8 1/2 x 11 inches. Only **\$2.40**

10 DAY MONEY BACK GUARANTEE
Make this book **PROVE** its value!
Unless you agree that it is the best investment you've ever made—return it, and we will refund your money.

Rush This Coupon Today

JOHN F. RIDER PUBLISHER, INC.
480 Canal Street, New York 13, N.Y.

Please send me _____ copies of "RECEIVING TUBE SUBSTITUTION GUIDE BOOK" at \$2.40 per copy. I am enclosing check money-order in the amount of \$_____. If, within 10 days, I am not satisfied—I will return the book(s) in good condition, for refund.

Name _____

Address _____

City _____ Zone _____ State _____

which may never be used." From another chassis producer came the comments that it could not conform with the conversion request since, first, no CBS color signals are available for engineering tests, and second, certain technical difficulties have been encountered in obtaining pictures of geometric linearity and brightness on higher frequencies, as well as reduced scanning efficiency due to the return time of the horizontal sweep. In the opinion of one of the leading set makers in the country, not over 5 percent of the ten-million sets which will be in service before the year is out, will ever be made compatible with the Columbia system. Still another large video receiver producer declared that they regarded the decision scientifically unsound and against the public interest. "No incompatible system is good enough for the American public," said this manufacturer, who added that the hundreds of millions of dollars that present set owners would have to spend and that future set owners would have to pay to obtain . . . "a degraded picture with an incompatible system reduces . . . the order to an absurdity."

One manufacturer, who said that he would make available adapters and converters for the disk system, declared that apparently their intentions were misinterpreted and hastened to release a statement which said, in part: "We are neither in agreement with nor do we condone the ill-considered decision of the FCC. . . . The decision, however, has been made. It probably will not, and we hope that it does not, remain. . . . It is our earnest hope that the present non-compatible system . . . will be replaced by a compatible system before it is necessary to market these devices."

Prior to the decisions there were rumblings that lawsuits would be filed, should the Commission adopt the wheel scanner. Two such suits appeared on the judicial calendar within a week after the second report appeared, one from a proponent and another from a set maker in New York City. Both complaints, filed in the U. S. District Court in Chicago, declared in part that industry, broadcaster, and set owner stands to be seriously affected by the field-sequential order. One complaint charged the order was contrary to public interest, was arbitrary and capricious, exceeded the authority of the Commission, and was not supported by the evidence. Continuing, this suit which attempted to restrain the Commission from enforcing its order, stated that . . . "Although the Commission has no jurisdiction over television manufacturers, the Commission sought to require that such manufacturers agree with the Commission to build all their black and white receivers according to the specifications laid down by the Commission. These specifications required extensive alterations in present production model receivers. The Commission stated to the television set manu-

FIRST TV OFFER EVER MADE ON THE 630 (10" to 20") BASIC TELEVISION PARTS KIT

(Totals over \$100 if purchased separately)

- PUNCHED & DRILLED CHASSIS PAN
- BRACKET & SHIELD KIT (18 items)
- VIDEO & I.F. KIT (19 items)
- POWER TRANSFORMER #201T6
- VERTICAL OUTPUT TRANSFORMER
- VERTICAL BLOCKING TRANSFORMER
- FLYBACK TRANS. #211T3 or #211T5
- FOCUS COIL, #202D1 or #202D2
- DEFLECTION YOKE, 60° or 70°

\$39.49

ALL FOR ONLY INCLUDING CIRCUIT DIAGRAM
TV PARTS FOR #630 IN COMPLETE SETS

VIDEO AND I.F. KIT (19 items)	\$7.84
ELECTROLYTIC CONDENSER KIT (6)	7.37
TUBULAR CONDENSER KIT (37)	4.28
CERAMIC CONDENSER KIT (28)	3.37
MICA CONDENSER KIT (11 condensers)	1.38
CARBON RESISTOR KIT (107 resistors)	6.98
WIREWOUND RESISTOR KIT (4 resistors)	2.31
OCTAL WAFER SOCKET KIT (13 sockets)	.72
MIN. WAFER SOCKET KIT (10 sockets)	.63
MIN. MOLDED SOCKET KIT (2 sockets)	.22
KNOB KIT, decal included (8 knobs)	.98
BRACKET AND SHIELD KIT (18 items)	8.63
TERMINAL STRIP KIT (19 strips)	.59
VARIABLE CONTROL KIT (9 controls)	5.83
PUNCHED CHASSIS PAN, cadmium plated	4.87
630-KIT, screws, nuts, rivets, washers	1.69
12 1/2" — CRT MOUNTING BRACKET SET	1.96
16" — CRT MOUNTING BRACKET SET	2.98
UNIVERSAL MOUNTING BRACKET SET	6.97
16" PLASTIC SLEEVE & RING SET	3.85
19" PLASTIC SLEEVE & RING SET	4.04

HOTTEST TV PACKAGE OF THE YEAR FOR "ONE BUCK"!

- 630TV Schematic Diagram with Modifications.
- Hints for Better Pictures on your 630TV.
- Illustrated Television Conversion Manual.
- Pulse Keyed Type AGC Circuit Diagram.
- RMA Handy Resistor and Mica Code Charts.

ALL FOR ONLY **\$1.00** POSTPAID

BROOKS RADIO & TELEVISION CORP.
84 Vesey St., Dept. B, New York 7, N. Y.

CAPACITANCE CHECKERS

••••• SOLAR CAPACITOR ANALYZERS •••••

Model CBB—Measures the capacity of any electrolytic, paper, mica or air capacitor between 10 mmf. and 800 mfd. Uses a Wien bridge circuit with a 6E5 tube to indicate balance. Measures the power factor of electrolytic cond. Checks resistance from 100 ohms to 7 meg. and insulation resistances at voltages up to 450 V. DC. Operates on 115 V. 50-60 cps.

Complete with tubes **\$42.49**

Shpg. Wgt. 9 lbs. . . . Your Cost, \$55-60

Model CBB-1—For operation on 110-220V AC, 50-60 cps. . . . Your Cost, \$35-40

SOLAR MODEL CF EXAM-ETER



An extremely versatile tester for measuring the capacity, power factor, leakage current and both AC and DC voltage. Wien bridge circuit is used to test capacity with a range of 10 mmf. to 2000 mfd. Measures power factor from 0-50%. Resistance measurements from 100 ohms to 7.5 meg. and insulation measurements from 3-10,000 megs. Leakage tests can be made at voltages up to 550. and read on a milliammeter. TVM checks voltages 0-600 DC, AC, and RF voltages. Complete with tubes and test leads. Operates on 115V 50-60 cps. **\$69.95**

Your Cost 20% deposit with order. Balance C.O.D.

JOBBERS—WRITE FOR DISCOUNTS
ARCEE ELECTRONICS CO.
ROOM 204 96 WARREN ST., N. Y. CITY, N. Y.

RADIO & TELEVISION NEWS

facturers that if they did not agree so to build their sets the Commission would forthwith and finally adopt the CBS color system."

Within twenty-four hours after the suits were filed, FCC issued a blunt statement which declared that they would vigorously oppose the issuance of any injunctive relief. Then, referring to a portion of the complaint which inferred that the Commission had been unduly influenced in its decision by an employee of the Commission who had patented a device usable in connection with the CBS system, the government specialists pointed out that their position in this matter was clearly detailed in the record.

During the hearings Harry Plotkin, FCC counsel, told those in the session room that Ed Chapin had constructed in the lab a receiver which featured automatic adaptation from one set of scanning records to another, and that such a set would be demonstrated in a room nearby. As soon as the circuit of the change and a description of it were received in evidence, and tagged with a legal exhibit identity, counsel for the dot-sequential proponent rose to say that he understood that . . . "this development of Mr. Chapin's constitutes what might be considered an improvement in the particular system being proposed by CBS in these proceedings." He then added that in this case the Commission might be considered as serving in a judicial capacity . . . "because it may have to choose between contesting proponents here, and when the Commission comes forward with a development which seems to be an improvement in the system proposed by one of the litigants, it sounds a little bit like a person in a judicial capacity assisting one of the parties in the contest. . . . I just want to make that statement and say that we take exception to putting this development into these proceedings, because we think it is inconsistent with the judicial position which the Commission should take in the proceedings."

Chairman Coy took one steely look at the attorney and said that Mr. Chapin is the head of the lab and not a member of the Commission, and in no way . . . "in position to determine the vote of a single member of the Commission; nor is any other member of the staff of the Commission." Declaring that the members are perfectly competent, the chairman added that they have . . . "the ability to determine between contesting forces." And then Coy remarked that he resented . . . "the suggestion very much that the Commission is influenced in its determination by the work of a single member of its staff or all of its staff when it comes to making a decision on the record." The chairman concluded this portion of his reply with the statement: "If there is anything else to be said on this, let's get it off our chest now." The attorney for the contestant arose again and repeated that he still thought the procedure

December, 1950

With RIDER MANUALS you can turn the tough TV repairs into "PUSHOVERS"

Don't waste time, patience and money trying to "dope out" the repair. Reach for your RIDER MANUAL! Just look up the make and model and follow the accurate, authentic servicing information!

NEW! Just Off the Press! And selling faster than any other manual we ever published! Make sure of your copy! Get it today!

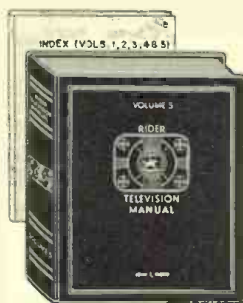

RIDER TV MANUAL Vol. 5

Authentic, Accurate, Reliable Servicing Information DIRECT From the Engineering Depts. of 74 TV Manufacturers!

RIDER TV MANUAL 5, the latest volume in the RIDER Library, covers all TV receivers manufactured up to July, 1950. All servicing information comes DIRECT FROM THE MANUFACTURER and is compiled by RIDER into easy-to-follow form. You can quickly trace the source of the trouble, and just as quickly do the required repairing. Tens of thousands of Service Technicians let RIDER TV MANUALS guide them on to the kind of servicing that means substantial time savings, satisfied customers, and more money in your pocket. ORDER YOUR TV MANUAL 5 from your JOBBER TODAY!

Larger page size, 12" x 15", with all pages filed in place. Giant pages are retained, but now have only one fold for easier handling and greater durability. Equivalent of 2320 pages (8½ x 11) Plus Cumulative Index Volumes 1, 2, 3, 4, 5.

Still being published at no increase in price \$21.00

NOTE: Are You Receiving your copy of "Successful Servicing?" It's a RIDER publication of intense interest to every Serviceman.

WRITE FOR IT!

NOTE: The C-D Capacitor Manual for Radio Servicing, 1948 Edition No. 4, makes reference to only one source of receiver schematics—Rider Manuals.

JOHN F. RIDER PUBLISHER, Inc., 480 Canal Street, New York 13, N. Y.

Export Agents: Rocke International Corp., 13 E. 40th St., N.Y.C. Cable, ARLAB

NOW ON PRESS!

. . . Place Your Reservation Now and Make Sure Of Getting This Valuable Copy from the First Printing. Demand is High! Quantity is Limited by Paper Shortages!



RIDER MANUAL Volume XXI

With a RIDER MANUAL Volume XXI in your Library you can sail through any servicing job on any AM-FM radio receiver built from December, 1949 through October, 1950 . . . and the same goes for auto receivers, record changers, tuners, disc and tape recorders. All information comes DIRECT FROM THE MANUFACTURERS (61 of them) and is compiled by RIDER into easy-to-follow form. There are 586 models, 351 chassis, with all pages and double spreads filed in proper place. All you have to do is to look up the make, model, chassis in the index . . . and let the factory-authorized servicing information help you do a better, faster, more profitable servicing job. 1648 Pages Plus Cumulative Index Volumes 16 through 21.

Only \$18.00

RIDER MANUALS

Television Manual Volume 5 (Plus Index)	\$21.00
Television Manual Volume 4 (Plus "How It Works" Book and Index)	21.00
Television Manual Volume 3 (Plus "How It Works" Book and Index)	21.00
Television Manual Volume 2—in new, larger page size, 12" x 15" (Plus "How It Works" Book and Index)	21.00
Television Manual Volume 1 (Plus "How It Works" Book and Index)	18.00
Volume XXI	18.00
Volume XX	18.00
Volume XIX	19.80
Volume XVIII	19.80
Volume XVII	16.50
Volume XVI	8.40
Volume XV	19.80
Volume XIV to VII (each vol.)	16.50
Volume VI	12.50
Abridged Manuals I to V (one volume)	19.80
Master Index, Covering Manuals, Vols. 1 to XV	1.50
PA Equipment Manual, Vol. 1	18.00

NOTE: The Mallory TV Service Encyclopedia, 1st Edition, makes reference to only one source of TV receiver schematics—Rider TV Manuals.

NOTE: The Mallory Radio Service Encyclopedia, 6th Edition, makes reference to only one source of radio receiver schematics—Rider Manuals.

RIDER MANUALS mean SUCCESSFUL SERVICING

a little bit out of order, a comment that riled Coy and prompted him to say that the Commission had asked for equipment from others so that they might have an opportunity to work on it. "I suspect," said Coy, "that some of our people have capabilities of effecting some improvement in that system and that we may, when and if we get hold of that equipment, file a patent on an improvement on that equipment for the benefit of the Government of the United States." Coy then pointed out to the attorney that . . . "you will recall privately that I have had something to say to you about equipment and have had some argument with you whether it is proper for us to have the equipment. We have not yet received the equipment. When we receive the equipment, we will have the same opportunity to work on the equipment as we do on CBS equipment." This brought forth a reply that . . . "We will welcome that, and as soon as we can get the equipment to you, we will."

In a parting blast, before the group left to look at the disputed receiver, Coy said: "Is there anybody else who has questions. I am perfectly willing to answer questions on this as chairman of the Commission, and I do not feel any one of us considers it improper for us to have taken such action, and want to add further, if you do not know it, that I have already signed the letters to patent the equipment that you are going to see."

In an attempt to clarify the operation of its system, CBS reviewed the basic features for the press. In their method, colors are changed after each vertical scanning period or field. There are 144 fields per second, and as in black and white, two-to-one interlacing is employed. The number of lines per frame is 405, or 205.5 per field (262.5 in black and white). Thus, the total number of lines per second, or horizontal line frequency, is 72 times 405 or 29,160, which is slightly less than twice the black and white horizontal line frequency, which is 30 times 525 or 15,750.

The colors are transmitted in the following sequence: red, blue and green. Each color lasts for 1/144th of a second, and the color sequence repeats itself after 1/48th of a second. This period is called a colorframe interval. Since only one-half the number lines will have been scanned in all colors in 1/48th of a second, twice this period, or 1/24th of a second is required for all lines to be scanned in all colors. This period of 1/24th of a second is called a color-picture interval.

The color disk rotates in front of the receiver tube at a rate of 1440 r.p.m. When six color filters are employed, two sets of red, blue and green filters are used. The over-all diameter of the color disk is determined by the size of the picture tube used. It will be slightly more than twice the diameter of the tube.

At the transmitter, a color filter disk, fully enclosed, rotates in front of the pickup tube and contains a series of color filters. If the camera disk has twelve filters or four red, four blue and four green, the disk rotates at 720 r.p.m. Every 1/144th of a second the camera scans electronically the image to be transmitted from top to bottom, while one of the colors in the filter disk, permits, let us say, only the red components of the scene to be picked up. The next 1/144th of a second, the blue filter is between the lens and the camera tube, and only blue components of the scene are scanned. The same sequence occurs to the green components. The vertical scanning rate of 1/144th of a second is synchronized with the disk rotation, and in addition, an extra pulse is inserted in the transmitted signal every third field, or every 1/48th of a second. This impulse permits the receiver disk to be phased automatically, if so desired.

As this column was being readied for the mailbag, about a half-dozen manufacturers had indicated that they would make adapters, converters, and switch models. A few others declared that they might follow along, but most indicated that they would not be able to produce CBS pickup chassis for quite awhile, with many saying that they just wouldn't make such sets at all. The year '51 should provide an intriguing answer to this tantalizing situation. . . . L.W.

MAIL ORDER ADDRESS
1060-2 N. ALLEN AVE.
PASADENA 7, CALIF.
SYCAMORE 4-7156
RYAN 1-8271

PHOTOCON SALES

DECEMBER SPECIALS

RETAIL SALES STORE
1240 EAST COLORADO ST.
PASADENA 1, CALIF.
SYCAMORE 6-7217

WE HAVE THOUSANDS OF TUBES AND OIL CAPACITORS

Send us your requirements

Write for Our Latest Sales Bulletins

We will buy new or clean used ARC-1, ARC-3, ART-13, BC-348 original condition or converted to 115V. A.C., BC-312, BC-342, Test Equipment, etc. All letters will be answered promptly. Please list equipment, condition, and lowest price.

TEST EQUIPMENT FOR SALE

RCA Voltohmyst. LIKE NEW	59.00
RCA Voltohmyst. Jr. EXCELLENT COND.	35.00
Megger 50 Megs. 500 V. EXCELLENT COND.	75.00
Audio Oscillator—20-20,000 C.P.S. Hickcock 198. EXCELLENT COND.	49.00
BC-1060 Oscillograph—Same as Dumont 224. LIKE NEW	175.00
Leeds Northrup Wheatstone Bridge. Type S. LIKE NEW	69.00
IE-19A Test Set for SCR-522 Complete with manual, original factory packing. GOOD USED \$225.00—BRAND NEW	325.00
BC-221 Frequency Meter with Calibration, Tubes, and Crystals. EXCELLENT COND.	79.50
I-100A Test set for ARN7 and 269 Compass. LIKE NEW	595.00
I-222 Signal Generator. EXCELLENT COND.	69.00
TS16/APN Test Set. GOOD COND.	29.50
TS23/UR Frequency Meter. NEW	450.00
TS-89/AP Voltage Divider. GOOD COND.	29.50
TS-100/AP Oscilloscope. EXCELLENT	75.00
RF Standard Signal Oscillator 9.5KC to 50MC. Similar to G.R. 605B—Less Power Supply. EXCELLENT COND.	200.00
Brown Instrument Co. Circular Chart Recorder O-500°F. I.C. NEW	150.00
Standard Signal Generator Measurement Corp. 78E. LIKE NEW \$79.00. 78B.	100.00

PLUGS

PLQ-171, PL-172, PLQ-60, PLQ-68, PL-147, PL-148, PL-151, PL-152, PL-153, PL-154, PL-156, PLQ-103. Plugs for ARC-1, ARC-3, ARC-5, BC-375, BC-522, BC-348, GP-6, GP-7. LM Frequency Meters, and many others.

RME45 Receiver with Speaker. EXCELLENT COND. \$125.00
Hallcrafters S-36 Receiver 27.8-143MC. AM-FM. EXCELLENT COND. 200.00
ARR-5 Receiver 27.8-143MC AM-FM. EXCELLENT COND. 95.00
Hallcrafters S-51 Marine Receiver. NEW. 125.00

BC-464 TARGET RECEIVER 5 channel Remote Sensitive Relays, Battery Case, Antenna, 68-73 mc. BRAND NEW \$14.95

Crystal and Coil Sets for Handy-Talkies 3885, 4280, 4840, 5327.5, 5437.5, 5500 K.C.—2 crystals and 2 coils per set. PER SET NEW \$1.95

APN-1 Altimeter Indicator, basic movement 0-1 ma., 5 ma. shunt, 270° dial. An excellent basic movement for constructing your own meters. BRAND NEW 1.95

BC-348, ATC, T47/ART13, T47A/ART13, MN26C, BC-342, BC-312, BC-224, MN-26C, RT13/ARC-1, RE/ARN7, SCR-522, RA-10, and Many others. Prices on Request.

APR5AX Receiver. LIKE NEW COND. \$350.00
BC-611 Handie Talkie. NEW or LIKE NEW 65.00

5 OHM. 25 Watt A25J Clorostat Resistors. NEW \$0.25 each \$18.00 per 100 \$150.00 per 1000

Mine Detector SCR-625 for locating metal, underground, pipes, etc. with manual. NEW \$69.50. GOOD USED \$39.50
BC-375 Transmitters complete with tuning units, plugs, dynamometer mountings, and microphones. NEW 89.50
ATD TRANSMITTER—540-9050 KC. 50W. CW and Phone. Complete with tubes, coils, dynamotor. NEW 100.00
BC-222 WALKIE-TALKIE—Frequency 28-52mc. with crystal—less tubes, battery, and antenna. NEW 14.50
BC-684 TRANSMITTER with tubes—Frequency 27-38.9 mc. Excellent mobile—25 watts. EXCELLENT COND. 12.95

SOUND POWERED CHEST SETS
Light Weight Type
Manufactured by U. S. Instrument Corp.
Excellent Used \$4.95 per set \$8.50 per pair
Fair used—
Tested 2.95 per set 5.00 per pair

WESTON TACHOMETER GENERATOR model 724 Type C. GOOD USED \$12.95
WESTON ELECTRICAL TACHOMETER Model 545 for use with 724 Generator. Speed 0-2000 R.P.M. Ratio 2:1. NEW 14.50
TRANSFORMER—6200V. @ 325 ma. easily C.T. for 3100-0-3100 @ 650 ma. Primary 105/110/115 V. 60 cycles. American Transformer Company. NEW 39.50

HS-23 Hi Imp. Headset with ear cushions. NEW \$2.45

Teletype paper 3 1/2" diam. White single Rolls \$.50
5 volt 190 amp. Amertran transformers. EXCELLENT COND. 18.50
PT-167 Federal transmitters, tubes. LIKE NEW 195.00
RU-19 Receivers—Complete. NEW 27.50
BC-640 Transmitter—EXC. COND. 750.00
PL-54 Plug \$0.15 each \$12.00 per 100
JK-26 Jack 0.15 each 12.00 per 100

TERMS: Prices f.o.b. Pasadena. 25% on all C.O.D. orders. Californians add 3% sales tax.

**Planning
Communications**
(Continued from page 37)

and radio relay, and then as emergency supplements to the wire and radio relay;

4. For emergency use within the Continental United States in case of disruption of wire or radio relay circuits.

The *Theater network* is the network which provides the circuits from the Theater Command down to the senior commanders of tactical ground, air, and naval units. This network functions under the control of the Theater Commander and serves as the vital link between the global network and the tactical networks.

The *combat or tactical networks* are the parts of the communications system by which the commanders of tactical units control and direct their commands. In the field army we envision two general types of combat networks, one down to approximately regimental level, which is more or less of an administrative type of network; and the other at approximately the regimental level and below, which is a fire and maneuver type network at all times directly under the control of the combat commander. *No combat commander is placed in the position where he is dependent on someone outside his command for his unit communications.*

Principles of integration, however, are applied to the combat network. The concept envisages, for example, that each switchboard serving a command (battalion or higher) may have a radio set connected to it. This radio station can be operated so that it will be possible:

1. To talk over a wire or radio channel, from any telephone connected to the switchboard, to another switchboard, and to any user connected thereto;

2. From any telephone user's position, to call a mobile or fixed radio station at any point within range of the calling radio-switchboard;

3. From a mobile or fixed radio installation, to cause a signal to appear at a called radio-switchboard, bringing the operator on the line and thus enabling the calling radio station to communicate with anyone connected to the communications system.

The general idea is to avoid using such huge amounts of field wire as were used in Europe during the last war; to augment and replace cable and wire to a much greater extent with radio.

That, briefly, is what the Signal Corps means by an integrated system of communications—in terms of planning. The concept must come first, of course, but to carry it out we must have the equipment which, because of its versatility, makes integration possible. Elsewhere in this issue (page 38) are outlined some of the *engineering* aspects of integrated communications.

BECOME AN ELECTRONIC TECHNICIAN IN 12 MONTHS

TRAIN NOW FOR IMPORTANT RESPONSIBILITIES

Do you have 12 months to invest in a training program that can bring immediate and life-long opportunities?

Then investigate the Technician courses available at this College of Electrical Engineering. For example, in those valuable 12 months you can earn your Electronic Technician's Certificate. You enter the fascinating field of Industrial Electronics. You are trained for responsibilities of tremendous growing importance to the strength and welfare of the nation.

This world-famous course also supplies the basic fundamentals so that you can progress into studies of radar, television and other branches of Communication Electronics.

• Faculty of 84 specialists •
1333 currently enrolled from
48 states and 23 foreign coun-
tries • Over 37,000 alumni.

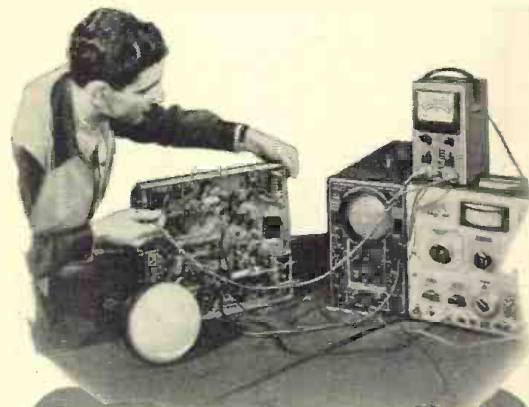

6 additional months make you a RADIO-TELEVISION TECHNICIAN

It is academically possible for the Electronic Technician to complete this course in 6 months of study. You are then ready for vital assignments in the fields of Communication Electronics.

TV and other branches of advanced Electronics requires men who are trained under the daily, personal guidance of specialists — through an intensive course such as offered here.

In 24 additional months become an ELECTRICAL ENGINEER

Under this internationally-known educational system, the Technician courses described here are complete in themselves but also serve as units of the College program leading to the B.S. degree with a Major in Electronics. Thus, if you must leave school after completing your Technician course, you are ready for immediate employment or specialized services. Or, you can continue here immediately or at any time and your Technician Course will be credited toward your B.S. degree.



Write today for new MSOE
RADIO AND TELEVISION
BULLETIN, indicating course
that interests you.

MILWAUKEE SCHOOL of ENGINEERING

Technical Institute • College of Electrical Engineering



A SPECIAL PREPARATORY program is offered.

MILITARY, ACADEMIC OR PRACTICAL training will be evaluated for advanced credit.

NEXT TERMS OPEN
JANUARY 8 . . . APRIL 2

MILWAUKEE SCHOOL OF ENGINEERING
Dept. RN- 1250, N. Broadway and E. State
Milwaukee, Wis.

Without obligation send your NEW RADIO AND TELEVISION BULLETIN.

Name.....

Address..... City..... State.....

Check if Veteran of World War II

EFFICIENCY IS THE KEYNOTE!

NEW DRIVE FOR PRODUCTION EFFICIENCY
MEANS NEW DEMAND FOR INTER-COM SYSTEMS!

Model
HU-15V
HU-24V



The model HU-15V is a medium sized speaker suitable for all paging and talk-back applications. All ATLAS paging speakers are designed to offer a maximum sensitivity in talk-back systems. The weather proof universal line matching transformers are easily attached to any model. Designed for constant impedance, constant voltage systems and 50 ohm lines. The model HU-24V is an oversized speaker having the obvious advantage of a longer air column length. Suitable for music as well as speech in industrial applications.

Our expanding anti-aggression effort calls for quick conversion of many plants to war production. New levels of efficiency must be attained.

For full efficiency, a modern inter-com and paging system is a must.

The demand for good sound equipment will be heavy. Will you be ready? NOW is the time for you to establish yourself as a dependable source of industrial electronic equipment.

ATLAS can help you build a profitable sound equipment business. We are ready to supply you with equipment to meet every conceivable inter-com and paging requirement.

Model TP-15V . . . TP-24V

The TP type speakers are available in two sizes. These dual two-way speakers produce two speaker results from a single location for long corridors, hallways, etc.

All ATLAS speakers are priced Right! COMPARE! But remember, we make no compromise with quality.

Don't miss your best new business opportunity in years. Write us TODAY for full details.



ATLAS Sound Corp.

1446 39th Street, Brooklyn 18, N. Y.

in Canada: Atlas Sound Corp., Ltd., Toronto, Ont.

International Short-Wave

(Continued from page 54)

national broadcasts is made through publications, advertisements in foreign newspapers, distribution of program schedules, and so on. "Our weekly programs are published in all Danish-American newspapers in the United States and Canada and in Danish papers elsewhere abroad."

During the fiscal year April 1, 1948-March 31, 1949, transmission hours totaled 5295 with an average of 14 1/2 hours per day. Percentages of the various broadcasts were—music, 44.6; talks and discussions, 8.2; instruction, 11.5; news service, 16.1; church services and morning prayers, 4.6; recitation, 4.2; drama, 2.3; running commentaries, relays of meetings, and so on, 4.3, and features (montages, and so on), 4.2.

Our best wishes go to the Danish State Radio for a long and successful career!

Club Notes

USA—QRA for the United 49'ers Radio Society is 28 Eisenhower Drive, New Britain, Connecticut; issues a nice monthly bulletin.

This Month's Schedules

(NOTE: In the interim from the time this was compiled until you read it, some stations will have reverted to winter schedules; in such cases, some schedules will be one hour later than listed herein.—KRB)

Albania—Scutari, 8.200, heard afternoons (EST) in Britain; bad CWQRN; signs off 1530 with Albanian National Anthem. (Pearc.)

Angola—CR6RN, 9.469, Louanda, noted 0135 in Portuguese; weak. (Cox, Dela.)

Argentina—LRT, 11.84, Tucuman, noted signing off 2300, good level. (Russell, Calif.)

Australia—At the time this was compiled, Radio Australia was using VLC4, 15.32, to North America 0700-1115, and was testing at 0715-0845 on parallel VLA8, 11.81; it is likely that by now will be using 11.81 regularly at least during the East Coast beam 0700-0900.

Belgian Congo—OTM2, 9.400, Leopoldville, noted with good signal afternoons to closedown 1606 with Belgian National Anthem. (Ferguson, N. C.) OTM1, 6.295, Leopoldville, heard opening 0000 with drums followed by news in French; weak level; parallel OTM2, 9.400; latter heard also around 1450-1500 or later. (Cox, Dela.) OTC3, 11.645, now runs 1600-2030 (parallel OTC2, 9.767). (Barry, Ill.)

Brazil—ZYK3, 9.565, Recife, has English program ("Brazil Calling") now around 2000-2038; asks for reports. (Ferguson, N. C.) The Brazilian outlet on 9.505 now is believed to be Radio Record, Sao Paulo. (Stark, Texas, others)

British Honduras—ZIK2, 10.598, Be-

NOW!

SPEED UP ALL SOLDERING WITH

UNGAR

FEATHER-LIGHT SOLDERING PENCILS WITH

HI-HEAT TIPS

INCREASED WATTAGE



For use with No. 776 Handle & Cord Set

Stop wrestling with big irons. New HI-HEAT TIPS in your Ungar Electric Soldering Pencil produce a really versatile tool that'll perform on a par with the big, bulky 100-150 watt irons. If you can't get immediate delivery, please be patient, for production hasn't yet caught up with demand. Ask your supplier for No. 1236 Pyramid or No. 1239 Chisel. List price, \$1.25 each.

Ungar

ELECTRIC TOOL CO., Inc.
LOS ANGELES 54, CALIFORNIA

!!XMAS ITEMS!!—POWER RHEOSTATS . . .

50 Watt—15 ohm . . .	\$1.29
50 Watt—50 ohm . . .	1.49
25W—350 Ohm—steel case, pointer knob98
13 V. MIN. BULBS—Bay, base . . .	ea. 12c; 10/1.00
1" AMBER JEWEL ASSEMBLY, D.C. bay 39c; 3/1.00	
NE-48 NEON LAMPS . . . 115V. 1/4 watt. 23c; 10/1.95	
NE-20 NEON LAMPS . . . 115V. 1/25 watt. 9c; 15/1.00	
HS-1 HEADPHONES, thumb screw, adj. forks39
DYNAMIC HEADSET & HAND MIKE (B19-MkII). 2.49	
PORTABLE UTILITY CASE . . . 10" x 9 1/2" x 3 3/4"	
Steel, with 68" adjust. web strap. 75c; 3/2.00	
VOLTAGE DIVIDER KIT, 10-50W. 10 assid. . .	1.75
MOULDED BAKELITE CONDENSERS (Micamold). RG-0001 2 mfd., 2000V. 50 assid. . .	1.98
RADIO CEMENT & SOLVENT, 3 oz. ea. . .	.69
brush	

4" SPEAKER PARTS SPECIALS!!

CONES . . . 9/16" V.C.	1.49
3" deep . . . \$46/M; 100/57.25	
5 1/2" CONES . . . 9/16" V.C.	
13/16" deep . . . \$50/M; 100/7.95	
6" CONES . . . 3/4" V.C.	1.00
deep . . . \$65/M; 100/9.95	
KITS OF 12 ASSID. LESS	
voice coil—O.D. . . 98c; kit: 5"	
O.D.—S1.25; 8" O.D. . . 1.49	
4" TO 12" ASSORTMENT . . .	1.75
(incl. free-order)	12/1.98
SPEAKER REPAIR KIT . . . Liberal assortment of: Spiders, Rings, Shims, Cement, Felt, Chamolite, Leather, V. C. forms & Instructions . . .	\$2.49
!!SPECIAL!!—BOTH \$1.98 CONE & REPAIR KITS	3.95

50W XMTR SOCKET . . . for 211's, etc. . . 49c; 6/2.49

1 1/2 V. FIL. TRANS. . . 115V, pri. 2" x 2 1/4" . . . 79

250 OHM LINE TRANS. to 8 ohms (4 taps) . . . 69

RG-13/D CO-AX . . . 20 ft., 2 conn., 74 ohm . . . 98

HANDY CARBON MIKE (RS-83) . . . Press-to-talk . . . 69

T-44A MAGNETIC MIKE . . . brand new . . . 69

HIGH FIDELITY CRYSTAL MIKE . . . Hi-imped.; rubber shock-mtd. 1 3/4" x 1/4". Less housing . . . 98

ALUMINUM HOUSING for crystal mike . . . 15

GRILLE CLOTH . . . Ivory, Tan or Wine—10" sq. . . 19

2 1/2 HP REVERSIBLE MOTOR . . . 3000 RPM; 3/8" shaft, 4 1/2" x 7" . . . 27V. DC. . . 3.95

4 RPM MOTOR . . . 115VAC. 2 1/2" x 2 1/2" x 1 1/2" shaft . . . 2.75

RM-4 RECORING MOTOR (GI) . . . 115VAC. 3 3/4" sq. x 2 3/4". Less TT, mtg. plate & drive wheel . . . 4.95

CABINET DRAW SLIDES . . . ball bearing . . . 13" 19" ext.—\$2.10 pr.; 15" (11")—\$2.25; 6 1/2" (12 1/2") . . . 2.39

Heavy duty, all-steel 1 1/2" x 1 1/2" . . . 3.25

EXPERIMENTAL TUBES for Testing, Research, Filament tested, 20 assid., recoding types . . . 1.00

2 1/2" SQ. PANEL METERS . . . 0-9V. DC. . . 1.29

0-100 AMPS. DC & shunt 98

3" BLOWER ASSEMBLY . . . blade impeller; bakelite housing. Less motor . . . 1.95

20" REMOTE CONTROL CABLE . . . 1/2" tips . . . 69

6 TUBE CHASSIS (10" x 4" x 3 1/2") . . . 3 locs. . . 49

BIRTCHER TUBE CLAMPS . . . #268. ea. 10c; 12/1.00

AN CONNECTORS . . . 3100-14S-2P—15c; 8/1.00; 2102-22-13S—2.45; 2.45; 8/1.00; 83-1AP (M-359) CO-AX ANGLE PLUG . . .

5 AG FUSES . . . 1, 3 or 6 Amps. . . 250V. 8c ea.; 18/1.00

FACTORY SPEAKER REPAIRS

Min. Orders \$3.00. 20% deposit on all COD's

Full Remittance with foreign orders

Please add sufficient postage—excess refunded

LEOTONE RADIO CO.

65 Dey Street
New York 7, N.Y.

BATHTUB CAPACITORS

Table with columns: MFD, VOLT, TYPE, PRICE EACH, 10 FOR. Lists various capacitor models and prices.

GIBSON GIRL The Emergency Radio Transmitter. Includes an image of the device and descriptive text.

RL 9 or RL 7 Interphone Amplifier. Includes an image and text describing its features.

400 M.A. Choke 12 HY. Includes an image and technical specifications.

0-30V DC Meter. Includes an image and text about its accuracy and uses.

Multimeter Mount. Includes an image and details about mounting options.

Special Oil Condensers. Lists various capacitor models and prices.

METERS. Includes an image of a meter and text about its specifications.

BC 696 Transmitters. Includes an image and text about its output and drivers.

Helmenan Ckt Bkrs. Includes an image and text about AC-DC operation.

Voltage Stabilizer. Includes an image and text about its output and uses.

MICROWAVE. Includes an image and text about surge protectors and accessories.

WOW! What Savings! Includes an image of a person and promotional text.

Birtcher Tube Clamps. Includes an image and text about various clamp models.

T.V. Transformer. Includes an image and text about its specifications.

BC 605 INTERPHONE AMPLIFIER. Includes an image and text about its features.

Aircraft Covers. Includes an image and text about various cover models.

XMTM COILS AIR WOUND. Includes an image and text about coil specifications.

HEADSETS & MIKES. Lists various headset and microphone models.

Regular Budd Boxed. Lists various transformer models and prices.

Tuning Units for BC375 & 191. Lists various tuning unit models.

1619-1619 Octal Base Pentode. Includes an image and text about its features.

Voltage Regulator. Includes an image and text about its specifications.

WAVE PROTECTORS. Includes an image and text about surge protectors.

COMMUNICATIONS EQUIPMENT COMPANY. Includes a logo and tagline.

TOP TRANSFORMER BUYS. Includes an image of transformers and text about their quality.

Table of transformer specifications including item, H.V., Amp., Filaments, and Price.

Table of transformer specifications including item, Rating, and Price.

Table of transformer specifications including item, Rating, and Price.

Table of transformer specifications including item, Pri., Output, and Price.

Table of transformer specifications including item, Pri., Output, and Price.

Table of transformer specifications including item, Pri., Output, and Price.

ARC 5 MODULATOR. Includes an image and text about its features.

DYNAMOTORS AT SURPLUS PRICES. Includes an image and text about various dynamotor models.

Table of dynamotor specifications including Type, Price, and other details.

MICA CAPACITORS. Includes an image and text about various capacitor models.

CHOKO SWINGING. Includes an image and text about various choke models.

AMPLIFIER. Includes an image and text about various amplifier models.

PE157 Vibropack. Includes an image and text about its features.

LP21 LM Radio Compass. Includes an image and text about its specifications.

LM Freq. Meter. Includes an image and text about its features.

GP7 Aircraft XMTM. Includes an image and text about its specifications.

All merch. guar. Mail orders promptly filled. All prices F.O.B. N. Y. C. send MO or Chk. Only shipping chgs. sent C.O.D. Rated

COMMUNICATIONS EQUIPMENT CO.

131 Liberty St., New York, N. Y. Dept. N-12 Chas. Rosen Phone: Digby 9-4124

December, 1950

UNIVERSAL MICROPHONES

"Better Than Ever"

• ANOTHER UNIVERSAL STAR!



MODEL 312-Crystal 308-Dynamic
 High Output—30 db response; 40 to 9000cps—Finish: Satin Chrom.
 Quality Features: Newly designed moisture proof cartridge with "permo-seal" construction insures uniform performance against varying humidity. The slight rising characteristic of Model 312 gives smooth response for clear-crisp speech and clear-tone music.
 Recommended for home recording on disc or tape, public address, orchestras, musical groups, and amateur.
 Moderately Priced! Guaranteed by Universal!

WRITE FOR LATEST CATALOG.

UNIVERSAL Microphone COMPANY

705 IVY STREET • GLENDALE 4, CALIFORNIA

DO YOU HAVE B-A's
 148 PAGE 1951
FREE CATALOG



INCLUDES
 33 PAGES OF
 DOLLAR-SAVING
 BARGAINS!

Complete Guide to the Latest Products of Top Makers in Radio, TV, Sound and Recording Fields

FREE

BURSTEIN-APPLEBEE CO.
 1012-14 McGee St.
 Kansas City 6, Mo.

Send me your 1951 Catalog.

Name.....
 Address.....
 City..... State.....

BURSTEIN-APPLEBEE CO.

OUTSTANDING - TV - VALUES

MODEL #300
 Folded dipole complete with reflector and high frequency adapter. Covers 13 channels. All alum. construction. Less mast. Shpg. wt. 7 lbs. PRICE..... \$4.95

MODEL #200-D
 Stacked array. Consists of 2 complete conicals and connecting bars. Very rigid construction. Covers all 13 channels. Matches 300 Ohm or 72 Ohm. Center impedance 150 Ohm. Ideal for low signal areas. An outstanding buy. Shpg. wt. 12 lbs. SENSATIONAL OFFER at less mast. \$9.75

MODEL #200-S
 Single array. Same construction as above. Shpg. wt. 8 lbs. Price, less mast. \$4.50

MODEL #500
 All-band folded dipole antenna. Ideal for rotator use. Maximum gain on any channel. All alum. construction. Less mast. Shpg. wt. 8 lbs. \$4.95

MODEL #Y-100
 5 element Yagi Hi-Gain beam designed specifically for fringe area use. All alum. construction. Cut to specific channels. Shpg. wt. 4 lbs. Channel #7, \$4.50; Channel #9, \$4.25; Channel #11, \$4.00; and Channel #13, \$3.75. The prices are less mast. "V" type antenna. Price \$4.25

ANTENNA ACCESSORIES

CM-100 Chimney Mount.....	\$ 1.50
5-ft. 1 1/2" OD Steel Mast. Plated.....	.75
6-ft. 1 1/2" OD Alum. Mast.....	1.50
6-ft. 1 1/2" OD Alum. Mast.....	1.25
3/2" 300-ohm stand-off insulators (for coax cable). Per 100, \$3.00; per 500, \$12.00;	
"U" Bolt Assemblies—ideal for most couplings.....	per 1000 20.00
Best Quality 300-ohm twin lead.....	12 for \$1.50; 50 for 5.00
High Quality 72-ohm Coax Cable.....	Send for prices.
Folded Dipole Hi-Frequency Adapters.....	1.35
Conical Hi-Frequency Adapters.....	1.50
Straight Dipole Hi-Frequency Adapters.....	1.25

TERMS: All shipments F.O.B. Newark, New Jersey. 25% deposit with orders, balance C.O.D. Minimum order \$2.00. Include ample postage.
 Prices Subject to Change Without Notice
EAST COAST ELECTRONICS
 40 St. Francis Street Newark 5, New Jersey

lize, noted Sundays around 1410-1501. (Ferguson, N. C.) Weekdays may be on the air as early as 1300.

British New Guinea—Reports for VLT5, VLT7 now should be sent direct to Australian Broadcasting Commission, Port Moresby, British New Guinea. (Starry, Pa., via NNRC)

Canada—CBNX, 5.970, St. John's, Newfoundland, heard 1545. CBRX, 6.160, Vancouver, British Columbia, noted with popular music 0050; QRM'd by Munich, weak. CKFX, 6.080, Vancouver, noted signing off 0205 after news. CJCX, 6.010, Sydney, Nova Scotia, heard with news 1300, weak but clear signal. (Cox, Dela.)

Canary Islands—Tenerife, approximately 7.515, noted 1615 to after 1700. (Pearce, England)

Cape Verde Island—Praia's CR4AA is now on approximately 5.895. (Pearce, England) Can be heard some days in eastern U. S. to closing 1700 when signs with "A Portuguesa."

Ceylon—Radio Ceylon seems to have added a "commercial service"; noted in South Africa with powerful signal on 21.62 around 0000-0200 with variety of musical programs, also "Voice of Prophecy"; plays requests at times. (Hannaford)

Chile—CE920, 9.200, Punta Arenas, heard well after 1800. (Sutton, Ohio) CE1180, 12.005, Santiago, noted from tuning 2015. (Ferguson, N. C.) CE625, 6.250, Santiago, excellent 2245; signs off 2310. (Russell, Calif.)

China—When this was compiled, Radio Peking was being heard mornings on (measured) 11.865 (claims 11.69) in parallel with 15.054V (claims 15.060); news was still at 0830 but by now may be changed to 0930. (Ferguson, N. C., others) I was still hearing the 10.260 outlet mornings but at 0830 carries separate (Chinese) program.

A station on approximately 6.040 is heard at times at 1000 in parallel with Radio Peking; fine signal; also noted from 0400. (Balbi, Calif.)

Colombia—"Emisoras Unidas," Barranquilla, is broadcasting on 4.785 in Spanish 0600-2300. (Copenhagen DX broadcast)

Costa Rica—San Jose is noted on (announced) 11.970 mornings to after 0900 and evenings until after 2130; at times has English program at 2100-2130, including about five minutes of news at end of the period. (Stark, Texas)

Cuba—COBZ, 9.525.6, heard 1810 with English grammar lesson in progress. (Oskey, N. J.) COCQ, 8.825, Havana, excellent evenings; signs off 0030. (Russell, Calif.) COCH, 9.437, 5 kw., is scheduled in Spanish 0700-2400 daily. (Kroll, N. Y.)

Curacao—PJC2, 5.010, Willemstad, has English on Mondays only 2000-2015. (Ferguson, N. C.)

Cyprus—Limassol noted recently 2325 on 6.17, 6.13, 9.65, with Arabic chanting. (Bellington, N. Y.)

Czechoslovakia—Prague, 11.84, noted signing on 1315 with horn notes. (Leary, Ind.) Noted recently on 9.55 with news 1530. (Mulvey, Conn.) An-



Long a valued contributor to the ISW Department, Roland S. Peddle is shown at his Listening Post in St. John's, Newfoundland. He has recently become a radio ham.

nounces *English* for 1715 on 9.550, 11.840. (Pearce, England)

Dominican Republic—When this was compiled, HI2L, "La Voz del Tropicos," Ciudad Trujillo, was using 3.240 (moved from 3.290); heard evenings; power is 500 watts. (Cox, Dela.)

Eire (Ireland)—Dublin, 17.84, is heard occasionally with news and market reports 1230-1245V. (Cox, Dela.)

El Salvador—YSO, 7.315.6, heard again after absence; noted 1905 with announcements in Spanish by man. (Oskay, N. J.) Heard in Delaware at 2140. (Cox)

French Equatorial Africa—Frequency of *Radio Brazzaville* has been shifted from 9.952 to 9.9685. (Oskay, N. J.) Noted on 6.025 with world news 0015. (Cox, Dela.)

French Morocco—*Radio Maroc*, Rabat, is radiating on 6.005 with 2.5 kw.; programs in French are broadcast 0145-0300, 0800-0930, 1515-1800; in Spanish, 0700-0730, 1300-1430. (Radio Sweden)

Germany—Reception reports on *Radio Free Europe*, 6.130, can be addressed to 350 Fifth Avenue, Room 311, New York, N. Y., USA. Is heard on 6.130 from 1200. (Pearce, England)

Nordwest Deutscher Rundfunk has replaced the s.w. transmitter at Elms-horn by a new 20 kw. transmitter at Norden-Osterloog/Ostfriesland; frequency remains 7.290 and schedule is unchanged—2300-0500, 0600-1900; reception reports requested. (Radio Sweden)

Greece—Athens, 9.607, heard with interval signal 2358, signs on 2359 with musical number, pips 2400, then identification by woman announcer; fair signal at start. (Cox, Dela.)

Larissa, 6.754, heard 0030 in native; weak with QSB. (Cox, Dela.) Pearce, England, lists this one currently on 6.745, says appears to have *English* only on Thursdays at 1530 although has claimed to have that language also on Mondays at 1530.

The Greek Armed Forces Radio Station, Athens, on 6.340, broadcasts an experimental program in *English* daily 2315-2330 and 1615-1630; reports are welcome to Armed Forces Radio Station, No. 3, Zalocosta St., Athens.

December, 1950

Here's why those in the know

-demand

CANNON PLUGS

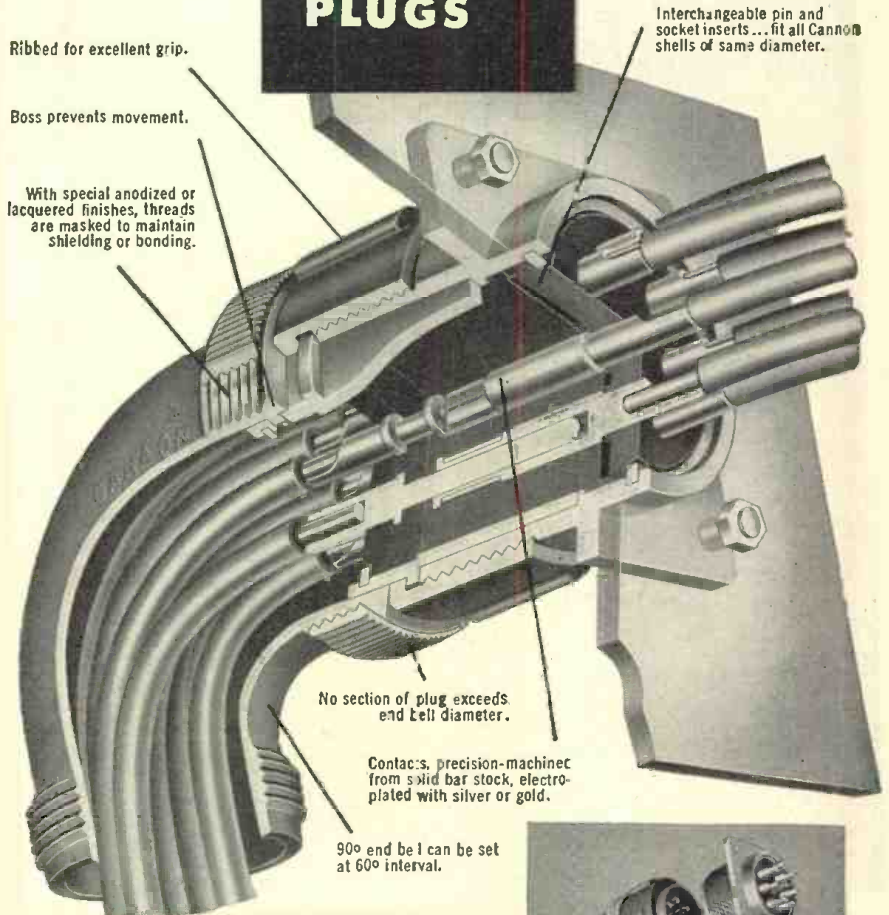

Type AN Connectors are made in 6 styles; straight and 90° cord plugs; box, wall, and extension cord receptacles; and special quick disconnect plugs. Fifteen diameters for inserts with contact arrangements from single to 100 contacts. Contact capacities from 5 to 200 amps. Peak voltages from 70 to 9,000 volts.

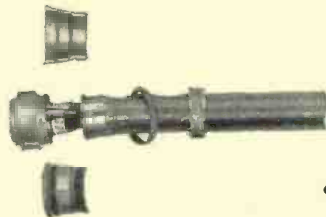

Cannon split-shell design advantages

no assembly tools needed
end bells are interchangeable
no slack in lines
test without disengaging plug
easy inspection and circuit changes

See that your circuit requirements are met. See that all control, communication and power circuits have firm positive contact, low dielectric loss... and see that each circuit is protected by the design advantages found only in Cannon Plugs. AN Connector Series is just one of the many Cannon types—world's most complete line. Request bulletins by required type or describe the connector service you need.

CANNON ELECTRIC

Since 1915

LOS ANGELES 31, CALIFORNIA
REPRESENTATIVES IN PRINCIPAL CITIES

These Men are Getting PRACTICAL TRAINING



IN TELEVISION-RADIO ON REAL TELEVISION SETS RADIO RECEIVERS F.M. RECEIVERS IN THE GREAT SHOPS OF COYNE

Big opportunities are waiting for men who know the practical and technical end of Television and Radio. That's what you get at COYNE—besides practical Shop Training in F.M., Electronics and other branches of this giant field. Remember, Television is the fastest growing opportunity field today, and Radio is one of the biggest.

NOT "HOME STUDY" COURSES

All Coyne Training is given in our mammoth Chicago training shops. We do not teach by mail. You train on actual equipment, under friendly instructors. Previous experience unnecessary. Hundreds of firms employ Coyne trained men.

OLDEST, LARGEST, BEST EQUIPPED SCHOOL OF ITS KIND IN AMERICA

Come to the Great Shops of Coyne in Chicago. Established 1899—now in our 51st Year. Fully approved for G.I. training. Finance plan for non-veterans.

MAIL COUPON FOR FREE BOOK

Send today for big new book packed with large pictures taken in Coyne Shops. No obligation. No salesman will call. Get the facts now!

COYNE B. W. Cooke, Pres.

ELECTRICAL & TELEVISION-RADIO SCHOOL
500 S. Paulina St., Dept. 30-1K
Chicago 12, Illinois



B. W. COOKE, Pres.
COYNE Electrical, & Television-Radio School,
500 S. Paulina Street, Dept. 30-1K Chicago 12, Ill.

Send FREE BOOK and full details on Television-Radio Course.

NAME.....
ADDRESS.....
CITY.....STATE.....

Greece. (Radio Sweden) Khania, 10-050, Crete, opens regularly 0530. (Bluman, Israel)

Haiti—A station noted on 6.166 evenings is believed to be 4VCM. (Stark, Texas) This station in Port-au-Prince is listed on 6.167 with 100 watts, as Magloire Broadcasting Circuit. **Radio Denmark** lists schedule as 0600-1000, 1200-1500, 1700-2300.

Holland—PCJ, Hilversum, is sending out a new card (with map of Holland on it). (Pearce, England)

Honduras—HROW, 6.02, Tegucigalpa, "Radio Monserat," excellent evenings; no English noted; signs off 0000. (Russell, Calif.)

Hungary—Budapest now appears to be using 6.248 and 9.834 for news 1600 and 1810 for Europe, but still is reported on 11.910 and 9.834 to North America at 1930 and 2300.

Indo-China—**Radio France Asie** ("The Voice of France in the Far East"), Saigon, is using its old 11.78 frequency for news 0900; reported on 11.83 yet for English ending around 0510; has been testing on 9.495 (claimed 9.524) around 0520-0550. Balbi, Calif., says that announces on 11.78 at 1000 that is parallel on 6.165 and m.w. 1055 kc. Russell, Calif., reports the 11.78 channel closes 1030 with playing of "La Marseillaise." Noted on this channel 1000 by Pearce, England. Neeley, Calif., reports the 6.165 channel is excellent mornings. Probably uses 11.78 or 11.83 for its "morning" program around 1800-2000 although has not been reported as heard in the U. S. recently at that time; may have moved to the 31-m. outlet for that beam?

The outlet on 6.19 still announces as **Radio Dalat**. (Balbi, Calif.)

Iran—EPB, 15.100, Teheran, noted to closing 1600. (Pearce, England) Should have five minutes of news 1500-1505.

Israel—Kol-Israel now has news 1515 on 9.000 and 6.830, and at 0700 on 6.830; the World Zionist Broadcast in English is daily 1700-1745 now on 9.000. (Pearce, England, Fargo, Ga., others)

Italy—Rome, measured 15.1194, noted with news 0600-0615. (Oskay, N. J.)

Jamaica—**Radio Jamaica**, 4.950, closes daily 2300; appears to have dropped its 3.48 channel entirely. (Russell, Calif., Bellington, N. Y., others) Verified via airmail in 10 days from Jamaica Broadcasting Co., Ltd., Broadcasting House, 32 Lyndhurst Road, Cross Roads, Jamaica, B.W.I. (Russell, Calif.)

Japan—JKM, 4.95, noted back again; good signal; now signs off 1030 as do all other Tokyo transmitters, including JKL. (Balbi, Calif.) JKH, 7.257, noted in Japanese 0600. (Cox, Dela.) JBD3, 15.225, and JBD4, 15.235, Tokyo, heard 2330-0000 with program for domestic listeners and Japanese in the Far East; verified in 15 days via airmail from Nippon Hoso Kyokai (NHK), Broadcasting Corporation of Japan, Radio Tokyo Bldg., Tokyo Cen- (Continued on page 147)

Audio Developments

(Continued from page 45)

equalizing action with the preamplifier, others merely compensate for the magnetic response characteristic in their preamplifiers, while still others assume a flat input. For this reason it is important to fully understand the operation of the various elements that make up the audio system. Otherwise it would be impossible to intelligently build a complete audio system unless all components are manufactured by the same company.

Amplifiers

The trend in amplifier (and preamplifier) design is to concentrate on reducing distortion and, after that is accomplished, obtain the widest possible frequency response. This is a departure from the thinking and philosophy in design of a few years ago, where the emphasis has always been to obtain a wide frequency response. Tests have shown that a wide frequency range amplifier which does not have good distortion and tonal balance characteristics is not pleasing to the ear.

Another new factor that has been emphasized is that intermodulation products sound most displeasing to the ear because they have no direct harmonic relationship with the frequencies producing them. Most sounds in musical instruments are rich in harmonic content and harmonics generated by non-linearities in an amplifier merely alter the amplitude of existing harmonics. It usually takes a very critical ear to detect a small amount of harmonic distortion.

Intermodulation distortion, on the other hand, will introduce frequencies which are not harmonically related. For example, if the input to an amplifier is 1000 and 49 cycles (most musical sounds have multi-frequencies), then a non-linearity will cause the following frequencies to appear: 1000, 49, 2000, 98, 1049, 951, etc. It is the presence of the 1049 and 951 cycle components that displeases the ear most.

For this reason manufacturers concentrate on minimizing intermodulation products and the intermodulation distortion method of testing and rating is being widely used not only by the amplifier companies but also by the recording companies and broadcasters.

Good tonal balance is another feature that is found in many new amplifiers. Tonal balance is the introduction of enough "treble" or "bass" into the response characteristic to be most pleasing to the ear. In more expensive units, tone controls are provided to permit the user to adjust the response to his own liking. In less expensive amplifiers the manufacturer has a rising low and/or high frequency characteristic which he finds presents the best sound.

Of course other factors such as low noise level and wide frequency response are also important. However,

"Premier"

Prices on TUBES and PARTS

TUBES

17BP4A	\$31.95	6J8G	\$1.60	12SH7	\$1.10
024	.83	6K5GT	1.20	12SH7GT	1.10
024G	.83	6K8GT	.83	12SJ7	.90
1A5GT	.90	6K7G	.83	12SJ7GT	.90
1A6	1.60	6K7GT	.83	12SK7	.90
1A7GT	1.00	6K8	1.20	12SK7GT	1.00
1B3GT/801G	1.33	6K8GT	1.20	12SL7GT	1.20
1C5GT	1.10	6L6	1.78	12SQ7	.75
1C6	1.60	6L6G	1.78	12SQ7GT	.83
1C7G	1.60	6L6GA	1.78	12SR7	1.10
1D5GP	1.05	6NGC	1.95	12SR7GT	1.10
1D7C	1.60	6P5GT	1.20	12Z3	1.33
1D8GT	1.95	6Q7	1.00	14A7	1.10
1F4	1.33	6Q7GT	.90	14A7T	1.20
1F5G	1.33	6R7GT	1.33	14B6	1.10
1G4GT	1.33	6S4	.90	14B8	1.10
1G6GT	1.33	6S7GT	1.60	14E6	1.10
1H6G	1.60	6S8GT	1.33	14E7	1.33
1J5G	1.33	6SA7	1.00	14F7	1.10
1J6G	1.60	6SA7GT	1.00	14F8	1.33
1J6GT	1.60	6SC7	1.00	14H7	1.20
1LA4	1.33	6SD7GT	1.45	14J7	1.33
1LC5	1.33	6SF5	.83	14N7	1.33
1NSGT	1.00	6SFGT	.90	14Q7	1.10
1P5GT	1.33	6S7	1.00	14X7	1.33
1Q5GT	1.33	6S7	1.00	14Y4	1.20
1R5	1.00	6S7H	1.10	19B6GG	3.00
1S5	.90	6S7HGT	1.10	19T8	1.45
1T4	1.00	6S7J	.90	20	1.95
1T5GT	1.33	6S7GT	.90	24	1.60
1U4	1.00	6W4GT	1.00	24A	1.10
1V	1.10	6SN7GT	1.10	25A7GT	1.60
1X2	1.33	6S7	.75	25AC5GT	1.45
2A3	1.60	6S7GT	.83	25BQ6GT	1.60
2A5	1.10	6SR7GT	.90	25D8	1.45
2A7	1.33	6S5T	.90	25L6GT	.90
2E5	1.33	6T7G	1.60	25L6GT	1.00
3A8GT	1.45	6V7GT	1.45	25Y5	1.45
3B7/1291	1.33	6U5	1.00	25Z5	.83
3C6	1.60	6U6GT	1.00	25Z6GT	.75
3E6	1.33	6U7G	.90	26	.90
3LF4	1.33	6V6GT	1.00	27	.75
3Q4	1.10	6V7G	.90	30	1.00
3Q5GT	1.20	6W4GT	.90	31	1.25
3S4	1.00	6W6GT	.90	32L7GT	1.60
3V4	1.00	6X4	.75	33	1.60
5T4	1.95	6X5GT	.75	35/51	1.00
5U4G	.83	6Y6G	1.20	35B5	1.00
5V4G	1.20	6Y7G	1.60	35C5	1.00
5W4	.83	7A4	1.00	35L6GT	.90
5W4GT	.83	7A5	1.10	35L6GT	.63
5X4C	1.00	7B6GT	1.00	35Y4	.90
5Y3GT	.68	7A7	.90	35Z3	.90
5V4G	.75	7A8	.90	35Z4GT	.75
5Z3	.90	7AF7	.90	35Z5GT	.75
5Z4	1.33	7B4	.90	35Z6G	1.33
6A4	1.60	7B5	.90	36	1.33
6A3	1.33	7B6	.90	37/44	1.33
6A7	1.00	7B7	.90	41	.83
6A8GT	1.00	7B8	.90	42	.83
6AB4	1.00	7C4	1.60	43	.83
6AB7	1.60	7C5	.90	45	.83
6AC5GT	1.45	7C6	.90	45Z5GT	.90
6AC7	1.45	7C7	.90	47	1.33
6AG5	1.20	7E5	1.10	47	1.20
6AC7	1.60	7E6	1.10	50	1.95
6AM6	1.95	7E7	1.33	50A5	1.10
6AK5	1.95	7F7	1.10	50B5	1.00
6AK6	1.20	7F8	1.33	50C5	1.00
6AL5	1.00	7G7	1.33	50CG6	1.45
6AL7GT	1.20	7H7	1.00	50L6GT	.83
6AQ5	1.00	7J7	1.33	50X6	1.10
6AQ6	.90	7K7	1.33	50Y6GT	.90
6AQ7GT	1.20	7L7	1.33	55	1.10
6AR5	1.33	7N7	1.10	56	1.00
6AS5	1.05	7P7	1.33	59	1.78
6AT6	.75	7Q7	.90	70L7GT	1.95
6AUSGT	1.33	7R7	1.10	73	1.00
6AU6	1.00	7S7	1.33	84	1.00
6AV6	.75	7W7	1.33	70L7GT	1.95
6AK5GT	1.68	7W7	1.33	71A	1.00
6B4G	1.60	7K7	1.33	75	.83
6B5	1.60	7Y4	.90	76	.83
6B8GT	1.60	7Z4	.90	77	.83
6BA6	1.00	10	1.80	78	.83
6BA7	1.20	10	1.80	79	1.33
6BC5	1.00	12A	.68	80	.68
6BC7	1.10	12A6	1.45	81	1.95
6BE6	1.00	12A7	1.60	81	1.95
6BF5	1.10	12A8GT	1.00	82	1.33
6BF6	.83	12AT6	.75	83	1.33
6BG6G	2.40	12AT7	1.45	84	.90
6BM6	1.00	12AUB	1.00	85	1.10
6BJ6	1.00	12AU7	1.20	89Y	1.10
6BN6	1.60	12AV6	.75	117L/	1.95
6BQ6GT	1.60	12AV7	1.60	M7GT	1.95
6C4	.83	12B7GT	1.20	117N7GT	1.95
6C5GT	.83	12BAG	.90	117TGT	1.95
6C6	1.00	12BA7	1.20	117Z3	.75
6CB6	1.00	12BB6	.90	117Z6GT	1.20
6DB5	.83	12BF6	.83	VR150	.50
6CDB6G	3.00	12FSGT	.90	VR150	.50
6DRG	1.60	12H6	.90	482B	.30
6FSGT	.83	12J5GT	.75	483	.30
6FGGT	.83	12K7GT	.83	49V9	.30
6FR6	1.60	12Q7GT	.90	807	1.50
6GG6	1.33	12S8GT	1.33	813	6.75
6H4GT	1.33	12SA7	1.00	1619	.10
6H6	.83	12SA7GT	1.00	1622	1.75
6H6GT	.83	12SF7	1.10	2050	2.25
6J5GT	.75	12SF5GT	1.00	2051	1.75
6J6	1.45	12SF7	1.00	7193	.18
6J7G	1.00	12SG7	1.00	9001	.36

Individuality boxed—Standard factory guarantee.

FILTER CONDENSERS

Very best brands. Fresh stock



450 Working Volts		150 Working Volts		40-40-150 V	
8-450 V	ea. 29c	8-150 V	ea. 23c	20-25 V	ea. 47c
10-450 V	ea. 35c	8-150 V	ea. 23c	50-30-150 V	ea. 47c
20-450 V	ea. 47c	10-150 V	ea. 23c	20-16-16-350 V	
30-450 V	ea. 59c	10-10-150 V	ea. 29c	Sprague type	ea. 47c
30-450 V w/		10-10-10-150 V	ea. 35c	25-25-150 V-200-10 V	ea. 47c
20-20-25 V	ea. 35c	15-150 V	ea. 25c	15-15-40-20	
10-10-450 V	ea. 52c	20-150 V	ea. 30c	150 V-25 V	ea. 35c
20-20-450 V	ea. 59c	30-150 V	ea. 35c	20-20-150 V-25 V	ea. 47c
10-10-10-20		40-150 V	ea. 35c	30-30-200-150 V-10 V	ea. 47c
450V-150-25 V	ea. 59c	15-15-150 V	ea. 35c	20-16-16-150 V	ea. 47c
30-30-400 V-350 V	ea. 47c	20-20-150 V	ea. 35c		
30-30-25-400 V-25 V	ea. 47c	30-30-150 V	ea. 47c		
		35-35-150 V	ea. 47c		
		40-20-150 V	ea. 47c		
		40-40-150 V	ea. 47c		

Output Transformers

STANDARD REPLACEMENT

For 50L6, 35L6, 50A5, 35A5, 117L7 **47c ea.**

For 6V6, 6F6, 3Q5, 3Q4, 35A, 3V4, 41, 42, 6K6, 2A3, 45, 6L6 **54c ea.**



UNIVERSAL OUTPUT TRANSFORMERS SPECIAL

Up to 12 watts to any speaker (while they last) **\$1.18**

World's Best Indoor TV Antenna

A beautiful antenna which is the ultimate in reception, highest signal gain, nothing to adjust.

List price \$9.95 Each **\$4.78**

TV Antennas:

Hi-Low Conical with 8-ft. mast **\$5.94**

World's Best Deluxe Conical

with 9-ft. mast and heavy cast fittings... **10.74**

300 ohm twin lead	
1000 ft. rolls	\$29.00
100 ft. rolls	\$3.25
100 ft. of twin lead with any TV antenna	\$1.98

Ballast Tubes for AC-DC TV Sets

TV Discriminator Transformers **ea. .83**

TV Screen Filters with suction cups—best quality INDI-VIDUALLY BOXED for highest re-sale value.

10" **1.40**

12" **2.34**

16" **3.06**

Oscillator Coils for any 5-tube AC-DC

Standard replacement crystal cartridge L70-L72 **\$1.96**

NYLON 1J CARTRIDGE **\$2.59**

RED HOT VIBRATOR SPECIAL!

Standard small size, 2 1/2" in height (the popular small size), bright and shiny, **\$1.29**

Stock up while they last, all 4-prong each Universal Vibrators.

6-FT. LINE CORDS

Good Rubber with plug 10 for **\$1.50**

Underwriters' Approved. 10 for **\$2.03**

TV PICTURE TUBE

10BP4	\$14.95
12LP4	\$19.95
14BP4	\$22.95
16RP4	\$29.95
16TP4	\$29.95

20% deposit with order, balance COD. \$1.00 handling charge for orders less than \$5.00. All shipments FOB Chicago. Our Parts and tubes are warranted to be 100% replacements for the prototypes in the listings above. Satisfaction Guaranteed. Illinois residents add 2% sales tax.

VOLUME CONTROLS

VERY BEST BRANDS

10 or more Each	Price Each
1/2 meg. or 1 meg. or 1/10 meg. with switch—long shaft	35c 42c
2 meg. for battery sets—switch, long shaft	35c 42c
1/2 meg., 1 meg., 1/10 meg. or 2 meg., long shaft, less switch	19c 23c
1000 ohm	19c 23c
5000 ohm	19c 23c
1/2 meg. with 6" shaft	59c 71c

IF TRANSFORMERS

Standard Replacement Regular size 455 Kc. **ea. 35c**

Midget 455 Kc **ea. 47c**

SPEAKERS Best Quality Alnico 5 PM

10 or more Each	Price Each
2 1/2", 3", 4", 5"	114 126
8"	\$2.94
10"	\$3.23
12"	4.74
5" PM with 50L6 o. p. Xformer	5.94
SPECIAL—6" PM Speakers, big Alnico 5 magnet. In lots of 10, each	6.54
Individual	\$1.67

SPECIAL—CONDENSER KITS

Kit of 50 BY-PASS CONDENSERS very best, assorted sizes. **\$1.98**

SELENIUM RECTIFIERS Standard 100 mil. Ea. **95c**

Special on No. 47, 44 and 51

100 Pilot Lights **\$4.74**

Box of 10 **59c**

PILOT LIGHTS—100 Bulbs

Box of 10 Bulbs **\$5.88**

No. 40 **65c** No. 41 **65c** No. 46 **65c**

OCTAL SOCKETS MOLDED

7-PIN MINIATURE SOCKETS **10 for 59c**

9-Pin Miniature Sockets **10 for 59c**

Local Sockets **10 for 59c**

BY-PASS CONDENSERS

100 Condensers assorted in package **\$7.14**

.001	6c	.0005	} 7c
.002	6c	.00025	
.005	6c	.0005	} MICA
.01	8c	500 mmf	
.02	8c	250 mmf	600 V.
.05	11c	100 mmf	
.1	11c	50 mmf	

BYPASS SPECIAL—SOLAR

In lots of 25 or more **ea. 11c**

.25 mfd. 600 V. **Less than 25 ea. 14c**

400-VOLT BY-PASS CONDENSERS

.05 mfd. **ea. 7c**

.2 mfd. **ea. 7c**

.25 mfd. **ea. 12c**

.5 mfd. **ea. 18c**

BUFFER CONDENSERS

.005 mfd. 1600 WV **ea. 18c**

.008 mfd. 1600 WV

.01 mfd. 1600 WV

VARIABLE CONDENSERS

Two-gang for superhet or TRF **ea. 83c**

PREMIER RADIO TUBE CO.

Phone: ANdover 3-1590
551 West Randolph St.
Chicago 6, Ill.

"Your Tube Source Since 1926"

Columbia

GEM OF THE SURPLUS

HAMS! BUY YOURSELF A GIFT WITH THE MONEY YOU SAVE ON THESE SENSATIONAL BARGAINS!

ASB-8 SCOPE INDICATOR. Complete with tube shield, but less tubes. Good condition. PLUS FREE SCHEMATIC \$7.50
 BC605 INTERPHONE AMPLIFIER. See April '50 RADIO NEWS for conversion dope. HAS A raft Q. USER BRAND NEW. \$3.95
 MN-26C RECEIVER. Frequency 150-1500 kc. 28 V. with control box, flex cables, azimuth indicator and loop. Especially hot for aircraft or marine use. Most parts brand new. SHARPI. Only \$32.50
 HS-23: hi-impedance. Brand new. \$2.95
 HS-30: used but good cond. LOOK! Only .69c

GOT A YEN FER CONDENSERS?

8 x 8 @ 600 V. \$0.89
 10 mfd @ 600 V. .69
 5 x 5 mfd @ 400 V. .69
 1 mfd. @ 3000 V. 1.95

GE RELUCTANCE PICK-UP

Give yer phonograph a new lease on life. NEW. \$1.95
 BC223AX TRANSMITTER. 25 W output. Terrific marine xmitr. Complete with 3 tuning units—2000-3000 kc., 3000-4500 kc., 4500-6000 kc. Plus tubes, plus SPARE PARTS BOX, plugs, tubes. New in original box. GRAB THE WHOLE DEAL. \$44.50

BC312 MARINE RECEIVER

6 bands. Freq. 1500-18000 kc. 12 V or 110 V. Excellent condition. WORTH DOUBLE THE PRICE! \$75.00

METAL CASES FOR BC375 TUNING UNITS

16 3/4" x 7 1/4" inches. Makes smart radio cabinet. Excel. cond. Ya won't believe it but they're only 59c ea.

CRADLE TYPE DESK PHONES

Absolutely no good for rocking baby to sleep but wonderful for your racket. Got a ringer in the base. Good condition. You can get one for only \$8.95
 But unless you enjoy talking to yourself, ORDER A PAIR for \$17.50

SIGNAL LAMP

Pistol grip. 12 V. amp. Use it on your car. Or even on yer boat, launch or yacht—you plutocrat! NEW in original box. Only \$2.50
 HEY! WE GOT A MARLBORO SPARE PARTS BOX!
 BC375 TRANSMITTERS AND COMMAND EQUIPMENT. TELL US YER NEEDS.

DYNAMOTORS

DM-35: 12 V. input. 660 V. output. Like new. \$14.95
 DM-38: 12 V. input. 220 V. output. Like new. 7.50
 PE-103: 6 or 12 V. input. 500 V. output. with filter base. 15.95
 PE-73: 24 V. input. 1000 V. output. NEW. 5.95
 BD-77: 12 V. input. 1000 V. output. BRAND NEW. 9.95
 PE-218 INVERTER: 28 V. input. 115 V. output. 1500 VA 380/500 cycles. Good cond. 17.95

METERS! THE BEST BUYS IN THE BOOK!

0-3 VDC 2 in. round. Simpson. \$2.49
 0-15 VAC 3 in. round. Weston or Roller-Smith. 3.29
 0-50 amp. AC 2 in. square Triplet. 2.99
 0-25 MADC 2 in. round. Weston. 2.99
 0-50 MADC 2 in. round. Simpson. 2.99
 0-800 MADC 3 in. square. DuJur. 3.49
 0-1 amp RF 2 in. round. G.E. 2.99
 0-2 amp RF 2 in. round. Thermouple type. 2.99
 0-5 amp RF 2 in. round. Westinghouse. 2.99
 1 MIL MOVEMENT with 0-10 scale. 2 in. round. Hickok. 3.29
 CONTROL UNIT C-58/APT-1 complete with 0-1 mil movement with 0-200 scale. Box contains 2 toggle switches, control knob, panel light, etc. all for only 4.50

ASB-3 RECEIVER

500-550 mc. Easily converted to citizen's band or 420 mc ham band. Less tubes. Excellent cond. \$7.50

ALL-PURPOSE TUBES

725A 4.95 75C \$14.95
 708A 4.95 705A 1.00
 713A 1.00 722A 1.95
 JRG559 1.25 707A 9.95
 531 4.95 601 7.95
 307A 4.95 2J62 24.95
 706PY 29.50 C5B 6.50
 715A 4.95 WE700C 12.50
 803 3.50 813 7.95

WIRE WIRE WIRE

Approx. 100 FT. REELS of hook-up wire. Multiple colored brand. PER REEL. 79c
 3 & 4 CONDUCTOR WIRE. Heavily insulated. 7c
 Per ft. 6c
 52 ohm coax cable. Per ft. 6c
 72 ohm coax cable. Per ft. 6c

CONTROL BOXES

BC48 ARC5. VHF \$0.75
 BC802 for SCR 522 1.39
 MN28 for MC26 Receiver. 3.95
 C-2 for the ARR-2 1.00

GP-7 NAVY TRANSMITTER

100 watt master oscillator type. Can be used on any freq. from 350-9050 kc. by using proper plug in tuning unit. Type 803 P.A. and built-in 115 V. 400 cycle power supply using a pair of 1616 rectifiers. Comes with 3000-4225 kc. tuning unit. \$12.50
 Additional Tuning Units. Ea. 3.50

ARC-5 OR 274-N TRANSMITTERS COMPLETE

2-1.5 mcs. Excel. for ship use. \$10.95
 3-4 mcs. Used. excel. cond. 10.95
 4-5.3 mcs. Used. excel. cond. 3.95
 5-3.7 mcs. Used. excel. cond. 4.50
 7-9.1 mcs. Used. excel. cond. 10.95

ARC-5 OR 274-N RECEIVERS

1.5-3 mcs. For ship use. Excel. cond. \$14.50
 3-6 mcs. excel. cond. 4.95
 6-9.1 mcs. excel. cond. 10.95
 190-550 kcs. excel. cond. 12.50
 Command Receiver flex. cable 6'.95
 Command Receiver 28V dynamotor.7.99
 Command Knobs for Receiver. Ea.69
 MD7/ARC-5 Plate Modulator.7.95
 BC-456 Screen Modulator.1.95

274-N ANTENNA RELAY BOX

Contains RF meter plus 50 mfd. H. V. vacuum cond. and relay. New in carton. 2.25

COLUMBIA ELECTRONIC SALES
 522 South San Pedro Street
 LOS ANGELES 13, CALIFORNIA

these factors are well known to most audio men and require no further discussion. One point that may be new to some readers is that it is possible to minimize the noise appearing in old records by use of special noise suppressing circuits.

Speakers

The quality of speakers is being constantly improved. However, at the present time, they appear to be the limiting factor in the audio system. High quality speakers are still essentially dual units, a woofer and tweeter combination. Sometimes they are placed concentrically, while other manufacturers prefer to supply them as two separate units. The placement of the speaker in the cabinet or baffle is quite important and beginners should not attempt to design their own bass reflex cabinets. The use of an infinite baffle by placing the speaker in the wall or large closet has proven very satisfactory in many instances.

A corner-horn speaker has recently appeared on the market and seems to have some advantages. It utilizes the walls of the room as part of the acoustical system and gives the impression that the speaker is extremely large. Excellent dispersion of sound has been effected without breakup of high and low frequencies, even though there are two separate speakers.

A point that the reader might consider is this. Is it possible to represent a large symphony orchestra, which fills an entire stage, by a single speaker, which we run at high volume to get the desired intensity? Perhaps we should have a number of speakers set in the wall to represent a large orchestra and in this way obtain a feeling of realism in sound reproduction. The author tried such a setup in the Terminal sound room for a couple of weeks and the consensus indicated that this system did have a desirable third dimensional effect.

The improvements made in the stylus, magnetic cartridge, pickup arm, equalizers, amplifiers, and speakers have resulted in vastly more enjoyable audio systems. Furthermore, the improvement has not only been effected in quality but in price as well. Hence, today it is possible to build an audio system for less than 200 dollars, using manufactured units, that compares favorably with many 1500 dollar sets of a few years ago.

Naval Communications

(Continued from page 49)

a cluster of special non-directional electric lamps, located near the ends of the yardarm.

Additional devices used in visual communications are pyrotechnics and panels. Pyrotechnics are merely fireworks of various types with special meanings assigned to each type or combination. The meanings may change, but usually deal with distress or emergency identification. Another kind of pyrotechnic is the smoke grenade, used to mark locations in the water. Panels are strips of material laid out on the ground to give instructions and information to aircraft. The position of the panels in relation to one another determines the meaning of the message.

Sound

Sound in communication is employed in underwater signaling devices. These devices can be used over short distances to communicate with submarines or surface vessels that carry similar echo-ranging equipment. Messages are sent by telegraph key. Underwater sound transmissions are slow, the range extremely limited, and security from interception poor. Reliability of communication is subject to variations in the temperature of the water, the salt content, the depth, and other conditions that affect the movement of underwater sound waves.

Wire Systems

Wire communication systems employed by the Navy include cables, landwire telegraph, telephone, and teletype. The Naval Communication Service does not own or operate cables. Therefore, when such facilities are required, the cables of commercial companies or foreign governments must be utilized. Landwire telegraph—the sending of Morse Code over wire—is now almost completely replaced by the faster and more efficient teletype. The telephone, being convenient and speedy, is, of course, especially suitable for administrative traffic at naval bases and shore stations.

The most widely used wire system for communication between stations ashore is teletype. The teletypewriter, broadly speaking, is little more than an electrically operated typewriter. Teletype may be defined as "typewriting at a distance." It is the most rapid and accurate system of recorded wire communication. Normal speed of transmission is in the vicinity of 60 words-per-minute, but much higher speeds are possible.

By operating a keyboard similar to that of a typewriter, signals are produced that print characters in page form, or on a tape. These characters appear at both the sending and receiving stations. One teletypewriter transmitting signals will actuate all receiving machines connected to the teletype system. For example, an op-



SAVE

THAT GOOD LOOKING OLD CONSOLE—
REPLACE THE OBSOLETE RADIO

with a modern, easily installed

ESPEY AM/FM CHASSIS

and your favorite console is "right-up-to-date"

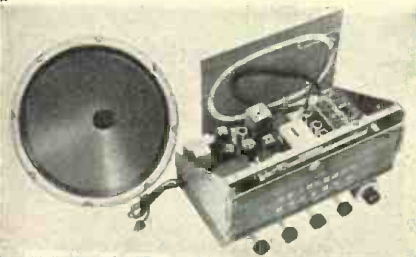

Rated an excellent instrument by America's foremost electronic engineers. Fully licensed under RCA and Hazeltine patents. The photo shows the Espey Model 511-B, supplied ready to play. Equipped with tubes, antenna, speaker, and all necessary hardware for mounting.

NEW FEATURES—Improved Frequency modulation circuit, drift compensated • 12 tubes plus rectifier, electronic tuning eye and pre-amplifier pick-up tubes • 4 dual purpose tubes • High quality AM-FM reception • Push-pull beam power audio output 10 watts • Switch for easy changing to crystal or variable reluctance pick-ups • Multi-tap audio output transformer supplying 4—8—500 ohms.

Makers of line radios since 1928:

Write for literature RN for complete specifications on Model 511-B and others.

ESPEY

TEL. TRafalgar 9-7000

MANUFACTURING COMPANY, INC.

528 EAST 72nd STREET, NEW YORK 21, N. Y.

**High score
every time with
"Safe Centers!"**



In Basketball there's no better assurance of victory than a lengthy lad jumping center . . . and there is nothing that scores higher in radio, TV and other electronic circuits than SELETRON miniature rectifiers with "Safe Center" plates.

When you specify SELETRON Selenium Rectifiers you eliminate arc-over danger, short circuits and heating at the center contact point. Assembly pressure, or pressure applied in mounting the rectifier cannot affect its performance—a SELETRON feature accomplished by deactivating the area of the plate under the contact washer.

The millions of SELETRON Selenium Rectifiers in satisfactory service as original equipment in the products of leading manufacturers are millions of reasons why you can specify SELETRON and be safe!

Look for Howard W. Sam's Red Book Supplement listing SELETRON replacements . . . and write for Bulletin No. TN-2

Seletron

RR RADIO RECEPTOR COMPANY, INC. RR

Since 1922 in Radio and Electronics
Factory: 84 North 9th St., Brooklyn 11, N. Y. • Sales Department: 251 West 19th St., New York 11, N. Y.

December, 1950

magic chemicals



WALSCO

the complete line
of quality chemicals for
every radio and TV service job.



WA_SCO cements • solvents • "No-slip"
"No-ox" • ccil dope • "Contactene"
"Walscolub B" • polishes • paints
lacquers • refinishing kits
special chemicals

WALSCO

➔ WRITE FOR FREE ILLUSTRATED CATALOG

WALTER L. SCHOTT CO. Beverly Hills, Calif. • Chicago 6, Ill.

121

Service-Dealers:
DO A
\$50,000
TV BUSINESS
ON A
\$500. INVESTMENT!

Get into the TELEVISION BUSINESS in a BIG WAY with the TRANSVISION FACTORY-AGENT PLAN!

YOU GET—

- EXCLUSIVE TERRITORY
- SPECIAL PRICES to undersell competition
- NO INVENTORY

You work from our MILLION-DOLLAR INVENTORY.

Requirements:

- You must be a Radio-TV Technician (experienced only).
- You must have a presentable location.

Write TODAY for complete FACTORY-AGENT PLAN, to—
TRANSVISION, INC.

Dept. RN, NEW ROCHELLE, N. Y.

FIELD STRENGTH METER

- A must for every TV Serviceman!
- Saves 1/2 the work.
- Improves installations.



NEW LOW PRICE

Model FSM-1, complete with tubes. Net \$79.50
All Transvision Prices are fair traded; subject to change without notice. Prices 5% higher west of the Mississippi.

TRANSVISION, INC.

Dept. RN NEW ROCHELLE, N. Y.

erator transmitting from New York to Boston has his message repeated, letter by letter, in Boston as soon as it is formed in New York. The same occurs at all receiving stations tied into the network.

One form of teletype operation is called "simplex." This provides transmission in a single direction at a time. Simultaneous flow of traffic in both directions is provided by a second method, "duplex." By employing separate wires, carrying incoming and outgoing signals, duplex can carry nearly twice as much traffic as simplex.

Special transmission devices, known as tape relay equipment, enable messages to be relayed from one point to another with a minimum of delay. A combination of transmitter-distributor, perforator, and printer gives the operator the choice of messages printed on a page, perforated on tape, or both. An incoming message may be received in page form for the record, and punched on tape by the perforator at the same time. The tape can be used for further relay by feeding it into the appropriate circuit transmitter-distributor.

Teletypewriter System

Prior to 1940, Naval Communications within the continental limits of the United States consisted of point-to-point radio circuits and one landline Morse telegraph circuit. Messages which could not be handled by the Navy's facilities were routed via commercial communication companies. In July 1940, a commercial teletypewriter network was developed to serve selected Naval activities. This became known as the TWX System. The Navy was charged at toll call rates, so much for the first three minutes, and additional charges for overtime. As the volume of messages increased, the cost of communication soared. It became mandatory in the interests of economy that a private teletypewriter service be installed for the Navy, to supplement TWX, and to serve activities which were handling large numbers of messages.

In May 1941, the first private Navy teletypewriter circuit was inaugurated between Washington and New London. This became the nucleus of the present extensive U. S. Naval Teletypewriter System, which is commonly called the NTX System. Primary relay stations are located in five communication centers, at Washington, San Francisco, Honolulu, Guam, and Balboa. The various Naval Districts tie into these primary stations either by landwire or by radioteletype. Each continental Naval District has a major relay station and is connected to Washington or San Francisco by direct wire circuits. Western districts channel traffic to San Francisco, eastern districts to Washington. San Francisco and Washington are connected by landline teletype. Ships at sea and major relay stations outside the continental limits feed into the primary stations by radioteletype. To provide complete

WHAT YOU WANT



WHERE YOU WANT IT

These three useful service kits put order and system into your problem of having the right condenser for the job . . . and knowing where it is. One holds "GP" Ceramicons; another holds Disc and Plate Ceramicons; a third holds "NPO" Zero Temperature Coefficient Ceramicons. A carefully planned assortment of each prepares you for every ordinary service job. The transparent plastic kits give you a constant knowledge of your stock, make it easy to put your fingers on the condenser you want . . . and all at no extra cost to you.

Your jobber has them in stock.

Electronics Division
ERIE RESISTOR CORP., ERIE, PA.
LONDON, ENGLAND • TORONTO, CANADA

SHOOTS TROUBLE FASTER!
MAKES MORE MONEY FOR YOU ON JOB OR AT SERVICE BENCH!



PRICE
\$9.95
at distributor or postpaid, direct. No C.O.D.'s, Please. Ohioans add 3% State Sales Tax

Signalette

MULTI-FREQUENCY GENERATOR

In radio service work, time means money. Locate trouble faster, handle a much greater volume of work with the SIGNALETTE. As a trouble shooting tool, SIGNALETTE has no equal. Merely plug in any 110 V. AC-DC line, start at speaker end of circuit and trace back, stage by stage, listening in set's speaker. Generates RF, IF and AUDIO Frequencies. 2500 cycles to 20 Megacycles. Also used for Checks on Sensitivity, Gain, Peaking, Shielding, Tube testing. Wt, 13 oz. Fits pocket or tool kit. Satisfaction, or money back! See at your distributor or order direct.

Clippard Instrument Laboratory, Inc.

DEPT. A, 1125 BANK STREET
CINCINNATI 14, OHIO
QUALIFIED JOBBERS WRITE, WIRE FOR DETAILS.

NTX coverage, minor and tributary stations are set up at activities within Naval Districts and at outside points, when the traffic load warrants. TWX (commercial) is still used where NTX coverage is not justified.

The NTX and TWX systems link district and sea frontier headquarters, naval bases, ordnance plants, manufacturers, supply depots, and the countless other naval shore establishments which supply and maintain the fleet.

Radioteletype

Navy Radioteletype, which applies the teletype to radio transmission and reception, is given the abbreviated title RATT. Prior to the development of RATT, teletype needed wire to connect it with communication points. Contact with ships at sea was limited to radiotelephone or radiotelegraph. At the present time, many warships have radioteletype equipment; in the future, radioteletype will handle the bulk of communication traffic for all ships in the Navy. A milestone in the history of radioteletype is the sending of messages to and from aircraft in flight. This was made possible by development of smaller and lighter equipment.

Radioteletype is simply an ordinary teletypewriter installation connected by means of a converter to the radio transmitting and receiving equipment. When receiving, the converter changes radio impulses into a form of electrical energy which actuates the teletype. When transmitting, the procedure is reversed. Teletype is so flexible that wire and radio systems can be combined as desired. This makes it possible for Naval Communications to span great areas of the globe with a network using Teletype alone.

Radiotelephone

Although radioteletype and radiotelegraph are the primary radio systems used in the Navy for long-distance work and for recorded communications, radiotelephone, or voice radio, is also extensively used. Its important advantages are speed and ease of operation and adaptability to lightweight portable equipment.

Voice radio is particularly valuable for comparatively short-range communication by aircraft and surface ships. When a number of ships are in company and time is a primary consideration, voice radio often steps in to replace visual methods. It is used for walkie-talkie, for communications between aircraft units, and in control tower operations. Ship-to-shore as well as tactical ship-to-ship communications are greatly aided by its use. Small craft, such as district craft, depend entirely on radiotelephone for radio communication.

Facsimile-Radiophoto

Facsimile, or radiophoto, performs the transmission of pictorial or graphic information by wire or radio and reproduction of the material in its original form at the receiving station. Navy radiophoto facilities, operating as a

5 Great Books to INCREASE YOUR EARNING POWER!

TRAIN FOR A RICH FUTURE IN RADIO-ELECTRONICS

36 courses in one . . . only \$5 complete



Ghirardi's famous 972-page **RADIO PHYSICS COURSE** book has given more radio-electronic beginners their start than any other book or course! During the war, it was more widely used in Signal Corps, Navy, etc. training than any other radio text—because it makes everything so perfectly clear and understandable. Contains complete training covering every phase of basic radio-electronics.

Over 300 pages make Basic Electricity easy to learn. Other subjects range from Radio Transmission to Receiving, Vacuum Tubes, Detection, Amplification, Photo Electric Cells, Short Waves—a total of 36 basic training subjects. If broken into lessons and sold as a course, you'd regard this great book as a bargain at \$50 or more—yet you buy it for only \$5 complete. Over 500 illustrations.



A famous Ghirardi book

Don't be a Screw-driver Mechanic!

LEARN MODERN, PROFESSIONAL SERVICE METHODS



A famous Ghirardi book

With today's complicated circuits, you've really got to know your stuff to get the good-paying jobs! Ghirardi's 1300-page **MODERN RADIO SERVICING** book teaches you basic, professional service methods from the beginning. Tells how to analyze any circuit and its components; how to make preliminary

trouble checks; how, when and where to use test instruments and to interpret their readings in tracking down the trouble—even how to start a successful service business of your own. 706 clear illustrations and 723 self-test review questions make study easy. Only \$5 for the complete training.



GET INTO THE FAST-GROWING END OF SERVICING

. . . Be a Television repair and maintenance Specialist!



Here's the book that can pave your way to real profits in the fastest-growing part of the business, **PRACTICAL TELEVISION SERVICING!** It tells what to do—exactly how to do it in installing modern TV receivers and keeping them working properly. It shows how television

differs from radio, explains what mistakes to avoid; outlines in clear, easily-understood terms how to troubleshoot, diagnose and repair television receiver troubles. 334 pages, over 230 helpful illustrations. Only \$4. Use coupon. Read it for 10 days at our risk!

There's Good Pay in this Uncrowded Field

LEARN ELECTRIC MOTOR REPAIR!

If you're looking for something different—something that not everybody and his brother are studying—then here's the book for you! Based on what can be learned at home from this big **ELECTRIC MOTOR REPAIR** book, you can train for profitable installation, service, repair

and even complete armature rewinding of practically any electric motor in common use. You learn about electric motor control systems, too! Quick reference guides show how to handle specific jobs. Practice from it for 10 days at our risk! 560 pages, over 900 special illustrations. Only \$5.



Save Time . . . Make More Money!

LEARN TO USE THE OSCILLOSCOPE FULLY!



Not one radio-electronic man in a dozen really knows how to use the oscilloscope—and, if he did, he'd be worth a lot more money! This great instrument saves time, assures far greater efficiency on almost any electronic design or service job. Learn how to use it and watch your

earnings soar! **MODERN OSCILLOSCOPES AND THEIR USES** gets right down to earth in explaining the entire subject in a way you can easily understand. Almost 400 illustrations make things doubly clear. 326 pages. Price only \$6. Use coupon for 10-day offer.

ORDER NOW! 10-DAY MONEY-BACK GUARANTEE!

MURRAY HILL BOOKS, INC., Dept. RN-120
232 Madison Avenue, New York 16, N. Y.

Enclosed find \$..... for books checked; or send C.O.D. for this amount plus postage and I will pay postman. If books are not satisfactory, I will return them in 10 days and you guarantee to refund my money. (Cash only outside U.S.A.—same 10-day return privilege).

- | | |
|---|---|
| <input type="checkbox"/> RADIO PHYSICS COURSE
\$5 (\$5.50 outside U.S.A.) | <input type="checkbox"/> MODERN RADIO SERVICING
\$5 (\$5.50 outside U.S.A.) |
| <input type="checkbox"/> PRACTICAL TELEVISION SERVICING
\$4 (\$4.50 outside U.S.A.) | <input type="checkbox"/> ELECTRIC MOTOR REPAIR
\$5 (\$5.50 outside U.S.A.) |
| <input type="checkbox"/> MODERN OSCILLOSCOPES
\$6 (\$6.50 outside U.S.A.) | |

Name.....
Address.....
City, Zone, State.....

*this is it—
this is the tuner
you designed!*

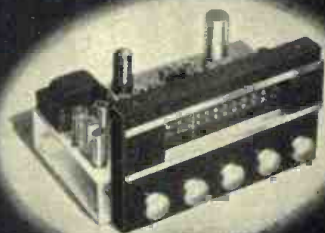

the
**CRAFTSMEN RC-10
HIGH FIDELITY
FM-AM TUNER**

This new tuner was your idea. It is the precisely engineered answer to hundreds of questions . . . the solution to scores of problems . . . the outgrowth of countless suggestions we've received from you. Developed from your ideas—and a few of ours—the RC-10 retains every feature of the famous RC-8. And it offers a host of innovations.

- Built-in pre-amplifier compensated for reluctance pickups.
- Automatic Frequency Control entirely eliminates drift, simplifies tuning.
- 5 microvolt sensitivity on both FM and AM.
- 10 kc filter on AM eliminates inter-station squeals.
- Base and treble tone controls for boost, cut, or 20—20,000 cycle flat response.

SEE . . . the RC-100A ultra-sensitive, custom TV with built-in booster.

HEAR . . . the RC-2 high fidelity amplifier. All units finished in chrome.

Write for information—or send 50¢ for instructions and schematics.

THE RADIO

craftsmen
INCORPORATED

function of the Naval Communication Service, are maintained at Washington, San Francisco, Pearl Harbor, and Guam. A basic operation of these units is the daily exchange of weather maps. They also provide a rapid method of delivering photographs, blueprints, and other material not suitable for transmission by other standard means of communication. The Navy is a participant in the joint national facsimile weather map network, which covers the entire United States and connects major air stations and weather centrals. This network is composed of facilities of the U. S. Air Force, Navy, Weather Bureau, and a few commercial stations. Mobile radiophoto units provide for operation aboard ship or at outlying points, as necessary to meet special requirements.

Radiophoto transmission is an important supplement to rapid communications, providing a previously unavailable method of handling pictorial—graphic intelligence. In comparing radiophoto with other advanced communication systems, radioteletype may be likened to typewriting, radiophoto to the printing press, and television to the motion picture.

Navy Communication System

It is clear from the preceding discussion that Naval Communications provides all types of facilities, from the most simple to the highly complex. These versatile facilities enable local commands to carry out in the most efficient manner whatever is the job of the moment. In any military organization, however, there must be overall control and a means for getting the word to all elements of the forces wherever located. Effective control of our widespread naval forces is made possible by the Navy Communication System, which is an integrated network providing basic communication coverage on a world-wide scale.

The chief components of the Navy Communication System ashore are the Primary Communication Centers at Washington, San Francisco, Honolulu, Balboa, and Guam. These are the "big five" of the system. The key station of the entire Navy Communication System is, of course, Washington. From this point, radio circuits and landlines tie together the entire Navy, making it possible for the fleet to perform its tasks as a single unit. From the radio standpoint, "Radio Washington" consists of several elements: a central communication office located in the Navy Department; a high power transmitting station at Annapolis, Maryland; a receiving and monitoring station at Cheltenham, Maryland; and a radio link transmitter and receiver station at Arlington, Virginia.

To get messages to all units of the Navy, a system of "broadcasts" is used. The word "broadcast" was introduced to communications by the Navy. This term is appropriate because messages are cast in all directions. Fleet Broadcast schedules are the primary means of delivering traffic to the fleet. The five major stations

transmit by this method on predesignated frequencies and schedules, appropriate to reach all points. Messages normally are transmitted "blind," that is, the ships do not use their transmitters to acknowledge receipt of the traffic. This insures security and safety, since any "enemy" is deprived of the opportunity to use direction finding equipment in detecting the location of fleet units. In addition to the primary broadcasts, which require very high power equipment, secondary stations are set up at appropriate points to provide local coverage for small units operating in a local area. In addition to these two types of broadcasts, there are a number of local, low-power transmitting facilities operated in various areas to disseminate hydrographic and weather information, and time signals.

Earlier descriptions of the Navy's vast teletype and radioteletype point-to-point circuits told how continental shore stations are linked to overseas points and to ships at sea. This comprehensive high-speed system handles huge volumes of traffic. Manual radiotelegraph also is used by ships to contact shore stations, when other facilities are not available.

The efficient and smooth operation of Naval Communications requires careful planning. Ashore, each Naval District has its own communication organization, supervised by the District Communication Officer. This officer draws up a communication plan that provides for complete communications with ships, aircraft, and all naval stations within his district. This plan also furnishes direct channels to the Navy Department, to other Naval Districts, and to the communication facilities of other military services. District plans take special note of measures to be taken in case of local emergencies, such as storms, floods, fires, and hurricanes, when normal communication circuits may be disrupted. Emergency planning makes particular provision for the utilization of the extensive Naval Reserve Communication System. There are over 850 radio stations located at Naval Reserve activities throughout the United States. Established primarily for the training of communications personnel, and located in practically every major city and in hundreds of small communities, these stations constitute a valuable communication potential in emergencies.

The seagoing counterpart of District Communication Plans are Fleet Communication Plans. These plans prescribe radio and visual procedures to be used by ships, and are drawn up to meet any situations that may arise.

To achieve better service, preparedness, and greater economy, Naval Communications planning involves full coordination with the Army and the Air Force. Joint use of facilities, whenever practicable, results in economy of men, material, and radio frequencies. Employment of standard operative procedures and equipment by the three services, further assists continu-

RADIO & TELEVISION NEWS

OUTSTANDING VALUES NOW AVAILABLE

G I—13-CHANNEL TELEVISION TUNER

For replacement or construction work. Capacity type tuner with fine tuning control. Using 3—6J6 tubes. Input for 300-ohm line. One of the finest front ends ever built.

Each.....\$6.95 less tubes
Lots of 3..... 6.50 each

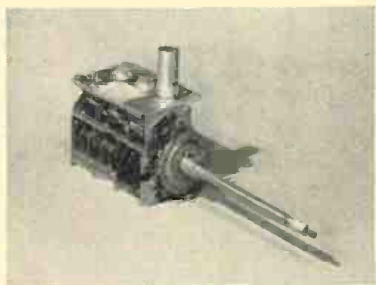

VOLUME CONTROL STEAL

250,000 } With switch—2 1/2" milled shaft
500,000 } 39c ea.
1 meg. } Lots of 10.....\$3.72
2 meg. } Asst. of 25..... 8.74

Standard Type Replacement Phono Cartridge

All New—All Guaranteed

Type No. 1 will replace Shure W58A
Webster N10
Astatic L70

Price—only \$1.85 ea. Lots of 10 \$17.90

Type No. 2 will replace Shure W56A
Webster N10
Astatic L-72

Price—only \$1.99 ea. Lots of 10 \$18.90

CERAMICON CONDENSERS

Standard Manufacture

Kit of 100 most often used ceramicons—now only.....\$4.95

GT TUBE CARTONS

Sturdy—Many Uses.

Box bulk tubes, spare parts, nuts and bolts.
\$.79 per 100
4.95 per 1000

KNOB ASSORTMENT

Includes half push on and half set screw knobs. All used often.

100 knobs only.....\$1.89

PM REPLACEMENT SPEAKERS ALL NEW—ALL GUARANTEED

4" Alnico V.....\$1.19 ea.
5" Alnico V..... 1.29 ea.
6" Pin Cushion Alnico V..... 1.69 ea.
6" Round Alnico V..... 1.69 ea.
4x6" PM Alnico V..... 1.59 ea.
7" PM Pin Cushion Heavy Alnico V
Offset holes for auto replacement. 2.29 ea.
6x9" PM Heavy Alnico V..... 2.29 ea.
8" PM Heavy Alnico V..... 3.25 ea.
10" PM Heavy Alnico V..... 3.95 ea.
12" PM Heavy Alnico V..... 5.25 ea.

NOW! LARGE 14" or 16" PICTURE FROM YOUR 10" or 12" TELEVISION SET

Servicemen: Convert customers' sets for extra profits! 90% of all conversions can be made by use of the RAPARCO conversion kit.



Includes 14BP4 CR tube, 70° deflection yokes, and attractive lucite mask.

Complete, only.....\$32.95

HIGHEST QUALITY TELEVISION COMPONENTS AT LOWEST PRICES YET!

Standard Manufacture—All New—All Guaranteed. All these parts are used constantly in repair or conversion work.

70° Deflection yoke—includes leads and resistors.....\$3.50 ea.
60° Deflection yoke..... 2.25 ea.
Flyback transformer for 12 1/2" set.. 2.75 ea.
Flyback transformer for 16" set.... 3.50 ea.
14" Attractive Lucite Square Mask.. 3.95 ea.
16" Attractive Lucite Square Mask.. 4.50 ea.
Single Magnet Beam Bender..... .39 ea.
Double Magnet Beam Bender..... .75 ea.
500 MMFD 20 KV..... .95 ea.
500 MMFD 10 KV..... .69 ea.

TV AUTOMATIC VOLTAGE REGULATORS

Keep your voltage stable. Remove that flicker from your television set. Voltage change from 90 to 140 volts kept at 115 volts. Protects your TV set and other electrical units from line changes. Especially fine for rural areas.

Model RPA—

For use with units of 200 to 300 watts.
\$2.00 List. YOUR COST.....80c

Model RPB—

For use with units of 300 to 375 watts.
\$2.50 List. YOUR COST.....\$1.00

INDOOR TELEVISION ANTENNA



Now TV reception without the outdoor antenna. Effective range 20 to 25 miles from station. Excellent reception. Easily installed—takes 5 seconds. Easily orientated. Heavy base—will not tilt. Attractive. Friction clutch-type action on the rods. Complete with lead in.....\$2.49
Case lots of 25..... 2.25

16" Rectangular CR tube. Replaces 17TP4, 16RP4, 16XP4. Guaranteed. Standard Manufacture.....\$27.95 ea.
(Must be shipped Railway Express or Truck)

C 7 1/2 Parallel 110 Volt Christmas Tree Lights Imported. Five Assorted Colors.

Carton of 25. One color.....\$2.50
500 Lights. 5 Assorted colors.....\$59.50

CRESCENT CHANGERS for the RCA 45-R.P.M. System



A complete changer ready for installation or attachment. Beautiful in appearance, built to last under constant service.

Each changer comes complete with Crescent "Rollway" mounting for custom installations.

Price complete.....\$8.59

Metal Base for RCA 45 R.P.M. changer—Mahogany Hammerloid Finish.\$1.00

Attractive, well-built carrying case for above changer. Leatherette covered. Brass fittings throughout. Limited quantity.....\$4.59 ea.

Radio Parts Company, 614 RANDOLPH ST., CHICAGO 6, ILL.

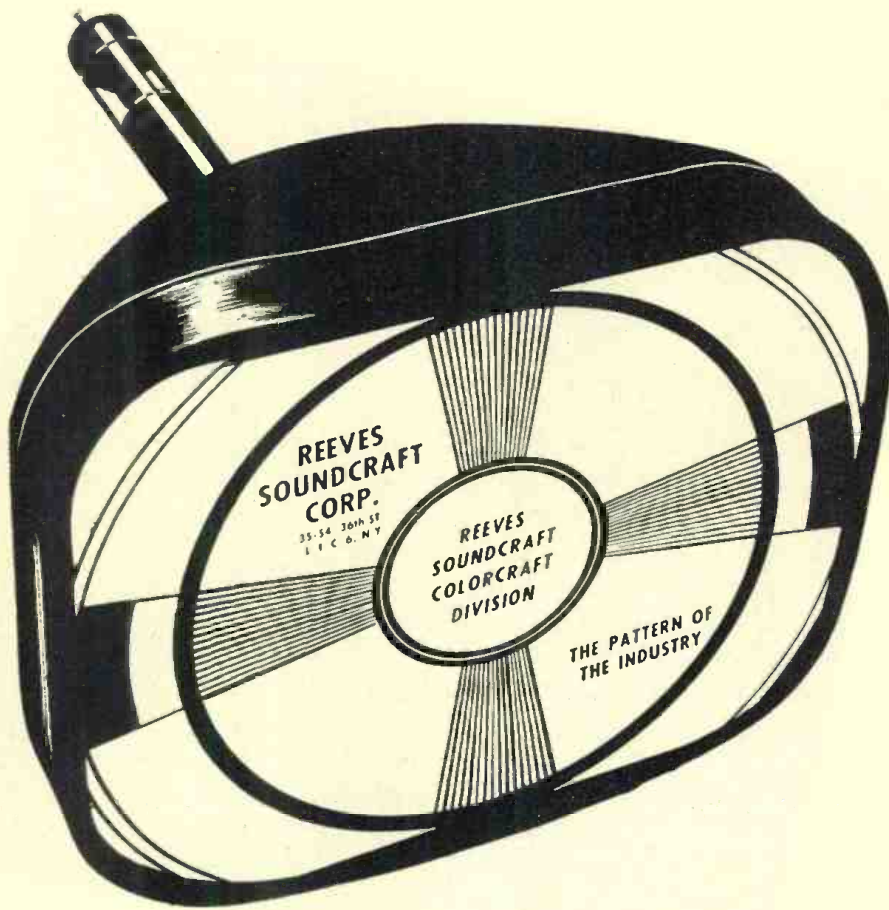

ing efforts toward maximum integration of military communications.

Aviation Communications

A close parallel can be drawn between the communication service required to support the operations of naval aircraft and that required by surface craft operations. In addition to the communication channels of tactical command, point-to-point flight operations require continuous circuits, fixed or mobile, between the point of departure and destination; continuous air-surface communication enroute; and reliable aids to navigation.

Similar functional communications apply to ships and aircraft, since both are mobile naval units with responsibility to operational commanders, with comparable ranges of operation, and need for full operating area coverage. Both have need for fixed circuits to provide command and supporting functions. Air-ground channels parallel ship-shore channel functions, with added air-surface ship channels being provided in the case of air operations with the fleet. Worthy of note is the mutual interdependence between installations provided for communication and for navigational purposes, voice transmissions being normally made over most radio aids to navigation, and normal radio channels being used on occasion for direction-finding purposes.

The preponderance of aeronautical communication is accomplished by voice radio, operated by the pilot, except when planes are at such distances from base as to necessitate radiotelegraph transmissions. Flashing light signals are useful between aircraft and surface craft under conditions where the use of radio is undesirable or impossible.

Communication Personnel

No matter how excellent the communication system, its effectiveness is no greater than the people who man it. That is why, in Naval Communications as in every other field, personnel is the most important factor. The Navy, in maintaining its Naval Communication Service, has a continuing need for both operational and technical personnel. The manual radiotelegraph operator, the wireline expert, the electronics technician, each finds an important job awaiting him.

The Future

In the past twenty years, tremendous strides have been made in the technological fields of communications. With faster ships, faster airplanes, and increased tempo in all fields, no communications organization can rest on its laurels. Continuing research has a prime objective of devising faster and more reliable means of communications. Naval Communications in the future, as in the past, will be quick to recognize new systems and techniques and to apply them wherever feasible, at all times working toward more reliable, secure, rapid and flexible communications.

FOR *Greater*
EARNINGS . . .

Learn

RADIO-
ELECTRONICS



Train for Success in TELEVISION, RADIO, RADAR and ELECTRONICS. Learn the application of RADIO-ELECTRONICS to Aviation, Petroleum Exploration and other industries.

You learn on the finest equipment. You build equipment. You may join Spartan's "Ham" Club. Many large organizations call on Spartan regularly for graduates. Often, students are hired months before graduation.

Spartan offers two complete, thorough courses, preparing you for Federal Communication Commission license tests—first class radio telephone, second class radio telegraph or class

"B" radio amateur.

SPARTAN

SCHOOL OF RADIO AND ELECTRONICS
TULSA, OKLAHOMA

Write Today!

MAIL COUPON TODAY

Spartan School of Radio and Electronics
Tulsa, Oklahoma, Dept. RTN-12

Please send complete information.

Name _____ Age _____

Street _____ City _____ State _____

G. I. Approved—Write Today

TESCO

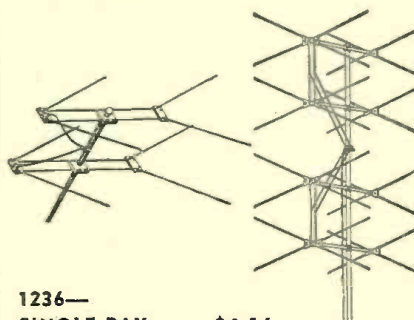

1236—
SINGLE BAY \$4.16

1237—
DOUBLE BAY \$8.32

NO. 1231
\$18.95

- 1230—Double Bay Conical \$8.69
- 1215—Swift Rig Folded Hi Folded Low 4.88
- 1814—Economy Chimney Mount . . . Dozen lots 1.20
- 1302 to 1306—Five El Yagi any Lo Channel . . . 12.38
- 1307 to 1313—Five El Yagi any Hi Channel . . . 5.45
- 1219—Swift Rig Folded Hi Straight Lo 4.47
- 2102—DeLuxe Indoor Antenna 2.25
- 1860—Chimney Mount Dozen lots 1.40
- 1905—3 1/2" Mast Snap On Standoff Per 100 4.00
- 1873—3 1/2" Mast Standoff Insulator Wrap
Around 6.50/C
- 1872—4" Nail In Insulator—lots of 250025
- 1870—3 1/2" Wood Screweye Insulator—lots of 250 .025
- 1229—Single Bay Conical 4.16
- 1231—Four Bay Conical 18.95

Send for quantity prices and complete list

TELEVISION SUPPLY CO.
Box 213 Gracie Square Station
New York, N. Y.



*We agree that it's hard to believe,
but here it is in the amazing new*

F-A-S AUDIO SYSTEM

ONE expert after another has listened to the FAS Audio System and summarized its performance as the greatest advance in sound reproduction since the days when headphones and mechanical phonographs were superseded by loudspeakers and electrical pickups.

More than five years were spent on perfecting the basis of this system by the inventor, E. T. Flewelling. He has this to say about it: "I have never made any claims for this system, because audio reproduction is something very personal to each listener. However, some five hundred experts have listened to installations of this design, and all agree that it is the most realistic and enjoyable reproduction they have ever heard."

Here are typical comments (with explanatory notes) made by those who have listened to the original test installation, but were not given technical information on its design:

BROADCAST ENGINEER: "You must use 150 watts at the low frequency end to get such a tremendous effect from the drums!" (Nominal output is less than 5 watts)

AUDIO CONSULTANT: "I'm satisfied that the only speakers in this room are the 8-in. and tweeter speakers set up on plain baffles, but it's impossible for them to deliver the quality that I am hearing!" (There's more to the FAS than meets the eye)

MUSIC CRITIC: "I can feel the vibration from low organ notes, just as I do in the big churches!" (Yes, that's quite true, even down to 32-ft. pipes) "And I still feel those low notes with the volume down almost to the limit of

audibility!" (True again. There's a feeling of vibration in the air, and in the floor, too)

AUDIO ENGINEER: "It sounds to me as if you have invented a new type of speaker with a flat efficiency characteristic down to 27 cycles, or an amplifier which increases enormously in output at the low end. But you tell me that you are using only a pair of 6L6's!" (Only conventional, low-priced speakers are used, and standard audio components)

VIOLINIST: "This is the first time I have heard reproduction when I could distinguish between a violin and a viola!" (That realism, plus a truly amazing presence effect, are characteristic of the FAS)

RADIO MANUFACTURER: "This is luxury performance. Few people can afford such installations!" (The cost is as surprisingly low as quality is high)

ORCHESTRA CONDUCTOR: "I have always tired quickly of listening to radio and phonograph music, but I have listened to this all evening!" (There seems to be no fatigue-factor in the FAS)

CUSTOM DESIGNER: "I can sell any number of jobs like this. How long before I'll be able to get the parts necessary?" (They are available now from any parts jobber.)

Here's how you can find out all the things that those people weren't told when they listened to the FAS:

The details of the FAS system are now being released in a series of exclusive articles in *FM-TV Magazine*.

Our own Fowler-Allison-Sleeper group spent six months on final checks of the design and performance of the equipment revealed in this series.

We do not hesitate to promise that you will find these articles on the FAS method of radio and phonograph reproduction the most intriguing and challenging ever written on any audio subject.

They present an entirely new concept of audio quality, based on speaker sound-power output, with revolutionary possibilities for designing custom installations. Most striking of all, you will learn how to get full 20-cycle response from a speaker that people can't see or locate!

GET COMPLETE DATA

The first article of this series describes the amplifier, operating with a radio tuner and either a crystal or reluctance pickup. The second reveals the amazing speaker system, and explains the construction of the crossover network. In the third, you will find data on the use of standard amplifiers for driving the FAS speakers. Subsequent articles will show special-purpose modifications, and completely new types of custom installations.

Because *FM-TV Magazine* is sold only by subscription, our supply of extra, single copies is very limited. Accordingly, since you will want the complete series, we urge that you enter a year's subscription to start immediately. The first issue will be worth the subscription price!

FM-TV MAGAZINE

Published by Milton B. Sleeper

Radio Building Great Barrington Massachusetts

December, 1950

FM-TV MAGAZINE Radio Building Great Barrington, Mass.
Please enter my subscription to start with the first article on the FAS Audio System, so that I will have the complete series. I enclose:
<input type="checkbox"/> \$3.00 for 1 year (12 issues)
<input type="checkbox"/> 6.00 for 3 years (36 issues)
YOU SAVE \$3.00
Name
Address
Foreign, add \$1.00 per year — Canada 50c



MAY 1950 ISSUE

**63 MANUFACTURERS
575 MODELS
MOST COMPLETE
UP-TO-DATE LISTING**

Get this easy-to-use, time-saving guide to exact replacements for all popular television receivers. Simplifies servicing, cuts repair-bench time. Write us today for your free copy!

**WATCH FOR Merit's
future issues of the
TV "Repl" Guide**



TAPE-MARKED TO HELP YOU!
Handy tape marking on every Merit Transformer shows permanent hookup data for quick reference.
Originated by Merit

MERIT TRANSFORMER CORP.
4437 NORTH CLARK ST., CHICAGO 40, ILL.

RADIO-TV Service Industry News

**AS REPORTED BY THE
TELEVISION TECHNICIANS LECTURE BUREAU**

**A new series devoted to the service industry.
Answers to your many problems will be covered.**

THE early enigma of television was the riddle of television service. Would the radio service industry eventually take over and handle television servicing? Or would it demand an entirely new type of service business expressly designed to handle the peculiar service requirements of this new medium of entertainment in a manner that would keep the public happy with their sight and sound receivers?

Those were the questions of three years ago. What is the over-all television servicing situation today?

While it is still too early to say that a definite business pattern for rendering successful and satisfactory television service has been established, the trends that will eventually determine the character of that pattern become clearer every day. It is obvious that this is one service industry whose future will be largely molded by the users of its products. John Q. Public has clearly demonstrated that he wants reliable, efficient television service—not cheap service—and he is showing that he will play an important role in the creation of the kind of television servicing industry

that he will support. He is throwing his weight around in quarters where it receives immediate attention by the pressures he is already applying through the Better Business Bureaus in practically every city where telecasting stations are located.

It is obvious that the acceptable audio deficiencies of AM radio that kept the public apathetic about the quality of service on aural receivers cannot and will not be tolerated in TV receivers. The ears of the general public were never critical about sound reproduction. But the eyes are sticklers for picture perfection. When a set is adjusted or repaired the picture must be good—or else.

This one factor alone, with the picture tube as a vigilant detective revealing servicing inefficiencies, will stimulate a capable, efficient, business-like service dealership and provide an effective deterrent against the ruinous price competition of neighborhood screwdriver mechanics and "electronic do-gooders."

We have already seen that when a family becomes television conscious the family life is readjusted to the schedule of video programs. And the

Ed Noll's discussion of antenna types is of special interest to this attentive audience in Reading, Pa., most of whom are service shop operators who have an antenna problem to solve on every television receiver installation. The equipment visible on the lecturer's table was used in the television servicing demonstration that was given as a part of the "Radio-TV Service Industry Day" program. The complete schedule of lectures and demonstrations was presented in Reading by the Television Technicians Lecture Bureau under the sponsorship of the George D. Barbey Co. stores in that area.



Happy Holidays to You

FROM **BUFFALO RADIO SUPPLY**



KITS & ASSORTMENTS

- Silver & Mica Condensers.....100 for \$4.95
- Ceramic Condensers.....15 for .95
- Resistors 1/2 & 1W.....100 for 2.95
- Wire wound resistors including adjustable and tapped.....12 for 1.00
- Rotary Switches.....6 for 1.75
- Grid & P1. Tube Caps Asst. 35 for 1.00
- Coil Forms Asst.....50 for 1.00
- Knobs Asst.....50 for 1.00
- Fuses Asst.....100 for 1.95
- Spaghetti Sleeving Asst.....75 for 1.00
- Solder Lugs.....300 for 1.00



DELUXE AC-DC RADIO KIT

High quality standard production line RADIO in kit form with complete instructions. No other advertised kit, regardless of price, offers these features. 2 Iron Core I.F. transformers. Polyethylene insulated edge-wound antenna loop. 2 gang condenser. Tubes include 12AT6, 12BA6, 12BH6, 50B5, and 35W4. Receives Broadcast Band from 550 to 1700 KC. Kit is \$8.75 or 2 for \$17.00. Assembled, wired and tested, \$12.95 or 2 for \$25.00.

Transvision 7" television kits complete with everything but cabinet, regular wholesale price, \$149.50. Your special bargain price.....\$69.95

A BETTER RAT TRAP (Or From Blind Mice to Electric Eyes)

We offer a limited quantity of sensitive photo-cell amplifiers complete with tubes, including the photocell. These were taken from an ingenious rat trap manufactured by the Krypton Optical Company of Rochester, N. Y. for use in flour and feed mills, etc., all over the world, in killing rats. This was done when the rodents interrupted a light beam, setting off a mechanism which electrocuted them. These amplifiers are useful for traffic counting, checking units in a production line, for opening garage doors, for burglar alarms, for smoke detectors on chimneys or fire alarms, for turning on street lights at dusk; and many other applications. Super Special, completely wired—\$9.95. Kit Form—\$6.95.

MICA CONDENSERS
100 assorted mica condensers, special \$3.95.

CHRISTMAS GIFT SUGGESTIONS

HEAT GUN

Streamlined pistol grip heat gun in vivid red housing, that delivers a Powerful 20 Cubic Ft. per minute blast of hot air at 160° Fahrenheit. Ordinary blowers have small fan motors, but this has a lifetime-lubricated AC-DC motor of the rugged vacuum cleaner type, that produces a hurricane of either hot or cold air. Perfect for blowing out dirt or dust, drying out ignition systems, warming up carburetors, drying paint, thawing out radiators, etc. Warning—Keep this away from your wife, or she will be using it to dry her hair because it will do it in half the time of her ordinary hair dryer, to say nothing of her using it to dry stockings or clothing, or defrost the refrigerator instantly. Only \$12.95. Satisfaction guaranteed or money refunded if returned prepaid within 5 days.



Drillmaster Electric Drill

A Terrific Christmas Gift. (But our stock won't last until Christmas.) Pistol Grip electric drill, ideal for hobbyists. Complete with sander, buffer, grinding wheels, etc.....\$9.95

Admiral Record Changers in metal cabinet. Play 12-10" or 10-12" records. Latest high output featherweight Shure Crystal cartridge. Free removable permanent needle. Original factory carton. Worth double our price of \$19.95 complete.

Mike with Push-to-Talk Switch \$0.98
War Surplus Headphones \$1.50 per pair
Guaranteed in Good Condition

SENSATIONAL VALUE IN AC-DC POCKET TESTER

This analyzer, featuring a sensitive repulsion type meter housed in a bakelite case, represents the culmination of 15 years' achievement in the instrument field by a large company specializing in electronic test equipment.

Specifications of the AC-DC Model Volt-Ohm-Milliammeter:
AC Volts—0.25, 50, 125, 250
DC Volts—0.25, 50, 125, 250
Milliamperes AC—0 to 50
DC Milliamperes—0 to 50
Ohms Full Scale—100,000
Ohms Center Scale—2400
Capacity—.05 to 15 Mfd.
Total Price, prepaid anywhere in the USA—\$7.00. Similar DC Meter, lacking the AC operated ranges of above, \$5.50 prepaid.

Super Special Condenser Bargains

- 40, 20, 20 MFD—150W condensers with common negative—55c or 10 for \$5.00.
- 20, 20 MFD—150W. plug in condensers, 40c or 10 for \$3.50.
- 8 MFD 475 W.V. Tubulars 35c or 10 for \$2.90.
- 16 MFD 475 W.V. Tubulars 55c or 10 for \$3.90.
- 8+8 475 W.V. Tubulars 60c or 10 for \$4.20.
- 8 MFD 475 W.V. Screw neck cans 65c or 10 for \$5.50.
- 16 MFD 350 W.V. Screw neck cans 65c or 10 for \$5.50.
- 10 MFD 450 W.V. Twist Lug 35c or 10 for \$2.90.
- 10+10 MFD 450 W.V. Twist Lug 60c or 10 for \$4.20.
- 10+15 MFD 450 W.V. Twist Lug 70c or 10 for \$6.00.
- 20+20 MFD 450 W.V. Twist Lug 80c or 10 for \$7.00.

Multi-Range Model 458 AC-DC Volt-Ohm-Milliammeter with Output Ranges

Specifications:
Volts DC: 0-5/10/50/100/500/2000-1000 Ohms per volt
Volts AC: 0-125/25/125/150/250/1250
Milliamperes DC: 0-1/10/100
Milliamperes AC: 0-2.5/25/250
Ohms Full Scale: 1000/200,000/2,000,000
Ohms Center Scale: 50/2250/22,500
Output: ± to +55 Decibels
This versatile instrument has a large 5 1/2" rectangular meter with two-tone aluminum scale, set at a 45° angle, to facilitate greater reading ease. Welded steel case, finished in brown wrinkle. All multipliers are bridge selected within one percent. Furnished with test leads. Shipping weight 8 lbs. Special \$26.00.



WE CAN MAKE IMMEDIATE DELIVERY ON THE FOLLOWING TUBE TYPES IN REASONABLE QUANTITIES

2A5 ... \$1.10	6J5 ... \$0.90	12AT6 \$0.90
2X2 ... 1.50	6J6 ... 1.74	12SL7... 1.40
5V4 ... 1.44	6K699	2680
5Z375	6K799	2780
5Z3 ... 1.08	6L6 ... 1.60	32L7... 1.50
6AC7 ... 1.74	6R7 ... 1.59	50 ... 1.25
6A15 ... 2.34	6SA799	5685
6AK5 ... 2.34	6SC7 ... 1.20	7689
6AK6 ... 1.44	6SD7 ... 1.40	7789
6E7 ... 1.50	6SF790	7880
6C480	6SK780	8080
6C6 ... 1.20	6SQ775	8490
6D599	10 or 210	85 ... 1.05
6F7 ... 1.73		117L7... 2.34

Many of the above are JAN tubes. Manufacturers quantities on some of the above. No price reduction while present shortage lasts.



HOME WORKSHOP AT BARGAIN PRICE. Accurate and Precise 2 speed guaranteed hobby lathe, the essential machine for the home workshop. Sturdy enough for light production work or factory stand-by service. Supplied with 50" of belting for connecting to any available electric motor or power take-off. Also included in this unbelievable offer are such accessories as a 1/2" drill chuck with specially hardened tool steel jaws, a 4" electric furnace high speed grinding wheel, a cotton buffing wheel and a large supply of buffing compound, and a 4" steel wire scratch brush. Your cost \$6.00. Sole export agent. Distributor in U.S.A. included.

"THE BIGGEST SHOW ON EARTH"

9-foot by 7-foot picture Compact—Self Contained—Portable For Theaters—Auditoriums—Churches—Institutions—Hospitals Imagine Clear, Bright, Steady TV with figures on the screen—

AS LARGE AS LIFE!!!

Picture can be regulated in size from 6 to 63 square feet. Colonial Vision Master projection model TV has 39 tubes, is complete with all accessories, including movie screen, and is fully guaranteed.

Regular price \$2195.00
Special Net—\$795.00

Bright Star "Flashlights of Tomorrow"

6 beautiful unbreakable plastic 2 cell flashlights on cool display card with 12 free batteries. Flashlights alone worth \$9.00. Your cost for this bargain \$4.95.

Musical Instrument or Contact Microphones

Assembly complete with two Microphones. On-Off Switch. Amplifying Transformer. Batteries. Battery Case and Connector to attach to any radio; AC, DC, or battery portable. Tremendous amplification up to the full volume output of the radio or sound system used. Perfect for watch or clock repair diagnosis, diesel engine injector adjustment, gasoline engine trouble shooting, or for use on any musical instrument with dance band or orchestra. Worth \$30.00. Your cost \$4.95.



COMPRESSED AIR INSTANTLY ANYWHERE

Portable Air Compressor and storage tank. Ruggedly built. Best materials. Lifetime lubricated ball-bearing on connecting rod and oil-impregnated main bearing on shaft. Unusual design forever eliminates valve trouble, the most common fault in air compressors. PATENTED unique air intake system increases efficiency tremendously so that air output is much greater than that from larger compressors powered by heavier motors. Delivers approximately 3500 cu. inches of air per minute at maintained pressure of 100 lbs., or will inflate a 60 lb. truck tire in less than one minute. Complete with 100 lb. gauge. Finger-tip adjustment allows setting of output pressure at any value, which will automatically be maintained. Works from any 1/2 H.P. motor. Useful for spraying paint, lac-ers, disinfectant, insecticide, annealing or brazing with natural gas, inflating tires, etc. Price \$4.50 postage prepaid anywhere in the U.S. Efficient, completely adjustable siphon type spray gun complete with 12 ft. of 100 lb. tested hose, only \$7.75 with pint container, also prepaid.

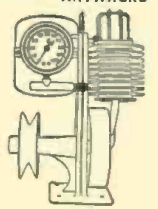

TRANSFORMERS

AUTO-TRANSFORMER—Steps up 110v. or steps down 220v. to 110v.—\$2.95.
FIL. TRANSF.: 6.3v. 1 Amp.—\$1.00; Universal Output Trans. 8 Watt—89c; 18 Watt—\$1.20; 30 Watt—\$1.69. AUDIO TRANSFORMER: S. Plate to S. Grid. 31—79c; S. Plate to P.P. Grids—79c; Heavy Duty Class AB or B. P.P. input—\$1.49; Midget Output for AC-DC sets—69c. MIKE TRANSFORMER for T-17 Shure microphone similar to UTC output type—\$2.00. Stancor SB or DB make to line or grid—\$1.95.

POWER TRANSFORMERS—Half-shell type, 110V. 60 cy. Center-tapped HV winding. Specify either 2.5 or 6.3V filament when ordering.

- For 4.5 tube sets—650V, 40MA, 5V & 2.5 or 6.3V.....\$1.75
- For 5-6 tube sets—650V, 45MA, 5V & 2.5 or 6.3V..... 1.90
- For 6-7 tube sets—675V, 50MA, 5V & 2.5 or 6.3V..... 2.35
- For 7-8 tube sets—700V, 70MA, 5V & 6.3 or two 2.5V..... 3.00
- For 7-8 tube sets—700V, 70MA, 5V & 6.3 (25 Cycles)..... 4.50
- For 8-9 tube sets—700V, 90MA, 5V-3A, 2.5V-3.5A, 2.5-10.5A... 3.50
- For 9-11 tube sets—700V, 5V & 6.3V..... 3.50
- For 9-15 tube sets—700V, 150MA, 5V&6.3V..... 4.00



BUFFALO RADIO SUPPLY, 219-221 Genesee St., Dept. RN-12, BUFFALO 3, N. Y.

Insist on VEE-D-X

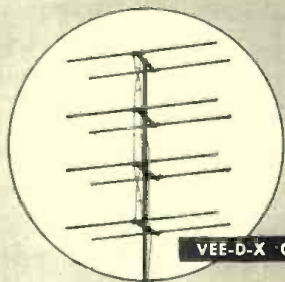

VEE-D-X Colinear

THE WORLD'S

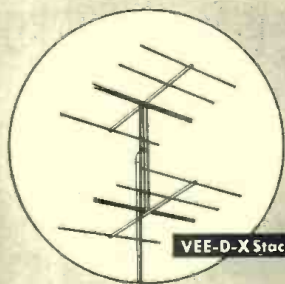

VEE-D-X Stacked Yagi

MOST POWERFUL



VEE-D-X Yagi

TV ANTENNAS

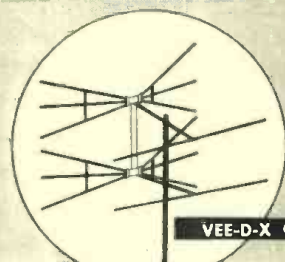

VEE-D-X Conical

LaPOINTE-PLASCOMOLD CORP. 3
WINDSOR LOCKS, CONN.

Please send me new 1951 catalog of VEE-D-X
antennas and accessories.

NAME _____
STREET _____
CITY _____ ZONE _____ STATE _____

trends indicate that video families will have the telephone number of their TV service dealer or contractor at the top of their "emergency call" lists. The governing factor in their selection of a television technician will not be price. It will be based on the speed, quality, and efficiency of the services rendered.

An analysis of hundreds of complaints about video service shows that such complaints don't arise because the customer feels that he was overcharged but because he feels that the technician failed to adjust or repair the receiver satisfactorily.

Public consciousness of the need for reliable television service is reflected in an excellent article in the October issue of "BETTER HOMES AND GARDENS" magazine under the title, "Look Out for Television Tinkerers." This article points up the important policing function that could be performed by a national organization of independent service contractors and service dealers patterned after the successful contractor organizations now operating in Chicago, Philadelphia, Boston, Los Angeles, and many other Cities. Members of these organizations adhere to a very strict code of ethics in the conduct of their businesses. Customer satisfaction with the members' services has been so satisfactory that in several cities the Better Business Bureaus have turned to these organizations to check user complaints and to help weed out the racketeers in television servicing.

The importance of a "good general press" to well-managed, honestly-operated service businesses was quickly and dramatically demonstrated as soon as this issue of "BETTER HOMES AND GARDENS" reached its readers.

The telephone of Paul V. Forte, executive secretary of the *Television Contractors Association* of Philadelphia,—one of the organizations named in the article—was kept busy by television owners requesting the name of some member of TCA who could fix their receivers. In every case, these people had been "stuck" by some so-called television service company, usually selected at random from the telephone directory by the customer.

Typical of the "gypery" that was being practiced was the experience described by one customer who phoned for a TCA contractor. She had picked the name of a television service company from the telephone directory and phoned to ask whether they could send a man out to adjust her receiver on one channel that was giving her trouble. The service company informed her that there would be a five dollar service charge for the call and she said that was all right. The next day a technician called at her home, switched the receiver to several channels and observed it briefly on the defective channel. Then he turned off the set. "The trouble is in your antenna," he said. "We don't work on antennas so you will have to call an installation company." He wouldn't

The Improved 1951

Concertone RECORDER



Model 1401

"just like
being there"

- Equalization conforms to NAB recommended standards • Extended frequency response—40 to 15,000 c.p.s. \pm 2db • Tape noise down to random level • More powerful drive motor • Improved braking system • Monitors directly from tape while recording • Plays up to 10½" NAB reels • Write for Bulletin No. 102.

MODEL NO. 1401—Complete for console installation, with dual track heads.....

\$345.00

Manufactured by

USER'S NET COST



Berlant Associates

4917 W. Jefferson Boulevard
Los Angeles 16, California

The BROOK High Quality AUDIO AMPLIFIER

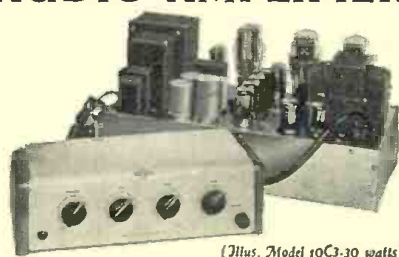

(Plus, Model 10C3-30 watts)
Also available: Model 12A3-10 watts.

All Low Mu Triodes Plus Brook made Transformers Plus Brook's own Circuits	}	Finest Audio Quality you ever listened to Minus Listening Fatigue Plus High Quality at extremely low volume Plus High quality at the full loudness of a band or symphony
---	---	---

"You can believe your ears when you listen with a Brook Audio Amplifier"

Write TODAY for FREE Technical Bulletin and Detailed Distortion Analysis

BROOK ELECTRONICS, Inc.
Dept. RL-O, 34 DeHart Place • Elizabeth, N. J.



Al Saunders explains use of a high voltage measuring device to W. R. Brown, chairman of Electronics Technicians Association of Toledo, Ohio, and several other service shop operators of that city. Mr. Saunders has pioneered many ideas for improving the efficiency of television servicing and is explaining these new methods to technicians attending his Television Technicians Lecture Bureau speeches.

recommend an installation company, collected his five dollar "service charge" and left.

These service racketeers can be weeded out through the combined efforts of the competent independent service dealers and contractors in co-operation with other segments of the radio-television industry. However, the independent service contractor or dealer must be willing to relinquish some of his "rugged individualism" in working in an association for the improvement of his business.

Since the successful operation of a television service business depends more on the management ability of the owner rather than on his individual technical knowledge or skills, there is a decided movement among competent television service dealers and contractors in all sections of the country to join in a concerted effort to improve the efficiency and effectiveness of independent TV service.

Aside from the inherently dishonest men who jumped into the television service contracting business to pick some "fast money" without any thought of building a business or rendering honest service for the contract dollars they received, most failures in the television servicing business are caused by mismanagement or by a complete lack of management ability on the part of the owner. The major factors in mismanagement leading to failure fall into three categories:

1. Over-expansion. Requirements for capital investment in trucks, installation equipment and supplies, shop equipment and replacement parts were met by using the contract monies that should have been escrowed for payroll and supply needs in fulfilling the 12-month terms of the contract agreements. These organizations ran into financial difficulties almost immediately when their volume of new contracts tapered off.

Many operators, particularly experienced radio service dealers, whose organizations rapidly mushroomed to an unwieldy size, saved their businesses by curtailing their operations and accepting only enough service and

AMAZING Automatic Radio SELF-CHARGING PORTABLE RADIO

RECORD SMASHING VALUES!

1949 and 1950
FORD AUTO RADIOS



List Price..... \$54.95

1949 and 1950
PLYMOUTH-DODGE RADIOS



List Price..... \$54.95

1949 and 1950
CHEVROLET RADIOS



List Price..... \$54.95

ATTRACTIVE DISCOUNTS TO DEALERS

Each auto radio is specifically designed to fit all 1949 and 1950 cars shown above and all incorporate the same outstanding features... Six-tube superheterodyne. Six-volt storage battery operation. Two dual-purpose tubes. Eight-tube performance. Installation in a few minutes. Three-gang tuning condenser and tuned R.F. stage for extreme sensitivity. Permanent magnet dynamic speaker with Powerful Alnico #5 magnet. Low battery drain. Weight 10 lbs.

SPECIALS

- R5/ARN-7 Radio Compass Receiver w/tubes. Used, excel. cond. \$34.95
- BC-433G Radio Compass Receiver w/tubes. Used, excel. cond. \$34.95
- Gibson Girl Distress Transmitter, complete with bag and parachute. New. \$8.95
- Gibson Girl Kit includes 2 balloons w/hydro. generators, kite, lamp, wire. New. \$8.95

CAPACITORS UPRIGHT MOUNT

	EA.	TEN.
2X.25MFD 400 VDC	.30	.25
.5MFD 400 VDC	.30	.25
1MFD 500 VDC	.30	.25
2X.05MFD 600 VDC	.30	.25
4MFD 600 VDC	.30	.25
2X.1MFD 600 VDC	.35	.30
.1MFD 600 VDC	.35	.30
.5MFD 600 VDC	.35	.30
1MFD 600 VDC	.35	.30
4MFD 600 VDC	.35	.30
10MFD 600 VDC	.35	.30
40MFD 50 VDC	.35	.30
4MFD 50 VDC	.45	.40
50MFD 50 VDC	.45	.40
4MFD 100 VDC	.45	.40
2X.1MFD 200 VDC	.20	.15
3X.1MFD 400 VDC	.30	.25
2MFD 600 VDC	1.45	1.40
.05MFD 600 VDC	.25	.20
.25MFD 600 VDC	.30	.25
.5MFD 600 VDC	.30	.25
1MFD 600 VDC	.30	.25
2MFD 600 VDC	.50	.45
2X.1MFD 1000 VDC	.55	.50
.05MFD 1000 VDC	.65	.60
2X.1MFD 1000 VDC	.65	.60
OIL FILLED 400 VDC	.35	.30
1MFD 500 VDC	.35	.30
1MFD 600 VDC	.35	.30
1MFD 600 VDC	.35	.30
2MFD 600 VDC	.40	.35
4MFD 600 VDC	.80	.75
5MFD 600 VDC	.85	.80
8MFD 600 VDC	1.10	1.00
1.8MFD 1000 VDC	1.45	1.35
10MFD 1000 VDC	1.60	1.50
.5MFD 2000 VDC	1.50	1.45
.25MFD 3000 VDC	1.95	1.75
1MFD 3000 VDC	2.50	2.00
.1MFD 7500 VDC	3.25	2.95
1MFD 7500 VDC	9.50	9.00
1MFD 12,000 VDC	12.25	12.00
.0008MFD 15,000 VDC	8.50	7.75
.045MFD 16,000 VDC	5.95	5.65
8-MFD Tube Filtermate 600 VDC	\$1.45	\$1.25
3X8MFD 600 VDC	\$1.75	\$1.45
8-MFD 650 VDC	1.75	1.45
160-160MFD 150 VDC	1.50	1.25
2500MFD 43 VDC	.20	.15
500MFD 12 VDC	.60	.55
25MFD 25 VDC	.25	.20
80MFD 30 VDC	.30	.25
1000MFD 25 VDC	.55	.50
150MFD 50 VDC	.30	.25

TRANSMITTING MICA

.002MFD 600 VDC	.20
.005MFD 2500 VDC	.25
.0038MFD 2500 VDC	.25
.005MFD 2000 VDC	.30
.0075MFD 5000 VDC	.90
.0075MFD 8000 VDC	.90
.003MFD 5000 VDC	1.80
.0015MFD 5000 VDC	1.50
.001MFD 5000 VDC	1.50
.007MFD 5000 VDC	4.10
.006MFD 6000 VDC	5.60
.0012MFD 20,000 VDC	15.95

VALUES

De-Lon Line Starter DPST 115V 60 Cy 15A 1 HP rating Westinghouse. New	\$4.95
Genuine Upright Desk Telephone and Ringing Box. New	\$4.95
1 Micro Second Delay Line 15 KVA 400 Cy 50 Ohm. New	\$14.95

The ONLY "SELF-CHARGING" Portable



RECHARGES the "B" Battery Features: Battery-AC-DC-Battery Charger Operation 5 Tubes Plus Rectifier 3 Gang Condenser Tuned RF Stage

List Price..... \$39.95

TUBES

2C34	.35	1G29	.50
2X2A	.70	2051	.75
2X2/879	.60	7183	.40
3C2A	.75	8011	2.40
7C4/1203A	.40	9006	.50
10Y	9.75	915	9.75
211	1.40	CEQ72	1.40
15R	.75	CK-70	3.50
39/44	2.25	CIP-72	1.40
45 SPEC.	.35	E1148	.30
203A	5.95	HY-615	.40
218	10.00	BKR-72	.75
316A	.75	RR-73	.75
WL-331	4.95	VT-127A	2.00
702B	2.50	VP-98	21.00
713A	.75	3BP1	3.45
801A	.40	3BP4	4.25
803	4.25	5FP7	1.95
826	.75	1J6G	.75
931A	3.60	3A4	.50
884	.45	88G7	.75
869B	23.95	6SJ7	.65
CK1005	.35	6Y8G	.95
CK1007	.30	12SN7GT	.65
192B	.30	33	.65

LINEAR POTENTIOMETERS WW

Ohms	Watts	Mfg	EA	Ten
200	2	Chicago Tel.	\$0.30	\$0.25
1000	2	Trefz	.30	.25
3000	2	Chicago Tel.	.30	.25
10,000	3	Trefz	.30	.25
7500	3	Trefz	.35	.30
10,000	3	Trefz	.35	.30
25,000	3	Wirtl	.35	.30
50,000	4	Trefz	.50	.45
15	25	Dejor	.65	.60
70	25	Ohmite	.65	.60
25	25	Dejor	.65	.60
50	25	Dejor	.65	.60
100	25	IRC	.65	.60
200	25	Dejor	.65	.60
25	25	Dejor	.65	.60
1000	25	Dejor	.75	.70
3000	25	Dejor	.80	.75
5000	25	Dejor	.85	.80
15,000	25	Dejor	.90	.85
20,000	25	Dejor	L00	.95
150/Switch	50	AN3155-50	1.10	.90
200/Switch	50	IRC	1.10	.90
800	50	Ohmite	1.10	.95
10,000	50	Dejor	1.75	1.50
15	60	Ohmite	1.50	1.25
15	75	IRC	1.50	1.25
750	150	Ohmite	2.45	2.10

ROUND PANEL METERS

0-5 RF Amps—Westing	3 1/2"	\$4.50
0-300 MA DC—Simpson	2 1/2"	3.75
0-300 MA DC—Westing	2 1/2"	3.75
0-5 MA DC—Weston with	50 MA Shunt	3 1/2" 4.25
0-50 Amps DC—Weston	3 1/2"	4.75
0-100 Amps DC—Hoyt	3"	3.50
0-3 Volts DC—Sun	2 1/2"	1.95
0-15 Volts AC—DC	3 1/2"	4.95
0-2500 Volts DC—Simpson with Multiplier	3 1/2"	5.95
0-5KVDC 0-10 MA DC	3 1/2"	5.50
0-150 Volts DC—Hoyt	3 1/2"	3.50
10-0-60B—Weston	2 1/2"	4.50

PORTABLE METERS

0-10 Amps DC—Weston	489	7.50
0-3-30 Volts DC—Weston	280	17.50
0-100 Amp DC—Weston with 100 AMP Shunt	269	19.95
0-25 Amps AC—Weston	433	29.95
0-1.5-6 Volts AC Output-meter—Weston	571	12.00

TIME DELAY SWITCHES

1 Minute 120V 60Cy Enc. in Watertight Metal Case. New. \$5.25

3 Micro Switches Make Contact at 40-41-42 Sec. Time Delay 110 VAC Motor. New. \$4.00

Thermo Switch 50° to 300° F. 115 VAC @ 5A 230 VAC @ 5A Breaks Contact with Increase of Temperature. New. \$1.35

30-40 Second Mercury Time Delay Relay 110 VAC Adia. New. \$6.50

POWER EQUIPMENT

Voltage Regulator Raytheon 95/190 V 60Cy 1.25 Amp Output 115V 60 Watt. New. \$9.50

Generator Voltage Regulator 115V 400CY GE-CRA-20C. New. \$4.95

Vibrapak VPG 360 12VDC Output 250V @ 70MA Synchronous Maltray. New. \$5.95

ATR Inverter and Regulator 12VDC to 110VAC 50/60 Cy 100 Watt Model 100. New. \$16.50

Vibrator ATR 2410 24VDC Output 110V 100W. New. \$2.50

RELAYS

6 VDC DPST Contacts 6A Coil	12	30
12 VDC DPST Allied Control	3	.65
# Box 32		1.25
12 VDC DPST 64 Ohms		.60
24 VDC DPST Allied B36D36		.60
24 VDC 3PDT Amp.		.95
24 VDC Solenoid Operates 2 Switches		1.25
40 VDC DPST-SPDT 1000 Ohm		.80
110 VAC DPST 1 Amp Contacts Strith's Dunn CNA 1970		3.65
110 VAC DPST 25 Amp Contacts Ward Leonard		3.95
115 VAC DPST Strith's Dunn CNA-2097		3.65
220 VDC DPST Strith's Dunn CX212		4.50

RECORD—REPRODUCER

Sound-on-Film Hartron Recorder. Reproduces 7.5-30 with Crystal Mike. Acces.—Inst. Book.—Plays Back Immediately. Necessary of Film Recorder. Brand New. \$170.00

MN-26V Radio Compag Recorder. New. \$39.95

SPECIALS

80.86 KC Crystal with Holder	\$1.50
CD-501A Cord Connects	10C.
654 Transistor to GN-45 Gen.	
Balloon with Hydrogen Gen.	1.59
Gibson Girl Box Kite 17"x17"x17"	2.50
36"	2.25
33-440 MMF Variable Condenser	.79

TERMS: Minimum order \$5.00—Mail orders promptly filled—All prices F.O.B. Boston, Mass. Send M.O. or check. Shipping charges sent C.O.D. 25% deposit required with all C.O.D. orders

Prices Subject to Change without Notice

SEND FOR OUR CATALOGUE

Inquiries from Dealers, Schools and Industrial Firms Invited

COMET ELECTRONIC SALES CO.

22 Washington St. Brighton 35, Mass.
Beacon 2-7863

GOLDEN WAND

INDOOR Television ANTENNA

Check THESE 5 EXCLUSIVE FEATURES POINT BY POINT!

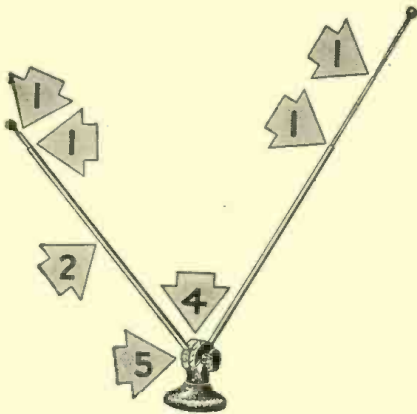

MODEL G84TV—3-section polished finish dipoles. Adjustable friction holds dipoles at any angle. Heavily weighted, felt padded base, gold finished. Harmonizes with any room or set. Supplied with 300-ohm lead-in.
LIST PRICE \$6.95

1. **Phosphor bronze** shims at all telescoping joints for **better** electrical contact. Constant tension; jamless telescopic action.
2. **Admiralty brass** dipoles for **better** electrical conductivity. Stronger; will not rust or corrode.
3. **Polystyrene** base for **better** insulation. Terminals completely housed to prevent lead breakage.
4. Terminals completely housed. No strain on terminals, hence breakage of wires impossible.
5. **Polystyrene** insulators for **better** insulation.

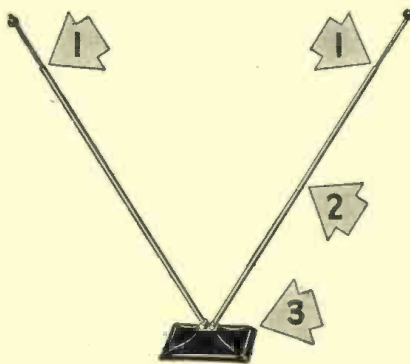

MODEL 50TV—2-section satin finish dipoles. Automatic friction holds dipoles at any angle. Walnut-mahogany polystyrene base, felt padded, heavily weighted. Will not tip when fully extended. Slot in base for mounting on wall, window frame or ceiling. Harmonizes with any set or furnishings.
LIST PRICE \$6.95

PEERLESS PRODUCTS INDUSTRIES

814 North Pulaski Road, Chicago 51, Illinois

**MORE LIGHT
MORE HEAT**
THAN ANY OTHER INSTANT
HEAT SOLDERING TOOL



**PHILLIPS
VERSA-
TOOL**

**NEVER BEFORE
THESE FEATURES**

No job too heavy or too delicate for the Phillips Versa-Tool. Compact, 110-115 Volt AC, 310 Watts, the Phillips Versa-Tool was designed for perfect balance and ease of operation.

- **Rigid Copper Tips**—Four interchangeable tips that absolutely won't sag or bend under pressure.
- **Infinite Heat**—Heat continues to build up as long as trigger is depressed.
- **High Intensity Light**—A concentrated light beam focused where it eliminates all shadows.
- **Two-Position Switch**—Position 1 gives operator light only. Position 2 gives both light and heat.

FOR COMPLETE DETAILS WRITE TODAY

Phillips Mfg Co.

2816 Aldrich Ave. S., Minneapolis, Minn.

STOP



those
costly
service
calls
with . . .

**ELECTRO
ANTENNA KOTE**

A newly developed Chemical compound of various Resins, Gums and Synthetics, **ANTENNA KOTE** is recommended for safely coating all exposed exterior television connections.

Dielectric Strength — Volts/Mil 1050.

(May be used for arrest of voltage leakage)
Dries hard in 8 hours.

(A non-electrical conductor)
Eliminates rust and corrosion.

(Does away with the use of tape)
Excellent resistance to heat, oil, acid, salt water, chemicals and moisture.

A Complete Line of Electronic Chemicals
Exclusive territories for sales representatives.
Write for particulars . . .

DAKOLINE CHEMICAL CO., INC.
ELECTRONIC CHEMICALS DIVISION
357 Atlantic Ave., Brooklyn 2, N. Y.

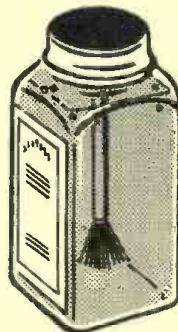

installation business to keep a smaller organization busy. Optimum size of any individual organization from the standpoint of personnel employed is determined by several factors. The first factor is the ability of the owner as an employer, manager, and executive. The second is the density of the population in the area where the business is located. And the third is the capital available for investment in capital and working equipment.

2. Inability to organize office and operating routine to provide for the efficient scheduling of the time of field and shop personnel is another contributing factor to failure in a television service business. Lost time is definitely lost money in any service business because the major product it sells is **TIME**.

3. And an unflinching red light against successful operation of a TV service business is the failure to set up an accounting to furnish the manager with accurate figures on his costs of operation. Lack of essential information on operating costs has long been the bane of radio service and the cause of most of its profitless pricing. But where the radio service operator might continue in business and eke out an existence despite his unsound pricing methods, it will soon put the television service operator out of business because of the broader scope of his commitments. As one television contractor expressed it—"When I found at the end of my first year in TV service that it had cost me \$11,000 to handle \$10,000 worth of service business I realized that I had to have accurate cost accounting records or I'd soon be out of business."

Whether the 12-month service contract is good or bad for the independent service contractor has long been a prime subject of discussion at meetings of television service contractors. They agree unanimously that the 12-month contract that calls for unlimited service is not sound; that it is not good business to commit your organization to supply an unknown amount of service over a long period of time for a fixed fee. Some contractors, however, look with favor on the limited service type of contract which provides for a maximum of six calls over the 12-month period and for which the standard charge in most cities has been \$30.00. But at the present time with the certain prospect of rising wages, increased costs of transportation, parts, etc., any long-term service commitment at a fixed price is economically unsafe.

The majority of contractors are now accepting only the 90-day service policies and they carefully avoid any commitments on the "one-year parts warranty" agreements that a number of receiver manufacturers have forced upon their distributor and dealer organizations as "tie-in" sales. These one-year parts warranty agreements have cost the independent service industry many thousands of dollars because of the restrictions and red-tape involved in getting replacements un-

RADIO & TELEVISION NEWS

der the warranty agreements from some of the distributors and manufacturers. In order to protect themselves, service contractors now charge the customer for the replacement parts used to repair a set and then give him a "due bill" for the parts from the set distributor. When the distributor supplies the parts replaced under the warranty agreement the service contractor refunds the charges to the set user.

While attention has been focused on the booming business of television installation and service, the production and sale of AM radio receivers has zoomed upward again to record heights. It would pass all previous records during this year if the necessary parts, tubes, and production facilities were available. Eight and one-quarter million AM radios were produced during the first eight months of 1950 and it is expected that the year's output will reach 12½ million.

Add to this record production of AM sets the many thousands of wire and tape recorders that the general public has purchased during the past three years and the countless number of automatic record changers of various speeds and it spells out a market for radio and electronic service that will keep many thousands of competent radio service shops profitably—or at least busily—occupied for many years to come.

Surveys that have been conducted in various parts of the country show that an immense volume of service business on AM radios, record players, and recorders is available to service dealers who solicit this business aggressively. As an example, the market for replacement phono cartridges is tremendous. Although most dealers recommend the replacement of the phono cartridge when record players or automatic changers are in their shops for service, very few dealers have ever employed a studied plan for soliciting this profitable plus-business.

Several simple, inexpensive service-sales promotional campaigns have been found successful. And they bring in more service work than the replacement cartridge business. Space does not permit a complete discussion of these excellent sales-service promotional campaigns in this article but the details of how to conduct them will be sent to any radio or TV service dealer who writes to RADIO & TELEVISION NEWS (Dept. SR-3), 185 No. Wabash Ave., Chicago 1, Ill.



LOWEST PRICES ON TV PARTS 'WHOLESALE RADIO' IS YOUR COMPLETE TELEVISION SUPPLY HOUSE

We Can't Be Beat on Antenna Quality & Price

UNBEATABLE TV RECEPTION

BEST FOR THE FRINGE AREAS

Snyder Lazy XX TV ANTENNA

Complete with three
3½ ft. masts & adj.
mounting base

Extremely hi-gain. Superior construction. Designed to withstand all weather conditions. Easily stacked double conical Lazy XX type. Just unfold, tighten and erect. All TV channels and FM. You also get guy wire rings, and connecting stubs. Completely pre-assembled. Can be used with any type lead-in 72 to 300 ohms. Order model TX-2.

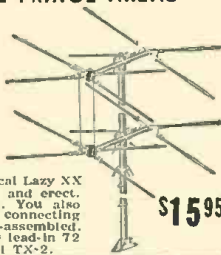

\$15.95

SENSATIONAL ANTENNA BUY

HI-LO ARRAY

Less Mast

SNYDER AR-21



\$4.39

We don't believe you'll find a finer antenna anywhere near this low price. Two folded dipoles (high and low) with reflectors.

HI-BAND ARRAY

Folded Dipole
and Reflector

Has adjustable mounting brackets to fit poles 1" to 1½". For channels 7 to 13. Model HF-3.

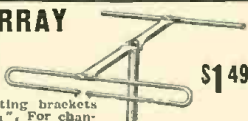

\$1.49

Lowest Price Conical Array!

Can Be Stacked for Fringe Areas
8 Interchangeable Elements

Covers complete TV-FM band. Hi-tensile 3/8" aluminum alloy elements. Includes mast clamp for use with poles up to 1½". Can be used with any type lead-in 72 to 300 ohms. Model XA-44. Less Mast. \$3.95



HI-LO INLINE ARRAY

Hi and lo dipoles with reflector. Complete with cross arm, hi band extension arm and mounting bracket. Less mast.



\$4.75

TV ANTENNA ACCESSORIES

High In Quality! Low In Price!

STEEL EXTENSION POLES. Weather treated.	
10 ft. long. 1¼" di.	\$1.69
5 ft. long. 1¼" di. Crimped end.	.98
3½ ft. long. 1¼" di. Crimped end.	.89
ANTENNA SWIVEL BASE. Aluminum.	
Fits 1¼" O.D. mast section.	.39
GUYWIRE. 6 stranded No. 22. Per 50 ft.	6.00
24 reels. 50 ft. each. Interconnected.	
72 OHM COAXIAL CABLE RG59U	
6c per ft. Per 100 ft.	5.25
CHIMNEY MOUNT BRACKETS. Complete with strap	1.59
3" 300 OHM STAND-OFF INSULATORS	
Wood screw-in type. (4c ea.) Per 100.	2.95
SAMS TV ANTENNA MANUAL.	1.25
SNAP-ON TWIN LEAD INSULATORS	
Fits 1¼" masts. Each.	.06
FLAT 4 CONDUCTOR LEAD-IN	
3c per ft. Per 100 ft.	2.50
JFO LIGHTNING ARRESTOR	1.35
TIE RODS. For connecting conical arrays. Pr.	.65
48 STACKING ASSEMBLY. 4 rods and a center tie-point. For stacking two double XX arrays.	1.95
MAST COUPLINGS. 10" long. for 1½" masts.	.90
TIE RODS. For inline type antenna Model TR-29.	.75
Pair	
TIE RODS. For conical type antenna. Pair.	.75

PEAK ROOF MOUNTS



\$2.69

For all types of antenna installations. Flat roofs, side walls, any angle of peaked roofs. Fits masts ¾" to 1½". Model PMA-148.

Address Orders to Dept. RN-12 or
Phone Mulberry 2134

WHOLESALE RADIO PARTS CO., Inc.

311 W. Baltimore St.
BALTIMORE 1, MD.

Write for Free Monthly "FYI" Bulletin

HEAVY DUTY MAST BRACKETS



WB-2
\$3.75
Pair

Adjustable up to 18" away from wall. Fits masts 1" to 1½" di.



GET THE GENUINE!

General Electric PICTURE TUBES

STP4 . . . \$40.90	12KP4A \$28.50	16MP4A \$34.00
7JP4 . . . 16.88	12LP4 . . . 24.00	16KP4 . . . 37.00
8AP4 . . . 16.50	12LP4A 24.00	16LP4 . . . 34.00
8AP4A . . . 16.50	14BP4 . . . 26.50	16LP4A 34.00
10BP4 . . . 22.25	14CP4 . . . 26.50	
10BP4A . . . 22.25	16AP4 . . . 40.00	19AP4 . . . 51.00
10FP4 . . . 26.80	16AP4A . . . 40.00	19AP4A . . . 51.00
10FP4A . . . 26.80	16GP4 . . . 34.00	19DP4 . . . 62.00
12KP4 . . . 28.50	16MP4 . . . 34.00	19DP4A . . . 62.00

Wholesale Radio Has Everything
You Need for Easy Conversion!

FOR 14" SCREENS

Shelden Rectangular Tube 14BP4 . . . \$26.50
G.E. Rectangular Tube 14CP4 . . . \$26.50
70" Deflection Yoke MD-70 . . . 7.00
For 14" or 16" Tubes . . . 4.95
Focus Coil 202D-2 . . . 6.60
Mounting Brackets for 202D-2
Type BR-67 . . . 2.65
14" Plastic Mask, Rectangular . . . 3.45
Deluxe Hi-Sweep Kit B . . . 9.45
(See Details below)



FOR 16" SCREENS

G.E. Rectangular Tube 16KP4 . . . \$37.00
70" Deflection Yoke MD-70 . . . 7.00
Greater deflection sensitivity for
16" rectangular tubes . . . 6.00
Focus coil 202D-2 . . . 6.60
16" Plastic Rectangular Mask . . . 4.75
Mounting Brackets for 202D-2
Type BR-67 . . . 2.65
Deluxe Hi-Sweep Kit B . . . 9.45
(See Details Below)



Hi-Sweep Voltage Multiplier Kit!



FOR CONVERTING TO 14", 16" or 19" TUBES

For converting 630 or similar type sets. Supplies 14 kv with full sweep using a single 18B rectifier. Kit complete with T77J1 flyback transformer, special width coil and all other components necessary to complete your voltage multiplier kit. Plus wiring instructions. Type A for 16" round tubes. Type B for 14-16 rectangular and 19" tubes . . . \$9.45

LOW COST HIGH FIDELITY AUDIO AMPLIFIERS

Compact Size—7"x3¼"x4"



CUSTOM CRAFT

Models PH-3 & MK-3

Substantially flat from 40 to 12,000 cps. PH-3 designed for use with either FM or AM tuner, or a record player. MK-3 identical to PH-3 plus microphone stage. Output transformer not included.

PH-3 . . . \$13.95 MK-3 . . . \$17.50

FOR HI-FIDELITY CUSTOM INSTALLATION 14 OZ. ALNICO 5 PERMANENT MAGNET



FAMOUS GE 1201 12" DELUXE SPEAKER

25 watts power handling capacity. Frequency response from 50 to 13,000 cps. Aluminum foil base voice coil. \$17.70

HARVEY

Presents the Newest
Development In
Tape Recording!

NEW

Magnecorder

PT63-AH

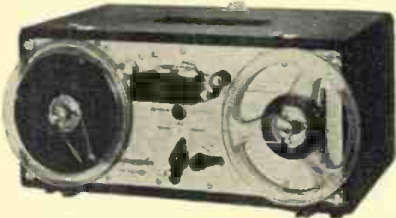

3 HEADS: Erase..Record..Playback

Designed To Monitor Directly From
The Tape While You Are Recording!

Developed from the famous PT6, the new MAGNECORDER PT63 offers 3 separate heads—Erase, Record, Playback—for MONITORING FROM THE TAPE while recording. The addition of this feature assures finer results by eliminating most recording errors. All heads, contained in a single housing, are individually alignable and replaceable, and each one is triple shielded to eliminate cross-talk and hum. 7½-inch and 15-inch tape speeds, easily interchangeable. (3 speeds... 3¾", 7½" and 15"... are also available at slight additional cost.) Attractive black grain leatherette over wood construction. \$350.00 Net, with Case.

PT63-J AMPLIFIER



A new single channel portable amplifier which contains a separate record and playback amplifier so that you can monitor from the tape while recording. In addition, 10 watts of audio is provided to drive both the 5-inch monitor speaker or an external loudspeaker. Response flat from 50-15kc at 15"/sec. The 19" x 7" control panel provides a switch to change equalization for either 7½" or 15" tape speeds. Switching is also provided for record, playback or bias readings on the 3" VU meter. May be directly rack mounted when removed from case. \$387.00 Net, with Case.

VISIT THE AUDIO-TORIUM—Come in and visit our new sound department... all these items and many more on working display at all times.

NOTE: In view of the rapidly changing market conditions, all prices shown are subject to change without notice and are Net, F.O.B., N. Y. C.

Telephone:  Luxembourg 2-1500

HARVEY
RADIO COMPANY INC.

103 West 43rd St., New York 18, N. Y.

Video Response

(Continued from page 58)

oughly for shorts, bad connections, and other mechanical defects. To make sure that the defect is in the video amplifier connect the vertical scope leads to the second detector load resistor and observe if a picture signal appears there. If it does, then the defect must be somewhere in the video stages. The next step is to check the operating voltages of each amplifier tube.

In the case of insufficient video gain the most likely suspect is the tube itself or a peaking coil. If a peaking coil opens then the high value damping resistor on which it is usually wound will reduce the gain of the video amplifier substantially. For example, if L_2 in Fig. 5 should open then the 22,000 ohm resistor would block most of the picture signal from the picture tube grid. This appears as a light gray image with poor frequency response and low contrast.

Other and more difficult service troubles include flat pictures, smeared or fuzzy images, and pictures blurred on very strong stations. Flat pictures are invariably due to poor high frequency compensation unless the i.f. amplifiers are misaligned. Occasionally wrong value peaking coils are found or the wax has melted, causing the coil to slip off its form and cause partial shorting. In such an instance the technician may not be able to identify the coil as to its inductance value. Exact replacement coils should be obtained from the set manufacturer if at all possible to avoid errors.

Smeared and fuzzy images are due to loss of low frequency components or overpeaking on the high side of the response curve. Overpeaking can be due to an open damping resistor or regeneration in the video amplifier section. To remedy the latter it is often sufficient to bend coils and condensers away from each other, especially to keep the grid and plate coils well separated. Loss of low frequencies is usually due to a defective coupling condenser or, if used, a defective part in the low frequency boosting network.

When pictures appear blurred only on very strong signals the defect may be in the i.f. section. The last i.f. amplifier stage may be overloaded and cause clipping of the video signal. If the signal from the second detector is observed on the oscilloscope and found to be free from distortion on both weak and strong channels, then the video stages may be at fault. Some low cost receivers use a direct connection from the detector to the grid of the video amplifier and let the diode load resistor double as grid return. On very strong signals the negative voltage across this resistor may exceed the grid bias cut-off value and cause clipping. Unless this condition is very bad, only a portion of the syn-

chronizing pulses will be clipped, but sometimes the level of the picture signals is also affected. The remedy is to either reduce the value of this resistor or to replace it with two series resistors and connect the grid to the center of this voltage divider. Excessive clipping can also occur in a two-stage amplifier when a coupling condenser becomes leaky and causes the grid to draw current. Whenever either of these defects are found, checking the peaking coils and coupling condensers is the fastest method of locating the trouble.

The operation of video amplifiers, its desirable and undesirable aspects, as well as how to control them, form an integral part of the technical knowledge required for profitable television servicing. It will be worthwhile for the technician to acquaint himself with the appearance of frequency response curves, sweep methods, and the many different peaking systems found in modern television sets. Once the principles of the video amplifier are understood it will be easy to adjust, repair, and improve these circuits. And, after all, the final quality of the picture depends on the proper operation of the video amplifier.

-50-

Multimeter

(Continued from page 55)

cellent 0-250 d.c. millivolt range. On the Model 260, the millivolt values are read directly from the 250 volt d.c. scale, while the 100 microampere range is being used. The resistance of the resulting millivoltmeter is 2500 ohms in the Model 260. The scale may be read down to 5 millivolts, and 2½ mv. may be estimated.

R. F. Voltmeter

The addition of an external 1N34 germanium crystal diode converts the 100 microampere d.c. scale of the multimeter into a satisfactory radio-frequency voltmeter useful to 100 megacycles. The r.f. voltmeter may be used in signal tracing, transmitter adjustments, and sundry experimental work.

Two r.f. voltmeter circuits are shown in Fig. 3. The series type (Fig. 3A) gives highest sensitivity but can be used only when the circuit under test is continuous and will complete the circuit from the crystal anode to the meter "Common" terminal. Furthermore, no d.c. voltage may be present in the circuit under test, otherwise the crystal and meter may be damaged.

The shunt-type circuit (Fig. 3B) contains an input condenser which blocks the crystal and meter from any d.c. component in the circuit under test.

Since there is some variation in electrical characteristics of crystals, a voltage calibration must be made for an individual r.f. voltmeter. This calibration may be made conveniently at 60 cycles, the a.c. voltage ranges of the multimeter being used to check

POWER TRANSFORMER BARGAIN

740 Volts CT @ 185 MA
6.3V @ 4A, 5 Volts @ 3A
110 V 60 cy. primary.

\$3.49



PEAK ELECTRONICS CO.

COMPONENTS

SELECTED AND GUARANTEED SURPLUS AT A FRACTION OF ORIGINAL COST.
188 WASHINGTON ST., NEW YORK 7, N.Y.

PHONE
CORTLAND
7-6443
7-6486

PANEL METER BARGAIN

0-500 microamps 2"
Simpson Bakelite case,
volt scale.

\$2.95



PANEL METERS

GE—General Electric
WH—Westinghouse
W—Weston S—Simpson
SU—Sun *—Special Size
SQ—Square Case



2" Meters

0-500 VA, WH*	\$3.25
0-5 MA, GRUEN	1.95
0-5 MA, S, SQ*	2.45
0-5 MA, GE*	1.95
0-20 MA, S*	1.75
0-25 MA, SU*	1.75
0-50 MA, SU*, SQ	1.95
0-50 MA, GE	2.45
0-2 AMP RF, S, SQ	1.95
0-4 AMP RF, GE	1.95
0-9 AMP RF, WH	1.95
0-250 MA, AC, GE	2.95
0-20 VOLT DC, W	2.45
0-30 AMP DC, GE	1.95
-10 +6 DB, W	4.95

3" Meters

0-20 UA, W*	\$12.50
40-0-40 UA, W*	7.95
50-0-50 UA, GE	8.95
0-75 UA, GE	9.95
0-1 MA, S*	4.50
0-2 MA, WH, S	3.95
0-5 MA, GE, SQ	3.95
0-10 MA, WH*	2.95
0-20 MA, S, WH	3.95
0-20 MA, GE, SQ	3.95
0-30 MA, GE, SQ	3.95
0-80 MA, WE	2.95
0-100 MA, GE, SQ	3.95
0-200 MA, GE, SQ	3.95
0-300 MA, GE, SQ	3.95
0-2 AMP, GE, SQ	3.95
0-2 AMP, WH	3.95
0-15 VOLT AC, GE	3.95
0-30 VOLT DC, DA	2.75
0-800 VDC, GE, SQ	4.50
0-3KV DC, GE, SQ	7.95

6" Meters

0-15 AMP DC, GE	\$6.95
0-30 VAC, GE	7.95
0-30 MA, DC, GE	6.95
0-12 KVDC, GE	12.95

CERAMICONS

MMF: 1.5, 3, 8, 10, 20, 22, 120, 50005 ea.

SILVER MICA CAPACITORS

MMF: 10, 50, 60, 340, 750, 800, 100009 ea.

METER MULTIPLIERS

2 Meg 1/5 of 1% Cage Enclosed 2 KV\$3.95
2 Meg 1/2 of 1% Tubular 2 KV1.95
4 Meg 1/2 of 1% Tubular 4 KV3.75

PANEL METER KIT

Here's what you get:
• 2" SQ bakelite cased meter.
Gov't. Surplus
• Scales for all the following ranges: 0-50 ma, 0-100 ma, 0-200 ma, 0-500 ma,
• Pre-calculated shunt sizes for all ranges.
• Complete instructions.
Only \$2.50 ea.3 for \$6.75



CHOKE BARGAINS

0-Open Frame	C-Cased
6 Hy, 50 MA, O \$0.39	6 Hy, 400 MA, C \$3.69
6 Hy, 80 MA, O .69	4 Hy, 450 MA, C 3.95
8 Hy, 175 MA, C 1.49	5 Hy, 170 MA, C 1.25

RAYTHEON SWINGING CHOKE
2 to 12 Henrys, 1 Amp to 100 Ma, 15 Ohms DC fully cased, High voltage insulation, ceramic insulators. Very conservatively rated. Weight 60 Lbs.\$14.95 ea.

HIGH WATTAGE ANTENNA RELAY
110/220 volt 60 cycle Solenoid, D.P.D.T. Heavy duty paralleled contacts rated 5000 Volts @ 15 Amps. Sturdy Construction. Insulating insulation.
As above but DPST \$12.50
As above but SPDT 12.50

GUARDIAN LATCHING RELAY
SPDT, 110 V 60 cy Coil, 15 Amp Contacts \$1.95

SENSITIVE RELAY
2000 ohm coil, SPDT, breaks at 3 MA, plugs into 5 prong socket \$5.99 ea.

POWER TRANSFORMERS
Fully Cased. Pri. 110 Volts 60 cy.
110 volts CT 50 MA, 920 volts CT 150 MA, 6.3V, 18A, 6.3V, 3.25V, 5V2A, 5V2A 4.95 ea.
300 volts CT 300 MA, 2.5V7A, 2.5V7A, 0.3V, 1.5A 2.75
1050 Volts @ 20 MA, 20V, 4A, 2.5V, 5A 2.75
940 Volts CT 425 MA, 65V BIAS 7.95
880 Volts CT 100 MA, 6.3V4A, 5V 3A 2.49
4400 V @ 4.5 MA, 5V 3A, 15 KV INS 4.95
550 Volts CT 125 MA, 5V @ 2A, 6.3V 4A 1.95
Vibrator Trans. 6V In, 300V @ 100MA Out. 2.95

FILAMENT TRANSFORMERS
110 V 60 Cy Primary—Full Casings
6.3V 12 AMPS. \$3.95 2.5V 20A, 2.5V 20A. \$6.95
2.5V 10A, HV INS. 3.95 2.5 VCT 3A75

WIRE WOUND RESISTORS
5 watt ohms: 25-50-200-2500 \$.09 ea.
10 watt ohms: 25-40-80-1325-2K-4K 15 ea.
20 watt ohms: 50-70-100-300-750-1K-1.5K 20 ea.
2.5K-2.7K-5K-16K-20K 20 ea.

30 WATT WIRE WOUND RESISTORS
Ohms: 100-2500-3K-4500-5300-18k 8 for .99

ADJUSTABLE SLIDER RESISTORS
20 Watt: 1, 5, 50 Ohms25
50 Watt: 100, 500 Ohms35
75 Watt: 100, 150, 200 Ohms39
100 Watt: 20, 50, 75, 100, 500 Ohms49

MISCELLANEOUS BARGAINS
7 mfd 330 VAC Oil Cond. \$.69
25 ohm 675 watt Rheostat 2.95
50 meg 35 watt Resistor99
250 mfd Midget Var, Ceramic Ins69
15 mfd Midget Var, Ceramic Ins39
4PST Lever Switch89
Ceramic RF Switch SP 11 pos 1.95
4PDT Relay, 4500 Ohm DC Coil 1.95

PICTAIL MICAS
MMF: 5, 20, 50, 80, 100, 150, 300, 400, 500, 750, 800, 1000, 2000, 3000, 4,000, 5,000, 6000, 10000. 50.09 ea.

SOLA CONSTANT VOLTAGE TRANSFORMER
2 KVA, 17.4 Amps, Input 95-135 Volts, 60 cy., 1 Phase. Constant Output 115 Volts, Type 4, 3 1/2" L, 9 1/2" H., 7 7/8" W. \$137.00 ea.

WESTON PORTABLE AC VOLTMETER
Model 433, 0-150 Volts AC, 25 to 2400 cycles, 3/4%, mirrored hand calibrated scale. Bakelite case with leather handle \$27.50



HIGH CURRENT MICAS

Type G4 Ceramic Case 5/8" High, 5" Diameter Tolerance 5% or Better.

CAP MFD	Amps	KV DC	Price Each	TYPE G1		Price Each	
				1 Mc	DC		
.00024	4	6	\$ 3.95	4	6	29.50	
.009	40	15	29.50	.01	43	15	29.50
.002	21	20	27.50	.0031	26	20	29.50
.001	18	25	26.50	.0005	9	30	26.50
.01	25	7	6.95	TYPE G2			

BAKELITE CASED MICAS

MFD	VDC	Price	0.05	2500	\$.55
.001	600	\$.18	.002	2500	.45
.002	600	.24	.004	2500	.50
.01	600	.26	.005	3 KV	1.00
.02	600	.26	.0001	5 KV	.70
.027	600	.26	.00045	5 KV	1.10
.01	1 KV	.45	.001	5 KV	1.60
.002	1200	.35	.0015	5 KV	1.60
.024	1500	.65	.003	5 KV	1.90
.033	1500	.75	.005	5 KV	2.50
.02	2 KV	.90	.0003	8 KV	2.50
			.0005	8 KV	2.90

OIL CONDENSERS

56 mfd 220 vac . . . \$3.95	10 mfd 2000 vdc . . . \$4.95
4 mfd 600 vdc . . . 59	2 mfd 4000 vdc . . . 4.90
6 mfd 600 vdc . . . 79	1 mfd 5000 vdc . . . 4.50
8/8 mfd 600 vdc . . . 1.39	1/2 mfd 7000 vdc . . . 2.25
10 mfd 600 vdc . . . 1.29	.05 7000 vdc85
6 mfd 1500 vdc . . . 2.95	1 7500 vdc1.25
10 mfd 1500 vdc . . . 3.75	2 mfd 6000 vdc . . . 9.95
2 mfd 2000 vdc . . . 2.25	2 mfd 7500 vdc . . . 12.75
8 mfd 2000 vdc . . . 3.95	.65 mfd 12,500 vdc . . . 12.95

PRECISION 1% W. W. RESISTORS
Ohms: 2K, 5K, 8500, 50K19 ea.
100 WATT NON-INDUCTIVE RESISTORS
Ohms: 250, 500, 12,500 \$0.75

NEW! the MEISSNER 9A

AMERICA'S GREATEST RADIO VALUE!

MEISSNER takes great pride in announcing their new 9A AM-FM chassis complete with Audio. The 9A brings real "Custom" quality reception into the low price field! A complete AM-FM unit — the 9A is a tuner, amplifier and power supply — everything you need for a deluxe custom installation or for converting older radios. Nine tubes, including rectifier, give the 9A ample power while a high degree of stability and selectivity is attained through superior MEISSNER circuit design and the use of high quality components. MEISSNER engineers stress that only a high quality speaker is capable of reproducing the wide range fidelity and tonal richness inherent in the 9A. See this fine instrument at your dealer now. Examine the workmanship — hear the glorious richness of its tone! Compare the MEISSNER 9A with units selling for twice its price. You will agree, it's MEISSNER — For Magnificent Reception!

AM-FM TUNER CHASSIS COMPLETE WITH AUDIO

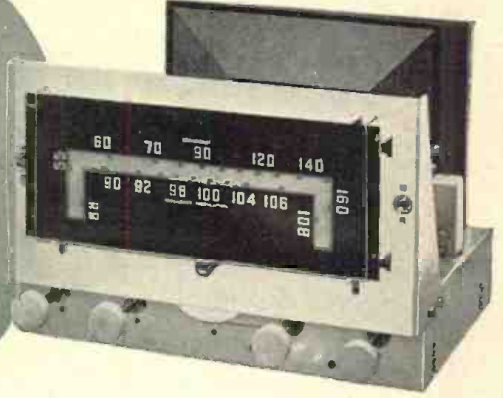

Here's the outstanding 9A — complete with tubes, power supply, built-in antenna, escutcheon, knobs, etc.



- High Selectivity and Sensitivity
- Full Audio Fidelity
- Full 4 Watts Output
- FM Circuit Temperature Compensated
- Air Wound FM Coils
- Separate AM and FM Condenser Sections
- Built-In High "Q" Die Stamped Loop Antenna
- Full Range Tone Control
- Complete Provision For Phono Input
- All Controls On Front Panel
- Power Outlet For Phono Motor

MEISSNER FOR MAGNIFICENT RECEPTION
MEISSNER MFG. DIVISION, MAGUIRE INDUSTRIES, Inc., MT. CARMEL, ILLINOIS

TECH-MASTER

TELEVISION

There is no finer TV made!

De Luxe 630 type CHASSIS

FOR ALL PICTURE TUBES FROM 12" ROUND TO 20" RECTANGULAR

Discriminate custom builders choose TECH-MASTER for they know from long experience that "there is no finer TV made" than a TECH-MASTER chassis. Every TECH-MASTER is designed by top-notch TV engineers . . . and constructed of the finest components. Automatic Gain Control is built in every chassis to provide the ultimate in picture quality.

Supplied "ready-to-operate" with TECH-MASTER guarantee and seal of rigid test. Contact your nearest jobber or write Dept. RN today for complete literature on TECH-MASTER chassis . . . a model available for every type of custom installation.



TECH-MASTER PRODUCTS CO.

443-445 Broadway, New York 13, N. Y.

More leading engineers and technicians have chosen Tech-Master for their own use than any other Television Kit.



WE DON'T RUN A HOSPITAL * . . .

. . . but we do have one of the most modern condenser plants in the industry today!

* It seems as though everyone who makes condensers today likes to talk about non-contamination, dust-free rooms, white coated and gloved workers, etc.

Well, we have all this too, but we have an idea that you fellows would rather hear the hard facts about the condensers you use. We would like you to know this about Illinois Condensers: (1) Every condenser that leaves our factory is *Unconditionally Guaranteed for One Full Year from Date of Purchase!* (2) We have been producing electrolytic capacitors continuously for 16 years. Literally millions of Illini-Hycap Capacitors are giving FAITHFUL SERVICE every day!

Write today for catalog — complete listings of highest quality tubular, twist prong, plug-in and screw mounted electrolytics in single or multiple units. Also tubular paper condensers, high voltage buffer and TV capacitors and auto generator condensers.



ILLINOIS CONDENSER CO.
1616 NORTH THROOP STREET • CHICAGO 22, ILL.



a message to music lovers and record playing enthusiasts!

Your records, (LP's or Standard) need not produce fuzzy, noisy, distorted music. Inherent in their sound grooves is fine musical realism of concert hall quality that can be recreated by record players equipped with fine audio components: pickup, arm, compensator, preamplifier, etc. Such components by Pickering are the finest available: the choice of engineers, leading record critics, music lovers and specialists in the production of custom record playing systems.

Pickering High Fidelity Components are available through leading jobbers and distributors everywhere; detailed literature will be sent upon request.



Pickering & Co., Inc.
Oceanside, N. Y.

For the utmost in quality specify Pickering Audio Components!

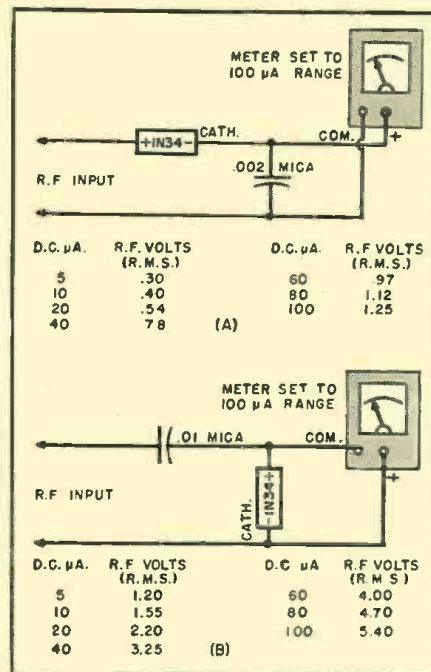

Fig. 3. Radio frequency voltmeters. (A) A series-type unit, and (B) a shunt-type.

the values of applied voltage. Fig. 3 also shows sample calibration figures obtained for the series- and shunt-type r.f. voltmeter circuits using the 100 microampere d.c. range of the Model 260.

Galvanometer

A sensitive center-zero d.c. galvanometer is useful as a balance (null) indicator in a Wheatstone bridge, and as an indicator in the alignment of discriminator and ratio detector stages in FM and television receivers.

Fig. 4 shows how the multimeter may be converted easily into a zero-center galvanometer by means of an external battery and potentiometer. Either the 2½ or 10 volt d.c. scale, or the 100 d.c. microampere scale may be employed. To set the instrument initially, temporarily short-circuit the two input terminals, and adjust the potentiometer to bring the pointer exactly to the center of the meter scale used. The battery voltage should be 1½ volts when using the 2½ volt or 100 microampere d.c. scale, and should be 6 volts when using the 10 volt d.c. scale.

—30—

Fig. 4. Center-zero d.c. galvanometer.

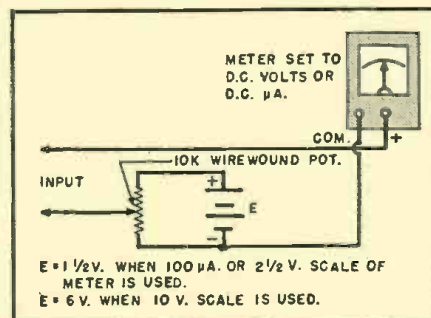

Technical BOOKS

"FATHER OF RADIO" by Lee de Forest. Published by *Wilcox & Follett Co.*, Chicago. 490 pages. Price \$5.00.

This is a rather nostalgic autobiography by the man whose life work helped to create the era of science which is synonymous with the Twentieth Century.

The scientific achievements of the "Father of Radio" are well-known to almost everybody connected with the radio industry but this book reveals many of the little-known sidelights and the "human interest" angles surrounding Dr. de Forest's monumental inventions. In this book he has revealed many heretofore unknown facets of his personality, details of his childhood, early education, and his courtship and marriage.

The full story of his inventions is a valuable contribution to the technical literature of the industry and the fact that all of this information has finally been captured between the covers of this book will be welcomed both by present and future historians of the radio art.

All of those interested in radio, television, the phonograph, radar, guided missiles, etc. (and that includes just about everybody) will find in this book the heartwarming story of a typical American boy from the Midwest who went forth to become one of the true geniuses of our era. Dr. de Forest deserves our gratitude for giving us this complete record of his important works.

* * *

"RADIO TUBE VADE-MECUM 1950" Published by *P. H. Brans, Ltd.*, Antwerp. Distributed in the U.S.A. by *Editors and Engineers Limited*, Santa Barbara, California. 508 pages. Price \$3.00 and \$3.20 (by mail). Eighth Edition.

This tube manual is so well known throughout the world that it hardly requires a review, however there are some new and particularly noteworthy additions to this edition which require comment.

Probably the greatest improvement is the consolidation of the material into a single volume. Thus, while the book is bulky it does possess the unquestionable advantage of having all of the data within a single set of covers.

The new edition includes data on the 7-grid tubes, the nonodes and phasitrons, planar-triodes, transducers, projection tubes, and accelerometers. A new section on crystal diodes and crystal triodes has been added in recognition of the increasingly important part these units are playing in electronics.

The entire manual has been revised and completed with information on new tubes from the entire world. Additional data on older types of tubes, which previously had been unavailable

due to war conditions, has now been secured and is included in this tube manual.

As with previous editions the manual is published in English, Dutch, French, German, Danish, Swedish, Italian, Spanish, Portuguese, Russian, Finnish, Greek, Serb, Czech, Polish, Turkish, Arabic, and Japanese. Complete instructions on the use of the manual are given in all of the listed languages.

* * *

"TELEVISION SERVICING" by Walter H. Buchsbaum. Published by *Prentice-Hall, Inc.*, New York. 330 pages. Price \$5.35.

This is a thoroughly practical handbook for the television technician. The

author has provided a completely understandable explanation of how and why a TV receiver works (or fails to work) without resorting to the use of mathematical formulas and complicated diagrams.

The book is divided into three parts, the first dealing with the theory of TV receivers, the second with installation practices, and the third covering troubleshooting.

Regular readers of this magazine will find this book written in the same straightforward manner that characterizes the author's articles. For technicians who are a little weak in the higher mathematics end of television, this book will provide a special boon.

-30-

BRINGS IN THE PICTURE!

Bright... Clear and Without Interference



WARD YAGI ANTENNA

Fringe and Super-fringe

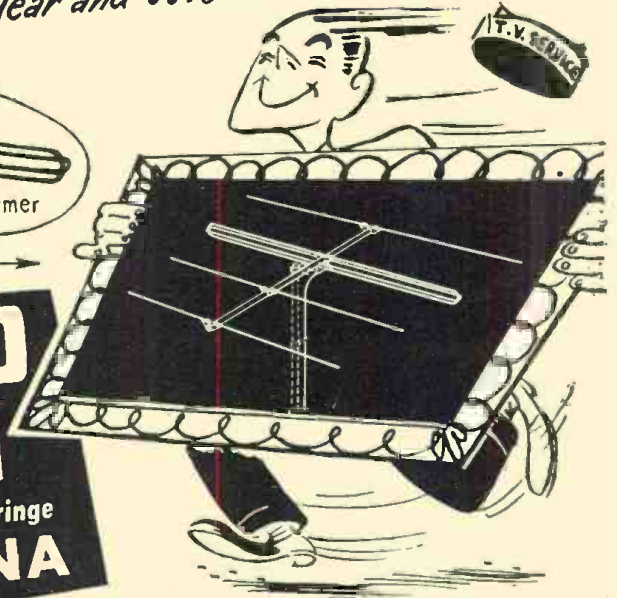

TELEVISION RECEPTION IS A LOCAL PROBLEM

Ward builds a type of antenna best suited for optimum performance at every location. Standardize on WARD, the profit line of antennas.

WARD YAGIs are producing amazing results! In many cases, acceptable pictures now enthuse set owners, where no image could be obtained by other antennas. Increased sensitivity and exceptionally high gain is developed through Ward's exclusive built-in impedance transformer. Having perfect match to a 300 ohm line, full signal strength is transmitted to the set. Designed with high front to back ratio, a clear, sharp signal is picked up, without co-channel interference. Being closely tuned to each channel, this highly directive antenna has a narrow, angular pattern cutting foreign interference and noise to the minimum.

Ward's Yagi is a highly specialized antenna, designed without compromise specifically for long distance TV reception. In distant areas, and areas intermediate between transmitting centers, where weak signals and co-channel interference obstruct reception, stacking of Ward Yagis enables the selection and maximum energy reception of the desired station.

Order a supply of Ward Yagis today. Satisfied customers make WARD your most profitable antenna.

only **WARD** OFFERS
TV-FM-AUTOMOTIVE-AM-SPP
ANTENNAS

THE WARD PRODUCTS CORP.
Subsidiary of the Gabriel Co.
1523 East 45th St., Cleveland 3, Ohio

COUNTER TYPE INSTRUMENT DIAL 3" x 3"
 1/4" to 1/2" Shaft, 3 Digit Counter..... \$1.95

MISCELLANEOUS

APA/10 PAN-ADAPTER.....	\$149.50
ART/13 Modulation Transformer.....	9.95
BC 221 FREQ. METERS, excellent cond.....	79.50
200 KC Xtal.....	4.95
BC 438 FREQ. METER, 195-235MC 110V 60cy, with calibration chart & antenna.....	39.50
0-15 Amp DC BENCH METER, NEW.....	4.95
2" AIRCRAFT METER 0-30 VDC, 0-120 Amp DC, complete with shunt, NEW.....	10.50
APN-1 altimeter transceiver, NEW.....	10.50
R89/ARN 3 receiver, with tubes, NEW.....	10.50
100 KC precision crystal.....	5.95
1000 KC xtal, \$3.95; 5 MC xtal.....	3.50
G.E. 2" 0-5 MA Meter amp scale.....	2.95
BEACHMASTER output transformer 250 W.....	9.95
FOUR QUADRANT PHASING CAPACITOR.....	2.95
G.E. 2" 0-500 MA Meter.....	3.25
CHAMER time delay relay 120 sec. 120 vac.....	9.95

METER SPECIALS

RD 3 1/2" 0-20 ua (0-100 Scale).....	\$14.50
SO 3 1/2" 0-200 ua DC.....	6.50
SO 2 1/2" 0-9 VDC.....	.99
SO 2 1/2" 0-100 AMP DC with shunt.....	.99

3" METERS

0-50 ua.....	\$14.50	0-50 AMP AC WH.....	\$5.95
100-0-100 ua.....	8.95	0-75 AMP AC TRIP.....	9.95
0-500 ua DC.....	6.95	JBT 31-FR.MTR.....	7.95
0-1 MA S Scale.....	3.95		
0-1 MA DC.....	2.95		
0-5 MA SP Scale.....	5.95		
0-15 MA DC GE.....	4.50		
0-20 MA DC WH.....	4.50		
0-20 MA DC GE.....	4.50		
0-50 MA DC WH.....	4.50		
0-80 MA DC WE.....	3.95		
0-100 MA DC.....	4.50		
0-150 MA DC WH.....	4.50		
0-200 MA DC GE.....	4.50		
0-300 MA DC.....	4.50		
0-500 MA DC.....	4.50		
0-1 AMP DC WH.....	4.95		
0-2 Amp DC SImp.....	5.95		
0-300 VDC SUN.....	4.50		
0-750 VDC.....	7.95		
0-8 VAC WES 476.....	4.50		
0-15 VAC GE.....	4.50		
-10+5 DB WES.....	4.95		
301.....	10.95		
0-150 VAC WH.....	5.50		
30-0-30 AMP DC.....	4.95		

2" METERS

0-500 ua SP Scales.....	\$3.95
0-1 MA DC SUN.....	3.85
0-1-2 MA 506.....	3.45
0-20 MA DC GE.....	2.49
Test Meter 0-200 MA and 0-2 Amp DC.....	3.95
0-20 MA SP Scale.....	2.49
0-50 MA SP Scale.....	2.49
0-25 MA SP Scale.....	2.49
0-500 MA DC.....	2.95
0-3 VDC, 1 MA.....	3.50
0-20 VDC.....	2.95
0-30 VDC.....	2.95
0-25 MA AC.....	3.50
0-10 VAC GE.....	3.50
0-300 VAC TRIP.....	4.95
0-4 AMP RF GE.....	3.50
0-1 AMP RF GE.....	3.50
0-2 AMP RF SO.....	3.50
0-4 AMP RF GE.....	3.50
0-9 AMP RF WH.....	3.50

CO-AXIAL RELAY

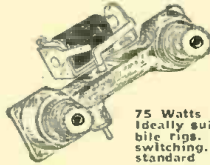

Allied Control type
 RA, SPDT, 6VDC operated.
 Designed to handle a maximum of
 75 Watts at 150 mc.
 Ideally suited for military
 applications. Features
 switching, etc. Uses
 standard co-ax connectors.
\$3.95
 Each
 10 for \$35.00

Set of 83-1SP Co-ax connectors for above \$0.99

CHOKES

7 HY 125 MA 200 OHM, cased.....	\$1.10 ea.	2/52
8 HY 50 MA.....	.59	
10 HY 80 MA 240 OHM.....	.89	
20 HY 110 MA Sub Sig Herm Seal.....	3.45	
10 HY 150 MA 140 OHM.....	3.99	
7 HY 200 MA 100 OHM Herm Seal.....	3.49	
4-16 HY 200 MA 140 OHM SWINGING CH.....	4.25	
4 HY 200 MA 20 OHM.....	1.25	
3 HY 250 MA 15 OHM Herm Seal.....	1.25	
15 HY 250 MA 60 OHM.....	3.49	
3-14 HY 300 MA 80 OHM SWINGING CH.....	6.20	
6 HY 300 MA 85 OHM.....	6.20	
8 HY 300 MA 80 OHM.....	6.10	
6 HY 350 MA 72 OHM.....	5.25	
12 HY 400 MA 60 OHM Herm Seal.....	4.95	
4 HY 450 MA 32 OHM.....	5.95	

115V FILAMENT TRANSFORMERS 60 CY

2.5 VCT 10 A, 10KV Insulation.....	\$3.95
2.5 V @ 6 Amps, 2.5 V @ 6 Amp.....	3.45
5 VCT 3A, 2.5 KV Insulation.....	2.35
5 V 20 A, 2.5 KV Insulation.....	6.25
6.3 V 1.2 A.....	.85
6.3 V 3 Amps.....	2.14
6.3 V 12 Amps.....	3.95
6.3 V 8 Amps, 6.3V 3 Amps.....	3.95
6.3 V 3.5 A, 2 x 2.5 V 3 Amps ea.....	3.95
6.3 V 3A, 2.5 V 6 AM Herm Seal.....	2.49
10 VCT 10 A, 2.5 KV Insulation.....	5.25
10 V 5 A.....	3.45
6.3 V 12A, 6.3 V 2 A Herm Seal.....	4.50

115V POWER TRANSFORMERS 60 CY

650 VCT 90 MA, 6.3V 2A, 5V 3A.....	\$3.02
700 VCT 90 MA, 6.3V 3A, 5V 3A.....	3.50
610 VCT 180 MA, 6.3V 3A, 5V 3A.....	4.24
700 VCT 150 MA, 5V 3 Amp.....	2.95
800 VCT 300 MA, 8.3V 10A, 6.3V 9A 3V 3A.....	9.35
800 VCT 300 MA, 6.3V 10.8A, 5V 6A 3V 2A.....	9.35
800 VCT 200 MA, 5V 3A, 6V 4A.....	6.50
300 V 100 MA, 22V VCT 100 MA, 6.3V 3.5A, 2.5V 10A.....	2.95
750-800-0-800-750, 225 MA.....	8.95
115V, 230V Tap, Pri-850V CT, 280MA.....	12.50
36V 7A-6.3V 3A-5V 3A.....	

OIL CAPACITORS

7 MF 330 VAC.....	\$0.95	1 MF 2000 VDC.....	\$1.79
5 MF 600 VDC.....	.45	1 MF 2000 VDC.....	1.95
2 MF 600 VDC.....	.79	1 MF 2000 VDC.....	2.10
4 MF 600 VDC.....	.90	2 MF 2000 VDC.....	2.75
6 MF 600 VDC.....	1.05	4 MF 2000 VDC.....	3.95
10 MF 600 VDC.....	1.35	8 MF 2000 VDC.....	5.95
2 MF 1000 VDC.....	.90	5 MF 2500 VDC.....	1.39
3 MF 1000 VDC.....	1.15	5 MF 4000 VDC.....	1.45
10 MF 1KV DC.....	2.75	5 MF 3000 VDC.....	1.49
15 MF 1KV DC.....	2.95	4 MF 3000 VDC.....	8.95
6 MF 1.5 KV DC.....	2.95	2 MF 5000 VDC.....	8.95
4 MF 1.5 KV DC.....	2.49	1 MF 7500 VDC.....	.89
6 MF 1.5 KV DC.....	2.95		

TERMS: 25% Deposit with order, balance
 C.O.D. Rated firms open account

"SEND FOR TUBE LIST"

ATTENTION! INDUSTRIAL USERS, MANU-
 FACTURERS, LABS., COLLEGES

Send us your specs., and let us quote—Large, Varied
 Stock of Tubes, Resist., Capacitors, Test Equip.,
 etc., available.

POLY-TECH

919 Dawson St., New York 59, N. Y.
 Tel. MUrray Hill 6-2650



Augusta—Camp Gordon

Signal Corps officers recently attached to the Signal Corps Training Center at Camp Gordon were guests of the Augusta-Camp Gordon Chapter on September 27th. The meeting was held at the Chateau of the Augusta Arsenal and was presided over by Colonel Henry J. Hort, chapter president.

Mr. Marion Symms, one of Augusta's civic leaders, gave an interesting historical sketch of early Augusta and a brief account of the history of the Augusta Arsenal itself. Mr. Scott Nixon, an amateur photographer, showed some excellent colored movies of the many beautiful gardens in Augusta.

A Dutch lunch was served at the conclusion of the meeting, and the chapter members and their guests had an opportunity to become acquainted.

Baltimore

Baltimore decided to have its first fall meeting in the form of a social affair to enable members and chapter officers to become acquainted. The meeting took place on September 27th at the Park Plaza Hotel, Baltimore.

After dinner, Chapter President Wilbur Webb, Director of Engineering and Research, *Bendix Radio Division*, introduced the new officers and Colonel George Dixon, AFCA National Executive Secretary, who had come up from Washington for the meeting. Colonel Dixon discussed the general objectives of the association and emphasized the importance of fraternization during chapter meetings to develop closer friendships among AFCA members.

At the conclusion of the meeting, the movie "Air Siege" was shown to the group.

Boston

Capt. Charles Horne, former Deputy Chief of Communications, USN, and now Director of Federal Airways, CAA, delivered an excellent talk on "Aeronautical Communications, Present and Future" before a meeting of the Boston Chapter on September 20th at the Boston Naval Shipyard. At the conclusion of his talk, he conducted an interesting and instructive question and answer period.

A social hour and dinner preceded the meeting. Chapter President T. F. Halloran of the *General Communication Company* greeted the members and guests and stressed the chapter's current membership drive. Membership Chairman John B. Russell of the *S. H. Couch Co.* reported on the progress of the drive.

Arrangments for the evening's pro-

This Association is a patriotic non-profit organization, with chapters in most of the larger cities, dedicated to developing and maintaining efficient personnel, commissioned, enlisted, civilian, for the supply (including design and development), installation, maintenance, and operation of communications and electronic equipment for Army, Navy, and Air Force and their supporting civilian activities. It publishes a magazine "SIGNALS" at its national headquarters in Washington. Every American interested in any way in communications is eligible and invited to join. Dues are \$5.00 per year. Application should be submitted to the secretary at 1624 Eye St., N. W., Washington 6, D. C., who will furnish details upon request.

gram were made by Raymond B. Meader of *New England Tel. & Tel. Co.*, who is chairman of the chapter's program committee.

Chicago

The Chicago Chapter held its opening meeting of the 1950-51 schedule at the Edgewater Beach Hotel on the evening of September 27th. Some seventy members and guests attended a double-feature program at the Sheridan Room, after an informal dinner at which reports of past national conventions were given and suggestions made for the 1951 convention to be held in Chicago.

The program was opened with a talk on "Research Applications of Photography" by Perry M. Thomas, Director of Sales Training at the *Bell & Howell Company*. The talk was illustrated with a series of spectacular slides of stroboscopic flash photographs made in connection with several actual military and civil research projects, including the investigation of icing conditions on aircraft propellers and wings, helicopter flight, and the flight of German "Buzz Bombs."

The second feature of the program was a panel discussion of defense procurement procedures. Moderator of the discussion was Harry C. McCluskey, executive vice president of the *Kellogg Switchboard and Supply Company*. Guest participant was John E. Nylin of the Chicago Office, Signal Corps Procurement Agency. Chapter members participating were Raymond K. Fried, expert on the legal aspects of procurement, and Carrington Stone, experienced in industry-military relationships.

Mr. McCluskey had prepared a series

of questions designed to bring out both the basic facts of procurement planning and procedure, and to develop specific answers to current problems. The questions were directed in turn to the panel members, who answered them on the basis of individual knowledge, or placed the subject in discussion.

Several interesting points arose in the panel discussion, and questions were accepted from the floor. On the question as to what Signal Corps contracts were subject to renegotiation, Mr. Nylin replied that to his knowledge renegotiation can apply to any negotiated contract or subcontract of \$1000 amount or over. On the question of supplier's rights for renegotiation, Mr. Fried stated that in a case within his knowledge a supplier had asked for renegotiation on the grounds that operations had been conducted at a loss, but that this was not sufficient grounds for renegotiation. Only recourse of a supplier for upward price revision is supplemental agreement, Fried said, based on changes in specifications or similar understanding.

On the question of government specifications, all members of the panel were in agreement that the phrase "or equal" has very little flexibility when used in connection with an item designed at a single source. The consensus was that to be able to bid on a proprietary item, it is virtually a necessity to have working drawings of the proprietary item together with drawings of your own equivalent, with the statement that the two are electrically and mechanically interchangeable. Naturally it is not customary to have available working drawings of a competitor's product, the panel pointed out, although some instances of supplier's drawings being available to government contractors for bid distribution have been known.

The meeting adjourned after questions from the floor had been answered.

New York

New York Chapter members turned out for a most interesting meeting on September 13th which featured Dr. J. O. Perrine, Asst. Vice President of the *American Telephone & Telegraph Co.*, and his demonstration-lecture on "Micro-Radio Waves in Civil and Military Communications." Dr. Perrine presented a similar lecture before AFCA's four Southern chapters last year.

Colonel George P. Dixon, AFCA National Executive Secretary, reported on some of the things that national headquarters are working on.

Chapter President Thompson H. Mitchell, *RCA Communications*, in calling the meeting to order introduced the following: Maj. Gen. H. C. Ingles, President of *RCA Communications* and former Chief Signal Officer of the Army; Brig. Gen. Carroll O. Bickelhaupt, Secretary and Vice President of the *AT&T Co.*; Rear-Admiral Elbery W. Stone, President of *All Amer-*

MICROPHONES

- Pressure
- Velocity
- Cardioid
- Varcoustic
- Hand Sets
- Sound Power Telephones
- Stands, Plugs, Cables and Connectors



AMPLIFIERS



- Pre-Amplifiers
- Line Amplifiers
- Voltage Amplifiers
- Power Amplifiers
- Remote Amplifiers

SPEAKERS



- Cone Type
- Horns and Drivers
- High-Fidelity Speakers
- Speaker Accessories

SPEAKER HOUSINGS



- Baffles, All Types
- Console Cabinets

INTERCOM SYSTEMS



- All Master Systems
- Master-Remote Systems
- Combination Systems

CUSTOM-BUILT EQUIPMENT



- Consoles
- Desks
- Turrets
- Cabinets

PORTABLE SOUND SYSTEMS



PROGRAM CONTROL UNITS



- Single Channel
- Dual Channel
- Custom-Built



Why shop around?

It's easy to get the right equipment from RCA's full line of matched sound products

Buy your sound products the easy way. The wide variety of RCA Sound Products simplifies your problem of finding the right equipment for your sound jobs.

Every item in RCA's extensive sound line is electronically engineered with its own special characteristics to give top performance, dependable long-life service with quality appearance. Not only is the

RCA Sound Products line built right, it is also priced right to enable you to build a steady volume of profitable business.

No other manufacturer offers so extensive a line of "matched" sound products from the smallest "ballyhoo" system to the largest systems for industrial, educational, institutional, church, hotel, hospital or commercial users.

See your RCA Sound Products Distributor for catalog and new sound sales manual



SOUND PRODUCTS

RADIO CORPORATION of AMERICA
ENGINEERING PRODUCTS DEPARTMENT, CAMDEN, N. J.

In Canada: RCA VICTOR Company Limited, Montreal

WE HAVE LARGE QUANTITIES OF

RADIO TRANSMITTING TUBES

TYPE	PRICE	PACKING
807	\$1.59	IN ORIGINAL CARTONS
805	\$3.50	" " "
813	\$6.50	" " "
1622	\$1.49	" " "

SUBSTANTIAL DISCOUNTS ON LARGE ORDERS

All tubes are brand new standard brands. This offer subject to change without notice and prior sale. Terms: 25% deposit with order, balance C.O.D. \$25.00 minimum order.

MANUFACTURERS: WANT MORE EXPORT SALES? CONTACT: MICHEL LEVIT
Domestic Division: TUBE DEPARTMENT

METROPOLITAN OVERSEAS SUPPLY CORPORATION
1133 Broadway, New York 10, N. Y. Telephone: CHelsea 3-1105

TEN OF THE BEST RADIO TEXTS

RADIO HANDBOOK IN TWO EDITIONS



11TH EDITION: The standard work on practical and theoretical aspects of all radio communication.

12TH EDITION: Detailed constructional information on a wealth of radio communication equipment; all brand-new.

BOTH these top-notch books are a necessity for everyone interested in radio communication. There is little overlap in coverage; each is a perfect companion volume to the other.

\$3.00

FOR EITHER EDITION AT YOUR DEALER — By mail, \$3.25 postpaid. Add tax in Cal. Foreign, \$3.50.

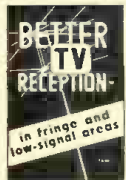

BETTER TV RECEPTION

THE "Fringe Area TV" Reference Book
By W. W. Smith and R. L. Dawley

TV signal propagation, evaluation of TV antenna, making a TV signal survey, types of masts and towers and recommended installation practices. Full data on rhombics, how to use open-wire feed line, how to eliminate ghosts, minimizing fading, TVI, etc.

\$2.50

AT YOUR DEALER — On mail orders from us, \$2.60 postpaid. Add sales tax in California.

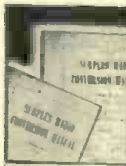

SURPLUS RADIO CONVERSION MANUAL IN TWO VOLUMES

This set of reference data has become standard for the most commonly used items of surplus electronic equipment. All conversions have been proven by testing on several units; each yields a useful item of equipment. For list of items covered, write us.

\$2.50

FOR EITHER VOLUME AT YOUR DEALER — On mail orders from us, \$2.60 postpaid.



ANTENNA MANUAL

The most practical, comprehensive book on antennas. 300 pages of down-to-earth help on antenna, feed line, radiation and propagation for all frequencies up to 1000 Mc. including FM and TV. Plain language; no need to brush up on math. A necessity for everyone interested in transmission or reception.

\$3.50

AT YOUR DEALER — On mail orders from us, \$3.60 postpaid. Add tax in Cal. Foreign, \$3.75



"RADIO-TELEVISION Questions and Answers"

A separate book for each element of the study-guide questions pertaining to the various classes of commercial U.S.A. radio operator licenses. You need buy only those elements required for the license you want.

NOW READY!

Element 2: Basic Theory and Practice
Element 3: Radiotelephony
Element 4: Advanced Radiotelephony

85¢

AT YOUR DEALER — On mail orders from us, \$1 EACH postpaid for one, or 90¢ each for two or more.

NOW AVAILABLE:

Element 1: BASIC LAW, temporary mimeographed edition. (Printed edition awaits pending revision of questions by F.C.C.) 40¢ per copy at your dealer; 45¢ from us postpaid.



RADIO AMATEUR NEWCOMER

Ideal for those just getting started for interested in radio. You need no other book to get your license and get on the air. How-to-build simple equipment for a complete station; operating instructions; simple theory; study questions needed to pass license exams; U.S.A. Amateur radio regulations. WRITTEN BY THE EDITORS OF "RADIO HANDBOOK."

\$1.00

AT YOUR DEALER — On mail orders from us, \$1.10 postpaid. Add sales tax in California.

OTHER U. S. A. ELECTRONIC BOOKS: You may order from us any such currently advertised book at standard prices; we maintain extensive stocks for prompt shipment. "SURPLUS" DIAGRAMS: We can furnish schematics of many surplus electronic items not included in our Conversion Manuals. Send stamp for list.

AT YOUR FAVORITE DEALER

OR DIRECT BY MAIL FROM

Editors and Engineers

LIMITED
1302 KENWOOD ROAD, SANTA BARBARA, CALIFORNIA

ican Cable & Radio Corp.; Robert A. Gantt, Vice-President of the IT&T Corp.; Vice Admiral W. S. Anderson, Vice-President, International Automatic Electric Corp.; Ralph S. Grist, Coordinator of Military Services, Southern Bell Tel. & Tel. Co., and President of AFCA's Atlanta Chapter; Col. H. R. Yeager, Communications and Electronic Officer, Continental Air Command; Brig. Gen. A. W. Marriner, Aviation Technical Director, IT&T Corp.

Colonel Mitchell announced the appointment of Col. Allen E. Wharton of the New Jersey Bell Telephone Co., Newark, N. J., as chairman of the New York Chapter's Civilian Defense Committee. This committee will assist and cooperate in all possible ways with the recently established state and city civil defense organizations for the New York metropolitan area.

Philadelphia

New officers were installed and committee chairmen appointed at the Philadelphia Chapter meeting on Oct. 3rd.

Retiring President W. W. Watts, Vice-President of RCA Victor Div., and National AFCA Vice-President, installed the officers as follows: President—Harry A. Ehle, Vice-President and General Manager, International Resistance Co.; 1st Vice-President—L. J. Woods, Vice-President, Philco Corp.; 2nd Vice-President—R. E. Cramer, Jr., Vice-President, Radio Condenser Co.; Secretary—J. R. Curley, RCA Victor Div.; Treasurer—L. C. Collier, Signal Corps.

New committee chairmen are: Program—James McLean, Philco Corp., and John Schimmel, Franklin Institute, as co-chairmen; Membership—Walter F. Denkhau, Bell Telephone Co.; Publicity—Erwin May, RCA; Civilian Defense Coordinating Committee for Philadelphia—Admiral J. Bowling, Philco Corp.; Civilian Defense Committee for Camden—W. W. Watts.

Guest speakers for the evening were: Col. George Dixon, AFCA National Executive Secretary; Col. Wellington Dillinger, new commanding officer, Signal Corps Procurement Agency; and Col. Glenn S. Meader, new commanding officer, Signal Corps Stock Control Agency.

Colonel Dixon outlined plans for the association for the coming year and brought the chapter members up to date on all aspects of AFCA national activities.

An eye-witness account of conditions as they exist today in Germany was given by Colonel Meader who very recently returned to this country from an extended tour of duty in Heidelberg. He stated that it was his personal impression that resentment against occupying nations is gradually waning in the non-Russian sectors.

A probing analysis of the present attitude of the Japanese was presented by Colonel Dillinger, who noted that the retention of the Emperor was perhaps the shrewdest of all General MacArthur's farsighted decisions in handling postwar Japan.

Eighty members and guests attended

Sound from the ceiling



A PROFITABLE MARKET for DISTRIBUTORS, SERVICEMEN and CONTRACTOR DEALERS

LOWELL Flush Mounting Ceiling Baffles quickly and easily solve the problem of speaker location and sound quality in thousands of places where conventional speakers would be unsuitable or in the way.

Model BL8-A, illustrated, has "floating conical action" and gives excellent low level response. Provides CONTROLLED SOUND with even distribution over 360°. Mounts to ceiling by 4 bolts. 1 3/4" dia. at top; 4 3/8" deep . . . all hardware furnished. Finished in any colored lacquer to match surroundings.

Write today for new catalog covering the complete line of Lowell baffles. Ideal for all ceiling installations.

LOWELL METAL PRODUCTS CORPORATION

1531 Branch St., St. Louis 7, Mo.

TUBE — OHM — CAPACITY TESTER!

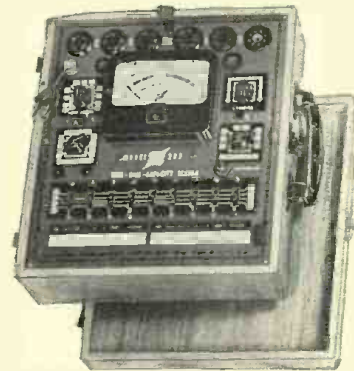

MODEL 202

- Line Voltage Control.
 - Checks shorts and leakages.
 - Checks resistance to 4 megs.
 - Checks capacity from .01 to 1 Mfd.
 - Checks condenser leakage to 1 megohm.
 - Individual sockets for every type tube base.
 - Built-in roll chart.
 - Tests tubes from .75 volts to 117 filament volts.
- Complete in sturdy, hand-rubbed portable oak case with carrying handle, **\$4650**
ONLY

Add \$6.00 for 220V operation

Export Dept., 303 W. 42nd St., N. Y. C.
Write Dept. A-12 for Free Catalog

Gives More Measurement Value Per Dollar



ELECTRONIC MEASUREMENTS CORPORATION

423 Broome Street, New York 13, N.Y.

RADIO & TELEVISION NEWS

the meeting and the dinner which preceded it at the Officers' Club, Philadelphia Quartermaster Depot.

Pittsburgh

A tour of the West Penn Power plant in Springdale, Penna., marked the first fall meeting of the Pittsburgh Chapter on September 12th.

The plant is the second largest power producing plant of the West Penn Power Company which supplies power for the area surrounding Pittsburgh, Northern Pennsylvania, West Virginia, Ohio and Maryland. The tour was of special interest to the chapter members since the plant is a part of a network vital to the defense industry in the Pittsburgh area.

San Francisco

Colonel T. F. McCarthy, Director, Disaster Planning for the City of Berkeley, Calif., gave an interesting and instructive talk on "Municipal Disaster Planning" before a meeting of the San Francisco Chapter at the Don Lee Studio of Station KFRC on September 21st. In addition to the problems of disaster relief planning for Berkeley, he had a number of up-to-date comments on the material which had been recently distributed by the National Security Resources Board.

Colonel Lloyd C. Parsons, Signal Officer, Sixth Army, brought the chapter up-to-date on the local military situation and stated that the Signal Corps units sponsored in San Francisco by RCA Communications, Graybar Electric Co., and the Associated Telephone Co. had all been called into active service. He also told of the changes in communications personnel recently made by the Navy in the San Francisco area.

Seattle

The Seattle Chapter has decided to forego its practice of holding bi-monthly meetings and instead meet every month until the present national emergency is over. Representatives from the chapter attended a recent meeting of the local civil defense authorities, and reported on the ways the AFCA chapter could be of assistance in the civil defense planning.

At the chapter's September 20th meeting, Mr. J. Dingwall, assistant to the Mayor of Seattle, spoke on the non-technical part of the Seattle civil defense board which is headed by the Mayor and is composed of the directors of the following departments: public health, fire, police, engineering, utilities and welfare (performed by the Red Cross). Mr. Dingwall explained plans for handling an atomic bomb attack and pointed out that an underwater atomic bomb burst is more dangerous than an air burst. Other phases of the defense plan he described were the development of a recruiting program, housing facilities, screening stations, purchasing division, mutual assistance with neighboring cities, and radiological monitoring equipment.

December, 1950

ODDS 'N ENDS SALE

DIEHL MOTOR

 Fan duty, brushless induction type (no TV interference). For 115 VAC 60 cycles, 46 watt, 1800 R.P.M. Shaft 1/4" diam. 1" long. Noiseless ball-bearings—heavy cast construction. Shpg. wt. 6 lbs.
 Brand new..... **\$4.50**

SILVER CERAMIC TRIMMERS
 5-20 Mmfd. Zero Temp..... 24c
 5-20 Mmfd. Neg. 300..... 24c
 4-25 Mmfd. Zero Temp..... 24c
 20-125 Mmfd. Neg. 650..... 33c

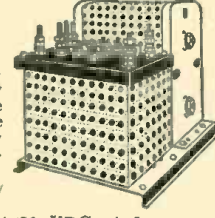
MISCELLANEOUS—LIMITED QUANTITIES
 Grain-O-Wheat Bulbs, 3 volts, Doz..... \$1.50
 Westinghouse Mtr. multipl. res. 1/2 meg. 1/2 %..... .89
 Circuit Breaker, 10 Ampere thermal..... .50
 140 mmd air trimmers, screwdriver adjust..... .35
 Weston 506 2 1/2 rd. 0-15 ma. Brand New..... 2.95
 Shunt 50 mv. 150 Amps. Westinghouse..... 2.00
 Ceramic couplings 1/4" to 1/2"..... .25
 Micro-switch YZ-R85 SPST (N.O.)..... .25
 8 MFD 600 VAC Oil Condenser C-D..... 3.50
 2 X .1 MFD 600 V. Bath tub C-D..... .25
 1/32 Ampere 8AG Littellfuse..... per doz. 1.00
 .5 MFD 400 VDC rectangular Oil Aerovox..... .35
 Guardian Relay 24 VDC 8 Ohm coil 1/4" silver contacts, aircraft starting..... 1.95
 8 MFD 3000 V. Pk. Photo-flash cond. Sprague..... 2.49
 Phase Inverter MC-13-A 1TR..... 5.00
 40 MFD 150 VDC FP electrolytic..... .20
 40 MFD 450 VDC FP electrolytic..... .35
 Thordarson Choke 10 Hys 55 ma. fully cased..... .85

DC POWER SUPPLY

 Limited quantity—Gov't Surplus. Ready to operate. Full wave bridge copper-oxide rectifier heavy duty multi-tapped transformer.
 Input: 85/95/105/115/VAC 50/60 cps.
 Output: 2.5/24/28/32/36 VDC at 5 amperes, unfiltered.
 For wall or bench mounting. Overall dimen. 9"x 8 1/4"x 8 1/2" high. Shpg. wt. 30 lbs. Tested and guaranteed..... **\$36.00**
 Filter Kit, 2% ripple..... 8.75

WHILE THEY LAST METER SPECIAL

 0-300 VDC, Basic 0-1 ma. 2 1/4" rd. Bakelite case. New, in original boxes. Shpg. wt. 2 lbs. Bargain price..... **\$2.25**

SELENIUM RECTIFIERS
 and associated transformers, filter chokes and condensers are listed in our Catalog No. 719. Write for your copy.

VACUUM CAPACITORS
 Standard Brands

 12 Mmfd. 20 Kv \$4.95
 50 Mmfd. 32 Kv 5.95
 Overall length 6 1/2", diameter 2 3/4", terminal diameter 1/4". Shpg. wt. 2 lbs.

EDISON THERMO TIME DELAY RELAY
 Heater voltage 115 V. Norm. open SPST contacts. 15-30 sec. delay. Contact rating 115 V. 3A., 440 V. 2A. Size 3 1/4"x 1 1/4" diam. Plug in type for standard 4-prong tube base. Each..... **98c**

HI-VOLTAGE!

 Oil condenser, voltage doubler type 2X .15 MFD-8000 VDC. Use both sections in parallel for 3 MFD 8 KV, or in series for .075 MFD 16 KV. G.E. 26F 381 New, Each..... \$3.25
 Lots of 6 in orig. box Each..... **\$3.00**

TEST EQUIPMENT
 TS-34AP Oscilloscope, like new with cords, probe, carrying case and technical manual. Price on request.
 Leeds & Northrup Capacitor Decade, Cat. No. 1071. Price on request.
 General Radio Variable Condenser 722-D, Dual range 110 MMFD and 1100 MMFD with hard wood case..... **\$85.00**
 Industrial Instruments Decade Resistor Type DR50 11,111 Ohms total in steps of .1 Ohm, like new \$25.00

AUDIO CHOKE

 SM Choke Type U7402 Hermetically sealed.
 50 Hys. .04 Amps DC
 1780 RMS Test Voltage 3 1/2"x 3 1/4"x 3 1/4". Shpg. wt. 6 lbs..... **\$2.25**

PILOT LIGHT ASSEMBLIES

 Aircraft type, panel mounting, amber jewel only. Knurled rim, controls "Dim-Bright." Bakelite and aluminum construction. Bulb replaceable from front panel. For single contact bayonet bulbs. T-3 1/4" or G-3 1/2" size, Dimensions: 2 1/4" overall length, 3 1/4" diameter, 1/8" panel mtg. hole.
 IMMEDIATE DELIVERY—500 to carton, nested. \$50.00 per carton. Prices on larger quantities on request.

WESTINGHOUSE AIRCRAFT MOTOR
 Brand new—24 VDC reversible. 1/50 H.P. 4800 RPM continuous duty. Length of leads 18". Dimensions 3 1/2" X 2 1/2" shaft 1/4" diam. by 1/2" long.
 Price..... **\$2.95**
 Reversing switch with "off" position. Each..... .79c

Minimum order \$5.00. All prices are FOB shipping point. Send check or M.O. We will ship transportation charges collect. Rated concerns send P.O.. Terms Net 10 days.

OPAD-GREEN COMPANY

71-3 WARREN ST., NEW YORK 7, N. Y. PHONE: BEekman 3-7385-6

AD-VANTAGE
 Take advantage of the world's biggest Classified Ad opportunity—Your ad in **RADIO & TELEVISION NEWS** Classified Section will get more action—more inquiries—quicker, and at less cost than in any other magazine. Monthly net paid circulation over 200,000.

RADIO and TELEVISION
 Over 30 years N.E. Radio Training Center. Train for all types FCC operators' licenses. Also Radio and Television servicing. FM-AM broadcasting transmitters at school. Send for Catalog M.

MASS. RADIO SCHOOL
 271 Huntington Avenue Boston 15, Massachusetts
 Lic. by Comm. Mass. Dept. Educ.

TV SERVICE MEN YOU NEED THIS \$3.95 TOOL for \$1.00!

 STRIPS and CUTS OUT any! length—both at same time
 WILL SAVE YOU HOURS.
 SMALL TOO—2" x 3 3/4" x 1/16" steel.
 Thousands sold at \$3.95.
 While they last **\$1.00 Post Paid!**
 Sorry no C. O. D.
R. W. HARTNETT CO.
 1025 Cherry St. Philadelphia 7, Pa.

Lowest prices!



SYNCHRON MOTOR
Model 600. 1 RPM. 115 Volts.
60 cycles. Brand New.
Special Price \$2.75 each



BEAM INDICATOR
1-82F Compass Indicator.
0-360°-5 in. dial. 26 v 400
cy. 8-12 v. 60 cy. Ideal
position indicator. Brand
new.

Price \$3.75 each

**C-1 AUTOPILOT
VERTICAL GYROS**



May be used to conduct many interesting and amusing experiments. Operates from 24 V. DC or may be operated for short periods on 110 V. AC. Gyro will run for approx. 15 minutes after actuating. Size—approx. 8"x8 1/2"x8 1/2". Less Amphenol Connector. Removed from new aircraft. Special..... **\$4.95**

**C-1 AUTOPILOT
AMPLIFIERS**



Three channel servo amplifier consisting of many valuable electronic parts including 6 relays, 7 tubes.
With Tubes..... \$5.95
Less Tubes..... \$3.95

DYNAMOTOR



WinCo Type 41S6.
Input 13 volts DC
at 13 amps. Total
output 250 volts at
0.060 amps. and
300 v. at .225
amps.

Price Only \$5.95 Each

SWITCHES



Mallory Water type. Double Wafer. 3 Position. Special 29c each.
Mallory Single wafer. Three Position. Special 29c each.
Hi-Detent—Heavy duty—4P.3T. Pos. #1, 3 on, 1 off. Pos. #2 all off. Pos. #3, 2 on, 2 off. Special low price 39c each.
Push button Switch—Enclosed—s.p.s.t. Metal housing for panel or chassis mtg. Special 19c each.

CONTACTOR RELAY



Cutler Hammer 6041H30B.
12 v. dc. (50 amps. contacts).
Special at \$2.95 Each

**PUSH-BUTTON
SWITCH SPECIAL**



D.P.D.T. Momentary type.
Special at 59c Each

TERMS: 20% cash with order—balance C.O.D. Orders accompanied by payment in full must include sufficient postage, otherwise shipment will be made via Railway Express collect. Minimum order \$2.00.

Electro Devices
INCORPORATED
BOX NO.1941 PATERSON, N.J.

Mae's Service Shop

(Continued from page 46)

scrawny TV signals that reach out here.

"Another more common example is the shifting of a radio's i.f. frequency a couple of kilocycles or so in order to move a bad heterodyne off a popular local station.

"But you have to be sure that you really are making an improvement. A horrible example of not doing so is the case of a technician I know who invariably places bypass condensers across the cathode resistors of sets that do not already have them. He figures this does good because it increases the volume, and he is of the opinion that the manufacturer was simply too cheap to include these condensers. Really, that is not always the case. Quite often these condensers have been deliberately omitted in order to introduce degenerative feedback and so produce better over-all frequency response. Using the condenser increases the volume all right, but it quite often impairs the tone."

"Any other cases where you suggest changes?"

"Well, sometimes you get one of these small radios that simply do not have enough sensitivity to pull in distant stations. After you have checked everything else, you will often find that moving the loop antenna away from the receiver a little way will increase the sensitivity tremendously. The reason is simple: in order to achieve 'smart compactness,' the manufacturer has jammed the loop coil right up against the metal chassis, with a resultant lowering of its 'Q' and an increase in the distributed capacity. When cardboard or wooden spacers are used to move the loop away from the chassis an inch or so, the 'Q' goes up, the receiver does a better job of separating stations, and distant stations can be received much more readily. On top of that, the receiver is usually better ventilated with the loop set back a short distance."

"Did you ever catch a manufacturer pulling an out-and-out boner?"

"You might call this one," Mac said as he picked up an a.c.-d.c. chassis. "See where this 110 volt bayonet base dial lamp is located? Notice that it is directly behind the speaker cone and only an inch and a half from that cone. Now listen."

He turned on the set, and Barney instantly detected an annoying scratching sound that seemed to play a sort of background accompaniment for the voice and music coming from the speaker.

"Get this," Mac said as he removed the pilot lamp. Instantly the noise stopped. In quick order Mac substituted a half-dozen other lamps from a new box, and every one was noisy. Then he removed the screw that held the lamp bracket in place and moved it to the rear of the chassis where it was shielded from the speaker cone

Your Best Buys in
**TRANSMITTING
TUBES**

By Nationally Known Tube Mfr.
**NEW, BOXED, FACTORY PRE-TESTED
GUARANTEED
IMMEDIATE DELIVERY**
10% Discount on Orders Over \$500

813...\$5.95
807...\$1.49
866A...\$0.98

24G\$.25	332\$	14.50
MF60	2.65	333	16.25
111H	5.45	343A	115.00
ZB120	4.50	450TH	19.95
MF130	8.25	450TL	30.00
MF140	5.50	468	8.50
MF150	6.25	520MT	87.50
MF175	7.25	562A	85.00
MF200	9.00	830	2.75
MF201A	9.00	846	100.00
204A	40.00	849	15.00
212E	32.50	849A	17.50
228A	100.00	849H	45.00
232CH	100.00	858	180.00
242C	4.50	859	175.00
249C	1.35	869B	17.95
MF250	10.00	872A	1.19
267B	8.95	889A	67.50
270A	45.00	891	80.00
MF300	14.95	891R	115.00
304E	4.50	1652	115.00
331	4.50	801185

**GET NORLO'S PRICES
ON OTHER TUBES BEFORE BUYING**

ALL PRICES F.O.B. N. Y. MINIMUM ORDER \$5
20% Deposit (Check or Money Order)
Balance Sent C.O.D.
Rated Companies—Send Purchase Order

Cash for your surplus inventories

Norlo
ELECTRONICS CORP.
190 Washington Street New York 7, N. Y.
Phone Worth 2-1042,3

leading custom-builders
choose
BROWNING FM-AM TUNERS

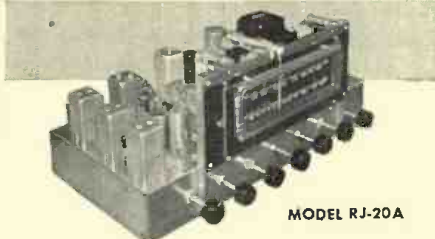

To satisfy discriminating music-lovers who wish the full splendor of beautiful music — "the very best" — brought into their homes. leading audio engineers feature Browning FM-AM Tuners in their custom-built radio phono systems.

And you will recognize the excellence of Browning — the instant you hear it — music flawless and noise-free — every instrument sounding true — speech clear, with amazing realism. Tuning is precise and drift-free.

Model RJ-20A—High-fidelity FM-AM Tuner (shown above) incorporating tone controls.

Model RJ-12B—High-fidelity FM-AM Tuner.

Model RV-10A—High-fidelity FM Tuner.

All with AFC on FM

BROWNING
LABORATORIES, INC.
WINCHESTER, MASS.

RADIO & TELEVISION NEWS

by the back of the speaker. With the lamp in this location, none of the bulbs caused any noise.

"The manufacturer slipped up there," Mac said. "When these fragile filaments are pushed around by the speaker vibrations, they make noise; and the only way to get rid of it is to place the lamp in a position where it is not buffeted around by the sound waves."

"As I get it," Barney said slowly, "the point you are trying to make is that there are times when, as you put it, the lily really does need gilding; but before you pick up the paint brush, you want to be sure that a little wiping off with a damp rag will not do the trick."

"That's a horribly involved way of putting it," Mac said with a grin, "but that's the idea. If you will just keep in mind the revolting thought that the fellow who designed the set you are working on was probably almost as smart as you are, you will be a better technician for it." —50—

Engineering Integrated Communications System

(Continued from page 39)

the terminal station, complete with associated carrier equipment, has been designed to fit into a vehicle of the three-quarter-ton weapons carrier type.

Intermediate area radio relay equipment will be under procurement before the end of the fiscal year in the form of a system with adequate bandwidth for 12 voice channels or the equivalent in facsimile, data transmission, or teleprinter channels. The same 12-channel carrier terminals being developed for wire systems will be utilized. Primary employment is contemplated for main-line communications from Army to Corps, and from Corps to Division.

To meet rear area requirements, development has been pointed toward 48- to 96-channel relay systems with ultimate ranges up to 1500 miles. Due cognizance has been given to engineering features necessary to assure the capability of satisfactory transmission of television and wide-band facsimile. While the equipment has reached the engineering model stage and tests have been satisfactory, it will probably not be ready for production this year. To provide a usable system in a shorter time, a modified version utilizing time division multiplex to obtain 24 channels is being placed in production in the next few months. Primary use will be for communications from Theater to Army Group to Army, and for providing main line circuits within the communications zone.

Amplitude Modulated Radio

The addition of FM and radio relay principles to the military radio system has not by any means reduced the necessity for conventional AM systems in certain applications. It is obvious, for example, that FM with its short range in the frequencies used—



The PROFIT-WISE
Serviceman Specifies . . .



New STANCOR PRODUCTS



8400
POWER
SERIES

A comprehensive line of 35 part numbers designed for replacement and new construction. Wide range of applications based on a thorough study of today's power transformer needs. Most ratings available in a choice of vertical or horizontal mountings.



OUTDOOR LINE
TO VOICE
COIL

Two new units designed to fit most needed outdoor applications. Primary impedances of 3,000/2,000/1,500/1,000/500 ohms; secondary impedances of 16/8/4 ohms. Part Number A-3333 rated at 14 watts. A-3334 rated at 25 watts.

STANCOR TRANSFORMERS

Using Stancor replacement transformers for your radio, TV and sound service jobs is the sure way to fatten your bank account. Here's why —

- Quality comes first with Stancor. Ability to "take it" cuts down call-backs—keeps your customers happy with a good job.
- Stancor has the largest line in the industry. A choice of 450 part numbers, in some 30 mounting and terminal styles, enables you to get exactly the right unit for almost any application.
- Easy-to-read instruction sheets and clearly marked terminals make your job quicker and easier. Saves valuable shop time.

New Stancor units are coming out all the time. Keep posted. Ask your Stancor distributor for our latest catalogs.



Most Complete Line in the Industry

STANDARD TRANSFORMER CORPORATION 3584 ELSTON AVE., CHICAGO 18, ILL.

RADIO ENGINEERING I

DEGREE IN
27 MONTHS

Complete Radio Engineering course incl. Telev., U.H.F., and F.M. B.S. Degree Courses also in Civil, Elect., Mech., Chem., and Aero. Eng.; Bus. Adm., Acct. Visit campus, see well equipped labs. Low cost. Prep courses. Personalized instruction. Grads successful. Founded 1884. Enter Jan., March, June, Sept. Write for Catalog.

TRI-STATE COLLEGE 16120 College Ave.
Angola, Indiana

ANOTHER OUTSTANDING JOBBER VARIETY Electric Co., Inc.

601 BROAD STREET
Newark 2, New Jersey

HAS THE
SENSATIONAL NEW
EICO 425-K 5"
SCOPE KIT
IN STOCK!



\$39.95

DX LOGGING SIMPLIFIED

with "Timing Devices"



24-HOUR
CLOCK!

IDEAL FOR SWL'S
AND AMATEURS

ALLIED HAS IT

Own this professional instrument now! Makes it easy to keep a log in 24-hour time (0000-2400). 10" dial with sweep-second hand; 6" inner dial shows time directly in all world zones. Self-starting; dependable. For wall or panel mount. Handsome gray finish, chrome bezel. For 110 volt 60 cycle AC. No. 78-325. Net FOB Chicago, including \$15 excise tax, only.

ORDER FROM **ALLIED RADIO**

833 W. Jackson Blvd.,

Chicago 7, Ill.

CUT ACCURATE HOLES IN RADIO CHASSIS



WITH A GREENLEE
RADIO CHASSIS PUNCH

● Make smooth, true holes quickly this easy way. Just turn GREENLEE punch with an ordinary wrench and have an accurately-sized opening for plugs, sockets, and other receptacles. No reaming or filing. A GREENLEE Punch for each of these sizes: 1/2", 3/8", 5/16", 3/16", 1", 1 1/8", 1 1/4", 1 3/8", 1 1/2", 1 3/4", 1 7/8", 2 1/4". Also GREENLEE Knockout Punches and Cutters for conduit and meter holes up to 3 1/2". Get facts now. Write Greenlee Tool Co., 1892 Columbia Avenue, Rockford, Illinois.



FOR THE "GOLDEN EAR" CROWD

THE STRAIN-SENSITIVE PHONOGRAPH PICKUP

Here's why this truly faithful reproducer appeals to people gifted with the "Golden Ear" . . . why the STRAIN-SENSITIVE PICKUP developed by the PFANSTIEHL CHEMICAL COMPANY brings out the brilliance of great voices and orchestras . . . the latent music on your records that other pickups leave untouched.

- The STRAIN-SENSITIVE PICKUP is an amplitude transducer with a CONSTANT RESISTANCE of about 250,000 ohms.
- Signal output is at a practically CONSTANT IMPEDANCE LEVEL.
- Excellent Transient Response.
- NO DISTORTION, phase shift or evidence of intermodulation is audible.
- LINEAR RESPONSE, free from peaks or resonances.

Cartridges are available for both standard and micro-groove, and can be had with Famous PFANSTIEHL M47B Precious Metal Alloy or diamond tipped styli.

A special preamplifier is necessary to provide the correct D.C. voltage for the pickup element and to provide the first stages of signal gain. Four styles are ready, or, if you prefer, you can build your own from the circuit in the literature.

Ask your radio supply man, or write today for complete FREE INFORMATION.

PFANSTIEHL
CHEMICAL COMPANY

101 Lake View Avenue, Waukegan, Illinois

and radio relay systems with their dependence on relays for range—would be of little use to an airborne division landed 100 miles behind the enemy lines. Mobile communications over intermediate ranges also obviously point toward AM sets. Global networks covering distances up to 12,000 miles must, of necessity, continue to utilize frequencies suitable for long ranges and methods of modulation giving maximum frequency conservation.

The main development being pursued currently in the low power AM field is a 100-watt set for use by lower echelons within divisions and by airborne troops. Ruggedness, reliability, small size, and simplicity are the keynotes that have governed the development. Quantity production is expected to start within the near future.

In planning development to satisfy requirements for sets working over ranges calling for wattages from 500 to 50,000 the Signal Corps has proceeded on the "building block" principle utilizing the 500-watt transmitter as the basic component. Addition of a 5 kw. power amplifier provides a set suitable for military communications in the 1000- to 2000-mile range, while the addition of a 50 kw. amplifier and necessary auxiliary equipment leads to a high-powered system for use on a global basis. Provisions are made for teleprinter, facsimile, voice, and c.w. transmission. Accessory equipment is provided for single sideband adaptation. In addition, parallel development is proceeding on a simplified single sideband transmitter. Within a few months production on 500 and 5000-watt sets will be under way. Receivers for the above equipment will be taken from a general receiver family being developed to fit communications, intercept, and direction finder roles.

Integration

While the above equipments have been discussed as individual items, it must be emphasized that they are developed within the concept of an integrated system and that devices for radio-wire integration are either integral to the equipment or furnished as auxiliary items.

Wire Communications

Wire systems are still considered in general to be the backbone of most Army communications despite the improvements being made in the radio field. Consequently, postwar effort on development of wire equipment has paralleled the effort on radio systems and is producing comparable results as will be indicated.

Wire and Cable

One of the really significant advancements now paying off in Korea and elsewhere is the new Signal Corps field wire which has been developed to replace both the well-known W-110-B field wire and the W-130 type assault wire of the past war. No rubber is contained in the new wire and

Let MILTON S. KIVER Help You
Prepare For COLOR TV
And...



Easy to TRAIN AT HOME This Practical Way!

Men with the right training in Television Servicing are in big demand . . . pull down big pay. T.C.I. TRAINS YOU RIGHT with easy-to-follow technical training designed by servicemen, for servicemen! You learn practical, professional type Television Servicing without leaving your present job. Included are money-making extras such as set conversion, master antenna installation, COLOR TV and field servicing short cuts. You can start earning Television money after the first few lessons. You learn to test, trouble shoot and repair all types of TV sets. You learn COLOR CONVERSION too!

HERE'S HOW YOU GET EXPERIENCE!

You train on your own 29-tube television receiver (12 1/2, 16 or 19" tube), furnished as part of your course. We loan you test instruments. As an optional feature you can get two weeks of actual field experience going out on service jobs and working on the repair bench for Chicago's largest independent servicing organization. You learn Television Servicing by actually doing Television Servicing . . . you get the practical know-how you need to qualify for BIG MONEY in this fast-growing field!

ACT NOW! Fill out and mail coupon for FREE Catalog and SAMPLE LESSON. Write TODAY!

**TELEVISION COMMUNICATIONS
INSTITUTE**
205 W. Wacker Dr., Dept. 1-C, Chicago 6, Ill.

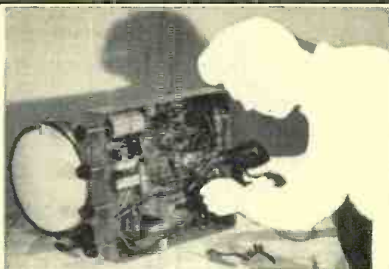

YOU GET and keep famous RCA 630 TS type Television receiver.

YOU DO actual testing, servicing, trouble shooting and repairing.

FOR THE BEGINNER
TCI offers a low-cost Pre-Television Course in Radio, especially designed to prepare you for television in just 5 to 7 weeks. Everything you need from basic radio through servicing . . . to Television.

MAIL NOW FOR FREE BOOKLET

MILTON S. KIVER, President
TELEVISION COMMUNICATIONS INSTITUTE
205 W. Wacker Dr., Dept. 1-C, Chicago 6, Ill.

O. K. Mr. Kiver! Rush FREE Catalog on your practical home study course in Television Servicing, including COLOR TV. Include FREE Sample Lesson. I am not obligated. Salesman will not call.

Name.....Age.....
Address.....
City.....Zone.....State.....
() BEGINNERS check here for information on Pre-Tel Radio Course.

substantial gain can be made in other structural elements. While W-110-B wire weighed around 140 pounds per mile, the new wire weighs only 48 and has an increased talking range, better abrasion and moisture resistance, and longer life. To facilitate wire laying, a new canvas wire dispenser has been perfected which allows high- or low-speed wire pay-out from the inside of the package without the use of reels or axles. Besides the obvious advantages, particularly to the forward area wire layers, a considerable saving in metal reels is realized. Also newly developed is a lighter and tougher spiral four field cable for use with 4- and 12-channel carrier systems. The basic cable for both systems is identical physically and electrically, with loading for 4-channel operation being accomplished by insertion of a small weatherproof loading coil between cable connectors.

Switchboards

The system of switchboards contemplated for the integrated system provides capacities required from battalion to theater level and utilizes, when possible, the "building block" system. Just going into production is a 12-line monocard board of the magneto type weighing about 22 pounds versus the 72 pounds of its predecessor and utilizing retractable cords. Capable of stacking up to three units, this board will be suitable for use up to regimental level. Also soon to be available for use at regimental and divisional level is a 30-line magneto board of the more conventional type capable of 60- to 90-line expansion and using many of the basic components of the smaller board. For use where larger capacities are necessary, a common battery board, based on a 70-line position and capable of expansion up to 2000 lines, is being developed. For ease and speed of installation, this board is equipped with plug-in type cables for interconnection between positions, and between main frame and switchboard. As with all Army equipment, the ability to stand the bumps and adverse weather conditions inherent in military operations has been built into the equipment.

Teleprinters

The Signal Corps' main contribution to the teleprinter field is the development of a simplified page printer weighing only 45 pounds, usable at speeds from 60 to 100 words-per-minute, and designed specifically for ruggedness and dependability and ease of maintenance. Due primarily to its 225 pound weight, and multitudinous parts the teleprinter previously standard for the Army was not suitable for use in lower units, whereas the new unit with only one-fifth the weight and 300 fewer parts will allow teleprinter service to be employed down to the regimental level. A 17-pound tape printer now in development will further extend the use of this most desirable means of communications to battalion level. Recently completed

SENSATIONAL TRIO TV YAGI PROVIDES HIGH GAIN ON 2 CHANNELS

Here's the New TV antenna everyone is talking about — the most desirable antenna for two band operation. Unlike customary yagis, where gain falls off sharply on adjacent channels, the new and revolutionary development by TRIO actually provides full 10 DB gain on each of two channels — in a lightweight, compact array. It's the reason it's the most sought after antenna in America today! It's available for channels 4 and 5, in the low band, and channels 7 and 9 in the high band. If it's dual channel performance you want for local or fringe area reception, here's the antenna that out performs them all — in better picture quality, cost and weight.

COMPARE THESE ADVANTAGES

- Provides gain on both channel 4 and 5 (or 7 and 9). Equal to Any Two conventional 4-element yagis!
- One bay replaces bulky stacked array!
- One lead replaces old-style 2-lead systems!
- Less weight-per-gain than any other TV antenna!
- Greatly reduced installation costs for complete TV coverage!
- Can be stacked for additional gain.

HOW IT WORKS

Antenna consists of 4 elements whose functioning is different on the two channels. For example: in Model 445, the elements, on channel 4, act as reflector, dipole, director, director, in that order; while on channel 5, the same elements act as reflector, reflector, dipole and director. Careful design insures proper impedance match with standard 300 ohm lead.

Eliminates Co-Channel Interference — Venetian Blind Effect

When used with TRIO "Controlled Pattern" System . . . Because of the high gain and front to back ratio of the new 2-channel single or stacked yagi, most co-channel interference is eliminated. When the problem is unusually difficult, such as when the TV receiver is located in the center of several TV stations operating on the same channel, co-channel interference CAN BE COMPLETELY eliminated with the use of the "Controlled Pattern" system. This unique system uses 2 bays, off-set stacked and tuned with the remarkable TRIO "Phasitron". TRIO antennas will give you TV reception when the rest fail.

- Model 445—Single bay Yagi for Channels 4 and 5.
- Model 445-2—Conventional 2 bay stacked array for Channels 4 and 5.
- Model 479—Single bay Yagi for Channels 7 and 9.
- Model 479-2—Conventional 2 bay stacked array for Channels 7 and 9.
- Model 645—"Controlled Pattern" System for Channels 4 and 5, and Model 679 for Channels 7 and 9.

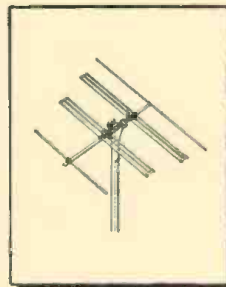

Single 4-element yagi with dual purpose elements. Provides high gain on two channels.

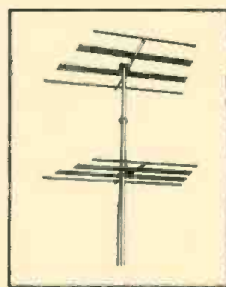

Two of the new TRIO yagis may be stacked to get up to 12 DB forward gain.

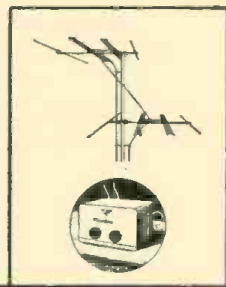

The "Controlled Pattern" System — eliminates "Venetian-Blind effect" when caused by co-channel interference.



Trio MANUFACTURING CO.
Griggsville Illinois

RADIO COURSES

- RADIO OPERATING ● CODE
 - RADIO SERVICING ● ELECTRONICS
 - F. M. TELEVISION
 - PREPARATION FOR CIVILIAN, MARITIME, ARMY AND NAVY LICENSE REQUIREMENTS.
- Write for Catalog T.S.



TRADE & TECH. SCHOOL 229 W. 66 St., N. Y. 23
ENdcott 2-8117

ANOTHER OUTSTANDING JOBBER

TRI-STATE Radio & Supply Co.



\$23.95

118 BARTLETT STREET
Poplar Bluff, Missouri

HAS THE
SENSATIONAL NEW
221-K
TEICO VTM KIT
IN STOCK!

PRINT YOUR OWN POST CARDS

COMPLETE OUTFIT
only
\$7.50

Amazing results in sales, inquiries and contacts . . . saves time and money . . . very easy to use GEM STENCIL DUPLICATOR is ideal for Advertising, Announcements, Notices, Labels, Forms, Price Lists—hundreds of uses for every type of business and organization. Comes complete with all supplies, instructions and 60-page Book of Ideas.

FREE TRIAL OFFER: Try it before you buy it! Write and a GEM OUTFIT will be sent you postpaid. After 10 days, send only \$7.50 or return the GEM, no questions asked. The GEM must sell itself; you be the judge.

BOND EQUIPMENT CO. • Dept. 111
6633 Enright • St. Louis 5, Mo.

SEND NO MONEY • FREE TRIAL OFFER

INVENTORY SALE ALL PRICES CUT TO BONE

Westinghouse Curox Rectifier 0.64 Amp. 28 Volts. Reg. \$11.00 on Special \$3.95
25c TUBE SALE—2 53-2A7-55-27-85-31-56-57..... 6 for \$1.00

TUBES—024, 79c; 117P7, 95c; 68L7..... 35c

12 BRAND NEW 10" PHONO RECORDS—Asst. Jazz—Pop—Hillbilly—Polkas \$1.79

3 Ft. 5 Wire Shielded Cable with Amphenol Connector..... 8 for \$1.00

7 Wire Shielded Cable, 24 in. with Octal Plug..... 6 for \$1.00

U. S. ARMY GAS MASKS

Has O.D. covered case suitable for lunch or tool bag and charcoal container for use in refrigerators to eliminate fish or other odors.
Brand new—39c each; 3 for \$1.00

TRANSMITTING PLATE TRANSFORMERS

A Pair of Signal Corps transformers connected in series to 110-125 Volts, AC, will deliver approximately 750 to 800 Volts, DC, 200 mls. when connected to a rectifier tube and filter condenser. Cost Uncle Sam \$23.00—our price per pair, \$2.98. Shipping weight 33 lbs.

Signal Corps Phones—2 M. Ohms (8 M. Ohms Imp.) \$1.00
2 Ft. Ext. Cord (and Plug)..... 40c

OIL FILLED FILTER CONDENSERS

1.-MFD—1000 working volts..... 6/99c; 12/\$1.75
CD. 4 MFD. 600 V. Upright Bottom Lug..... 49c

TUBE TUBULAR ELECTROLYTICS

20-20 MFD. 150 V..... 35c 30-30 MFD. 150 V..... 37c
40-40 MFD. 150 V..... 39c

Low-Loss Short Wave

Lock Type Air Trimmer

Variable Condensers

3 Pl.—12-15 Mmfd. 12c

7 Pl.—25-30 Mmfd. 15c

8 Pl.—30-35 Mmfd. 16c

10 Pl.—40 Mmfd. 17c

14 Pl.—56 Mmfd. 24c

27 Pl.—100-110 Mmfd 35c

3 GANG T.R.F.

VARIABLE CONDENSERS

.000365 Con. 65c

D.P.D.T. SLIDE

ROGGLE

SWITCH

..... 15c



4 PR. WAFER SOCKETS—\$1.49 per C. each..... 3c
PHILCO 4 MF—300 V—1% CAN CONDENSER—10c ea.
5-6 PRONG WAFER SOCKETS..... \$2.50 per C
100 ASST. SOCKETS—4-5-6-7..... \$3.50 per C
1,000 OHM WIRE WOUND POTENTIOMETER..... 15c
30 HY-FILTER CHOKE SHIELDED..... 3 for \$1.25
UNSHIELDED..... 3 for 1.00
2,000 ohm Wire Wound Rheostats..... \$4 per doz.
CARTER WIRE WOUND C.T. VARIABLE 20 OHM
RESISTORS..... 85c per doz.
RCA 6 OHM POWER RHEOSTATS..... 14c for \$1.00
GEN. ELEC. WESTINGHOUSE, etc. 60 CYCLE WATT
HOUR METERS, slightly used, perfect condition,
same as used in your home. 110-125 volts.
5 Amps. \$2.95; 10 Amps..... \$3.95

PIEZO CRYSTAL HOLDERS with cover..... 12 for \$1.00

Grind your own crystals—Pure Brazilian Quartz, all sizes and thicknesses—1/2 lb. package..... \$1.00

RCA Band Switches—

3 gang, 3 pos. 3 band. 30c 6 gang, 4 pos. 4-5 band. 40c

Trimmer-Padder Asst.—all Isolantite—singles, dual, triplex—100 asst. pieces..... \$2.25

Philco Push Button Rotary Switch Double Pole..... 35c

ATTENTION: Prospectors, Explorers for Hidden Treasures! Construct a U.S. Army Type of Metallic Mine Detector Amplifier. Amplifier unit only (less tubes and batteries) with cables, headphone cord, and jack. See wiring diagram. Type AN/PRS-1..... \$1.95

RCA Asst. Mica By-Pass Cond. .001, .002, .0025, .005, .01, .02, .05, .1, .2, .5, 1, 2, 5, 10, 20, 50, 100 for..... 95c

8 or 9 Gang Push Button Switch..... 59c

DRILLED CHASSIS FOR 5-6 tubes 5"x10"x1 1/4"..... 25c

PHONE JACKS—OPEN & CLOSED AUTO..... 18c

NATIONAL 20 MFD—450 VOLT CAN FILTER CONDENSER..... 25c

EBY SPEAKER VOL. CONTROL—60 OHMS..... 15c

SALE—PHONO RECORD ALBUMS—12"—3 comp. 15c; 10"—5 comp. 15c; 4 comp. 20c; 12 comp. 49c

4 Post Terminal Strip with Lugs & Screws..... 10c

Lots of 100..... \$9.00

4 Wire Shielded Cable, 6 Ft. with Plug..... 7 for \$1.00

IRC—300 Watt—300,000 OHM Wire Wound Res. 95c

6 Prong Amphenol Sockets..... \$4.00 per C

AMERTRON FILAMENT TRANSFORMER—6.3 V., 1.0 Amp. Encased Isolantite Terminal Posts..... \$1.50

AMERTRON XMITTING AUDIO XFORMER—For Class B or Modulator, Pri. 6400/1600—Sec. 5560 @ 160 MA. Cost \$75.00..... SPECIAL \$2.49

AMERTRON AUDIO OUTPUT XFORMER—Pri. 10,000 @ 15 MA; Sec. 300. 6:1 Ratio..... \$1.49

AMERTRON MIXER AUDIO XFORMER—Pri. 600-10,000 Ohms..... \$1.00

156-1 RATIO VERNIER DIALS—4 in., 3/4 in. Hub. 35c

LINE VOLTAGE NOISE ELIMINATOR—Plugs in Between Radio and Elec. Socket..... 35c

NATIONAL VELVET VERNIER DIAL—1/4 in. Hub, 4 in. Diam. Silver Plated..... \$2.19

12 in. MAGNAVOX SPEAKER, 2500 Ohms..... \$2.95

HEARING AID CORDS—Assortment of 12 for..... \$1.00

BY-PASS COND. ASST.—25 Cans. Bake., Paper, etc..... \$1.00

MINIMUM ORDER \$2.00—NO C.O.D.
SHIPMENTS—PLEASE INCLUDE POSTAGE

**NEWARK
SURPLUS MATERIALS CO.**

Dept. DE

324 Plane Street NEWARK 7, N. J.

voice frequency line units for use with these two equipments will allow the utilization of radio voice channels on tactical radios for teleprinter service. Of comparable importance, the voice frequency principle will make possible the use of teleprinters over local subscriber telephone circuits and through standard telephone switchboards.

Carrier Equipment

Commercial telephone and telegraph carrier equipment is designed for fixed station operations under controlled conditions where size, weight, and ruggedness are not determining factors. The Army requirements for carrier equipment include lightweight, small equipment built to take rough usage, and operate with little attention under adverse weather conditions and over communications lines subject to considerable electrical variations. To fill this need three carrier systems are currently under development, a 4-channel telephone carrier, a 12-channel telephone carrier, and a 48-channel system. A new 8-channel telegraph terminal can be used as needed in conjunction with any of the above terminals. The terminal equipment of each of the above systems will be used not only in the 4-, 12-, and 48-channel wire sets but also with the 4-, 12- and 48-channel radio relay equipment. Commercial standards for transmission levels and quality are being closely followed in development of such equipment so that long distance communications over the integrated communications network will approximate, insofar as practical, that found in American commercial systems.

Conclusion

Any brief article dealing primarily with the results of development in the communication field has the danger of leaving the reader with the impression that a completely short-range program is being pursued. Such is certainly not the case. The Signal Corps maintains at its own laboratories, and sponsors in the laboratories of universities and industry, a long-range program of research and development having as its objective the constant search for new basic knowledge, principles, techniques, and materials; and their application to the Integrated Communications System. By continuing a vigorous, long-range effort, the Signal Corps expects always to provide the best military communications in the world.



It's

SPELLMAN TELEVISION

for . . .

- COLOR TELEVISION PARTS
- HIGH VOLTAGE REGULATED POWER SUPPLIES (0-30 KV)
- HIGH VOLTAGE COILS
- PROJECTION TV SCREENS
- SCHMIDT CORRECTING LENSES for pictures up to 6x9 Ft.
- SCHMIDT OPTICAL BARRELS

Direct Inquiries to

SPELLMAN TELEVISION CO., Inc.
Dept. R—3029 Webster Ave., Bronx, N. Y.
Telephone Kingsbridge 7-0306

STAY OFF THE BEAM WITH ATLAS "Multi-Cellular" Wide Angle TWEETER

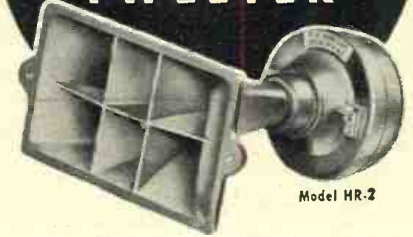

Model HR-2

SIX CELL, WIDE ANGLE DISTRIBUTION: 100° x 50°
Clean and efficient to 15,000 cycles. 25 watts of program material above 1000 cycles.

The new ATLAS TWEETER does not produce a "hot" high frequency sound beam on the center axis but a wide angle coverage in both horizontal and vertical planes.

Heavy die cast sectoral horn, flush mounting 6 3/4" wide, 3 1/2" high, 8" deep. A new high in realism—smooth and clean musical brilliance. Perfect articulation and sibilance in voice reproduction.

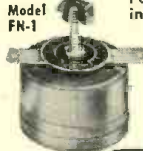

VARIABLE HIGH PASS FILTER

Write for our new catalog—the most complete line of speakers, microphone stands and sound accessories.

ATLAS SOUND CORP.
1446 39th St., Bkn. 18 N.Y.
In Canada, Atlas Sound Corp. Ltd., Toronto, Ont.

International Short-Wave

(Continued from page 118)

tral P. O. Area, Tokyo, Japan; sent nice souvenir folder commemorating first Japanese broadcast of March 22, 1925. JKM2, 9.69, Tokyo, excellent 0130 in Japanese; announces "NHK." (Russell, Calif.)

Madagascar—Radio Tananarive currently is using French on 3.900, 6.172, and 9.515 weekdays 2230-0030, 0400-0600, 1000-1430, Saturdays at 2300-0245 (Sundays), 0350-0600, 0915-1430; news in French is at 2310 weekdays, 0000 weekdays, 0015 Sundays, 0400, 1100, and 1315. Programs in Malgache are broadcast on 7.375 and 9.693. (Copenhagen DX broadcast) Stark, Texas, hears 9.515 and 9.693 both opening 2230 with "La Marseillaise"; former takes French program, latter uses Malgache.

The 9.515 outlet is heard at 1200 in Israel. (Bluman)

Malta—FBS, Middle East, has dropped 4.965 and is now using 6.015 in parallel with 7.220 at 2300-0115 (has BBC news relay 0100); announces will reopen 0430 on 11.895, 7.220. (Pearce, England, Bellington, N. Y., others) Also noted on 6.015 afternoons around 1300-1400 and later; probably runs to 1600 or 1700. (Pearce, England)

Mozambique—Pearce, England, has heard Lourenco Marques on approximately 15.278 (believed CR7BG moved from 15.191) at 1425; signed off with "A Portuguesa" at 1459; all-Portuguese.

New Caledonia—Radio Noumea, FK8AA, 6.038, is heard daily 0200-0532; signs on and off with "La Marseillaise"; no English noted as yet. (Neeley, Calif.)

Norway—Radio Sweden reports a new schedule for Radio Norway in which "Norway This Week" (a 15-minute program in English) is now radiated Sundays 0700, 0900, 1500, 1900, 2100; four channels are used—one of which is always 15.170.

Pakistan—Radio Pakistan, measured 7.1402 (probably Dacca?), noted in oriental program 0630; at 0700 is parallel with measured 11.5782 and 11.845 with news. (Oskay, N. J.)

Paraguay—ZPA3, 11.85, Asuncion, noted with weak signal; at 1915 announced for ZPA, ZPA3, "Radio Teleco"; followed with program of announcements in Spanish, then popular music; at 2100 had "Reporte Esso" (news in Spanish) and left air 2105. (Ferguson, N. C.)

Peru—OAX4Z, 5.895, Lima, heard to 2329 sign-off; slogan is "Radio Nacional del Peru"; listed 14 kw. (Neeley, Calif.) QSL from this station lists schedule of 1900-2330; frequencies are OAX4A, 854 kc.; OAX4T, 9.562, 10 kw., inactive; OAX4Z, 5.895, 10 kw. QRA is Av. Petit Thouars, 447, Lima, Peru; transmitters are located at San Miguel; card was in English; asked for further reports. (Slutter, Pa.)

Philippines—Radio Australia reports that DZH8, Manila, Far Eastern

Broadcasting Corporation, is temporarily using 15.300; noted from 0100 to closedown 1105; has program summary daily 0300. Heard by Balbi, Calif., at 0100 with news.

Manila, 6.17, has news 0745 daily. (Balbi, Calif.)

DZH4, 6.000, Manila, noted 0900 with request program; DZFM, 6.17, "The People's Station," heard 0915 with weather report, marine news, and report of how many cases of different diseases have broken out in various countries, badly squeezed by Saigon on 6.165 and BFEB, Singapore, on 6.175; DZH2, 6.140, noted 0930 with popular music, fair signal, relays DYRC. (Neeley, Calif.)

Poland—A station heard widely in

USA on 9.523 to closing 2030 is believed to be Radio Warsaw.

Noted in England on 9.523 with English 1215-1245 in parallel with 6.215; second broadcast 1300-1400 is on 6.215 only; announces as "The Peace Station." (Pearce)

Sao Tome—"Radio Clube de Sao Tome" sent this schedule—CR5SA, 11.785, 1 kw., inactive; CR5SB, 17.6775, 1 kw., 0700-0800 on Thursday and Sunday only; CR5SC, 4.8075, 1 kw., 1430-1600 daily; CR5ST, 9.615, 1 kw., inactive. (Mann, N. Y., via NNRC)

Southern Rhodesia—A further verification from Salisbury stated broadcasts on 4.880-4.890 were only test transmissions with power of 1 kw.; present frequencies are "local day-

6 Easy-to-Build RCP INSTRUMENT KITS

MORE THAN 150,000 RCP INSTRUMENTS PURCHASED IS THE PROOF OF OUTSTANDING VALUE AND LEADERSHIP

NOW, you can get in kit form the best professional test equipment! Made by Radio City Products, one of 18 years. You get kits that are complete with all necessary parts and easy-to-follow assembly instructions. There is nothing else to buy! Yes! An RCP kit provides an enjoyable few hours of instruction and construction plus a finished test instrument at a tremendous saving!

...1



MODEL 345K SUPER VACUUM TUBE VOLTMETER

Features long scale $\frac{1}{2}$ " meter in burn out proof meter circuit—electronic balanced bridge type push pull circuit—negligible current drawn due to high input impedance of 25 megohms—Isolation Probe—center of ohm scale 10 ohms—5 ohmmeter ranges reading from 2 ohms to 1 billion ohms (1000 megohms). 20 voltage ranges 0-1000 volts including AC and DC—Complete D.B. meter. Discriminator alignment scale with zero center permitting operation in both directions. Operates on 105-130 volts. 50-60 cycles—Extra heavy panel, case and chassis. Size 10" x 6" x 5". Weight 8 $\frac{1}{4}$ lbs. Shipping weight 11 lbs.

MODEL 345K KIT COMPLETE. \$23.95

...2



MODEL 322AK TUBE TESTER KIT

Fully engineered to test all recently developed tubes and television types. Has provision for checking individual sections of multi-purpose tubes as well as miniature and subminiature receiving tubes. Jack for head-phone noise test to check noisy swinging or high resistance internal tube connections. Neon lamp for rapid short and leakage tests between elements.

KIT MODEL 322 AK, only. \$25.95

...3



MODEL 447BK MULTI-TESTER KIT

3" square D'Arsonval meter. DC Voltmeter: 0-5-50-250-500-2500 Volts at 1000 Ohm per Volt. AC Voltmeter: 0-10-100-500-1000 Volts. Output Voltmeter: 0-10-100-500-1000 Volts. DC Milliammeter: 0-1-10-100-1000 MA. DC Ammeter: 0-1-10 Amperes. Ohmmeter: 0-10-100 Ohms—1 Megohm—10 Megohms Ext. Decibel Meter: -8 to +55 decibels. Complete with batteries.

KIT MODEL 447BK, only. \$12.95

...4



MODEL 777AK DYNATRACOR

New Model Signal Tracer—Ultra Modern-Circuit design provides exceptionally high amplification so that actual gain measurements may be made. Accurate meter gives calibrated indications. Provides the speediest type of trouble shooting tool for tracing any type of disturbance or circuit defect from the antenna to the speaker. Indicates noise pickup at the aerial—checks AVC—AFC, link and filter circuits.

Tube Complement 6AT6—6AT6—6AQ5 and 6X4. Crystal Rectifier 1N34. Speaker employs Alnico 5 magnet. Beautiful hammertone grey steel panel and case with new slendertized Probe. Kit supplied complete, 105-130 volts, 50-60 cycles. Size 6 $\frac{1}{2}$ " x 8 $\frac{1}{2}$ " x 11". Weight 9 $\frac{1}{2}$ lbs.

MODEL 777AK \$32.95

...5



RCP HIGH VOLTAGE MULTIPLIER KIT

Permits multiplying all ranges X100 of Model 345 or any similar impedance V.T. voltmeter. Special ceramic helical high voltage resistor certified safe for all ranges up to 33,000 volts.

KIT MODEL HVMP-1K, only. \$6.45

...6



RCP ULTRA HIGH FREQUENCY PROBE KIT

Uses germanium crystal with low impedance network permitting measurements up to 400 megacycles.

KIT MODEL HFP-1K, only. \$3.95

Available at your Jobber. Insist on R.C.P. Instruments. Write for Catalogue 12RN

RADIO CITY PRODUCTS CO., INC.

152 WEST 25th ST —•— NEW YORK 1, N. Y.



COMMERCIAL SURPLUS SPECIALS

PHONOGRAPH PICKUPS & CARTRIDGES

Mfrgr.	Model	Needle Tip	Needle Pres.	O.P. Volts	Range in C.P.S.	List Price	Your Cost
Astatic	MILP-3	Pr. Metal	1 oz.	.85	50-10,000	8.90	3.20
Astatic	Nylon 1J	Sapphire	1.25 oz.	1.0	50-10,000	7.75	2.80
Astatic	QL 3-M	Pr. Metal	1 oz.	.85	50-10,000	8.40	3.00
Astatic	L70-A	None	1.25 oz.	1.0	50-4,000	5.55	2.00
Astatic	L71-A	None	1 oz.	1.0	50-8,000	6.65	2.40
Astatic	L72-A	None	1.25 oz.	3.5	50-4,000	6.65	2.40
Astatic	L73-A	None	1.5 oz.	1.4	50-4,000	10.00	2.40
Astatic	L74-A	None	1.5 oz.	1.4	50-4,000	10.00	2.40
Astatic	L75-A	None	1.25 oz.	1.0	50-4,000	5.55	2.00
Amer Mic	S-2	Pr. Metal					2.50
Shure	W57A	None	.75	1.6	To 6,000	5.55	2.00
Shure	W21A	Pr. Metal	5 gram	1.0	To 10,000	8.75	3.15
Webster	Q1	Pr. Metal	1 oz.	1.0	To 8,000	8.50	3.05
Webster	F1P	None	1 oz.	1.0	To 5,000	5.00	1.80
Webster	NT	None	.75	5	To 10,000	6.50	2.35
Webster	F6P	None	1 oz.	1.0	To 5,000	5.00	1.80
Electro-Voice	16-0	(1 mil-Sapph) (3 mil-Pr. Met)	6 gram	.9		8.50	3.05

WEBSTER-CHICAGO Replacement Cartridges

Crystal Cartridges for Webster-Chicago. Two and three speed changers Nos. 246, 256 and 356. Furnished less needle. Regular Net \$5.10 ea.

Stock No. XC-45 **\$2.25** your cost
Same as above, less mounting bracket.

Stock No. XC-45A **\$1.95** net ea.

TRANSCRIPTION Pickup Arm

Astatic model HP-16. This is a long slender, straight arm crystal pickup for use on all lateral transcriptions. Ball-bearing swivel base. One ounce needle pressure. Employs LP-21 crystal cartridge with permanent jewel type stylus. 0.85 output voltage. Response to 7000 C.P.S. List Price, \$27.85.

Model HP-16... **\$4.95** your cost

G.E. VARIABLE Reluctance Cartridges

RPX-040. Standard cartridge for 78 R.P.M. records. Stylus pressure 12-14 grams. Output 15 MV at 1000 C.P.S. With replaceable .003" sapphire tip needle.

LIST \$9.95... **\$2.50** your cost

10% DISCOUNTS ON ORDERS OF \$50.00 OR MORE

TERMS: Cash with order or 25% deposit on C.O.D.'s. \$1.00 service charge on orders less than \$5.00. Shipments F.O.B. Chicago, Ill. Prices subject to change without notice. All items subject to prior sale. We reserve the right to limit quantities.

IRVING JOSEPH RADIO PARTS, INC.

215 S. HALSTED STREET • CHICAGO 6, ILLINOIS

Seein's Believin'

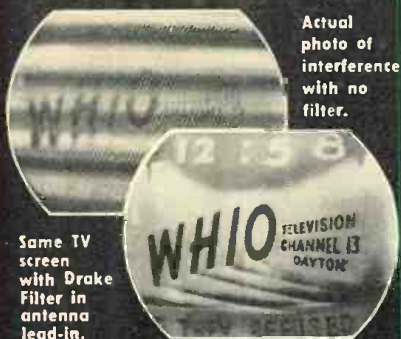

THE R. L. DRAKE

High Pass Television Filter

protects the R.F. and I.F. bandpass of the TV set from strong radio frequency interference generated by:

- Amateur Radio Transmitters
- Shortwave Broadcast Stations
- X-ray and Diathermy
- Industrial R. F. Heating
- Auto Ignition and Motors
- Neon Lights, Appliances, etc.

Two models available—TV-300-50HP for 300-Ohm Twin Lead and TV-72-50HP for Small 72-Ohm Coax.

\$5.95
LAST

Discount to dealers, radio stores and amateurs.

Drake Filters are sold by all leading distributors. Try one today.

Many dealers include one with each installation.

THE R. L. DRAKE CO.
11 Longworth St., Dayton 2, Ohio

CHICAGO RADIO AND APPLIANCE MULTITESTER



Model 458A

New Wider Ranges

NEW CASE DESIGN FOR EASY READING

AC and DC VOLTS: 0-2.5/10/50/250/1000/5000
AC AMPS: 0-0.5/1/5/10 DC AMPS: 0-1/10
AC and DC MILS: 0-1/10/100
OHMS FULL SCALE: 1000/200,000/2,000,000
OHMS CENTER SCALE: 50/2250/22,500
SIZE OVERALL: 10 1/2" x 6 1/2" x 6" Meter: 4 1/2" wide.
Handsome brown Hammerloid case with leather strap.
1000 Ohms per volt. Net Price \$26.00

We manufacture a complete line of fine portable multimeters.

Chicago

Write for circular

INDUSTRIAL INSTRUMENT CO.

536 W. ELM ST. • CHICAGO 10, ILL.

time" on 7.290, testing on 9.490; "local evenings" on 3.320, testing on 6.018 and 9.490. (Pearce, England)

Spain—Radio Nacional de Espana has been heard near 6.125 with recordings at 0805 and noted signing off 1100; frequent announcements; news in Spanish from 0825; believed to sign on 0700. (Pearce, England)

Switzerland—Via airmail comes this winter schedule from Berne—To Europe—Weekdays 0015-0140, Sundays 0055-0140, HER3, 6.165, and HER4, 9.535; Mon-Fri., 0500-0830 and 1000-1700, Saturday 0500-1700, Sunday 0245-1700, HER3, 6.165, and HER4, 9.535.

To Africa—Daily 0015-0140, Sunday 0055-0140, HER6, 15.305, 0500-0730, HER8, 21.520, and 1000-1700. HER6, 15.305. *To Australia, New Zealand, Far East*—Daily 0215-0445, HER5, 11.865, HER8, 21.520, and HER7, 17.784. *To Japan, South East Asia*—Daily 0745-0930, HER5, 11.865, HER7, 17.784, and HER6, 15.305. *To India and Pakistan*—Daily 0945-1130, HER7, 17.784, and HER5, 11.865. *To The Middle East*—Daily 1145-1330, HER7, 17.784, and HER5, 11.865. *To The United Kingdom and Ireland*—Daily 1345-1530, HEU3, 9.665, and HER5, 11.865. *To Spain and Portugal and to South America* (first broadcast)—Daily 1545-1715, HER5, 11.865, and HEU3, 9.665.

To North America (first period)—Daily 1730-1815, HER5, 11.865, HER3, 6.165, and HER4, 9.535. *To South America* (second broadcast)—Daily 1830-2000, HER5, 11.865, HEI5, 11.715, and HEU3, 9.665. *To North America* (second period)—Daily 2030-2300, HER5, 11.865, HER3, 6.165, and HER4, 9.535. A free illustrated program schedule will be sent on request to Swiss Shortwave Service, Neuengasse 23, Berne, Switzerland.

Taiwan—BED7, measured 7.134.6, Taipei, now has news 0630-0640; good signal in Eastern U. S. (Oskay, N. J.) Should be using 11.735 in parallel.

Tangier—Pan American Radio, 15-048, noted testing around 0700-0743. (Pearce, England)

Thailand—At the time this was compiled, HSSPD was using 6.240 again for the Overseas Service daily 0500-0630; news 0615. (Oskay, N. J.) Fair signal here in West Virginia but some CWQRM; should have news also 0515.

Trinidad—Despite overseas reports that VP4RD has moved to 9.640, at the time this was compiled it was on listed 9.625. Slutter, Pa., received schedule of 0600-2300 daily on 1295 kc. and 9.625; gave QRA as Broadcasting House, Port-of-Spain, Trinidad, B.W.I. Heard by Mulvey, Conn., on Sunday 1530 with "Bringing Christ to the Nations." I recently heard this one from 0500 although lists schedule as from 0600.

Turkey—By this time, Radio Ankara should be using TAP, 9.465, again for Mailbag Program on Sundays 1630-1700.

USSR—Radio Tashkent noted on 6.825 with news 1115-1130; stated has two daily broadcasts in English—0900 and 1115. (Pearce, England) Charkov

has been heard at good strength at 1100 on 7.330. (Radio Sweden)

Venezuela—YVKR, 4.92, Caracas, heard at 2330 sign-off. (Russell, Calif.)

Last Minute Tips

I have received word direct from Henry J. Nolan, S. J., of *Vatican Radio* that when the new high-powered transmitter is put into operation next year (1951), it will operate on medium-wave, long-wave, and short-wave. Apparently, this refers to the transmitter being presented by Dutch Catholics to His Holiness the Pope in commemoration of Holy Year.

Officials of *Radio Brazzaville*, French Equatorial Africa, recently announced—"We have no printed schedules available but hope soon to start a monthly magazine which will be sent to all who care to subscribe to this. It will consist of articles and photographs about this country and also about our station." Has a new verification card.

"Radio Watani el Kurds," the Kurdish National Radio, is now on 7.040 at 1030-1130; no location is given but local news items indicate may be Kermanshah, Iran. (Bluman, Israel, via Radio Sweden)

A flash from Hannaford, South Africa, indicates Lourenco Marques, Mozambique, has been heard testing "mornings" (presumably around 2300-0100 or later) in the 42-meter band, asking for reports.

Saigon has been reported testing around 0520-0559 on 9.495 (claims 9.524) and on that channel until 1630 (in latter period is parallel with approximately 17.722). (Radio Australia)

In a letter to Neeley, Calif., *Radio Malaya*, Singapore, stated that when new installations—now in progress—are completed, more transmitters, increased powers, and extended schedules will be effected. Present schedule was listed—*Red Network*—6.135 at 2330-0115 Indian program, 0115-0130 Chinese program; 4.780, 0430-0630 Indian program, 0630-0830 Malay program, and 0830-1030 Chinese program. *Blue Network*—7.250 at 2330-0030 Malay program, 0030-0130 *English*, 0430-0530 Chinese program, and 0530-1030 *English* program; on Saturdays has additional *English* programs at 0130-0425 and 0425-1100; on Sundays has additional *English* programs from (Saturday) 2030 to 2330 (Sunday), 0130-0425, and 0425-1100. Kuala Lumpur, 6.025, relays the Blue Network programs.

Latest schedule for the International Service of *Radio Canada* is—*European Service*—0915-1130, CKNC, CKCX; 1130-1345, CKNC, CKCS; 1345-1400, CKCS; 1400-1545, CKCS, CHOL; 1545-1600, CHOL; 1600-1830, CHOL, CKLO. *Australasian Service*—2250-2320, CKLX, CHOL, commentaries from the United Nations (except Sat., Sun.); 0340-0530, CHOL, CKLO, Sun. only. *Caribbean and Latin American Service*—1850-2045, CKRA, CKCX; 2045-2100, CKRA; 2100-2235, CKRA, CKLO; (*English* is 2100-2145). *Northwest Territories (Northern Messenger)*—Sunday only in *English* and

French 2320-2400, CKLO, CKOB. Channels are CKNC, 17.82; CKCS, 15.32; CKCX, 15.19; CKLX, 15.09; CKRA, 11.76; CHOL, 11.72; CKLO, 9.63, and CKOB, 6.09.

Press Time Flashes

At the time this was compiled, *Radio Ankara* had started experimental tests in *English* daily 1600-1645 (some days to 1700) over TAS, 7.285 (best), and TAP, 9.465; by this time may be using some other channel/s experimentally. Has news now 1445, and the Mailbag Program on Sunday and Talks on Turkey (also *English*) on Thursday are now over TAP, 9.465 (and whatever experimental channel/s currently used) at 1630-1700.

New schedules of *Radio New Zealand* are—Australian Service daily 1300-1545, ZL3, 11.78, 1600-0145, ZL10, 15.220, and 0200 to closedown, ZL3, 11.78; the Pacific Service is on ZL4, 15.28, at 1300 to closedown, which is 0500 Sun., 0530 Mon.-Fri., and 0630 Sat. (Cushen, N. Z., via Radio Australia)

At press time, *Radio Peking* was using 11.6853 in parallel with 15.054V mornings, news 0830 yet; the old 10.260 channel was being used irregularly for communications and at times for relaying broadcasts, and was also reported in Eastern USA opening 1800 (buried in CWORD by 1830), carrying regular "morning" broadcast in Chinese (*no English noted*).

YOU GET MORE FOR YOUR MONEY IN CHELSEA'S FAMOUS C-4 CHASSIS NOW BETTER-THAN-EVER!

**A Great Buy Before!
A Greater Value Today!**

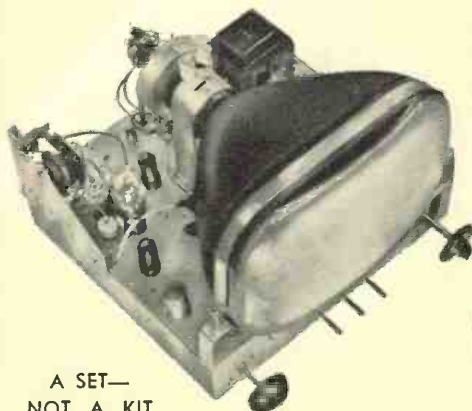

A SET—
NOT A KIT

Full R M A Guarantee

Free Chelsea 1-Year Warranty

JUST PLUG IT IN—AND IT WORKS!

- Completely wired
- Improved AFC
- Phono jack & switch
- Super-power circuit
- Keyed AGC
- One-Knob Control
- Factory-engineered
- Front End down
- Greater Sensitivity
- aligned and tested
- to 45 microvolts
- Long Range Reception

In the NEW, Improved, 1-Knob Control Chelsea Chassis you get all the quality-controlled features for which it has become nationally famous—PLUS many operational improvements—at the low prices for which Chelsea is equally famous!

**NEW, BETTER-THAN-EVER
1-KNOB CONTROL C-4-11**

FOR LESS CRT
16" — \$119⁹⁵
round or plus \$1.40
rect. tube Fed. Tax

**NEW, BETTER-THAN-EVER
1-KNOB CONTROL C-4-13**

FOR LESS CRT
19" — \$129⁹⁵
round tube plus \$1.40 Fed. Tax

GUARANTEED FACTORY-FRESH PICTURE TUBES IN SEALED CARTONS

16" — round, \$40	16" — rectangular, \$41	17" — rectangular, \$42 ⁵⁰	19" — round, \$60
----------------------	----------------------------	--	----------------------

ALSO AVAILABLE—630 TYPE CHASSIS

Write Dept. Y for latest literature and prices—AND COMPARE!

Phone and mail orders filled on receipt of certified check or Money Order for \$25.00 as deposit. Balance C.O.D., F.O.B., N. Y. Visit our street-level salesroom at 187 Seventh Ave., at 21st St., New York

The House of Bargains

CHELSEA TELEVISION CENTER, INC.

Office and Showroom: 130 West 42nd Street, near Broadway
New York 18, N. Y. Longacre 5-2254-5-6

Prices and Models subject to change without notice.

Not a kit, but a complete chassis assembled and checked by professional experts

14 reasons why our **RCA 630** chassis is your best TV buy!

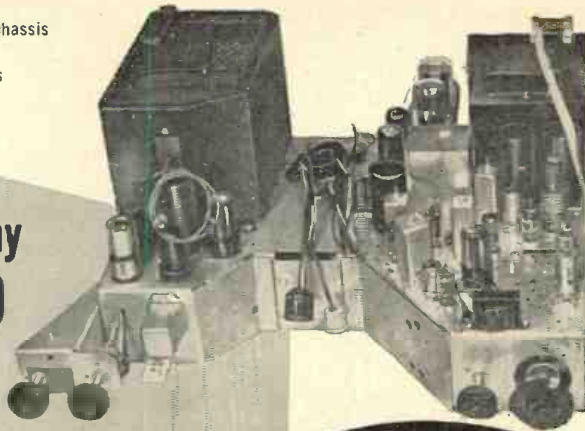

Contact us immediately for low price of this unbelievable buy!

manufactured by

TRAD TELEVISION CORP.

Tradtel sold by **DISTRIBUTORS, INC.**

a division of TRAD TELEVISION CORP.

Dept. 12N, 1001 First Avenue Asbury Park, New Jersey
Asbury Park 2-7447. In New York, WOrth 4-1197

1. 30 tubes—27 tubes, 3 rectifiers
2. AFC horizontal hold, featuring Synclok
3. High voltage doubler circuit
4. Maximum brilliance with any picture size up to 19"
5. Co-channel sound, featuring good limiting for maximum noise immunity
6. Keyed AGC (using extra 6AU6 tubes) minimizes airplane flutter, keeps picture level constant and uniform when switching from channel to channel
7. Overall band width four m. c. for maximum definition and picture crispness
8. Original 630 sync chain for maximum picture stability
9. Molded condensers throughout
10. Full complement of electrolytics as specified in original design
11. Focus coil and yoke assembly with removable plugs for easy servicing
12. Top quality video amplification assuring good contrast range for full "blacks and white"
13. Same chassis used in highest-priced sets and custom installations
14. Complete with mounting hardware ready for installation

By this time, *Radio Moscow* will have effected winter schedule to North America—daily 1820-2300 on 15.23, 11.88, 11.82, 9.67, 7.29, 7.24; it is believed the "morning" beam 0800-0830 will not be affected (is heard here in West Virginia best on 15.18).

Radio Australia is now using old VLC7, 11.81, to North America 0700-1115.

Hannaford, South Africa, flashes that Salisbury, Southern Rhodesia, is now operating Monday-Saturday 0400-0615, Sunday 0330-0615 on 7.280; 1100-1500 Mon.-Thur. and Sat., 1000-1500 Friday, 1300-1500 Sunday on 3.320, 6.018, 9.490.

CBNX, 5.970, St. John's, Newfoundland, 300 watts. is scheduled 0600-2230; CBNX on 3.480 and 9.470 is inactive. VONW, 3.490, 100 watts, Labrador, is heard Sundays irregularly. (Peddle, Newfoundland)

Serrano, Brazil, airmails me this data on Brazilian outlets—*Radio Inconfidencia* operates on 880 kc., m.w., PR13, 22 kw., and on s.w. 5.995, PRK5, 5 kw., scheduled 0500-2200; reports may be sent in practically any language—including *English*—and all correct ones will be answered by QSL card (reverse shows partial view of Belo Horizonte) by surface mail; *IRC should be enclosed*; QRA is *Radio Inconfidencia*, Feira Permanente de Amostras, Belo Horizonte, Minas Gerais, Brazil. *Radio Record*, Sao Paulo, definitely has moved from 9.605 to 9.505. A new station heard on (announced) 9.37, poor level, closing 1200, is at Sao Paulo, operated by the Astronomical and Geophysical Institute of the University of Sao Paulo; has service similar to WWV. *Radio Nacional*, Rio de Janeiro, noted in dual on 9.72 and 6.147 lately.

DZB2, 3.320, logged 0530; is Far Eastern Broadcasting Co. (missionary station), Manila, Philippines; heard announcing DZB2, 3.320, DZH6, 6.03, and DZH8, 15.300, "The Call of the Orient." (Cushen, N. Z., via *Radio Australia*)

Don Trelford, Ontario, Canada, has just informed me that he has resigned as North American Representative of the *New Zealand Radio DX League*, and that all requests for *World Radio Calls* (price 35 cents—seven 5-cent stamps are acceptable) should be addressed to Lincoln A. Mayo, 783 Madison Ave., New York 21, New York.

CS2MA, 6.374, and CS2MF, 9.745, Lisbon, have extended "evening" beam to North America to 2100 (formerly signed off 2030). (Grove, Ill., others)

BED4, 15.235, Taipei, Taiwan, is scheduled now 2300-0100; first hour in *English*; improved signal noted on West Coast. (Balbi, Calif.)

New is XEX, 11.900, "La Voz de Mexico," noted to after 1300, announcing "Servicio Internacional." (Stark, Texas, others)

Radio Tripolis, Greece, is operating on 7.010 at 0000-0200, 0500-0700, 1200-1400. (Radio Sweden)

Sofia, 7.671, Bulgaria, heard with news 1545 and 1645. (Cox, Dela.) Noted in Georgia signing on 2255 with

RADIO & TELEVISION NEWS

SAVE

BATTERY RENEWAL COSTS
CONVERT
BATTERY RADIOS TO
AC ALL-ELECTRIC

Now is the time to change your dry battery radio into a dependable hum-free AC receiver with an Electro Battery Eliminator. Eliminates batteries, high operating costs, uses only 11 wats. Fits most radios, easily slips into battery space. Operates 1.4 volt, 4, 5, or 6 tube battery radio from 115 volt, 50 to 60 cycle source. Has selenium rectifier. Guaranteed three years.



NEW
Model "S" Battery Eliminator

Also available for 220 volt operation

ELECTRO PRODUCTS LABORATORIES
4509-S Ravenswood Ave., Chicago 40, Ill.

Send me FREE literature and name of nearest source.

Name _____
Address _____
City _____ State _____



Pioneer Manufacturers of Battery Eliminators

FOR BETTER TOWERS AT LOWER COST! Ask about AERO

• COST LESS

Because Aero Towers are aircraft-designed, lower manufacturing costs offer you a lower price. Lower weight and lower shipping costs are passed on as savings to you.

• LAST LONGER

Coated INSIDE and OUT. DIP-COATED process keeps Aero Towers bright and new. Rust resistant. Will not brown.

• EASY TO CLIMB AND SERVICE

Strong electric aircraft welds at EACH joint (not just one or two) prevents sway. Provides sturdy safe ladder-like cross members.

• QUICKER TO INSTALL

Aircraft precision tolerances assure accurate fit of components. Light and easy to erect. Strong durability assures customer satisfaction.

Jobber Territories Open
Dealers—Write for FREE Booklet



AERO TOWER DIVISION
Knepper Aircraft Service
1016 Linden Street
Allentown, Pa.

strong signal but soon deteriorates. (Fargo)

Ponta Delgada, Azores, 11.090, is definitely now on winter schedule 1500-1600. (Bellington, N. Y.)

Warsaw, 9.525, Poland, seems to open 2000 and close 2030. (Stark, Texas)

EDV10, 7.170, Madrid, heard 1536, good signal for 1 kw.; EA8AB, Tenerife, Canary Islands, 7.514, noted 1548; CS9MA, 7.018, Ponta Delgada, Azores, noted 1715 with music. (Cox, Dela.)

A new radio club is *World Radio Champion Society*, Box 19,033, Stockholm 19, Sweden; is arranging many special programs from foreign stations, of programs recorded in Sweden; first was aired by HCJB, "The Voice of the Andes," Quito, Ecuador. A DX-band contest is being sponsored by "World Radio Handbook" in conjunction with *International Short Wave League*. OTC, Belgian Congo, has been holding a similar contest on its own activities. These are all marks of increased interest in short-wave broadcasting and in international good fellowship.

English periods from Hilversum, Holland, are now (weekdays only) 0500-0555 to Australia, New Zealand, and Pacific Area on 21.48, 17.775, 15.22, and (for listeners in Europe) on 6.025; 1230-1325 to South Africa, Great Britain, Ireland, and Continental Europe on 11.73, 9.59, 6.025; 2100-2155 to United States and Canada on 11.73, 9.59; "Happy Station Programs," prepared and presented by Eddie Startz, are radiated Sundays 0930-1100 on 15.22, 6.025 to East, Far East, and Europe, 1600-1730 on 9.59 and 6.025 to South America, Africa, and Europe, and 2200-2330 on 11.73, 9.59 to North America; Tuesdays 0600-0730 on 21.48, 17.775, and 6.025 to the Pacific, Australia, New Zealand, and Europe; and Wednesdays 0930-1100 on 15.22 and 6.025 to East, Far East, and Europe, 1600-1730 on 9.59 to South America, Africa, and Europe, and 2200-2330 to North America on 9.59. (Hankins, Pa.)

SRI, Buenos Aires, became SIRA (the International Broadcasting Service of Argentina) on the Argentine Republic's "Loyalty Day." A new 100 kw. shortwave transmitter was inaugurated by the president of Argentina, Gen. Juan Peron and the First Lady of the Land, Senora Eva Peron, both of whom sent greetings of friendship and good-will to all the nations of the world. Concerts of native music, performed by Argentine composers rounded out the several-hour inaugural broadcast of SIRA. The new transmitter is using various frequencies, including (announced) 9.69 which is beamed to North America (in *English*) evenings around 2115-0100. I hope to have further details soon on the expansion of Argentina's International Service.

Acknowledgement

Thanks for the splendid cooperation! Reports are welcome from anyone, anywhere in the world—to 948 Stewartstown Road, Morgantown, West Virginia, USA. KRB.

SAVE UP TO 95% SENSATIONAL SURPLUS VALUES!

BC-906 ABSORPTION-TYPE FREQ. METER
 Freq. range 150-225 Mc. Uses 0-500 DC Microammeter for indicator. In black crackle carrying case with handle. 12 1/2 x 8 1/2 x 6 1/2". Net 18 lbs. With tubes and calibration chart. New. **\$14.95**



COMMAND RECEIVERS
 Tested Before Shipping
 190-550 KC Used. Orig. \$40. Now **\$12.50**
 3-6 MC Used. Orig. \$30. Now **4.95**
 3-6 MC New. Orig. \$35. Now **6.95**
 6-9-1 MC Used like new **7.95**
 1.5-3 Meg Brand New... **24.50**
 R-28 / ARC-S 100-156 Megs. **25.00**

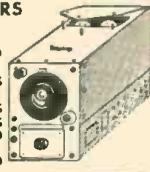

COMMAND XMITTERS
 T-22 ARC, 5 MC. Used. SAME as BC-459... **9.95**
 T-22 ARC-5.7-9.1 New. Orig. \$50. Now **12.75**
 3-4 MC Used. Orig. \$50. Now **12.50**
 T-23 ARC-5.100-156 Megs. 4-channel Xtal. Used... **25.00**
 T-21 ARC-5.3-3.7 New. Orig. \$40. Now **5.95**
 4-5.3 MC. Used. Orig. \$30. Now **4.95**
 2-1.3 MC. LN. Orig. \$40. Now **9.95**

GO-9 XMITTER. Frequency range 3-18 MC and 300-600 KC. Band switching 100 w output. Brand new, in original mfg. crates. Comes complete with tubes and spare parts kit, comes in three units; high and low frequency xmitter and rectifier. Dimensions: 14" deep x 27" long x 29 1/4" high. Net wt. 137 lbs. Shpg. wt. approx. 250 lbs. Finished in black crackle, shock mounted. Has 7 meters for indicating plate and grid current, also antenna current. Operates 110V 800 cycles. Single phase and 24V DC. Contains 2-803 tubes, 1-807, 1-801, 2-837, 1-523, 2-1616. Comes with maintenance manual and test data. **\$72.50**

EXPORT QUANTITIES AVAILABLE. Write for discounts.

SURPLUS RADIO CONVERSION MANUAL NO. 2 containing conversion information for GO-9 to 10 meters and 110V 60 cycles. Contains 18 other popular conversions and complete information. **\$2.50**

BC-221 FREQ. METER... **\$72.50**
 BC-221 AK Modulated Freq. Meter... **\$92.50**
 BC-434 RADIO COMPASS CONTROL BOX, contains tuning meter. Brand new in original carton. **\$2.95** each or... 10 for **\$19.95**
 AN-29C ANTENNA for BC 659 FM Unit **\$2.95** new

WESTERN ELECTRIC AUDIO AMPLIFIER TYPE D-150300
 An excellent mod. driver or PA system with hi-quality components. Input stage consists of 2-6J7's into 2-6L7's feeding 2-6C5's. Impedance couple to 6L5's in PP parallel. Class A 40 W output 225 ohms output impedance. Power supply 110V 60 cyc. using 2-514's. Has built-in limiter and compression circuits. Maximum gain 110 DB. Fits standard 17" rack. Tube sub-chassis is hinged and folds back for easy servicing in rack as shown. Excell. cond. COMPLETE WITH TUBES AND DIAGRAM... **\$49.95**



EXPORT INQUIRIES FROM FOREIGN COUNTRIES INVITED
 We give immediate answers and prompt service. Many items now in stock listed here. Let us quote prices on your requirements.

IMPORTANT
 NO ORDER LESS THAN \$5.00. Send 30% deposit on cost of item or full amount to save COD charges. Do not send shipping costs. It will be COD only. Shipments sent via railway express unless other instructions given. Merchandise subject to prior sale. Prices subject to change at any time.

CANDID "ON-THE-SPOT" RECORDER-TRANSCRIBER
 WALKIE-RECORDALL-8 lb. miniature BATTERY RECORDER PLAYBACK. Continuous, permanent, accurate, indexed recording at only 5c per hr. Instantaneous, permanent playback. Picks up sound up to 60 ft. Records conferences, lectures, dictation, 2-way phone & sales talks; while walking, riding or flying. Records in closed briefcase with "hidden mike".
 MILES REPRODUCER CO., INC., Dept. RNI
 812 E-way, New York 3, N. Y., SP 7-7670

ANOTHER OUTSTANDING JOBBER
Westchester Electronic Supply Co., Inc.
 420 MAMARONECK AVENUE
 White Plains, N. Y.
HAS THE SENSATIONAL NEW EICO 425-K 5" SCOPE KIT IN STOCK!
\$39.95



BC-620 FM TRANSCEIVER and PE 120 VIBROPACK. 20 to 27.9 Megacycles. Xtal Controlled. Part of SCR-509. Includes PE-120 Vibrator Power Supply Battery Case, Shock Mounting, Used, but in excellent condition **\$22.50**

NEW STANDARD BRAND CHOKES

SWINGING CHOKES		SMOOTHING CHOKES		SMOOTHING CHOKES WITH HUM BUCKING TAP		
HY	MILS	OHMS	PRICE	VOLTAGE	CASE	WT.
8-40	175	100	2.25	3KV	Closed	3.5
8-30	200	80	2.95	3KV	Closed	4.5
5-25	200	100	2.20	2KV	Closed	5
5-25	300	90	6.95	5KV	Closed	18
8-25	300	80	4.95	5KV	Open	8 1/2
5-25	300	80	3.95	3KV	Open	4
5-25	500	60	9.95	7KV	Closed	28
8-40	1 amp	50	24.95	10KV	Closed	58

HY	MILS	OHMS	PRICE	VOLTAGE	CASE	WT.
7	150	200	.95	2KV	Open	2
10	500	60	6.95	7KV	Closed	28
12	300	80	5.95	5KV	Closed	9
12	375	105	5.95	5KV	Closed	8
12	400	400	4.95	2KV	Closed	15
15	200	120	2.00	3KV	Open	4.5 lbs.
20	300	80	3.95	3KV	Closed	9 lbs.
20	300	90	4.50	4KV	Closed	10 lbs.
20	400	85	4.95	5KV	Closed	14 lbs.
20	550	60	7.75	6KV	Closed	14 lbs.

HY	MILS	OHMS	PRICE	VOLTAGE	CASE	WT.
20 Series	1A	50	39.50	19KV	Closed	80
5 Parallel	2A	12.5				
16 Series	175	96	5.95	2.5K	Closed	15
4 Parallel	150	24				
26 Series	200	112	6.95	3.5K	Closed	15
6.25 Parallel	400	28				

1-98A SIGNAL GENERATOR. 6 to 15 meg. Operates on 110 V., 60 cycles. **\$14.95**
 BC-347 INTERPHONE AMPLIFIER. Contains 6F8 Dual Triode and matching transformer. New. **1.49**
 TA-21 BENDIX TRANSMITTER, good shape. **17.50**
 HS-33 HEAD SETS. New **3.50** Used **1.50**
 TBY VIBROPACK for TBY Transceiver. Supplies all voltages. Operates on 4-volt source. Brand new. Only **\$12.50**
 T-85 APT-5 VHF TRANSMITTER. New, 350 to 1200 meg. 5 to 30 watts output. Brand new complete with tubes **\$59.50**

BC-1072 XMITTER
 157-187 MC. Input 117 VAC 60 cy. Has parallel rod OSC using 2-826 PP, contains power supply, general radio variac 1.5A. 3 1/2" 0-5 kilovoltmeter, 10 tubes and loads of other parts too numerous to mention. Complete with tubes. Less **\$19.75** blower. Used.

BC-924 FM XMITTER
 Frequency range 27-39 Mc. 35 watts output 4 channels, tunable throughout entire range, band width 20 Kc ECO controlled, 2-6S17, 2-615, 1-SAG7, 1-6V6, 1-VR150/30, 1-6S17, and 2-815. Complete with tubes, with dynamotor. Used... **\$61.95**

Just a Few Left!
PORTABLE FM XMITRS AND RCVRs!
 Operate on 6V DC. 34 MC varied either direction depending xtals, xmitr and Rcvr has aluminum case with antenna relay. Xmitr uses 1073, 125 KC extra in osc. stage followed by 4 doublers and 1 fin. amp. all using HY 65 tubes. Mike amp. and Fre. Mod. use 1C7G tubes. Xmitr stages have metering jacks. Rcvr is superhet. Xtal cont. local osc at 8060 KC. Power Supply on chassis using Carter 6V Ben. output 450 v, 250 ma 6V vibrator power supply for receiver. All tubes inst. heating. Included is control box, hand set, 8" speaker and extra microphone. Used, complete set only **\$45.00**



SEND 10c FOR NEW CATALOG
V&H RADIO & ELECTRONICS SUPPLY DEPT.R-16, 2033-37 W. VENICE BLVD., LOS ANGELES 6, CALIFORNIA

WAR EQUIPMENT MAIL SALE!
SAVE up to 70% on Electronic, Radio, Mechanical Equipment!
 For home experimenters, laboratories, schools, etc. New, fully guaranteed. Fraction of original cost. 100s of items including:
 • 2500-watt A-C Power Plants **\$279.00**
 • G.E. Selsyns (pair) **3.39**
 • Raytheon 110-v Electronic Timer **8.94**
 • Meg-A-Lite Continuity Condenser 110-v Tester **1.99**
 • Resistor, Capacitor Asst. 4 lb. **1.89**
 • City Desk Telephones **5.98**
 • Photo Cell Light Control Kit **4.87**
 • Other bargains—Compressors, Paint Spray Guns, Engines, Pumps, Tools, etc. 18 yrs. in business in Lincoln. Satisfaction Guar. We prepay all shipments. Card brings catalog, 100s bargains.

BURDEN SALES COMPANY
 853 "O" ST. Lincoln, Nebr.

**YOU CAN STILL
Buy—
TROUBLEPROOF
TELEVISION
THE 630 TV WILL WORK
WHERE OTHERS FAIL!**

Own the Television Set preferred by more Radio and Television Engineers than any other TV set ever made! **THE ADVANCED CLASSIC 630 TV CHASSIS.**

With the latest 1950 improvements the 630 TV will out-perform all other makes in every way. The 30 plus tube circuit should not be compared to the cheaply designed 24 tube sets now being sold under standard brand names.

• **Greater Brilliance**

Assured by the new 14-16 KV power supply.

• **Flicker-Free Reception**

Assured by the new Keyed AGC circuit—no fading or tearing of the picture due to airplanes, noise, or other interference.

• **Greater Sensitivity**

Assured by the new Standard Tuner, which has a pentode RF amplifier and acts like a built-in High Gain Television Booster on all channels! The advanced 630 chassis will operate where most other sets fail, giving good performance in fringe Areas, and in noisy or weak locations.

• **Larger—Clearer Pictures—for 16" or 19" tubes**

Assured by advanced circuits. Sufficient drive is available to easily accommodate a 19" tube.

• **Trouble-Free Performance**

Assured by use of the finest materials such as molded condensers, overrated resistors, RCA designed coils and transformers, etc.

• **RMA Guarantee**

Free replacement of defective parts or tubes within 90 day period. Picture tube guaranteed fully for an entire year at no extra charge!

PRICE COMPLETE, **\$169.50**
LESS PICTURE TUBE Plus Excise Tax

EXTRA CLEAR PICTURE TUBES

Standard Brands

ONE YEAR GUARANTEE

12½" (Black or White)...	\$21.00	Glass 16" Round (Black)	\$39.95
Glass 14" Rectangular (Blk.)	24.00	Glass 16" Rectangular (Blk.)	39.95
19" or 20" rectangular tubes.....			\$74.95

Plus Excise Tax

TELEVISION CABINETS

16" Table Model Cabinet

A gorgeous table model cabinet for the average size living room. Outside dimensions 23½" Wide x 24" High x 24" Deep. Walnut or Mahogany..... **\$42.50**

16" Economy Console Cabinet

An exceptional buy in a console cabinet made of fine veneers to house the 630 TV chassis, tube and speaker. Outside dimensions are 39" High x 24" Wide x 22¾" Deep. **\$44.95**

16" DeLuxe Full Door Console

Gracefully designed to be one of the beauty spots of your home. Doors swing open to view television. Exquisitely finished. Outside dimensions 26¼" Wide x 41" High x 25". Walnut or Mahogany..... **\$84.95**

16" Exotic Chinese Console

The distinctive beauty of the Chinese design cabinet makes it one of the most charming of our entire stock. The full doors conceal the TV set and controls. Outside dimensions 41" High x 26¼" Wide x 25" Deep. Walnut, Mahogany or Ebony..... **\$124.50**

SPECIAL!!

THE NEW DOUBLE V TV ANTENNA

Price—Only \$5.95 Less Mast

5 Ft. Sectional Mast \$1.25

All Merchandise Subject to Prior Sale. All Prices Subject to Change without Notice.

WRITE FOR COMPLETE CATALOG N-12

EDLIE ELECTRONICS INC.

154 Greenwich St. New York 6, New York

Within the Industry

(Continued from page 28)

ELECTRIC PRODUCTS INC. . . . **THE AUDIO-MASTER CO.**, manufacturers of transcription players, has moved to larger quarters at 341 Madison Avenue, New York 17, N. Y. . . Application for a building permit for the construction of a new television plant in Raritan Township, New Jersey has been filed by **WESTINGHOUSE ELECTRIC CORPORATION** . . . **The GENERAL ELECTRIC COMPANY** has announced that it will reopen its Clyde, New York plant and transfer the production of germanium products now being made at the company's Thompson Road plant in Syracuse to the Clyde factory . . . **PYROFERRIC COMPANY** has acquired a manufacturing plant at 14 Bleeker Street, Mount Vernon, New York to supplement its present facilities for the production of iron cores . . . **CENTRAL TELEVISION SERVICE** of Chicago has opened a South side branch at 6901 South Anthony.

* * *

CHARLES M. ODORIZZI has been elected to the post of operating vice-president of the *RCA Victor Division of Radio Corporation of America*.



He has served as vice-president in charge of service for the division since July of 1949. In his new post he will continue as chairman of the board of the *RCA Service Company*.

Mr. Odorizzi joined the company in 1949 as administrative head of service activities for the *RCA Victor Division*. Most recently, he completed organization and establishment of a special Government Service Division to facilitate and expedite the handling of government requirements.

Before joining *RCA* he served as vice-president and general manager of the mail order division of *Montgomery Ward & Co.*

* * *

RADIO-TELEVISION MANUFACTURERS ASSN., through its president, Robert C. Sprague, has recently named a fifteen-man "Town Meetings" Committee which will function under the continued leadership of Harry A. Ehle, vice-president of *International Resistance Co.*

The RTMA committee is currently conducting "Town Meetings" for television dealers and technicians in television areas throughout the country. The programs are being financed on a voluntary basis by TV set manufacturers.

Serving on the newly-appointed committee are: Benjamin Abrams, *Emerson Radio & Phonograph Corp.*; A. T. Alexander, *Motorola Inc.*; A. A. Brandt, *General Electric Company*; H. C. Bonfig, *Zenith Radio Corp.*;

Leonard F. Cramer, *Allen B. Du Mont Laboratories, Inc.*; J. B. Elliott, *RCA Victor Division*; G. M. Gardner, *Wells-Gardner & Co.*; H. L. Hoffman, *Hoffman Radio Corp.*; J. J. Kahn, *Standard Transformer Corp.*; Stanley H. Manson, *Stromberg-Carlson Co.*; Leslie F. Muter, *The Muter Co.*; Henry T. Paiste, *Philco Corporation*; A. D. Plamondon, Jr., *Indiana Steel Products Co.*; and Edward C. Tudor, *Industrial Development Engineering Associates, Inc.*

* * *

JOSEPH H. MOSS, JR. has been appointed to the newly-established post of manager of distribution for the receiver sales division of *Allen B. Du Mont Laboratories, Inc.*



Mr. Moss will handle the administration of the company's distributors throughout the country. He will be responsible for distributor follow-through on all sales and merchandising policies formulated at the firm's New Jersey headquarters. He will make his offices at the East Paterson, N. J. plant.

He has been a member of the *Du Mont* sales force since 1947 and was the company's first regional sales manager. He established the Central States Regional Sales office in Chicago and set up the company's present distribution pattern in the Middle West.

* * *

MICHAEL D. KELLY, formerly assistant television sales manager of *The Hallcrafters Company* has been named regional television sales manager for the central region with headquarters in Chicago . . . **EDWARD FISHBEIN** is the new head of the parts sales and service division of *Emerson Radio & Phonograph Corp.* . . . *Reeves Soundcraft* has appointed **ROBERT G. KILGORE** to the post of manager of government operations for the company

. . . **DR. P. N. HAMBLETON**, formerly of the *Philco Tube Development Laboratory* has been appointed electronics engineer in charge of the Electronic Laboratory at *Superior Tube Company*, Norristown, Pa. . . **SAUL D. LEWIS** of *Air King Products Company, Inc.* has been promoted to the post of purchasing agent . . . **O. W. PIKE**, manager of engineering for the *General Electric Divisions* in Schenectady, passed away recently in that city. He was associated with *G-E* for 30 years . . . The new director of advertising and sales promotion for *Packard-Bell Co.* is **GEORGE OLIVER** . . . **WALTER R. JONES**, associate professor of electrical engineering at Cornell University, has been retained as a member of the editorial staff of *Howard W. Sams & Co., Inc.*

. . . **HARRY R. SMITH** has been named head of the television transmitter development department of *Standard Electronics Corporation* . . . **E. ARTHUR HUNGERFORD, JR.** has joined the

sales staff of *General Precision Laboratory* . . . The *W. H. Brady Company* of Chippewa Falls, Wis. has named **WILLIAM E. SCHNEIDER** as merchandising manager of the firm . . . **M. W. CRADDICK** is the new sales manager for *Starrett Television Corp.* in the metropolitan New York and New Jersey areas . . . **ARTHUR H. TRACY** has been named credit manager of *Quam-Nichols Co.* . . . **L. R. WANNER** has been appointed plant manager in charge of plastics operations for the Parts Division of *Sylvania Electric Products Inc.* . . . **JOE H. MORIN** was recently named sales manager of the distributors' division of *Shure Brothers, Inc.* . . . **H. E. COLLIVER** is now serving as manager of the newly-established midwestern regional office of *National Electric Products Corp.* . . . **GERALD LIGHT** has been named manager of the government contracts division of *Emerson Radio & Phonograph Corp.* . . . The *Allen B. Du Mont Laboratories, Inc.* has named **ALBERT C. ALLEN** as assistant central states regional sales manager with headquarters in Chicago . . . **JOHN L. DOONER** has joined the *Brach Manufacturing Corporation* as an antenna research engineer . . . **LOUIS J. CHATTEN**, formerly vice-president of *North American Philips Co.*, has become associated with *Olympic Radio & Television, Inc.* as merchandising consultant and contact on electronics matters with federal procurement agencies . . . **REX L. MUNGER** has been named jobber sales manager of *Permoflux Corporation* of Chicago . . . **ARTHUR E. CHAMPAGNE** has been appointed to the post of New England district sales manager for the *National Company* of Malden and Melrose, Mass. . . . **E. W. MERRIAM**, manager of the *Teleset* service control department of the *Allen B. Du Mont Laboratories, Inc.* has been named chairman of the Radio-Television Manufacturers Association's service committee.

JEROME BERGER, formerly manager of the Devices Division of *The Brach Manufacturing Corporation*, has been named assistant sales manager for all of the company's TV and electrical products.



In his new post Mr. Berger will be responsible for specialized sales engineering programs for TV manufacturers and their distributors who incorporate the company's 2, 4, and 16 set TV "Mul-Tel System" in their TV set sales campaign, and for the sale of custom and brand products. He will also act as assistant to Ira Kamen, the company's new director of TV sales, in promoting TV products to the jobber market.

Mr. Berger has been with the company eleven years and has held various posts with the organization during that time.

—30—

December, 1950

TRAP INTERFERENCE with DON GOOD TRAPS— TELEPASS*—TELETRAPS* (FM & DIA.)

DON GOOD TRAPS, known as "DARN GOOD TRAPS," do their intended job—they do eliminate unwanted interference. That's why they're so well liked—and used.

NEW DON GOOD TELEPASS*

A TV HIGH PASS FILTER that eliminates—or greatly reduces—interference which may be picked up by I. F. Amplifier or TV Receiver and also interference which may arise from strong, local low-frequency fields radiated from Amateur Radio Stations, Diathermy and X-Ray Equipment, Industrial Induction Heaters, Household Appliances, Neon Signs, etc. . . . Pretuned at factory—no adjustments required. . . . Easily installed at receiver antenna terminal. . . . In compact, low-loss Polystyrene Case— $2\frac{3}{8} \times 1\frac{1}{4} \times 4\frac{1}{8}$ No. 72—for 72 Ohm Line. No. 300—for 300 Ohm Line.

PRICE—EITHER—\$3.95.

NEW DON GOOD VARIABLE TELETRAPS*

No. R-301 FM—88 MC to 110 MC. This effectively eliminates interference from FM Stations operating within its tuning range.

No. R-302 DA—26 MC to 32 MC. This effectively eliminates interference from DIATHERMY and AMATEUR SIGNALS within its tuning range.

EITHER TELETRAP* ABOVE—PRICE: \$3.95

For quick, simple installation at TV receiver antenna terminals.



Here's the NEW LEADLINE that does a remarkable job. It eliminates excessive losses found in ordinary feedlines used in TV and AMATEUR INSTALLATIONS. . . . TV installers know that losses through leakage of the signal in the dielectric web between wires of ordinary feedline can be so excessive that proper clear, sharp "snow-free" pictures are impossible to obtain.

With the NEW GOODLINE AIRLEAD* 80% of the loss producing dielectric web is removed, permitting maximum practical trans-

ASK YOUR LOCAL DEALER OR WRITE

*PATENT PENDING

*TRADE MARK

Don Good, INC.



POPULARLY PRICED—ALL AT \$3.95—
ALL NEW ITEMS



NOTE: DON GOOD TELETRAPS* are tunable. . . . Enclosed in a round, compact low-loss Polystyrene Case: $3\frac{3}{8}$ " diameter by $1\frac{1}{8}$ " thick.

ELIMINATES 80% OF FEEDLINE LOSSES



fer of the signal. Standard close wire spacing and standard nominal 300 Ohm impedance eliminates losses through re-radiation due to poor balance to ground so prevalent in wide-spaced lines. . . . GOODLINE AIRLEAD* EFFECTIVELY ELIMINATES WET WEATHER LOSSES. Installation is simple—with standard insulators. No special transformers or "experimenting" required. Weather resistant low-loss dielectric—nominal dimensions of .375" x .083". . . . Standard lengths: 500'—1000'—2500'.

1014 Fair Oaks Avenue
SOUTH PASADENA, CALIF.
PHONE: SYcamore 9-1194

POWER!

Your ad in the Classified Section of **RADIO & TELEVISION NEWS** is read by the largest audience in the field—monthly circulation—over 200,000.

TELEVISION

PREPARE FOR A GOOD JOB!
BROADCAST ENGINEER
COMMERCIAL OPERATOR (CODE)
RADIO SERVICEMAN

Television Servicing

(Approved for Veterans)
SEND FOR FREE LITERATURE
BALTIMORE TECHNICAL INSTITUTE
1425 EUTAW PLACE. BALT. 17, MD.

COMPLETE DELUXE ANTENNA KIT

Ten bar conical or flying arrow type, 50 ft. twin lead in—30 ft. of guy wire—8 ft. mast—base and guy ring—standoff insulators and roof hooks with complete instruction sheets. Add 3c ft. for additional lead in if needed.

7.95

NOTHING ELSE TO BUY
20% Deposit on C.O.D. orders. Shipping weight 7 lbs.

Davis
TELEVISION
SUPPLY CO.
3047 W. OLYMPIC BLVD. • LOS ANGELES 6, CALIF.

USE PHOTOFAC

the world's best Radio-TV service data—it pays for itself every working day



Try **PHOTOFAC!**

FREE We'll send you any Photofact Folder listed in the Photofact Cumulative Index

WE'LL PROVE YOU'LL SAVE TIME and EARN MORE WITH PHOTOFAC

NOW—learn for yourself—at our expense—how PHOTOFAC makes your Radio and TV work quicker, easier, more profitable! Examine an actual PHOTOFAC Folder. Use it. You'll learn first-hand why over 35,000 successful service technicians use PHOTOFAC daily. You'll learn that no other service gives you PHOTOFAC'S completeness, accuracy, uniformity, and lowest cost. PHOTOFAC is the only radio and TV service data prepared from laboratory analysis of the actual equipment. Know the facts—get your FREE Folder now. Examine, use, compare—learn why no modern service shop can afford to be without PHOTOFAC!

WRITE FOR FREE INDEX

PAY AS YOU EARN! Ask your distributor about this amazing plan. Only \$18.39 puts the entire profit-boosting Photofact library in your shop now!

NOTE: Our FREE Folder offer is limited to Service Technicians only. Attach coupon below to your letterhead and mention your jobber's name. If you have no letterhead, send coupon to your jobber. Experimenters and others may obtain the Photofact Folder by remitting amount shown below.

HOWARD W. SAMS & CO., INC.
2201 E. 46th St., Indianapolis 5, Ind.

- Send FREE Photofact Cumulative Index
 Send Full Easy-Pay Details

I am a Service Technician:

- Send FREE Folder for set model.....

I am an Experimenter: Enclosed \$.....

- Send Folder for set model.....
TV-\$1.00. Record Changer or Comm. Receiver-75c. AM/FM-50c

Name.....

Address.....

City.....Zone...State.....

Strategic Air Communications (Continued from page 65)

this is no enemy decoy message, it's the real thing. He acknowledges the message and switches the intercom to "call" to pass the message to the aircraft commander.

Thousands of miles away in the operations room of the Strategic Air Force commander the line on the map showing the progress of the bomber from base toward target is now dog-legged toward the secondary target assigned to this aircraft.

The worried Intelligence Officer wrinkles his forehead and mutters, "Well, he got it; there'd have been hell to pay if he hadn't."

Yes, there'd have been hell to pay if he hadn't. These bombers pack a punch—the Sunday punch. And command has to stretch all of the way—clear to the instant of bomb release. But the message has been put through. The airborne operator has functioned more reliably than any little black-box. He had transmitted to the pilot the change in order of the strategic air commander, communicated over the ground-air radio.

Liaison Set Development

After the close of World War II the U. S. Air Force began concentrating great effort toward providing aircrews with the improved radio communications equipments which were so sorely needed.

Queries were sent out to all operational agencies asking for comments on the weaknesses of existing equipments and a statement of desires in improving radio sets. The replies seemed at first to be demanding the impossible but careful evaluation disclosed many major deficiencies in the currently standard equipments.

Of all the radio communications equipments presented for scrutiny, the liaison set provoked the greatest comment—much of which may have been interpreted as a scathing denunciation. There seemed to be little about it that was right. Although it was a substantial advance over its predecessor, it was a far cry from what could be considered the ideal set.

A recap of the criticisms revealed that they all came to focus at one point: it was not possible to train radio operators to the required degree of proficiency in the limited time available between induction and assignment to a combat aircrew. In other words, aircraft manufacturers could produce radio operator positions in heavy aircraft faster than we could man them. It was difficult enough to teach operators the Morse Code, combined Communications Procedures, radio circuit discipline, and communications security, but when he was placed in front of his liaison radio equipment, the profusion of knobs and switches proved to be just so many statistical opportunities for error.

The radio operator had already been

TWIN LEAD, TELEVISION LIGHTNING ARRESTER

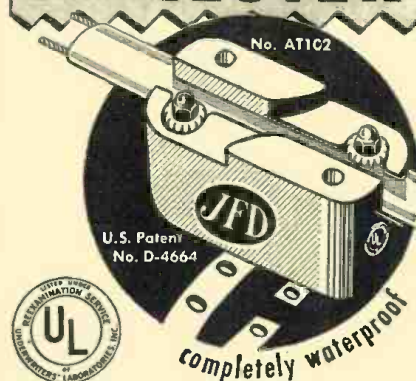

APPROVED for OUTDOOR-INDOOR Use \$2.25
Protects Television Sets Against Lightning and Static Charges

JFD SAFE TV GUARD

Simple to install everywhere and anywhere...no stripping, cutting or spreading of wires. More than 300,000 in use today!

SEE YOUR JOBBER OR WRITE TO

JFD MANUFACTURING CO., Inc.
6127 16th Avenue, Brooklyn 4, N. Y.
First in Television Antennas & Accessories



At Last!
INTERLOCKING SMALL PARTS CABINETS TO FIT ANY SPACE

MULTI DRAWERS are the handy small parts steel storage cabinets you and your friends have always wanted! Each 5 x 2 7/8 x 2 1/4 drawer (painted green) interlocks on top, bottom or sides making it possible to fit them around existing fixtures for economy of space. Card holder on front of each MULTI DRAWER. Immediate delivery in sets of 12 at \$3.50 per set. Mail coupon now!

THE CINCINNATI VENTILATING CO., INC.

Third and Madison Sts., Covington, Ky.

- Please send ___ sets of MULTI DRAWERS @ \$3.50 per set
 C.O.D. Check Money order enclosed.
agree to pay postage.
 I am interested in being a MULTI DRAWER dealer.
Send full information.

Name.....

Address.....

City and State.....

relieved of as many of the knob settings as was possible. The maintenance crews had set up the preset frequencies in the storage mechanisms of the ten-channel transmitter, leaving him only the task of tuning the antenna circuits, a task that accounted for frequent communications failures. His receiver was a bandswitching, "coffee-grinder tuning" equipment containing sufficient permutations and combinations of operator-error to account for additional communications failures when the requisite skills were missing.

"Give us a set," pleaded the tactical operators, "where the operator turns it on, sets the exact frequency in a window, and starts beating the key, knowing that his transmitter and receiver frequency could be used for calibrating WWV." "Make the antenna tuning automatic," echoed others, "regardless of whether he's on the fixed-wire or trailing antenna." "Let him store up at least twenty frequencies so that he can QSY within a few seconds to another assigned channel." "Take all of the knobs away from him but a channel selector and a volume control." "Make it so simple that a pilot can operate it."

Five years have gone by since the new liaison set was visualized by the operational commands and several hundred man-years have been expended in developments and monitoring activities. The needs of the two services having major interest, the USAF and the USN, have been combined in Joint Military Characteristics and each service has engaged in separate developments—all with the aim of providing a single, jointly standard liaison radio equipment. The products of these separate developments are nearing the evaluation stage—both having demonstrated that the ideals expressed by the operational commands were attainable. True, there were compromises. Neither of the developments could meet the desired weights or QSY times—and the cost of attaining some of the ideals has caused some last-minute soul-searching on the part of the operational commands.

The sets are not simple. As a criterion, let's consider the number of tubes as an index of complexity. The present USAF standard liaison radio set, AN/ARC-8, contains 23 vacuum tubes. The several developments currently assessable contain 54, 86, and 137 vacuum tubes respectively. Just how much of the automatic operation should be accepted, and how much could be given back to the intelligence of the radio operator with a net saving in circuit complexity?

Representatives of the major USAF commands were invited to observe the detailed functioning of the 137-tube development and the questions were propounded. "Here is the set you've dreamed about" they were told, "you've seen it perform in accordance with your desire of five years ago. We can save a lot of tubes and complex circuits here and there by giving some

of the tasks back to the radio operator. Just which of the automatic functions do you feel that you can dispense with?"

Generals turned to confer with their specialists. Radio operators looked at each other quizzically. Engineers looked expectantly for a sign of weakness—for some indication that the operational personnel were appalled with the complexity of frequency synthesizers, were suspicious of mechanical brains, or were skeptical that the set could function under service conditions. A hand went up tentatively.

"I don't think the channel-storage function is absolutely necessary," one general observed. "As a matter of

fact, I like the idea of the radio operator being 'frequency-conscious' rather than 'channel-number-conscious.'"

"We like the channel-storage feature," said a representative of another command, "most of our frequencies are firm assignments and they can all be set in."

When the comments from the USAF representation were analyzed, it became clear that no one was willing to forego any of the automatic features, that the suggestions and comments were for additional features and advances. They would like to have a flexible liaison radio set that would answer any of the requirements of the

SEE LEO FIRST . . .

for hallicrafters!

HALLICRAFTERS S-78 FM/AM CHASSIS

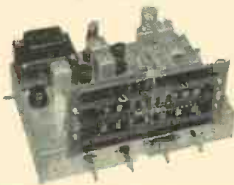

Superb broadcast performance for custom installations. 10 tubes, rectifier. 8 watt output. One RF, 21F.

Only **\$89.50**

Low Down Payment

HALLICRAFTERS SX-71 RECEIVER



Double Conversion sharp selectivity, plus built-in NBFM at moderate cost. 11 tubes plus voltage regulator and rectifier.

\$199.50

Low Down Payment

GIANT RADIO REFERENCE MAP

Just right for your control room walls. Approximately 28" X 36" Contains time zones, amateur zones, monitoring stations. Mail coupon today and **25c**



LEO I. MEYERSON
WØGFQ

CU ON 20 -

10 & 75 METERS



FREE WRL 1951 CATALOG

Send for the new 1951 complete WRL catalog containing everything new in radio and television. Our new catalog is bigger than ever, jam-packed with bargains, completely indexed and arranged for quick easy reference. Send for your FREE catalog today!

PHONE 7795

WRITE—WIRE

World Radio Laboratories
LABORATORIES COUNCIL BLUFFS, IOWA
INCORPORATED IOWA

WORLD RADIO LABORATORIES
744 West Broadway
Council Bluffs, Iowa

R-12

Please send me:

Radio Map

SX-71 Info

New Catalog

S-78 Chassis Info

List of Guaranteed Used Equipment

Name

Address

City State

Speed Up Small Wire Tinning

Lectrohm SOLDER POTS



These small capacity solder pots are particularly designed for the individual operator tinning of small wires and leads. They answer the special need for melting limited quantities of solder at one time. Thus current consumption is re-

duced and maximum efficiency on the assembly-line is attained.

Single-heat, porcelain nickel-chrome heating element. Model 200, 1 1/4 lb. capacity; Model 250, 2 lb. capacity.

Lectrohm Solder Pots
are available
at leading
Radio Supply Houses



5907 Archer Avenue, Chicago 38, Illinois
Division of The National Lock Washer Co., Newark, N. J.

major operational commands without interfering with the ideal of interchangeability of major components. Even when the engineers made little pleas for the relaxation of certain demands, they were received coldly. The concept of a fully automatic liaison radio sat rather well with the operators in spite of the increased dependence upon tubes and integrity of circuit components.

As an innovation in the unveiling of a new development, the maintenance activities were given an opportunity to assess the impact of such a complex device upon the various echelons from the squadrons to the major repair depots. The representatives of Training Command came to the alert. Just how could a man—an ordinary man—be trained to find the source of a malfunction in such a complicated mechanism within his own lifetime?

"Maintenance of this equipment," began the speaker, "is divided up into three echelons—the organizational, the field, and the depot." As the narrative of maintenance actions unfolded, the Training Command representatives relaxed in their chairs. What had appeared as an insurmountable difficulty now was as simple as A, B, C—the equipment was designed so that it would practically maintain itself—at least, it is possible for a uniformed lad to take a simple test set and be guided unerringly to a faulty section of the transceiver. Employing a number of "go-no go" tests, the organizational mechanic would isolate a faulty removable section and replace it on the spot, placing the set back in service within the hour. The faulty chassis would be sent to the field repair shops where additional test equipment would single out the faulty sub-assembly, allowing the return of a serviceable section back to the organizational supply shelves within the day. In neither case was it necessary to heat up a soldering iron. The sub-assemblies are divided up into two categories: those capable of economical repair and those to be thrown away. The former are returned to the rear areas for depot repair. It seems at first glance that the maintenance activities have simply unloaded their problem onto the already sagging shoulders of the supply organization, however, upon arrival at a realistic level of supplies to be maintained at each echelon, the problem of "not-in-stock" disruption of maintenance operations appears surmountable.

Now that an acceptable piece of hardware appears to be within the capabilities of industry, the whole problem of liaison radio communications is in need of review. The existing developments have produced an equipment that has relieved the radio operator of certain skills that are purely apart from his basic skill of transmitting and receiving intelligence with the dots and dashes of the Morse Code. The time available for his training in these respects is still too short to provide the required degree of pro-

LEARN DAY and EVENING CLASSES
TELEVISION
ELECTRONICS-RADIO
Modern Laboratory
Instruction in

- SERVICING
- BROADCAST OPERATING
- ELECTRONIC and TV ENGINEERING

WRITE FOR ILLUSTRATED CATALOG
ELECTRONICS INSTITUTE, Inc.
21 HENRY, DETROIT 1, MICH.

G.I. APPROVED

RCA 630 TV CABINETS
FULL CONSOLES \$39.95
AVAILABLE TO FIT MOST SETS
In Mahogany—Walnut—Blonde
FULL DOOR SPECIAL \$64.95
JACK CANTOR, 74 Cortlandt St., NYC

ANOTHER OUTSTANDING JOBBER
MIDWAY Radio & Television Corp.
60 WEST 45th STREET
New York 19, N. Y.

HAS THE
SENSATIONAL NEW
EICO 425-K 5" SCOPE KIT
IN STOCK!
\$39.95

NOW FOR THE FIRST TIME!

SIGNAL TRACING by SIGNAL SUBSTITUTION OF ALL TV RECEIVER CIRCUITS!



MODEL 101
SUBSTITUTION TESTER
Has test speaker with voice coil, transformer connections, range of resistors, paper, ceramic, electrolytic condensers, variable pot.—and a simple signal tracer—can be used as audio signal tracer for radio & TV.
Dealers' Net. **\$17.95**



MODEL 103
SIGNAL GENERATOR
Combines small size, sturdiness, ACCURACY and dependability. Locates trouble fast, from antenna to CRT or speaker. Packed with features to make TV servicing easier, faster, and more profitable!
Dealers' Net. **\$33.50**



MODEL 104
"SYNCHRO-SWEEP"
New invention for TV testing, widely endorsed by experts. Supplies own sync. and sweep pulses for signal tracing sync. and sweep circuits with or without test pattern, scope, or bench equipment!
Dealers' Net. **\$44.50**
* Pat. App. For

Designed for the TV Serviceman
EXCLUSIVELY by OAK RIDGE

A group of revolutionary new MINIATURE instruments (each 5 3/4 x 4 1/4", in black bakelite case) built to exacting standards of HIGH PRECISION and amazing ruggedness—permit TV servicemen to do ON-THE-SPOT TV servicing by the only fool-proof method: Signal Tracing by Signal Substitution! Included in above group (not illustrated), is Model 102 High Voltage Meter for TV Testing. Dealers' Net. **\$17.95**
SEE THESE INSTRUMENTS AT YOUR JOBBERS or write for information to

**PORTABLE
PRECISION
INSTRUMENTS**



OAK RIDGE

PRODUCTS Mfg. Div. of
VIDEO TELEVISION, INC.
37-01-N Vernon Blvd., Long Island City 1, N.Y.

iciency. In the last war, the greatest fault was poor radio discipline—radio operators were under such compulsion to get their own messages through that they transmitted out of turn and caused interference to other aircraft or ground stations by persistent calling. Code speeds were those of the slowest operator—too slow, in fact, to permit clearing the transmissions of several aircraft within a short space of time. An attempt was made to relieve congestion by permitting only the lead aircraft of a formation to transmit operational messages, screening the organizations for the most accomplished operators and assigning them to lead crews. This, of course, caused a deterioration of interest on the part of the remaining operators and they found themselves so far down in proficiency when an emergency did arise that they were unable to place the radio equipment on the air and establish communication with navigation or rescue agencies.

The success experienced in attaining our aspirations in radio transmitting and receiving equipment led us also to believe that the problems of the radio operator could be solved by employing some "visual message presentation system" for transmission and reception of the intelligence contained in a purely operational message. Numerous systems were reviewed against the stated objective of a three to six thousand mile transmission path and each was found to be considerably less than automatic. Considered were standard teletype, facsimile, telautograph, lighted "marble-board" panels, and specialized printing systems. There was one insuperable difficulty. In spite of CRPL assistance in determining optimum working frequencies, there remained propagation phenomena such as selective fading and multi-path reception, as well as a hopelessly congested high frequency spectrum. Who was to "clear" the channels needed for printing systems that can't tolerate radio interference? Who was to predict in advance of a flight the channels that could be presumed to be free of interference at various geographical points far removed from monitoring stations? When would the optimum frequencies be so cluttered with multi-path reception that teletype or facsimile would be out of the question. It seems hopeless to design a machine with the intelligence of a trained c.w. operator—a machine that can selectively "listen" to a desired signal to the exclusion of all others present and put down on paper the desired intelligence and none other.

The experience of our point-to-point communications activities was consulted for a solution. It was found that in spite of a constant transmission path, use of optimum frequencies, erection of large directive antenna arrays, employment of high power, and operation by personnel of skill and experience, there was a constant level of unpredictable and unscheduled circuit outage. Take away from the fixed communications station its con-

For **INDUSTRY • RESEARCH • PRODUCTION • SERVICE**

You can get it-
at MILO!



FAIR DISTRIBUTION FOR ALL
is the MILO Watchword!

Yes, in these days of war and re-armament there are plenty of shortages in electronic components and equipment. But **Milo comes through for you!** And here's why:

Because Milo believes in **just and equitable distribution** to all its customers, whether old or new.

This is the fair-play creed of service and cooperation that built Milo—and Milo sticks to it, scarcities or no. Because Milo's great warehouse holds **complete stocks of all the best lines**. Just look at this partial list of the more than 150 first-rate manufacturers whose products are available now from Milo:

ADVANCE ELECTRIC
AEROVIX
ALPHA WIRE
AMERICAN TELEVISION & RADIO
BELDEN • BLILEY
DAVID BOGEN
BUD • BURGESS
BUSSMANN
CLAROSTAT
CONDENSER PRODUCTS
CORNELL OUBILIER
CONTINENTAL CARBON
DEJUR-AMSCO
DIALCO • DRAKE

EITEL-McCULLOUGH
ERIE
GENERAL CEMENT
GENERAL ELECTRIC
GUARDIAN ELECTRIC
HAMMARLUND
HICKOK • HYTRON
INSULINE • IRC
E. F. JOHNSON
KESTER
KINGS ELECTRONICS
LITTELFUSE
JAMES MILLEN
NATIONAL COMPANY
OHMITE
PAR-METAL
POTTER & BROMFIELD

PRECISION APPARATUS
PREMAX
SANGAMO
SHALLCROSS
SHURE BROS.
SIMPSON ELECTRIC
SDLA ELECTRIC
SPRAGUE
STANDARD TRANSFORMER
SUPERIOR ELECTRIC
SYLVANIA • TUNG-SOL
TRIPLETT
UNGAR ELECTRIC
WARD LEONARD
WESTON



Write for
your
MILO
Catalog

Milo's newest catalog, jam-packed with 1053 pages of descriptions, specifications, illustrations and prices, is the key to the latest electronics products you want. Write for it today—on your company letterhead, please, stating your position, since it is limited to responsible officials only.

MILO doesn't just talk cooperation.
MILO GIVES YOU COOPERATION!

MILO
PHONE
BEekman 3-2980

Radio & Electronics Corp.

200 Greenwich Street, New York 7, N. Y.

Cable Address: MILOLECTRO

The ONE source for ALL your electronic needs

RADIO ENGINEERING DEGREE IN 27 MONTHS

Radio engineering is a big field. There's room for you in it—if you're good. Get first-class training at Indiana Tech. Intensive specialized course, including strong basis in mathematics and electrical engineering, advanced radio theory and design, television. Modern laboratory. Low tuition. Also 27-month courses in Aeronautical, Chemical, Civil, Electrical and Mechanical Engineering. Approved for G.I.'s. Enter December, March, June, September. You can earn part of your expenses right here in Fort Wayne while you are studying.

INDIANA TECHNICAL COLLEGE

9120 E. Washington Blvd., Fort Wayne 2, Indiana
Please send me free information on B.S. Engineering Degree in 27 months as checked.

Radio-Television Aeronautical
 Civil Mechanical Electrical

Name
Address

AMERICA'S most advanced—the **TWIN-TRAX** SERIES

TAPE RECORDERS
models for —> professional
—> semi-professional
... and —> experimental use

WRITE TODAY for 12-page 1951 catalog. Fully illustrated, containing complete technical specifications and direct factory prices.

AMPLIFIER CORP. of AMERICA
398-2 Broadway, New York 13, N. Y.

QUAM

Adjust-A-Coil

SPEAKERS

FIRST in Replacement Field FIRST for Original Equipment



with the ADJUSTABLE VOICE COIL

NO RUBBING VOICE COILS

There is nothing more annoying than a squawking speaker with a rubbing voice coil! It can easily happen to any conventionally built speaker where the spider is cemented in place with no means of adjustment.

But not on a Quam Adjust-A-Coil Speaker. Just before it is packed for shipment, as the last production operation, the Quam Adjustable Voice Coil is carefully and exactly centered. Rubbing Voice Coils are unheard of on Quam Speakers, and dissatisfied customers will be equally rare when you

"REPLACE WITH QUAM"

WRITE FOR COMPLETE QUAM CATALOG

Also Makers of Quam Focalizer Units and Ion Traps

QUAM-NICHOLS COMPANY

522 E. 33rd Place Chicago 16, Illinois

MAKERS OF QUALITY SPEAKERS FOR 27 YEARS, UNDER THE SAME MANAGEMENT

Advance with ELECTRONICS CITY

You need firm grasp of fundamentals to keep pace with these complex, fast-growing fields. In thorough 2-year course learn electricity, electronics, physics, mathematics, drafting, etc. Employers want Franklin graduates. Coed. G.I. approved. Day, evening. 43rd year. Write for Catalog.

FRANKLIN TECHNICAL INSTITUTE
46 Berkeley Street Boston 16, Mass.

ANOTHER OUTSTANDING JOBBER BARNETT BROS. Radio Co.

117-119 NORTH 7th STREET Philadelphia 6, Pa.

HAS THE SENSATIONAL NEW **EICO** 221-K VTM KIT IN STOCK!



\$23.95

stant path, its optimum frequency, its efficient antenna system, its high power, and experienced maintenance attendants and you have the equivalent of an airborne communications terminal. It can be seen that the probabilities of an aircraft, say, at three thousand miles from its ground station, making an initial unscheduled contact employing radioteletype or facsimile is remote indeed. Consequently, for the time being until a suitable system comes along, we are still considering c.w. as the primary emission from the liaison radio equipment. Secondly, for certain specialized applications, it appears that teletype and facsimile show promise, however, for ranges up to six thousand miles, nothing is in sight that can compete with manual radiotelegraphy that is adaptable to the airborne radio installation.

As a result of this conclusion, attention was redirected toward the development liaison radio set with the aim of tightening up the c.w. features and reviewing its capabilities for this method of communication. The transmitter was found to be at the highest state of development as a radiotelegraph set, having the capabilities of a secondary frequency standard in accuracy and stability. With the aid of automatic antenna tuning systems, it could deliver the maximum amount of available power to the antenna, whether fixed wire, wing-cap, or trailing wire. The emission was pure c.w. with no spurious components or frequency modulation. A study of the receiver showed room for improvement. In the initial form it was—in accordance with the military characteristics—a simple, straightforward receiver (embodying refinements, of course) using the usual beat-frequency oscillator "C.W.-Tone" control. The frequency accuracy was the same as the transmitter (being slaved to the same synthesizer) but the normal passband placed a lot of emphasis upon the skill of the radio operator in reading his desired signal through interference. It appeared that some improvement could be made in the rejection of unwanted signals by inserting the narrowest possible passband in the receiver output, permitting the radio operator to slice away on interfering signal even though it was only 500 cycles removed from the desired signal. The "C.W.-Tone" control then became the "Fine-Tune" control, allowing the radio operator some latitude in netting with stations that haven't the frequency accuracy or stability of the liaison set. Fortunately, the "C.W.-Slot" idea of adjacent channel rejection was attained without adding a single extra control, thus staying within the basic philosophy of a minimum of knobs and switches.

Considering the liaison set for c.w. communications, certain features begin to take on importance—features that are available for the first time in military communications history. The first, that of frequency stability and accuracy, permits an altogether new

PRESENT STOCKS WILL BE SHIPPED AT THESE LOW PRICES UNTIL EXHAUSTED!

SPEAKERS		Ainco V Magnets	Lots of 5	VOLUME CONTROLS	
Fresh Stock!	oz.	oz.	Asst.	With Switch & Long Shaft.	Less Switch & Short Shaft.
3 1/2" P.M.	.68	1.00	.58	100.00	25.000
4" P.M.	.68	1.10	1.04	150.00	50.000
4" P.M.	1.47	1.15	1.09	100.000	100.000
4" X6" P.M.	1.01	1.64	1.54	250.000	250.000
5" P.M.	.68	1.07	.94	ohms	ohms
5" P.M.	1.47	1.03	.86	25.000	50.000
5" P.M.	1.47	1.15	1.09	50.000	100.000
6" P.M.	1.47	1.55	1.47	100.000	200.000
10" P.M.	6.34	3.74	3.64	250.000	250.000
12" P.M.	4.64	4.80	4.55	350.000	500.000

BRUSH CRYSTAL PHONE: (Singer Unit) 60-10,000 CPS, High Impedance. Can also be used as mike. Includes shielded 4 ft. cord. ea. \$2.29

Make Swedgal Your Headquarters for Transformers

OUTPUT TRANSFORMERS

3Q5	34P.P.	6V8	55c
45P.P.	43P.P.	6V8P.P.	44c
184P.P.	2E26P.P.		59c
3S4P.P.	6H9P.P.		69c

6V6 Push Pull, 15 Watts, Secondary caps 4, 8, 15, 250 & 500 Ohms. Fully shielded. ea. \$1.49

POWER TRANSFORMERS: 60A. #1043-1. Pri. 115 V. or 230 V. Sec. 5 V. @ 3 A. 800 V. CT @ 300 MA. Bins Tap 55 V. AC. ea. \$9.95

POWER TRANSFORMERS: #29-12. Pri. 115 V. AC. Sec. 5 V. @ 2 A. 8.3 V. CT @ 2.5 A. 800 V. CT @ 120 MA. ea. \$6.95

POWER TRANSFORMERS: #P784-1. C & L. Pri. 115 V. Sec. 6.3 V. CT @ 2 A. 880 V. CT @ 75 MA. ea. \$3.95

POWER TRANSFORMERS: 580 V. CT @ 50 MA. Filament Voltage 5 V. @ 2 A. ea. 99c

ISOLATION TRANSFORMERS: With 6 V. heater winding. 115 V. pri. 250 V. @ 60 MA. 0.3 V. @ 2 ohms. ea. \$1.79

AUTOTRANSFORMERS: 117 V. AC. Input 117 V. AC. Output 190 V.—7 V. Can also be hooked up to deliver secondary V.—70 V., 4.5 V. (Open circuit ratings) ea. 89c

OUTPUT TRANSFORMERS: #F935-1. 200 W. P.P. Pri. to 125 ohms or 500 ohms. Pri. 12. 400 ohms P. to P. Dual sec. 125 ohms. ea. \$9.95

OUTPUT TRANSFORMERS 60 W. #47-1. P.P. Parallel grids to 500, 250, 15, 8, 4 ohms. ea. \$4.95

OUTPUT TRANSFORMERS: #F215-1. Pri. 8,000 ohms P. to P. 10D MA. DC per section. Sec. 250, 60, 15, 7.5, 4 ohms. ea. \$3.95

FILAMENT TRANSFORMERS 200 W. #F1269-1. 10,000 V. Insulation on 5 V. winding. Pri. 115 V. AC. Sec. 6.3 V. @ 10 A. 8 V. @ 2 A. ea. \$3.95

DRIVER TRANSFORMERS: #F330-3. 1/2 SSN. 7 to P. Parallel grids (6L6). Pri. to 1/2 Sec. 1.42. ea. \$4.25

DRIVER TRANSFORMERS: #10-6. Turns ratio Pri. to 1/2 Sec. 1. ea. \$2.95

VIBRATOR POWER TRANSFORMER: #F860-3. Input 8V. Output 117 V. ea. \$1.95

SWINGING CHOKES: #F744-7. 200 W. 125 ohms. 5-25 HY. 300 MA. ea. \$4.95

Electro-Voice Dynamic Microphone No. 615 Complete with cable, desk stand and adaptor for floor stand. Complete only \$4.95

TUNER MAGNET CONTACT PICKUPS FOR MUSICAL INSTRUMENTS: Model MM. With built-in volume control and 50 ft. cable. Complete for only \$11.95

SWEDGAL RADIO, INC.
96 Warren St. Dept. N-9 New York 7, N. Y.
Min. Order: \$5.00—F.O.B. NYC

NEW MUSIC LOVERS AMPLIFIER

the GROMMES CUSTOM

undisputed best... "Ears" or Instruments!



MODEL 50 PG Dealer's Net \$4500

MODEL 200 PG Dealer's Net \$1500

Exclusive feedback circuits. Model 200 PG offers frequency response of to 1 DB, 10 to 50,000 CPS. Distortion at 20 watts is 0.2%—no phase shift or transient oscillations of any kind. Write today for free technical bulletin.

PRECISION ELECTRONICS, INC.
641-13 M-LWAUKEE AVENUE • CHICAGO 22, ILLINOIS

RADIO & TELEVISION NEWS

concept in netting a number of scattered airborne communications terminals with a group of ground stations on the same frequency. In the first place, there is no possibility of off-frequency operation—a contingency that has plagued us from the beginning—and a listening station employing a receiver of the same accuracy and stability as the airborne liaison set can receive transmissions from any number of aircraft without necessity of making readjustments in tuning to accommodate variations in frequency from one aircraft to another. All aircraft on a given frequency will practically “zero-beat” with one another. This will require radio discipline of a higher order than ever achieved previously since the ground operator will no longer be able to separate two interfering signals by taking advantage of slight frequency inaccuracies between two aircraft calling at the same time. The signals will be inseparable and both will be unreadable. On the credit side of the ledger is the fact that no longer can there be a missed contact caused by an airborne liaison set being off-frequency just enough to fall outside of the passband of the monitoring station receiver. He will be heard in exactly the same tuning position as all previous aircraft on the same channel. As a corollary, of course, ground station receiving equipment must have tuning accuracy and stability adequate to long channel guards on a given frequency without drift or inaccurate setting. Since the airborne liaison radio receiver will have a “broad” position for monitoring and a “fine tune” range of about plus or minus three kilocycles for any given channel setting, netability with existing ground transmitting equipment is assured even when using the narrow “C.W.-Slot.”

There will be no further necessity for long call-ups or tuning transmissions with this degree of frequency accuracy nor any necessity of making constant fine adjustments because of receiver oscillator drift. The radio operator will be freed of any adjustments to transmitter or receiver other than selecting a frequency, putting the desired signal in the “slot,” and adjusting the volume to a comfortable level. It is altogether conceivable that he will never see any part of the transceiver or antenna—all of his operations being conducted from a control box no larger than a folded pocket-handkerchief.

Until the sets are out of development it is not possible to reveal more of the details, but the feeling is shared in all quarters that the substantial advances in liaison set communications have been attained at a respectable cost and will soon be released to the field.

We used to say that “communications is a function of command.” Now we may well say: “Communications is command.”

PERFECT FOR FRINGE AREA RECEPTION

30 TUBE 630 CHASSIS

DIRECTLY ADAPTABLE FOR COLOR

LICENSED
By RCA

THE IDEAL CHASSIS FOR 16"-17"-19"-20" PICTURE TUBES

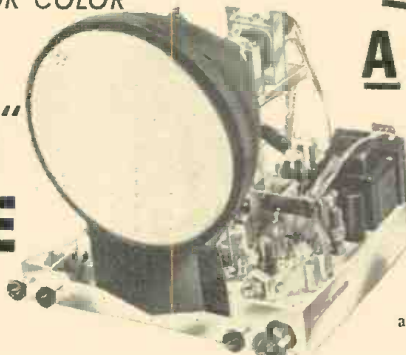

A SET

MOUNTING
BRACKETS
FOR TUBE
\$350*

**RMA &
AIREX**
Guarantee
Factory wired,
aligned & tested.
Ready for use

\$154.95*

Without Cathode Tube
With Standard Coil Tuner
and 5x7 Speaker

Thousands of our 16", 17", 19" & 20" sets are giving new viewing thrills to TV watchers all over the country. This extra powerful super chassis is designed to bring in sharp, clear pictures, even in fringe areas. Works in most areas on only an indoor antenna. Has Improved Keyed AGC; Full 4 Megacycle Band Width; 16 KV output; 3 stage SYNC Separator & clipper; Moulded Plastic Condensers; Uses new Mark Transformer; 5-hour Min. Heat Run at Factory; Improved high gain front end; Down to 45 microvolts; Synchron Lock; Freedom from arcing & corona leakage; Armstrong FM Sound System; Improved linearity adjustment & second horizontal linearity control.

AVAILABLE with DUMONT INPUTUNER FM RADIO & **\$164.95***
5x7 SPEAKER



A PRICE-SMASHING VALUE IN TV CABINETS FOR THE 630 CHASSIS

Full Doors for
16"-17"-19"-
20"
Picture Tubes

Without Doors
for 16" Picture
Tubes

Beautiful, richly finished, hand rubbed mahogany cabinets specially designed to house the 630 chassis with a 12" speaker. A perfect picture deserves a perfect cabinet. It will be a focal point of beauty in your home. 40" high x 24" x 24". All complete with brackets, mask & hardware. Above cabinets in blond—\$10 EXTRA.

\$86.95*

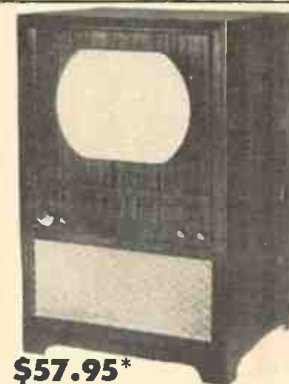

\$57.95*

REGENCY BOOSTERS—DB 400—\$19.97* 12" Wide Range RCA Speaker, \$4.95*

TV TUBE SCOOP

All Black, Glareless

Dumont, Sheldon, Zetta, TRL
16" Rect or Round... \$42.50*
17" Rectangular... 46.95*
19" Round... 69.95*
20" Rectangular... 74.95*

All Tubes Fully
Guaranteed for 6 Months

Plastic ring and sleeve
for metal tubes... \$4.95

RECORD CHANGER SALE

SAVE UP TO 65%

\$12.95*

PHILCO

WEBSTER 3-SPEED

\$29.95*



Automatic
Record
Changer 78
RPM. Perma-
nent point
needle. Uni-
versal mount-
ing. Plays
10-12" or
12-10" rec-
ords auto-
matically.
Reg. \$39.50

Plays 12 rec-
ords auto-
matically. All
sizes. All
speeds
33 1/3-45-78
RPM. Perma-
nent point
needle.
In original
carton.
Reg. \$48.00



All merchandise is brand new, factory fresh & fully guaranteed. Mail & phone orders filled upon receipt of certified check or money order for \$25 as deposit on TV chassis. 30% on other items. Balance C.O.D. F.O.B., N. Y. *Add 10% for Fed'l excise tax. Prices subject to change without notice.

AIREX RADIO CORP. 171 WASHINGTON ST., N. Y. C. 7, N. Y.
Worth 2-4029; Worth 2-9578

When Answering Advertisements Please Mention
RADIO & TELEVISION NEWS

EASY TO LEARN CODE

It is easy to learn or increase speed with an Instructograph Code Teacher. Affords the quickest and most practical method yet developed. For beginners or advanced students. Available tapes from beginner's alphabet to typical messages in all subjects. Speed range 5 to 40 WPM. Always ready—no QTA!

ENDORSED BY THOUSANDS!

The Instructograph Code Teacher literally takes the place of an operator-instructor and enables anyone to learn and master code without further assistance. Thousands of successful operators have "acquired the code" with the Instructograph System. Write today for convenient rental and purchase plans.



INSTRUCTOGRAPH COMPANY

4711 SHERIDAN ROAD, CHICAGO 40, ILLINOIS

TECHNICAL DECALS



GIVE PRODUCTION LINE
APPEARANCE TO YOUR
ELECTRONIC EQUIPMENT!

EASY-TO-APPLY! • PERMANENT!
SAVES TIME! • SAVES ERRORS!

Complete decal sets for labeling Transmitter, Receiver, Audio, Instruments, Television and Dial markings. Each set labels several items. State type of decal set and color preference (black or white letters) with order. See your local jobber. If he cannot supply you—order direct and include his name and address. Price per set... \$1.35 net.

TEKNI-LABELS COMPANY DEPT. R • 732 SO. VICTORY
BURBANK • CALIFORNIA

**World Headquarters
for TV ★ RADIO ★
★ INDUSTRIAL ★
Test Equipment
and Supplies**

- ★ Dumont
- ★ Simpson
- ★ Sprague
- ★ Supreme
- ★ Eico
- ★ Supertor
- ★ Jackson
- ★ Precision
- ★ Hickok
- ★ R.C.A.
- ★ R.C.P.
- ★ E.M.C.
- ★ Silver
- ★ Weston

**Simpson
Model
260
Portable
Tester
\$45.03**



Black bakelite roll top safety case prevents injury or damage to meter or tester. Ranges: Volts AC and DC 0-2.5/10/50/250/1000/5000 at 20,000 ohms/volt. DC and 1000 ohms/volt. AC Output 3C volts 0-2.5/10/50/250/1000/5000. DC micro-amperes 0-100. Milliamperes 0-10/100/500. DC amps 0-10. Decibels -10 to plus 52 db. Resistance 0-2000/200,000 ohms and 0-20 megohms. Polished black case with roll-top cover. 5 1/2" x 7 x 3". With test leads. Shipping weight 3 lbs. Same as above but less roll-top case features. Shipping weight 3 lbs. **\$38.17**

**RCP
Model
447B
Multitester**



1000 ohms/volt. DC volts: 0-5/50/250/500/2500. DC ma: 0-1/10/100/1000. DC amps: 0-1/10/AC volts: 0-10/100/500/1000. Ohms: 0-10M/1 meg/10 meg ext. DB -8 to plus 55 db. Output ranges same as AC volts. Open-face hardwood case. Test leads, battery. **\$15.63**
Model 447 BP in portable hardwood case. Shpg. wt. 3 lbs. **\$19.55**

**Sensational
F.M.
Signal
Generator**

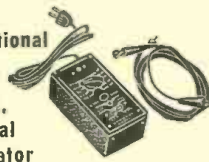

• Stable High Output • Accurate
• Good Attenuation
Complete with tubes, shielded output cable line card and plug ready to operate—attractive hinged case with carrying case and panel. Size 3x6x6 2 3/4 inches. Weight 2 lbs. **\$14.95**

20% deposit with order required. Balance express collect. Orders under \$5.00 send check or Money Order PLUS postage.

VARIETY ELECTRIC CO., Inc.
Box 100—11 Hill St., Newark, N. J. R.N. 1



RADIO and TELEVISION

Thorough Training in All Technical Phases

APPROVED FOR VETERANS

WEEKLY RATES DAYS—EVENINGS

FREE PLACEMENT SERVICE FOR GRADUATES

For Free Catalog write Dept. RN-50

RCA INSTITUTES, INC.

A Service of Radio Corporation of America
350 West 4th St., New York 14, N. Y.

**ANOTHER OUTSTANDING JOBBER
BURROUGHS RADIO CO.**

711 SECOND STREET, N.W.
Canton 3, Ohio



\$29.95

HAS THE
**SENSATIONAL NEW
EICO 360-K SWEEP
GENERATOR KIT
IN STOCK!**

RADIO & TELEVISION NEWS

INDEX TO VOLUMES 43-44 (1950)

AMATEUR

ANTENNAS

- A New Approach to Beam Antennas (Spitz, W7JHS)..... 58 Feb.
- A Two-Band Piece of Wire (Dreher WØWO) 42 Feb.
- A Two-Meter Quad (Oberto)..... 43 Jan.
- Duo-Band Ham Antenna (Buchanan, W3DZZ) 66 Dec.
- Mobile Antenna for 75 Meters (Jones, W6EDG) 62 June
- No Space for an Antenna? (Johnson, WØLBV) 60 Apr.
- Six Bands — But Neat (Johnson WØLBV) 74 Oct.

CONVERTERS

- A Ten Meter Midget Power House (Minor, W4PCA) 57 Sept.
- Broadband Converters (Kaufman, W6YOV) 38 Mar.
- Using the BC-454 and BC-455 for 20 Meter Operation (Sullivan, W8UYK) 91 Aug.

MISCELLANEOUS

- A.C.-D.C. Conversion of BC-1206 (Woolley, WØSGG) 142 June
- A 500 Watt R.F. Amplifier for the Ham (Hooton, W3KPX) 42 June
- A Single-Tube Electronic Key (Gepert, W5KFP) 42 Oct.
- Modulate a KW. with 3-Tubes (Kline, W6CXM) 38 Sept.
- NBFM and Frequency Shift Keying Unit for Self-Excited Oscillator (Jones, W6EDG) 63 May
- Putting the 304TL to Work (Dexter). 54 Sept.
- Safety Switch Plus (Kauke)..... 90 Oct.
- Simplified Ham TV Station (Part 1) (Popkin-Clurman, W2LNP) 35 May
- Simplified Ham TV Station (Part 2) (Popkin-Clurman, W2LNP) 53 June
- Simplified Ham TV Station (Part 3) (Popkin-Clurman, W2LNP) 46 July
- Sterling—First "Ham" on FCC (Terry) 58 May
- The Beginning Amateur (Part 12) (Hertzberg, W2DJJ) 40 Jan.
- The Mini-Rack Modulator (Clemens, W9ERN) 42 Apr.
- Transmitter Keying and Biasing Problems (Whitaker, W2BFB) ... 64 Apr.
- Troubleshooting Chart for the New Ham (Herzer, W2CEP)..... 62 Oct.
- 21 Years a Ham (Cloutier, W8GJX). 56 Sept.

RECEIVERS

- A Compact, Amateur Band Superhet (Zimmerman, W3KOY) 51 Aug.
- Bandswitching Superhet for Ham Bands (Jones, W6EDG) 49 Oct.

SUPERMODULATION

- A Supermodulated Phone Transmitter (Turner, K6A1 & Graves, W6MYR) 51 May
- Understanding Super-Modulation (McCord, W1BJI) 66 Feb.

TRANSMITTERS

- A "Sumodget" Transmitter (Lowe, W6NBF) 53 July
- A Ten Meter Midget Power House (Minor, W4PCA) 57 Sept.
- A Versatile, Low-Power Transmitter (Countryman, W3HH) 62 Jan.
- Compact 100 Watt AM-NBFM Transmitter (Patterson, W5DAH & Mid-delton, W5CA)..... 59 Dec.
- The Mini-Rack Transmitter (Clem-

ens, W9ERN) 45 Mar.

TRANSCEIVERS

- A Portable 40-Meter C.W. Station (Gould, W1KWU) 40 June
- Complete 30 Watt Ham Station (Johnson, WØLBV) 61 Aug.
- Converting the TR-4 for 420 mc. (Rogers, W2MLF) 48 Jan.
- Something New in Transceivers (Kortge, W8AHT) 39 May

AM-FM

MISCELLANEOUS

- A Crystal Receiver with Transistor Amplifier (Turner, K6A1) 38 Jan.
- A Receiver Detuning Alarm (Taylor) 138 Oct.
- FM Quiz (Bukstein) 152 Apr.
- The Batwing FM Receiving Antenna (Barritt) 35 Mar.

SERVICING

- Receiver Servicing Without a Signal Generator (Kauke) 84 Feb.
- Troubleshoot with This Condenser Substitution Box (Wortman)..... 84 Sept.

AUDIO

AMPLIFIERS

- A Flexible General Purpose Amplifier (Hawkins) 52 Nov.
- A High Efficiency Triode Amplifier (Sprinkle) 55 May
- A High-Quality Sound System for the Home (Olson & Morgan)..... 59 Nov.
- An Unusual Public Address System (Southworth) 71 Nov.
- A Self-Equalizing Preamp (Hoadley) 48 Nov.
- A Wide-Range Feedback Amplifier (Mitchell) 66 Oct.
- Building the "Williamson" Amplifier (Keroes) 52 Dec.
- Cathode Follower Driven Amplifier (Hoadley) 49 June
- Dynaurl Preamplifier Provides Wide Compensation (Scott) 56 Jan.

INTERCOMS

- An Intercom from the BC-605 (Schulman) 140 pr.
- Intercom Applications (Ledbetter).. 34 ug.

MISCELLANEOUS

- A Collapsible Speaker Cabinet (Wolfe) 47 sb.
- A High-Quality Volume Expander (Southworth) 50 ly
- An Electronic Loss Compressor (Miller & Jones) 64 cv.
- A New Beam Power Tube (Atkins). 42 apt.
- A 3-Channel Unitary Loudspeaker (Plach & Williams) 66 ov.
- A Volume-Compensated Tone Control (Schwan) 70 Jan.
- Central Control for the Home Entertainment System (Ellis) 44 Sept.
- Fixed Bias vs. Self Bias (Boegli)... 88 May
- Improving Performance of Small P.A. Amplifiers (Ledbetter)..... 64 Jan.
- New Audio Developments (Simon). 43 Dec.
- Selecting Your High-Fidelity System (Becker) 80 Nov.
- Sound on Wheels (Epstein) 74 Nov.
- The "Auditioner" (Dezettel) 50 Nov.

PHONO

- A Preamp for Magnetic and Crystal Pickups (Boegli) 36 July
- A Strain-Sensitive Phono Pickup (John) 40 Feb.

Micromodulation (Southworth)	65 Sept.
Problems in Phonograph Record Reproduction (Goodell)	39 Nov.
Processing Radio Transcriptions (Healy)	31 Feb.
3-Tube Amplifier for Variable Reluctance Pickup (Hill)	57 Feb.

RECORDING

ABC Uses Magnetic Tape for Delayed Broadcasts (Speirs)	41 Apr.
A Flexible Record-Reproduce System (Part 1) (Read)	42 Nov.
A Two-Channel Magnetic Recording Amplifier (Hust)	45 Nov.
A Versatile Recording and Playback Amplifier (Southworth)	62 Mar.
Dual-Input Tape Recorder Amplifier (Southworth)	46 Oct.

TESTING TECHNIQUES

Controlling Hum in Audio Amplifiers (Fleming)	55 Nov.
Design Considerations for High-Quality Reproducing Systems (Part 1) (Matthews)	52 Apr.
Design Considerations for High-Quality Reproducing Systems (Part 2) (Matthews)	69 May
How To Judge Audio Quality (Marshall)	44 Nov.
Improving Response of Home-Assembled Coaxial Speakers (Becker)	52 June
Linearity Distortion in Audio Equipment (Southworth)	54 Apr.
Linearity Tests with an Oscilloscope (Southworth)	66 June
Let's Put Square Waves To Work (Anthony)	83 Nov.
Noise Reduction for High Quality Reproducing Systems (Matthews)	70 Sept.
Power Level and Volume Indicator Meters (Tremaine)	84 Nov.

BOOK REVIEWS

Amateur Radio Map of the World (ARRL Staff)	84 June
Better TV Reception in Fringe and Low-Signal Areas (Smith & Dawley)	127 Oct.
Business Helper, The (Rucker)	123 Apr.
Data and Circuits of Receiver and Amplifier Valves (A Symposium)	201 Nov.
Dial Cord Stringing Guide (Sams Staff)	84 June
Essentials of Electricity for Radio and Television (Slurzberg & Osterheld)	132 Sept.
Facsimile (Hills & Sullivan)	151 Feb.
Facsimile (Jones)	94 Mar.
Father of Radio (de Forest)	137 Dec.
40 Uses for Germanium Diodes (Sylvania Staff)	92 Aug.
Frequency Modulation (Sturley)	126 Oct.
How to Buy a Television Set (Gary)	94 Aug.
International Radio Tube Encyclopaedia (Babani, ed.)	152 Feb.
Maintenance Manual of Electronic Control (Miller, ed.)	152 Feb.
Mobile Radio Handbook (Sleeper, ed.)	124 Oct.
Modern Oscilloscopes and Their Uses (Ruiter, Jr.)	157 Jan.
Most-Often-Needed 1950 Radio Diagrams and Servicing Information (Beitman, ed.)	126 Oct.
Most-Often-Needed 1950 Television Servicing Information (Beitman)	84 June
Oscillograph, The (Weiss)	92 Mar.
Outline of Radio, Television and Radar	114 July
Practical Television Engineering (Helt)	124 Oct.
Practical Television Servicing and Trouble Shooting Manual (Coyne Staff)	154 Feb.
Radio Amateur's Handbook, The (ARRL Staff)	84 May

THE NEW TURNER



**MODEL 50D DYNAMIC
FOR TV - AM - FM**
Recording • Broadcast
Public Address

SPECIFICATIONS

FREQUENCY RESPONSE: 50 to 15,000 c.p.s. flat within $\pm 2\frac{1}{2}$ db.
OUTPUT LEVEL: 56 db below 1 volt/dyne/sq. cm.
IMPEDANCE: 15, 200, 500 ohms or high impedance.
POLAR PATTERN: Essentially non-directional in any position.
MOUNTING: Ball and swivel type, tilts in any direction. Standard $\frac{5}{8}$ " — 27 thread.
CABLE: 20 ft., high quality rubber covered, two conductor shielded cable with Cannon quick-disconnect plug.

★ The crown jewel of dynamic microphones. See it, handle it — use it on highest quality recording, public address or broadcast work. New beauty, new styling, new utility and new performance make the Turner Aristocrat the finest of the fine. Use it anywhere, indoors or out — in hand, on stand, suspended, or concealed in stage settings. The Aristocrat is quickly and easily detached from ball swivel coupler for hand use. Non-directional polar pattern picks up sound from any direction. Equally effective for individual or group pickups with wide range, high fidelity reproduction of voice or music. Its high output dynamic generator requires no closely associated auxiliary equipment for outstanding results. Built of finest materials with flawless workmanship, each unit is laboratory calibrated to insure specification standards . . . Write for complete details.

THE TURNER COMPANY

900 17th Street N. E., • Cedar Rapids, Iowa
IN CANADA: Canadian Marconi Co., Montreal, P. Q., and Branches
EXPORT: Ad. Auriema Inc., 89 Broad Street, New York 4, N. Y.



Microphones **BY TURNER**

BARGAINS!

• We still have plenty of them—but, we are doing so much business that we are afraid we won't have anything left to sell in a few months. Most of the material we have been advertising is still available—check with us for current prices.

WANTED!

• Right now we are more interested in buying than selling. We want to buy large or small quantities of new or used electronic components, equipment, tubes, etc., gov't or mfrs. surplus. Cash or trade for standard test equipment or electronic material of your choice.

ELECTRONIC RESEARCH LABS
1021-R Collowhill St. Phila. 23, Pa.

SENSATIONAL NEW BOOK

ELEMENTS OF SINGLE and DUAL TRACK MAGNETIC TAPE RECORDING and 1001 APPLICATIONS

by A. C. Shaney

INFORMATIVE! INSTRUCTIVE! INTERESTING!

ONLY \$1.00
POSTPAID

The book that brings you up-to-date on tape recording. Complete history, theory, design and uses. 144 pages of FACTS!

Order today. Remit with order, please. Booklet mailed same day.

AMPLIFIER CORP. OF AMERICA
398-2 Broadway, New York 13, N. Y.

THE LAST of our LUCKY BUYS!

Schools! Laboratories! Manufacturers! Hams! These and thousands of other items not listed here are the last of the Surplus buys available! Because of Gov't. curtailments this may be your last chance to buy at these low, low prices. So order now—and send us your requirements. We'll reply promptly with complete information!

New Shipment Just Received ARR-1 RECEIVERS

Complete with 4 RCA
954 ACORN TUBES
(Reg. \$5.65 ea.)

Schematic
Diagrams
and
Conversion
Information

All for

\$4.95

Complete
Postpaid
In U.S.A.

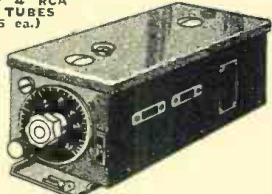

Thousands Sold for \$9.95

Just think! Only \$4.95 complete—for the Receiver, 4 Tubes, Schematic Diagrams and a reprint of "A 220 mc Converter from the Surplus R-1/ARR-1" by Leroy W. May, Jr. (WSAJG), an article which appeared in RADIO & TV NEWS, January 1949 issue. These receivers are ideal for 50, 144, 220 mc Converters or Pre-Selectors, also for TV boosters—FB for hopping up the SCR-522 Receiver on 2 meters. Grab 'em while they last at this low price!

Transformer "Steals"

All 110 V. 60 Cycle
Primary

5-V 60-amps. fine for
304-TL's \$9.95
5-V 115 amps. for weld-
ing, pipe thawing \$14.95
5-V 190 amps. for weld-
ing, pipe thawing \$19.95
40-Watt Modulation,
Stancer A-3843 \$2.95
125-Watt Mod. Thordar-
son T-19N16 \$9.95
UTC S-39 Power Trans-
former, 980 V ct. 175
ma.-5V-3A. 6.3V-3A.
6.3V-3A \$5.95
UTC S-41 Power Trans-
former, 1200V ct.-200
ma.-1V-3A. 7 1/2V-3A.
6.3V-3A \$4.95
UTC S-42 Power Trans-
former, 1200 V ct.-300
ma. 5V-3A. 7 1/2V-3A.
6.3V-3A \$6.25
UTC S-47 Power Trans-
former, 3000 ct. 2500
ma. 5V-3A. 7 1/2V-3A.
6.3V-3A \$9.95

UTC L5 184 POWER
TRANSFORMER
7000V ct. 500 ma.
Sht. wt. 102 lbs. \$69.50

Just Received! Large Quantity of Brand New
Amphenol AN Connectors @ 75% OFF
o LIST!
WRITE FOR COMPLETE LISTING!

ORDER DIRECT FROM THIS AD!
Prompt and speedy shipment of all orders. Cash with
order. Minimum order \$3.00. 25% deposit on
C.O.D. orders. Shipments by truck or R.R. Express
collect. California buyers please add state sales tax.
All prices subject to change. All merchandise subject
to prior sale.

ALVARADIO SUPPLY CO.

Dept. A-8, 341 S. Vermont
Los Angeles 5, Cal.
DUNKirk 8-2211

R. & T. BARGAINS BIG VALUE KIT

Spaghetti, Coils, Wire, Knobs, Switches,
Condensers, Etc.

FIFTY ITEMS 98c

CODE KEY J-38.....\$ 0.69
Famous "PUTT-PUTT" gaso. generator HRU
DC 24-28v at 70 amp. 2000 watt. Used, good
condition, 115 lbs. 49.95
SERVO UNITS W/1/4 HP 24v DC motor, part
of M-1 automatic pilot—new..... 5.95
THROAT MIKE—new..... .69

F.O.B. Berwyn, Md. Cash with order. Orders with-
out postage will be shipped express collect. No ex-
ports.

R. & T. ELECTRONICS CO., Inc.

9723 Baltimore Blvd.
Berwyn, Maryland Phone: TOwer 5384

Radio Handbook, The (Dawley)... 123 Apr.
Radio Manual, The (Sterling &
Monroe) 132 Sept.
Radio Operating Questions and An-
swers (Hornung) 84 May
Radio Operator's License Q & A
Manual (Kaufman) 84 June
Radio Technology (Vogt) 84 May
Radio Tube Vade-Mecum 1950 (P. H.
Brans, Ltd.) 137 Dec.
Recording and Reproduction of
Sound, The (Read) 123 Apr.
Saturating Core Devices (Crow)... 156 Jan.
Servicing TV Receivers (Sylvania
Staff) 114 July
16 mm. Sound Motion Pictures (Of-
fenhauser, Jr.) 92 Mar.
Technique of Radio Design, The
(Zepler) 151 Feb.
Television and F-M Receiver Servic-
ing (Kiver) 133 Sept.
Television Components Handbook
(Matthews) 114 July
Television for Radiomen (Noll)... 153 Feb.
Television—Medium of the Future
(Gorham) 94 Aug.
Television Servicing (Buchsbaum)... 137 Dec.
Television Servicing (Heller & Shul-
man) 94 Aug.
Television Servicing for Radio Men
(Manly) 156 Jan.
Television Simplified (Kiver)... 92 Aug.
Television Tube Location Guide
(Sams Staff) 84 June
TV Installation Techniques (Mar-
shall) 201 Nov.

BUSINESS MANAGEMENT

Clever Idea Promotes Dealers'
Sales 35 Dec.
Customers Can Be Friends, Too
(Hiner) 96 June
Cut Rates Today—Bankruptcy To-
morrow (Ashe) 96 Aug.
Discount Those Material Bills (Ashe)
39 July
Extra Income for the Service Shop
(Ledbetter) 46 May
How Do You Figure Profit? (Ashe) 132 June
Insurance for Service Technicians
(Nunneker) 43 Aug.
Mac's Radio Service Shop (Frye)
..... 44, Jan.;
50, Feb.; 60, Mar.; 56, Apr.; 68,
May; 48, June; 59, July; 63,
Aug.; 67, Sept.; 71, Oct.; 82, Nov.; 46 Dec.
The Ad-Viser (Part 1) (Settel)..... 37 Sept.
The Ad-Viser (Part 2) (Settel)..... 108 Oct.
The Ad-Viser (Part 3) (Settel)..... 178 Nov.
The Ad-Viser (Part 4) (Settel)..... 74 Dec.

GENERAL

CIRCUITS (THEORY)
Constant-Resistance Network Induc-
tor Design (Gallagher, W5HZB)... 48 Apr.
Experimental Magnetic-Type D.C.-
A.C. Signal Inverter (Kauke)... 64 May
Instant Heating Devices (Chalfin)... 64 Feb.
Microwave Quiz (Bukstein)..... 104 June
New Applications for Crystal Di-
odes (Turner, K6A1)..... 64 June
Oscilloscope Quiz (Bukstein)..... 132 Jan.
Printed Circuits (Part 2) (Frye)... 53 Jan.
Wheatstone Bridge Applications
(Wolfe) 61 June

COMMUNICATIONS (BROADCASTING)

Elimination of Radio Interference by
Off-Frequency Inversion (Freed-
man) 53 Mar.
Mobile Two-Way Radio (Ripani)... 29 July
The Microwave Era Begins (Sands) 35 Oct.

MISCELLANEOUS

A Home-Built Electronic Organ (Kirk,
W6DEG) 42 Mar.
Aircraft Radio (Holahan)..... 31 Jan.
An Electronic Musical Novelty (Kirk,
W6DEG) 38 Aug.

Aerosound

THE
FINEST
OUTPUT TRANSFORMERS*

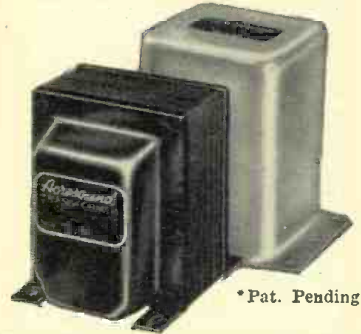

*Pat. Pending

Featuring the TO-290 specifically de-
signed for use with 807's in the famed
Williamson circuit.

(Described on page 52, this issue)

F.O.B. Phila. \$1375 Net
25% Deposit C.O.D.'s

Other top quality models as low as \$9.75
All models available fully potted in seamless
steel case with silver-gray hammertone finish
at \$2 extra.

Write for FREE information on entire line—
descriptive literature, performance data and
suggested circuits for high fidelity applications.

ACRO PRODUCTS CO.

★ 215 Arch St. Phila. 6, Pa. ★

3 TUBE PHONO AMPLIFIER

Designed for use with
all types of records.
2 1/2 watt output, com-
pletely wired. Has 2
controls, Volume and
on-off switch, and
tone control. Com-
pact—that it is easy to
mount
anywhere. \$239
Only

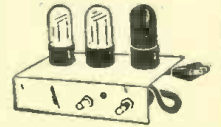

SET OF TUBES FOR THE ABOVE AMPLIFIER. \$1.89
50L6 output Trans. for above..... .39
4" PM Speaker99
5" PM Speaker 1.15
6" PM Speaker 1.55
12" PM Speaker 5.89
Hi-Volt Phono Pickup & Hardware..... 1.95
Med.-Volt Phono Pickup & Hardware..... 1.75
Hi-Volt Crystal Cartridge..... 2.69
7.8 RPM Phono Motor & Turntable..... 2.69
3 Speed Phono Motor & Turntable..... 4.95
178, 33 1/2, 45 RPM
3 Speed Pickup with Hardware..... 5.25

We Carry a Complete Line of Condensers, Re-
sistors, Receiving Tubes, Radio & TV Parts.
Write for free descriptive literature to Dept. 12RN.
All Prices F.O.B. New York. 25% deposit required
on all orders. Minimum order \$5.00.

THE ROSE COMPANY 98 Park Place
New York 7, N. Y. (Corner Greenwich St.)

ANOTHER OUTSTANDING JOBBER MIDWAY Radio & Television Corp.

60 WEST 45th STREET
New York 19, N. Y.
HAS THE
SENSATIONAL NEW
EICO 221-K
VTVM KIT
IN STOCK!

SCHEMATICS—CONVERSIONS FOR SURPLUS GEAR

NEW LIST! MANY ADDITIONS!
Send stamped, self addressed envelope for
List B. Add 25c for char: explaining AN
nomenclature.
R. E. 345 1/2 N. PALM DRI
GOODHEART BEVERLY HILLS, CALIF.

Capacity Operated Relay (Dibble, W9KFF)	40 Sept.
First Degrees Granted in Audio Engineering	102 July
Portable Marine Radio Provides Direction Finding	100 Aug.
Radio Control of Model Boat (North, W4GEB)	29 Aug.
Servicing Speedlights (Slaughter)	40 Aug.
Shock Mounting of Vacuum Tubes Can Be Simple Yet Effective (Prouty)	114 June

PHOTOELECTRIC

Make Your Own Self-Generating Photocell (Dexter)	50 Jan.
Photoelectric Control for Industry (Bukstein)	40 Oct.
Sensitive Bridge-Type Photoelectric Circuit (Kauke)	76 Sept.

POWER SUPPLIES

Electronically Controlled D.C. Load (Kaufman, W30XT)	54 Feb.
Voltage Regulation for Higher Fidelity (Hoadley)	47 Aug.

SHORT-WAVE

Around the Clock with Short-Wave English Newscasts	58 Mar.
International Short-Wave (Boord)	
61, Jan.; 56, Feb.; 59, Mar.; 62, Apr.; 54, May; 60, June; 52, July; 64, Aug.; 52, Sept.; 61, Oct.; 79, Nov.; 54, Dec.	
The Mike on Matterhorn (Henderson)	106 Nov.

INDUSTRY

Foreign Set Ownership	156 June
Foreign Set Ownership	132 July
Frank Andrea—Radio and Television Pioneer (Pine)	40 May
Quality Control by "Type Testing" (Gartner)	39 June
Radio Paris Show Program of Events	24 May
Standards Control—Key to Quality Tube Production	100 Oct.
The Antenna Research Laboratory (Boyer)	31 Mar.

MILITARY

Engineering the Integrated Communications System (Petzing)	38 Dec.
Naval Communications (Redman)	47 Dec.
Planning Integrated Signal Communications (Guest)	36 Dec.
Technical Aspects of Naval Communications (Morrison)	50 Dec.
Why, Strategic Air Communications (Ankenbrandt)	63 Dec.

TELEVISION

ANTENNAS

Built-in TV Antenna (Albright)	59 May
Consistent Fringe Area TV Reception (Buchan, W0TJF)	58 Oct.
Development of Fan Type TV Antenna (Greenberg & Harris)	66 May
Multiplex TV Antenna Systems for Stores (Donaldson)	45 Apr.
Multi-TV Receiver Operation from Single Antenna (Lerner)	79 May
Survey of Television Antennas (Smolen)	31 Dec.
Two-Channel TV Yagi Design (Carmichael)	54 Oct.

BOOSTERS

Custom Video Has Built-in Booster (Jackson)	51 Feb.
---	---------

COLOR

RCA's New Direct-view Tri-color Kinescopes	46 June
Your Stake in the Color Decision (Kiver)	65 Nov.

December, 1950

RCA *Tops in Quality, Value and Dependability!*
HUDSON
RADIO & TELEVISION CORP.

Our Giant Store and Warehouse features Every Modern Shopping Convenience, including a Complete Line of RCA Tubes, Test Equipment, Batteries, Radio and TV Replacement Parts, etc. Visit our Elaborate Sound Studio and New York's First "Radio Super-Market"—Serve Yourself and Save on Thousands of Standard and Surplus Items! Mail Orders Shipped to All Parts of the World—Quickly, Completely!

NEW RCA WO-56A 7" OSCILLOSCOPE

Unequaled in Performance, Unmatched in Versatility! This new extremely sensitive RCA 7" Scope features DUAL CONTROLS for Coarse and Fine adjustments, Identical Vert. and Horiz. Amplifiers... for response flat down to DC... for measuring DC component in AC signal circuits. Push-Pull throughout, High Amplifier Output and Gain, Phase Equality. Advanced sweep facilities include preset fixed positions for TV vert. and horiz. waveforms, plus or minus sync for easy lock-in of upright or inverted pulse waveform, line-frequency sweep and sync, with phasing. Frequency Response of both amplifiers flat within —2 db from DC to 500 Kc; within —6 db at 1 Mc; useful beyond 2 Mc. Square wave response — no tilt and over-shoot. Both amplifiers have frequency-compensated and voltage-calibrated attenuators. Peak-to-peak calibrating voltage source.



No. A19, Ship. Wt. 31 lbs.....Net **\$197.50**

TERRIFIC! RCA 515S2 15" Duo-Cone SPEAKER

Engineers and professional sound technicians have nothing but praise for this sensational new RCA unit. A development of Dr. H. F. Olson, famous RCA speaker authority, it provides remarkable listening quality at a moderate price. Employs two voice coils, each driving one of the duo-cones, which vibrate as a single cone, at crossover frequencies (around 2,000 cps), avoiding "crossover" interference. Has high sensitivity at high power levels — will handle up to 25 watts. Delivers superb, high fidelity performance from 40 to 12,000 cps, over 60° angle. Requires no crossover network. Magnetic structure contains a bridge network to supply equal flux density to the air gap for each voice coil, from a 2 pound Alnico V magnet. 16 ohms impedance.

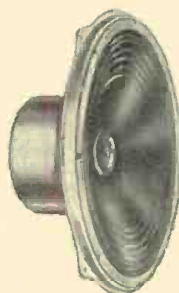

No. A53, RCA 515S2 Speaker, Ship. Wt. 18 lbs.....Net **\$48.50**
Price Includes 2% Discount

RCA TV COMPONENTS

All RCA Television Components are "originals," designed with characteristics which are correct both electrically and mechanically for the tubes and circuits. They are competitively priced!



RCA TUBES

RCA's unparalleled research facilities and manufacturing experience contribute to the quality, dependability, and operating economy of EVERY RCA tube. The Quality of RCA tubes is Unquestioned!



FREE!

SEND FOR OUR
NEW 1951
CATALOG

HUDSON
RADIO & TELEVISION CORP.

212 FULTON ST.
NEW YORK 7, N.Y.
Digby 9-1192

Hudson Radio & Television Corp. Dept. 12R
212 Fulton St., New York 7, N. Y.

Please send: 515S2 Speaker, RCA WO-56A
Enclosed: Full Payment, 20% Dep.

SEND FREE HUDSON CATALOG—Just Out!

Name.....
Address.....
City.....Zone.....State.....

**Most Complete Stock of Radio, Television,
Electronic and Sound Equipment in the East!**

FREE NEW 1951
SOUND & PUBLIC ADDRESS
CATALOG

ALL OF THE NAME BRANDS
IN ONE COMPLETE CATALOG
MICROPHONES, CABLE, AMPLIFIERS, STANDS,
INTERCOMMS, PHONO, SPEAKERS, BAFFLES,
CONNECTORS

Send your name and address to . . .

INTERSTATE SUPPLY CO.
24 So. TENTH—ST. LOUIS 2, MO.



TWIN-TRAX
TAPE
RECORDER

Available to you direct from the factory at savings that make TWIN-TRAX the only professional-type recorder in the popular-price field. More than a dozen model variations for portability, long-play, continuous operation, etc. For a better tape recorder that combines professional quality with operating ease and trouble-free construction, it's TWIN-TRAX. Write today for complete literature. *Trade Mark Registered

AMPLIFIER CORP. OF AMERICA
398-2 Broadway • New York 13, N. Y.

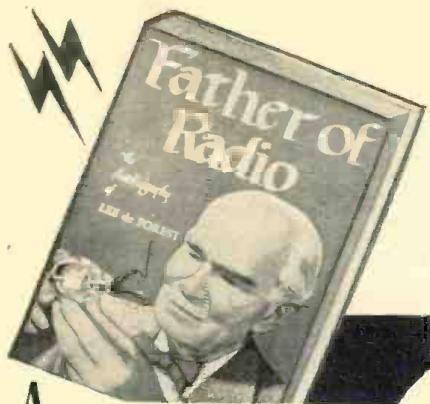

Autobiography of LEE de FOREST Father of Radio

Here's your "code" to radio communications history by the man who made it—Lee de Forest!

In this dramatic life-record of the inventor of the radio vacuum tube, you'll read in his own words a thousand behind-the-scenes facts of radio's Historic Firsts — all aimed to interest "wireless hams," radio and television fans.

528 pages with 16 pages of 6" by 9" photographs. Send now for this great autobiography.

ORDER YOUR COPY TODAY Satisfaction Guaranteed.

Enclosed find \$____, please send ____ copies postpaid.

Name _____

Address _____

City _____

State _____

Wilcox & Follett \$5.

Dept. RNF, 1255 S. Wabash, Chicago, Ill.

STAR SPECIAL!

FOR IMMEDIATE DELIVERY

WS100—Single heat
100 Watt, \$11.71 ea.;
(Lots of 6) \$10.53 ea.

WD135—Dual heat
100/135 Watt, \$13.67
ea.; (Lots of 6)
\$12.30 ea.

WS200—Single heat
200 Watt, \$12.69 ea.;
(Lots of 6) \$11.42 ea.
WD250—Dual Heat
200/250 Watt, \$14.65
ea.; (Lots of 6)
\$13.18 ea.

Extra Tips for All Models Also Available.

COMPLETE STOCKS
All Standard Brands

Just off the press

BIG BARGAIN BULLETIN

STAR

**ELECTRONIC
DISTRIBUTORS, INC.**

Dept. RN 2-7736 S. Halsted, Chicago 20, Ill.

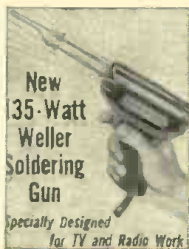

MISCELLANEOUS

Behind the Scenes at a Television Show (Brown)	41 Mar.
Bell System TV Network	42 July
Better Business Bureau Moves to Curb TV Evils (Hertzberg)	102 Sept.
Is Stratovision the Answer? (Boord)	36 Jan.
Mountain Top TV City (Perlee)	48 Feb.
Putting TV on the Air (Abel)	35 Apr.
Simplified Ham TV Station (Part 1) (Popkin-Clurman, W2LNP)	35 May
Simplified Ham TV Station (Part 2) (Popkin-Clurman, W2LNP)	53 June
Simplified Ham TV Station (Part 3) (Popkin-Clurman, W2LNP)	46 July
Ultra-Modern WOR-TV is 84th Television Station (Smith)	36 Feb.

SALES PROMOTION

Custom-Built Projection TV Is Still Profitable (Armstrong)	35 June
New Techniques Make Outdoor TV Practical (Blumay)	100 July
Portable Showroom Sells TV Sets (Brenton)	77 Aug.
Television Gets Boost	36 Sept.

SERVICE NOTES

A Handy TV Service Kit (Hahn)	86 Jan.
An Effective Sync "Lock-in" Circuit (Gnessin)	44 Mar.
A Single Tube A.F.C. Circuit for TV Deflection Systems (Cornell)	58 Jan.
A TVI Filter for Coaxial Transmission Lines (Forrest)	61 Mar.
Eliminating Broadcast Interference Caused by TV Receivers (Najork, W2HNH)	52 Jan.
Ghosts (Propser)	40 July
How Good is Your Television Receiver? (Kiver)	33 Sept.
Modern Television Receivers (Part 21) (Kiver)	45 Jan.
Modern Television Receivers (Part 22) (Kiver)	43 Feb.
Modern Television Receivers (Part 23) (Kiver)	50 Mar.
Modern Television Receivers (Part 24) (Kiver)	57 Apr.
Oscillations in the Video I.F. Amplifier Circuits (Tretter)	56 Aug.
Picture Distortion Due to Horizontal Foldover (Lerner & Howell)	76 Oct.
Radio-TV Service Industry News (Television Technicians Lecture Bureau)	128 Dec.
Servicing TV Sync Circuits (Part 1) (Heller & Orne)	57 Aug.
Servicing TV Sync Circuits (Part 2) (Heller & Orne)	60 Sept.
Simulating TV Interference Patterns (Louis)	49 Mar.
Television Troubleshooting Without Instruments (Buchsbaum)	64 Mar.
The "Tapered Line" TV Tuner (Lerner)	55 Aug.
The Turret Type TV Tuner (Lerner)	58 June
TV Interference from Horizontal Deflection Circuits (Lerner & Howell)	50 Sept.
TV Interference Problems (Lerner)	62 July
TV Servicing with Grid-Dip Oscillator (Roger, W1DFS)	64 Oct.
TV Shop on Rollers (Hertzberg)	39 Oct.
Use Test Pattern to Align Your TV Set (Kubanoff)	42 May
Video Amplifier Frequency Response (Buchsbaum)	56 Dec.

TEST EQUIPMENT

AMATEUR	
An Inexpensive Grid-Dip Oscillator (Yuenger, W01OK)	57 July
A Simple Noise Limiter (Haviland)	46 Aug.
Crystal Diode Field Strength Meter (Moses)	35 Feb.
AM-FM	
Add a Noise Localizer to Your Signal Tracer (Tretter)	44 Oct.



MAGNAFILTER

**NOW!
The 22" Size!
BETTER
VISION**

on your 19" screen

Magnafilter offers a new experience in restful tele-viewing. This zero-zero optical lens is easy-on-your-eyes, filters out the glare, gives third dimensional effect and distortion free enlargement.

Magnafilter is beautifully made of clear, oil filled plastic, and adds to the beauty of the finest television installation. Chrome top bracket or floor stand. Available in 10", 14", 16", 18" and 22" sizes.

For full information and name of your nearest dealer*, write to:

• • • • • **RUSSELL LENS CO.** • • • • •
11056 Cumpston St.
North Hollywood, California

*A few dealer opportunities available.

Dear Om: Wondering what to do with your excess tubes?

Send list of quantities and types.

I'll buy all types of new tubes in small or large quantity and pay you highest cash offer.

B. N. GENSLER
W2LNI
136 Liberty St. New York 6, N. Y.

COLUMBIA Distributors, Inc.
ROUTE B (opp. school), COLUMBIA, N. J.

**CARRIES THE ENTIRE LINE OF
EICO KITS**
and factory-wired Instruments

	425-K 5" SCOPE KIT \$39.95		221-K VTVM KIT \$23.95
	625-K TUBE TESTER KIT \$29.95		HVP-1 HIGH VOLTAGE PROBE (wired) \$6.95

Write us about your TV needs!

BARGAIN HUNTING?

RADIO SERVICEMEN!

Write for SENSATIONAL CATALOG

HENSHAW RADIO SUPPLY
3619 TROOST KANSAS CITY, MO.

AM Oscillator-Signal Tracer (Greenlee)68 Sept.
 A 79-Cent Signal Source (Dexter)..134 Aug.
 The "Signal Snatcher" (Garner, Jr.) 60 July

AUDIO

Adding α Frequency Sweeping Circuit to the Wien Bridge Audio Oscillator (Sear) 56 Oct.
 An Audio Oscillator and V.T.V.M. (Watkins, W5JXO) 68 June
 An RC Beat-Frequency Oscillator (Dorf) 68 Nov.
 A Variable Width Square-Wave Generator (Hoadley) 69 Oct.
 Build a Sweep Frequency Audio Oscillator (Southworth) 60 Feb.
 Oscillator and Gain Set for Audio Measurements (Bumbaugh, W6HI) 66 Jan.
 Wide Frequency Range Square-Wave Clipper (Garner, Jr.).... 36 Mar.

MISCELLANEOUS

An Inexpensive Condenser Ager (Lassler) 84 Oct.
 An L-C-Q Meter (Brookshier) 67 Apr.
 An Oscilloscope Calibrator (Kimball) 72 Oct.
 An Oscilloscope Preamp (Garner, Jr.) 53 Sept.
 A 100 kc. Square-Wave Generator (Garner, Jr.) 44 Aug.
 A V.T.V.M. for a.c.-d.c.-r.f. (Turner, K6AI) 43 July
 Design Data on High Impedance Probes (Middleton) 48 Oct.
 Easily-built 10 kc. to 1 mc. Multivibrator (Dexter) 75 June
 Extending Multimeter Utility (Turner, K6AI) 55 Dec.
 Frequency Measurements for Citizens Radio (McKay) 35 Jan.
 Home-Built 2" Oscilloscope (Anderson, W9UFE) 65 Aug.
 Home-Built U.H.F. Grid-Dip Oscillator (Turner, K6AI) 47 Sept.
 Oscilloscope for R.F. (Dexter) 33 July
 R. F. Power Output Meter for V.H.F. and U.H.F. (Houser, W2VCM).. 63 Apr.
 Small Capacity Condenser Tester (Benham) 48 Mar.
 Test Equipment for Citizens Radio (McKay) 38 Feb.
 The Electronic Switch (Beckstrom) 38 Apr.
 The Variable Permeability Sweep Generator (Clark) 48 May
 Wide-Range RC Oscillator 43 Sept.

TIMERS-COUNTERS

An Electronic Metronome (Taylor).. 62 Feb.
 A Simple Electronic Metronome (Dexter) 45 May
 Radioactivity "Sniffer" (Kaufman) 46 Apr.
 The Era of Geiger Counters (Norman) 34 July

TELEVISION

A TV Contrast Generator and Gamma Checker (Popkin-Clurman, W2LNP) 40 Dec.
 A TV Linearity-Pattern Generator (Vendeland) 49 Apr.
 Home-built Linearity Test Pattern Generator (Turner, K6AI)..... 36 Aug.
 The Genescope—A TV Test Instrument (Kiver) 60 May

-50-

This Yearly Index
 of
RADIO & TELEVISION NEWS
 Articles
 Has Been Published for
 Your Convenience
SAVE IT!

December, 1950

BUILD 15 RADIOS ONLY \$14⁷⁵

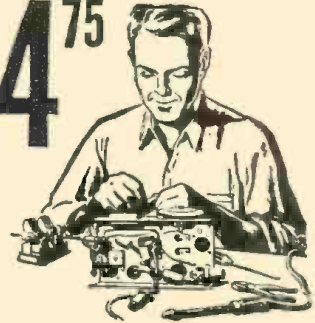

- Absolutely No Knowledge of Radio Necessary
- No Additional Parts Needed
- Excellent Background for Television

The PROGRESSIVE RADIO EDU-KIT will help you, if you want an EDUCATIONAL AND INTERESTING HOBBY, or if you want to get into a WELL-PAYING BUSINESS, or if you want to INCREASE YOUR KNOWLEDGE OF RADIO.

Absolutely no knowledge of radio is necessary. The PROGRESSIVE RADIO EDU-KIT is the product of many years of teaching and engineering experience. The detailed instructions and quizzes are clearly written and illustrated, so that they can be understood by anyone between the ages of 12 and 80.

The PROGRESSIVE RADIO EDU-KIT is not merely a collection of radio parts accompanied by a radio diagram. IT IS PRACTICALLY A RADIO COURSE, offered at a mere fraction of its real value. You will be taught to build radios in a progressive manner. First, you will build a very simple 1-tube receiver. The next set is a little more advanced. Gradually you will find yourself constructing elaborate radio sets, and doing work like a professional radio technician. Every part is illustrated. EVERY STEP INVOLVED IN BUILDING THESE SETS HAS BEEN CAREFULLY PLANNED. YOU CANNOT MAKE A MISTAKE.

Each of the 15 radios you will build operates on 110-120 volts, AC or DC. These sets have been designed to teach you the PRINCIPLES OF RADIO. Therefore, you will build a variety of circuits. The PROGRESSIVE RADIO EDU-KIT is EXCELLENT FOR LEARNING THE PRINCIPLES OF RECEIVER, TRANSMITTER, AND AMPLIFIER DESIGN. It is used in many Radio Schools and Colleges in U.S.A. and abroad. It is used by the Veterans Administration for veteran training.

Quizzes are provided as part of the PROGRESSIVE RADIO EDU-KIT. They will be corrected by our staff at no extra cost.

FREE

1950 EXTRAS:

- ELECTRICAL AND RADIO TESTER
- ELECTRIC SOLDERING IRON
- SCREWDRIVER
- ALIGNMENT TOOL
- BOOK ON TELEVISION
- SPOOL OF ROSIN CORE SOLDER
- GENEROUS HANK OF WIRE
- MEMBERSHIP IN RADIO-TV CLUB

ORDER YOUR PROGRESSIVE EDU-KIT TODAY, OR SEND FOR FREE "KIT-KATALOG" POSTAGE PREPAID ON CASH ORDERS. C.O.D. ORDERS ACCEPTED IN U.S.A.

PROGRESSIVE ELECTRONICS CO. 497 Union Ave., Dept. RN-12
 Brooklyn 11, New York

THREE DECADES OF RADIO-TELEVISION "KNOW-HOW"

an **insuline** cabinet or chassis for every need

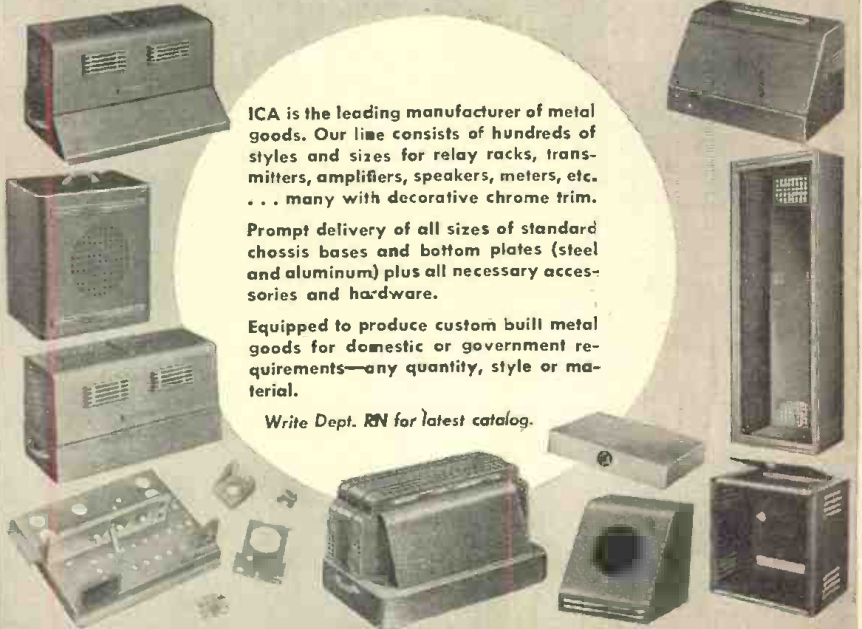

ICA is the leading manufacturer of metal goods. Our line consists of hundreds of styles and sizes for relay racks, transmitters, amplifiers, speakers, meters, etc. . . . many with decorative chrome trim.

Prompt delivery of all sizes of standard chassis bases and bottom plates (steel and aluminum) plus all necessary accessories and hardware.

Equipped to produce custom built metal goods for domestic or government requirements—any quantity, style or material.

Write Dept. RN for latest catalog.



insuline CORPORATION OF AMERICA

INSULINE BUILDING • 36-02 35th AVENUE • LONG ISLAND CITY, N. Y.
 West Coast Branch and Warehouse: 1335 South Flower Street, Los Angeles, Calif.
 Exclusive Canadian Sales Agents: CANADIAN MARCONI COMPANY, Montreal

ELECTRONICS TECHNICIANS WANTED

The RCA Service Company, Inc., a Radio Corporation of America subsidiary, needs qualified electronics technicians for U. S. and overseas assignments. Candidates must be of good character and qualified in the installation or maintenance of RADAR or COMMUNICATIONS equipment or TELEVISION receivers. No age limits, but must have at least three years of practical experience.

RCA Service Company offers comprehensive Company-paid hospitalization, accident and life insurance programs; paid vacations and holidays; periodic review for salary increases; and opportunity to obtain permanent position in our national and international service organization, engaged in the installation and maintenance of AM, FM and TV transmitters, electronic inspection devices, electron microscopes, theatre and home television, r-f heating equipment, mobile and microwave communications systems, and similar electronic equipment.

Base pay, overseas bonus, payments for actual living and other expenses, and benefits mentioned above add up to \$7,000 per year to start for overseas assignments, with periodic review of base salary thereafter. Openings also available at proportionately higher salaries for specially qualified technicians with supervisory ability.

Qualified technicians seeking an advantageous connection with a well-established company, having a broad-based, permanent peacetime and wartime service program, write to:

MR. G. H. METZ,
Personnel Manager,
RCA SERVICE COMPANY, INC.,
CAMDEN 2, NEW JERSEY

RADAR, COMMUNICATIONS

AND

SONAR TECHNICIANS

W-A-N-T-E-D

For Overseas Assignments

Technical Qualifications:

1. At least 3 years practical experience in installation and maintenance.
2. Navy veterans ETM 1/c or higher.
3. Army veterans TECH/SGT or higher.

Personal Qualifications:

1. Age, over 22—must pass physical examination.
2. Ability to assume responsibility.
3. Must stand thorough character investigation.
4. Willing to go overseas for 1 year.

Base pay, Bonus, Living Allowance, Vacation add-up to \$7,000.00 per year. Permanent connection with company possible.

Apply by Writing to
D-4, P.O. Box 3575,
Philadelphia 22, Pa.

Men qualified in RADAR, COMMUNICATIONS or SONAR give complete history. Interview will be arranged for successful applicants.

Classified

Rate 35c per word. Minimum 10 words

RADIO ENGINEERING

RADIO Engineering Broadcasting, Aviation and Police Radio, Servicing, Marine Operating and Electronics taught thoroughly. Expenses low. Write for catalog, Valparaiso Technical Institute, Dept. N, Valparaiso, Ind.

PANELS for electronic, nucleonic construction projects. Complete service for designers, custom builders. Circular upon request. Gilpin Instrument Works, P. O. Box No. 8, Mt. Clemens, Mich.

SALE

BRAND new 10BP4 in original carton and Tube Mask \$25. A. Munari, Marseilles, Ill.

FIVE Element TV Yagi Beams. High band \$6.75. Low Band \$8.50. Aluminum Tubing, etc. Willard Radcliff, Fostoria, Ohio.

BARGAINS. New and reconditioned Hallcrafters, National, Collins, Hammarlund, RME, Meissner, other receivers, tuners, television receivers, transmitters, amplifiers, speakers, etc. Lowest wholesale prices. Terms. Shipped on trial. Liberal trade-in allowances. Write Henry Radio, Butler, Mo., and 11240 W. Olympic, Los Angeles, Calif.

HOTTEST surplus list in the country. Electronics-Hydraulics, Aircraft-Gadgets, Dick Rose, Everett, Wash.

RADIO Diagrams 50c; Record Changers, Recorders 60c; Television Diagrams with service data \$1.00 up. State Manufacturer and model number. Kramer's Radio Service, Dept. RX, 36 Columbus Ave., New York 23, N. Y.

COLOSSAL bargain in radio parts, over 150 assorted radio parts including resistors, condensers, controls, coils, etc. All new, \$75.00 value, guaranteed satisfaction or money refunded, postpaid in U. S. A., \$2.50. Write for catalog. Buyers Syndicate, 30 N. Taylor St., Springfield 3, Mass.

RECORD Changer Parts for leading makes. We ship everywhere. Friend's Wholesale Distributors, 106 N. 6th St., Philadelphia 6, Pa.

STARTLING values! Example, hook-up wire 1/3c ft. Free lists, Airline Salvage, 1275 N.W. 33rd St., Miami 42, Fla.

53 OHM coax: 100 feet \$3.95. Harry Van Dick, Little Falls, N. J.

5% PRECISION 8.8mfd/600v Oil Filtermlte, Plug-in, new, 69c plus postage. Free bargain list. No dealers. Betz, 73 Caroline Ave., Yonkers 5, N. Y.

WANTED

SNIPERSCOPE & Snooperscopes wanted. Any type, any condition. Needed immediately. Box 495, 1/2 Radio & Television News, 185 N. Wabash Ave., Chicago 1, Ill.

WANTED: APR-4 receiver and tuning units. State condition and price. W2DB, 274 Boulevard, Scarsdale, N. Y.

AN/APR-4, other "APR." Receivers; "ARC-" "TS-" "IE-" Equipment; R-89/ARN-5, ARR-5, ARR-7, ART-13, Ferris, Bonton, G-R Test Equipment, etc. Describe, price in first letter. Littell, Fairhills, Box 26, Dayton 9, Ohio.

WANTED, BC-312, BC-342 and BC-348 Receivers. Good used or new surplus. SCR-284 complete, original packing. Advise, stating price, condition, any modification made. G. & M. Equipment Co., Inc., 7315 Varna Ave., No. Hollywood, Calif.

HELP WANTED

INSTRUCTORS in Electronics and Radio. Prefer former Navy Radio Technician instructors willing to locate in the Detroit, Mich., area. Write to Box 452, c/o Radio & Television News, 185 N. Wabash Ave., Chicago, Ill.

CORRESPONDENCE COURSE

USED Correspondence Courses and Books sold and rented. Money back guarantee. Catalog free. (Courses bought.) Lee Mountain, Pisgah, Ala.

USED Correspondence Courses and Educational Books bought, sold, rented, catalog free. Educational Exchange, Summerville, Ga.

PATENT ATTORNEYS

LANCASTER Allwine & Rommel Registered Patent Attorneys. Patent practice before U.S. Patent office. Validity and infringement investigations and opinions. Booklet and form "Evidence of Conception" forwarded upon request. Suite 414, 815 15th St., N.W. Washington 5, D.C.

TRIPLEX WAVE MASTER

TRIPLE DIRECTORS

1/4 Wavelength Stacked

Conical with 3-Element Dipole

GHOST FREE RECEPTION

ALL CHANNELS

NO BOOSTER REQUIRED

YOUR COST
\$770

INSTANT ASSEMBLY

MATCHES ANY OHM WIRE

75-150-300

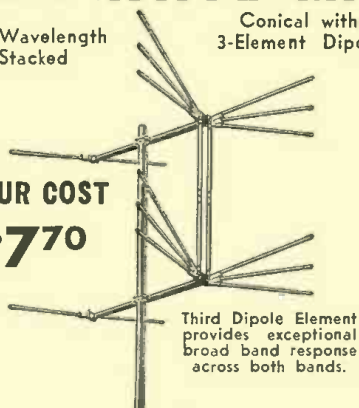

Third Dipole Element provides exceptional broad band response across both bands.

EASY INSTALLATION APPROX. WT. 7 POUNDS

Price List
\$2690

UNDER ACTUAL TESTS...PROVED!

- 30% more gain than former 4X antennas.
- Reception available in fringe and formerly unsatisfactory locations, all channels.
- Most advanced design to date.

- Easier tuning, added selectivity on any receiver.
- These tests conducted in fringe areas and locations up to 250 miles from transmitting stations—not by meter or laboratory tests, but under average home installation.

SOLD DIRECT—WRITE—WIRE—CALL—FAIRFAX 9171

RAY MFG. CO.

441 SUMMIT ST.
TOLEDO, OHIO

HERMAN Lewis Gordon, Registered Patent Attorney. Patent Investigations and Opinions. Warner Building, Washington, D. C.

MISCELLANEOUS

SPEAKER repairs done with guaranteed factory methods. Send for free folder. New low prices. Amprite Speaker Service, 70 Vesey St., New York City 7.

RENEW noisy controls quickly, easily. Secret instructions 50c. Drelus Enterprises, 6585 St. Lawrence, Montreal.

RADIOMEN, Servicemen, Beginners. Make more money, easily, quickly, \$250 weekly possible. We show you how. Information free. Merit Products, 216-32R 132 Ave., Springfield Gardens 13, N. Y.

15 TESTED One-Tube circuits 25c, including "Radiobuilder," catalog. Laboratories, 578-H, San Carlos, Calif.

PHOTO CREDITS

Page	Credit
35	Philco Corporation
36, 37, 38, 39, 90	U. S. Army
43	Terminal Radio Corporation
45	Pickering & Co., Inc.
47 (Top), 48 (Top Left), 49 (Top left & Right), 50 (Top)	U. S. Navy
47 (Bottom), 48 (Top Right, Bottom), 49 (Bottom), 50 (Bottom), 51 (Top & Center)	Dept. of Defense
51 (Bottom)	General Electric Company
52	Acro Products Company
55	Simpson Electric Company
63, 64, 65	U. S. Air Force
103	Radio Club of America
128, 131	Television Technicians Lecture Bureau

STATEMENT OF THE OWNERSHIP, MANAGEMENT, AND CIRCULATION REQUIRED BY THE ACT OF CONGRESS OF AUGUST 24, 1912, AS AMENDED BY THE ACTS OF MARCH 3, 1933, AND JULY 2, 1946 (TITLE 39 UNITED STATES CODE, SECTION 233) Of Radio & Television News, published monthly at Chicago, Ill., for October 1, 1950.

1. The names and addresses of the publisher, editor, managing editor, and business managers are: Publisher, William B. Ziff, 185 N. Wabash Ave., Chicago 1, Ill.; Editor Oliver Read WYETT, 185 N. Wabash Ave., Chicago 1, Ill.; Managing editor, Wm. A. Stocklin, 185 N. Wabash Ave., Chicago 1, Ill.; Business manager, G. E. Carney, 185 N. Wabash Ave., Chicago 1, Ill.

2. The owner is: Ziff-Davis Publishing Company, 185 N. Wabash Ave., Chicago 1, Ill.; William B. Ziff, 185 N. Wabash Ave., Chicago 1, Ill.; B. G. Davis, 185 N. Wabash Ave., Chicago 1, Ill.; A. Ziff, 185 N. Wabash Ave., Chicago 1, Ill.; S. Davis, 185 N. Wabash Ave., Chicago 1, Ill.

3. The known bondholders, mortgagees, and other security holders owning or holding 1 percent or more of total amount of bonds, mortgages, or other securities are: Modern Woodmen of America, Rock Island, Illinois.

4. Paragraphs 2 and 3 include, in cases where the stockholder or security holder appears upon the books of the company as trustee or in any other fiduciary relation, the name of the person or corporation for whom such trustee is acting; also the statements in the two paragraphs show the affiant's full knowledge and belief as to the circumstances and conditions under which stockholders and security holders who do not appear upon the books of the company as trustees, hold stock and securities in a capacity other than that of a bona fide owner.

G. E. CARNEY, Business Manager.

Sworn to and subscribed before me this 27th day of September, 1950.

SEAL Remice Batkin Fusch, Notary Public. (My commission expires November 4, 1953.)

if you are commercially or professionally interested in TV, read

TELEVISION ENGINEERING

for news of all that's NEW in the lab, plant and station involving design, manufacture, operation and maintenance of TV equipment for research, production, testing, receiving and transmitting.

Special Rate: 3 yrs. (36 issues) \$5

Bryan Davis Publishing Co., Inc. (Publishers of SERVICE)

52 Vanderbilt Ave., New York 17, N. Y.

THINGS AIN'T WHAT THEY USED TO BE, BUT... WE STILL HAVE WAR SURPLUS BARGAINS

R9A-APN-4 160 meter Loran receiver plus high and low voltage power supply. Three chans, tunable 1.6-3.3 mc. 1 chan, tunable 1.5-1.75 mc. Excellent schematic and instructions for use on 60 cy. Excellent used, \$4.50

VHF TRANSCEIVER. Ideal substitute for SCL-522. With original schematic plus practical wiring diagram plus complete instructions for power supply and for re-tune to any VHF frequency, Ham, CAP, Marine, etc. Crystal controlled, 10 watts. Receiver has two individual RF sections feeding a common 3-stage 10 MC IF. Both RF sections may be operated simultaneously or individually. Receiver uses 13 tubes. Transmitter is of straightforward design. It uses 7 tubes including one 2B2 as final, modulated by two push-pull 6L6. Complete unit in one neat case. Excellent used, less tubes and dyno in hamotor, a steal at only \$6.95

DM-42-A. 12 v. two outputs: 1030 v. 260 ma for PA. plus 515 v. 215 ma, for mod., etc. NEW \$9.95
PE-32. 24 v. two outputs: 1150 v. 350 ma; plus 400 v. 400 ma. NEW (less base) \$7.95
PE-73. 24 v. 1000 v. 350 ma; with starting relay, filters, etc. NEW \$5.95; FAIR USED \$4.95
INVERTER PE-218. 24 v. in. output 115 v. regulated. 400 cy. 1500 va. NEW \$17.50

LOOK WHAT \$2.65 WILL BUY!
A 6 v DYNAMOTOR. Very low battery drain. Multiple windings! 250 v DC, 100 ma; to 300 v DC, 70 ma. No brushes to add or shift around. No extra work. Or use as a 2:1 or 1:2 step-up or step-down transformer for DC voltage! Change 6 to 12, or 12 to 24, or vice versa. Handles up to 3 amps. Or use as a GENERATOR. Turn with motor, get 12 v DC at 12.6 A, or 24 v DC at 6.3 A, plus high voltage. Complete dope sheet furnished. BRAND NEW \$2.65

FIL. XFORMER. HV Amertron type W.S.: 115 v. 60 cy pr; sec 5 v CT at 10 A, insulated for 35 KV test. 12 KV DCWV. Built-on socket for 872A. \$2.50
250T. 371. Ctg. With new 872A. \$4.95

274N AND ARC-5 TRANSMITTERS
T-19/ARC-5. 3-4 mc. repacks, like new \$10.95
 Excellent used \$8.95
BC-457. 4-5.3 mc. Excellent, used \$4.95
BC-458. 3-3.7 mc. Excellent, used \$5.95
BC-459. 7-9.1 mc. Excellent, used \$9.95
T-22/ARC-5. 7-9.1 mc. repacks, like new \$9.95
MD-7/ARC-5. Push-pull modulator. Excellent \$9.95
MOD BC-456. Brand New \$5.95
 Excellent, used \$2.49

274N AND ARC-5 RECEIVERS
BC-454. 3 to 3.5 mc. Excellent, Good used \$4.95
BC-455. 6 to 9 mc. NEW \$12.95. Good used \$7.95
 Local Control Adaptor parts for 274N or ARC-5 receiver. Exact pot, switch, knobs, etched plate, and instruction data. Ready to mount \$4.29
 Spline tuning knob \$5.9c

RCA ceiling speaker, 23" dia., 6 ohm \$8.95
AC Voltmeter. New, boxed, Weston 476, 0-130 V AC, flush 3 1/2" round. Complete dope sheet \$3.95
 Oil Filled 4 x 8 mid. 600 v condenser, in one case, common end, new, with mtg. hooks \$2.89

EXPERIMENTER'S SPECIAL
 A receiver you can do wonders with! Make intermod. analyzer for testing audio amplifiers, convert to PH. etc. Has dual bridge instrument rectifiers, also superb AVC system. RF is 108.3 to 110.9. Has 3-717A tubes (use as direct replacement for 6SK7, with much more gain), 2-12SR7, 1-12SQ7, 1-12A6, 1-12AH7, 2-12SR7. With schematic, all conversion done, excellent condition \$7.95
 3-30'S Throat Microphone, New \$6.9c

3-DIGIT resettable Vee-Root counter with pilot lamp assembly, water switch, nice case. New \$7.9c

TU-25 Plug-in tuning unit for BC-223, freq. 3500-5550 kc., includes 80 meters, seal, low power xmtr, foundation, or a feast for parts. Ant. coupler, ant. inductance, xtal selection switches, coils, condensers \$1.29
 In 20, lined-top, steel case. NEW \$1.29
 Willard 2-2 wet cell battery, 2V, 20AH, New...98c

MARINE SPECIALS
 Tuning Units for BC-375. Specify freq. coverage desired. Excellent condition. With schematic showing parts description \$1.95

BC-347-C Booster Amplifier, especially useful as mike-input amplifier to boost modulation, excellent as mike or phono preamplifier. Compact, only 3 1/2" x 2 1/2"; contains dual-triode power tube 6F8G and two high-ouicer transformers, one for mike to push-pull grids, one for push-pull push-pull. Requires external power source. Original use was for interphone amplifier. Good used, special \$2.95
BC-347-C, brand new \$2.95

Citizen's Band Antenna, with director, radiator, 98c reflector, hardware. Two complete sets \$1.95

GADGETEER'S SPECIALS
ZA Test Oscillator CDE-60050. Used to feed 90 and 150 cy. modulation to rec. input. Controls 12 v. vibrator (we tried it on 6 v and it works there, too). Has two vibrating reeds giving separate tone outputs. In black plastic case with nice plastic instruction and schematic. Has switch, capacitors, chokes, pot., octal socket, etc. Brand new, orig. pack \$4.9c

Position Transmitter of Mark-18 Nightingull Unit, Eastman-Kodak, brand new. Full of valuable components. Original packing \$4.9c

BABY WINCH. Geared motor. Dozens of uses around home, boat, or shack. Just the thing for operating garage doors, gates, etc. Makes excellent beam rotator or barndrive. Both either are stopped and/or reversed by both reversible by electrical switching. One is a sprocket-toothed wheel, the other is a ratchet-coupled cable drum. Both are either stop and/or reversed by adjustable limit switch or remote electrical control. 24 v DC universal motor runs perfectly on 8 to 24 v, 60 cy AC geared down to nice, easily-controlled low speed. With simple instructions \$4.95
 Only \$4.95

G.L. "MARINER" TRANSMITTER. 180 w. input, 120 w. to antenna, 90% modulated, 4 chan. xtal cont., 12 or 24 v input (specify volt & freq. when ordering), w/Dynamotor, connecting cord, xtal. tubes (parallel 814's final), mike, all aligned and ready to operate. Built-in rear. break-in relay in addition to ant. switching relay. Dimensions: 8 1/2" deep, 13 1/4" wide, 19 1/2" high. Tubes included: 40Y speech amp, two 211 mod., 12J5 osc., 1625 1PA, two 814 PA. This xmtr. built from \$1200 govt. cost surplus. W/instructions FCC license approval guaranteed... \$275.00

G.L. "MARINER" RECEIVER. Long wave, broadcast, marine and short wave reception. A beautiful conversion of finest Navy surplus! All cond'ns. wiring, including BFO ON-OFF and AVC-MVC on entirely new front panel. Coaxial type antenna fittings furnished. Tagged wires out of rear to connect to battery, to power DU loop and to kill B+ with xmtr. break-in relay, 12 or 24 v DC. Compact: 15 1/2" long 8" wide, 6 1/2" high. No plugs needed, ready to go (less speaker). \$69.50

NAVY TYPE ARA SCR-274N Receiver. 1.5-3 MC. Re-tune for 12 v. with dynamotor mtg. on back. Phone plug built into rear, rebuild for front panel control. With harness and plug for 12 v input and for output to power DU-1 loop. New, converted (less speaker) \$27.50
 Same as above, but for 24 v. \$27.50

DU-1 Manual Directional Finder. Goes ahead of G.L. "Mariner," ARA, or any other receiver. Converted for Marine bands, still retains half of broadcast band and all the light-house and beacon band. 2 tube pre-amplifier. No 180° ambiguity. True bearing in 32.50 immediately. New, converted \$32.50

Waterproof Bulkhead Speaker with matching Univ. transformer, cord, plug; very high, finished case \$9.95

WANTED! Your spare Surplus Equipment and Tubes. Dynamotors, Recrs. Xmtrs. Test Equipment. Send list, stating condition and your FOB bottom price.

G. L. ELECTRONICS 905 S. VERMONT AVE. LOS ANGELES 6, CALIF.

ALL PRICES F.O.B. LOS ANGELES. CALIF. BUYERS ADD SALES TAX

SURPLUS CLEARANCE

All Prices Lowered Drastically! New Inventory Arriving!

ARC-5 Receivers and Transmitters

TRANSMITTERS
BC 696-3-4Mc.—Excellent shape—with tubes, xtal. . . \$ 9.95
BC 457-4-5.3Mc.—Used as is —some with tubes, xtal. . . 3.25
BC 458-5.3-7Mc.—Used as is —some with tubes, xtal. . . 3.25

RECEIVER
BC-453-190-550 KC—Good condition—Less Tubes \$4.95

SPECIAL OFFER—The above 3 transmitters and 1 receiver (quantity limited—order now) \$17.50

Marker Beacon Receiver Two tube—new \$2.25
Navy Dual Range receiver and transmitter test sets. Complete with antennas, tubes, dry batteries, carrying sacks, schematics, UHF. A FEW LEFT and Reduced. Brand New. For the pair \$12.95

Other types available, write for quotations
 TERMS: 25% with order. Balance C.O.D. Shipped Railway Express F.O.B., N. Y.

GREENWICH SALES CO.
 59 Cortlandt St. New York 7

EASY TO LEARN IN YOUR HOME... ELECTRONICS RADIO and TELEVISION

GET YOUR F.C.C. LICENSE

- Step ahead with Central training!
- Broadcast Engineers (AM-FM-TV)
- Manufacturing Technicians
- Radio-Television Servicemen
- Emergency Radio Operators
- Airlines Radio Operators
- Public Address Servicemen

ALL essential jobs in a NEW, RICH field of OPPORTUNITY. Free placement service has put our graduates in top positions from coast to coast. Plan your professional career now, by sending for FREE LITERATURE.

CENTRAL RADIO AND TELEVISION SCHOOLS, Inc. Dept. RTN, 1644 Wyandotte, Kansas City, Mo.

I want complete information on how I can succeed in Radio, Television and Electronics. This does not obligate me in any way.

Name _____
 Address _____ Age _____
 City _____ Zone _____ State _____



GET THE LATEST IN
RADIO & TELEVISION
From These **BRAND NEW**
PAY RAISING BOOKS!

**Yours for 7 Days
FREE TRIAL**

**COMPLETE SECTION
IN FULL COLOR ON
COLOR TELEVISION**

Handle the toughest, big-pay television and radio jobs with Coyne's brand new 5-volume APPLIED PRACTICAL RADIO-TELEVISION. Gives you practical working knowledge of Radio-Television servicing. Includes latest time-saving, trouble-shooting and servicing methods. Written in simple, down-to-earth language. Covers everything from basic principles to newest in Television and FM. Explains UHF and color TV, adapters and converters, picture tubes, testing instruments, alignments, as well as public address systems, short wave, auto radio, aviation radio, other important phases. More than 1500 pages, 1000 illustrations, charts and diagrams you can work from.

UP-TO-DATE!

FREE TRIAL OFFER!

SEND NO MONEY! Examine this new pay-raising set of books for 7 days at our expense. Just fill in and mail coupon below. It is not an order. Merely a request to see books.

RADIO-TV DIAGRAMS BOOK FREE!

Act promptly and receive FREE with APPLIED PRACTICAL RADIO-TELEVISION our big new book, "150 Radio and Television Diagrams Explained." If you keep the set, send \$3 in 7 days and \$3 a month until \$16.90 is paid. (Cash price \$13.40.) Return the set alone in 7 days at our expense and you OWE NOTHING. Either way, Diagrams book is yours FREE! Mail coupon TODAY!



MAIL THIS FREE BOOK COUPON NOW!

Educational Book Publishing Division
COYNE ELECTRICAL & TELEVISION-VIDEO SCHOOL
500 S. Paulina St., Dept. CO-73, Chicago 12, Ill.
O.K. I Rush "Applied Practical Radio-Television" post-paid for FREE 7-day trial per your offer. Include FREE Book of "150 Radio & Television Diagrams."

Name..... Age.....
Address.....
Town..... Zone..... State.....
Where Employed.....

SPECIAL SALE!

1N34 CRYSTALS..... 69c

THROAT MIKE (MT 81-A). 2 mikes in leather zipper case with 56" cord & PL 58—Brand New 49c
CARBON MIKE T-17. Slightly used. Guaranteed. Has 5-ft. cord and PL 68. 89c

VERNIER DIAL (From BC-221)

2 1/2" Dia. 0-100 in 360°. Black with silver marks. Has thumblock. 85c

VERNIER DRUM (From BC-221)

0-50 in 180° black with silver marks. 85c

OIL FILLED CONDENSER SPECIALS

4 mfd. 2,000 V.D.C. \$3.85 | 8 mfd. 2,000 V.D.C. \$4.95
2 mfd. 4,000 V.D.C. 2.50 | 4 mfd. 600 V.D.C. .79

HAYDON Timing Motor. 4 R.P.M. .115 Volt. 60 cycle. \$1.79

FILAMENT TRANSFORMER

Prl. 115V. 60 Cyc.—Sec., 5 V., 115 Amp. 6000 volt insulation. \$9.95 each

SELSYNS 2J1G1—Brand New—400 Cyc. \$1.65

SOUND POWERED Handset—

Includes 6-ft. cord \$17.60 pr.

Minimum order \$3.00—All orders FOB, Phila.

RELIANCE Merchandizing Co.

2221 Arch Street Philadelphia 3, Pa.
Telephone: Rittenhouse 6-4927

CODE SENDING SPEED
RECEIVING SPEED



Free Book

HIGH SPEED

WITHOUT NERVOUS TENSION

REVEALING BOOK shows how "crack" operators develop high speed and proficiency. Learn code for Amateur or Commercial Radiotelegraph License, or improve your sending and receiving with the Candler System which develops radiotelegraph experts and code champions.

CANDLER SYSTEM Box 928, Dept. 2-0, Denver, Colorado

INDEX OF Advertisers

DEC. 1950

While every precaution is taken to insure accuracy, we cannot guarantee against the possibility of an occasional change or omission in the preparation of this index.

ADVERTISER	PAGE	ADVERTISER	PAGE
Acorn Electronics Corporation	94	La-Pointe Plasmold Corporation	130
Aero Products Company	162	Lampkin Laboratories, Inc.	169
Airex Radio Corp.	159	Lectrohn, Incorporated	156
Alliance Manufacturing Company	17	Lectronic Research Laboratories	161
Allied Radio Corporation	9, 143	Lentone Radio Company	111
Altec Lansing Corporation	76	Lowell Metal Products Corporation	140
Alvaradio Supply Company	162		
American Television & Radio Company	108		
Amplifier Corporation of America	157, 161, 163	Mallory & Company, P. R.	Fourth Cover
		Mass. Radio School	141
Arcel Electronics Company	110	Meissner Mfg. Div. Maguire Industries, Inc.	96, 135
Arrow Sales, Incorporated	105	Merit Transformer Corporation	128
Ashe Radio Company, Walter	24	Metropolitan Overseas Supply Corp.	139
Atlas Corporation, The	73	Midwest Radio & Television Corporation	14
Atlas Sound Corporation	114, 146	Miles Reproducer Company, Inc.	151
		Milo Radio & Electronics Corp.	157
Baltimore Technical Institute	153	Milwaukee School of Engineering	113
Bell Telephone Laboratories	20	Murray Hill Books, Inc.	123
Berlant Associates	130	McGee Radio Company	88, 89
Bond Equipment Company	145		
Boyce-Koche Book Company	95	National Radio Institute	3
Brook Electronics, Incorporated	130	National Schools	Third Cover
Brooks Radio & Television Corp.	110	National Union Radio Corp.	27
Browning Laboratories, Incorporated	142	Newark Surplus Materials Co.	146
Bryan Davis Publishing Co., Inc.	167	Niagara Radio Supply Corporation	102, 103
Burford Radio Supply	129	Norio Electronics Corporation	142
Burden Sales Co.	151		
Burstein-Applebee Company	116	Oak Ridge Products	156
		Offenbach & Reimus Company	86
Candler System	168	Ohmite Mfg. Company	15
Cannon Electric	117	Olson Radio Warehouse, Inc.	92, 93
Cantor, Jack	156	Opad-Green Company	141
Capitol Radio Engineering Institute	91, 98		
Central Radio & Television Schools, Inc.	167	Peak Electronics Company	135
Centralab, Division of Globe-Union, Inc.	10, 11	Peerless Products Industries	132
		Penn Boiler & Burner Mfg. Corp.	18
Chelsea Television Center, Inc.	149	Pfanstiel Chemical Company	141
Chicago Industrial Instrument Company	148	Phillips Manufacturing Company	132
Chicago Transformer Company, Inc.	28	Photocon Sales	112
Cincinnati Ventilating Company, Inc.	154	Pickering & Co., Inc.	136
Cleveland Institute of Radio Electronics	5	Platt Electronics Corporation	100, 101
Clippard Instrument Laboratory, Inc.	122	Poly-Tech	138
Columbia Electronic Sales	120	Precision Electronics, Inc.	158
Comet Electronic Sales Company	131	Premier Radio Tube Company	149
Communications Equipment Company	115	Progressive Electronics Company	165
Concord Radio Corp., Export Division	87	Pyramid Electric Company	6, 26
Coyne Electrical & Television-Radio School	118, 168		
		Quam-Nichols Company	158
Dakolite Chemical Company, Inc. The	132		
Davis Television Supply Co.	153	R. & T. Electronics Co., Inc.	162
DeForest-Samabria Corporation	75	RCA Institutes, Inc.	160
DeForest's Training, Inc.	7	R.C.A. Service Company, Inc.	166
Drake Company, R. L.	148	Radio City Products Co.	147
		Radio Corporation of America	Second Cover, 12, 139
East Coast Electronics	116	Radio Craftsmen, Inc.	124
Editors & Engineers, Ltd.	140	Radio Ham Shack, Inc.	107
Eddie Electronics, Inc.	152	Radio Parts Company	125
Electro Devices, Incorporated	142	Radio Receptor Company, Inc.	121
Electro Products Laboratories, Inc.	150	Radio Wire Television (Lafayette Radio)	22
Electro-Technical Industries	90	Ray Manufacturing Company	166
Electronic Instrument Company, Inc.	23, 104, 143, 145, 151, 156, 158, 160, 162	Raytheon Manufacturing Company	109
Electronic Measurements Corp.	140	Raytheon Television	29
Electronics Institute, Inc.	156	Red Arrow Sales	106
Eric Resistor Corporation	122	Reeves Soudercraft Corporation	126
Espey Manufacturing Company, Inc.	121	Reliance Merchandizing Company	168
		Rider, John F.	110, 111
FM-TV Magazine	127	Rose Company, The	162
Fair Radio Sales	169	Russell Lens Company	164
Federated Purchaser, Incorporated	24		
Feiler Engineering Company	189	Sams & Company, Howard W.	154
Franklin Technical Institute	158	Schott Company, Walter L.	121
		Spartan School of Radio & Electronics	126
G. L. Electronics	167	Spellman Television Company	146
General Electric Company	25	Sprague Products Company	16
General Electronic Distributing Company	69, 70, 71, 72	Sprayberry Academy of Radio	19
General Test Equipment	104	Standard Transformer Corporation	143
Gensler, B. N.	161	Star Electronic Distributors, Inc.	164
Good, Inc., Don.	153	Sun Radio of Washington D. C.	74
Goodheart, R. E.	162	Supreme Publications	85
Greenlee Tool Company	144	Swedgal Radio, Inc.	158
Greenwich Sales Company	167	Sylvania Electric Products, Inc.	30
Hallierafters Company, The	21	Tab	97, 170
Hartnett Company, R. W.	141	Tech-Master Products	98, 136
Harvey Radio Company	134	Tekni-Labels Company	159
Heath Company, The	77, 78, 79, 80, 81, 82, 83	Television Communications Institute	144
		Television Supply Company	126
Henry Radio Stores	106	Thomas Electronics, Inc.	104
Henshaw Radio Supply	164	Trad Television Corp.	150
Hudson Radio & Television Corp.	163	Transvision, Inc.	129
Hy-Grade Electronics, Inc.	109	Tri-State Collectors	143
Hytron Radio & Electronics Corp.	13	Trio Manufacturing Company	145
		Turner Company, The	161
		Ungar Electric Tool Company, Inc.	114
Illinois Condenser Company	136	Universal Microphone Company	116
Indiana Technical College	157		
Instructograph Company	159	V & H Radio & Electronics Supply	151
Insuline Corporation of America	165	Valparaiso Technical Institute	104
Interstate Supply Company	163	Variety Electric Co., Inc.	160
J. F. D. Manufacturing Company, Inc.	154	Ward Products Corporation	137
Jensen Industries, Inc.	96	Weller Electric Corporation	8
Joseph Radio Parts, Inc., Irving	148	Wells Sales, Inc.	99
		Wholesale Radio Parts Co., Inc.	133
		Wilcox & Pollett	164
		World Radio Laboratories	155
Knepfer Aircraft Service	150	Y M C A Trade & Tech. School	145

TV Antenna Survey

(Continued from page 34)

gain. Both antennas are characterized by high gain and narrow bandwidth. The bandwidth is so narrow that it is just sufficient to cover a single channel in some cases. Because of the sharp radiation pattern, installation is quite critical but a gain of 9 db. can be obtained in the proper direction for any channel in the TV band.

(B) *Square Corner Reflector.* Another type of high gain antenna is the square corner reflector which acts as a mirror to the signal energy, catching the signal and reflecting it back to the dipole. This antenna is available for high frequency stations only and is cut for a particular frequency. (A low frequency reflector would be prohibitively large.)

This antenna has a gain of approximately 9 db. and a beamwidth of only 25 degrees (sharper than a yagi of equal complexity) and a front-to-back ratio of 20 db.

Conclusion

The author has tried to cover the important features of many of the popular antennas on the market today. The important characteristics of these antennas are summarized in Table 2. Grateful acknowledgement for data supplied is made to the following manufacturers: *Technical Appliance Corp., Ward Products Corp., American Phenolic Corp., Telrex, Shore Engineering, Dielectric Products Co., and Channel Chief Co.* —30—

FIBER FUSE PULLER

By H. LEEPER

A handy tool for television servicing can be adapted from an ordinary fiber fuse puller.

This versatile, seven-inch unit can be used as a tool for removing small tubes and performing other operations around a television chassis.

Because the tool is made of fiber, it is light in weight and is less likely to damage the picture tube should it be dropped or accidentally brought in contact with the cathode-ray tube. —30—

A fiber fuse puller can be used for many servicing operations around a TV chassis.

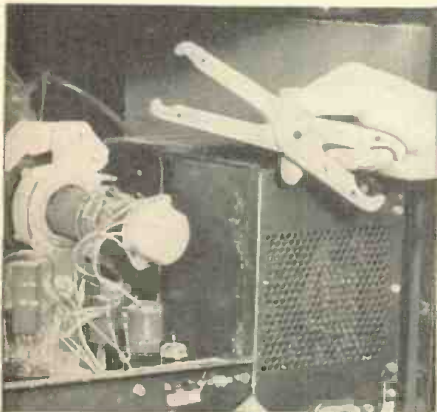

December, 1950

RECEIVER

MOBILE—BOAT—AIRCRAFT

BENDIX RA-10 RECEIVER—8 Tube Set covering frequency range 150 to 1100 KC. and 2000 to 10000 KC. in four bands by use of remote control unit. Set size: 18 1/2" L. x 10 1/2" W. x 8 3/4" H. Wt. 32 1/2 lbs. Comes complete with remote control unit, dynamotor, and plugs. BRAND NEW.

Order RA-10 CA f/ 14 Volt DC operation. \$49.95
Order RA-10 DA f/ 28 Volt DC operation.

BC-223 TRANSMITTER PARTS:

TUNING UNITS: TU-17—2000-3000 KC.; TU-18—3000-4500 KC.; TU-25—3500-5250 KC. \$3.50 EACH
SPARE TUBE KIT in metal box. f/BC-223... \$4.95
OPERATING MANUAL for BC-223... \$2.00
PE-125 POWER SUPPLY f/BC-223—12/24 Volt input; output 500 Volt 150 MA. NEW: \$9.95
SPARE VIBRATOR & TUBE KIT f/BC-223... \$4.95
SHOCK MOUNTING for PE-125... \$1.50

COMMAND TRANSMITTERS and RECEIVERS with SCHEMATICS

	USED:	NEW:
BC-453 Receiver—160-550 KC.	\$1.95	
BC-454 Receiver—3 to 6 MC.	5.95	
BC-455 Receiver—6 to 0.1 MW.	8.95	
BC-457 Transmitter—4 to 5.3 MC.	5.95	\$8.95
BC-458 Transmitter—5.3 to 7 MC.	5.95	\$8.95
BC-459 Transmitter—7 to 9 MC.	14.95	24.95
BC-696 Transmitter—3 to 4 MC.	14.95	24.95
T-23/ARC-5 Trans.—100 to 156 MC.		29.50

TRANSMITTERS and RECEIVERS:

	USED:	NEW:
BC-1206C Receiver, 200-400 KC.	\$ 5.95	
BC-357 Marker Beacon Rec.	2.95	
BC-347C Amplifier with Tubes.		\$2.95
BC-709 Amplifier	3.95	4.95
TA-12 Transmitter	29.95	
BC-230 Transmitter, 1 coil set.	4.95	6.95

BC-375 TRANSMITTER

BC-375 Transmitter—100 Watt Voice, CW, MCW covers frequency range 200 KC. to 12 MC. by the use of Plug-in Tuning Units, as listed below. Complete. \$18.95 with tubes, less Tuning Units. USED:

TUNING UNITS FOR BC-375 OR BC-191 TRANSMITTERS (Listed Below). \$3.95 EA.
TU-5—1500 to 3000 KC. TU-9 — 7700 to 10000 KC.
TU-8—3000 to 4500 KC. TU-10—10000 to 12500 KC.
TU-7—4500 to 6200 KC. TU-26 — 200 to 500 KC.
TU-8—6200 to 7700 KC. BC-306—Antenna Loading
FT-151 Shock Mounting for BC-375-101. \$2.00
CABLES F/BC-375-191 w/PL-64, 59, or 61 ea. end. \$2.00 EA.

TRANSFORMERS—110 V. 60 CYCLE PRIMARIES:
SEC. SEC.
24 V. 1 amp. \$1.95 24 V. 1/2 amp. \$1.50
36 V. 2.5 amps. 2.95 24 V. 4 1/2 amps. 3.95

Address DEPT. RN • Minimum Order \$2.00 • Prices F.O.B., Lima • 25% Deposit on C.O.D. Orders

FAIR RADIO SALES

132 SOUTH MAIN ST.
LIMA, OHIO

A-220 MC. CONVERTER FROM THE SURPLUS R-1/ARR-1 RECEIVER

Ideal compact unit for conversion to the 1 1/2 meter band. Uses four 954 Acorn tubes. Size: 3 1/2" x 3 1/2" x 10". For complete conversion instructions, see Radio News Jan., 1949. Price..... \$6.95

3/4 RPM ANTENNA ROTATOR MOTOR

High torque, reversible motor—operates directly from 110 Volt 60 cycle by use of condenser. Light weight, quiet running, ruggedly built, positive stop, easily mounted. Normally operates from 110 Volt 400 cycle. Complete with instructions. NEW..... \$4.95
10 MFD 400 Volt Cond. \$1.00. SPST Momentary Switch. 35c. DPDT Momentary Switch. 75c. Resistor. 100 ohm 25 Watt, 50c. 4 Wire Cable. 5c per ft.



DYNAMOTORS:

INPUT	OUTPUT:	STOCK No.	PRICE
9 V. DC	450 V. 60 MA.	DM-9450	
@ 6 V. DC	275 V. 50 MA.	w/Blower	\$3.95
12 or 24 V. DC	440 V. 200 MA. &		
	220 V. 100 MA.	D-104	9.95
12 V. DC	600 V. 300 MA.	BD-86	7.95
12 V. DC	350 V. 150 MA.	BD-87	6.95
12 V. DC	375 V. 150 MA.	BD-83	6.95
12 V. DC	1000 V. 300 MA.	BD-77	7.95

PERMANENT MAGNET FIELD DYNAMOTORS:
12 or 24 V. DC 275 V. 110 MA. USA/0516 \$3.95
12 or 24 V. DC 500 V. 50 MA. USA/0515 2.95
@ V. DC 240 V. 50 MA.

Tell Us Your Dynamotor, Inverter, & Small Motor Needs!

METERS:

0-150 Volt 400 Cycle 2 1/2" Round.....	\$2.95
0-5 Amp. AC 3" Rd. 0-100 A. Scale.....	3.95
0-5 Amp. AC 3" Rd. 0-75 A. Scale.....	2.95
0-5 Millamp DC 2 1/2" Square.....	6.95
0-500 Microamp 2 1/2" Rd. w/0-15 & 0-600 DC Volt Scale.....	3.95



WHIP ANTENNA EQUIPMENT

MAST BASES—INSULATED:

MP-132—(Illustrated) 1" heavy coil spring, 2" insulator. Overall length: 11 1/2". Weight 2 3/4 lbs. Price..... \$3.95
MP-22—Spring action direction of bracket. 4" x 8" mounting. Price..... \$2.95
MAST SECTIONS FOR ABOVE BASES:
Tubular steel, copper coated, painted, 3 foot sections, screw-in type. MS-53 can be used to make any length, with MS-52-51-50 for taper.
Price—any section..... Ea. 50c
MS-54 or 55. Larger sections than MS-53... Ea. 75c
BAG BU-56 for carrying 5 Mast Sections..... 50c

Address DEPT. RN • Minimum Order \$2.00 • Prices F.O.B., Lima • 25% Deposit on C.O.D. Orders

MR. SERVICEMAN

Get Your Foot in the Door!

• The day is soon coming when the mobile radio telephone will be almost as common as the telephone in your home. Connect yourself with this fast-growing field.

• For a minimum investment in a Lampkin MFM* you can set up a frequency-measuring service and open a wide field of contacts.

*The Lampkin Type 105-A Micrometer Frequency Meter (MFM) costs but \$202.00 and exceeds FCC precision requirements.

Write TODAY for detailed information

LAMPKIN LABORATORIES, INC.

MFM DIVISION

BRADENTON, FLORIDA



EVERY RADIOMAN

Can Use These

SERVICE HINTS!

Valuable Manual Yours—FREE!

Every page of "How to Simplify Radio Repairs" is packed with on-the-bench, practical ideas. Contains photos, charts, diagrams—no fluff—no vague theory. In plain every-day language it gives you priceless suggestions—new servicing ideas. You'll use and benefit from the experience of experts. Partial list of contents: How to Localize Trouble; How to Service Amplifiers; How to Test for Distortion; How to Test Audio Circuits; How to Test Speakers; How to Find Faults in Oscillators; How to Test Radio Parts—and it's all yours—FREE! No obligation.



FEILER

SEND COUPON OR PENNY POSTCARD FOR YOUR FREE COPY TODAY!

FEILER ENGINEERING CO., Dept. 12M5
1601 S. Federal St., Chicago 16, Illinois

Please RUSH my FREE copy of "How to Simplify Radio Repairs."

Name

Address

City..... Zone..... State.....

"TAB" YEAR-END SALE!

MICA CAPACITORS

Fig. A. Postage 1/2 Postage (*Silver) Mfd. Each Mfd. Each

000015*	50.14	.0011*	3.4
000022	.07	.0012*	.12
000024*	.14	.0024*	.23
000025*	.14	.0025	.12
00004*	.07	.003	.14
00005*	.14	.003/1KV	.14
000082	.07	.0033*	.29
0001	.07	.004	.18
0001*	.14	.004*	.36
0003	.07	.005	.29
001	.14	.006	.19
0011	.07	.01	.23

Fig. B. .001 mf, 8c; .006 mf, 19c; .01 mf .29c

Brand NEW Made to Rigid Gov't Specs

Core, Oil Impreg. 1400vct/30ma, 6.3v/4a, 5v/3a H'Sid. 4.98
1000vct/150ma, 300v Bias, 6.3/3a 5v/3a, 2x6.3v/65a, 6.3v/1.25a H'Sid. 4.50

TRANSFORMERS

15 V 60 cye Input TV & CR Pwr Xfmr for 7" to 20" Tubes. HI VOLTS to 20KV (w/quadripole ckt). ALL Tubes, PL & HL wngds divrtng, 30V VDC/97.5A Full Va. 6.4V/10.3A, 5.4V/8A, 2.5V/3A Hypersil 58.98

1000vct/45ma, 795vct/80ma & 360 vct/55ma, 3x5v/3a, 6.3vct/1a, 6.3vct/3a, Csd HVInsl. 3.98
900v/35ma, 2x2.5v/2a, H'Sid HVIns. 2.98
700vct/100ma, 115v/100ma, 2x6.3V/1a, 5v/2a, Csd HVInsl. 2.98
570v/150ma, 5v/3a, 12v/4a, H'Sid HVIns 3.29
480vct/80ma, 6.3vct/4a, 5v/3a, 4.189
420vct/120ma, 6.3v/1.9a Wngds G-12-24-115vdc & 115/230vac. 1.98
360vct/340ma, 2x6.3vct/3a HVIns. 3.29
220v/80ma, 6.3v/2a, G-12-24-115vdc & 115/230vac. 1.89

RCA UNIV OUTPUT XFMR

10V, to 10KC. Matches ANY Line or Spkrs w/VC's 3 to 4 or 150 ohms on ANY Load & W/100 to 50 1000 ohms. Over 1000 combinations! Acts as EXG Band Pass Filt or Freq. Attn Unit for Dyn Mike, Cds, BAs or LOWS. IDEAL Lazy Q.5 action C'wv Phone. Gets ONLY Signal you WANT to hear. W/dta \$1.89; 3 for \$4.98.

SUBMINIATURE TUBES

Never Before At These LOW Prices:

2E32	1.19	CK330AX	50.89
2E32	1.19	CK330DX	.98
CK301AX	1.26	CK330DX	.98
CK301DX	1.26	CK341DX	.98
CK302AX	1.89	CK342DX	.98
CK303X	1.89	CK343DX	.98
CK305AX	1.29	CK344DX	.98
CK306AX	1.79	CK351AX	1.89
CK309AX	1.26	CK367E	1.98
CK312AX	1.79	CK367E	2.48
CK329AX	1.79	CK368T	1.89
CK325AX	1.39	CK3702*	.98
CK326AX	1.98	CK365CX	5.98
CK328AX	1.98	CK3703	1.25
CK331DX	.98	CK3703	5.79
CK332DX	.98	CK3704	.98
CK334AX	1.39	CK3819CX	2.98
	.89	CK3875	3.59
		CK3875	1.98

Fig. C. Solder Lug Terminals & Mtg Holes

Mfd. Each Mfd. Each			
600 WV	50.24	.02	\$0.65
.001	.35	.03	\$0.68
.002	.41	1200 WV	
.003	.41	.002	\$0.55
.004	.43	.004	.57
.005	.45	.005	.57
.006	.49	.01	.65
.008	.53	2500 WV	
.01	.55	.00047	\$0.49

PLATE TRANSFORMERS

7500V or 15000V Obtr/35ma. \$18.95
3000V/10ma, Csd HVInsl. 4.50
1800V/4ma, H'Sid. HVIns. 3.29
1200V/300ma, 6.3v/1a CSD HVIns. 4.98
490 & 355vct/325ma Csd HVIns. 4.98
2x220vct/10ma (or 600vct) H'Sid. .98

FILAMENT TRANSFORMERS

2x5V/12A ca. Wngd/12.5Kv Ins. 58.98
6.3vct/4A (stud 6.5A) H'Sid HVIns. 1.69
12V/2A ca. 5.39; 6.3v/6A. 5.95
2.5V/2A. .69; 7.5vct/12A. 4.98
24v/6a csd. .3.89; 24v/2a csd. 1.59

TV CONICAL ANTENNA (DUBL-X)

Sturdy Prefab Const Versatile 72, 150 or 300 ohm Match. Incl. 8 elements. Cross Bar & Hd'ware. Brand New. Only \$4.98
DUBL-Stacked Conical Array. Similar above, but with 16 elements & all hardware plus 2 crossbars. Brand New \$9.49

NEW GERMANIUM CRYSTAL DIODES

CK705	1N34, 1N43, 1N48	\$0.77
CK706	1N60, 1N64	.54
CK707	1N47, 1N63	1.80
CK708	1N48	3.98
CK709	1N40	3.98
CK710	1N21B, 1N28, G-7	1.35

Fig. D. Screw Terminals & Mtg Holes

Mfd. Each Mfd. Each				
600 WV	50.24	.01	1200 WV	
.001	.35	.01	\$0.65	
.002	.41	.013	\$0.75	
.003	.41	.033	1.59	
.004	.43	.004	\$0.49	
.005	.45	.0082	.55	
.006	.49	.02	.55	
.008	.53	.022	.89	
.01	.55	.035	.98	
		.039	.99	
		.043	1.09	
		.043	1.09	
		.05	1.19	
		.06	1.59	
		.07	1.79	
		.08	1.79	
		.09	1.79	
		.10	1.79	
		.15	1.79	
		.20	1.79	
		.25	1.79	
		.30	1.79	
		.35	1.79	
		.40	1.79	
		.45	1.79	
		.50	1.79	
		.55	1.79	
		.60	1.79	
		.65	1.79	
		.70	1.79	
		.75	1.79	
		.80	1.79	
		.85	1.79	
		.90	1.79	
		.95	1.79	
		1.00	1.79	
		1.05	1.79	
		1.10	1.79	
		1.15	1.79	
		1.20	1.79	
		1.25	1.79	
		1.30	1.79	
		1.35	1.79	
		1.40	1.79	
		1.45	1.79	
		1.50	1.79	
		1.55	1.79	
		1.60	1.79	
		1.65	1.79	
		1.70	1.79	
		1.75	1.79	
		1.80	1.79	
		1.85	1.79	
		1.90	1.79	
		1.95	1.79	
		2.00	1.79	
		2.05	1.79	
		2.10	1.79	
		2.15	1.79	
		2.20	1.79	
		2.25	1.79	
		2.30	1.79	
		2.35	1.79	
		2.40	1.79	
		2.45	1.79	
		2.50	1.79	
		2.55	1.79	
		2.60	1.79	
		2.65	1.79	
		2.70	1.79	
		2.75	1.79	
		2.80	1.79	
		2.85	1.79	
		2.90	1.79	
		2.95	1.79	
		3.00	1.79	
		3.05	1.79	
		3.10	1.79	
		3.15	1.79	
		3.20	1.79	
		3.25	1.79	
		3.30	1.79	
		3.35	1.79	
		3.40	1.79	
		3.45	1.79	
		3.50	1.79	
		3.55	1.79	
		3.60	1.79	
		3.65	1.79	
		3.70	1.79	
		3.75	1.79	
		3.80	1.79	
		3.85	1.79	
		3.90	1.79	
		3.95	1.79	
		4.00	1.79	
		4.05	1.79	
		4.10	1.79	
		4.15	1.79	
		4.20	1.79	
		4.25	1.79	
		4.30	1.79	
		4.35	1.79	
		4.40	1.79	
		4.45	1.79	
		4.50	1.79	
		4.55	1.79	
		4.60	1.79	
		4.65	1.79	
		4.70	1.79	
		4.75	1.79	
		4.80	1.79	
		4.85	1.79	
		4.90	1.79	
		4.95	1.79	
		5.00	1.79	
		5.05	1.79	
		5.10	1.79	
		5.15	1.79	
		5.20	1.79	
		5.25	1.79	
		5.30	1.79	
		5.35	1.79	
		5.40	1.79	
		5.45	1.79	
		5.50	1.79	
		5.55	1.79	
		5.60	1.79	
		5.65	1.79	
		5.70	1.79	
		5.75	1.79	
		5.80	1.79	
		5.85	1.79	
		5.90	1.79	
		5.95	1.79	
		6.00	1.79	
		6.05	1.79	
		6.10	1.79	
		6.15	1.79	
		6.20	1.79	
		6.25	1.79	
		6.30	1.79	
		6.35	1.79	
		6.40	1.79	
		6.45	1.79	
		6.50	1.79	
		6.55	1.79	
		6.60	1.79	
		6.65	1.79	
		6.70	1.79	
		6.75	1.79	
		6.80	1.79	
		6.85	1.79	
		6.90	1.79	
		6.95	1.79	
		7.00	1.79	
		7.05	1.79	
		7.10	1.79	
		7.15	1.79	
		7.20	1.79	
		7.25	1.79	
		7.30	1.79	
		7.35	1.79	
		7.40	1.79	
		7.45	1.79	
		7.50	1.79	
		7.55	1.79	
		7.60	1.79	
		7.65	1.79	
		7.70	1.79	
		7.75	1.79	
		7.80	1.79	
		7.85	1.79	
		7.90	1.79	
		7.95	1.79	
		8.00	1.79	
		8.05	1.79	
		8.10	1.79	
		8.15	1.79	
		8.20	1.79	
		8.25	1.79	
		8.30	1.79	
		8.35	1.79	
		8.40	1.79	
		8.45	1.79	
		8.50	1.79	
		8.55	1.79	
		8.60	1.79	
		8.65	1.79	
		8.70	1.79	
		8.75	1.79	
		8.80	1.79	
		8.85	1.79	
		8.90	1.79	
		8.95	1.79	
		9.00	1.79	
		9.05	1.79	
		9.10	1.79	
		9.15	1.79	
		9.20	1.79	
		9.25	1.79	
		9.30	1.79	
		9.35	1.79	
		9.40	1.79	
		9.45	1.79	
		9.50	1.79	
		9.55	1.79	
		9.60	1.79	
		9.65	1.79	
		9.70	1.79	
		9.75	1.79	
		9.80	1.79	
		9.85	1.79	
		9.90	1.79	
		9.95	1.79	
		10.00	1.79	

MODULATION AND AUDIO XFMRs

MODUL/240 Watts Peak PP Pwr 107's to PP807's RF 2000 ohm Load STANCOR 3.95
OUTPT/500 Watts 3600 or 900 to 30 or 60 ohms/2.5KvIns AMER-TUBAN 12.95
UNIV OUTPT/12 Watts Any Tube Any Voice Coil UTAH 5999. 1.39
Line Auto Former 30V UTAH 11 Mike or Line to Grid "bouncer" UTC 0-14 50:1/200 ohms to 1/2 meg \$13 List. 2.98
OUTPT/300 Watts Hi-Fi PP805 to 9 ohm VC. WEco H'Sid HVIns. 12.98

FILAMENT CHOKES

8M/150ma New UTC cored T'rd 2 for \$1.98
12M/300ma, Csd. 3 for 1.00
3M/40ma, Csd. 2 for 1.00
50H/125ma, Csd. 1.95
Dual 24v/300ma. 2.19
10H/30ma, Csd HVInsl. 1.95

SNOOPSCOPE

Image-Converter Tube HiSense! Type simplified design dia. 1.5" W/1000 Line-Resolution up to 350 Lines/in. Complete data & tube. "TAB" SPECIAL each \$4.98; 2 for \$9.49.

CATHODE RAY TUBES

2AP1	54.85	5CP1	51.75
2AP5	7.98	5CP7	3.39
2AP6	1.05	6CP1	4.81
3BP1	2.49	6CP1	5.25
3BP1A	14.98	6HP1	4.95
3BP1-S1	2.57	6HP1	9.95
3BP1A	3.00	6HP1	39.95
3DP1-S2	4.65	5P2	9.45
3DP1	1.60	5P1	1.45
3HP1	4.89	5N1	3.98
3HP1A	2.85	7BP7	4.05
3HP14	1.48	7CP1	12.95
3J1	15.00	9LP7	10.98
4AP10	4.35	12DP7	12.45
5AP10	1.05	12CP7	12.00
5BP1	2.25	905	2.45
5BP4	4.50	910/3AP1	4.63

Fig. E. Upright Xmtg Micacs

Mfd. Each Mfd. Each				
250 VDC	50.39	.005	3000 VDC	1.35
.05	.59	.008	1.49	
.2	1.50	.015	3500 VDC	1.49
.4	3.75	.030	5000 VDC	1.49
.8	9.00	.060	7500 VDC	1.49
1.6	18.00	.120	10000 VDC	1.49
3.2	36.00	.240	15000 VDC	1.49
6.4	72.00	.480	20000 VDC	1.49
12.8	144.00	.960	25000 VDC	1.49
25.6	288.00	1.920	30000 VDC	1.49