

RADIO & TELEVISION NEWS

JUNE 1950

RADIO-ELECTRONIC ENGINEERING EDITOR

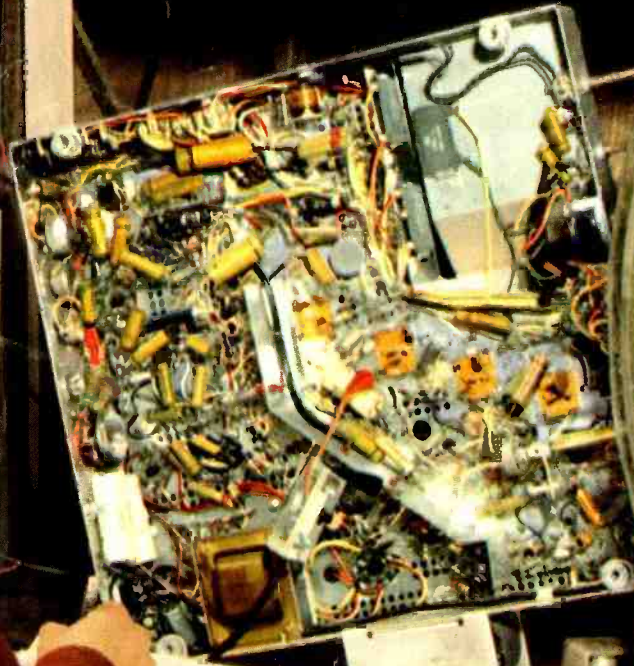

QUALITY OF TELEVISION RECEIVERS MAINTAINED BY "TYPE-TESTING" Page 39

Built for Service . . . **SINCE 1950**

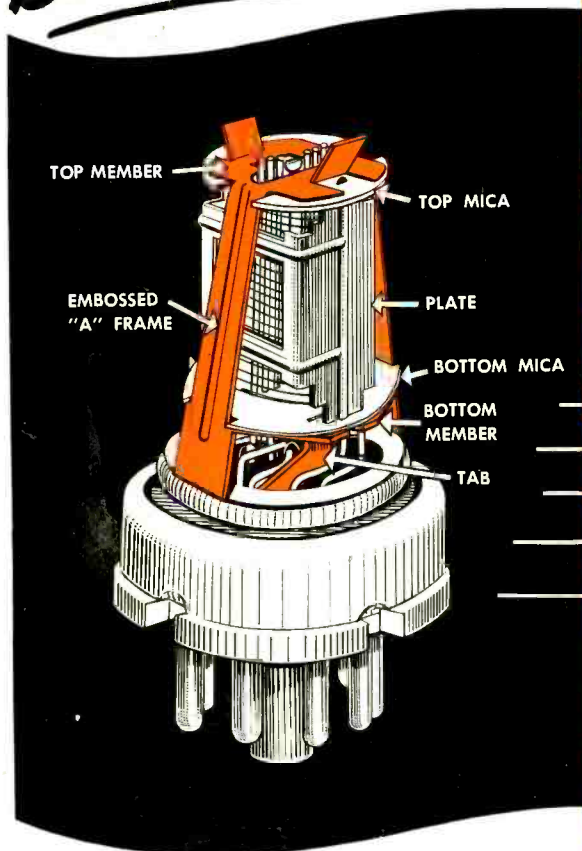

The inside story of *Cunningham* quality

2. How the Cunningham "A" Frame Minimizes Vibration. The unflagging search for ways to make Cunningham tubes ever better accounts for their *first-line* quality. A case in point is the RCA-developed "A" frame construction used in 6 of the metal-type r-f amplifier tubes.

The "A" frame—shown in color—consists of a top member, two vertical members, and a bottom cross member. The ribbed uprights are welded to the cross member; the feet of the uprights are welded to the grounded metal header. In effect a truss, this rigid "A" frame acts as the supporting member for the tube elements. Its increased resistance to vibration reduces the possibility of electrode displacement due to wear on the holes in the mica spacers . . . and thereby plays an

important role in reducing microphonics and maintaining uniform tube characteristics.

In addition to imparting rigidity to the tube elements, the top and bottom members of the "A" frame serve as shields. The two ears on the top member add to its effectiveness in reducing grid-to-plate capacitance; the tab on the lower member—which extends down to the stem—provides additional shielding between grid and plate leads.

The "A" frame construction is but one of many improvements that contribute to the dependability and long life of Cunningham tubes. Its use explains why more and more servicemen are placing their confidence in Cunningham.

ALWAYS KEEP IN TOUCH WITH YOUR CUNNINGHAM DISTRIBUTOR



RADIO CORPORATION of AMERICA
ELECTRON TUBES
HARRISON, N. J.

You Practice COMMUNICATIONS

I Send You Parts To Build This Equipment

As part of my new Communications Course I send you parts to build your own Transmitter. Conduct actual procedure demanded of Broadcast Station Operators, practice many interesting experiments and tests, learn how to put a transmitter on the air.



BE A RADIO-TELEVISION TECHNICIAN

You Practice Radio SERVICING

On This Modern Radio You Build With Parts I Send

As part of my Servicing Course, I send you the speaker, tubes, chassis, transformer, loop antenna, EVERYTHING you need to build this modern Radio Receiver that brings in local and distant stations. You use it to conduct many tests and experiments.



Learn Servicing or Communications

by Practicing in Spare Time

with MANY KITS OF PARTS I Send

YOU BUILD this Tester as part of my Servicing Course. It soon helps you earn \$5, \$10 and more a week EXTRA MONEY fixing neighbors' Radios in spare time while learning.



YOU BUILD this Power Pack as part of my new Communications Course. Use it to conduct fascinating experiments with frequency amplifiers and multipliers, buffer stages, etc.



YOU BUILD this Superheterodyne Receiver Circuit and conduct Frequency Modulation experiments and many other tests as part of my Servicing Course.



YOU BUILD this Signal Generator as part of my Servicing Course for more valuable experience. It provides amplitude-modulated signals for many interesting tests and experiments.



VETERANS

GET THIS TRAINING

UNDER G. I. BILL MAIL COUPON

YOU BUILD this Wavemeter as part of my new Communications Course. Use it with Oscillator you also build that furnishes basic power to transmitter and determines transmitter frequency.



J. E. SMITH, President National Radio Institute

Want a good-pay job in the fast-growing Radio and Television industries or to be boss of your own money-making Radio and Television shop? I've trained hundreds of men with no previous experience to be Radio technicians. I can do the same for you! Or now, for the first time, enroll in my new practical course in Radio—Television Communications—learn to be a Broadcasting and Communications technician. You learn Radio and Television principles from clear, illustrated lessons. You get practical Radio experience with MANY KITS OF PARTS I SEND in my train-at-home method. All equipment yours to keep.

MAKE EXTRA MONEY IN SPARE TIME

As part of my Radio Servicing Course, I send EXTRA MONEY booklets, starting the day you enroll. Use your know-how to make \$5, \$10 and more a week EXTRA MONEY fixing Radios in spare time while training. The next step is your own Radio shop or a good-pay Radio servicing job. Or, if you prefer, get into Government, Police, Aviation or Marine Radio, Broadcasting, Radio Manufacturing or Public Address Work.

BRIGHT FUTURE IN TELEVISION

Think of the present and future opportunities in the fast-growing Television field. New stations are going on the air every month. . . . Television manufacturers are producing over 100,000 sets a month. It's a fast-growing field and the man who knows Television will be in demand.

GET ACTUAL LESSON AND BOOK FREE

Send now for my special DOUBLE FREE OFFER. Get actual lesson on Radio Repairing short-cuts absolutely free. Also get 64-page book, "HOW TO BE A SUCCESS IN RADIO—TELEVISION—ELECTRONICS." See how quickly, easily you can start. J. E. SMITH, President, Dept. OFR, National Radio Institute, Pioneer Home Study Radio School, Washington 9, D. C.

I TRAINED THESE MEN AT HOME



Good Job In Radio Station
"Am Chief Engineer of Station W O R D, in charge of four men. Owe all I know about Radio to NRI."—CLYDE J. BURDETTE, Spartanburg, South Carolina.



Makes Extra Cash In Spare Time
"Earned enough spare time cash to pay for my course by time I graduated. NRI training is tops!"—ALEXANDER K. ISH, Carteret, New Jersey.



Operates Own Radio Business
"Now have two Radio shops servicing about 200 sets a month. Have largest service establishment in Southeast Missouri."—ARLEY STUDYVIN, DeSoto, Mo.

MAIL COUPON! FIND OUT ABOUT THIS TESTED WAY TO BETTER PAY

Good for Both—FREE

MR. J. E. SMITH, President, Dept. OFR National Radio Institute, Washington 9, D. C.

Mail me FREE Sample Lesson and 64-page book about how to win success in Radio and Television—Electronics. (No salesman will call. Please write plainly.)

Name.....Age.....

Address.....

City.....Zone.....State.....

Check If Veteran APPROVED FOR TRAINING UNDER G. I. BILL

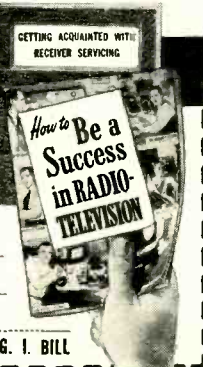

Editor
OLIVER READ, Litt.D., W9ETI

Managing Editor
WM. A. STOCKLIN, B.S.

Technical Editor
H. S. RENNE, M.S.

Associate Editor
RAY FRANK, W9JU

Contributing Editor
R. HERTZBERG, W2DJJ

Television Consultant
MILTON S. KIVER

Short-Wave Editor
KENNETH R. BOORD

Editorial Assistants
I. M. CARROLL

E. V. HITZEL

P. B. HOEFFER

Staff Artist
R. S. KUPJACK

Advertising Manager
L. L. OSTEN

Midwest Adv. Manager
JOHN A. RONAN, JR.

Art Director
HERMAN R. BOLLIN

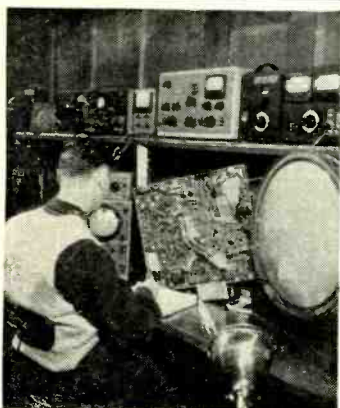

COVER PHOTO: John J. Mihalik compiles performance data on a production model television receiver at Allen B. Du Mont Laboratories, Inc. (Kodachrome by V. Stack, Du Mont)

Chairman of the Board and Publisher
WILLIAM B. ZIFF

President
B. G. DAVIS

Secretary-Treasurer
ARTHUR T. PULLEN

Vice-Presidents
MICHAEL H. FROELICH
Dir. Eastern Div.

H. J. MORGANROTH
Production Director

H. G. STRONG
Circulation Director

BRANCH OFFICES
NEW YORK (17)
336 Madison Ave., MUrray Hill 7-8080

LOS ANGELES (14)
815 S. Hill St., TUcker 9213
Manager, WILLIAM L. PINNEY

RADIO & TELEVISION NEWS

First in
radio-television-electronics

Average Paid Circulation over 200,000

Radio News Trademark Reg. U.S. Pat. Office No. 378427 • Television News Trademark Reg. U.S. Pat. Office No. 517468
Radio & Television News Trademark Reg. U.S. Pat. Office No. 517025

CONTENTS

JUNE, 1950

Custom-Built Projection TV Is Still Profitable.....	David T. Armstrong	35
Quality Control by "Type Testing".....	Carl Gartner	39
A Portable 40-Meter C.W. Station.....	Harold C. Gould, W1KWU	40
A 500 Watt R.F. Amplifier for the Ham.....	Harry D. Hooton, W3KPK	42
RCA's New Direct-view Tri-color Kinescopes.....		46
Mac's Radio Service Shop.....	John T. Frye	48
Cathode Follower Driven Amplifier.....	J. Carlisle Hoadley	49
Improving Response of Home-Assembled Coaxial Speakers.....	Norman V. Becker	52
Simplified Ham TV Station (Part 2).....	J. R. Popkin-Clurman, W2LNP	53
The Turret Type TV Tuner.....	Daniel Lerner	58
Wheatstone Bridge Applications.....	Michael Wolfe	61
Mobile Antenna for 75 Meters.....	R. W. Jones, W6EDG	62
New Applications for Crystal Diodes.....	Rufus P. Turner, K6AI	64
Linearity Tests with an Oscilloscope.....	Glen Southworth	66
An Audio Oscillator and V.T.V.M.	Loren C. Watkins, Jr., W5JXO	68
Easily-built 10 kc. to 1 mc. Multivibrator.....	Guy Dexter	75
Customers Can Be Friends, Too!.....	Phil Hiner	96
Microwave Quiz.....	Ed Bukstein	104
Shock Mounting of Vacuum Tubes Can Be Simple Yet Effective.....	Robert E. Prouty	114
How Do You Figure Profit?.....	Harold J. Ashe	132
A.C.-D.C. Conversion of BC-1206.....	Otto L. Woolley, WØSGG	142
Foreign Set Ownership.....		156

DEPARTMENTS

For the Record.....	The Editor	8	What's New in Radio.....	89
Spot Radio News.....		16	New Portable Receivers.....	106
Within the Industry.....		26	New TV Products.....	119
Short-Wave.....	K. R. Boord	60	Manufacturers' Literature.....	126
MARS.....		81	Letters from Our Readers.....	136
Technical Books.....		84	AFCA News.....	152



COPYRIGHT 1950
ZIFF-DAVIS PUBLISHING COMPANY
185 North Wabash Ave., Chicago 1, Ill.
VOLUME 43 • NUMBER 6



Member
Audit Bureau of
Circulations

RADIO & TELEVISION NEWS is published monthly by the Ziff-Davis Publishing Company, 185 N. Wabash Ave., Chicago 1, Ill. Subscription rates: in the United States \$4.00 (12 issues), single copies 35c; in Canada \$4.00 (12 issues), single copies 40c; in Mexico, South and Central America, and U. S. Possessions, \$4.00 (12 issues); in British Empire, \$5.00 (12 issues)—all other foreign countries \$5.00 (12 issues). RADIO-ELECTRONIC ENGINEERING Edition subscription rates: in the U. S. \$6.00 (12 issues), single copies 50c; in Canada \$6.00 (12 issues), single copies 60c; in Mexico, South and Central America, and U. S. Possessions, \$6.00 (12 issues); in British Empire, \$7.00 (12 issues)—all other foreign countries \$7.00 (12 issues). Subscribers should allow at least 2 weeks for change of address. All communications about subscriptions should be addressed to: Director of Circulation, 185 N. Wabash Ave., Chicago 1, Ill. Entered as second class matter July 21, 1948, at the Post Office, Chicago, Illinois, under the Act of March 3, 1879. Entered as second class matter at the Post Office Dept., Ottawa, Canada. Contributors should retain a copy of contributions and include return postage. Contributions will be handled with reasonable care but this magazine assumes no responsibility for their safety. Accepted material is subject to whatever revisions and byline changes that are necessary. Payment made at our current rates, covers all authors' contributors' or contestants' rights, title and interest in and to accepted material, including photographs and drawings.

RADIO & TELEVISION NEWS

Want To Double Your Pay?



How To Pass **FCC** **COMMERCIAL** RADIO OPERATOR **LICENSE** **EXAMINATIONS**

GET THIS AMAZING NEW BOOKLET FREE!

Add Technical Training to Your Practical Experience and

GET YOUR **FCC** **COMMERCIAL** RADIO OPERATOR **LICENSE**

IN A MINIMUM OF TIME!

It's **EASY** if you use **CIRE** Simplified Training & Coaching **AT HOME** in **SPARE TIME**

Get your license easily and quickly and be ready for the jobs open to ticket holders eventually paying \$3000 to \$7500 (average pay reported by FCC nationwide survey).

Ours is the **ONLY** Home Study Course of Coaching and Training Primarily Planned to Lead Directly to an FCC Commercial License

CIRE Job-Finding Service

Brings Amazing Offers of Jobs!

"I am working at WRJM as transmitter engineer, and I received this position in response to one of the employment applications sent me upon completion of my course and the receiving of my Diploma. I received my 1st class Radiotelephone License on March 2, 1949. I want to express my sincere appreciation to the staff of CIRE."

George Hugo, 1141 Townsend Ave., New Haven, Conn.

"Thanks for the Application for Employment you recently prepared for me. I found satisfactory employment. I submitted 57 letters, enclosing the résumé you supplied. I received 17 letters indicating my application was filed for future reference; 3 telephone calls, and one letter requesting personal interviews."

"As a result, I am employed in a development engineering capacity."

Kenneth Forsberg, 26 Soler St., Charlestown, Mass.

A NEW CIRE SERVICE When you get your FCC License your name is automatically mailed to every Chief Engineer in the U.S.A. every month, until you get a job. Find out how this new service can help you get the job you want.

CLEVELAND INSTITUTE OF RADIO ELECTRONICS
Desk RN-18 • 4900 Euclid Bldg • Cleveland 3, Ohio
Approved for Veteran Training under the "G. I. Bill of Rights"

June, 1950

1. Tells of Thousands of Brand-New, Better Paying Radio Jobs Now Open to FCC License Holders.
2. Tells How We Guarantee to Train and Coach You Until You Get Your FCC License.
3. Tells How Our Amazing Job-Finding Service Helps You Get the Better Paying Radio Job Our Training Prepares You to Hold.

YOUR FCC TICKET IS ALWAYS RECOGNIZED IN ALL RADIO FIELDS AS PROOF OF YOUR TECHNICAL ABILITY



Get All 3 FREE Send Coupon Now!

CLEVELAND INSTITUTE OF RADIO ELECTRONICS
Desk RN-18—4900 Euclid Bldg., Cleveland 3, Ohio
(Address to Desk No. to avoid delay)

I want to know how I can get my FCC ticket in a minimum of time by training at home in spare time. Send me your amazing new FREE booklet "Money Making FCC License Information" as well as a FREE sample FCC-type exam and FREE booklet, "How to Pass FCC License Examinations" (does not cover exams for amateur License).

Name

Address

City Zone State

Veterans check for enrollment information under G.I. Bill

Another **NATIONAL** First!
TELEVISION

A SENSATIONAL NEW BOOSTER FEATURING A TURRET TUNER

The turret tuner is recognized as the most efficient television input tuning device yet designed because of (1) its exceptionally high gain and (2) its uniform bandwidth on all channels. It is used in today's finest television receivers. Now, for the first time, National makes available all the advantages of a turret tuner in a truly sensational-performing new television booster.

COMPARE THESE FEATURES:

(1) Turret tuner with an individually tuned set of coils for each channel. (2) Removable polystyrene coil-mounting contact panels. (3) A single 6AK5 for maximum usable gain. (4) A built-in power transformer (not AC-DC — no "hot" chassis). (5) Selenium rectifier for long life. (6) Channel selector and fine tuning in a single, easy-to-operate, dual-purpose control. (7) Pilot light illuminates selected channel.

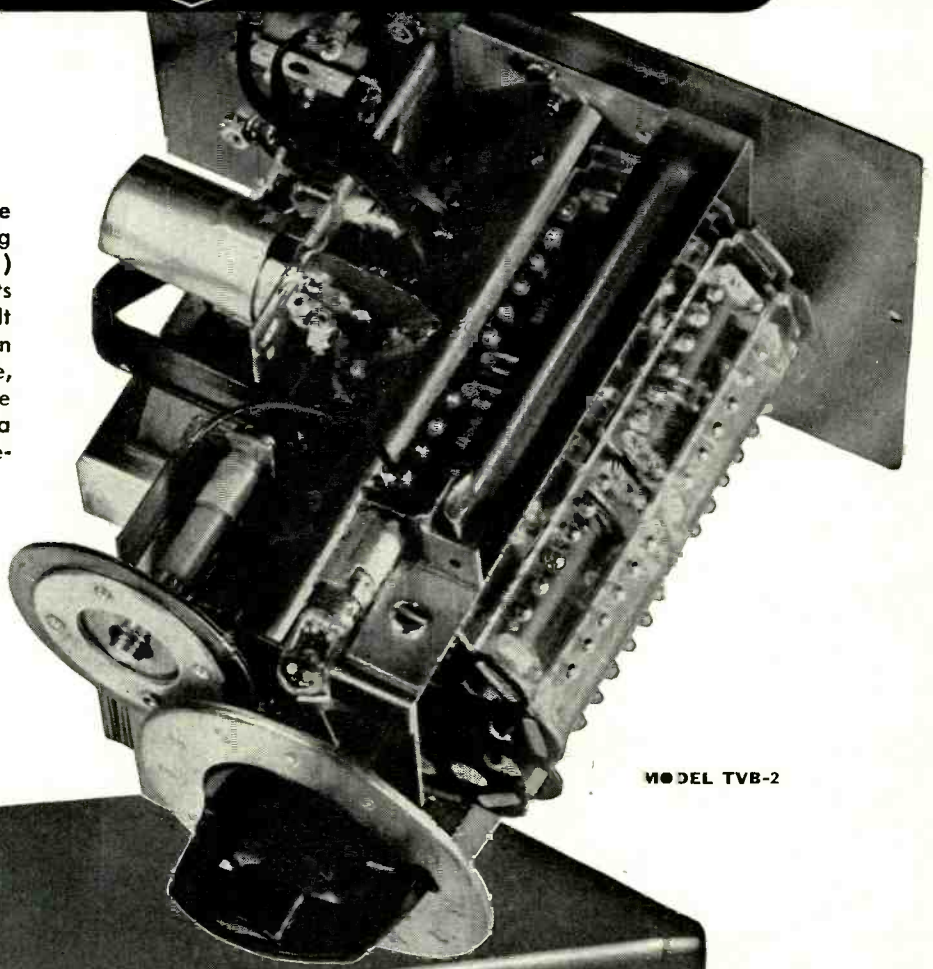

MODEL TVB-2

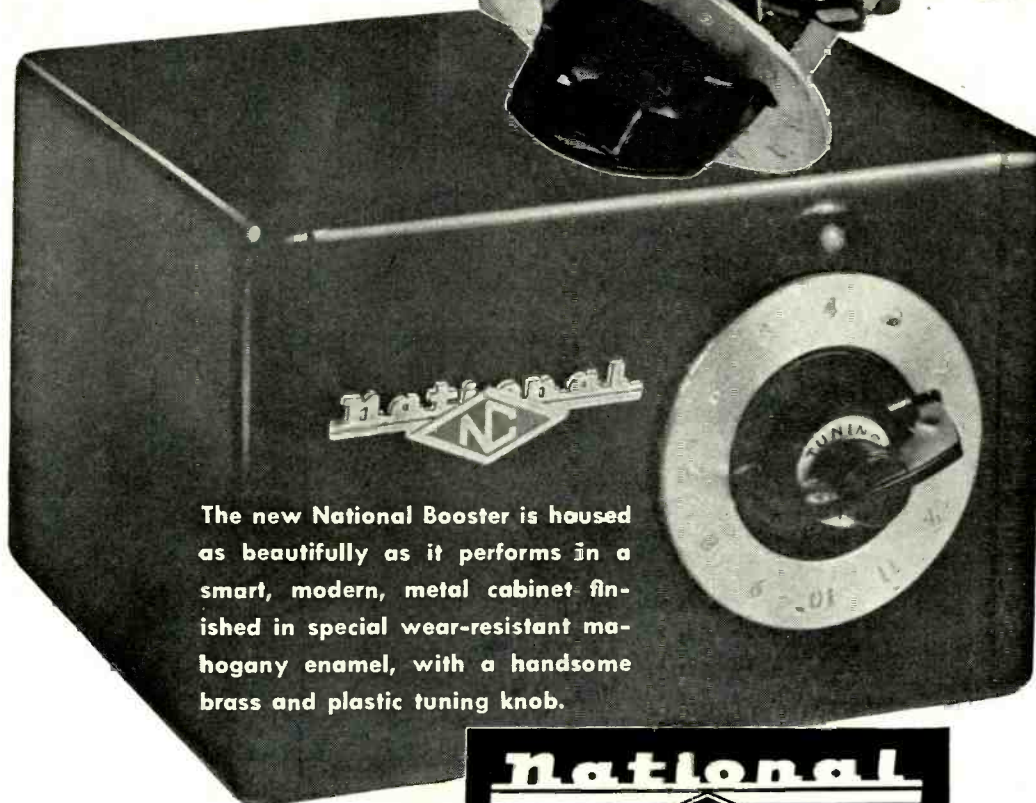

The new National Booster is housed as beautifully as it performs in a smart, modern, metal cabinet finished in special wear-resistant mahogany enamel, with a handsome brass and plastic tuning knob.

\$39.95
list price

P.S. No other booster has a turret tuner!



RADIO & TELEVISION NEWS

TELEVISION



RADIO and ELECTRONICS OFFER YOU

REAL MONEY and REAL JOB OPPORTUNITIES!

OPTIONAL FEATURE BUILD AND KEEP FULL-VIEW 16-INCH RECTANGULAR "BLACK" PICTURE TUBE TELEVISION RECEIVER

PREPARE AT HOME . . . Become a TELEVISION · RADIO · ELECTRONICS TECHNICIAN! No Previous Experience Necessary

Here is everything you need to prepare you at home for FASCINATING WORK, GOOD MONEY and a THRILLING FUTURE in one of America's most promising fields. This includes the opportunity to build and keep the top-quality 16 inch rectangular picture tube television receiver shown above or a 10 or 12½ inch ROUND picture tube set . . . if you choose. No matter which tube you select, you will get bright, sharp, steady pictures. This is an optional feature—available at slight additional cost when you complete your training described below. Get the complete facts. See how D.T.I.'s wonderfully practical method meets industry's needs. No previous experience needed. Mail coupon today!

16 Big Shipments of Parts — Plus Lessons
Work over 300 electronic experiments and projects from 16 big shipments of parts. This includes building and keeping all test equipment and radio set shown at left side of page. Modern easy-to-read lessons with handy fold-out diagrams simplifies your entire training.

You Also Use Home Movies
D.T.I., alone, includes the modern, visual training aid . . . MOVIES to help you learn faster, easier at home. See electrons on the march and other fascinating "hidden action" — a remarkable home training advantage that speeds your progress.

EMPLOYMENT SERVICE
When you complete your training, our effective Employment Service helps you get started toward a real future in Television-Radio-Electronics.

Modern Laboratories
If you prefer, you can get ALL your preparation in our new, Chicago training laboratories . . . one of the finest of its kind. Ample instructors . . . modern equipment. Write for details!



LEARN-BY-DOING



LEARN-BY-READING



LEARN-BY-SEEING

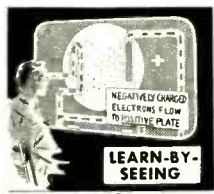

MAIL THIS COUPON TODAY!

DeFOREST'S TRAINING, INC.
2533 N. Ashland Ave.,
Chicago 14, Illinois

RN-G-6

If under 16, check here for special information.

Without obligation, give me complete facts showing how I may make my start in Television-Radio-Electronics.

Name _____ Age _____
Street _____ Apt. _____
City _____ Zone _____ State _____

DeForest's Training, Inc.
CHICAGO 14, ILLINOIS
A DeVry Institution



light or
HEAVY
soldering

DO
BOTH
WITH

New 250-watt
WELLER GUN



RIGID-TIP

5-SECOND
HEATING

STREAMLINED

LONGER REACH

SOLDERLITE

DUAL HEAT

single heat
200 watts;
dual heat
200/250 watts;
115 volts
60 cycles.

You'll save on tools and time with the new Weller Soldering Gun WD-250. Whether the job is rugged or delicate, your Weller Gun does it with the same ease and efficiency. Chisel-shaped RIGID-TIP provides more soldering area for faster heat transfer. New "over-and-under" terminal design gives bracing action to tip. Your Weller Gun is light-weight and compact, gets into the tightest spots.

Weller Guns actually pay for themselves in a few months. Fast 5-second heating saves time on every job. Trigger-switch control saves power—no need to unplug gun between jobs. Prefocused spotlight and longer length mean easy soldering, even when the job's buried deep. No other soldering tool gives you so many time-and-money-saving features. Order your new 250-watt Weller Gun from your distributor today, or write for bulletin direct.

SOLDERING GUIDE Get your copy of "SOLDERING TIPS"—new fully illustrated 20 page booklet of practical soldering suggestions. Price 10c at your distributor's or order direct.



WELLER
MANUFACTURING COMPANY

810 Packer Street, Easton, Pa.

For the **RECORD.**

BY THE EDITOR

TELEVISION ANTENNA INSTALLATIONS

IN THE not too far distant future will emerge a vast u.h.f. television system comprising hundreds of transmitters and many millions of u.h.f. receivers. Television will be available for all to see and viewers will have a choice of black and white or color for their entertainment. These sets will probably be greatly simplified and channels will be restricted to those required in the area in which the set is designed to operate. Channels not needed probably will be eliminated from the circuitry. New audio circuits will be developed and special attention given to the matter of stability, which will be most critical in the u.h.f. region.

It is highly probable that these sets will, except in remote cases, employ built-in antenna systems and will be capable of interference-free reception in practically every town and hamlet in the United States.

In the meantime, however, there exists a situation which is preventing many set owners, particularly in fringe areas, from enjoying their television programs. We refer to sloppy and inadequate outside television antenna installations. Common sense tells us, after seeing typical television arrays, that many customers are literally being robbed of precious signal strength.

We had an occasion recently to drive through several suburbs and cities in the Chicago area. These were industrial centers for the most part and workers lived in modest homes, situated near oil refineries, steel mills, railroad yards, and other manufacturing centers. Hundreds of television antennas were to be seen, many of them close enough for inspection. We paid particular attention to approximately 200 such installations and it became quite obvious that in most cases the antennas and lead-ins were placed at random with little apparent concern or consideration for good engineering practice.

The great majority of those we saw were mounted to chimneys or on poles and many of these arrays were completely enveloped in clouds of smoke. However, the worst examples were to be seen in the manner of connecting the twin-lead from the antenna to the receiver. A great many of these lead-ins were tacked directly to the roof shingles for stretches up to 100 feet in length. Most of these twin-leads lay flat and did not employ a recommended twist which is considered, by most television technicians, as essential.

Many of these twin-leads were casually draped over rain gutters and

others were seen twisted around downspouts before entering the building.

It is amazing how little regard is given by some television technicians to the tremendous loss in signal strength that results from such careless installation. There is apparently no regard given to the leakage to ground of weak signals. Not only does the customer wind up with only a small percentage of the available signal, but the technician is often called in to troubleshoot unnecessarily. The time to make a happy customer is right at the time of installation. A few cents' worth of stand-off insulators can do wonders to improve signal strength, make for a better and neater job, and result in an all-around good installation. Needless to say the inclusion of a lightning arrester is a *must* and any good technician will make sure that he includes one with every installation.

It is common knowledge that in industrial areas there is a high content of carbon deposit from smoke. Considerable conductivity exists on roof tops in such areas. If precautions are not taken to keep transmission lines free of contact with these surfaces, there will naturally be considerable leakage to ground of high frequency signals. By the same token, contact between gutter pipes and transmission lines, particularly twin-leads, can result in severe loss of signal strength, due to the fact that such gutter pipes are grounded. On the other hand, it is highly desirable to ground all metal masts used for supporting television arrays. It affords further protection against lightning and reduces interference caused by the building up of static electricity on antennas, due to high wind velocity.

Another common source of trouble encountered in television antenna systems is contact resistance developed by using regular iron bolts for making electrical connections of the antenna to the lead-in. It is far better to use non-ferrous bolts for such applications, or if these are not available, to use aluminum or other non-rusting materials. All of the above becomes of prime importance when we consider the fact that many television sets are not capable of producing quality pictures unless the input section is provided with adequate signals. Any precautions that can be taken to insure maximum signals from the antenna system are certainly worth-while and will result in better performance to the customer and will alleviate many headaches for the television technician. O.R.

RADIO & TELEVISION NEWS

IT'S ALLIED FOR RCA



**TUBES RECEIVING,
KINESCOPE, INDUSTRIAL
AND BROADCAST TYPES
BATTERIES
PARTS TV & RADIO
TEST EQUIPMENT**

It's RCA for quality! It's ALLIED for dependability! You can count on immediate delivery from ALLIED because we constantly maintain the world's largest stocks of RCA Tubes, Parts, Batteries and Test Instruments. Look to ALLIED first and always—your Headquarters for RCA Parts and Equipment . . .

ALLIED presents 3 NEW RCA TV TEST INSTRUMENTS

RCA WR-59B TV SWEEP GENERATOR. Features continuous IF coverage up to 50 mc, including video and intercarrier sweep ranges; sweep width is 10 mc. Provides output on 13 television RF channels, in steps. Output, 100,000 microvolts rms or better on every range; amplitude varies less than ± 1 db on all ranges. RF output attenuator is balanced capacitor type, and is 20,000-to-1 continuously variable. Has blanking control to provide single image and base line on scope; also has phase control. RF output impedance 300 ohms, balanced to ground. IF/Video Frequency range has 100-ohm termination and single-ended output. Intended for use with Model WR-39B TV Marker Generator, for highly accurate measurement of television receiver bandwidths on oscilloscope, such as WO-57A. Supplied complete with tubes, IF/VF and RF output cables, and instruction manual. Blue-gray Hammeroid case; $9\frac{3}{4} \times 13\frac{1}{2} \times 7\frac{1}{2}$ ". For 105-125 volts, 50-60 cycles AC. Shpg. wt., 35 lbs. **\$274.50**
84-074. NET



\$27.45 down, \$21.80 monthly for 12 months



RCA WR-39B TV MARKER GENERATOR. Crystal-calibrated variable frequency signal generator plus 2 built-in crystal oscillators. Provides dual markers with WR-59B or any sweep generator when measuring receiver bandwidth on scope. Ranges: 19-110 mc in 4 bands: 170-240 mc in 2 bands—all on fundamentals. Variable 100:1 attenuator. Output, 0.1 rms v, 100 ohms. Permits TV set linearity adjustments in absence of test pattern when variable oscillator is modulated by internal crystal or external oscillator. Serves as heterodyne frequency meter; has detector audio amplifier with speaker. Markers removed 4.5 mc and 250 kc from main marker for TV IF and sound discriminator alignment. Provision for external marker injection. Has crystal-controlled 4.5 mc output for alignment of sets with intercarrier sound. Complete with all tubes, 3 crystals and leads. Blue-gray Hammeroid case, $9\frac{3}{4} \times 13\frac{1}{2} \times 7\frac{1}{2}$ ". For operation on 105-125 v, 50-60 cycles. Shpg. wt., 22 lbs. **\$224.50**
84-072. NET

\$22.45 down, \$17.85 monthly for 12 months

RCA WO-57A 3" OSCILLOSCOPE. Features high sensitivity: 25 millivolts/inch deflection. Vertical amplifier response, flat within 3 db from zero to 500 kc, down only 55% at 1 mc and useful beyond 2 mc. Has frequency-compensated and voltage-calibrated step attenuation with vernier control and calibrating voltage source. 60-cycle sweep with phasing control. Separate input jacks for DC and AC signal tests. Linear sweep range is 15 to 30,000 cps. Has exclusive RCA sweep direction-reversing switch—positive or negative syncing. Direct-coupled amplifiers provide low frequency square-wave reproduction essential for correct sweep alignment. High-frequency square-wave response up to 100 kc reproduces blanking and sync pulse wave shapes with excellent fidelity. Provision for external sync. Hammeroid case; $9\frac{3}{4} \times 13\frac{1}{2} \times 8\frac{1}{2}$ ". With tubes, type WG-214 probe to reduce input capacity to 10 mmf., cable assembly, and instructions. For 105-125 volts 50-60 cycles AC. Shpg. wt., 20 lbs. **\$145.00**
84-073. NET



\$14.50 down, \$11.50 monthly for 12 months

IT'S ALLIED FOR RCA

**FOR ALL YOUR TV & RADIO NEEDS
SEE YOUR ALLIED CATALOG . . .**

Refer to the Leading Buying Guide—your ALLIED Catalog—for everything in Radio and Television. Get every advantage: largest stocks, fastest shipment, lowest prices, finest personal service—always!



ALLIED RADIO

ALLIED RADIO CORP., Dept. 1-F-O
833 W. Jackson Blvd., Chicago 7, Illinois

- Enter order for RCA Test Instrument Model.
- Enclosed \$ Full Payment
- Send FREE ALLIED Catalog Down Payment

Name

Address

City Zone State

NOW! Convert 10"-12½"

Quickly, Profitably, Easily with

NEW! NORELCO DUO-VUE
 world's first dual-purpose TV offers
 3' x 4' picture — \$199.50 list*

NEW! PROTELGRAM "CONVERSION PACKAGE"
 makes possible huge 234 sq. in.
 picture for trade-in buyers



This 2½" 3NP4 is smallest projection tube on market, is lowest in cost (\$19.50 retail), produces largest home picture (3'x4').

NORTH AMERICAN PHILIPS COMPANY, INC.



PROTELGRAM

North American Philips has really **BIG PROFIT NEWS** for you—and **BIGGER, BETTER PROTELGRAM** TV pictures for your customers, up to 3' x 4' in the sensational **NORELCO DUO-VUE** now making its world premiere at \$199.50 — more television picture for less money than ever before offered!

What is there in it for you? **PROFITS** from **PROTELGRAM'S** Four-Way Plan described on the right.

Philips makes it easy and profitable for you to—

1. Sell **PROTELGRAM** to set builders interested in bigger pictures — 13½" x 18".
2. Sell **PROTELGRAM** for custom-built, large-screen installation, up to 3' x 4' for homes, clubs, bars, hotels, etc.

3. Sell **NORELCO DUO-VUE**, television's newest, finest and biggest picture used with the customer's direct-view table set to produce 3' x 4' pictures on a home-movie screen. A flip of a switch selects either picture, and you can connect **DUO-VUE** to almost any table-model receiver in less than an hour.

4. Sell **PROTELGRAM** in a conversion cabinet to customers wanting to convert their 10 or 12½" direct-view receivers to a picture larger than a 20" tube gives. And you can make the conversion in less than one hour following the simple, straightforward instructions provided.

Right **NOW** is the time to make extra profits with **PROTELGRAM**. Read every word of this ad. Then get in touch with your distributor or send the coupon now for all the facts.

**Prices slightly higher west of Rockies. Connection charges extra.*

NORTH AMERICAN PHILIPS COMPANY, INC.

100 E. 42nd Street, New York 17, N. Y.

16" Sets to BIG PICTURE TV

PROTELGRAM

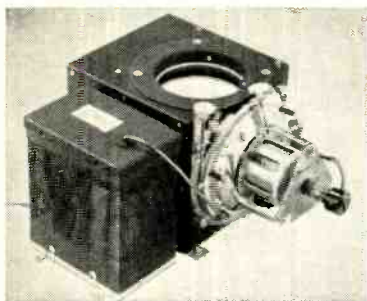

PROTELGRAM UNIT

Projection box measures only 8½" x 9" x 13", contains optical system and alignment assembly, is designed for quick easy service and adjustment. The 2½" 3NP4 projection tube is long-lived, extremely low in cost. Compact 25KV high-voltage unit is only 8½" x 4½" x 7".

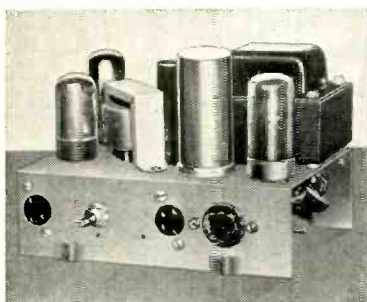

AUXILIARY CHASSIS

New auxiliary chassis fills additional electrical requirements essential to adaption of TV chassis to PROTELGRAM; makes change-over quick and easy. Measures only 8" x 12" x 4".



CONVERSION CABINET

Console cabinet measuring 22" x 27¾" x 46½" provides space for installation of customer's 630 Type TV chassis, comes equipped with complete PROTELGRAM system, auxiliary chassis, cabinet mirror and viewing screen.



NORELCO DUO-VUE

Beautiful cabinet contains PROTELGRAM unit. Only 23½" high. 20" x 26" top holds most any 10" or larger direct-view table model. Concealed ball-bearing casters make it easy to pull out from wall for 3' x 4' viewing on external screen. Offers customers choice of two picture sizes for small and large group viewing.

FOUR-WAY Profit Plan

Sell PROTELGRAM to the man who builds his own!

Thousands of TV kits have been sold to the man who likes to build his own equipment. These handymen are ripe for PROTELGRAM, because they can combine it with a TV chassis, get life-size TV at a reasonable cost.

Sell PROTELGRAM to custom set buyers

Clients who want built-in installations in walls or cabinets are perfect prospects for PROTELGRAM. Huge picture size, plus compactness and flexibility, makes it the answer for this type of user.

Sell PROTELGRAM to trade-in customers

PROTELGRAM sells itself to customers who want bigger pictures, but are reluctant to take a trade-in loss. You can now use their present TV chassis, connect it with PROTELGRAM in a cabinet such as shown at (3) left. They get a 234 square-inch picture, 13½" x 18".

Sell NORELCO DUO-VUE for largest home-TV pictures

Only with NORELCO DUO-VUE can you offer both direct-view and 3' x 4' movie-size TV . . . and at a reasonable price. This is the newest thing in television for your customers who want the best. Lots of sales opportunities in bars, clubs, institutions and hospitals, too.

CONTACT YOUR DISTRIBUTOR OR SEND COUPON TODAY

NORTH AMERICAN PHILIPS COMPANY, INC.
Dept. PK-6, 100 East 42nd Street, New York 17, N. Y.

Gentlemen: Please send full information as checked

- | | |
|---|---|
| <input type="checkbox"/> PROTELGRAM SYSTEM | <input type="checkbox"/> NORELCO DUO-VUE unit |
| <input type="checkbox"/> PROTELGRAM SYSTEM with auxiliary chassis | <input type="checkbox"/> PROTELGRAM SYSTEM for conversion console |

NAME..... POSITION.....

FIRM NAME.....

ADDRESS.....

CITY..... STATE.....

- Check here for Dealer Information on
- | | |
|--|--|
| <input type="checkbox"/> Norelco Electric Shaver | <input type="checkbox"/> Lady Norelco Electric Razor |
|--|--|

CHANNEL MASTER'S

Super-Fan!

BM 313 SERIES

• STRENGTH • RIGIDITY • SENSITIVITY

SUPERSEDES
THE BM 312
FAN FLECTOR
SERIES

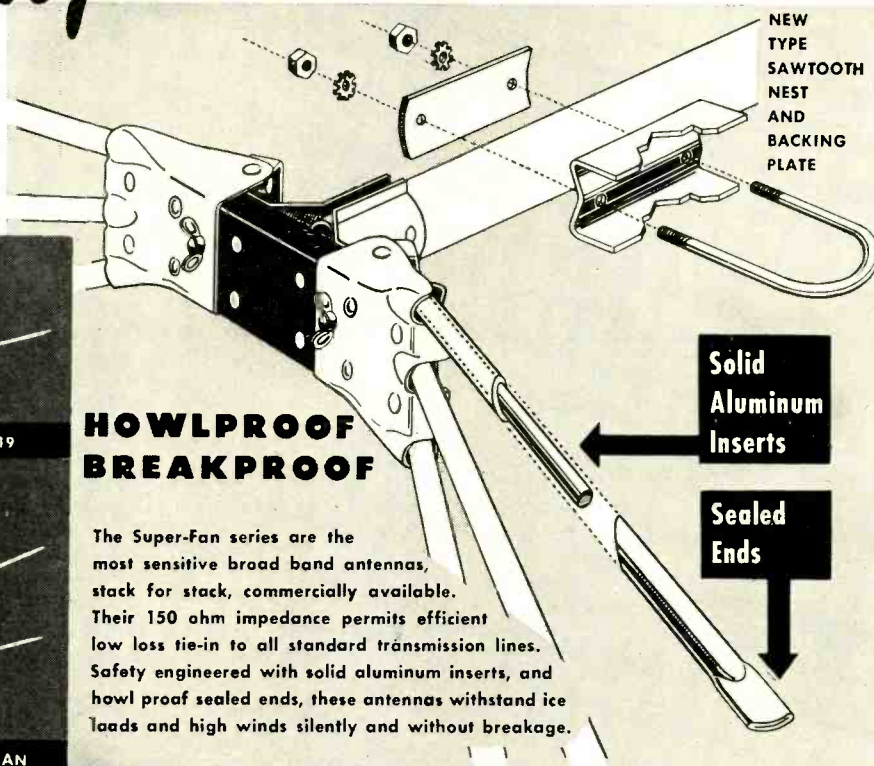

NEW
TYPE
SAWTOOTH
NEST
AND
BACKING
PLATE

- LOWER PRICES
- SMALLER BOX
- SUPERIOR PREASSEMBLY

HOWLPROOF BREAKPROOF

The Super-Fan series are the most sensitive broad band antennas, stack for stack, commercially available. Their 150 ohm impedance permits efficient low loss tie-in to all standard transmission lines. Safety engineered with solid aluminum inserts, and howl proof sealed ends, these antennas withstand ice loads and high winds silently and without breakage.

Solid
Aluminum
Inserts

Sealed
Ends

These models also feature Swing-Lock-Action, the patented preassembled feature of all Channel Master antennas. Just swing out elements and lock them in place — as easy as that.

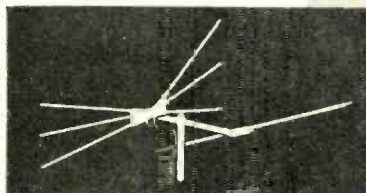

BM 313 SUPER-FAN L:ST 12.19

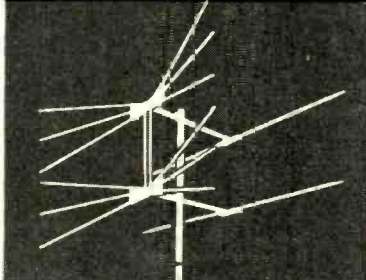

BM 313X2 STACKED SUPER-FAN
L:ST 76.25

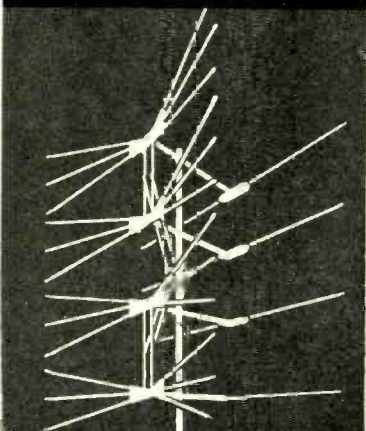

BM 313X4 DOUBLE STACKED SUPER-FAN
LIST 57.10

A TELEVISION SET IS NO BETTER THAN ITS ANTENNA
THERE IS NO BETTER ANTENNA THAN THE SUPER-FAN

Send for **FREE** Technical Literature

GAIN OF THE SUPER-FAN SERIES

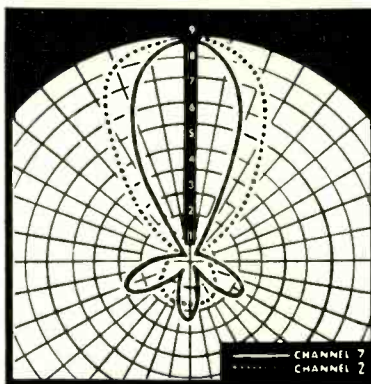

HORIZONTAL POLAR DIAGRAMS

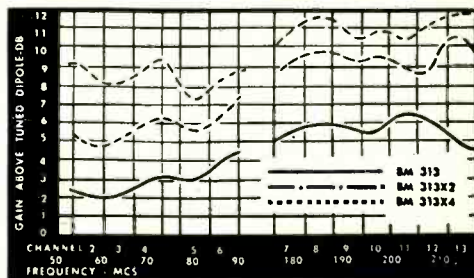

GAIN CURVES

CHANNEL	2	3	4	5	6	7	8	9	10	11	12	13
313	21	22	30	30	40		53	58	54	57	63	60
313X2	40	50	61	57	68		90	97	93	94	98	90
313X4	90	83	90	75	85		110	114	106	108	103	113

GAIN IN DB. ABOVE TUNED DIPOLE



FIRST IN PREASSEMBLED ANTENNAS

ELLENVILLE, N. Y.

IF IT'S NEW...

KEN-RAD DEALERS HAVE IT!

THE way to get ahead, stay ahead, in radio-TV servicing, is stock and install Ken-Rad tubes! New types—because Ken-Rad designing sets the pace—come to you ahead of time. As 1950 home receivers appear in your neighborhood, G-E and Ken-Rad tube research enables you to service new sets with the ultra-modern types they require, whether TV-picture, metal, glass, or miniature. Ken-Rad tubes you receive today, fill tomorrow's needs!... 6AV5-GT is one of many advanced types you will find in modern TV circuits. Your Ken-Rad distributor has this new tube, and others, that will give you rail position in the race for more service business. Phone or write him at once!

6AV5-GT BEAM POWER TUBE

With its companion type the 25AV5-GT (heater requirement 25 v as against 6 v), this new tube serves as a horizontal-deflection amplifier in TV. Operating direct from a 125-v power supply, accessories such as a transformer and high-voltage filter capacitors can be done away with, which adds to circuit simplicity and economy. Design of the tube gives it the ability to withstand high surge plate voltages... By stocking the Ken-Rad brand, you will have the 6AV5-GT and 25AV5-GT—and other important new types—*now*, when required to service late-model receivers!



V NOW COMPLETE!

The Ken-Rad TV-service course is ready from A to Z—eight helpful lessons packed with down-to-earth instruction in how to service TV receivers successfully... and profitably. See your Ken-Rad distributor for your income-building copy!



KEN-RAD *Radio Tubes*

PRODUCT OF GENERAL ELECTRIC COMPANY

Schenectady 5, New York

182-JA6

NOW..A NEW, WIDER LINE

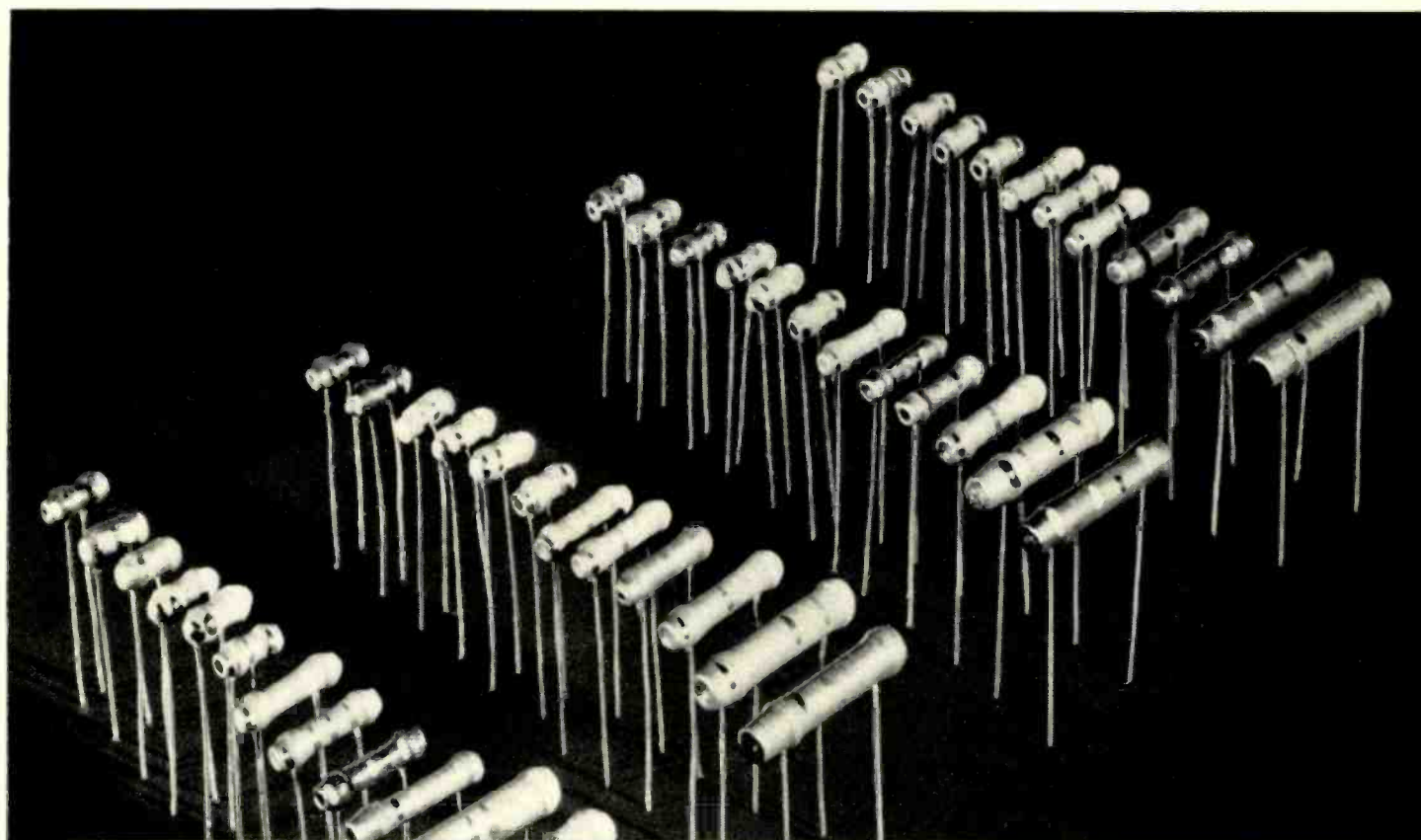

Choose from this Complete Ceramic Capacitor Line

Your radio parts distributor can supply you with these BC HI-KAP Tubular Ceramic By-pass and Coupling Capacitors in the following values — all rated at 600 WVDC, flash tested, 1000 VDC. Packaged in cellophane envelopes, 5 of one value per envelope.

Capacity	CRL Cat. No.	Capacity	CRL Cat. No.	Capacity	CRL Cat. No.
10MMF	D6-100	120MMF	D6-121	1,000MMF	D6-102
12MMF	D6-120	150MMF	D6-151	1,200MMF	D6-122
15MMF	D6-150	180MMF	D6-181	1,500MMF	D6-152
18MMF	D6-180	200MMF	D6-201	1,800MMF	D6-182
20MMF	D6-200	220MMF	D6-221	2,000MMF	D6-202
25MMF	D6-250	250MMF	D6-251	2,200MMF	D6-222
27MMF	D6-270	270MMF	D6-271	2,500MMF	D6-252
33MMF	D6-330	300MMF	D6-301	2,700MMF	D6-272
39MMF	D6-390	330MMF	D6-331	3,000MMF	D6-302
40MMF	D6-400	390MMF	D6-391	3,300MMF	D6-332
47MMF	D6-470	400MMF	D6-401	4,700MMF	D6-472
50MMF	D6-500	470MMF	D6-471	5,000MMF	D6-502
56MMF	D6-560	500MMF	D6-501	5,600MMF	D6-562
68MMF	D6-680	560MMF	D6-561	6,800MMF	D6-682
75MMF	D6-750	680MMF	D6-681	7,500MMF	D6-752
100MMF	D6-101	750MMF	D6-751	10,000MMF	D6-103

For other ceramic capacitor replacement needs, use CENTRALAB's line of TV HI-VOL-KAPS, KOLORDISKS and TC capacitors.

OF TUBULAR BC HI-KAPS!

Mr. Service Engineer . . . If your profits and reputation depend on guaranteed repairs, then this message is for You! Centralab . . . the First name in ceramic components . . . gives you famous ceramic tubular BC Hi-Kaps in 48 different and many new values. Check their advantages . . . see why CRL BC Hi-Kaps are absolutely safest for guaranteed repairs.

The present trend to *guaranteed service policies* demands that service engineers take no profit-risking chances with replacement parts of doubtful performance and durability.

Chart below gives you the facts. Read them. See why we say *no other tubular by-pass and coupling capacitors made will outperform or outlast CRL Tubular Ceramic BC Hi-Kaps!*



DIVISION OF GLOBE-UNION INC., MILWAUKEE, WIS.

Check these Features . . . See for Yourself why CRL BC Hi-Kaps are "safest"

"HI-KAP" FEATURES	DESCRIPTION			WHAT IT MEANS TO YOU
1. Impervious to moisture	Ceramic-X is non-hygroscopic. Moisture absorption is .007% or less.			No deterioration, no shorting. Longer life even under the most adverse conditions of humidity.
2. Low mass weight	AV. WT.	DIMENSIONS	VALUES	For unit size and weight, Centralab BC "HI-KAPS", made with Ceramic-X, are the only capacitors on the market which provide these voltage ratings.
	.029 oz.	D— .260" L— .530"	10—390 mmf.	
3. Small Size	.044 oz.	D— .260" L— .810"	400—3000 mmf.	
	.050 oz.	D— .280" L— .900"	3300—5000 mmf.	
4. High capacity	.082 oz.	D— .330" L— 1.200"	5600—10,000 mmf.	
	Ratings: 600 WVDC — 1000 flash test.			
5. Special insulation	Low power factor resin and high temperature wax coatings, with an additional special phenolic jacket.			Prevents any possibility of shorting to adjacent leads, chassis or components.
6. Convenient side leads	Heavy No. 22 gauge tinned copper, silver soldered to electrodes.			Permit rapid, close-coupled connections. No tricky bending or fitting required.
7. Low power factor	Initial — .6%. After 100 hours, 95% humidity test — 3.0%.			More efficient circuit operation, fewer failures.
8. High leakage resistance	Initial — 5000 megohms. After humidity — 500 megohms.			Long life, more efficient performance.
9. Maximum dependability	Pure silver electrodes, electro-bonded to Ceramic-X dielectric. Protected against oxidation or mechanical damage by coatings of electrolytic copper and solder.			Moisture and puncture proof. Will not short or become intermittent.
10. Factory tested	For your protection, all units 100% factory tested before packaging and shipping.			Your guarantee to your customers of reliable service and performance.

PREMIUM QUALITY AT NO EXTRA COST

Sprague Black Beauty Telecap® Tubulars are different from and superior to every other molded paper capacitor because they are made by the same dry assembly process as large metal-encased oil capacitors. They *cannot* be contaminated by dust or moisture during manufacture.

Ask for Black Beauty Telecaps at your jobber's.

*Trade Mark

Non-flammable,
dense bakelite
phenolic-molded
housing

Hollow eyelet terminal for oil impregnation after molding

Uniform windings of high purity paper and aluminum foil

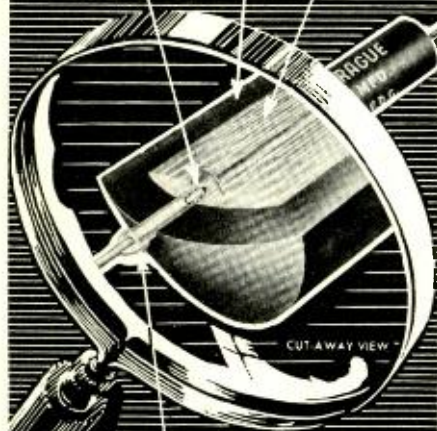

Solder seal as in large metal-encased oil capacitors

SPRAGUE

SPRAGUE PRODUCTS COMPANY
(Distributors' Division of Sprague Electric Co.)
51 Marshall Street
NORTH ADAMS, MASS.

Spot Radio News

★ Presenting latest information on the Radio Industry.

By RADIO & TELEVISION NEWS'
WASHINGTON EDITOR

COLOR DOTS, three hundred and fifty-one thousand of them on the face of a picture tube, paraded before the anxious eyes of officialdom and the press, during what it was expected would be the *cleanup* hearings on color by the Commission, as the first direct-view color TV tube made its debut in studios in downtown Washington, with a gala show from WNBW to spark the occasion.

Three receivers were employed for the demonstration, picking up the colorcasts from the Wardman Park Hotel, three air-miles away over the standard black-and-white channel four. In two of the receivers the color tubes had been installed, while the third was a run-of-the-mill black and white model. On view was a festive affair, *Pan Americana*, with strikingly garbed Latin-American singers and dancers, and quite a large orchestra, whose members were attired in plenty of reds, greens, and blues.

In one of the receivers was a single-gun picture tube, while a three-gun picture tube was featured in the second set. (*Editor's Note: For a complete discussion of the technical details of the new tubes see page 46 of this issue.*)

While members of the Commission were hesitant to voice their opinions about the new-tube results, there was a general air of optimism about the studios among the specially-invited audience, some frankly declaring that the pictures were the best they had seen in any color test.

Dramatic single-color-tube developmental news also hit the hearing rooms, from another source, about a week before the elaborately-prepared demonstrations. Testifying in what appeared to be a routine manner, *Philco's* research head, David B. Smith, suddenly declared that his company was developing a direct-view tube, which was, as he described it, in the research stages. The Commissioners perked up when they heard this report, and began peppering him with questions. Commissioner George Sterling wanted to know if the tube might be installed in present receivers, through some modification. Smith replied that it was feasible, although he wouldn't recommend the step. Further questioning revealed that it was his opinion and that of his company

that direct-view color tubes were the answer to the eventual color receivers, but no standards should be set until the tubes had been field tested thoroughly, and the variously described systems had been subjected to exhaustive tests, under all types of conditions. Madame Commissioner Frieda Hennock quizzed Smith, asking when commercial color TV might be available, and when the test period might be over. And, as in earlier sparring sessions on the witness stand, Smith declared that he didn't know the answers, and then repeated that standards should wait until we know more about the art.

The explosive testimony period continued, shortly after the special tests, with both *NBC* and *CBS* contributing to the fireworks. In one session *NBC* Prexy John H. McConnell told the color judges that if the *RCA* system received their blessings and standards were prescribed for it, WNBW would extend its color programming to a twelve-hour schedule, and that WNBW, in New York, would receive equipment to inaugurate colorcasts.

Describing the possibilities for transmissions from other cities, McConnell said: "Our stations in Chicago and Cleveland would receive color over a relay of the telephone company, which has said that such facilities would be available this summer. . . . Thus these stations would be able to transmit in color before they had their own facilities for originating color broadcasts."

Detailing the extent of the relays which would be available for service to other stations, McConnell noted that he understood such intermediate points as Providence, Philadelphia, Pittsburgh, Toledo and Davenport-Rock Island, would be linked before the summer was over.

The *CBS* front lines were buzzing as the *NBC* executive left the witness box, and soon after *CBS* Prexy Frank Stanton began explaining what his network would do with color. He declared that within three months, *CBS* would be able to present twenty hours of color programs, emanating from both studio and remote spots. An extremely revealing analysis of the costs *CBS* has had to meet in evolving color was also placed in the record by Stanton, who stated that over four million dollars had been spent thus far, with

RADIO & TELEVISION NEWS

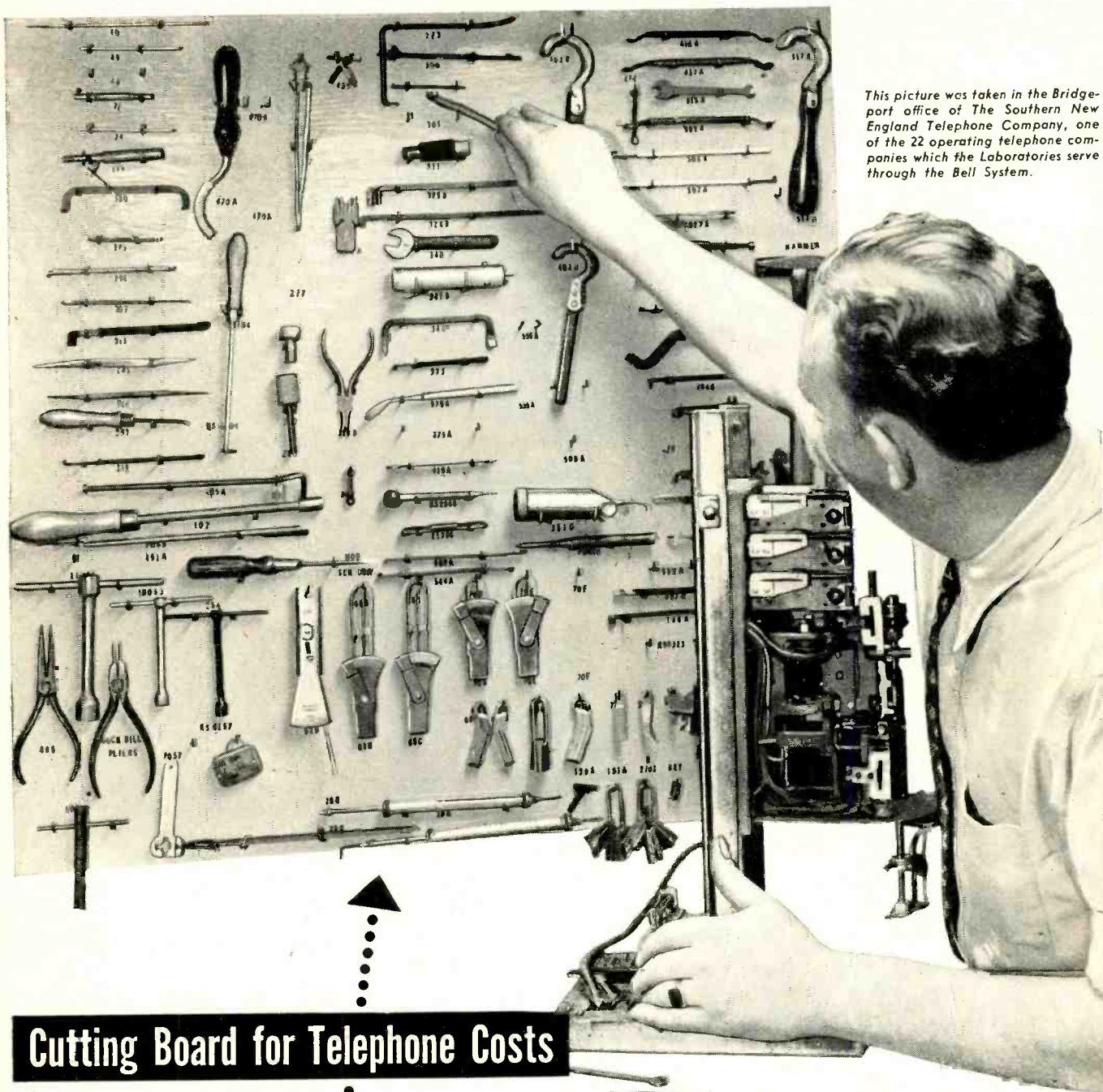

This picture was taken in the Bridgeport office of The Southern New England Telephone Company, one of the 22 operating telephone companies which the Laboratories serve through the Bell System.

Cutting Board for Telephone Costs

Few of these tools have sharp edges. But they are powerful cost cutters. Whenever a telephone craftsman reaches for one, he finds the right tool ready to his hand. There's no time wasted trying to do a complicated job with makeshift equipment.

Most telephone tools are highly specialized. 90% of dial system tools

were designed by Bell Laboratories. Each saves time in maintenance, installation or construction.

There are tools with lights and mirrors to work deep within relay bays; tools to brush, burnish and polish; tools that vacuum clean—even a tool to weld on new contact points without dismantling a relay. There are gauges to

time dial speeds, others to check spring tension. Some look like a dentist's instruments. Some you have never seen.

Keeping the telephone tool kit abreast of improvements is a continuing job for Bell Telephone Laboratories. It's another example of how the Laboratories help keep the value of your telephone service high, the cost low.

BELL TELEPHONE LABORATORIES

WORKING CONTINUALLY TO KEEP YOUR TELEPHONE SERVICE BIG IN VALUE AND LOW IN COST



Penn Pares Prices 25%

APPLIES NEW COST CUTTING PRODUCTION LINE METHODS To Teletower... Thriftowers

For a long time, Penn's prices for Teletowers and Thriftowers have been the lowest ever set on tripod-type towers of accepted quality. Now, Penn expeditors have adapted mass production techniques that squeeze the last possible excess penny out of manufacturing costs. Result — a 25% reduction in Penn's already low prices! The new Penn prices establish an all-time "rock bottom" in the tower field.

This is not a "bargain" offer by a green, insecure organization. The makers of Teletowers and Thriftowers—the Penn Boiler & Burner Manufacturing Corporation — have been leading manufacturers of heating equipment since 1932.

Mail Coupon TODAY for
free bulletin with
NEW PRICE LIST

PENN BOILER & BURNER MFG. CORP.
Dept. J., Lancaster, Pa.

Please send me a copy of your Teletower
Bulletin complete with new retailer price list.

Name

Company

Address



RUGGED! Three "huskies" (total weight over 540 pounds) are easily supported by this steel tower even though no guy wires have been erected.



EXCLUSIVE ASSEMBLY GUIDE! Pilot hole construction safeguards installer... cuts installation cost and time.

Manufactured by
PENN BOILER & BURNER MFG. CORP.
Lancaster, Pa.

two-and-a-half million for the old 12 megacycle system and the remainder for the present 6 megacycle development.

The possibilities of multiple standards, offered as a means of solution during earlier hearings, received quite a beating from both the *CBS* and *NBC* headmen, with McConnell declaring that only a compatible system would be suitable, since a dual setup, involving converters and adapters, would upset program scheduling. Broadcasters would be unable to transmit color during the choice evening hours because, he declared, they would lose a large part of the black-and-white viewing audience.

Stanton didn't think the multiple idea would work out either, because he felt that industry would not cooperate voluntarily on standards, and the *CBS* system could not be made to operate on a completely compatible basis.

The compatible headache was bounced around by others who came to the stand, as the days went on, particularly during the reappearance of David Smith, who during a cross examination session, on behalf of *Philco* and an RMA committee, said that the selection of a non-compatible system could put manufacturers out of business. He pointed out, too, that a change in the present standards, which would prompt the need for attachments, would cause a public reaction that could seriously affect receiver sales.

The double-standard idea was also riddled by criticism from Smith who indicated that his company probably would not produce sets for testing during a limited commercial trial period.

Blistering remarks seemed to be the order of the day, with even mild-mannered FCC Lab Division Chief E. W. Chapin striking out with some bold commentary. Reviewing a series of tests completed at the Laurel, Maryland labs, Chapin said that from the data available, it appeared as if the *RCA* color system may require some 2 db. more protection from offset co-channel interference than the *CBS* system. Observations indicated a figure of near 30 db. for both of the systems for offset operation, and it was believed that such a value would be sufficiently accurate for allocation purposes. These values, Chapin said, were tolerable for satisfying only fifty percent of the listeners in a given region and higher values will be required, depending on the percentage which it is decided to protect in a given region. The *CTI* system did not fare too well in the Chapin report, the review revealing that *CTI* pictures, as received on an ordinary monochrome receiver, were so degraded that it was not possible to attempt to determine interference ratios.

Commenting on the subject of interference, Chapin said that with either the *CBS* or *RCA* transmission in black and white there was no significant

(Continued on page 128)

RADIO & TELEVISION NEWS

JUNE, 1950

**RADIO &
TELEVISION
NEWS**

RADIO-ELECTRONIC *Engineering*

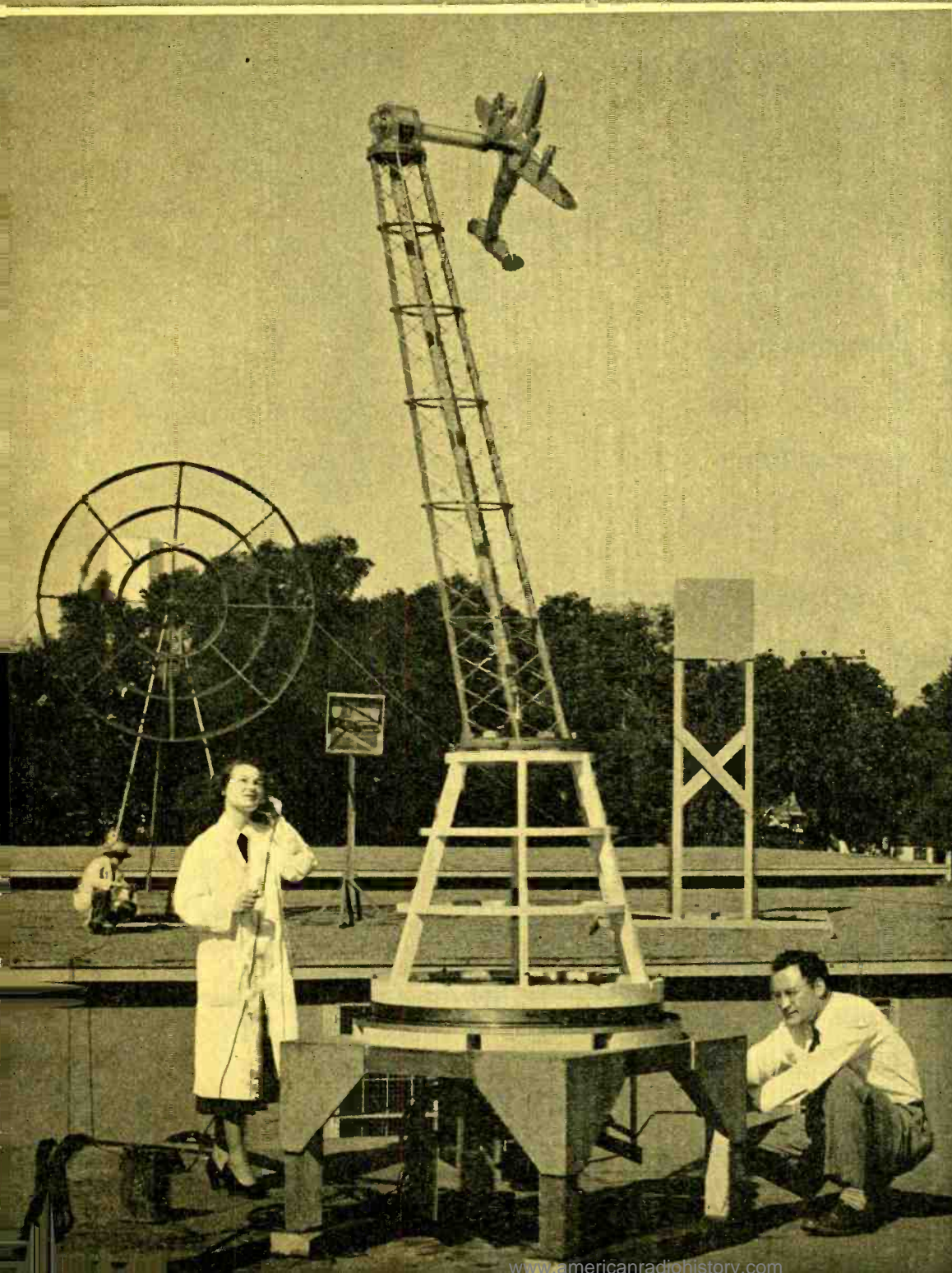

TELEVISION

RADAR

ELECTRONICS

RESEARCH

COMMUNICATIONS

MAINTENANCE

RADIO-ELECTRONIC

Engineering

Trade Mark Registered U.S. Patent Office No. 1,672,877

ELECTRONICS • COMMUNICATIONS • TELEVISION • RESEARCH • MAINTENANCE

JUNE, 1950

FM IN THE POWER INDUSTRY.....P. M. Ohlinger 3

ELECTRONICALLY DRIVEN RIPPLE-TANK.....Allen H. Schooley 6

FREQUENCY DIVIDERS.....Harold E. Bryan 7

LOADING QUARTZ CRYSTALS..... 9

AUTOMATIC ANTENNA PATTERN RECORDER.....Samuel Freedman 10

MICROWAVE TRANSMITTERS.....J. Racker 13

DEPARTMENTS

NEWS BRIEFS20	PERSONALS24
NEW PRODUCTS22	TECHNICAL BOOKS.....28



RADIO-ELECTRONIC ENGINEERING is published each month as a special edition in a limited number of copies of RADIO & TELEVISION NEWS, by the Ziff-Davis Publishing Company, 185 N. Wabash Avenue, Chicago 1, Illinois.

VOLUME 14, NUMBER 6, Copyright, 1950, Ziff-Davis Publishing Company

COVER PHOTO—Courtesy of Stanford Research Institute

Irene Reese, junior research engineer, and Robert DeLiban, research engineer of the Aircraft Radio Systems Laboratory, Stanford Research Institute, studying an experimental antenna on a 1/43rd-scale model of a Lockheed Constellation to determine the manner in which the antenna characteristics depend upon the angular heading of the aircraft.



FM in the POWER INDUSTRY

By P. M. OHLINGER

Design Engineer

Equipment and techniques used in both fixed and mobile installations for communications and control purposes.

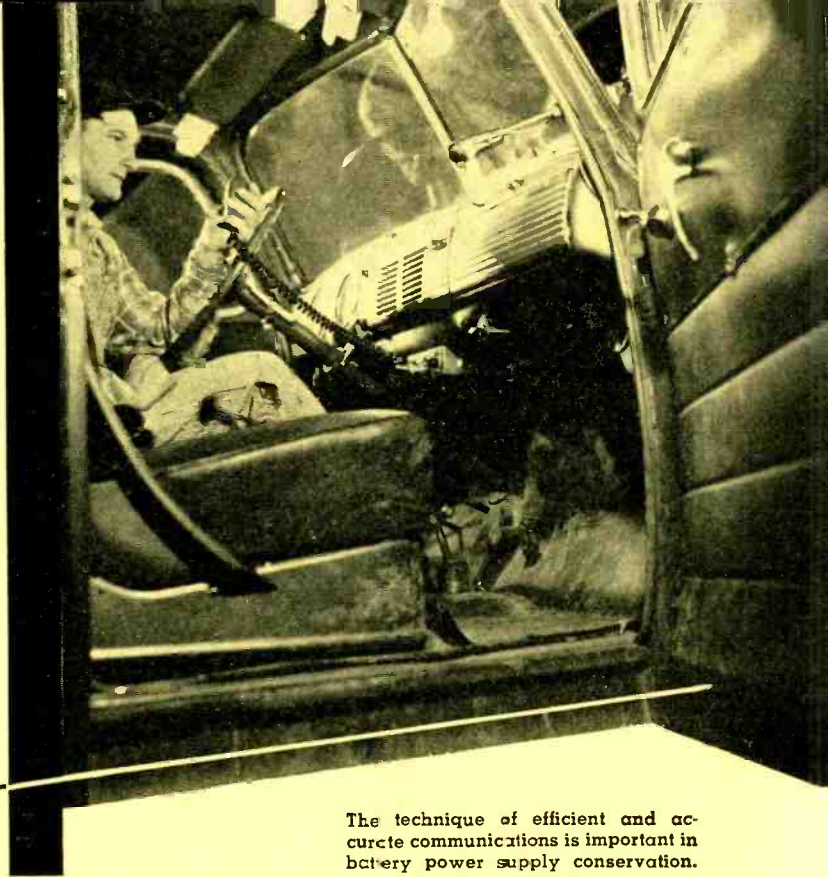

The technique of efficient and accurate communications is important in battery power supply conservation.

“THE power is off.” This phrase used to mean only the inconvenience of hunting up the old lamp or candle, but now, with the ever widening application of electrical power to daily life, serious problems are presented when service is suddenly interrupted.

Outages are bound to occur and the only thing to do is to cut their duration. Lines and equipment are being constantly improved but Mother Nature can be quite rough at times. It is at these times, when outages occur simultaneously over a widespread area, causing maintenance crews work which seems to be set at them as though by a well-planned diversified attack, that the most efficient use of man power and equipment is urgently needed.

FM two-way radio communication is now being employed by the REA and private power companies as a means of shortening outage time while materially cutting maintenance costs and providing better service.

In this article, the equipment and installations in use by REA and private power companies will be discussed. Illustrations are of the Nishnabotna Valley Rural Electric Cooperative, Harlan Iowa. This REA installation has been in successful operation for over a year. Field experiences, problems, operating procedures, maintenance, licensing, system planning and costs are very similar whether the installation be for the REA or a private power utility. The equipment used in the illustrations of the installation to be described was manufactured by *Motorola, Inc.*

The electrical and operational characteristics of two-way radio equipment of different manufacturers are similar although physically and mechanically the equipment may be different.

Since the opening of this field of communication, sales competition has increased sharply and customer's prices and manufacturer's service have been to the advantage of the customer.

Planning the System

After it has been decided that two-way radio communication is needed for better system operation, there are several things which must be considered in planning the system:

1. *Area to be covered.* The equipment to be installed must be that which will

do the job. Equipment size and type, antenna installation, terrain, boundary pattern of the area to be covered and the frequency to be used are all factors to be investigated.

a. Equipment size and type. The area to be covered, the antenna installation to be used, the terrain and the noise levels where the receivers are to be used dictate the size and type equipment which must be used. The installation may be made with equipment having either 30, 60 or 250 watts r.f. power output.

b. Terrain. The power of the transmitter and antenna installation in the Central or Land station is always important, but more so when the type of terrain is such that receiving conditions

Compactness, making for space conservation, features the transmitter-receiver installation in the manager's car.



↓ Antenna, atop a water tower, is fed by coaxial cable from the central station transmitter at the base.



Central station installation has both front and rear cabinet door openings to permit easy access for maintenance.

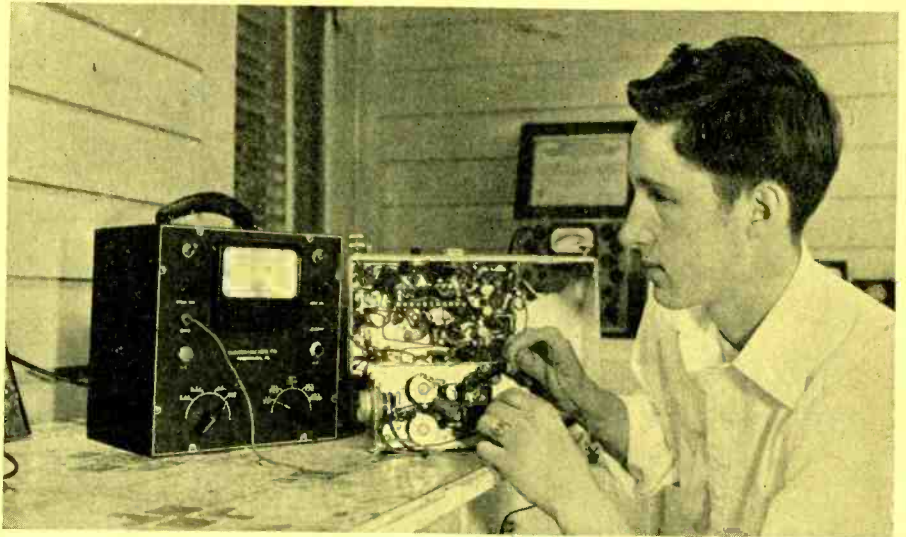
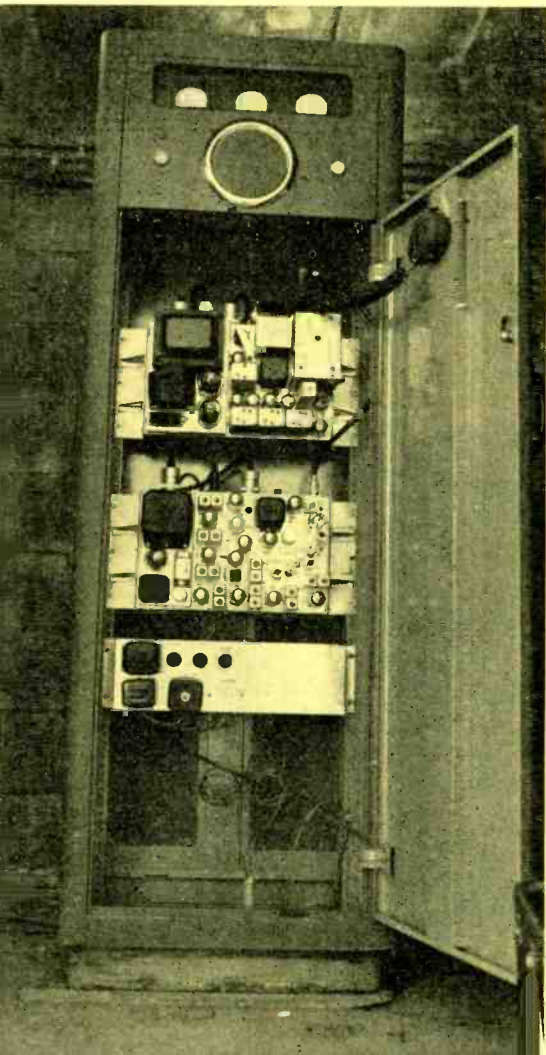

are spotty. If the sending range of the central station is increased by either a power increase or more efficient antenna installation or both, satisfactory one-way sending may result and then it is possible for mobile units to maneuver into favorable positions for returning calls that ordinarily would not be possible. If there are hills and valleys in the area, the mobile unit moves to the top of a nearby hill where communication can be established.

c. Boundary pattern. If the area to be covered forms a long and narrow pattern, or if the central or land station and antenna installation are at one extreme end of the area, satisfactory coverage is more difficult.

An increase of transmitter power may not be economically feasible, whereas increasing the height of the antenna or a directional antenna installation may be the answer at a less cost than a power increase.

In a situation such as this, noise levels are going to be much higher because of the added receiver sensitivity needed. However, if the boundary forms a long and narrow pattern, it is very probable that additional substations are in operation in these outlying districts to insure satisfactory voltage regulation out on the far ends of the power lines. In this case, pole mounted antennas located at these substations or other well-chosen points can be connected too by the mobile units to maintain communication with the central station. It is sometimes necessary to install remote receivers in locations where noise levels are very low, and then bring their output back over land lines to the central station and office which may be necessarily located in a very high noise level district.

d. Frequency to be used. Frequencies in the 30-40 megacycle and 152-162 megacycle bands are in theory strictly "line of sight" as far as range is concerned. Both bands are being used at

the present time. The 30-40 megacycle band is very crowded and considerable sky wave interference is resulting in this band. The 152-162 megacycle band, while more reliable, is slightly shorter in range than the 30-40 megacycle band. The 152-162 megacycle band has been recommended by the FCC as a result of its field tests. If the 30-40 megacycle band is to be used, it will probably be necessary to supply the FCC with data to show that the 152-162 megacycle band cannot be satisfactorily used.

The REA Cooperatives like to have their adjoining neighbors on the same frequency so that they can form a network to be used in an emergency. It is true that transmissions from neighboring two-way radio systems break through that of adjoining systems, but they say that after they become familiar with voices and styles of transmission, they experience little trouble from this factor. Recently, a cyclone swept through an REA district. Very shortly after, the Nishnabotna Valley REA had their trucks and crews down in their neighbor's district helping him restore his lines. Immediate intercommunication between districts paid off in this instance.

2. *First cost, operating costs, and benefits.* In estimating costs of equipment needed in an installation the following items must be considered, although they will not all be required for the average installation:

Central station transmitters and receivers.

Central station remote control console.
Mobile transmitters and receivers.

Antenna systems.

Test equipment and freq. monitor.

Facilities for housing central station equipment.

Heavy duty batteries and oversize automobile generators.

Spare parts and units.

Land lines for remote controlled central station equipment.

← Under chassis view of mobile receiver. Power supply is self contained on a separate removable chassis.

By means of the remote control console, Dean Jorgenson, REA Manager, has his maintenance crews at his fingertips. →

↓ A wood housing is constructed for the transmitter-receiver installation directly back of the cab of the truck.

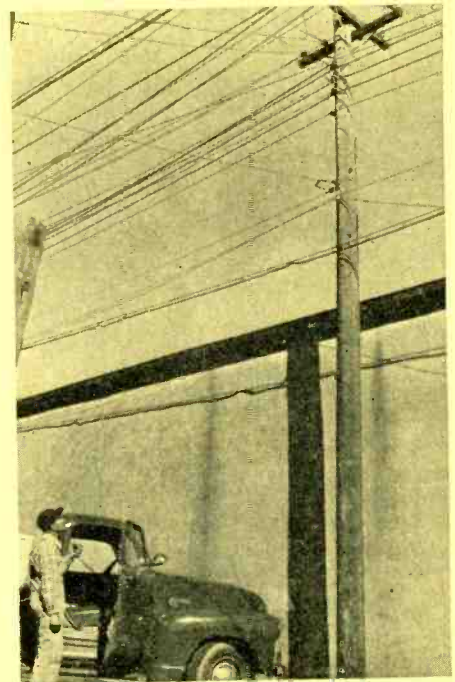
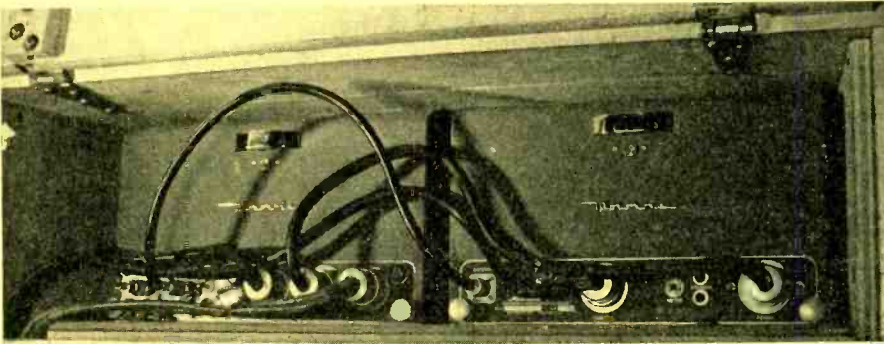
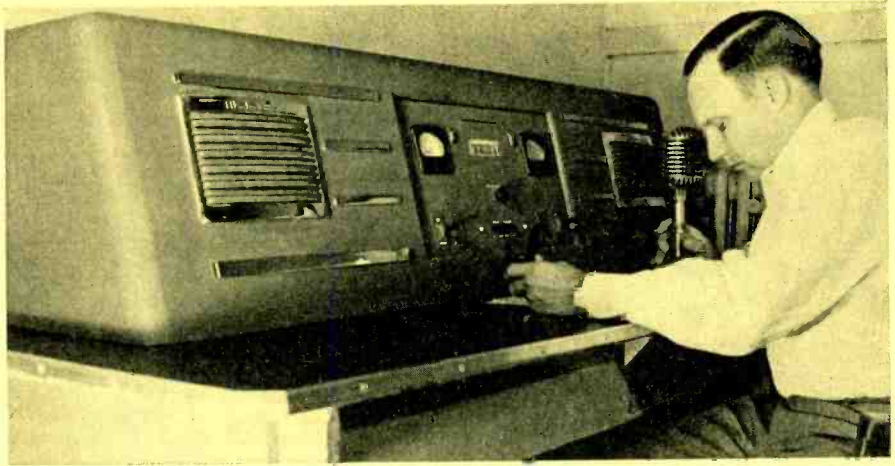

A.c. power line to remote controlled central station equipment.

An auxiliary power supply.

Purchase, lease, or rental of sites necessary for the remotely operated equipment.

Any taxes that may be applied.

Installation and engineering cost.

If the installation is such that terrain or geography provide an unusual problem the following equipment may become necessary:

Either automatic one-way or two-way repeaters.

Remotely operated receivers.

Additional antenna installations.

The construction, purchase, lease or rental of land lines and necessary sites and power supplies for remotely operated equipment.

In the average size two-way radio system used by the REA, the equipment cost can be estimated at \$6000.00 which would include 6 mobile units, one fixed central station, remote control console and the antenna less the antenna tower.

If oversize generators and batteries are required in the trucks, an additional \$90.00 will be needed for each installation. The installation cost of a system of this size can be estimated at \$25.00 per mobile unit.

In the installations for the larger power systems, the equipment cost and installation should be proportionately greater, about \$525.00 per mobile unit.

It is hard to fully evaluate the benefits received from an expenditure such as this in monetary terms because two-way radio is a very important "good

will" ambassador. Some examples of savings to be made are:

A maintenance crew may be in some remote corner of the district and a trouble call received from a location near where they are working. To either have the crew in this location make the trip back to the office for instructions or to send another crew out on this call will cost approximately \$25.00 per trip. Two-way radio gives the crew in the locality all the information they need, saves another trip and allows more efficient use of manpower. Again, a crew may be out to locate a certain geographic point. When customers' names are similar, it is sometimes difficult to pin down locations exactly, but help from the dispatcher greatly assists in this matter. It has been found that when, as is the custom in some power companies, customers read their own meters and mail them in, a fictitious looking reading can be immediately checked by the maintenance crew in that locality.

One of the largest public power utilities in Iowa is using two-way radio in conductor stringing and sagging. Because of the high construction cost, high voltage transmission lines usually follow a direct line and cut across country over private right of way. This means that to patrol them, the maintenance man must walk the distance. The larger power companies are now using "walkie talkie" type radio for this purpose. The "walkie-talkie" radio is also a great time saver for the surveying crew.

Where joint construction is involved, multi circuits are quickly checked.

3. *Maintenance cost.* The large power companies generally maintain their own radio service departments. REA power companies usually have a service contract with a company or individual calling for a definite time of inspection of the equipment. The maintenance cost is determined by the type and manufacture of the equipment, the amount and severity of the usage and the quality of the maintenance and inspection work. An estimate of the average over-all maintenance cost per month could be approximately \$10.00 for each mobile installation and \$17.00 for each central or fixed station. However, it is reasonable to expect that in the first 5 years of operation these estimates will not be approached as the normal replacements should be tubes and vibrators during this period. Reports so far bear out this replacement record.

3. *Licensing.* All radio stations in the
(Continued on page 28)

Electronically Driven RIPPLE-TANK*

Water ripples and synchronously chopped light may be used for the qualitative and semi-quantitative study of phase fronts near models of antenna structures.

has been used extensively to demonstrate most of the two-dimensional phenomena of physical optics,¹ it appeared suited for solving some problems of phase-front visualization met by electronics engineers. New techniques in the operation of the electronically driven ripple-tank were devised and applied to antenna problems, and photographs of phase-front shadow patterns near two-dimensional models of a few familiar antenna configurations were made.

Basic components of the electronically driven ripple-tank include an audio oscillator to drive a synchronous motor which has a slotted (light chopper) disk attached to its rotor. The light from a lamp is projected through the slotted

neath the light chopper disk. The disk is usually cut with the required number of slots to show one phase front for each cycle. However, for some demonstrations it may be advantageous to use one-half this number to spread out the pattern by showing every other phase front. On the other hand, twice the normal number of slots may be used to reduce the light flicker. In so doing the number of phase fronts in the pattern is doubled.

Intelligent use of the ripple-tank requires some knowledge of the techniques and limitations of ripple-tank operation. It is usually disturbing to note that the velocity of water-ripple propagation is dependent on wavelength, which is not the case for electromagnetic waves. However, the variation in velocity with wavelength is unimportant in most two-dimensional antenna model work because the basic scaling relationship that should be maintained is:

$$d_m/\lambda_m = d_a/\lambda_a$$

were d_m and d_a are corresponding dimensions of the model and antenna, respectively, and λ_m and λ_a are the wavelengths for the model and the antenna, respectively. Since most work requires the use of only one frequency at a time, it makes no difference what the velocity of propagation may be as long as the relationship in Eq. (1) is maintained. All the measurements should be made in terms of wavelength and not in terms of frequency. It is interesting to note that the velocity of ripple propagation is less than the velocity of electromagnetic waves by a factor of the order of 10^9 .

The increase in the phase velocity of ripples passing through a wave guide may be demonstrated by means of the ripple-tank. This suggests that some aspects of Kocks' wave guide antenna may be simulated by the ripple-tank. Such a lens, shown above, was designed for an index of refraction of about 0.55, and was made of 1/4-inch thick brass, milled with 32 slots spaced

(Continued on page 27)

*Exhibited by the Naval Research Laboratory at the 1950 National Convention of the Institute of Radio Engineers.



A scientist studies a radar antenna model in the ripple tank.

Wave pattern produced by a wave guide lens with water ripples.

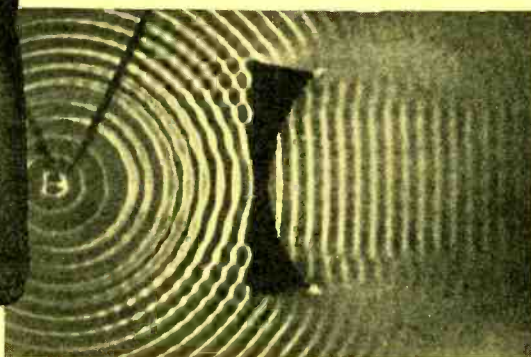

by

ALLEN H. SCHOOLEY
Naval Research Laboratory

IN electronics work it is not unusual to have an antenna aperture across which the phase of radiation should be constant or vary in a particular manner. Often, in scanning systems, the beam tilt and the deviation from phase-front linearity with various placements of the feed point are of interest. Also it is desirable to know how the phase fronts are affected by changes in the excitation frequency. Since the calculation or experimental determination of phase-front patterns is usually a tedious operation, it appears that there is a need for a simple analog device to aid visualization of such patterns.

Since the ripple-tank is a device that

disk and through the glass ripple-tank to a ground glass screen. The oscillator also drives an electromechanical transducer. A probe attached to the transducer touches the surface of the water contained in the tank and excites ripples in synchronism with the pulses of light coming from the lamp. Thus, the ripples, acting like cylindrical lenses, cast stationary light and shadow patterns upon the ground glass screen in accordance with the phase-front pattern set up in the ripple-tank.

The 11-inch square ripple-tank has beveled glass sides high enough to contain about 1/4-inch of water. Two electromechanical transducers are used, one of which has a probe vibrator at the focus of a small parabola.

The light consists of a 50 candle-power automobile headlight bulb, be-

FREQUENCY DIVIDERS

By HAROLD E. BRYAN

The design of circuits which will produce accurate submultiples of a given frequency.

FREQUENCY dividers have not enjoyed the popularity that they deserve, due in part at least to a lack of understanding of their capabilities. To many people the term *frequency divider* means *multivibrator*. The latter is capable of very reliable operation as a frequency divider, but has a bad reputation because of many improperly designed circuits. There are in addition a number of circuits other than multivibrators available for divider service. All of these have individual advantages and disadvantages; which type is to be preferred depends on such factors as waveform, stability requirements, etc.

Frequency division has essentially the same applications as multiplication—production of signals controlled by and definitely related to other signals of different frequency. In most applications the output of the divider is harmonically related to the driving frequency, although this is not always true. It is possible to construct dividers which will divide by fractional as well as integral ratios. Equivalent results can usually be obtained otherwise, although probably at greater cost economically and operationally. The use of dividers is essential to the operation of such devices as crystal savers*, which would not be economically feasible without them.

Generally speaking, there are two types of frequency dividers—those that deliver sinusoidal signals without external filters, and those that don't. Aside from the waveform requirements, the divider must be sufficiently stable that tube and voltage changes normally experienced do not change the division ratio. It must also be easy to synchronize so that it is not affected by changes in the driving signal.

Dividers with sinusoidal waveform

may be used when it is not necessary to have exact control of the relative phases of the driving and output signals. Since many of the applications which have pushed the development of dividers have been those that require phase control, like radar and television, not much information is available on the sinusoidal type.

One of the simplest sinusoidal dividers is the synchronized oscillator, illustrated in Fig. 2A. Harmonics in the output of an oscillator produce instability. At the same time, these harmonics are necessary to the synchronization process. Therefore, if the oscillator is quite stable, it is hard to synchronize. Synchronization in this type of circuit occurs due to interaction of an oscillator harmonic with the driving frequency. Since the effective synchronizing signal is the result of modulation in the oscillator itself, the driving signal must usually be quite large in order to obtain the necessary control. The higher the Q of the circuit the harder it will be to drive and therefore the easier it will be for it to drop out of sync without notice. Also, the higher the grid excitation, the greater will be the driving signal needed for control. If excitation is reduced, instability may result due to partial or almost complete loss of modulation action. Thus, although this type of divider has its place, due to its simplicity, it does have serious disadvantages.

Fig. 1. Disadvantages of Fig. 2A are partially overcome in this circuit by separating oscillator and modulator functions.

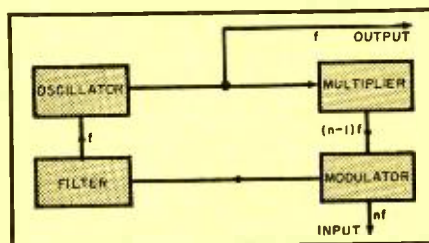

One way of overcoming some of the disadvantages of the simple circuit is illustrated in Fig. 1. Although this still uses a free running oscillator with its disadvantage of continued operation with loss of signal, the oscillator and modulator functions are separated. The oscillator output feeds a multiplier, generating a frequency at $(n-1)f$, where f is the synchronized oscillator frequency. The difference frequency in the output of the modulator is f (driving signal = nf) and this is selected and used as a synchronizing signal for the oscillator.

Elimination of the major disadvantage of the above (continued operation without controlling signal) is easy—eliminate the oscillator, as shown in Fig. 3. We saw above that the output of the modulator driven by signals of nf and $(n-1)f$ contains the frequency f , and this is the desired output frequency. The signal at $(n-1)f$ is supplied from the output itself through a frequency multiplier. If the gain around the loop containing the modulator and frequency multiplier is equal to or greater than one, the circuit will operate just like any regenerative oscillator, provided the driving signal is present. The loop gain is made less than one at all other frequencies to prevent improper operation. High ratios may be obtained with this type circuit, although high selectivity is necessary in the multiplier to prevent change in the ratio.

The discussion so far assumes the use of square-law modulators. Higher orders may be used to obtain different results. By selecting a harmonic in the frequency multiplier as an output frequency, it is theoretically possible to multiply or divide by any rational ratio.

This type of circuit is not all advantage. It is relatively complex and may not be self-starting. Sometimes it is necessary to supply a starting signal by means of thyratrons or similar devices. These dividers are limited in operating frequency only by the limitations of the modulators and frequency multipliers employed, and therefore may be used in many radio frequency applications.

An interesting application of this type of circuit is shown in Fig. 5. Here the input frequency is divided by two and then multiplied, providing outputs at $f/2$ and $nf/2$, where n is an odd integer. This is accomplished with one modulator and one tube.

Dividers With Non-Sinusoidal Output

Of the relaxation types of frequency dividers, the multivibrator is the best known. A free running type may be used if continuous division is desired, although the same disadvantage is ex-

*Bryan, Harold E., "Crystal Savers", RADIO-ELECTRONIC ENGINEERING, March, 1950.

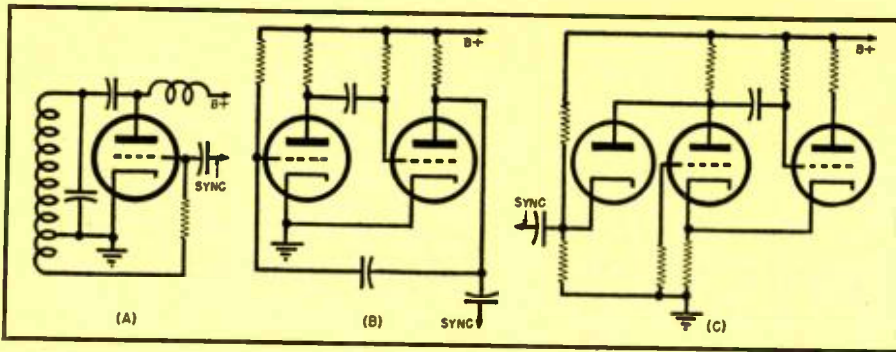

Fig. 2. (A) Synchronized oscillator. (B) Free-running multivibrator frequency divider. (C) Frequency divider which oscillates only when triggered.

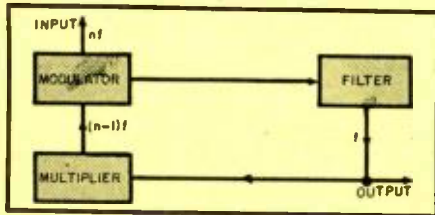

Fig. 3. Circuit resulting from eliminating the oscillator in Fig. 1.

perienced here as in the previous types, since oscillation continues in the absence of synchronizing signal. All of the relaxation types of oscillators are easy to synchronize, however, and simple in construction.

In the free running multivibrator, proper design is important; otherwise unsatisfactory operation is certain. In the preferred design the unsynchronized portion of the period is slightly less than half the total, and the synchronized part thus a little greater than half. Grid resistors should be large, at least one megohm if possible, and plate resistors used should provide large plate swing. If these factors are considered, the divider will be very stable under synchronized conditions, and quite tolerant of driving waveform. Synchronizing signals are applied to the grid or plate of one tube. A multivibrator of this type is illustrated in Fig. 2B.

A more desirable type of multivibra-

tor oscillates only when triggered. It has one stable and one unstable state, and depends for its action on the fact that when it is in its unstable state synchronizing signals have no effect. As seen in Fig. 2C, this type multivibrator is maintained in the stable condition by cut-off bias on one grid, and zero or low bias on the other tube. A trigger signal cuts off the originally conducting tube and opens up the other. Since there is nothing but a time constant to maintain this condition, it returns to the original state when the charge has leaked off the grid enough to allow conduction to again take place. Because the tubes are connected in a regenerative manner, the change from one state to the other is abrupt rather than gradual. The cathode coupled circuit is popular, the cut-off tube being maintained so by the current from the conducting tube through the cathode resistor. This resistor should be relatively large in value. The plate resistor of the cut-off tube should also be large, in order to provide a large plate swing and supply a maximum of signal to the following grid. The negative trigger required is usually fed to the plate of the cut-off tube through a biased diode. The diode insures that no triggering signals are applied during the unstable period, since it is cut off during this time. Satisfactory operation is obtained with almost any kind of triggering signal of sufficient ampli-

tude, and the division ratio will be quite stable with respect to voltage and tube changes.

Blocking oscillators may be used as frequency dividers where pulsed output is desired. A typical circuit is shown in Fig. 4A. Since the blocking oscillator presents a very low impedance to the driving signal, it is difficult to synchronize. Triggering from a high impedance source is possible through a shunt feed sort of circuit, but there may be severe reaction on the driver. The blocking oscillator is more sensitive to voltage, tube and signal changes than the other types so far discussed.

Operation is normally such that the free running frequency is slightly lower than the synchronized frequency. A positive signal voltage is applied to the grid, driving the plate in the negative direction. Due to the regenerative connection between the plate and grid, the drop in plate voltage causes a rise in grid voltage, driving it still more positive. When plate saturation is reached, the plate voltage begins to rise and the grid voltage to drop. Again the regenerative action takes hold and the grid is rapidly driven beyond cut-off. After the tube has been cut off, nothing can happen until the grid voltage leaks off to the point where a trigger pulse can start conduction again. The signal pulses are ineffective while the tube is conducting and when the grid bias in the quiet period is greater than the trigger amplitude. The trick is to get the circuit constants and driving signal so adjusted that the tube will fire on the n th but not on the $(n-1)$ th pulse. Any variation in these values will tend to produce a change in the division ratio.

The blocking oscillator has the same major disadvantage, also, as the other types of free running dividers—continued operation without driving signal—and so gives no warning of trouble in previous stages. Its principal use is in the production of very short pulses. These dividers can be stabilized to some extent through the use of resonant circuits in the cathode lead. The voltage developed across this circuit so modifies the timing waveform on the grid that the n th trigger pulse is accentuated with respect to the others. Sometimes more than one such circuit is used, each with different resonant frequency. Frequency for the resonant circuits is usually chosen such that it is $(A + \frac{1}{2})$ times the output frequency, where A is an integer.

The phantastron may be used as a divider, and in such service offers a high ratio of utility to cost. This circuit, developed during the late war for use in gate and sweep generators, is very stable and reliable, and requires a minimum of parts. The division ratio is

(Continued on page 30)

Fig. 4. (A) Blocking oscillator circuit. (B) The phantastron circuit used as a frequency divider. (C) Thyatron used for frequency division.

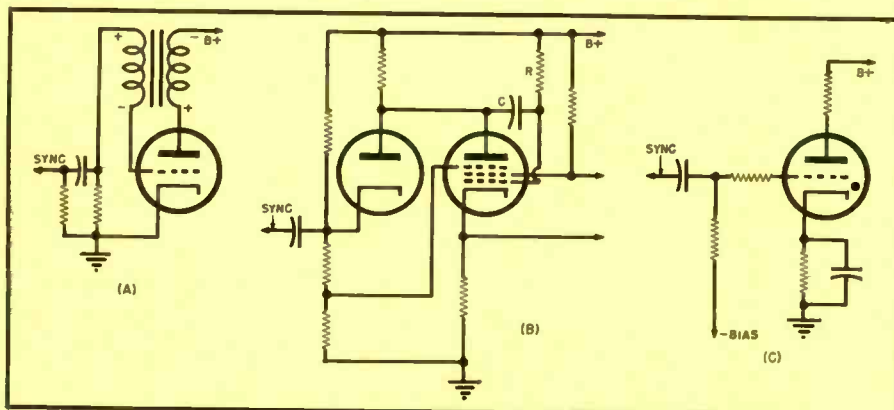

LOADING QUARTZ CRYSTALS

**The performance of certain types
of quartz crystals may be improved in
some instances by loading with inert materials.**

Experimental arrangement used at NBS to investigate a phenomenon associated with wedge-shaped crystals.

THE ERRATIC performance of piezoelectric plates has long been a problem in the production of oscillator units, and many investigations have been undertaken to determine the causes of instability. Experimental results obtained by Leland T. Sogn of NBS over the past few years show that it is possible to improve the performance of certain types of thickness-shear quartz plates by coating their surfaces with some inert material. Two distinct effects have been noted: first, that produced by an amount of the loading material so small that the resultant frequency change is as little as 0.03% of the crystal fundamental; and, second, that produced by a much larger mass of the loading material properly distributed over the central area of the crystal. The latter seems to have the beneficial effects now achieved by contouring, a difficult and expensive process. The potential usefulness of loading thin crystals to improve performance as well as to recover plates ground too thin in the production stage should encourage further research on the various aspects of quartz-crystal loading.

A phenomenon associated with a wedge-shaped 0.5 x 0.6-inch BT oscillator plate (width parallel to the x -axis) prompted the present investigations. When the electrodes coupling the oscillator plate to the electronic circuit were placed over the thicker portion of the plate, the frequency was not only lower, as anticipated because frequency is inversely proportional to thickness, but the activity was considerably higher, shown by the magnitude of the grid current. Lower frequency was associated with higher activity or amplitude of vibration, and vice versa.

To investigate this phenomenon a small 1/4-inch probe electrode was employed. With this electrode, it was possible to confine the energy fed back from the electronic circuit to a small area of the plate and thereby obtain a series of frequencies and activities as the electrode was moved in short steps from the thick to the thin portion of the plate. In "flat" plates the frequency fluctuated about a mean value as the electrode was moved over the plate surface, and it was found that activity measurements as well as frequency measurements can be used to detect minute differences in thickness which were not disclosed even by instruments sensitive to differences of less than 20 microinches. Activity readings were actually used to check and control the contour of plates during the process of hand-grinding.

In most of the hand-finished plates used in these experiments, positions de-

termining a certain frequency were found to be scattered indiscriminately over the surface although some oscillator plates had contour and edge conditions such that only a few, nearly equal frequencies could be obtained. For example, in an 8.7-mc. plate with only two frequencies about 5 kc. apart, the frequencies would alternate from one to the other as the electrode was moved across a line roughly parallel to the x -axis, which divided the plate into two approximately equal areas. This plate apparently was composed of two approximately equal flat areas which differed in thickness by the equivalent of a 5 kc. difference in frequency. The balance between the two frequencies was so delicate that a rapid alternation between the two frequencies could be obtained by adjusting the temperature or circuit constants, resulting in an audible "motorboating" effect in the measuring equipment. Changing the length, or z dimension, by alternately grinding opposite edges (parallel to the x -axis) produced anticipated results. When the edge bounding the thick end of the plate was ground, the higher frequency became dominant because the area of the thin, high-frequency plateau became relatively larger. Subsequent grinding on the other edge reversed the effect: when the thicker area was relatively larger, its lower frequency was dominant. This procedure was repeated several times with identical results.

Experiments were also carried out using machine-lapped convex crystals. Results were similar, but one new fact was disclosed. The lowest frequency, excited when the small electrode was placed at the exact center of the plate,

(Continued on page 24)

Schematic representations of the various "load patterns" applied to quartz plates in an investigation of the effects of loading on performance.

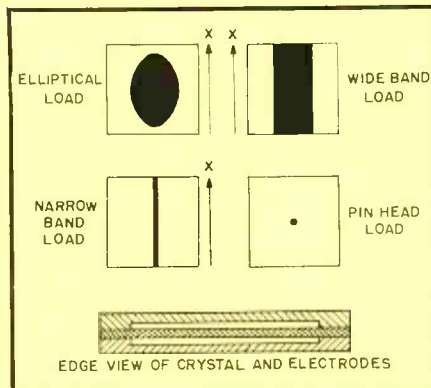

AUTOMATIC ANTENNA PATTERN RECORDER



Fig. 1. Components of the automatic antenna pattern recording system. Left to right—logarithmic amplifier, antenna mount, and graphic recorder.

By **SAMUEL FREEDMAN**

Details of a system for determining antenna radiation patterns rapidly and accurately.

THE efficient transmission and reception of electromagnetic waves in the radio portion of the frequency spectrum is primarily dependent on the utilization of antennas of proper shape and dimension to provide the best radiation patterns.

This has made necessary the development of facilities for checking antennas and equipment performance into antennas. Such checking of performance and radiation patterns is necessary in any phase of the radio art whether it corresponds to basic research, development, prototype or quantity production. It is particularly true for microwave equipment where the smallest dimensional design or manufacturing discrepancy, or a deformation, of the antenna system is appreciable with respect to the operating wavelength.

Consequently, throughout the nation today, hundreds of laboratories, manufacturers and field parties are engaged in antenna radiation pattern studies. Offshoots of this work include checking ship radar antenna behaviour as influenced by ship structural work, checking GCA (Ground Controlled Approach) equipment on runways, the efficiency of surveillance radars, and the beamwidths of microwave relay systems. Invariably, much time and expense is lost in setting up for such measurements with manual recordings and arrangements. Under such conditions, as little as two patterns per day are obtained.

When the radar antenna firm of *Dalmo Victor* in San Carlos, California, had the problem of taking hundreds of antenna radiation patterns, quicker and simpler means of setting up for each pattern was imperative. Furthermore, these had to be extremely precise and permanently recorded since one-half of the value of any radar is its ability to get precise angle or directivity information; the other half being the range or distance.

Accordingly, there was developed the "Automatic Antenna Pattern Recording System" for presenting the antenna pattern on a recorded sheet. On this sheet, rectangular coordinates are used with the abscissa representing angle in degrees, and the ordinate the log of the power and the intensity.

Fig. 1 shows the three basic units comprising the entire automatic antenna recording system. From left to right these are:

1. Logarithmic amplifier to amplify the signal picked up from the antenna.
2. Tripod antenna mount to support and change the angle of the antenna under test.
3. Graphic recorder to record the information.

The system is unique in the use of an extremely universal antenna mount, ability to take readings or recordings in three minutes per pattern instead of up to half a day as in the past, ability to reproduce the pattern and provide a

permanent record, and the equipment is simple enough to be operated by untrained personnel.

Antenna patterns can be taken in any arbitrary plane through a full rotation of 360 degrees, or any fraction thereof, over a power range of 0-50 db. to an accuracy of plus or minus 1 db. The equipment is connected together by means of cables. A common ground wire connects all the units together.

For ease in adjustment, an antenna reversing switch is provided at the antenna mount while the on-off switches and the 115 volt a.c. cords are on the graphic milliammeter and the logarithmic amplifier. Antenna position is transmitted to the recorder by means of a selsyn system and it is so adjusted that 10 degrees of rotation causes a movement of 1 division on the graph paper. The antenna patterns are recorded in only one direction. A small throwout gear is provided for disengaging the recorder while the antenna is being adjusted or reversed in direction. This same gear also makes it possible to properly engage the selsyn system so that the zero degree reference point falls upon a given line of the graph paper.

The additional equipment required for pattern measuring work consists of a suitable transmitter and receiver system with a square law detector. Sufficient amplification should be available to present the logarithmic amplifier with 100 volts at the zero db. level.

Antenna Mount

The antenna mount (center of Fig. 1) consists of a tripod stand which is adjustable in height from 42" to 60"



Fig. 4. Antenna pattern penthouse test shacks atop the Dalmo Victor plant.

Should noise or other reasons make it necessary in a particular installation to ground the instruments, the grounding of either the tripod or graphic recording milliammeter should suffice since a ground connection between the two sections has already been provided.

Logarithmic Amplifier

The use of a logarithmic, rather than linear, amplifier is desirable where large variations in output are involved as in the case of automatically recorded antenna patterns. While there have been many methods described for obtaining a logarithmic response, no circuitry of a usable logarithmic amplifier over a range as great as 100 db. has been previously described to the best knowledge of the authors or their associates.

A logarithmic response from an amplifier is readily obtainable through the use of remote cut-off tubes, whose characteristics are inherently logarithmic. Such tubes can be used either in tandem or cascade. In a tandem circuit, the tubes are connected in parallel, with the control grid of each successive tube biased at a different level. Each tube then works between cut-off and saturation with its grid voltage-plate current characteristics operating over a given portion of the logarithmic output range. By proper overlapping of the working characteristics of the successive stages, a rather good logarithmic response can

be obtained. The cascade amplifier as described in this article consists of several stages of amplification connected in series in a conventional manner. By applying the output of such an amplifier as negative bias voltage to its grids, it is possible to obtain a non-linear amplifier whose output is proportional to the logarithm of the input. This approach has been found preferable even though greater ranges may be obtained from the tandem circuit at a cost of less stability and having its response dependent upon individual tube characteristics.

It can be used over a frequency range of 200 to 20,000 cycles per second between 0-100 db. to an accuracy of plus or minus 1 decibel. The a.v.c. circuit, however, will not faithfully respond to frequencies above 200 cycles per second. As used in practice, with a square law detector such as a bolometer or crystal, the effective range of this amplifier is reduced by a factor of two. Therefore, in antenna recording equipment, it can be thought of as having an effective range of 0-50 db.

Fig. 3 shows the circuit diagram and parts values of the logarithmic amplifier with cascade amplification as successfully employed in this automatic antenna pattern recording system. Tubes V_1 , V_2 and V_3 are three 6SK7 amplifiers in cascade. The type 6SK7 tube is an extended cut-off pentode. Its grid voltage-plate current characteristics are approximately logarithmic in nature.

The output of the last stage of 6SK7 cascade amplification (V_3) drives a rectifier circuit (one-half section of type 6H6 tube V_4) which in turn directly drives a 6SN7 d.c. output stage (V_5). A balance circuit has been placed in the cathode circuit of the 6SN7 stage to account for unbalance caused by tube differences and the emission potential of the 6H6 rectifying circuit. The meter is driven directly by the difference in potential existing between the two cathodes of the 6SN7 tube with various input voltages applied.

The a.v.c. voltage needed to obtain

logarithmic response over a 100 db. range is approximately 15 times greater than the voltage available from the last 6SK7 tube. This deficiency is taken care of by having the last cascade stage (V_3) drive a 6J5 a.v.c. amplifier (V_4) which has a constant gain exceeding 15. This in turn drives the other section of the 6H6 tube which supplies and rectifies the a.v.c. voltage and feeds it back to the grids of the cascade amplifier.

It can be observed in the graph of Fig. 5 that the d.c. amplifier characteristics tend to level off toward the high end of the scale. This tends to flatten out an opposing characteristic of the 6SK7 cascade amplifier, producing an improved logarithmic response over the entire range.

Best results are obtained from the amplifier in the 10-.001 volt range. Since standard bolometer and crystal amplifiers most used in the field are designed for a maximum output of 100 volts, a 10:1 voltage divider (R_1) has been placed in the input circuit of the amplifier. This voltage divider needs to be changed if the amplifier is used in an application that differs in this respect, so that a maximum signal of 10 volts will be applied to the grid of the first 6SK7 at the 0-db. level.

A calibration switch has been included at the input of the amplifier for R_1 . This switch controls a calibrated attenuator having five positions in steps of 20 db. each. When used with a square law detector, it can be considered to be in steps of 10 db. each. It is used for calibration purposes and as a step gain control.

The logarithmic amplifier can be best calibrated as follows:

1. With the calibration switch at the 0 db. position and 100 volts input to the amplifier, adjust the a.v.c. potentiometer until a 1 milliamper movement is noted on the graphic recorder.

2. Change the calibration switch to its lowest position (80 db. down) and adjust the balance adjustment (R_2) so that a 0.2 ma. movement is noted on the graphic milliammeter. Repeat this procedure until these two positions are in full agreement.

For high stability and low noise, the amplifier is supplied with a low impedance regulated power supply. The voltage of this supply can be regulated for values between 200 and 250 volts and will maintain a given voltage for changes in a.c. voltage from 90 to 135 volts. Its internal resistance is approximately 25 ohms. For best logarithmic results, the voltage should be maintained at 225 volts d.c.

The manufacture of this amplifier requires all of the finery normally encountered in high gain amplifier design, particularly in this case where the

(Continued on page 28)

Fig. 5. D.c. output current vs. d.c. grid voltage to cathode follower.

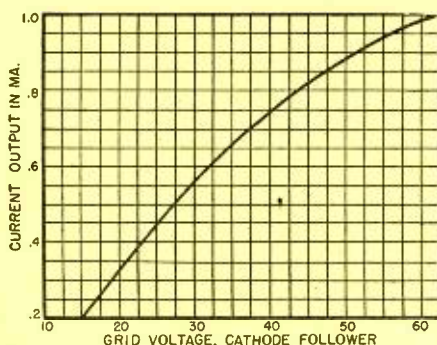

By **J. RACKER**
Federal Telecommunication Labs.

MICROWAVE TRANSMITTERS

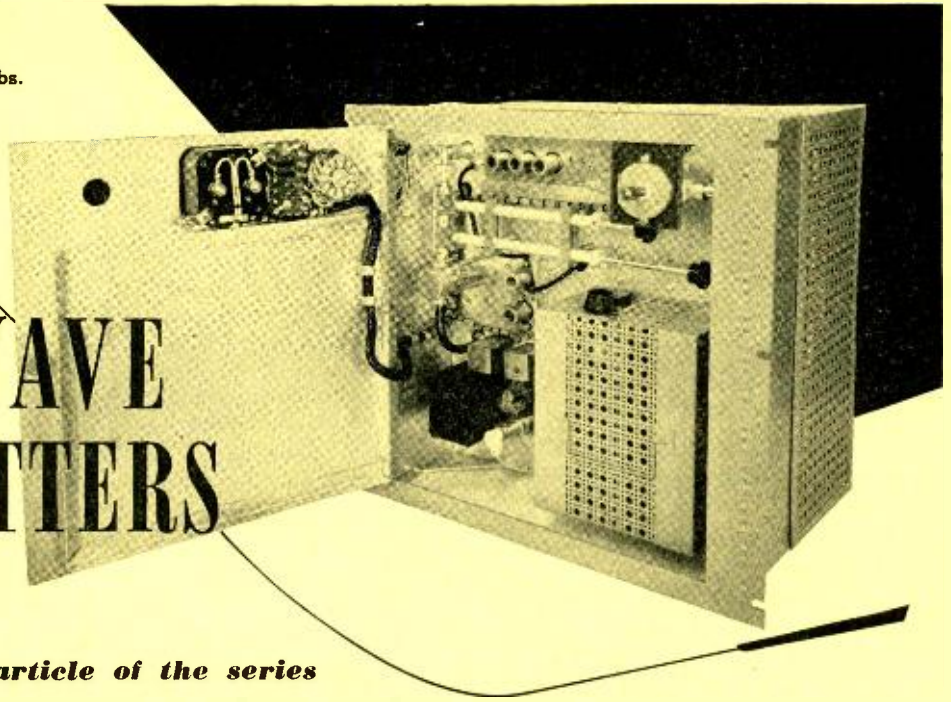

Part 2. The concluding article of the series on microwave transmitters includes a discussion of positive-grid oscillators, klystrons, and magnetrons.

Microwave transmitter operating in the 952 to 960 mc. band. Klystron is located within shield on righthand side of chassis.

IN THE first article on Microwave Transmitters¹, it was shown that in order to employ standard negative-grid oscillators at microwave frequencies it was necessary to develop special triodes in which the electron transit time was small compared to a period of oscillation. In this case the effects of electron transit time were considered detrimental to the power output and efficiency of the circuit. In this article we shall consider microwave transmitters which depend upon the finite period required for an electron to travel between plate and cathode to effect oscillation. These oscillators, sometimes referred to as transit time oscillators, include positive grid oscillators, klystrons, magnetrons, traveling wave tubes and resnatrons.

Positive-Grid Oscillators

The simplest and earliest type of transit time oscillator is the positive-grid oscillator. This type of oscillator is not used very often today because of its low power output and efficiency. However, for the purpose of this article, it has more than historic importance since it clearly demonstrates the basic principles upon which all later type oscillators operate. A clear picture of the operation of this circuit would greatly help the reader to understand the principles of the more complicated tubes.

Consider the motion of an electron leaving the cathode of the simple circuit shown in Fig. 3 in which the grid is positive with respect to both cathode and plate (with plate and cathode at same potential). The electron emitted

from the cathode is accelerated as it approaches the grid plane. Passing between the grid wires, the electron enters the grid-plate region where it is decelerated. It comes to rest momentarily in the vicinity of the plate, reverses its direction of travel, and is accelerated towards the grid plane, which it then "overshoots" and the process is repeated. The phenomenon is very closely parallel to that of the oscillation of a damped pendulum (damped due to the

fact that the electron loses some energy during each cycle). Eventually the electron will strike a grid wire and be absorbed in the grid circuit.

If no other parameters were introduced in the circuit, many individual electron oscillations would occur in the space between cathode and plate; the exact phase and amplitude of oscillation between any two electrons would depend upon the time at which the electrons were emitted and space charge at that time.

Now assume that an alternating voltage is superimposed on the grid potential whose frequency is double that of the natural oscillation of the electron stream as shown in Fig. 2, and maximum amplitude very much smaller than the d.c. voltage V_0 . Let us define the velocity v_0 as the velocity of the electron at any point in the cathode-plate space with the grid potential at the d.c. value V_0 .

Consider the relative velocities of electrons leaving the cathode during grid a.c. potential of A, B, and C shown in Fig. 2. An electron leaving during time A, travels at a velocity less than v_0 in the cathode-grid plane because during this time the grid is always at negative a.c. potential. It loses more velocity between grid and plate since during this time the grid is positive. Thus, its over-all velocity is less than v_0 .

An electron leaving the cathode with grid at time B will travel at about v_0 since both during its cathode-grid and grid-plate paths the grid is positive half the time and negative half the time. Finally an electron emitted at time C

Fig. 1. Plot of (A) $f(x)$ and (B) $g(y)$ for Eq. (2).

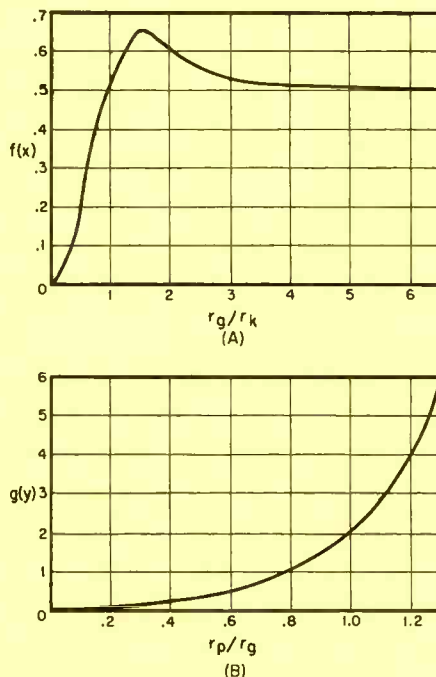

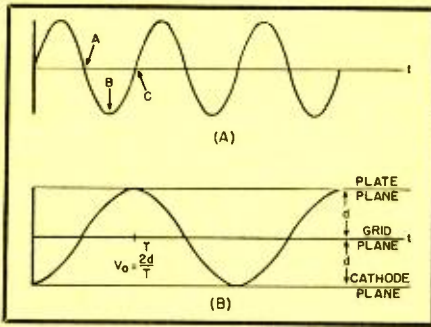

Fig. 2. Graph of (A) grid a.c. voltage and (B) electron transit with frequency double that of the natural frequency of a positive grid oscillator.

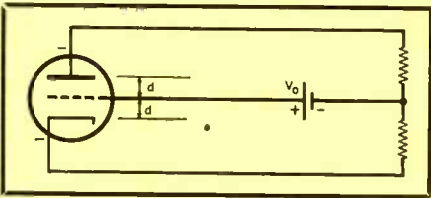

Fig. 3. Simplest positive grid oscillator.

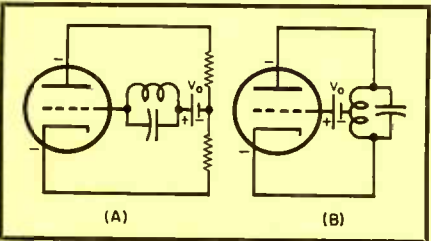

Fig. 4. Schematics diagrams of two different types of positive grid oscillators.

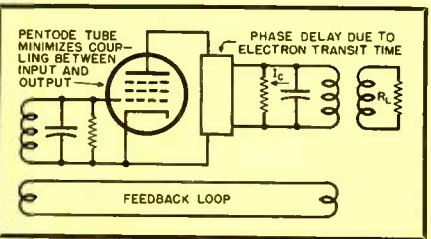
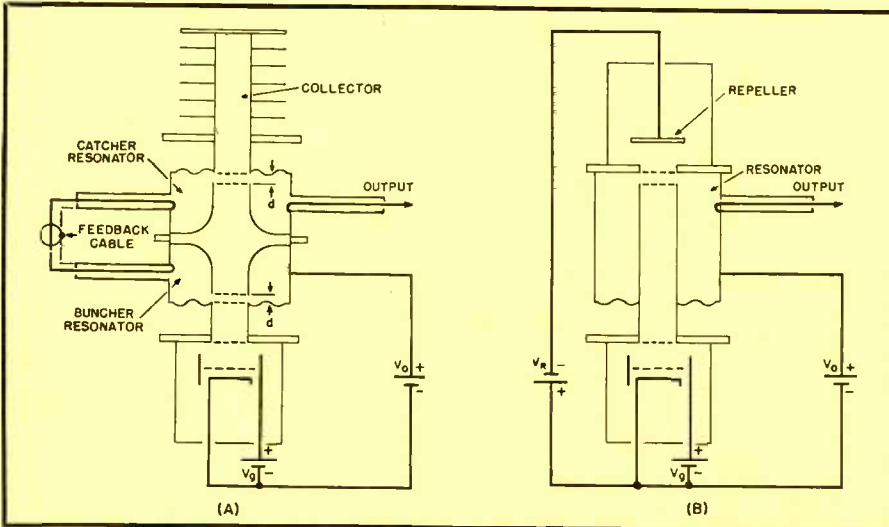

Fig. 5. Equivalent circuit diagram for a double resonator klystron oscillator.

Fig. 6. (A) Double resonator klystron, and (B) reflex klystron construction.



will travel at a velocity greater than v_0 , since grid is positive when it is in grid-cathode plane and negative in the grid-plate plane. It is readily seen that electrons emitted at time C tend to catch up to electrons emitted at time A, so that electrons will tend to oscillate in "bunches" instead of completely at random. Of course this analysis is very approximate assuming that no space charge exists to vary the progress of the electron stream and that a.c. variation is very small compared to the d.c. so that an electron leaving the cathode at time A arrives at the grid at time B although grid a.c. potential has been negative.

To obtain the desired a.c. potential on the grid, two circuits may be used as shown in Fig. 4. The tuned circuits shown in this figure would be either a resonant line or cavity depending upon frequency of operation. These circuits operate in the following manner: The oscillating electron space charge induces an alternating component of current in the external circuit. The resulting voltage drop across the load impedance produces an alternating field in the interelectrode space of the tube. Those electrons which oscillate in this field in such a phase as to be retarded by it transfer a portion of their energy to the resonant circuit during each cycle of operation.

The frequency of the circuit shown in Fig. 4A, for V_m (maximum value of a.c. component) much smaller than V_0 , is given by the following relationship*:

$$f = \frac{148 \times 10^7}{V_0 d} \dots \dots \dots (1)$$

where d is in cm.

Eq. (1) indicates that the frequency of oscillation is completely independent of the resonant frequency of the external circuit and depends only on V_0 and the distance between cathode or plate and grid. In practice it has been found

that oscillation can exist even though the resonant frequency of the external circuit differs from the fundamental frequency or a harmonic of the frequency of electron oscillation. However, an abrupt change in wavelength and pronounced increase in power output occurs when the external circuit is tuned to the fundamental or a harmonic frequency. A possible explanation for this is that when the external circuit is tuned to the electron oscillating frequency, it absorbs more power. This increases the a.c. potential amplitude V_m —which causes a shift in frequency.

The frequency of the circuit using cylindrical-electrodes shown in Fig. 4B, which acts in much the same manner as far as its external circuit is concerned as the circuit discussed previously, is given by*:

$$f = \frac{1.5 \times 10^7 \sqrt{V_0}}{[f(x) + g(y)] r_0} \dots \dots (2)$$

The quantities $f(x)$ and $g(y)$ are function of the cathode radius r_c , grid radius r_g , and plate radius r_p . These functions are plotted in Fig. 1.

Klystron Oscillators

A tube that utilizes the basic principles of the positive-grid oscillator with greater efficiency and power output is the klystron. It is apparent that the more effectively the electrons are "bunched" the higher the frequency stability, power output and efficiency. Three conditions are necessary to achieve optimum bunching and they are: 1) The velocity of the electrons must be very large compared to the change in velocity caused by the a.c. voltage for reasons previously outlined. 2) The change in velocity due to the a.c. voltage must be great enough for the faster electrons to catch up to the retarded ones, and 3) space charge must be negligible.

The klystron tube is designed to optimize each of these conditions as much as practical. Two types of klystrons, shown in Figs. 6A and B, are available. Consider the klystron shown in Fig. 6A, known as the double-resonator klystron. The cathode and grid of this tube comprise an electron gun which accelerates the electron stream to a very high velocity. This permits condition 1 mentioned above to be satisfied with relatively large a.c. amplitudes.

This electron stream is further accelerated by a "buncher" grid which is at high d.c. potential and—due to the action of the buncher resonator—contains an a.c. component. The frequency of this a.c. component—determined by the cavity resonance frequency—should be the same as the desired "bunching" frequency. This a.c. component will retard or further accelerate the electrons, depending upon its instantaneous value,

and cause bunching as accelerated electrons catch up to retarded ones.

The electron stream then passes through another grid known as the "catcher" grid. Immediately behind this grid is a collector. Both "catcher" grid and collector are at the same potential as the bunching grid. The catcher grid is tuned to the bunching frequency through another resonator, known as the catcher resonator. The phase of this grid a.c. is such as to retard the beam during the periods that the "bunched" electrons are passing so that energy is transferred from the beam to the resonator circuit. The collector carries off the excess electrons so that the space charge will be minimized.

It should be noted that a traveling wave effect occurs across each grid, i.e., the instantaneous voltage is not constant over the entire grid but varies sinusoidally as a function of distance. If the grid length is large compared to a wavelength, many harmonics will be set up. This is indicated graphically by the Applegate diagram shown in Fig. 7. It is therefore possible to use the klystron as a frequency multiplier by feeding in a signal and tuning the catcher cavity to a harmonic of the input signal. Similarly it is possible for one klystron to operate over a series of harmonically related frequencies—all other parameters remaining constant.

Fig. 5 is a schematic diagram of the equivalent circuit of a klystron oscillator. The multigridd tube emphasizes the isolation of catcher and buncher circuits. The two tuned circuits represent the two resonators. The current I_c is the induced current flowing in the catcher resonator. The output to input coupling represents the feedback circuit. The resistance R_L represents the load.

Using this equivalent circuit and the Applegate diagram shown in Fig. 7 as a basis, it is possible to derive a relationship between the voltage stability of the double resonator klystron and the accelerating voltage, the harmonic at which the klystron is operating, and the Q of the tank circuit. This relationship is

$$\frac{\Delta f}{f} = \frac{N}{2Q} = \frac{dV_0}{V_0} \quad \dots (3)$$

where N is the harmonic of operation, and Q is the loaded Q of the resonator (catcher).

Two characteristics of the double resonator klystron are apparent from Eq. (3). One is that the frequency stability is proportional to the voltage stability and the Q of the resonant circuit. The second is that it is possible to frequency modulate or tune a klystron by changing the accelerating voltage.

Another form of klystron oscillator, shown in Fig. 6B, utilizes the reflex principle for obtaining feedback. The

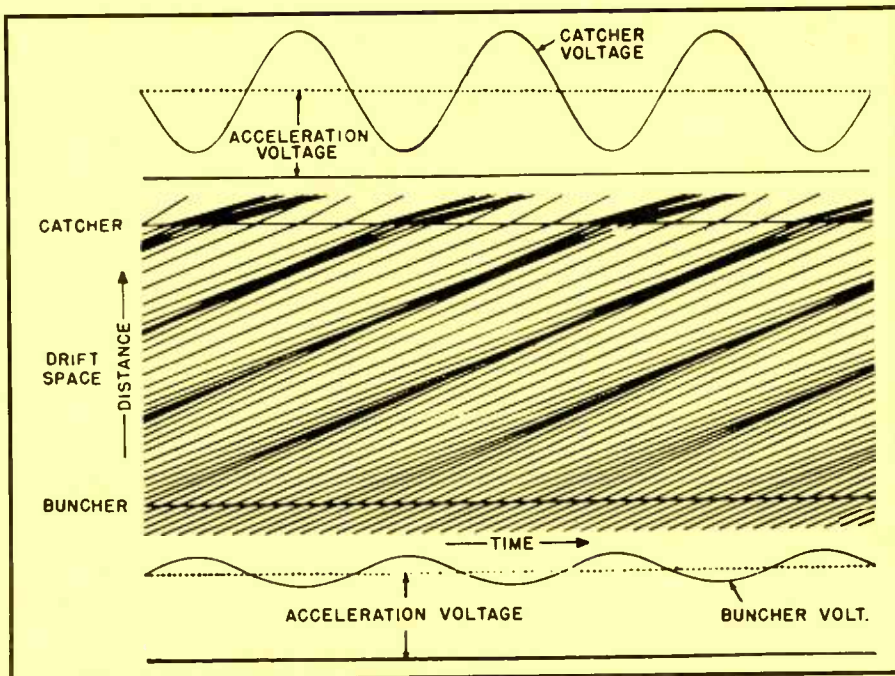

Fig. 7. Applegate diagram showing electron bunching in a klystron.

electron beam is velocity modulated as it passes between the resonator grids. A retarding electric field beyond these grids due to the repeller which is operated at a highly negative voltage causes the beam velocity to decrease to zero and reflects the beam back through the resonator grids. Bunching occurs during the transit interval during reflection. The reflector distance may be much shorter than the drift space in a double resonator klystron because the electrons travel the distance twice and their velocity is nearly zero during a part of the transit time.

The reflex klystrons are used for low power (of the order of up to 10 watts) oscillators. They are more convenient to use because only one resonator must be tuned rather than two. As in the double resonator klystrons harmonics are set up within the tube so that it may be operated at a number of harmonically related frequencies.

The frequency of a reflex klystron is primarily dependent upon the reso-

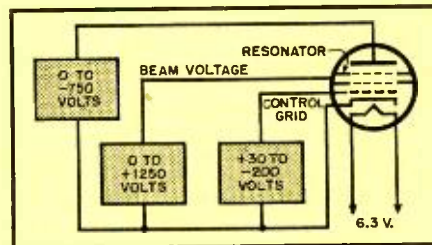

Fig. 8. Block diagram of basic oscillator circuit for a reflex klystron.

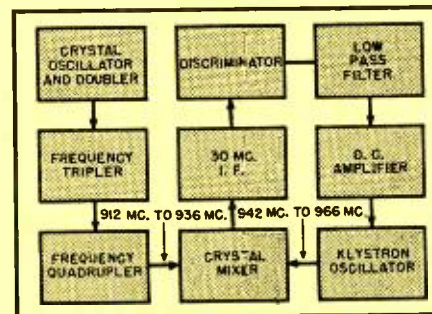
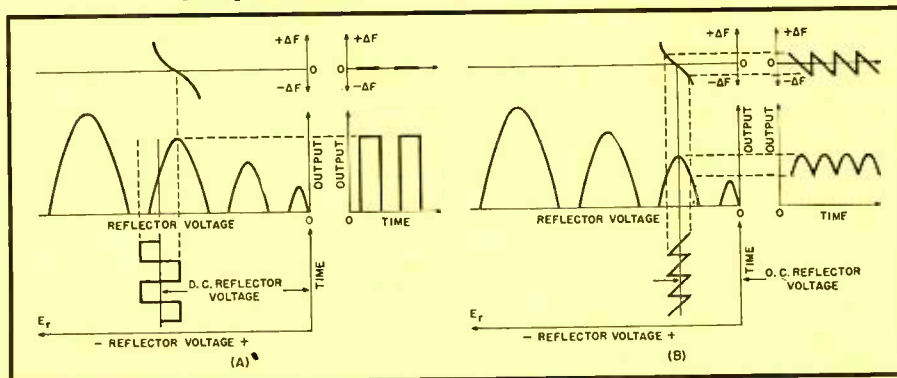

Fig. 9. Typical crystal controlled center frequency stabilization system.

Fig. 10. (A) Typical pulse modulation and (B) typical frequency modulation of a reflex klystron type of oscillator.



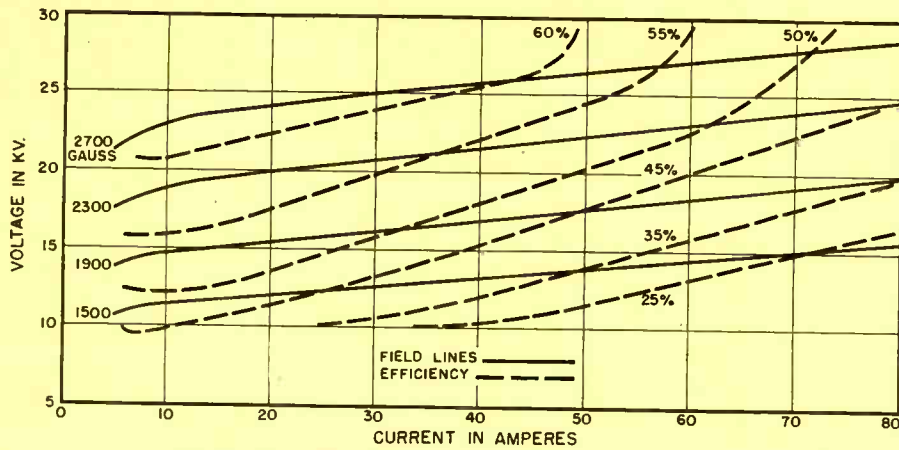
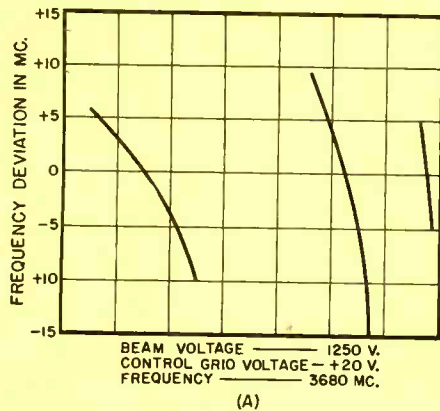
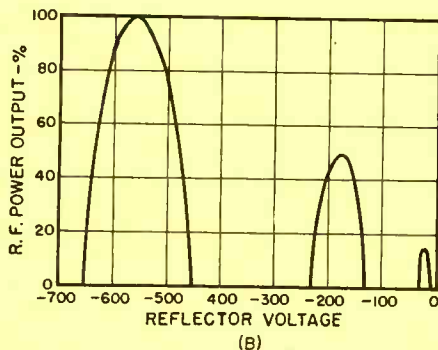

Fig. 11. Typical performance chart of magnetron including plots of voltage, current, magnetic field and efficiency.



(A)



(B)

Fig. 12. Typical reflector characteristics for reflex klystron oscillator.

nant frequency, the accelerating voltage, and the repeller voltage. The most sen-

sitive of these parameters is the repeller voltage—i.e., a small change in repeller voltage causes a relatively large change in frequency. Consequently it is this voltage that is usually varied for tuning or frequency modulation purposes.

Power Output and Efficiency

The ideal theoretical efficiency of a klystron is 58 per-cent for a double resonator type operating at its primary mode. At higher modes this theoretical maximum decreases, as shown in Table I. The reflex klystron theoretical maximum efficiency is somewhat less than those given for the double resonator type.

Several factors prevent attaining this ideal value of efficiency. The usual beam efficiencies are of the order of magnitude of 50 to 75 per-cent—meaning that the energy of only part of the electrons is available for conversion to r.f. power. Debunching, secondary electrons, resonator losses and other factors reduce the efficiency. Reflex oscillators are usually more efficient than double resonators at low voltages because their starting currents are lower and they oscillate with less power. Increasing the current beyond the starting current—by raising beam voltage—increases the output rapidly at first, then a saturation effect

Fig. 13. Performance chart of magnetron showing voltage, current, frequency and power.

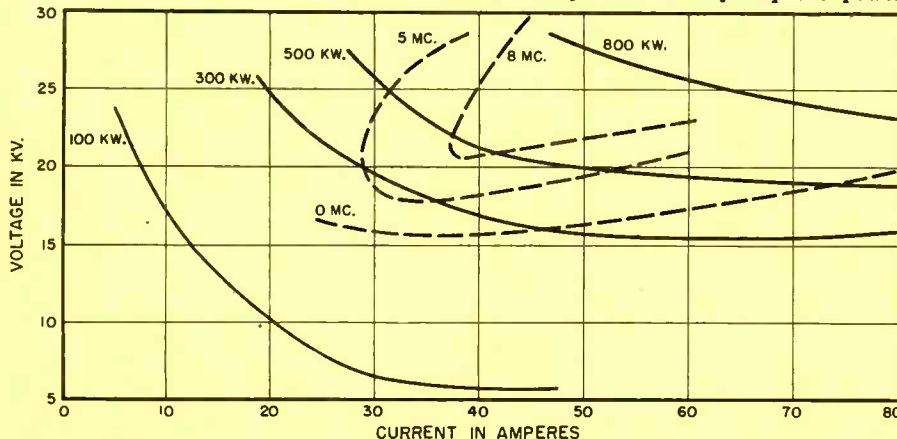

occurs due to over-bunching in the single resonator (space charge effect) and best efficiency may occur with rather low beam current in the reflex klystron. This behavior also explains the inability to obtain an output comparable to that possible with a double resonator klystron when operated at high voltages and high starting currents.

Reflex klystrons now manufactured have a maximum power output rating of the order of 10 watts and an efficiency of about 5 per-cent. The double resonator klystrons operate somewhat more efficiently at rated maximum outputs as high as 200 watts.

Practical Problems in Design

When the evaluation of the various methods of microwave generation for an individual application dictate the use of a klystron (the considerations involved will be covered in a later article on "Systems Planning for Microwave Links"—usually klystrons are used in low power frequency modulation systems), the engineer proceeds in the following fashion.

From manufacturer's catalogs, the klystron which most closely meets the requirements of the system, i.e., the power output, frequency range, tuning range, efficiency, frequency stability, etc., is selected. From the characteristic curves given with the klystron selected, the design of the oscillator can be undertaken.

Fig. 12 is the repeller characteristic curve of a typical reflex klystron used in circuit shown in Fig. 8. Curves at left in this figure represent the r.f. power output as a function of repeller voltage and with the resonator set for $f = 3680$ mc., beam voltage at 1250 volts, and control grid at 20 volts. The other curves indicate the frequency of operation for different repeller voltages. For example, with the repeller voltage equal to -600 volts, the frequency of operation will be 3682.5 mc. at 90 per-cent of peak r.f. output for these conditions. It should be noted that these values given assume a matched load. To effect matching, principles discussed in previous articles should be utilized.^{2,3}

The klystron may be frequency or pulse modulated by superimposing a modulation voltage on the d.c. voltage of either the beam control, or repeller sources. The highest degree of sensitivity and linearity can usually be obtained by modulating the repeller voltage. Fig. 10 indicates typical pulse and frequency modulating conditions. When frequency modulating it is important to operate over the linear portion of the repeller voltage versus frequency curve to minimize distortion.

The frequency stability of the oscillator is a function of the three d.c. supplies mentioned above as well as the

If it's a problem calling for **PRECISION POTENTIOMETERS**

Bring it to Helipot

For many years The HELIPOT Corporation has been a leader in the development of advanced types of potentiometers. It pioneered the *helical* potentiometer—the potentiometer now so widely used in computer circuits, radar equipment, aviation devices and other military and industrial applications. It pioneered the *DUODIAL*—the turns-indicating dial that greatly simplifies the control of multiple-turn potentiometers and other similar devices. And it has also pioneered in the development of many other unique potentiometric advancements where highest skill coupled with ability to mass-produce to close tolerances have been imperative.

In order to meet rigid government specifications on these developments—and at the same time produce them economically—HELIPOT® has perfected unique manufacturing facilities, including high speed machines capable of winding extreme lengths of resistance elements employing wire even less than .001" diameter. These winding machines are further supplemented by special testing facilities and potentiometer "know-how" unsurpassed in the industry.

So if you have a problem requiring *precision potentiometers* your best bet is to bring it to The HELIPOT Corporation. A call or letter outlining your problem will receive immediate attention!

*Trade Marks Registered

In this panel are illustrated standard models of HELIPOT multi-turn and single-turn precision potentiometers—available in a wide range of resistances and accuracies to fulfill the needs of nearly any potentiometer application. The Beckman DUODIAL is furnished in two designs and is furnished in two designs and four turns-ratios, to add to the usefulness of the HELIPOT by permitting easy and rapid reading or adjustment.

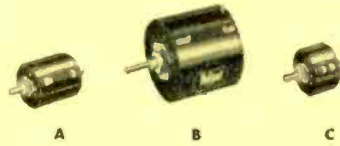

MODELS A, B, & C HELIPOTS
 A—10 turns, 46" coil, 1-13/16" dia., 5 watts—resistances from 10 to 300,000 ohms.
 B—15 turns, 140" coil, 3-5/16" dia., 10 watts—resistances from 50 to 500,000 ohms.
 C—3 turns, 13-1/2" coil, 1-13/16" dia., 3 watts—resistances from 5 to 50,000 ohms.
 — Ask for Bulletin 104—

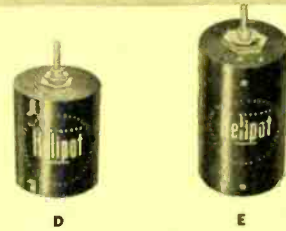

MODELS D AND E HELIPOTS
 Provide extreme accuracy of control and adjustment, with 9,000 and 14,400 degrees of shaft rotation.
 D—25 turns, 234" coil, 3-5/16" dia., 15 watts—resistances from 100 to 750,000 ohms.
 E—40 turns, 373" coil, 3-5/16" dia., 20 watts—resistances from 200 ohms to one megohm.
 — Ask for Bulletin 104—



MODELS F AND G PRECISION SINGLE-TURN POTENTIOMETERS
 Feature both continuous and limited mechanical rotation, with maximum effective electrical rotation. Versatility of designs permit a wide variety of special features.
 F—3-5/16" dia., 5 watts, electrical rotation 359°—resistances 10 to 100,000 ohms.
 G—1-5/16" dia., 2 watts, electrical rotation 356°—resistances 5 to 20,000 ohms.
 — Ask for Bulletin 105—

LABORATORY MODEL HELIPOT
 The ideal resistance unit for use in laboratory and experimental applications. Also helpful in calibrating and checking test equipment. Combines high accuracy and wide range of 10-turn HELIPOT with precision adjustability of DUODIAL. Available in eight stock resistance values from 100 to 100,000 ohms, and other values on special order.
 — Ask for Bulletin 106—



MODELS R AND W DUODIALS
 Each model available in standard turns-ratios of 10, 15, 25 and 40 to 1. Inner scale indicates angular position of HELIPOT sliding contact, and outer scale the helical turn on which it is located. Can be driven from knob or shaft end.
 R—2" diameter, exclusive of index.
 W—4-3/4" diameter, exclusive of index. Features finger hole in knob to speed rotation.
 — Ask for Bulletins 104 and 114—

The versatility of the potentiometer designs illustrated above permit a wide variety of modifications and features, including double shaft extensions, ganged assemblies, the addition of a multiplicity of taps, variation of both electrical and mechanical rotation, special shafts and mounting bushings, high and low temperature operation, and close tolerances on both resistance and linearity. Examples of potentiometers modified for unusual applications are pictured at right.



MULTYTAPPED MODEL B HELIPOT AND 4-GANGED TAPPED MODEL F
 This Model B HELIPOT contains 28 taps, placed as required at specified points on coil. The Four-Gang Model F Potentiometer contains 10 taps on each section. Such taps permit use of padding resistors to create desired non-linear potentiometer functions, with advantage of flexibility, in that curves can be altered as required.

3-GANGED MODEL A HELIPOT AND DOUBLE SHAFT MODEL C HELIPOT
 All HELIPOTS, and the Model F Potentiometer, can be furnished with shaft extensions and mounting bushings at each end to facilitate coupling to other equipment.
 The Model F, and the A, B, and C HELIPOTS are available in multiple assemblies, ganged at the factory on common shafts, for the control of associated circuits.

THE Helipot CORPORATION, SOUTH PASADENA 4, CALIFORNIA

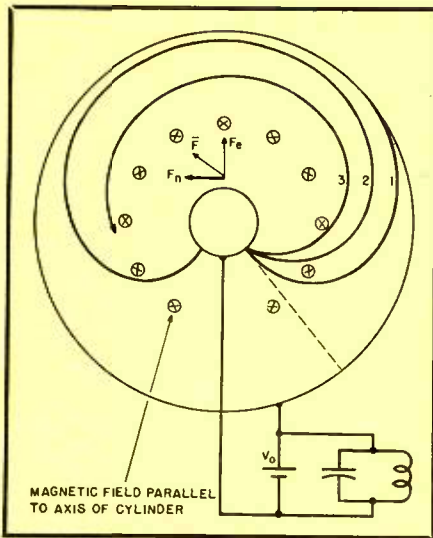

Fig. 14. Simple magnetron showing trajectories of electron with (1) a.c. voltage in phase with d.c., (2) a.c. voltage zero, (3) a.c. out of phase with d.c.

cavity used within the klystron (and the load—but matching has been discussed in previous articles). Electronically regulated power supplies are usually employed to minimize the first effect and automatic frequency control circuits used to compensate for the other factors.

The a.f.c. circuit shown in Fig. 8 of the previous article¹ can be used with the discriminator output used to either operate a motor or electronically tune the oscillator by varying the repeller voltage. This latter method can readily be employed by operating on the electronically regulated power supply which inherently contains a d.c. amplifier. The disadvantage of the electronic system is that it may swing the repeller voltage beyond the linear portion of the repeller-frequency curve. This factor becomes important only where large frequency deviations are used.

Instead of checking the frequency of the klystron against a reference cavity, it is possible to compare it with a crystal oscillator. A crystal oscillator a.f.c. system is shown in Fig. 9 in which the output of a crystal operating in the

Fig. 16. Typical Rieke diagram.

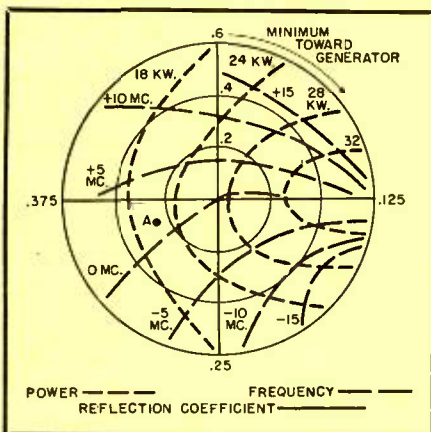

38 to 39 mc. range is frequency multiplied to 912 to 936 mc. The klystron normally operates in the 942 to 966 mc. range—the crystal frequency selected so that a difference of 30 mc. exists between klystron and crystal multiplier frequency—this difference is then fed to a discriminator so designed that it presents a zero output with a 30 mc. input, and an either positive or negative output when the i.f. frequency deviates above or below 30 mc. This output is then fed to the frequency regulating circuit.

Magnetron Oscillators

Magnetron oscillators are widely used when high power output and efficiency are primary design factors. In its simplest form the magnetron, as shown in Fig. 14, is a diode, usually cylindrical, with a magnetic field parallel to its axis and a tuned circuit applied between plate and cathode.

The magnetron shown in Fig. 14 operates in the following manner: An electron leaving the cathode is driven by

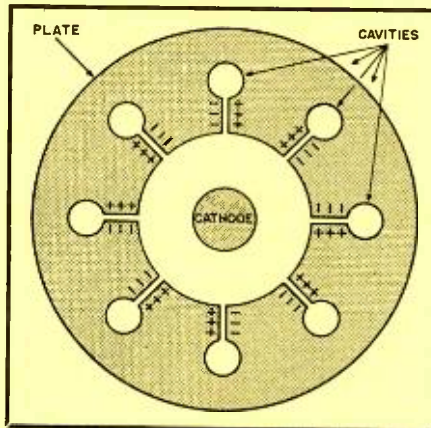
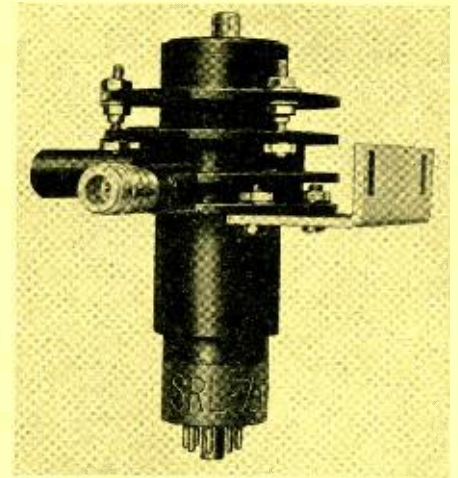

Fig. 15. Multicavity magnetron.

two force vectors. One force is due to the potential V_0 on the plate and this vector is directed radially from cathode to plate. The other force, due to the magnetic field B , is perpendicular to electron and magnetic field. When the electron travels radially towards the plate, the force due to the magnetic field would be parallel to the diameter of plate and cathode. The magnitude of the vectors will be a function of the strength of electric and magnetic fields.

It can readily be seen that if the magnetic force is relatively weak the electrons leaving the cathode will travel along a curved path but reach the plate eventually. As the magnetic field increases, the angle at which electron strikes the plate becomes increasingly smaller until at some point it grazes by and returns to the cathode. This point is reached when the following relationship is true:

$$\frac{V_0}{B^2} = \frac{er_a}{8mc^2} \left[1 - \left(\frac{r_c}{r_a} \right)^2 \right]^2 \quad (4)$$



Reflex klystron operating in the 1875 to 2100 mc. range provides an output of approximately 10 watts.

where r_c is the radius of the cathode
 r_a is the radius of the anode
 m is the mass of an electron
 e charge on an electron
 c is the velocity of light

The curves shown in Fig. 14 show the effect of an r.f. voltage superimposed on V_0 , where the value of V_0 chosen is such that equation (4) is satisfied. Curve (1) represents the trajectory of an electron emitted at an instant when the r.f. field is in the same direction as the d.c. field. Thus the effective V acting on the electron is increased with the result that the electron strikes the plate.

Curve (2) represents the trajectory of an electron for the r.f. voltage equal to zero, while curve (3) indicates the path of an electron leaving when the r.f. potential opposes the d.c. field. This electron contributes energy to the r.f. oscillation and the process will continue as long as the electron is retarded by the r.f. field. A characteristic of this type of magnetron, which is important in the operation of many magnetrons, is the quick removal from the field of electrons whose phase is unfavorable to the support of oscillation and the retention of electrons aiding in the support of the r.f. oscillations.

Many forms of magnetrons, all of which employ the basic principles described above, have been made in the
(Continued on page 30)

Table I. Ideal efficiency of klystron oscillator for various modes of operation.

Harmonic	Ideal Efficiency
1	58
2	48
3	43
5	37
10	30
15	27
20	24

GREAT LITTLE TUBES FOR A GREAT LITTLE INSTRUMENT

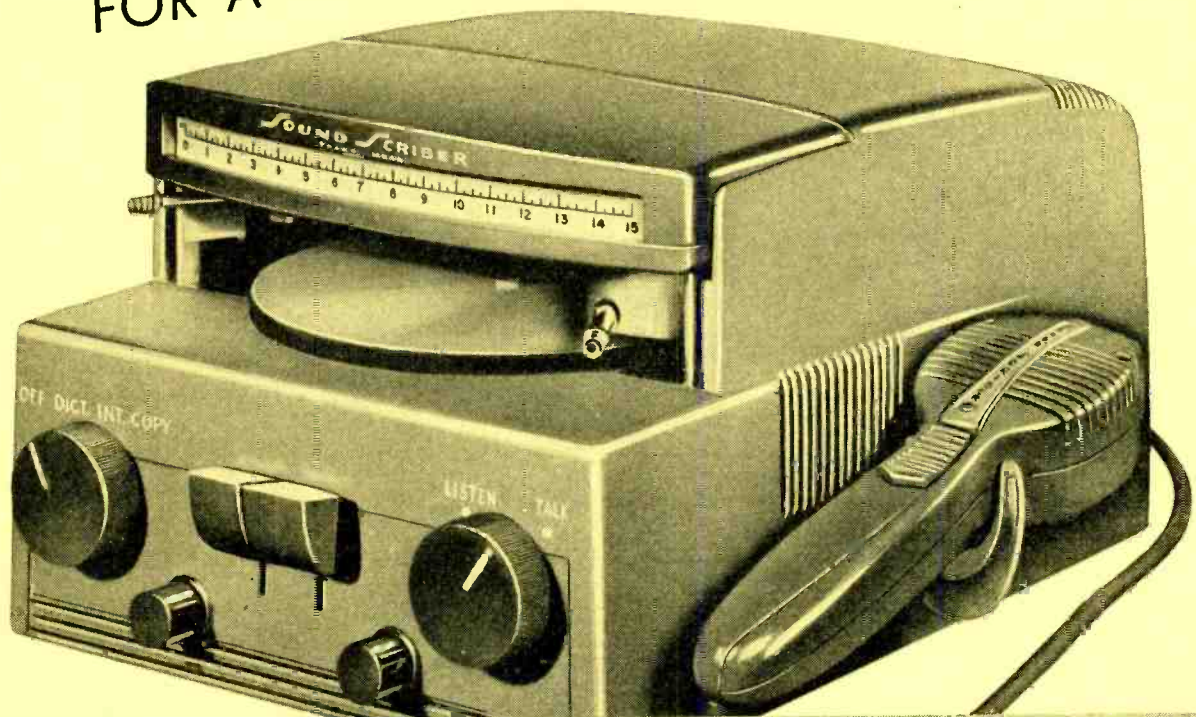

Here is the heart of the SoundScriber "Tycoon". Note how Sylvania's three subminiature tubes (1-6BA5 and 2-6AD4's) are mounted directly on the plastic card—allowing all-round compactness of design.

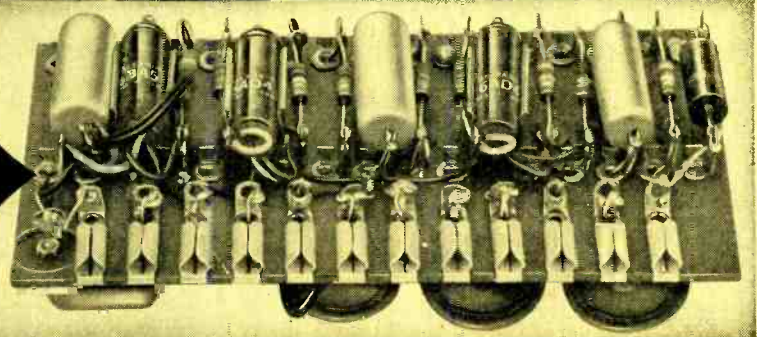

Sylvania's subminiature tubes are one of the secrets that enable SoundScriber to make the world's lightest, most compact dictation instrument. Only 15 lbs., the "Tycoon" covers as little desk space as an ordinary letter. Such concentration of electronic efficiency is typical of the advantages offered by Sylvania's subminiature tubes.

The "Tycoon" also owes much of its reputation for reliability to the Sylvania subminiature

atures that serve it . . . for they are lightweight little wonder-workers that stand up to heavy-weight treatment.

In electronics, wherever compactness demands minimum size . . . wherever dependability is wedded to economy . . . you'll find Sylvania subminiatures at work, cutting space, cutting costs, cutting servicing requirements and replacement. Write Sylvania Electric Products Inc., Dept. R-2306, Emporium, Pa.

SYLVANIA ELECTRIC

RADIO TUBES; TELEVISION PICTURE TUBES; ELECTRONIC PRODUCTS; ELECTRONIC TEST EQUIPMENT; FLUORESCENT LAMPS, FIXTURES, SIGN TUBING, WIRING DEVICES; LIGHT BULBS; PHOTOLAMPS; TELEVISION SETS



ATOM SMASHER

Dr. C. C. Suits, vice president and director of research for the *General Electric Company*, has announced that



a machine known as a "non-ferromagnetic synchrotron" is being built under the joint sponsorship of the Office of Naval Research and the *GE Research Laboratory*.

According to Dr. Suits, this atom smasher has been operated thus far up to about a million volts and probably will be in operation at much higher energies before the end of the year. It will be used to study the effects of high-energy radiation, particularly in nuclear research. First erected in one of the old buildings of the *GE Research Laboratory*, the new synchrotron is now being installed in its own building at the laboratory's new quarters at the Knolls, in nearby Niskayuna.

In charge of its design and construction shown from left to right above are Dr. James L. Lawson, and his associates, Drs. H. R. Kratz, W. B. Jones, H. G. Voorhies and G. L. Ragan.

RADAR INTERCEPT

A miniature magnetron radio tube that might be important in radio and radar intercept work has been developed by the Signal Corps Engineering Laboratories.

Compared with the 20,000 to 30,000 volts normally required by commercial type magnetrons, the miniature tube can be operated on less than 100 volts from dry batteries. The tube is approximately the diameter of a lead pencil and is four inches in length.

The basic theory of the new tube was derived from a captured German magnetron used in radar and television,

but the design and operation were improved by the Signal Corps.

INSTRUMENT TO MEASURE FARADAY

The National Bureau of Standards has developed an instrument which makes possible measurement of the numerical value of the faraday with exceedingly high precision. Developed by J. A. Hipple, H. Sommer, and H. A. Thomas, the omegatron is basically a miniature cyclotron.

For the first time the faraday is being evaluated directly by physical methods, all previous faraday measurements having been electrochemical. Also, the value of the nuclear magneton may now be determined very precisely so that the ratio of the mass of the electron

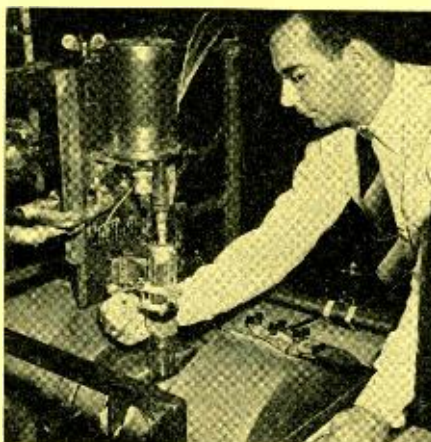

to the mass of the proton will be known with greater precision than ever before.

The omegatron with its associated electromagnet, vacuum system, and electrometer amplifier is shown here in use as a mass analyzer. Mr. H. Sommer is checking the position of the omegatron in the magnetic field.

RESEARCH ON GERMANIUM

Speaking at the M.I.T. Conference on Physical Electronics at the Massachusetts Institute of Technology recently, Dr. B. J. Rothlein of The Physics Laboratories of *Sylvania Electric Products Inc.*, described researches he has conducted on the photoresistive properties of germanium previously reported by other research workers during World War II.

Dr. Rothlein showed that a ger-

manium photoswitch may be made to operate a relay for applications such as automatic door openers without the aid of photocells, amplifiers or direct current power supplies.

NEW RCA PLANT

Dedication ceremonies for the new television picture tube plant of the



Radio Corporation of America at Marion, Indiana were held recently. Honored guest was Governor Henry F. Schricker of Indiana, who also officiated at groundbreaking for the new plant last year.

Major product of the plant is *RCA's* recently developed short 16-inch metal picture tube. The new Marion plant is the fourth of the thirteen *RCA* plants to be located in Indiana.

REMINGTON BUYS "UNIVAC"

Announcement of the purchase of more than 95 per-cent of the stock of the *Eckert-Mauchly Computer Company* of Philadelphia, whose founders, Dr. John W. Mauchly and J. Presper Eckert originated the "electronic brain", has been made by James H. Rand, president and board chairman of *Remington Rand, Inc.*

Dr. John W. Mauchly, left, and Prof. J. Presper Eckert, right, inspect the mercury memory assembly of the Univac with Lt. Gen. Leslie R. Groves, U.S.A. (Ret), *Remington Rand's* Vice

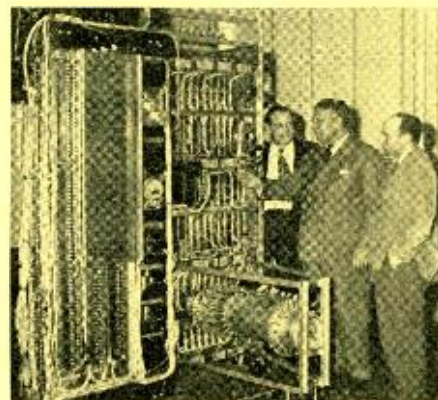

President and Director of the company's Laboratory for Advanced Research
(Continued on page 25)

EL-MENCO CAPACITORS

Hold!



UNDER STRAIN

In capacitors performance depends on dielectric strength to withstand strain. Before *El-Menco* capacitors leave the factory they must pass severe tests for dielectric strength—at *double the working voltage*, insulation resistance and for capacity value. El-Menco fixed mica condensers meet and beat strict Army-Navy standards. That's why you can rely on El-Menco performance in *your* product.

SO ALWAYS

Specify Pretested Capacitors by El-Menco . . .

THEY HOLD UNDER

STRAIN

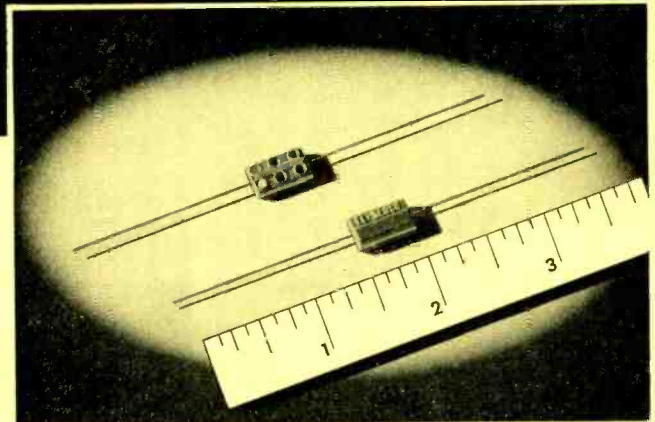

CM 15 MINIATURE CAPACITOR

Actual Size $\frac{3}{32}'' \times \frac{1}{2}'' \times \frac{3}{16}''$. For Radio, Television and Other Electronic Applications.

2 to 420 mmf. capacity at 500v DCw.

2 to 525 mmf. capacity at 300v DCw.

Temp. Co-efficient ± 50 parts per million per degree C for most capacity values.

6-dot color coded



THE
ELECTRO MOTIVE MFG. CO., Inc.
WILLIMANTIC CONNECTICUT

Write on your firm letterhead for Catalog and Samples

MOLDED MICA

MICA TRIMMER

CAPACITORS

FOREIGN RADIO AND ELECTRONIC MANUFACTURERS COMMUNICATE DIRECT WITH OUR EXPORT DEPT. AT WILLIMANTIC, CONN. FOR INFORMATION.
ARCO ELECTRONICS, INC. 135 Liberty St., New York, N. Y.—Sole Agent for Jobbers and Distributors in U.S. and Canada

NEW PRODUCTS

RECORDING AND TRANSCRIBING UNIT

The *Permoflux Corporation*, 4900 W. Grand Avenue, Chicago 39, Illinois, is



now introducing a combination recording and transcribing unit under the name of the *Tape Riter*.

The unit is compact and on the spot recordings can be made with ease. The tape may be used over and over again simply by erasing previous recording with the new message. There is no overtone from the previous recording and correction and deletion of any portion of the message is easily accomplished.

Fast forward and reverse enables the user to find any particular spot on the tape in seconds and accurate indexing is provided.

MOTOR SPEED CONTROL

A simplified thyatron type motor speed control system which operates d.c. motors from the a.c. line has been developed by *Servo-Tek Products Co.*, 4 Godwin Ave., Paterson, N. J. Shunt wound type 115 volt motors of from one thousandth to one tenth horsepower may be controlled over a speed range of better than 50 to 1 with nearly constant speed versus torque regulation.

A physically identical model is avail-

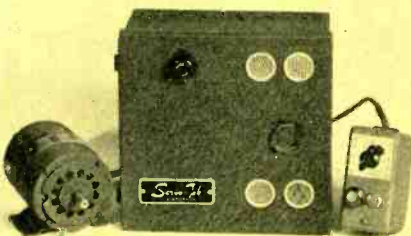

able for operation from the 220 volt line to control d.c. motors of the shunt

wound type up to one-sixth horsepower. Speed range is identical for either unit.

The manufacturer believes that applications of this motor speed control system to industrial applications are many and varied, and has offered to assist in application problems.

OSCILLOSCOPE CAMERA

Fairchild Camera and Instrument Corp., 88-06 Van Wyck Blvd., Jamaica 1, N. Y., has announced a new recording camera for photographing the screen of a cathode-ray oscilloscope and producing a print for engineering study within one minute.

Designated as the *F-284 Fairchild-Polaroid Oscilloscope Camera*, this

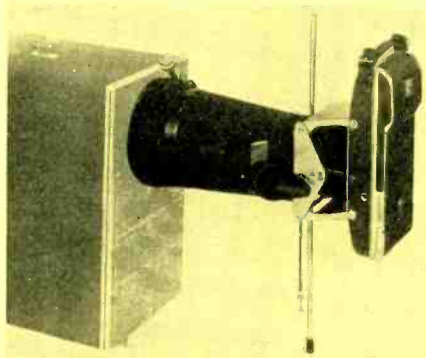

camera is expected to prove extremely useful to engineers in that it quickly delivers an accurate photographic record of single transients or repetitive phenomena without the need for dark-room processing.

The camera is designed for use with any standard 5" cathode-ray oscilloscope. Writing speeds up to 1 inch per microsecond have been recorded with an accelerating potential of 3000 volts. Print size is 3¼ x 4¼ inches with the two recorded images reduced by a ratio of only 2 to 1 from the original trace.

Further information may be obtained from *Fairchild* by writing to Mr. W. J. Schubert.

MOBILE COMMUNICATIONS UNIT

Type *ES-12-A*, announced by the *General Electric Company*, Syracuse, N. Y., is a 10-watt mobile radio transmitter-receiver designed for adjacent channel operation in urban and metropolitan areas.

Features of this unit include triple-

tuned transformers for extra high selectivity, peak audio output of 2 watts, adjustable i.f. gain control, and built-in



low pass harmonic filter that reduces interference to other services, including television.

Further information on the *ES-12-A* mobile communications unit may be obtained from the Commercial Equipment Division.

TIME DELAY RELAYS

Westinghouse Electric Corporation, Pittsburgh, Pa., is now offering type *AM* pneumatic time delay relays with adjustable delay from 0.2 to 200 seconds. A large graduated dial permits delay adjustment throughout this range for general industrial timing functions.

These type *AM* relays are available as open or enclosed units, the latter in *NEMA* type *I* enclosures with conduit knockouts at top and bottom. Operating coils are designed for satisfactory service down to 85 per-cent of rated voltage. Coils are available in ratings up to 600 volts a.c., 25 to 60 cycles.

Further information may be obtained by writing the company at P. O. Box 2099, Pittsburgh 30, Pa.

MOLDED PLASTIC PARTS

General purpose and low loss dielectric molded phenolic plastic products for the electrical and electronic indus-



tries are now available from the Parts Division, *Sylvania Electric Products*,
(Continued on page 26)



Assembly Costs Take a Tumble with Change-over to **CLUTCH HEADS**

Users Certify 15% to 50% Production Increases for Lower Final Costs

In view of this testimony you may confidently expect these exclusive time and cost-saving CLUTCH HEAD features to deliver a similar ratio of production increases on your assembly line . . . to lower your final costs by producing more for less.

Higher Visibility of the clutch recess eliminates operator hesitation. Even "green" help drives with speed and confidence. No "break-in" needed.

No Damaged Heads . . . Dead-center entry with the Center Pivot Column prevents driver canting, makes straight driving automatic, and checks out delay and expense fixing burred or chewed-up heads.

Now, Non-Tapered Driving that sends skid damage to zero; safeguarding manpower and material. With CLUTCH HEAD's all-square driving engagement there is no need for end pressure to combat "ride-out" (as set up by tapered driving) and the drive home is effortless. This safety factor and elimination of fatigue steps up production.

One-Handed Reaching at "Bottlenecks." Only CLUTCH HEAD provides a frictional Lock-On that joins screw and bit as a unit to permit one-handed reaching into inner spots and driving from any angle.



214,000 Screws Driven Non-Stop. This is the record established by the rugged Type "A" Assembly Bit . . . continuous high torque driving on a main assembly line of one of America's largest automotive plants.

New Bit Life in 60 Seconds. Consider the added tool economy of simplified reconditioning this bit REPEATEDLY . . . by a 60-second application of the end surface to a grinding wheel.

Curing Field Service "Headaches." For simplified field service, CLUTCH HEAD alone has a recess that is basically designed for operation with a common screwdriver or with any flat blade which need only be reasonably accurate in width.

These advantages are fully detailed in the New CLUTCH HEAD Brochure . . . along with technical information your engineers and plant executives will want for reference. Start your investigation of CLUTCH HEAD's potential savings for your assembly by sending for a copy . . . and indicate sizes and types of screws which interest you.

UNITED SCREW AND BOLT CORPORATION

CLEVELAND 2

CHICAGO 8

NEW YORK 7

Personals



JAMES N. DAVIS, formerly a senior research engineer for the Physics Laboratories of *Sylvania Electric Products Inc.*, Bayside, New York, has been appointed technical representative for the company at Washington, D. C. Before joining the *Sylvania* research staff in 1946, Mr. Davis served as Radar Officer in the Naval Research Laboratory. He graduated from Purdue University with a B.S. degree in general science.



LYNN C. HOLMES has been made associate director of research for *Stromberg-Carlson Company*, Rochester, New York. Senior electrical engineer since he joined the company in 1943, Mr. Holmes is well-known in the field of magnetic sound recording. He is an active committeeman in the AIEE, RMA, the American Standards Association, and is a member of the IRE and the Acoustical Society of America.



DAVID LEO HOWARD, Assistant General Manager of Canadian Pacific Communications, has been appointed President and General Manager of the *Canadian Overseas Telecommunication Corporation*, Ottawa. As representative of Canadian wireline companies, Mr. Howard has appeared many times before Canadian Parliamentary Committees and United States Senate and Congressional hearings in the coordination of telecommunication services.



GEORGE C. JELLIFFE has been named Eastern District Manager for the *Ilg Electric Ventilating Company* of Chicago. Mr. Jelliffe's headquarters will be at 15 Park Row in New York City. A graduate of Stevens Institute of Technology with an M.E. degree, Mr. Jelliffe first became associated with *Ilg Electric* in 1946 as assistant to the vice-president. He was formerly associated with *Western Union Telegraph Company*.



G. PRYOR MOLLOY, formerly associated with *RCA's* Tube Department, has been appointed head of the Field Engineering Department, Industrial & Electronics Division of *American Structural Products Company* with headquarters at Columbus, Ohio. A graduate of Newark College of Engineering, Mr. Molloy is a senior member of the IRE, a member of the AFCA, American Society of Naval Engineers, and an associate member of the U. S. Naval Institute.



HOWARD D. MATTHEWS, consulting engineer for the *W. M. Chace Company*, Detroit, Michigan, passed away recently. Mr. Matthews was widely known for his work in the application of thermostatic bimetal to various problems of temperature-responsive devices. He was a Fellow of the AIAS and a Fellow in the AIEE.

Loading Crystals

(Continued from page 9)

did not give greatest activity. Instead the optimum activity, 50 per-cent higher, was obtained by moving the electrode to a different position near the center. Shifting to the thinner edges was accompanied by increasing frequency and decreasing activity; moving from the optimum point toward the center caused both activity and frequency to decrease. The area of the crystal and the frequency range over which this anomalous behavior occurred were small. For example, in a 10 mc. plate which had an edge-to-center frequency variation of 25 kc., the frequency which gave maximum activity was about 5 kc. higher than the lowest frequency obtainable; the electrode position in this case was about one-fifth the distance from the center of the corner of the plate. Typical activity values as indicated by the rectified grid current from the oscillator tube, were 0.5 at the center of the plate, 0.8 at the optimum position and 0.2 at the corner.

Temperature runs (-60° to $+90^{\circ}\text{C}$) were made on several $\frac{1}{2}$ -inch-square 10 mc. plates which had centers about 0.00005 inch concave. All had activities which varied constantly between 0 and 0.2 milliamperes over the temperature range, and frequencies which were correspondingly unstable. These oscillator blanks were etched slightly to raise their frequencies 3 to 5 kc., and then were loaded to their original frequency, thereby reestablishing the original relationship between the fundamental and other secondary modes. The loading material was woods metal, applied lightly in a $\frac{1}{4}$ -inch diameter circle concentric with the center of the plate. The effect was a more than threefold increase in the activity (0.2 to 0.7 ma. or more). Subsequent temperature runs revealed that the increased activity was associated with a general improvement in operating characteristics over the entire temperature range. Also, the resistance at series resonance, R_s , decreased several fold while the Q increased correspondingly. Since the same frequency-dimension relationships were maintained, factors other than the usually ascribed coupling phenomena are responsible in some measure for the erratic behavior; perhaps the most important of these is the frequency at which the plate is being driven. In general, it appears that plates whose central active areas have a frequency that is too high for the plate as a whole tend to have poor frequency stability and activity. Elimination of this condition can very easily be effected through a lowering of the frequency by placing a small mass of material upon the central areas.

Loading certain areas of lower-frequency plates very heavily has also been found to be beneficial. It has long been known that giving a slight convexity to some types of oscillator plates results in improved performance. Recent experiments indicate that if this contouring takes the form of a plateau at the center with tapering edges, the performance is improved even more. It appears that heavily loading the central portion of the plate produces effects very similar to those produced by the plateau with tapering edges. It is believed that in both cases the thickness-shear vibration is mainly confined to the central area because the surrounding area is so far off frequency that it remains relatively inert. A difficulty commonly found in mounting low-frequency plates is their failure to oscillate when pressure is applied to the corners,—e.g., when a plate is pressure-mounted between electrodes with raised areas at the corners. Although the active portion of very thin plates in thickness-shear is mostly restricted to the central area, the flexural vibrations which may also be present become quite active at lower frequencies (thicker plates). This may be corrected either by contouring or by properly loading the plates, which may then be securely clamped at the corners with no great reduction in activity.

Several loading materials, both metallic and non-metallic, have been used effectively. Woods metal has certain advantages in hand application because it is soft, adheres well to the quartz, and can easily be removed. The amount of metal for satisfactory results varies with the percentage of the area coated as well as with the shape of the coated area. An elliptical pattern with the long axis parallel to the x -axis has good effect, and a band across the plate in the x -axis direction, covering about $1/3$ the area of the plate, is also effective. A narrower band parallel to the x -axis is less effective while similar patterns rotated 90° (long dimensions perpendicular to the x -axis) are still less effective: a narrow band perpendicular to the x -axis appears to have a deleterious effect. In most of the experiments, an equal amount of woods metal was applied to both faces of a plate. (When the coated area was the size of a pinhead, an interesting effect occurs: the frequency decreases at first, as expected, but further application of metal causes the frequency to jump to a point many kilocycles higher than the original frequency).

A better understanding of the theories involved in quartz-crystal loading and how the most beneficial effects may be produced must await more comprehensive study. A considerable improve-

ment over the hand-loading technique could no doubt be effected through evaporation processes similar to those used for coating mirrors.



News Briefs

(Continued from page 20)

search, South Norwalk, Connecticut.

According to Mr. Rand, plans were begun immediately for developing the amazing new mathematical marvels for use by business concerns requiring large amounts of computing and recording. Manufacture and distribution of the "Univac" will be coordinated with Remington Rand's complete line of business equipment.

COPPER WIRES

Nickel-clad copper wires for aircraft, industrial and laboratory equipments, and many other applications where product fabrication or end use is in high temperature or corrosive atmospheres is being produced by Sylvania Electric Products Inc.

Mr. Howard M. Boyd, sales manager, said that Sylvania is specializing in diameters ranging from .010" to .005" which are particularly well suited for stranding and for lead wire applications where high temperature working of hard glass frequently renders solid copper wires brittle and unworkable.

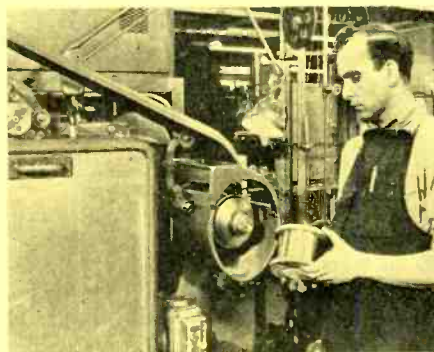

Production of nickel-clad copper wire is controlled so that a practically uniform ratio of nickel to copper is maintained through a series of cold drawing operations in which the nickel-cladding ranges from 27% to 29%. This material is being marketed under the brand name "Kulgrid".

WEATHER FORECASTING TECHNIQUES

Scientists of the Geophysical Research Directorate, a branch of the Air Force Cambridge Research Laboratory, are conducting studies of new weather forecasting techniques with an analytical mass spectrometer.

The high-sensitivity range of the mass spectrometer, which was designed

2x10⁻⁷

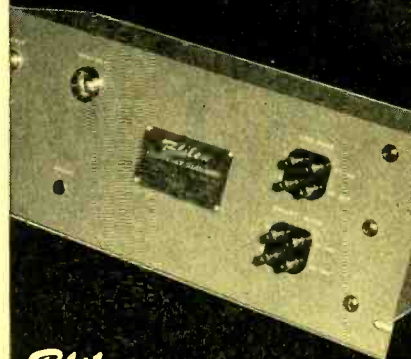

Bliley

**TYPE
BCS-1A FREQUENCY STANDARD**



**Stability better than 2x10⁻⁷
over any 24 hour period**

FOR THE FIRST TIME . . . A COORDINATION OF ALL DESIGN FEATURES THAT CONTRIBUTE TO HIGH FREQUENCY STABILITY.

THE RIGHT COMBINATION AND BALANCE OF CIRCUITRY UTILIZING A SPECIAL BLILEY CRYSTAL AND TEMPERATURE CONTROL OVEN. A PRECISION REFERENCE INSTRUMENT WITH EXCEPTIONAL QUALIFICATIONS.

Write for Bulletin 40C

**A COMPLETE FREQUENCY
STANDARD BY THE MAKERS OF**

Bliley CRYSTALS

BLILEY ELECTRIC COMPANY
UNION STATION BUILDING
ERIE, PA.

and built in the *General Electric Company's* General Engineering and Consulting Laboratory at Schenectady, N. Y., is expected to be of aid in the study of reactions which meteorologists believe take place among constituents of the atmosphere as a result of absorption of radiant solar energy. Because it separates molecules of different weights, or masses, the instrument is useful in



recording presence of isotopes, particles which react chemically in the same way as the original, but differ from them in mass and atomic structure.

GE Engineer J. G. Neuland is shown seated before the control panel of the instrument as he watches the chart on which weights of molecules in gas being analyzed are automatically recorded. At the right is the electronic tube rack into which gases are introduced for analysis.

NEW LITERATURE

Measurement of Resistance

The first definitive results of a new and satisfactory method devised for independently checking the stability of the standard of electrical resistance in terms of length, time, and the permeability of free space, are described in detail in a new paper, *An Absolute Measurement of Resistance by the Wenner Method*.

Published by the National Bureau of Standards, this method can detect a change of a few parts in a million in the standards used to maintain the unit.

This paper may be obtained from the Superintendent of Documents, U. S. Government Printing Office, Washington 25, D. C. at a price of 30c a copy.

Mass Spectrometer Leak Detector

Vacuum-Electronic Engineering Co., 316 37th St., Brooklyn 32, N. Y. has issued a new 4-page bulletin titled *Veeco Mass Spectrometer Leak Detector*.

Contents of this bulletin describe typical applications, wherever a vacuum, fixed pressure or special atmosphere must be maintained for extended periods of time; principle of operation, features, and pertinent data pertaining

to vacuum testing and pressure testing with explanatory illustrations.

A copy of this bulletin may be obtained by writing the company and requesting a copy of Bulletin LD-95.



New Products

(Continued from page 22)

Incorporated, Warren, Pennsylvania.

Available in black, white or colors for specific product identification, parts can be fabricated to close specifications at low unit cost. Facilities include product design and the design and production of required molds for use with modern automatic high-speed rotary and multiple flat-press equipments.

Plastic parts may be supplied as molded pieces, as subassemblies with staked, eyeletted or stitched metal parts, or as complete assemblies of molded plastic and small metal parts.

PRESSURE CONNECTORS

Five lug models comprise the "Wide Range" line of medium-priced pressure connectors for use with copper, aluminum or steel wire in sizes from 14 AWG to 500 MCM, announced by *National Electric Products Corp.*, Chamber of

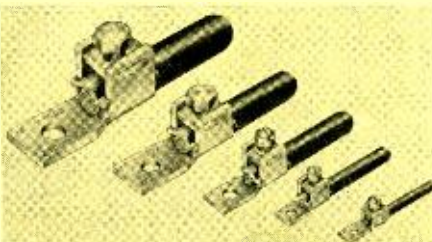

Commerce Building, Pittsburgh 19, Pa.

These pressure connectors are complete assemblies and each connector is said to be capable of handling a wide range of wire and cable sizes. The three smaller sizes, NE 35, 60 and 100 can be installed with a screwdriver; the larger sizes, NE 200 and 400, with a wrench. All sizes were made with minimum over-all dimensions to expedite installation in small gutters. The entire unit is cadmium plated for corrosion protection.

SAFETY DEVICE

A new kind of electrical control designed as a safety device to protect water-cooled, electrically-operated equipment, such as air compressors, vacuum pumps and the like, against damage through water failure is announced by *The Electro Chemical Supply & Engineering Co.*, 750 Broad St., Emmaus, Pa.

The Esto Water Control can be adjusted to operate at any water flow the equipment requires. If the water supply fails, a weighted lever falls which opens the circuit and the relay stops the equip-

ment or sounds an alarm or both. Also, an Esto-controlled compressor will not start until the water has been turned on.

VOLTAGE SUPPLY

Sola Electric Company, 4633 W. 16th St., Chicago 50, Illinois, is manufacturing an adjustable, regulated, a.c. voltage supply designed for use with equipment that requires an adjustable source of constant a.c. voltage from 0 volts to 130 volts of undistorted wave shape.

The "Solavolt" type CVL provides all of the voltage stabilizing characteristics



of the standard SOLA constant voltage transformer; $\pm 1\%$ regulation for line input changes from 95-125 volts with less than 3% harmonic distortion of the input voltage wave. The voltage regulation is automatic and substantially instantaneous.

Each unit is provided with attached input cord and plug; line on-off switch; one standard receptacle for a fixed, regulated 115 volts; one standard receptacle for a variable, regulated output of 0-130 volts; and a pair of jacks with regulated, variable output of 0-130 volts for connecting instruments with plugs or wire type leads.

Technical Bulletin P96 CVL-140 gives full mechanical and electrical specifications and is available on request.

MARKING DEVICE

The *M. E. Cunningham Company*, 192 East Carson St., Pittsburgh 19, Pa., has developed a special stamping fixture for marking metal name plates in mass

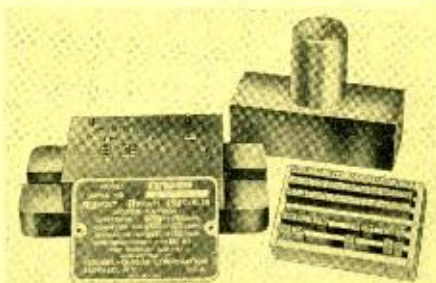

production operations. Model PSF-10 is designed for use in a small power press,

screw press, kick press or similar device.

This marking device is composed of a chase block which contains the steel marking letters and a striking block which is held in the throat of the press by set screws. Slots for containing the letters are machined out of the solid tool steel chase block to suit the setup of the name plate layout and logotypes are supplied when the same style plate is used for several different models.

Data sheets and additional information may be obtained by writing the company.

POTENTIOMETER

Technology Instrument Corporation, 1058 Main Street, Waltham 54, Mass., has announced a new type precision potentiometer now being manufactured.

Type RVC2 features a crank arm and drive pin assembly which transmits shaft rotation. At the point of contact between crank arm and drive pin the crank arm is spring loaded to eliminate back lash. Use of this method makes it possible to remove a single potentiometer from a ganged assembly by simply loosening the clamp ring and slipping potentiometer out of the assembly.

RVC2 potentiometers are available in a wide range of resistance values and can be furnished with linear or non-linear windings. Full details are available upon request from the manufacturer.

D.C. AMPLIFIER

A wide-band d.c. amplifier designed specifically to increase the sensitivity of cathode-ray oscilloscopes with extended



low frequency response is now being manufactured by *Furst Electronics*, 12 S. Jefferson St., Chicago 6, Illinois.

Model 120 is also suitable to extend the range of vacuum-tube voltmeters, frequency analyzers and other instruments. The amplifier uses push-pull amplification throughout and a special cross-coupled circuit is used to achieve stability and low drift.

Two sets of input terminals are provided, one marked "DC" and con-

nected directly to the input attenuators, the other marked "AC" and connected through a pair of coupling condensers to the d.c. input terminals. The maximum gain of the amplifier is adjusted to approximately 100 and the input attenuators reduce this gain to approximately 10 and 1 (40 db., 20 db., and 0 db. resp.).

SCREEN ROOMS

Pre-built screen rooms for laboratory and production line use which offer maximum radio interference screening efficiency are now available from *Ace Engineering and Machine Company, Inc.*, 3644 N. Lawrence St., Philadelphia 40, Pa.

Available in "cell units", these screen rooms are built to provide a minimum of 100 db. attenuation from 0.15 to 1000 megacycles. Of sectional, double-mesh construction the units require no soldering between sections.

Background radio interference is held to an absolute minimum to facilitate accurate radio interference measurements, r.f. calibrations, inspection tests, fractional voltage measurements, and other research where background noise must be eliminated to assure real accuracy.

Literature giving complete details will be sent on request to the manufacturer.

Ripple-Tank

(Continued from page 6)

1/16 in. on centers. The slots were 0.040 in. wide and 3/32 in. deep; and the concave side had a radius of 1 1/4 in. Since there is no possibility of interference between the back radiation of the primary pattern and the secondary pattern in the case of the wave guide lens, the side lobe structure due to this cause is absent. Appreciable reflection from the first surface of the lens is evident. It should be possible to simulate some aspects of Kock's³ path-length delay microwave lenses by using somewhat wider, "zig-zag" slots and a convex model.

Conclusion

It has been the purpose of this condensed report to bring to the attention of electronic engineers some of the virtues and some of the limitations of the ripple-tank as an aid to antenna phase-front visualization. It is believed that this device will be of value to the electronics teacher as well as to the research engineer.

REFERENCES

1. Sutton, R. M., "Demonstration Experiments in Physics," pp. 149-154, New York: McGraw-Hill.
2. Kock, W. E., "Metal-Lens Antennas," *Proc. IRE* 34: 828-836, November 1949.
3. Kock, W. E., "Path-Length Microwave Lenses," *Proc. IRE* 37: 852-855, August 1949.

Over 1000 Sizes

PARAMOUNT SPIRAL WOUND PAPER TUBES

SEND FOR ARBOR LIST OF OVER 1000 SIZES
Convenient, helpful listing of over 1000 stock arbors. Includes many odd sizes of square and rectangular tubes. Write for Arbor List today. No obligation.

Square • Rectangular • Triangular
Round and Half-Round

With a wide range of stock arbors... plus the specialized ability to engineer special tubes... PARAMOUNT can produce the exact shape and size you need for coil forms or other uses. *Hi-Dielectric*, *Hi-Strength*. Kraft, Fish Paper, Red Rope, or any combination, wound on automatic machines. Tolerances plus or minus .002". Made to your specifications or engineered for YOU.

Inside Perimeters from .592" to 19.0"

Write on company letterhead for Arbor List

PARAMOUNT PAPER TUBE CORP.

613 LAFAYETTE ST., FORT WAYNE 2, IND.

Manufacturers of Paper Tubing for the Electrical Industry

TECHNICAL BOOKS

"ELECTRONIC PRINCIPLES AND APPLICATIONS" by Ralph R. Wright, Associate Professor of Electrical Engineering, Virginia Polytechnic Institute. Published by *The Ronald Press Co.*, 15 E. 26th St., New York 10, N. Y. 387 pages. \$5.50.

This textbook presents in a clear and coherent manner the basic electronic principles slanted to meet the requirements of nonelectrical students. By no means limited to the nonelectrical student, the author has also used this material in instructing electrical engineering students and physics majors.

In order to keep the text both flexible and suited to the many different curricula now offered in engineering colleges, more material is offered than will usually be covered in the average one-quarter or even one-semester course. This allows the instructor to choose those topics which he believes most valuable for the class at hand.

The first three chapters present basic electronic principles. Chapter 4, containing a brief review of d.c. and a.c. circuits, may be omitted in cases where the student does not require such a review without affecting the continuity of the text. The remaining eight chapters are devoted to electronic circuits and basic applications of electron tubes.

Only basic equations have been included and these are simply stated with the terms in each equation explained sufficiently to enable the student to use them intelligently.

"PULSES AND TRANSIENTS IN COMMUNICATION CIRCUITS" by Colin Cherry. Published by *Dover Publications, Inc.*, 1780 Broadway, New York 19, N. Y. 317 pages. \$3.95.

An introduction to network transient analysis for television and radio engineers, this volume introduces circuit analysis, bridging the gap between simple alternating current theory and operational methods of analysis.

For those who have attempted to supplement their knowledge of transients and have been at a loss to know where to start, this book will be of valuable help. It provides the essential groundwork, using in most instances rigorous physical arguments and only elementary mathematics. Electric waveforms are dealt with rather than analytical functions.

References to published books and papers are given throughout the text, thus enabling the reader to continue beyond the limits of the volume itself. ~⊕~

Antenna Pattern

(Continued from page 12)

range exceeds 100 db. This includes excellent shielding of the various stages, common point to point grounds for individual stages and an excellent d.c. regulated power supply. The power drain is approximately 62 watts.

The only critical portion is in the wiring of the first stage of amplification. All grounds of the first stage of amplification including those of the input jack and calibration switch should be grounded to the chassis at only one point. Shielding of individual stages or particular components has not been found to be necessary.

Fig. 4 shows the two antenna pattern testing shacks on the roof of the *Dalmo Victor* building where this automatic antenna pattern recording system has been successfully used. Transmissions from one of these penthouse shacks is received in the other penthouse shack and fed into the automatic antenna pattern recording system. ~⊕~

FM in Power Ind.

(Continued from page 5)

United States and its possessions must be licensed. A construction permit is needed and the first step taken is to make application to the Federal Communications Commission on FCC Form 401-C made out in duplicate, and FCC Form 401-A when it is necessary. If the height of the antenna is in excess of 150 feet or within 3 miles of an airport, FCC Form 401-A is to be filled out and sent in in quadruplicate. The frequency desired is sent in with the application. The applications should be signed by an officer or official of the organization rather than by an employee.

When the construction permit is granted, call letters are assigned; equipment can then be purchased and construction completed within 8 months.

Following the construction of the station, a 30-day test period is allowed, providing the radio inspector in charge in the district is notified two days in advance.

When construction and testing are completed, an application for station license is filed on FCC Form 403. This is done well in advance of the expiration of the construction permit. A separate license is required for the land station and one for the mobile units.

The manufacturer's representative usually helps the customer with the license application procedures.

A restricted radio telephone operator's permit is required by persons operating the land or central station. No operator's license is required for mobile units operating on frequencies above 25 megacycles.

Any person making adjustments, tak-

ing frequency readings, or doing any maintenance work on either land station or mobile units must have a first or second class radio telephone operator's license.

The Federal Communications Commission also requires that an accurate log be kept of the station's operation.

Equipment Description and Installation

The manufacturer's representative usually supervises the installation work performed by technicians from the factory or from some independent company.

1. *Antennas.* If the area to be covered is from 12 to 20 miles airline, an antenna installation made on the top of the town's water tower or other high point generally gives satisfactory results. If the distance is greater than this, a special tower can be used. In the REA antenna installation illustrated, the antenna is mounted on the top of the water tower which is 125 feet in height.

The central transmitter used has an r.f. output of 30 watts. The farthest point in the system to be reached is 32 airline miles distant. Over the past year of operation, excellent coverage has been obtained. The antenna is fed by coaxial cable from the central transmitter located at the base of the tower in the housing provided for it.

The antenna should be located on a high hill if it is possible to keep it within 10-15 miles of the remote control unit.

A power gain antenna may be used at the central station to make more efficient use of the transmitted signal.

In practice, communications are being carried on over much greater distances than theory seems to indicate should be possible.

2. *Central or Land station.* The central or land station is located as near as possible to the antenna installation. When satisfactory conditions exist and the antenna installation may be made at the location where the dispatching is to be carried on, equipment is being manufactured which has all of the units self contained in a cabinet somewhat similar to the remote control console pictured. Where the r.f. power output does not have to exceed 30 or 60 watts and the antenna installation permits, this type equipment then eliminates the remote control unit, land lines, central station installation and housing facilities.

In the central station housing facilities, some means of even temperature control must be provided as these houses are heated during the winter months. A thermostatic type control is usually used.

3. *Remote control console.* The console in the illustration consists of a standard receiver and preamplifier-line amplifier

chassis to remotely monitor and control a single frequency transmitter and receiver over one pair or two pair of control lines.

The unit is supplied with a control panel which is provided with meters, switches and controls for complete control of the station such as:

- a. D.b. meter for modulation and line level indications.
- b. Microammeter for signal and frequency checks of transmitter.
- c. Speaker selector switch.
- d. Modulation control.
- e. Clock.
- f. Intercom. and send switch.
- g. Tone-signal switch.
- h. Call letter holder.
- j. Pilot lights for carrier indication, transmitter-on and speaker indicators.

The remote control console may be supplied with an additional line amplifier, a frequency monitor or both. The frequency monitor works in conjunction with the monitor receiver and is useful for monitoring r.f. carrier and frequency and indicating modulation. It is also possible to get consoles which will control a two frequency transmitter and two receiver system plus the features mentioned above.

The following functions can be accomplished over one twin conductor cable:

- a. Turn transmitter on and off.
- b. Modulate transmitter.
- c. Amplify audio from receiver from remote central station.
- d. Intercommunicate with paralleled remote units on same control line.

The following functions may be added later if new system requirements arise in the future:

- e. Turn transmitter on and off for a second frequency.
- f. To amplify audio from a second remote receiver.
- g. Turn on and off a second receiver or monitor at a remote location.

The console is operated with a dynamic microphone with push-to-talk control or foot switch control. When the output of the console is fed into a matched line, it is possible to operate this unit over very great distances. However, it does not appear economical to operate over a land line over 15 miles in length. It has been estimated that land line service can be had from telephone companies for a rental of about \$4.00 per mile per month.

If the power company constructs its own line, a cost of about \$300.00 per mile can be expected, depending on labor and material costs and the number of circuits used.

When land line construction is not possible, radio remote control circuits can be used when equipment is adapted for this purpose.

4. *Mobile units.* These installations are divided into two different types, one in the trucks and the other in the passenger car, usually that of the manager, official or superintendent.

Units for truck operation employ a transmitter having 30 watts r.f. output from a 6 volt d.c. battery power input. The plate supply is furnished by a dynamotor—420 volts, 250 ma. Modulation is 30-3000 cycles, 20 kc. deviation each side of carrier. Testing is accomplished by a rotary switch which meters all circuits. A one quarter wave roof top antenna is used. The driver and final tubes of the transmitter use no current until the microphone is removed from the hang-up box. This turns on the tube filaments and brings them up to operating temperature in the short space of time required to lift the microphone from the instrument panel to the operating position. Replacing the microphone on the hang-up box again turns the filaments off.

The mobile receiver has a battery drain of 6.0 amperes at 6.0 volts d.c. input using a synchronous vibrator power supply. In testing, all circuits are metered with a selector switch.

After a little practice, smooth system operation can be especially noted by the absence of useless chatter, and the direct and to the point communications being used. At the time the two-way radio of the Nishnabotna Valley Rural Cooperative was put into operation, the truck batteries and generators used were standard equipment. Trouble was experienced in keeping truck batteries charged. However, the crews soon learned the technique of operating so that oversize batteries and generators were not needed and no further trouble has ever arisen in this respect. Some power companies use code words to convey messages, thus shortening their transmissions and allowing some privacy. One of the methods used by maintenance crews to pin point the location of power line trouble is: Two maintenance crews go out, one proceeding on ahead. This crew disconnects line taps and the crew in the rear then calls in to have the line energized. This crew, in a location where they can observe to see if the oil circuit reclosers hold in, know that if the reclosers do not reopen, the trouble is on one of the disconnected taps. The first crew then reconnects these taps until the defective branch circuit is located. Communication between the two trucks makes this method speedy and sure.

In this swiftly growing field, employment should be gained by many licensed operators needed for the necessary checking and maintenance work on the equipment.

This form of communication is allowing customer service to keep in step

put an
added

Selling Factor
into your
COIL WINDINGS

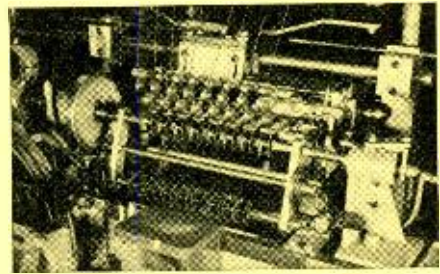

PRECISION
BOBBINS

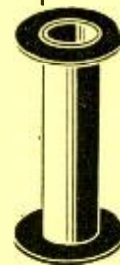

by
Performance,
Publicity,

PRECISION QUALITY has
the outstanding reputation for
superior Coil Bases thruout the
electrical field.

Some of the reasons:

Tubes spirally wound of finest dielectric materials for greatest strength—better heat dissipation—less moisture absorption—vulcanized fibre flanges—swaged tube ends for secure locking—entire assembly impregnated—perfect seal—meeting Underwriters' requirements.



Send today for samples to your specifications. Round, square, rectangular. LOW COST. Any quantity. Phone, wire or write

PRECISION PAPER TUBE CO.

Also Precision paper tubes.
Ask for new Mandrel List over 1,000 sizes.
2063 W. Charleston St., Chicago 47, Ill.
Plant No. Two, 79 Chapel St., Hartford, Conn.

with customer power consumption, and is rapidly paying its way through better service, economy in operation and better public relations. Yes, this formerly undreamed of convenience now fathers the so often used, "I don't know what we would do without it".

Frequency Dividers

(Continued from page 8)

almost independent of tube characteristics—practically speaking at least.

A typical circuit is shown in Fig. 4B. A tube which has two grids capable of controlling the plate current is required, such as the 6SA7 and the 6AS6. The 6AS6 is especially suitable. In its stable state, a high cathode current flows, due to the low bias on the first grid. There is no plate current, the suppressor (or second control grid) being biased beyond cut-off. Consequently, the screen current is high. The plate is held at its initial level by the current through the diode. A negative trigger is fed to the plate through the diode, and the reduction in plate voltage is passed on to the control grid. The resulting drop in screen current drops the cathode voltage, reducing the suppressor bias by an amount sufficient to allow the flow of plate current. This causes a further reduction in plate voltage, and the regenerative connection between the plate and grid continues the action. This goes on until the plate voltage is essentially zero and the control grid at or near cut-off. At this point the grid starts to rise on the time constant RC and the cathode follows. Through regeneration, again the process is continued until the cathode potential is high enough to cut off the plate current and the circuit is ready for another trigger. With all voltages fixed, the delay time is proportional to the time constant RC . Since the distance (voltage-wise) the plate has to fall is determined by its initial level, the delay time can be varied by varying the diode bias, and thus the initial plate voltage. During the time the plate voltage is falling the circuit is unaffected by trigger signals, because the diode is cut off. The output is rectangular and may be taken from either the cathode or the screen. Control may

be established with almost any triggering waveform, as long as it has a negative portion of sufficient amplitude.

Design is for a given output frequency and it will divide to that from any of its harmonics. Since all voltages maintain a given ratio regardless of the plate supply voltage, the latter may be varied over wide limits without causing a change in dividing ratio or failure to operate. No output is obtained without triggering signals. The total delay time may be calculated from the time constant as follows:

$$T = \frac{E_p - E_c}{E_b - E_c} RC$$

where E_p and E_c are the initial plate and control grid voltages and E_b is the plate supply voltage. The resistance R should be relatively large, to keep grid current down. The frequency of operation is limited only by the stray capacities of the circuit and by the tube capabilities. The phantatron is one of the most satisfactory and reliable of circuits for use in frequency division.

Thyratrons can be used—see Fig. 4C—for frequency division much the same as other relaxation oscillators. The major disadvantages are due to changes in triggering level resulting from temperature and emission changes, and the upper frequency is limited to some twenty or thirty kilocycles by the deionization time. The timing circuit may be either in the plate or cathode circuits, but the cathode type is favored since the timing wave has more effect there due to the amplification factor of the grid. Gas diodes can be used, but the firing and extinction potentials are relatively close together and stability is usually poor.

Any of the dividers discussed may of course be operated in chains in order to obtain stable high order ratios. By the use of feedback complex fractional ratios may be obtained. The feedback voltage is fed back from one stage to an earlier one such that the early one is triggered a little before it would ordinarily be. The duration of that stage's operation is therefore reduced slightly from normal and so of course the overall ratio of the chain is altered slightly, resulting in a complex but stable ratio of input to output frequencies.

While no attempt has been made in this article to give detailed design information, it is believed that sufficient information has been given to enable the user to determine what type he should or would prefer. In some, notably the synchronized and blocking oscillators, design is by experiment anyway to a considerable extent; and in others, design can probably be effected through a combination of the information herein presented and experiment in as short a time as would be required for

detailed design preliminary to construction. A bibliography is included for those who wish further and more detailed information on the subject.

BIBLIOGRAPHY

1. Kent, E. L.—Use of Counter Circuits in Frequency Dividers—Acoustical Society of America, Journal, January, 1943.
2. Easton, Allan and Odessey, P. H.—Counter Circuits for Television—Electronics, May, 1948.
3. Briggs, B. H.—The Miller Integrator—Electronic Engineering, October, 1948.
4. Silver, M. and Shadowitz, A.—High-Ratio Multivibrator Frequency Divider—Electrical Communication, June, 1948.
5. Maddock, A. J.—Thyratrons and their Applications to Radio Engineering—Electrical Communication, 1945, No. 4.
6. Davis, K. H.—Multivibrator Step-Down by Fractional Ratios—Bell Laboratories Record, March, 1948.
7. McGraw-Hill—Radiation Laboratory Series, Volume 19, Waveforms.

Microwave Trans.

(Continued from page 18)

past and several kinds of operation have been employed. The type of tube that is now almost universally employed is the multicavity magnetron, shown in Fig. 15, in which the anode is broken up into a number of segments, each of which contains a cavity resonator. In the simplest mode, called the π mode, alternate segments are in phase with each other, while adjacent segments have opposite polarity.

All electron trajectories are bent in the same way and they travel around the cathode as a cloud rotating at some average rotational velocity. Electrons moving across the gaps between cavities have their rotational velocity increased or decreased depending upon their phase. A bunching action occurs, similar to that in the klystron, which amplifies r.f. power across a later gap. A probe or a slot couples one of the cavities to an output circuit using either coaxial or waveguide transmission lines. In this type of magnetron, the conditions for oscillation are given by the following relationship⁵:

$$f = \frac{4\pi n V}{r_a^2 B^2} \dots \dots \dots (5)$$

where n is the number of pairs of segments.

The starting voltage at which oscillations occur is given by⁶:

$$V = \frac{\pi f}{nc} (r_a^2 - r_c^2) \left(B - \frac{2\pi n f r_a^2}{nc} \right) (6)$$

This voltage is known as the Hartee voltage after Hartee who developed the theory.

Magnetron Design Information

As in the case of the klystron oscillator, the engineer can usually select a commercially available magnetron to meet most requirements. For interpretation of magnetron performance it is necessary to make a number of observations

Fig. 5. Circuit for dividing input frequency by 2 and then multiplying it to give various outputs as indicated.

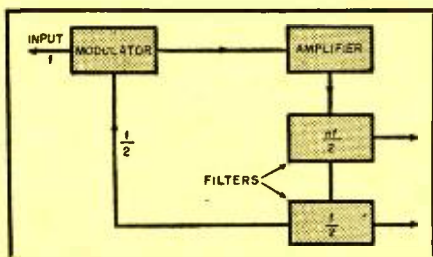

that are not made at lower frequencies using conventional type tubes. In addition to the fact that different modes of operation exist and multiple cavities are involved, the magnetron employs a magnetic field, instead of the usual grid voltage, as the controlling parameter.

Two types of charts are normally presented with commercial magnetrons. One type, known as the performance charts, describes the operation of the magnetron in terms of its input circuits. The other type, called the Rieke diagram, describes the operation of the magnetron in terms of its output circuits. A typical set of performance charts are shown in Figs. 11 and 13. Consider the chart shown in Fig. 11. In this chart four parameters are shown, i.e. plate voltage, plate current, magnetic field, and power output. Knowing any two of these parameters, the other two can be determined from this chart. For example, if a plate voltage of 20 kv. and a magnetic field of 2300 gauss are employed, the plate current will be 20 amperes and the power output approximately 225 kw. It should be noted that these charts assume a matched load impedance.

The second performance chart (usually 11 and 13 are combined in one chart—however the author separated them to clarify their use) plots plate voltage, plate current, efficiency and frequency deviation. Hence for the example cited above with plate voltage at 20 kv. and plate current at 20 amperes the efficiency would be approximately 58 per-cent and the frequency deviation about 2 megacycles.

A Rieke diagram, (Fig. 16 shows a typical one) expresses the performance of a magnetron in terms of the r.f. loading for a given input operation. To use this diagram, the standing wave ratio η_0 and distance d from magnetron output to voltage minimum are measured. These parameters are then expressed in terms of reflection coefficient K and phase angle β_1 by the following equations:

$$K = \frac{1 - \eta_0}{1 + \eta_0} \dots \dots \dots (7)$$

$$\beta_1 = \frac{d}{\lambda} \dots \dots \dots (8)$$

The point corresponding to these values is then found on the Rieke diagram and the power output and frequency

deviation determined. For example, assume that a standing-wave ratio of 2 is measured with a voltage minimum 1 cm. from a magnetron operating at a frequency of 10,000 mc. The reflection coefficient, K , is therefore equal to 0.25 and the phase angle 0.33. This corresponds to the point marked *A* on the Rieke diagram and indicates an output of approximately 30 kw. at a frequency deviation of about 4 mc.

There are a number of terms that have been developed to express the performance of magnetrons. One of these is the "pulling figure" which is defined as the maximum change in frequency as the load phase is changed over all values while the voltage standing-wave ratio is held at 1.5—expressed in megacycles. Another is the "pushing figure" defined as the rate of change of frequency as the current is varied with constant magnetic field and load, expressed as megacycles per ampere. "Temperature coefficient of frequency" is the change in frequency due to change in temperature. These terms are frequently used in describing the over-all performance of magnetrons.

The degree of frequency stability of a magnetron oscillator is a function of these three parameters. To increase the frequency stability an external high Q cavity is placed between magnetron and load. This decreases the pulling figure. Automatic frequency control circuits such as the ones described in the previous article¹ can be used to further improve frequency stability. In general, mechanical tuning systems are used for the same reason that they are used in lighthouse oscillators.

The magnetron is normally used in pulsed systems, though recently a number of frequency modulated microwave links have been developed which employ magnetrons. There are a number of ways in which a magnetron may be frequency modulated. An external reactance tube, which varies the r.f. loading, can be used to vary frequency. Another method involves placing a thin filamentary type wire across the axis of one cavity in the magnetrons. It has been found that amplitude modulating the current flowing through this wire frequency modulates the magnetron output.

Conclusion

The lighthouse, klystron, and magnetron oscillators are used in virtually all microwave transmitters developed thus far. Other tubes such as the resonatron and the traveling wave tube show great promise and will probably be more widely used in the future. Use of these tubes as oscillators, however, usually entails the design of the tube itself and this subject is far be-

yond the scope of this series of articles. The traveling wave tube will be discussed when the r.f. amplifiers are considered, since at the present time this tube seems to have its widest application as a wideband amplifier.

BIBLIOGRAPHY

1. Racker, J., "Microwave Transmitters—Part 1" RADIO-ELECTRONICS ENGINEERING, May, 1950, p. 6.
2. Racker, J., "Microwave Transmission Lines" RADIO-ELECTRONIC ENGINEERING, March, 1950 p. 14.
3. Racker, J., "Microwave Components", RADIO-ELECTRONIC ENGINEERING, April, 1950, p. 7.
4. Racker, J., "Microwave Techniques," RADIO-ELECTRONIC ENGINEERING, February, 1950, p. 3.
5. Bronwell & Beam, "Theory and Application of Microwaves", McGraw-Hill Book Company, p. 74 to 145.
6. Collins, G. B., "Microwave Magnetrons", McGraw-Hill Book Company.

ZOPHAR

WAXES COMPOUNDS and EMULSIONS



FOR
INSULATING and WATERPROOFING
of ELECTRICAL and
RADIO COMPONENTS

•

Also for
CONTAINERS and PAPER
IMPREGNATION

•

FUNGUS RESISTANT WAXES

•

ZOPHAR WAXES and COMPOUNDS
Meet all army and navy
specifications if required

•

Inquiries Invited

ZOPHAR MILLS, INC.

FOUNDED 1846

122—26th ST., BROOKLYN, N. Y.

HAVE YOU A JOB FOR A TRAINED TECHNICIAN?

We have a number of alert young men who have completed intensive training in Radio and Television Repairing. They learned their trades thoroughly by working an actual equipment under personal, expert supervision.

If you need a trained man, we invite you to write for an outline of our course, and for a prospectus of the graduate. No fees, of course. Address:

Placement Manager, Dept. P-106-6
COMMERCIAL TRADES INSTITUTE
1400 Greenleaf Chicago 26

PHOTO CREDITS

- 6.....Naval Research Lab.
- 12, 14.....Dalmo-Victor Co.
- 15.....Federal Telecommunication Labs.
- 20.....Sperry Gyroscope Co.

CIRCULAR WAVE GUIDE CUT-OFF FREQUENCIES

The cut-off frequency scale at right is aligned with the particular type of wave and mode selected on the scale at left, and the diameter determined from scale in center.

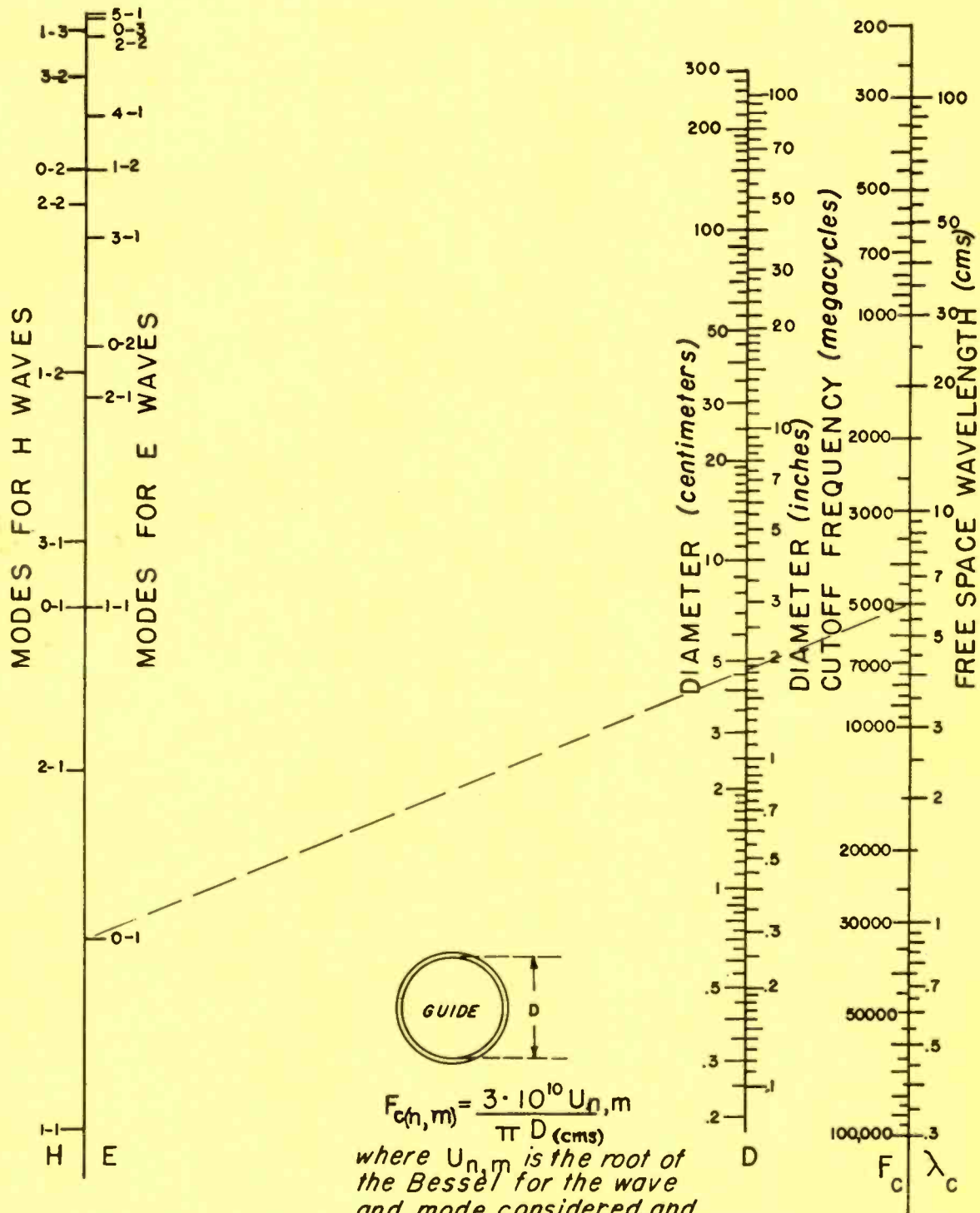

HERE IS THE LONG SOUGHT ANSWER IN TELEVISION TRAINING FOR THE MAN
ALREADY IN RADIO! TRAIN AT HOME—FULL PROGRAM—4 TO 8 WEEKS!

Low Cost—Monthly Payments. Everything You Need to Learn...

TELEVISION

I Send You NOT JUST an Ordinary TV Kit—But a Complete
Training System Including TV Test Equipment

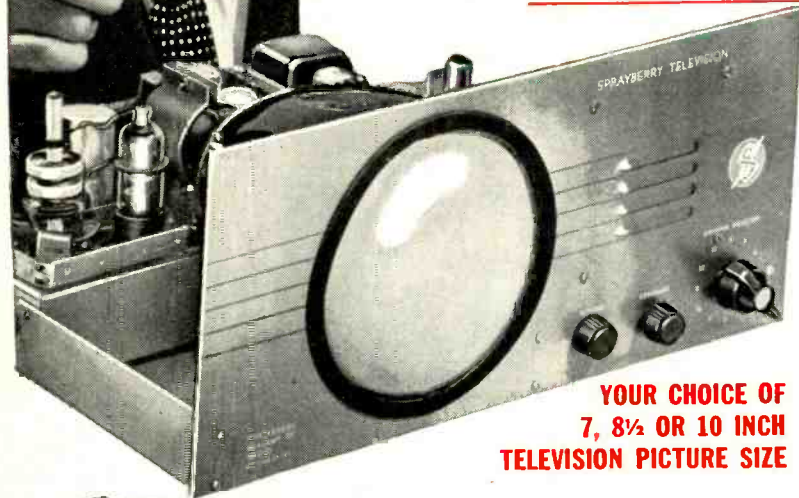

Here is the NEW Combination Sprayberry
Television Training System

Out of my laboratory has come an entirely new Television Training...cutting months off the time required in old methods. I give all the knowledge and experience you need in weeks instead of months. I start where your present radio experience ends. The same day you enroll with me, I rush the first of many big Television kits that I will send during your training. From the first hour you are experimenting and testing practical TV circuits...and you keep right on from one fascinating experiment to another. You build the remarkable new Television Receiver-Tester illustrated at the left and useful TV Test Equipment. I give you theory, too, but it's 100% practical stuff that will make money for you in Television.

YOUR CHOICE OF
7, 8½ OR 10 INCH
TELEVISION PICTURE SIZE

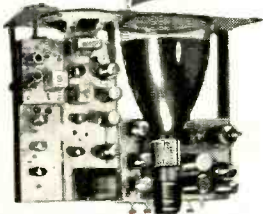

Exclusive THREE-UNIT Construction

You build my Television Receiver-Tester in three separate units—one unit at a time...each complete and self contained within itself. With each unit you perform dozens of important experiments—and each unit may be used in actual Television receiver servicing. In this way my training may save you many dollars by eliminating the need for costly TV Test Equipment. With these three units you can locate most TV Receiver troubles quickly and easily.

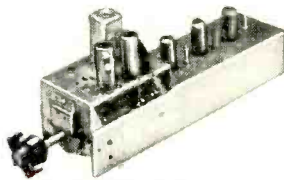

TV Tuner—I.F. Unit

Contains the RF amplified local oscillator, mixer and three stages of broad band IF amplification and the video second detector. The output constitutes the video signal and audio IF signal. For training, it is used to build and test video second detector, and stagger tuned IF amplifier obtaining 4.5 mc band pass. For TV servicing, it becomes a TV calibrator for IF alignment, substitute tuner, IF signal injector and second detector.

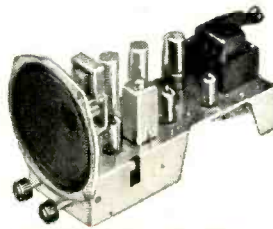

Video-Audio Amplifier Unit

Provides 4.5 mc IF ratio detector, low voltage power supply. For TV, it becomes the audio output, including speaker, video output and low voltage power supply for RF and IF stages. For training, it is used to build and test transformer type power supplies, audio, video, IF amplification and FM detection. For TV servicing, it is an audio signal tracer, IF signal tracer, video signal tracer and low voltage power supply.

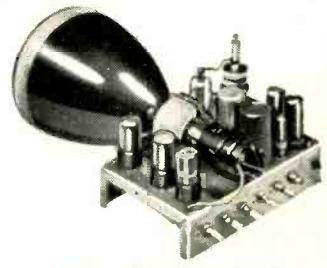

Video Tube "Scope" Unit

Scope unit contains low and high voltage (6000 V.) power supply for independent operation. For television, it becomes the sync, vertical and horizontal sweep circuits and their power supplies. For training, it is used to build and test most TV power supply, deflection, sweep, oscillator, and sync circuits. For TV servicing, it is a video signal tracer and sweep signal analyzer as well as substitute high and low voltage power supplies.

BE READY FOR TOP PAYING TELEVISION JOBS

If you are a radio-serviceman, experimenter, amateur or advanced student... YOUR FUTURE IS IN TELEVISION. Depending upon where you live, Television is either in your town now... or will be there shortly. This is a vast new industry that needs qualified trained men by the thousand to install and service TV sets. There's really big money in Television, but you MUST know what you are doing to "cash-in" on it. I will train you in a few short weeks if you have had previous radio training or experience.

IMPORTANT—FOR MEN JUST STARTING OUT IN RADIO-TELEVISION

If you have no previous experience in Radio work, be sure to mark that fact on the coupon below. I will send you complete information about my Radio-Television training that starts with basic fundamentals and carries you right through my new Radio and Television Training. I will send you my two big Radio-Television books, including an actual lesson selected from my course. I want you to know exactly what this great industry has in store for you. There is no obligation, of course, and NO SALESMAN WILL CALL.

VETERANS—Radio portion of training available under G. I. Bill

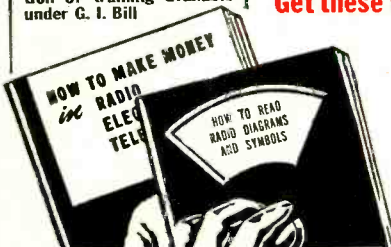

FILL OUT AND MAIL COUPON
Get these Valuable Books **FREE!**

Every Radio Serviceman today realizes his future is in Television. He knows he MUST have training—the right kind of practical training such as I am now offering—to protect his job, his business for the future. This is equally important for the man just starting out. And so I urge you to get the facts I offer you FREE and without obligation. Learn how quickly and easily you can get into Television. Fill out and mail the coupon TODAY.

SPRAYBERRY ACADEMY OF RADIO, Dept. 25-K
111 North Canal St., Chicago 6, Ill.

Please rush to me all information on your Radio-Television Training plan. I understand this does not obligate me and that no salesman will call upon me.

Name..... Age.....

Address.....

City..... State.....

Please Check Below About Your Experience

Are You Experienced?

No Experience

SPRAYBERRY ACADEMY OF RADIO, 111 N. Canal, Dept. 25-K Chicago 6, Ill.

VEE-D-X

LOW PRICED

Yagi Arrays

- Transformer ratio of stepped-up driven element provides perfect match to 300 ohm line.
- Lowest standing wave ratio insures maximum transfer of signal.
- High front to back ratio prevents co-channel interference.
- Sharp horizontal pattern helps reject unwanted interference of all types.
- Extra high forward gain makes this the ideal antenna for single channel fringe reception.
- Not designed to replace the famous heavy-duty RLY and EC series.

J SERIES

JA

V. S. W. R. = 1.34
Z = 335 ohms

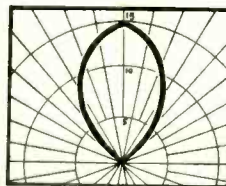

Forward gain in decibels

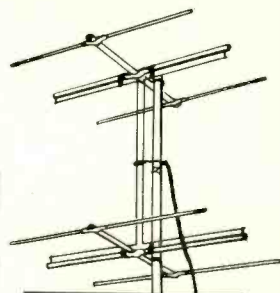

LOW CHANNEL
\$17.35 list
HIGH CHANNEL
12.50 list
For double stack as shown

Including harness but less mast

JB

V. S. W. R. = 1.26
Z = 315 ohms

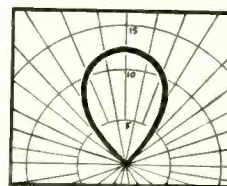

Forward gain in decibels

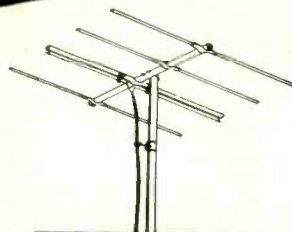

LOW CHANNEL
\$13.20 list
HIGH CHANNEL
6.95 list

JC

V. S. W. R. = 1.28
Z = 317 ohms

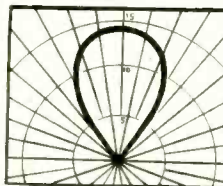

Forward gain in decibels

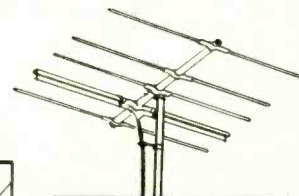

LOW CHANNEL
\$14.60 list
HIGH CHANNEL
7.95 list

PRE-ASSEMBLED FOR FAST, EASY INSTALLATION

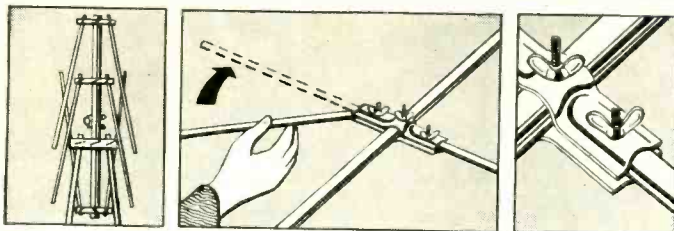

All the parts are in one package ready for assembly. The new clamp type construction makes it easy to swing each element in place and secure it firmly with the wing nut. No bag of hardware to fuss with — no bolts or screws to lose.

THESE ANTENNAS STAY UP

Only the highest quality duraluminum alloys are used.

Yield Strength	36,000 lbs. per sq. inch
Ultimate Strength	41,000 lbs. per sq. inch
Shearing Strength	24,000 lbs. per sq. inch
Endurance Limit	20,500 lbs. per sq. inch

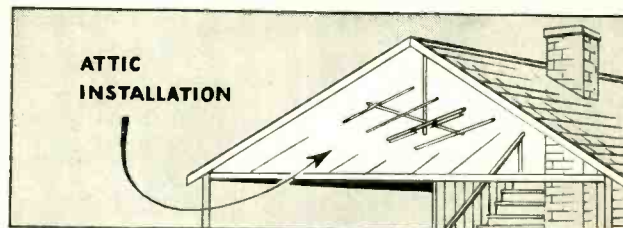

ATTIC
INSTALLATION

Because of the high gain of this antenna, many people have found that they can obtain excellent results with a single bay attic installation.

LAPOINTE-PLASCOMOLD CORP.,
UNIONVILLE, CONNECTICUT

3

Send me information on the entire line of VEE-D-X antennas and accessories.

NAME

COMPANY

STREET

CITY ZONE..... STATE.....

10 reasons why C-D type UP electrolytics are superior

For TV and auto radio
applications; and wherever extremes
of heat and cold are encountered



A special formation process which results in low leakage; permits operating temperatures as high as 85° C.



Special separator — exclusive with C-D electrolytics — prevents breakdowns under the worst field conditions.



Special construction results in lowest intercoupling between sections.



Special winding results in good RF impedance.



Etched cathode construction (Type UPE) where high ripple currents require it for permanence of capacity.



Rubber diaphragm type of construction results in a positively operated vent.



Spot welded anode risers to lugs.



Spot welded cathode tabs to mounting rings.



Saddle lug permitting easy wiring of the lugs.

See your Classified Phone Book for nearest jobber.

Catalog No. 200B
on request.
CORNELL-DUBILIER
ELECTRIC CORPORATION,
Dept. RN60, South
Plainfield, New Jersey.
Other plants in New
Bedford, Brookline
and Worcester, Mass.;
Providence, R. I.;
Indianapolis, Ind.,
and subsidiary,
The Radiart Corp.,
Cleveland, Ohio.

For better servicing results insist on superior
C-D Electrolytics—Best by Field Test!



CONSISTENTLY DEPENDABLE
CORNELL-DUBILIER
CAPACITORS • VIBRATORS • ANTENNAS • CONVERTERS



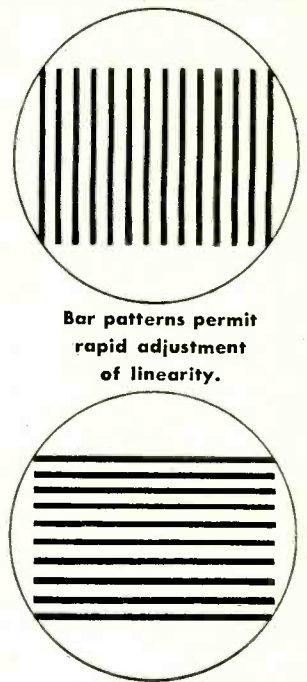

Bar patterns permit rapid adjustment of linearity.

Here's what it is —

1. A crystal-calibrated TV marker generator with dual markers for All TV Frequencies.
2. A linearity-pattern generator for making linearity adjustments.
3. A 12-channel miniature TV re-broadcast transmitter.
4. A heterodyne frequency meter including amplifier and speaker.
5. A TV-FM signal generator operating on fundamentals in all bands.

Here's what it does —

1. Puts dual markers of crystal accuracy on television sweep-alignment response curves.
2. Provides signals of crystal accuracy for peak-alignment of stagger-tuned TV IF amplifiers.
3. Generates a bar-pattern IF carrier frequency for adjustment of TV set linearity controls.
4. Develops a crystal-controlled amplitude-modulated signal for alignment of intercarrier sound IF's.
5. Applies triple-markers of crystal accuracy on discriminator and ratio-detector "S" curve patterns.
6. Measures with crystal accuracy the frequency of unknown IF signals within its range.
7. Calibrates other signal generators at 2.5 Mc and .25 Mc points over range of 250 Kc to 480 Mc.
8. Allows adjustment with crystal accuracy the frequency of local oscillators in TV front ends.
9. Checks video reception on all 12 channels, using signal from normally operating TV set.

Check these features!

Crystal-controlled 4.5-megacycle output for alignment of TV receivers employing intercarrier sound
 Crystal-controlled markers, 4.5 Mc removed from main marker, for television rf and if alignment
 Crystal-controlled markers, 250 kc removed from main marker, for sound-discriminator alignment
 Provision for injection of external marker
 Internal audio and rf modulation of variable frequency oscillator
 Crystal-calibrated heterodyne frequency meter

CHARACTERISTICS

Variable Oscillator

Frequency Range 19-110 Mc in 4 bands
 170-240 Mc in 2 bands

Tuning Drive Ratio 10 to 1

Output Attenuator Range from 100% to 1%

Crystal Oscillators

0.25/4.5-Mc oscillator stage

Accuracy 0.03%

Output at probe more than 50 millivolts

2.5-Mc oscillator stage Accuracy . . . 0.01%

Internal Mod. Freq. . . 0.25 or 4.5 Mc and audio

Power Supply . . . 105-125 volts, 50/60 cycles

HARVEY brings you the new RCA WR-39B Television Calibrator with Crystal-Controlled Markers for all TV Frequencies

Now — in one compact, portable unit — the new RCA WR-39B provides crystal-controlled markers for all TV frequencies...included in this one instrument is a crystal-calibrated variable-frequency oscillator, two crystal-controlled oscillator stages with three crystals supplied, a wide-band modulator stage for internally modulating the output at audio and rf frequencies, and an audio amplifier with speaker.

The variable-frequency oscillator covers all commercial television bands and the FM rf bands. An internal 4.5-Mc crystal-controlled oscillator modulates the output of the vfo to provide marker "pips" spaced 4.5 Mc from the marker pip of the vfo. These markers are indispensable in the alignment of TV front ends. Similarly, a 0.25-Mc crystal-controlled oscillator may be used to provide marker "pips" spaced 0.25 Mc from the frequency of the vfo. Such markers are indispensable for determining the response characteristics of discriminator and ratio detectors. The fundamental 4.5-Mc output may be used by itself for alignment of television receivers employing inter-carrier sound.

In addition to its function as a marker generator, the WR-39B can be used as a heterodyne frequency meter to identify unknown frequencies. The vfo, when tuned to any TV channel and modulated with the 0.25-Mc crystal oscillator, will put vertical bars on the raster; or when modulated with

an external audio oscillator will put horizontal bars on the raster. Thus the instrument can be used for making linearity adjustments in the absence of a test pattern.

TV Station Need Not Be On Air For You To Align Receivers

The WR-39B may be modulated by the video signal from a television set, any channel, and will re-transmit the signal on any of the 12 channels to receivers under test on your bench. When using it as a transmitter in this manner, the WR-39B transmits the picture image, not just a raster!

For complete details on the WR-39B, see it at our store, or write for free literature.

\$224⁵⁰
Net

IN STOCK FOR IMMEDIATE DELIVERY

NOTE: Price Net, F.O.B., N.Y.C. and subject to change without notice.

Telephone: **hrc** LUxemburg 2-1500

HARVEY
RADIO COMPANY INC.
103 West 43rd St., New York 18, N. Y.

*"We've proved **Rauland** is the ideal 'plus' line..."*



... Says **MIKE EBINGER**, owner
Ebinger Radio Company
2211 Gravois Street, St. Louis, Missouri

"We've proved to ourselves that Rauland Television Tubes are ideal to round out our picture tube line, for several reasons. There's no question about the quality of their tubes and time and again the Rauland people have been first to offer important improvements for the industry.

"Another 'dollar-and-cents' reason for our selection of Rauland tubes is that the company specializes in picture tubes and offers an unusually large number of tube types for replacement purposes. In combination with our receiving tube line and the picture tubes available with it, Rauland's tubes enable us to offer a complete picture tube service to meet our customers' requirements.

"Illustrative of it being the ideal 'plus' line of picture tubes is the new Indicator Gun feature developed by Rauland. With this feature, the service man is enabled to make positively correct adjustment of the ion magnet quickly and without need of mirrors, thus eliminating possible compensating misadjustments of components."

With the Rauland line, you too can meet picture tube service requirements completely and with assured customer satisfaction. The Rauland line includes metal and all glass tubes, plain, aluminized and Luxide (the original "Black" tube; screens and aluminized Luxide screens.

The new Rauland Indicator Gun (patent pending) provides a visible and accurate indication for the service man making ion trap magnet adjustment, and is visible from the back of the set while adjustment is being made. No other guide is needed for correct magnet adjustment.

THE RAULAND CORPORATION



Perfection Through Research

4245 N. KNOX AVENUE • CHICAGO 41, ILLINOIS



WORLD'S FASTEST AUTOMATIC CHANGER FOR RCA 45 RPM RECORDS

Developed by RCA, built by Crescent, a famous name in the changer field. Plays 8 to 10 records—50 minutes of continuous music. Plays one hour and 40 minutes with one turnover of the discs. New design does away with posts, clamps which harm records. Discs slide easily down 1 1/2" diameter spindle. Changes records in less than 2 seconds. Crystal cartridge has flat response from 50-10,000 cycles. Needle pressure is only 6 grams. Has built-in precious tipped 1 mil needle. Size 10 1/4"x7 1/8"; height overall, 6 3/4" requires 3 1/2" above and 3 1/4" below base plate. For 105-125 volts AC. Shpg. wt. 8 lbs. Factory sealed cartons.



Price slashed
by Olson

\$9.95
each

RA-45



THE HOUSE OF RADIO AND TELEVISION BARGAINS



Model TV-10

\$39.50

SUPERIOR ALL-PURPOSE TUBE TESTER

Speedily, efficiently tests every type receiving tube made in the past plus new types since TV and FM Specifications. Tests all tubes including 4, 5, 6, 7, Octal, lock-in, Peanut Bantam, Hearing Aid, Tetratron, Miniatures, Sub-Miniatures, Novals, etc. Will also test Pilot Lights. Tests by the well-established emission method for tube quality, directly read on the scale of the meter. Tests for "shorts" and "leakages" up to 5 Megohms. Uses the new self-cleaning Lever Action. Switches for individual element testing. Because all elements are numbered according to pin-number in the RMA base numbering system, the user can instantly identify which element is under test. Tubes with filament terminating in more than one pin are truly tested with the Model TV-10 as any of the pins may be placed in the central position when necessary. The Model TV-10 does not use any combination type sockets. Instead individual sockets are used for each type of tube by inserting it in the wrong socket. Free-moving built-in roll chart provides complete data for all tubes. Newly designed Line Voltage Control compensates for variation of any line voltage between 105 and 130 volts. The Model TV-10 operates on 105-130 Volt 60 cycle A.C.

Comes to you housed in a beautiful handsome oak cabinet complete with portable cover. Model TV-10. \$39.50

Stancor Power TRANSFORMERS

A sensational buy on Olson's part brings these high quality Stancor transformers to you at a tremendous reduction. Limited quantity on hand. For 5 or 6 tube sets. High voltage 600 volts CT @ 55 MA; 6.3 volts @ 3 amps; 5 volts @ 2 amps; 5 volts @ 2 amps. 2"x2 1/2" mtg. centers. Shpg. wt. 5 lbs. \$2.25

For 6 to 8 tube sets. High voltage 620 volts CT @ 70 MA; 6.3 volts @ 3 amps; 5 volts @ 2 amps. 2"x2 1/2" mtg. centers. Shpg. wt. 6 lbs. \$2.49

For 11 to 13 tube sets and amplifiers. High voltage 700 volts CT @ 120 MA; 6.3 volts @ 3 amps; 5 volts @ 2 amps. 2 1/2"x2 3/8" mtg. centers. Shpg. wt. 8 lbs. \$3.39

For sets over 13 tubes and amplifiers. Never before a value like this on genuine Stancor transformers. 700 volts CT @ 200 MA; 6.3 volts @ 5 amps; 5 volts @ 3 amps. Shpg. wt. 11 lbs. \$3.99

ASTATIC CRYSTAL CARTRIDGES

Model L-82. One of the most popular types. Standard replacement for millions of cartridges. 3.5 volts output, 50-5000 cps. with built-on lead shield. Regular price \$5.55. Individually boxed. \$1.99

Model QT-3M. Exceptional fine Astatic cartridge with smooth response over entire frequency range. 1 oz. needle pressure. 50-10,000 cps. Equipped with precious-metal needles. Regular list price \$8.40. Individually boxed. \$2.78

Model AC-32, single, each. \$2.78

Note: Above cartridges may be assorted for 10 lot prices.

PHONO AMPLIFIER

Easily connected to any phono and speaker or just the thing for a portable. Uses 1 each: 12SQ7, 50L6, 35Z5 tubes. 2 controls on 100% volume and tone. 7"x3 1/4"x2" chassis. Shpg. wt. 2 lbs. \$2.98

GE LONG-PLAY RECORD PLAYER

Model 19
Only \$7.95

A close-out worth much more. Attractive streamlined cabinet contains quiet 33 1/3 RPM motor, on-off switch and handsome pick-up with GE variable reluctance phono cartridge and permanent needle. Brand new factory sealed cartons. Can be used on any set with pre-amp. Operates on 115 volts AC. Regular price \$19.95. Shpg. wt. 5 lbs.

HOW TO ORDER: Order directly from this ad. State quantity desired, stock number, description and price. You may send remittance on parcel post shipment, or, if you prefer, SEND NO MONEY. Olson will ship merchandise and postage.

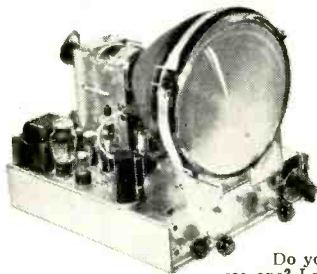

OLSON TELEVISION SCOOP!

NEVER OFFERED BEFORE—TV CHASSIS WITH 12" TUBE!

NOT A KIT—READY TO USE! COMPLETELY ASSEMBLED!

Do you know a bargain when you see one? Look at this TV chassis.

Check over its features . . . then RUSH your sample order for just one set. You'll wonder how Olson could bring you such a terrific TV receiver at such a ridiculously low price.

Every set is brand new and comes to you in original factory packing. Tubeline-up: 3-6AG5; 2-6AU6; 2-6AL5; 1-6BG6G; 3-6SN7; 1-6AC7; 1-6J6; 1-6T8; 1-6V6; 1-6W4; 1-1B3G/8016; 1-5U4G.

Set is pre-aligned and tested. All parts are the finest and the workmanship is really precision. PM speaker is furnished. There is absolutely nothing in the country to compare with this terrific Olson bargain in TV. Pictures are the steadiest, clearest and brightest you ever saw. You get superb performance even in fringe areas. Here's a TV set that defies comparison.

Comes to you complete with all tubes including 12LP4 picture tube, speaker, knobs, cables and mounting template. Chassis size: 16" wide, 18" deep, 17" high. Operates on 115-v AC. Shpg. wt. 70 lbs.

RA-33
Olson's great TV bargain, ONLY \$129.95

SAFETY GLASS AND MASK

For above set or any 12" TV set. Double shatter-proof glass and handsome mask. X-200. Both for only \$4.95

ALLIANCE TENNA-ROTATORS

PRICE REDUCED!

Here's the answer to your antenna problems TV, FM and amateur bands. Actually aims your antenna to the broadcast station by the touch of a finger on the remote control box. Turns antenna full 360° in one minute. Starts, stops, reverses at any point. Heavy-duty, trouble-free motor built into weatherproof case.

CHOICE OF 2 MODELS

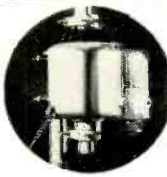

Complete Motor unit for installation on mast and control box which sets on radio. Light in control indicates end of 360° rotation but no direction antenna is pointing. Shpg. wt. 9 lbs. \$20.53

AU-15 Model ATR, your cost.

Complete motor unit for installation on mast and control box which sets on radio. Control box has indicator which shows exact direction antenna is pointing. Shpg. wt. 9 lbs. \$26.43

AU-12 Model DIR, your cost.

4-Conductor cable for either Alliance Tenna-rotator. Shpg. wt. 4 lbs. W-62, 100 ft. \$2.49

Thrust ever Bearing Bracket if extra heavy-duty antenna is used. Shpg. wt. 4 lbs. AU-13, each. \$2.91

2-TUBE PHONO OSCILLATOR KIT

Build in one evening. Connect to any phono and it will transmit to any radio in the house without wires between. Full instructions, all parts and tubes included. Shpg. wt. 3 lbs. RA-46 Oscillator Kit, each. \$3.29

Also available completely assembled. RA-47, completely built with tubes. \$4.29

ASTATIC "TURNOVER" PICK-UP ARM

Cartridge turns knob on front. One side plays 33 1/3 and 45 RPM records and other side plays 78 RPM. Only 8 grams needle pressure. Employs the famous ASTATIC IQD-1 Double-needle cartridge. Die cast curved arm. Equipped with 2 long-life needles. Frequency response 50-7000 cps output 1.2 volts. Shpg. wt. 2 lbs. Reg. list price \$15.90. M-64, each. \$4.95

RIM DRIVE PHONO MOTORS

Famous Makes! Real bargains at these low prices. Self-starting; complete with turntable. All parts included. Shpg. wt. 4 lbs. M-52, 78 rpm for 115 volts AC. \$2.75

M-63, 3-speed, 33 1/3, 45 and 78 rpm. 4.95

GENUINE ASTATIC PICKUP ARM

With crystal cartridge at less than you'd normally pay for the cartridge alone. M-58, Lots \$1.99 Single each. 2.19

SPECIAL BARGAIN AT OLSON'S

TV-FM ACCESSORIES

TV Booster Kit
Build your own TV-FM booster. Improves reception in low-signal, low-terrain and "fringe" areas. 3 to 5 db gain in signal to noise ratio. All channel tuning. Complete with 6AK5 tube, pre-aligned coils, components, instructions. Shpg. wt. 5 lbs. RA-26, complete. \$9.95

TV FOCUS COIL
Same as RCA Part No. 202D1. Perfect for all RCA 630-type or similar sets. Regular list price is \$7.50. Shpg. wt. 2 lbs. T-80, Only at Olson's. \$1.49 each

Adjustable Chimney Antenna Mount
Worth Twice Our Price! Strongly made of heavily plated steel. Makes it easy to attach any antenna mast through a 1 1/2" diameter to any chimney. Comes complete with slapping a S. Patent 2482575. The best. Shpg. wt. 10 lbs. Single, each. \$1.59

X-207, lots of 10, each. \$1.39

Olson Hi-Gain Conical Bay
Amazing TV antenna outsells all others. Delivers high gain on all channels. Eliminates ghosts and has excellent signal to noise ratio. Features include silicone-treated insulator marine type dural elements and butt seamed tubing. Assembled in a few minutes. Shipped without mast which is available locally. AU-17 includes universal mounting clamp for attaching to any mast from 3/4" to 1 1/4" dia. Single, each. \$4.49

Special, price lots of 10, each. \$3.99

TELEVISION-FM ANTENNAS

Finest ever Bearing Bracket if extra heavy-duty antenna is used. Shpg. wt. 4 lbs. AU-13, each. \$2.91

Finest opened! Exceptionally high gain on a 11 channels. Most efficient for "fringe" areas. Low standing wave ratio permits use with 72, 150 or 300 ohm lines. Special conical section design minimizes noise. reduces "ghosts"—results in sharp, clear picture. Easily assembled. Double bay with 10 ft. mast. Shpg. wt. 16 lbs. \$5.99

Same antenna with single bay and 5 ft. mast. Shpg. wt. 10 lbs. AU-60 \$5.99

TV DEFLECTION YOKE

Same as RCA 201-D1 for 12" or 10" picture tubes. Shpg. wt. 2 lbs. T-84 \$2.95

TV FLYBACK TRANSFORMER

Same as RCA 211T1. Supplies high voltage to 12" or 10" picture tube. Has filament winding and feeds horizontal scanning coil of deflection yoke. Shpg. wt. 3 lbs. T-82 \$2.79

SUPERIOR ACCURATE POCKET SIZE VOLT-OHM MILLIAMMETER

(SENSITIVITY: 1000 ohms per volt)

Compact, measures 3 1/8" x 5 1/4" x 2 1/4". Uses latest design 250 micro-ammeter movement. Same zero adjustment holds for both resistance range to another. This is an important time-saving feature never included in other meters. Housed in rounded, molded case. Beautiful black etched panel. Depressed letters filled with permanent white, assures long life even with constant use.

Specifications: 6 A.C. Voltage Ranges: 0-15/30/150/300/1500/3000 volts ● 6 D.C. Voltage Ranges: 0-7 1/2/15/75/150/750/1500 volts ● 4 D.C. Current Ranges: 0-1/2/15/150 ● Ma. 0-1/5 Amps ● 2 Resistance Ranges: 0-500 ohms. 0-1 Megohm ● Comes to you complete with self-contained battery, test leads and all operating instructions. Model 770 \$13.90

OLSON RADIO WAREHOUSE, INC.
73 E. MILL ST. • DEPT. RN650 • AKRON 8 OHIO

the New
PYRAMID
"Humidi-Seal"

(TUBULAR PAPER CAPACITOR)

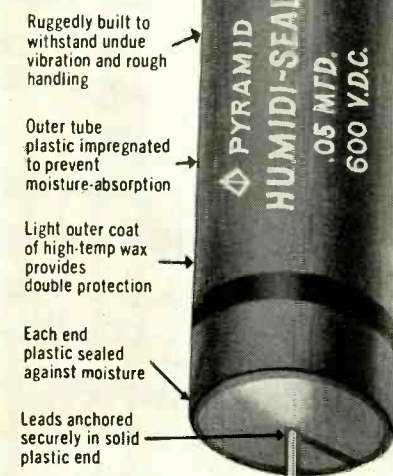

Type 85TOC "Humidi-Seal" capacitors are specially designed for 85° C. operation, even in the most humid atmospheres, and will meet the severe present-day demands of endurance in television receivers, auto radios, etc.

WRITE FOR COMPLETE LITERATURE

Representatives and Distributors throughout the U.S.A. and Canada



PYRAMID

PYRAMID ELECTRIC COMPANY

155 Oxford Street
Paterson, N. J., U.S.A.

TELEGRAMS: WUX Paterson, N. J.
CABLE ADDRESS: Pyramidusa

Within the
INDUSTRY

NATIONAL ELECTRONIC DISTRIBUTORS ASSOCIATION recently held a meeting of its executive committee in Atlantic City at which several far-reaching decisions were made.

Plans were outlined and progress reports were given on the distributors' convention to be held in Cleveland during August. Present plans are that the convention proper will convene on August 27 and 28th with the exhibition being held between the 29th and 31st.

Also discussed were plans whereby NEDA would construct or buy a building to house its national headquarters.

CLAUDE NEON, INC. has recently acquired 100 per-cent of the stock of *Standard Electronics Corporation*.

The new wholly-owned *Neon* subsidiary has taken over *Western Electric Company's* inventories of AM and FM transmitting equipment, replacement parts, product designs and drawings, thus gaining a strong position in the broadcast field.

The company will also manufacture a line of television broadcast transmitting equipment in addition to the AM and FM units. The new company has already taken over the servicing and replacement business for all *Western Electric* broadcast transmitting equipment used throughout the United States.

Graybar Electric Company, formerly national distributors for *Western Electric*, will act as distributors for the new subsidiary firm.

WALTER LEFEBRE has been appointed acting field sales manager for the *Sylvania Television* division of *Sylvania Electric Products Inc.*

Since January of this year, Mr. Lefebre has been the southern district sales manager for the company. He has been active in radio and TV sales and merchandising for twenty years during which time he was associated with such firms as *Sears-Roebuck*, *Philco Corporation*, *Westinghouse*, and *Emerson Radio and Television Corporation*.

RADIO CORPORATION OF AMERICA'S RCA Victor Division has recently completed installation of an elaborate television display which will become a permanent exhibit at Chicago's Museum of Science and Industry.

The exhibit comprises 18 units, ranging from reproductions of the mechanical spinning discs with which

early television images were first created to modern electronic facilities permitting visitors to see themselves on television. Also included in the exhibit is a panel containing four television screens on which programs from all Chicago television stations may be seen at once.

Like all exhibits at the museum the new installation is designed to be operated by the visitor.

EARL L. OLSON has been named chief engineer of *Jensen Industries, Inc.*, Chicago manufacturer of phonograph needles.

Well-known throughout the industry, Mr. Olson joins the company with a background of many years of experience as a needle and cartridge engineer with leading phonograph manufacturers. In his new position, Mr. Olson will be in complete charge of all of the engineering and new development work at *Jensen*.



ADMIRAL CORPORATION of Chicago has recently purchased the *Midwest Mfg. Company* of Galesburg, Illinois. The new firm, which brings the total of *Admiral* plants to nine, will be known as the *Midwest Mfg. Company Division*. The new division will continue to manufacture package kitchens . . .

RADIO ELECTRIC SERVICE CO. of Philadelphia has opened a new warehouse, showroom, and sales building at 452 N. Albany Avenue in Atlantic City . . . New quarters at 66 Day Street in New York City were recently opened by **FEDERATED PURCHASER, INC.**

The company also rounded out a quarter of a century in the electronic, radio, and electrical field . . . In order to provide increased production and engineering facilities,

THE WORKSHOP ASSOCIATES, INC. has acquired a new building on Crescent Road, Needham Heights, Massachusetts. The company was formerly located in Newton Highlands . . .

TIN-NERMAN PRODUCTS, INC. has announced the opening of a district office in St. Louis. The new offices, headed by Carl F. Marcussen, are located at 7614 Wydown Blvd. . . .

GLOBE-UNION, INC. has acquired the buildings formerly occupied by *Eclipse Molded Products Co.* in Milwaukee and will use the additional 42,000 square feet in the production of wave switches and printed circuits made by the *Centralab Division* of the company . . .

AIR KING PRODUCTS COMPANY, INC. has added 40,000 square feet to its

RADIO & TELEVISION NEWS

THESE LEADING SET MAKERS

Emerson

hallicrafters
air-OKing

Admiral

Spartan

Sentinel

BENDIX RADIO
REG. U.S. PAT. OFF.

STROMBERG-CARLSON

Westinghouse

Majestic

SETCHELL-CARLSON, INC.
CROSLLEY

Seen these Hytron firsts in popular new TV sets? The prominent TV set makers shown are using them. And the list is growing.

DuMont, for example, now uses the 1X2 and 6BQ6GT. You'll see many more of these famous tubes. And many more new Hytron types designed for low-cost TV for the mass market. When you buy these Hytron firsts, follow the leading set manufacturers. Buy the original. Buy Hytron!

choose one or more of
THESE HYTRON TV FIRSTS

HYTRON
TV FIRST

1X2
compact,
high-voltage
TV rectifier.



HYTRON
TV FIRST

6U4GT
high-
performance
damping
diode.



HYTRON
TV FIRST

162P4
original rectangular
TV picture tube.

HYTRON
TV FIRST

6BQ6GT,
25BQ6GT
extra-
performance
deflection
amplifiers.



HYTRON
TV FIRST

12BH7
twin-mode
sweep ampifier
with superior
efficiency.



Relax! LET HYTRON TOOLS
EASE YOUR WORK

SOLDERING AID 49c net

The Soldering Aid is a new, revolutionary tool for the electronics technician. It is designed to heat the tip of a soldering iron, so that the solder will flow more readily and the work will be done more quickly and easily. It is made of a special alloy which is resistant to heat and corrosion. It is available in two sizes, 1/2 inch and 3/4 inch. Price, 49c net.

TUBE LIFTER 15c net

The Tube Lifter is a new, revolutionary tool for the electronics technician. It is designed to lift tubes from their sockets without the use of a screwdriver. It is made of a special alloy which is resistant to heat and corrosion. It is available in two sizes, 1/2 inch and 3/4 inch. Price, 15c net.

TUBE TAPPER 5c net

The Tube Tapper is a new, revolutionary tool for the electronics technician. It is designed to tap the pins of a tube without the use of a screwdriver. It is made of a special alloy which is resistant to heat and corrosion. It is available in two sizes, 1/2 inch and 3/4 inch. Price, 5c net.

BY THE MAKERS OF
HYTRON TUBES

FREE

New Hytron Tool Catalogue. Describes all the famous Hytron Service Shop tools to date: Soldering Aid, Tube Lifter, 7-Pin and 9-Pin Straighteners, Tube Tapper, and Auto Tool. Find out how these Hytron Tools can ease your work. Learn how you can save money. Send for your free copy today!

OLDEST MANUFACTURER OF RECEIVING TUBES
HYTRON
RADIO AND ELECTRONICS CORP.

MAIN OFFICE: SALEM, MASSACHUSETTS



Keeping up with radio



THE FIRST BOOK OF ITS KIND!

Especially for

- TV Installation Engineers
- TV Experimenters
- TV Reception Enthusiasts

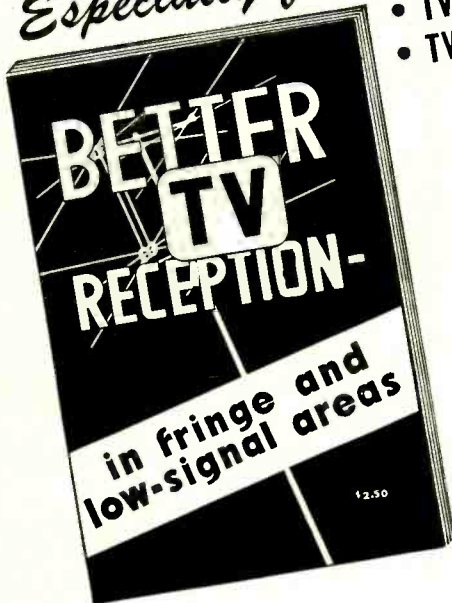

"BETTER TV RECEPTION

in fringe and low-signal areas"

WRITTEN BY:

W. W. SMITH, author of the "ANTENNA MANUAL"

and R. L. DAWLEY, editor of the "RADIO HANDBOOK"

\$2.50 PER COPY

- Emphasis on concise, clear how-to-do-it information.
- Many tried-and-proved practical suggestions to improve that poor picture when standard set-ups fail.
- The only book of its kind, with much new information and a compilation of all the most useful data from many sources.

Practical, how-it-works data on TV signal propagation into the fringe areas. Evaluation of all common TV antennas in terms of their performance under low-signal conditions. Selecting the best transmission line. Making a rapid TV survey of an area, locating the "hot" radials and areas of high signal caused by focussing. Eliminating ghosts in difficult installations. Practical methods of minimizing fading.

Selection of boosters and receivers; practical suggestions for improving receiver performance in fringe areas. Full information on rhombics of all practical sizes. Using open-wire line when the antenna must be at a distance from the receiver.

Full treatment of masts and towers including data on installation and guying.

Keeping the antenna from coming down in a high wind. One complete chapter on reducing TV interference.

\$2.50 AT YOUR FAVORITE DEALER . . . on mail orders from us, \$2.60 postpaid. Add sales tax in California.

SURPLUS RADIO CONVERSION MANUAL IN TWO VOLUMES



This set of reference data has become standard for the most commonly used items of surplus electronic equipment. All conversions have been proven by testing on several units; each yields a useful item of equipment. For list of items covered, write us.

\$2.50 FOR EITHER VOLUME AT YOUR DEALER — On mail orders from us, \$2.60 postpaid

WORLD'S RADIO TUBES (Radio Tube Vade Mecum)



The only book of its kind in the world. 18 languages with more than 15,000 tubes listed. The most complete set of tube data in existence. Many carefully prepared charts. Tube characteristic data of U.S., British, French, Czech, German, Swiss, Australian, Italian, Russian, Japanese, Scandinavian and all other available types . . . all in one book!

\$3.00 AT YOUR DEALER — On mail orders from us, \$3.20 postpaid. Add tax in Cal. Foreign, \$3.35

ANTENNA MANUAL



The most practical, comprehensive book on antennas. 300 pages of down-to-earth help on antenna, feed line, radiation and propagation for all frequencies up to 1000 Mc, including FM and TV. Plain language; no need to brush up on math. A necessity for everyone interested in transmission or reception.

\$3.50 AT YOUR DEALER — On mail orders from us, \$3.60 postpaid. Add tax in Cal. Foreign, \$3.75

RADIO AMATEUR NEWCOMER



Ideal for those just getting started (or interested) in radio. You need no other book to get your license and get on the air. How-to-build simple equipment for a complete station; operating instructions; simple theory; study questions needed to pass license exams; U.S.A. Amateur radio regulations. WRITTEN BY THE EDITORS OF "RADIO HANDBOOK."

\$1.00 AT YOUR DEALER — On mail orders from us, \$1.10 postpaid. Add sales tax in California.

holdings in the Kenyon Building, Brooklyn, in order to handle the demand for its television receivers . . . The **SHAKEPROOF INC.** division of *Illinois Tool Works* has opened an Eastern sales office in the Chrysler Building, New York City.

LAWRENCE HYLAND has received the highest award that the Navy can bestow on a civilian for his pioneering work in radar.



Mr. Hyland, who is vice-president of *Bendix Aviation Corporation* in charge of engineering research, made his original discoveries in 1931 while stationed at the Anacostia Naval Air Station as an enlisted man.

During routine transmission of radio signals from the ground to a plane in flight in connection with high-frequency direction finding, he noticed the erratic behavior of the signals when the plane was airborne.

Thereafter, Mr. Hyland conclusively demonstrated that the reflection of radio waves from aircraft was sufficient to fix the plane's presence and, to some extent, its position in space, thus establishing one of the important elements of radar.

NATIONAL TELEVISION DEALERS ASSOCIATION, INC. has elected seven new members to its board of directors.

Edward A. Dempsey, Executive Director of the Association, announced the election of the following men: Edward C. Beetem, II, Baltimore; Earl Campbell, Washington; Robert T. Dowd, Washington; William H. Frederick, Wilmington; William H. King, New York; Bernard Lewis, Trenton; and Milton Rabovsky, Baltimore.

WHITE SALES COMPANY of Boston has been appointed exclusive representatives of the *Burlington Instrument Company's* line in the New England territory . . . **RAMSEY-BENNETT COMPANY** of Cleveland has been appointed northeastern Ohio distributor for the *Andrea* line of television receivers . . .

The *Sightmaster Corp.* of New York is now being represented in the Philadelphia area by **TWIN-VEX MANUFACTURING CO., INC.** . . . **RADIO ELECTRIC SERVICE CO.** of Philadelphia has been named exclusive distributor for the *Peerless* line of transformers in the Philadelphia-Camden area . . .

FORREST VALENTINE of Fort Wayne and **VERN BALLANTYNE & ASSOC.,** Portland, Oregon, will handle the *Circle "X"* *Antenna Corporation* line in their respective areas . . . *Allied Control Company, Inc.*, has named **G. E. HARRIS** as its sales representative in the Kansas and western Missouri territory . . .

TERMINAL RADIO CORPORATION is the new New York area distributor for the *Victoreen Instrument Company* . . . The appointment of **HENRY D.**

(Continued on page 130)

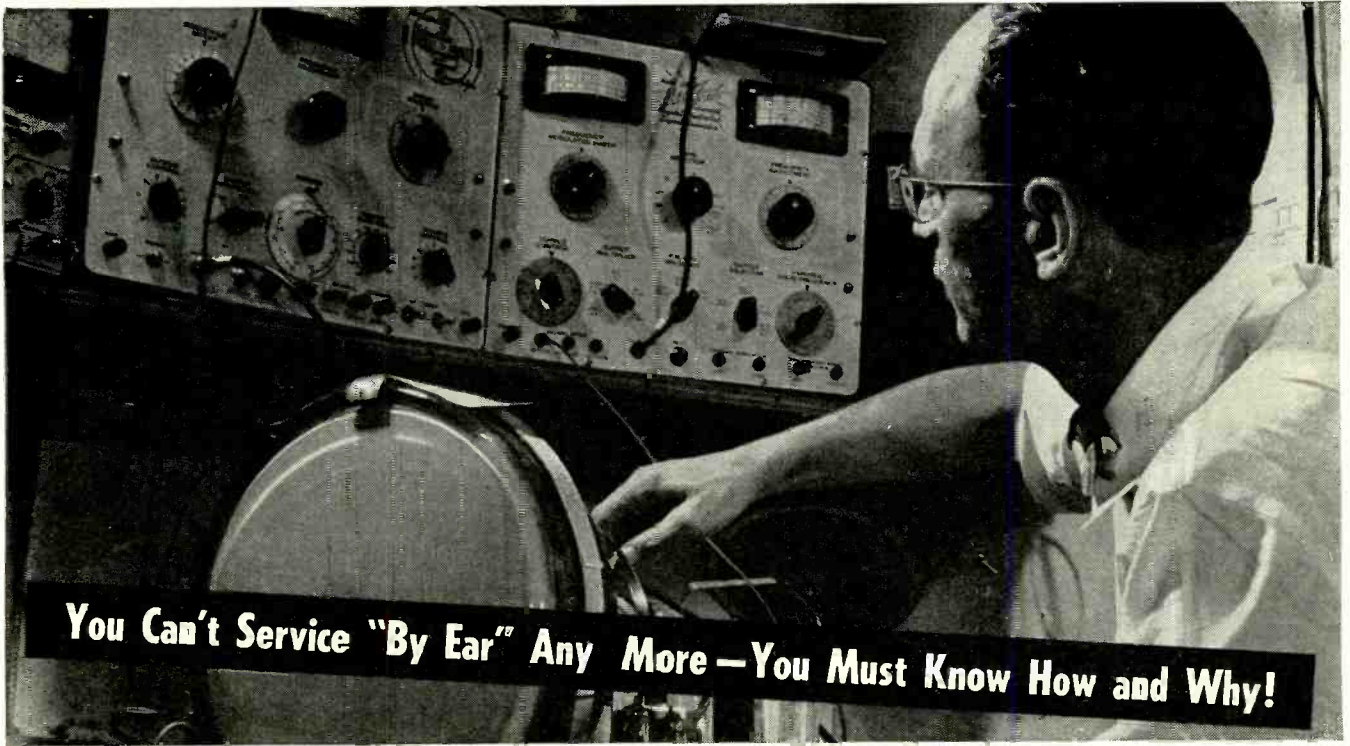

CREI's Practical Course Can Mean MORE Money for You in **TELEVISION & FM SERVICING!**

THE days of servicing "by ear" are gone forever. It is no longer possible for a screwdriver mechanic to do a service job on a TV or FM receiver. Anyone in the field—if he is to stay in business—needs to know how to use modern test equipment, how a TV set works, why it works, and how to make it work better. Hit-and-miss methods are not only inefficient; they are unsuccessful and unprofitable.

That's why alert technicians have been quick to use CREI's practical course in TV-FM servicing. Every lesson in the course has specific use in day-to-day repair work. Designed by top-notch teachers, taught by practical TV instructors, reviewed and checked by qualified service experts, **KEPT UP-TO-DATE**

THROUGH DIRECT CONTACT with manufacturers, dealers, and service specialists, the CREI course equips you properly to thrive and earn more money in your career.

TV is developing at breath-taking speed. Extraordinary opportunities await *qualified* service technicians. CREI offers you—in one practical course at a popular price—the opportunity for greater earnings and a more secure future. Don't put it off! Start your training immediately and start applying your new-found knowledge in your daily work. It costs you only a few minutes' time to read the interesting facts. Mail the coupon now for complete details.

THE THREE BASIC CREI COURSES:

- ★ **PRACTICAL RADIO ENGINEERING**
Fundamental course in all phases of radio-electronics
 - ★ **PRACTICAL TELEVISION ENGINEERING**
Specialized training for professional radiomen
 - ★ **TELEVISION AND FM SERVICING**
Streamlined course for men in "top-third" of field
- ALSO AVAILABLE IN RESIDENCE SCHOOL COURSES

CAPITOL RADIO ENGINEERING INSTITUTE

An Accredited Technical Institute Founded in 1927

**Dept. 116B, 16th Street & Park Road, N. W.
Washington 10, D. C.**

Branch Offices:

New York (7) 170 Broadway • San Francisco (2) 760 Market St.



**SEND FOR
FREE BOOKLET!**

CAPITOL RADIO ENGINEERING INSTITUTE

Dept. 116B, 16th & Park Rd., N. W. Washington 10, D. C.

Gentlemen: Send me complete details of the TV and FM Servicing home study course. Also send brochure that explains the CREI self-improvement program and gives complete details and outline of course. I am attaching a brief resume of my experience, education and present position.

- Check the Field of Greatest Interest
- TV, FM & ADVANCED AM SERVICING
 - PRACTICAL TELEVISION ENGINEERING
 - PRACTICAL RADIO ENGINEERING
 - AERONAUTICAL RADIO ENGINEERING
 - BROADCAST RADIO ENGINEERING (AM, FM, TV)
 - RADIO-ELECTRONICS IN INDUSTRY

NAME _____ AGE _____

ADDRESS _____

CITY _____ ZONE _____ STATE _____

SEND DETAILS ON RESIDENCE SCHOOL.

Billions of speeding electrons set phosphors "on fire"

Gleaming luminescent materials, excited by an electron beam, help create television pictures

No. 5 in a series outlining high points in television history

Photos from the historical collection of RCA

● "Specpure Laboratory," said a sign at RCA Laboratories, "Do Not Enter. Dust Is Our No. 1 Trouble-maker." On the floor were moistened rugs to trap shoe-borne dust. Scientists and technicians had to change to clean white clothing before entering the room.

Purpose of this meticulous housekeeping was to provide a place where no speck of dirt would handicap the work in progress. RCA scientists were studying *luminescent materials*—seeking ways to produce them in bulk, while maintaining utmost quality and purity. Not even

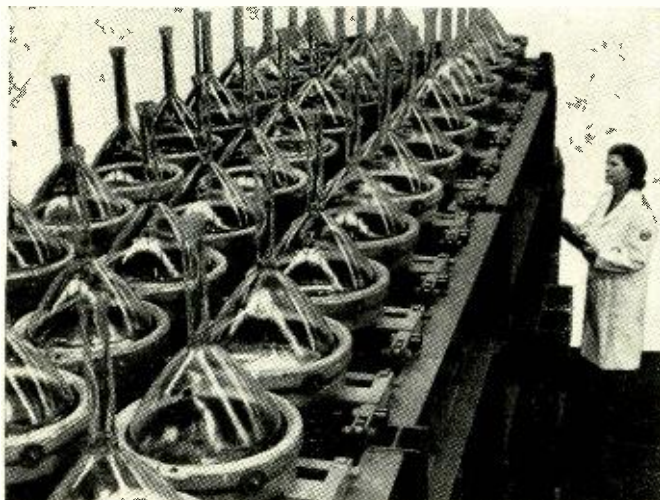

In a special vibration-free room, air-conditioned—and with temperature and humidity evenly controlled—tubes move at a snail's pace along this settling belt, while the luminescent coating settles on the face of the bulb in a delicate, film-like covering—a flawless surface, smooth and uniform.

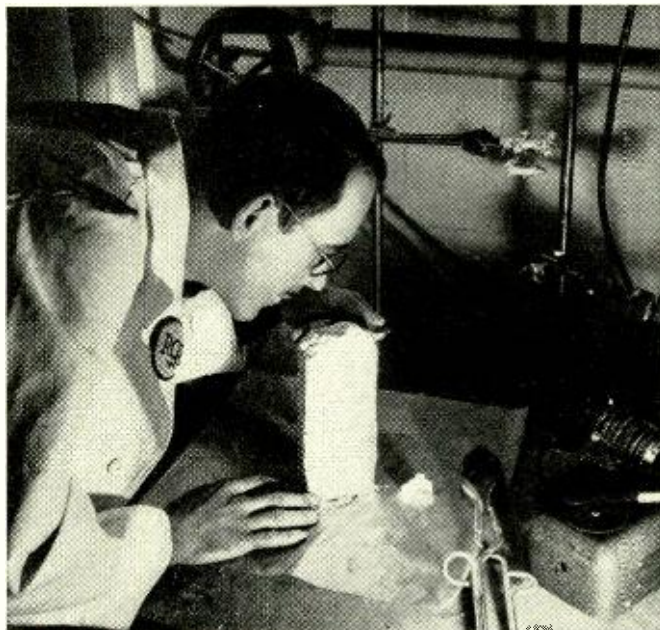

This block of luminescent material, energized by ultraviolet light, provided illumination for this photograph. Luminescent materials of the highest purity are produced in bulk at RCA Tube Plant.

a speck of foreign matter could be tolerated. One part of copper in *ten million* will show up as green spots on a television screen.

Although phosphors have been known for centuries—since even sugar, salt, and diamonds have been found to have luminescent properties—little intensive research was done until scientists began seeking to perfect these glowing materials for use on the screens of television receivers. A scientist at RCA Laboratories, in the Specpure Room, was one of the first to develop the fundamentals for a way of making luminescent materials in bulk for television.

This development is one of the reasons why, at RCA Tube Plant in Lancaster, Pa., they can now be made by the tankful! Even in mass production, each "batch" has uniform characteristics. White light, of the type most suitable for creating television pictures, is produced by mixtures of luminescent materials combined in exactly the correct proportion.

Guarded at every step against any trace of contamination, these phosphors are deposited in a delicate film-like coating on the faceplates of television tubes . . . where they cling to the glass by a form of molecular attraction. Excited by an electron beam, they glow with a brilliant white light and thus produce the crisp black-and-white pictures we see on television.

To television, the phosphors developed by RCA scientists are as important as paint is to a painter. The face of the kinescope tube is the "canvas." A picture appears as a visible image when the electron gun acts as a "paint brush" to create patterns in the phosphors!



Radio Corporation of America

WORLD LEADER IN RADIO—FIRST IN TELEVISION

(Advertisement)

RADIO & TELEVISION NEWS

**YOU BUILD 'EM
IN ONE EVENING
BUT...**

THEY LAST A LIFETIME!

SAVE 50% WITH

**LABORATORY
PRECISION**



**INSTRUMENTS
& KITS**

SENSATIONAL NEW

**EICO Model 360-K TV-FM SWEEP
SIGNAL GENERATOR**

• Crystal marker oscillator with variable amplitude. • Covers all TV and FM alignment frequencies between 600 kc. and 228 mc. • Sweep-width variable from 0-30 mc. with mechanical inductive sweep. • Extremely wide sweepwidth allows gain comparison of adjacent RF TV Channels. • Provides for injection of external signal generator marker. • Phasing control included. • Large, easy-to-read dial is directly calibrated in frequencies. Vernier tuning condenser. Comes complete with all tubes (including new, high-frequency miniature types): 6X5GT, 12AU7, two 6C4's. Crystal not included. 10"x8"x6 3/4". 6 Mc. Crystals available for above, each \$3.95.

\$29.95

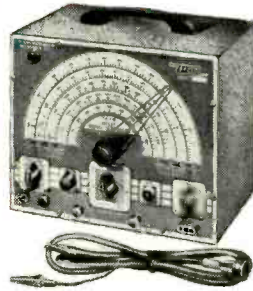

Model 360. Ready to use Sweep Signal Generator. \$39.95
See it at your local jobber!

**ANYONE
CAN BUILD
THEM!**

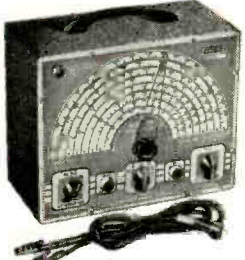

**NEW! MODEL 320-K
SIGNAL GENERATOR**

For FM, AM alignment and to provide TV marker frequencies. Highly stable Hartley oscillator has range of 150 kc. to 102 mc. with fundamentals to 34 mc. Colpitts audio oscillator supplies pure 400 cycle sine wave voltage for modulation. Vernier tuning condenser. Use audio oscillator voltage to test distortion in audio equipment, bridge measurements, etc.

FACTORY-WIRED AND TESTED \$29.95
Model 320. Ready to use.....



**VERSATILE MULTI-SIGNAL
TRACER**

Model 145-K. High gain—high frequency. Self-contained test speaker permits audible signal tracing of RF, IF, FM, audio and video circuits. Provision for visual tracing with VTVM. Response is well over 200 mc. 3-color hammertone panel. 110-125 V. AC. Size: 10"x8"x4 3/4". Comes complete with tubes and diode probe in kit form.

FACTORY-WIRED AND TESTED \$28.95
Model 145. Ready to operate.....

**NEW PUSH-PULL
5" TV
OSCILLOSCOPE
Model 425-K Kit**

ALL-NEW laboratory precision scope has Push-Pull deflection and .05 to 1 volts per inch sensitivity. Wide range, flat from 5 cps to 500 kc. with full gain setting, useful to 2 1/2 mc. Wide-range, multi-vibrator, sweep circuit from 15 cps to 75,000 cps. Direct connection to plates of CRT available at rear of cabinet. Z axis intensity modulation feature included. Size: 8 1/2"x17"x13" high. Complete with 8—6SN7s, 2—6J5s, 2—6Y3s, and 5BP1 CRT.

\$39.95



FACTORY-BUILT OSCILLOSCOPE \$69.95
Model 425. Fully wired and tested

**HIGH PRECISION
VACUUM TUBE
VOLTMETER
Model 221-K**

Tops in workbench versatility—15 different ranges! AC and DC ranges: 0/6/10/100/500/1000 volts. Electronic ohmmeter ranges from .2 ohms to 1000 megohms in 5 steps. New features include Zero Center for TV discriminator alignment, 26 Meg. DC input impedance. Accurate, 4 1/2" meter cannot burn out. Double triode balanced bridge circuit assures guaranteed performance. Sturdy portable steel base with etched rubproof panel. Will measure up to 30,000 V. and 200 MC. when used with our HVP-1 or P-75 probes, 110-130 V. AC 50-60 cycle. Size: 9 7/16"x6"x5".

\$23.95



FACTORY-WIRED AND TESTED \$49.95
Model 221. Same, but completely wired, calibrated, and tested....

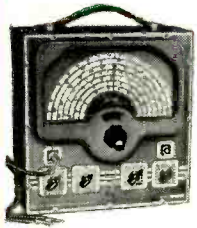

**DELUXE SIGNAL
GENERATOR
MODEL 315**

Completely wired, ready-to-use Signal Generator with 1% accuracy! A wonderful instrument with dozens of expensive features. Frequency range: 75 kc to 150 mc. Has microcycle band-spread vernier tuning for FM, AM, and TV. Voltage regulator. Write for full details.

\$59.95

Model 511-K. A "Must" for every serviceman! Small, handy instrument used a thousand times a day. Large 3" meter, beautifully etched panel. A perfect kit for beginners. Simple to assemble. Ranges: DC—5/20/250/500/2500 volts. AC—0/10/100/500/1000 volts. Output—0/10/100/500/1000 v. DC Ma—0/1/10. DC A m.p.s.—0/1/10. Ohm meter—0/500/100,000 ohms/0/1 meg. DB—0/100,000 meter—8 to +55 Db. \$14.95

ASSEMBLED—READY TO USE Model 511—Completely wired, tested, and assembled at the factory. Rugged, built for heavy duty. \$17.95

**VOLT-OHM
MILLIAMMETER
Complete Pocket Kit**



\$14.95



**Model HVP-1
HIGH VOLTAGE PROBE**
Complete top-quality High Voltage Test Probe measures up to 30,000 volts. Special Helical-Wound Ceramic HV Multiplier Resistor adaptable to most VTVM's and 20,000 ohms per volt meters with 1000 or 5000 volt scales. Lucite head, plywood bakelite handle, large flashguards for additional safety. Specify your instrument. Complete ready to use \$6.95

ASK YOUR LOCAL JOBBER
About EICO's new Tube Tester Kit Model 625K—"The most 'versatile' Tube Tester ever designed!"

Don't settle for a substitute if jobber is out of stock. Insist on EICO, leading name in kits.

ELECTRONIC INSTRUMENT CO., INC.
276 Newport Street, Brooklyn 12, N. Y.

**Model P-75K
HIGH FREQUENCY RF PROBE**

Model P-75K germanium crystal probe for visual RF signal tracing and measurements to over 200 megacycles. Can be used with models 221 or 113A Eico instrument (state which when ordering). 6 1/2" long, 1/2" O.D., with wire, plugs, and all components. **\$3.75**
IN KIT FORM. \$3.75
Model P76K same as above, but for oscilloscopes; in kit form. \$3.75
Models P75 or P76 similar to above but factory wired, ready to operate. Each. . . \$7.50

**EASY-TO-FOLLOW SCHEMATIC
& PICTORIAL DIAGRAMS**

Come complete with every EICO instrument kit. Each kit fully guaranteed to operate perfectly when assembled according to our simple instructions!

EXCLUSIVE LIFE-TIME REPAIR SERVICE: For a nominal charge, we will repair and service your EICO instrument, regardless of its age!



Write For New Catalog "R"
Prices Higher on West Coast

AMAZING McINTOSH AMPLIFIER! MOST STARTLING DEVELOPMENT IN 15 YEARS

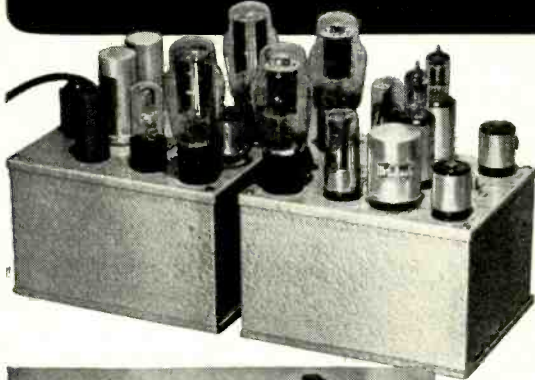

50W2 McIntosh Amplifier. Complete with 6 tubes (including pre-amp.) and 2 rectifiers; in 2 units each 8 $\frac{1}{4}$ " x 6 $\frac{3}{4}$ " x 4 $\frac{3}{4}$ " Shpg. Wt. 60 lbs.
2-438. Net \$249.50
Liberal Terms Available.

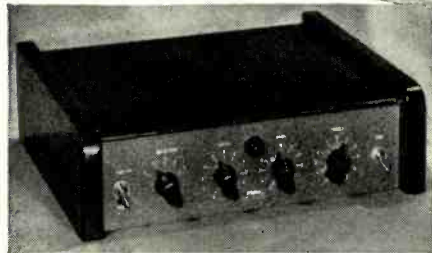

AE-2 Equalizer for use with McIntosh Amplifiers. Has 8 stages plus rectifier. Handles 5 different types of inputs with individual controls. 300 & 600 cps turnover at 6 db per octave on switch. Size 10" x 10 $\frac{1}{4}$ " x 2 $\frac{3}{4}$ ". Shpg. Wt. 8 lbs.
2-436. Net \$74.50
Liberal Terms Available.

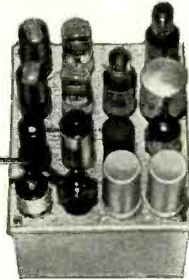

20W2 McIntosh Amplifier. Similar to 50W2 unit, with 6 tubes and rectifier. Range 20cps to 180KC! Single freq. distortion less than 1% 20-20,000 cps. Balanced output 600 ohms, also 4, 8, 16 or 32 ohms. Shpg. Wt. 25 lbs.
2-435. Net, ea. \$149.50
Liberal Terms Available.

CHECK THESE ADVANCED FEATURES

- At 117 volts or 125 volts, 60 cycles power input:
- ★ FULL 50 watts output from two 6L6's.
- ★ BANDWIDTH, 10-180,000 cps, \pm 1 db.
- ★ PLATE EFFICIENCY of final stage 60-65%, 20-20,000 cps, at 50 watts output.
- ★ INTERMODULATION distortion less than 1% for 100W peak power, 20-20,000 cps.
- ★ SINGLE frequency harmonic distortion less than 1%, 20-20,000 cps, at 50W output.
- ★ RMS noise components 85 db below rated output.
- ★ PHASE SHIFT \pm 5° maximum, 20-20,000 cps.

FIRST real design improvement in over 15 years—gives you the closest to a perfect amplifier ever built! The startling performance is made possible for the first time by the patented circuit utilizing a take-turn primary providing 50% coupling between these windings and a usually low internal generator impedance. Superior for laboratory work, electronic organs, and fine music amplifier applications. Range: 10 cps to over 180KC! Easy servicing with plug-in circuits. With optional AE-2 Equalizer handles 5 inputs individually. AN AMAZINGLY DIFFERENT—BETTER—instrument for the laboratory, engineer, broadcaster and fine music lover!

THOUSANDS OF OTHER GREAT BUYS IN TV, RADIO, ELECTRONIC SUPPLIES



INTERCOM SPECIALS

Complete, dependable communications to any of 5 stations. For office, factory or home. Easily installed without special tools. With 1 sub-station and 50 ft. wire. 110V, AC-DC. Shpg. Wt. 10 lbs.
99-9585. Net, each \$19.95
Extra Sub-station for above with 50 ft. wire. Shpg. Wt. 3 lbs.
99-9586. Net, each \$3.95
99-16013. Extra connecting wire. Per Ft. 1 $\frac{1}{2}$ c

TERRIFIC VALUE! Special 2-way Intercom. For homes, offices, factories, nurseries, sickrooms. Works up to 2000 ft. Complete, with 50 ft. wire. For 110V AC-DC. Shpg. Wt. 8 lbs.
99-9582. Net, each \$13.95

LOW-PRICE PORTABLE PHONO



Easily carried portable phonograph contained in neat cabinet with brown plastic handle. Excellent for the children and the 'teen agers. Contains high-fidelity, 2-tube amplifier with speaker, volume control and on-off switch. Fine quality pickup arm and cartridge. Has needle box for new needles. For 110-volt, AC operation. Plays single records up to full 12-inch size at 78 rpm with good response and life-like tone. Very handy to move about in the house or take along on outings. Shpg. Wt. 12 lbs.
34-22704. Net, each \$13.75



Oak Ridge High Voltage Meter, Model 102. Small, light, yet rugged. Has sensitive 100 microampere meter movement, and sensitivity of 10,000 ohms per volt. Meter is 3" square—easy to read. Voltages: 0 to 30,000 volts in three ranges. High voltage insulation throughout. Complete with 30,000 insulated probe. 5 $\frac{3}{4}$ " x 4" x 2 $\frac{3}{4}$ ".
25-21534 Net \$14.95

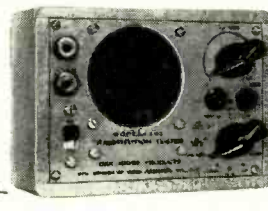

Oak Ridge Substitution Tester, Model 101. Simplifies over 90% of radio and TV trouble-shooting. Makes loudspeaker testing easy. Quickly checks for defective output transformer; has substitutes for seven different condenser values, including filter condensers; provides various resistor values to determine correct value of needed replacement. Also supplies a simple audio signal tracer for video or audio amplifiers and sweep circuits. Size 5 $\frac{3}{4}$ " x 4" x 2 $\frac{3}{4}$ ".
25-21533. Net \$16.25

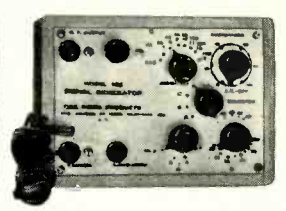

Model 103 Signal Generator for TV and FM set adjustment. Generates RF sound carrier on channels 2-13 for TV receivers and 88-108MC for FM sets. Generates modulated RF picture carrier. Has 500 cps audio note for checking audio systems. Useful in orientating TV antennas by generating radiant RF signal. Has many other laboratory and service uses; such as for comparison of sensitivity of TV and FM antennas. Rugged, small and light. Size: 5 $\frac{3}{4}$ " x 4" x 2 $\frac{3}{4}$ ".
25-21535. Net, each \$29.95

BIG-VALUE OAK RIDGE MINIATURE TEST EQUIPMENT

EXPORT: Address all export orders and inquiries to Concord Radio EXPORT DIVISION, 901 W. Jackson Blvd., Chicago 7, Ill.

CONCORD RADIO

Mail Order Center and Showroom
901 W. Jackson Blvd., Chicago 7, Ill.
Branch Showroom: 265 Peachtree St., Atlanta 3, Ga.

CONCORD RADIO CORP. Dept. RF-50
901 W. Jackson Blvd., Chicago 7, Ill.

Enclosed \$..... (include shipping charge.
Any excess will be refunded.) Rush me the following equipment:

Send FREE latest Catalog & Bargain Bulletin.

Name

Address

City..... Zone..... State.....

Hiawatha was a PIKER!



"Go out into the world," said Pops* "and don't come back 'till you're proved tops!"



The water test he passed with ease. Earning a feather was just a breeze...



Heat was applied to test his worth In "hot spots" he then won a berth...



The life test took a long, long time Though others quit — he kept his prime...



His leads proved strong—his casing tough It did no harm to treat him rough!

His Pops was pleased when he came through We know you'll like the Redskin, too!

Sangamo's New Molded Paper Tubular Capacitor gives LONG LIFE under severe conditions!

The REDSKIN is easy to work with—on production line or on the bench—because the especially designed flexible leads resist breakage and can't pull out! It offers greater mechanical strength because of its plastic construction. It is molded under *low* pressure, assuring elements undamaged in fabrication, longer life and greater dependability. It is an 85° C tubular which offers assurance of long life under television and other severe operating conditions.

A trial of these *better* molded tubulars will convince you. See your jobber—if he can't supply you, write us.

*Big Chief Sangamo

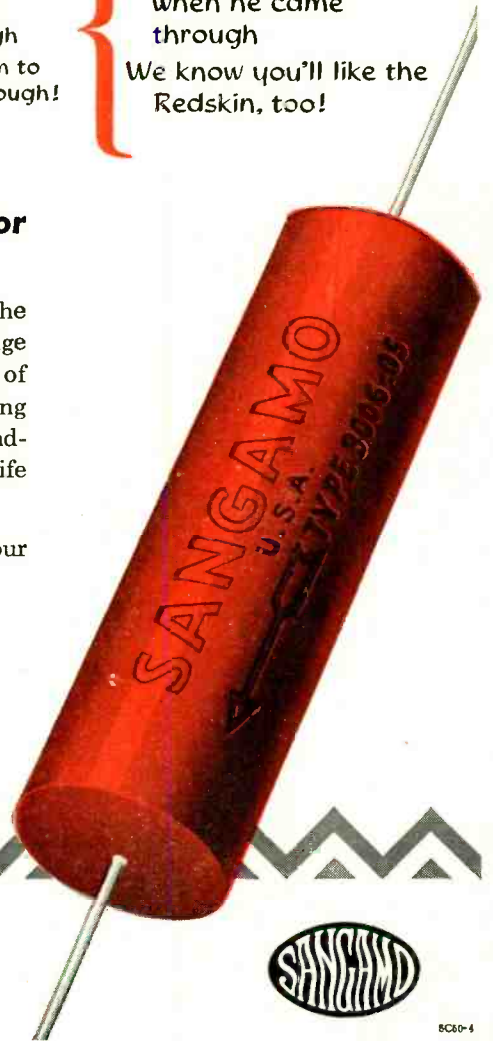

SANGAMO ELECTRIC COMPANY
SPRINGFIELD, ILLINOIS

In Canada: Sangamo Electric Company Limited, Leaside, Ont.

June, 1950



EC50-4

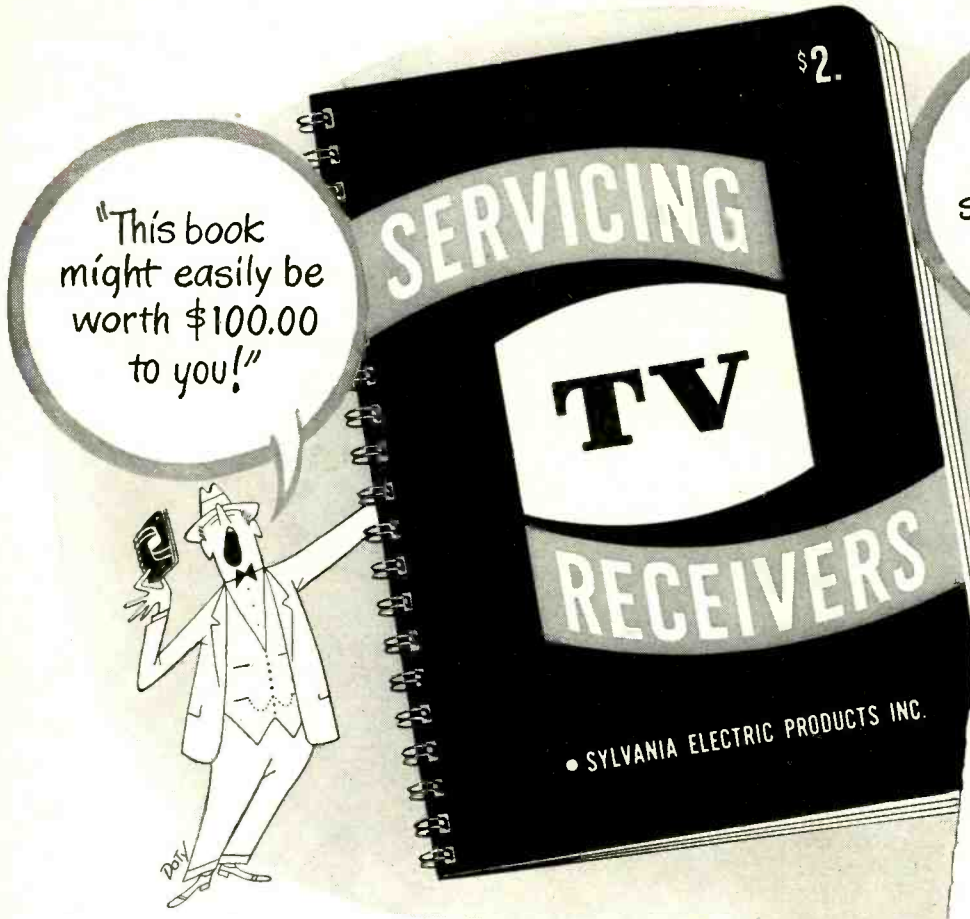

"This book might easily be worth \$100.00 to you!"

"The most complete TV servicing book ever printed"

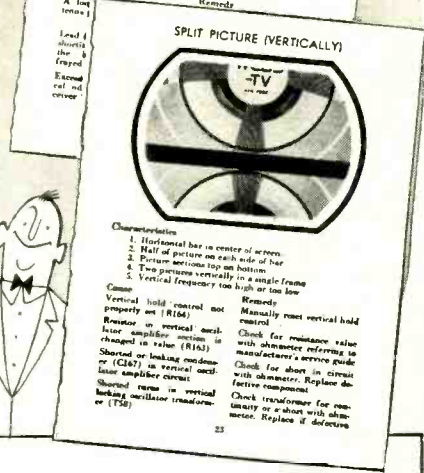
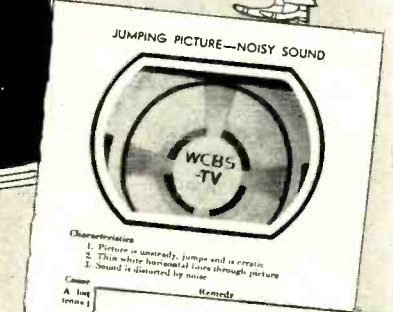
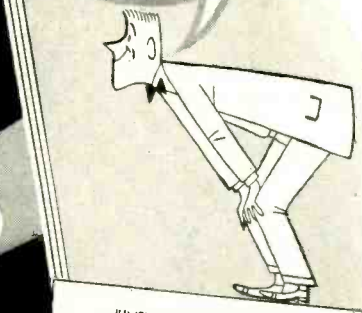

FREE NOW!...

with your order for 100 Sylvania Receiving Tubes or 3 Sylvania Picture Tubes

Could be this book'll be worth its weight in dollar bills. For it explains in clear, plain language and illustrations how to identify TV set trouble . . . and what to do about it.

Contains more than 100 pages . . . filled with diagrams and photos to help you more quickly locate trouble . . . solve problems . . . improve your TV set repair business.

FREE only until August 31st

Remember, you can't buy this book. It's yours free from your regular Sylvania distributor during June, July, and August, with the purchase of 100 Sylvania Receiving Tubes or 3 Sylvania Picture Tubes.

So call your distributor today . . . while his supply lasts. Ask him for the book that will improve your television service, and the tubes to improve your profits . . . SYLVANIA.



HERE'S WHY YOU NEED THIS BOOK

- Shows more than 80 actual photos of screen test patterns. Shows how to identify trouble by pattern behavior.
- Gives simple, concise instructions for making repairs, proper adjustments.
- Contains complete circuit diagrams of typical television receiver.
- Explains latest television developments.
- Tells about television test equipment and what each instrument will do.
- Provides a practical dictionary of television set trouble.

SYLVANIA ELECTRIC



RADIO TUBES; TELEVISION PICTURE TUBES; ELECTRONIC PRODUCTS; ELECTRONIC TEST EQUIPMENT; FLUORESCENT LAMPS, FIXTURES, SIGN TUBING, WIRING DEVICES; LIGHT BULBS; PHOTOLAMPS; TELEVISION SETS

CUSTOM-BUILT PROJECTION TV Is Still Profitable

By
DAVID T. ARMSTRONG
Vice-Pres., Electronics Research

Fig. 1. An adaptation, by Ansley Radio Co., of the Protelgram system which produces a 1728 sq. inch picture.



Is projection the TV of the future? To date it is the only way to obtain a truly large-sized picture.

AMERICA is the land of competition. In the battle of survival of the fittest, woe to the fit or only more fit. This is as true in television as it was in the case of evolution. Unfortunately, in the practice of many people the "good" becomes the enemy of the "best," for they seem to say, "Since what we have now is good enough, let's stay with it and let the better come along and make its own way in the world."

That attitude may be all right for the average customer, but it is not all right for the enterprising service technician who wants to be in business tomorrow as well as today. He *must* learn to read the handwriting on the wall without being too critical of the typography. If one interprets the handwriting correctly, it seems that the only logical answer to the problem of securing truly large-sized pictures is with projection units and that the next boom in television will be in this field. Sure, there are many who will protest that projection has made its appearance and did not "go over." This is true only to a cer-

tain extent. Prices asked for the early projection units were high—ranging as they did from \$650.00 up. This economic factor naturally limited the sale of these sets to a relatively small group of consumers. Like all television receiver prices the price-tags on projection sets have been lowered to the point where the average-income family is now a potential customer.

The trend today is obviously toward larger and larger pictures. The seven inch sets, so popular a year or so ago, are now obsolete. The time is coming when today's ten and twelve inch receivers will have to make way for the newer sixteen and nineteen inch units. In fact the trend is so definitely in the direction of large pictures that one well-known manufacturer is working on a thirty-inch cathode-ray television tube.

It's a funny thing, but the company that made the very earliest cathode-ray tubes and controls the basic patents, has been content recently to license other manufacturers to make the direct view tubes under their patents. They are concentrating on pro-

jection tubes entirely. If you think they are making a mistake, stick to direct view; but if you suspect they may be right, begin to think about projection.

Most technicians specialize. The author's field is custom installations and we do about two or three a month, the year around. Actually it makes little difference whether a client or prospect wants a direct view, *RCA* projection, or the *Norelco* Protelgram. We are in business to serve our customers. But at the same time we have the responsibility of providing the very best possible television service at prices our customers can afford. Therefore it pays us to look into the new developments in the field and to offer the best of these to our discriminating clients.

We have installed *RCA* direct view and projection, *GE* direct view and projection, *Du Mont*, etc., and plans are now under way to use a number of the *Norelco* Protelgram units. There must be reasons. Figs. 2 and 3 show the fundamentals of the optical principle employed by *RCA* and the *North American Philips Company*.

Custom building is expensive and presents many specialized and difficult problems. A custom installation is not flexible, for once it is installed there

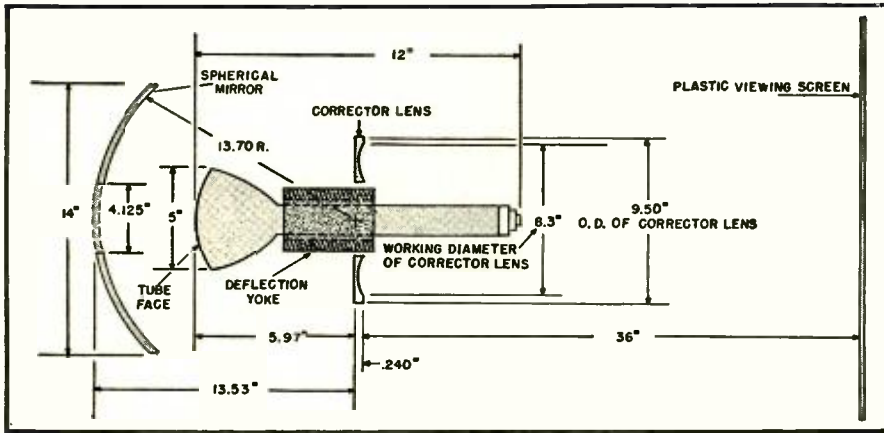

Fig. 2. A typical RCA or GE projection system which requires a space 50 inches long by about 16 inches in diameter to house the component parts. This is not the most efficient optical system because of the size of the tube face and the losses attributable to the size of the deflection coils, the leads, etc.

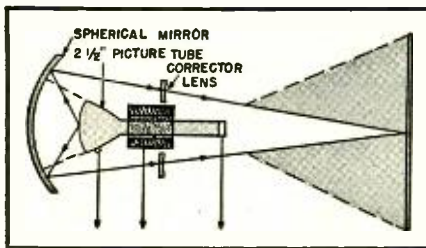
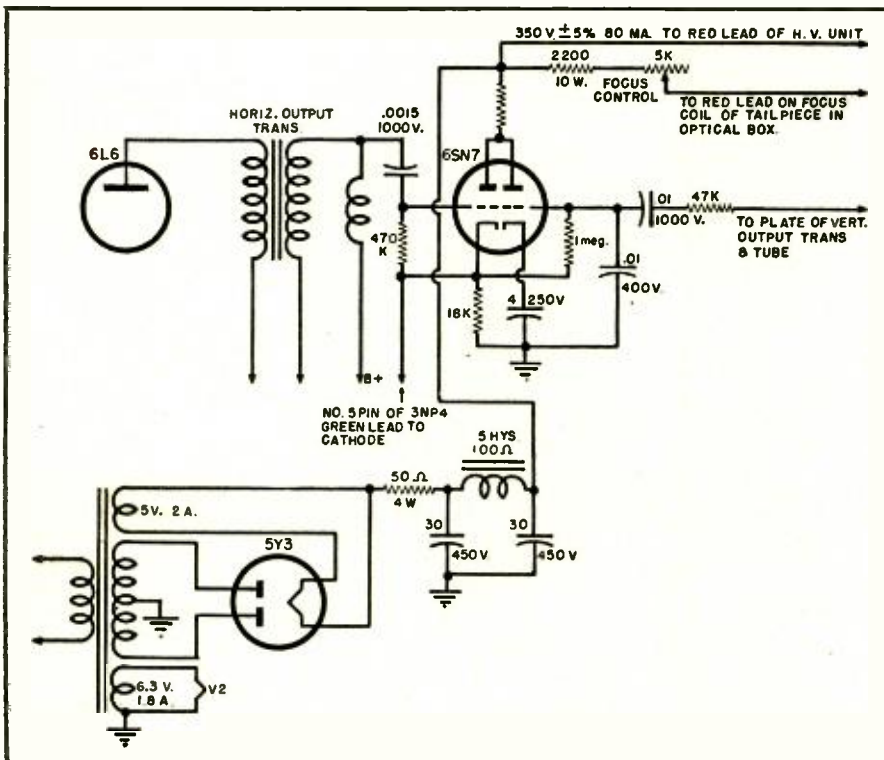

Fig. 3. Fundamental principles of the Schmidt optical system. The tube directs its light to the concave mirror which bounces it back through the corrector lens to the plane surface mirror or a screen. This was one of the early applications of the Schmidt optical principle. It is more efficient than the one of Fig. 2 because of its smaller tube diameter.

it remains. Thus, great care and much thought must be given to the placement of the viewing screen. Custom-minded customers and prospects must like an installation, because the best possible advertisement comes from satisfied customers who are proud of their installation and say so to their friends and guests.

Formerly, one of the special problems involved in installation of a projection unit was the great amount of space taken up by the projection components alone. Heretofore, this has required 50 inches of straight line space and about 16 inches of diameter. A study of the required dimensions, shown in Fig. 2, clearly indicates this. Then the supporting frame for the

Fig. 4. Schematic of the power supply and protection tube circuit. Although the 630TS has sufficient low voltage d.c. for the input to the high voltage unit, the use of this circuit cuts down the drain on the chassis as a whole. The protection tube prevents screen burns in the event of either vertical or horizontal sweep failure.



projection apparatus was bulky. In many instances it was difficult to find suitable depth to house such a unit.

The advent of Protelgram has been hailed by custom-installation technicians because outside of the standard chassis, which may be of the typical 630TS type, a minimum of space is necessary to install the two small additional components required for projection. Most of the basic units needed to operate the projection components are supplied by the 630TS chassis. A few minor circuit changes which may be readily performed by the average service technician will convert such a chassis to operate as an excellent projection unit.

In fact, the changes are so simple that we have rigged up a small portable assembly for demonstration purposes. This assembly contains a viewing screen, the optical box, and the high voltage unit, the basic parts necessary for this projection system. In addition, a separate power supply and a picture tube protection circuit have been incorporated. A schematic of this circuit is shown in Fig. 4. Another circuit for the production of the necessary video output voltage has also been included for use with such receivers as do not have the required 90 volts peak-to-peak to insure adequate modulation of the high cut-off tubes. This is not generally necessary as any standard 630TS chassis that can drive a 10BP4 or the 12LP4 has sufficient output and power supply to drive the projection unit. However, since the demonstration unit might be called upon to perform "miracles," all the necessary circuits to meet any demand presented by any television receiver in the field have been included. The special video output circuit is detailed in Fig. 6. This circuit is typical of that required and has adequate bandwidth for good definition. Be sure that the receiver to be adapted for projection work has an i.f. system capable of passing the full 4.5 mc. band if good results are to be obtained. A receiver with a too narrow bandwidth will not give a sufficiently detailed picture.

The actual video circuit changes needed will depend on the particular receiver. In many cases, the only changes necessary are the increase of the video bandpass. Choice of the proper inductances and capacities will accomplish this in most cases. The values specified in Fig. 6 will serve as a guide in converting present amplifiers if a complete new video section is not contemplated.

This little gadget has been worth its cost many times over. Although it was originally designed to demonstrate the desirable features of the large pictures that are possible with only a few additions to an existing receiver, its use has grown and expanded.

There is a minimum number of leads, usually five to seven, depending on the chassis being used, that must be connected to various points on the television chassis. All that is necessary is to expose the under side of the

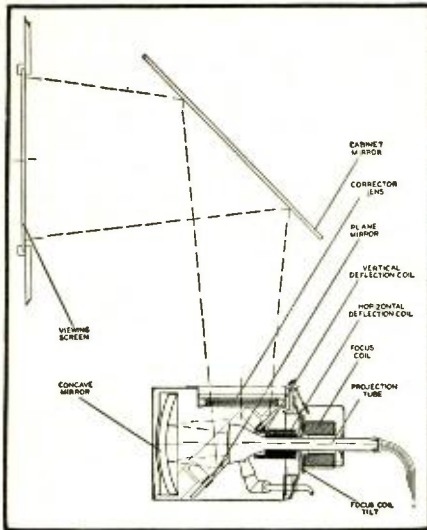

Fig. 7. The modified Schmidt optical system as used in Protelgram television. The image on the face of the 2½-inch cathode-ray tube, which may be seen in the "optical box" at the bottom of diagram, is reflected from concave mirror (left) to the plane mirror, which is inclined at a 45 degree angle. The image then passes through the corrector lens and is "folded" by the cabinet mirror, which projects the image on the viewing screen (upper left). Protelgram is a development of North American Philips Co., Inc.

This is classed as a "dual system." It is possible to have a 10 or 12 inch direct view and switch over to the large size picture should the situation warrant. There may be times when a small family group would rather use the direct view tube or there may be other times when the projection picture would be preferable. With a conversion job like this both types of reception are possible. Then, if a tube goes in the middle of a good program, simply switch to the built-in "ace in the hole."

There is another excellent reason why this dual system offers possibili-

ties for the service technician or engineer. A television installation in a bar is an investment and the picture should be as good as possible. With a dual unit, involving both direct view and projection, it is possible for the bartender to tune the program in at its best and then switch over to projection. All the controls are accessible to him without leaving his post. In a large bar, say 50 or 60 feet long, it might be possible and desirable to have two projector units, one at each end of the room. Both could be controlled by a single master tuner with some modifications; and nobody would be outside of the optimum viewing range.

This "slave" system could be applied to a club which might find it desirable to have projection in various club-rooms; for a hotel which wants to provide multiple installations in the better class rooms, or for a school which wants high quality television in a number of key locations, all to be operated from a master tuner.

There are still other interesting features possible with the Protelgram system. It makes large scale projection possible with a quality of resolution, definition, brightness, and clarity that make a living room a telemovie center.

This latest television innovation has been incorporated in the *Ansley* unit shown in Fig. 1. This type of projection is television at its finest. The cabinet projector throws a 3x4 foot picture through a lens in the front of a "coffee table." The controls are revealed by moving the top of the cabinet forward about 6 inches.

One of the advantages of this type of unit is that the television receiver is an unobtrusive piece of furniture because the cabinet by the side of the upholstered chair closely resembles a cabinet type coffee table.

Probably the ultimate in simplicity

and appeal in the use of Protelgram is in a unit made by Avery Fisher, president of the *Fisher Radio Company* of New York City. He has gone into projection in a big way and has had tuner and sweep components designed and manufactured to fit into the unused space of the projection receiver. As a result, he has been able to produce a table model with over-all dimensions of 25¾" long, 21" deep, and 14" high.

The top lifts up to reveal a viewing screen. The simplicity of the unit is manifest in the three controls, one for tuning in the various channels, another for brightness, and a third for vertical or horizontal focusing.

Because the cost of the optical box and the high voltage unit is moderate, it is entirely possible that soon television receivers incorporating the Protelgram feature will be available at prices comparable to those now asked for 16 inch direct view receivers.

Obviously you will get the best out of projection if you design a special chassis to provide just the right output required for the optimum operation of the system. In their haste to cash in on something good, too many manufacturers have simply added Protelgram to existing cabinets and chassis. The waste of space and undesirable cable lead length which results have proven costly. By redesigning the tuner chassis, sweep chassis, and power supply to fill in all the space surrounding the optical box, it is possible to produce a compact unit.

Some manufacturers are alert to the importance of this new kind of television and have designed special circuits to feed the 3NP4 projection type kinescope. The service technician who knows his circuits will readily appreciate the fact that there are no particular changes from standard design for television circuits. This circuit represents straightforward television engineering up to the point of feeding the picture into the Protelgram system.

In the *Scott* circuit recognition was given to the fact that the electrical focus of the Protelgram system changes the signal strength with brightness or contrast more sharply than with direct view receivers, and a focus control has been provided on the front panel. This control might have been eliminated by controlling the maximum end of the brightness control by introducing a screwdriver-actuated or service control, which would limit the amount of brightness available to a point at which the focus control need not be shifted.

The *Scott* circuit also provides the proper input d.c. voltage to the *Philips* 25 kc. high voltage unit. A 6SN7 tube is used as a protection tube to cut off the high voltage to the 3NP4 in the event of failure in the sweep circuits. This is good engineering since the screen on the picture tube face will be burned if the electron beam is concentrated on it in a narrow line for even a few seconds.

-30-

Fig. 8. Newest application of the Norelco projection featuring the 13½x18 inch screen, AM and FM radio, and 3-speed record changer in a Stewart-Warner console.



QUALITY CONTROL by "TYPE TESTING"



By **CARL GARTNER**

Quality Control Mgr., TV Rec. Mfg. Div.
Allen B. Du Mont Laboratories, Inc.

"Type Testing"—a system whereby production line sets are laboratory-tested at regular intervals as part of quality control. Reports on all sets tested are also used in planning engineering designs on new model receivers.

Part of "Life Test" section of the Receiver Quality Control Dept. where a percentage of all sets manufactured are checked from a consumer's point of view before and after operational cycles of from 12 to 72 hours. Additional tests covering as long as 500 hours are frequently run on the sets.

Sensitivity measurements on a standard Du Mont set are made with a Measurements Corp. Model 80 signal generator, a Du Mont 264B voltage calibrator, and a Du Mont oscillograph. In the foreground is safety enclosure for 19" metal and glass tube and near the operator's head is a light box which projects a test pattern which is used as comparison standard during tests.

ALTHOUGH all television receivers coming off the production lines at *Du Mont* are subjected to the usual visual and audio inspection procedures, a limited number of chassis are removed from the run each day to undergo an abbreviated form of "Type Testing."

These "Type Testing" procedures, in addition to providing quality control data, supply valuable material to the engineering and manufacturing departments of the company. In this way information of vital interest in the design and construction of future models is fed to the departments concerned in a never-ending stream.

Normally, every television set receives a detailed visual and audio examination based on the use of certain minimum and maximum test signals. These tests are in the nature of "Go"-,"No-Go" gauges. Sensitivity is checked in production by having a signal of fringe sensitivity applied to the set. The set must resolve a usable picture or be rejected. At this stage in the production no measure of actual sensitivity is made. In order to provide a more detailed, objective, and accurate picture on how the set might be expected to perform, a sampling of the day's run is removed for further testing.

The selected sets are taken to special screen rooms where the receivers are put through a standardized series of tests. The results are noted on specially-prepared control forms which cover each of the attributes measured in these tests. This data is useful in determining statistically the final acceptance specifications. It may happen that a particular specification is unrealistic. During the pilot and early production runs a careful analysis of the "Type Test" data shows whether this is the case or not. For each of the measurements to be made there is a specific procedure outlined for making these tests.

Thus, in addition to its major purpose in controlling the quality of current production, "Type Test" data is useful in reviewing specifications, design, and the over-all quality index of the company's line of television receivers.

-50-

Another view inside the screen room. Test engineer is measuring oscillator drift using Cardwell TS 174/U frequency meter.



A Portable 40-Meter C. W. Station

By

HAROLD C. GOULD*, WIKWU

Construction details on a combination 1-watt transmitter and receiver which was designed and built by WIKWU.

NO matter how long you have been a ham (I am a member of the Old Timers' Club myself) your appreciation of a really good low-power portable rig never wanes. The portable to be described is not intended to replace the more elaborate and higher powered rigs in the ham shack but has been designed for service on week-end trips, vacation use, or emergency operation in locations distant from power lines.

The unit was designed to meet my own particular requirements with the result that, in a cabinet less than a foot square, I have a self-powered portable transmitter and receiver which operates on the 40 meter c.w. band.

The parts layout is far from critical so other hams can make use of what they have on hand in the way of

parts and cabinets. My requirements for the rig covered eight points: 1. small portable size, 2. a simple yet reliable means of communication (c.w.), 3. a small battery power supply which would be capable of delivering at least a watt, 4. simple construction, 5. low current drain and low voltage, 6. one-and-a-half volt tubes, 7. a transmitter with a crystal oscillator plus a final amplifier, and 8. a receiver with a t.r.f./detector plus a two-stage amplifier. If such a rig would provide contacts in the surrounding states and insure emergency contact in times of stress or distress, that was all I required.

In operation it is possible that I broke the record for one watt of power for DX on 40 meters. In less than a week I had contacted W7GHT (Idaho)

Author with his 40-meter portable rig.

over 2000 miles away! W9KQB reported the signal RST479 through Wisconsin. W1BVB relayed a message for me and checked RST579X in Connecticut from my portable location in Carroll, New Hampshire, a town surrounded by mountains. I have the QSL cards to prove it!

It is fun to see what can be done with one small watt of power. Once you have run contacts around the world with a big rig it is a real thrill to see what can be done with the "Little Nifty." Your operating will deserve more credit and you won't contribute your call to "Silent Keys" because of any operational dangers connected with this little job.

This rig spells absolute safety for the operator. I am not disputing the rightful existence of high power rigs, but there are advantages in small, low-power jobs such as this one.

Construction

Two antennas are used with this rig, one for transmitting and the other for receiving. The transmitting antenna is 133 feet, end-fed, and full-wave. The free end must be raised about 20 feet above the ground. Any 2 by 4, tree, flagpole, or building within reach can be used to support the antenna. It is important that the antenna be strung as high as possible since putting it six or so feet off the ground won't work.

The receiving antenna consists of 60 feet of single wire which can be strung on any tree or structure ten feet or more above the ground. A single, 66-foot, end-fed wire for half-wave can be used and switched over from trans-

* Chief of Illustration Unit (Publications), AAF Electronics Research Laboratories, Cambridge, Mass.

Underchassis view of the portable station showing location of component parts.

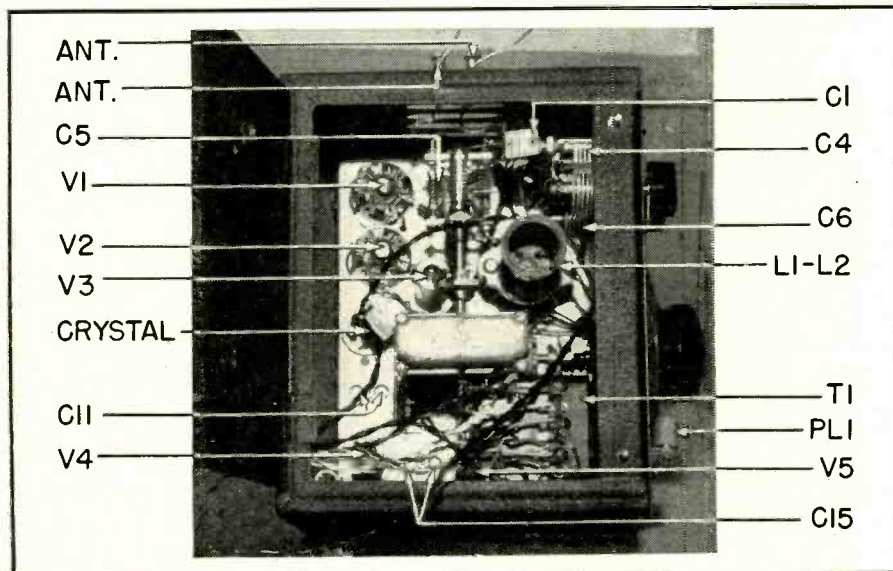

mit to receive but separate antennas give much better results. No external ground is used on the rig.

The chassis and cabinet can be any convenient size. The one used in this construction was a *Bud* unit, measuring 10"x8"x7", with a hinged cover and removable front panel. Two binding posts are used to secure the cover and the portable handle started life as a piece of screen door hardware.

The layout of components is not critical. The tubes, variable condensers, PWO mechanism for the bandspread condenser, crystal, plug-in coil of the receiver, antenna trimmer for the receiver, headphone jack, and connection block for the external cable to the batteries, key, and meter are all mounted on the top of the chassis.

The under chassis provides a shielded location for the transmitter tank coils, r.f. chokes, fixed condensers and resistors, the variable resistor control, tank trimmer condensers, and the hook-up wiring.

The mica trimmer condensers used in the transmitter are adjusted through twin holes drilled in the cabinet. These units are for adjusting the resonating oscillator and the final amplifier—a job which is done with a standard insulated trimmer adjustment rod. Once these are adjusted the transmitter is in action on the frequency of the crystal.

A *National* drive unit was used for bandspread on the receiver but any vernier control can be used. This unit drives a 50 μ fd. variable condenser to spread the 40 meter band over 200 divisions.

A plug-in coil is used for the receiver inductance L_1, L_2 . The coil L_1 requires 16 turns of #24 d.c.c. wire closewound on a 1 1/2 inch diameter form. A 5 turn feedback winding L_2 of the same size wire is wound directly below the first winding in the usual manner. If the receiver does not oscillate in the final test reverse the connections to this winding.

While all of the tubes could have been 1S4's, in the rig described 958A's were used for the detector and first amplifier.

Room is available in the cabinet to house small internal batteries if the constructor does not wish to use the heavy-duty batteries indicated. However, for general use, it is more economical to use the larger units.

Receiver Adjustment

First, plug in the headphones and snap the changeover switch S_2 to the "receive" position. Connect the receiving antenna to its post and adjust the antenna trimmer C_1 to about half capacity. Rotate the bandspread condenser C_3 to near maximum capacity for approximately the 7 mc. end of the band. If a superhet communications receiver is available turn it on for c.w. on the low end of the 40 meter band. The correct position of the bandspread variable condenser C_4 can be quickly found when both receivers beat together on a similar frequency. As the bandspread condenser is ro-

June, 1950

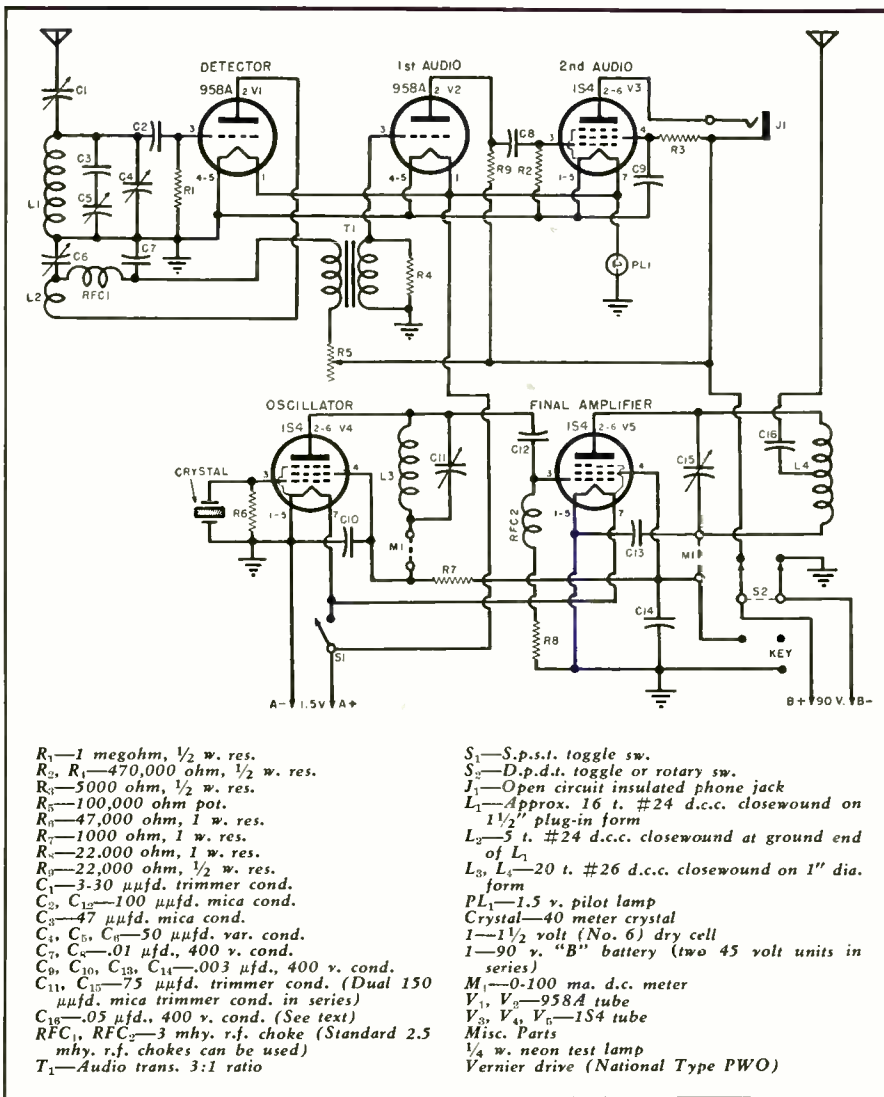

Circuit diagram and parts list covering 40-meter portable c.w. transmitter-receiver.

tated the 40 meter band will be fully covered by about half of its capacity. Later the constructor may decide to

remove a plate or two, but don't overdo it! Adjust the variable resistor con- (Continued on page 82)

Panel view of rig with its auxiliary equipment. Unit was built of junk box parts.

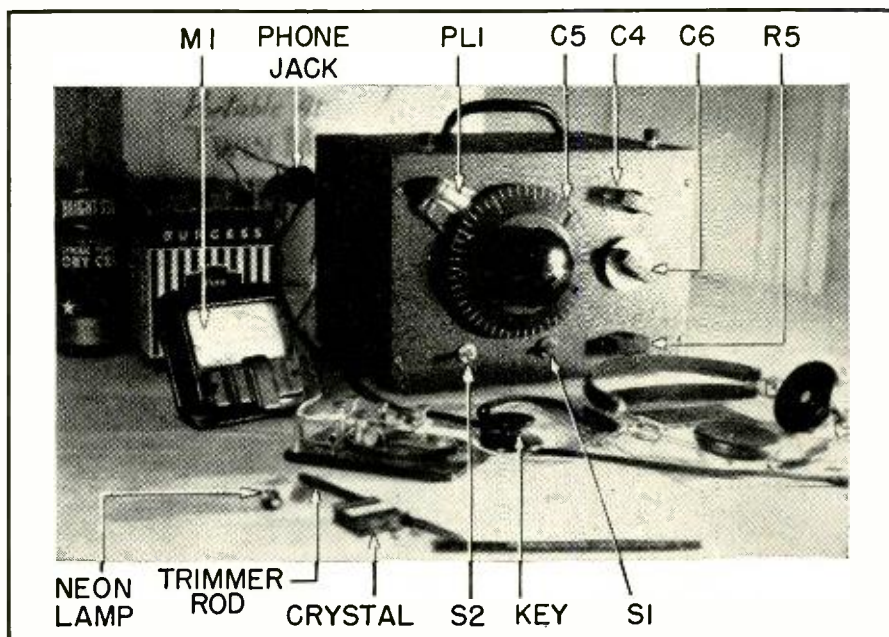

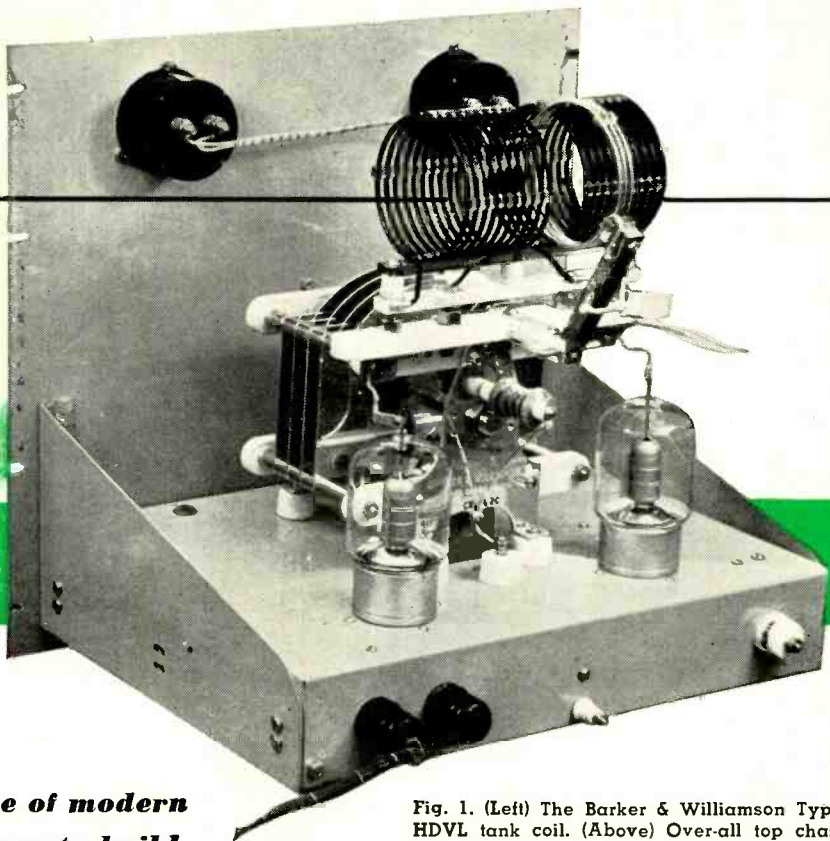
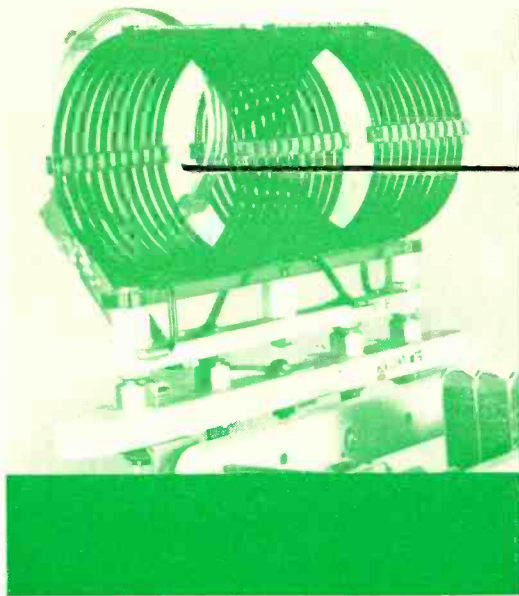

By
HARRY D. HOOTON, W3KFX

Standard components and the use of modern pentode-type tubes make this easy-to-build.

Fig. 1. (Left) The Barker & Williamson Type HDVL tank coil. (Above) Over-all top chassis view of the 500 watt r.f. amplifier.

A 500 WATT R.F. AMPLIFIER FOR THE HAM

THE 500 watt radio frequency amplifier to be described in this article is a good example of modern high-power transmitter design. Using modern pentode-type tubes and standard, commercially-available components, it can be completely assembled and readied for operation in one evening. It may be used as a high-power amplifier for a code transmitter or, when used with suitable auxiliary equipment, it may be amplitude modulated in the plate and screen or suppressor circuits. If the transmitter is used mostly for code work and only occasionally for phone, suppressor modulation will afford a simple and inexpensive method of getting on the air with voice transmission. Last, but not least, the excitation requirements for this amplifier are so low that it may be driven on all bands from 80 meters down to, and including, 10 meters with nothing greater than the output from a standard 6F6 crystal oscillator or a v.f.o. unit.

As the photographs and schematic show, the amplifier consists of two HK-257-B pentodes connected in push-

pull arrangement. The physical design is such that all of the components associated with the plate circuits are placed above the metal chassis and all components of the grid circuit are below. The chassis acts as a shield between the two circuits and thereby eliminates any tendency toward instability or oscillation. This type of assembly also permits very short and direct plate and grid leads, thus improving the efficiency of the amplifier and reducing the possibility of parasitic oscillation due to stray plate or grid lead inductance or capacitance. The amplifier shown in the photographs is perfectly stable even when plate and screen voltage is applied with the excitation removed. There is no perceptible change in the plate or screen current when either the grid or plate tuning condensers are rotated to any point on their scales.

The plate tank condenser is a *Barker & Williamson CX62C* "butterfly" type which has a rated capacitance of 62 μfd . per section; the tank coils are *Barker & Williamson HDVL* type and are designed to handle power in-

puts up to 1000 watts. As shown in Fig. 1, the jack bar for the HDVL coils mounts directly on the terminals of the CX62C condenser thus practically eliminating leads between these two components. The tank condenser is so designed that the r.f. currents in the tank circuit do not flow in the frame of the unit as they do in the so-called "standard" transmitting condenser. In this manner stray inductance in the plate circuit is held to the very minimum and the inductance is kept in the tank coil where it can serve a useful purpose. Precautions such as these do not produce readily apparent effects on the lower frequencies, such as 80 meters for example, but they do make a tremendous difference in amplifier stability and efficiency on 10 meters. Most of the troubles encountered in high-power pentode r.f. amplifiers can be traced to excessively long grid and plate leads, distributed inductance and capacitance or r.f. currents circulating in the tank condensers or chassis which create fields, the phase of which is such that oscillation or parasitics are produced. The flexible leads from the plate tank coil and condenser to the HK-257-B plates are exactly one and one-half inches in length.

The HDVL jack bar is equipped
RADIO & TELEVISION NEWS

with a 3-turn swinging link coupling coil. Transmission lines with impedances of from 50 to 300 ohms may be connected directly to the link terminals and the amplifier loading adjusted by varying the position of the link with respect to the tank coil. The position of the link, as shown in the photographs, is approximately correct for a 70-ohm line connected to the center of a 40-meter half-wave dipole and using 2500 volts on the HK-257-B plates. On 10 meters, lines of from 400 to 600 ohms impedance may be connected directly to the link, provided that the lines are of the correct length, electrically, to terminate in a current loop at the link. In general, better efficiency will be obtained by the elimination of coupling devices between the link coil and the transmission line. However, when feeding 600-ohm or other high-impedance lines on the lower frequency bands, there is insufficient inductance in the link to properly load the amplifier plate tank circuit when the high impedance line is connected directly to the link. The details of a satisfactory impedance-matching transformer for use on 20, 40 and 80 meters is shown in Fig. 3.

As mentioned previously, the components associated with the grid circuit are placed under the chassis. The grid tank condenser shown is a two-section transmitting type with a rating of 100 $\mu\text{fd.}$ per section and a spacing of 0.030 inch between the plates. Any good quality receiving-type condenser of 100 $\mu\text{fd.}$ per section will be satisfactory. The condenser frame is connected directly to the metal chassis. The grid coil is a standard *Barker & Williamson* 150-watt swinging-link type. The use of a 150-watt coil in this position is not necessary as the greatest amount of power dissipated in the grid circuit, even under extreme conditions, will never be more than one or two watts. However, the coils and their jack bar were on hand

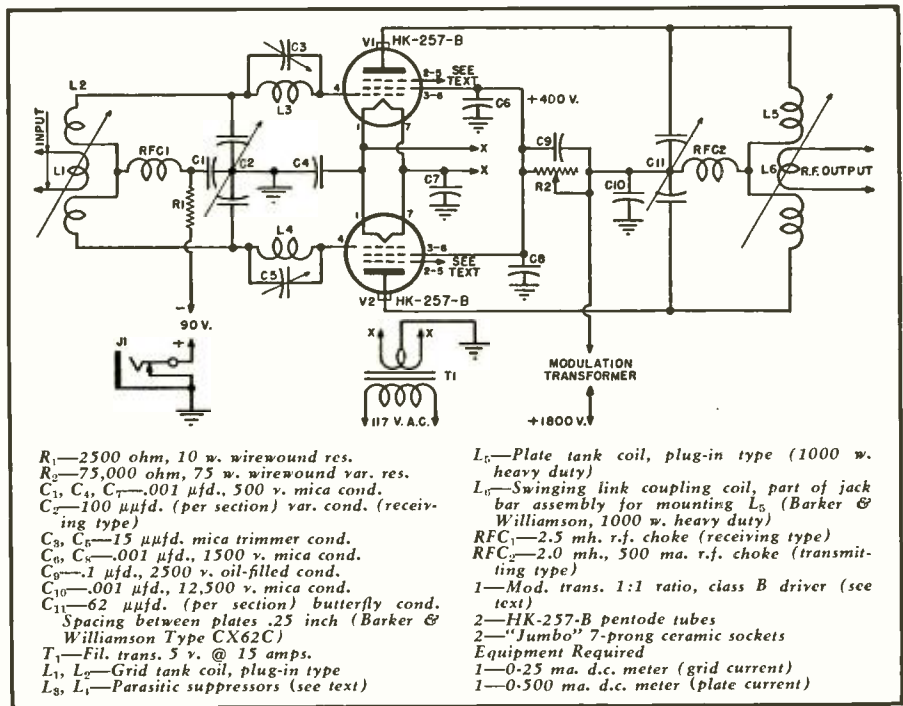

Fig. 2. The W3KPX 500 watt, plate and screen amplitude modulated r.f. amplifier.

and the swinging link does afford an easy means of adjusting the final amplifier grid excitation to the proper value.

The wiring between the grid coil and its tuning condenser and the grid terminals of the HK-257-B sockets must be kept as direct and short as possible. A parasitic trap, consisting of six turns of No. 14 enameled copper wire, wound on a $\frac{1}{2}$ inch diameter and $\frac{3}{4}$ inch long form, is inserted in each HK-257-B grid lead between the socket terminal and the fixed plates of the grid tank condenser. It may or may not be necessary to tune these traps; usually the distributed capacitance of the small coils will resonate the trap circuits somewhere in the very-high-frequency region and

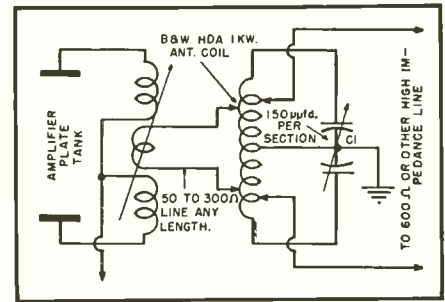
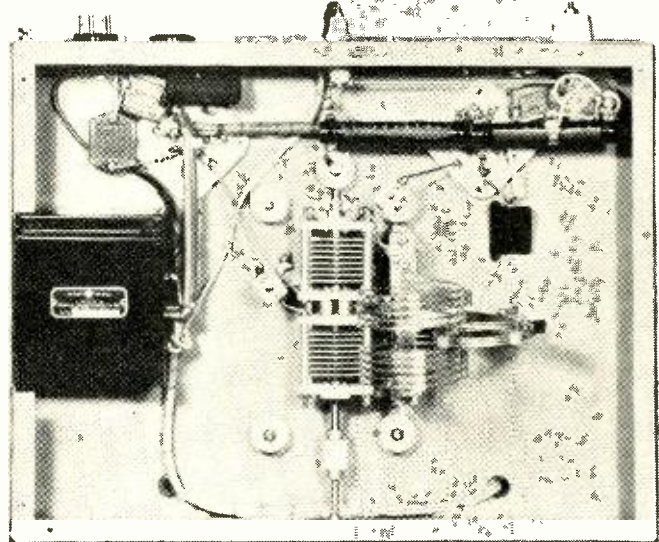
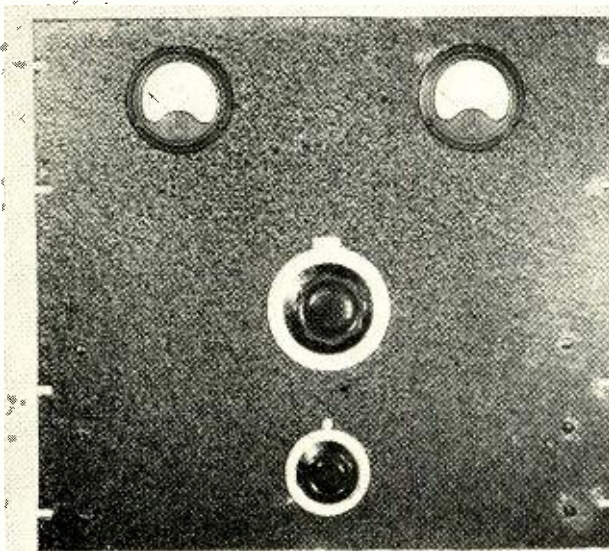

Fig. 3. Details of an impedance-matching transformer for use on 20, 40, and 80 meters.

no adjustments are necessary. However, small mica or air-dielectric trimmers may be shunted across the coils, if desired. Those shown in the

Fig. 4. Panel and under-chassis views of the r.f. amplifier unit. The components comprising the grid circuit are placed under the chassis while those in the plate circuit are above chassis, the chassis acting as an effective shield.



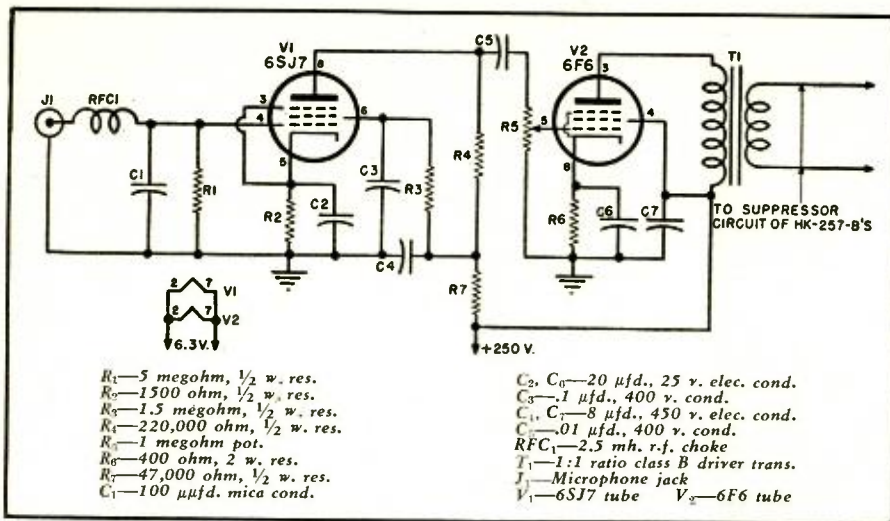

Fig. 5. Modulator unit for the suppressor modulation of the HK-257-B tubes.

bottom chassis view are 15 μ fd. receiver-type mica trimmers. This particular amplifier had no parasitics and, therefore, did not actually require the traps. In working with pentode and tetrode amplifiers, however, particularly those using relatively expensive type tubes, it is good insurance to incorporate the traps until it is definitely known that the amplifier is stable. Sometimes the presence of parasitics will cause excessive plate current to be drawn with a possibility of damage to the tubes. These parasitic traps are *not* harmonic suppressor circuits for elimination of interference to nearby television receivers. The use of harmonic suppressors will be covered later in the article.

The filament transformer for the two HK-257-B's is mounted under the chassis, as shown in the photograph. The wiring from the secondary of the transformer to the filament terminals of the sockets must be heavy—at least No. 8 copper—and dressed very close together. As shown in the photograph, the filament leads between the two sockets are insulated by means of flame-proof extruded tubing and then *laced* very closely in parallel. This type of construction effectively places both sides of the filaments at the same r.f. potential due to the high capacitance between the

leads. The filament terminals of the two sockets are also placed at ground r.f. potential through mica bypass condensers, as shown on the schematic, Fig. 2.

The male plug mounted at the rear left corner of the chassis is the 117 volt a.c. connection for the filament transformer; the 5-prong socket, to the right of the male plug, is the control-grid bias connection. The small porcelain feedthrough insulator at the center is the screen voltage terminal (used only when the amplifier is operated as a suppressor-modulated phone or a telegraph transmitter); its purpose is to permit voltage from a supply other than that used for the plates to be applied to the screens. This arrangement makes adjustment of the various circuit conditions easier when suppressor modulation is used and improves the screen voltage regulation during telegraph operation. The large porcelain insulator at the right rear of the chassis is the HK-257-B plate high voltage terminal.

The amplifier should be checked for parasitics and spurious or self-oscillation before placing it on the air. The outlined procedure is generally followed by the author before any new amplifier is connected to an antenna and excited. Light the tube

filaments and apply approximately 90 volts of negative fixed bias to the HK-257-B grids (two 45-volt "B" battery blocks will serve). Now place about 1000 volts on the plates and about 350 volts on the screens of the two tubes. The plate voltage may be reduced by connecting a 300 watt, 110-volt lamp in series with the primary of the high voltage transformer. The plate current milliammeter should indicate a small plate current flow—possibly 30 to 40 milliamperes; *no grid current should be indicated*. Rotate the plate tank tuning condenser to approximately half maximum capacitance and rotate the grid tank condenser to minimum and then to maximum capacitance. Watch the grid and plate milliammeters during the rotation of the grid condenser; if grid current is indicated at any point or if there is a change in the plate current indication, the amplifier is oscillating and steps to correct this condition should be taken before proceeding further. The metal base shells of the HK-257-B's may require grounding (they did not in this amplifier) or larger filament bypass condensers may be necessary. All preliminary checking should be carried out with the highest frequency (10 meter) coils in place. It is also a good practice to have the receiver in operation, with the b.f.o. turned on, during this period. Oscillations usually will manifest themselves by causing whistles or loud rushing noises in the receiver; the presence of parasitics may sometimes be detected by tuning the receiver over its highest frequency range, listening for whistles, or by adjusting the small trap trimmer condensers, leaving the receiver tuned to its highest frequency band.

If the amplifier appears to be stable, leave the 90 volts of negative bias connected to the grids but remove the plate and screen voltages. Connect the r.f. output from a crystal oscillator or other r.f. excitation source, through a 70-ohm low-impedance line to the grid tank link coil terminals. The coupling between the link and the grid tank coils should be very loose. Rotate the grid tank condenser and watch the grid circuit milliammeter for an indication of grid current. The coupling between the link and tank coils should be increased slightly and the grid tank condenser retuned for maximum indication on the grid milliammeter. Continue this procedure until the grid current is approximately 12 milliamperes when the grid condenser is "peaked." Leave the grid circuit in this condition.

Now, apply approximately 60 volts of positive potential to the suppressors of the HK-257-B's. Connect the transmission line from the antenna to the plate tank link coil terminals and adjust the link position to approximately that shown in the photographs. Apply the plate and screen voltages (2000 and 500 volts respectively) and quickly tune the plate tank circuit for minimum plate current. *With the*

Table 1. Operating characteristics of the HK-257-B pentode-type tubes

GENERAL CHARACTERISTICS		CLASS C TELEPHONE R.F. AMPLIFIER (Two Tubes)	
Max. plate dissipation	75 watts	Plate volts	1800
Filament	5 v., 7.5 amp.	Screen volts	400
Max. plate volts	4000	Suppressor volts	60 (pos.)
Max. screen volts	750	Control grid bias	-130
Max. screen dissipation	25 watts	Plate current	270 ma.
Grid-to-fil. capacitance	13.8 μ fd.	Screen current	22 ma.
Grid-to-plate capacitance	0.04 μ fd.	Control grid current	16 ma.
Plate-to-fil. capacitance	6.7 μ fd.	Driving power	3.4 watts
Max. freq. rating	120 mc.	R.f. power output	356 watts
Base	Jumbo 7-prong		
CLASS C TELEGRAPH R.F. AMPLIFIER (Two Tubes)		SUPPRESSOR-MODULATED R.F. AMPLIFIER (Two Tubes)	
Plate volts	2000	Plate volts	2000
Screen volts	500	Screen volts	500
Suppressor volts	60 (pos.)	Suppressor volts	-300
Control grid bias	-200	Control grid bias	-130
Plate current	300 ma.	Plate current	110 ma.
Screen current	22 ma.	Screen current	54 ma.
Control grid current	12 ma.	Control grid current	6 ma.
Driving power	2.8 watts	Driving power	0.8 watt
R.f. power output	460 watts	R.f. power output	70 watts

tank condenser and coils shown, the "dip" in plate current should occur between 60 and 80 on the dial scale on the 10 and 20 meter bands. If no plate current dip is indicated, or if the minimum is too high, loosen the coupling between the link and tank coils and retune the circuit. The link should be adjusted so that the plate current drawn by the two tubes is from 250 to 300 milliamperes (500 to 600 watts input). It is advisable to keep the power input down to about 500 watts until it is certain that the amplifier is operating at good efficiency. The operator should practice varying the loading on the plate tank circuit while watching the change in color of the HK-257-B plate. It may be found that the greatest plate circuit efficiency does not occur when the plate tank is tuned for minimum plate current. This is a characteristic of pentode r.f. amplifiers and may be somewhat confusing at first. If the amplifier is loaded by varying the antenna coupling and re-tuning for minimum plate current and then carefully readjusting the plate tank condenser for minimum color brilliance in the HK-257-B plates, it will be found that a greater r.f. output for a given d.c. input will be obtained. If an r.f. ammeter is available, tune the plate tank circuit for maximum r.f. current indication on the meter and adjust the link for the proper plate current value.

The above description assumes that the amplifier is to be used for c.w. (code) or narrow-band FM transmission. For AM phone operation, the HK-257-B's are operated under slightly different conditions. The plate and screen voltages are reduced to 1800 and 400 volts respectively and the control grid bias is reduced to minus 130 volts. The required driving power is 3.4 watts and the control grid current is 16 milliamperes. The plate current should not exceed 270 milliamperes (486 watts input). In areas where interference with television reception is likely to occur, it may be necessary to reduce the grid driving power and the amplifier efficiency. These adjustments will be covered in detail later in this article.

For AM operation the screens should be modulated as well as the plates. The easiest method of modulating the screens is to return them to the plate high-voltage supply through a voltage-dropping resistor, as shown in Fig. 2. The screen voltage-dropping resistor should be returned to the plate side of the modulation transformer as shown. The condenser C_s across resistor R_s is not absolutely necessary. However, when modulating the HK-257-B's above 85% this condenser will prevent peak distortion due to a phase difference between the audio voltage applied to the plates and screens. The correct value of C_s will depend upon the values of C_s and C_{10} , the three condensers forming a capacitance-voltage divider network. In this amplifier, C_s is a 0.1

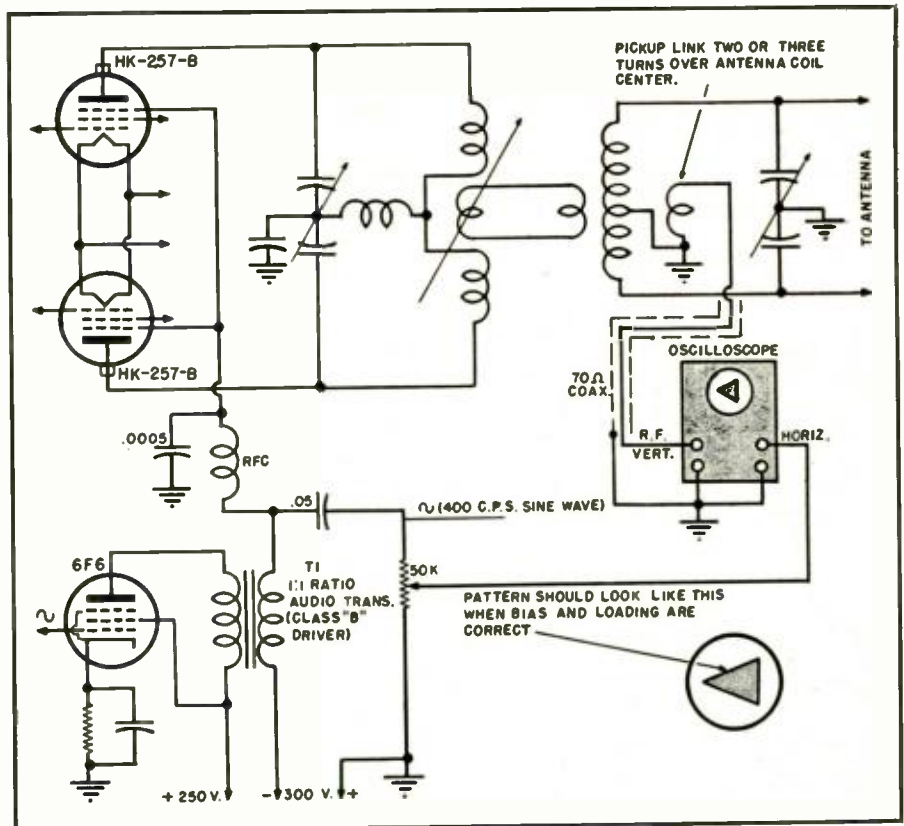

Fig. 6. Setup for adjusting the HK-257-B amplifier for suppressor modulation.

μ fd., 2500 volt, oil-filled condenser. The voltage dropping resistor is a 75,000 ohm, 75 watt, wirewound adjustable type. It should be adjusted so that the screen voltage is 400 when the amplifier is loaded to 250 milliamperes with 1800 volts on the plates. A modulator unit capable of supplying 175 to 225 watts of audio frequency power will be required for 100% modulation of the HK-257-B plates and screens. A pair of TZ-40's in push-pull, Class B operation with 1250 volts on the plates will be suitable. The modulation transformer should be rated at 225 watts and preferably should be of the adjustable impedance-matching type. The r.f. amplifier should be tuned up and thor-

oughly checked for stability before applying any type of modulation.

A speech amplifier suitable for suppressor modulation of the HK-257-B's is shown in Fig. 5. The modulation transformer, T_1 , is an ordinary 1:1 ratio, Class B audio driver type.

The suppressor modulated r.f. amplifier is not difficult to adjust but for best results the use of an oscilloscope is recommended. The suppressors of the HK-257-B's are returned through the modulation transformer secondary to approximately minus 300 volts with respect to the filament center tap, as shown. No r.f. excitation or screen and plate voltage should be applied to the HK-257-B's at this point. The

(Continued on page 134)

Fig. 7. Two circuits for eliminating interference. (A) A harmonic bypass circuit, and (B) a trap for eliminating the third harmonic signal which causes interference.

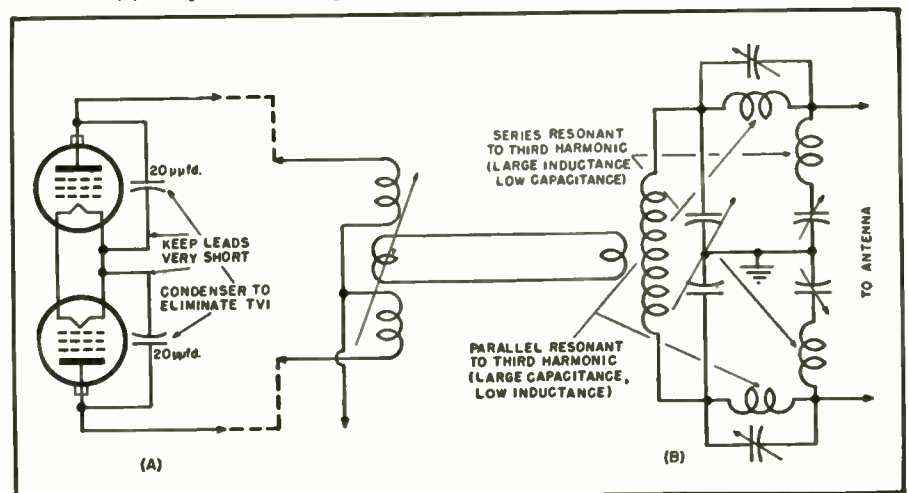

RCA's New Direct-view Tri-color Kinescopes



H. B. Law, E. W. Herold, and R. Law, RCA engineers, discuss the tri-color TV tube.

Color television problems simplified by introduction of single- and three-gun tubes.

RCA's long-awaited and eagerly-discussed color television tube was recently demonstrated to the public in Washington, D. C., as part of the color video hearings.

The new picture tube was shown in two direct-view types. The color picture is viewed directly on the face of the tube the same as black-and-white pictures are seen on the majority of the television receivers now in use. The new tube is all-electronic, high-definition, and completely compatible with existing receiving standards. According to the company, so close is the relationship between the new tube and the present system that both color and monochrome are capable of existing or operating on the same channels, with the same transmitters, and on the same receivers, except that present sets reproduce the color programs in monochrome. To receive the programs in color, the present television receiver in the home can be adapted to use the new color tube, or a new receiver designed to operate with the color tube can be used.

The color receivers used in the demonstration were similar in size and outward appearance to the standard RCA table model television receivers. The face of the tube appears to the ob-

server exactly the same as in a black-and-white receiver except that the picture is in natural color.

During the demonstration, receivers employing both types of the new color tubes were used. In one set the tube with three electron guns was incorporated while in another receiver the tube with a single electron gun was demonstrated.

In the first type the electron beams which pass through the same tube neck and the same deflection yoke strike the color screen. In the single electron gun type the single deflection yoke is also employed. Both of the assemblies are housed in 16 inch metal cones and produce pictures approximately 9 by 12 inches.

The direct-view color screen is composed of an orderly array of small, closely-spaced, aluminized phosphor dots arranged in triangular groups, each group comprising a green-emitting dot, a red-emitting dot, and a blue-emitting dot. The laboratory sample tubes used in the demonstrations had 351,000 such dots, 117,000 of each color.

Three-gun Kinescope

The manner in which the color screen produces a color picture may be

best understood by first considering the operation of the three-gun tri-color kinescope. An apertured mask is interposed between the three guns and the dot-phosphor screen in such a manner that the electrons from any one gun can only strike a single color phosphor no matter which part of the raster is being scanned. The mask is comprised of a sheet of metal spaced from the phosphor screen and containing 117,000 holes, or one hole for each of the tri-color-dot groups. This hole is so registered with its associated dot group that the difference in the angle of approach of the three oncoming beams determines the color. Thus, three color signals applied to the three guns produce independent pictures in the three primary colors, the pictures appearing to the eye to be superimposed because of the close spacing of the very small phosphor dots.

Insofar as the color aspects are concerned, this three-gun tri-color kinescope may be utilized in a receiver in much the same manner as three single-color kinescopes, except, of course, that no optical superimposing or registration means need be provided and deflection power is necessary for only one deflection yoke.

One of the research-type receivers demonstrated employed the three-gun tri-color kinescope and high-level sampling. This single-kinescope receiver utilized 46 tubes and consisted essentially of a 27 tube black-and-white television receiver to which had been added 19 tubes for color synchronization, sampling, additional power supplies, etc.

Single-Gun Kinescope

The operation of the single-gun tri-color kinescope is analogous to the operation of the three-gun tri-color kinescope in that the beam from the single gun is magnetically rotated so that, in effect, it occupies, in time sequence, the three positions of the three guns in the three-gun kinescope. Thus, when the beam is in a position corresponding to the green gun of the three-gun kinescope it excites only the green phosphor dots and is at this particular time modulated only by the green component of the video signal. A short time later the beam has been rotated to a position corresponding to the red gun of the three-gun kinescope and is modulated by the red component of the video signal to excite red phosphor dots. A third position similarly produces the blue picture. Sampling is automatically provided by rotating

the beam synchronously at sampling frequency.

The research-type receiver employing the single-gun tri-color kinescope utilized 37 tubes and consists essentially of a 27 tube black-and-white television receiver to which had been added 10 tubes for color synchronization, beam rotation, additional power supplies, etc.

Three-Gun Tube Sets

A block diagram of the principles of the circuit arrangement employed in the receiver utilizing the three-gun tri-color kinescope is shown in Fig. 1. Video signal from a conventional black-and-white television receiver is applied simultaneously to the three, internally-connected control grids of the three-gun kinescope. Another signal, derived from the video amplifier, is used to actuate an automatic color phasing and sampling synchronization circuit which produces a local 3.58 mc. sampling wave. The latter is applied through an amplifier tube and appropriate delay lines to three gating tubes which supply three sampling pulses, differing in phase by 120 degrees at 3.58 mc., to the three cathodes of the kinescope. Thus, each gun is turned on in time sequence corresponding to the original sampling process at the transmitter and the beam current from each gun excites only one of the three phosphor colors.

The tuning adjustment in the plate circuit of the 3.58 mc. sampling-signal amplifier permits fine adjustment of the over-all color phasing. However, proper color phasing is essentially determined by the permanently installed delay lines which are initially cut to proper length.

The front-panel operating controls are the same for color as for black-and-white operation. Individual service adjustment controls are provided in the cathode circuits of the three guns in order to permit initial equalization of the control characteristics of the three guns.

The deflection circuitry is of the conventional type. Minor changes in deflection-tube types have been made to supply additional deflection power occasioned by the increased kinescope second-anode potential (18 kv.). The deflection yoke is of the anastigmatic type and has an internal diameter of two inches to accommodate the converged beams from the three guns.

The registration in this three-gun tube is built in by the proper registration of the masking apertures with their corresponding groups of phosphor dots. Means are also provided to converge the three beams to the same point on the phosphor screen during scanning. This is done for the undeflected beams by a convergence electrode, operated at 9000 volts, and, when necessary, by small correcting magnets set up initially as a permanent service adjustment when the tube is installed. Because of the essentially flat face of the phosphor screen, simple geometrical considerations show

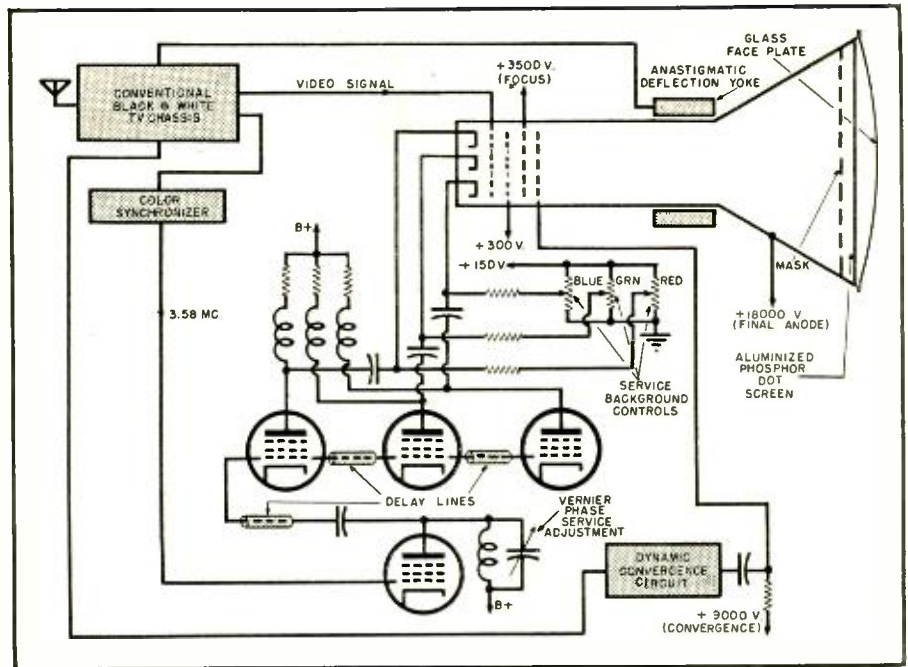

Fig. 1. Block diagram of receiver circuit principles for three-gun, tri-color kinescope.

that slightly less convergence is desirable as the beam is deflected from center. This dynamic convergence is accomplished by deriving a voltage from vertical and horizontal deflection circuits of the receiver and applying it to the convergence electrode through a condenser.

An r.f. anode voltage supply provides a potential of 18 kv. for the kinescope final anode, 9 kv. for the electrostatic converging electrode and approximately 3.5 kv. for the parallel-connected first anodes which produce initial electron-beam focus. A small auxiliary power unit provides heater and "B+" power for the other added circuits.

Single-Gun Tube Set

A block diagram of the principles of the circuit arrangement employed in

the receiver utilizing the single-gun tri-color kinescope is shown in Fig. 2. Video signal from the output of the video amplifier of a conventional black-and-white television receiver is applied to the control grid of the single-gun kinescope in the conventional manner. Here again, as in the previous receiver, another signal from the video amplifier actuates an automatic color phasing and sampling synchronization circuit which produces a local 3.58 mc. signal which is locked in step with the transmitter sampler. Circular deflection of the beam, which produces sampling automatically, is provided by a small deflection yoke having two sets of coils which are fed with quadrature currents at sampling frequency to produce a rotating field. Service adjustment of color phasing is provided by

(Continued on page 118)

Fig. 2. Block diagram of receiver circuit principles for single-gun, tri-color kinescope.

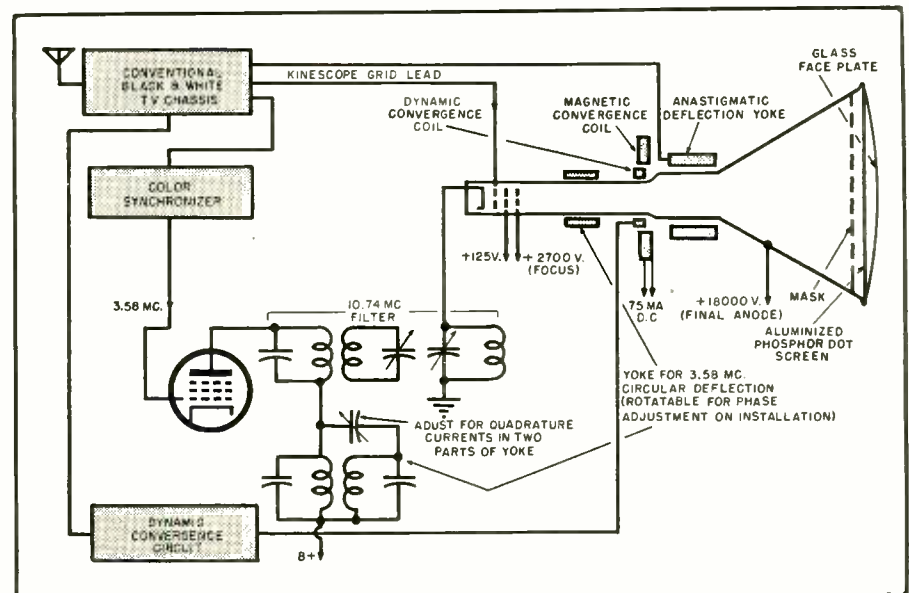

Mac's RADIO SERVICE SHOP

By JOHN T. FRYE



HASTY CONCLUSIONS

MISS PERKINS, the office force of Mac's Radio Service Shop, was a little surprised to find that Barney, the apprentice radio man, had not arrived yet when she came to work; but she thought to herself that no one could be blamed for staying outside in that glorious sun-drenched June morning as long as possible. Mac, of course, already had a couple of sets blatting away back in the service department.

Scarcely had she seated herself at the desk, though, when the laggard arrived—and how! He burst through the door and went skipping and leaping around her desk with all the awkward gamboling grace of a ham-strung faun. Cradled in his left arm was his disreputable old felt hat, and from this he kept plucking handfuls of rose petals and tossing them wildly into the air as he frolicked about the room. The rapt look on his freckled face, the easily-recognized parody of ballet dancing, the half-graceful half-clumsy movements of his lanky frame—all three combined to render the performance screamingly ludicrous.

"Sit perfectly still, Matilda; don't move," Mac admonished from where he stood grinning broadly in the open door of the service department. "Just as soon as I find my butterfly net I'll get him!"

Amid a final burst of rose petals, Barney plumped himself down on Miss Perkins' desk. "Whew!" he panted; "that's hard work, but I feel better now. We sensitive souls simply must express our feelings when spring really hits us, you know. Where's the broom, Tilly? I'll clean up this mess."

"No you won't," Miss Perkins said as she wiped tears of laughter from

beneath her glasses. "If I live to be a hundred, I never expect to see anything funnier than that 'Dance of Spring' of yours. I'll take care of the rose petals."

"Yes, Sensitive Soul, suppose you come on back and brighten the service department with your gleaming presence," Mac invited.

A few minutes later Barney was busily installing a new volume control when Mac stopped him by asking, "Look, Nature Boy, where are you putting that lockwasher?"

"Why, underneath the nut, where I always put them," Barney answered in the patient tone of a parent answering one of those childish Why-is-grass-green? sort of questions.

"In short, you conclude that since lockwashers *usually* go beneath nuts they *always* go there," Mac said. "It is true that lockwashers go beneath volume control nuts when the control has a projecting finger that fits into a hole in the chassis and keeps the control from turning, but in this case there is no such projection or hole. All that keeps the control from turning is the friction between the small mounting surface and the chassis. In such a case, the proper place for the lockwasher is between the control and the chassis. In this position, its sharp edges will bite into both surfaces and keep the control from turning even under extreme twisting pressure applied to the shaft."

"See what you mean! see what you mean!" Barney interrupted as he started to remove the control. "If I hadn't been a dummy, I'd have thought of that myself."

"Don't be too hard on yourself," Mac consoled him. "We all jump to conclu-

sions. Take the case of the little speakers that have no provision for recentering the cones. Some of the fellows jump to the conclusion that since these little jobs do not have moveable spiders and since re-coning them is not considered practical, the only thing to do when one develops a voice-coil-rubbing-on-the-pole-piece condition is to replace the whole speaker."

"What do you do, Professor?"

"Sometimes I replace them, too," Mac admitted, "especially when the cone itself is warped, worn-out, or torn. But we get in many almost-new sets with this complaint. Most of the trouble lies in the fact that there is very little clearance between the coil and the pole piece in these PM jobs. If the voice coil becomes the least bit out of position or alignment, it rubs. In these little sets, the speaker is subjected to a good bit of heat. Unless the voice coil is perfectly centered to begin with, the expansion and contraction of the frame of the speaker will cause trouble either when the set is cold or when it is warmed up.

"To correct this, the first thing to do is find out *where* the voice coil is actually rubbing. You can do this by removing the felt dust cap with acetone and examining the center opening of the cone in a good light and by doing a little delicate probing around the pole piece with the thinnest of speaker shims.

"Sometimes you find that the voice coil is oval rather than circular in shape. Ordinarily you can correct this by simply stretching the coil back into a circle. Work two fairly-thick shims into position at the diametrically opposite points where the coil comes nearest the center pole. The 'pushing-out' of the coil at these points and the accompanying 'pulling-in' along the sides will usually produce the desired circular shape."

"But how about those cases where the voice coil is round enough but where it has moved over so that one side is touching the pole?"

"The trouble there is that the spider is not holding the coil properly centered. The spider must be softened and allowed to 'set' again while the coil is held in its proper place. First, work a speaker shim in between the coil and the pole piece at the narrowest gap. Then work three other slightly thinner shims into position at points every ninety degrees around the pole. This 'over compensation' for the original incorrect positioning of the coil will allow a bit of spring-back to put it right where it should be after the shims are removed.

"With the shims in place, the next thing to do is to soften the fabric-type spider. This is done by applying acetone *very carefully* to the outside edges of the spider where it is cemented to the speaker frame. It is of the most importance that the acetone be used sparingly and that it be kept entirely away from the voice coil proper. Just the outside rings of the spider should

(Continued on page 149)

Cathode Follower DRIVEN AMPLIFIER

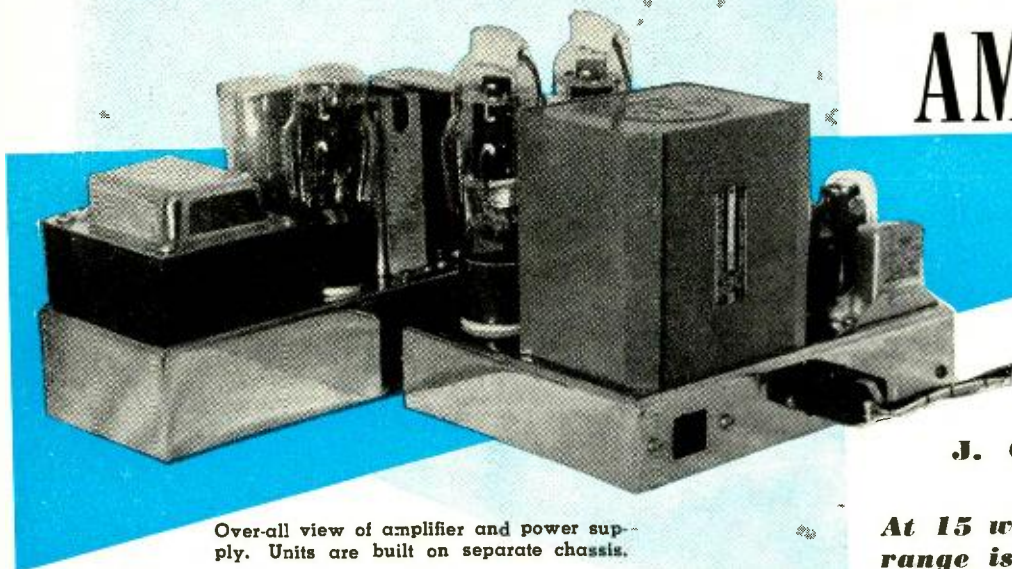

Over-all view of amplifier and power supply. Units are built on separate chassis.

By
J. CARLISLE HOADLEY*

At 15 watts output, amplifier's range is 38-20,000 c.p.s. (± 1 db.) with 2 per-cent distortion.

THE proper reproduction of recordings or FM program material demands a carefully integrated high fidelity system. A variable reluctance pickup cartridge, properly equalized, or a live FM broadcast will produce a signal of such excellent quality that much thought and care must be given to the power amplifier in order not to impair the fidelity of the program.

It is not enough that the signal is delivered at the output terminals with good fidelity and adequate power, but this signal must be capable of driving the loudspeaker in a positive manner. The loudspeaker must be a slave to the output stage and not inject its own personality in the form of resonances, harmonic generation, and hangover into the reproduction.

To control unruly speakers, the output stage must deliver its power from such a low impedance as to offer a veritable short circuit to any wayward excursion of the speaker cone.

There are three basic choices for the power amplifier. Pentode output tubes with heavy negative feedback, triode output tubes with or without negative feedback, or cathode follower connected output tubes may be selected. Each has its advantages and drawbacks.

The pentode or beam power tubes have high power sensitivity and will deliver considerable power output with low drive requirements and modest power supply demands. They are, however, inherently a high impedance device and require the application of generous amounts of negative feedback to properly drive a loudspeaker.

The triode tubes are harder to drive and are relatively inefficient, but by virtue of their low output impedance are eminently suited for driving a loudspeaker.

The cathode follower requires a very large driving voltage and is extremely inefficient without special driver design and high voltage power and bias supplies. It does have a very low output impedance and constitutes an almost ideal speaker driving circuit.

An excellent compromise would be a combination of the desirable characteristics of each of these output systems. Favorable characteristics would include ease of drive, good efficiency, and low output impedance with adequate power output to provide the desired sound level with negligible distortion. The author set up each type of output stage and made comparative measurements.

Certain limitations were imposed. Among these were the power supply requirements of 350 volts at not over 200 ma., a UTC Linear Standard LS-55 output transformer, and a negative bias supply of not over 105 volts if fixed bias were required. It was further decided that the minimum power output was to be 8 watts and preferably 10 watts over a frequency range of 30 to 20,000 cycles per second at very low distortion.

The cathode follower amplifier could not meet the power requirements without using a large number of output tubes in parallel, which would exceed the current rating of the output transformer. Sufficient feedback could not be applied conveniently around the pentodes to give the desired low output impedance and low distortion, so the

triode output stage was decided upon.

6B4G tubes were tried and met all the requirements, but it was found to be next to impossible to eliminate the residual hum level in these directly heated tubes when using a sensitive loudspeaker. These tubes require considerable driving voltage and worked best with a driver transformer (UTC LS-19), which would have entailed the expenditure of an additional \$14.00.

Since RCA had recently released triode characteristics on the 807 tube, they were tried. As a triode, the 807 (screen hooked to plate) requires a peak grid-to-grid driving voltage of 90 volts, which is considerably lower than the 124 volts required by the 6B4G's. This driving voltage was low enough to consider driving the output tubes with cathode followers.

A cathode follower as a driver tube has the desirable characteristics of a perfect driver transformer, *i.e.*, low impedance, and no audio frequency dis-

Fig. 1. (A) Setup for determining the effect of damping. (B) Circuit for measuring the effective output impedance of transformer.

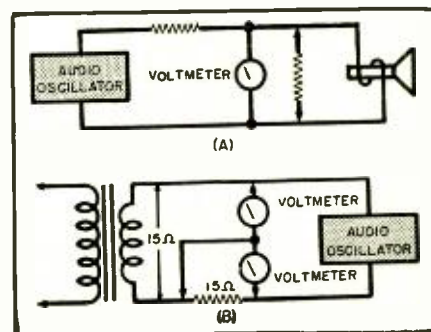

* Audio Sub Section Head, Radio and Communications Section, Electronics Test Division, Naval Air Test Center, Patuxent River, Maryland.

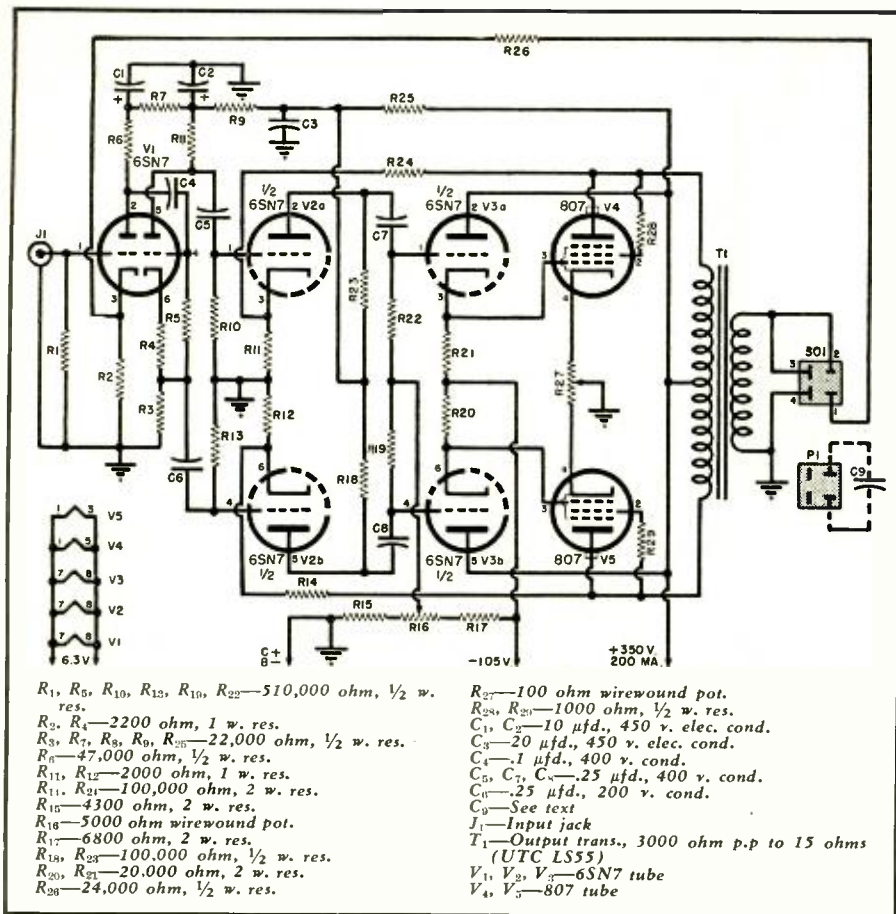

Fig. 2. Schematic diagram of amplifier. The power supply is diagrammed on page 140.

crimination. The cathode follower drivers could supply appreciable power to the output tube grids, if necessary. This would allow the output tubes to be driven into class AB conditions with the low distortion associated with class A operation.

The cathode follower had the further advantage that it could be direct-coupled to the output tube grid, eliminating low frequency losses. It also has the desirable characteristic of having very high input impedance, so that it does not appreciably load the previous stage.

The output circuit was designed with a 6SN7 push-pull cathode follower driving a pair of 807 tubes triode connected with fixed bias. Triode output stages are much improved by the use of fixed bias. The output impedance is lowered by the elimination of the current feedback caused by the conventional self bias resistor. Greater output with less distortion is realized. There is no shift of operating characteristics with increase in signal level with fixed bias when triodes are operated class AB as there is with self bias. Heavy bypassing of the self bias resistor will not completely correct this bias shift condition, and will cause other troubles.

Fixed bias was obtained from a 105 volt negative supply. The 807 grid voltage is dropped to the proper value by adjusting the negative voltage on the grids of the cathode followers. This changed the cathode followers' plate

current which causes the drop across the cathode resistors to change. The circuit was designed so that the proper voltage would appear at the 807 grids without exceeding the dissipation of the 6SN7 (2.5 watts).

The cathode follower operates differently from a conventional amplifier stage. When the grid is driven positive, the cathode follows it in a positive direction. The cathode swing in the plus direction is limited by the plate supply voltage and the maximum current the tube will stand.

When the grid swings negative, the cathode follows the grid negative. The cathode, however, can swing negative only the number of volts that it takes to cut the tube off.

The application of negative voltage to the bottom of the cathode resistor has the effect of increasing the plate voltage by that much. In this case, the total plate voltage amounted to 455 volts, yet none of the power supply electrolytic condensers are required to withstand over 350 volts, a factor which contributes greatly to their life.

With this high plate voltage, the cathode followers require a greater negative bias to limit the quiescent plate current to a value within the tube's rating. With this higher negative bias, the tube may swing farther in a negative direction.

Because these cathode followers are operated in push-pull driving output tubes in push-pull, the clipping which occurs from driving the cathode fol-

lowers so far negative as to cut them off does not show up at the output of the output stage. The cathode followers are operating almost class B but, because of their good inherent regulation and the push-pull connection of the output tubes, the output wave is not distorted.

This phenomenon was observed on an oscilloscope. The cathode followers were driven to the region beyond cut-off with an audio oscillator. The negative peaks were heavily clipped, yet the output waveform was an excellent sine wave with low measured distortion. Although the driver tubes started clipping at a power output of 11 watts, the output tubes could be driven to 15 watts with less than two per-cent harmonic distortion! Intermodulation distortion was negligible below a power output level of 10 watts.

The tube manufacturers always recommend the use of low resistances in the grid circuits of power triodes when they are operated with fixed bias. This is because even when operating in pure class A, the grids draw a small current which increases with an increase in signal level.

This current causes a voltage drop across the grid resistor which is of such polarity as to subtract from the fixed bias voltage. So, under large signal conditions where the full bias is essential, it is inadequate, causing serious distortion and limited power output.

The cathode followers' cathode load resistors form the grid resistors of the output stage. They are far lower in value than could be used with a conventional RC coupled driver stage. Even fair low frequency response at 30 cycles per second would require the use of 3 μfd. coupling condensers with 20,000 ohm grid resistors.

The cathode followers were preceded by a push-pull 6SN7 voltage amplifier stage. Negative feedback was introduced from the cathodes of these voltage amplifier tubes to the plates of the 807's. No reactances were included in this feedback loop, so that equal feedback would be applied at all frequencies. This feedback loop reduced the already low output impedance of the triode-connected 807 tubes to a value more nearly that of cathode followers.

The output transformer, looking back into the 807's, sees a nearly ideal low impedance generator, which is particularly desirable at low frequencies where the transformer impedance is low. These three stages, together, then have approximately the same gain as beam tetrodes (6L6's) but all the desirable features of output triodes plus the noise and hum reduction of negative feedback. The addition of a triode voltage amplifier stage and a split load phase inverter completed the tube lineup.

Several phase inverter circuits were tried but the split load type was found to be superior where its two disadvantages are not objectionable. This inverter cannot be used in low level stages because of the hum which results when operating the cathode so far

above ground. The gain is low, in the order of 1.5 times.

In contrast to these disadvantages, the split load inverter produces output voltages which are exactly 180 degrees out-of-phase, and if the load resistors are low enough the output impedances are similar. Its low gain and excellent stability are the result of the large amount of inherent degeneration caused by the large resistance in the cathode circuit, plus the unbypassed cathode resistor.

Because of the various feedback loops within this amplifier circuit, it was possible to apply an appreciable amount of feedback around the entire five stages from the voice coil winding of the output transformer to the cathode of the input stage, without instability. This outside feedback loop served to improve the output transformer characteristics and provided a greater damping factor.

This damping factor turned out to be seven, at 40 cycles per second. It might be noted here that cathode follower output tubes could provide a higher damping factor, but in trying to provide the increased damping factor, the law of diminishing returns is encountered. The effect of increasing the damping factor beyond a certain value is small.

The effect of this factor was determined experimentally (see Fig. 1A). A 15-ohm loudspeaker with pronounced low frequency peaks was connected to an audio oscillator through a high resistance (500 ohms). A voltmeter was connected across the voice coil of the speaker and was used to read the voltage across the speaker as the frequency was varied. This amounted to operating the speaker from a very high impedance.

The low frequency peaks in the speaker were very pronounced, demonstrating the inadvisability of driving a speaker from a high impedance source. Then the speaker was shunted with successively lower resistors until the value of 2 ohms was tried. The peaks were much smaller and considerably broadened. Lowering the resistance below this value of 2 ohms did not appreciably affect the amplitude of the

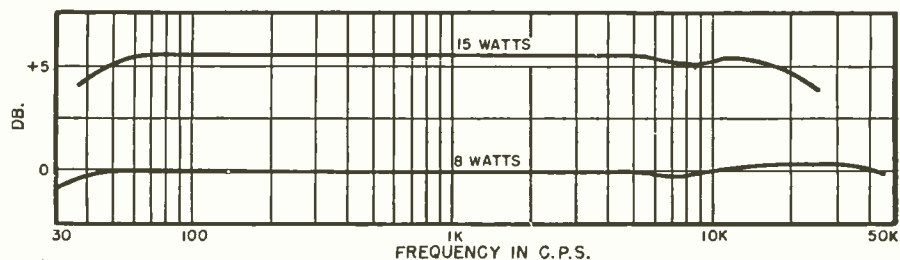

Fig. 3. Frequency vs. output of the 807 amplifier with a 15 ohm resistive load.

peaks. We should, therefore, insure that the effective output impedance of our amplifier be 2 ohms or less, at the 15-ohm tap.

The effective output impedance was easily measured. The setup is shown in Fig. 1B. It consists of an audio oscillator connected to the output transformer through a resistance R_1 . It was merely necessary to measure the voltage drop across R_1 and compare it with the voltage across the output transformer winding with the amplifier turned on and its input short circuited.

The nominal impedance of the output transformer secondary was 15 ohms. The ratio of the voltage across R_1 (also 15 ohms) to the voltage across the transformer is equal to the damping factor. The nominal output impedance divided by the damping factor gives the effective output impedance, i.e., if the voltage across the transformer secondary were 2 volts and the voltage across the resistor R_1 were 4 volts, then the damping factor would be $4/2$ or 2, and the effective output impedance would be $15/2$ or 7 ohms. The effective output impedance as measured by the above method was 2 ohms across the 15-ohm tap of the output transformer.

Although a high damping factor is desirable throughout the audible frequency range, the most important point for the amplifier to exhibit a high damping factor is at the resonant frequency of the low frequency loudspeaker. This will reduce the single note bass effect and diminish the generation of higher harmonics which the speaker cone would generate when its amplitude of swing became so great as to be actually outside of the linear

portion of its voice coil's magnetic gap.

The amplifier exhibited a frequency characteristic (see Fig. 3) which was flat within plus or minus 0.5 db. from 30 c.p.s. to over 40,000 c.p.s. at an output level of 8 watts. At 8 watts output the total measured harmonic distortion was less than one per-cent. The amplifier was flat plus or minus 1.0 db. from 38 c.p.s. to 20,000 c.p.s. at a power level of 15 watts and a total distortion of two per-cent.

This variation at the two power levels is partly a function of the output transformer frequency vs. power output characteristic. For all practical purposes, the amplifier will deliver 15 watts to a loudspeaker load from any recording or frequency modulation broadcast.

After the development of the amplifier (Fig. 2), a layout was decided upon. The multi-chassis layout is desirable from several standpoints. First and foremost, isolation of the power supply results in lower hum level. Secondly, any one of the units may be changed or replaced without spoiling the others, and the amplifier system may be tucked into odd shaped spaces in a desired cabinet more readily.

The amplifier was built on a $6\frac{1}{4}$ " by $8\frac{1}{4}$ " by $1\frac{1}{2}$ " chassis made of $\frac{1}{16}$ " brass. The layout was chosen to eliminate as much wiring as possible and point-to-point wiring was used. All the grounds were returned to one point located on the multiple section electrolytic condenser, and the input connector was insulated from the chassis. When completed, although the chassis is almost obscured by the various small parts, the wiring is neat and the unit is eas-

(Continued on page 139)

Bottom view of amplifier. Chassis is $6\frac{1}{4}$ x $8\frac{1}{4}$ x $1\frac{1}{2}$ inch brass.

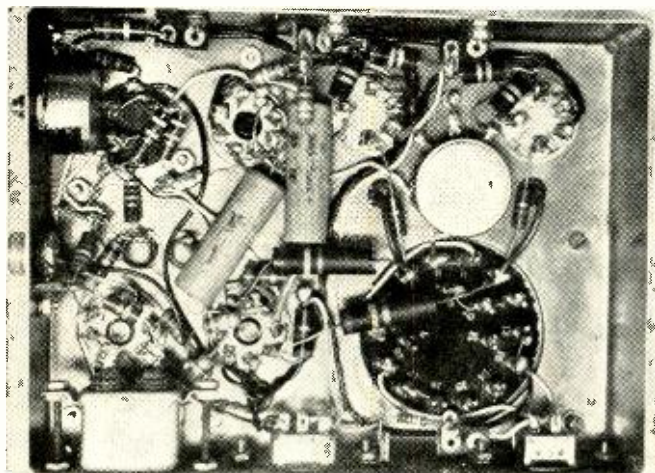

Top view of amplifier. Power supply is on a separate chassis.



Improving Response of Home-Assembled COAXIAL SPEAKERS

By

NORMAN V. BECKER

Description of a method by which the frequency range of "low-cost" coaxial speaker assemblies can be substantially extended at little expense.

MOST low-budget, serious-minded audio enthusiasts, like myself, are forced to make drastic compromises in the selection of wide range speaker systems. It's fun to look through the elegant slick paper bulletins describing elaborate professional type speakers, but when the chips are down, very few of us can afford to peel off two or three hundred dollars for such a unit.

Occasionally, such speakers are overrated, and in actual operating conditions they do not deliver the extraordinary performance their laboratory data implies. Then too, we sometimes overlook the fact that in order for professional speakers to function at their peak they must be used with equally costly auxiliary equipment, and must be fed program material of highest quality, for example, live, well-engineered FM studio productions.

Even though FM is becoming more generally popular and is now available to most communities, its wide range potentialities are seldom realized. Smaller FM stations, particularly, seem to overlook the importance of good audio. I know of one such outfit that maintains the latest, most beautifully designed FM transmission equipment at a distance of ten miles from its AM station. All program material is fed to it over very poor class telephone lines direct from the AM console, and in the process no special attention is given to line equalization. As a result, the same material—broadcast simultaneously over both AM and FM—shows no improvement in being frequency modulated.

So, with the exception of a few good FM studio broadcasts, the audio man has no source of really pure sound. (A sine wave generator might be mentioned, but it doesn't make very enjoyable listening!)

In light of this, it behooves us shoe-string experimenters to forget about that "dream speaker" and come face to face with practicalities. In the first place, residential radio-phono systems should never be operated at public address sound levels—unless you have tolerant neighbors and a fool-proof lease. There is no need to invest in a speaker that can, for example, take a continuous input of 40 watts. Low bass notes and transients can be handled beautifully by speakers of half this rating at moderate listening levels. Further, there is no practical need for a speaker that can respond in the supersonic region, because of

the aforementioned limitations of audio sources. These very limiting factors, however, reduce the home builder's speaker problems considerably.

The speaker system to be described was constructed of "bargain" units and enclosed in a solid, non-resonant cabinet at a total cost of less than \$40. Its performance, determined on the basis of comparative listening tests, is equal in many respects to its higher priced counterparts. Its electrical efficiency, however, is much lower and thereby hangs a tale.

It is a known fact that loudspeakers are deplorably low in efficiency, the best of them averaging not more than 30 per-cent. So in order for a speaker to produce a sound of given intensity it must be connected to a power amplifying source capable of putting out far more wattage than can actually be converted into sound energy.

In comparison with the cost of "efficient" speakers, audio power is a cheap commodity. Let's assume we have an amplifier capable of producing 20 watts with negligible distortion. Connected to a speaker of average efficiency and run at full output it would produce a painfully loud sound for mere "listening" purpose. Since my concern is primarily for the best possible *quality* at *moderate* levels, and since I have 20 watts of clean audio available from my amplifier, the circuit to be described was designed to provide this at the expense of reserve audio power *only* and with *no* additional equipment costs.

Referring to Fig. 1, *R* is a variable wirewound 10 watt resistor which equals the voice coil output impedance of the amplifier. The "woofer" is a 15", 20-watt job purchased from a wholesale supply house for \$17. The "tweeter" is a common garden variety 5" PM costing \$1.50. The high pass filter section *C* consists of two 1 μ fd., 400 volt paper condensers connected in parallel. As can be seen from the illustration the "woofer" operates across one portion of *R*, while the "tweeter" operates across the remainder. By moving the contact up and down the resistor element the "woofer" receives more or less of the total output—resulting in an effective volume control of this unit. The "tweeter" is connected in such a manner as to *increase* its volume as the "woofer's" is *decreased*. Therefore, by properly adjusting the contact the *relative* efficiency of the "tweeter" can be made to approximate expensive horn type units which require *LC* networks for their operation.

At first glance this might appear to be a crude method by which to achieve the results desired, but a little analysis reveals two very distinct advantages. First, loading of the output transformer is more resistive than with the speakers connected directly to it. Consequently, there is less inductive reactance reflected to its primary, and the output transformer takes on smoother response characteristics.

(Continued on page 88)

Fig. 1. Hookup of coaxial speaker system.

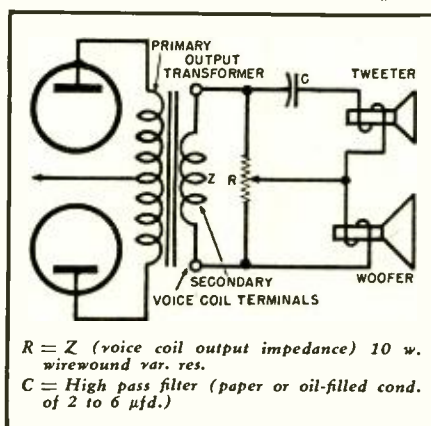



Flying spot CRT 7BP7 generator with transparency in front of tube. Inexpensive mounting is constructed of plywood and twin-lead straps.

Simplified HAM TV STATION

Part 2. Construction details on flying spot scanner, pickup amplifier, and blanking and sound circuits. The receiver and r.f. transmitter will be covered in next month's issue.

By

**J. R. POPKIN-CLURMAN
W2LNP**

Hazeltine Electronics Corporation

THE station units to be described in this, the second, article are those which were shown in the block diagram (Fig. 2) which appeared in the first article of the series (May 1950 issue). These particular units are shown in the block diagram as items 1, 2, 3, 4, 5, 6, and 8.

A standard television receiver may be used as a source of standard RMA synchronizing pulses (which are taken from the complete received picture signal) and may also be used for obtaining the necessary high voltages, sweeps, focusing, and accelerating voltages for the picture tube which is to be used as the flying spot scanner.

Even a television receiver is not necessary, as a small separate receiver can be used for the sole purpose of obtaining the sync information from the television station. Its bandwidth would have to be no more than 400 to 600 kc., as the synchronizing information can be obtained within this bandwidth. The sync pulses thus derived would not have the same fidelity as those obtained from a standard television receiver but would be adequate for synchronizing purposes. Similarly, a separate chassis which gives the necessary accelerating high voltage,

sweeps, blanking source and focusing voltages might be built for the flying spot scanner alone. Because of the large differences in various television receivers and the obvious impossibility of giving definite modification data except in a general manner for all television sets, it was decided to build a separate deflection chassis corresponding in most details to the design found in the back end of magnetic deflection television receivers. This is shown in Figs. 1 and 2.

The usual television set, having a 10-inch tube, rarely has a second anode voltage exceeding 9000 volts. The sharpest and brightest possible raster that can be obtained will be the best for flying spot use, in order to provide a good signal-to-noise ratio in the derived video picture. Such a raster is obtained by higher voltages on the second anode of the cathode-ray tube. It was decided, therefore, to add a voltage doubler to the standard RCA type 211T1 transformer, as shown in Fig. 2.

A piece of polyethylene insulated wire, about the same length (approximately two feet) as the present high voltage filament winding and having sufficient insulation to withstand 18,000 volts, is carefully wrapped over the present high voltage filament winding. The inside conductor and insulation from RG/59-U coaxial cable is suitable. The winding gives the heater power for the second 1B3GT voltage doubler. When this high volt-

Fig. 1. Sweep circuits, high voltage, sync and blanking generators used in lieu of TV set.

age is applied to the CRT, it will be found that the raster will be reduced to about two-thirds of its former dimensions. Additional current will now be required through the focus coil to bring the raster into focus. The current for the focusing coil may be taken from the power supply described last month or one of the new permanent magnet type focus coils may be used. The raster will be considerably brighter and sharper, and no loss in the resolving ability of the flying spot will occur. The additional high voltage doubler is, of course, not necessary to make pictures, but if the phototube used is not particularly sensitive there may be considerable noise in the picture as the video gain is increased if no added high voltage is used. The more light available, the less noise.

A switch is used for changing over the receiver's kinescope grid circuit from receiver video output to a blanking connection. The switch should be of the low-capacity type, such as a wafer switch, in order not to lose definition due to the high frequencies in the video signal being attenuated by the added shunt capacity of the switch. An internal-external sync switch S_1 should be added if it is desired to run the flying spot scanner without the benefit of the RMA sync transmitted by the station. This switch allows the vertical oscillator to be synced from the 60-cycle line, at the same time allowing the horizontal oscillator to run

The vertical oscillator may be synchronized internally or by pulses from a TV receiver. A voltage doubler flyback-type high voltage supply is used.

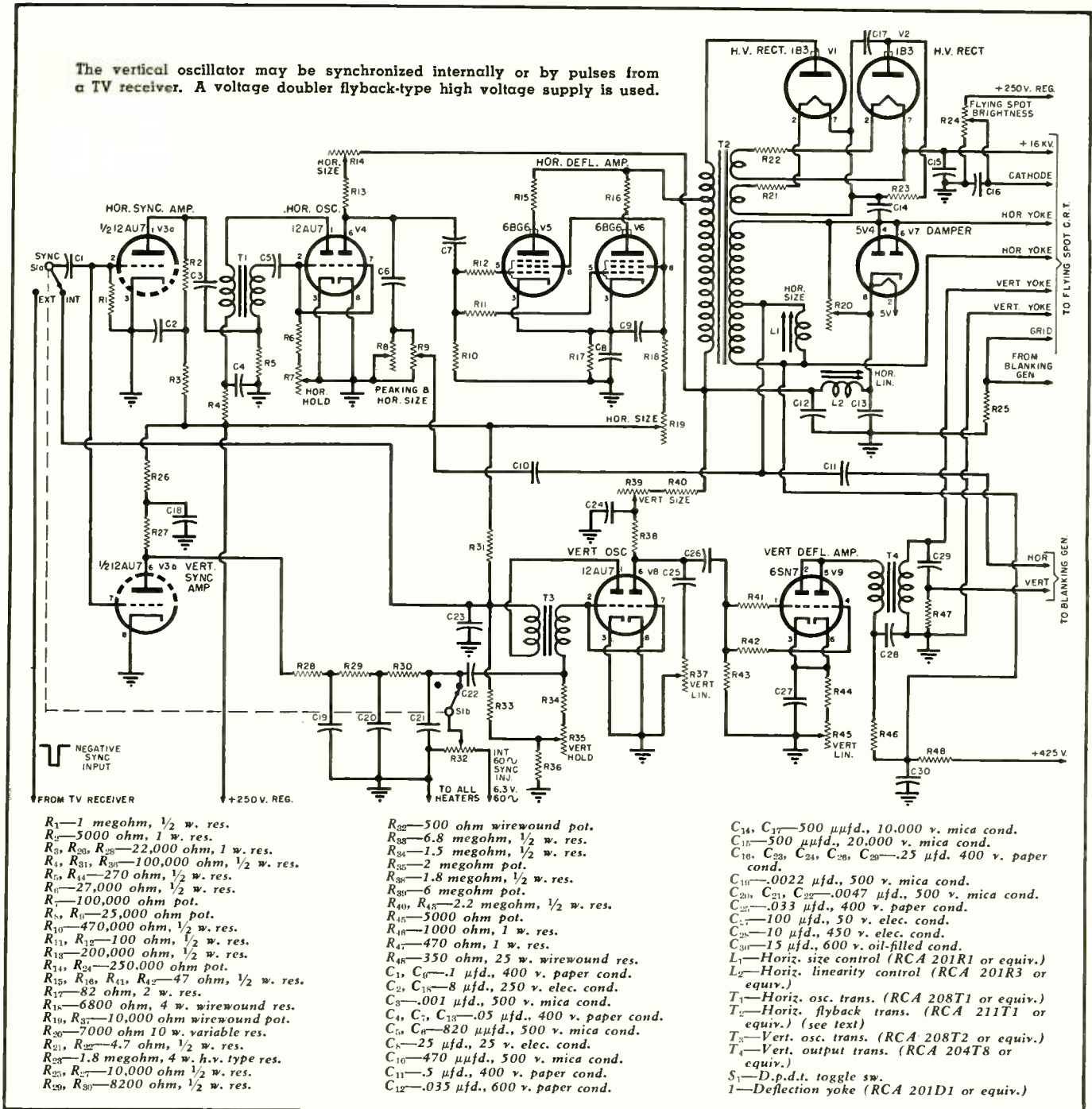

Fig. 2. Schematic diagram of flying spot scanner unit and high voltage supply. Photograph of the unit assembly is shown in Fig. 1.

free at approximately 15,750 cycles per second. A sync output lead for supplying the RMA transmitted sync should be taken off the output of the sync separator in the TV receiver. In the case of the type 630 RCA receiver the sync output is taken from the grid of the last sync limiter (following the 6SH7 tube). Should the television station sync source not be used, means will be discussed later for obtaining the sync from blanking pulses which are themselves derived from the return traces of the horizontal and vertical sweeps.

The use of coaxial cables or shielded leads for the blanking and sync outputs is desirable, but not necessary, in order to minimize cross coupling and

pick-up on unshielded leads. If the television receiver is used for receiving the amateur television signals then a double-pole, double-throw switch or relay should be arranged to switch the input of the receiver from its television antenna to the output of the 420-megacycle converter.

Adjustments

The adjustments referred to in the following discussion are those pertaining to the sweep chassis which has been built especially for the flying spot scanner source in order to leave the television set unchanged. The adjustments apply equally well to any television receiver which is to be modified as a source for the flying spot scanner.

Standard RMA negative sync from the TV receiver is fed into the external sync connection of the sweep chassis. The blanking input lead to the grid of the flying spot picture tube is disconnected and in its place the video output of a television receiver, tuned to a commercial station, is fed into the CRT grid as in the normal receiver. The horizontal and vertical controls should be adjusted (preferably while looking at a test pattern) to obtain the proper pattern from the television station. With the exception of the hold (or speed) controls, it will be found that each of these controls affects the adjustment of the others. The horizontal size control R₁₄ in the plate of the 12AU7 and the screen of

the 6BG6G's affects the right-hand side of the pattern, while the peaking and horizontal size controls R_8 , R_9 affect the left side of the pattern. The horizontal-linearity resistor R_{20} across the 5V4G damper tube affects the left side of the pattern as does the horizontal linearity control L_2 in the cathode of the damper tube. The vertical size control R_{30} in the plate of the 12AU7 blocking oscillator affects the bottom portion of the pattern and the vertical linearity control R_{45} in the cathode of the 6SN7 vertical deflection amplifier affects the top of the pattern. The vertical linearity control R_{37} , in series with the .033 μ fd. condenser, C_{25} , affects both parts of the vertical pattern. The focus and brightness adjustments for the CRT are the same as for a standard television set.

In general, after all these adjustments are made, a sharper, brighter, and clearer picture should be obtained on the face of the CRT than the one normally present on the screen of a television set. No particular attention need be paid to the contrast range of the picture as the flying spot tube is operated at the brightest light output which will still give a sharp raster.

Raster Linearity

The sync switch S_1 is thrown to internal sync. A 60-cycle sine wave of 6 volts or so is fed into the CRT grid and the vertical hold control R_{35} on the sync is adjusted until one black and one white horizontal bar appear on the CRT screen. This assures that the vertical blocking oscillator is locked to the local 60-cycle line. The size of the raster should be adjusted so that it has the proportions of three units high to four units wide.

The 60-cycle source is then disconnected from the CRT grid and an audio signal between 600 and 900 cycles is fed into the grid of the CRT. A series of horizontal black and white bars will appear on the CRT face and the vertical size and linearity controls should be adjusted until the bars are

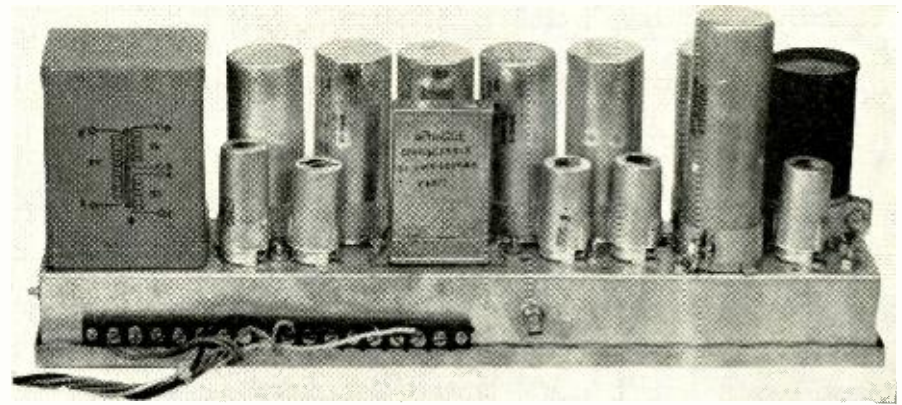

Fig. 3. Top view of pickup strip, video amplifier, and phase splitter unit. The 931A pickup phototube is shown at right of chassis, mounted within the black shielded case.

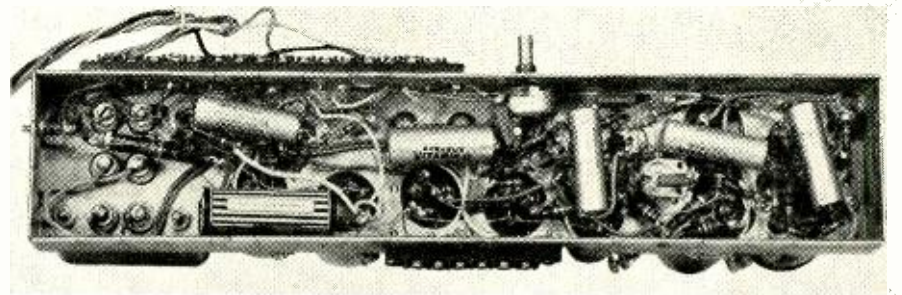

Fig. 4. Bottom view of the pickup strip, video amplifier, and phase splitter assembly.

evenly spaced. Should the bars not stand still, the input signal frequency should be adjusted to give a multiple of 60 cycles.

For adjusting the horizontal linearity the audio tone is disconnected and a radio-frequency signal of 150 kc. or higher is fed into the grid. This time a series of black and white vertical lines will appear and the horizontal linearity and size controls should be adjusted for equal spacing. Should the bars not stand still the radio frequency source should be varied until it is approximately in synchronism as a multiple of the horizontal sweep frequency. It is also possible to feed some

of these signals simultaneously into the external sync input to lock the sweep oscillators in step with the signal. In the event that r.f. sources, such as a signal generator, do not have enough output, several stages of video amplification can be used to raise the level sufficiently to modulate the CRT grid.

Flying Spot Tubes

It has been found that practically any surplus CRT can be used as the flying spot source with the exception of the P1 tubes which are very hard to compensate for their phosphor decay characteristics.

Fig. 5. Complete schematic diagram of the pickup strip, video amplifier, and phase splitter. Switch (S_1) permits choice of picture polarities.

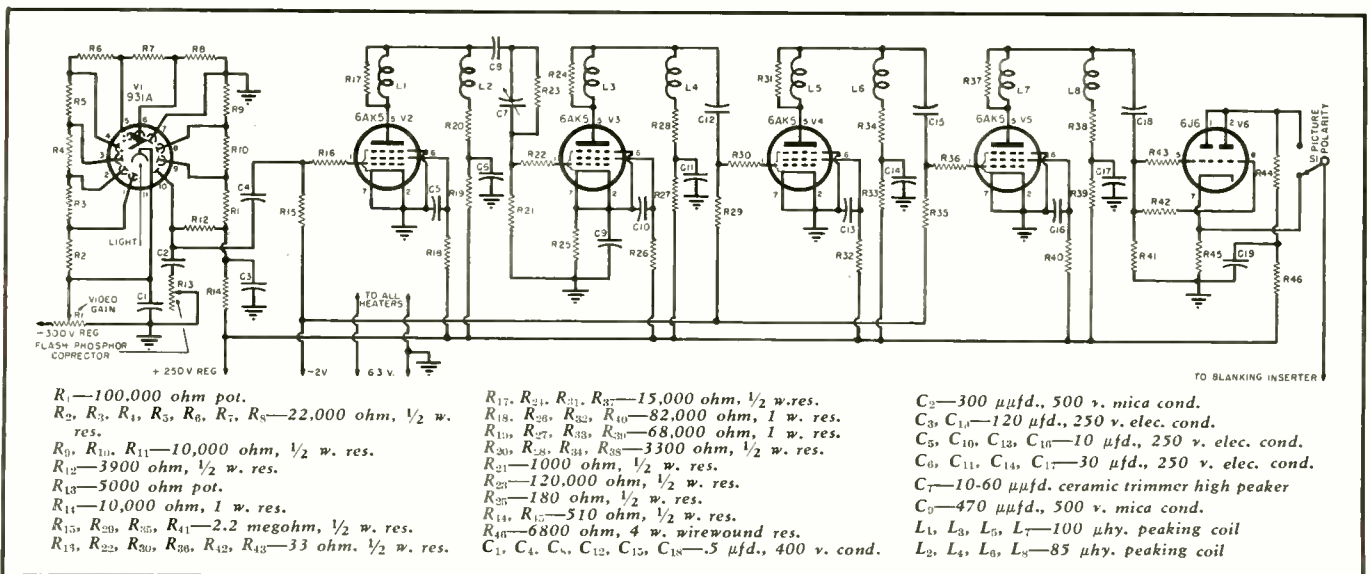

of a 3000 ohm potentiometer R_{13} and a 300 $\mu\text{fd.}$ condenser C_2 is used to correct the initial fast decay time of the CRT phosphors. This adjustment can be made most easily while looking at a test pattern or picture transparency where it will be seen that a short "ghost" or blur directly follows a black or white line or the edge of a face or object. The proper adjustment of this control will remove the "ghost."

Should the phototube be mounted separately from the video amplifier strip, as in the case of 35 mm. transparencies (see Part I, published in May issue), then the same shielding precautions are required. The d.c. supply leads to the phototube should also be filtered for r.f. and audio. In addition, a preamplifier and cathode follower are desirable to prevent the loss of high frequencies and picture detail if the phototube is connected by cable to the video amplifier. The video gain control need not be located near the phototube as long as the .5 $\mu\text{fd.}$ bypass condenser C_1 is located near socket pins 1 and 11.

The same precautions that apply to the phototube and multiplier apply equally well to the video amplifier. Failure to shield the bottom wiring of the video amplifier with a cover will probably result in picking up all the local broadcasting stations, completely spoiling the picture.

It should be remembered that the same layout and wiring precautions that would be observed in designing a multi-stage, high-gain 6 mc. r.f. amplifier apply to the video amplifier since it is carrying frequencies in this range.

Peaking coils, load resistors, and coupling condensers for each stage should be separated from the corresponding components in the next stage. In addition, they should be as small sized as possible. For example, the coupling condensers, although large in value, should be of the "Solite" type, manufactured by Solar, or the "Vitamin Q" type, manufactured by Sprague. The coupling components should be mounted away from the chassis in order to minimize high-frequency losses due to distributed shunt capacitances.

The peaking coils can be the same as those used in ordinary video amplifiers of television sets with some loss in the picture detail, if they are used unmodified. Peaking coils having a tuning slug for varying the available inductance give the best results.

The 2 volt bias supply can be derived from a battery, which will have a very long life, since no current is drawn. This battery can be mounted inside the video amplifier chassis. An alternative bias supply from a higher negative voltage can be obtained by using high-resistance dividers to obtain the proper bias. The electrolytic condensers are mounted as close as possible to the stage that they bypass. The filament transformer, shown in the photographs, does not have to be mounted on the video amplifier, nor is a separate one necessary, but in this

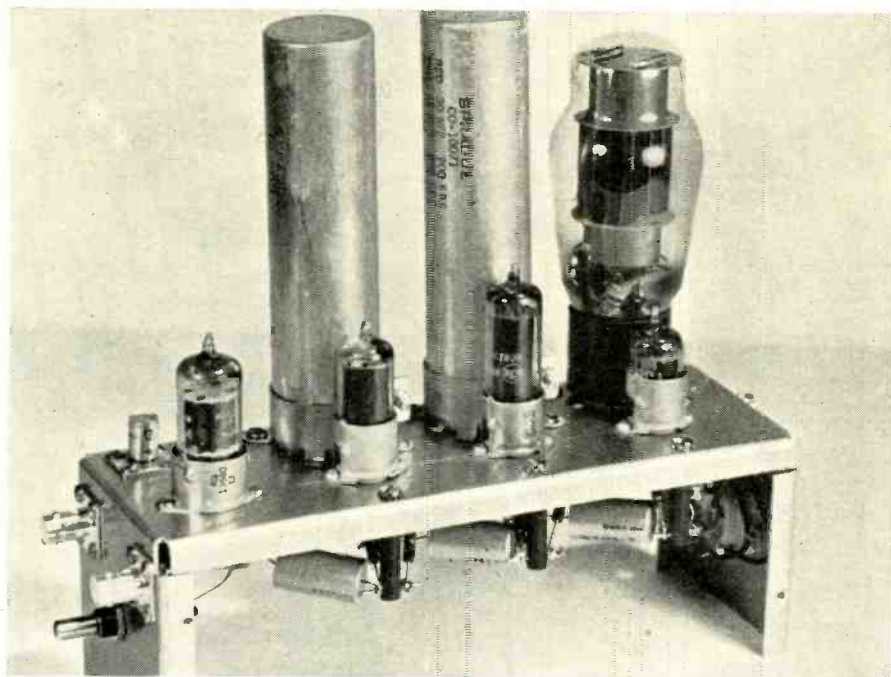

Fig. 9. The top view of the video modulator, the sound mixer, and the sync generator.

case it was found convenient because it was possible to buck out any hum induced in the video amplifier through the heater circuits.

The high peaker stage V_3 is essentially the same as an ordinary video amplifier stage with the exception of the capacity coupling and the high-frequency bypass C_9 on the cathode resistor.

The capacity coupling network consists of a resistance divider R_{21} , R_{22} having all frequencies attenuated 120 to 1, with a condenser C_7 emphasizing the higher frequencies. It will be seen that if the 120,000 ohm resistor R_{23} is removed, the same condition holds as for bass suppression in an audio amplifier. The use of a 470 $\mu\text{fd.}$ condenser C_9 across the cathode resistor is further assurance that the low frequencies will have degenerative feedback, while high frequencies will not. Therefore, this stage will amplify the high frequencies much more than the low frequencies.

It has been found that if the high peaker stage is subjected to mechanical vibration there will be a series of
(Continued on page 109)

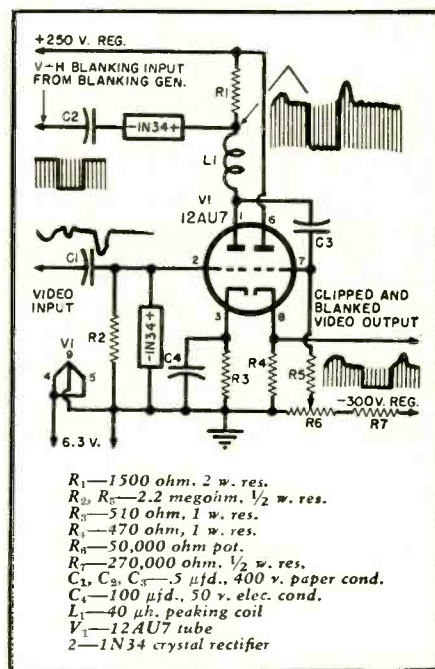
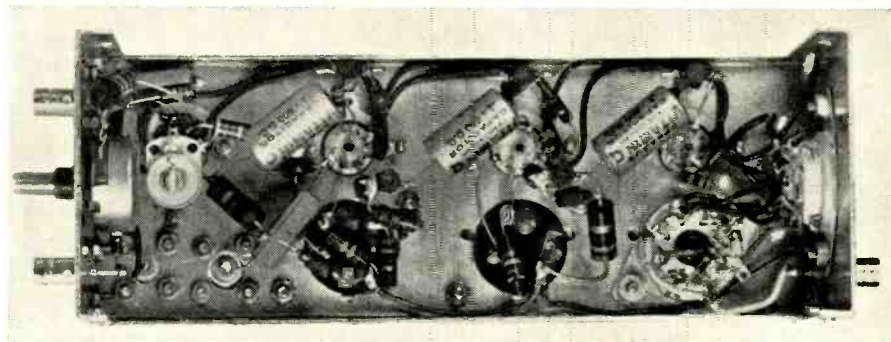

Fig. 10. Blanking inserter and clipper circuits. This is a part of the assembly shown in the photographs of Figs. 9 and 11.

Fig. 11. Bottom view of the video modulator, sound mixer, and sync generator. The sync delay condenser and sync level adjust are shown at left, video output, right.



The TURRET TYPE TV TUNER

By
DANIEL LERNER

TV Field Service Eng.
Philco Corporation

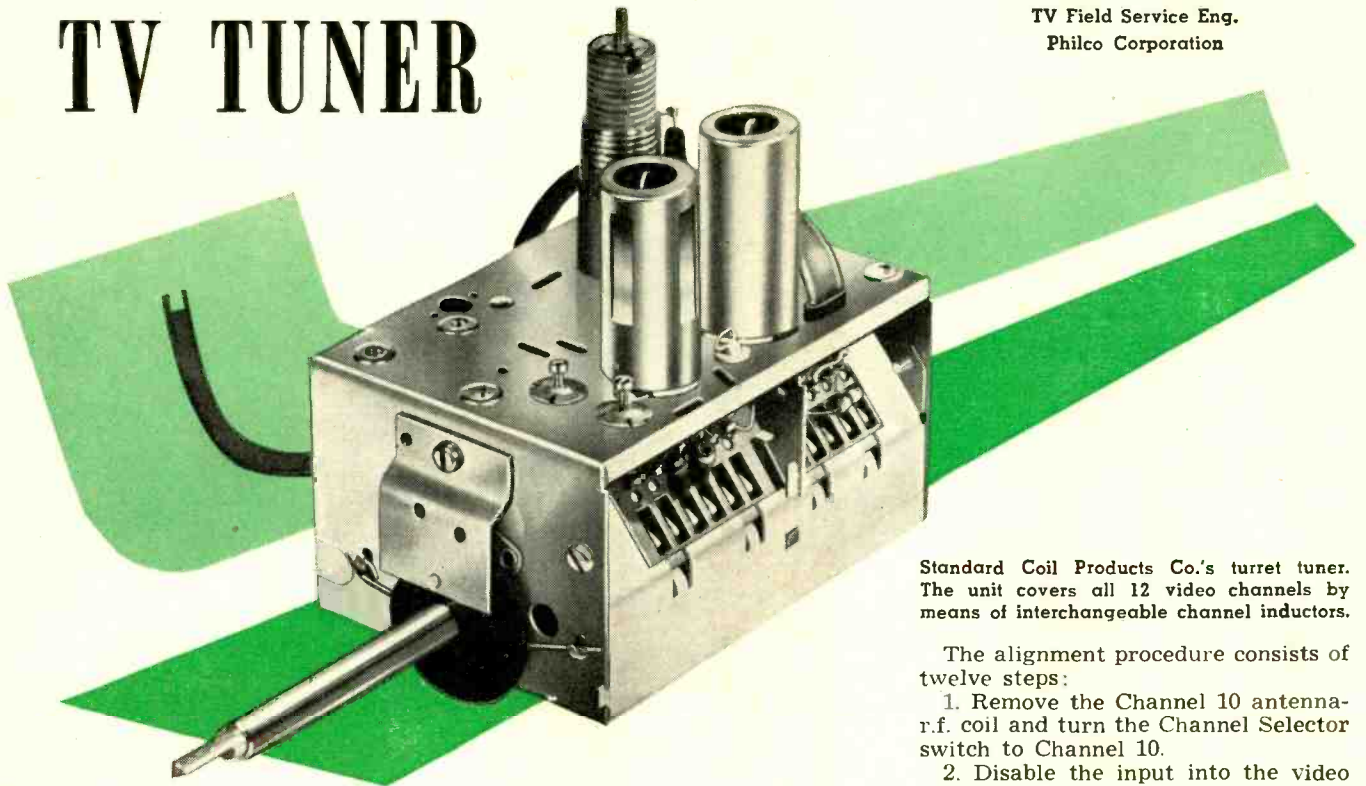

Standard Coil Products Co.'s turret tuner. The unit covers all 12 video channels by means of interchangeable channel inductors.

The alignment procedure consists of twelve steps:

1. Remove the Channel 10 antenna-r.f. coil and turn the Channel Selector switch to Channel 10.

2. Disable the input into the video i.f. by shunting the video i.f. output lead of the tuner to ground with a 470 ohm resistor. This will reduce the "Q" of the first i.f. transformer and remove any "notch" which appears in the r.f. response pattern as a result of mixer grid-plate coupling.

3. Connect the vertical input of the oscilloscope to the test tuner jack, J_1 , as shown in Fig. 3.

4. Remove the component cover plate and connect the alignment generators to the grid of the r.f. tube, pin 1 (terminal 7 of the contact-panel assembly).

5. Set the sweep generator to the approximate center frequency of Channel 10 (195 mc.) and the sweep width to approximately 12 megacycles.

6. Set the marker generator to 192 mc. and 198 mc., respectively, and observe the marker pips on the response curve.

7. Tune C_2 and C_3 for maximum and symmetrical response as far as the two peaks are concerned.

8. Replace the Channel 10 antenna-r.f. coil and the component cover plate. Disconnect the generators.

9. Connect the generators to the antenna input terminals through the antenna matching dummy.

10. Tune C_2 for maximum and symmetrical response, as shown in Fig. 4.

11. Remove the short from the tuner video i.f. output lead.

12. Remove the input of the oscilloscope from the tuner test jack, J_1 , and connect it to the ratio detector or discriminator output. Set the marker generator to 197.75 mc. which is the sound carrier for Channel 10. Now us-

Alignment data on a popular TV tuner. With minor changes fringe area reception can be improved.

THE Standard Coil Products Company's turret type tuner is being used in television sets made by such large television receiver manufacturers as Philco, Admiral, and Emerson. It has proven to be one of the most versatile and efficient tuners on the market. It is also a unit that can be serviced without using any special or complicated test equipment.

The turret tuner consists of a rotating turret which has twelve antenna-r.f. snap-in coils and twelve mixer-oscillator snap-in coils. As the turret is rotated, the terminals of the appropriate coils are brought into contact with the two contact panels, which

provide connections to the antenna, r.f. amplifier, mixer, and oscillator circuits. This type of channel switch insures the low contact resistance and inductance which is so essential to high frequency operation. The antenna input circuit is flexible as it is designed for 300 ohm line, balanced to ground, or unbalanced 72 ohm line.

Whenever a parts replacement is made in the tuner, or when the tuner is to be checked for proper response for optimum operating conditions especially in fringe area work, the tuner should be realigned according to the following procedure.

Three pieces of test equipment are required: a sweep generator covering all TV channels, a marker generator covering all of the television channels, and an antenna-matching dummy (see Fig. 1). This matching network is comprised of carbon type resistors and their values should be as near those specified on the diagram as possible.

Television v.h.f. band carrier frequencies.

Channel	Channel Limits (mc.)	Video Carrier Freq. (mc.)	Sound Carrier Freq. (mc.)
2	54-60	55.25	59.75
3	60-66	61.25	65.75
4	66-72	67.25	71.75
5	76-82	77.25	81.75
6	82-88	83.25	87.75
7	174-180	175.25	179.75
8	180-186	181.25	185.75
9	186-192	187.25	191.75
10	192-198	193.25	197.75
11	198-204	199.25	203.75
12	204-210	205.25	209.75
13	210-216	211.25	215.75

Fig. 1. Matching dummy, 75 to 300 ohms.

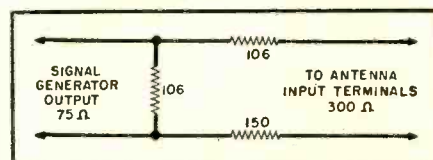

ing low signal generator output and high oscilloscope gain, adjust C_{11} for minimum indication on the oscilloscope. C_{11} is in parallel with the fine tuning control and thus its correct setting assures proper range for fine oscillator tuning.

As shown in Fig. 4 it is apparent that this tuner has a relatively wide bandpass, approximately 11 megacycles. It also should be noted that the sound and picture carrier are placed on the curve so that they never appear less than 70% up on the response. Naturally the 4.5 mc. separation is maintained between the carriers at all times.

In fringe areas where the signal available at the antenna input terminals is in the order of 50 microvolts with the total equivalent noise about 20 microvolts, the front-end performance is of prime importance. A large percentage of the inherent receiver noise occurs in the front-end with most of it in the mixing process.

What can be done to a turret type tuner to increase its signal-to-noise ratio? Primarily this becomes a problem of increasing the front-end sensitivity at the channel frequencies involved.

As was shown in Fig. 4., the normal bandwidth of the tuner, when measured at the 70% point of the response curve, is about 7 megacycles. By changing the coupling of the coils in the r.f. section, the bandwidth of this response can be narrowed and the gain increased so that the selectivity and the sensitivity are increased. In striving to secure the greatest tuner gain, it is important to keep the video carrier at the 100% response level of the curve.

Fig. 2 shows the effects of coupling on the sensitivity and selectivity of transformer system. Notice that over-coupling causes a "saddle" in the response and hence a decrease in selectivity. Also notice that loose coupling causes a high sensitivity and an increase in selectivity.

The procedure for realigning the tuner to improve its performance for fringe areas is as follows:

1. Connect the equipment as outlined in the alignment procedure discussion.

2. Referring to Fig. 5, remove the r.f.-antenna form (Z_1 in Fig. 5).

3. Move the primary of the antenna coil (L_{1a}) away from the secondary (L_{1b}) turn-by-turn. This has to be done experimentally to check whether the sensitivity is increasing without affecting the shape of the response curve.

4. Decrease the coupling of Z_2 by increasing the physical spacing of L_{2a} and L_{2b} . This will decrease the frequency distance between peaks as mentioned previously. Adjustment of the inductances L_{2a} and L_{2b} by spreading turns may be necessary in order to secure symmetrical response after the windings have been separated.

5. The local oscillator injection, which affects tuner gain directly, can be checked at the tuner test point with

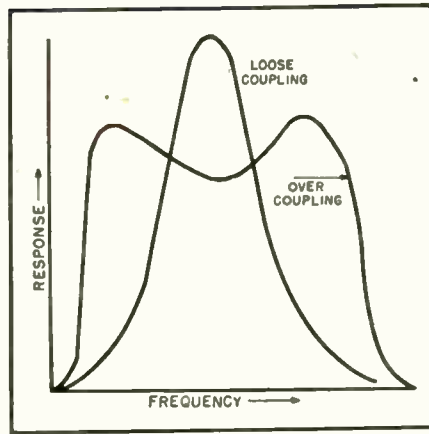

Fig. 2. Effects of coupling on response.

a v.t.v.m. If it is low (below 1.5 volts), the 6J6 should be replaced.

6. In some cases an improvement in noise figure, with a consequent decrease in "snow," can be effected by raising the values of the damping resistors, R_1 —3900 ohms and R_2 —10,000 ohms. Making R_1 larger increases the gain of the antenna transformer, Z_1 . However, too great a change in the value of R_1 will also increase the standing wave ratio, which in turn, makes the length of the antenna lead-in critical with respect to phase shift (ghosts, etc.).

7. The 6BC5 tube, which is directly interchangeable with the 6AG5, may be used to advantage since it will provide greater r.f. gain.

8. In extreme fringe areas excellent results can be obtained by removing the a.v.c. bus line (white wire) and grounding it. This retains a.v.c. on the i.f. strip and removes it from the r.f. tube.

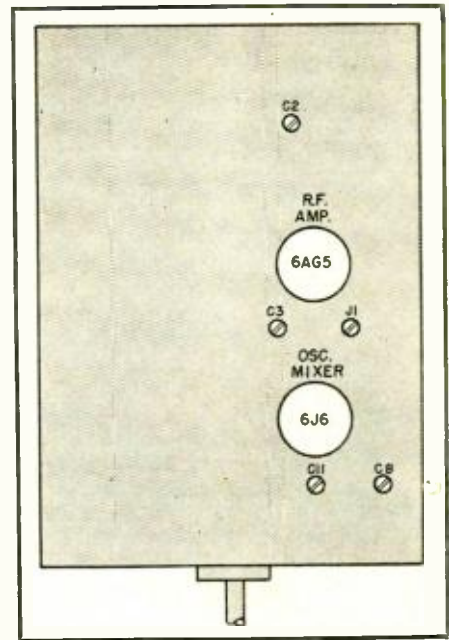

Fig. 3. Location of the various turret tuner trimmers involved in alignment.

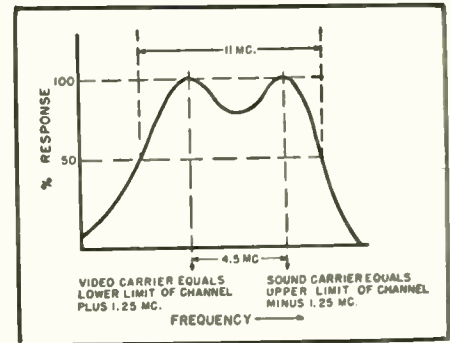
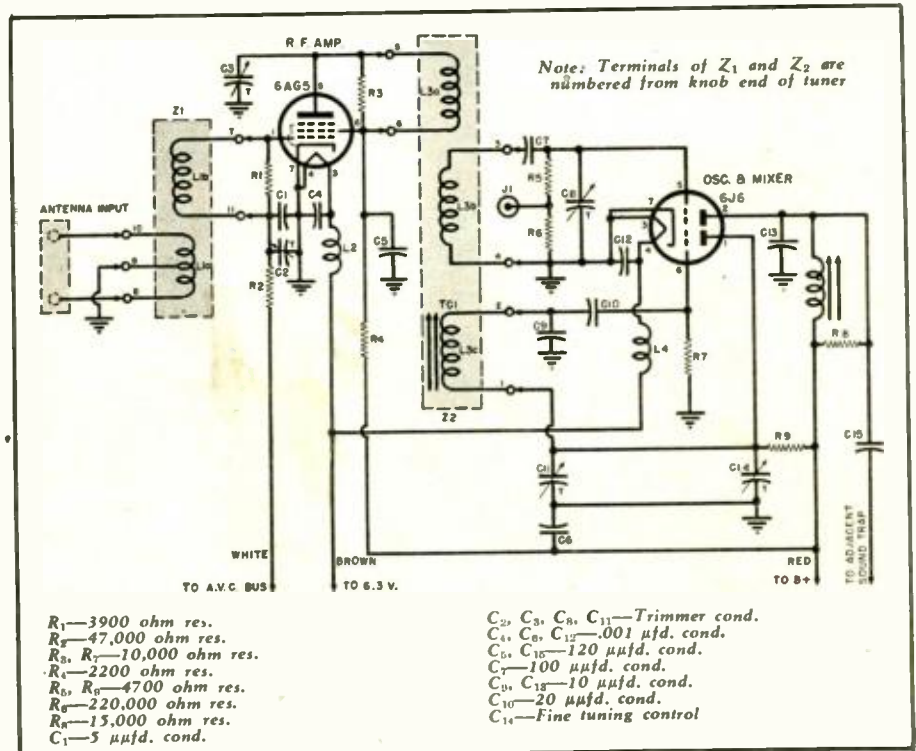

Fig. 4. Response curve of the turret tuner.

Fig. 5. Schematic diagram of the Standard Coil Products Company's turret type tuner.





International SHORT-WAVE

Compiled by **KENNETH R. BOORD**

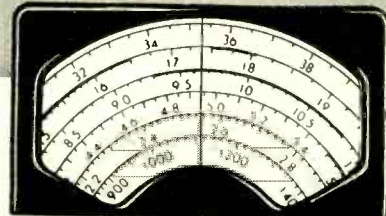

HIRAM PERCY MAXIM, famous American inventor, once said: "Amateurs can be found somewhere in the world on some band every minute of the day." Mr. Maxim, the first president of the American Radio Relay League and of the International Amateur Radio Union, was referring to the radio amateurs or "hams"—as they are self-nicknamed.

Radio amateurs, active in almost every country of the world, have won fame as pioneers in the development of short-wave communications. Time and again they have provided invaluable assistance during emergencies. Their national networks and international communications are important foundations of good will and mutual understanding.

Hence, the 15-minute broadcasts of, by, and for the radio amateurs of the world inaugurated in June 1949 by the English Section of the *Voice of America* are of interest to SWL's as well as amateurs.

The programs are prepared in cooperation with the American Radio Relay League, pioneer amateur organization which has an active membership of some 68,000 enthusiasts. George Bailey, president of both the ARRL and the IARU, appeared on the first broadcast.

The *Voice of America's* "ham" show features Bill Leonard, a popular radio

personality in the United States, whose medium-wave program, "This is New York," is well-known in the metropolitan area over station WCBS. Mr. Leonard holds amateur station call letters W2SKE. Everyone directly connected with the *Voice of America's* "ham" show is an active licensed radio amateur. Henry T. Miller (W2AIS) provides the script; Larry Weintraub (W2ECL) is the studio engineer, and Gene Kern (W2BAK)—Assistant Chief of the English Section—is in charge of the series.

Each program is composed of news of amateur activities, technical advice, "DX" news, interviews with leading radio amateurs in the United States and abroad, and a regular feature on radio propagation predictions in the amateur bands (these predictions oft-times are also helpful to SWL's).

If you're a member of the amateur radio fraternity, or if you're just interested in "ham" activities, the *Voice of America* and the American Radio Relay League invite you to tune in every Sunday. At the time this was

(Note: Unless otherwise indicated, all time is expressed in American EST; add 5 hours for GCT. "News" refers to newscasts in the English language. In order to avoid confusion, the 24 hour clock has been used in designating the times of broadcasts. The hours from midnight until noon are shown as 0000 to 1200 while from 1 p.m. to midnight are shown as 1300 to 2400.) The symbol "V," following a listed frequency indicates "varying." The station may operate either above or below the frequency given.

compiled, the Amateur Program was scheduled (originating in New York City) from the West Coast beamed to the Orient over KWID, 9.570, KCBR, 15.130, KNBA, 9.515, KNBI, 9.650, KGEX, 11.730, KNBX, 17.830, with relays from Honolulu over KRHO, 11.79, and from the Philippines over Manila I, 11.89, Manila II, 15.330, and Manila III, 17.780, and beamed to Latin America over WLWR-1, 15.350, and WLWS-1, 17.800; time is 0845-0900 (1345-1400 GMT); with repeat beamed to Central and Southeastern Europe at 1415-1430 (1915-1930 GMT) over WOOW, 21.500, WCBN, 15.270, WNBI, 17.780, and relayed from London over BBC frequencies of 7.200, 15.230, 9.700.

While the *Voice of America* had no definite plans formulated for a DX broadcast for short-wave listeners when this was compiled, the idea was being given consideration by VOA officials.

* * *

Propagation Notices

WWV, Bureau of Standards, Washington, D. C., USA, notifies listeners of expected interference to radio signals. The letter "U" covers unstable conditions during which many circuits have difficulty in getting messages through natural interference; "W" indicates an ionospheric storm within 12 hours; "N" indicates conditions normal. On all frequencies, this propagation notice is given at 19 and 41 minutes past the hour; the single letter follows the c.w. station call and is given (in c.w.) 6 times; voice announcement of station and time follow. (W1AW via NNRC)

* * *

Short-Wave Census

Arthur E. Bear, London, secretary of the *International Short Wave Club*, informs me that ISWC is conducting a worldwide census of opinion to discover the most popular short-wave broadcasting stations or services. The club asks listeners—whether members of ISWC or not—to send ISWC the names of their five (5) favorite stations in order of popularity. A postcard will do. It is believed that interesting information will be derived and it will be published and communicated to the stations in question. QRA is ISWC, 100, Adams Gardens Estate, London, S.E. 16, England.

* * *

Club Notes

Canada—A newcomer to the radio club ranks is the *Canadian DX Club* (Continued on page 98)

Bill Leonard, who holds amateur station call letters W2SKE, conducts the "Radio Amateur Program," broadcast in English every Sunday over the "Voice of America."



WHEATSTONE BRIDGE APPLICATIONS

By
MICHAEL WOLFE

TO MANY readers the Wheatstone bridge will be associated chiefly with precision test equipment and other applications in which the value of an unknown quantity is to be determined. Less well known are the uses to which this versatile circuit may be employed in other fields. One of these is in controlling a number of circuits, remotely located, over a single transmission line. One solution, commonly used, is the triggering of resonant circuits and relay combinations by means of appropriate audio or supersonic frequencies. A simpler method is to adjust the spring tension or series resistance in a number of paralleled d.c. relays in such a manner that the separate relays will close at various values of voltage impressed across them (Fig. 1A). This system has an obvious disadvantage in that all of the remote circuits must be energized in order to operate the last relay of the sequence, although the arrangement may be made somewhat more flexible by impressing both an a.c. and a d.c. component on the control line and using a simple resistance-capacitance network at the receiving end to separate the two components which may then be used to operate two separate relay sequences.

An interesting and flexible arrangement may be set up by using a number of relays in a modified bridge circuit such as shown in Fig. 1B. In this instance, each relay will have current flowing through its coil at all times except when its particular portion of the bridge element is balanced. As a result it is possible to open or close any relay in the series by manipulation of a variable resistance or voltage source at the control point. A system of this nature is analogous to the tuned circuit method in that the total current change available in the bridge system has a counterpart in the total bandwidth or frequency range available in the resonant circuit technique. Similarly, the sensitivity of the relay used is analogous to the "Q" of the resonant circuit. This places a limitation on the number of circuits that may be controlled by a given set of conditions. For example, if the relay sensitivity is one milliamperere and the maximum permissible current is twenty milliampereres, then the total number of circuits would probably not exceed ten, as each relay would operate over a range of plus or minus one mil-



A compact, a.c. operated Wheatstone bridge used as an electronic lock and if desired, for remote control applications.

Several relay-operated control circuits designed around the well-known Wheatstone bridge principle.

liampere or a total of two milliampereres.

More flexible operation may be secured by using a tube operated relay system. In Fig. 2, the two sections of a 6SN7 dual triode are used as two legs of the bridge circuit. The reference voltage is applied to the grid of one section and the signal voltage to the grid of the other. Advantages are that no energy need be contributed by

the signal source and any reasonable amount of time delay may be obtained by inserting the proper resistance-capacitance network in the signal grid circuit. Likewise, the tube tends to perform a current limiting function and isolates the relay so that the other relay circuits are not affected by an accidental relay burnout or short circuit. In addition, extra relay sensitivity may be secured by tube amplification, thus increasing the number of usable circuits.

The particular value of the bridge circuits described is that they will function at one point only. This characteristic may be used in cases where indication or warning of any phenomenon may be converted into a change of voltage or resistance. Many pieces of industrial equipment make use of this fact in indicating variations of temperature, pressure, or other physical changes, and in production line work, similar circuits are used to automatically reject components which exceed the tolerance limits.

Probably the application that will appeal most to the home constructor is the construction of an electronic lock (Fig. 3). Conventional locks suffer from a physical restriction. If a key of reasonable dimensions is to be used, then the elements of the lock must be

(Continued on page 102)

Fig. 1. (A) Diagram of simple relay group. Control sequence may be varied by adjusting resistance in series with relay or changing relay spring tension. (B) A modified bridge setup. Any relay in the series may be opened by applying a voltage equal to that developed across relay.

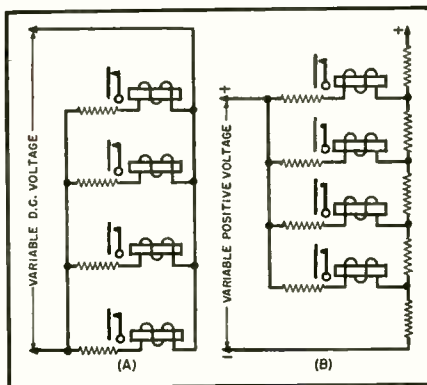

MOBILE ANTENNA FOR 75 METERS

By
R. W. JONES,
W6EDG

Details on a center-loaded whip. A test unit for adjusting it to exact resonance is included.

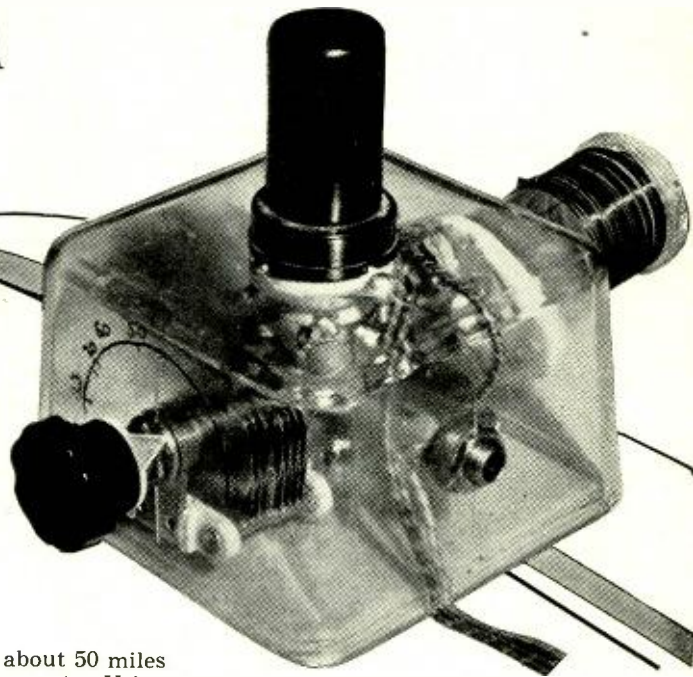

Fig. 1. Close-up view of the test oscillator used to adjust antenna to resonance.

OPERATION of mobile rigs on 75 meters is becoming increasingly popular; it is a lot of fun and opens a new field for ham operation and experimentation. Most mobile operation in the past has been confined to 10 meters and the higher frequency bands. Some good DX records have been made on 10 meters with mobile rigs but these contacts lack the personal touch of the relatively local QSO's on 75 meters. On a recent trip from Sonoma, California to Bremerton, Washington the writer's 75 meter mobile rig was used for contacts with hams along the route and these QSO's were followed up by visits in person. In one case a QSO with W7HHH, Bea and Carl Austin

in Bend, Oregon, saved about 50 miles and took us over a better route. Using the 75 meter rig on this trip made the otherwise dull trip one to remember.

Generally the first question asked of a mobile station when he makes a contact is, "What type antenna are you using?" This article will describe an antenna that has worked very well on the mobile installation for W6EDG and will also give some ideas on pruning a mobile antenna to the operating frequency for those that already have mobile antennas in use.

The general practice on mobile rigs is to use an electrical quarter-wave antenna. A normal quarter-wave for 75 meters is about 60 feet long so it is obviously impossible to have that much antenna on the automobile. The next best thing is to have the antenna an electrical quarter-wave by lumping some of the inductance of the antenna in a loading coil.

The portion of any antenna that does the most radiating is that part of the antenna carrying the highest current. The high current section of a quarter-wave antenna is the section

near the base or ground end. The best place for the loading inductance would, therefore, be at the top of the antenna. If the loading coil is put at the top of the antenna there must be a top loading capacity of a disc or can. The top loading job would probably be the best system but there are mechanical limitations with the antenna installed on the rear of the car. The antenna to be described in this article is a center-loaded job which gets the high current portion of the antenna out in the open and not in a base-loading inductance. This antenna has the top section adjustable for tuning the antenna to the operating frequency. Another advantage of a center-loaded antenna is that rain and ice will have less detuning effect since the bottom of the antenna is at ground potential. With base-loaded jobs or with transmitters using loading inductances in the output circuits the base of the antenna will have some r.f. potential and be affected by weather changes.

The antenna is made in three sections: bottom section, center loading inductance, and top adjustable section. The bottom section is a mast section from a whip antenna, available as surplus for 50 cents. The bottom section is part of a 5-section whip and is marked part number MS51. The center section, the loading inductance, is made up of a 1" diameter, 12" long bakelite rod with the ends drilled to fit the MS51 mast section and the adjustable top portion of the antenna. The top section of the antenna is an adjustable automobile antenna made for cowl mounting. The extended length of the top section is 96". The top adjustable section is adjusted, as explained later, to tune the antenna to the correct frequency. The

Fig. 2. Detail of form for loading inductance (left), antenna dimensions (right).

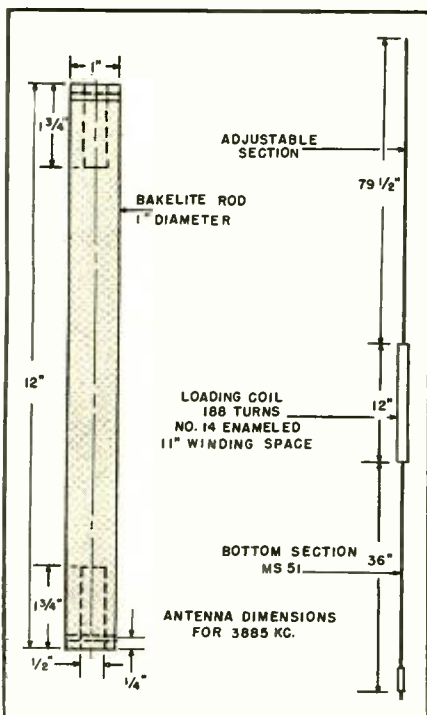
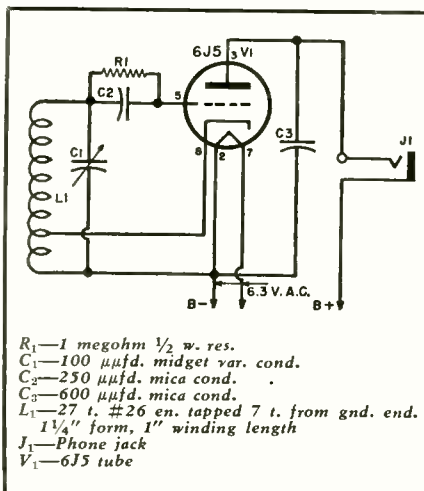

Fig. 3. Wiring diagram of test oscillator.



antenna is mounted on the car bumper on a base that was purchased as surplus and strengthened with two braces to hold the extra weight. The two braces are bolted to two pieces of bakelite that are clamped on the top of the base section.

The holes in the ends of the bakelite rod were drilled out on a lathe to make sure they were properly centered. Both holes are $\frac{1}{2}$ " diameter and $1\frac{3}{4}$ " deep. The knurled end of the MS51 section is $\frac{1}{2}$ " diameter and will be a snug fit into the bottom of the bakelite rod. In the top, a brass collar was fitted into the $\frac{1}{2}$ " hole and the top adjustable section fitted into the brass collar. This supplies extra mechanical support. After the MS51 section and the top automobile whip has been fitted into the bakelite rod two small holes are drilled $\frac{1}{4}$ " from either end of the bakelite rod, completely through the bakelite rod and the antenna sections. These holes should be a tight fit for a machine screw that can be screwed through the bakelite rod and antenna sections. These two screws, one at each end of the bakelite rod, serve as connections for the loading inductance winding. The winding is started $\frac{1}{2}$ " in from the end of the rod and 188 turns of #14 enameled wire are closewound on the bakelite rod. The ends of the winding are connected to the two machine screws that go through the rod and antenna sections.

In using a mobile antenna with a transmitter of moderate power it is important that the best efficiency be obtained from the antenna and transmitter installation. Experience has shown that the two most important things for good results with a low power mobile transmitter are 100% modulation and a good radiating system. A good radiating system means not only an antenna that is well built but one that is tuned to the operating frequency. An antenna that is self-resonant at the operating frequency will require no loading section in the transmitter or additional inductance at the base of the antenna. The best way to check for the resonant frequency of an antenna is with a grid dip meter. The antenna will act like a tuned circuit, giving a reading on the grid dip indicating device when the grid dip meter is tuned through the resonant frequency of the antenna. To couple the antenna, a two-turn loop is connected from the bottom of the antenna to the car body and the grid dip meter coupled to the two-turn link. Fig. 4 shows a reading being taken with a grid dip meter. If the resonant frequency indication of the antenna is too low the antenna is shortened by adjusting the top section. If the resonant frequency is too high the top adjustable section is made longer. The antenna should be checked and adjusted until it is resonant at the frequency of the transmitter. Fig. 6 shows the relative effect of change of length on resonant frequency. This graph will not be cor-

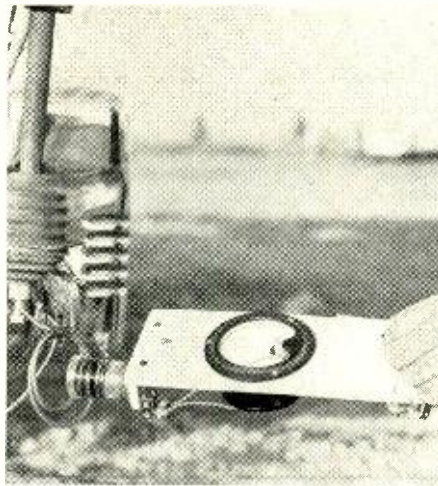

Fig. 4. Checking the resonant frequency of the mobile antenna with a grid dip meter.

rect for all antenna installations but will give some idea of the amount of adjustment required for a specified frequency shift. It may be necessary to remove or add turns to the loading inductance. After the antenna has been checked at the correct resonant frequency, with the antenna installed on the car at its normal position and the trunk lid closed, it is ready for operation. The antenna should be fed at the base with some type of low impedance line.

I have stressed the importance of checking the resonant frequency of the antenna with a grid dip meter. I realize that many amateurs do not have grid dip meters and therefore a junk box substitute was built up to see if a circuit could be used that would do the same job as a grid dip meter.

Fig. 1 shows a close-up of the "Bloopers," as I call it. This little rig
(Continued on page 161)



Fig. 5. A close-up view of the loading inductance as used in the mobile antenna.

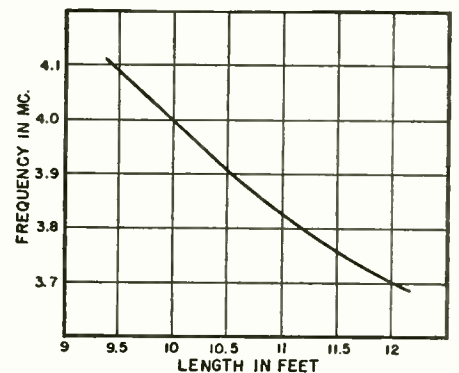
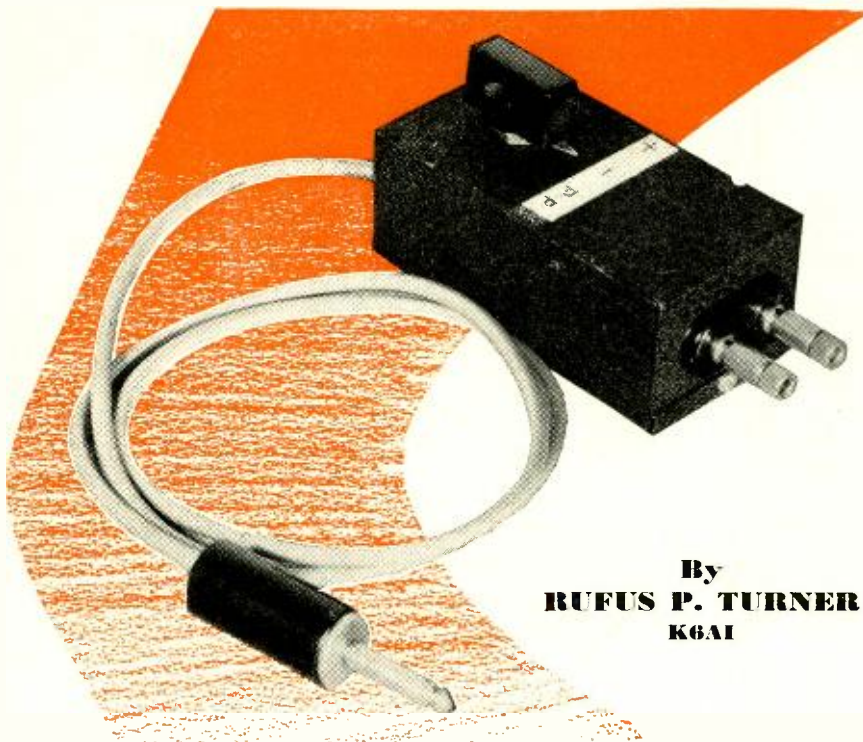

Fig. 6. Effect of length of antenna on resonant frequency. This is an example only and is designed to show the change of resonant frequency with length variations. The actual resonant frequency will vary with different installations due to different capacity effects of car body. Final adjustments should be made only after antenna is in its normal position and trunk is closed.

Fig. 7. (Left) Taking a reading of the resonant frequency of the mobile antenna with the "Bloopers." When the audio tone stops in the headphones the resonant frequency is indicated on the dial. The rods used to strengthen the base mounting are also visible. (Below) The antenna is attached to the rear bumper of the car and coupled to the transmitter through a low impedance line.



By
RUFUS P. TURNER
K6AI

NEW APPLICATIONS for CRYSTAL DIODES

A description of several interesting and handy gadgets which use the popular germanium diodes.

THE versatility of the germanium crystal diode is unsurpassed by any other simple circuit component. Intended primarily as a signal-powered 2-terminal rectifier, this war-spawned refinement of the ancient crystal detector has been adapted to a variety of interesting and useful devices. Presented herewith are several of the most recent gadgets from the author's workbench. These devices will be of particular interest to experimenters and amateurs.

Combination Meter Probe

In audio and r.f. testing, it very often is desirable to know peak-to-peak voltage values. Conventional cable-end probes of both crystal and tube types employed with d.c. vacuum tube voltmeters commonly indicate either positive or negative peaks only, depending upon polarity of the diode.

The probe circuit shown in Fig. 2 permits measurement of peak-to-peak voltages with a d.c. vacuum tube voltmeter. The peak-to-peak voltage is read directly on the scale of the d.c. instrument, except at low voltages (less than 2 volts r.m.s.) in which instance the meter reading deviates slightly from true peak values.

The circuit consists of two shunt-connected diodes in parallel. The left-hand 1N34 is the negative peak rectifier; the right-hand 1N34, the positive peak rectifier. Condensers C_1 and C_2 are charged approximately to peak

Fig. 2. Circuit diagram of the peak-to-peak probe with details of switch wiring for three-way voltage measurements. Position A is for measuring positive peaks, B for negative peaks, C for peak-to-peak.

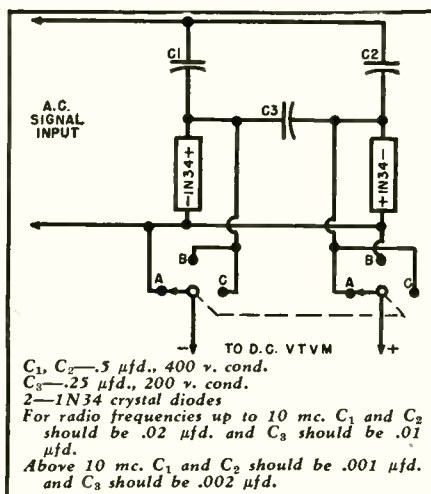

← Fig. 1. Combination probe using the circuit shown in Fig. 2. Setting the 3-position switch enables the d.c. vacuum tube voltmeter, to which the probe is attached, to read either negative peaks, positive peaks, or peak-to-peak voltages.

voltage levels by alternate half-cycles of input voltage, and serve also to isolate the crystal diodes from any damaging d.c. component which may be present in the signal voltage.

For use throughout the audio-frequency spectrum; condensers C_1 and C_2 each must be 0.5 $\mu\text{fd.}$, and C_3 must be 0.25 $\mu\text{fd.}$ These can be the new miniature metallized units. At radio frequencies, up to 10 megacycles, C_1 and C_2 each must be 0.02 $\mu\text{fd.}$ and can consist each of two 0.01- $\mu\text{fd.}$ mica condensers connected in parallel. C_3 must be 0.01 $\mu\text{fd.}$ Above 10 mc., C_1 and C_2 must be reduced to 0.001 $\mu\text{fd.}$ and C_3 must be 0.002 $\mu\text{fd.}$

By connecting a small 2-pole, 3-position, single-wafer selector switch in the circuit, as shown in Fig. 2, the probe may be used at will for checking positive peak, negative peak, or peak-to-peak voltages. A completed probe of this latter type is shown in the photograph, Fig. 1.

Use of both probe circuits (Fig. 2) is limited to a.c. input voltages not in excess of 20 volts r.m.s. (56.6 volts peak-to-peak).

Germanium Diode Modulator

The non-linear characteristic of the germanium diode may be used to advantage in obtaining amplitude modulation in a very simple manner. Fig. 3A gives the circuit of a modulator of this type. Ring modulators have been used formerly for comparable modulation, but the ring circuit has two important disadvantages for some applications—it requires four closely-matched crystals and it suppresses the r.f. carrier, delivering upper and lower sideband output. The circuit of Fig. 3A requires only one 1N34, which need not be specially selected, and delivers amplitude-modulated carrier.

An unmodulated (pure c.w.) signal is fed into one pair of input terminals, and a modulating voltage into the other pair of input terminals. The output terminals deliver a modulated r.f. signal at the original carrier frequency. The modulating signal may be a single audio tone of any desired frequency, speech, or r.f., and may be sine-wave or complex-wave. The modulating voltage level may be adjusted (for example, by means of the output control of a modulating audio oscillator) to obtain complete modulation, or any percentage of modulation, with low distortion.

The diode modulator can be used to modulate the c.w. output of a signal generator which has no provision for external modulation. It may be used similarly to modulate the output of a frequency standard. An application which undoubtedly will interest c.w. operators is use of the modulator to tone-modulate incoming straight c.w.

signals. Fig. 3B shows one way of connecting the modulator into a receiver for this purpose. Here the unit is inserted between two successive i.f. amplifier stages or between the last i.f. amplifier and 2nd detector. It can be connected similarly between two tuned r.f. amplifier stages. A simple 1-tube audio oscillator can be employed as the audio signal source.

The circuit of Fig. 3A has the advantage that a common ground is provided between r.f. carrier source, modulating source, and output.

Fig. 6 shows a complete modulator unit mounted on a small phenolic sub-panel ready to be wired into a receiver circuit or installed in a metal can.

Harmonic Accentuator

The non-linear characteristic of the germanium diode also may be employed to intensify radio-frequency harmonics in the output of a frequency standard or of a low-powered oscillator or buffer in a transmitter. Fig. 4 is the circuit of a tubeless harmonic accentuator built especially for intensification of harmonics from a 100 kc. standard frequency oscillator.

Two Type 1N56 high-conduction diodes are used. These are connected back-to-back so as to operate on each half-cycle of signal voltage. The distortion introduced by these diodes serves to intensify harmonic output.

Tuning condenser C_1 will be 50 or 100 $\mu\text{fd.}$ maximum for the amateur bands. For general coverage, use a 350- or 365- $\mu\text{fd.}$ broadcast-type tuning condenser. The coils may be wound according to instructions which may be found in the coil tables in the amateur handbooks.

In order to operate properly, the crystals must have a complete d.c. return path. This generally is provided by the output coupling coil or attenuator in the r.f. signal source. When the latter has condenser output, however, the return path is blocked, and a resistor (R_1) must be connected into the accentuator circuit, as shown by the dotted lines in Fig. 4. The resistance of R_1 is not critical, but it is a good rule to make it equal to the output impedance (in ohms) of the r.f. signal source. If this output impedance is of an undetermined high value, 10,000 ohms will be a good compromise value for R_1 .

Condenser C_1 is tuned to resonate coil L_1 at the desired harmonic frequency. Both L_1 and L_2 may be wound on a single 4-prong, plug-in coil form.

The r.f. input voltage must be held to a maximum of 10 volts r.m.s., in order to keep within crystal ratings.

Voltage Regulator

The germanium diode can be used to regulate low d.c. voltages in a fashion somewhat comparable to the use of VR-type gaseous regulator tubes for regulation of higher voltages. Fig. 5 shows the simple circuit of a germanium regulator.

While the crystal does not maintain a constant voltage drop across itself

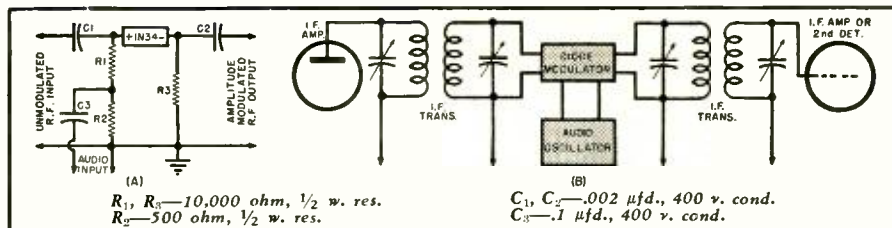

Fig. 3. (A) Circuit of diode modulator. (B) Arrangement for tone-modulating receiver signals.

as the VR tube does, its change in voltage is small as the output current drain varies over rather wide limits. A regulator of this type was set up to supply $1\frac{1}{4}$ volts for a particular application. The input voltage was $1\frac{1}{2}$ v. and the current limiting resistor, R , was 10 ohms. The no-load and 1-ma. output voltage was $1\frac{1}{4}$ v., and the output voltage at 50 ma. drain was 1.10 v. Between 1 ma. and 50 ma. drain, this performance represented a voltage drop of only 12 per-cent for a current increase of 50 times.

The current limiting resistor, R , must be adjusted with each particular d.c. supply voltage to pass maximum rated current through the crystal when the load circuit is disconnected from the output terminals. This maximum current value is 40 milliamperes for the 1N34, 38, 39, 54, 55, and 58 and is 50 ma. for the 1N56. The exact value of resistance required will vary with individual crystals and different supply voltages. It must be determined by experiment.

When R must be reduced in order to obtain more output current, connect two or more crystals, as required, in parallel to handle the increased current. When higher output voltage than about 2 volts d.c. is required, connect several crystals in series, allowing about 2 volts per crystal.

"R" Oscillator

The reverse conduction curve of the germanium diode (when the crystal anode is connected to the negative

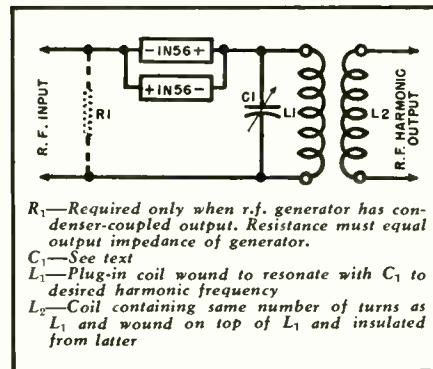

Fig. 4. Diagram of a harmonic accentuator.

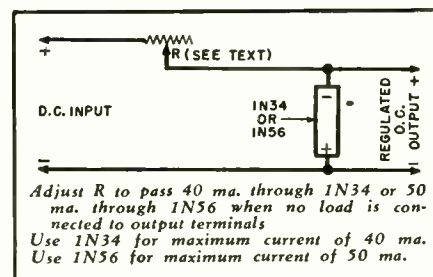
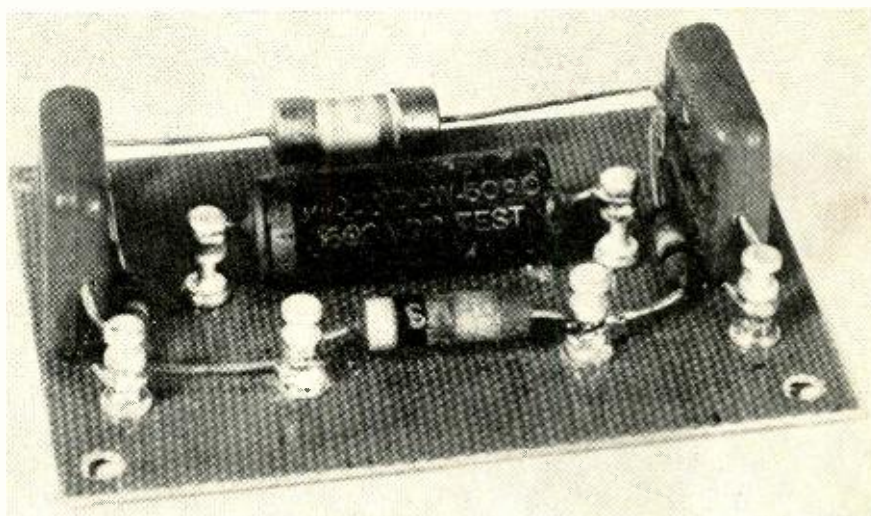

Fig. 5. Circuit for a low-voltage regulator.

terminal of a d.c. supply) is interesting in that it shows a sharp increased-current slope at a relatively high back voltage. The point at which this rapid increase in reverse current starts is designated as "X" in the curve in Fig. 7. The actual voltage at this point varies with individual crystals, but lies
 (Continued on page 150)

Fig. 6. Crystal diode amplitude modulator using the circuit shown in Fig. 3A. This simple device permits modulation of a low-level r.f. signal with either an audio frequency source or speech. It may be used for external modulation of a signal generator and also to tone-modulate received continuous wave signals.



Linearity Tests with an OSCILLOSCOPE

By
GLEN SOUTHWORTH

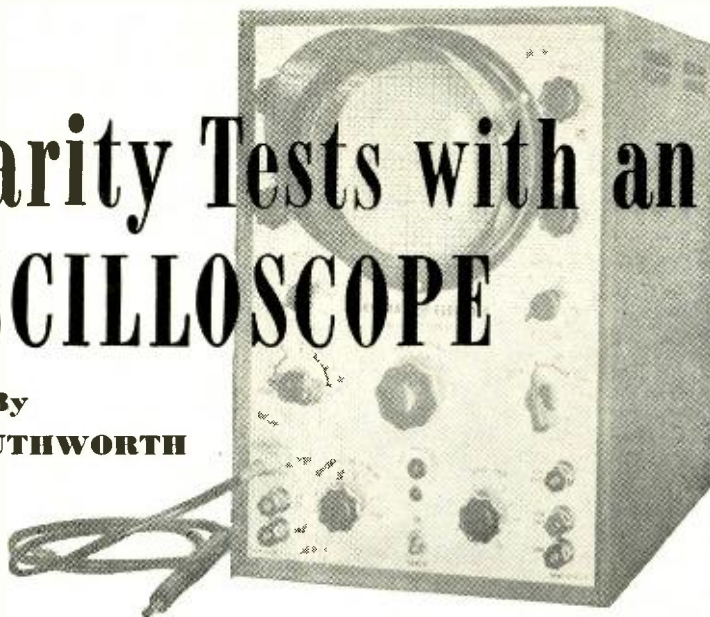

An easily-assembled amplifier test setup which uses an audio oscillator and an oscilloscope.

AN AUDIO oscillator in conjunction with an oscilloscope makes an excellent and flexible means of providing an almost literal representation of linearity. If the same signal is applied to the horizontal and vertical amplifiers of a scope a diagonal line will result, the direction of which will depend upon the relative magnitudes of the signals applied to the two deflection plates. A system of this nature is very easy to set up and is versatile in that it may be used to quickly identify nonlinearity, harmonic distortion, phase shift, or frequency response variations in an audio system. A block diagram of a test setup that may be used to identify all of these characteristics is shown in Fig. 1. The output of a variable frequency audio oscillator is fed into an attenuator, the output of which feeds both the equipment under test and the horizontal scope amplifier. The output of the equipment under test is connected to the vertical scope amplifier.

Probably the best known test is for phase shift. In this case a straight diagonal line will be formed if the output of the equipment under test has a zero or 180 degree phase relationship with the input. Other phase shifts will produce an oval pattern, while a 90 degree relationship will tend to produce a nearly circular pattern. The phase characteristic is important because in order to achieve maximum accuracy in the other tests, the phase distortion should be as low as possible.

If harmonic distortion is present in a system, the input-output relationships will not be such as to produce a straight diagonal line on the oscilloscope screen, but will result in curvature or a sudden discontinuity. Harmonic percentages as low as approximately three per-cent may be detected

in this manner, and due to the fact that no careful tuning or adjustment of controls is necessary, such as in the case of wave analyzers or other types of distortion meters, rapid checks over a wide frequency range may be made.

The oscilloscope patterns shown in Fig. 2 illustrate some of the traces likely to be encountered. *A* is the straight diagonal line resulting from undistorted input-output relationships. *B* is the same case but with less than 180 degree phase shift causing the pattern to assume an oval shape which makes small discontinuities less easy to detect. The third pattern illustrates second harmonic distortion such as is likely to be encountered in single-ended amplifiers. The bend is caused by gradual flattening of the positive peaks, such as shown by the accompanying sine wave pattern. This form of second harmonic distortion appears to be most common and is caused by out-of-phase harmonic components. Less often found is the in-phase form shown in *E* and in which one of the peaks develops an extra projection. This type of distortion may occasionally be observed in push-pull output stages where a split load or "kangaroo" type of phase inverter is used. The cause for this seems to be that if the output tubes are driven hard enough to draw grid current, a partial short circuit of the driver cathode resistor may result due to the change in grid impedance; this, in turn, may cause the gain in the plate circuit of the driver to considerably exceed unity during peaks.

G shows the pattern of out-of-phase third harmonic distortion, often found in push-pull amplifiers. Both positive and negative peaks are suppressed with the result that not only are har-

monics produced but high frequency components of a complex wave will tend to be modulated in a negative sense. *I* illustrates in-phase third harmonic distortion characterized by extension of the sine wave peaks. In this instance, positive modulation of the high frequency components of a complex wave will occur due to the relatively greater gain during the peaks of a low frequency cycle.

Although presumably everyone knows what distortion sounds like, an experiment was performed in order to see if there were any readily identifiable characteristics of systems producing almost exclusively third harmonic distortion of considerable amplitude. The comparison between systems generating in-phase and out-of-phase third harmonics were very interesting and it might be noted that simple harmonic distortion is not necessarily of an unpleasing character although it may produce wide variations in apparent dynamics and tone color.

In the first experiments in-phase third harmonics were obtained by means of a circuit similar to a modified class B amplifier. The resultant reproduction tended to resemble that which might be produced by an inertialess volume expander in that high intensity sounds received added emphasis. This, in turn, gave rise to an effect of an apparent change in acoustics due to the rapid decay of damped wave trains following high level transients. The resulting reproduction had a somewhat hard, mechanical effect with apparent added emphasis to the mid-frequencies producing a somewhat monotone effect, much of which was assumed to result from the greater stimulation of speaker, cabinet, and room resonances due to the higher amplitude peaks involved, although harmonic products tend to be most audible in the mid-frequency region.

Out-of-phase operation appeared to secure almost the reverse effects. Amplitude peaks tended to be suppressed with the result that the apparent decay period was longer. Suppression of high frequency components due to negative modulation gave the effect of added bassiness, while dynamic effects tended to resemble those produced by volume compression.

The previous observations were made with equipment which, by virtue of their linearity characteristics, produced relatively large amounts of third harmonics without producing appreciable higher order distortions. This is of importance in achieving acceptable reproduction due to the fact that the ear, itself, has a nonlinear characteristic—that is, it is capable of perceiving sounds varying over an intensity range of more than 100 decibels. From this it might be inferred that it would be almost impossible to achieve perfect reproduction of even simple tones because the distortion in the reproduction should then not exceed one thousandth of one per-cent. As a matter of practice it has been

shown that due to the nonlinear characteristic of the ear three per-cent simple harmonic distortion is usually undetectable even if the original signal is available for direct comparison. However, high order harmonics, especially in the lower frequencies, are readily detectable at much lower percentages due to the lowered masking of the harmonic by the fundamental and the nonlinear frequency characteristic of the ear.

In connection with the foregoing paragraph, a factor seldom considered is the waveform of an amplifier output at saturation. It is often the practice to use feedback or other means to hold the distortion percentages to a low value until maximum output is very nearly reached. Above this point a very abrupt flattening of the sine wave peaks may occur with resultant high order harmonic distortion. This effect is not particularly important in cases where adequate power reserve for any situation is available, but becomes a factor in public address work or other applications in which maximum efficiency must be achieved. The abrupt flattopping of the output may cause the load line to change greatly and in the case of an inductive load, such as a loudspeaker, cause a high intensity transient, such as illustrated in K, to be produced. If the output is too lightly loaded, the primary inductance of the output transformer may react to the square topped wave by producing a transient pulse of up to several thousand volts, often resulting in punctured insulation and subsequent failure of some component. In practice, a condenser is often placed across the primary of the output transformer in order to create a relatively low reactance at high frequencies where the loudspeaker may not represent sufficient impedance, but this may have the disadvantage of resonating with the transformer inductance somewhere in the audio range and causing distortion of impulse noise as well as other effects. Triodes, due to the fact that they have lower plate resistances, may have a somewhat superior damping effect on the output transformer, and usually require lower values of primary inductance, thereby decreasing the likelihood of excessive leakage reactance.

In many instances flattopping appears to result from the use of driver stages with insufficient capacity. In the case of a conventional class AB amplifier, driven by an RC-coupled phase inverter, the grids of the output stage will represent a relatively high impedance up to the point at which grid current is drawn. At this point a sharp decrease in grid impedance will occur, resulting in driver mismatch and peak clipping. One solution to this problem found in some high quality amplifiers is the use of a relatively low impedance driver stage, such as a cathode follower, capable of delivering power to the output grids during momentary periods of

overload. The peak output available is somewhat increased by this method and the peaks of the waveform at overload are somewhat rounded rather than presenting sharp discontinuities. The effect is somewhat analogous to the peak clipping used in communications in which limiting is accomplished without accompanying splatter.

Although by Fourier analysis, a flat topped or essentially square wave can be resolved into a fundamental and series of harmonics, in many cases neither a loudspeaker nor the ear will act as a perfect wave analyzer and waveforms with sharp discontinuities may act as transients which excite any resonances in the system. In woofer-tweeter systems using a high frequency crossover network, the clipping of a sudden peak may result in the application of a sharply differentiated pulse to the tweeter with disagreeable reproduction ensuing.

Although nonlinearity is usually associated with harmonic distortion, under certain circumstances there is no exact relationship and there are several methods of achieving a high degree of nonlinearity without appreciable harmonic production. Probably the

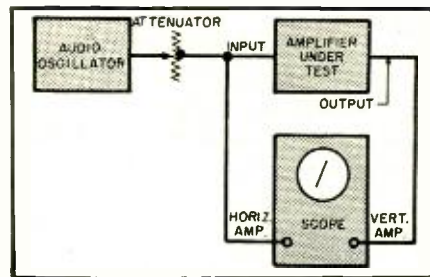
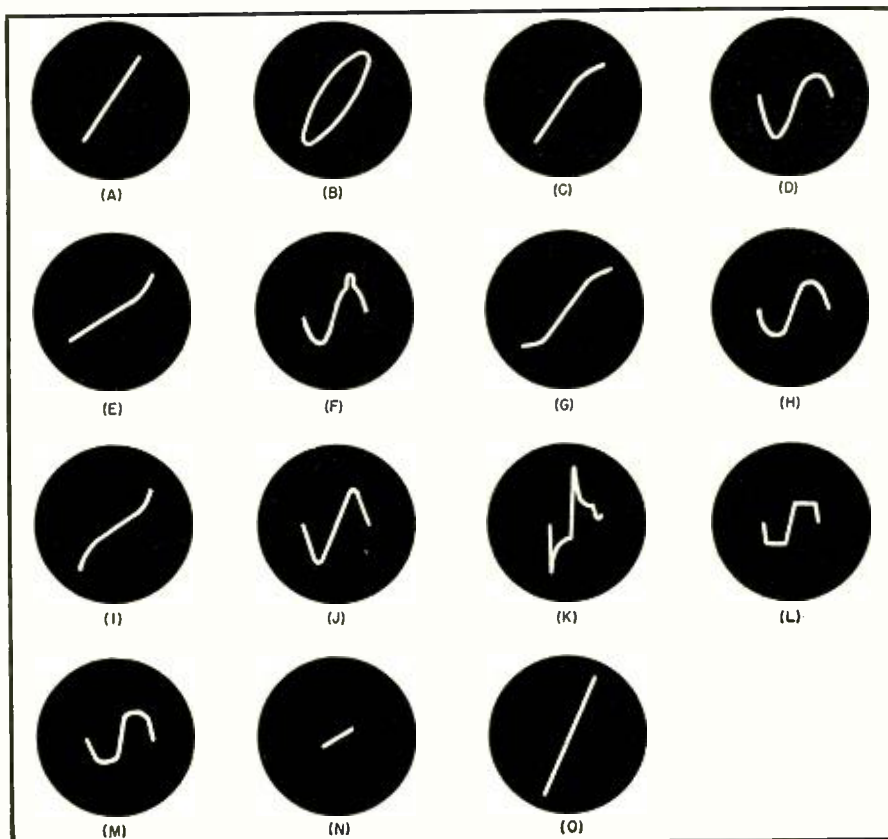

Fig. 1. Block diagram of simple test setup for checking phase shift, frequency response, harmonic distortion, and nonlinearity.

most familiar example of this is the conventional volume expander or compressor, although a certain amount of electrical inertia is usually associated with this effect. A more recent device makes use of nonlinearity to achieve inertialess noise reduction by splitting the audio spectrum up into octave bandwidths and clipping or otherwise altering the audio frequency components in the desired manner. Any harmonics produced by this process are suppressed due to the limited individual bandwidths involved and
(Continued on page 157)

Fig. 2. (A) Trace obtained by method described in text when no phase shift or harmonic distortion is present. (B) Shows same trace but with some phase shift present. (C) Illustrating trace obtained when out-of-phase second harmonics are present. (D) Corresponding sine wave trace of (C). (E) In-phase second harmonic distortion. (F) Corresponding sine wave trace. (G) Trace of out-of-phase third harmonic distortion. (H) Resulting sine wave pattern. (I) and (J) Representative in-phase third harmonic patterns. (K) Illustrating the high intensity transient pulses that may be caused by an overdriven amplifier feeding an inductive load. (L) Showing the trace of the same amplifier feeding a resistive load while (M) illustrates pattern of an amplifier feeding a resistive load in which the output tubes are driven into the grid current region thus producing a waveform with more rounded peaks. (N) The reference pattern of a nonlinear device, such as a volume expander at low level. (O) Pattern of same device at high output levels showing change of direction of trace caused by nonlinearity.



An AUDIO OSCILLATOR and V.T.V.M.

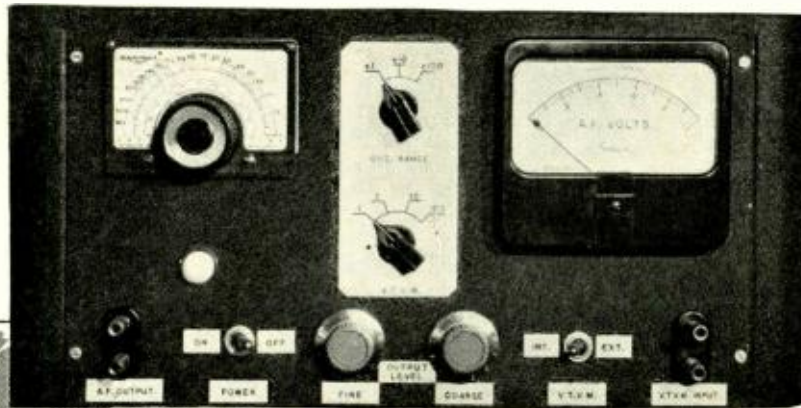

By
LOREN C. WATKINS, JR.
W5JXO

Fig. 1. Front view of completed unit. Frequency range covered is from 21-35,000 c.p.s.

Construction details on a versatile test instrument. Frequency range of oscillator is 21 to 35,000 c.p.s. The v.t.v.m. features linear meter scale, one-tenth volt maximum full-scale sensitivity, and flat response from 20 to 200,000 c.p.s.

THE many uses for a good, continuously variable frequency audio oscillator and dependable vacuum tube voltmeter for audio frequency use are well known to the amateur fraternity, "hi-fi" enthusiasts, and for service work in general. Several excellent articles on the subject have appeared in *RADIO & TELEVISION NEWS* and other radio magazines in recent years. A rather thorough review of this information is highly recommended to anyone contemplating the construction of such a unit as we are about to describe.

In our unit the oscillator and v.t.v.m. are actually independent devices, utilizing the same power supply and cabinet. The oscillator covers a frequency range, continuously variable, from 21 c.p.s. to 35,000 c.p.s. This is accomplished in three "decaded" ranges with only one dial calibration necessary. The output voltage remains constant within 1 decibel and the total distortion present in the output is less than 1%. Coarse and fine output level controls are provided so that the output voltage may be smoothly varied from a few millivolts to the maximum of approximately 20 volts.

The v.t.v.m. may be switched to read either the output voltage of the oscillator or an external audio voltage. Maximum full scale sensitivity is 0.1 volt, with additional full scale ranges of 1, 10, and 100 volts. The frequency response is flat from 20 to 200,000 c.p.s., these figures being the limits of our standard frequency source. No special scale is required for the 0-1 ma. meter used in this instrument, as the tracking error is well within the inherent percentage accuracy of the meter itself, or 2%. The v.t.v.m. input impedance remains nearly constant at

10 megohms so negligible loading occurs of a circuit under test.

The Audio Oscillator

In the schematic diagram, Fig. 2, V_1 is the oscillator tube. V_2 acts as a feedback amplifier. The 3-watt lamp in the cathode circuit of V_1 serves to stabilize the amplitude of oscillation. The Wien Bridge oscillator may conveniently be made to produce a wide range of frequencies, with excellent frequency stability. The frequency at which the circuit oscillates is $f_0 = 1/2\pi RC$. For example, if R is 20 megohms and C is 380 μfd . the frequency of oscillation is 21 cycles per second.

Two methods are commonly used to vary the frequency of oscillation of the Wien Bridge circuit. We may use a dual potentiometer and switch in different values of fixed condensers to cover the desired range, or we may use a ganged variable air condenser and switch in fixed values of resistance. The first method may immediately be eliminated from consideration for use in a quality oscillator. The tracking error cannot be tolerated where we wish to use a decaded range switch and a one-calibration dial for all ranges. A small percentage of tracking error will introduce considerable distortion, among other ill effects. It is also easier to obtain precision resistors than fixed condensers within the necessary tolerance. A variable air condenser tracks almost perfectly, and used with the economical *IRC* "Precistors" of 1% accuracy a satisfactory solution to the problem is obtained. The variable condenser used in this unit actually costs less than a standard dual potentiometer at regular net prices.

There remains one other problem to be solved in connection with the vari-

able condenser method of changing frequency. Commercial practice has been to employ a total frequency variation of 20 to 20,000 c.p.s. obtained in three decaded ranges, that is from 20 to 200 c.p.s., etc. This allows the dial to be engraved with only one set of numbers, from 20 to 200 c.p.s., the two higher ranges being read by adding either one or two zeros to the indicated dial setting, depending upon the position of the range switch. The above mentioned frequencies adequately cover the audible frequency range and so were used as the design basis of our unit. We also desired to use the decade system of range switching in order to avoid the inconvenience of a separate dial calibration for each frequency range. Reference to the frequency of oscillation formula indicates that a capacitance variation of ten to one must be obtained to vary the frequency over a range of ten to one. If we mount the variable condenser on the chassis without a shield cover the oscillator will usually have a stubborn tendency to lock in with the a.c. line frequency and multiples thereof due to stray a.c. fields. If we place a shield around the condenser we eliminate that trouble but immediately increase the minimum capacitance to the point where difficulty may be had in maintaining the desired ten to one variation in capacity.

It has been common practice to employ a high capacitance per section, 4-gang variable condenser with two sections tied in parallel for each half of the bridge circuit. A total capacitance of around 900 to 1050 μfd . is thus obtained for each parallel group permitting the use of relatively low values of fixed decade resistors and a resultant decrease in circuit impedance to hum pickup, among other factors.

The large physical size of the condenser, and shield cover if used, results in a quite high minimum capacitance. Nevertheless, the desired ten to one variation in capacity is obtained with a good overlap. The main disadvantages of the use of a 4-gang variable is that the physical size of the completed oscillator is increased considerably, it is not a common stock item at most supply houses, and the cost is rather high even if a suitable high capacitance unit can be located.

We felt that the home constructor would gain a considerable advantage if a common two-gang variable could be used satisfactorily. Both sections of the condenser must have the same capacity and we need a condenser of small physical size to avoid increasing the frame capacity to chassis more than necessary. Condensers of this type are commonly used in broadcast receivers. One can easily be obtained from a junked chassis at the local ra-

dio service shop, or most junk boxes will yield a suitable unit. The condenser we used is a "junk box special" and saw former service in a small t.r.f. broadcast receiver. After a bath in carbon-tet and a drop or two of oil on the bearings it appeared good as new. Its capacity, as measured on a *General Radio* capacity bridge, went from 13 μf d. minimum to 375 μf d. maximum. We felt that, by taking a few precautions, the minimum capacitance could be held to about 30 μf d. after the condenser was mounted on the chassis. On this basis the maximum capacitance could be expected to increase by not more than about 10 μf d. Taking these allowances into consideration we still obtain a capacity variation of over 10 to 1. A few rough calculations indicated that a resistance of 20 megohms would be needed with 385 μf d. to obtain an oscillator frequency of 20 c.p.s. This same 20 megohm value should then yield a frequency of about 300

c.p.s. at the minimum capacitance setting of the condenser. Following through with our range "decade" scheme we note that a resistance of 2 megohms will give a frequency range from 200 to 3000 c.p.s., and a resistance of 200,000 ohms will provide the remaining coverage from 2000 to 30,000 c.p.s. These resistors must be the precision type of 1% accuracy, unless facilities are at hand to bridge a number of stock resistors and select suitable ones. The resistances specified are standard stock values in the *IRC "Precistor"* line and are economical in price. Reference to the photograph of Fig. 3 will show that we used various types of precision resistors from the junk box. Suitable *Ohmite* units were on hand for the 2 megohm and 200,000 ohm values. A quantity of standard *IRC* Type BTA composition resistors were bridged and a matched pair selected for the 20 megohm values. As it is quite difficult to obtain accurate

Fig. 2. Complete circuit diagram and parts list for the sine wave audio oscillator and audio frequency vacuum tube voltmeter.

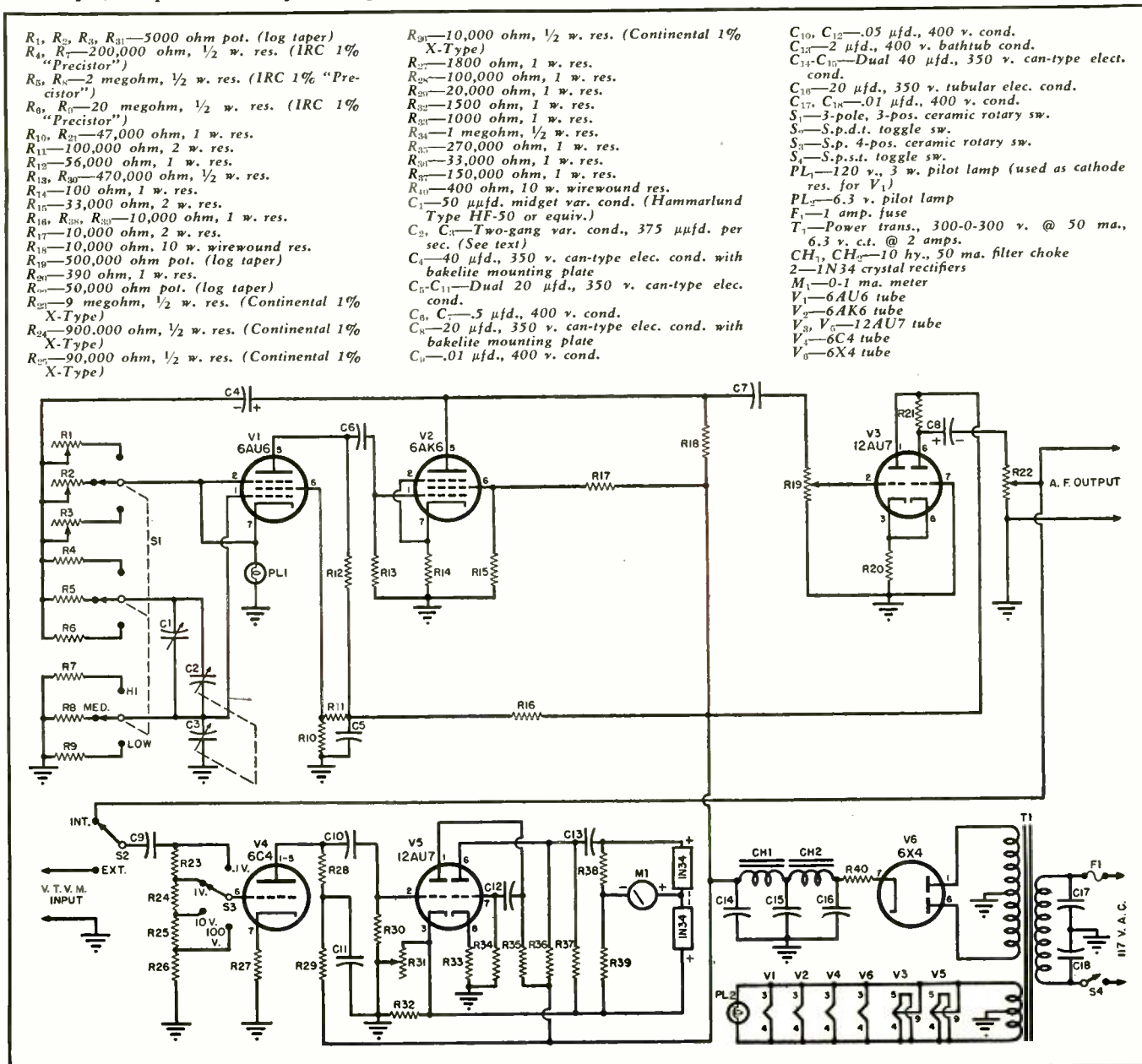

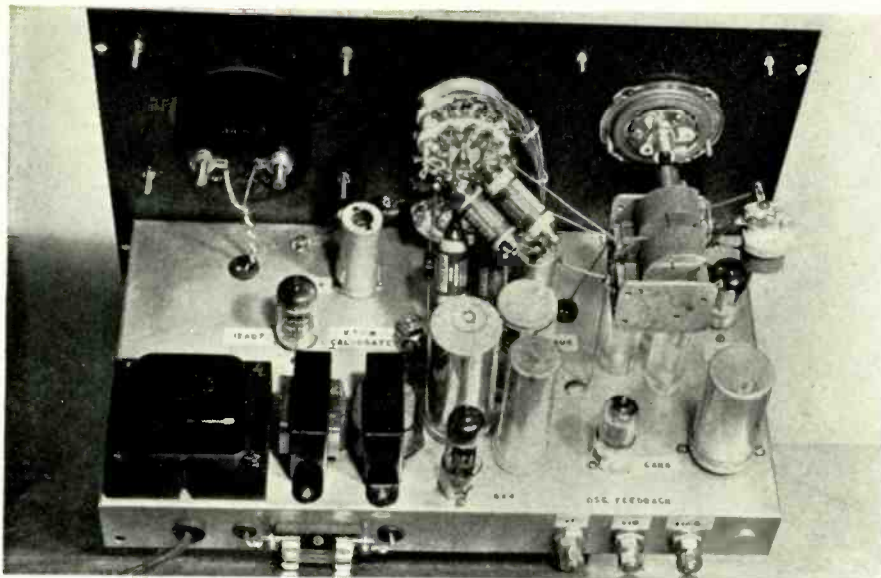

Fig. 3. Rear view of the completed instrument showing general layout of parts.

bridge measurements at 20 megohms of resistance, except by use of laboratory type equipment, it would be advisable to purchase precision resistors. The *IRC* Type DCH deposited carbon "Pre-cistors" are readily available and, to the best knowledge of the writer, are the only 20 megohm, 1% precision resistors available at low cost at the present time. The resistors specified in the parts list were chosen for their ready availability and low cost, although any resistors of suitable accuracy may be used. In case a variable condenser has to be purchased new, a suitable unit may be obtained from *Allied Radio*, Stock No. 61-061. This unit has a minimum capacitance of 13 μf d. and a maximum of 498 μf d. With the same values of range resistors the lowest obtainable oscillator frequency would then be about 16 c.p.s.

To avoid using a shield cover on the variable condenser, and thereby raising the minimum capacitance, certain component parts were placed on the chassis so that a natural shield was formed between the power supply components and the variable condenser. See Fig. 3 to get an idea of the arrangement. The condenser was mounted above the chassis on three polystyrene rods, $\frac{1}{2}$ inch in diameter and 2 inches long. The rods were drilled and tapped on each end for 6/32 screws, the bottom of the condenser already being provided with three tapped 6/32 holes. As the condenser shaft must be insulated from the chassis, a length of $\frac{1}{4}$ inch polystyrene rod and a solid shaft coupling is used from the variable shaft to the dial. This method was favored over an insulated flexible coupling which gave too much "slop" to the tuning action. The condenser should be spaced on the chassis so that about 2 inches of clearance is obtained in every direction from chassis or cabinet. The small compensating condenser, C_1 , is supported at one side of the front section of the main condenser by

short, heavy bus leads soldered directly to the terminals. This mounting method results in a very low minimum capacitance, and once the chassis is in the cabinet no tendency of the oscillator to lock in at the a.c. line frequency is observed. It will do so, however, if the unit is operated out of the metal cabinet.

That we were successful in keeping the minimum capacitance to a low value is indicated by measurements of the frequency range by use of a *General Radio* audio frequency bridge after the unit was completed. The lowest frequency obtained was 20.8 c.p.s. and the highest frequency for the "x1" range was just over 350 c.p.s. Substitution in the formula then reveals that the actual values of capacitance in use in the circuit are approximately 384 and 22.8 μf d. respectively, which is even better than the original approximations. It is also seen that the capacity ratio is 16.84 to 1 which serves as a check on our calculations, as the actual measured frequency variation bears the same ratio.

We have now obtained, in three ranges, a total frequency variation from 21 to 35,000 cycles per second and with the use of standard, easy to get, components. Reference to the front view of the unit, Fig. 1, will show that only one scale calibration has been made on the *National* Type MCN dial, from 21 to 350 cycles. This is, of course, a greater coverage than one decade, but we felt that it would be convenient to utilize the extra coverage that the unit provides, namely from 210 cycles to 350 cycles. Thus the upper frequency limit of 35,000 cycles can be made available on the calibrated dial. As a matter of convenience, and with the above idea in mind, we shall continue to refer to the three oscillator frequency ranges as being "decaded."

One other interesting feature of the

¹ Smith, Richard M.; "An RC-Type Audio Signal Generator," *QST*, January, 1950.

circuit should be examined at this point. In a typical oscillator of this type, only one feedback adjustment is usually provided. The problem then is to secure a setting of the feedback potentiometer such that oscillation is maintained over the total frequency range. If the feedback voltage is adjusted to the point where the unit will oscillate at the highest frequency then the feedback will usually be too great at the lowest frequency with a resultant large increase in output distortion. In addition, the frequency tracking problem of the decaded ranges is also the further problem of trying to hold the output voltage constant over the entire range of frequencies. These problems were solved nicely by using three identical feedback potentiometers, one for each range, and switching them by an extra deck on the range switch. The added cost of the two extra pots is insignificant and the final operational results many times repay the extra expense and trouble. The three potentiometers are mounted along the rear chassis drop, as may be seen from the photograph of Fig. 3. Shaft locks are used to prevent accidental turning of the shafts once calibration of the oscillator has been effected.

The electrolytic coupling condensers, C_1 and C_2 , must have their cans isolated from ground or chassis, so must be mounted on insulating plates. In Fig. 3, C_1 is located just to the left of the tuning condenser and C_2 is mounted in the right rear corner of the chassis. Tube V_1 is simply a voltage amplifier and isolating stage to prevent undesirable loading effects on the oscillator proper. Potentiometer R_{10} acts as the "coarse" output level control and determines the amount of signal voltage fed to the grid of the first triode in V_2 . This first section of V_2 acts as a cathode follower, its output being coupled through the common cathode resistor, R_{20} , to the second triode section which acts as a grounded grid amplifier. This particular type of amplifier is capable of nearly distortionless amplification up to about 20 volts of output level, and requires but few parts. Potentiometer R_{20} is the "fine" output level control.

Coupling condenser C_1 is shielded by a strip of copper or tin wrapped around the condenser and spot soldered. A ground lead is soldered to the shield and run to chassis ground. This shielding was found necessary to prevent undesired coupling into the nearby v.t. v.m. input circuit components at the higher audio frequencies. This condenser may be seen located near the output level potentiometers in the bottom view of Fig. 4.

Calibration of the oscillator is probably best accomplished by use of another oscillator of known accuracy and an oscilloscope, utilizing a "one to one" indication on the scope. The Lissajous figure method¹ may also be used but is rather tedious and requires considerable care in interpretation of the scope patterns. Before the actual frequency

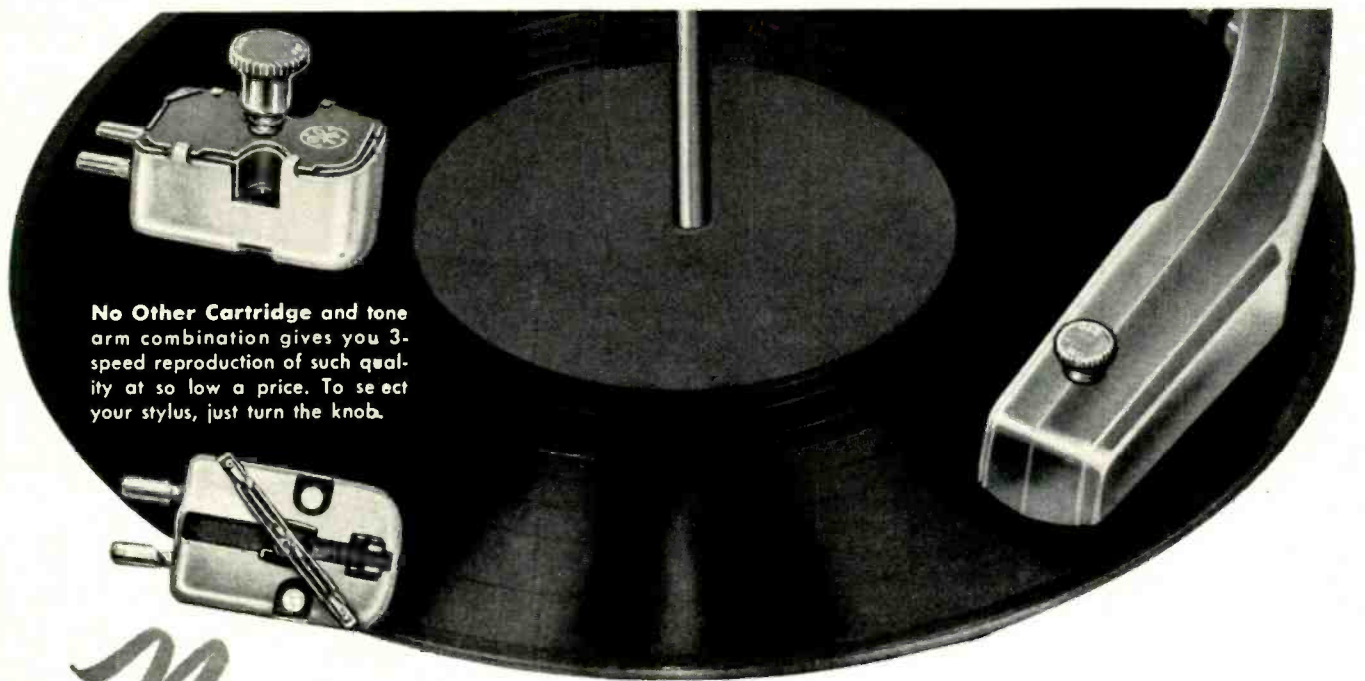

No Other Cartridge and tone arm combination gives you 3-speed reproduction of such quality at so low a price. To select your stylus, just turn the knob.

New GENERAL ELECTRIC TONE ARM PLAYS 3 SPEEDS WITH ONE CARTRIDGE!

SUPERB QUALITY AT LOW COST!

A simple twist of the red button—*without changing the position of the cartridge in the tone arm*—and you can play 33½, 45 and 78 rpm records at a constant pressure of 6 to 8 grams!

Nothing to take apart—nothing to add... the famous General Electric Triple Play Cartridge is actually built into the tone arm for quick, simple operation. To switch from a standard to narrow groove stylus just depress and turn the red knob on top of the arm. This positions the stylus without moving the cartridge. To change from narrow groove back to standard—turn the knob again... that's all there is to it.

Complete tone arm assembly—including Triple Play Cartridge with diamond or sapphire styli—is now available to distributors and dealers *at a price so low it will rock the trade!*

Write or wire today for full particulars and ask for descriptive bulletin R78-028: *General Electric Company, Section 960, Syracuse, New York.*

MAKE IT EASY FOR YOUR CUSTOMERS

Demonstration of this new tone arm offers dramatic proof that it's the simplest, most economical answer to quality reproduction at low cost!

Call your distributor today and stock this merchandise!

You can put your confidence in—

GENERAL  **ELECTRIC**

*this is it—
this is the tuner
you designed!*

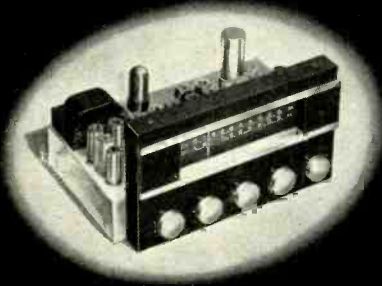

the
CRAFTSMEN RC-10
HIGH FIDELITY
FM-AM TUNER

This new tuner was your idea. It is the precisely engineered answer to hundreds of questions . . . the solution to scores of problems . . . the outgrowth of countless suggestions we've received from you. Developed from your ideas—and a few of ours—the RC-10 retains every feature of the famous RC-8. And it offers a host of innovations.

- Built-in pre-amplifier compensated for reluctance pickups.
- Automatic Frequency Control entirely eliminates drift, simplifies tuning.
- 5 microvolt sensitivity on both FM and AM.
- 10 kc filter on AM eliminates inter-station squeals.
- Base and treble tone controls for boost, cut, or 20—20,000 cycle flat response.

SEE . . . the RC-100A ultra-sensitive, custom TV with built-in booster.

HEAR . . . the RC-2 high fidelity amplifier. All units finished in chrome.

Write for information—or send 50¢ for instructions and schematics.

THE RADIO
craftsmen
INCORPORATED

Dept. F, 1617 S. Michigan Ave., Chicago 16, Ill.

calibration is attempted the feedback potentiometers and balancing condenser must be adjusted. Install the completed unit in the cabinet, tighten the panel mounting screws, and be sure the cabinet lid is closed. Advance both output level controls full on, set the oscillator range switch to the "x1" position and the v.t.v.m. range switch to the "100" position. (Operation and calibration of the v.t.v.m. will be covered in later paragraphs.) An oscilloscope is then connected to the "A.F. Output" terminals so that the output waveform may be observed. Set the main tuning condenser and the small compensating condenser to the minimum capacity position. Adjust feedback potentiometer R_3 so that oscillation is just obtained in a stable manner. The output voltage should then approach 20 volts. Swing the tuning condenser back and forth between maximum and minimum capacity and adjust the compensating condenser, C_1 , so that the output voltage is maintained constant over the entire tuning range at about 20 volts. A small readjustment of the feedback control may be necessary. Keep one eye on the scope during the adjustments to see that a good waveform is being obtained at all times. When the proper adjustments have been obtained the oscillations will be stable over the tuning condenser range, the output voltage will hold constant at about 20 volts, and the output waveform will be excellent. If the oscillator, installed in the metal cabinet, shows any tendency toward locking in with the 60 cycle a.c. line frequency or multiples thereof, look the wiring over for a possible coupling path that can be eliminated. It was not found necessary to shield the a.c. filament leads in our unit, however the a.c. line from the power transformer to the power "On-Off" switch on the front panel was shielded. Tube V_1 should also be shielded. After completion of the "x1" range adjustments, proceed to the two higher ranges in order and adjust the feedback potentiometers as above. As the oscillator

frequency is increased the compensating condenser adjustment may be made to a finer degree and will reach its final setting at the high frequency end of the "x100" range. If these adjustments are made carefully the oscillator frequency should "decade" quite accurately on all three ranges, at least within a few per-cent. The actual frequency calibration of the oscillator may now be accomplished and the scale inked in on the dial.

The V.T.V.M.

The vacuum tube voltmeter circuit consists essentially of a three stage amplifier with a suitable rectifying system for the 0-1 ma. meter, M_1 . The original scale on the meter need not be altered as it will be read directly, keeping in mind the position of the range multiplier switch. The calibration is linear from zero to full scale indication. Although a large 4½ inch meter was used in our unit for ease in reading, any size or style meter may be used, providing only that it has basically an 0-1 ma. movement and that it is in good condition. The advantage of the 0-1 milliammeter over a microammeter sometimes used in this type of circuit will be apparent when the instrument prices are compared.

Due to the inverse feedback employed the voltmeter circuit has excellent stability against aging or changes in tube characteristics as well as supply voltage variations. Assuming the input decade resistors have been accurately chosen, only one calibration adjustment need be performed for the meter to indicate accurately on all ranges. Merely apply an audio frequency voltage of known amplitude to the input terminals, with the v.t.v.m. range switch in the proper position, and adjust potentiometer R_{a1} until the meter indicates that same value of voltage. It should be noted that, regardless of the position of the range switch, one-tenth volt is always present at the grid of V_1 for full scale deflection of M_1 .

Fig. 4. Under chassis view. A.c. wiring should be twisted and dressed close to chassis.

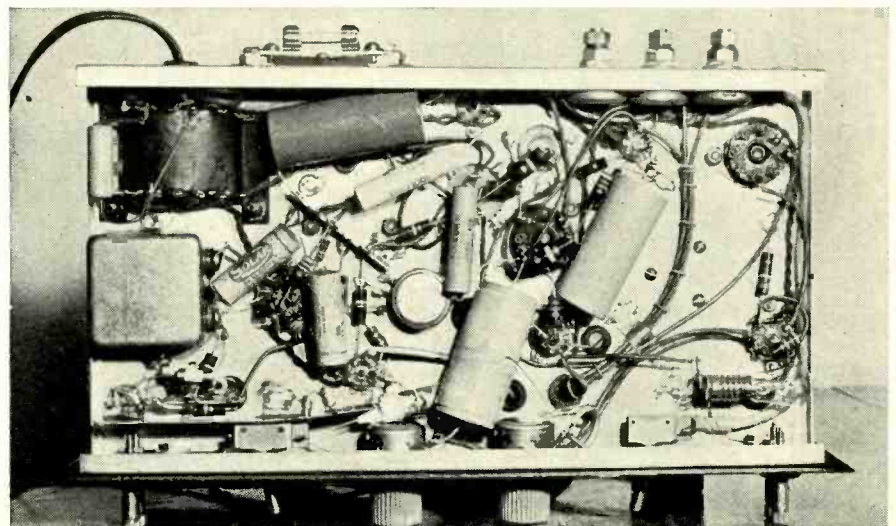



The Trade Winds
are blowing your way
 with the **BIGGEST BARGAINS**
EVER! ...made possible by...
"SURPRISE" TRADE-IN
ALLOWANCES on your **USED**
TEST & COMMUNICATION
EQUIPMENT

Ahoy, mates! Feast your eyes on the trade-in bargain opportunity of a lifetime! Here's your chance to get brand, spankin' new TV Test Instruments or Amateur gear at amazing reductions. Simply trade your old, unwanted (factory-built) units for the merchandise of your choice. Select from one of the largest and most diversified stocks in the country. Take advantage of "Surprise" Trade-In allowances today. Wire, write, phone or use the handy coupon below.



Amazing Hallicrafters
SX-71 \$17950
 Shpg. Wt. 33 lbs.Only
 Less "Surprise" trade-in value
 of your used equipment!

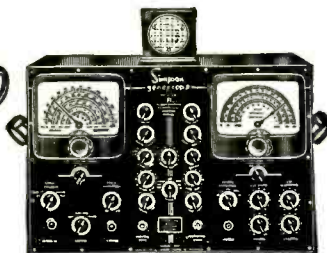

Simpson Model 480
FM-TV Genescope
 Shpg. Wt. 48 lbs.
\$36750

That's the established price but you'll pay far less by taking advantage of our "Surprise" allowance on your used equipment.

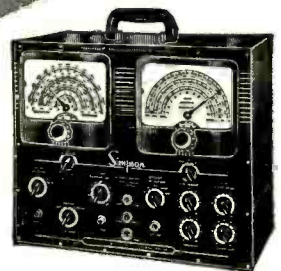

Simpson Model 479
TV-FM Signal Generator
 Shpg. Wt. 35 lbs.
\$24010

Save real money on this unit by applying our "Surprise" allowance against the above price. What have you to trade?



Sensational National HRO-50 \$34900
 Shpg. Wt. 80 lbs.Only
 Above price subject to our special, "Surprise" allowance and that means a bargain!



FREE!
 New 164 page catalog. Features brand new, big-name Test Instruments and Communication Equipment. Send for your copy today!



Simpson Model 303
VTVM
 Shpg. Wt. 9 lbs.
\$5758

Got a piece of used equipment to trade? If so, count on our "Surprise" allowance to save you plenty on this Simpson 303.

Easy Terms on Your New Equipment Purchases
 "Your Trade-In's Worth More at the Walter Ashe Store!"

MAIL THIS COUPON TODAY

Walter Ashe Radio Co.
 1125 Pine St., St. Louis 1, Mo. RN-50-6

O. K. Walter, Rush "Surprise" Trade-in offer on my _____
 (describe used equipment)

for _____
 (show make and model No. of new equipment desired)

Rush Free Copy of your new 164 page Catalog

NAME _____
 ADDRESS _____
 CITY _____ ZONE _____ STATE _____

Walter Ashe
RADIO CO.
 THE HOUSE OF "SURPRISE" TRADE-INS
 1125 PINE ST. • ST. LOUIS 1, MO.

All Prices
 F. O. B.
 St. Louis
 Phone:
 CHestnut
 1125

You Asked for Them—So Here They Are!

CHELSEA'S OWN TV TRIUMPHS

at Chelsea's Famed Terrific Values!

Complete sets, with built-in antenna and quality controlled features throughout! Standard RMA Guarantee, of course

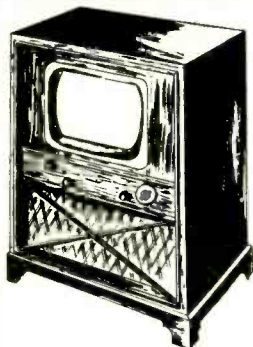

**CHELSEA'S OWN
16" CONSOLETTA**
Complete with Picture Tube

\$189⁹⁰

plus \$1.80 Fed. Tax

HERE are 3 striking examples of Chelsea's own quality construction and performance in complete TV sets—at typical Chelsea low prices. Superior in every way, from high-lustre custom cabinets to standard coil front ends down to 45 microvolts, these sets have improved AGC and AFC, insuring powerful reception even in fringe areas. Newest electronic built-in antenna, high fidelity sound and brilliant, non-flicker picture.

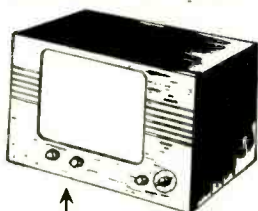

**CHELSEA'S OWN
16" TABLE MODEL**

Complete with Picture Tube

\$171³³

plus \$1.80 Fed. Tax

**CHELSEA'S OWN
Latest Improved
LIC RCA 19" CHASSIS**
Complete with Picture Tube

\$199⁹⁵

plus \$1.80 Fed. Tax

JUST PLUG IT IN . . . IT WORKS
A set, not a kit . . . completely wired, factory engineered, aligned and tested.

**CHELSEA'S OWN
12½" TABLE MODEL**

Complete with Picture Tube

\$138⁹³

plus \$1.40 Fed. Tax

12½" Consolelette
\$157.81

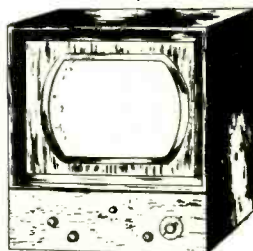

WHY PAY MORE ELSEWHERE? . . . Write Dept. 5 for latest literature and prices—and COMPARE. Phone and mail orders filled on receipt of certified check or money order for \$25 as deposit . . . balance C.O.D., F.O.B. N. Y. For Free Demonstrations, visit our street-level showroom.

The House of Bargains

CHELSEA TELEVISION CENTER, INC.

187 Seventh Ave., New York 11, N. Y. CHelsea 3-4425-6-7

Prices and Models subject to change without notice.

Condenser C_9 must be shielded to avoid stray pickup since the input impedance of the circuit is quite high. For the same reason a shield strip is soldered in place along the chassis behind the v.t.v.m. input jack and "Int.-Ext." switch, as shown in Fig. 4. The only other shielding needed is on top of the chassis where a 1½ inch wide strip was soldered to the chassis and looped up and over the voltmeter range switch to prevent stray coupling from the adjacent oscillator range switch. Tube V_1 should also be shielded.

The power supply employs a two-section, condenser input filter system with the output voltage dropped to 250 volts by R_{40} . The sensitivity of the various circuits to hum voltages is large and the filter system shown is superior to several other ones tried. Note the paralleled filament connection for 6.3 volt operation of the 12AU7 tubes.

The entire unit is housed in a *Bud* streamlined cabinet, 8 x 16½ x 8¼ inches, panel size 8 x 14 inches, enclosing the 7 x 13 x 1½ inch chassis. The front panel name plates were cut from white card-file stock. All lettering was done with a *Le Roy* lettering set, including the oscillator dial calibration and the "A.F. Volts" on the meter scale.

The writer wishes to express his appreciation for the assistance of Louis J. Frenkel, Jr., W5PQJ, in taking the photographs of the completed unit.

-50-

TV IN LATIN AMERICA

By KENNETH R. BOORD

FLAVIO SERRANO, Rio de Janeiro, a monitor for the International Short-Wave Department of RADIO & TELEVISION NEWS informs me that the first Latin American television station will be located in Rio de Janeiro and will be on the air this year. Studio and mobile equipment, as well as the 5 kw. transmitter manufactured by General Electric at a cost of \$1,000,000, are already in Rio de Janeiro.

The transmitter and the antenna (probably a super-turnstile) will be installed atop world-famous Sugar Loaf Mountain, 1400 feet above sea level. Every effort is being made to get the station on the air in July. The first programs will include telecastings of education programs and the International Soccer Tournaments.

The station is owned by "Radio Tupi," which recently purchased television equipment from the Radio Corporation of America for its projected TV outlet in Sao Paulo. A third television transmitter, manufactured by General Electric, may be installed in the near future in Rio de Janeiro by "Radio Televisao do Brasil," a new organization.

According to a recent broadcast from the Voice of America, the first television station in Mexico will be on the air next September. Call letters will be XEW-TV, and the station is owned by "Cadena Radiodifusora Mexicana," which also operates XEW on m.w. and XEWW on s.w. For the first three months, transmissions will be purely experimental.

A Cuban television station is slated to go on the air in 1951.

-50-



RADIO ENGINEERING TELEVISION ELECTRONICS

Thorough training in all phases of radio and electronics, open to high school and junior college graduates. Old established school specializing in Radio training exclusively. Modern laboratories and courses. Enrollments limited. Approved veteran training.

VALPARAISO TECHNICAL INSTITUTE
Dept. RD Valparaiso, Ind.

SPOT SURPLUS SPECIALS

100 Insulated Resistors—RMA Color Coded ¼, ½, 1, 2 watt. Over 50 val. Complete \$1.75

50 Bypass Condensers—Tubular, Bakelite Molded, etc. Pop. val., all purposes. GUARANTEED \$1.75

FOB Phila. No COD's. Write for complete listings.

THE ELECTRIC SPOT

132 S. 11th St. Philadelphia 7, Pa.

AUDIO ENGINEERING SCHOOL

Practical engineering training in Audio fundamentals, Disc, Film, Magnetic recording, and Audio frequency measurements.

Studio training simulates Broadcast, Motion Picture, Television, and Commercial Recording work.

Approved for Veterans

HOLLYWOOD SOUND INSTITUTE, Inc.

1040-N North Kenmore, Hollywood 27, Calif.

Specify if Veteran or Non-Veteran

Easily-Built

10 kc. to 1mc. Multivibrator

By GUY DEXTER

Construction details on a dual-range multivibrator which can be incorporated into existing equipment.

IT IS common knowledge that multivibrators are used for frequency division. Thus, a 10 kc. multivibrator driven by a 100 kc. oscillator effectively divides the 100 kc. by 10. But few experimenters are aware of the fact that the scheme also works the other way, that is, a standard frequency oscillator can be used to control a multivibrator at a higher, rather than lower frequency. This latter method of operation may be employed to obtain strong 1000 kc. points from a 100 kc. oscillator.

Fig. 1 shows the circuit of a multivibrator which, at the flip of a switch, will deliver either 10 kc. or 1000 kc. spot-signal output. It may be driven by any 100 kc. oscillator already on hand, such as the miniature *Hammarlund* Type FS-135-C frequency standard recently bought by hundreds of experimenters at closeout prices. A space of only 2" x 2" is required by the complete multivibrator, so it can be installed comfortably on the chassis of most receivers or 100 kc. oscillators. No special tricks are necessary to get the circuit into operation.

The 100 kc. control oscillator output is available at the multivibrator output terminals via coupling through the 12AX7 miniature tube and associated circuit components. The 100 kc. points are strong enough to be useful up to about 10 or 15 megacycles with receivers of good sensitivity. The 10 kc. points are useful up to about 4 mc. The 1 mc. points may be heard up to 50 or 100 megacycles, depending upon sensitivity of the receiver or monitor used.

It is a simple matter to place the multivibrator in operation. The only adjustable control is the 10,000 ohm wirewound potentiometer, R_1 , adjustment of which locks the multivibrator into step with the controlling oscillator. When R_1 is set for synchronization at 1000 kc. (with switch S_1 in its 1 mc. position), the multivibrator will be synchronized for 10 kc. operation (with switch S_1 in its 10 kc. position), and vice versa. Hence, only one adjustment of R_1 is required, and only one sync control is needed. To adjust the multivibrator: (1) Connect the filament and plate voltage terminals to proper sources of voltage (these conveniently can be the "B+" and "B-" terminals and 6.3 volt filament terminals of the receiver or 100 kc. oscillator with which the multivibrator is operated). (2) Throw S_1 to its 10 kc. position. (3) Throw S_2 to its "Off" position. (4) Connect the output terminals of a 100 kc. oscillator (in operation) to

the multivibrator input terminals. (5) Connect the multivibrator output terminals to the antenna and ground terminals of a broadcast receiver which can be made to regenerate or oscillate slightly. (6) Tune the broadcast receiver, noting that a signal is heard at each 100 kc. point on the dial. (7) Throw switch S_2 to its "On" position and retune the broadcast dial, noting that somewhat weaker extra signals now are tuned-in between the louder 100 kc. points. Count these weaker signals. (8) If the multivibrator is operating at 10 kc. as it should be, nine such signals will be heard between any two adjacent 100 kc. points. If the number is greater or less than 9, adjustment of potentiometer R_1 will bring the number exactly to 9. (9) To check 1000 kc. operation, it is best to use an oscillating (or regenerating) all-wave receiver tuning continuously above 10 mc. Throw switch S_1 to its 1 mc. position, and tune the receiver, noting that a strong signal is heard at each 1000 kc. point on the dial. If the 100 kc. points are also heard, note that each adjacent 1 mc. point is much stronger than the

nine 100 kc. points heard in between.

The Bureau of Standards station, WWV, broadcasts standard frequencies on 2.5, 5.0, 10.0, 15.0 and higher frequencies. These may be used to check the accuracy of the basic 100 kc. oscillator, enabling the user to make accurate measurements at intermediate points.

The 1000 kc. output of the multivibrator may be amplified readily for use in applications requiring an accurate signal at this frequency. Such applications include operation of a radio-frequency bridge, 1-mc. "Q"-meter, etc.

This multivibrator unit is economical in two ways. It does away with the separate tubes and circuits which ordinarily would be used to produce the two frequencies. And it is cheaper and more accurate than the dual-mode crystals usually employed for 100-1000 kc. operation. Power supply requirements are 250 to 300 volts d.c. at 9.8 milliamperes, and 6.3 volts a.c. or d.c. at 0.3 ampere.

The writer is indebted to Mr. C. T. Corey, at whose suggestion this dual-range multivibrator was produced.—30—

Fig. 1. Schematic diagram and parts list covering the dual-range multivibrator unit.

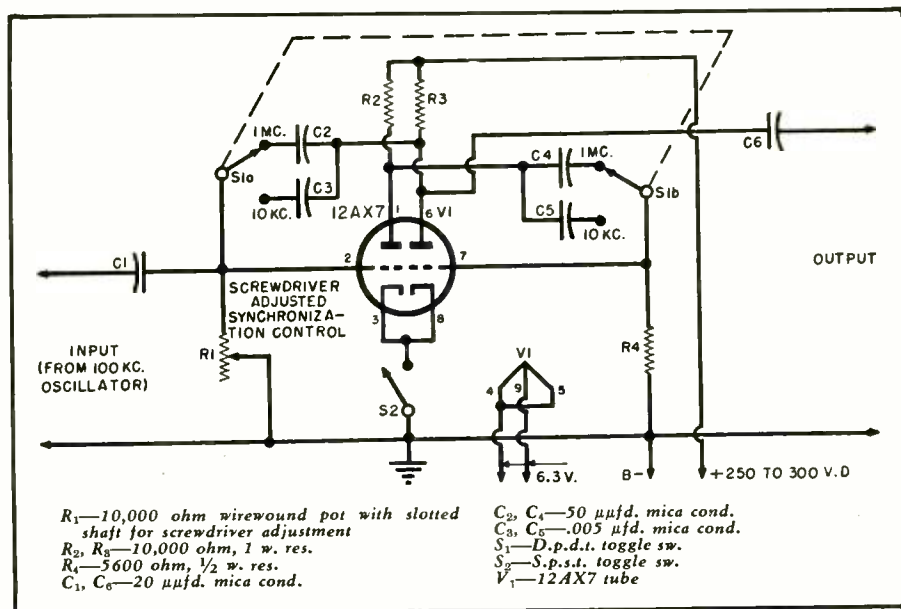

NEW 1950

Heathkits

have all the Features

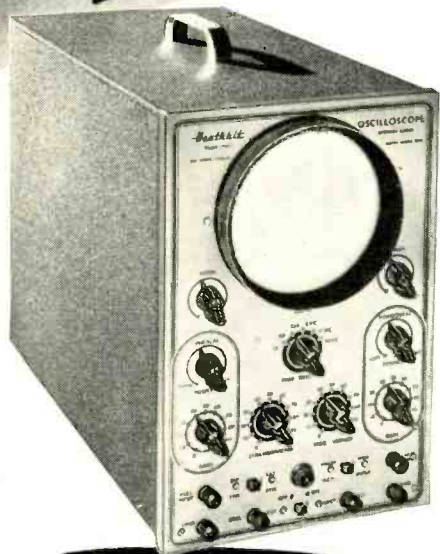

\$39.50

New 1950 Heathkit
**PUSH-PULL EXTENDED RANGE
 5" OSCILLOSCOPE KIT**

Features

- The first truly television oscilloscope.
- Tremendous sensitivity .06 Volt RMS per inch deflection.
- Push-pull vertical and horizontal amplifiers.
- Useful frequency range to 2½ Megacycles.
- Extended sweep range 15 cycles to 70,000 cycles.
- New television type multivibrator sweep generator.
- New magnetic alloy shield included.
- Still the amazing price of \$39.50.

The new 1950 Push-Pull 5" Oscilloscope has features that seem impossible in a \$39.50 oscilloscope. Think of it—push-pull vertical and horizontal amplifiers with tremendous sensitivity only six one hundredths of a volt required for full inch of deflection. The weak impulses of television can be boosted to full size on the five inch screen. Traces you couldn't see before. Amazing frequency range clear useful response at 2½ Megacycles made possible by improved push-pull amplifiers. Only Heathkit Oscilloscopes have the frequency range required for television. New type multi-vibrator sweep generator with more than twice the frequency range. 15 cycles to 70,000 cycles will actually synchronize with 250,000 cycle signal. Dual positioning controls will move trace over any section of the screen for observation of any part. New magnetic alloy CR tube shield protects the instrument from outside fields. All the same high quality parts, cased electrostatically shielded power transformer, aluminum cabinet, all tubes and parts. New instruction manual now has complete step by step pictorials for easiest assembly. Shipping Weight 30 lbs. Order now for this winter's use.

CONVERSION FOR OTHER MODEL HEATHKIT OSCILLOSCOPES

A conversion for all 03 and 04 scopes is available changing them to the new push-pull amplifiers (does not change the sweep generator). Complete kit includes new chassis, tubes and all parts. For a small investment, add the latest improvements to your present oscilloscope (Except C.R. Tube Shield). Shipping weight 10 lbs.

Order 05 Conversion Kit No. 315..... **\$12.50**

THE NEW *Heathkit*
HANDITESTER KIT

MORE Features THAN EVER BEFORE

- Beautiful streamline Bakelite case.
- AC and DC ranges to 5,000 Volts.
- 1% Precision ceramic resistors.
- Convenient thumb type adjust control.
- 400 Microampere meter movement.
- Quality Bradley AC rectifier.
- Multiplying type ohms ranges.
- All the convenient ranges 10-30-300-1,000-5,000 Volts.
- Large quality 3" built-in meter.

The instrument for all—the ranges you need—beauty you'll enjoy for years and you can assemble it in a matter of minutes—an instrument for everyone. The handiest quality volt-ohmmeter of all. Small enough to put in your pocket yet a full 3" meter. Easy pictorial wiring diagrams eliminate all assembly problems. Uses only 1% precision ceramic divider resistors and wire wound shunts. Twelve different ranges. AC and DC ranges of 10-30-300-1,000-5,000 Volts. Ohms ranges of 0-3,000 ohms and 0-300,000 ohms. Milliampere ranges of 10MA and 100MA. Hearing aid type ohms adjust control fits conveniently under thumb for one hand adjustment. Banana type jacks for positive low resistance connections. Quality test leads included. The high quality Bradley instrument rectifier was especially chosen for linear scales on AC. The modern case was styled by Harrah Engineering for this instrument. The 400 microampere meter movement comes already mounted in the case protected from dust during assembly. An ideal classroom assembly instrument useful for a lifetime. Perfect for radio service calls, electricians, garage mechanics, students, amateurs and beginners in radio. The only quality volt-ohmmeter under \$20.00. An hour of assembly saves you one-half the cost and quality parts give you a better instrument. Order today. Shipping weight 2 lbs.



\$13.50

Note
**HANDY
 OHMS
 ADJUST.**

EXPORT DEPT.
 13 East 40th St.
 NEW YORK CITY (16)
 CABLE: ARLAB-N.Y.

The **HEATH COMPANY**

... BENTON HARBOR 15, MICHIGAN

MORE QUALITY in

1950 Heathkits

The NEW V-4 Heathkit VACUUM TUBE VOLTMETER KIT

Features

- Meter scale 17% longer than average 4½" meter.
- Modern streamline 200 ua meter.
- New modern streamline styling.
- Burn-out proof meter circuit.
- 24 Complete ranges.
- Isolated probe for dynamic testing.
- Most beautiful VTVM in America.
- Accessory probes (extra) extend ranges to 10,000 Volts and 100 Megacycles.
- Uses 1% precision ceramic divider resistors.
- Modern push-pull electronic voltmeter circuit.
- Electronic AC circuit. No current drawing rectifiers.
- Shatterproof plastic meter face.

The new Heathkit Model V-4 Vacuum Tube Voltmeter has dozens of improvements. A new modern streamlined 200 microampere meter has Alnico V magnet for fast, accurate readings. The new electronic AC voltmeter circuit incorporates an entire new balance control which eliminates contact potential and provides greater accuracy. New simplified switches for quicker assembly. New snap-in battery mounting is on the chassis for easy replacement.

The Heathkit VTVM is the only kit giving all the ranges. Check them — DC and AC—full scale linear ranges of 0-3V, 0-10V, 0-30V, 0-100V, 0-300V, 0-1000V and can be extended to 0-3000V and 0-10,000V DC with accessory probe at slight extra cost. Electronic ohmmeter has six ranges measuring resistance accurately from .1 ohm to one billion ohms. Meter pointer can be offset to zero center for FM alignment.

The DC probe is isolated for dynamic measurements. Has db scale for making gain and other audio measurements.

The new instruction manual features pictorial diagrams and step-by-step instructions for easy assembly. The Heathkit VTVM is complete with every part — 110V transformer operated with test leads, tubes, light aluminum cabinet for portability, giant 4½" 200 microamp meter and complete instruction manual.

Order now and enjoy it this entire season. Shipping weight 8 lbs., Model V-4

Accessory: 10,000V high voltage probe, No. 310, \$4.50.
Accessory: RF crystal diode probe kit extends RF range to 100 Mc., No. 309, \$6.50.



\$24⁵⁰

New 1950 VERNIER TUNING R.F. Heathkit SIGNAL GENERATOR KIT

Features

- New 5 to 1 ratio vernier tuning for ease and accuracy.
- New external modulation switch—use it for fidelity testing.
- New precision coils for greater output.
- Cathode follower output for greatest stability.
- 400 cycle audio available for audio testing.
- Most modern type R.F. oscillator.
- Covers 150Kc. to 34Mc. on fundamentals and calibrated strong harmonics to 102 Mc.



\$19⁵⁰

The most popular signal generator kit has been vastly improved—the experience of thousands combined to give you the best. Check the features in this fine generator and consider the low price \$19.50. A best buy for any shop, yet inexpensive enough for hobbyists. Everyone can have an accurate controlled source of R.F. signal voltage.

The new features double the value—think of being able to make fidelity checks on receivers by inserting a variable audio signal. Internal 400 cycle saw-tooth audio oscillator modulates R.F. signal and is available externally for audio testing. The new 5 to 1 ratio vernier drive gives hairline tuning for maximum accuracy in scale settings. The coils are already precision wound and calibrated. Uses turret type coil and switch assembly for ease of construction. The generator is 110 V. 60 cycle transformer operated and comes complete in every detail—cabinet—tubes—coils—beautiful two color calibrated panel and all small parts—new step-by-step pictorial diagrams and complete instruction manual make assembly a cinch even for novices. Why try to get along without a signal generator when you can have the best for less than a twenty dollar bill. Better order it now. Shipping weight 7 lbs. **\$19.50**

CONVERSION KIT FOR G-1 GENERATORS

Conversion kit for G-1 generators for vernier tuning and external modulation includes new high band coil for greater output. Gives all the features of new G-5 listed above. Order G-5 Conversion Kit No. 316. **\$4.50**

EXPORT DEPT.
13 East 40th St.
NEW YORK CITY (16)
CABLE: ARLAB-N.Y.

The **HEATH COMPANY**

... BENTON HARBOR 15, MICHIGAN

Beauty · Quality · Economy



Only
\$69.50

Nothing
ELSE TO BUY

New Heathkit **IMPEDANCE BRIDGE KIT**

**A LABORATORY INSTRUMENT NOW WITHIN
THE PRICE RANGE OF ALL**

Measures Inductance from 10 microhenries to 100 henries capacitance from .00001 MFD to 1000 MFD. Resistance from .01 ohms to 10 megohms. Dissipation factor from .001 to 1. "Q" from 1 to 1000.

Ideal for schools, laboratories, service shops, serious experimentors.

An impedance bridge for everyone — the most useful instrument of all, which heretofore has been out of the price range of serious experimentors and service shops. Now at the lowest price possible. All highest quality parts. General Radio main calibrated control. General Radio 1000 cycle hummer. Mallory ceramic switches with 60 degree indexing — 200 micro-amp zero center galvanometer — 1/2 of 1% ceramic non-inductive decade resistors. Professional type binding posts with standard 3/4" centers. Beautiful birch cabinet. Directly calibrated "Q" and dissipation factor scales. Ready calibrated capacity and inductance standards of Silver Mica, accurate to 1/2 of 1% and with dissipation factors of less than 30 parts in one million. Provisions on panel for external generator and detector. Measure all your unknowns the way laboratories do — with a bridge for accuracy and speed.

Internal 6 volt battery for resistance and hummer operation. Circuit utilizes Wheatstone, Hay and Maxwell circuits for different measurements. Supplied complete with every quality part — all calibrations completed and instruction manual for assembly and use. Deliveries are limited. Shipping weight, approximately 15 lbs.

Heathkit **CONDENSER CHECKER KIT**

\$19.50



Features

- Power factor scale
- Measures resistance
- Measures leakage
- Checks paper-mica-electrolytics
- Bridge type circuit
- Magic eye indicator
- 110V. transformer operated
- All scales on panel

Checks all types of condensers, paper-mica-electrolytic-ceramic over a range of .00001 MFD. to 1000 MFD. All on readable scales that are read direct from the panel. **NO CHARTS OR MULTIPLIERS NECESSARY.** A condenser checker anyone can read without a college education. A leakage test and polarizing voltage for 20 to 500 volts provided. Measures power factor of electrolytics between 0% and 50%. 110V. 60 cycle transformer operated complete with rectifier and magic eye tubes, cabinet, calibrated panel, test leads and all other parts. Clear detailed instruction for assembly and use. Why guess at the quality and capacity of a condenser when you can know for less than a twenty dollar bill. Shipping weight, 7 lbs. Model C-2.

New Heathkit **TELEVISION ALIGNMENT GENERATOR KIT**



\$39.50

Nothing **ELSE TO BUY**

Everything you want in a television alignment generator. A wide band sweep generator covering all TV frequencies 0-46 54 to 100 — 174 to 220 Megacycles, a marker indicator covering 19 to 42 Megacycles, AM modulation for RF alignment — variable calibrated sweep with 0-30 Mc. — mechanical driven inductive sweep. Husky 110V. 60 cycle power transformer operated — step type output attenuator with 10,000 to 1 range — high output on all ranges — band switching for each range — vernier driven main calibrated dial with over 45 inches of calibration — vernier driven calibrated indicator marker tuning. Large grey crackle cabinet 16 1/8" x 10 3/8" x 7-3/16". Phase control for single trace adjustment. Uses three high frequency triodes plus 5Y3 rectifier — split stator tuning condensers for greater efficiency and accuracy at high frequencies — this Heathkit is complete and adequate for every alignment need and is supplied with every part — cabinet — calibrated panel — all coils and condensers wound, calibrated and adjusted. Tubes, transformer, test leads — every part with instruction manual for assembly and use. Actually three instruments in one — TV sweep generator — TV AM generator and TV marker indicator.

EXPORT DEPT.
13 East 40th St.
NEW YORK CITY (16)
CABLE: ARLAB-N.Y.

The **HEATH COMPANY**

... BENTON HARBOR 15, MICHIGAN

all in HEATHKITS...

Heathkit TUBE CHECKER KIT Features

1. Measures each element individually
2. Has gear driven roller chart
3. Has lever switching for speed
4. Complete range of filament voltages
5. Checks every tube element
6. Uses latest type lever switches
7. Uses beautiful shatterproof full view meter
8. Large size 11" x 14" x 4" complete
9. Checks new 9 pin piniaures

Check the features and you will realize that this Heathkit has all the features you want. Speed—simplicity—beauty—protection against obsolescence. The most modern type of tester—measures each element—beautiful Bad-Good scale, high quality meter—the best of parts—rugged oversize 110V. 60 cycle power transformer—finest of Mallory switches—Centralab controls—quality wood cabinet—complete set of sockets for all type tubes including blank spare for future types—fast action gear driven roller chart uses brass gears to quickly locate and set up any type tube. Simplified switching cuts necessary time to minimum and saves valuable service time. Short and open element check. No matter what arrangement of tube elements, the Heathkit flexible switching arrangement easily handles it. Order your Heathkit Tube Checker today. See for yourself that Heath again saves you $\frac{2}{3}$ and yet retains all the quality—this tube checker will pay for itself in a few weeks—better build it now.

Complete with detail instructions—all parts—cabinet—roller chart—ready to wire up and operate. Shipping Wt., 15 lbs.



Only
\$29⁵⁰

Nothing
ELSE TO BUY

Heathkit SINE AND SQUARE WAVE AUDIO GENERATOR KIT



Nothing
ELSE TO
BUY

\$34⁵⁰

Experimenters and servicemen working with a square wave for the first time invariably wonder why it was not introduced before. The characteristics of an amplifier can be determined in seconds compared to several hours of tedious plotting using older methods. Stage by stage, amplifier testing is as easy as signal tracing. The low distortion (less than 1%) and linear output (\pm one db.) make this Heathkit equal or superior to factory built equipment selling for three or four times its price. The circuit is the popular RC tuning circuit using a four gang variable condenser. Three ranges 20-200, 200-2,000, 2,000-20,000 cycles are provided by selector switch. Either sine or square waves instantly available at slide switch. All components are of highest quality, cased 110V. 60 cycle power transformer. Mallory F.P. filter condensers, 5 tubes, calibrated 2 color panel, grey crackle aluminum cabinet. The detailed instructions make assembly an interesting and instructive few hours. Shipping Wt., 13 lbs.

New Heathkit BATTERY ELIMINATOR KIT

Nothing
ELSE
TO BUY

\$22⁵⁰



Now a bench 6 Volt power supply kit for all auto radio testing. Supplies 5 - 7 $\frac{1}{2}$ Volts at 10 Amperes continuous or 15 Amperes intermittent. A well filtered rugged power supply uses heavy duty selenium rectifier, choke input filter with 4,000 MFD of electrolytic filter. 0 - 15 Volt meter indicates output. Output variable in eight steps. Excellent for demonstrating auto radios. Ideal for servicing—can be lowered to find sticky vibrators or stepped up to equivalent of generator overload—easily constructed in less than two hours. Complete in every respect. Shipping Wt., 18 lbs.

NEW Heathkit SIGNAL TRACER AND UNIVERSAL TEST SPEAKER KIT

Nothing
ELSE
TO BUY

\$19⁵⁰



The popular Heathkit signal tracer has now been combined with a universal test speaker at no increase in price. The same high quality tracer follows signal from antenna to speaker—locates intermitents—defective parts quicker—saves valuable service time—gives greater income per service hour. Works equally well on broadcast—FM or TV receivers. The test speaker has assortment of switching ranges to match push pull or single output impedance. Also test microphones, pickups—PA systems—comes complete—cabinet—110V. 60 cycle power transformer—tubes, test probe, all parts and detailed instructions for assembly and use. Shipping Wt., 8 lbs.

EXPORT DEPT.
13 East 40th St.
NEW YORK CITY (16)
CABLE: ARLAB-N.Y.

The **HEATH COMPANY**

... BENTON HARBOR 15, MICHIGAN

MARS

Station of the Month

MARS BEAMS WEEKLY BROADCASTS

MARS—Army Headquarters station, WAR, located at the Pentagon Building, Washington, D. C., broadcasts a weekly message each Tuesday at 0100Z and at 0400Z. (This is Monday at 8 p.m. and 11 p.m., Eastern Standard Time; Monday at 7 p.m. and 10 p.m., Central Standard Time; Monday at 6 p.m. and 9 p.m., Mountain Standard Time; and Monday at 5 p.m. and 8 p.m., Pacific Standard Time.)

Simultaneous broadcasts are made on frequencies 3497.5 kc., 6997.5 kc., 14,405 kc., and 20,994 kc. Each message is sent three times, once at 10 words per minute, once at 15 words per minute, and once at a higher rate of speed—usually 20 words per minute.

Designed especially to transmit quasi-official traffic and training information to MARS members, the broadcast offers an excellent opportunity to all amateurs in building up their code proficiency.

AN OLD timer, well known to traffic men and rag chewers alike, is A3ANK/W3ANK, handle "Bill" (William H. Hurst) named station of the month by Captain E. L. Nielsen, Chief of MARS—Army. The nomination came as a recognition of the outstanding service performed by A3ANK as net control station for the Military Amateur Radio System Pennsylvania State Net.

A look at the paper on 3ANK's shack wall should convince even the unbeliever that Hurst spends a good deal of time on the air. For, in addition to the QSL cards from near and far, are framed parchments attesting that A3ANK is WAS, WAC, RCC, 35 w.p.m., and a member of ARRL, Philadelphia Amateur Society, and the Old Timers Club.

Hurst can claim twenty-eight years as an amateur. And he is proud of the fact that after almost three decades of hamming his interests are still varied enough to permit his enjoying activity on eight bands—that's right—

eight of them: 2, 6, 10, 11, 20, 40, 80, and 160 meters.

Keeping his rig to a minimum amount of equipment, A3ANK uses a "Signal Shifter" or Xtal, with an 807 driving an 813 and a final input of 150 watts, bandswitching, A-1, A-3, or FM emission. He uses an HRO with *Selecto-Jet* for reception on the low frequencies and an S36 (not shown in picture) for a v.h.f. receiver.

Antennas used are folded dipoles for the low frequencies and a four-element *Collinear* for 144 mc.

When not relaxing in his home shack, William H. Hurst is better known to his fellow townsmen as Director of Admissions and Placements at Spring Garden Institute, Philadelphia, Pennsylvania. Not strictly a one-hobby man, Hurst fills off duty hours with golf, bowling, etc.

His military affiliation is with Detachment Number 1, Organized Reserve Corps Control Group of Philadelphia, in which unit he holds the rank of Major.

William H. Hurst A3ANK/W3ANK, net control station for the MARS Pennsylvania State Net.



Become an Electrical Engineer

B. S. Degree in 36 Months

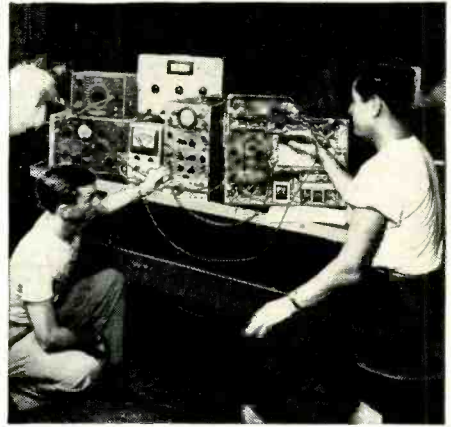

Major in Electronics

IMPORTANT advantages are yours at this nonprofit Technical Institute and College. A valuable year is saved by gaining your B. S. degree in 36 months of continuous study. You get both practical, specialized training in well-equipped laboratories—and a solid education in Electrical Engineering and related arts.

The program includes 19 technical specialty courses in Engineering Electronics, along with four courses in Electronic Design—plus Chemistry, Physics, Mathematics, Economics and basic Electrical Engineering subjects.

You Become an ELECTRONIC TECHNICIAN after 12 months study in the Electrical Engineering course. Electronics is of tremendous growing importance in communications, broadcasting, radio-television, power-system control, high frequency heating, printing and other fields.

The Radio-Television Technician's certificate can be yours in 18 months. You are then equipped for specific positions in receiver and transmitter testing, servicing, sales and production. This course will be credited toward your B. S. degree in Electrical Engineering.

Military, Academic or Practical Training is evaluated for advanced credit. Preparatory courses are also available.



Faculty of 85 specialists. 1555 currently enrolled from 48 states and 23 foreign countries. Over 35,000 alumni. Terms open July, Oct., Jan., April.

MILWAUKEE SCHOOL of ENGINEERING

Technical Institute • College of Electrical Engineering

Write for free 110-page catalog and 48-page pictorial booklet, "Your Career."



MILWAUKEE SCHOOL OF ENGINEERING
Dept. RN-650
1020 N. Broadway, Milwaukee, Wis.

Without obligation, send me the 110-page catalog and 48-page "Your Career" booklet.

I am interested in.....course.

NAME.....AGE.....

ADDRESS.....

CITY.....ZONE..STATE..

Check if World War II Veteran

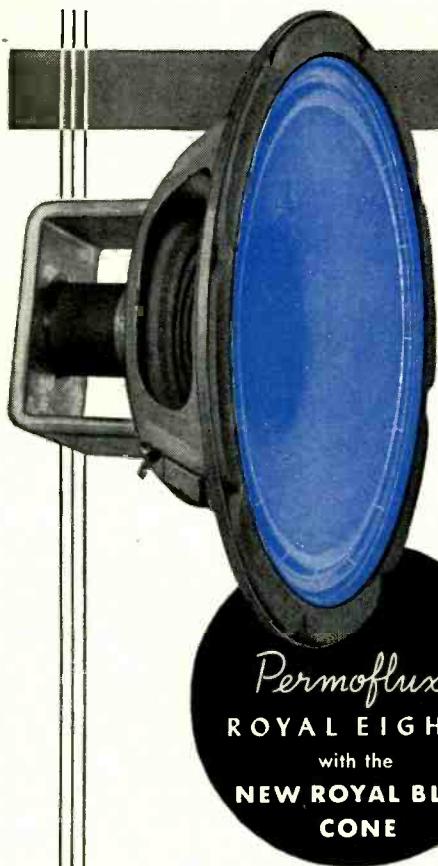

new

Permoflux
ROYAL EIGHT™
compares with
any 12" speaker!

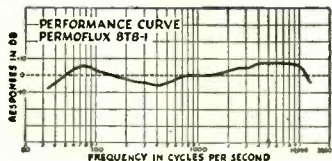

This averaged laboratory response curve of the Permoflux 8TB-1 proves that it compares with the finest speakers regardless of size or price.

It's Your "Springboard" to Extra Sales with Customers who want 12" performance but don't want to pay a 40% higher price.

Permoflux
ROYAL EIGHT™
 with the
NEW ROYAL BLUE CONE

From the resonant boom of jungle drums to the light warble of the flute, this new 8" speaker reproduces sound with superior sensitivity and fidelity. The tonal qualities of this magnificent speaker can only add to the excellence of any audio equipment.

Special processing provides extra-strong cone; allows cone to be soft-suspended from basket and held at coil-end by extra-large spider. Permits more faithful reproduction at lower frequencies. Deeper, curvilinear cone greatly extends high-frequency response.

Permoflux Royal Eight™ (Model 8TB-1) is ruggedly-built, and simple to install. Provides big speaker performance in a small frame—uses smaller, more economical baffle. List Price \$15.00.

Send for Catalog No. J201—Dept. TE



"SOUND IN DESIGN"

PERMOFLUX CORPORATION

4900 W. GRAND AVE., CHICAGO 39, ILL. • 236 S. VERDUGO RD., GLENDALE 5, CALIF.

TROUGH LINE FRONT ENDS

For FM Broadcast Band and 2-Meter Amateur, Featuring

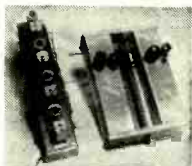

2-Stage RF Amp.-Mixer-Oscillator. Hottest and most stable front end available.

- High Gain, High Image Rej., Low-noise Factor
- Can be used as Converter or fed direct into IF amp.
- Stock Models for (1) Amateur 2-meter and Mobile Phone (140-160MC) (2) FM Broadcast Band (80-120MC) priced at \$18.95 each
- Special models for freq. between 75-300 MC including fixed freq. Crystal Control
- Special Purpose Receivers
- High Gain 10.7 MC IF Amp.—\$50.00

WARDELL SMITH

Manufacturing Communications Engineer
 65 Glenwood Rd. Upper Montclair, N. J.

25 POWER PRECISION POCKET MICROSCOPE



Compound Optical System—4 Precision Lenses—Aluminum case—5 inches long
 A professional instrument. Ideal for:
 • Machinists • Hobbyists • Photographers
 • Engineers • Students • Naturalists, etc.
 Satisfaction Guaranteed or Money Back Postpaid
MICROSCOPE & LENS CO.
 Dept. RN-6, 170 Nassau Street, New York 7, N. Y.

\$2.79

RADIO COURSES

- RADIO OPERATING • CODE
- RADIO SERVICING • ELECTRONICS • F.M. TELEVISION
- REFRIGERATION SERVICING

Write for Catalog T.S. and Picture Brochure



TRADE & TECH. SCHOOL
 229 W. 66 St., N. Y. 23
 ENdicott 2-8117

Portable 40-Meter Rig

(Continued from page 41)

trol R_s to near maximum rotation and increase the regeneration condenser C_s slowly toward maximum capacity (just where it breaks into regeneration) and c.w. signals should come through.

We will now assume that the receiver is operating correctly and proceed to the adjustment of the transmitter.

Transmitter Adjustments

A connection block is used for the external cable. This block was made by soldering the lugs of the nut-and-bolt units to the contacts of a resistor block section but any piece of insulated base could be constructed to serve the purpose. The unit must be capable of supporting at least six pairs of connecting posts for the cable, etc.

One pair of posts is used to connect the phone jack. A second pair is for checking the oscillator by attaching leads to a 0-100 ma. meter. This is bridged with a short piece of insulated wire when the meter is not in use. Another pair is required for checking the final amplifier. Normally these posts are bridged with a short piece of insulated wire but during tune-up they are left open. A fourth pair is needed to connect the cable wires to the external hand key while the fifth and sixth sets of posts are used to connect the "A" and "B" battery cables.

To adjust the transmitter snap the changeover switch S_2 to its "transmit" position. Do not connect the transmitting antenna at this time. Make sure the filament switch S_1 of the transmitter is on. Short the key and the meter will indicate the current reading of the oscillator stage. With the insulated trimmer adjustment rod adjust the oscillator trimmer condenser C_{11} for minimum current as indicated on the meter. If a superhet receiver is available and tuned to the frequency of the transmitter, you should be able to hear the oscillator in action.

Next open the key and replace the meter with a short piece of insulated wire. The oscillator should now be working properly. Connect the meter cable to the connector posts for the final amplifier and short the key again. With the insulated trimmer rod adjust the final trimmer C_{15} to the minimum current reading on the meter. If a ¼ watt neon lamp is touched to the antenna post (minus antenna) it will show an r.f. glow. This will indicate resonance.

Now, release the key and connect the transmitting antenna to its post. Short the key again and retune the final trimmer for minimum current reading on the meter.

There will now be no indication of r.f. with the neon lamp but the signal will be present. The milliammeter will read around 12 mils. The tap-off

point, on the final tank, of the lead to the antenna post is a couple of turns from the plate end of the coil, and must be determined by experiment. It is important that the tap-off point, which will dip the meter to a minimum, is chosen when the final trimmer is being adjusted. For this tap-off lead I used about a foot of polyethylene insulated wire in order to avoid any r.f. loss.

The meter cable may now be removed from the final tank position and the connectors shorted with a short wire bridge. The meter should now be inserted in the positive lead of the "B" battery for a general reading. When the key is depressed the meter will read somewhere between 36 and 40 mils — the total transmitter current. Snap the changeover switch to the "receive" position and the meter will read between 28 and 30 mils of receiver current drain.

The first contact I made from the home location was with WSDEV in Ohio. This convinced me that it was a good little rig with a hot signal. Let's go portable, OM, but don't forget to drop the District Inspector a card as to the location of your portable operations!

-30-

"ELECTRIC EYE"

BELL Telephone Laboratories has announced the development of a new "electric eye" which is said to be much smaller and sturdier than present photoelectric cells.

The new device which has been named the "Phototransistor" is capable of delivering very high power for a photoelectric device so that in some instances enough power is generated to operate a switch directly without the preliminary amplification usually required.

The whole apparatus is housed in a tiny cylinder about as big as a .22 caliber rifle cartridge. Like the Lab's recently-developed "Transistor", the new unit has no vacuum, no glass envelope, no grid, plate or hot cathode.

The Phototransistor is similar in operation to the amplifying Transistor, but it is controlled by light rather than by the electric current of the emitter. It also uses a piece of germanium but only a single collector wire. The tip of this wire rests in a small dimple ground into one side of the germanium disc. At this point the germanium disc is only three-thousandths of an inch thick.

-30-

Bell Labs' new "Phototransistor" unit compared in size to an ordinary paper clip.

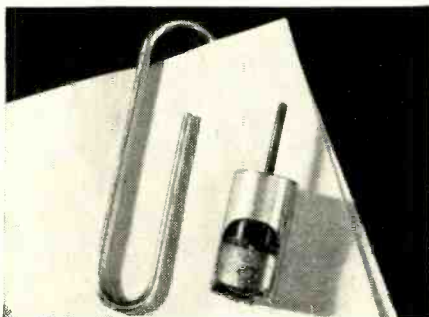

June, 1950

TOP SALES PROVE TV SET OWNERS WANT THE QUALITY PERFORMANCE AND QUALITY APPEARANCE OF



... The Astatic **MODEL AT-1** *Television Booster*

YES, the proof is in! When TV set owners want improved reception, they want the best in boosters — as witness the soaring sales of Astatic's Model AT-1. This is the powerful booster with four tubes, and such exclusive features as dual tuning and variable gain control, the latter permitting pinpoint tuning for exact amount of boost required for best picture and sound. The Astatic AT-1 Booster not only outperforms any other on the market, but it looks the part — in handsome, furniture-finish mahogany or blond cabinet to complement the finest receivers and other costly furnishings. These are typical advantages which have made the Astatic Model AT-1 Television Booster the undisputed leader today. Why not write for complete details, technical data?

Astatic Crystal Devices manufactured under Brush Development Co. patents



83



VIBRATORS!
By every test
ATR
is Best!

ATR
AUTO RADIO
VIBRATORS
have Ceramic Stack Spacers



A COMPLETE LINE OF VIBRATORS . . .
Designed for Use in Standard Vibrator-Operated Auto Radio Receivers. Built with Precision Construction, featuring Ceramic Stack Spacers for Longer Lasting Life. Backed by more than 19 years of experience in Vibrator Design, Development, and Manufacturing.

**ATR PIONEERED IN THE
VIBRATOR FIELD.**

NEW MODELS NEW DESIGNS
NEW LITERATURE
"A" Battery Eliminator, DC-AC Inverters
Auto Radio Vibrators
See your jobber or write factory

ATR
AMERICAN TELEVISION & RADIO CO.
Quality Products Since 1931
SAINT PAUL 1, MINNESOTA-U. S. A.

Technical BOOKS

"TELEVISION TUBE LOCATION GUIDE" by the Sams Staff. Published by *Howard W. Sams & Co., Inc.*, Indianapolis. Price \$1.50.

As another step toward providing the television technician with new and faster ways of servicing video receivers, this tube location guide covers hundreds of the popular model sets.

Designed to permit the preliminary diagnosis without chassis removal this book presents layout charts showing the tube lineup and the function of each tube. The index lists manufacturer, chassis number, and the chart number that applies for that particular make and model.

A little practice with this guide will undoubtedly give the service technician many good ideas for the fullest possible utilization of this servicing tool.

* * *

"AMATEUR RADIO MAP OF THE WORLD" by the ARRL Staff. Published by *The American Radio Relay League*, West Hartford, Conn. Price \$2.00.

The new and revised postwar edition of this map is prepared in four colors especially for use by amateur radio operators.

A special projection by *Rand McNally*, the new map measures 30 by 40 inches and shows the various countries of the world together with the call sign prefixes used by the hams of those countries. In addition to the regularly assigned prefixes, the map lists those used by the various military occupation forces throughout the world.

This map is a modified equidistant azimuthal projection, centered on Wichita, Kansas, allowing distance measurements of reasonable accuracy to be made between points in North America and the rest of the world. The map may also be used for determining great circle bearings from most points in the U. S. Besides the country boundaries, the map also gives the time zones, principal cities and the International Amateur Radio Union continental subdivisions.

Most amateurs will welcome this new map as a valuable and important addition to their ham shacks.

* * *

"MOST - OFTEN - NEEDED 1950 TELEVISION SERVICING INFORMATION" by M. N. Beitman. Published by *Supreme Publications*, Chicago. 144 pages. Price \$3.00.

This new and considerably enlarged edition of a popular servicing manual contains all of the well-known models produced by the leading television manufacturers in their 1950 lines.

Blueprint type circuit diagrams of the receivers are inserted in the manual where they can be used in conjunction with the service notes or

removed and then used separately on the service bench. Complete i.f. amplifier and trap alignment charts are presented for the various models along with step-by-step procedures for testing the various sections of the receiver.

The material is clearly and concisely written to provide the maximum amount of information in the least space. Service technicians will find this a handy volume to have on hand when they are faced with a tricky servicing problem.

* * *

"RADIO OPERATOR'S LICENSE Q & A MANUAL" by Milton Kaufman. Published by *John F. Rider Publisher, Inc.*, New York. 575 pages. Price \$6.00.

This new volume for the neophyte amateur or commercial license applicant contains a wealth of carefully prepared and arranged material covering the FCC examination questions.

As is customary with such a text the material is divided into the six elements in accordance with subject matter covered on the actual tests. The elements include the basic radio laws, rules, and regulations; basic theory and practice; radiotelephone; advanced radiotelephone; radiotelegraph; and advanced radiotelegraph. The balance of the text is devoted to amateur radio questions and answers, rules governing amateur radio service, and Classes A, B, and C amateur radio license examination questions and answers. Five valuable appendices have been included treating the rules concerning commercial radio operators, extracts from radio laws, conventional abbreviations and the international Morse Code, small vessel direction finders, and automatic alarm.

Written by an instructor at the *RCA Institutes*, the book is thoroughly practical and may be used either as a basic study guide or as a text for quick review or reference.

* * *

"DIAL CORD STRINGING GUIDE" by the Sams Staff. Published by *Howard W. Sams & Co., Inc.*, Indianapolis. Price \$1.00.

This is Volume 2 of a handy little reference book for the service technician. Like its predecessor this volume presents a maximum of information in the minimum amount of space.

The guide covers receivers manufactured in the two years since the appearance of Volume 1, and includes all of the receivers covered in the Photofact Folders through Set No. 70. The index in the front of the new book covers both the first and second volumes with the same numbering system retained to provide proper continuity.

Service technicians who own and use the first volume will need no introduction to this co-volume while newcomers would do well to investigate its time-saving advantages.

-50-

BRAND NEW—OVER \$80.00 LIST
MOTOROLA 8-TUBE
AUTO RADIO \$39.95
 With Speaker and Cables

Universal Under Dash Control \$1.95 Extra
FITS MOST CARS AND TRUCKS
Push Pull 6K6 Audio 8-Watts Output

Priced less remote control. For all trucks and cars, order our 2A1 universal underdash control, or pick custom controls from our limited selection listed below. Of course you may buy a custom control from your Motorola jobber. Merchandised by Tucker but branded Motorola. A real distance getter with high fidelity audio. Tone control and push buttons. Fits most cars and trucks. Compact size, 9 7/8 x 5 1/2 x 6 3/8". Everything furnished, including 6" PM speaker, cables, hardware, etc. You furnish any push button custom control or buy our 2A1 universal underdash control at \$1.95 extra. Shipping weight 15 lbs. List price over \$80.00. Motorola 708-T6 complete, less remote control, Net \$39.95. 2A1 underdash remote control, \$1.95 extra. (Will supply 7", 6x9", or 8" PM speaker in place of the 6" for \$1.95 extra.)
 Note: Pick a custom control from our limited list below for \$1.95 extra.

REG. \$7.95 DCF-3 FENDER or COWL ANT. \$2.95

Regular \$6.95, 3 section top cowl or fender mounting antenna. 3 section 36" or 31 1/2 inches exposed when collapsed. A universal mounting design. May be ordered with your Motorola set or purchased extra for \$2.95. Stock No. DCF-3. Weight 2 lbs.

10 Assorted Motorola Remote Control Heads \$14.95

10 assorted genuine Motorola remote control heads with knobs, pilot light, 46-47 Packard, 40 Hudson, 46-47 Hudson, 42 Cadillac, 42 Oldsmobile, 41 Nash, 41 Packard, 40 Pontiac, 40 Lincoln Zephyr, 40 Nash, 42-46 Lincoln Zephyr, 41 Nash, 42 Cadillac, 42 Hudson, 46-47 Hudson, 40 Nash, 42 Oldsmobile, 46 Packard, 42-46 Lincoln, 40 LaSalle, 42-46 Cadillac, 40 Hudson, 41 Lincoln Zephyr. \$1.95 each; 10 for \$14.95.

1950 MODEL PORTABLE TAPE RECORDER \$99.50

Our brand new 1950 model portable tape recorder. Response, 60 speed, 7 1/2 feet per second. Tape lam records 1 hour on 120' reel of turn spool over and record second 30 minutes. Fast rewind. Record 30 minutes. Includes an AC transformer type amplifier with 6" speaker. Inputs for mike and radio. External speaker jack. Price includes 30 minute reel of tape and mike. Hinged lid is removable. Case is attractive leatherette covered. Size 10x13x14". Shipping weight 29 lbs. Stock No. PLT-3. Net price \$99.50. Extra reels of recording tape. Latest type recording tape, plastic with red oxide coating. 5" reel \$2.10 each. 7" reel \$3.30 each. Latest type Kraft base, red oxide coating. 5" reel \$1.35 each. 7" reel \$2.10 each.

RECORDER PLAYER \$99.50 KIT

Complete record player kit, for 78 RPM records. All parts, tubes and diagram for building a 70L7 type and an Astatic pickup with permanent magnet. Shipping weight 10 lbs. Model No. MD-78. Net price \$9.95. Three-speed model No. D-3378, same as above only has 3 speed motor and Webster flip-over pickup and twin needles. Net price \$14.95.

3-SPEED AUTOMATIC PLAYER KIT \$39.95

Walnut cabinet, automatic 3 speed record player kit. Attractive cabinet with high grade wood. Two tube amplifier kit of parts including diagram, tubes and Alnico V PM speaker. Latest 3 speed automatic record changer that intermixes records of the same speed. 33 1/3, 78 and 45 RPM changer Model VM-406, with twin needles. A complete easy to assemble kit with instructions. Shipping weight 20 lbs. Stock No. LL-374. Net price \$39.95. Model LB-23 same as above only with 78 RPM changer, \$24.95.

McGEE HAS INTERCOMS AT TERRIFIC PRICES

10 STATION MASTER \$19.95
SUBS, \$3.95 EACH

Super heavy duty, 10 station intercom master, designed for continuous service. A powerful AC transformer type with 80 rectifier, 6V6 output and 6S7 driver. 5" speaker with 2-15" Alnico V magnet. Housed in a walnut cabinet 14" long, 8 1/2" deep and 7 1/2" high. Designed to install as a 3 wire system. Talk-tiston switch has silent position. Made to sell for a much higher price. McGee made a fortunate purchase and passes the bargain on to you. Shipping weight 12 lbs. Stock No. 2520. Net \$19.95 each. Remote station with call bell switch, use with the above master, \$3.95 each, 10 for \$35.00.

RADIO AND RECORD PLAYER \$14.95

For your children's room. Buy this superhet radio and record player. Here is what you get: A full 15 tube superhet broadcast chassis all wired and tested. Walnut cabinet, 78 RPM phono motor and crystal pickup. All you do, when you receive your set to drill mounting holes in cabinet. We are offering you this radio-phonograph at the price of an ordinary record player. Shipping weight 15 lbs. Stock No. JA-70. Net price \$14.95. Stock No. AUT-10. Same radio chassis and cabinet as above, but furnished with a 78 RPM automatic record changer. Shipping weight 25 lbs. Net price \$24.95.

Our Leader Changer Scoop \$10.95, 2 for \$20.90

Our leader, automatic changer scoop. Base size 13 x 13". Plays 10 1/2" or 12 1/2" 78 RPM records automatically. Has Astatic record pickup. Priced complete with a metal base, which can be used in slide away compartment or as a table top base, or changer can be lifted off base to save space. Stock No. AD-12. Shipping weight 6 lbs. Scoop price \$10.95 each; 2 for \$20.90.

VM-800 78 RPM changers \$12.95. VM-400 78 RPM changers \$12.95. Farnsworth 3 post 78 RPM changer with variable reluctance cartridge and needle \$14.95. Aero-Stewart Warner 78 RPM changer \$12.95. Crescent Model 350 78 RPM changer \$12.95.

WEBSTER 356-1 \$24.95

Brand new in original factory cartons. Only 50 to set. Webster 3 speed automatic record changers with crystal cartridge and tandem tip permanent needle. Webster-Chicago Model 356-1. Shipping weight 16 lbs. Sale price \$24.95 each while 50 last.

SCOOP ON CARTRIDGES

Astac N-1-J Nylon 1" with 1/2" tip. Net, \$2.79. M.P.1 Astac cart. with needle. Net, \$1.19. Astac L-70 or Webster equal. 3 volt output. Net, \$1.79. Astac L-70 or Webster equal. 1 volt output. Net, \$1.79. Flip-over cartridge with twin needles. Net, \$2.98.

G.E. RPX010 V.R. CART. \$2.95

G.E. RPX010, with permanent needle. \$2.95 each, 10 for \$24.95. A lucky purchase enables us to offer these to you for only \$14.95. Include postage for 8 lbs. Stock No. MB-35.

BUY YOUR S-56 HALLICRAFTERS WITH A 15 INCH COAXIAL \$77.95

S-56 HALLICRAFTERS
 11-TUBE FM-AM CUSTOM CHASSIS. A \$110.00 VALUE **\$59.95**
 AT McGEE FOR ONLY . . .
 • WIDE RANGE • AUTOMATIC FREQUENCY CONTROL ON F.M.
 Receives 88 to 108 MC F.M. and Broadcast 550 to 1650 K.C.

Fine for custom installation. Model S-56 Hallicrafters 11 tube AM-FM radio receiver chassis for broadcast and FM 88 to 108 MC. Automatic frequency control on FM, holds the receiver in perfect tune. Phono connection on rear of chassis. Full range tone control with bass boost. Push-pull 6K6 tubes in audio system. Frequency response essentially flat from 50 to 14,000 CPS. Wide vision accurately calibrated slide rule dial, with pre-selection on broadcast band. Output transformer matches any 8 ohm speaker. 4 antenna terminals, two for AM and two for FM. This is the finest type of home radio that we know of today. Better get your order in early. Designed to be used in commercial radio selling in the \$400 to \$600 class. The regular dealers' net on this chassis is \$110.00. However, a lucky purchase enables us to offer these brand new factory cartoned S-56 Hallicrafters chassis complete with tubes and operating instructions, at only \$59.95 less speaker. Chassis size 12 1/2 x 14 1/2 x 3 1/2". Shipping weight 25 lbs. Net price \$59.95. Buy your S-56 with a wide range FM speaker.

S-56 chassis with our \$62.50 list 15" coaxial (P15-8) PM speaker, on sale for \$77.95.
 S-56 chassis with our \$32.50 list 12" coaxial (CU-13X) PM speaker, both for \$69.50.
 S-56 chassis with our new 12" curvilinear cone (1202-X) PM speaker, both for \$67.95.
 VM-406 Tri-O-Matic, 3 speed changer \$33.21.
 VM-406GE, 3 speed changer with new GE RPX-050 V.R. cartridge \$36.01.

Pre-amplifier for S-56 \$3.95

Dual purpose pre-amplifier for either S-56. Only 4 wires to connect (instructions furnished). With this pre-amplifier you can convert set to operate either a G.E. variable reluctance pick-up or a crystal or dynamic mike, making your S-56 a home P.A. system. Preamp Model SS-69. Size 3 1/2 x 4 x 3". Shipping weight 2 lbs. Net price \$3.95. Buy your S-56 with a crystal mike and desk stand, \$4.95 extra.

BUY YOUR S-56 WITH A CHANGER AND CABINET

A Arm Chair Cab. \$29.95 **B VM-406 3-Speed \$33.21** **C Furniture Baffle \$29.95** **D Radio Changer Compartment \$29.95**

A Armchair radio-phonograph combination cabinet. Specify when ordering whether you want the radio panel cut for the S-56 or blank. Size, 24" high, 27" long and 16 1/2" wide. Will hold a changer up to 14" square. Changer panel 18" x 18". For any speaker up to 12". Radio chassis area is 14" long, 9" high and 10" deep. Top quality furniture construction and finish. Will also accommodate 78-22 chassis, but not offered cut for armchair cabinet, cut for S-56 or blank, net price \$29.95. Mahogany armchair cabinet, cut for S-56 or blank, net price \$29.95. Blond armchair cabinet, cut for S-56 or blank, net price \$34.95. Shipping weight 40 lbs.

B The new VM model 406 Tri-O-Matic automatically plays all records, all sizes and all speeds now on the market. Protective features: records are lowered, not dropped, no wobbling down the spindle, no slip or scrape, no possibility of the tiny microgrooves on the new type records being damaged. Plays 12 1/2", 33 1/3 or 78 RPM, 10 1/2", 33 1/3 or 78 RPM, any 10 or 12" record of the same type intermixed, 12 1/2" 33 1/3 RPM and 12 1/2" 45 RPM records. Automatically shuts off on the last record, base size 13 1/2" x 16 1/2" x 2 1/4", 7 1/4" high overall. Equipped with flipover crystal cartridge and needles. Stock No. VM-406. Shipping weight 12 lbs. Net price \$33.21. New 1950 Model VM-406 with All-in-one General Electric Variable Reluctance Cartridge and Twin Needles. Model 406GE. Specify VM406-GE. Add \$2.85 to above cost.

C A fine furniture quality speaker baffle, made of 3/4" brown mahogany. Will hold either a 12 or 15" speaker. (Specify size speaker you intend using when ordering.) You may buy this baffle by itself or for use with our radio and changer compartment. The two pieces are a matched pair. Set the radio cabinet by your chairside and the speaker other radio. This baffle is of high quality, non-rattle construction. Stock No. LS-4. Shipping weight 40 lbs. Net price \$29.95.

D A fine furniture quality changer compartment (no space for speaker). Intended for use with the speaker baffle on the left, or may be purchased separately. You have some place to put your speaker. Cabinet is made of 3/4" brown mahogany and is of furniture quality. It is 25" high, 8 1/4" x 17 1/4". Consists of two drawers, one for the record changer 14 1/2" x 14 1/2" x 2 1/4" above the motor board; the other drawer has space for radio panel cut for the S-56, the 78-22 utility chassis, or blank. We can supply with the ordering. Stock No. LB-2. Shipping weight 38 lbs. Net price \$29.95.

McGEE OFFERS YOU A NEW IMPROVED 4-PRONG VIB IN SERRATED ALUMINUM CANS—1950 ENGINEERING AND PRODUCTION

McGee's new 1950 AX quality vibrators. Extremely long life construction. New assembly techniques and design makes a more perfect vibrator. This research found that resin vapor attacks the latex rubber boot inside vibrator. The new model eliminates that trouble. A full floating select unit with latex rubber boot and mounting, housed in a new aluminum serrated can. All McGee AX vibrators are unconditionally guaranteed for one year. Price \$1.19. All most of your vibrator needs. V-53, standard 4 prong vibrator. Replacement for Motorola, Chrysler original equipment, Mallory, etc. Net price \$1.19 each. VO-13, 4 prong offset non-synch vibrator. Replacement for Delco 1301 and Mallory 852, General Motors, etc. Net price \$1.29 each. FF-4, small can 4 prong vibrator used in Ford, Zenith original equipment radios. Net price \$1.29 each.

NEW VERSATILE 12 TUBE FM-AM CHASSIS \$49.95

★ **BUILT IN PRE-AMPLIFIER FOR G.E. VARIABLE RELUCTANCE PICKUP**
 ★ **WIDE RANGE AUDIO**
 ★ **MAY BE USED WITH A CRYSTAL MIKE AS A HOME P.A. SYSTEM** **78-22 CHASSIS \$49.95**

McGee's new 1950 model 12 tube FM-AM chassis. Latest design with phono inputs for all types of record players, crystal or variable reluctance. Receives standard broadcast 550 to 1700 KC and FM 88 to 108 MC. Wide range audio response (push-button 705) and base boost tone control. Loop antenna for broadcast and 300 ohm line type antenna may be stored in cabinet. Attractive lighted slide rule dial. Chassis size, 13 1/2 x 20" high and 9" deep. Shipping weight 20 lbs. Stock No. 78-22. Made to sell at a much higher price. McGee's sale price is \$49.95, less speaker (output matcher, 8 ohm). 78-22 chassis with our 12" PM model 1202-X for \$57.95. 15" coaxial PM, P-158, both \$67.95. Crystal mike, new style recording type, plugs in to variable reluctance input of the 78-22 chassis. Buy a mike for your chassis and have a home P.A. system. Model CS-50. Net \$4.95.

AMERICAS BEST VALUES IN
WIDE RANGE PM SPEAKERS
 "THEY WOOF AS THEY TWEET"

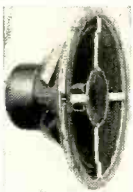

MODEL P15-8
15 INCH "COAXIAL" P.M. SPEAKER
 • NEW 1950 MODEL
 • REGULAR \$62.50 LIST
\$19.95

"IT WOOF AS IT TWEETS"

REPRODUCES ALL MUSIC AND SPEECH WITH NATURAL CLARITY This 15", 35 watt peak coaxial PM speaker is not surplus. It is manufactured by a leading speaker company, to our own specifications. We buy them by the hundreds in order to offer them to you at this low \$19.95 price. They are comparable to any \$62.50 list speaker on the market. The 15" woofer will reproduce down to 20 cycles. It has a 22 oz. Alnico V magnet and molded cone with 1 1/2" voice coil. The high frequency tweeter is coaxially built in, with a special cone that will produce notes up to 17,500 cycles. The input impedance of both reproducers combined, is 8 ohms. Matching network is concealed under the pot cover. Just hook this up like any other 8 ohm speaker and hear the difference. Shipping wt. 14 lbs. Stock No. P15-8. Sale price, \$19.95; 2 for \$38.00



MODEL CU-13X
12 INCH "COAXIAL" P.M. SPEAKER
 • New Aluminum Voice Coil Model
 • Wide Range, 40 to 17,500 CPS.
 • Reg. \$32.50 List of McGee
\$9.95

REPRODUCES ALL MUSIC AND SPEECH WITH NATURAL CLARITY McGee announces its new 1950 Model 12" coaxial PM speaker. A regular \$32.50 list price, but mass production enables a new low price of \$9.95. Made especially for McGee by a famous speaker manufacturer, to our own specifications. It's a new 1950 model. The sale of 10,000 coaxial speakers assures you that this speaker is a smart choice. The speaker consists of a 12" Alnico V magnet with 1" voice coil and heavy one piece ribbed cone. This responds to the lower register of the audio spectrum. The tweeter has its own separate 2 1/2" Alnico V magnet. A high pass filter is concealed under the pot cover. This prevents low frequency from reaching the tweeter. The 3" tweeter has a very stiff cone and responds only to the upper register of the audio spectrum. With all this the speaker is still just as simple to connect as any ordinary PM. Only two wires to connect. Input impedance is 8 ohms. Designed especially for the critical music listener with a keen ear for the higher audio register. Response is from 40 to 17,000 cps. 18 watts. This speaker is ideal for the home market. Generally used in only \$400 to \$800 radio installations. The high piano, cymbal and violin notes will reproduce clearly with our new 12" coaxial speaker. Model CU-13X. Shipping weight 8 lbs. Net price, \$9.95; 2 for \$19.00



MODEL 15-LS
15 INCH 40 WATT P.M. SPEAKER
 • A Super Heavy Duty Deluxe P.M.
 • 21.5 Oz. Alnico V Magnet
\$15.95

A regular \$45.00 list 15" molded cone Alnico V PM speaker. 21 1/2 oz. Alnico V magnet, with molded cone and 1 1/2" 8 ohm voice coil. A super heavy duty speaker that will take 35 watts with ease, up to a 50 watt peak. The King Juke PM. Response down to 20 cps and up to 2,000 cps. Shipping weight 14 lbs. Model 15-LS. Net price, \$15.95; 2 for \$30.00 Model 15-Kit, standard juke box PM. 15" with 8 ohm voice coil and 12 oz. Alnico V magnet. Shipping weight 10 lbs. Net price, \$9.95; 2 for \$19.00



MODEL A-50
12 INCH 40 WATT P.M. SPEAKER
 • FOR RUGGED P. A. USE
\$13.95

Model A-50, 12" 40 watt super heavy duty permanent magnet speaker. Has 1 1/2" 8 ohm treated voice coil and one piece molded cone. Heavy half inch machined pot, with bolt secured 21 oz. Alnico V magnet. Frame is of heavy construction with metal pot cover. Finished in silver-grey enamel. This speaker is the best possible value today. Efficiency is two or three that of ordinary speaker. Especially recommended for all public address systems and high quality home audio systems. Will handle 35 watts with ease and 50 watts peak for short lengths of time. Its retail value is \$50.00. Wt. 8 lbs. But by our large purchase, we are able to offer it to you for only \$26.00 TWO FOR



MODEL 1202-X
12 INCH WIDE RANGE P.M. SPEAKER
 RESPONSE 35 TO 12,500 CRS.
\$9.95

Why pay more? McGee's new 1950 model 1202-X Music Lovers' Reproducer. A full heavy duty 14 1/2 oz. Alnico magnet PM speaker. Full 1 1/2" 8 ohm voice coil. One piece molded curvilinear cone forms a trumpet for the high note distribution. An ideal speaker for high fidelity music system and P.A. work. The rugged construction of this speaker enables handling of low notes down to 35 cps; organ lows, etc. High up to 12,500 cps. Made for us by a famous speaker builder, to our own specifications. Lustre-grey finish, metal pot cover. Shipping weight 7 lbs. Stock No. 1202-X. Net price, \$9.95; 2 for \$19.00

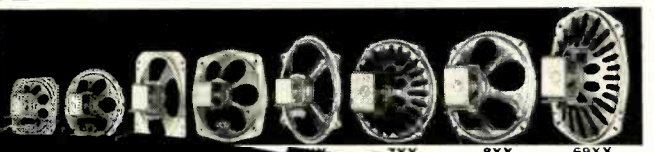

WIDE RANGE PM SPEAKERS

in—In Cartons

COIL SPEAKERS

Quality guaranteed. All in speaker builder, to our order. High up to 12,500 cps. Made for us by a famous speaker builder, to our own specifications. Buy from McGee and

A 3.2 ohm V.C.

\$1.09 ea., 10 for \$10.00
1.09 ea., 10 for 10.00
1.69 ea., 10 for 14.95
1.95 ea., 10 for 17.95
2.29 ea., 10 for 20.95
1.95 ea., 10 for 17.95
2.79 ea., 10 for 24.95
2.95 ea., 10 for 27.95
2.95 ea., 10 for 27.95
or single plate and size strap
10 for \$ 7.50
10 for 9.50
10 for 11.00
10 for 13.95
10 for 14.50
10 for 14.50

BROADCAST QUALITY TRANSFORMER KIT

Response 18 to 22000 C.P.S. The Same Quality as Used in the Finest Quality Audio Amplifiers

Why Pay More **Sale Price \$12.95**

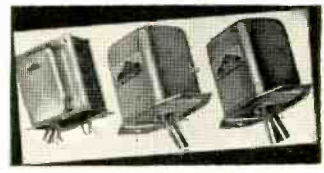

You Get—1. Broadcast Quality Push Pull 6V6 Output. 2. Power Trans., Rectifiers. 3. Filter Choke. 4. Hook Up Data and Suggested Diagram.

If You Build a Music Lover Amp Build the Best

Here is the hottest transformer kit we have ever offered. Originally intended for use in the high priced Lear recorder amplifier. Made of the best possible material to give broadcast station frequency response: 18 to 22,000 CPS. A suggested diagram is furnished to build your own amplifier; with inputs for G.E. variable reluctance phono pickup, crystal phono pickup or radio tuner. Here are the transformer specifications: 18 to 22,000 CPS, matches 2-6V6 in push-pull (15-watts), output taps match 4 or 8 ohm speaker. The power transformer is a fully shielded upright model, 3 1/2" x 4 1/2" x 4 1/2" tall, weight 9 1/2 lbs. This transformer is utilized in a full wave selenium rectifier bridge, (easy to hook up, full details included), which delivers 300 volts at 200 mA. The power transformer is a fully shielded upright model, 3 1/2" x 4 1/2" x 4 1/2" tall, weight 9 1/2 lbs. The choke weight 2 1/2 lbs. and is the same size as the output. You get full description of the kit, including a suggested schematic. You supply the other parts. We furnish the power transformer, choke, output and rectifiers. Shipping weight, 15 lbs. Stock No. TD-1822. Net price, \$12.95

WIDE RANGE AMP KITS COST LESS AT MCGEE

34 WATT WIDE RANGE AMP KIT \$29.95

- RESPONSE 20 TO 20,000 C.P.S.
- TWIN ELECTRONIC TONE CONTROLS

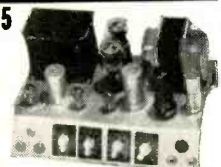

It's the newest thing in audio amplifiers. McGee's wide range, 34 watt amplifier kit with inputs for crystal or diode pickup, Alnico V magnet phono cartridge, as well as the new G.E. variable reluctance cartridge. Output transformer in wax impregnated, weighs 6 lbs. Voice coil taps 4-8-15-250 and 500 ohm. Push-pull 6L6 output tubes. Separate electronic base and treble boost. Inverse feedback. Input tube filament is DC heated to reduce hum level to nil. Frequency response from 20 to 20,000 cps. Easy to follow diagram and photos for easy assembly of this kit. Ready punched chassis. Every part furnished, including tubes: 2-6L6, 5V4, 3-12AX7. Shipping weight 25 lbs. Stock No. XX-34. Net price, \$29.95. XX-34 WT (wired and tested) \$10.00 extra. Buy a mike: see our listing below.

NEW 15 WATT UTILITY AMP KIT

- INPUT FOR VARIABLE REL. PICK UP
- MIKE INPUT
- TONE CONTROL
- FADER CONTROL
- COMPLETE KIT



Kit Model TM-15, push-pull wide-range 15 watt amplifier. Ideal for a high quality record player, as a P.A. system or recording amplifier. Matched component parts, ready punched chassis. One control fades from phono to mike. Input impedance 100 mil power transformer. Complete with tubes, photos and diagram. 2-6V6, 2-12AX7 and rectifier. Variable tone control. Model TM-15. Weight 10 lbs. Net price, \$12.95. Wide range output transformer to 8 ohm voice coil \$3.95 extra.

MODEL ZZ-30—30-WATT Commercial Quality Amp Kit \$19.95

"Build an Amp Like You Would Buy"

A complete kit of parts to build a factory quality 30 watt push-pull amplifier. Services you can wire this amplifier and have a commercial looking unit. Pan and cover are ready punched and grey splatter finished. Size 5 1/2" x 12". Inputs for two mikes and one phono. Bass boost tone control. Full range output transformer. Full size power transformer. 2-12AX7, 6SN7, 2-6L6 and 5U4. Shipping weight 10 lbs. Net price, \$19.95. All small parts furnished, nothing else to buy. Printed diagram furnished. Why not order a mike? See our specials below. Wide range Capehart (regular \$7.95) Output transformer \$5.00 extra.

MODEL CN-1232 12 INCH 25 WATT P.M. \$5.95



1232. Net price \$5.95 each, 4 for \$22.00.

SCOOP!

8" Speaker \$2.95
 8" Baffle \$1.95
 Stock 8-8X 8 inch heavy duty 6.8 ohm Alnico V PM with 1 1/2" 8 ohm voice coil (as illustrated) \$2.95 each 10 for \$27.50.
 Stock No. 8-RCM 8 inch tri-color, plastic front wall Baffle. Very popular with music box operators. Sale price \$1.95 each, 10 for \$17.50.
 8 inch 6.8 ohm Alnico J PM speaker made by Jensen for Bell and Howell. A terrific bargain. Stock No. JEN-8. Net \$2.95, 10 for \$27.50.

McGee's Super High Fidelity OUTPUT TRANS. \$6.95 Best Value in U.S.A.

Model A-403 High fidelity output transformer. Why pay \$20 or \$30 for an output, when our A-403 is available at \$6.95! Impedance, 600 ohms plate to plate, (for PP 6L6 or 6V6), 10% feedback winding, 4-8-15-250 and 500 ohm secondary. Housed in a potted case. Net weight 8 lbs. Recommended for all amplifiers up to 34 watts. Size 3 7/8" x 4 1/2" x 3". Suggested diagram furnished. Shipping weight 8 lbs. Net Price A-403 \$6.95.

DYNAMIC \$9.95 MIKE

Our leader dynamic mike Model D-4. Our leader high impedance dynamic mike. Shipped with 12 ft. cable. Very special at \$9.95 each. Top Quality Chrome Floor Mike Stand, \$4.95.

MCGEE'S DOUBLE X LINE OF TRUMPETS & DRIVERS



10 WATT PAGING SPEAKER \$11.95

McGee's XX quality paging speaker. Made by a big name mfr. Outdoor or indoor, all-weather paging speaker. A 10 watt, 15 ohm Alnico V driver, attached to a spun metal exponential horn, with swivel bracket. Stock No. 10-XXP. This is a complete speaker driver and horn attached. Full 1 year guarantee. Bell diameter is 7". Shipping weight 4 lbs. McGee's scoop price, \$11.95. Why pay more?

25 WATT DRIVER, \$12.50
 3 1/2 Foot Horn, \$13.50 Both for \$23.95
 XX-100, 11" weather 3 1/2" reflex trumpet. Aluminum castings and spinings. Exponential curve for best low frequency efficiency 19" bell diam. Hammer-tone finish, adjustable angle mounting bracket. Can be used with all standard driver units (13x18 threaded). Sh. wt. 13 lbs. Stock No. RM-30. A new model driver, designed to fit all standard trumpets and especially for use with the XX-100 described above. Net weight 8 lbs. Recommended for all amplifiers up to 34 watts peak. An Alnico V job that is completely weather and water proof. 1 year guarantee. Impedance 15 ohm, standard 1 3/4" x 1 3/4" Sh. wt. 13 lbs. McGee's XX quality second to none. Why pay more? Stock No. RM-30, McGee's price, \$12.50.
 Notes: To have a complete exponential speaker, order a RM-30 driver unit and XX-100 trumpet. Stock No. XX100-RM30. Both for \$23.95.

Prices F.O.B. K.C. Send 25% Deposit with Order, Balance Sent C.O.D. With Parcel Post Orders, Include Postage

TELEPHONE VICTOR 9045. WRITE FOR FLYER 1422 GRAND AVE., KANSAS CITY, MISSOURI





HENRY HAS THE NEW hallicrafters MODEL SX-71 NOW!



This new type of receiver—the first of its kind on the market—has extra sensitivity, selectivity, and definitely superior image rejection. Continuous AM reception from 538 kc to 35 Mc, and 46 to 56 Mc. One RF, 2 conversion, and 3 IF stages. 105-125 volts AC. 11 tubes plus voltage regulator and rectifier. Only \$179.50.

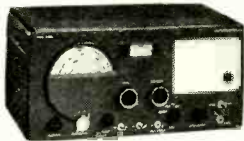

MEDIUM PRICED HALLICRAFTERS MODEL S-40A
540 kc. to 43 Mc. Temperature compensated. One RF, 2 IF, 3-watt output, 4 bands. 115 V. AC. 8 tubes plus rectifier. Internal speaker. Only \$79.95. Other popular Hallicrafters models: S38-A, only \$39.95; S-72, only \$89.95; SX-43, only \$159.50; SX-62, only \$269.50.

I have a complete stock of Hallicrafters receivers and transmitters. I'll make you the best deal on a trade-in for your communications receiver. I give you prompt delivery, and 90-day FREE service. Nobody can beat Bob Henry on a trade-in, and I offer you the world's lowest credit terms. Write, wire, phone, or visit either store today for the best deal.

Bob Henry
W5ARA

Ballter 2, Missouri

HENRY RADIO STORES

11240 Olympic Blvd
LOS ANGELES 25
CALIF.

"WORLD'S LARGEST DISTRIBUTORS OF SHORT WAVE RECEIVERS"

Improving Response

(Continued from page 52)

teristics. Second, since the impedance source of the "woofer" is pure resistance it has a tendency to smooth out resonant peaks, and to improve transient response noticeably.

Not having access to speaker testing apparatus, I was forced to rely on my ear in determining the final results of this arrangement. Using a steady state frequency test record in conjunction with a *General Electric* variable reluctance pickup I found that tones up to 12,000 c.p.s. were very clearly audible (with reference to a 1000 cycle tone). Beyond this range there was a gradual roll-off until, at 16,000 cycles there was no audible output. Considering the fact that the *General Electric* pickup has an inherent roll-off commencing at the 10,000 cycle region, and remembering that the human ear, itself, loses sensitivity at this point, it is safe to assume that the speaker's response extends with negligible attenuation to at least 15,000 cycles. With proper amplifier equalization, speaker response could be made to extend all the way to 20,000 cycles.

Using the same test set-up it was found that the low range held up wonderfully to 50 cycles, at which point it began to roll-off. Twenty cycles was the lowest audible sound detected.

If you have intentions of trying this circuit on your own speaker, it would be a good idea to first use a variable resistor as the diagram shows. Later, if you desire to make a permanent installation, a potentiometer could be substituted for the resistor and installed in the speaker cabinet. This would allow instant, convenient adjustment of speaker response to suit different program material. A switching arrangement could also be employed whereby this circuit could be cut out entirely and the speakers reconnected directly to the amplifier output terminals in the normal manner. This would permit full output of the amplifier to be utilized in cases where maximum power is required.

Your amplifier should be capable of furnishing at least 10 watts of low-distortion power in order that this circuit can function to the best advantage.

At Last!

**INTERLOCKING
SMALL PARTS CABINETS
TO FIT ANY SPACE**

MULTI DRAWERS are the handy small parts steel storage cabinets you and your friends have always wanted! Each 5 x 2 7/8 x 2 1/4 drawer (painted green) interlocks on top, bottom or sides making it possible to fit them around existing fixtures for economy of space. Card holder on front of each MULTI DRAWER. Immediate delivery in sets of 12 at \$3.50 per set. Mail coupon now!

THE CININNATI VENTILATING CO., INC.

Third and Madison Sts., Covington, Ky.

- Please send ___ sets of MULTIDRAWERS @ \$3.50 per set
 C.O.D. Check Money order enclosed. I agree to pay postage.
 I am interested in being a MULTI DRAWER dealer. Send full information.

Name _____

Address _____

City and State _____

CHICAGO RADIO AND APPLIANCE MULTITESTER

Model
458A



New
Wider
Ranges

NEW
CASE
DESIGN
FOR EASY
READING

AC and DC VOLTS: 0-2.5/10/50/250/1000/5000
 AC AMPS: 0-0.5/1/5/10 DC AMPS: 0-1/10
 AC and DC MILS: 0-1/10/100
 OHMS FULL SCALE: 1000/200,000/2,000,000
 OHMS CENTER SCALE: 50/2250/22,500
 SIZE OVERALL: 10 1/2" x 6 1/2" x 6" Meter: 4 1/2" wide.

Handsome brown Hammerloid case with leather strap.
 1000 Ohms per volt. Net Price \$26.00

We manufacture a complete line of fine portable multitesters.

Chicago

Write for
circular

INDUSTRIAL INSTRUMENT CO.

536 W. ELM ST. • CHICAGO 10, ILL.

What's New in Radio

FM-AM TUNER

A moderately priced FM-AM tuner is currently being marketed by *Approved Electronic Instrument Corp.* of 142 Liberty Street, New York 6, New York as the Model A-710.

The unit, measuring only 8 1/4" x 5 3/8"

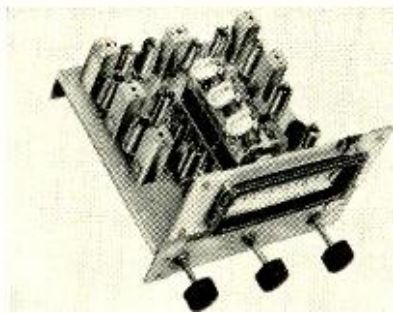

x 8", is particularly suitable for custom installations in confined spaces. The tuner can be mounted either horizontally or vertically and is available with the appropriate scales for either mounting. The tuner covers from 88 to 108 mc. and from 540 to 1800 kc.

Power requirements are 170 volts d.c. at 20 ma. or 140 volts d.c. at 37 ma. and 6.3 volts at 4 amps.

COILS AND CHOKES

A new line of coils and chokes adaptable to "tailor-made" specifications has been introduced by the *Shallcross Manufacturing Company*, Collingdale, Pa.

Available types include high "Q" radio-frequency chokes, progressively-wound slug-tuned broadcast coils, and oscillator coils, all of them having special characteristics which cannot be matched by standard coil types. The r.f. chokes may be made up as two separate coils having a specified coupling coefficient. High permeability iron cores are sometimes used to provide greater inductance in a small unit.

For full details on these new units, write direct to the company.

HANDY TOOL

Service technicians will find the new flashlight screwdriver being offered by *Commonwealth Sales Company* of 576

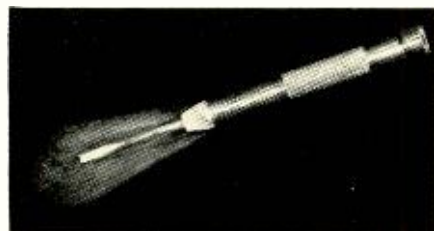

Broadway, New York 12, New York a handy addition to the tool kit.

Moderately priced, this sturdy hand tool is built for rough usage. Of polished aluminum with a knurled handle

For additional information on any of the items described herein, readers are asked to write direct to the manufacturer. By mentioning RADIO & TELEVISION NEWS, the page, and the issue number, delay will be avoided.

and hardened steel blade set in plastic, the screwdriver measures 8 1/4" overall and has a 3/16" blade.

The flashlight, which takes standard batteries and bulbs, permits the illumination of hard-to-see areas in radio and television chassis.

SOUND SYSTEM

Atlas Sound Corp. of 1449 39th Street, Brooklyn 18, is currently introducing a new multi-cellular tweeter reproducer and high pass filter for use in connection with any suitable type of cone speaker woofer.

The horn, because of its six cell construction, offers a wide angle distribution pattern and the response is clean and efficient to 15,000 cycles, according to the company.

The unit will handle 25 watts of program material above 1000 cycles. The die cast sectoral horn with flush

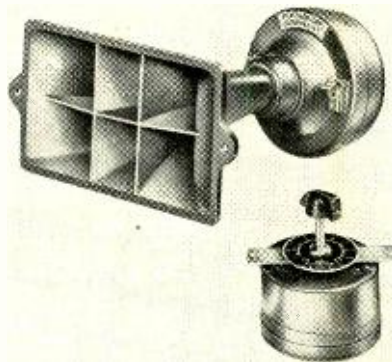

mounting measures 6 3/4" wide, 3 1/2" high, and 8" deep. The new unit has been designated the Model HR-2.

PORTABLE INSTRUMENTS

A new line of portable instruments has been introduced recently by *Westinghouse Electric Corporation* of 306 Fourth Avenue, Pittsburgh 30, Pa.

Both single and multiple range models are available in the new line. Ammeters are available in full-scale ranges from 20 microamperes to 50 amperes d.c. and from 5 ma. to 50 amperes a.c. For d.c. voltages, the full-scale ranges run from 10 millivolts to 800 volts, with a.c. ranges from 1.5 volts to 300 volts. Rectifier milliammeters are available in full-scale ranges from .5 to 10 milliamperes, and rectifier voltmeters from 2 to 800 volts.

The meters, which are rated in the 2% accuracy class, measure 3 5/16" wide, 4 1/4" long, and 1 25/32" deep for the d.c. type while the a.c. meter is the same size except that the depth is 2

5/16". The line, Type P-12, utilizes both moving iron and permanent magnet moving coil mechanisms housed in compact molded cases.

UTC SUBMINIATURES

The development of a subminiature audio transformer, so small that 30 of

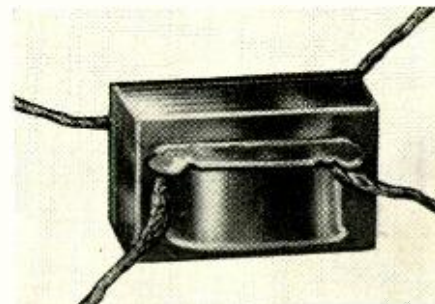

the units will fit into a cigarette pack, has been announced by *United Transformer Company* of 150 Varick Street, New York 13.

The UTC Type SSO transformer's dimensions are only .4 x .75 x .56 inches and it weighs only .28 ounce. Five stock types cover input, interstage, output, and reactor applications. All of these units are vacuum impregnated to assure dependable operation under high humidity conditions.

INTERFERENCE LOCATOR

A new radio interference locator for the 550 kc. to 30 mc. frequency range has just been introduced by *Sprague Products Co.* of North Adams, Mass.

Designed specifically for use by public utility troubleshooters and others interested in tracking down and eliminating man-made radio noise, the new Model 302 locator is compact and easy to operate.

The instrument uses a sensitive 8-tube superheterodyne circuit and operates either from self-contained batteries or 115 volt power lines. An auxiliary inverter power supply is available for automobile battery operation.

Each locator is supplied with both a loop and a collapsible rod antenna for normal use. An r.f. search probe, insulated for 35,000 volts a.c., is also available for field use as is an audio probe for circulating current faults and cable fault locations.

The unit features a built-in loudspeaker, built-in dual range output meter and battery test meter, calibrated r.f. and audio gain controls, a b.f.o. for detecting unmodulated signal sources, etc.

PARTS at LOWEST PRICES! FILTER CONDENSERS



Very best
brands
Fresh stock

10 or more
assorted
5% discount

450 Working Volts		150 Working Volts	
8-450 V	ea. 21c	8-150 V	ea. 19c
10-450 V	ea. 24c	10-150 V	ea. 19c
10-450 V w/		10-10-150 V	ea. 24c
20-20-25 V	ea. 29c	15-150 V	ea. 29c
15-450 V	ea. 29c	16-150 V	ea. 21c
20-450 V	ea. 39c	20-150 V	ea. 23c
30-450 V	ea. 45c	20-150 V	ea. 25c
30-450 V w/		40-150 V	ea. 29c
20-20-25 V	ea. 29c	15-15-150 V	ea. 29c
8-8-450 V	ea. 39c	20-10-150 V	ea. 24c
8-8-450 V		20-20-150 V	ea. 29c
50-50 V	ea. 29c	20-20-150 V	ea. 39c
8-8-8-450 V	ea. 39c	25-25 V	ea. 39c
8-8-8-450 V		25-25 V	ea. 39c
50-50 V	ea. 39c	30-50 V	ea. 39c
10-10-450 V	ea. 43c	100-25 V	24c ea.
20-20-450 V	ea. 49c		
10-10-10-20-			
450 V-150-			
25 V	ea. 49c		
25-10-450 V	ea. 49c		
30-20-20-450			
V-25 V	ea. 49c		
30-30-400 V	ea. 39c		
350 V	ea. 39c		
30-30-25-400	ea. 39c		
V-25 V	ea. 39c		
30-10-20-400	ea. 39c		
V-25 V	ea. 30c		

30-20-150 V	ea. 29c
30-30-150 V	ea. 39c
35-35-150 V	ea. 39c
40-20-150 V	ea. 39c
40-30-150 V	ea. 39c
40-20-25 V	ea. 39c
40-40-150 V	ea. 39c
20-25 V	ea. 39c
50-30-150 V	ea. 39c
50-50-150 V	ea. 39c
60-60-150 V	ea. 39c
20-16-16-350 V	
Sprague	
type	ea. 39c
25-25-150 V	
200-10 V	ea. 39c
15-15-40-20-	
150 V-25 V	ea. 29c
20-10-5-10-	
150 V-25 V	ea. 39c
20-20-150 V-	
25 V	ea. 39c
20-20-160-40-	
150 V-25 V	ea. 39c
20-10-15-150	
V	ea. 39c
30-5-20-150	
V	ea. 39c
30-30-20-150	
V	ea. 39c
30-30-200-	
150 V-10 V	ea. 39c
30-20-20-150	
V	ea. 39c
30-30-20-20-	
150 V-25 V	ea. 39c
30-30-15-20-	
150 V-25 V	ea. 39c
10-16-16-	
150 V	ea. 39c
Cathode Condensers	
10-25 V	
20-20-25 V	
20-20-20-	
25 V	16c ea.
20-25 V	
25-25 V	
30-50 V	
100-25 V	24c ea.

Bulletin M-446 covering the new Model 302 locator is available upon letterhead request.

POWER PLANTS

Kato Engineering Company of Mankato, Minnesota, has recently added a

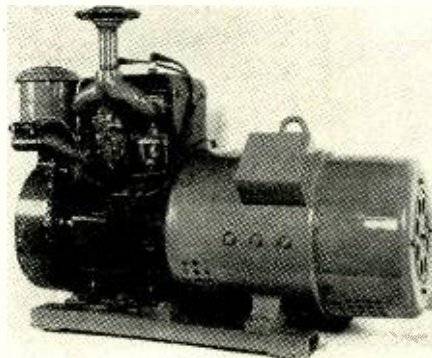

new model plant to its line of standby power units.

The Model 45HFW4 is a 5 kw., self-excited, a.c. generator which provides 110/220 volts, three wire service, 60 cycles at 1800 r.p.m. The unit is powered with a Wisconsin Model TF, two cylinder, air-cooled engine. The plant measures 37" long, 28" high, and 22" wide.

Because the engine is air-cooled there is no radiator and consequently no necessity for anti-freeze solutions. The engine is equipped with a high-tension magneto which permits hand cranking and there is no requirement for batteries of any kind unless electric cranking is desired in which case that feature is available.

TURRET-HEAD ARM

An answer to the problem of playing back an assortment of 33 $\frac{1}{2}$, 45, and 78 r.p.m. recordings both vertical and lateral without the use of a number of pickups is being offered by Fairchild Recording Equipment Corporation of 154th Street & 7th Avenue, White-stone, Long Island, N.Y., in their Turret-Head Arm.

The new design provides for three separate cartridges all in one pickup. Vertical, standard, lateral, and micro-groove cartridges, in any combination of three, can be mounted on a turret contained within the head of the Fairchild pickup. Mounting has been made

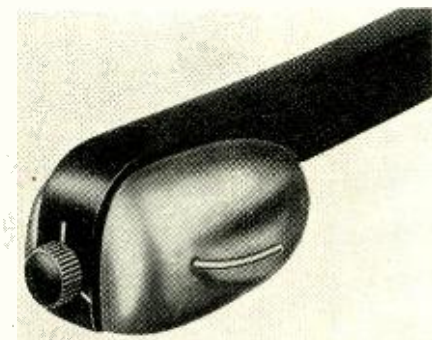

possible by the miniaturization of the company's moving coil cartridge. A knob on the front of the head is rotated to select the desired cartridge.

Stylus pressure changes automatically to conform with the requirements of the individual cartridges. Another feature of the new arm is the viscous damping used at the pivot point to isolate the pickup from mechanical coupling with the transcription turntable and eliminate tone arm resonance within the audio spectrum.

CRYSTAL CALIBRATOR

Measurements Corporation of Boonton, New Jersey, is now in production on its new Model 111 crystal calibrator.

This new instrument has been designed for the frequency calibration of signal generators, transmitters, receivers, grid dip meters, and other equipment in the range of 250 kc. to 1000 mc. The frequency accuracy is $\pm .001\%$.

The Model 111, a dual-purpose unit, not only provides a test signal of crystal-controlled frequency, but also has a self-contained receiver with a sensitivity of 2 microwatts.

The circuit arrangement utilizes the cross modulation products of three



separate oscillators operating at the fundamental frequencies of .25, 1 and 10 megacycles.

MAST CLAMP

A one-piece, self-gripping mast standoff insulator is being produced by Radio Merchandise Sales Co., Inc. of 1165 Southern Blvd., New York 59.

The rib-reinforced, integral unit construction is claimed to provide greater strength than that afforded by welded or riveted section types. The clamp is also provided with a plating which is resistant to corrosive attack.

Both twin-lead and coaxial cable can be accommodated in the high-efficiency universal polyethylene insert.

Full details on the new mast clamp are available on request. Send your letters direct to the company.

MICRO-MINIATURES

Smaller than any miniaturized tubulars previously available, the new Type P83Z "Aerolite" capacitors have just been introduced by Aerovox Corporation of New Bedford, Mass.

These new micro-miniature units measure only $\frac{3}{16}$ " in diameter and $\frac{1}{16}$ " long. They are all made in one size and are particularly applicable to ra-

TV PARTS and ANTENNAS



HI-LO TV and FM ANTENNA

Model 101
Indoor
Model
101R&W for
roof and
window use

This beautiful antenna is the ultimate in reception, highest signal gain, nothing to adjust. Gleaming walnut plastic and gold anodized aluminum.

List price	\$9.95 ea.
100 or more	\$3.97 ea.
25 to 99	4.47 ea.
13 to 24	4.98 ea.
7 to 12	5.37 ea.
1 to 6	5.97 ea.

Fair trade prices, no deviations.

TV Antennas:

Hi-Low Conical with 8-ft. mast	\$5.75
World's Best Deluxe Conical with 9-ft. mast and heavy cast fittings	8.95
Hi-Low folded dipole array, 8-ft. mast	6.95
300-ohm line	\$1.09 per 100 ft. \$9.25 per 1000
Ballast Tubes for AC-DC TV Sets	ea. .50
TV Discriminator Transformers	ea. .69
TV Screen Filters with suction cups—best quality INDIVIDUALLY BOXED for highest re-sale value.	10" \$1.17 12" 1.95 16" 2.55

PREMIER RADIO TUBE COMPANY
551 West Randolph St., Chicago 6, Ill.
Phone: Andover 3-1590
"Your Tube Source Since 1926"

LOWEST PRICES TUBES and PARTS

29c ea.	1S5 2C26 2C34 3A4 01A 6A3	10 12A 39/44 47 50 71A	112A 182B 183 25S 482B 483	1A4 1A4P 1A6 1B5 1D5GT 1D7	1D8GT 1F4 1F5G 1G4GT 1G6GT	1H4G 1H6GT 1J6G 1619 1626
-------------------	--	---------------------------------------	---	---	--	---------------------------------------

FREE! NEW OFFER
10 high list price tubes over \$25.00
list value FREE with each 100 tubes
LIMITED QUANTITY.

79c each	1B3GT 1X2 2A3 2A4 3Q5 6A7 6AK5 6BQ6GT 6E5	6G5 6L6G 6S D7GT 6U5 32L7GT 50A5 70L7GT 350B 807
--------------------	---	--

39c ea.	1T4 5Y3GT 35W4	35Z5GT 6C4 6X5GT	25Z6GT 30 31	32 33 34	35 35Z4GT 36	37 38 46	VT-52 56 57	58 76 80	89 HY-615
-------------------	----------------------	------------------------	--------------------	----------------	--------------------	----------------	-------------------	----------------	--------------

49c ea.	3Q4 3S4 3V4 5W4GT 5X4G 5Y4G 6AB4 6AC4 6AC5GT 6AG5 6AL6	6AQ5 6AQ6 6AR5 6AS5 6AT6 6AU6 6ABGT 6B6 6BA6 6BA6 6BE6	6BH6 6B J6 6C5 6C8G 6D6 6F5GT 6F6GT 6G6 6H6GT 6J5GT 6J7GT	6K7GT 6K8GT 6L5 6S4 6SA7GT 6SC7GT 6SG7GT 6SM7 6SJ7GT 6SK7GT	6SQT 6SR7 6U6GT 6U7 6V6GT 6W4 6X4 6Z4 12A8GT 12AT6 12AU6	12AU7 12BA6 12BE6 12F5GT 12H6 12J5GT 12J7GT 12K7GT 12K8GT 12SF5 12SF7	12SH7GT 12SR7GT 16Z9 (eye) 24A 25L6GT 25W4GT 25X6 26 27 35B5 35C5	35Z6GT 50B5 50C5 50Y6 51 77 78 85 99
-------------------	--	--	---	--	--	---	---	--

89c each	6B5 6BN6 12BN6	25AC5GT 25BQ6GT 117L7GT 117P7GT
\$1.19 ea.	6BG6G 19BG6G	

59c ea.	1C7G 1LA4 1LE3 1Q5GT 1T5GT 1V 2B7 1A7GT 1C5GT 5U4G	5V4 5Z3 5Z4 6A8 6AC7 6AJ5 6AK6 6AL5	6AV6 6B4G 6BA7 6B8 6C6 6C8G 6D8G 6F8G	6J6 6K5 6P5GT 6R7 6S8GT 6SF5GT 6SL7GT 6SN7GT	6S57 6SU7 6Q7GT 6T7G 6W7G 6Y6G 6Z7G 7A4	7A6 7A7 7B5 7B6 7B8 7C4 7C6 7E5	7E6 7E7 7F7 7G7 7H7 7J7 7L7 7N7	7Q7 7S7 7T7 7V7 7W7 7Y4 12A7 12AT7	12AV6 12AX7 12BA7 12BF6 12C8 12C8 12J5 12Q7GT 12SA7GT	12SG7 12S8GT 12S J7GT 12SK7GT 12SL7 12SN7GT 12SQ7GT 12Z3	20 35/51 35L6GT 40 41 42 43 50L6GT	53 75 84/6Z4 11Z73 VR150 XXL
-------------------	---	--	--	---	--	--	--	---	---	---	---	---

69c ea.	1A3 1AB5 1H5GT 1LA6 1LB4	1LC5 1LC6 1LD5 1LH4 1LN5	1NSGT 1P5GT 1S4 2V3G 2X2	3LF4 4AG6 6B7 6BF6	6J8G 6S7G 6SUTGT 6T8	7A8 7C5 12A6 12BF6	14A4 14A5 14A7 14AF7	14B6 14B8 14E6 14E7	14H7 14J7 14N7 14Q7 14W7	14X7 14Y4 19T8 25Z5 35Y4	35Z3 45 2050 2051 50C6	81 83 117Z6GT 9001 XXB
-------------------	--------------------------------------	--------------------------------------	--------------------------------------	-----------------------------	-------------------------------	-----------------------------	-------------------------------	------------------------------	--------------------------------------	--------------------------------------	------------------------------------	------------------------------------

Tube prices are for 50 tubes or more—may be assorted. Less than 50 tubes, 5c per tube extra. Individually boxed—Standard factory guarantee.

50L6, 35Z5, 12SK7, 12SQ7, 12SA7... 5 tubes for **\$2.19**

1R5, 1S5, 1T4, 3V4 Battery Tube Special... 4 tubes for **\$1.49**

7JP4 \$9.95 12LP4 \$19.95
10BP4 14.95 16AP4 39.50

Miniature tubes 12AT6, 12BA6, 12BE6, 35W4, 50B5... 5 tubes for **\$1.89**

3-Way Portable Tube Kit, 117Z3, 1U5, 3V4, 1R5, 1T4... all for **\$1.99**

3S4, 1T4, 1S5, 1R5... 4 tubes for **\$1.49**

1U4, 3S4, 1S5, 1R5... 4 tube kit **\$1.49**

3Q4, 1T4, 1R5, 1S5... 4 tube kit **\$1.49**

50A5, 35Y4, 14A7, 14B6, 14Q7... 5 tubes for **\$2.95**

Best Quality **SPEAKERS** Alnico 5 PM

10 or more Each Price Each

5" -95c - \$1.05

2 1/2", 3", 4"—95c-\$1.05

6"	\$1.49	\$1.59
8"	2.95	3.25
10"	4.25	4.50
12"	4.95	5.95

JENSEN 8" SPEAKERS

Jensen 8" Speakers 9 watts output, heavy duty 10 oz. Alnico V magnet Sound Men and JOBBERS... buy them packed 12 to each carton... **\$3.25 ea.**

Utah Speaker Baffles—completely enclosed for 8" speakers and smaller... **\$2.00**

Jobbers: write for quantity prices.

IF TRANSFORMERS

Standard Replacement Regular size 455 Kc... **ea. 29c**

Midget 455 Kc... **ea. 39c**

VIBRATORS

Red Hot Vibrator Special. 4-prong, small size Universal, fits 80% of all jobs... **ea. 89c**

Jobbers: Write for quantity price.

4 PRONG VIBRATORS—VERY BEST BRANDS

Standard Replacement Universal. Sensational Value... **\$1.29 ea.**

4 Prong PHILCO VIBRATOR... **\$1.29 ea.**

RED HOT VIBRATOR SPECIAL!

Standard small size, 2 7/8" in height (the popular small size), bright and shiny... **\$1.29 ea.**

Stock up while they last, all 4 prong Universal Vibrators.

OCTAL SOCKETS MOLDED... 10 for **49c**

7 PIN MINIATURE SOCKETS... 10 for **49c**

9 Pin Miniature Sockets... 10 for **49c**

Loctal sockets... 10 for **49c**

Standard replacement crystal cartridge. Each **\$1.39**

NYLON 1J CARTRIDGE... **\$2.59**

VOLUME CONTROLS

10 or more Price Each

VERY BEST BRANDS

1/2 meg. or 1 meg. or 1/10 meg. with switch—long shaft... **29c 35c**

2 meg. for battery sets—switch, long shaft... **29c 35c**

1/2 meg., 1 meg., 1/10 meg. or 2 meg., long shaft, less switch... **16c 19c**

1000 ohm... 16c 19c

4 meg... 16c 19c

5000 ohm... 16c 19c

1/2 meg. with 6" shaft... 49c 59c

VOLUME CONTROL KITS

1/2 meg., 1 meg., 2 meg., with switches and good shafts. 10 controls for... **\$2.89**

1/2 meg., 1 meg., 2 meg.—long shaft, no switch. 10 controls for... **\$1.59**

Special on No. 47 Pilot Lights Only—**100 Bulbs... \$3.95 Box of 10... 54c**

PILOT LIGHTS—100 BULBS \$4.90

Box of 10 bulbs... **54c**

No. 4Q 6-8 V .15 Amp No. 44 6-8 V .25 Amp
No. 41 2.5 V .10 Amp No. 46 6-8 V .25 Amp
No. 51 6-8 V .20 Amp \$3.79 per 100

6-FT. LINE CORDS

Appliance Cord, up to 1,000 watts, 1 rub-ber plug, 5 for... **99c**

Appliance Cord as above, with UL label 5 for... **\$1.29**

Good Rubber with plug, 10 for... **\$1.25**

Underwriters' Approved, 10 for... **\$1.69**

SPECIAL—CONDENSER KITS

Kit of 25 BY-PASS CONDENSERS best assorted brands and sizes... **\$1.19**

Kit of 50 BY-PASS CONDENSERS very best, assorted sizes... **1.98**

Kit of 50 MICA CONDENSERS, complete... **1.98**

100 resistor—packed in a box, IRC, etc. Best values only—1/2 watt, 1 watt, 2 watt... **1.98**

SELENIUM RECTIFIERS

Standard 100 mil. Each... **79c**

PUSH-BACK WIRE 100-ft. rolls... **39c ea.**

OUTPUT TRANSFORMERS STANDARD REPLACEMENT

For 50L6, 35L6, 50A5, 35A5, 117L7... **39c ea.**

For 6V6, 6F6, 3Q5, 3Q4, 354, 3V4, 41, 42, 6M6, 2A3, 45, 6L6... **45c ea.**

Additional Standard Replacement Outputs

2000 ohm... 39c ea. 8000 ohm... 45c ea.

3500 ohm... 45c ea. 12000 ohm... 45c ea.

5000 ohm... 45c ea.

KIT of 10 Outputs of above numbers... \$3.90

All outputs match standard voice coils.

UNIVERSAL OUTPUT TRANSFORMER SPECIAL Up to 12 watts to any speaker (while they last)... **ea. 98c**

KIT OF IF TRANSFORMERS 455 KC universal contains regular and miniature sizes. 10 for... **\$2.69**

BY-PASS CONDENSERS SPECIALS

100 Condensers assorted in package... **\$5.95**

.001	5c	.0005
.002	5c	.00025
.005	5c	.0005
.01	7c	500 mmf
.02	7c	250 mmf
.05	8c	100 mmf
.1	8c	50 mmf

600 V. 6c
600 V. MICA 6c

BYPASS SPECIAL—SOLAR In lots of 25 or more... each 9c

.25 mfd. 600 V... Less than 25 each 12c

400-VOLT BY-PASS CONDENSERS

.05 mfd... ea. 6c

.2 mfd... ea. 6c

.25 mfd... ea. 10c

.5 mfd... ea. 15c

BUFFER CONDENSERS

.005 mfd. 1600 WV }
.008 mfd. 1600 WV } ea. 15c
.01 mfd. 1600 WV }

VARIABLE CONDENSERS

Two gang for superhet or TRF... **ea. 69c**

Oscillator Coils for any 5 tube AC-DC... **19c**

RF and Antenna Coils Standard Broadcast Band... **ea. 29c**

Rated accounts—10 Days

All others 20% deposit with order, balance COD **\$1.00** handling charge for orders less than \$5.00

All shipments FOB Chicago. Prompt attention paid to foreign orders. ORDER TODAY. Our parts and tubes are warranted to be 100% replacements for the prototypes in the listings above. Satisfaction Guaranteed. To speed up delivery, sign your order and your remittance with the same name. Illinois residents add 2% sales tax.

CURRENT ADVERTISED PRICES APPLY.

FILTER CONDENSERS

See Preceding Page

PREMIER RADIO TUBE COMPANY

551 West Randolph St., Chicago 6, Ill.

Phone: Andover 3-1590

"Your Tube Source Since 1926"

FEDERATED CELEBRATES 3 GREAT EVENTS!

1. A Quarter Century in business 2. New expanded New York store 3. Opening of an ultra-modern Sound Equipment studio. In appreciation of your loyal support, here are just a few of the values we offer:

NEW ESPEY AM-FM HI-FI CHASSIS

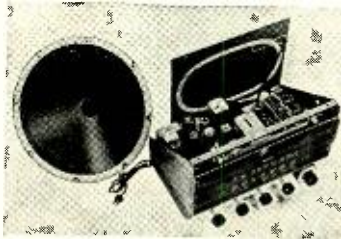

Specifications for Model 511

Supplied complete with antennas, tubes and all necessary hardware for mounting in a table cabinet or console, including escutcheon. Power requirements 105/125 volts AC, 50/60 cycles.

FEATURES

- Improved Frequency Modulation Circuit, Drift Compensated
- 12 Tubes plus rectifier and electronic Tuning Indicator
- Treble Tone Control
- Full-range bass tone control
- Hi-Fidelity AM-FM Reception
- Automatic Volume control
- 13-Watt (max.) Push-Pull Audio Output
- 12-inch PM speaker with Alnico V Magnet, 25 watts rating
- Indirectly illuminated Slide Rule Dial
- Antenna for AM and folded dipole antenna for FM reception
- Provision for external antennas
- Wired for phonograph operation
- Multi-tap output trans., 4-8-500 ohms

\$93 less speaker **\$98** complete with speaker

ESPEY MODEL 512 CHASSIS AM-FM TUNER

Similar in design to Model 511 above but does not include audio amplifier. Comes complete with 9 tubes including rectifier. Designed for application where other audio amplifier is desired. **\$82.15** complete with tubes less speaker

ESPEY MODEL 514 DELUXE AUDIO AMPLIFIER

For use in conjunction with model 513 tuner. This deluxe power supply and audio amplifier contains 6 tubes plus 2 rectifiers in a high-gain, Push-Pull circuit. Provides for output impedance for any speaker requirement from 4 to 500 ohms. **\$38.60**

Visit our new enlarged quarters at
66 Dey Street, New York City.

Federated Purchaser
INCORPORATED
NEW YORK CITY ALLENTOWN, PA.
66 DEY STREET 1115 HAMILTON ST.
Dlgy 9-3050 Allentown 3-7441

dio-electronic usages calling for extra-tiny, low-capacitance paper capacitors.

Metalized dielectric is used in place of the conventional foil-paper, providing both dielectric and electrodes. Capacitance is predetermined mechanically in the initial processing. The Hyvol K impregnated section is molded in humidity-resistant thermoplastic. Operating temperatures range from -15 to +85 degrees C.

The units are available in .0005 to .003 μ fd., 400 v. and .005 and .01 μ fd., 200 v. They may be substituted for usual mica and ceramic types.

TEST UNIT

Precision Apparatus Company, Inc. of Elmhurst, Long Island, New York, has just introduced a new portable v.t.v.m. and multi-range test set, the "Series EV-20."

This portable circuit-testing laboratory has been designed for general electronic, AM, FM, and television applications. It is a complete v.t.v.m.-megohmmeter with true zero-center on all v.t.v.m. ranges, plus direct-reading high frequency scales. In addition it provides full standard 100 ohms-per-



volt functions. The unit provides 48 ranges to 1200 volts, 2000 megohms, 12 amperes, + 63 db. and d.c. v.t.v.m. ranges to 12,000 and 30,000 volts when used with the company's TV super-high voltage test probe.

Full details on this new test instrument are available on request.

GEIGER COUNTER KIT

Science Kits, Limited of 5514 Hollywood Blvd., Hollywood 28, California, has just released a Geiger Counter unit in kit form.

No special knowledge is needed to assemble the kit. Complete and illustrated instructions come with each kit for easy assembling.

The "Searchmaster" kit contains all components needed to assemble the Geiger Counter which is sensitive enough to detect both gamma and beta radiation.

Each set includes tubes, batteries, resistors, condensers, sockets, a type SK-1 Geiger tube, headset, and a metal case which measures 9 $\frac{1}{4}$ by 4 by 3 $\frac{1}{2}$ inches. All parts are laboratory-tested and fully guaranteed by the manufacturer.

A radioactive specimen and a copy of the Atomic Energy Commission's book "Prospecting for Uranium" are also included with the kit.

COMPLETE TEST UNIT

General Electric Company in currently offering a complete test instru-

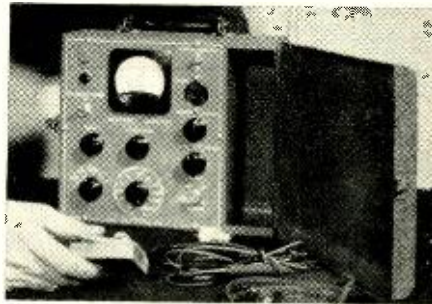

ment for the service technician which eliminates the need for separate multi-meters, r.f. generators, and field strength meters for in-the-field tests on radio communication equipment.

The new Type EX-1-C is designed for use with equipment operating in the 25-50, 72-76, and 148-174 mc. bands. It is housed in a compact steel carrying case and weighs 11 pounds.

One of the primary purposes of this new unit is to align sensitive land-mobile communication receivers which require a very weak signal. The attenuator on this self-contained crystal-controlled oscillator is adjustable down to substantially zero r.f. output.

A crystal diode pickup head, supplied with the instrument, permits comparative measurement of antenna power output. The new instrument also contains a full range of current and voltage scales as well as a resistance scale which provides for continuity checks.

The Commercial Equipment Division of the company at Syracuse, New York, has further details on the EX-1-C available on request.

D.C. POWER SUPPLY

A low-cost d.c. source of filtered power which utilizes the same exclusive application of selenium rectifiers as found in the company's Model "B" has just been announced by *Electro Products Laboratories, Inc.*, 4501 N. Ravenswood Avenue, Chicago 40, Illinois.

Known as the Model "BJ" Junior, the new unit supplies 1 to 12.5 amps., 6



volts continuous duty, with an intermittent rating up to 25 amps. The supply is capable of providing 3 to 9 volts at other ratings, operating from 115 volts, 50/60 cycle power source.

RADIO & TELEVISION NEWS

CIRCLE X ANTENNA

ENGINEERED TO PROVIDE CLEAR SHARP PICTURES ON ALL CHANNELS

COMPARE CIRCLE-X
TO ANY OTHER TV ANTENNA

No other antenna combines all the mechanical and electrical features engineered into the Circle-X.

The high gain of the Circle-X is equal to stacked arrays. It is made of light weight corrosion resistant aluminum alloys that stand up in all atmospheric conditions.

When you use Circle-X you stock only one type of antenna for all jobs. It has one wire lead-in and weighs only 2 1/2 lbs.

We urge you to compare Circle-X TV Antennas to any other TV antenna on the market.

Use Circle-X on your next tough TV installation. It may save you a lot of "no profit" call backs.

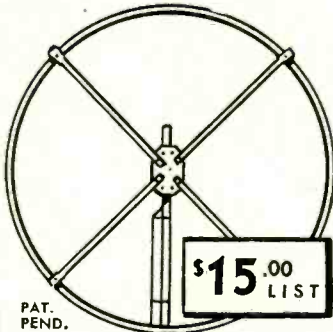

\$15.00 LIST

PAT. PEND.

DEALERS: Air Express or Parcel Post Special Delivery direct from factory to you through your jobber, if he cannot supply you with the Circle-X from his stock.

CIRCLE-X ANTENNA CORP.
507 MARKET ST., PERTH AMBOY, N. J.

CIRCLE X

ANTENNA CORPORATION

AUDIO (SOUND) ENGINEERING HOME STUDY TRAINING
Practical, easy-to-understand lessons, written by competent Audio Engineers and Educators, prepare you for a better job and a good future in the Television, Radio, Motion Picture, and Recording Industries.
Write today for details—Learn while you earn!!
HOLLYWOOD TECHNICAL INSTITUTE
Div. R.N.
4925 Santa Monica Blvd., Hollywood 27, California

TELEVISION FILTERS
Polaroid Type Television Filter
Eliminates All Glare and Reflection
10-10 1/2" \$1.75 16-16 1/2" \$3.00
12-12 1/2" \$2.50 19-20" \$4.50
Dealers Inquiries Invited
HOUSE OF PLASTICS
8648 Linwood Dept. T-1 Detroit, Mich.

SWEDGAL declares a Buyer's DIVIDEND!

REPEATED BY CUSTOMERS' DEMAND! Get this PLASTIC PILLOW blows up easily as a balloon (deflates as quickly), sturdy, waterproof, no metal parts, anti-allergic. For home, office, shop, ball games, beach, picnics, etc. Has 100's of uses. **GET YOURS FREE**—for each \$5 order. A \$10 order brings 2 Plastic Pillows FREE, etc. You'll want quite a few... one for each member of your family!

TUBES All Guaranteed—Brand New—Individual Cartons
DEDUCT: 5c from the price of each tube when ordering any 20!

24e ea. 6C6	12BE6	12SQ7
6C4	6D6	12SN7
12A6	6F6	1A5
34e ea. 6H6	24A	1A5
6X4	6H6	25L6
38	6K5	28
38e ea. 6K6	27	14Q7
1R5	6SA7	35Z5
1S5	6SH7	47
1U5	6S7	77
5U4G	6SK7	78
5Y3	6SL7	85
5Y4G	6SN7	117Z3
6AL5	6SQ7	1625
6AL7	6SR7	2051
6AR5	6V5GT	45e ea.
6AT6	6V6	1T4
6AU6	6W4	1U4
6BA6	6X5	6AG5
6BE6	6Y6G	12SA7
6C5	12BA6	12SK7

SPEAKERS All brand new... fresh magnets... extra low prices... guaranteed top quality. All Alnico V.

3 1/2" P.M.	5 Asst.	5 Asst.
.68 oz.	\$.79	\$.75
4" P.M.	.68 oz.	.89
4" P.M.	1 oz.	.99
4" P.M.	1.47 oz.	1.05
4"x6" P.M.	1 oz.	1.49
5" P.M.	.68 oz.	.89

OUTPUT TRANSFORMERS

3Q5	34c	154 P.P.	49c	6K6 P.P.	49c
6V6	38c	354 P.P.	49c	6V6 P.P.	49c
25L6	34c	3V4 P.P.	49c	25L6 P.P.	38c
35L6	34c	6F6 P.P.	49c	35L6 P.P.	38c
50L6	34c			50L6 P.P.	38c

VOLUME CONTROLS Standard Brands with switch, long shaft.

100,000 ohms	500,000 ohms
350,000 ohms	1 megohm

Order any 10 for \$3.00

6V6 P.P., 15 Watts. Sec. taps. 4, 8, 15, 250 & 300 ohms. Fully Shielded. Only 89c ea. **34c**

STANDARD BRAND PHONO MOTOR 110 V., 60 cycle, A.C. 3-speed, 33 1/3, 45 and 78 R.P.M. Complete with turntable. Only **\$4.75** ea.

CORNISH WIRE: Corlac or No Flame, Stranded No. 22 hook-up, white with tracer. 100 ft. Only 34c

MALLOY ROTARY SWITCH: 2-pole, 5-position. Shorting type, for meters or hand-switches, 3/4" Shaft. Only 29c

AC LINE CORDS: 7 ft. Molded bakelite plug. 32c ea. 10 for \$1.10; 6 ft. Reinforced rubber plug. 14c ea., 10 for \$1.25

PANEL BEARINGS: Precision made flatted shaft extends 1 3/8". bushing for 3/8" hole. 6c ea., 10 for 50c

TO SPEED DELIVERY, Order Now! Minimum \$2.50. For C.O.D. shipment enclose 25% deposit. Include adequate postage excess will be returned. All prices F.O.B. New York, N. Y. WRITE FOR FREE CIRCULAR!

SWEDGAL RADIO, INC.

96 Warren Street, Dept. N-3 New York 7, N. Y. COrtlandt 7-6753

Special features of the power supply include new type heavy duty selenium rectifiers; 8 position tap switch; 0-10 volt voltmeter, 5% accuracy; 0-20 amp. ammeter, 5% accuracy; heavy duty transformer and choke; 2000 μ fd. filter condenser, and a readily-accessible fuse.

AUDIO OSCILLATOR

A lightweight, portable audio oscillator has just been introduced to the trade by Radex Corporation of 2076 Elston Avenue, Chicago 14, as the Model 500.

This test instrument is RC tuned, has an output of 10 volts into 2000 ohms, and an input impedance of 100



ohms at full output. The oscillator covers the frequency range from 145 to 145,000 c.p.s. in four ranges. Stability is 2% and distortion is 1/4 of 1% with high impedance load and 1% with 2000 ohm load. Output variation is \pm 1 db. The hum level is 50 db. below signal at any output level.

Housed in a 9x5x6 inch cabinet, the new unit weighs only 8 pounds and operates from any 110 volt, 50 or 60 cycle a.c. source. It uses three tubes, a 6SN7, a 6V6, and a 5Y3.

AUTO AERIAL

Trio Products, Franklin, Michigan, has developed and is marketing a unique radio aerial for an automobile or boat patterned after a television antenna.

The unit is manufactured from five feet of brightly chromed material. This

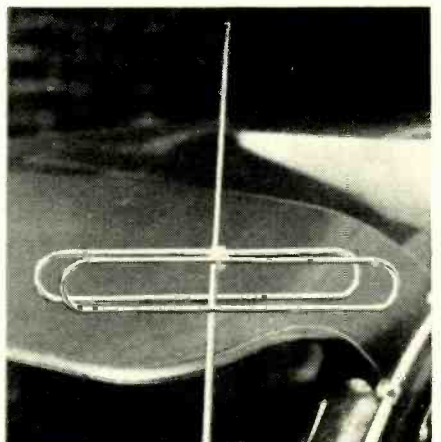

added length is said to provide clearer and longer distance reception with increased volume.

The new accessory may be attached to any aerial in less than a minute. It retails in the low price class.

Get MORE stations...

CLEARER pictures...

make COSTLY TV TUBES LAST LONGER with a

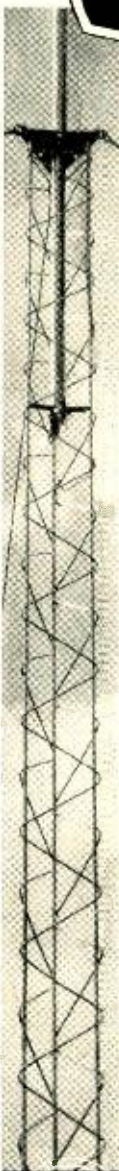

As almost every dealer knows by now, built-in television antennas are really satisfactory in only a small percentage of installations. Even indoor antennas often leave a lot to be desired. But that's only part of it!

AVOID TUBE STRAIN!

Indoor antennas of any kind usually mean that sets must be operated at high volume. This means a big reduction in tube life—including the costly picture tubes!

An outdoor antenna mounted on a Trylon Mast assures clear pictures, reduces interference, brings in more stations. Also, it enables the set to operate at lower power with a minimum of tube strain. A leading dealer states: "I'm convinced that a Trylon Mast actually pays for itself in what it saves the TV set owner on tube replacements!"



Trylon TV Masts are easy to install—safe and easy to climb. Supplied in 10-foot sections for heights to 60 feet. Weight is about 2 lbs. per foot at a dealer cost of only about \$1.00 per foot. They're hot dip galvanized against the weather—designed for real dependability under all conditions. Write for Catalog N.



WIND TURBINE CO.
Mast and tower specialists for over 17 years
WEST CHESTER, PENNA.

CUSTOMERS Can Be Friends, TOO!

By PHIL HINER

Your customers can be a real and valuable "capital" asset. Treat them right and you'll stay in business.

IF YOU are one of the fellows who makes a living selling radio and television service, you're well acquainted with the customer who screams to high heaven that he's being robbed and anybody else would have done the job for half the price, and he has half a mind to report you to the Better Business Bureau, et cetera . . . You'll doubtless agree that he has half a mind, you may even tell him so, should he happen to be the fifth or sixth weeper you've encountered during the day.

Now looking at this oft-repeated drama with cold, business logic we know that while telling an irate customer to go jump may give us a measure of personal satisfaction, it isn't exactly a wholesome business practice. We need our customers, even the screaming ones. Although his disposition isn't as good as the next fellow's, his money is!

How, then, to collect the cash—and a smile at the same time? We have here a problem that has been pretty generally ignored by both the profession and those who write for the profession. Outside of knowing our craft it's the most important daily problem we face. It's not only the one customer we lose that hurts; he may, in an attempt at self-justification, blackball us with a half dozen cronies.

It's a serious problem, too, from the standpoint of what it can do to you. I've talked to hundreds of technicians during my years in the profession and the conversation invariably turns to the unreasonableness of customers and their inability to understand that a technician must collect more than fifteen cents for installing a fifteen cent coupling condenser. I talked to a shop owner the other day who told me that he just lost his best technician via the nervous breakdown route. And it wasn't troubleshooting that cracked up his boy.

So, you ask, what can I do about an irate customer? It's his disposition that needs a retread, not mine.

Actually, there's a lot you can do. Try the suggestions outlined here and I guarantee you'll be amazed at your control over situations that too often turn an otherwise pleasant profession into something distinctly unpleasant.

In the first place why does the customer holler? Let's analyze the basic cause of his unhappiness. To this question most technicians would immediately answer he thinks he's been overcharged. Could be, but I'm going to be different and say that that's not the reason but merely the line he follows once the argument gets underway. In nine out of ten cases it's the element of uncertainty, nothing else, that brings on the tempest. Call it a feeling of insecurity in business relations, if you like, because you the technician set the price, on your own terms, and he the customer is at your mercy with no clear-cut recourse.

Mr. Average Customer knows he has a radio in for repair but he doesn't know what it will cost him. Human nature being what it is, he expects the worst. He returns for his property in fear and trembling, hand hovering protectively close to his pocketbook. In short, friend, he's already in the mood for an outburst and the stage is set for same even before he gets the bad news.

Psychologically, this set-up is all wrong. If the customer could be given in advance some assurance of a fair charge within certain definitely prescribed limits he would resign himself as he does to the cost of his daily bread or cigarettes. He would enter your shop in the same gentle mood as his wife enters the grocery.

Setting up this idyllic situation is not at all difficult. And you don't have to worry about expensive and time consuming estimates, either. Let's begin with the small a.c.-d.c. set which makes up a goodly percentage of your business. The great majority of these sets are fixed for \$5 or less. As you know, one new tube usually brings this set back to life and you will probably, in addition, touch up the alignment, treat the volume control with contactene, clean the tuning condenser, tighten the dial cord, and clean the dial face and cabinet. Some of your customers ask for an exact estimate, others do not. Eliminate this confusion by explaining to each one as they bring in their sets that it is your policy to call the customer if repairs amount to more than \$5 but to go ahead with-

out a call if it can be done for that amount or less.

It's a rare customer, indeed, who won't agree to this. And with agreement all basis of argument is dissolved. Your man knows it may cost him a fiver, maybe less; he's prepared mentally. If it's under \$5, he's agreeably surprised. You're a fine fellow.

There's an interesting variation of this idea I would like to pass along. One shop owner of my acquaintance advertises with flamboyantly colored signs—*ANY A.C.-D.C. SET FIXED FOR \$3.50*. He does a big business and claims it's a paying proposition for although he loses money on some sets he more than compensates for it by increased business, time saved by eliminating estimates and calls, and the large number of jobs which require but little servicing.

On larger sets carried into the store, I set a limit of \$10 before making a special call. If the customer will not agree to this limit I find out how much he is willing to spend. If I can do it for that and make money—well and good. If not, I at least retain his friendship.

House calls on floor model combinations require a different customer technique. You have a definite charge for house calls, don't you? Tell your customer what it is when he calls for service. Once in the house and you discover that the set must go to your shop don't be afraid to give your customer a rough idea of what to expect by way of charge. Believe me, that's what the little woman's worried about! If there's any dissent, better to have it now than after the job is done. By making a few simple checks any competent technician can eliminate as the probable source of trouble the more expensive components such as speaker or power transformer. And what does that leave? Condensers, resistors, small coils. . . Give the lady a rough estimate. If, as will occasionally happen, you miss by a country mile, get on the phone and explain. She'll respect you more for the interest you show.

Most of us are charging more for television than for straight radio service. That's as it should be and most customers expect it. Again, don't be timid in stating the facts. We in the radio and television business could take a lesson from some of the other service professions. Did you ever watch a plumber operate when he comes into your home? He can make a \$200 estimate without batting an eye. Nary a blush, either. The radio technician himself has made his lowest paid of all service professions largely by his apologetic attitude. We have nothing to apologize for. Ours is a profession that takes brains, skill, and a highly technical knowledge.

Practice a little psychology on your customers. They'll like it. The art of handling people consists chiefly in recognizing their wants, likes and dislikes, and acting accordingly. First

TV Engineers & Servicemen Say:

"The NEW 1950 30 Tube RCA 630 Lic. Chassis is TV'S GREATEST VALUE"

THE PERFECT CHASSIS FOR 16" & 19" PICTURE TUBES

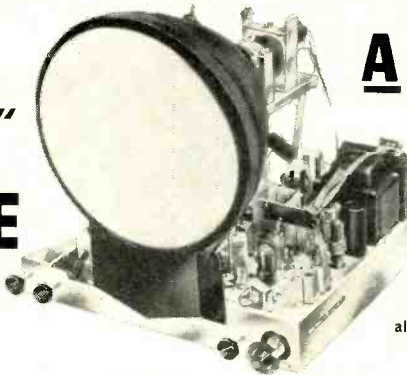

A SET

NOT A KIT

RMA & AIREX

Guarantee
Factory wired,
aligned & tested.
Ready for use

Thousands of our 16" and 19" sets are giving new viewing thrills to TV watchers all over the country. This extra powerful super chassis is designed to bring in sharp, clear pictures, even in fringe areas. Works in most areas on only an indoor antenna. All you have to do is insert a 16" or 19" picture tube (this chassis is designed for use with either size), plug into socket and you can enjoy your television set immediately.

\$144.95

Plus \$1.79 Fed. Tax

Without Cathode Tube

AVAILABLE WITH
DUMONT INPUTUNER & FM RADIO
Complete with dial plate and escutcheon

\$10.00
More

✓ CHECK THESE EXCLUSIVE FEATURES!

- Improved Keyed AGC
- Full 4 Megacycle Band Width
- Standard Coil Tuner
- Moulded Plastic Condensers
- Voltage Doubler, supplies 14,000 volts
- 5-Hour Min. Heat Run at Factory
- Improved high gain front end, down to 45 microvolts
- Synchro Lock
- Freedom from arcing & corona leakage
- Armstrong FM Sound System
- Improved linearity adjustment and second horizontal linearity control

DUMONT TV TUBES

16" TUBE

Glareless, standard round or rectangular.

\$39.95

19" TUBE

Black, glareless, standard round.

\$69.95

Mounting Brackets—\$2.50. All Tubes Guaranteed for 1 Year

ANOTHER PRICE SMASHING VALUE!

24 Tube Lic. RCA CHASSIS with DuMont FM Inputuner For 16" and 19" PICTURE TUBES

Only **\$129.95**

Plus \$1.79 Fed. Tax

Without Cathode tube

DOES NOT HAVE INTER-CARRIER SOUND

- AFC Horizontal Hold
- Keyed AGC
- Stabilized Vertical Hold
- 14,000 KV Output
- 2 Stages Video Amplification
- Improved Sync Separator & Clipper
- Noise Saturation Circuit
- 4 Megacycle band width

Factory Wired, Aligned and Tested. Ready for Use.

A Set! Not a Kit! RMA and AIREX Guarantee.

Phone and mail orders filled on receipt of certified check or money order for \$25 as deposit. Balance C.O.D., F.O.B. N. Y.

AIREX RADIO CORP.

171 Washington St. (Corner Cortlandt), New York 7, N. Y. WOrth 2-9578; 2-4029



MAY 1950 ISSUE

**63 MANUFACTURERS
575 MODELS
MOST COMPLETE
UP-TO-DATE LISTING**

Get this easy-to-use, time-saving guide to exact replacements for all popular television receivers. Simplifies servicing, cuts repair-bench time. Write us today for your free copy!

**WATCH FOR Merit's
future issues of the
TV "Repl" Guide**



4437 NORTH CLARK ST., CHICAGO 40, ILL.

and foremost, people crave respect so treat them with courtesy and genuine interest. Don't act bored, indifferent, or superior. Here is the most common fault of clerks who meet the public today. When the lady drops her set upon the counter and tells you it needs a new condenser—and how much is a condenser, please—don't exhibit contempt for her lack of knowledge but patiently explain that her set contains dozens of condensers of varying sizes, shapes, and functions. Maybe you don't know what's inside of a watch, either!

Don't overlook another courtesy—the statement that should accompany the finished set. Put it in writing! Give your customer a bill itemizing repairs, parts used, and cost breakdown. You're not ashamed of it, are you? A statement is dignified and business-like. People like to know how they spend their money. They feel better if they think their cash outlay is well spent.

One parting needle. When you do get into an argument, take the few minutes that you usually spend afterwards mentally condemning the customer to a fiery oblivion to analyze the situation. What went wrong? What different approach might you have used to prevent the unpleasantness? A little hindsight, later applied, can prevent recurring incidents of this type and the subsequent loss of customers that inevitably follows.

Let's eliminate the squawks. Give this problem a little thought and you'll undoubtedly come up with some ideas of your own. Your customers can be your friends, too. It'll mean more money in your pocket, greater peace of mind, and best of all it doesn't take one cent of additional capital.

—30—

ADDING A PM SPEAKER

By R. L. PARMENTER, W1JXF

HERE IS a little kink that might prove helpful to owners of some models of war surplus receivers. Most of these units had output jacks for phones only. A PM speaker may be used without digging into the "innards" of the receiver.

One of the small transformers that are used on the IIS-30 earpiece-type headphones may be used as an output transformer by replacing the headphones with a small PM speaker. There is an impedance mismatch but it is not serious enough to interfere with fair communications quality.

Mount the transformer in the same case as the speaker. A cord with the phone plug will be the only connection coming from the speaker case. Change-over from phones to speaker is made by inserting the proper plug.

Even better quality and output may be obtained by using other transformers, some of which were not originally designed as output transformers. The author has used filament transformers of various sizes as well as a small vibrator-type power transformer for this particular application with fair-to-good results.

—30—

International Short-Wave

(Continued from page 60)

which issues a bi-monthly club bulletin. While the chief aim of this new organization is to foster DX-ing in Canada, the club welcomes members (both SWL's and hams) from anywhere in the world. Each year it will have at least one contest reserved for Canadian members. Details can be obtained from R. Orville Lyttle, 140 Lake Street, North Bay, Ontario, Canada, who comments that "the CDXC is not an organization for profit, but a club that belongs to all members." The CDXC already has members in four Canadian Provinces, the United States, England, and Northern Ireland.

USA—The Newark News Radio Club will hold its annual summer convention and outing on Sunday, June 25, at the home of Vice-President and Mrs. Harold Robinson, Mapine Farm, Lansdale, Pa. Director Dick Daneker, also Lansdale, is helping to plan the session.

* * *

This Month's Schedules

(NOTE: By this time, many stations will be operating on Summer Time in which cases you may find schedules one hour earlier than listed herein.—KRB)

Algeria—Radio Algerie, 9.57, is fair to poor in Chicago in French 1730-1800 sign-off; French news 1745, and identifies as "Ici Radio Algerie" just prior to sign-off; closes with "La Marseillaise." (Lambach)

Angola—"Radio Clube do Huambo," Nova Lisboa, has dropped its 31-m. channel and has moved to approximately 11.925; heard in South Africa with excellent signal 1315-1530; also has "afternoon" session around 0700-0800; identifies as "Acqui Nova Lisboa, Radio Clube do Huambo" at frequent intervals. (Laubscher) This one is still a good signal afternoons in Conn. (Boice)

Argentina—SRI, Buenos Aires, now transmits daily programs in Swedish at 1225-1330 and in German at 1330-1430 on 15.290. (Radio Sweden)

Australia—VLX2, 6.130, Perth, heard 0315-0330 with sports news, then weather report. (Cox, Dela.)

Austria—The Blue Danube Network, Salzburg, noted back on 9.530 at 1755. (Pearce, England)

Azores—Summer schedule for Ponta Delgada is 1400-1500 on 7.015. (Pearce, England)

Brazil—Grove, Chicago, says PRL5, 11.95, has not "replaced" PRL5, 9.770; he recently heard the 11.950 outlet closing 2030 with choral music; the 9.770 outlet closed 2130 (as always) with military band selection (as always).

British Honduras—Ferguson, N.C., says the schedule of ZIK2, 10.598, Belize, varies from day to day but appears approximately 1315-1415.

British Somaliland—Radio Somali, VQ6MI, 7.125, Hargeisha, has brass band recordings from around 0820 for

modulation purposes; has program in Somali (only) 0830-0930. (Bluman, Israel, via ISWC, London)

Burma—Rangoon, 6.035, heard in California 1000 with news. (Baker)

Canada—CBNX, 5.97, St. Johns, Newfoundland, noted in Quebec City at 1600. (Gauvreau)

CFVP, Calgary, Alberta, operates on 6.030 at 0830-0200 relaying medium-wave CFCN, 1060 kc., and announces "Dial 1060, CFCN, Calgary"; power is 100 watts and operates into a Hertz antenna 20 ft. high. Station has had reports from all over the world; QRA is CFVP, c/o CFCN, The Voice of the Prairies, Ltd., Toronto General Trust Bldg., Calgary, Alberta, Canada. CBRX, 6.160, Vancouver, British Columbia, heard with news 0000. (CDXC)

China—Another new Chinese outlet has been heard on approximately 6.630 at 0845; other Chinese outlets noted in parallel recently at 0915 were 5.985, 6.090, 6.155 with talk in Chinese. (Rose-nauer, Calif.)

Cuba—COCH, 9.437, 5 kw., states it is out of verie cards but enclosed rate card as souvenir; QRA is Union Radio, S.A., Prado Num 107, Habana, Cuba. (Taylor, Ill.)

Cyprus—Bluman, Israel, has heard FBS, Middle East (formerly testing on 11.850) more recently on 12.040 testing around 0330, calling Malta and Fayid (Suez Canal Zone). (ISWC, London)

Ecuador—QRA for HC1AC, 6.210, is Radiodifusora La Voz de la Democracia, Apartado 288, Quito, Ecuador. (Taylor, Ill.)

Egypt—SUX, 7.863, Cairo, noted in N.C. from tuning 1608 to sign-off 1620; Arabic and Eastern music. (Ferguson) Also reported by Oskay, N.J.

El Salvador—YSUA, 6.250, has QRA of YSU, Radio Mil Cincuenta, La Avenida Sur No. 50, San Salvador, El Salvador, C.A. (Taylor, Ill.)

France—In connection with changes in long- and medium-wave frequencies according to the Copenhagen Plan, Paris has started broadcasting its English program at 1400-1515 on short-wave 6.200 instead of on m.w.; programs are of high entertainment value with selections from the Home Service, serial story, French lessons, a weekly quiz, and so on. (Radio Sweden) Fine signal in Britain. (Pearce)

French Equatorial Africa—Radio Brazzaville's 17.84 channel noted signing off 1600 instead of former 1700. (Balbi, Calif.) ISWC, London, says now has news 0115, 0515 on 15.595; at 1315, 1550 on 11.972, 9.440.

French West Africa—Radio Dakar, 11.897, is now scheduled 0200-0300, 0700-0830, 1320-1800 daily; on 15.340 daily 1400-1530. (ISWC, London)

Gold Coast—A card from Accra states it is using 1.8 kw. and 5 kw., respectively, on 9.640 and 4.915; scheduled 0530-0630 on 9.640, 1028-1255 on 4.915; QRA given as Senior Programmes Officer, P.O. Box 745, Accra, Gold Coast, West Africa. (NATTUG-GLAN, Sweden)

Greece—Radio Macronissos, 7.100, has notified a Stockholm DX-er that

BC-223 TRANSMITTER and SPARE PARTS

30 Watt Transmitter with crystal or MO control on four pre-selected channels, 2000 to 5250 KC., by use of three plug-in coils. Five Tubes: two 801 & three 46. With TU-17 Tuning Unit 2000 to 3000 **\$24.95**
 KC. and Cable, less mtg.NEW: **\$2.00**
OPERATING MANUAL for BC-223..... **\$2.00**
SPARE TUBE KIT for BC-223—Contains 5 spare tubes in metal box. Price..... **\$4.95**
TUNING UNITS: TU-17—2 to 3 MC.; TU-18—3 to 4.5 MC.; TU-25—4.5 to 5.2 MC.
 NEW: **\$3.50** Ea. USED: **\$2.50** Ea.
PE-125 VIBRATOR POWER SUPPLY for BC-223 Transmitter. 12/24 Volt input; output 500 Volt 150 MA. PriceNEW: **\$9.95**
MOUNTING for PE-125..... **1.50**
SPARE VIBRATOR & TUBE KIT. For PE-125—Contains 2 spare tubes, 2 spare vibrators and fuses in metal box. Price..... **\$4.95**
CABLE only—Transmitter to Power Supply..... **1.75**



BLOWERS:

110 VOLT 60 CYCLE (Pictured), 4" intake, 2" outlet. Approx. 100 Cu. Ft. Dis. Motor size: 3"x3". 1750 RPM. Quiet running. Prices: NEW: **\$6.95**—Motor only **\$3.95**
24 VOLT DC or **36 VOLT AC**—6" intake, 3" outlet. Approx. 200 Cu. Ft. Dis. Also has adapter for Dual outlet. Unused. Price..... **\$5.95**

MARK II TRANSMITTER & RECEIVER

Ideal for mobile or stationary use. 15 Tube Set transmits and receives 2 to 8 MC. Phone, CW and MCW 25 Watt Master Oscillator Control. Transmits and receives 240 MC. Phone Also an intercommunicating set. Comes complete with 15 Tubes, Headset, Micro., Antennas, Control Box, 12/24 Volt Power Supply, and Instructions—ready to operate. Set size: 27"x10"x13 3/4". Pts. Dis. Also has adapter for Dual outlet. NEW **\$59.50**. USED (TESTED) **\$39.50**
 Available—All Parts and Accessories for Mark II Sets!

NEW TRANSFORMERS

And CHOKES

ALL FOLLOWING TRANSFORMERS—CASED 115 V.A.C. 60 CYCLE INPUT:

OUTPUT: 750-0-750 V.A.C. (600 V.D.C. after choke input filter at 250 MA.) Includes 6.3 V.A.C. winding at 5 amps and 5.0 V.A.C. winding at 4 amps. NH-106 **\$8.75**
OUTPUT: 600-0-600 V.A.C. at 250 MA. 12 V.A.C. at 3 amps; 12 V.A.C. at 3 amps and 5 V.A.C. at 3 amps. Designed for Army surplus transmitters. NH-108 **\$7.75**
OUTPUT: 250-0-250 V.A.C. at 60 MA. 24 V.A.C. at .6 amps; 6.3 V.A.C. at .6 amps. Designed for Army Surplus Receivers. NH-109..... **\$3.50**
TRANSFORMERS—110 V. 60 CYCLE PRIMARIES:
 SEC.:
 12 V. 1 amp..... **\$1.50** 24 V. 2 amps... **\$2.25**
 24 V. 1 amp..... **1.95** 24 V. .5 amp... **1.50**
 36 V. 2.5 amps... **2.95** 24 V. 4 1/2 amps... **3.95**
 Sec. 14-14 or 28 V. 7/8" or 15 amps..... **4.95**

CHOKES—CASED:

NH-115—8 Henries at 500 MA. filter choke, 5,000 volt insulation **\$10.95**
 NH-116—5-20 Henry 500 MA. swinging choke, 5,000 volt insulation **\$10.95**
 NH-121—13 Henries at 250 MA. filter choke, 1,500 volt insulation **\$4.95**
 NH-412—4-12 Henries 81 ohm. Gov't conservative test voltage 2500 V. 300 MA..... **\$4.95**

GENERATOR 12 Volt 100 Amp. Mfg. by Emerson. 5400 RPM with 3/4" x 3/4" shaft and 4 mtg. holes on each end for right or left. Motor size: 7 1/2"x4 3/4". Price..... **\$12.95**
P1 GENERATOR 24 Volt 200 Amp. NEW..... **\$30.00**

SELSYNS TRANSMITTER AND INDICATOR SYSTEM. Ideal for antenna direction indicator to remote position. Complete with Autosyn Trans., 3" I-81 Indicator, Transformer, and Instructions..... **\$6.75**
 Autosyn Trans. only: **\$2.95** Plug f/I-81: **1.00**

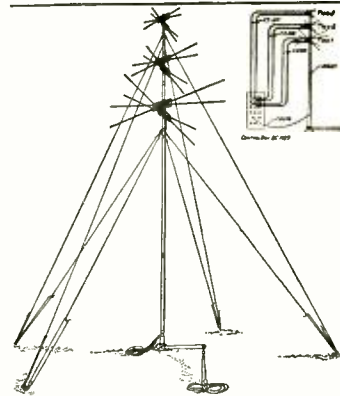

ANTENNA EQUIPMENT RC-173

Antenna Equipment RC-173 is an ultra-high-frequency and low frequency antenna system which provides either directional or non-directional ultra-high-frequency antennas for use with several radio receivers simultaneously. It consists of an insulated 30 foot, 3 section tubular steel mast and three tiers of dipole assemblies, two in each tier at right angles to each other. Each dipole assembly covers a specific frequency band within the range of 27-145 megacycles. The mast is used as an antenna for low frequencies. When erected, the mast will withstand high wind velocities and adverse weather conditions.

Complete system consists of 30 foot 2 1/2" OD Mast, in three sections, no taper. Elements: Steel, 10 each, Tier #1: 23"; Tier #2: 41"; Tier #3: 71", w/assemblies.

Coaxial Cable RG-22U 95 ohm: 6 of 50 ft. and 2 of 40 ft. lengths; RG-11U 75 ohm: 1 of 21 ft. lengths w/ittings and terminal box. Also Guys, Gin Pole, Stakes, etc., as illustrated. Shipping Weight: 400 lbs. Packed in two wooden chests. **\$49.50**

Price—F.O.B. Canton, Ohio.....

Address DEPT. RN • Minimum Order \$2.00 • Prices F.O.B., Lima • 25% Deposit on C.O.D. Orders

FAIR RADIO SALES 132 SOUTH MAIN ST. LIMA, OHIO

BC-645-A TRANSCEIVER

110 VOLT TRANSFORMER AND CHOKE

15 Tube Transceiver, ideal for conversion to 460 MC. Citizen Band. Frequency coverage 435 to 500 MC. With conversion instructions. **\$14.95**
 Price: New and Boxed BC-645-A.....
TRANSFORMER for BC-645-A—110 Volt 60 cycle input; output 400 Volt 150 MA. after filter. 12, 9, and 6 V. AC. 4 amps and 5 V. 3 amps. No. NH-645..... **\$6.95**
CHOKE—15 Hly. 150 MA. Order No. NH-646... 2.95
PE-101 DYNAMOTOR—13/26 V. input..... **2.95**

CONDENSER ASSEMBLIES:

5 Gang with vernier tuning, 25 MMFD to 450 MMFD each section. Size: 7 1/2"x3 1/2"x3 1/2". Price..... **\$2.95**
 3 Gang Condenser, 25 MMFD to 450 MMFD each section. Size: 6"x3 1/4"x3". Price..... **\$1.95**

GUN SIGHTS

Illuminated Sight Mark 8—Mod. 3. Contains the following lenses: 3 1/2" Concave Convex FL 4 1/2"; 3 1/2" Double Concave FL 5"; 3 1/2" Double Convex FL 3"; 3 1/2" Plain and Convex FL 8 3/4" Coated; also 1 3/4" Plain Rd., 5" x 3 3/4" x 1 1/2" Oblong Plain Optical—all mounted in a 4 1/2" Barrel with light socket **\$6.95**
 level indicator and pistol sight holder. Price:

WHIP ANTENNA EQUIPMENT

MAST BASES—INSULATED:
 MP-132—1" heavy coil spring, 2" insulator, overall length: 11 1/2". Wt.: 2 1/2 lbs. Price..... **\$3.95**
 MP-22—Spring action direction of bracket, 4"x 6" mounting. Price:..... **2.95**

MAST SECTIONS FOR ABOVE BASES:

Tubular steel, copper coated, painted, 3 foot sections, screw-in type. MS-53 can be used to make any length, with MS-52-51-50-49 for taper. Price—any section..... **50c** Ea.
 MS-54-55 Larger sections than MS-53..... **75c** Ea.
 BAG BG-50 f/carrying 5 mast sections..... **50c**

GEARED MOTOR

Ideal reversible motor for rotating antennas, displays, etc. Weight: 4 lbs. Overall size: 7 1/2" long, less shaft. Gear Box size: 3 3/4" x 3 3/4". Motor size: 4" x 2 1/2". Shaft size: 3/8" x 1 3/4" threaded. Operates from 24 volt DC, 2.9 A., 9 RPM or 36 volt AC at 75 lbs. per inch torque. Price..... **\$5.95**
TRANSFORMER—110 Volt 60 cycle primary, secondary 36 Volt AC, 2.5 A. Price: **\$2.95**. RHEOSTAT to control speed 30 ohm. 50 Watt. **97c**



DYNAMOTORS:

INPUT:	OUTPUT:	STOCK NO.	PRICE
9 V. DC	450 V. 60 MA.	DM-9450	
@ 6 V. DC	275 V. 50 MA.	w/Blower	\$3.95
12 or 24 V. DC	440 V. 200 MA. &		
	220 V. 100 MA.	D-104	9.95
12 V. DC	600 V. 300 MA.	13D-86	7.95
PERMANENT MAGNET FIELD DYNAMOTORS:			
12 or 24 V. DC	275 V. 110 MA.	USA/0516	\$3.95
12 or 24 V. DC	500 V. 50 MA.	USA/0515	2.95
@ 6 V. DC	240 V. 50 MA.		

PM FIELD DYNAMOTOR POWER SUPPLY—Completely filtered. Has two PM Dynamotors as listed directly above **\$5.00**
 Write—Tell Us Your Dynamotor or Inverter Needs!

TRANSMITTERS and RECEIVERS:

	USED:	NEW:
BC-357 Marker Beacon Rec....	\$2.95	
BC-347 Amplifier, less tubes....	1.00	\$2.95
BC-347C Amplifier, with Tubes.....		\$2.95
BC-1206 Receiver, 2000 KC.....	\$4.95 (LN)	\$6.95
BC-458 Transmitter, 5.3 to 7 MC.....	5.95	8.95
T-20/ARC-5 Transmitter, 4 to 5.3 MC.....		8.95
BC-454 Receiver, 3 to 6 MC.....		6.95
BC-453 Receiver, 190-550 KC.....	\$11.95	

CABLES:

Four Conductor Shielded Cable—50 Ft..... **\$2.00**
 Eight Conductor Cable, Not Shielded. Per 100 Ft..... **.08 Ft.**
 Coaxial Cable—125 ohm—cotton covered. 50 Ft..... **1.00**
 Heavy Rubber Cable—Two #16 Cond. Wire. 20 Ft..... **1.00**

LEARN IT YOURSELF

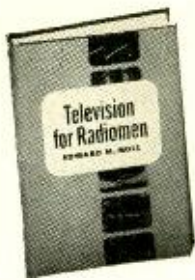

E. M. Noll's
Complete course
of study and
working
instructions
in the book

TELEVISION FOR RADIOMEN

will help you take advantage of the good jobs open to skilled television technicians today.

● This book is not only a valuable handbook on television installation and servicing. It is also a complete course in television fundamentals. Written by a man widely known for his articles on television in the radio magazines, it explains in practical, easy-to-understand terms the construction and operating principles of every part of the television receiver and the essentials of television transmission.

● Full working instructions show each step in the installation, adjustment, alignment, and trouble-shooting of today's receivers, with especially helpful material on antennas and handy charts for locating trouble quickly and accurately.

WHAT IS YOUR PROBLEM?

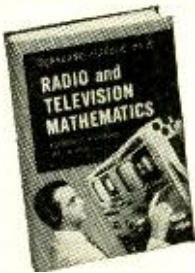

You will find the answer in the 721 problems and solutions in

RADIO & TELEVISION MATHEMATICS

● Here are step-by-step solutions to every problem commonly arising in work on receivers, power supplies, antennas, amplifiers, tubes, transmitters, etc. If you are ever "stuck" on a calculation; if you need a check on your figuring; or if you want to refresh your memory on the formulas to use for a certain problem—you will find your answer quickly and easily in this book.

● Good practice for your FCC exams. This book shows you how to solve every problem requiring mathematics in the FCC STUDY GUIDE for licenses of all classes. You will find no better handbook for practice in solving problems with ease, speed and accuracy.

SEE THEM FREE

The Macmillan Co., 60 Fifth Ave., New York 11

Please send me a copy of the books checked below. I agree to remit in full or return the books within ten days without further obligation.

Television for Radiomen, \$7.00

Radio & Television Mathematics, \$6.00

Signed

Address

reception reports are much appreciated because the station is still experimenting; output is only 80 watts but it is hoped to increase power in the near future; schedule listed 0030-0230, 0530-0800, 1030-1400. (Radio Sweden)

Haiti—4VRW, Port-au-Prince, verified for Hankins, Pa., and others, recently; card lists schedule 0600-0830, 1200-1500, 1800-2200 except Sunday when is on the air 1200-1700; confirmed reception on 10.205, stated 4VRW was formerly HH3W and that 4VW, 1350 kc., was formerly HHW; QRA is P.O. Box 117, Port-au-Prince, Haiti.

4VCM, 6.165, is scheduled 1200-1430, 1700-2200; sent nice QSL letter; QRA is Magloire Broadcasting Circuit, P.O. Box 118, Port-au-Prince, Haiti. (Taylor, Ill.)

Holland—Current schedules for the "Happy Station Programs" produced and presented by Eddie Startz are—Sunday, 0930-1100, to East and Near East, 15.22, 6.02; 1600-1730, to Africa and South America, 9.59, 6.02; 2200-2330, to North America, 11.73, 9.59. Tuesday, 0600-0730, to Pacific, Australia, New Zealand, 21.48, 17.77, 15.22, 6.02. Wednesday, 0930-1100, to East and Near East, 15.22, 6.02; 1600-1730, to Africa and South America, 9.59; and 2200-2330, to North America, 9.59. Programs consist of musical entertainment linked by polyglot announcements, "Spotlight on Holland" (local-color news), musical interlude, "Mailbag" (answering listeners' mail by calls to all parts of the world), and musical sign-off.

India—Direct via airmail from AIR, New Delhi, comes this list of current English periods—1930, 15.16, 11.85; 2130 (news), 17.78, 15.29, 15.16, 11.83, 11.76, 9.68, 7.275, 7.225; 2315, 17.78, 15.16; 0230, 21.51, 17.84, 17.78, 15.16; 0300 (news), 17.76, 15.29, 11.83; 0730 (news), 17.78, 15.29, 11.83, 9.68; 0830, 17.84, 15.19; 1000, 17.76, 15.21; 1215, 15.21, 11.79; 1400, 11.85, 11.76, 9.62, 7.24. Most of these periods include at least a short newscast.

Indochina—Direct via airmail from Jean Pipon, head, English Department, Radio France-Asie ("Voice of France in the Far East," formerly Radio Saigon), comes this interesting data about the present set-up of s.w. outlets in Indochina—Under French Authority, Radio France-Asie, Saigon, 6.165, 11.830, 1050 kc.; under Vietnamese Authority, "The Voice of Vietnam," Saigon, 7.263, 9.670, Radio Dalt, 6.180, Radio Hue, 7.205, and Radio Hanoi, 6.190; under Cambodian Authority, Radio Cambodge, Phnom-Penh, 6.090. Radio France-Asie has English news on 11.830 (moved here from 11.780 and not using 9.524 as had originally planned) daily at 1845, 1945, 0500, 0545, 0900; Listeners' Letter Box is radiated on Friday at 0450 with repeat at 0930. Other languages used include French, Chinese (Mandarin on 11.830, Cantonese on 6.165). QRA for Radio France-Asie remains 86, Rue Mac-Mahon, Saigon, Vietnam, Indochina. From other sources, I understand that Radio France-Asie is hav-

ing new QSL cards printed, to bring station data thereon up-to-date.

Indonesia—At the time this was compiled, YDF2, 11.785, was in the clear during the English hour for Europe 1400-1500; news around 1402 and 1445 or 1450. (Boice, Conn.) Good signal here in West Virginia.

Makassar, Celebes, 11.084, noted in California 0900-1000 sign-off with fine signal. (Rosenauer) The 9.55 outlet also signs off 1000. (Balbi, Calif.)

Iran—Bluman, Israel, has logged a new Iranian station on 4.050 at 1030-1330 relaying Radio Teheran; at 1130 has "Voice of America" program in Persian, and at 1300 has local news (presumably in Persian), and then announces a further program for the Issahan region; not definitely identified as yet; Radio Sweden reports this one at 2330-0030, 1100-1315.

Iraq—Swedish DX-ers have heard the call "Emisol Al Basra, Iraq," on 11.935 at 0049-0110. (Radio Sweden) "The Voice of Iraq," 7.062, noted by Bluman, Israel, at 0830-1115 in Kurdish; 1115-1200 in English. (ISWC, London)

Ireland—At the time this was written, the new 100 kw. transmitter at Dublin was not yet on the air, but some days the low-powered transmitter on 17.840 was audible to readable during the 1330-1350 news period.

Israel—When this was compiled, the Overseas Service was operating daily on 9.000 at 1200-1745, with news 1515-1530, and with a special English period, sponsored by the World Zionist Organization, at 1700-1745; the latter period originates in Jerusalem and is announced as coming from "IBS, the Israel Broadcasting System"; fair to poor signals here in West Virginia. By this time Israel will be on Summer Time and schedules will probably be one hour earlier.

Italy—Radio Italiana, Rome, is reported on a new frequency of 11.900 in parallel with 9.630, 11.810 at 1230-1515. (Radio Sweden) Pearce, England, reports the 25-m. channel at 11.890 and believes it may have "replaced" 11.810.

Japan—Tokyo, 6.13, heard irregularly in parallel with 4.91 around 0500, strong in California. (Balbi)

Korea—Hilka, 7.935, heard in Britain 1600-1800 in Korean mostly, but at times in English. (Staples)

Lebanon—Beirut, 8.036V, has English at 1000 weekdays but not Sunday. (Pearce, England)

Madagascar—Radio Tananarive, 7.380, noted 1140 with French program. (Pearce, England)

Mexico—The Mexican Government issues a free list of its m.w. and s.w. outlets; QRA is Department of Communications and Public Works, Radio Division, Mexico, D.F. (Callarman, Oregon)

Mozambique—Lourenco Marques announces its 25-m. outlet as operating on 11.764; is in use from 2300 (from 0000 on Sunday) to 1000. (Laubscher, South Africa)

New Caledonia—Radio Noumea has



TOP VALUES at BEST PRICES!

TUBES

Drastically Reduced from 10 to 50%
Nationally Advertised Brands

Type	Net Price	Type	Net Price	Type	Net Price
1A4P	\$0.24	6SF5GT	\$0.34	38	\$0.24
1A6	.19	6S7G	.39	39/44	.24
1B5/25S	.24	6S8GT	.69	49	.39
1B22	1.40	6S97	.39	50	.39
1B26	2.29	6SF7	.39	56	.24
1B29	.39	6S7J	.69	57	.24
1B32-532A	2.29	6T7G	.39	76	.24
1C6	.19	6U7G	.29	77	.24
1C7G	.19	6Z7G	.39	211/Vt4L	.29
1D5GP	.24	6Z95G	.29	316A	.34
1D7G	.19	7C4/1203A	.24	371B	.34
1F4	.24	7E5/1201	.39	700A	7.95
1F5G	.24	10YV25A	.19	703A	1.49
1H4G	.24	12A6	.34	705A	.79
1J6G	.24	12A6GT	.34	714AY	6.95
1J6GT	.24	12A7	.34	724B	4.95
1F5GT	.24	12A8CT	.19	801A	.39
2A5	.39	12F5GT	.29	813	6.95
2A6	.39	12H6	.29	829	6.95
2A7	.24	12J5GT	.24	832	4.95
2C26A	.19	12J7GT	.24	837	1.49
2V3G	.49	12Q7GT	.24	841	.29
2X2/879	.25	12S6GT	.24	864	.29
3F7	.98	12S5F5GT	.24	872A	.98
4A10	.98	12S7	.24	954	.19
5B9A	2.95	12SH7	.24	955	.34
5C1	2.95	12SR7	.24	957	.34
5D21	9.95	12SR7GT	.29	1625	.19
5F7	.95	12SN7GT	.89	1626	.24
5J23	6.95	12Z3	.29	1630	.29
5W4	.49	15R	.19	1642	.29
5Z4	.49	19	.69	2050	.89
6A7	.69	2J22	.24	2051	.45
6AJ5	.89	28D7	.34	7193	.19
6B8	.39	30SPEC	.59	9002	.34
6C4	.39	(Vt67)	.59	9003	.39
6D8G	.69	30	.24	9006	.39
6F5GT	.39	304TL	1.29	GL4A21	.29
6F6G	.59	32L7GT	.39	Amperite	.29
6H6	.29	33	.24	10T1	.29
6J7GT	.39	34	.24	Jan CRP72	.98
6K6G	.59	35/61	.24	REL36	.69
6L5G	.39	36	.24	VR150	.39
6L7G	.39	37	.24	VR105	.69
6R7	.34				

WRITE FOR QUANTITY PRICES

BEAM INDICATORS

I82-5"	New	\$4.95
Transmitter Selsyn for above		2.45
	both for	7.00
I81-3"	New	3.45
Transmitter Selsyn for above		2.45
	both for	5.25
I81	Used	2.45

T-85/APT5 UHF TRANSMITTER

Operating over a frequency range of 300 to 1400 MCPC with a nominal output of from 10 to 30 watts. Unit is equipped with 110 V 60 CPS filament transformer; blower; lecher wire test frequency set, and 8 tubes—1-931A, 2-6AC7, 2-6AG7, 1-6L6G, 2-829B, 1-3C22 (GL522) (oscillator).
New in original box with Operating Instruction Manual. **\$69.50**

BC 620

Receiver-Transmitter—2 crystal channels—20 to 27.8 MC FM—13 tubes. Metered, Plate and Filament. New **\$14.95**
Used **9.95**
PE 97 Power Supply for above 6-12 volt vibrator type. Used—complete. **\$6.95**
Used less tubes, vib. & cond. **2.95**
FT 250 Mount for both BC 620 and PE 97 New **\$1.50**

BC 223

Brand new Transmitter with all three tuning units, two tuning unit cases, spare tube carrying case, shock mount and brace, but less tubes at new low price of **\$19.95**
Set of 8 tubes. **\$3.95**
Tuning units are available separately at. Ea. **\$2.50**
Cases at. Ea. **.95**
PE 125—12-volt Vibrator Pack. New **\$12.95**
Used **8.95**
Spare parts kit for PE 125 containing 2 tubes; 2 vibrators and 13 tubes in metal container with handle and clasp (BX 41). New **\$2.95**

RECEIVER—Easily Converted for Use in Citizens Band

Crystal Controlled Local Oscillator. Broad Band Pass—20.7 MC IF's. Complete with 7-6AJ5, 1-12SR7, 2-12SN7, 1-28D7, relays, crystals. Schematic furnished. **NEW \$7.95**

Miscellaneous SPECIALS

	Used	New
ID 6/APN 4 Scope, Excellent	\$29.50	
R 7/APS 2 Receiver-Indicator		\$79.50
R 78/APS-15 Receiver-Indicator	34.50	
BC 1287 A Scope	75.00	
ASB 7 Indicator Scope	12.95	
SCR 522 Transceiver 100 to 150 MC	34.95	75.00
BC 1206 Receiver, 200 to 400 KC	3.95	5.95
MN 26 C	17.50	24.95
RA 10 DA Receiver	17.50	24.95
T26/APT2 Transmitter	8.95	
RT7/APN1 Transceiver	4.95	9.95
APN 1 Complete	24.50	
BD 71 6 Pos. Switchboard	9.95	12.95
EE 8 Field Phones	7.95	
BC 347 Interphone Amplifier	2.95	
I-70 Tuning Meter	.89	
AM 61 Indicator Amplifier	9.50	
SCR 625 Mine Detector	39.50	
PE 237 Power Supply	12.95	
BC 461 Veeder Root Counter	.59	
BC 442 Less Condenser	1.49	1.95
BC 746—Bantam one watt foundation (See QST Jan. 1948). Contains 2 crystals, coil, tuning condensers, etc. Numbers 1-7-10-11-12-13-76.		\$0.95
Each		\$0.95
A 27 Phantom Antenna	.98	
APS 13 UHF Antenna, Pair	.98	
Manual for BC 312 & 342 J	1.00	
Manual for SCR 269 G	2.50	
FL 8 Filter	2.95	
I-97 Bias Meter	\$4.95	3.95
RM 29 Remote Telephone Control	7.95	9.95
BC 602 Control Box	.98	

One Tube Interphone Amplifier—Small compact aluminum case fully enclosed. 2 1/4" x 3 3/4" x 5 3/4". Less Tube **79c**

BC 717 Transmitter, New but less Tubes **\$24.50**
96Q1 Complete Autotune assembly with motor and frame as used in ARC-1 Transmitter New **\$35.00**
BC 709 Battery operated lightweight interphone amplifier. Complete with tube and shock mount, but less battery. New **\$3.95**
SCR 183 Complete. New **\$49.50**
Motor—Universal Electric, 24 VDC, will also operate on 24 VAC Diameter 1 5/8"; Length 2 3/4"; Shaft 1/4" x 3/4". New **\$1.49**
BC 1291 Control box contains motor rheostat control rated 10 ohms at 3.88 amps. Brand new with cord and plug-in ventilated, mounted case. **\$1.95**
MC 385A—Headset Adapter. New **\$0.49**

Information and Prices on Request

BC 639 Receiver with RA 42 Rectifier
RTA 1B Transceiver
TA 2J24 Transmitter and MP 10G Power Pack
SCR 269 Compass Installation
R 5/ARN 7 Compass Installation
MN 26 Compass Installation
I. L. S. Installation (R 89-BC733)
SCR 584 Components
R-132/TPS 10 Radar Receiver
MD-22-URA/T1 Radar Modulator
AN APRI Receiver and Tuning Units
ASB7 Complete Radar Installation
TS-251 Test Set BC 221 Freq. Meter

MONTHLY SPECIAL!

MN 26 Y Compass Receiver

12 tube superhet covering frequencies of 150 to 325 KC; 325 to 695 KC; 3400 to 7000 KC in three bands. Complete with dynamotor and tubes, Like New **\$14.95**

SURPRISE PACKAGE

20 lbs. Ass't radio parts. A \$25.00 value for only **\$1.95**

HEADSETS—MIKES

HS-23 Hi Imp. Headsets	New	\$2.95
HS-33 Lo Imp. Headsets	New	2.95
HS-30 Hi Imp. Headsets	New	1.50
	Used	.79
T-17D Carbon Mike	New	2.75
T-24 Hi Imp. Carbon Mike	New	1.19
T-30 Throat Mike	New	.98
T-45 (or Navy) Lip Mike	New	.98
CD-307 Extension Cord for Headsets	New	.59

Send for free 8-page illustrated BULLETIN No. 103 listing many exceptional values

ARROW SALES, Inc.

Dept. N

1712-14 S. Michigan Ave., Chicago 16, Ill.

PHONE: HARRISON 7-9374

BC-605 Interphone Amplifier

Easily converted to an ideal intercommunication set for office—home—or factory.

Original—New **\$4.95**
Like New **3.95**
(With Schematic)

See April 1950 Radio News for complete conversion data.



All necessary parts and instructions to convert the above to AC operation with one remote station \$8.25 additional.

BC-604 Transmitter FM 20-28 MC

11 and 15 meters. Can be operated on 10 meters —10 channel push button crystal. With all tubes and meter but less dynamotor. **\$12.95**

Excellent Condition **\$12.95**
Crystals—Set of 80 **14.95**

BC-603—Companion receiver to above with tubes but less dynamotor. Used **\$17.50**

COMMAND (SCR 274N) EQUIPMENT

	Used	New
BC-453	\$12.95	
BC-454	4.95	\$6.95
BC-455	7.95	9.95
BC-456	1.95	2.95
BC-457	5.95	
BC-458	5.95	8.95
BC-696 (or T19)	14.95	24.95
BC-450—3 Receiver Remote Control	.89	1.95
BC-442		2.95
3 Receiver Rack	1.95	
2 Transmitter Rack	1.50	
Complete Command set as removed from aircraft—3 receivers—2 transmitters—Relay unit—control boxes—mounting racks—plugs—modulator and dynamotors—crated. Set		\$34.50

DYNAMOTORS

DM-28—For BC-348 with Mount and Filter	New	\$6.95
	Used	3.95
DY-12—For ART-13 less filter and base	New	6.95
DM-36	Used	.95
BD-77	New	1.95
PE-206	New	5.95
	Used	2.95
PE-101	New	2.75
PE-73	New	3.95
DM-53	New	3.95
	Used .95	(3 for \$2.00)
DM-32	New	1.95
	Used .95	(3 for \$2.00)

TEN TUBE SUPERHET RECEIVER

with crystal controlled local oscillator. Has provisions for six crystal channels between 108 to 112 MCPS complete with tubes and crystals but less dynamotor. New **\$7.95**
Like New **5.95**
Less Tubes and dynamotor but New **3.95**

HERMETICALLY SEALED CHOKES

10 H. 100 M.A.	59c	3.7 H. 145 M.A.	59c
59 H. 100 M.A.	95c	10 H. 20 M.A.	39c
5x.5x1x1 H—4 winding layer wound.			
		5 H at 3.56 A 140 ohms	
		1 H at 1.56 A 320 ohms	New 49c

CONDENSERS

	Each
2 mfd. 4000 VDC. OIL FILLED	\$2.95
	4 for 10.00
1 mfd. 6000 VDC. OIL FILLED	1.98
.25 mfd. 15000 VDC. OIL FILLED	4.95
.00025 mfd. 25000 VDC. OIL FILLED	2.95
4 mfd. 1500 VDC. OIL FILLED	.29
	10 for 2.49
2 mfd. 600 VDC. OIL FILLED	.39
	3 for 1.00
1 mfd. 600 VDC. OIL FILLED	.24
	5 for 1.00
1x.1x.1—1200 VDC. OIL FILLED	.59
	2 for 1.00
50 mmd—SKV—5 Amp. Vacuum Cond.	1.19

All shipments FOB Chicago. 20% Deposit required on all orders. Minimum order accepted—\$5.00. Illinois residents, please add regular sales tax to your remittance.

now....the amazing
ALTEC 21B
 miniature microphone
 for lapel use!

actual
 size



perfect
 quality
 hardly
 visible

The new Altec 28A Lapel Microphone permanently incorporates the Altec 21B. Its small size makes it practically invisible when clipped to the clothing of the user. Here is a development that offers public speakers and professional people a microphone that is invisible, gives them complete freedom of movement and provides them with quality that was never before available. The 28A is held to the clothing by a jewelry clip and is equipped with 6 ft. of cable.

The 154A Matching Unit is used with the 28A and contains the necessary impedance matching tube. The size of a pack of cigarettes, it is easily carried in the pocket. Equipped with 25 ft. of cable.

Write for full information on this and other models of the Altec 21B microphone.



1161 N. VINE ST., HOLLYWOOD 38, CALIFORNIA
 161 SIXTH AVENUE, NEW YORK 13, NEW YORK

moved from 6.000 to 6.035 where it has a definitely better signal; noted 0500 to closing down 0545. (Rosenauer, Balbi, Calif.)

Nicaragua—Stark, Texas, has noted a station on 6.719 around 2230 announcing "Radio Fox en Managua."

Norway—From Arne Halvorsen, Oslo, comes this summer schedule of *Radio Norway*—To Norwegians Abroad, 2000-2100 (Sun. 2000-2115), LKV, 15.17, LKQ, 11.735, LLH, 9.645, to North American waters, North Atlantic; 0600-0700 (Sun. 0600-0715), LLP, 21.67, LLN, 17.825, LKV, 15.17, LKQ, 11.735, to Far East; 0800-0900 (Sun. 0800-0915), LLP, 21.67, LLN, 17.825, LKV, 15.17, LKQ, 11.735, to Indian Ocean; 1400-1500 (Sun. 1400-1515), LLP, 21.67, LKQ, 11.735, LKV, 15.17, LLG, 9.610, to African Waters and South Atlantic; 1800-1900 (Sun. 1800-1915), LKV, 15.17, LKQ, 11.735, LLH, 9.645, to South America. Home Service—0115-0230 (Sun. 0255-0550), LLP, 21.67, LLN, 17.825, LKV, 15.17, LKQ, 11.735, to African Waters and South Atlantic; 1300-1400 (Sun. 1000-1400), LLP, 21.67, LKQ, 11.735, LKV, 15.17, LLG, 9.610 (Sats. 1200-1400), to African Waters and South Atlantic; 1500-1700 (Sun. 1515-1700), LLP, 21.67, LLN, 17.825, LKV, 15.17, LLH, 9.610, to African Waters and South Atlantic. Home Service over the Tromsø s.w. transmitters—LKJ, 9.540, to North Atlantic, weekdays 0115-0230, Sundays 0255-0945, Saturdays 0115-0320; LKJ, 9.540, to North Sea, weekdays 0520-0740, Saturdays 0250-0735, off Sundays; LLS, 7.210, to North Atlantic and North Sea, weekdays 1045-1700, Sundays 1015-1715, Saturdays 0930-1700. It is emphasized that approximately the last quarter of an hour in the special Norwegian s.w. transmissions is given to Norwegian music or to music by Norwegian artists; "Norway This Week" (*English*) is presented Sundays 0700-0715, 0900-0915, 1500-1515, 1900-1915, 2100-2115.

Pakistan—Dacca seems to have moved from 7.635 to 7.140 where it is heard weakly with news 0700 in parallel with Karachi on 11.548, 11.845. The 2100 newscast appears to be radiated now on 9.645, 15.335.

Philippines—At the time this was compiled, Manila s.w. relay outlets of VOA were scheduled—Manila III, 9.530, 1800-2000 to East Asia; Manila I, 11.890, 0400-0915, 0945-1045 to Far East, 1645-1700 to Korea, and 1800-2000 to East Asia; Manila II, 15.250, 1645-1700 and 1800-2000 to East Asia; Manila II on Tue.-Sat. at 0215-0345 with United Nations Radio on 15.330 to East Asia, daily on 15.330 to East Asia at 0400-0915 and 0945-1045; Manila III, 17.780, 0400-0915, 0945-1045 daily to East Asia; Manila I, 21.570, on Tue.-Sat. at 0335-0345 to South East Asia.

Bacolod City, 4.985, continues to be heard by Rosenauer, Calif., around 0830-0930; some days in Filipino and others in *English*.

DYH3, 6.10, Manila, *Radio Philippines*, heard 0430 onwards; news 0556;

(Continued on page 143)

Wheatstone Bridge

(Continued from page 61)

close to the surface and vulnerable to physical attack. A combination lock may have the selecting elements separated from the dial by a fairly long shaft, but this represents problems when space is limited, such as in an ordinary door frame. The electronic lock has the advantage that the "key-hole" may be located virtually any place while the selector circuits and solenoid-operated bar may be located in a well protected place.

A simple form of lock uses a bridge, with one element missing, in order that current will flow through a sensitive relay at all times other than when the "key," a resistance of correct value, is applied across the open ends of the bridge. This has a disadvantage in that an ingenious person may open the lock by means of a variable resistance. This handicap may be overcome by making it necessary to balance two separate bridges simultaneously or by using a time delay circuit, in conjunction with a tube operated relay, to provide a delay of five or ten seconds after the proper combination is reached. A number of other variations could be discussed, but the potential constructor is advised to consider all of the factors before installing a system of this nature. Shock hazard should be considered as well as the matter of stability over long periods, and what happens in the event of power failure. Nevertheless, this system

Fig. 2. (A) Modified a.c. bridge circuit. The a.c. input may be 60 cycles from power line or a higher frequency from an oscillator. One of the potentiometers is used for the reference voltage and the other for signal voltage. (B) Basic a.c. bridge circuit. The a.c. supply should not be grounded. If low impedance circuits are used, the relay may be operated directly from the output of the rectifier.

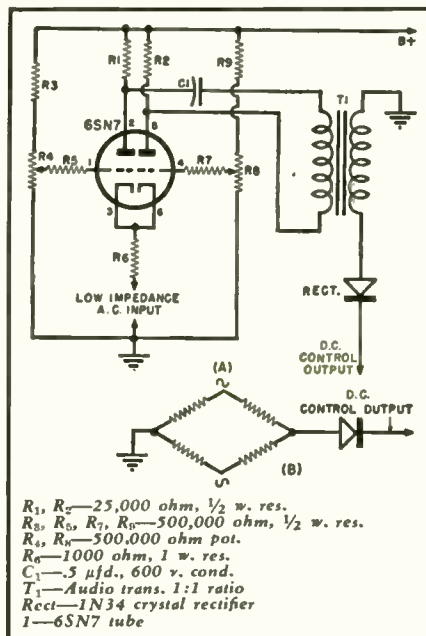

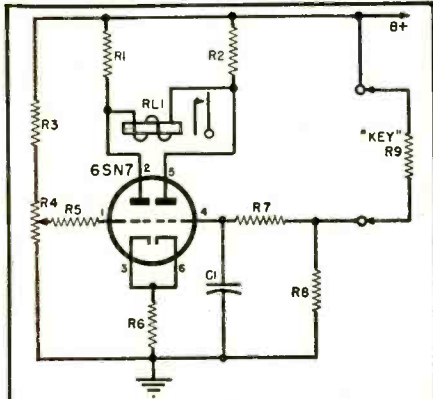

R₁, R₂—25,000 ohm, 1/2 w. res.
 R₃, R₅, R₆, R₈—500,000 ohm, 1/2 w. res.
 R₄—500,000 ohm pot.
 R₇—2500 ohm, 1 w. res.
 R₉—5 megohm, 1/2 w. res.
 C₁—5 μfd., 600 v. cond.
 RL₁—1 ma. (d.c.), 8000 ohm relay
 1—6SN7 tube

Fig. 3. Diagram of d.c. tube-operated relay set up as an electronic lock with time delay. The grid resistor, R₇, and condenser, C₁, give a delay of approximately 5 seconds. The "key" and R₉ may be replaced by a potentiometer for remote control.

has several aspects of novelty and usefulness which might find application in private clubs and other organizations which distribute a fairly large number of door keys.

Several other applications of the bridge circuit that might appeal to the constructor are suggested. One of these is a variation of the "light organ," a device which automatically turns on vari-colored lights in accordance with the musical content of the output of a radio or phonograph. In this case a portion of the output is rectified and used as the control voltage for a series of bridges and relays, thus turning on the appropriate lights in relation to the amplitude of the music. More elaborate arrangements may be constructed by using frequency division as well. Use of relay control means that nearly any amount of light intensity desired may be obtained by use of the proper size bulbs, however, if small bulbs are used, the lack of thermal inertia may give a somewhat jerky effect. On the other hand, if large lights are used, it may be necessary to take precautions to prevent clicks and pops in the musical reproduction that may result from sudden line voltage variation.

A similar use that may interest those engaged in dramatics or lighting effects, is the use of a relay sequence for remote dimming of spots or floods. Usually a simple sequence involving the adjustment of relay tension or series resistance should suffice. A ten-step system should be adequate for most applications involving large lights as the thermal inertia should make smooth dimming possible. Conventional Nichrome wire may be used as a resistance in series with the light to be dimmed, and the relays set to short out portions of the series resistance. In this manner, voltage across the individual relay contacts will be low, resulting in longer life, and a kil-

The NEW Automatic Radio

CUSTOM-BUILT AUTO RADIO

1949 and 1950 FORD AUTO RADIOS



List Price..... \$4995

Each auto radio is specifically designed to fit all 1949 and 1950 cars shown above and all incorporate the same outstanding features. . . Six-tube superheterodyne. Six-volt storage battery operation. Two dual purpose tubes. Eight-tube performance. Installation in a few minutes. Three-gang tuning condenser and tuned R.F. stage for extreme sensitivity. Permanent magnet dynamic speaker with Powerful Alnico #5 magnet. Low battery drain. Weight 10 lbs.

RECORD SMASHING VALUES!

1949 and 1950 PLYMOUTH-DODGE RADIOS

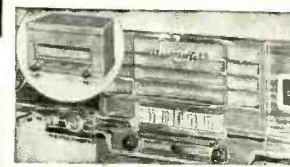

List Price..... \$4995

ATTRACTIVE DISCOUNTS TO DEALERS

1949 and 1950 CHEVROLET RADIOS



List Price..... \$4995

CUSTOM-BUILT BY

Automatic Radio

SPECIALS

- R5-ARN-7 Radio Compass Receiver w/Tubes Used Excel. Cond. \$18.95
- BC-439G Radio Compass Receiver w/Tubes Used Excel. Cond. \$18.95
- Gibson Girl Distress Transmitter complete with bag and parachute. New. \$8.95
- Gibson Girl Kit includes 2 balloons, w/Hydro. Generators, Lights, Lamp, Wire. New. \$8.95

CAPACITORS

MATCH BOX TYPE		EA.	TEN
2X.25 mfd	400 VDC	\$0.25	\$0.20
.5 mfd	400 VDC	.25	.20
1 mfd	500 VDC	.30	.25
2X.05 mfd	600 VDC	.25	.20
2X.1 mfd	600 VDC	.25	.20
.1 mfd	600 VDC	.30	.25
.5 mfd	600 VDC	.30	.25
1 mfd	600 VDC	.35	.30
BATHTUB			
40 mfd	25 VDC	.30	.25
4 mfd	50 VDC	.35	.30
50 mfd	60 VDC	.40	.35
4 mfd	100 VDC	.40	.35
2X.1 mfd	400 VDC	.15	.10
2 mfd	400 VDC	.20	.15
2 mfd	400 VDC	.45	.40
.05 mfd	600 VDC	.20	.15
.25 mfd	600 VDC	.25	.20
.1 mfd	600 VDC	.25	.20
1 mfd	600 VDC	.35	.30
2 mfd	600 VDC	.40	.35
.05 mfd	1000 VDC	.50	.45
2X.1 mfd	1000 VDC	.55	.50
OIL-FILLED ANGLE PYRANOL			
.5 mfd	400 VDC	\$0.35	\$0.30
1 mfd	500 VDC	.30	.25
1 mfd	600 VDC	.30	.25
2 mfd	600 VDC	.35	.30
4 mfd	600 VDC	.45	.40
5 mfd	600 VDC	.50	.45
8 mfd	600 VDC	1.00	.90
1-8 mfd	600 VDC	1.10	1.00
10 mfd	700 VDC	.65	.60
.5 mfd	1000 VDC	.45	.40
2 mfd	1000 VDC	.55	.50
.5 mfd	2000 VDC	1.10	.90
.25 mfd	3000 VDC	1.95	1.60
.5 mfd	3000 VDC	1.40	1.20
.1 mfd	7500 VDC	2.60	2.30
1 mfd	7500 VDC	5.25	4.45
.0008 mfd	15,000 VDC	6.95	6.50
.045 mfd	16,000 VDC	4.15	3.25
TAPER			
8-8 mfd	400 VDC	\$1.00	\$0.90
Tobe Filtermite			
3X8 mfd	600 VDC	1.45	1.25
8-8 mfd	600 VDC	1.45	1.25
160-160 mfd	150 VDC	1.25	1.00
ELECTROLYTICS			
2500 mfd	12 VDC	\$0.15	\$0.10
500 mfd	12 VDC	.50	.45
25 mfd	25 VDC	.20	.15
50 mfd	25 VDC	.25	.20
1000 mfd	25 VDC	.50	.45
150 mfd	50 VDC	.25	.20
2000 mfd	50 VDC	1.00	.90
500 mfd	200 VDC	1.00	.90

SPECIALS

- 80.86 KC Crystal with Holder. \$1.50
- CP-501A Cord Connector BC-654 \$1.50
- Transceiver to GIV-45 Gen. 1.59
- Balloon with Hydrogen Generator 2.50
- Gibson Girl Box Kite 17"x17"x36" 2.25
- 50 Watt Tube Socket 872-211. 2.25
- NE-Neon Lamp 9 VDC \$0.15 \$0.05
- Anti-Capacity Lever Switch 8-PDT .80
- 35-440mmf Variable Condenser .69
- 7-100 mmf Variable Condenser .69
- 24-750 mmf Tapered Rotor Plates .90
- PL-150 Plug for BC-223 X Miter .39
- Battery Test Meter 0-10V. .85
- 0-35A Helipot, 20,000 Ohms 5W .50
- 0.5% Linear. New. Ea. 4.50
- 10 for Ea. 4.50

CHECK THESE VALUES

- Sound-on-Film Hartron Recorder Reproducer Records up to 4 hours on a 62 foot loop of film. Plays back immediately. No processing of film required. Brand New \$150.00
- BC-709 Interphone Amplifier Ideal for Aircraft Booster Telephone. New \$4.00
- BC-312 Receiver. Used. Good Condition .25 \$75.00
- BC-224 Receiver. New. Less Mtg. \$100.00
- BC-412 Radar Oscilloscope \$49.95
- BC-1072 Radar Transmitter \$24.95

TUBES

2C34	\$.025	C5B	\$.60
3X2A	.55	6E07	.25
2X2/879	.35	CK-70	3.50
3C24	.38	CRP-72	1.25
7C4/1203A	.35	E-1148	.30
107	.45	BY-615	.25
15E	1.20	RKR-72	.60
15E	.45	HK-75	.60
39/44	.25	VT-137A	2.00
15E	1.20	VT-1	.50
HK-54	1.65	3BP1	2.50
801A	3.25	5CP1	1.95
804	6.50	5BP4	2.45
805	3.40	6AC7	.75
806	3.25	16GT	.20
864	.35	6H6	.45
869B	23.95	6K8GT	.40
872A	1.30	6K8	.75
922	2.25	6L6	1.00
1626	.25	6SG7	.50
1629	.20	6SH7	.40
2051	.35	6S17	.55
7193	.20	6Y8GT	.65
8011	2.00	12SN7GT	.50
922	.25	6SL6GT	.50
9003	.35	25Z5	.45
9006	.20	33	.65

TRANSMITTING-MICA

.002 mfd	600 VDC	\$.15
.0005 mfd	2500 VDC	.20
.0039 mfd	2500 VDC	.20
.002 mfd	2000 VDC	.65
.00075 mfd	5000 VDC	.65
.000375 mfd	5000 VDC	.65
.002 mfd	6000 VDC	3.95
.005 mfd	8000 VDC	3.95
.0012 mfd	20,000 VDC	10.95

LINEAR POTENTIOMETERS WW

OHMS WATTS	MFG'R	EA.	TEN
200	2 CHIC. TEL.	\$.25	\$.20
1000	2 TREFZ	.25	.20
3000	2 CHIC. TEL.	.25	.20
10000	2 CHIC. TEL.	.30	.25
5000	3 TREFZ	.25	.20
7500	3 TREFZ	.25	.20
10000	3 TREFZ	.30	.25
25000	3 WIRT	1.25	1.00
50000	4 TREFZ	.50	.45
15	25 DEJUR	.45	.40
20	25 OHMITE	.45	.40
25	25 DEJUR	.45	.40
50	25 DEJUR	.50	.45
100	25 DEJUR	.55	.50
200	25 DEJUR	.55	.50
500	25 DEJUR	.55	.50
1000	25 DEJUR	.55	.50
3000	25 DEJUR	.65	.60
15000	25 DEJUR	.70	.65
20000	25 DEJUR	.85	.70
6	50 DEJUR	1.00	.90
50	50 AC	1.00	.90
800	50 OHMITE	1.10	.95
10000	50 DEJUR	1.50	1.25
15	50 OHMITE	1.50	1.25
15	75 DEJUR	1.50	1.25
750	150 OHMITE	2.45	2.10

TERMS: Minimum order \$5.00—Mail orders promptly filled—All prices F.O.B. Boston, Mass. Send M.O. or check. Shipping charges sent C.O.D. 25% deposit required with all C.O.D. orders.

SEND FOR OUR CATALOGUE NOW! Inquiries from Dealers, Schools and Industrial Firms Invited

COMET ELECTRONIC SALES CO. 22 Washington St. Brighton 35, Mass. BEacon 2-7863

COMPLETE TRAINING

FOR BETTER JOBS
in Radio-Electronics



ONLY
\$14

5 MONTHS TO PAY!

Here are three world-famous books so thoroughly covering radio theory, troubleshooting and servicing methods; so clearly explaining every phase of the work that, with a minimum of time, you'll soon be able to handle repairs on any type of Radio-Electronic Equipment and qualify for better jobs, bigger pay checks! You couldn't get a finer, more complete or easier to understand training course AT ANY PRICE. Remember! These are the same Ghirardi books that were more widely used for wartime radio-electronic training than any other books or courses of their type!

Ghirardi's BIG-3 RADIO SERVICING LIBRARY

These three big books contain a total of 3016 pages and 1214 illustrations covering the complete range of basic radio-electronic and service subjects:

1—RADIO PHYSICS COURSE

Complete basic training for beginners. Makes even the most difficult subjects easy to understand! 972 pages, 508 illus. Price \$5.00.

2—MODERN RADIO SERVICING

The 1300-page book that teaches you to work by truly professional methods. Explains all about test instruments, how to use them, circuit analysis, component replacements and dozens of other subjects. 1300 pages, 706 illus. Price \$5.00.

3—RADIO TROUBLESHOOTER'S HANDBOOK

The great Ghirardi book that cuts service time in half on most jobs. Tells what to do, exactly how to do it in making quick repairs on over 4800 specific radio models. 744 manual-size pages, \$5.00.

Let A. A. Ghirardi train you for Radio-Electronics—AT ABSOLUTE MINIMUM COST! Starting with the fundamentals of basic electricity, these 3 books take you step-by-step through the efficient radio testing, adjustment and repair procedures that mean time saving and more profitable work. Hundreds of working data on tubes, color codes, transformers, resistors, capacitors, record changers and other components help you solve job snags in record time.

NEW LOW PRICE . . . Easy Terms

Bought singly, the books in this fact-packed library would cost you \$15. Under this special offer, you save \$1 and also have the privilege of paying in easy monthly installments, while you use the books. No waiting for monthly lessons. You learn fast—and you learn right!

10 DAYS' MONEY BACK EXAMINATION

Dept. RN-60, MURRAY HILL BOOKS, INC.,
232 Madison Ave., New York 16, N. Y.

Send me GHIRARDI'S BIG-3 Radio-Electronics Library. I enclose \$2 as my first installment and will send you \$3 a month for four months until the total special price of only \$14 is paid. It is understood I may read the books for 10 days. Then, if not satisfactory, I will return them postage paid and you agree to refund my \$2 and cancel the remaining installments.

Name.....

Address.....

City, Zone, State.....

Occupation.....

owatt or larger dimmer may be built at moderate cost.

Thus far the operation and modifications of the current operating bridge have been discussed. By changing the circuit somewhat, a system may be derived in which a voltage null rather than a current null is produced. One of the best ways to do this is to excite the bridge circuit with an a.c. voltage. Rectification of the bridge output then produces a voltage which is always either positive or negative, depending upon the rectifier connection used, except when the bridge is balanced and zero output occurs. By amplifying the a.c. output of the

bridge for a stage or two before rectification, this system may be used to achieve very high sensitivity with stable operation. Voltage controlled operation may be obtained by using the two halves of a 6SN7 as a form of balanced modulator, with zero output occurring when the two sections of the tube are balanced.

Further interesting effects may be obtained by using a radio frequency or supersonic tone to excite the balanced modulator system. It then becomes possible to introduce a considerable amount of modification of audio signals due to nonlinearity of the circuit.

-30-

MICROWAVE QUIZ

By ED BUKSTEIN

Northwestern Vocational Institute

- As defined by the FCC, the microwave spectrum extends from (a) 3 to 30 mc. (b) 88 to 108 mc. (c) 6.28 to 1592 mc. (d) 3000 to 30,000 mc.
- A wavelength of one centimeter corresponds to a frequency of (a) 186,000 mc. (b) 3000 mc. (c) 108 mc. (d) 30,000 mc.
- The microwave spectrum is also referred to as (a) s.h.f. (b) u.h.f. (c) v.h.f.
- The klystron tube employs two sets of grids which are referred to as the (a) buncher and catcher (b) pitcher and catcher (c) catcher and returner.
- An external magnet is used in conjunction with the (a) rhumbatron (b) ignitron (c) magnetron (d) phanotron.
- Velocity modulation is employed in the (a) klystron (b) plotron (c) magnetron (d) ignitron.
- Electrons are made to follow a curved or spiral path in the (a) phanotron (b) thyatron (c) magnetron (d) ignitron.
- The repeller plate is an element of the (a) lighthouse tube (b) reflex klystron (c) cavity magnetron.
- A waveguide will pass (a) all frequencies equally (b) all frequencies above a critical value (c) all frequencies below a critical value.
- A metallic insulator is a (a) shorted quarter-wave line (b) a type of thermoplastic material (c) a microwave lens (d) a low-pass filter terminated with a resistive load.
- Fig. 1 is a photograph of a (a) klystron (b) magnetron (c) lighthouse tube.
- The term "transit time" refers to (a) the velocity of light at sea level (b) the length of time a cathode must be heated before plate voltage is applied (c) the time required for electrons to travel from cathode to plate of a tube.
- The Barkhausen-Kurz oscillator is (a) another name for the cavity magnetron (b) a type of oscillator using a diode tube (c) a type of positive grid oscillator.
- A parabolic reflector is a (a) coil placed around the neck of a cathode-ray tube (b) half-wave section of transmission line (c) metallic "dish" used in conjunction with a microwave antenna.
- Fig. 2 is a photograph of (a) reflex klystrons (b) lighthouse tubes (c) electron multiplier tubes (d) magnetrons.

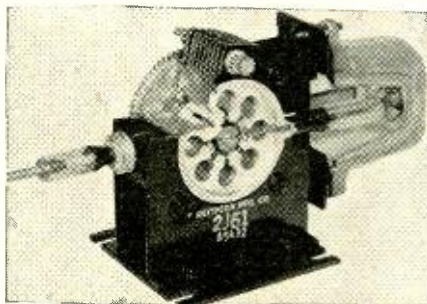

Fig. 1.

(See page 159
for answers.)

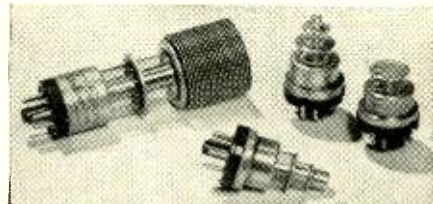

Fig. 2.

SELENIUM RECTIFIERS

— and —

ELECTRONIC COMPONENTS

SINGLE PHASE FULL WAVE BRIDGE RECTIFIERS

Input 0-18VAC Type No.	Current	Output 0-12 VDC Price
B1-250	250 MA.	\$0.98
B1-1	1 AMP.	2.49
B1-1X5	1.5 AMP.	2.95
B1-3X5	3.5 AMP.	4.50
B1-5	5 AMP.	5.95
B1-10	10 AMP.	9.95
B1-20	20 AMP.	15.95
B1-30	30 AMP.	24.95
B1-40	40 AMP.	27.95
B1-50	50 AMP.	32.95

THREE PHASE FULL WAVE BRIDGE RECTIFIERS

Input 0-234VAC Type No.	Current	Output 0-250 VDC Price
3B13-1	1 AMP.	\$ 22.00
3B13-2	2 AMP.	32.00
3B13-4	4 AMP.	56.00
3B13-6	6 AMP.	81.50
3B13-10	10 AMP.	105.00
3B13-15	15 AMP.	120.00

CENTER TAPPED RECTIFIERS SINGLE PHASE FULL WAVE

Input 10-10VAC Type No.	Current	Output 0-8 VDC Price
C1-10	10 AMP.	\$ 6.95
C1-20	20 AMP.	10.95
C1-30	30 AMP.	14.95
C1-40	40 AMP.	17.95
C1-50	50 AMP.	20.95

RECTIFIER MOUNTING BRACKETS

For Types B1 through B6, and Type C1..... \$.35 per set
For Types 3B..... 1.05 per set

Input 0-36VAC Type No.	Current	Output 0-26 VDC Price
R2-150	150 MA.	\$0.98
R2-250	250 MA.	1.25
R2-300	300 MA.	1.50
R2-2	2 AMP.	4.95
R2-3X5	3.5 AMP.	6.95
B2-5	5 AMP.	9.95
B2-10	10 AMP.	15.95
B2-20	20 AMP.	27.95
B2-30	30 AMP.	36.95
B2-40	40 AMP.	44.95

Input 0-115VAC Type No.	Current	Output 0-90 VDC Price
B6-250	250 MA.	\$2.95
B6-600	600 MA.	5.95
B6-750	750 MA.	6.95
B6-1X5	1.5 AMP.	10.95
B6-3X5	3.5 AMP.	18.95
B6-5	5 AMP.	24.95
B6-10	10 AMP.	36.95
B6-15	15 AMP.	54.95

CUSTOM DC POWER SUPPLIES

Built to your specifications
We will be pleased to quote on your requirements.
Kindly send for our specification form.

RECTIFIER CAPACITORS

CF-14	3000 MFD	12VDC	\$1.69
CF-15	6000 MFD	12VDC	2.95
CF-1	1000 MFD	15VDC	.98
CF-2	2000 MFD	15VDC	1.69
CF-20	2500 MFD	15VDC	1.95
CF-3	1000 MFD	25VDC	1.25
CF-4	2X3500 MFD	25VDC	3.45
CF-6	4000 MFD	30VDC	3.25
CF-7	3000 MFD	35VDC	3.25
CF-8	100 MFD	50VDC	.98
CF-10	500 MFD	50VDC	1.95
CF-16	2000 MFD	50VDC	3.25
CF-21	1200 MFD	60VDC	3.25
CF-9	200 MFD	150VDC	1.69
CF-13	500 MFD	200VDC	3.25

Mounting clamps for above capacitors. .15 ea.

RECTIFIER TRANSFORMERS

All Primaries 115VAC 50/60 Cycles

Type No.	Volts	Amps.	Shpg. Wt.	Price
XF15-12	15	12	7 lbs.	\$ 3.95
TXF36-2	36	2	5 lbs.	3.95
TXF36-5	36	5	8 lbs.	4.95
TXF36-10	36	10	12 lbs.	7.95
TXF36-15	36	15	20 lbs.	11.95
TXF36-20	36	20	30 lbs.	17.95
XFC18-14	18VCT	14	10 lbs.	5.95

All TXF Types are Tapped to Deliver 32, 34, 36 Volts, XFC Type is Tapped to Deliver 16, 17, 18 Volts Center Tapped.

RECTIFIER CHOKES

Type No.	Hy.	Amps.	Dc Res.	Price
HY5	.02	5	.25	\$3.25
HY5A	.028	5	.20	3.95
HY10	.02	10	.30	9.95
HY10A	.014	10	.04	7.95
HY20A	.007	20	.02	12.95

Type "A" low resistance chokes are specially suited to circuits requiring excellent voltage regulation.

ADDITIONAL SELENIUM RECTIFIER TYPES AND GENERAL INFORMATION MAY BE FOUND IN OUR CATALOG No. 719



VACUUM CAPACITORS

Standard Brands
12 Mmfd. 20 Kv \$4.95
50 Mmfd. 32 Kv 5.95
Overall length 6 1/2", diameter 2 1/4", terminal diameter 3/4", Sapp. wt. 2 lbs.

EDISON THERMO TIME DELAY RELAY

Heater voltage 115 V. Norm. open SPST contacts. 15-30 sec. delay. Contact rating 115 V. 3A., 440 V. 2A. Elze 3/4"x1 1/2" diam. Standard 4-prong tube base..... Ea. **98c**



WHILE THEY LAST METER SPECIALS

0-300 VDC, Basic 0-1 ma. 2 1/2" rd. Bakelite case. New, in original boxes. Shpg. wt. 2 lbs. Bargain price..... **\$2.25**



DIEHL MOTOR

Fan duty, brushless induction type (no TV interference) For 115 VAC 60 cycles, 46 watt, 1800 R.P.M. Shaft 3/4" diam. 1" long. Noiseless ball-bearing—heavy cast construction. Shpg. wt. 6 lbs. Brand new..... **\$4.50**

D-C PANEL METERS

Attractive, rugged, and reasonably priced. Moving vane solenoid type with accuracy within 5%. 0-6 Amperes D-C Any range \$2.49 each
0-12 Amperes D-C
0-15 Volts D-C

WESTINGHOUSE AIRCRAFT MOTOR

Brand new—24 VDC reversible. 1/50 H.P. Will also reverse and operate on AC. 4500 RPM continuous duty. Length of leads 18". Dimensions 3 1/2"x2 1/2"x 3/4" diam. by 3/4" long. Price..... **\$2.95**
Reversing switch with "off" position. Each..... 79c



AUDIO CHOKO

SM Choke Type U7402 Hermetically sealed. 50 Hys. .01 Amps DC 1780 IRMS Test Voltage 3 1/2"x3 1/2"x 3/4". Shpg. wt. 6 lbs.....\$2.25

DC POWER SUPPLY

Limited quantity—Gov't Surplus

Ready to operate. Full-wave bridge, copper-oxide rectifier, heavy-duty multi-tapped transformer. Input: 85/95/205/115 VAC 50/60 cps. Output: 2.5/24/28/32/36 VDC at 5 amperes, unfiltered.

For wall or bench mounting. Overall dimen. 9"x8 1/2"x8 1/2" high. Shpg. wt. 30 lbs. Like new. Tested and guaranteed..... **\$36.00**
Filter Kit. 2% ripple..... **\$6.65**

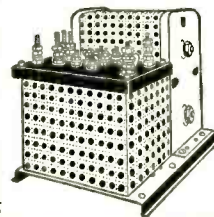

POWER SUPPLY KITS 24 to 28 VDC Filtered

Designed for continuous duty ground operation and bench testing of aircraft equipment, these kits provide a reliable means of obtaining a source of low-ripple 24 VDC, from a 115 VAC 60 cycle line. Full-wave bridge Selenium Rectifiers insure instantaneous and efficient operation. Adjustment of the DC output voltage is accomplished by transformer primary taps. Ripple is limited to within 2% of the average DC output by choke-input filters.

Kit No.	Amperes DC	Net Price
242	2.0	\$16.39
245	5.0	22.39
2410	10.0	47.44
2420	20.0	79.44

Write for descriptive Bulletin No. 201.

RECTIFIER KIT No. 612-10 6 and 12 VDC at 10 Amperes

This unit will deliver unfiltered direct current for operation of motors, dynamometers solenoids, relays and similar equipment. Employs full-wave Selenium Rectifier and heavy-duty primary tapped transformer. The two output voltages can be used simultaneously and may be adjusted between 6.7-7.5 VDC and 13-15 VDC under full load. For 115 VAC 60 cycle input. With schematic diagram and instructions. Shpg. wt., 12 lbs..... **\$15.95**

Minimum order \$3.00. No C.O.D.'s. Add 10% for Prepaid Parcel Post and Handling. Terms: Net 10 days in the presence of approved credit.

All prices subject to change without notice. Prices and delivery F.O.B. our NYC Warehouse.
All merchandise subject to prior sale.

WESTERN ELECTRIC BLOWER

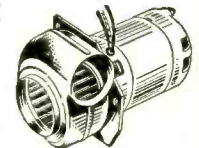

#KS5881—Brand New—Heavy-duty Sirco type blower, capacitor start, 1/4 H.P., 3400 RPM, 115 VAC, 60 cycles. Displaces 84 CFM. Extremely quiet operation. Opening 2 1/4", overall size 7 1/2" long, 6" diam. Moisture and fungus resistant. With capacitor. Shpg. wt. 15 lbs. Quantity limited..... **\$13.95**

BATTERY ELIMINATOR SIX VOLT KIT

For testing and demonstrating auto radios. Supplies 5-8 volts at 10 amperes continuous duty, 15 amperes intermittent. Step voltage control, ripple less than 3%. Power on instantly—no warm-up period required.

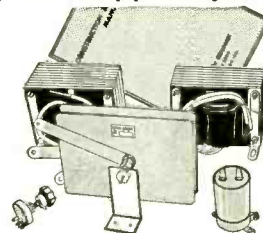

HERE'S WHAT YOU GET:

- Heavy duty Transformer. Type XFC18-14
- Rugged Selenium Rectifier. Type C1-10
- Filter Choke, Type HY10A
- Filter Condenser, Type CF-2
- Multi-position Tap Switch

A terrific value at..... **\$19.50**

OPAD-GREEN COMPANY

71-3 Warren St.
New York 7, N. Y.

Phone: BEekman 3-7385-6



...HAS NO APPRECIATION OF TONE...

It is possible to produce amplifiers that measure up to the most rigid requirements and tolerances of a "mechanical ear"... amplifiers that show perfect laboratory measurements, BUT may, despite their mechanical and technical perfection fall short of providing enjoyable "listening-quality."

When you buy a phonograph amplifier you buy one thing... listening quality. That elusive characteristic which, after all, is any amplifier's prime reason for being.

Newcomb amplifiers must not only measure up to the highest standards electrically... but in addition are subjected to critical "listening quality" tests by trained experts. That is why Newcomb amplifiers provide more real listening pleasure.



LET YOUR OWN EARS BE THE JUDGE...

Insist upon hearing a Newcomb. Compare the listening quality of Model KXLP30 from the standpoint of enjoyment with that of any other amplifier. Your ear will readily hear the pure natural quality and true character of each deep bass note. Now, listen to the clear, undistorted, brilliant, high tones with their remarkable freedom from surface noise made possible by Newcomb's exclusive MACIC RED KNOB. A comparison will convince you that Newcomb Sound is without question the closest you can get to "Live Music" quality.

Newcomb Phonograph Amplifiers from \$59.50



AUDIO PRODUCTS CO.

Dept. F, 6824 Lexington Avenue, Hollywood 38, Calif.

NEW PORTABLES for the Vacation Market

LUGGAGE-PHONO

Of special interest to the campus crowd is the "Collegiate" portable phonograph recently announced by *Steelman Phonograph & Radio Co., Inc.* of 742 E. Tremont Avenue, New York 57, N. Y.

The new portable is housed in a lightweight, rayon-satin lined traveling bag and is completely removable. When the case is used for carrying the phonograph there is enough additional room to slip in all overnight travel necessities. When the phonograph is removed the case is a separate travel bag with removable mirror and two large pockets and ample room for a travel wardrobe.

The phonograph is a complete 3-speed amplified phonograph with a tone and volume control and a deluxe tone arm. The unit is lightweight and fits easily on a table, dresser, or any other convenient spot. When not in



use it can be replaced in the case to keep it dust-free and give it the desired protection.

The case measures 8 $\frac{3}{4}$ " by 12" by 16 $\frac{1}{2}$ " and is available in cream-color simulated rawhide with contrasting dark brown genuine alligator trim.

ARVIN PORTABLE

Noblitt-Sparks Industries, Inc. of Columbus, Indiana is in production on a straight battery-operated portable which will retail in the moderate price class.

Housed in a high-styled, streamlined plastic cabinet, the new *Arvin* Model 446-P has a fluted plastic grille face over neutral-toned grille cloth. The set has semi-recessed control knobs at the top of opposite ends of the case. Numerals and legends are debossed and color filled.

The portable is powered with one 67 $\frac{1}{2}$ volt "B" battery and two "A" flashlight cells. It has a four-tube circuit with two full intermediate frequency transformers. A 3S4 tube is used for adequate volume and high

fidelity tone. The variable condenser is direct-driven by a right hand control knob and the volume control, with

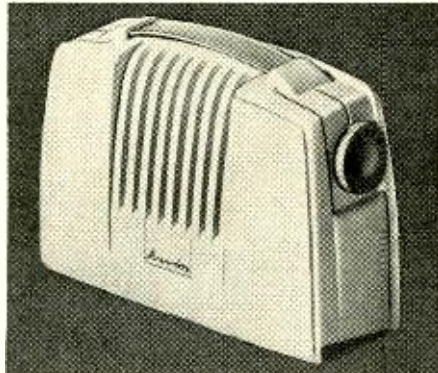

coincidental "on-off" switch, is driven by the knob at the opposite end of the case. The control knobs are milled for finger-tip operation.

The set weighs only three and one-half pounds with batteries.

AIR KING UNIT

Air King Products Co., Inc. of 170 53rd Street, Brooklyn 32, New York has rounded out its line of home receivers with a new polystyrene three-way portable which has been designated the Model A-520A.

This new portable, which is available in maroon and ivory, features a new battery complement which is said to give power and tone not usually found in a portable set of its size.

Delivery is currently under way on this model.

PERSONAL PORTABLE

A new personal portable, the Model 631, which features the novel "Magnecor" long-distance aerial, has been added to *Philco Corporation's* line of receivers.

The novel tubular built-in aerial is

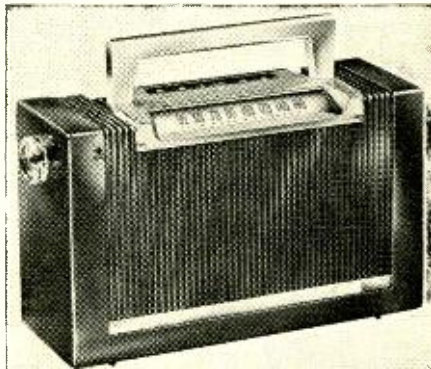

an integral part of the modern plastic cabinet in which the set is housed. It is designed to operate with a new circuit operating on a.c., d.c., or battery, to bring in distant stations with clear, noise-free tone.

RADIO & TELEVISION NEWS

FOR OUR
4th ANNIVERSARY
CELEBRATION

NIAGARA SLASHES TUBE PRICES

50% to 90%

ALL BRAND NEW — STANDARD BRANDS

1B22	3.45	6AS6	2.89	713A	1.00	5516	5.95	WL468	6.75	6AB7/1853	.78	6ST7	.88	1488	.88
1B23	8.45	6C21	24.95	714A	4.75	5562	10.00	WL522A	1.75	6AC5GT	1.16	6SV7	.88	14C5	.88
1B24	4.49	6F4	5.95	715A/B	1.18	7193	6.75	WL582A	150.00	6AC7/1852	0.76	6T7G	.97	14C7	.88
1B25A	4.95	6J4	4.95	716A	22.50	8005	4.60	WL616	85.00	6AD6	.88	6U5/G5	.64	14E6	.72
1B26	4.45	7BP1	4.95	717A	.58	8011	2.00	Z225	1.95	6AD7G	1.28	6U6GT	.72	14E7	.88
1B27	3.95	7C25	4.50	720DY	34.95	8012A	1.25	ZB120	6.95	6AF6G	.78	6U7G	.54	14F7	.88
1B29	.89	7C25	75.00	721A/B	2.60	8013A	1.25	ZB3200	150.00	6AG5	.76	6V6	.96	14F8	.88
1B32	1.95	7C25	90.00	723AB	7.95	8014A	24.95	0A2	1.56	6AG7	.97	6V6GT	.82	14H7	.88
1B38	84.50	7D4P	17.95	724A/B	2.75	8016	1.10	0A2VR75	.98	6AH6	1.28	6W7G	.88	14J7	.64
1B60	4.95	9C2Z	230.00	725A	6.75	8020	1.25	0A4G	.94	6AJ5	.78	6X4	.58	14N7	.88
1N21	.89	9GP7	15.00	728A/B/C	13.50	8025A	7.95	0B2	1.74	6AK5	.84	6X5GT	.48	14Q7	.56
1N23	1.95	9LP7	15.00	730A	9.75	8026	12.95	0B3/VR90	.64	6AK6	.78	6V6G	.66	14R7	.66
1P25	14.50	6NPI	7.95	750TL	49.50	BR	2.50	0C3/VR105	.78	6AL5	.64	6V7G	.88	14S7	1.06
IS21	3.95	10Y	.39	800	1.75	BH	4.95	0D3/VR150	.54	6AL7GT	1.06	6Z7G	1.14	14W7	1.06
2AP1	3.59	10SPEC	.69	801A	.28	C1A	4.95	0Y4	.88	6AQ5	.58	7A4/XXL	.58	14X7	.88
2B22	3.95	10BP4	22.45	802	4.25	C5B	12.95	0Z1A	.56	6AQ7GT	.88	7A5	.72	19	.97
2C4	1.18	10CP4	29.50	803	3.45	C6A	7.50	0Z1G	.56	6AR5	.66	7A6	.66	1978	1.56
2C21	.25	12BP7	12.00	804	8.50	C6J	3.75	0Z1A	.24	6AS7G	1.95	7A7	.56	22	1.28
2C22	.28	12FP7	14.95	805	3.50	CEQ72	1.95	I A3	.43	6AT6	.46	7A8	.72	21A	.66
2C26A	.18	12GP7	12.95	807	1.25	CK1005	.08	I A4	1.08	6AU6	.58	7AD7	1.06	25A6	1.06
2C34	.25	12HP7	12.95	808	1.35	CK1090	2.75	I A5GT	.48	6AV6	.46	7AF7	.72	25A8G	1.06
2C40	2.98	12KP4	49.50	809	2.50	EF50	.35	I A6	.78	6B4G	.88	7AG7	.71	25AC5GT	1.16
2C43	9.50	12LP4	25.50	810	7.75	EL30	4.35	I A6GT	.56	6B6G	1.58	7AH7	.56	25L6GT	.52
2C44	1.75	15E	1.25	811	2.00	I123A	12.50	I B3GT	1.49	6B8G	.78	7B4	.88	25Y5	1.16
2C46	7.50	20B7	15.00	812	2.50	I128A	70.00	I B4	1.18	6B7	.88	7B4	.72	25Z5	.48
2C51	6.50	23D4	.49	812H	6.90	I631A	125.00	I B5/25S	.88	6B8	.88	7B6	.58	25Z6GT	.48
2D21	1.16	24G	.35	813	6.75	I660	10.00	I B7GT	1.06	6B8G	1.28	7B7	.58	26	.56
2E22	1.25	35T	4.95	814	2.40	FG17	2.75	I C5GT	.66	6BA6	.54	7R8	.72	27	.46
2E24	4.95	45SPEC	.25	815	1.25	FG27A	8.95	I C6	.88	6BE6	.56	7C4/1203A	.36	28D7	.34
2E25A	4.25	53A	24.95	816	1.19	FG32	5.35	I C7G	.88	6BE6G	1.46	7C5	.56	30	.56
2E26	3.95	75T	3.00	826	3.45	FG32	5.35	I D5GP	.56	6B8G	.56	7C6	.72	31	.86
2C30	2.39	110FH	1.00	827	9.95	FG81A	3.75	I D7G	.88	6B8G	.56	7C7	.58	32	.96
2I21A	10.75	100TS	7.25	829A/B	9.95	FG95	9.95	I D8GT	.94	6C4	.24	7C7	.58	32	.96
2I26	6.95	101F	4.95	830	2.95	FG104	17.50	I E5GT	1.38	6C5	.46	7E5/1201	.66	32L7GT	.96
2I27	13.95	114A	.69	830B	3.25	FG105	9.50	I E7G	1.56	6C5GT	.46	7E6	.58	33	.68
2I30	19.95	114B	1.25	832/A	4.95	FG166	49.50	I F4	.74	6C6	.56	7E7	.68	34	.68
2I31	8.95	120	5.95	833A	34.25	FG172A	13.75	I F5G	.74	6C7	1.28	7E7	.68	35/51	.56
2I32	11.95	121A	2.65	834	5.50	FG190	14.95	I F6GT	1.56	6C8G	.68	7F7	.68	35A5	.66
2I33	11.95	203A	16.95	835	1.25	FG238B	160.00	I G7G	.68	6D6	.16	7F7/1232	1.06	35B5	.64
2I34	19.50	203B	1.75	837	1.50	GL146	9.75	I G4GT	.68	6D8G	.87	7G8	1.06	35L6GT	.53
2I36	75.00	205F	4.50	838	2.25	GL415	21.00	I G6GT	.68	6E5	.68	7H7	.63	35W4	.38
2I37	12.95	211	.40	841	.30	GL451	4.95	I H4G	.68	6E6	1.06	7I7	1.06	35Y4	.48
2I38	12.95	215A	.50	843	.25	GL473	65.00	I H5GT	.53	6F3	.46	7K7	1.06	35Z4	.56
2I48	24.50	217C	9.80	845 W	4.00	GL502A	65.00	I H6GT	.86	6F6	.66	7N7	.66	35Z4GT	.43
2I49	19.50	218	12.50	849A/H	69.50	GL503	49.50	I H8GT	.86	6F6GT	.46	7Q7	.58	35Z5GT	.40
2I50	29.50	219	1.75	850	25.00	GL559	5.35	I J6GT	.88	6F7	.84	7R7	.68	36	.39
2I55	21.50	227A	2.65	860	5.75	GL697	65.00	I L4	.54	6F7G	.86	7S7	1.06	37	.34
2I54B	24.95	231D	1.20	861	35.00	HF100	3.95	I LA6	.88	6G6G	.88	7V7	.79	38	.27
2I61	24.50	239C	1.75	864	.35	HF200	17.95	I LB4	.88	6G8G	.88	7W7	.88	39/44	.26
2K23	24.95	250R	7.00	865	1.95	HF300	17.95	I LB5	.88	6H6	.46	7X7/XXFM	.88	41	.51
2K25	24.95	250TH	19.50	866A	1.25	HF400	17.95	I L8	.56	6H6GT	.46	7Y4	.56	42	.48
2K28	24.95	252A	4.95	866R	1.19	HK254	19.95	I L5	.78	6I5	.48	7Z4	.56	43	.48
3AP1	4.75	259A	4.95	870A	1.30	HV18	12.95	I L3	.88	6I5GT	.78	10	.69	45	.51
3B22	2.50	274	1.00	874	.35	HY69	2.75	I L6	.88	6J9	.66	12A	.56	45Z3	.56
3B23	4.95	275A	7.95	876	.28	HY615	2.75	I L4H	.64	6J7GT	.66	12A6	.18	45Z5GT	.48
3B24	1.98	282A/B	9.95	878	1.75	HY1269	2.75	I L5	.66	6J8GT	1.28	12A7	.18	47	.68
3B24W	2.95	283A	10.95	881	1.49	HY1148	2.75	I N5GT	.58	6K5GT	.96	12A7G	.96	49	.88
3B25	4.80	286A	10.95	885	.98	KU23	15.00	I O5GT	.66	6K6GT	.54	12A7GT	.84	50	1.56
3B26	1.50	287A	9.95	891	110.00	KU23	15.00	I R5	.68	6K7	.48	12A7S	.80	50A5	.68
3B27	1.95	290A	4.95	902PI	2.75	KU610	15.00	I S4	.78	6K7GT	.48	12A7G	.84	50B5	.54
3B28	5.95	291A	4.95	905	1.00	ML101	75.00	IS4	.78	6K8	.78	12A7G	1.16	50L6GT	.54
3BP1	2.50	294A	4.50	922	.75	MX408U	.49	IS5	.56	6K8GT	.78	12A7G	.66	50Y6GT	.56
3C23	2.25	301A	6.95	923	1.40	R100	3.75	IS4	.56	6L5G	1.06	12A7G	.78	51	.86
3C24	.35	304B	5.95	925	2.60	R200	1.75	IT4	.78	6L6	1.16	12BA6	.56	53	.43
3C30	3.50	304TH	3.50	931A	69.50	R130	1.95	IT5GT	.78	6L6GT	.86	12BA6G	.48	57	.37
3C31	3.50	307TL	1.30	919A	9.50	REL36	2.50	I U5	.72	6L8A	.86	12CB6	.48	58	.48
3C35	12.80	307A	4.95	954	.30	RK12	2.50	I U5	.68	6L7	.78	12CF5GT	.57	59	.88
3CP1	4.40	310A	7.95	955	.35	RK19	1.50	2A3	.96	6L7G	1.16	12D5GT	.26	71A	.66
3D1A	1.10	310A	6.95	956	.35	RK20A	7.50	2A4G	1.06	6N7	.78	12D7G	.80	75	.52
3EPI	2.50	316A	.50	957	.19	RK21	1.25	2A5	.88	6N7GT	.78	12K7GT	.53	77	.42
3E29	7.95	327A	2.50	958A	.18	RK22	4.95	2A6	.78	6Q6G	1.06	12K8	.58	78	.44
3FP7	1.75	331A	14.50	958B	.35	RK25	4.95	2A7	.88	6Q7	.58	12K8GT	.66	79	.88
3GP1	4.95	338A	3.75	958A	2.95	RK28A	3.95	2V3G	.98	6Q7GT	.58	12K8GT	.48	80	.38
3HP7	3.50	348A	5.95	975A	14.95	RK31	2.50	2X2A	.68	6R7	.78	12SA7	.56	81	1.28
3IP7	7.95	350A/B	2.75	991	.23	RK32	3.95	3A4	.36	6R7GT	.78	12SA7GT	.56	82	.86
4-65A	14.50	354C/D	19.95	1603	3.50	RK33	.25	3A5	1.98	6S7	.88	12SC7	.56	83	.71
4-125A	27.50	357B	49.50	1611	1.25	RK34	.25	3A8GT	1.98	6S7G	1.06	12SF5	.56	83V	.85
4-250A	37.50	371A/B	.50	1612	1.50	RK39	1.75	3V4	.80	6S8GT	.88	12SF5GT	.56	84/624	.62
4A1	4.90	374A	2.50	1613	.45	RK47	3.95	3V4	.80	6SA7	.43	12SF7GT	.56	85	.68
4A10	4.90	374A	2.50	1614	1.35	RK48A	3.95	3V4	.80	6SB7Y	.88	12SG7	.56	89	.38
4B25	7.90	393A	3.50	1614	.15	RK51	3.95	3Q4	.58	6SC7	.68	12SH7	.54	89Y	.38
4C21	.69	394A	3.50	1616	.50	RK52	4.50	3Q5GT	.66	6SD7GT	.68	12S7	.48	117L7GT	1.28
4C35	19.45	399A	2.50	1619	.49	RK59	1.75	3S4	.66	6SF5	.48	12S7GT	.48	117M7GT	1.56
4D22	1.00	400A	3.25	1620	4.95	RK60	.79	3S4	.66	6SF5GT	.48	12S7GT	.48	117N7GT	1.36
4D22	9.95	401A	1.95	1621	.98	RK63	12.95	5A74	.50	6SH7	.58	12SK7	.56	117P7GT	1.26
4Q32	4.95	403A/B	1.75	1622	1.75	RK65	24.95	5IPI	24.50	6SG7	.58	12SK7GT	.56	117Z4GT	1.16
4E27	12.50	417A	9.50	1624	.35	RK72	.65	5R4GY	1.09	6SH7GT	.58	12SN7GT	.51	117Z	

GET ON THE BEAM

with

TELE-TURNER®

OFFERING YOU THE PERFORMANCE OF AN ELECTRIC ROTOR AT ONLY A FRACTION OF ITS COST

SIMPLE, FOOLPROOF, MECHANICALLY OPERATED

- Precision Antenna Alignment
- Clear, Sharp Pictures—Pin-Point Reception
- Year-'round, Trouble-Free Operation
- Inside Control with Direction Indicator
- Ball-Bearing Equipped
- Antenna Positions Positively Locked
- Easy Installation
- Tele-Turner Is Backed by the Shaw Guarantee

MAXIMUM TELEVISION RECEPTION **\$14⁹⁵**
MINIMUM COST RETAIL

COMPLETE WITH DIRECTIONAL INDICATOR, INSIDE MANUAL CONTROL AND ALL NECESSARY HARDWARE



JOSEPH SHAW COMPANY

6225 BENORE ROAD

TOLEDO 12, OHIO

Acrosound



QUALITY OUTPUT TRANSFORMERS

The outstanding performance of these units is demonstrated in the characteristics of the famous WILLIAMSON circuit using the TO-290 (12,000 ohms for optimum match with triode 807's). In this rigorous usage, intermodulation distortion is less than 1% at 10 watts output; frequency response FLAT from 7 cps to 70 kc. All ACROSOUND transformers conform to the following high standards:

- Response \pm 1 db 10 cps to 40 kc
- Full power from 20 cps to 20 kc
- Low phase shift permitting over 30 db of stable feedback
- Superior transient response measured by 20 kc square wave

	12.5 WATTS	
TO-240	4,000 ohms	@\$8.75 net
TO-250	5,000 ohms	@\$8.75 net
TO-260	6,000 ohms	@\$8.75 net
TO-270	10,000 ohms	@\$8.75 net

	20 WATTS	
TO-280	9,000 ohms	@\$10.75 net
TO-290	12,000 ohms	@\$13.25 net

Also available fully potted in seamless steel case with silver grey hammerstone finish at \$2.00 extra. All units have pushpull primaries and 4, 8 and 16 ohm secondaries

Descriptive literature, suggested circuitry, and performance data on Williamson circuit available on request.

Prices F.O.B., Phila.
*Pat. Pending

25% deposit
with C.O.D.'s

ACRO PRODUCTS COMPANY

5328-30 Baltimore Ave. Philadelphia 43, Pa.

PREMAX

New Low-Cost

Marine Antenna

FOR 2 AND 3 MC.

Premax Series "B" Center Loaded Marine Radiators will increase effective power 5 times over that radiated by straight whips. 2' base section, 18" coil and 72" whip—9½' overall. Will resonate at center of 2-3 Mc. band. Comes with heavy ceramic insulator Mountings, complete.



Type SL

Write for special bulletin and amazingly low prices!

Type V

PREMAX PRODUCTS

DIVISION CHISHOLM-RYDER CO., INC.

5006 Highland Ave., Niagara Falls, N. Y.

The portable has four tubes plus a selenium rectifier. The functionally-styled plastic cabinet, with concealed "Magnecor" aerial and recessed handle, is available in teal green, maroon, Caribbean blue, and Swedish red. The set measures 5 7/8" x 9 1/4" x 3 1/2".

G.E. DELUXE

One of the new receivers to be added to General Electric Company's line of portables is the Model 650 deluxe.

This set is an a.c.-d.c. and battery operated unit which is housed in a



maroon cabinet. The sensitivity of this model is increased by the addition of a tuned r.f. stage. Special attention has been given to the circuit design in order to provide good performance in remote locations.

The set is being manufactured by the company's Receiver Division at Syracuse, New York.

THREE-BAND PORTABLE

Of interest to the traveler is the new three-band portable receiver just released by DeWald Radio Manufacturing Corp. of 35-15 37th Avenue, Long Island City 1, New York.

Known as the D-508 luxury portable, the new unit covers from 18-62 meters, 62-125 meters, and 190-560 meters, providing for standard broadcast and two short-wave band coverage.



The set operates on either batteries or 110 and 220 volt power lines.

The portable, which measures 9 9/16" x 12 1/2" x 5 3/16", is housed in a leatherette, non-breakable case.

3-SPEED PHONOGRAPH

Tone Products Corporation, 225 West 17th Street, New York, New York has released a three-speed port-

RADIO & TELEVISION NEWS

able phonograph unit as one of an extensive line of such instruments.

Known as the Model 148, the new unit is housed in an alligator luggage-type case with saddle-stitched top. The unit plays all sizes of records up to and including 12" discs. The phonograph will handle all three speeds of records, 33½, 45, and 78 r.p.m. and employs a single, all-purpose long-life needle. The unit has a super-powered



5" Alnico speaker, full range tone control, constant speed motor, featherweight tone arm, and no shock hazard.

-50-

Ham TV Station

(Continued from page 57)

annoying high-frequency noise bands running across the picture horizontally. Care should be taken to select as non-microphonic a tube as possible for this stage. The 10 to 60 μ fd. variable high peaker condenser C₁ adjusts the "tails" or streaking "ghosts" which would follow objects if there were no frequency compensation. Proper adjustment of this control will result in elimination of smears in the picture, at the same time providing the requisite sharpness of detail.

The video phase splitter V₂ has such low plate and cathode loads that their resistance, compared to the shunt effect of the capacity, makes the effect of shunt capacity negligible for these frequencies. Therefore, no peaking coils are needed to maintain good video response.

The 33 ohm resistors in all the grids are to prevent parasitic oscillations.

Many circuit simplifications are possible over those shown. For example, blanking can be directly injected into the video amplifier through decoupling resistors instead of through a coupling diode. Also, it is not necessary to use blocking oscillator transformers; multivibrator saw-tooth generators will perform equally well. Other types of horizontal and vertical output systems can be used. An r.f. type power supply can be used in place of the flyback method of securing high voltage.

Many variations are also possible in the types of tubes used in the equipment. The video amplifier tube types are not necessarily limited to the 6AK5. The 6AU6, 6SG7 or 6AC7 can be used, as well as other similar tubes

CLEARANCE SALE

DRASTIC PRICE REDUCTIONS ON DOZENS OF SHORT-LOT AND OVERSTOCK ITEMS!

These are real values . . . prices are absolute rock-bottom!

FL-8 FILTER
AND
"FILTER FACTS" BOOKLET

BRAND NEW
Both for
98c

TUBES . . .

316A, (WE)	\$.049 ea., 4 for	\$1.80
815	1.15 ea., 4 for	3.95
826	.39 ea., 4 for	1.40
829	1.35 ea., 4 for	5.00
807		4 for 3.95
615, (HY)	.29 ea., 4 for	1.00
114B, (HY)	.29 ea., 4 for	1.00
388A, (WE)	.49 ea., 4 for	1.80
708A, (WE)	.39 ea., 4 for	1.40
8012	.75 ea., 4 for	2.80
532	.39 ea., 4 for	1.40
211		2 for .90
836		2 for 1.10
5MP1	1.25 ea., 4 for	4.40
20-4 Reg. tube	.15 ea.	
3FP7	1.25 ea., 4 for	4.40
3DP1A	2.50 ea.	
805		2 for 6.50
2X2	.39 ea.	
5U4	.39 ea.	
5Z3	.35 ea.	
6AC7	.39 ea.	
6K7GT	.30 ea.	
6SN7GT	.45 ea.	
6L6 Metal	.90 ea., 4 for	3.40
6L6G	.79 ea., 4 for	3.00

TRANSFORMERS-CHOKES:

2.5V, 10A. Heavy-duty, 15kv insulation. Suitable for 866, 836, etc. Only a few. Reg. \$4.95 reduced to **\$2.95 ea.**
5H, 400ma chokes. Fully shielded, drawn steel case. Made by Chicago Transf. Reg. \$4.95, reduced to **\$2.95 ea.**
10H, 50 ma choke. Strap mounting. Handy for dozens of applications. Reg. 98c, reduced to **65c ea.**

CAPACITORS:

1 mfd, 6000V, oil. GE Pyranol. . . . only **\$2.00 ea.**

MICROPHONES:

Aircraft-type, push-to-talk mike. Button on top. NEW. A real buy! Were \$1.15 ea. now reduced to **59c**

RCA Hand Mike. Hi-grade, single button. Bronze colored w/cord and plug. NEW. Were \$1.98 now reduced to **98c ea.**

CODE PRACTICE EQUIPMENT:

Code practice sets. (See former ads.) NEW, original boxes. Formerly \$49.50, now **\$16.95 ea.**
McElroy Tape Pullers. Variable speed, 115 V motor. Excellent condition, like new. Now motor. . . . only **\$5.95 ea.**

TELEPHONE EQUIPMENT:

EE89 Repeaters. (See previous ads.) Only a few left. NEW. Regularly \$9.95 ea. now **\$6.95 ea.**
EE8 Field Telephones. Used, good condition. Tested before shipment. Rg. \$18.95 pr. Reduced to **\$10.95 per pair.**

RM-29A Telephones. BRAND NEW. With TS-13 handsets. Formerly sold at \$25.95 pr. . . . now only **\$17.50 per pair.**
Used handsets. Reg. \$2.95 ea. now **\$1.85 ea.**

CRYSTAL SETS:

A real treat for the kids, old-fashioned crystal sets. Made by Philmore. Large model, reduced to **79c.** Small model, reduced to **59c.**
HS-16 tones, fine for above sets. . . . **\$1.35 ea.**
R89/ARN 5A RECEIVERS. See March Radio-Electronics for converting to FM set. Brand new, orig. boxes. Now only **\$10.95 ea.**



NEW! HIGH-GAIN Impedance-matching PRE-RF STAGE

Now available, a pre-RF stage of advanced design. Designed to take full advantage of the superior W-E717A tube. Provides a tremendous signal boost to any receiver. Variable input and output circuits, highest stability achieved by excellent shielding and by disc-type, silver-button mica by-passes. Input designed to match 52 ohm co-ax—better signal-to-noise ratio, maximum effectiveness of your antenna! Output couples to any receiver. Available for either 10 or 20 meter band. Please specify desired band. Aluminum chassis, air, variable tuning capacitors, finest parts. In kit form, cinch to assemble and wire. Punched chassis, all parts and W-E717A tube. (Similar to 6AK5.) Only. . . . **\$5.95**

FONE PATCH!

Now available, the superior new O-R. \pm 6008 phone patch. Provides you with exactly what you need to patch your phone into transmitter or receiver. Featuring a hi-impedance input suitable for X₁ mike. Both hi and lo impedance outputs to insure proper match to your particular receiver. Unit is complete—"sure-fire" ready to go to work for you. Only. . . . **\$3.95 ea.**



RU-16 RECEIVERS

With conversion sheet.

With 3 coils, used, **\$ 4.95**

good condition. Only

NEW, with 5 coils and plug. Only. . . . **16.95**



AN-75-D WHIP ANTENNA

A great buy for you mobile men. 7'3" collapsible to 14". Has 9 sections—corrosion-proof brass. Sturdy bakelite mount with jiffy wing-nut fastener. These sold formerly at \$2.50 ea. Now, BRAND NEW, only. . . . **\$1.25 ea.**



ALUMINUM CHASSIS

A beautiful little drawn, .025" aluminum chassis, 5¼" long, 3¼" wide, 1⅞" deep. Bright-dipped finish. Use for RF stages, TV filters, amplifiers, etc. Only 49c ea.; 3 for. . . . **\$1.35**

CONDENSER TESTER

• One of our best sellers! Useful, versatile laboratory item, in kit form. Simple and easy to build in less than an hour. Checks condenser leakage and continuity up to 8 megs. Will test any paper, electrolytic, mica or oil capacitor from 50 mmf. to 50 mfd. Self-contained power supply and neon bulb indicator with socket and bezel. Drilled metal cabinet. Complete instructions and diagrams included with each kit. Only **\$4.85.**

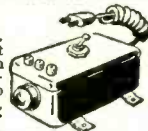

Just arrived . . . limited quantity SMALL PRECISION LATHE—110-V. AC

Now with Larger Motor
\$44.50

A small lathe for radio shops, jewelers, laboratories, dentists, hobby-crafters, model makers, machine shops, schools, etc. Automatic Feed. Work capacity 3" between centers. Swing over bed 2". Constructed of steel and cast iron. Accurately machined and finished. Fan-Cooled Motor mounted inside the base. Complete with 1¼" face plate, 2 lathe centers, tool post and rocker, one lathe dog, one tool-bit and test rod.

COMPLETE ACCESSORY KIT

including 4-jaw chuck, drill chuck, center counter-sink drill, 2 tool-bits, 2 lathe dogs, 1 face plate with 8 drilled and tapped holes, 4 collets, 1 collet chuck, 1 Allen wrench. . . . **\$24.50**

MINIMUM ORDER \$2.00. ALL ITEMS SUBJECT TO PRIOR SALE.
ALL PRICES SUBJECT TO CHANGE WITHOUT NOTICE.

★ 4-HOUR MAIL-ORDER SERVICE. WE SHIP ANYWHERE.
20% DEPOSIT MUST ACCOMPANY ALL ORDERS, BALANCE C.O.D.

OFFENBACH & REIMUS CO.

372 ELLIS ST. SAN FRANCISCO, CALIF.

PHONE—ORdway 3-8551

The BROOK All Triode High Quality AUDIO AMPLIFIERS

bring into your home

MUSIC AS IT IS PLAYED

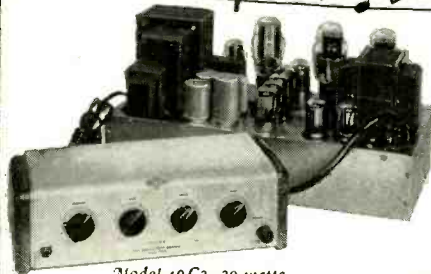

Model 10 C3—30 watts.



Model 12A3—10 watts

Write Today for FREE Booklet,
"BETTER LISTENING"
Technical Bulletin and
detailed Distortion Analysis.

- The full volume of a symphony in your home with all its brilliance.. or reduced to a whisper.. still keeping its natural tone.
- Extreme low volume without loss of quality.
- Reduction of listening fatigue.
- Distortion and intermodulation at a new low.
- Separate controls stepped for bass and treble.

BROOK ELECTRONICS, Inc.

Dept. RF-0 • 34 DeHart Place • Elizabeth, N. J.

WHY PAY MORE!

Save on Surplus Buys

BC-929 INDICATOR SCOPE

Wonderful deal for a cheap test scope. Contains 8 tubes: 1—3BP1, 2—6SN7, 2—6H6, 1—6G6, 1—2X2, and 6X5. Full instructions for use with light bulb. Can be used for over-modulation meter. **\$14.95**

BC-906 FREQUENCY METER

A real laboratory instrument at a fraction of original cost. Can be modified for many other uses. Absorption-type. Range a prox. 150-225 MC. Power requirements: 2 batteries, 1.5V and 45V. Uses precision friction-type vernier dial for frequency variation. Black wrinkle-finish metal cabinet with door. Complete with tubes and frequency charts! Good used condition. **\$14.95**

BC-1206 RCVR. Beacon Revr. 200 to 400 KC. 28V plate and filament. Easily converted to broadcast band by adjusting of slug and tuned coils. A cheap Q-5cr. Used. Each **\$3.95**

BC-457 TRANSMITTER

Tunes 4-5.3 MC. In good used condition. With tubes and crystals. **\$3.95**

BC-221 FREQUENCY METER

Don't pass this up! They're all reconditioned and guaranteed in perfect operating condition. Crystal-calibrated in all ranges: 125-250 KC and 2000-4000 KC. These frequency meters are just the thing for use as signal generators and VFO. Remember, they've been electrically and physically inspected. Limited quantity—so hurry and order yours today—now! Complete with tubes, crystal and calibration book. Cases may be scratched, but meters are electrically perfect. **\$49.50**

WESTON MODEL 426 AC VOLTMETER
0-130 volts, AC. 3". Bakelite case. **\$3.95**
boxed, Brand new.

DEJUR DC MILLIAMMETER
0-1000 MA. 3". Brand new, **\$2.95**
boxed.

ORDER DIRECT FROM THIS AD!

Cash with order. 25% deposit on all C.O.D. orders. All orders shipped by truck or railroad express collect. Prices subject to change. All merchandise subject to prior sale.

ALVARADIO SUPPLY CO.

Dept. A-4, 341 S. Vermont
Los Angeles 5, Cal.
DUnkirk 8-2211

NOW... quickly, easily
cut SQUARE and
OBLONG openings
in radio chassis



WITH THE GREENLEE No. 731
SQUARE RADIO CHASSIS PUNCH

Now, in 1½ minutes or less you can do hole-cutting jobs that might take an hour with old "drilling and filing" methods. Simply insert GREENLEE Punch and turn with an ordinary wrench... a square or oblong opening is cut immediately. An indispensable, timesaving tool that pays for itself in a hurry.



In sizes ⅝", ¾" and 1"



Write today for facts and prices on this handy Punch. Greenlee Tool Co., 1886 Columbia Ave., Rockford, Ill.

having a high figure of merit, which is the ratio of transconductance divided by the input plus output capacities, or:

$$g_m / (C_{input} + C_{output})$$

Of course suitable screen voltage, bias voltage, plate load, and peaking coils will have to be substituted for the present ones if different tubes than shown are used. However, 6AG5's, 6AU6's and 6BH6's can be substituted for one another or for the 6AK5's in the present circuit with very little difference in performance.

Similar considerations apply to tube choice for the video phase splitter, taking care that the plate dissipation and the bias and plate voltages are within the tube ratings if other tubes are used.

In the sweep chassis, type 6SN7, 6N7, or pairs of 6C5's may be used instead of the 12AU7, and instead of the 6BG6G tubes, 807's or type 1625's with a different filament supply can be used.

Blanking Generator

The blanking generator and FM sound subcarrier circuits are constructed on a single chassis, as shown in Figs. 6, 7, and 8. Adjustment details on the FM generator will be described later.

While the composite signal from the television station has blanking pulses inherent in it, it is not generally possible to use these pulses in the same manner as the sync, because the amount of "setup" (or difference in amplitude between the black portions of the signal and the blacker-than-black portions used for blanking) is very small and it is difficult to separate this difference. If RMA received picture blanking were used, it is possible that instead of having a pure white flying spot raster there will be some darker portions in it due to scenes having intense blacks in them getting separated along with the blanking information. To avoid this, the blanking is derived from the return traces of the sweeps. Since the blanking obtained in this way is not as wide as in the standard RMA sync, brighter lines at one side of a received amateur picture may be noticed. This does not affect the resolution or quality of the picture. The bright lines may be minimized by proper masking of the raster and picture.

The blanking for the horizontal is obtained from the secondary of the horizontal output transformer where it has the proper polarity and width to blank the end-of-line return of the flying spot. Similarly the vertical blanking is obtained from the output of the vertical output transformer. These blanking signals have much greater amplitude than is needed and are fed to a blanking generator which serves to isolate the blanking signals from the sweep generators and at the same time eliminate amplitude variations in the low-impedance blanking output. The circuit uses a combined cathode follower and clipper.

RADIO & TELEVISION NEWS

AMERICAN'S SENSATIONAL AM-FM TUNER VALUE!

DESIGNED AND BUILT BY FAMOUS MANUFACTURER FOR USE WITH ALL TV CHASSIS

Famous Brand but because of price we agreed not to disclose the name. You will recognize it! With 5 band switch for On-Off-TV-AM-FM-Phono Control. Designed for use with standard TV chassis and any amplifier. Complete with dial-hardware-dual knobs—complete hookup instructions—schematics.

Compact for installation with TV. Chassis size —8½" W 10"L 4½"H.

- 4 tube complement
- 1 12AT7 converter
- 2 6BA6 IF Amplifiers
- 1 6T8 FM Disc.-AM Det.
- 2 Dual controls for tuning-tone-volume-switching
- 4 Gang AM-FM Tuning Condenser

PERFORMANCE
 AM-535KC-1650 KC.
 FM-87.5 Mc-108.5 MC.

FM SENSITIVITY
 UV FOR
 FREQ. MC 30DB S/N

90	50
98	40
108	40

Image Ratio
 13X
 10X
 8X

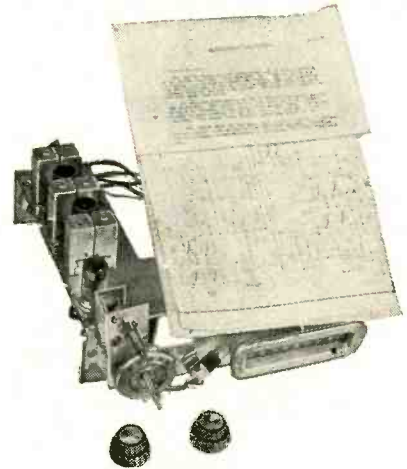

Selectivity 2X 170-250 KC
 6 IF s 3 for AM 3 for FM
 Truly a fine tuner.

WHILE THEY LAST only \$24.95

COMPLETE WITH TUBES—LIMITED QUANTITIES

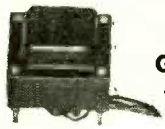

TRANSFORMERS GE—STANCOR—PHILCO —LIMITED QUANTITIES AT THESE PRICES



POWER

50 MA. PRI. 115V. sec. 600 VCT 6.3V 3 Amp. 5V. 2.5 Amp.	\$1.95 each
80 MA. PRI. 115V. sec. 700 VCT 6.3V 3 Amp. 5V. 2.5 Amp.	2.35 each
100 MA. PRI. 115V. sec. 600 VCT 6.3V 3 Amp. 5V. 2.5 Amp.	2.95 each
150 MA. PRI. 115V. sec. 700 VCT 6.3V. 4 Amp. 5V. 3 Amp.	3.95 each
150 MA. PRI. 105-120V. sec. 700 VCT 6.3V. 5A6.33A 5V. 3A.	4.95 each
50 MA. PRI. 110-120V. sec. 600 VCT 6.3V. 3 Amp.	2.25 each
60 MA. PRI. 110-220V. sec. 600 VCT 6.3V. 3 Amp.	2.75 each
50 MA. PRI. 110-260V. with Switch sec. 600VCT 6.3V. 3 Amp.	3.25 each
125 MA. PRI. 110V. sec. 750V. 6.3V. 5 Amp. 5V 3 Amp.	3.50 each
200 MA. PRI. 115V. sec. 750 VCT 6.3V. 5 Amp. 5V. 3 Amp.	4.50 each

VIBRATOR POWER

50 MA. PRI. 6V. Vibrator sec. 600V.	\$1.75 each
70 MA. PRI. 6V. Vibrator sec. 600V.	1.95 each

CHOKES

60 MA. 300 ohm 10HY.	45c	50 MA. 100 ohm 20HY AC-DC.	35c
80 MA. 150 ohm 10HY.	75c	20 MA. 2000 ohm 50HY Plate.	35c
185 MA. 60 ohm 4HY.	95c		

SPECIAL PHONO SCRATCH FILTERS 29c

OUTPUT TRANSFORMERS

2500 ohms 50L6.	\$0.39	8000 ohms 3Q5.	\$0.49
5000 ohms 6V8.	.49	PP 1000 ohms 6V6.	.69

SPECIAL FILAMENT AND ISOLATION TRANSFORMER

PRI. 115 Volts sec. 120V. and 6.3V. 3 Amps.	\$1.45 each
---	-------------

FAMOUS BRAND ELECTROLYTIC CONDENSERS

Tubulars—Aluminum tubulars—Papers—FP
 You will recognize these expensive condensers. Stock up while they are still available.

TUBULARS

15 MFD 150 Volts.	\$0.19
20 MFD 150 Volts.	.19
30 MFD 150 Volts.	.25
40 MFD 150 Volts.	.30
20x20 150 Volts.	.27
30x30 150 Volts.	.32
40x40 150 Volts.	.35
50x30 150 Volts.	.35
10 MFD 25 Volts.	.15
25 MFD 10 Volts.	.15
100 MFD 25 Volts.	.25
250 MFD 15 Volts.	.35
1000 MFD 25 Volts.	.45
3000 MFD 10 Volts.	.45
10 MFD 450 Volts.	.25
20 MFD 450 Volts.	.35
30 MFD 450 Volts.	.45
40 MFD 450 Volts.	.50
10x10 MFD 450 Volts.	.45
20x20 450 Volts.	.55

Multi-Section FP Aluminum Cans

30x20 MFD	10x10 MFD
150V	450V
30x20x20 MFD	20x10 MFD
150V	450V x 25V
20x20x20 MFD	30x30 MFD
150V	450V
40x40x30 MFD	20x20x20
150V	450V x 25V
50x50x15x20	10x10x20
150V 25V	450V 25V
30x30 MFD	40x40 MFD
250V	450V
80x10 MFD	10x10x10 MFD
350V	450V
15x10x20 MFD	16x16x16 MFD
400V 25V	450V
10x10 MFD	16x16 MFD
400V	450V
20x20 MFD	30x20x10 MFD
400V	450V x 150V
25x10 MFD	40x30x30 MFD
400V	450V
20x10x20 MFD	60x50 MFD
400V 350V X 25V	450V x 50V
30x10x5 MFD	30x10 MFD
300V	475V
	40x35x10 MFD
	475V

Single FP Aluminum Cans

150 Volt	450 Volt
10 MFD..15c	8 MFD..25c
20 MFD..20c	10 MFD..28c
40 MFD..30c	15 MFD..30c
80 MFD..45c	20 MFD..35c
	30 MFD..40c
	40 MFD..45c
	80 MFD..50c

Your Choice 35c each

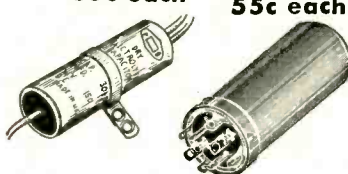

Your Choice 55c each

SPEAKER SPECIALS

FAMOUS BRANDS

GE-MAGNAVOX-CAPEHART-JENSEN

Square 4" PM Alnico V 1 oz.	
Magnet	\$1.00 each
Round 5" PM Alnico V 1 oz.	
Magnet	1.05 each
Round 6" PM Alnico V 1.47 oz.	
Magnet	1.45 each
Pin Cushion 6" PM Alnico V 3.16 oz.	
Magnet	1.95 each
Pin Cushion 8" PM Alnico V 2.16 oz.	
Magnet	2.45 each
Round 8" PM Alnico V 3.16 oz.	
Magnet	2.75 each
Round 10" PM Alnico V 4.16 oz.	
Magnet	3.75 each
Round 12" PM Alnico V 4.16 oz.	
Magnet	4.25 each
Round 12" PM Alnico V 6.8 oz.	
Magnet	4.75 each

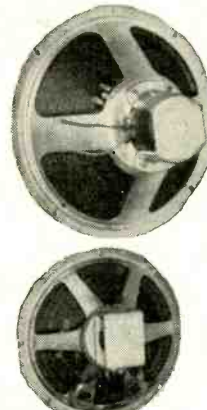

ELECTRO DYNAMIC SPECIALS

4" 500 ohm field.	\$1.50 each
4"x6" 85 ohm field (TV).	1.95 each
4"x6" 500-800 ohm field.	1.95 each
5" 450 ohm field.	1.75 each
5" 1000 ohm field.	1.75 each
6" 450 ohm field.	1.95 each
6"x9" 1000 ohm field.	2.25 each
8" Speakers Your Choice	\$2.25 ea.
60 ohm (TV) 675 ohm 750 ohm	
900 ohm 1000 ohm 1300 ohm	
1800 ohm fields.	
10" Speakers Your Choice	\$2.95 ea.
1000 ohm 1800 ohm fields.	

12" Speakers Your Choice
 While They Last!... \$3.95

FOR TV

85 ohm 160 ohm 250 ohm
 425 ohm 600 ohm 650 ohm
 1000 ohm 1800 ohm 2700
 ohm fields.

ALL SPEAKERS
 BRAND NEW
 AND GUARANTEED

Minimum order shipped \$5.00. Remit 20% deposit with all orders. Balance COD FOB New York. Remit in full and save COD charges

AMERICAN RADIO SUPPLY CO.

417 LAFAYETTE ST.

NEW YORK 3, N.Y.

TYPE "DP" SERIES for Rack & Panel

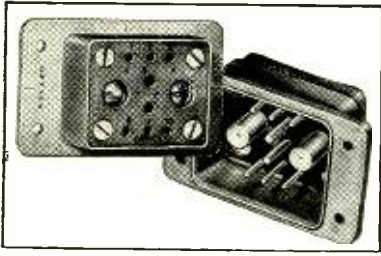

Type DPB—Pin and Socket

CONNECTORS

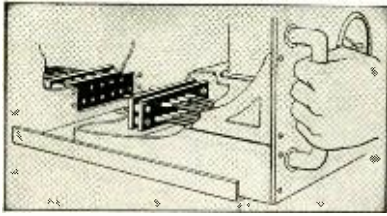

Type
DPD with
Socket
Insert



Type
DPD with
Pin Insert



DPB with twinax
contact on program
monitor for radio.

LANGEVIN CO. PHOTO

This type series of Cannon Electric Connectors contains a wide range and many variations of rack and panel connectors for radio equipment, quick-disconnect and instrument applications. For engineering data, write for DP Bulletin; brief data are included in the C48 Catalog.

Cannon Electric also manufactures signal equipment for hospitals, industrial plants, schools, institutions and many other electrical specialties such as conduit fittings, D. C. Solenoids, fire alarm relays, cable terminals, indicator, pathway and pilot lights, etc., etc.

Address Cannon Electric Development Co., Division of Cannon Manufacturing Corporation, 3209 Humboldt Street, Los Angeles 31, Calif. Canadian offices and plant: Toronto, Ontario. World export: Frazar & Hansen, San Francisco.

SINCE 1913

CANNON ELECTRIC

www.cannon.com

It will probably be necessary to adjust the amplitude of the blanking fed to the blanking inserter. This is not shown on the diagram but the amplitude may be readily adjusted by tapping down on the load resistor used to feed the blanking voltage output. The level of blanking delivered to the CRT grid of the flying spot scanner is not critical since it does not matter how far negative the grid goes, but should be at least 40 volts peak-to-peak. If insufficient vertical blanking voltage is present then slanted return trace lines will become visible and also a "ghost" on the left of each portion of picture will be seen if there is insufficient horizontal blanking.

Blanking Inserter and Clipper

The blanking inserter and clipper is a part of the modulator chassis and is shown in Figs. 9, 10, and 11. The proper polarity of video signal (black-positive) is fed into the grid circuit of the left hand section of the 12AU7. A 1N34 germanium crystal is used as a d.c. restorer. Input from the blanking generator is fed to the plate circuit of this section. Since the video signal is now black-negative after being amplified by the left hand section of the tube, the negative blanking pulses added to the video signal are superimposed on the black side of the video, making a blacker-than-black voltage. The combined video and blanking sig-

nal is now fed into a cathode-follower output stage (the right hand section of the 12AU7), which is also arranged to clip the tops of the blanking pulses.

The purpose of the clipper is to have an undisturbed flat voltage plateau in the blacker-than-black region of the video signal upon which to superimpose the sync information.

The construction of the blanking inserter and clipper is straightforward. The only adjustments required will be the level setting of the blanking input voltage and the level at which the combined video and blanking-signal output is clipped. Clipping control can be obtained by returning the 2.2-megohm resistor at pin 7 to the center arm of a 50,000 ohm potentiometer which is connected between ground and a 30-volt negative source, or derived by a voltage divider from -300 v.

At the clipper output a full video signal capable of giving a picture directly is available. If the same sync as was used on the flying spot scanner is used to sync the sweeps of another CRT (a monitor tube), a duplicate picture of that appearing on the transparency will be obtained. The mixer for video and sound, and the modulator are also built on this same chassis.

How the sync and sound are added to the video signal, how it is modulated, sent out over the air, and received, will be described in next month's article. (To be continued)

R & TV NEWS EDITOR ADDRESSES SAPPHIRE CLUB

THE Sapphire Club of Hollywood, California, whose membership is made up of some of the outstanding authorities in the field of audio engineering, recently celebrated its Fourth Anniversary at a dinner meeting held in Hollywood.

In addition to an impressive turnout of charter members, a representative group of guests from the radio, television, and motion picture industries attended the anniversary event.

The principal speaker of the evening, and guest of honor, was Dr. Oliver Read, Editor of RADIO & TELEVISION NEWS, who delivered a talk on the trials and tribulations confronting the editors and publishers of technical magazines. He encouraged members of the Sapphire Club, as individual au-

thorities and engineers, to submit technical articles to magazines because, by so doing, they can offer valuable assistance to their profession.

A technical talk on color television was the high point of his address. The members' interest in the subject was evidenced by the lengthy general discussion and their participation in the question and answer quiz conducted by Dr. Read upon completion of his principal address.

Dr. H. M. Tremaine, vice-president and director of education of the University of Hollywood, acted as chairman of the evening's program as well as of the Fourth Anniversary celebration. Art Partridge of Radio Recorders is the chapter secretary.

-30-

Fourth Anniversary Dinner of the Sapphire Club of Hollywood. Standing at the speakers' table, from left to right, are: Art Partridge, chapter secretary; Oliver Read, editor of RADIO & TELEVISION NEWS; Dr. H. M. Tremaine, vice-president of the University of Hollywood; and Ben M. Klekner, president of the University of Hollywood.



RADIO & TELEVISION NEWS

OUTSTANDING VALUES NOW AVAILABLE

- AMPLIFIERS
- COILS
- INVERTERS
- METERS
- RESISTORS
- TEST EQUIPMENT
- AN CONNECTORS
- CORDS
- JACKS
- MOTORS
- SELSYNS
- CABLE
- CRYSTALS
- KLYSTRONS
- POTENTIOMETERS
- SCOPE ACCES.
- CAPACITORS
- DELAY LINES
- KNOBS
- POWER PLANTS
- SHOCK MOUNTS
- CHOKES
- FILTERS
- MAGNETRONS
- POWER SUPPLIES
- SOCKETS
- CIRCUIT-BREAKERS
- FUSES
- MAGNETS
- PROJECTION LAMPS
- SWITCHES
- COAX-CONNECTORS
- HANDSETS
- MICROPHONES
- RECORDERS
- TELEPHONE EQUIP.
- WIRE

RADIO HAM SHACK broadcasts its sincere thanks to all its old friends and a hearty welcome to new ones.

TO OUR OLD FRIENDS, it is not news that RADIO HAM SHACK is the house of value. They know that our mass purchasing policy of vast quantities of surplus equipment and the maintenance of one of the largest stocks of radio tubes and electronic components in the United States enables us to offer them **LOW, LOW** prices that are difficult to beat anywhere in the world.

TO THE NEW FRIENDS we should like to meet, we extend our services and facilities to bring them the best of equipment at the lowest prices. Deal with us in confidence, secure in the knowledge that our tubes, components and equipment are of standard manufacture, rigidly inspected and securely packed to insure that only first **QUALITY, BRAND NEW MERCHANDISE** reaches you.

Send for our monthly value packed flyer. Your requirements for immediate quotation will receive a prompt reply.

REMINDER—RADIO HAM SHACK is a BIG BUYER of tubes, components and equipment. Submit your surplus stock inventory to us for fast action. No lot too large—none too small.

WIRE! WRITE! today for latest prices. **SPECIAL DISCOUNTS** for large quantity purchases.

OVERSEAS BROADCAST!! WE SHIP ALL OVER THE WORLD!! SPECIAL HANDLING BY OUR EXPORT DIVISION INSURES SWIFT, CHEAP DELIVERIES TO ALL DESTINATIONS. CORRESPONDENCE IN ALL LANGUAGES. CABLE ADDRESS: HAMSHACK—NEW YORK.

TUBES!! BRAND NEW! STANDARD BRANDS! NO SECONDS! COMPARE! TUBES!!

0A3/VR75	\$1.05	3C22	\$39.50	227A/5C27	\$2.69	815	\$1.59	9004	\$2.24	0A4G	\$.89	5Z4	\$.77	6SN6GT	\$.97	12SR7	\$.49
0B3/VR90	.65	3C23	3.75	299A	1.49	816	.99	9005	1.35	0B2	1.67	6A3	.92	6SN7GT	.54	12Z3	.69
0C3/VR105	.48	3C24/24G	.35	250R	.95	826	.39	9006	.15	02A	.57	6A4LA	1.09	6S07	.45	14A4	.79
0D3/VR150	.48	3C30/809	1.89	250TH	18.95	828	10.95	C1JA	9.95	01A	.39	6A6	.79	6SR7GT	.52	14A7	.52
1B21/GL471A	2.87	3C31/C1B	2.98	250TL	18.95	829	.745	C5B	6.95	1A3	4.45	6A7	.69	6S57	.49	14B6	.67
1B22	2.87	3C45	12.95	274B	2.69	830B	3.19	830B	7.95	1A4	1.09	6A8	.75	6S77	.72	14F7	.69
1B23	8.75	3CP1	1.39	293A	2.98	832A	4.89	C6J	3.25	1A4	.49	6A9	.79	6SUTGT	1.25	14F8	.79
1B24	4.59	3DP1	2.79	294A	2.95	833A	33.95	C100D	.98	1A5GT	.49	6AC7	.74	6S7V	.79	14H7	.59
1B26	2.79	3DP1-S2A	2.79	300B	9.95	836A	1.97	CK502AX	2.25	1A6	.79	6AD7G	1.09	67G	.89	14J7	.87
1B27	7.95	3D21A	.98	304TH	3.49	E37	1.19	CK503AX	1.95	1A7GT	.69	6AF6G	.79	6U5G	.65	14N7	.85
1B29	.79	3EP1	2.59	304TL	1.29	838	1.98	CK505AX	2.25	1A85	.57	6AG5	.69	6U6GT	.63	14Q7	.53
1B32	1.89	3E29	8.95	305A	24.95	841	.29	CK506AX	1.95	1B3/8016	1.15	6AG7	.98	6U7G	.89	14R7	.67
1B36	3.95	3FP7	.97	307A	3.69	843	.29	CK507AX	1.95	1B4	1.19	6U7G	.98	6U8	.89	14A4	.69
1B38	36.50	3GP1	5.95	310A	.29	845	4.25	CK512AX	2.25	1B5/25S	.89	6A85	1.29	6V6GT	.57	24A7	.49
1D21	.35	3HP7	3.95	327A/6C37	12.95	851	12.95	CK571AX	8.45	1C5GT	.59	6AK5	.85	6W4	.63	25L6GT	.53
1N21	.49	4-65A	14.21	331A	1.95	860	14.95	CK1005	.09	1C6	.89	6AK6	.79	6W7G	.77	25Z5	.44
1N21A	.89	4-125A	26.05	350A	1.98	861	9.95	CK1006	.85	1C7G	.99	8A15	.59	6X4	.57	25Z6GT	.43
1N21B	1.39	4-250A	36.25	350B	1.39	864	.29	CK1007	.89	1D5GP	.87	6AQ5	.49	6X5GT	.47	26	.42
1N22	.98	4AP10	1.98	368A/S	4.98	865	.79	EF148	.29	1D7G	.89	6AG6	.59	6Y6	.57	27	.42
1N23	.79	4B22	9.98	371B	.47	866A	1.05	EF50	.39	1D8GT	.95	6AG7	.52	6C7G	.98	28D7	.35
1N23A	.79	4B24	1.98	388A	.47	866JR	1.05	F123A	7.95	1F4	.75	6AT6	.44	6Z5G	.59	30	.37
1N23B	1.89	4B25	7.95	393A	3.69	868B	26.50	F127A	15.95	1F5G	.75	6AU6	.59	7A4 XXL	.49	31	.59
1N27	1.29	4B26	4.49	394A	3.69	872A	1.12	F128A	69.50	1G4GT	.69	6AV6	.47	7A6	.59	32	.85
1N34	.82	4B28	2.47	417A	9.95	874	.39	F606	37.50	1G6GT	.65	6B4G	.89	7A7	.53	32L7GT	.89
1P23	2.49	4B32	9.95	446A	1.25	876	.29	F660	49.50	1E7G	.65	6B6G	.79	7AG7	.72	33	.69
1P24	.59	4C35	19.38	446B	1.79	878	1.98	F68A	397.50	1H6G	.89	6B8	.87	7B4	.75	34	.77
1P36	2.85	4D22	19.95	450A	1.19	884	.59	F617	6.95	1H8GT	.54	6B8G	.69	7B5	.67	35A1	.57
1S21	3.95	4E25	9.95	450TL	44.50	885	1.19	F627A	6.95	1H6GT	.54	6BA6	.55	7B6	.56	35A5	.63
2AP1	3.89	4E27/257B	12.45	527	5.95	902	3.39	FG32	4.95	1J6G	.75	6BE6	.52	7B7	.59	35B5	.55
2C21/RK33	.24	5AP1	2.95	559	.98	905	2.49	FG33	7.95	1J4	.48	6BF6	.57	7C4	.34	35C5	.59
2C22/7193	.15	5AP2A	2.95	575A	11.95	908	4.95	FG57	12.95	1L4A	.79	6BG6	1.47	7C5	.49	35L5	.52
2C26A	.15	5BP1	2.29	631P1	3.75	918	1.49	FG81A	3.25	1L6A	.69	6BH6	.59	7C7	.59	35W4	.49
2C34/RK34	.22	5BP2	1.95	631P2	1.89	919	1.95	FG105A	8.95	1L8A	.89	6B16	.57	7E5	.67	35Y4	.49
2C39	17.95	5CP1	1.29	700B	19.95	923	.29	FG172	13.95	1LC5	.69	6C4	.19	7E6	.54	35Z3	.57
2C40	4.95	5CP7	2.95	700C	19.95	927	1.25	FG190	12.95	1LC6	.79	6C5	.47	7E7	.62	35Z4	.44
2C43	7.95	5D21	24.45	701D	19.95	930	.98	GL146	9.95	1LD5	.79	6C6	.57	7F7	.59	35Z5	.39
2C44	.98	5FP7	1.19	701A	3.55	931A	2.98	GL434A	2.69	1LE3	.69	6C6G	.69	7H7	.59	36	.67
2C46	6.95	5GP1	2.98	702A	2.69	954	.16	GL671A	2.85	1L6G	.79	6D6	.74	7K7	.89	37	.52
2C51	5.95	5J12	39.50	704A	1.89	955	.25	GL562	89.50	1LH4	.79	6D8G	.79	7L7	.69	38	.37
2D21	9.95	5J22	39.50	704A	1.49	956	.25	GL697	69.50	1LN5	.67	6E5	.69	7N7	.67	39/44	.27
2D29	1.39	5J24	39.50	705A	.69	957	.22	HF100	6.95	1NSGT	.59	6F5	.47	7Q7	.59	41	.49
2E22	1.19	5J23	12.95	706B	18.95	958	.22	HF125A	14.95	1PSGT	.67	6F6	.57	7R7	.69	42	.49
2E26	3.39	5J29	12.95	706CY	18.75	959	.35	HF200	14.95	1Q5GT	.67	6F6GT	.57	7T7	.79	43	.49
2E30	2.39	5J30	47.50	706FY	47.50	991/NE16	.24	HF300	17.45	1R4	.59	6F7A	.69	7W7	.79	44	.52
2J21A	7.95	5LP1	12.95	707A	47.50	1613	.49	HY114B	.69	1R5	.59	6F8G	.87	7X7	.79	45Z3	.57
2J22	7.95	5MP1	9.95	707B	14.95	1614	1.35	HY115	.59	1S4	.59	6G6G	.69	7Y4	.47	45Z5	.55
2J26	6.95	5NP1	4.98	708A	3.59	1616	.49	HY615	.19	1S5	.49	6H6	.39	7Z4	.57	46	.62
2J27	12.75	6C21	19.69	713A	.79	1619	.17	KU610	6.95	1T4	.53	6H6GT	.69	12A	.57	47	.69
2J30	49.50	6F4	5.59	714AY	3.59	1624	.67	KU627	6.95	1T5GT	.69	6J5	.47	12B	.17	48	.85
2J31	8.49	6J4	4.49	715A	5.49	1626	.25	KC4/WL100	37.50	1V	.57	6J5GT	.39	12A7	.89	50	1.39
2J32	12.95	7BP7	9.95	715B	6.59	1626	.25	ML101	49.50	1V	.57	6J6	.77	12A8GT	.49	50A5	.69
2J33	18.75	9GP7	6.95	715C	19.95	1629	.19	MX408U	.39	2A3	.87	6J7	.67	12AH7GT	.80	50B5	.59
2J34	18.95	9IP1	6.95	717A	.49	1630	.49	REL21	.98	2A4G	1.07	6J7GT	.65	12AT6	.44	50L6GT	.52
2J36	97.50	9LP1	19.95	721A	1.98	1631	.98	RK59	1.69	2A5	.68	6K5GT	.79	12AT7	.79	50Y6	.57
2J37	12.95	9LP7	1.98	723A/B	12.95	1632	.69	RK60	.42	2A6	.79	6K6GT	.44	12A06	.57	53	.87
2J38	11.95	10BPA	19.69	724A/B	2.95	1633	.79	RK65	24.50	2A7	.79	6K7	.49	12A07	.67	56	.45
2J39	19.95	10Y	7.25A	6.45	1634	.98	RK72	.59	2V3G	.69	6K8	.79	12AV6	.54	57	.45	
2J40	24.50	12DP7	14.95	726A	6.75	1635	1.09	RK73	.59	2X2	.37	6L5GT	.79	12BA6	.55	58	.49
2J46	49.50	12GP7	12.75	726B	29.50	1636	1.98	RX21	2.39	2X2A	.65	6L6	1.05	12BE6	.49	59	.89
2J48	12.75	12HP7	13.95	726C	49.50	1638	.65	RX120	8.95	3A4	.34	6L6G	.99	12C8	.34	70L7	.99
2J49	39.50	12LP4	24.95	730A	9.95	1644	.98	V70D	7.35	3A5	.79	6L6GA	.79	12F5GT	.58	71A	.59
2J50	22.50	15E	1.19	750TL	69.50	1654	2.45	VCR138	5.95	3S4	.34	6L7	1.59	12H6	.27	75	.53
2J54B	22.50	15R	69.50	800A	1.49	1665	1.10	VRS3	1.19	3B7/1291	.29	6L7G	.87	12J5GT	.34	76	.44
2J55	16.49A	16AP4	49.50	801A	.19	1851	.69	VR78	.29	3D6/1299	.29	6N7	.75	12J7GT	.67	77	.43
2I61	34.50	19T8	.29	802	4.19	1960	.89	VT127A	2.19	3LF4	.79	6Q7	.64	12K7GT	.52	78	.44
2I62	34.50	23D4	.29	803	2.95	205											

LS/BFP (LARGE SAVINGS) —BUY from PEAK

BARGAIN OF THE MONTH
Filter Choke GHY @ 400 MA, 97 Ohms.
Hermetically Sealed. Size 3 1/2 x 4 1/2 x 5 1/2.
Wt. 10 Lbs. **ONLY \$3.95**

PANEL METERS—NEW SURPLUS

2" 0-200 microamp	3.95	2" 0-20 volts DC	1.89
2" 0-1 ma Basic	2.95	2" 0-30 volts DC	2.50
2" 0-5 ma Basic	1.89	2" 0-300 volts AC	2.95
2" 0-10 ma	1.89	3" 0-1 amp DC	3.95
2" 0-20 ma Basic	1.89	3" 0-2 amp DC	3.95
2" 0-25 ma Basic	1.89	3" 0-1 ma Basic	3.95
2" 0-50 ma Basic	1.89	3" 0-2 ma	3.95
2" 0-250 ma AC	2.95	3" 0-20 ma	3.50
2" 0-1 amp RF	1.89	3" 0-80 ma	2.95
2" 0-2 amp RF	1.89	3" 0-200 ma	3.95
2" 0-4 amp RF	1.89	3" 0-75 amps AC	2.95
2" 0-30 amps DC	1.89	3" 0-500 Volts AC	3.95



SENSITIVE RELAY

SPDT breaks at 3 ma; delicately pivoted. Housed in dust-proof aluminum shield, plugs into standard 5-prong socket. Approx. 2000 ohms DC.

Only 99c ea. 3 for \$2.75

JUNE SPECIALS

.001 600 VDC Pigtail Micas	15 for \$.99
.004 1000 VDC Pigtail Micas	12 for .99
250 mfd Midget Variable, Steatite Ins.	2 for .88
1/2 meg Potentiometers	23 ea. 5 for .95
50,000 ohm 1% WW Prec. Resist.	6 for .95
6 Henry 50 ma Filter Chokes	4 for .95
.07 1000 VDC Xmitting Mica	3 for .99
.02 600 VDC Xmitting Mica	6 for .99
.001 600 VDC Xmitting Mica	10 for .99
3/3 mfd 600 VDC Oil Condenser	ea. .49
6 mfd 1000 VDC Oil Condenser	ea. .99
.1 mfd 7500 VDC Oil Condenser	ea. .88
.35 mfd at 16 KV plus .7 mfd 8 KV	ea. 3.95
1 x 1 x 1 mfd 1200 VDC Oil Cond.	ea. .49
100 ohm 100 Watt Adjustable Resistor	ea. .39
500 ohm 50 Watt Adjustable Resistor	ea. .29
5 or 50 ohm 25 Watt Adjustable Resistor	ea. .19
.02 400 Volt Tubulars	20 for .99
10 K or 15 K pots	19 ea. 6 for .99
.0005 mfd Pigtail Silver Micas	10 for .95
.006 mfd 600 VDC Pigtail Micas	12 for .99
.01 mfd 600 VDC Pigtail Micas	10 for .99
2 mfd 250 VAC GE Oil Cond	6 for .99
Miniature Headphones Type HS30	ea. .89
Transformers for above	ea. .39

FILAMENT TRANSFORMER

6.3V, 12 amps Pri, 110 Volts 60 Cy. W. x 2 7/8" W x 2 1/2" D. Wt. 3 1/2 lbs. Fully shielded as illustrated. Worth \$4.50—While They Last. **Only \$1.69 ea.**



HIGH CURRENT TRANSF. 820 Volts CT at 775 Ma. Pri. 110/220 Volts 60 cycles. Fully Cased. \$5.95

RELAY SPECIALS

Advance Antenna Relay 110V 60 Cy Coil Ceram. Insulation DPDT	ea. \$1.89
Allen Bradley Solenoid, 110V 60 Cy Coil	ea. 2.95
DPST, 25 amp contacts	ea. 2.95
GE "PHC" Instantaneous overload relay act.	ea. 7.50
100-200 Ma DC, reset 110V 60 Cy. 4PDT	ea. 1.99
GE overload relay, 640 Ma DC, easily adjustable, elect. reset 110V 60 Cy. Only—ea.	1.99

UTC type PA 5000 ohm plate to 500 ohm line and 5 ohm v.c., 10 watt, 60 to 10,000 cps. \$1.99

FILAMENT TRANSFORMERS

110 V 60 Cy Pri. Fully Cased.	
2.5 Volt 10 Amp	\$3.49
2.5 Volt CT 21 Amp	4.75
5 Volt 4a, 6.3V, 5A	2.45
2.5V CT 20A, 2.5V CT 20A	6.95

OIL CONDENSERS

42 mfd 440 vac—\$6.95	10 mfd 2000 vdc—\$6.95
2 mfd 600 vdc—3.99	2 mfd 4000 vdc—4.95
4 mfd 600 vdc—5.99	1 mfd 6000 vdc—4.50
6 mfd 600 vdc—7.99	.1/.1 mfd 7000 vdc—2.25
8x8 mfd 600 vdc—1.39	1 mfd 7000 vdc—5.95
10 mfd 600 vdc—89	.01/.01 mfd 12 kv dc—5.75
4 mfd 1000 vdc—95	.005/.01 mfd 12kv dc—5.50
2 mfd 1500 vdc—1.25	.65 mfd, 12,500 vdc—12.95
4 mfd 1500 vdc—2.25	2 mfd 18 kv dc—39.50
6 mfd 1500 vdc—2.95	1 mfd 18 kv dc—15.95
1 mfd 2000 vdc—1.45	
2 mfd 2000 vdc—2.25	
8 mfd 2000 vdc—5.95	

CHOKE BARGAINS

6 Henry 80 ma 220 ohms	2 for \$0.99
8 Henry 150 ma 140 ohms	ea. .99
1.5 Henry 250 ma 72 ohms	ea. .59
Swing. 1.6/12 Hy 1 Amp/100 ma 15 ohm	ea. 19.95

SCOPE TRANSFORMERS

Pri 110V 60 Cy—Hermetically Sealed	
1050V RMS @ 20 Ma. 20V 4.5A, 2.5V 5A	\$4.75
4400V RMS 4.5 Ma., 5V 3A, 15Kv Ins	4.95

GENERAL PURPOSE TRANSFORMERS

Ideal for Bias, Filament, Isolation, Stepdown, etc. 2 isolated 110v pr. sec. 110v at 900 ma plus 6.3 @ 2 amps. Fully cased Now \$1.49 ea.

30 WATT WOUND RESISTORS

OHMS	100-150-2500-3k-4k-4500-5300-
10k-15k-18k	15 ea. 8 for \$0.99

PEAK ELECTRONICS CO.
188 Washington St. MR
New York 7, N. Y.

Shock Mounting Of Vacuum Tubes Can Be Simple Yet Effective

By
ROBERT E. PROUTY



Fig. 1. An "exploded" view of the shock mounting assembly.

Details for constructing a relatively simple, yet mechanically rugged, vacuum tube shock mounting.

IN THIS day of tape recorders and other electronic equipment having high gain input circuits, the problem of shock mounting the input stage becomes quite a problem for manufacturer and home builder alike. Shock mounts invariably seem to develop into complex mechanisms involving springs, counter springs, and what nots. Adequate shock mounting can be relatively simple, yet mechanically rugged. Furthermore, quite effective shock mounts can be manufactured at home, both easily and inexpensively.

Because of its simplicity of design, ease of construction, and satisfactory application to vacuum tube shock mounting problems, the shock mount to be described is believed adequate for most applications.

It might be noted at this point that a shock mount can be no better than the flexibility of the connecting lead wires associated with the terminal pins on the shock mounted socket. Additional flexibility can be incorporated into the leads by spiral winding them, as illustrated.

Although adaptable to any standard size tube socket, the dimensions given in the text are for a standard 7-pin shielded miniature socket.

Figs. 4 and 5 show both front and back views of the shock mount as it is installed on the chassis. The particular application illustrated required the input tube to be mounted horizontally rather than in the conventional upright position.

Fig. 1 shows an "exploded" view of the

Fig. 2. Details for constructing a shock mount for a 7-pin shielded miniature tube socket.

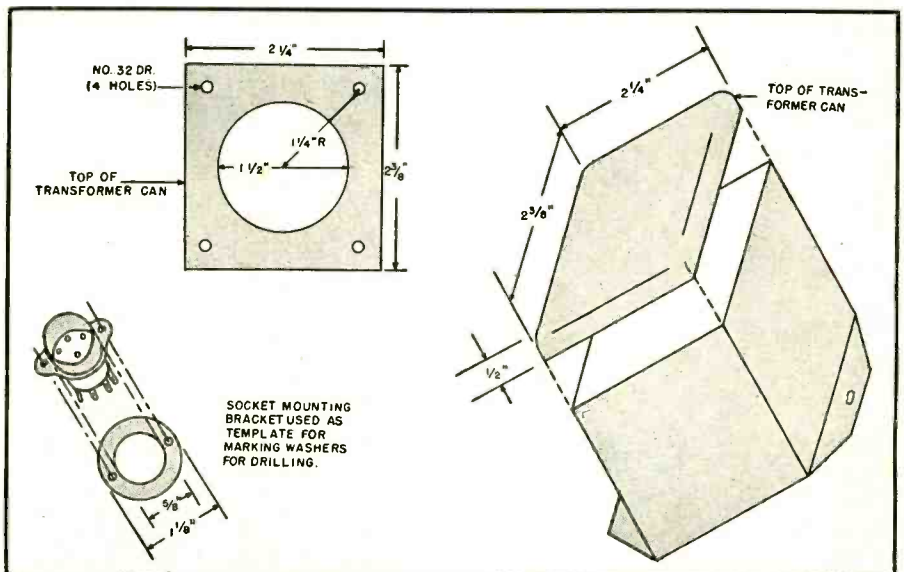

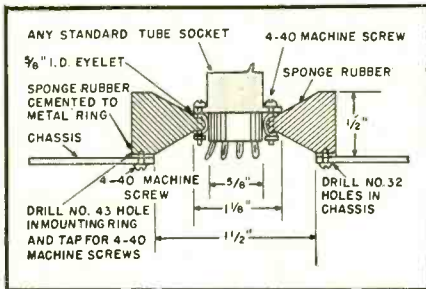

Fig. 3. An elaborated version of the shock mount which provides a "commercial" touch.

assembly. Note that the tube shield can be used as is, or weighted by wrapping with solder, depending upon requirements.

Fig. 2 shows construction layout detail for the shock mount. The cover plate is made by sawing off the top of a standard $2\frac{3}{8} \times 2\frac{1}{4}$ " transformer can. A pencil line is drawn around the sides of the can $\frac{1}{2}$ " down from the top. (If a transformer can is not available, any round or square can lid of appropriate size can be employed, since the cover plate is effectively the mounting bracket.) Establish dead center on the top of the cover plate and cut a $1\frac{1}{2}$ " hole. (A $1\frac{1}{2}$ " socket punch is recommended for this and the $1\frac{1}{2}$ " chassis hole.) Measuring approximately $\frac{3}{8}$ " in from each corner toward center, mark and drill a No. 32 hole.

Use the completed cover plate as a template for marking the chassis, and cut, or drill, matching holes in the chassis.

Next, cut out a section of $\frac{1}{2}$ " sponge rubber to fit snugly inside the cover plate. (The stiffness of the sponge rubber chosen has a very marked effect on the behavior of the shock mount. It should be just stiff enough to support the tube and shield can in an upright position for best results.) With the sponge rubber snugly fitted into the cover plate, again use the cover plate as a template for marking the sponge rubber for cutting. Using an appropriate cork punch, cut a $\frac{5}{8}$ " hole in the center of the inscribed $1\frac{1}{2}$ " circle on the sponge rubber. Be careful that the cork punch does not creep to one side and result in a slanting hole. A satisfactory punch can be made from a 3" or 4" section of thin-walled $\frac{5}{8}$ " o.d. brass tubing. File the edge flat, and sharpen by sanding or

Fig. 4. Top view of shock mounted tube shown in position on equipment chassis.



NEW WORKSHOP

DUBL-VEE

TV ANTENNA

Outstanding ALL-CHANNEL Performance

THE "end-fire" DUBL-VEE sets a new standard in TV antenna performance. Higher gain, sharper directivity, and closer match assure superlative reception — clearer, steadier, sharper pictures. In fact, a single DUBL-VEE actually outperforms double-stacked models of most other types. Rugged — easy to assemble — economically priced. Your best buy at any price.

Clearer Pictures—higher gain brings in stronger signal — especially on higher channels

Clearer Pictures — narrow beam cuts down multi-path ghosts

Clearer Pictures—better impedance match on all channels maintains high signal strength

Clearer Pictures — true horizontal polarization—no out-of-phase ghosts

Clearer Pictures—no parasitic elements — all driven

Clearer Pictures—designed by the pioneers in the antenna industry

MODEL VV

Write for Bulletin A

THE WORKSHOP ASSOCIATES, Inc.

133 CRESCENT ROAD,
NEEDHAM 94, MASS.

\$10.95 LIST

Model 2VV Double-Stack \$21.95 List

Specialists in High Frequency Antennas

100,000 FACTS at Your Finger Tips in this Latest, Complete TV MANUAL

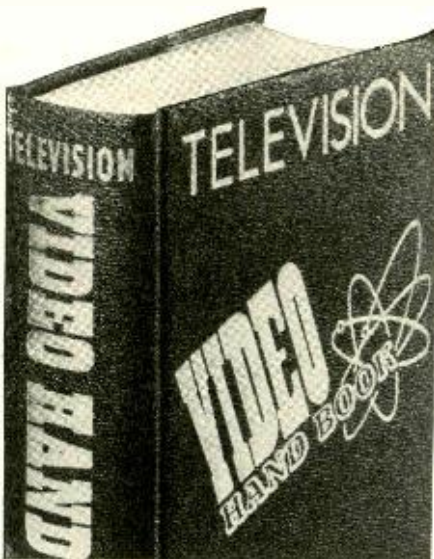

OVER 900 PAGES—860 ILLUSTRATIONS
REALLY 14 BOOKS IN ONE—The a-b-c of TV. Complete, authoritative. Covers every phase of television from basic through advanced data and techniques. Gives you the answers and procedures in *quick, easy-to-understand, practical form*. Photographs, charts, diagrams, schematics. *Invaluable daily reference* for engineers, technicians, executives, students, or anyone in television. *Saves you time and work*. Helps you get ahead and increase your earnings. Handsomely bound in DuPont Fabrikoid. Order this best-seller now!
 Only **\$5.00**



RADIO DATA BOOK

Over 900 pages—fully illustrated. All data and basic knowledge in radio and electronics digested into 12 sections, in a complete, quick-to-find, easy-to-read handbook!
 Only **\$5.00**



COMPLETE RADIO AND TV LIBRARY

SAVE MONEY by ordering both the Radio and Video Handbooks in attractive slip case. Gives you a complete library for only **\$9**

Get them at Your Dealer or
MAIL ORDER-COUPON NOW

BOYCE-ROCHE BOOK CO.
 MONTCLAIR, NEW JERSEY

RTV6

Please send the following, postpaid:

- VIDEO HANDBOOK @ \$5.00
- RADIO DATA BOOK @ \$5.00
- RADIO & VIDEO LIBRARY @ \$9.00
- Check or M. O. enclosed for \$.....
- Send C.O.D.

Name.....

Address.....

City..... Zone..... State.....

filing the sides down until a sharp edge is obtained.

The inside diameter of the two washers used is $\frac{5}{8}$ ". The outside diameter (o.d.) is approximately $1\frac{1}{2}$ ". Use the socket mounting bracket holes as a template for marking the corresponding holes in each washer.

To assemble the shock mount, first place one washer in position on the base of the tube socket. Install two $\frac{1}{2}$ " 4-40 machine screws and insert the socket base through the mounting hole in the sponge rubber. Place the second washer in the same manner as the first, and press firmly down until the mounting screws extend far enough through the bottom washer to allow lock washers and nuts to be attached. Tighten the screws until the bottom washer is flush with the base of the tube. (See illustration.) Place the cover plate over the tube side of the socket, insert four $\frac{3}{8}$ " 4-40 machine screws and secure in position.

To those who wish to add a "commercial" look to their product, the following is suggested: Cut a $1\frac{1}{4}$ " diameter section of sponge rubber, and

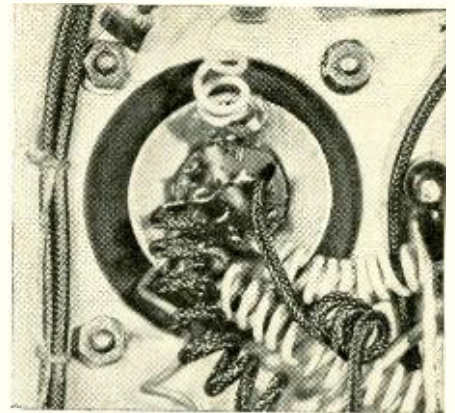

Fig. 5. Bottom view of shock mount assembly.

a $\frac{5}{8}$ " hole in its center. Drill 3 or 4 equally spaced holes in a $1\frac{1}{2} \times 1\frac{1}{4}$ " metal ring (No. 43 drill) and tap for 4-40 machine screws. Insert and affix a $\frac{5}{8}$ " i.d. metal grommet (eyelet) in the $\frac{5}{8}$ " hole in the sponge rubber and drill holes for mounting the socket. Cement the sponge rubber to the mounting ring. (See Fig. 3.)

-30-

SIMPLE DESK STAND LETS MIKE RIDE ON RUBBER

By ARTHUR TRAUFFER

THUMPS, bumps, and vibrations won't spoil your public address reproduction or ham ragchews if you build this simple and economical desk stand that lets your mike float on rubber. Since most microphones are very microphonic, especially when high audio gain is used, you will soon appreciate the fact that the rubber mount is capable of absorbing much of the mechanical shock which would otherwise shock-excite the microphone element.

Construction is very simple and is clearly shown in the photograph and diagram of Fig. 1. It shouldn't cost over 50 or 60 cents to build this unit although it is certainly worth more. A Lord mount of the type shown (these can still be purchased as war

surplus) is mounted onto the center of a round hardwood base by means of four round-head wood screws. Give the base and the Lord mount assembly a coat of enamel to match the microphone head and enhance the "professional" appearance of the unit.

A five-inch length of $\frac{3}{8}$ -inch diameter plastic, metal, or hardwood rod is reduced on one end to fit into the metal sleeve in the center of the Lord mount, and the other end is reduced to fit into the male half of a microphone connector from which the spring has been removed. These mike connectors have standard $\frac{1}{8}$ -27 threads which fit the threaded sockets in all microphone heads. A felt disc can be glued to the bottom of the wood base to protect polished desk tops.

-30-

Fig. 1.

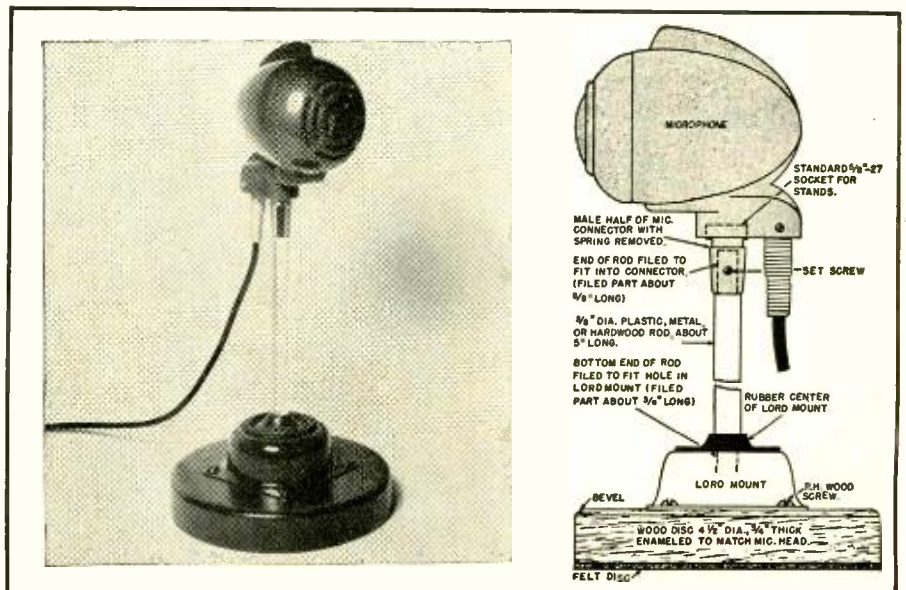

RADIOMEN'S HEADQUARTERS * WORLD WIDE MAIL ORDER SERVICE!!

TWIN COAXIAL CABLE at a Sensational Price

Two No. 12 stranded conductors within a copper shielded, vinyl jacketed, polyethylene core. Can handle over 5 KW. of R.F. power. The ideal TV lead-in for the most exacting installations such as apartment house antenna systems. Perfect for any twinax use calling for cable within the range of 70 to 95 ohm nominal impedance. Regular price 72¢ per ft. Your cost \$15.00 per hundred feet. Ask for RC-57U. Your cost 5¢ per ft. or \$4.50 per C.

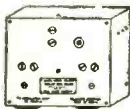

SIGNAL CORPS INTERCONNECTOR RELAY BOX 730A

This valuable unit, made by Bell, and more familiarly known by the U. S. Army designation BC-616, is encased in a highly polished aluminum case 6 1/2" x 5 1/2" x 2 1/2", and contains 150 mfd. of condenser capacity, sensitive relays, resistors, and terminal strips. Order several at the give-away price of only **\$1.95**

SUPER SPECIAL

FAIRCHILD bombsight POWER UNITS. Brand new, contains 9 tubes with a value of \$15.00; 2 electric motors or generators, 6 of the permanent magnet field type; relays; and 20 valuable precision resistors plus a multitude of the ordinary kind, in addition to many condensers and potentiometers. All for only **\$14.95**



CYBERNETICS!

RT1463 12 Stage Electronic Brain containing 3—7F7, 1—7Y4, 3—7N7, 4 potentiometers, numerous resistors, filter and bypass condensers, filter chokes, power and audio transformers, and six sensitive plate relays. A military development that provided amazing stepless control proportional to correction required, in the original application. This phenomenal unit, with its 3 multistage push-pull amplifiers and six 5,000 ohm relays in bridge circuits, will accurately control any 3 operations, related or unrelated, in minutely adjustable uniquely quantitative variations in either forward or reverse directions. 9"x7"x8" black crackle aluminum case. Brand new in original carton. **\$9.95**

YOU PAYS YOUR MONEY YOU TAKES YOUR CHOICE!

SCR-274 COMMAND SET . . . THE GREATEST RADIO VALUE IN HISTORY

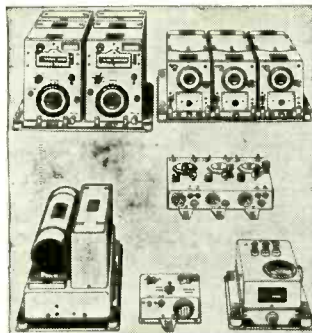

A mountain of valuable equipment that includes not 1 but 3 of the hottest superlative Communications Receivers, the famous RC-453, RC-454 and RC-455, each with tuned R.F. stage, 3 gang condenser, crystal, and 6 working tubes not counting rectifiers. Included are 2 Tuning Control Boxes; 1 Antenna Coupling Box with R.F. meter to measure power into antenna; 4—28V dynamometers (alteration of set to 110V operation is quick and simple); 2—40 watt transmitters including crystals; and pre-amplifier and modulator so transmitters can be used for voice or code. 29 tubes supplied in all. Guaranteed electrical condition. A super value at **\$59.95.**

MICROPHONES

Super Special—Highest quality all chrome bullet-shaped **CRYSTAL MIKE** of top-flight, nationally-known brand—**\$5.95.** Bullet **DYNAMIC MIKE**, \$7.85 **T-32 MIKE** with desk or table stand **\$2.95** **MIKE Jr.** **60c**

Phonograph Scratch Eliminator

Consists of 2 condensers and powdered iron core choke connected in filter network. Same as used in most jukeboxes to improve tone response and eliminate scratch. Connects instantly between pick-up and amplifier. A super bargain at **\$2.00**

MOTOR DRIVEN

Bandswitching Tuning Turret

4 bands above 100 Mc. #14 silver plated coil wire. Tuning condensers, driving motor diagram included. Only **\$2.95**



Eliminate the danger of fatal shock. Use our G.E. Interlock Safety Switch priced at only **\$1.00** each.

STROMBERG CARLSON

Power Switching Relay Box. Neat 3 1/2"x4x5 1/2" Steel case with tight fitting. Beautiful crackle finish **\$9.95**

"DRILLMASTER" ELECTRIC DRILL

Pistol grip electric drill, ideal for hobbyists. Complete with grip.



SOS EMERGENCY TRANSMITTER SOS

This is the famous Gibson Girl Transmitter that saved so many lives during the war. It is used as a distress call transmitter on boats and airplanes. The Gibson Girl is the easiest transmitter in the world to operate. No instruction or experience necessary. No external power supply required for operation. It is merely necessary to turn the crank on the top of the transmitter and power is generated as the distress signal is automatically sent out on the international distress frequency. Brand New Gibson Girl transmitter complete with tubes. **\$9.95**



ANTENNA KIT

For Gibson Girl transmitter, 300 ft. antenna wire, 2 balloons, 2 hydrogen generators, box kite for windy weather, search light. Complete kit. **\$9.95**

CO-AXIAL CONNECTORS

Army No. PL 259 or Amphenol 83-15P
Army No. 80 239 or 83-1R
Army No. PL 258 or 83-1J
Army No. M 359 or 83-AP
49c each—in lots of 10 assorted, 39c each

1000 CYCLE AUDIO FILTERS

Navy PD52010-1 low pass audio filters as mentioned in the "Peaked Audio" article in June CQ, and designated by the above number, are the exact electrical and physical equivalent of commercial audio filter units selling for \$35.00 wholesale. They are infinitely better than the surplus "Radio Range Filters" being sold for reducing QRM, and at 2 KC off resonance for example, a 2 section filter using PD52010-1 is capable of twice the selectivity available through the use of the QR-er (the RC-453 section of the 274N which has provided the amateurs' previous highest standard of interference elimination). **EXTRA SPECIAL—NAVY PD52010-1** with diagram **\$2.00**

AC-DC POCKET TESTER

This analyzer featuring a sensitive reulsion type meter housed in a bakelite case, represents the culmination of 15 years' achievement in the instrument field by a large company specializing in electronic test equipment. Specifications of the AC-DC Model Volt-Ohm-Milliammeter: AC Volts—0-25, 50, 125, 250, DC Volts—0-25, 50, 125, 250, Milliampers AC—0 to 50, DC Milliampers—0 to 50, 0 h n s Full Scale—100,000, Ohms Center Scale—2400, Capacity—.05 to 15

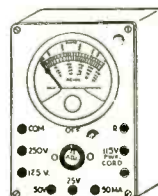

Mfd. Total Price, prepaid anywhere in the USA **\$7.00**

NO FOOLING

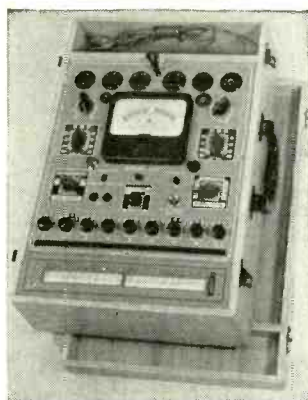

A real professional serviceman's tube analyzer that makes it possible to predict the life expectancy of a tube. The new, different, sensational 1950 Model Dynamic Mutual Conductance Tube Tester checks all tubes for gas, microphonics, hum, emission, shorts and mutual conductance in microhms. Detects more weak tubes. Unexcelled in accuracy. Completely new wiring arrangement that is really outstanding. Exclusive in the assembly. Best future investment. The tester can be Model

POWER RHEOSTAT

Exceptionally Rugged. Trouble-free design. Withstands severe overloading to many times the nominal 25 watt rating without burning or smoking. Perfect for motor speed control or line voltage adjustment. 3 sizes available: 50, 60, and 200 ohms. Regular price \$5.20. Special **\$1.00**



\$12.95 TAKES ALL THREE BIG BARGAINS

1. SENSATIONAL, FASCINATING, MYSTERIOUS SELYSAL DYNAMS made by G. E. Company. Two or more connected together work perfectly on 110V AC. Rotation of the shaft of one Selysal and all others connected to it rotate exactly as many degrees in the same direction, following unerringly as if the units were connected together by sharing instead of wire. This is true whether you twist the shaft of the master unit a fraction of a revolution or many revolutions. Useful for indicating direction of weather vanes, rotating directional antennas, or controlling innumerable operations from a distance. Complete with diagram and instructions. Matched pair **\$4.95**, 2. **ALUMINUM GEAR BOX 18x8x7** that contains powerful electric motors and two matched gear trains, 62 gears in all varying in size from 1/2 to 4 inches in diameter. This unit is readily converted to rotate a beam antenna or for any other similar use, **\$5.00**, 3. **HOME WORKSHOP AT BARGAIN PRICE**. Accurate and precise 2 speed complete hobby lathe, the essential machine for the home workshop. Sturdy enough for light production work or factory standby service. Supplied with 6" of belting for connecting to any available electric motor or power take-off. Included in this unbelievable offer are such accessories as 1/2" drill chuck with specially hardened tool steel jaws, a 4" electric furnace, high speed grinding wheel, a cotton handkerchief with a large supply of buffing compound, and a 4" steel wire scratch brush. Your cost **\$6.00**. Sole export agent. Distributor Inquiries invited.



NEW G-E TRANSMITTER

Brand new General Electric BC-375 or BC-101 transmitters, export packed complete set of spare tubes as well as 10 and



SPECIAL

MF, 24 plate Cond., 29c or \$ for 99c



ACRO

Just a few of the many

SUMMER SUPER SPECIALS

from EDLIE'S FREE CATALOG, R6

Super Special No. 1

**TUBES—ALL NEW, GUAR-
ANTEED, STANDARD BRANDS**

Any of Following Types—\$.15 each

1R4	12A6	14E6	1632	1643	2051	30 Spec.
45 Spec.	23D4	RK34	VR78	HY114B	841	843
864	954	957	E1148	9006		

Following Types Are Priced As Indicated

Type	Price	Type	Price	Type	Price
2A5	\$.88	65C7	\$.45	81	\$.55
2X2	.28	6Y6	.55	83	.59
5Z3	.55	7C5	.55	85	.45
6B7	.45	7Y4	.55	3B27	.89
6AQ5	.55	14A7	.55	RK72	.69
6BA6	.45	14B6	.55	RK73	.69
6C4	.28	14Q7	.55	350B	1.19
6C5	.45	16Z5	.45	388A	1.19
6F7	.55	16Z6	.28	866A	.95
6G6	.55	70L7	.89	872A	.75
6C5	.35	78	.35	878	.89
				Tungar	
				Rectifier	.89

Super Special No. 2

**QUARTZ CRYSTAL CHECKER
(DUPLICATOR)**

Manufactured by Finch Telecommunication.
Housed in a hinged steel cabinet with 19" Panel,
9" High and 13½" Deep.

2 Meters mounted on panel, "O-I Milliampers"
and "0-500 Cycles Second."

Complete with tubes and power Supply.

2-VR105; 2-6J5; 1-6L7G;
1-6SJ7; 1-6F6; 1-5Z4

Crystal sockets mounted on front panel. Sold
as-is. Instruction book not available.

Shipping weight approximately 45
lbs. Price **\$14.95**

Super Special No. 3

SMALL POWER TRANSFORMER

Pri. 115 Volts, 60 cycles; Secondary 560
Volts C.T., 50 Ma. 6.3 Volts @ 3½A;
with shell case. Price **\$1.35**

Super Special No. 4

250 WATT POTENTIOMETER

20,000 ohms. Muter type 433-AC. Brand
new, while they last. Price **\$1.35**

Super Special No. 5

FILTER CHOKES

Tri-Color TV Tube

(Continued from page 47)

mechanical positioning of this yoke. The amplitude of the circular deflection is adjusted to produce the proper convergence angle as required by the mask and phosphor-dot screen. The duration of the sampling period is controlled by a signal having a frequency three times the sampling frequency which is injected into the kinescope cathode circuit. The amplitude and phase of this 10.74 mc. signal are determined by the alignment of a filter circuit which utilizes the third harmonic of the circular-deflection driver tube.

As in the receiver for the three-gun tube, the front panel controls of the single-gun set are the same as those used in a conventional black-and-white receiver. Because a single gun is used in this kinescope, color balance may be achieved by proper deposition of the phosphor dots.

The deflection circuitry and deflection yoke are the same as those employed in the three-gun receiver described in the preceding section.

The kinescope gun which is employed is the same as that used in the commercial type 5TP4 kinescope. Potentials of 18 kilovolts for the final anode and 2.7 kv. for the electrostatic focus electrode are derived from the kickback voltage on the horizontal-deflection output transformer just as in conventional black-and-white receivers. A small auxiliary power unit provides heater and "B+" power for the other added circuits.

Convergence of the circularly deflected beam is produced by a magnetic lens in this single-gun kinescope instead of the electrostatic method employed in the three-gun version. A coil similar to the focus coil normally employed in conventional black-and-white receivers is used for this purpose. The dynamic convergence variation is likewise applied magnetically in this tube and is introduced by means of a smaller auxiliary coil located near the main convergence coil. As in the previous receiver, the dynamic convergence waveforms are derived from the deflection circuits.

AD-VANTAGE

Take advantage of the world's biggest Classified Ad opportunity—Your ad in RADIO & TELEVISION NEWS Classified Section will get more action—more inquiries—quicker, and at less cost than in any other magazine. Monthly net paid circulation over 200,000.

WANTED SELENIUM RECTIFIERS

Any type, any quantity. State condition and best price in first letter.

Box No. 504, %
Radio & Television News

185 N. Wabash Ave. Chicago 1, Illinois

REMOTE CONTROL SHAFTS

SCR274N/ARC5 Flexible Tuning Shaft 6-ft. length ea. 75¢.
11-ft. length \$1.25. 18-ft. length \$1.65.

ARB, AD7, MN26, RU16 Flexible Tuning Shaft 10-ft. length ea. \$1.95. 13-ft. length ea. \$2.20. 15-ft. length ea. \$2.45.

New, complete with all fittings—add 25¢ postage and handling.

LONG ISLAND RADIO CO.
164-21 Northern Blvd., Flushing, N. Y.

IRVING JOSEPH

Cordially invites

NEW TV PRODUCTS on the Market

TV SWEEP GENERATOR

A new sweep signal generator, especially designed for servicing television and FM receivers, has been announced by the Radio Tube Division of *Sylvania Electric Products Inc.* of 500 Fifth Avenue, New York 18, N. Y.

The instrument incorporates electronically controlled sweep circuits and provides good sweep linearity and consequent distortion-free scope patterns. The FM sweep range is from 0 to 600 kc. and the television sweep is from 0 to 15 mc. Fundamental output



frequencies are provided ranging from 2 to 230 mc. in four bands.

Output is at least 100 mv. on all bands and is controlled by a smooth attenuator. Double shielding prevents signal leakage and good frequency stability is assured by a voltage regulated power supply. Wide range phasing control permits adequate adjustment for single oscilloscope response curve. Voltage for driving or synchronizing horizontal oscilloscope deflection is provided.

The new unit measures 11½" x 8¾" x 7" and weighs 12½ pounds.

MOUNTING BRACKETS

Philson Manufacturing Co., Inc. of 60-66 Sackett Street, Brooklyn 31, New York, is now producing a set of chimney mounting brackets which consists of two heavy weight mounting brackets with adjustable eye bolts on each side of both brackets.

The new set comes complete with all parts for mounting masts to the chimney including extra-heavy gauge ¼" hardware straps which are heavily galvanized. The units are riveted with ¼" solid rivets that cannot pull apart. The brackets will fit masts from 1" to 1¾" in diameter and come packaged in individual sets.

ALLIANCE ROTATOR

The *Alliance Manufacturing Company* of Alliance, Ohio, is currently

running an intensive television and advertising campaign designed to familiarize the public with its "Tenna-Rotor" unit.

Available in two models, the standard and deluxe, these antenna rotators are *Underwriters' Laboratories* approved. A special point-of-sale counter display, designed to tie-in with current advertising, features a miniature antenna which is attached to one of the rotators mounted in the rear of the display. The customer can operate the control case on the counter. New window streamers and other sales aids are also available to dealers.

WINDOW ANTENNA

Radion Corporation of 1137 North Milwaukee, Chicago, Illinois, has just introduced a new packaged conical window-mount antenna to fill the gap between portable indoor units and engineered outdoor antennas.

The *Radion TA-51* comes packaged, fully assembled, and complete with a 15 foot lead. The unit has full 360 degree orientation. It may be adjusted to a universal position for all 13 channels. The new conical model has four triple-chromeplated telescoping dipoles, a triple-chromeplated mast, dielectrically correct bakelite head, and a black oxide swivel base. The unit is completely weatherized and retails in the low priced bracket.

PRINTED TV TUNER

The Tube Department of *Radio Corporation of America* has announced the development of a printed circuit television tuner which is said to provide greatly improved performance, superior reception in fringe areas and in receivers operated with built-in antennas.

A radical departure from conventional wound-coil units, the new tuner utilizes a unique photo-etch process to reproduce the critical circuits. The



process eliminates the complicated process of mechanically winding separate coils and at the same time produces precision circuits of excellent performance.

ATTENTION ALL ELECTRONIC- TELEVISION ENGINEERS

For more than 6 years **RADIO-ELECTRONIC ENGINEERING**, a special edition of **RADIO & TELEVISION NEWS**, has kept alert engineers dependably and thoroughly informed on all that's really important in electronic engineering.

Selected and exclusive articles and other specialized features of practical and lasting value to electronic engineers are added to the content of the regular edition of **RADIO & TELEVISION NEWS**.

Subscribers to the regular edition may change to the **RADIO-ELECTRONIC ENGINEERING** edition by remitting an extra dollar for each 6 months of the unfulfilled portion of their subscriptions.

New subscribers please use the lower half of order card in this issue.

The **RADIO-ELECTRONIC ENGINEERING** edition is available only by subscription.

**RADIO-ELECTRONIC
Engineering**

edition of
RADIO & TELEVISION NEWS
185 N. Wabash Ave.
Chicago 1, Ill.

TELEVISION SCOPE

SUPERIORITY AT A GLANCE!

The vertical response of this economy TV scope is usable to 5000 kc, not 50 kc. Response is flat to 750 kc, down 3 db at 1000 kc. Amplifier supplies a voltage gain of 20 at 5000 kc.



AR-3

Check this necessary feature before you buy any scope for TV use.

The R.S.E., AR-3 Scope has been built by Ross Armstrong to our rigid specifications. It's a complete unit that embodies standard horizontal amplifier and sweep circuits with normal sensitivity.

The case is 8" high x 5" wide x 14" long, attractively finished in "homered" opalescent blue enamel. Operates on standard 110 volts—60 cycles—40 watts. Tubes, 3BP1-6AC7-6SJ7-6X5-5Y3-8B4. Instructions included. Complete specifications upon request. Satisfaction or your money back.

PRICE
\$49.95

AVAILABLE TO JOBBERS
IN QUANTITY

F. O. B.
DETROIT

INTERCOM & RADIO

AT A PRICE THAT CAN'T BE BEAT



6 tube superhet—3 tube intercom permits communication between radio-master and up to 4 sub-stations.

Original cost \$64.50

WHILE THEY LAST

\$29.95

With 1 sub-station and 50 feet of cable
Extra Sub-stations \$3.95 each

PUSHBACK WIRE



25% BELOW MILL COST!

1st class, Essex or Lenz, ALL SOLID tinned copper, double cotton serve, waxed finish.

SIZE	COLORS	100 feet	1000 feet	Production Reel
22	BLACK-BROWN	.39	3.79	3.65M
20	RED-WHITE-BLUE	.49	4.49	3.95M
18	BROWN	.69	5.98	

ORDER INSTRUCTIONS

Minimum order—\$2.00. 25% deposit with order required for all C.O.D. shipments. Be sure to include sufficient postage—excess will be refunded. Orders received without postage will be shipped express collect. All prices F.O.B. Detroit.



Demand This Seal of Quality

Quantity and Export Orders Solicited

RADIO SUPPLY & ENGINEERING CO., Inc.
89 SELDEN AVE. DETROIT 1, MICH.

With a tuner design involving twelve channels, each containing four tuner circuits, the printed circuit technique is especially well adapted to its manufacture. In design, the new RCA unit is a cylindrical turret-type tuner. The turret assembly employs individual coil strips or segments each containing the printed circuit for a separate television channel. The strips are easily removed for service or replacement. All the tuned circuits are printed with the exception of the oscillator coils for channels two to six.

ANTENNA ROTATOR

The U. S. Devices Corp. of Oak Tree, South Plainfield, New Jersey has entered the antenna rotator field with the introduction of its new unit for rotating FM, television, and ham antennas.

The new unit features the in-line thrust from top mounting through the center shaft of the rotator and down to the mast. It also features a 3/4" solid steel rotating shaft, rotating on a 5/8" case hardened steel ball bearing which, in turn, rests on a stainless steel plate.

The assembly is completely weather-proof. It is made entirely of alu-

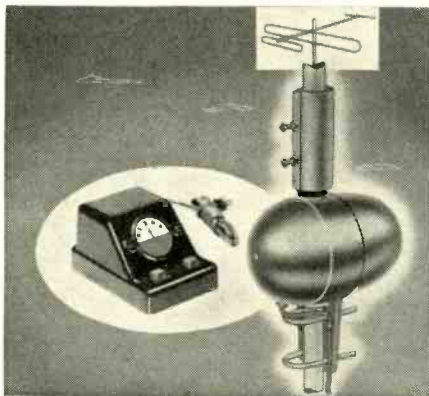

minum, bronze, brass, and stainless steel. In addition, the unit is fully lubricated at the factory for life. The rotator uses a heavy duty tandem motor which operates on 110 volt, 60 cycle a.c. with an input of 25 watts. It rotates 370 degrees clockwise or counterclockwise and is instantly reversible from any point. An internal magnetic brake prevents coasting.

Control boxes are made of unbreakable and fireproof plastic in colors to blend with most home furnishings. Two models of the control boxes are available.

NEW TV TUBES

Three new television tube types have been recently added to Raytheon's receiving tube line, the 1V2, 6AU5GT, and the 6CB6.

The 1V2 is a miniature type half-wave rectifier. Its principal application will be as a high-voltage rectifier in television receivers. The 6AU5GT is a beam power amplifier intended for use as a horizontal deflection amplifier in video receivers, while the 6CB6 is a miniature type sharp cut-off pentode. This type will be in general use in television sets as an i.f. amplifier, replac-

RUNNING TIME METERS

Sangamo Model 17-B

In hours and 1/10 hours to 9999.9. 110/230 V. 60 Cycles, A.C. (Please specify voltage.)
110/230 V. \$3.50
230 V. Only \$2.95



TOP QUALITY TELEPHONES

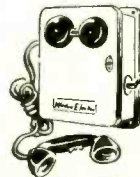

Standard magnet ringer type as used for farms, factories, intercoms, etc. Connect with two wires or single wire and ground. Range 15 miles or more. Ringer box, new, with handset, 800d. Instructions \$8.95

VARIABLE RESET TIMER

Sangamo Model 21

Opens circuit from 0 to 3 minutes. Calibrated in 5-second intervals. 110/230v 60 cycles AC. Will handle 10 Amperes or more. (Please specify voltage.)
110/230 V. \$3.50
230 V. Only \$2.95



G. E. TRANSFORMERS

110 V. 60 Cy. AC
850V CT. 6.3V @ 3A.
6.3V @ 3A, 5V @ 3A.
Conservatively rated @
148 mil. tested @ 250
mil and will handle more.
A steal
at \$2.95

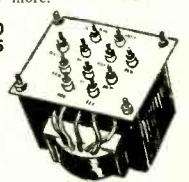

G. E. 12 HENRY CHOKE

Made as companion to above, only. \$1.95

F.O.B. Oakland. 25% cash with order. Balance C.O.D.

EMMONS RADIO SUPPLY

405 - 10th ST. OAKLAND, CALIF.
Phone TWinoaks 3-9103

FOR THE TAPE RECORDING ENTHUSIAST



Written for the layman, technician and engineer by A. C. Shaney, outstanding author and engineer.

96 pages crammed with facts. Contains circuit diagrams, parts lists, construction hints, as well as elementary and advanced theory and design. Contains data never before in print.

Send dollar bill. No C.O.D's.

AMPLIFIER CORP. OF AMERICA

398-92 Broadway New York 13, N. Y.



DESK MODEL

Priced only \$17.95

Pair of Two (interchangeable) complete with wire, power supply and instructions. 25% deposit with order, balance C.O.D.

FRENCH TELEPHONE SYSTEMS

719 Westminster Road Brooklyn 30, N. Y.
CUSTOM MADE TELEPHONE SYSTEMS OUR SPECIALTY

FRENCH TELEPHONES

Available again for immediate delivery smartly designed De Lux French Telephones in two attractive models.

You may connect any number of telephones to one system. A child can install. Button and bell in each telephone for signalling.

WALL MODEL



FOR BARGAINS IN

Receivers, Transmitters, Amplifiers, Television Sets, Batteries, Surplus Parts, Phonograph Records, and many more items

Read
RADIO AND TELEVISION NEWS
Classified Columns Every Month

RADIO & TELEVISION NEWS

ing, in many circuits, a type 6AG5 tube. Further details are available from the Radio Receiving Tube Division, Raytheon Manufacturing Company, 55 Chapel Street, Newton 58, Massachusetts.

RESONANT ANTENNA

A television antenna which was especially developed for bad locations and fringe areas has just been introduced by The Cameron Tool & Supply Company of Cameron, West Virginia as the Haines Resonant Antenna.

This antenna features telescoping elements that are calibrated and marked for the various channels, thus the lengths of the director, reflector, and folded dipole can be set properly as well as their spacings from each other.

The low band unit is manufactured in two weights, seven and three and

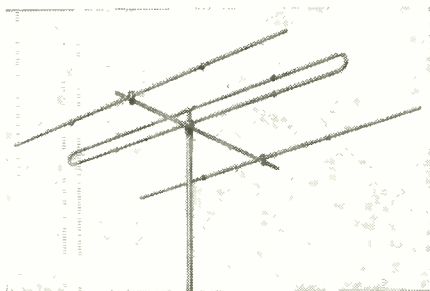

one-half pounds each, and covers channels two to six. The high band antenna covers channels seven to thirteen inclusive. A molded polystyrene insulator is used in the folded dipole. Mounting clamps are furnished for antennas where stacking is required.

This antenna is also suitable for amateur applications because the elements are adjustable.

DETENT SWITCH CONTROLS

JFD Manufacturing Co., Inc. of 6101 Sixteenth Avenue, Brooklyn 4, New York, is producing four detent switch controls for use as replacements in RCA, Emerson, Admiral, Air King, Capehart, De Wald, Garod, Philmore, Packmaster, Fada, Olympic, Regal, Packard-Bell, Truetone, Coronado, and U. S. Television video receivers.

The four detents are: No. DT10 (short shaft replacing RCA Part No. 71463); No. DT11 (long shaft replacing RCA Part No. 72743); No. DT12 (extra long shaft replacing Admiral Part No. 76B14); and No. DT13 (all-phenolic shaft replacing RCA Part No. 73440).

Detailed information and complete reference charts listing all television receiver makes according to the respective detent required are available from the company.

DISTRIBUTION SYSTEM

The Brach Manufacturing Corporation of 200 Central Avenue, Newark, New Jersey, has developed a low-cost multiple TV distribution system which is designed especially for television dealers.

The new "Mul-Tel" system will operate from any antenna and may be installed quickly and easily. No splic-

"Wholesale" Brings You Red-Hot Values In TELEVISION ANTENNAS · ACCESSORIES · PARTS

UNBEATABLE TV RECEPTION BEST FOR THE FRINGE AREAS

Snyder Lazy XX TV ANTENNA

Complete with three 3 1/2 ft. masts & adj. mounting base

Extremely hi-gain. Superior construction. Designed to withstand all weather conditions. Easily stacked double conical lazy XX type. Just unfold, tighten and erect. All TV channels and FM. You also get guy wire rings, and connecting stubs. Completely pre-assembled. Can be used with any type lead-in 72 to 300 ohms. Order model TX-2.

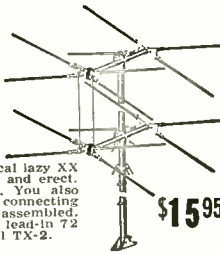

\$15.95

Sensational Antenna Buy! SNYDER HI-LO ARRAY

Complete with Mast Sections Model TV 21

We don't believe you'll find a finer antenna anywhere near this low price. Two folded dipoles (High and Low) with reflectors. Complete with two 3 1/2 ft. mast sections, guy rings. Ready for easy, quick installation.



\$5.95

\$5.75 in Lots of 6 or More.

72 to 300 OHM MATCHING TRANSFORMER

\$2.40



Matches 72 ohm coaxial cable such as RG59U to 300 ohm receivers. Voltage step-up 2:1 with a flat response over the TV channels from 52-215 mc. Negligible mismatch when used with 52 ohm coaxial cable and W-100 adapter. Model T-72. Complete with RG59U adapter.

The Sensational New ANCHOR 2 STAGE BOOSTER

Increases signal strength 5 times

Operates in fringe areas formerly unworkable. ARC 101-100



\$26.97

More Top Booster Values!

ASTATIC Model AT-1.....\$29.70
STANDARD Model B-50.....17.97
RMS Model SP-4.....22.50

Midget 300 Ohm Line Antenna Relay

Double Pole, Double Throw



300 ohm transmit-receive relay. Up to 500 watts RF on Reasonably flat lines. (Measured on input.) Silicone glass insulation size 1 7/8 x 1 9/10 x 1 5/16" Advance Relays K1504 RF 15 dBV \$2.70 each K1504 RF 6 DCV

Attention! TV Installers! Save Time & Labor with Wheeler SOUND-POWERED HANDSETS

No Batteries or Power Supply Needed High fidelity speech transmission. Satisfactory operation up to 25 miles with #16 twisted wire. Perfect for businesses, homes and installations of radio and TV antennas. Model SPT-102.....each \$8.75 \$17.50 per set of 2.



STOP TVI Signal Kleer WAVE TRAP

Eliminates Ham interference from 14 to 28 mc bands. Model 300-10-30. Eliminates FM image interference with. Model 300-80-110. Either Model.....\$1.65



T. V. 30,000 Volt Tester

TV ball-gap Kilo-voltmeter. Measures AC-DC - Pulse voltages up to 30 KV. Pocket size. Reads direct in KV. Seg Hy-Volter \$3.45



Address Orders to Dept. R-31 or Phone Mulberry 2134

WHOLESALE RADIO PARTS CO., Inc.

311 W. Baltimore St. BALTIMORE 1, MD.

Write for Free Monthly "FYI" Bulletin

Lowest Price Anywhere! Compare! HI-BAND ADAPTER

Folded dipole and reflector. Adjustable mounting bracket for complete orientation. Fits existing pole 1 1/2" O.D. Order model HF-3...



\$1.49

\$1.35 ea. in lots of 6 or more.

T.V. ANTENNA ACCESSORIES

High in Quality! Low in Price!

STEEL EXTENSION POLES. Weather treated. 30 Ft. Long, 1 1/4" di.\$1.49
3 Ft. Long, 1 1/4" di. Crimped end.89
3 1/2 Ft. Long, 1 1/4" di. Crimped end.69
ANTENNA SWIVEL BASE, Aluminum.39
72 OHM COAXIAL CABLE RG59U 4c per ft. Per 100 ft.3.75
300 OHM TWIN LEAD (\$1.45 per 100 Ft.) 1000 ft. 11.50
CHIMNEY MOUNT BRACKETS Complete with strap 1.39
3"-300 OHM STANO-OFF INSULATORS Wood screw-in type, 3c ea. per 100.2.50
SAMS TV ANTENNA MANUAL.1.25
SNAP-ON TWIN LEAD INSULATORS. Fit 1 1/4" masts.06
MAST COUPLINGS. Galvanized steel 8" long. Will couple masts of 1 1/2" or 1-5/16" di.45
FLAT 4 CONDUCTOR LEAD-IN 2 1/2c per ft. Per 100 ft.2.25

Heavy Duty Mast Brackets

Adjustable up to 18" away from wall. Fits masts 1" to 1 1/2" diameter. Model WB-2.....\$2.75



WB-2

WB-2

WB-2

WB-2

WB-2

WB-2

WB-2

WB-2

WB-2

WB-2

WB-2

WB-2

WB-2

WB-2

WB-2

WB-2

WB-2

WB-2

WB-2

WB-2

WB-2

WB-2

WB-2

WB-2

WB-2

WB-2

WB-2

WB-2

WB-2

WB-2

WB-2

WB-2

WB-2

WB-2

WB-2

WB-2

WB-2

WB-2

WB-2

WB-2

WB-2

WB-2

WB-2

WB-2

WB-2

WB-2

WB-2

WB-2

WB-2

WB-2

WB-2

WB-2

WB-2

WB-2

WB-2

WB-2

WB-2

WB-2

WB-2

WB-2

WB-2

WB-2

WB-2

The New SUPERIOR TV-10 TUBE TESTER

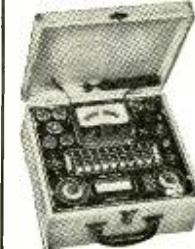

Tests all tubes including 4, 5, 6 7 octal, lock-in, Peanut, Bantam, Hearing-aid, Thyatron, Miniatrons, sub-miniatrons, novals, etc. Individual sockets for each type of tube. Tests by the proved emission method. Operates on 105-130 volt, 60 cycles AC. Built in roll chart provides complete data for all tubes. Housed in beautiful, hand-rubbed oak cabinet with portable cover. 8" x 11 1/2" x 12". Wt. 14 lbs.

\$39.50

**Speed Up
Small Wire Tinning
Lectrohm
SOLDER POTS**

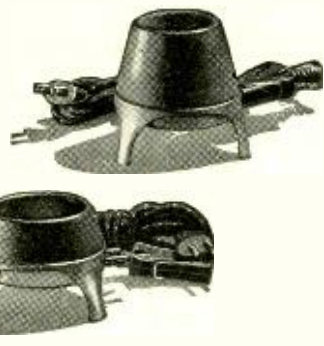

These small capacity solder pots are particularly designed for the individual operator tinning of small wires and leads. They answer the special need for melting limited quantities of solder at one time. Thus current consumption is reduced and maximum efficiency on the assembly-line is attained.

Single-heat, porcelain nickel-chrome heating element. Model 200, 1 3/4 lb. capacity; Model 250, 2 lb. capacity.

Lectrohm Solder Pots are available at leading Radio Supply Houses



ing, cutting, or taping is necessary and the entire installation can be completed in just a few minutes without any tools but a screwdriver. In strong signal areas, the system provides the same quality picture and sound to as many as sixteen receivers from a single antenna, according to the company.

Three differently rated units are available to permit proper matching of either 72-ohm or 300-ohm receivers to any good antenna lead-in system where it is desired to operate more than four sets. Transmission can be multiplied by the use of more units. The four-set system is the basic unit.

The system may also be used in garden-type apartment houses or other multiple dwellings, multi-room restaurants, taverns, or clubs.

LOW-PRICED YAGIS

The LaPointe-Plascomold Corporation of Unionville, Connecticut, has announced production on a low priced line of "Vee-D-X" Yagi antennas.

Known as the "J" series, these new antennas feature high gain and pinpoint directivity for fringe area reception applications. Three models are currently available in the new series; the JA, a two-bay, three-element unit; the JB, a four-element antenna; and the JC, a five-element array. Each antenna incorporates clamp type construction and is shipped completely assembled with all elements folded against the boom.

"TELE-BEAMER"

Designed to improve TV, FM or amateur reception, Koenig Engineering Co. of 735 Southwest Blvd., Kansas City 3, Kansas, is currently offering a low cost antenna rotator, the "Tele-Beamer."

The new unit will turn the antenna in any direction by push-button action at the compact remote control box. A continuous service direction indicator shows the exact antenna bearing at all times. The rotator will turn all TV masts from 3/4" to 2" in diameter and

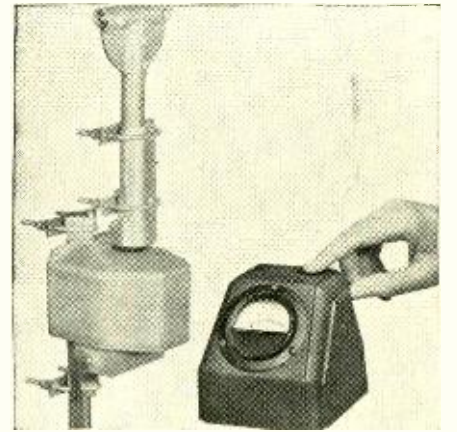

will carry the highest and heaviest arrays with the addition of the company's radial mast bearing.

Two motors drive the lifetime lubricated steel and bakelite gears. Electrical stops turn off the motors when the unit reaches one full turn; auto-

STAHL SEZ!

My Bargain Columns are always worth reading

METERS

ALL BRAND NEW WESTINGHOUSE

3" Round & Square 0-15 Mil DC.	Each
3" Round 0-1 Amp DC.	\$3.45
3" Round 0-150 Amp AC.	
3" Round 0-50 Amp AC.	
3" Round 0-300 Amp AC.	

GENERAL ELECTRIC

2" Round 0-15V AC & DC.	\$2.50
3" Round 0-15 Mil DC.	3.45
3" Round 200 Mil DC.	3.45

MISCELLANEOUS

3" Round 1 Mil McClintoc.	\$3.45
2" Round 0-3 Amp RF Simpson.	2.25
3" Round 75 Amp AC Burlington.	3.45
3" Round 1000 Mil DC Beede.	1.95
2" Round 5-0-5 Amp DC.	19.50
Roller Smith portable lab 0-15V DC with handle: 5 1/2 x 6 x 3 1/2.	19.50

INCLINOMETER—Jaeger E3-2-in 3 inch round case. Has an adjustment knob for leveling purposes. This is Govt. surplus, Brand New. It cost the Govt. many times the low price we ask...\$7.95

We have available CODE PRACTICE

TAPE, which was used for code practice work by the Signal Corps—from slow to fast practice. 15 rolls on 16MM metal reels in heavy wooden slotted case, to be used with McElroy TG10 Keyers, Tone Keyers or any code practice unit using printed tape. Special. **\$9.95**

GIBSON GIRL

The Emergency Radio Transmitter. Sends S O S signals automatically on 500KC. 150-mile range. No batteries required. It is a hand-driven generator, tubes, 300 ft. antenna wire; like new. **\$2.95**

It's only.....
Instruction Manual.....50c

Prompt Delivery—25% deposit required on C.O.D. order. Shipped F.O.B. New York.
Write Dept. RN-6

MICHAEL STAHL, INC.
39 VESEY ST.
WO 4-2882 New York 7, N. Y.

CODE SENDING RECEIVING SPEED

Free Book

HIGH SPEED

WITHOUT NERVOUS TENSION

REVEALING BOOK shows how "crack" operators develop high speed and proficiency. Learn code for Amateur or Commercial Radiotelegraph License, or improve your sending and receiving with the Candler System which develops radiotelegraph experts and code champions.

CANDLER SYSTEM Box 928, Dept. 2-G Denver, Colorado

EVERY RADIOMAN Can Use These SERVICE HINTS!

Valuable Manual Yours—FREE!

Every page of "How to Simplify Radio Repairs" is packed with on-the-bench, practical ideas. Contains photos, charts, diagrams—no fluff—no vague theory. In plain every-day language it gives you priceless suggestions—new servicing ideas. You'll use and benefit from the experience of experts. Partial list of contents: How to Localize Trouble; How to Service Amplifiers; How to Test for Distortion; How to Test Audio Circuits; How to Test Speakers; How to Find Faults in Oscillators; How to Test Radio Parts—and it's all yours—FREE! No obligation.

FEILER SEND COUPON OR PENNY POSTCARD FOR YOUR FREE COPY TODAY!

FEILER ENGINEERING CO., Dept. 6H5
1601 S. Federal St., Chicago 16, Illinois

Please RUSH my FREE copy of "How to Simplify Radio Repairs."

Name

Address

City Zone ... State.....

matic interlock lets only one motor work at a time. The unit comes complete with instructions for installation.

ROOF MOUNT

T-V Products Company of 152 Sanford Street, Brooklyn 5, New York, is currently marketing a new multi-pitch roof mount unit, the Model RM-5.

This novel scissors-type unit automatically holds the antenna mast in true vertical position regardless of the pitch of the roof. When the mast is inserted, the mast holding section can be either upright or lying along the roof.

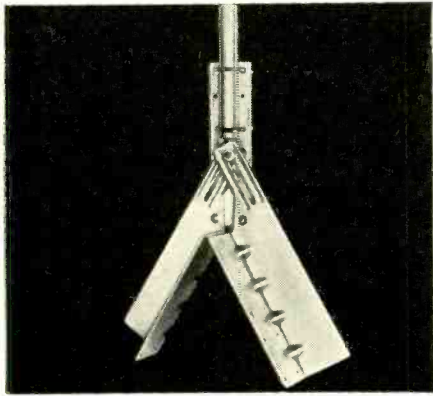

The RM-5 is constructed of heavily-plated steel and is engineered to withstand maximum strain. Multiple reinforcing ribs are incorporated into its design to insure strength

and durability. The unit comes complete with necessary hardware and instructions.

LIGHTNING ARRESTER

Designed to minimize damage to television sets from lightning and static charges collected on television antennas, JFD Manufacturing Co., Inc. of 6101 Sixteenth Avenue, Brooklyn 4, New York, has recently introduced the new "safeTVguard" twin lead lightning arrester.

Made of glazed porcelain, the new unit bears the Underwriters' Laboratories seal of approval for both outdoor and indoor use. In addition, it complies with fire insurance regulations of the National Board of Fire Underwriters and the National Electrical Code for outdoor antenna installations.

The arrester can be installed anywhere, on the mast, a grounded pipe, any wall or window sill. No wire stripping or cutting is necessary. The twin lead transmission line is slipped into the slot on the top of the arrester and tightened in place. A 4-foot length of ductile aluminum ground wire is supplied for use when mounting the unit on walls.

Three models of the arrester are available to fit all types of twin lead transmission lines.

NEW TV TOWER

Production on a new all-aluminum home antenna tower has begun at the Brownstown, Indiana plant of Thompson & Ruby, Inc.

An unusual feature of this mast is that the riveted tower sections are shipped completely cartoned, ready for the installer to join together. The tower is adaptable to any type of mounting due to its light weight and unique swivel base.

Full information on this new unit is available from the company.

HIGH VOLTAGE COUPLER

Clarostat Mfg. Co., Inc. of Dover, N. H., has announced the availability of a high-voltage coupler and spacer assembly to be used on replacement controls for TV, oscilloscope, and other high-voltage circuits.

The new coupler assembly, 59-186, with a nylon insulator shaft, RN-3", rounds out the current assortment of a dozen "Pick-A-Shafts" or attachable shaft types and may be purchased separately.

The high-voltage insulator sleeve screws on to the control bushing while its threaded metal stud end takes the mounting nut. The nylon shaft with a standard "Pick-A-Shaft" keyed end, slips into the control's slot and is gently tapped to snap it firmly and permanently in place for integral control and shaft combination.

The coupler is rated at 10,000 volts breakdown test and

Koenig

Telebeamer ROTATOR

2 HEAVY DUTY MOTORS GIVE . . .

BETTER PERFORMANCE.. LONGER LIFE!

Koenig Telebeamer Rotator gives the *peak* of performance. Telebeamer is the *most dependable* rotator made today; it holds heavy antennas through 80-mile winds. Absolutely weatherproof, trouble-free, easy to install. Positive acting electrical stops at both ends of 360° turn eliminates lead damage. Children can't damage the Koenig Telebeamer by continuous operation.

Indicator shows exact antenna bearing at every instant; comes in plastic, mahogany or walnut case. Motors work independently; one turns rator clockwise, the other counter-clockwise.

Write for prices and specifications

Koenig Engineering Co.

735 SOUTHWEST BLVD. KANSAS CITY, 3, KANSAS

INVENTORY SALE

ALL PRICES CUT TO BONE

25c TUBE SALE—#53-2AT-55-27-85-31-
56-57.....8 for \$1.00

12 BRAND NEW 10" PHONO RECORDS—Ass't.
Jazz—Pop—Hillbilly—Polkas.....\$1.79

WOOD MIDGET CABINET, 8 1/2x5 7/8x4 1/4".....89c

3 Ft. 5 Wire Shielded Cable with Amphenol Connection.....8 for \$1.00

U. S. ARMY GAS MASKS

Has O. D. covered case suitable for lunch or tool bag and charcoal container for use in refrigerators to eliminate fish or other odors.

Brand new—39c each; 3 for \$1.00

TRANSMITTING PLATE CONDENSERS

A pair of Signal Corps transformers connected in series to 110-250 Volts, AC, will deliver approximately 750 to 800 Volts, DC, 200 mills, when connected to a rectifier tube and filter condenser. Cost Uncle Sam \$23.00—our price, per pair, \$2.98. Shipping weight 33 lbs.

JONES 20 TERMINAL BARRIER TYPE STRIP... 25c

Signal Corps Phones—2 M. Ohms (8 M. Ohms Imp.).....\$1.00
2 Ft. Ext. Cord (and Plug).....40c

OIL FILLED FILTER CONDENSERS

1.—MFD—30 volts.....75c ea.
1.—MFD—1000 working volts.....6/99c; 12/91.75

FAMOUS BRAND RECORD CUTTING HEAD
Size 1 3/8x2 7/8 ready to fit your cutting arm or bracket. SPECIAL.....\$2.95

TOBE TUBULAR ELECTROLYTICS

20-20 MFD. 150 V.....25c 30-30 MFD. 150 V.....30c
40-40 MFD. 150 V.....32c

2 1/2 M.H. R.F. CHOKE COIL—27c ea. 5 for \$1.00

3 BAND OVAL DIAL—7 1/4" L x 5 1/4" H.....60c

100 RESISTOR ASST. 1/4-1/2 WATT.....95c

Low-Loss Short Wave

Lock Type Air Trimmer

Variable Condensers

3 Plate—12-15 MMFD.....12c
8 Plate—30-35 MMFD.....16c
10 Plate—40 MMFD.....17c
14 Plate—56 MMFD.....24c
20 Plate—80-100 MMFD.....28c
27 Plate—100-110 MMFD.....35c

3 GANG T.R.F. VARIABLE CONDENSERS
D. N. S. E. R. S.
.000365 Con. 85c

D.P.D.T. SLIDE TOGGLE.....23c

SWITCH.....23c

2 piece 5-pole Male and Female Separable Plug. Both with Flex. Cord. 4 prs. \$1.00 35c per pr.

4 PR. WAFER SOCKETS—\$1.49 per C. each.....3c
PHILCO 4 MF-300 V. 7 1/2 CAN CONDENSER.....10c ea.

5-6 PRONG WAFER SOCKETS.....10c ea.
100 ASST. SOCKETS—4-5-6-7.....\$3.50 per C.

1,000 OHM WIRE WOUND POTENTIOMETER.....\$1.25

30 HY-FILTER CHOKE SHIELDED.....3 for \$1.00

UNSHIELDED.....3 for \$1.00

10 WIRE WOUND RES. KIT—5-50 W. ASST.....49c

2,000 ohm Wire Wound Rheostat.....\$1 per doz.

CARTER WIRE WOUND C.T. VARIABLE 20 OHM RESISTORS.....85c per doz.

RCA 6 OHM POWER RHEOSTATS.....7c ea.

PHILCO AUTO SUPPRESSORS—\$5.00 per C.....7c ea.

GEN. ELEC. WESTINGHOUSE, etc., 60 CYCLE WATT HOUR METERS, of grade used in perfect condition, same as used in your home. 110-125 volts.....\$3.95

10 Amps.....\$3.95

PIEZO CRYSTAL HOLDERS with cover.....12 for \$1.00

Grind your own crystals—Pure Brazilian Quartz, all sizes and thicknesses—1/2 lb. package.....\$1.00

RCA Band Switches—3 gang, 3 pos. 3 band. 30c 6 gang, 5 pos. 4-5 band. 40c

I. C. A. 30 MH RF choke.....25c

Trimmer-Padder Asst.—all isolantite—singles, dual, triples—100 asst. pieces.....\$2.25

5"—450 ohm AC-DC dynamic speaker.....\$1.35
Philco rotary tap tone control.....25c

ATTENTION! Prospectors, Explorers for Hidden Treasures! Construct a U.S. Army Type of Metallic Mine Detector Amplifier. Amplifier unit only (less tubes and batteries) with cables, headphone cord, and jack. Army wiring diagram. Type AN/PRS-1.....\$1.95

TUBES—024, 79c; 68C7, 35c; 117P7.....95c

6 ASST. WET ELECTROLYTIC CONDENSERS.....59c

RADIO EXPERIMENTER'S SURPRISE PACKAGE—CONTAINS BYPASS & FILTER CONDENSERS, SHORT WAVE TUNING UNITS, POWER AND AUDIO TRANSFORMERS, SOCKETS, RESISTORS, CHASSIS HARDWARE. OVER 20 LBS. OF VALUABLE PARTS.....\$4.95

DRILLED CHASSIS FOR 5-6 tubes 5"x10"x1 1/4".....25c

RCA ADJUSTABLE CODE INTERFERENCE WAVE TRAP 456-475 K.C.....25c

PHONO JACKS—OPEN & CLOSED AUTO.....18c

NATIONAL 5-15-450 VOLT CAN FILTER CONDENSER.....39c

EBY SPEAKER VOL. CONTROL 80 OHMS.....15c

SALE—PHONO RECORD ALBUMS—SALE

10"—3 comp.—15c; 4 comp.—20c; 12 comp.—49c
12"—3 comp.—15c

WESTERN ELEC. TRANSMITTING STEP-DOWN TRANSFORMER—AC, 190, 210, 230, 250 V. W.E. 20 AMP RETARD CHOKE TO MATCH. Wt. 125 lbs. ea. Freight Shipments Only. SPECIAL.....\$5.00 ea.

75 MFD., 25 V. Tubular Cond.....15 for \$1.00

Line Noise Elim. R.F. Choke, #14 Wire.....10c

4 Wire Shielded Cable, 6 Ft. with Plug.....7 for \$1.00

Upright Elec. Cond. Clamps, 1 3/8" Diam. 25 for \$1.00

IRC—300 Watt—300,000 OHM Wire Wound Resistor.....95c

6 Pr. Amphenol Sockets.....\$4.00 per C

Majestic 6 V. Auto Vibrator.....50c

Tube Ring Holders.....75c ea.; 15 for \$1.00

10 MFD., 300 V. Cond.....\$1.00 per doz.

Transmitting Filter Cond. Asst. W.E. Parvoit, RCA, G.E., Etc. Cap. 1 MFD—3 1/2 MFD.....6 for \$1.00

MINIMUM ORDER \$2.00—NO C.O.D. SHIPMENTS—PLEASE INCLUDE POSTAGE

NEWARK

SURPLUS MATERIALS CO.

Dept. JE

324 Plane Street NEWARK 1, N. J.

is available in all of the company's type controls, Types AM and AT.

NEW G.E. TUBE

Production is now under way on a 14" rectangular television picture tube at the General Electric Company's Buffalo, New York, tube plant.

The new tube, the 14CP4, has a use-

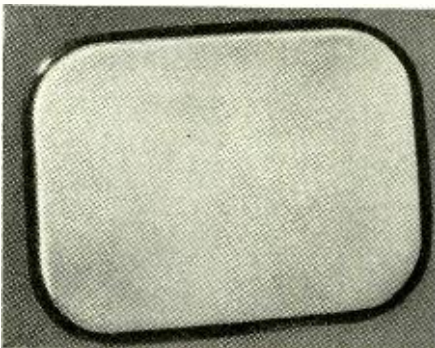

ful picture area of 99 square inches and a neutral density faceplate for increased picture contrast and detail. The electron gun in the tube is designed to be used with an external ion-

trap magnet for prevention of ion-spot blemish.

The maximum ratings of the 14CP4 are: anode voltage, 14,000 volts; grid No. 2, 410 volts; grid No. 1, 125 volts negative and 0 volts positive bias.

Complete details on the new tube are available from the Tube Divisions, of the company at Schenectady, New York.

MASTER ANTENNA

Masta TV Antenna Corporation of 1133 Broadway, New York 10, New York is in production on a new amplified master antenna which includes high gain for all present TV channels, thorough shielding against outside interference, and complete isolation between sets.

The new equipment consists of seven amplifying units, one for each channel in the New York area, each with a specially designed antenna. As a master antenna it will service up to 140 television sets, eliminating many of the antennas presently required and providing each set with clear reception.

94% OF TV SERVICING DONE IN THE FIELD

By ROBERT HERTZBERG

WHEN an RCA engineer stated at a recent TV meeting that 94% of all field service calls handled by the nationwide organization of the RCA Service Co. Inc. are completed in the customers' homes, with the assistance of only materials carried in the standard panel truck, I remarked, "Those trucks must be loaded with scopes, sweep and marker generators, and all the other expensive equipment in the catalog."

"Funny thing, everybody has that idea," the engineer said. "Actually, the trucks carry only one test instrument, a standard vacuum-tube voltmeter. Most of the space in the vehicle is taken up with picture-tube cartons. You don't believe me? Come down to Camden and I'll show you."

I went, and was shown. Here is a pho-

tograph to convince independent TV service technicians that they don't have to move out half of their shops to do justice to calls from set owners. Besides the basic v.t.v.m., the cargo includes the following: a steel carrying case of common small tools, soldering gun, service manual, a complete assortment of replacement tubes ranging from 7-pin miniatures up to 16-inch picture tubes, loudspeakers, power cords, switch shafts, indoor type antenna, and a handful of small resistors and condensers. That's all! With the exception of the big 16-inchers, all of this stuff certainly can be pushed into the trunk compartment of any postwar sedan; the picture tubes can be put on the rear seat without damaging it.

Equipment carried in a typical RCA Service Co. Inc. television servicing truck. Tubes constitute most of the cargo. Note that only one test instrument, a v.t.v.m., is used.

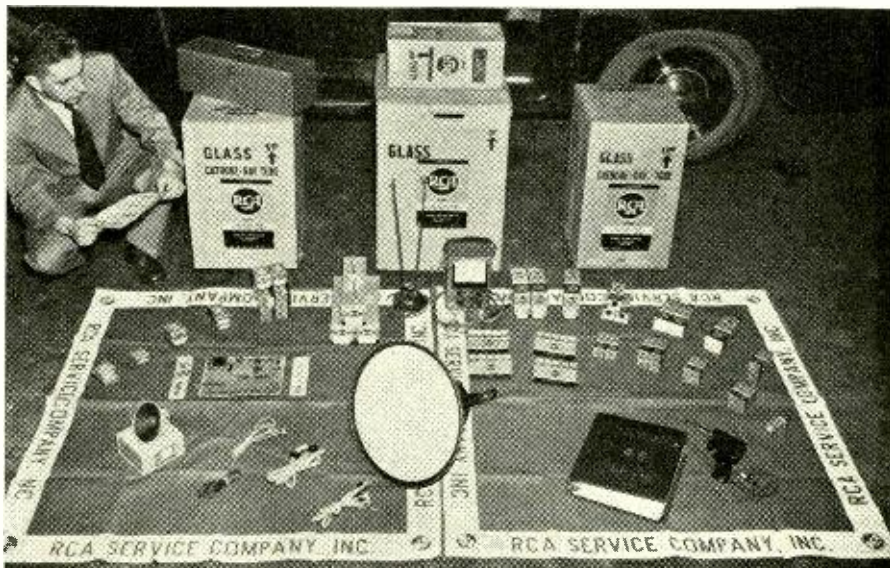

MAIL ORDER ADDRESS
1060-2 N. ALLEN AVE.
PASADENA 7, CALIF.
SYCAMORE 4-7156
RYAN 1-8271

PHOTOCON SALES

RETAIL SALES STORE
1240 EAST COLORADO ST.
PASADENA 1, CALIF.
SYCAMORE 6-7217

JUNE SPECIALS

Please write for our 1950 complete catalog

TEST EQUIPMENT

- IE-19A Test Set for SCR-522
Complete with manual, original factory
packing—..... BRAND NEW **\$325.00**
Excellent Used Condition..... **200.00**
- IE-36 Test Set for SCR-522—EXCELLENT
USED **\$22.50**..... BRAND NEW **29.50**
- BC-376, E, G, & H test oscillator models
GOOD USED **17.50**
- TS-184A/AP Test Set for APS-13—GOOD
USED **\$44.50**..... BRAND NEW **64.50**
- I-90 Test Set..... EXCELLENT **9.95**
- BC-906 Frequency Meter..... EXCELLENT USED **12.95**
- I-100A Contains BC-713 and BC-714—
Test Set for ARN-7 and 269 Compass
..... LIKE NEW **650.00**
- TS-16/APN Test Set for APN-1 Altimeter
BC-221 AJ and AK Frequency Meters. NEW **125.00**
- BC-221 AJ and AK Frequency Meters....
EXCELLENT USED **89.50**
- BC-221 Frequency Meters...GOOD COND. **69.50**
- LM Frequency Meters—
GOOD USED **\$69.50**..... NEW **79.50**
- I-122 Signal Generator by Espy Mfg. Co.
15-27, 95-127 M.C.....EXCELLENT **79.50**
- I-222 Signal Generator..... EXCELLENT **75.00**
- TS-45A/APM-3 Signal Generator 9200-
9600 M.C., 110 V. 60-800 cps.
LIKE NEW **125.00**
- ARC-1 AIRCRAFT TRANSMITTER-RE-
CEIVER—10 channel RT18/ARC-1
—Excellent condition with tubes,
mtgs, control boxes..... **\$595.00**
- T47/ART-13 Transmitter with tubes in
excellent condition..... **195.00**
With Low Frequency Oscillator.... **325.00**
- APN-1 ALTIMETER—Complete.....
BRAND NEW **34.50**
- WELDING TYPE TRANSFORMER—5 V. @
190 amperes secondary Primary 115 V.
60 cycles, American Transformer Com-
pany..... NEW **\$16.95**

SCR-522 EQUIPMENT

- SCR-522 TRANSMITTER - RECEIVER
UNIT with tubes. EXCELLENT COND. **\$59.00**
- PLUGS—Set for SCR-522 (6 plugs) ..
..... NEW **3.75**
- PE-94—24 Volt Dynamotor power unit
for SCR-522..... NEW **4.50**
- BC-602 Control Box..... NEW **.95**
- BC-631 Jack Box..... NEW **.79**
- AN-104A Antenna—
NEW STEEL **\$1.95**..... COPPER **2.95**
- MN-26C—BENDIX RADIO COMPASS RE-
CEIVER—150-1500 K.C., tubes.....
EXCELLENT **\$17.50**
- MN-20—Antenna Loop for MN-26C...NEW **9.50**
- PE-103 DYNAMOTOR POWER
SUPPLY. Complete with dyna-
motor filter, relay battery
cables, and shock mount. Part
of SCR-284. Operates on 6 or
12 V. D.C. BRAND NEW **\$19.50**
- FL-8 Range Filter..... NEW **\$1.95**
- FL-30 Range Filter..... NEW **1.95**
- HS-23 Hi Imp. headset with ear cushions ..
..... NEW **2.45**
- CD-307 Extension Cord for HS-23, HS-33... **.49**
- MC-885D—Headset adapter..... **.35**
- T-32 Desk Mike..... **2.25**
- HS-30 Headset—Complete with matching
transformer, 6' cord and PL55 plug. NEW **1.95**
- HS-30 Headset..... NEW **.95**
- Dynamic Headset and Mike—P. O. Mark II ..
..... NEW **1.95**
- BC-348 Mounting Base..... NEW **\$2.25**
- BC-348 Outlet Plug..... NEW **.69**
- BC-348 Mounting Base and Outlet Plug...
..... NEW **2.50**
- APN-1 Altimeter Indicator, basic movement,
0-1 ma; 5 ma. shunt, 270° dial. An ex-
cellent basic movement for constructing
your own meters..... BRAND NEW **\$1.95**
- Meter Rectifier—full wave midget Selenium
—10 volts—30 ma..... NEW **.29**

BC-620 MOBILE FM TRANSCEIVER—20 to
27.8 M.C. Excellent cond. with tubes... **\$11.95**

WESTON TACHOMETER GENERATOR—Model 724
Type C..... GOOD USED **\$14.95**

WESTON ELECTRICAL TACHOMETER METER
Model 545 for use with 724 generator. Speed
0-2000 R.P.M.—Ratio 2:1..... NEW **17.50**

BC-464 TARGET RECEIVER—5 Channel Re-
mote Sensitive Relays, Battery Case, An-
tenna, 68-73 MC..... BRAND NEW **\$14.95**

Crystal and Coil Sets for Handy Talkies. 2670,
3885, 4280, 4840, 5327.5, 5437.5, 5500
K.C.—2 crystals and 2 coils per set.....
PER SET, NEW \$ **2.25**

MINE DETECTOR SCR-625 for locating metal,
underground pipes, etc., with manuals,
NEW **\$59.50**, EXCELLENT USED **39.50**

I.F. Transformers for SCR-522—1st, 2nd, & 3rd.
NEW EACH **.35**

CD-501 Cable for PE-103—BC-654..... NEW **1.95**

SPEAKER—6" Compartment P.M. Weatherproof—
25 watts..... EXCELLENT **6.95**

TRANSFORMER—200-0-200 @ 50 ma.—6.3 V.
@ 3 amps, 115 V. primary..... NEW **1.95**

TRANSFORMER—700-0-700 @ 75 mils, 6.3 V.
@ 1.2 amps, 5 V. @ 3 amps—115 V. primary
60 cycle..... NEW **2.25**

TRANSFORMER—6200 V. @ 325 ma. easily
C. T. for 3100-0-3100 @ 650 ma.—Primary
105/110/115 V.—60 cycles, American Trans-
former Company..... NEW **39.50**

TUBE SPECIALS

5CP1—5" Cathode Ray Tube—New Boxed.
4 for **\$4.25**. EACH **\$1.45**

APN-4 INDICATOR SCOPE—Excellent with tubes
and crystal..... **\$29.50**

APN-4 RECEIVER-POWER SUPPLY UNIT—Excel-
lent with tubes..... **14.50**

Plug for APN-4 Scope and Receiver—
Complete set..... NEW **3.75**

Mountings for APN-4 Scope and Receiver... EACH **2.00**

SOUND POWERED HEAD AND CHEST SETS—T. V. INSTALLATIONS

FIELD TELEPHONES HOME INSTALLATIONS

LIGHT WEIGHT TYPE

MANUFACTURED BY U. S. INSTRUMENT CORP.

New..... **\$6.95** per set **\$13.50** per pair

Excellent Used..... **4.95** per set **8.50** per pair

Fair Used—Tested.... **2.95** per set **5.00** per pair

TERMS: Prices f.o.b. Pasadena, 25% on all C.O.D.
orders. Californians add 3% sales tax.

For Greater Earnings... LEARN RADIO-ELECTRONICS

This fast-growing science of RADIO, TELEVISION, RADAR and ELECTRONICS, offers tremendous opportunities, and in no industry is RADIO-ELECTRONICS more important than in aviation. A skilled technician who knows the modern application of electronic devices, as used in the aircraft industry, is always in demand... not only in aviation, but in many other industries. Many large organizations call on Spartan regularly for graduates. Often, students are hired months before graduation.

Don't confuse the RADIO-ELECTRONICS course offered by SPARTAN with other courses, offered anywhere! As a graduate from this famous school you will know the application to industrial control devices; to the search for petroleum; and the important uses of radar, television and other electronic equipment.

SPARTAN offers two complete and thorough courses. You will work on the most modern and complete equipment. You will build equipment. You may join the SPARTAN "Ham" Club. Either course prepares you for Federal Communication Commission license tests—first class radio telephone, second class radio telegraph, or class "B" radio amateur.



SPARTAN'S 21 years of teaching civilian and army personnel is your assurance of receiving the best possible training in the least possible time. You'll not need MORE than Spartan training—you cannot afford to take LESS.

BIG CATALOG—Free

NAME..... AGE.....

ADDRESS.....

CITY..... STATE.....

G. I. APPROVED—Write TODAY for Complete Information

SPARTAN

SCHOOL OF RADIO AND ELECTRONICS

SCHOOL OF AERONAUTICS
MARWELL W. BALFOUR, DIRECTOR

COLLEGE OF ENGINEERING
ADDRESS DEPT. RN-60

TULSA, OKLAHOMA

Included in the listing are various models of crystal and dynamic microphones for all types of sound applications. Units for hand-held, floor stand, desk stand, hearing aid and lapel use are listed and described. A group of the company's microphone accessories is also included in the catalogue.

LABORATORY EQUIPMENT

A comprehensive, 90-page catalogue, covering the company's complete line of laboratory equipment for application of radioisotopes to research, industry, medicine, agriculture, etc., has just been issued by *Tracerlab Inc.* of 130 High Street, Boston 10, Massachusetts.

Included in Catalogue B is descriptive material on instruments, Geiger-Mueller tubes, tagged organic and inorganic chemicals, and industrial beta ray thickness gauges. The laboratory instruments feature three different types of scalers, an automatic sample changing system, survey and rate meters, and preamplifiers.

ELECTRONICS DICTIONARY

Allied Radio Corporation of 833 West Jackson Boulevard, Chicago 7, Illinois, has issued a handy and practical dictionary of 2500 terms used in television, radio, and industrial electronics.

Edited by Dr. Harry L. Van Velzer, Associate Professor of Electrical Engineering at the University of Illinois, the new "Dictionary of Electronic Terms" answers the need for an accurate, up-to-date reference source of words used in the electronics field.

Definitions cover mostly modern techniques and equipment but range from many words no longer in general use, retained for historic reasons, to the new language of color television and the electronics of nuclear physics.

Over 125 illustrations and diagrams of components, equipment, and electronic circuits are included, along with an appendix section containing useful radio data.

Copies of "A Dictionary of Electronic Terms" are available from the company at twenty-five cents each, prepaid.

SALES AIDS

A new series of advertising and sales promotional material for use by retailers has been released by *Majestic Radio & Television, Inc.* of 70 Washington Street, Brooklyn 1, New York.

Included in the series are eight newspaper mats, descriptive literature, two new window streamers and a new fluorescent-printed rayon banner.

All of this material is available from local *Majestic* distributors.

DU MONT TUBE CHART

A handy tube chart covering the company's line of "Bent-Gun Teletrons" has just been issued by *Allen B. Du Mont Laboratories, Inc.* of 750 Bloomfield Ave., Clifton, New Jersey.

The new chart presents, in tabular form, all of the essential data on over

MICROPHONES

- Pressure
- Velocity
- Cardioid
- Varacoustic
- Hand Sets
- Sound Power Telephones
- Stands, Plugs, Cables and Connectors



AMPLIFIERS



- Pre-Amplifiers
- Line Amplifiers
- Voltage Amplifiers
- Power Amplifiers
- Remote Amplifiers

SPEAKERS



- Cone Type
- Horns and Drivers
- High-Fidelity Speakers
- Speaker Accessories

SPEAKER HOUSINGS



- Baffles, All Types
- Console Cabinets

INTERCOM SYSTEMS



- All Master Systems
- Master-Remote Systems
- Combination Systems

CUSTOM-BUILT EQUIPMENT



- Consoles
- Desks
- Turrets
- Cabinets

PORTABLE SOUND SYSTEMS

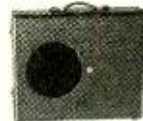

PROGRAM CONTROL UNITS



- Single Channel
- Dual Channel
- Custom-Built



Why shop around?

It's easy to get the right equipment from RCA's full line of matched sound products

Buy your sound products the easy way. The wide variety of RCA Sound Products simplifies your problem of finding the right equipment for your sound jobs.

Every item in RCA's extensive sound line is electronically engineered with its own special characteristics to give top performance, dependable long-life service with quality appearance. Not only is the

RCA Sound Products line built right, it is also priced right to enable you to build a steady volume of profitable business.

No other manufacturer offers so extensive a line of "matched" sound products from the smallest "ballyhoo" system to the largest systems for industrial, educational, institutional, church, hotel, hospital or commercial users.

See your RCA Sound Products Distributor for catalog and new sound sales manual



SOUND PRODUCTS
RADIO CORPORATION of AMERICA
ENGINEERING PRODUCTS DEPARTMENT, CAMDEN, N.J.

In Canada: RCA VICTOR Company Limited, Montreal

New and Used Surplus Bargains

APS-13—Transceiver—410 to 420 MC—30 MC IF, New.....	\$13.50
BC-788—Transceiver—Ideal for Citizens Band, Used.....	10.00
BC-1206—Beacon Receiver—Overseas Packed.....	5.50
BC-457—Command Transmitter, New \$7.50, Used.....	5.50
BC-458—Command Transmitter, New \$7.50, Used.....	5.50
RT-7/APN-1—Altimeter Transceiver 418-462 MC FM, Used.....	6.50
BC-603—FM Receiver 20 to 28 MC Excellent Condition, Less 12v Dynamtr. With Dynamotor.....	14.50 17.00
BC-604—FM Transmitter 20 to 28MC	

Excellent Condition, Less Crystals, Crystal Drawer & Dynamotor.....	9.95
Less Crystals but with Dynamotor.....	12.50
With 80 Crystals and Dynamotor.....	24.75
BC-603 & 604 Both Complete.....	39.95
Case of 80 Crystals for BC-604.....	12.95
DM-34—12v Dynamotor for BC-603.....	3.50
DM-35—12v Dynamotor for BC-604.....	3.50
BC-683—FM Receiver 27 to 38.9 MC Less Dynamotor—Excellent Condition.. With Dynamotor.....	24.95 27.50
BC-684—FM Transmitter 27 to 38.9 MC Less Crystals, Drawer and Dynamotor.. Less Crystals with Dynamotor..... With Crystals and Dynamotor.....	27.50 29.95 42.50
BC-683 & 684 Both Complete.....	67.50

DAVE RUMPH CO. P. O. Box 4178 FORT WORTH 6, TEXAS

AGAIN IN 1950... IT'S

ATLAS



Again Atlas leads
the field with its new line of
speakers and projectors.

Again Atlas makes the news in
the Sound System field.



Atlas Reproducer units continue to retain the famous "Atlas V Plus" super-efficient magnetic assembly and in addition many more "Extra Plus" features. A new reversed dome, blast proof diaphragm is now standard in the high power, high fidelity models. Built-in transformers, designed for either constant 70 volt or constant impedance audio circuits are included. Improved appearance—functionally designed for maximum convenience. Double seal weather-proofing. All this and more without any general increase in price.

Atlas projectors have a new micrometrically calculated and controlled rate of expansion. Atlas non-vibrant projectors are rugged and fine in appearance. Sound energy is not dissipated in rattle vibration, distortion or cancellation.

The new improved line of Atlas speakers are really new from the voice coil to the final lock washer. It's really the "modern look" in speakers, a new high in overall performance.

Let Atlas speakers play an important part in your SOUND PROFITS.



Write for our new catalog —
the most complete line of
speakers, microphone stands and
sound accessories.

ATLAS SOUND CORPORATION

1447 39th Street
Brooklyn 18 N. Y.

fifty different cathode-ray tubes. Included are dimensions, basing data, deflection angle, envelope, contact, ion trap magnet, maximum design center values, and comparative operating conditions.

A copy of the chart and a 4-page data sheet on the company's "Teletrons" is available on request.

TV BULB DATA

The *American Structural Products Company*, Box 1035, Toledo 1, Ohio, has recently issued a twelve-page book designed to assist television tube and set manufacturers to take full advantage of the new *Kimble* all-glass rectangular television bulbs.

The new booklet contains scale drawings showing all dimensions of the rectangular bulb in 14, 16, and 19 inch sizes and round bulbs in 12½, 16, and 19 inch sizes. It illustrates the advantages of rectangular bulbs over round bulbs by comparisons of area, shape, and completeness of the picture.

Copies of the book are available from the company's Sales Promotion Division.

REFERENCE GUIDE

Hytron Radio & Electronics Corp. of Salem, Massachusetts has recently issued a fourth edition of its handy "Reference Guide for Miniature Tubes."

The miniature tubes of all manufacturers which have been released to date are listed in the new booklet. 132 miniatures are included along with 41 new tubes. There are 70 basing diagrams and a tabulation of comparable prototypes in the standard sized tubes. Copies are free on request.

SAMS SUPPLEMENT

As an added service to "Photofact" subscribers *Howard W. Sams & Co., Inc.*, of 2201 East 46th Street, Indianapolis has recently announced the publication of a 64 page TV data supplement which is being distributed without charge with the purchase of the "Photofact" Set No. 91.

This preliminary data is being released to service technicians in advance of complete coverage of the equipment by regular "Photofact" TV folders. The 64 page supplement consists of double-page schematic diagrams covering over 100 TV models.

The second TV supplement will be issued with "Photofact" Set No. 93.

REPLACEMENT GUIDE

The Rectifier Division of *Sarkes Tarzian Inc.*, 415 North College Avenue, Bloomington, Indiana, has started distribution on a handy replacement guide chart for selenium rectifiers.

The chart lists direct replacement rectifiers for over 100 models manufactured by 39 different companies. The material is tabulated for easy reference with the manufacturer's name, part number, and then the *Sarkes Tarzian* replacement part number.

Copies of this replacement guide are free for the asking. Write the company direct for your guide. —50—

Spot Radio News

(Continued from page 18)

variation from the values required for the reception of the present black and white signals. However, interference from other emissions, which do not satisfy either the normal tolerance limits or the offset conditions, were found to be of considerable importance by Chapin, who emphasized that they will tend to become worse because of . . . (1) The filling up of the spectrum which will result in more transmitters and receivers, increasing the probability of interference, and making it increasingly difficult or impossible to handle harmonic or local oscillator radiation problems by allocations problems; and (2) the use of the ultra-highs which will aggravate the oscillator radiation problems.

The probability of in-channel signal interference with the *RCA* color system, was reported by Chapin to be about twice as great as for a standard black and white signal, during preliminary tests. He said that this increased susceptibility appeared to result from the presence of a 3.6 megacycle subcarrier. Chapin then added that the double susceptibility of the *RCA* color signal to interference appeared to require abandonment of the approach to reduction of interference by allocation, and thus the allocation plan might, therefore, be substantially different, depending on the color system involved. Chapin also noted that susceptibility to interference was basic to the dot-sequential system and might become worse, with additional stations, additional receivers and other devices employing radio frequency, such as diathermy and industrial radio-frequency heating equipment. Use of the ultra-high band might also aggravate the situation, he said.

No sooner had Chapin returned to his chair along FCC Staff Row, than cannonading really began, with FCC Attorney Harry Plotkin as the principal fuse setter. The blasts arose during the testimony of RMA Prexy Raymond C. Cosgrove, who told the Commission that he didn't know the attitude of the individual members of the association about possible insistence on the production of receivers which would provide black and white signals under a non-compatible system, such as that fostered by *CBS*. The FCC counsel had pointed out that if the Commission approved a compatible system, there would probably be no problem of continuing manufacture, but if a non-compatible system were selected by the FCC, the official decision would be frustrated unless industry cooperated, and thus compulsory action by the FCC might be necessary.

When the RMA Headman could not supply an appropriate production answer, Plotkin roared out that FCC might call on all manufacturers to appear in Washington and reveal if they would or would not make equip-

RADIO & TELEVISION NEWS

ment which could provide reception from the CBS system, if it were adopted. The issuance of a subpoena to perhaps General David Sarnoff and Frank Folsom of RCA was also suggested by Plotkin, which was immediately protested by RCA's attorney and then subsequently pigeon-holed by Commissioner Paul A. Walker, who acting as chairman in the absence of Wayne Coy, declared that there was no need for a subpoena at this time. Plotkin then aimed his questions at Dr. Engstrom who was asked what his company might do if the CBS system were approved. He replied that RCA probably would make the CBS-type models, according to public demand, but his company had no faith in the system.

The arguments for government pressure appeared to stem from the vitriolic statements made earlier by Senator Edwin C. Johnson, during a speech on the Senate floor, when he blasted industry for its attitude towards the FCC and its talk about a Congressional investigation on television. At that time, the fiery Senator said: "If there is to be an investigation of television by Congress, let's have one which goes into monopoly controls. . . . Our committee may decide that the time has come to thoroughly explore what is going on."

Commissioner Jones' tart comments during a luncheon meeting earlier in the year were also recalled as playing a role in the present tirade against industry during the hearings. The Commissioner declared then: "I need not remind you that the Justice Department has taken steps to use the anti-trust laws where it appeared that an art was being suppressed for advancement of private interests and to the prejudice of the interests of the American people. Concerted action by industry groups to delay, if not prevent, the establishment of color television might well lead to the same type of action."

CBS also had entered its plea of industry restraint in an early Spring petition, requesting that the FCC dismiss certain evidence of the RMA, which indicated a . . . "studied course of indifference."

The hammering "we-must-have-an-answer-now" attack also fell on an A.T.&T. man, when he appeared to review the coaxial-cable situation. The victim was Frank A. Cowan, head of the engineering and long lines department of the telephone company, who came to testify when the color lines would be available. When told that such lines, with a bandwidth of 4 megacycles would not be available until perhaps in 1952, Madame Commissioner Hennock fired a . . . "too late" commentary at the telephone representative. Cowan declared that it was impossible to promise an earlier installation, unless the broadcasters were prepared to shoulder some of the financial burden of the line-laying. The burying of the wide-band lines would take at least two to three years,

he said, but perhaps with the aid of broadcasters could be completed by the end of '51.

As this column was being prepared, the color debate was drawing to a close, to be followed by an equally stormy series of sessions on whether the 470 to 500 megacycle band should be allocated to multi-channel common carrier mobile operation or to television broadcasting. Thus far seven parties have declared that they will testify in these hearings: *Bell Telephone Laboratories*, *United States Independent Telephone Association*, *National Mobile Radio System*, *Mutual Telephone Company*, *Philco*, *Television Broadcasters Association* and *DuMont*.

A review on this interesting phase

of the allocation snarl will appear in our report next month.

A DISASTER COMMUNICATIONS SERVICE will soon be announced in Washington. The plan, which was probed in the '45 allocation plan, will provide for the use of facilities of amateurs, and other non-government and government groups operating fixed, land and mobile stations, all merged into a single integrated service for the handling of emergency communications in times of disaster.

Eight frequencies in the 1750-1800 kilocycle band have been set aside: 1752.5, 1757.5, 1762, 1770, 1778, 1786, 1792.5 and 1797.5. A limit of 1 kilowatt has been set for power, this rep-

YOUR NEW STANCOR CATALOGS

are ready!

CATALOG OF TRANSFORMERS FOR RADIO, SOUND AND OTHER ELECTRONIC USES.

Here's a "must" for every user of transformers—serviceman, ham, experimenter, engineer. Detailed listings of more than 400 Stancor part numbers. Includes accurate electrical and physical specs, dimensions, prices, illustrations. Complete and up-to-date. Handy charts and easy-to-use indexes help to make this new Stancor catalog the book you'll want to find the part you need.

TELEVISION CATALOG AND REPLACEMENT GUIDE.

The sixth edition of the popular Stancor TV Replacement Guide (50,000 copies printed to date). Now combined in a big, 30-page book with a complete catalog of all Stancor TV components. Original part numbers, with Stancor replacements, are listed for more than 600 TV receiver and chassis models made by 64 manufacturers. Every Stancor component recommended in the guide is listed in the catalog section with complete specs, dimensions and prices. Gives you one convenient source of information. Makes your job quicker and easier.

And remember, when you buy a Stancor transformer, you get a quality product used by the country's biggest set makers as original equipment. Stancor transformers have to be good!

See your Stancor distributor today for your free copies of these books. If he is out of stock, we'll be glad to send you copies. Write Standard Transformer Corporation, 3584 Elston Avenue, Chicago 18, Illinois.



Most Complete Line in the Industry

NOW! PLATT'S SET WITH SUMMER SPECIALS

VISIT THE NEW PLATT STORE AT
489 BROOME ST., N. Y. C.



MARINE SPECIAL!

BC-223 TRANSMITTER

30 Watt Transmitter with crystal or MO control on four pre-selected channels, 2000 to 3250 KC. by use of three plug-in coils. Five Tubes: 2-801 & 3-46. With TU-17-18-25 Tuning Units. Tubes and mount included.

Specially Priced.
BRAND NEW. Only

\$25.95

MICROPHONES

T-24-G, 200 ohms, plug & jack, brand new... \$1.95
T-17-B, carbon, 200 ohms, cord and plug, new... 1.95
T-30 Throat Mike, cord & plug, Original Packing 1.29
T-36-C, carbon, 24 ft. cord, 3 contact plug... 2.95

20 POUNDS OF ASSORTED RADIO PARTS

Transformers, Chokes, Wire, Condensers, Knobs, Sockets, Switches, Dynamotor.
ONLY **\$2.39**

100 ASSORTED RESISTORS

Non-insulated, various ohmages and wattages.
SPECIAL **97c**

KIT OF 15 CONDENSERS

Bathubs and Electrolytics.
NOW **98c**

HEADSETS—Excellent Buys!

HS-33 with cord and plug, used, good condition... \$1.19
HS-25—Brand New with ear pads 2.75
HS-32—Brand New with ear pads, cord and PL54 plug... 2.75
TH-37A—1200 ohms with dual plugs... 2.95
HS-16A—520 ohms... 2.95



FILTERS

FL5 Lazy Q Radio Filter Unit, high impedance.
NEW... \$0.75
FL5 Filter, Good Condition... 1.29

DYNAMOTORS

Dynamotor for DY-12 Power Supply for ART-13... Only \$7.95
Type DM-33-A, in. 28, 90 V, 540 VDC, 250 mills... Brand New 1.95 (Excellent—Used \$1.25)
Type DM-53-A, 24 V, in. 220 V, 80 MA out... Brand New 1.95
INVERTER-PE-206, 28 V, in. 80 V at 500 VA, 800 cy. out... Brand New 4.95 (Used Excellent Condition NEW 5.95)
BD-77... Used .75
DM-32... NEW .75
PE-94C... NEW 5.95
PE-73C... NEW 3.95
BC-348 Receiver—NEW... \$165.00
BC-224 Receiver—Excellent Condition... 135.00
BC-342 Receiver—Excellent Condition... 135.00
BC-221 Frequency Meter—Excellent Condition 79.50
BC-939 Antenna Tuner for BC-610. NEW... 75.00
SCR-694 and SCR-284. Complete. New Conditioned. Prices Sent Upon Request.
MN-26C Compass Receiver. NEW... 29.50
453G Compass Receiver—Excellent Condition. 39.50
ARN7 Compass Receiver—Excellent Condition. 49.50
733D Localizer Receiver—NEW... 8.95

274-N COMMAND EQUIPMENT

Sensational Buys!

USED	NEW	
BC-442	\$ 1.85	\$ 2.75
BC-450, 3 Receiver	1.99	1.95
Remote Control	12.95	21.95
BC-454	4.95	6.95
BC-455	6.95	9.95
BC-456	4.95	2.95
BC-457	5.95	7.95
BC-458	5.95	24.95
BC-459	14.95	24.95
BC-696	1.95	1.50
3 Receiver Rack	1.95	
2 Transmitter Rack	1.50	



CORDS AND PLUGS

CD 508A Cord Assembly with SW 14-U Switch and 2 cord attachments with JK 48 Jack and PL 68 Plug. Value—\$5.00. Our Special Low Price, Brand New... 59c
CD 307A with PL 55 and JK New... 58c
JK 36 Jack with cord, good condition... 12c
JK 26 Jack only—Brand New... 12c
PL 55 Plug—NEW... 35c
PL 68 Plug—NEW... 15c

CATHODE RAY TUBES

3CP1... 59c 211... 39c
801A... 39c In lots of 10—10% off

MINIMUM ORDER \$2.00

Immediate Delivery—Send 25% deposit on C.O.D. orders. All shipments F.O.B., N.Y.C. (N.Y.C. residents add sales tax to your remittance.)

PLATT ELECTRONICS CORP.

Dept. A, 489 Broome St., N. Y. 13, N. Y.
PHONES: RE 2-8177 and WO 4-2915

representing the total direct-current plate input power to the amplifier stage, or stages, supplying radio-frequency power to the antenna.

The term disaster, according to the FCC, shall include, but not be limited to, floods, earthquakes, hurricanes, explosions, and consequences of armed attack, but shall exclude strikes.

Authority to operate in this new service will be granted to stations already authorized to operate in other services and will also be granted to new stations.

Commenting on the organization of networks, FCC has revealed that in any particular area there may be several networks and each network may be independent of the others. Wherever there are several networks in the same area, it is expected that all will share the available frequencies. Various networks in different areas, will be expected to try to establish proper liaison arrangements so that in case of need they might all work together.

Here is a vital service with which every amateur should be thoroughly familiar. Contact your local FCC office for complete details. . . . L.W.

Within the Industry

(Continued from page 28)

SARKIS as sales representative in the metropolitan Chicago and metropolitan Milwaukee areas has been announced by *Clarostat Mfg. Co., Inc.* . . . *Noblitt-Sparks Industries, Inc.*, has named two new distributors to handle *Arvin* radio and television receivers. **COASTAL EQUIPMENT CO., INC.** of Houston, Texas, will serve Houston and southeastern Texas while the **H. C. NOLL COMPANY** of Omaha will handle Omaha and other eastern Nebraska cities . . . *John Meck Industries, Inc.* has named **FALL RADIO SUPPLY CO.** of Canton, Ohio and **M. W. ZIMMERMAN** of Springfield, Mass. as distributors in those areas.

THE NAVY DEPARTMENT has announced a redesignation of the title "Chief of Naval Communications."

Henceforth the post will carry the title "Director, Naval Communications" or "DNC." Rear Admiral John R. Redman, USN, thus becomes the first "DNC" since 1945 when the now-abandoned title was adopted.

PAUL K. KELLEY, former Export Sales Manager of *Standard Transformer Corporation* of Chicago, died recently in the British-American Hospital in Lima, Peru, after a brief illness.

Mr. Kelley, who was 31, was traveling in South America on business. News of his passing reached the company through a Chicago ham and former associate who had received the news over the air from a ham in Lima.

LEONARD ASHBACH COMPANY, parent company of *Garod Radio Corporation*, manufacturers of radio and television receivers under the *Garod* and *Majes-*

tic tradenames, has announced the acquisition of a substantial equity interest in *Wilcox-Gay Corporation*, manufacturers of television and recording devices.

Under terms of the transaction Leonard Ashbach will assume chairmanship of the board of the Charlotte, Michigan firm. Plans are now under way for full production and expansion of the *Wilcox-Gay* plant for the manufacture of television receivers, recorders, and TV cabinets.

PAUL W. NIEF is the new sales manager for *Jewel Radio Corporation* of Long Island City . . . *The Magnavox Company* has named **ROBERT B. BARNES** to the post of district sales manager in the Delaware, eastern Pennsylvania, and southern New Jersey territories . . . The Home Radio Division of *Westinghouse Electric Company* has appointed **W. M. ANDERSON** as southwestern district sales manager with headquarters in Dallas . . .

JAMES F. LUCKER, youngest member of the *Air King Products Company, Inc.'s* television engineering department, passed away recently in New York . . .

C. J. HASSARD has been appointed general merchandise manager for the *Bendix Radio and Television Division* . . . The appointment of **ADOLPH S. PEXOLDT, JR.**, as purchasing agent for *Morrison Steel Products, Inc.*, was announced recently by the company . . .

LEONARD C. TRUESDELL has been elected to the post of vice-president in charge of household radio by *Zenith Radio Corporation*. He joined the company in September of 1949 as sales manager of household radio and television . . .

ARNOLD K. WEBER, personnel manager of the Camden Plant of *RCA Victor*, was elected president of the South Jersey Manufacturers Association at its annual meeting . . . The newly-created Industrial Television Products Group of the *RCA Engineering Products Department* will be headed by **M. CHARLES BANCA**, according to a recent announcement made by the company . . . The new national merchandising manager of the auto radio division of *Motorola Inc.* is **HOWARD C. HANDWERG** while **J. BENTON MINNICK** has been named national merchandising manager for television . . .

EDWARD E. STOUT is the new representative of *Raytheon's* broadcast equipment in the northwest territory. He will have offices in Seattle . . .

S. M. DECKER is the new assistant chief engineer of *Air King Products Co., Inc.'s* television department . . . *Trac-erlab, Inc.*, has named **DANA W. ATCHLEY, JR.**, to the post of director of engineering . . . Regional sales in the Midwest area for *Starrett Television Corp.* of New York will be handled by **STUART D. CLAYTON** . . .

ALFRED ZUCKERMAN has been elevated to the post of vice-president of *David Bogen Co., Inc.* He will continue to serve as chief engineer of the sound equipment firm . . . **NORMAN A. WOODFORD** has assumed the post of sales manager for *North American Philips Company,*

Inc.'s television division . . . **CAPTAIN GEORGE WILBUR McENTIRE** (USAF, Ret.), sales engineer for the *AiResearch Manufacturing Co.* of Los Angeles, died recently in the Veteran's Wadsworth General Hospital after a short illness . . . **HOWARD M. BOYD** has been named sales manager of the Parts Division of *Sylvania Electric Products Inc.* . . . **GEORGE E. FROST** has been appointed manager of the newly-created Products Service Division of *Winchester Repeating Arms Company*, division of *Olin Industries, Inc.* . . . **T. E. SANSOM** and **G. R. ODOM** have been named *General Electric* district representatives with responsibility for the sale of radio communications equipment in the west central district and the Atlantic district respectively . . . *Raytheon Manufacturing Company* has recently promoted three officers of the company. **PERCY L. SPENCER** was named vice-president in charge of the Power Tube Division, **NORMAN B. KRIM** was promoted to the post of vice-president in charge of the Receiving Tube Division, and **ERNEST F. LEATHEM** was named assistant to the president . . . **DR. DONALD B. SINCLAIR** has been appointed chief engineer of *General Radio Company*, succeeding Melville Eastham who retired in February . . . **BARNEY BALABAN** and **EDWIN L. WEISL**, representing *Paramount Pictures Corporation*, were recently elected to the board of directors of *Allen B. Du Mont Laboratories, Inc.* *Paramount* now holds all the outstanding Class B common stock of the *Du Mont* organization . . . **JAMES WHITE** is the new manager of contract sales for *Air King Products Company, Inc.* . . . *Atwater Television Co.* of Brooklyn has selected **I. R. ROSS** to serve as director of sales for the organization . . . **DONALD E. STEELE** has recently joined the manufacturer's representative firm headed by *Arthur E. Akeroyd*. The company maintains offices in Boston . . . **HARRY ZIMMERMAN**, cabinet engineer for *Bendix Television and Broadcast Receiver Division*, has been named chairman of the Committee on Cabinets and Finishes by the Radio Manufacturers Association . . . **ROBERT C. BENNETT, JR.**, is the new vice-president and sales manager of *National Electric Products Corp.* of Pittsburgh.

-30-

SAVE

THAT GOOD LOOKING OLD CONSOLE
WITH THE OBSOLETE RADIO!

install a modern

ESPEY AM/FM CHASSIS

and your favorite console is "right-up-to-date"



Rated an excellent instrument by America's foremost electronic engineers. Fully licensed under RCA patents. The photo shows the Espey Model 511, supplied ready to play. Equipped with tubes, antenna, speaker and all necessary hardware for mounting.

ATTENTION SERVICEMEN—Did you know there are over 19 million consoles waiting to have a modern AM/FM chassis installed? Here is a gigantic sales market just waiting for you to develop. In fact there are thousands of out-moded radios in your "backyard" just waiting to be replaced.

Makers of fine radios since 1928.

Write for literature RN for complete specifications on Model 511 and others.

ESPEY TEL. TRafalgar 9-7000
MANUFACTURING COMPANY, INC.
528 EAST 72nd STREET, NEW YORK 21, N. Y.

BIG MONEY IN RADIO and TELEVISION NOW!

See **COYNE'S Brand New 5 Volume Set**

"APPLIED PRACTICAL RADIO-TELEVISION" FREE!



Here is a BRAND NEW Set of books written for men who want to "go places" in TELEVISION and RADIO . . . men who know how much a PRACTICAL working knowledge helps to get the BIG MONEY. Over 1500 pages, 5000 subjects of the latest Radio and Television "know how" . . . easy to understand with hundreds of crystal-clear illustrations. It's ALL here! EVEN COLOR TELEVISION AND UHF. How to install, service, align, balance ALL radio and TV sets . . . how to use new and old testing instruments for TV service . . . latest data on adapters, converters and more, more, MORE. You name it and COYNE'S GOT IT, in this amazing new money-making 5-Volume Radio-Television Library.

**PRACTICAL!
CLEAR!
COMPLETE!**

5 fact-packed volumes—1000 illustrations and diagrams with step-by-step photographs which "break down" the equipment to show what makes it "tick." Up-to-the-minute, complete, easy to follow.

Color Television Is Here!

Set contains most complete section ever published on Color Television and UHF, adapters and converters. FULLY ILLUSTRATED AND PRINTED IN 4 COLORS.

Act Now and Get FREE Book

Now you can see these new Coyne books for 7 days without cost and get Coyne's book of 150 Radio and Television Diagrams FREE. It's free just for examining the new 5-Volume Set. Full details of this sensational Coyne "prove it" offer are given below. Mail the coupon at once.

SEND COUPON—SEE SET FREE FOR 7 DAYS

You must SEE these new books to know how easy it is to prepare for the big jobs in radio and television. Here's our special offer:—we'll send the complete 5-volume set for your 7-Day FREE Examination. And with it, we'll include our valuable new guide for all radio men, "150 New Radio-Television Diagrams Explained," absolutely FREE! If you keep the 5-volume Set all you pay is \$3.00 within 7 days after the books arrive and \$3.00 per month until \$16.50 is paid—or you can pay \$15.00 cash price. If you don't want the set, return it and you OWE NOTHING. But either way you keep the Radio and Television Diagrams Book as a gift. That book is ABSOLUTELY FREE.



SEND NO MONEY Coupon is just a request to see Set free and get FREE BOOK. Offer limited—act now.

COYNE Electrical and Radio-Television School

500 S. Paulina St., Dept. 60-F3, Chicago 12, Ill.

Mail This Coupon NOW

Educational Book Publishing Division
COYNE ELECTRICAL & RADIO-TELEVISION SCHOOL
500 S. Paulina St., Dept. 60-F3, Chicago 12, Ill.

O.K. Send me postpaid, your new 5-volume set, "Applied Practical Radio-Television," on 7 days' Free Trial per your offer. Be sure to include as a gift the book of 150 Radio-Television Diagrams absolutely FREE.

NAME _____ AGE _____

ADDRESS _____

TOWN _____ ZONE _____ STATE _____

Where employed _____

ESEGE SLASHES SURPLUS PRICES!

COMMAND EQUIPMENT
(274N, ARC-5, ATA)

Receivers	New	Used
150-550 KC	\$14.95	\$10.95
1.5-3 Mc.		14.95
3-6 Mc.	5.95	3.95
6-9 Mc.	9.95	7.95
3-Rec. Rack		1.50
3-Control Head		1.50

TRANSMITTERS

BC-696, 3-4 Mc.	\$14.95
T-19, ARCS, 3-4 Mc.	14.95
BC-457, 4-5.3 Mc.	5.95
T-20, ARCS, 4-5.3 Mc.	5.95
BC-458, 5.3-7 Mc.	5.95
T-22, ARCS, 7-9.1 Mc.	9.95

MODULATORS

BC-456	\$ 2.95	\$ 1.95
MD-7, ARCS Push-pull		9.95

SCR-522	\$29.52
BC-602, 522 con. box	.95
ARC-4 con. box	.97
ARC-4 Xmitter Rcvr	16.95
APN-4 Receiver	12.95
APN-4 Indicator	17.95
APN-1 Xmitter-Rec.	9.95
APS-13 Xmitter-Rec. New	17.95
BC-645 Xmitter-Rec. New	14.95
ARB Receivers	24.95
BC-375 Transmitter	11.95
BC-191 Transmitter	17.95
Tuning Units for above	10.95
BC-223 with I TU	49.50
I-152C indic. 3' CRT	9.95
ASB series Receiver	17.95
BC-929A Indic. New	15.95
APQ 2 HF Transmitter	19.95
T-10 code practice mach. with 1 set new tapes	49.50
BC-683 Rec. Lim. Quant.	24.95
RAX Receiver 200-1500 Kc.; 1.5-9 Mc. 7-27 Mc. Each	15.95
RA-10 Receiver Models FA, DA	39.95
MN-26 C Receiver. New	21.95
MN-26 Y Receiver	19.95
BC-433 Receiver	10.95
MN-20 E Loop. New	6.95
BC-434 Control Box. New	1.49
ARN-7 Receiver	12.95
CAARN-7 Control Box	4.95
PE-237 Vibra-Pack 6, 12, 24 V. Input. Output: 525 V, .095 A; 100V, .042A; 6.5 V, 2 A; 6 V, .5 A; 35 V, .450 A	12.95

DYNAMOTORS

Input	Output	Price
6-9v	250v-450v	\$ 3.95
12v DM34	220v-.08A	6.95
12v DM35	625v-.225ma	14.95
14v BDB69	440v-.08A	4.95
14v—fits command Rcvr.		
18v	250v-.06A	7.95
18v	450v-.06A	1.95
28v DM32	250v-.06A	3.00
28v DY8	590v-100A	3.00
12v BD77	1000v-.35A	9.95
12v winco	440v-.200A	4.95
28v BD73	1000v-.35A	6.95
28v DA3A	300v-.26A	
	150v-.010A, 14.5v-.5A.	3.95
19.5v DA31A	360v.06A 100v-.01A.	1.95

NEW TRANSFORMERS

All 110V Primary

600vct 070A, 6.3v 2.5A	\$ 1.19
600vct 050A, 5v 2A ct 2.5v 5A	1.19
660vct 040A, 5v 2A ct 2.5v 4A	1.19
3200vct 3A no ct. ea. \$3.95; 2 for	14.95
250v DC-.150A, 5v 3A, 6v 5A	3.95
880vct .115A, 6.3v 4.5A, 1.5v 5A	4.95
12-24v. 2A	2.19
5v 3Act. 6.3vct 6A, 33v .15A	1.95
FL 5 1000 cycle audio filter	\$0.97
FL 8 1000 cycle audio filter	1.89

METERS

3" round, 15ma movement, scale 0-300A	\$1.95
60-0-60 Amp/DC	.97

MISCELLANEOUS BARGAIN ITEMS	
2 Ft. whip collap.	\$.49
TV Booster—National manufacturer	12.95
Headphones, HS 33, Low Imped. New	2.95
Headphones, HS 23, Used	1.95
EE 8 Field phones, Pr.	14.95
Corona balls, VT 127, etc.	12 for 1.00

FILTER CHOKES	FILTER CONDENSERS
10 hy, 150ma. . . . \$1.49	2 ufd, 600v. . . . \$0.19
10 hy, 200ma. . . . 3.19	10 ufd, 600v.99
12 hy, 150ma. . . . 1.59	1 ufd, 1000v. . . . 1.19
6 hy, 100ma. . . . 1.19	8 ufd, 2kv. . . . 3.49
Dual 12 hy, 200 ma 3.95	2 ufd, 2500v. . . . 2.39
	1 ufd, 3600v. . . . 2.95
	1 ufd, 4000v. . . . 2.95
	3 ufd, 4000v. . . . 3.95
	2 ufd, 5000v. . . . 4.95

MICA CONDENSERS

5c ea.	29c ea.	49c ea.
.002-400v	11-1200v	
.0062-400v	112-1200v	00007-5000v
.0001-400v	112-2000v	00003-2000v
.0002-400v	006-3000v	00009-3000v
.004-600v		
.005-600v	002-5000v	.97c

ESEGE SALES COMPANY, LTD.

1306 Bond Street at Pico Los Angeles 15, Cal.
Terms: Cash with Order—Prices subject to change

HOW DO YOU FIGURE PROFIT?

By HAROLD J. ASHE

Are you making a fair return on investment plus compensation for your personal services in shop?

HOW do you figure your net profit from your radio and television service shop? Talks with several shop owners and an examination of their books and preparation of their income tax returns have given rise to a strong suspicion that many have delusions of grandeur as to what constitutes their net earnings from business.

Take the case of a fellow we'll call Joe. Joe came out of the Army in 1945 and immediately opened a small service shop in a thriving western community. Joe is really a whiz of a service technician, himself, and he is assisted by another GI who is just as capable. The business has grown rapidly.

In 1948 Joe's net profit, as reported in his income tax return, was \$6100. Joe, in his quiet and modest way, feels he has hit the jackpot. After all, before entering the services in 1941, he made about \$30 a week working for another shop owner, so he can be pardoned if he feels a slight glow of achievement.

The trouble with Joe is that he is comparing the two unlike periods of 1941 and 1949, and two unlike situations. In 1941 he was working for wages without any investment on his part. In 1949 he is a shop owner with a considerable amount of money tied up in a business of his own. In addition to his own services, his wife helps him in the shop, keeps his books, answers the telephone, and makes herself generally useful in the business. If it were not for his wife's assistance, Joe would be obliged to hire an office girl.

Now the facts of Joe's situation are simply these. He could get a job with another shop for at least \$75 a week, with two weeks of paid vacation annually. His wife who has had a wide business experience could easily command at the very least a \$35 a week salary. Between them they could have drawn down salaries aggregating \$5720 a year.

By rigid economies in his home, Joe has kept ploughing his profits back into the business until, today, he has close to \$6000 invested in his small shop. If he did not have this money tied up in his business he could put it

out at interest which would bring him \$360 a year income without risk or worry.

If Joe and Mrs. Joe worked for wages and drew interest from their savings, they'd have an income of \$6080 a year. Now Joe's business operation starts coming into focus. Instead of making \$6200 a year profit, Joe and his wife are making \$5720 in wages, \$360 in interest, and *only \$120 in real net profits!*

What is misleading Joe and giving him the illusion of big profits that, in fact, do not exist is his income tax return. In the income tax return he is not permitted to deduct any wage or salary for himself or his wife. The purpose of the income tax return is to determine the amount of income subject to income tax, and in this respect there is no quarrel with the tax return.

However, most individual taxpayers view the tax return as an infallible indication of their *net profits*. To determine the true net profit on his investment, which is the traditional method of calculating net profit, Joe should, for his own information at least, pay himself a salary and also pay one for his wife's services.

It has already been pointed out that Joe would be able to earn a salary of \$75 with another shop. There Joe would work 40 hours a week, 50 weeks a year, with pay for 52 weeks. Joe doesn't put in any overtime, or lie awake nights worrying about how to increase business, when working for a salary. He does plenty of that in his own business.

Working for an employer, Joe would be covered by unemployment insurance and have old age benefits. He has neither in his own business. Neither is his wife covered by such benefits.

We are not suggesting that, in view of the foregoing, Joe dispose of his business and seek out an employer. Quite the contrary. We are trying to underscore a situation that is too seldom appreciated by the small shop owner, namely, that he is entitled to something more than a going wage plus 6 per-cent interest on the money he has tied up in his shop as his reward for being in business. Until he understands this circumstance in the con-

duct of his shop, he is actually getting no substantial reward for the risk he is taking in being an independent venturer, but is only selling his time piecemeal.

We do feel that if Joe and the thousands of other Joes operating little service shops around the country get a proper perspective on their operations, they may be persuaded to the conclusion that they, too, have been working only for wages. They may come to a realization that what they have been happily calling their "net profits" are actually illusory.

Considering the time that his wife contributes to the business and the overtime he, himself, puts in, Joe is actually not making hour for hour much more than his employee, though Joe would be shocked if he were aware of this.

What's the answer? First, Joe must continue to determine his net profit from his shop for income tax purposes in the same manner that he has in the past, and that is *not* to deduct wages for himself or his wife.

However, merely for his own information, he should scrupulously make wage or salary deductions for both himself and his wife to determine the real net profit accruing to him for his investment and for his managerial services over and above his labor as a technician.

When he does this he may have a true picture of what ownership of the business is worth to him in hard dollars and cents. At this point he may question the soundness of present service charges which are not sufficient to permit a *real profit*. If enough Joes get the same idea there may be a sharp reduction in the throat-cutting and price-slashing that now bedevils shop owners trying to make an honest profit-on-investment over and above full compensation for their personal services in the shop.

-30-

NEON LIGHT WITH STROBOSCOPIC DISC

WHEN turntable speeds are checked with a stroboscopic disc, much better indications of the bars on the disc can be had by the use of a neon bulb as the light. The reason for this is that the light from the neon bulb actually goes off completely (at the rate of twice the line frequency); whereas, with the incandescent bulb, the light does not go completely off at the zero voltage instant of the line voltage sine wave because of the resistance of the filament. In other words, the filament will emit light for a minute length of time after it is heated, hence the filament is still emitting light when the sine wave passes thru zero.

The 2-watt, 115-volt neon bulb with the standard size screw base works effectively because it can be directly used in any light socket. The best way to see and appreciate the better results using the neon bulb is to actually try it, and compare it to the incandescent bulb.

Similar results can be had with fluorescent lights, as they also are a gas-filled lamp. M.K.

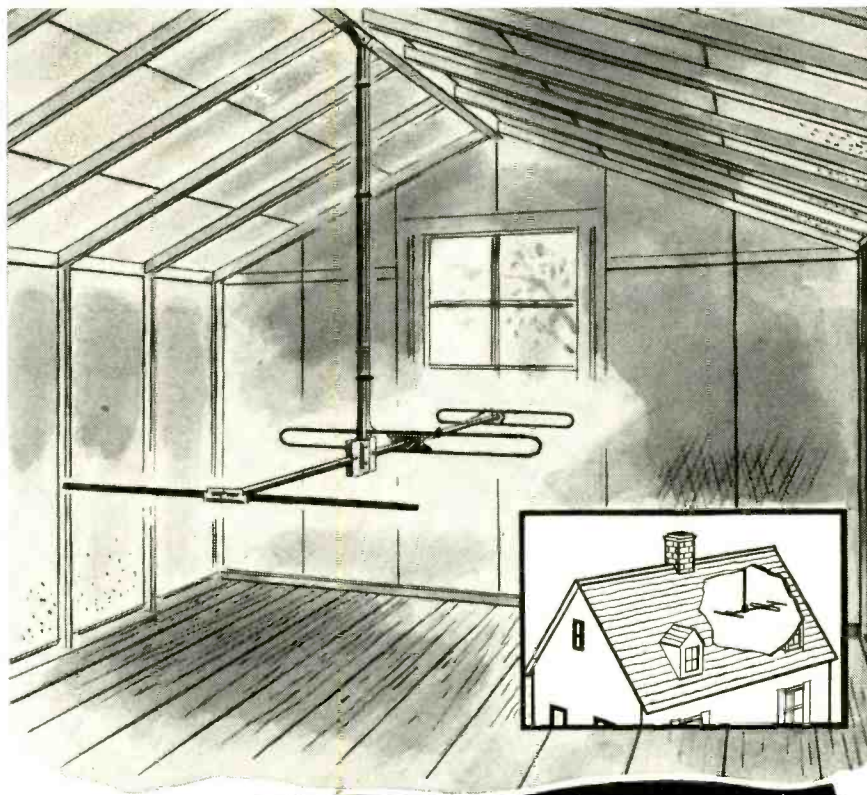

for a PERFECT ATTIC INSTALLATION

• WARD TVH-52 is a high-gain high-low antenna that can be conveniently hidden away inside a building and yet give you the best *outdoor* reception. Suspended upside down with WARD bracket C-14 it occupies no usable space whatever! This is a neat trick that has many, many uses and has been thoroughly field-tested. You can use it.

TVH-52



WARD PRODUCTS CORPORATION

Division of the Gabriel Co.

1523 EAST 45TH STREET • CLEVELAND 3



RADIO and TELEVISION

Thorough Training in All Technical Phases

APPROVED FOR VETERANS

WEEKLY RATES DAYS—EVENINGS

FREE PLACEMENT SERVICE FOR GRADUATES

For Free Catalog write Dept. RN-50
RCA INSTITUTES, INC.
A Service of Radio Corporation of America
350 West 4th St., New York 14, N. Y.



BARGAIN HUNTING?

RADIO SERVICEMEN!

Write for SENSATIONAL CATALOG
HENSHAW RADIO SUPPLY
3619 TROOST KANSAS CITY, MO.

Compare

TESCO'S PRICES

1230—Double Bay Conical.....	\$7.31
1215—Swift-Rig Folded Hi and Lo.....	4.43
1814—Economy Chimney Mount—dozen lots.....	.89
1302-1306—Five El. Yagi any Lo-Channel.....	11.25
1307-1313—Five El. Yagi any Hi-Channel.....	4.95
1219—Swift-Rig Folded Hi Straight Lo.....	4.07
2102—Deluxe Indoor Antenna.....	1.95
1860—Chimney Mount—dozen lots.....	1.00
1873—3 1/2" Mast Standoff Ins.—lots of 100.....	.06
1870—3 1/2" Wood Screw-Eye Ins.—lots of 250.....	.02
1874—4" Nail-in Insulator—lots of 250.....	.02
1862—10'-1 1/4" Galv. Steel Mast—dozen lots.....	1.20
1229—Single Bay Conical.....	3.90
1231—Four Bay Conical.....	15.89

Send for quantity prices and complete list

TELEVISION SUPPLY CO.
Box 213 Gracie Square Station
New York, N. Y.



NOW!
AT Hy-Grade!

the **SKY-HIGHEST VALUE** in Television Today!

World Famous Quality

630 TV CHASSIS
only **\$139.95**
less CRT



Yes, you can believe your eyes! Here's the exact duplicate of the incomparable RCA 630TS Circuit—television's unmatched standard for super-sensitivity and stability—now with all the newest features of trigger-fast Keyed AGC, Voltage Doubler, Standard Tuner, molded condensers, plus the finest quality components, Yoke, Focus Coil, Mounting Brackets, plus 30 tubes. Supplies 13 to 14KV under load for full brilliance and width for all rectangular and round 12½, 16 and 19" tubes.

At only \$139.95 this is the TV super-value you can't afford to miss! Order several NOW! Immediate Delivery! 25% deposit with order, balance COD, f.o.b. Brooklyn, N. Y.

for **SKY-HY VALUES** at rock-bottom costs—it's **HY-GRADE!**

Hy-Grade Electronics, inc.

1509 EAST NEW YORK AVE., BROOKLYN 12, N. Y.

National Distributors
of Electronic Parts
and Equipment

**NEW MUSIC LOVERS
AMPLIFIER**
the **GROMMES CUSTOM**

undisputed best... "Ears" or Instruments!



MODEL 50 PG
Dealer's Net
\$45.00

MODEL 200 PG
Dealer's Net
\$150.00

Exclusive feedback circuits. Model 200 PG offers frequency response of ±0.1 DB. 10 to 50,000 CPS. Distortion at 20 watts is 0.2%—no phase shift or transient oscillations of any kind. Write today for free technical bulletin.

PRECISION ELECTRONICS, INC.

641-43 MILWAUKEE AVENUE • CHICAGO 22, ILLINOIS

**59¢ REPLACES
BROKEN DETENTS!**



Send us your broken RCA-type detents, with 59 cents for each, and we ship you expertly factory-rebuilt detent replacements, guaranteed as new! Immediate delivery from stock—Shipped f.o.b. Brooklyn, N. Y. Round up those detents NOW!

**BARBER-COLMAN
CONTROL MOTOR**

TYPE AYLC 5091

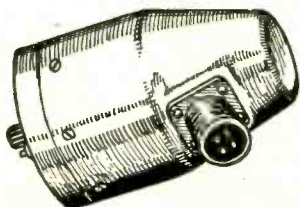

24 Volts D.C. 7 Amp. 1 R.P.M. Reversible, Torque 500 in. lbs. Contains two adjustable limit switches with contacts for position indication. Ideal for use as a remote positioner or beam or television antenna rotor. Will operate on 60 Cy. **\$6.50** Ea. Net Complete with instructions.

GENERAL ELECTRIC SELSYN

Type 2J1G1

Will operate from 110 volts, 60 cycle by using a resistor or a condenser in series. Size is 2¼" in diameter x 4¾" long. Ideal for beam antenna position indicator.

Price **\$2.75** per pair — removed from new equipment



INSTRUMENT ASSOCIATES

37 EAST BAY VIEW AVE.
GREAT NECK, N. Y.
IMperial 7-1147

500 Watt R.F. Amplifier

(Continued from page 45)

vertical plates of the oscilloscope are connected, through a shielded line, to the two or three turns of insulated wire, wound over the center of the antenna coil, which are used for r.f. pickup; the horizontal plates are connected to the modulation transformer secondary through a 50,000 ohm potentiometer and a 0.05 μfd. isolating condenser. The purpose of the potentiometer is to keep the sweep trace within the screen area of the cathode-ray tube while making necessary adjustments.

Apply plate and screen voltage and r.f. excitation to the HK-257-B's and adjust the input coupling so that approximately 6 milliamperes of grid current is obtained. The coupling between the antenna and the amplifier plate tank is adjusted for approximately 110 milliamperes of plate current. Now, feed a 400 cycle audio frequency signal to the speech amplifier microphone input and bring up the gain until a slight movement of the plate current milliammeter is noticed. Set the gain control just below the point where this slight change in plate current occurs. Adjust the 50,000 ohm potentiometer until the sweep trace covers about three-fourths of the diameter of the cathode-ray tube screen. The pattern on the oscilloscope should be triangular with straight sides as shown in Fig. 6. If the pattern is not of the shape indicated, adjust the antenna coupling, the grid excitation and the speech amplifier gain until the desired pattern is obtained. The bias values shown in the table are approximately correct for the plate and screen voltage indicated and these values should not be changed unless the triangular pattern cannot be obtained with the adjustments outlined above. The grid excitation and antenna loading, while not extremely critical, require careful adjustment in a suppressor modulated amplifier.

One of the greatest problems encountered in amateur radio today is interference with other services, particularly television. This type of trouble is likely to become more and more prevalent as the city residential areas become saturated with video receiver installations. The amplifier described if properly constructed, adjusted, and operated in a well-shielded rack should not cause interference in television receivers unless the receiving antenna is located nearby. It has been found that a great deal of television interference from amateur transmitters is due to the excessively large amounts of driving power used in the average rig. This is especially true where doubler amplifiers are used to drive the final amplifier. The doubler is usually operated with large amounts of grid bias in order to obtain better efficiency and

greater output at the operating frequency. It must be remembered that not only second harmonic energy is produced but higher harmonics as well. This high order harmonic signal energy is coupled through the interelectrode capacitance of the final amplifier tubes to the antenna where it is radiated into space. In checking interference of this type it generally will be found that operation of the final amplifier will make but little difference in the interference intensity. This amplifier will tend to reduce this type of interference.

However, if the amplifier is to be operated in a locality where television interference is likely to occur, several precautions may be taken at the time the amplifier is being constructed. First of all, do not use a doubler type of driver stage; use some type of tube which will operate "straight-through" and do any necessary doubling in the previous stages. Doublers should be receiving type tubes, well shielded and operated at very low power inputs. Make certain that all racks and cabinets are grounded. It may be necessary to place an r.f. choke in each leg of the 117 volt a.c. line; if so, the chokes should be placed in a shielded metal box which is connected to ground.

If the interfering signal is being radiated by the antenna, its intensity usually will vary when the antenna coupling is changed or the antenna is removed. If no change is noticed, the interference is probably reaching the television receiver through the house wiring or by radiation from the transmitter wiring. If it is certain that the interference is coming from the transmitting antenna, certain changes in the final amplifier will tend to reduce or eliminate the trouble. A small air-dielectric fixed condenser of approximately 20 μ fd. value may be connected directly from each HK-257-B plate to filament. These condensers may be similar to those used for neutralizing purposes and should be of sufficiently high voltage rating to stand the plate voltage plus the modulation voltage peaks. The leads to the plates and filaments should be extremely short to eliminate any inductance effect. Since these condensers add capacitance to the tank circuit, it will be necessary to readjust the plate tank tuning condenser in order to restore resonance.

The most likely cause of interference from the amplifier itself would be radiation of third harmonic energy since the second harmonic will be cancelled if the two tubes are properly balanced. Fig. 7 shows a trap arrangement used by the author to eliminate a third harmonic signal which caused interference with an FM receiver. In this case, a voltmeter was placed across the receiver discriminator load resistor and the traps were adjusted for minimum reading on the voltmeter.

ART RADIO Gives You 50-10 OFF

On Orders of 100 Tubes or More
50 & 5 On Orders of 25 Tubes or More
ONLY 50% DISCOUNT ON ORDERS LESS THAN 25 TUBES

All prices below are List prices, not selling prices. To find your cost, total the list price of the tubes selected. If 25 or more tubes are selected take 50% and 5% Off. If 100 or more tubes are selected take 50% and 10% Off. Only 50% Off on orders of less than 25 tubes . . .

STANDARD BRANDS

BRAND NEW! JOBBERS FRESH STOCK. ALL IN ORIGINAL CARTONS! RCA, SYLVANIA, TUNGSOIL, HYTRON, NATIONAL UNION, RAYTHEON, KEN-RAD, AND GE. No orders accepted for individual Brands. Orders will be filled with whatever brand is available at time orders are received. You can depend on receiving First Class merchandise. All tubes carry standard RMA guarantee. No orders under \$5. All prices are subject to change without notice. 10% Deposit with all C.O.D. orders.

Type	List	Type	List	Type	List	Type	List	Type	List	Type	List		
0Y4	\$3.55	2A4G	\$4.80	6AV6	\$1.50	6L7G	\$2.90	7B4	\$1.80	12SG7	\$2.20	35/51	\$2.00
0Z4	1.65	2A5	2.20	6AW6	2.65	6N6G	3.20	7B5	1.80	12SF5GT	2.00	35A5	1.80
0Z4G	1.65	2A6	2.65	6AX5GT	1.35	6N7	2.40	7B6	1.80	12SF7	2.00	35B5	2.00
1A4P	3.90	2A7	2.65	6B4G	3.20	6N7GT	2.40	7B7	1.80	12SF7GT	2.00	35C5	2.00
1A5GT	1.80	2B7	2.65	6B5	3.20	6P5GT	2.40	7B8	1.80	12SG7	2.00	35L6GT	1.65
1A6	3.55	3A8GT	4.80	6B6G	2.20	6Q7	2.00	7C4/1203	2.65	12SH7	2.00	35W4	1.25
1A7GT	2.00	3B7/1291	2.65	6B6	3.20	6Q7G	1.80	7C5	1.80	12SJ7	1.65	35Y4	1.80
1A85	2.65	3C6/XXB	3.20	6B8G	3.20	6Q7GT	1.80	7C6	1.80	12SJ7GT	1.65	35Z3	1.80
1B3GT	2.65	3D6/1299	2.65	6BA6	1.80	6R7	2.65	7C7	1.80	12SK7	1.65	35Z4GT	1.50
1B4P	3.90	3E6	2.65	6B7A	2.40	6R7GT	2.65	7E5/1201	2.65	12SK7GT	1.65	35Z5GT	1.25
1B5/25S	3.20	3L4	2.65	6B85	1.65	6S4	1.65	7E6	2.20	12SL7GT	2.40	36	2.65
1B7GT	3.20	3Q4	2.20	6B0C	2.00	6S7G	3.20	7E7	2.65	12SN7GT	2.20	37	1.80
1C5GT	2.20	3Q5GT	2.40	6B6E	1.80	6S8GT	2.65	7F7	2.20	12SQ7	1.50	38	2.60
1C6	3.20	3S4	2.00	6B7F	1.65	6S7A	1.65	7F8	2.65	12SQ7GT	1.50	39 44	2.25
1C7G	3.20	3V4	2.00	6B6GG	4.80	6SA7GT	1.65	7G1/1232	2.65	12Z3	2.65	41	1.65
1D5GP	3.90	5A2A	1.35	6B85	2.00	6S7Y	2.40	7H7	2.65	12Z87	2.20	42	1.65
1D7G	3.20	5T4	3.90	6B16	2.00	6S7	2.00	7I7	2.65	14A4	2.65	43	1.65
1D8GT	3.90	5U4G	1.50	6B0GGT	3.20	6S07GT	2.90	7K7	2.65	14A5	3.90	45	1.65
1E5GP	3.90	5V4G	2.40	6C4	1.65	6S7S	1.65	7L7	2.65	14J7/12B7	2.20	45Z3	1.80
1E7GT	3.90	5W4	1.65	6C5	1.65	6S7SGT	1.80	7M7	2.20	14F7 (XXD)	2.40	45Z5GT	1.80
1F4	2.65	5W4GT	1.65	6C5GT	1.65	6S7T	2.00	7O7	1.80	14B6	2.20	46	2.65
1F5G	2.65	5X4G	1.80	6C6	2.00	6S7	2.00	7R7	2.20	14B8	2.20	47	2.40
1F6	3.90	5Y3G	1.05	6C8G	3.20	6S7H	2.20	7S7	2.65	14C5	2.65	50	3.90
1F7G	3.90	5Y3GT	1.05	6C8E	2.00	6S17	1.65	7V7	2.65	14C7	2.40	50A5	2.20
1C4GT	2.65	5Y4G	1.50	6C0GG	6.00	6S17GT	1.65	7W7	2.65	14E6	2.20	50B5	2.00
1G6GT	2.65	5Z3	1.80	6D6	1.65	6SK7	1.65	7X7 (XXFM)	2.65	14E7	2.65	50C5	2.00
1H4G	2.20	5Z4	2.65	6D8G	3.20	6SK7GT	1.65	7Y4	1.80	14F7	2.20	50L6GT	1.65
1H5GT	1.65	6A3	3.20	6E5	2.20	6SL7GT	2.40	7Z4	1.80	14F8	2.65	50X6	2.20
1H6GT	3.20	6A6	2.65	6F5	1.65	6SN7GT	2.20	12A6	2.65	14H7	2.40	50Y6GT	1.80
1J6GT	3.20	6A7	2.00	6F5GT	1.65	6SQ7	1.50	12A7	3.20	14J7	2.65	50Y7GT	2.00
1L4	2.00	6A8	2.00	6F6	2.00	6SQ7GT	1.50	12A8GT	2.00	14N7	2.65	53	2.65
1L4A	2.65	6A8G	2.00	6F6G	1.65	6SR7	1.80	12AH7GT	2.65	14Q7	2.20	55	2.20
1L4A6	2.65	6A8GT	2.00	6F6GT	1.65	6SR7GT	1.80	12AL5	2.00	14R7	2.65	56	1.80
1L4B	2.65	6A8A	2.00	6F7	3.20	6SS7	1.80	12AT6	1.50	14S7	2.65	57	2.00
1L4C5	2.65	6A8S/6N5	2.65	6F8G	3.20	6SV7	2.90	12AT7	2.90	14W7	2.65	58	2.00
1L4C6	2.65	6A8T	3.20	6G6G	2.65	6T7G	3.20	12AU6	2.00	14Y4	2.40	59	3.55
1L4D5	2.65	6AC5GT	2.90	6H6	1.65	6T8	2.90	12AU7	2.40	19	3.20	70L7GT	3.90
1L4E3	2.65	6AC7	2.90	6H6GT	1.65	6U4GT	2.65	12AV6	1.50	19B6G	6.00	71A	2.00
1L4G5	2.65	6AD7G	3.20	6J5	1.50	6U5	2.80	12AV7	3.20	1916	3.20	74	1.65
1L4H4	2.65	6AF6G	2.65	6J5GT	1.50	6U7G	1.80	12AW6	2.65	19T8	2.90	76	1.65
1L4N5	2.65	6AG5	2.65	6J6	2.90	6V8	3.20	12AX7	2.40	2A4	2.20	77	1.65
1H5GT	2.00	6AG7	3.20	6J7	2.00	6V8GT	2.00	12BAG	1.80	25A6G	2.65	78	1.65
1P5GT	2.65	6AH6	3.90	6J7G	2.00	6W4GT	1.80	12BA7	2.40	25AC5GT	3.90	80	1.15
1Q5GT	2.65	6AK5	3.90	6J7GT	2.00	6X4	1.50	12B06	2.00	25B06GT	3.20	81	3.90
1R4	2.65	6AK6	2.40	6J8E	3.20	6X5GT	1.50	12B6E	1.80	25L6GT	1.65	82	2.65
1R5	2.00	6AL5	2.00	6K5GT	2.40	6Y6G	2.40	12B7	2.40	25W4GT	2.00	83	2.65
1S4	2.40	6AL7GT	2.65	6K6GT	1.50	6Z5YG	2.20	12F5GT	1.80	25Y5	2.90	83V	3.20
1S5	1.80	6AQ5	2.00	6K7	1.65	7A4 (XXL)	2.00	12J5GT	1.50	25Z5	1.59	84/6Z4	1.80
1T4	2.00	6AQ6	1.80	6K7G	1.65	7A5	2.20	12J7GT	2.00	25Z6GT	1.35	85	2.20
1T5GT	2.65	6AQ7GT	2.40	6K7GT	1.65	7A6	1.80	12K7GT	1.65	26	1.80	117L/M7GT	3.90
1U4	2.00	6AR5	1.65	6K8	2.40	7A7	1.80	12K8	2.40	27	1.50	117N7GT	3.90
1U5	1.80	6AS5	2.00	6K8GT	2.40	7A8	1.80	12K8GT	2.40	30	2.00	117P7GT	3.90
1V	2.20	6AT6	1.50	6L5G	2.65	7AD7	3.20	12Q7GT	1.80	32	3.55	117Z3	1.50
1V2	2.65	6AU5GT	2.65	6L6	3.55	7AF7	1.80	12S8GT	2.65	32L7GT	3.20	117Z4GT	2.40
1X2	2.65	6AU6	2.00	6L6G	2.90	7AG7	2.20	12SA7	1.65	33	3.20	117Z6GT	2.40
2A3	3.20	6AV5GT	3.20	6L7	2.40	7AH7	2.20	12SA7GT	1.65	34	3.20	1273	2.40
												1280	2.40
												FM1000	3.20

WHEN ORDERING TUBES ON THIS PAGE STATE "JOBBERS STOCK."

ALL MERCHANDISE SHIPPED F. O. B. NEW YORK

WRITE FOR BARGAIN CATALOG N-6

ART RADIO CO. 115 LIBERTY St., New York 6, N.Y.

Phone: COrtlandt 7-2918

When answering Advertisements please mention
RADIO & TELEVISION NEWS

A. C. ANYWHERE

with Katolight Plants. Dealers who use these portable Plants for electric drilling, testing wiring circuits, etc., will find easy sales to other tradesmen such as carpenters, wool blowers, plumbers, etc.
Mfrs. of A.C. Generators up to 375 KVA. Rotary Converters, Motor Generator Sets, A.C. and D.C. Motors.



Write for pamphlet

KATO ENGINEERING COMPANY

1460 First Avenue
Mankato, Minnesota

RADIO Engineering

Complete Radio Engineering course incl. Telev., U.H.F., and F.M. B.S. Degree Courses also in Civil, Elect., Mech., Chem., and Aero Eng.; Bus. Adm., Acct. Visit campus, see well equipped labs. Low cost. Prep courses. Personalized instruction. Grads successful. Founded in 1884. Enter Jan., March, June, Sept. Write for catalog.

DEGREE
IN 27
MONTHS

TRI-STATE COLLEGE
1460 COLLEGE AVENUE ANGOLA, INDIANA

SAVE \$180!
BANISH FOREVER
HOT DAYS!
HOT NIGHTS!
VARIABLE ELECTRIC
(PATENTED FILTER)
FOR COOL—CLEAN AIR
WINTER & SUMMER
BRAND NEW!

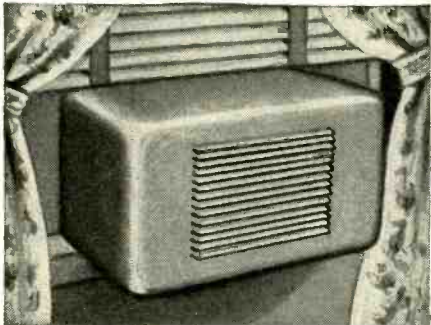

No Dirt—No Draft—No Noise
Continuous Variable Control

PLUG IN LIKE A RADIO—NO INSTALLATION REQUIRED

DELIVERS 695 (C. F. M.) CUBIC
FEET PER MINUTE IN FREE AIR

PERFECT VENTILATION. Air filtration is assured by use of PATENTED FILTER for ELIMINATING DUST, DIRT, and POLLEN from outdoors.

Ventilates your room with CLEAN, COOL, FILTERED AIR SUMMER or WINTER. Enables you to SUBDUCE outside NOISES by keeping windows closed and to get the amount of air you want, whether calm or stormy.

Easily ADAPTED TO ANY WINDOW without cutting or marring; mounted flush with inside of window for pleasing appearance.

Cabinet is made of HEAVY STEEL with "BAKED ON" BRONZE HAMBERTONE FINISH. Will blend with all home, office, or factory surroundings.

A SENSATIONAL BUY! Mfg. List \$85.00 **\$44.95** F.O.B. N.Y.C.
110V 60 Cycle AC Your Price

220-230 V.A.C., Mfg. List \$125—YOUR PRICE...\$59.95
110 V.D.C., Mfg. List \$125—YOUR PRICE...\$59.95
220-250 V.D.C., Mfg. List \$125—YOUR PRICE...\$59.95
 (Plus 10% U. S. Excise Tax)

TERMS: 20% Deposit, Balance C.O.D., F.O.B. N. Y. C. Rated firms open a/c net 10 days.

References: Marine Midland Bank & Trust Co., 143 Liberty St., N. Y. C., N. Y.

FREE! FREE! FREE!

Send for Full Color Literature and Specifications. Penny Postcard Will Do.

MANUEL KLEIN
76 CORTLANDT STREET
NEW YORK 7, N. Y. REctor 2-6460

LETTERS

from our readers

MODEL-T VIDEO

IN YOUR January issue you have an editorial 'Is Television Going Model T' which we think is one of the best things we have yet read on the subject.

"We enjoy the 'News' every month. Keep up the good work!"

Chet Nowick
 Preferred Stores, Inc.
 North Pelham, N. Y.

* * *

PROSPECTIVE HAM

IT HAS been my earnest desire to obtain a ham ticket for many years.

"At this writing I find myself with the available time. As the sales representative of a large corporation, I travel the eastern half of Iowa and the northern portion of Illinois, excluding Chicago. Evenings are spent in all of the large towns in this area. I promise to answer all hams who contact me, and if agreeable with them, to drop around for a look at their rigs when in their cities."

William E. Wheeler
 333 South Osborn
 Kankakee, Illinois

* * *

MALIGNED HAMS

WHILE the armed services, government agencies, electronics industry, and a small part of the public generally laud radio amateurs for their various services (traffic handling, contributions to technical development, availability during national emergencies, etc.), the greater part of the public seems to take an extremely dim view of us once they've heard a click on their receivers or observed a flicker on their TV screens—even though the fault, in most instances, lies with inferior radios and TV sets.

"Not infrequently I have heard assertions like 'Those d— amateurs should be put off the air.' Some of these statements are made with such arrogant airs that they seem to imply an encroachment by amateurs upon public frequencies. Indeed many of these people are quite ignorant of the fact that amateurs are government licensed. I hesitate to contemplate the technical status of radio today had not amateur radio existed—perhaps these people who are so ready to condemn the ham would still be using t.r.f. receivers.

"While most of us are aware that the word 'amateur' denotes one who loves an art for the art's sake alone it unfortunately has the connotation of second or third rater. People, therefore, labor under the delusion that an amateur radio operator is a Peck's Bad Boy surreptitiously diddling in a cellar

with a broken light bulb and a hammer, whereas the truth of the matter is quite the opposite. Many hams have attained levels of technical knowledge and skill equalling or surpassing that of some graduate engineers.

"I submit that a considerable part of the scorn evidenced by the public toward hams is brought on by the very name of our hobby—'amateur radio.' I proposed that it be renamed. 'Avoradio,' a composite word comprised of the words 'avocational' and 'radio,' should be of benefit in erasing the described stigma."

Peter N. Saveskie, W5QXH
 Baton Rouge, La.

* * *

SERVICE LIABILITY

IHAVE read RADIO & TELEVISION NEWS with great interest for an extended period of time. Your magazine publishes excellent technical and practical articles. I do believe, however, that you are omitting advice to your readers who are in the radio service and installation business concerning the pitfalls which lie on every side. I refer to the possibility of serious financial loss in the event that these technicians do not have the proper and adequate forms of insurance coverage!

"In New York, for one example, if a radio shop engages to install an antenna, and particularly a television antenna, if he has one employee, he must under the State Workmen's Compensation Law, have compensation insurance, particularly if such employee performs the erection work. You are aware, of course, that the erection of a television antenna, particularly in a fringe area, is a task more hazardous than installing a roof on the same building. The roofer contemplates a large job and, therefore, employs adequate equipment such as safe ladders, scaffolding, life belts, safety stops for the worker's feet to rest on, and other safety devices. We question that the smaller radio shops are so equipped. If they are not, they should abstain from accepting such erection operations, but should arrange with a reliable roofing or similar concern to install the antenna. If the shop persists in such operation and an employee is injured or killed and the employer does not have compensation insurance, he is not only liable for penalties for violating the state law, but is also liable for the medical bills and lost time arising from the injury sustained.

"In the event of death of an employee, he is liable to the dependents of the deceased. These are substantial sums of money, the payment of which can wipe out the effort of a lifetime in building the business. Furthermore, insurance on a risk of this type is gen-

RADIO & TELEVISION NEWS

erally undesirable to the many insurance companies because the hazards involved are extreme and the possibility of losses acute.

"This is not the only phase of the insurance problem. Let us assume that in the erection operation the device, which is awkward and bulky to handle, gets out of control and falls. If it falls to the street and injures or kills a passerby, the proprietor is liable for such injury to a member of the public. He is liable also to the owners of any property which may be damaged by the falling material. This coverage is known as Contractors' Bodily Injury and Property Damage Liability insurance.

"In our appraisal of the possibilities of financial loss to the radio service technician, we find additional booby traps. Let us assume that the installer has completed the job and that the equipment is presumably safely and satisfactorily installed. A short time later, a windstorm blows the installation, or part of it, away and someone is injured by the flying parts or someone's property is damaged. Subsequent investigation proves that a relatively unimportant part, a chimney strap for example, was designed for a smaller installation and gave way under a strain beyond its capacity. Similarly a guy wire may have been omitted which would have been required by ordinary consideration of good, safe practice. The victims of the accident have a right of action to recover damages

against the person or firm who performed the installation on the theory that the installation should have been strong enough to withstand the strain applied to it by the windstorm. This form of coverage is Products Liability (Completed Operations) insurance.

"It is well-known that until the lucrative rewards of television appeared, the plight of the average radio service technician was not one to be envied. Long hours and relatively low prices were his lot. Now that he has an opportunity to establish himself firmly, it is unfortunate that he has not been informed of his minimum insurance requirements, by a magazine to which he devotes considerable study. It may be that he would purchase protection against these hazards. I hope your magazine will publish a series of articles furnishing such information.

"This letter is not a plug for business but just a helpful bit of advice to the service technician."

C. L. Nunneker, Manager
Compensation Department
The Shelby Mutual Casualty Co.
Shelby, Ohio

* * *
MORE "MODEL T"

"YOUR editorial 'Is Television Going Model T' was not only a masterful piece of writing, but it was a wonderful display of moral courage. How could you ever muster up enough courage to call your shots like that and also put them where they hurt, or where they might do some good? Crit-

icizing TV manufacturers and advertisers is hardly editorial 'cricket,' I'd say.

"At any rate, I admire your bravery in letting these TV makers know that they 'ain't doin' right by the Nells' who purchase the late model TV sets. Such a piece should have some good effect. What you stated in your editorial is something that service technicians have long known, namely, that radio and TV makers are not putting out the best they have, nor the best they know how to make. It is just as well that they know that you and I know that!

"I suppose the present practice of cheapening TV set quality is a throwback from the days of making those \$8.95 'service technicians' nightmares' known as a.c.-d.c. midget radios that flooded the country after the set makers stopped making the good, transformer-type, straight a.c. models that we so sadly miss now.

"Curious indeed are the ways of manufacturers! They'll spend large sums for research to develop a product that is better than others. Then, when they have achieved their goal *rigor mortis* sets in, after which follows the process of cheapening the article until it is no longer worthy of purchase.

"Of course, as you stated, we must have 'cheapie' sets, since all can't afford the higher quality grades. But we should also have sets of the better quality for those who want something finer. Moreover, these better sets should be better sets of higher quality

NEW! the MEISSNER 9A

AMERICA'S GREATEST RADIO VALUE!

MEISSNER takes great pride in announcing their new 9A AM-FM chassis complete with Audio. The 9A brings real "Custom" quality reception into the low price field! A complete AM-FM unit — the 9A is a tuner, amplifier and power supply — everything you need for a deluxe custom installation or for converting older radios. Nine tubes, including rectifier, give the 9A ample power while a high degree of stability and selectivity is attained through superior MEISSNER circuit design and the use of high quality components. MEISSNER engineers stress that only a high quality speaker is capable of reproducing the wide range fidelity and tonal richness inherent in the 9A. See this fine instrument at your dealers now. Examine the workmanship — hear the glorious richness of its tone! Compare the MEISSNER 9A with units selling for twice its price. You will agree, it's MEISSNER — For Magnificent Reception!

AM-FM TUNER CHASSIS
COMPLETE WITH AUDIO

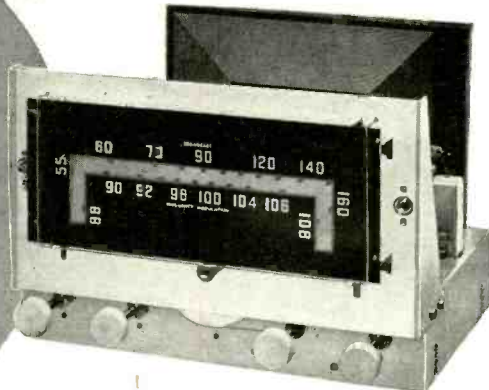

Here's the outstanding 9A — complete with tubes, power supply, built-in antenna, escutcheon, knobs, etc.

features that place the 9A in a class by itself

- High Selectivity and Sensitivity
- Full Audio Fidelity
- Full 4 Watts Output
- FM Circuit Temperature Compensated
- Air Wound FM Coils
- Separate AM and FM Condenser Sections
- Built-In High "Q" Die Stamped Loop Antenna
- Full Range Tone Control
- Complete Provision For Phono Input
- All Controls On Front Panel
- Power Outlet For Phono Motor

MEISSNER

FOR MAGNIFICENT RECEPTION

MEISSNER MFG. DIVISION, MAGUIRE INDUSTRIES, Inc., MT. CARMEL, ILLINOIS

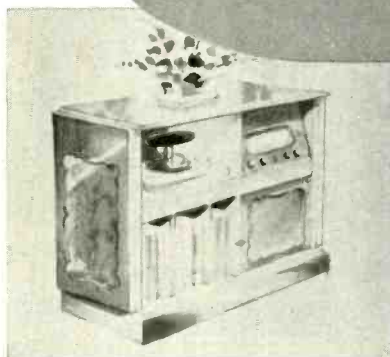

NEW!

**RECTANGULAR
BLACK TUBE**

16in. TELEKIT

**PRICES
BEGIN AT \$49.95
LESS TUBES**

**JOBBERS: WRITE FOR CONFIDENTIAL
PRICE INFORMATION**

TELEKIT 16BR
\$79.95 Less
Tubes

Now you can build your own rectangular black tube TV set! This exciting new Telekit has a big 160-inch screen from a non-flare rectangular black tube. The entire set is engineered for simplicity, and has new 70% deflection, with video tube mounted directly on chassis. Brightness is assured by a 14KV hi-voltage doubler circuit. The streamlined circuit is easy to assemble. No previous knowledge of TV is required. All you need is pliers, screw driver and soldering iron. The tuning unit and hi-voltage supply are factory wired and assembled for you. A big 54-page illustrated instruction book guides you through easy assembly. Satisfactory performance is guaranteed by our Telekit Factory Service Plan and warranty. Write today for full details.



12-B Telekit
\$69.95 Less
Tubes

8-B Telekit
\$49.95 Less
Tubes

Here are new low prices on Telekits. Now you can have a fine 8½- or 12½-inch set at a price far below comparable commercial sets costing much more. Over 30,000 Telekits have been assembled by following the big Telekit instruction book. No previous knowledge of TV is required. Satisfactory results are guaranteed under the Telekit Factory Service Plan. Write for full information.

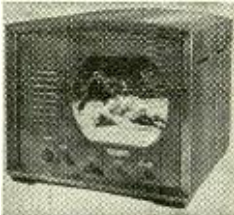

**TELEKIT
BOOSTER**
\$12.95

This Telekit Booster will bring in TV signals bright and clear. Especially helpful in fringe areas. Will give brilliant performance with any TV set. NOT A KIT. Completely assembled. With Tubes.



FREE—Write for catalogue listing Telekits, cabinets, tubes, antennas, boosters, and television accessories.

TELEKIT

ELECTRO-TECHNICAL INDUSTRIES
1432 N. BROAD ST. DEPT. R PHILADELPHIA 21 PA.

parts and performance, not the same cheap set stuck in a higher priced mahogany cabinet with an astronomical price tag attached. Too many manufacturers have been guilty of this trick.

"To the radio-minded individual it has been quite painful to observe radios of the sturdy, well-made, a.c. type degenerating into the present stock of a.c.-d.c. junk incapable of operating more than a few months before the rectifier or filter condensers peter out. Granted, this feature is profitable for the service technician, but it is still distasteful to him. I can tell you it has left a bad taste in the mouth of more than one customer—this frequent need for repair! It is most unfortunate to hear that TV makers are treading the same path and casting a blemish on tradenames that have been held in high regard by consumers for years. Such practices will not have a very salutary effect on the booming TV industry—in fact they may well 'boom—erang.'"

Dante Amorose
Amorose Radio
Richmond, Va.

* * *

RADAR DATA

"I HAVE a comment to make regarding an item appearing in 'Spot Radio News' in the April issue. "The writer was reporting on a speech by Commissioner Webster who posed the problem of supplying radar information to small ships.

"It seems to me that this problem could be solved very easily by feeding radar pictures through a low power television transmitter. This transmitter could be low powered and operate on the broadcast band. Since it would have to serve only the area out to sea, the transmission could be directional.

"Then all a ship at sea would have to have aboard to receive the radar service would be a broadcast TV receiver, which when compared to radar equipment would be very inexpensive.

"Other facilities that could be supplied by the shore station could include pictures of the harbor facilities, weather maps, and various other navigational aids. The sound channels could be used to advantage for instructions and weather data."

Roland Meister
54 Maple Street
Gardner, Mass.

* * *

ELECTRONIC ORGAN

"I JUST wanted to let you know that I built the instrument described by Jim Kirk in his article 'A Home-Built Electronic Organ' in the March issue and the little gadget works like a dream.

"I had a little trouble tuning up the organ but I soon found that I had the polarity of the audio transformers reversed and when I switched the leads the thing started oscillating perfectly.

"While it has been fun playing around with this small unit, and I have been using it for over a month now, I am looking forward to seeing an ar-

**It's
here!**

**The World's Finest
3-SPEED
RECORD CHANGER
Model RC-80
GARRARD
"Triumph"**



**PLAYS ALL
3 SPEEDS
—fully
automatic
with
automatic
stop**

**PRICED LOWER
THAN ANY PREVIOUS
GARRARD CHANGER**

Inexpensively installed
in your present set

At your dealer
or write to

GARRARD SALES CORP., 164 DUANE ST., N.Y.C.

**FREE
SAMPLE**

**Finest Solder
in the World!**



**the only 3 core solder
made with non-corrosive,
extra-active ERSIN FLUX!**

Actual performance proves that ERSIN MULTICORE melts more rapidly due to multiple core construction • removes surface oxides and prevents reforming • bonds properly on difficult metals • saves money • saves time

MULTICORE SALES CORP. N650
164 DUANE ST., NEW YORK 13, N. Y.

FREE!

Please send me a generous sample of Multicore Solder and helpful booklet, "Modern Soldering," at no obligation.

Name
Address
City
Zone State



MULTICORE SALES CORP.
164 Duane Street • New York 13, N. Y.

RADIO & TELEVISION NEWS

ticle on the more elaborate unit that Kirk mentioned he was building. I hope that you are planning to give us the dope on this in an early issue!

"Since building and using this organ I have been surprised to find out how many of my friends and acquaintances are interested in this same sort of deal. There isn't an awful lot of information available on how to home-build this kind of unit and I'd like to see you run more articles on the subject. A lot of your readers aren't hams or service technicians—just basement builders like myself—and this sort of article gives us something to get our teeth into and we really have something to show for our efforts.

"Keep up the good work and let's have more articles on audio equipment, and gadgets that we "unlicensed" guys can build and use.

Paul Bradford
Chicago, Illinois

Plans are already under way to carry an article on Mr. Kirk's more ambitious model electronic organ. The new unit covers a 66 note keyboard and can be used to play chords. Watch for it in a forthcoming issue of the magazine.

Audio Amplifier

(Continued from page 51)

ily serviced. The signal leads are so short that no shielded wire was necessary.

The power supply was built on a 4" by 9½" by 2¼" ¼" brass chassis. It is conventional except for the gimmick of connecting a 6.3 volt filament transformer backwards with a selenium rectifier to provide a bias supply which is isolated from the power line.

Tests were run on the completed amplifier and it was found to perform as had the development model. In the interests of stability, 1000-ohm resistors were inserted in the screen circuits of the 807 tubes to eliminate the possibilities of the screen current rising to a dangerous value and the generation of parasitic oscillations.

It will be noted from the circuit diagram (Fig. 2) that a 100 ohm potentiometer was provided in the cathode circuits of the 807 tubes to balance their plate currents. This unbalance must be less than 5 ma. or the low frequency response of the system will suffer. The plate currents may be metered by breaking the plate voltage returns to each tube and inserting a 0-100 milliammeter; or, a voltmeter can be used to read the voltage drop across each half of the output transformer primary. The former method is preferable but the latter method is adequate. A control is also provided to set the negative bias voltage on the grids of the 807 tubes to minus 32 volts. This control is shown as R₁₆ in the schematic diagram of the amplifier shown on page 50.

The output tubes will then draw in the neighborhood of 95 ma. with no signal. Under signal conditions, the

TERRIFIC VALUE!

100 Assorted TUBES \$27⁵⁰

1A4P	1D7G	1G4GT	1V	3V7	6K5GT	6ZY5G	12SN7GT	32L7GT	39/44	75
1A6	1D8GT	1G5G	2A5	6A3	6K7GT	6Z7G	19	33	46	82
1B4P	1F4	1G6GT	2A6	6A8G	6R7GT	12A6	20	34	53	85
1B5	1F6	1H4G	2A7	6AR5	6S7	12A8GT	22	35/51	54	89
1C6	1E7GT	1H6G	2E5	6AW6	6SD7GT	12AX7	24A	36	56	9002
1C7G	1F5G	1H6GT	3A4	6C4	6SH7GT	12BA7	25Z6GT	37	57	X99
1D5GT	1F7	1LE3	3A5	6D8G	6SR7GT	12Q7GT	27	38	58	V99
		1R4	3Q4	6F5GT	6SV7M	12SF5GT	30			

All orders filled promptly. These are Guaranteed Quality Tubes, individually boxed. Order now! This offer limited to stocks on hand. Any tube above 32c each. Add 50c Handling Charge on Orders under 100 tubes.

NOBODY but OWL has these 100 Assorted Tubes for 29⁹⁵

1LC5	6AK5	6J6	7A5	12SL7GT
1N5GT	6AK6	6J7GT	7C4	12SQ7GT
1P5GT	6AL5	6K6GT	7C5	19BG6G
1Q5GT	6AQ5	6L5G	7E7	25BQ6
1R5	6AS5	6N6	7F7	25L6GT
1S5	6AT6	6P5GT	7L7	25W4GT
1T4	6AU6	6S8	7Y4	35B5
1T5GT	6AV6	6SA7GT	12AL5	35C5
1U4	6BA6	6SK7GT	12AT6	35L6GT
1U5	6BA7	6SL7GT	12AU6	35W4
3S4	6BE6	6SN7GT	12BA6	35Z5GT
3V4	6BH6	6SQ7GT	12BE6	45Z5GT
6AB4	6BJ6	6SS7	12BF6	50B5
6AB7	6B8	6SU7	12J7GT	50C5
6AC5GT	6BQ6GT	6V6GT	12K7GT	50L6GT
6AG5	6C5GT	6W4GT	12K8GT	70L7GT
6AJ5	6F6GT	6X4	12S8GT	11Z3
	6H6GT	6X5GT	12SA7GT	
	6J5GT	6Y6	12SK7GT	

Any tube above 34c each. Add 50c Handling Charge on Orders under 100

ALL ORDERS SHIPPED C.O.D.

OWL RADIO TUBE COMPANY

32 BEECHER STREET • NEWARK 2, N. J.



TRIPLEX WAVE MASTER

TRIPLE DIRECTORS

NO BOOSTER REQUIRED

MATCHES ANY OHM WIRE

75-150-300

¼ Wavelength Stacked

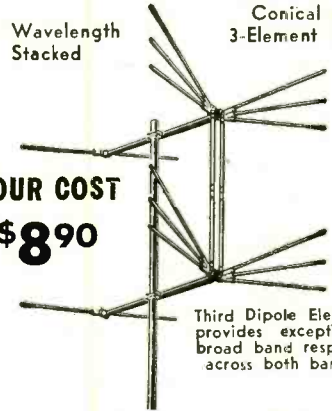

Conical with 3-Element Dipole

Third Dipole Element provides exceptional broad band response across both bands.

GHOST FREE RECEPTION ALL CHANNELS

INSTANT ASSEMBLY

EASY INSTALLATION APPROX. WT. 7 POUNDS

Price List **\$2690**

YOUR COST **\$890**

UNDER ACTUAL TESTS...PROVED!

- Most advanced design to date.
- Easier tuning, added selectivity on any receiver.
- 30% more gain than former 4X antennas.
- These tests conducted in fringe areas and locations up to 250 miles from transmitting stations—not by meter or laboratory tests, but under average home installation.
- Reception available in fringe and formerly unsatisfactory locations, all channels.

SOLD DIRECT—WRITE—WIRE—CALL—FAIRFAX 9171

RAYTRON MFG. CO. 441 SUMMIT ST. TOLEDO, OHIO

SPECIAL! 69¢

1N34 CRYSTALS.

SELENIUM RECTIFIERS		
Half Wave—Output 130 V.D.C.		
75 MA.....	\$0.58	250 MA..... \$1.21
100 MA.....	.72	400 MA..... 1.51
150 MA.....	.91	

AN CONNECTORS

Large Stock—Send Us Your Inquiries

FILTER CHOKES

10 Henry 400 MA 90VDC res. Hermetically sealed; high voltage insulation..... \$3.77
 13 Henry 250 MA 120V—Full shield upright..... 3.22

115 V., 60 CYC. SELSYNS

- Type C-78248—3 1/2" D x 3 1/2" L. Heavy Duty..... per pair, \$7.20
- Extra high torque—bronze housing, 4 1/2" D x 6" L..... per pair, \$9.76

AT-48 UP 3CM ANTENNA HORN, \$3.95 each
 Type N plug to mate with probe fitting in horn..... \$0.67

SELSYN INDICATOR KIT

FOR 110V, 60 CYCLE OPERATION
 Includes 1-82 5' indicator, Selsyn transmitter, transformer and instructions.
 All items brand new—\$6.15

1-82 Indicator only—NEW..... \$3.95

TUBE SPECIALS—GUARANTEED BRAND NEW

—STANDARD BRANDS ONLY—

SELECTED FROM OUR COMPLETE LISTING

1B3GT.....	\$1.18	6X4.....	\$0.59	5HP4.....	\$3.35
2X2.....	.49	6X5GT.....	.59	1P24.....	.29
5V4G.....	.84	7C4.....	.19	2051.....	.49
5Y4G.....	.46	10Y.....	.19	24G.....	.44
5Z3.....	.65	12A6.....	.24	304TL.....	1.25
6AC7.....	.79	12AT6.....	.59	316A.....	.66
6AG5.....	.89	12AT7.....	.99	446A.....	.79
6AK6.....	.82	12AU6.....	.72	807.....	1.25
6AL5.....	.69	12AU7.....	.86	810.....	7.95
6AQ6.....	.72	12AX7.....	.86	813.....	7.15
6AT6.....	.54	12BA6.....	.64	815.....	1.72
6AU6.....	.72	12BA7.....	.86	829.....	4.91
6BA6.....	.65	12BE6.....	.64	832A.....	4.91
6BE6.....	.65	12S47GT.....	.59	837.....	1.38
6BG6G.....	1.72	12SK7.....	.59	838.....	2.93
6BH5.....	.72	12SQ7GT.....	.59	866A.....	1.15
6BJ6.....	.72	35L6GT.....	.59	1619.....	.19
6C4.....	.21	35W4.....	.45	1624.....	.69
6J5.....	.49	35Z5GT.....	.44	1625.....	.19
6J6.....	.89	50B5.....	.69	1626.....	.29
6K6GT.....	.52	50L6GT.....	.57	1629.....	.29
6L6A.....	.87	3AP1.....	4.63	9001.....	4.42
6SL7GT.....	.69	3BP1.....	2.59	9002.....	.39
6SN7GT.....	.64	58P1.....	2.40	9003.....	.39
6V6GT.....	.59	5CP1.....	2.87	9004.....	.39
6W4GT.....	.65	5CP7.....	3.76	9006.....	.29

COAXIAL CONNECTORS

83-1AC.....	\$0.42	83-1SP.....	\$0.28	UG-21/U.....	\$0.67
83-1AP.....	.15	83-1SPN.....	.28	UG-23/U.....	.63
83-1F.....	1.12	83-1T.....	1.12	UG-27/U.....	.68
83-1H.....	.80	83-22AP.....	.85	UG-29/U.....	.83
83-1J.....	.80	83-22F.....	.88	UG-58/U.....	.57
83-1R.....	.28	83-22R.....	.48	UG-85/U.....	.62
83-1RTY.....	.45	83-22SP.....	.60	UG-87/U.....	.68

Full Line of Coaxial Connectors in Stock.
 Prices Sent on Request.

COAXIAL CABLE

RG-8/U—6c ft.....	\$27.50/500 ft.
RG-59/U—4 1/2 c ft.....	20.00/500 ft.
RG-62/U—6c ft.....	20.00/500 ft.

OTHER TYPES IN STOCK

OIL-FILLED CONDENSERS

C-D, Aerovox, GE, Solar, etc.			
2 mfd 600 VDC.....	\$0.39	1 mfd 7000 VDC.....	\$1.79
4 mfd 600 VDC.....	.69	.045 mfd 16KV DC.....	4.70
8 mfd 600 VDC.....	.87	50 mfd 220 VAC.....	2.95
3.5-5 mfd 1000 VDC.....	.77	60 mfd 330 VAC.....	4.89
1-1.5 mfd 2000 VDC.....	.67	7 mfd 660 VAC.....	2.95

HOOK-UP WIRE

No. 22 stranded, tinned copper wire. Plastic insulation with overall cotton braid. 10 colors available, per 100 ft., 19 rolls for..... \$4.25
 Cut wire—plastic insulation, ends stripped and tinned. Lengths from 2' to 20'..... \$0.59 lb.
 10 lb. for \$4.90

AN/APS-13 TRANSMITTER RECEIVER

Excellent Condition—Complete with Tubes \$14.95

WESTINGHOUSE INERTEEN

Type FP Capacitor—2mfd, 12,500 VDC..... \$23.95

SOUND POWERED PHONES

For TV antenna installation crews.
 RCA TS-10 handset
 RCA S.P. chest set (Headset and chest mike)
 EITHER TYPE, \$8.92 each—\$17.60 pair
 RCA Sound Power Unit; use as mike or receiver..... \$2.22 pr.

MICAMOL MOLDED BAKELITE

OIL-IMPREGNATED PAPER CONDENSERS			
Cap. Volts	Wkg. Price Each	Cap. Volts	Wkg. Price Each
.02 200	\$0.04 1/2	.1 400	\$0.09
.05 200	.04 1/2	.005 600	.04 1/2
.1 200	.04 1/2	.01 600	.07
.25 200	.05	.05 600	.50

HAYDON SYNCHRONOUS MOTOR

110 V., 60 Cyc., 3.2 W., 4 RPM. BRAND NEW \$1.79

HAMMARLUND VARIABLE CONDENSER

Dual 50 mmf—.030" spacing—micalex insulation—1/4" diameter shaft..... \$1.29
 RCA High Fidelity Universal Output Transformer. 15Watts—Pri., 1,000 to 16,000ΩCT; Sec., 2/6/15ΩCT \$1.69 each..... Lots of 10, \$1.52 each

LOW VOLTAGE TRANSFORMERS

Fully Shielded. All Primaries 115 V., 60 Cyc. Made by G.E. and Jefferson Electric.
 Sec. 6V. @ 8 1/2 A..... \$1.24
 Sec. 6V. @ 12 1/2 A..... 1.84
 Sec. 6V. @ 16 1/2 A..... 2.84
 Sec. 7V. @ 7 A..... \$1.54
 Sec. 7V. @ 11 A..... 2.34
 Sec. 7V. @ 14 A..... 3.34
 7V. Sec. consists of 2 parallel windings which can be connected to give 14 volts.

Write for FREE Monthly Bulletin

Include Postage with Orders

ELECTRONIC RESEARCH LABS.

1021-R Callowhill St. Phila. 23, Pa.

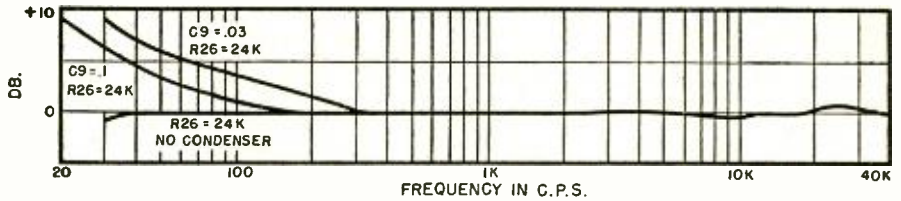

Fig. 4. Low frequency boost possible with various condensers in the main feedback loop.

plate current will swing to as high as 165 ma. for full power output. 807 tubes will vary somewhat, as will any output tubes, and, if possible, two should be chosen that draw nearly the same plate current with the same bias voltage. Any balancing means is a compromise, and the amplifier will be limited by the characteristics of the poorer tube in respect to power output and distortion.

The outside feedback loop was brought out at the output plug, as indicated by the dotted lines in Fig. 2, so that a reactance might be inserted externally to provide a low frequency rise to compensate for speaker or baffle fall-off at very low frequencies. The curves in Fig. 4 show the effect of several condenser values. The amplitude of the boost can be varied by shunting a resistor of appropriate value across C_1 .

The amplifier requires about one volt input across 500,000 ohms to drive it to full output. The hum and noise level were down so far that they could not be measured conveniently. It is sufficient to say that when the unit was connected to a highly efficient Klipsch type horn-loaded woofer, one could not tell when the unit was turned on.

The amplifier may be driven directly from an FM tuner, in which case the volume control is usually mounted on the tuner. If the amplifier is operated with a reluctance pickup, a preamplifier recommended by the pickup manufacturer can be inserted between the cartridge and this amplifier.

Listening tests were conducted with several FM tuners tuned to live local FM broadcasts over several loudspeak-

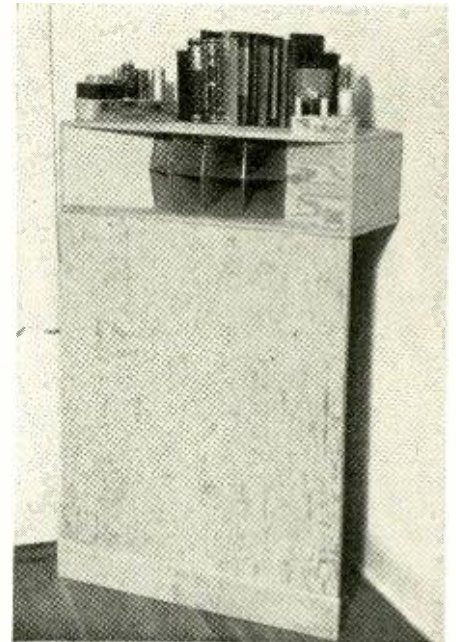

The amplifier and power supply set atop author's Klipsch-type speaker system.

ers and the clean, live reproduction was startling. The speakers included an 8" Altec 400B in a reflex cabinet, an Altec 604B in the Altec reflex cabinet, and the large Klipsch corner horn woofer with 800 cycles crossover and Stephens tweeter. The clean natural reproduction with each speaker was sufficient compensation for the considerable effort expended in the design and development of this unit.

—30—

Fig. 5. Circuit diagram of the power supply unit. Amplifier diagram is shown in Fig. 2.

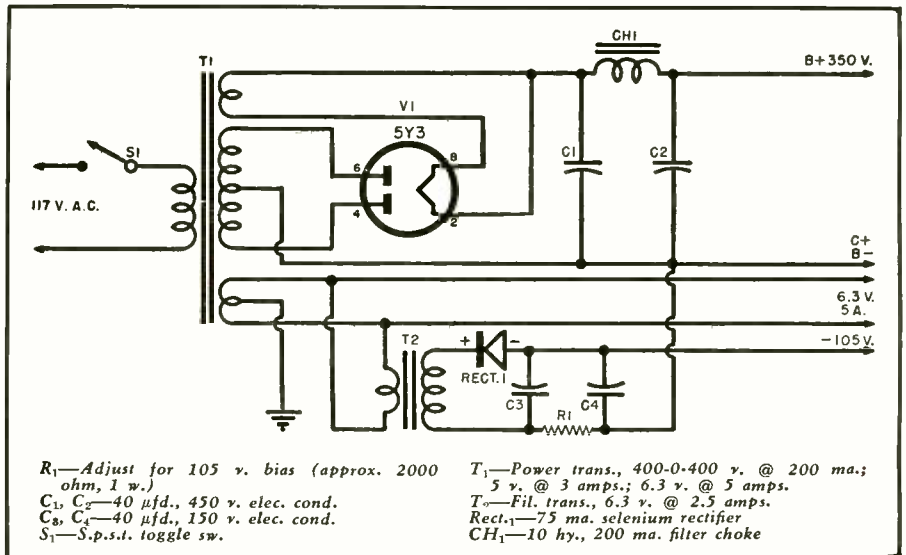

TWIN-TRAX* TAPE RECORDERS

feature

- WIDER FREQUENCY RESPONSE
- GREATER DYNAMIC RANGE
- LONGER PLAYING TIME
- - - - - and lower price!



For the Home
\$285



Broadcast Studio
\$375



Educational Institution
\$335



Wired Music System
\$495

Professional-type specifications that mean professional quality, operating ease, and trouble-free construction that you would normally associate with recorders selling at \$1000 and more. Yet the Twin-Trax Recorder series is available to you direct from the factory at low factory prices, starting at \$285 for complete high-fidelity recorders, and \$89.50 for precision-built basic tape transport mechanisms.

If you are thinking of buying a tape recorder, or if you use recorded sound for any purpose—for personal enjoyment or in your business, there is a Twin-Trax instrument for you. There are more than 30 standard and special Twin-Trax models available, including continuous-playing instruments, two-speed models, 24-hour recorder, etc.

Learn why Twin-Trax is the only professional recorder in the popular-price field. Save many dollars by dealing direct with the factory. Write today for illustrated 16-page catalog, including complete technical data.



Tape Chassis
\$89.50

*TRADE MARK REG. U.S. PAT. OFF.

AMPLIFIER CORP. OF AMERICA

398-2 Broadway

New York 13, N. Y.

Like peas in a pod

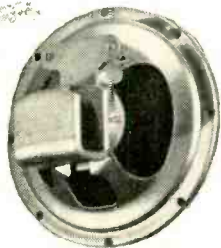
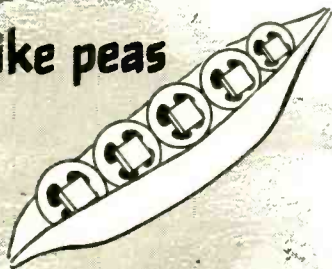

But

QUAM is different!

You can tell by the U-SHAPED COIL POT, an exclusive QUAM feature. It provides an unbroken path for the magnetic lines of force, producing a stronger magnetic field with higher efficiency and improved performance.

You can tell by the QUAM Adjustable Voice Coil, which permits accurate centering after assembly and virtually eliminates rubbing voice coils.

You can tell that QUAM has been making speakers for more than a quarter century, for no other speaker offers such outstanding extra features and extra value. For all your replacements, specify QUAM.



FREE CATALOG
MAIL TODAY!

QUAM-NICHOLS CO.

522 E. 33rd Place
Chicago 16, Illinois
Please send me Quam catalog.

Name
Address
City State

LOOK
who's
excited...

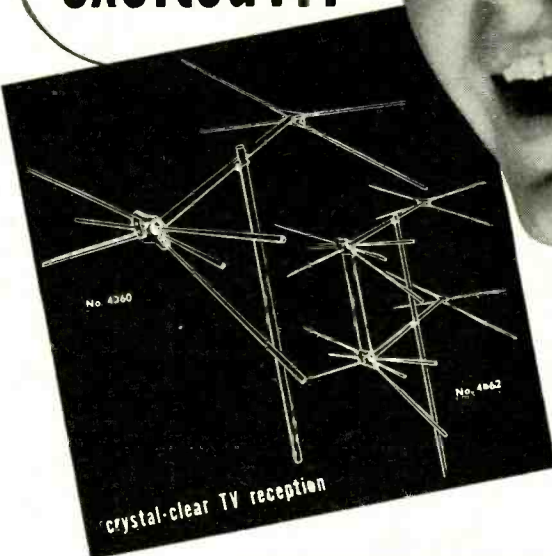

"selling

WALSCO

faster than all others!"

It's no trick to sell WALSCO. Dealers and jobbers from coast to coast report amazing sales volume with WALSCO TV Antennas.

WALSCO offers several exclusive advantages available in no other antenna.

ONLY WALSCO features a silicone-treated styron molded insulator.

ONLY WALSCO uses marine type high tensile chromium aluminum alloy for elements... with a yield point 94% higher than ordinary aluminum.

ONLY WALSCO uses butt-seamed tubing for elements to assure the highest elasticity.

WRITE FOR FREE ILLUSTRATED CATALOG 94-R

WALSCO new TV Alignment Tools are used everywhere. Available at your local jobber.

WALTER L. SCHOTT CO

Beverly Hills, California • Chicago 6, Illinois

NOW!

a book
to help you
"GROW UP" WITH
TELEVISION!

700 pages
of helpful
how-to-do-it
engineering
know how!



PRACTICAL TELEVISION ENGINEERING

by SCOTT HELT

Research Division Allen B. DuMont Laboratories —Instructor, Columbia University
700 pages, 6x9, 385 illus.....\$7.50

Here, for the first time, is a really modern book that can help pave your way to a good paying job in Television manufacturing, laboratory, or broadcasting studio work—the ideal book for study, reference or actual engineering practice!

PRACTICAL TELEVISION ENGINEERING is exactly what its name indicates—a complete, easy-to-understand book that equips you with factual TV engineering know how from the ground up. Starting at the very beginning—with a clear explanation of picture transmission fundamentals—it guides you through every phase of Television equipment and station engineering.

AN UP-TO-DATE GUIDE!

Best of all, PRACTICAL TELEVISION ENGINEERING is the first book written since the close of the war which covers Television from the viewpoint of a practical engineer actually employed in the field.

Written by an experienced engineer, it provides a comprehensive knowledge of both fundamental theory and practice, particularly as related to Television manufacturing and broadcasting.

Fundamentals of Picture Transmission
Cathode-Ray Tubes
Cathode-Ray Oscillographs
Electron Tubes and Image Pickups
Synchronizing Generators—Timing, Shaping, and Deflection Circuits

The Video Amplifier and Cathode Follower
Voltage-regulated Power Supplies
Television Receivers
Television Camera Chains
Television Transmitters
Television Broadcasting Techniques

Glossary of Terms

IT PAYS TO SPECIALIZE!



PRACTICAL TELEVISION ENGINEERING explains the cathode-ray tube fully—shows the part played by each element of the Television camera chain; explains telecasting techniques and studio problems. Other helpful data ranges from circuit and component explanations to transmitting problems, theoretical and practical aspects of lenses, lighting, oscillographs, camera tubes, synchronizing generators, video amplifiers, regulated power supplies, TV receivers and transmitters and many other subjects.
Use coupon today. Read this big new book for 10 full days AT OUR RISK!

10 DAY MONEY-BACK GUARANTEE

Dept. RN-60, Murray Hill Books, Inc.,
232 Madison Ave., New York 16, New York
Enclosed find \$7.50 (\$8.00 outside U.S.A.) for Helt's PRACTICAL TELEVISION ENGINEERING; or send C.O.D. and I will pay postman this amount plus postage. In either event, if book is not what I want, I may return it within 10 days and you GUARANTEE to refund the purchase price. (Cash only outside U.S.A., same return privilege.)

Name.....
Address.....
City, Zone, State.....

A.C.-D.C. Conversion Of BC-1206

By OTTO L. WOOLLEY, W0SGG

Make a handy Q5'er or aircraft and weather station receiver from this popular 5-tube surplus superhet.

THE surplus BC-1206 radio receiver is a five tube superhetrodyne covering the frequencies from 195 to 420 kc. It was originally designed to be used as a beacon receiver in aircraft and to be operated from a 28 volt d.c. source. The set is easily converted to a.c.-d.c. operation and is useful for listening to aircraft and weather stations and as a Q5'er. For use as a Q5'er the receiver is tuned to the extreme top of the dial where it will be found that most of the popular i.f. frequencies may be tuned in, the set actually going up to around 475 kc.

First step in the conversion is the removal of the two chokes and two condensers mounted on the rear of the chassis, leaving the terminal strips in place for tie points for the 117 v. supply. Also remove all connections to the 28D7 output tube socket, and disconnect the two "B+" leads on one lug of the switch leaving the black wire on the remaining lug intact.

Now start with the 14H7 i.f. stage and wire the heaters of the tubes for series operation as shown in the schematic. Bring out a wire from the number 8 pin of the 28D7 socket as a supply line for the d.c. supply. Bring out a wire from the number 3



Over-all view of converted BC-1206 receiver.

pin of this socket as a "B+" supply lead into the receiver. These two wires and the filament wires are brought out the hole in the rear of the chassis that originally carried the d.c. supply lines. Wire the 28D7 socket to receive a 50A5 output tube. Connect the two wires that were removed from the switch lug and tape the junction. Connect the vacant switch lug to a ground point on the r.f. tube socket. Make a connection from pin 3 of the 14H7 i.f. tube socket to the unused tie point on the side of the chassis, and connect a 1 megohm, ½ watt resistor between this tie point and the number 5 pin of the 14R7 detector-first audio tube, the original wire to this pin having been removed. The "B+" supply leads (red and white) of both i.f. transformers are brought to the tie point mentioned above. In the original wiring the "B+" leads were connected to the 28 volt points on the heater string and it should be made certain that these leads were removed when wiring the heaters for 117 volt operation.

Mount the power supply components on the rear of the chassis as shown in the photograph and wire according to the schematic diagram. Replace the 28D7 with a 50A5 and the receiver is ready for operation. With the arrangement shown the measured "B+"

Wiring changes for a.c.-d.c. operation.

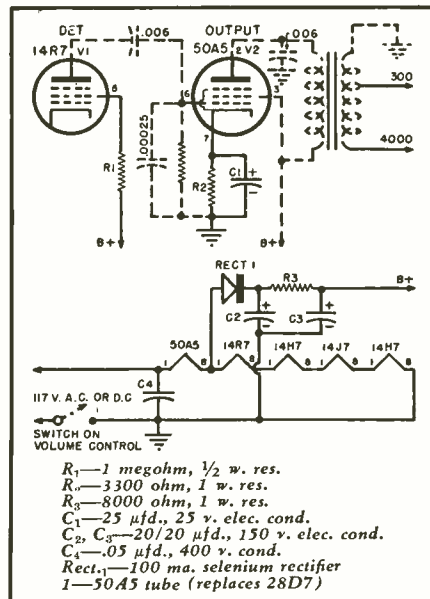

supply voltage is 30 volts—very close to the original figure for which the set was designed. Inasmuch as the set is quite lively and has ample headphone volume there isn't much reason for raising the voltage.

The output transformer is tapped at 300 and 4000 ohms, and the tap giving the best volume with the headphones to be used can be selected. The usual precautions that apply to a.c.-d.c. equipment should be observed. The headphones may be insulated by operating the output transformer secondary above ground and insulating the headphone jack from the chassis.

—50—

International Short-Wave

(Continued from page 102)

signal weak to fair; is below WLKS, 6.105, Kure, Japan. DZH7, 9.73, and BEA8, Nanking, see-saw one another most days, evidently vary in frequency. (Balbi, Calif.)

DYH2, 6.140, noted to after 0830. (Stark, Texas)

A new Philippine station is the Republic Broadcasting System, DZI3, 6.110, heard around 0600-1200; noted in the United States and in Australia.

Pitcairn Island—Black, Pa., reports that these calls and frequencies were listed in a QSL from ZKG4 which he received in 1946—ZKG, 8.290 and 12.450; ZKG3, 8.635; ZKG4, 12.110; ZKG5, 17.270 or 7.270. (NNRC) There have been vague reports from overseas sources that Pitcairn Island is now on the air again. *Details would be welcomed.*

Portuguese India—Radio Goa has been heard in the United Kingdom testing on 17.790; frequently mentioned regular daily transmission on 9.615 at 0600-1030. (Radio Australia)

Portuguese West Africa—Sao Tome's CS5SB, 17.677, is scheduled 1000-1200 beamed to Portugal; CS5SA, 9.615, is used 1300-1500 for Africa. (Bluman, Israel, via ISWC, London)

Taiwan—BCAF, approximately 8.996, Taipeh, the Chinese Air Force Station, heard in Calif. 0400; program readable although signal strength was weak. (Rosenauer)

BED4, 11.7246 (measured), is now heard only after CHOL, 11.72, signs off at 2400; therefore, the English period 2300-2400 is completely covered up. (Treibel, Washington State)

Tangier—Schedules in effect when this was compiled, for the VOA relay stations at Tangiers, were—Tangier II, 6.060, 1700-1730 to Europe; Tangier II, 7.214, 0800-0900 to North Africa (RDF); Tangier I, 11.790, 1500-1730 to Europe; Tangier II, 15.210, 1215-1645, to Europe; Tangier I, 15.250, 1100-1500 to Europe.

Radio International, Societe Africaine de Radiodiffusion, 34 Rue Goya, Tangier, 1238 kc. and 6.110, broadcasting commercial programs in English, French, Arabic, Spanish, sent schedule of 0700-0730 English; 0730-0815 French; 0815-0900 Spanish; 0900-1100 (close-

HELP US MOVE!

On or about July 1st we'll be located at our new address, 905 S. Vermont Ave., Los Angeles 6. The moving bill will be terrific, but we'd just as soon pay you for these drastic price reductions) as pay the movers!

HS-33 Headsets. We got a beautiful lot of these (red plug) Two sizes: HS-33 and HS-34. We call them new (and they probably are) **\$1.89**
HS-33 with discolored headbands. **89c**
ID-6A/APN-4 INDICATOR. Uses 5CP1. Loran Scope, convert to test scope, panadapter, etc. Contains extremely accurate 100 KC xtal to limit sweeps and marker pips at 2, 20, and 100 KC. Two parallel horizontal sweeps; time the differences between sig. between half power points on pass band curves, and many other scope uses. Double-deck tube shelves, lots of room for any circuit you can dream up. For example, make start-top sweep circuit to start both xtal and sweep, and one cycle of your input sig. will always be stationary. Contains 27 tubes, 22 pots, loads of switches, condensers, transformers, and small parts. Used. With schematic. Lowest prices ever offered. Exc. condition. **\$24.95**
 Fair used, may be short the xtal and few tubes **\$17.50**

R-9A/APN-4. Companion recvr. and power supply to indicator described above. Easily converted to 60 cy. operation for use as a 160 meter, 4 chan. recvr. or as a high voltage power supply for oscilloscope. Used. With schematic and conversion instructions. Less tubes. **\$5.95**

ATTENTION AIRLINE SHOPS!

Antenna AT-4/ARN-1, replacement for radio altimeter. With undamaged porcelain ring and no rattle. No rattle and noise or like new. **\$2.95**
 With damaged ring and/or rattling bead, can't be replaced for housing and SO fitting. **50c**

BC-375 100 watt xmt. unit, 200 KC to 12.5 MC when used with appropriate tuning units. With schematic showing complete parts description for use with dynamotor PE-73 and also with AC power supply conversions. Instructions, used, special Army warehouse clearance price, while they last, only **\$12.95**

Tuning Units for BC-375. Specify freq. coverage desired. Excellent condition. With schematic showing parts description. **\$1.95**

BC-906 FREQUENCY METER. Laboratory precision instrument. Frequency range 150-225 MC (upper TV channels), or modify for any other use. Use one as is and modify a second to cover lower TV channels. Simple DC power, needs only 2 batteries (1.5 v and 45 v). Precision vernier dial. Hand calibrated tuning charts. Diode-rectifier circuit. Frequency measured. Pickup from tuned resonant cavity is detected by diode. Negative DC is applied to triode grid, and dips the plate current. Complete, with plug-in antenna, crackle aluminum carrying case. (15" x 8 3/4" x 6 1/2") with leather handle. Schematic in-cluded. In original wood storage case **\$12.95**

AN/ART-13. Famous Collins Auto-tune xmt. 100 w. 200 KC. range 2 channels to cover lower TV channels for marine use with no conversion. 813 final, modulated by 2-811's. Excellent used condition, complete with all tubes, schematic, and calibration charts. **\$125.00**

PULSE ATTENUATOR. Voltage Divider TS-80/AP. Use your low range voltmeter or your scope to measure or view AC or pulses up to 20,000 volts. Two ranges, 10:1 or 100:1. Accurate RC circuits preserve exact waveform. Flat from 150 cycles to 100 mc. In small, neat case with HV insulators and coax cables and plugs for connection to scope and to V source being measured. A steal at only **\$4.95**

Remote Scope, Indicator ID-41/APQ-13. Radar PPI. SFP7 in stepped cylindrical container with beautiful set of selsyn-driven coils. With selsyn. Other controls: Vert. cent., Hor. cent., Focus, Brightness, Scale Illumination. Use for beam-borne indicator. Rotated against fixed compass calibration. 0.6AK5 tube and input circuit in back end. Ranges are 4, 10, 20, 60, and 100 nautical miles. With cords attached to junction box at the other end. Excellent condition **\$14.95**

I-82-A Autosyn angular position indicator. Navigator's ADF indicator with rotary reference compass scale. Use for beam-borne indicator. Use your \$3.79 loop, motor, and autosyn-xmt. Special Army warehouse clearance price, while they last. Used, only. **\$2.95**

EXPERIMENTER'S SPECIAL

Here's a recvr. that you can do wonders with! High-Q 90 cy. only and 150 cy. only filters. Make intermediate frequency analyzer for testing quality of audio amplifiers by putting 60 cy. and 90 cy. (beater) hash thru 90 cy. filter) to input. Output thru 150 cy. filter, divided by input, gives percentage of modulation distortion. Contains dual bridge instrument receiver. Also best AVC system yet devised, flat from 5 to 100,000 v. uses 1000 VDC RF power supply for AVC bias, lift out intact to wire into your recvr. RF is 108.3 to 110.3 as selected by 6 relays in local oscillator. 18th harmonic beats with RF to give 6.9 MC IF. Lots of IF amplification, excellent for FM Broadcast use. Set has 6-717 tubes, use as direct replacement for your 6SK7, with much more gain. Also 2-12SF7, 1-12SQ7, 1-12AB7, 1-12AH7, 2-12SR7. With schematic, and conversion charts. Dope to home FM recvr. Excellent condition. **\$3.95**

BC-347-C Booster Amplifier, especially useful as mike-input amplifier to boost modulation, excellent as mike or phono preamplifier. Compact, only 3 1/2" x 2 1/2"; contains dual-triode power tube 6FG6 and two hi- μ uncoupled transformers, one for mike to push-pull grid, one for push-pull output. Requires external power source. Original use was for interphone amplifier. Good used, a special **69c**

PP-4/APQ-2 Rectifier power supply. Consists of two thermionic rectifiers with separate filter circuits which supply independent voltages. Parts alone worth ten times selling price: 4-5R4G5 tubes worth \$1.25 ea., 2-1mf and 1500 VDC electrolytic capacitors worth \$1.50 ea., 2-4 mfd. 1000 VDC or 660 VAC condensers worth \$1.50 ea., 400-2600 cy. transformers; chokeless bleeder resistors, small parts. Many taps on xformers; use as autotransformers also, get many voltages. Net wt. 37 lbs. **\$3.95**

Desk Mike T-48. Desk telephone xmt. Weighted bottom. Excellent hand shade mike. Long rubber covered cord terminating in PL-68 plug. **\$1.95**

Precision Resistor Special. Control Box, Angle Selector, C-230/AIQ-7. Cannibalize for a nice black-wood aluminum case 3" x 4" x 1 1/2". Single pole rotary selector switch with standard pointer knob; a SPST spring-loaded snap-action push switch; and precision resistors. Some models have 21 matched gold-lead 1/2 watt resistors. Others have 100 1/4% resistors. Special at only **79c**

ATTENTION, MARINE RADIOMEN!

(1) **G.L. MARINER XMT.** 10 to 125 KC. 100 w. to antenna. 90% modulated, 4 chan. Mal. cont. 12 or 24 V input (specify voltage & freq. when ordering) w/dyna., connecting cord, xtals, tubes (813 final), and all aligned & all adjusted to operate. Controls are On-Off switch, chan. selector, antenna tuner to match any antenna. Built-in break-in relay in addition to ant. switching relay. Panel has RF current meter & total current meter. This xmt. built from \$1200 govt. cost surplus. We offer it at the **\$225.00**

ascending to Marine band, still retains half of Broadcast band and all the lighthouse and beacon band. 2-tube pre-amplifier. No 180° ambiguity, true bearing immediately. Goes ahead of G.L. Mariner or any other receiver. NEW, converted. **\$32.50**

(2) **G.L. "MARINER" RECV.** specify 12 or 24 V DC. BFO On-Off, AVC-MVC. Long wave, Broadcast, Marine, Short Wave. A beautiful conversion of a doggone Navy surplus receiver, entirely new front panel, vernier on-the-nose retuning tuner, all controls on front panel, no plugs needed, ready to go **\$49.50**

(3) **Command Recvr SCR-274M.** Rewired for 12 volts with brand new 12v dynamotor mid. on back end. Phone plug built into front panel. Built-in volume control (on-off, vol., CW-MCW, tuning). With harness and plug for 12v input and for output to power 16-1 loop and output to speaker use. 50L6 xmt. in speaker baffle. BRAND NEW **\$34.50**

Same as above, but for 24 V **\$29.50**
 (4) **DU-1 Manual Direction Finder,** specify 12 or 24 V. Excellent for Marine band, still retains half of Broadcast band and all the lighthouse and beacon band. 2-tube pre-amplifier. No 180° ambiguity, true bearing immediately. Goes ahead of G.L. Mariner or any other receiver. NEW, converted. **\$32.50**

(5) **BC-223 TRANSMITTER.** 15 watts. Brand New. 4 with used 12 v Dynamotor, PE-55, connecting cables, and marine freq. xtals, mike. Specify frequency. **99.50**

(6) **PE-55 DYNAMOTOR.** 12 V for BC-223, 500 V @ 400 ma. w/relay, filter, etc., EXC. USED. **\$9.95**

(7) **CONNECTING CORD** with plugs. 10' long. PE-35 to BC-223 **\$1.50**

AN/AP5-13. Tall warning Radar xmt-recvr. 410-420 MC with 30mc IF strip. 19 tubes: 9-6AB5, 5-6J6, 2-2B21, and VR-105. Xmt cond. complete with all tubes with schematic. **\$14.95**

274N AND ARC-5 TRANSMITTERS
274N TYPE. 2.1-3 mc, repacks, like new. **\$ 9.95**
T-18/ARC-5. 2.1-3 mc, repacks, like new. **10.95**
T-19/ARC-5. 3-4 mc, repacks, like new. **10.95**

Excellent used **8.95**
BC-457. 4-5.3 mc, excellent used **4.95**
 As is, less xtal. **2.49**
BC-458. 5-3.7 mc, excellent used **5.95**
 As is, less xtal. **2.95**
BC-459. 7-9.1 mc, excellent used **4.95**
 As is, less xtal. **2.95**
T-22/ARC-5. 7-9.1 mc, repacks, like new. **9.95**

274N AND ARC-5 RECEIVERS
BC-453. 190 to 550 kc. Good used. **\$12.95**
BC-454. 3 to 6 mc. NEW \$6.95, Good used \$4.95
BC-455. 6 to 9 mc. NEW \$12.95, Good used \$7.95
R-28/ARC-5. 100 to 156 mc. Excellent used \$17.50

Local Control Adapter parts for 274N or ARC-5 recvr. Exact pot, switch, knobs, etched plate, and instruction data. Ready to mount. **\$1.29**

SPLINE TUNING KNOB. **59c**
AN/APN-1 Xmt-Recvr. 420-447 mc. Xmt basis for experimental bands. 14 tubes: 2-8004, 4-12SF7, 1-12SR7, 2-12H6, 2-955, and VR-105. Pwr. requirements only 300 V DC at 75 ma. Contains voice-coil type magnet-actuated variable capacity freq-modulator. Use to sweep freq. bands for modulation. Xmt condition, complete with all tubes, dynamotor and schematic **\$4.95**

WANTED! Your Spare Surplus Equipment and Tubes! Dynamotors, Recvs., Xmts., Test Equipment. Send us stating condition and your rock bottom price.

G. L. ELECTRONICS

1260 S. ALVARADO ST. LOS ANGELES 6, CAL.
 All prices F.O.B. Los Angeles. California Buyers add Sales Tax
 SEND FOR OUR LATEST CATALOGUE

The July issue of RADIO & TELEVISION NEWS will be on sale June 30.
 Be sure to reserve your copy with your Newsdealer.

DON'T "CHOP"
 RECORDING TAPE
 SPLICE IT PROFESSIONALLY WITH
JIFFY-SPLICE

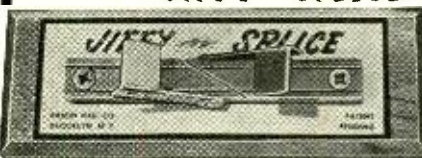

GET THIS FAST-MOVING ITEM!

RASON MANUFACTURING CO. **\$2.50** LIST
 61 Myrtle Ave., Brooklyn 1, N. Y.

RADIO ENGINEERING IN 27 MONTHS

Radio engineering is a big field. There's room for you in it—if you're good. Get first-class training at Indiana Tech. Intensive specialized course, including strong basis in mathematics and electrical engineering, advanced Radio Theory and Design, Modern Laboratory. Low tuition. Also 27-month courses in Aeronautical, Chemical, Civil, Electrical and Mechanical Engineering. Approved for G.I.'s. Enter June, September, December, March. You can earn part of your expenses right here in Fort Wayne while you are studying.

INDIANA TECHNICAL COLLEGE

960 E. Washington Blvd., Fort Wayne 2, Indiana
 Please send me free information on B.S. Engineering Degree in 27 months as checked.

Radio-Television, Aeronautical,
 Civil, Mechanical, Electrical

Name

Address

NOW AVAILABLE! THE PFANSTIEHL STRAIN-SENSITIVE PHONOGRAPH PICKUP!

The PFANSTIEHL STRAIN-SENSITIVE PICKUP is a constant resistance amplitude type transducer of about 250,000 ohms. Impedance variation with audio frequency is practically zero.

Signal output is presented to the input grid of the preamplifier at a practically constant impedance level regardless of frequency. This characteristic, together with fine construction makes possible a quality performance which has been pronounced superior to other fine pickups by many critical listeners.



ELEMENT (enlarged)



CARTRIDGE

QUICK
CHANGE
CARTRIDGE
HOLDER



PREAMPLIFIER

A preamplifier is available which will provide a flat response to 10,000 cycles and then taper cleanly to over 15,000 cycles. The output of the preamplifier is about 1.5 volts. Correct compensation for any type record may be obtained by proper setting of the controls.

Cartridges for micro-groove records, (.001 tip radius) and for standard groove records, (.0027 tip radius) are available along with a quick change cartridge holder. Proper stylus forces are: standard groove, (.0027 tip), 15 to 20 grams; micro-groove, (.001 tip), 5 to 6 grams.

Styli are tipped with famous PFANSTIEHL M47B precious metal alloy which will wear to less than a .003 flat in 1000 plays on standard records at the proper stylus pressure. This is just about the beginning of any distortion caused by needle wear that can be detected by the most critical listener. For good quality performance, the use may be extended for many more plays. The inevitable wear should be on the stylus rather than on the record.

The excellent transient response is amazing . . . practically no distortion, phase shift or evidence of intermodulation is apparent when tested with a good frequency band record in conjunction with the PFANSTIEHL 3 PPRC Preamplifier and a 5" Oscilloscope.

Proof of the excellence of this new pickup is apparent both in tests and in actual listening, when its wide range flat response is best demonstrated. If your jobber does not have the PFANSTIEHL Pickup, kindly send your inquiry to the factory, and complete information will be sent to you promptly. For those who prefer to build a preamplifier, a wiring diagram and layout is included.

PFANSTIEHL CHEMICAL COMPANY
(METALLURGICAL DIVISION)
104 LAKE VIEW AVE., WAUKEGAN, ILL.

down) French and Spanish; 1300-1500 Arabic; 1500-1615 French; 1615-1715 Spanish; 1715-1900 (closedown) French and Spanish. (Whitman, Ill.)

Tibet—DeMyer, Mich., has received word from an amateur radio operator in Lhasa confirming that the Tibetan Government has started broadcasting irregularly, radiating on 7.200, usually three times a week—Monday, Wednesday, Friday, with Tibetan, *English*, and Chinese recordings, and occasional Tibetan Government Bulletins in Tibetan, *English*, and Chinese. Time of broadcast, unfortunately, was not stated. I hope to have more details on this one soon.

Turkey—Summer schedules of *Radio Ankara* include *English* over TAQ, 15.195, daily 1345-1400 (news), and Thursdays (talks for the United Kingdom), and Sundays (Mailbag) at 1530-1600.

Radio Ankara soon should have its new 100 kw. transmitter on the air when it hopes to extend present schedules, to direct programs to the United States, and perhaps to start a World Friendship Club and to give Turkish-*English* lessons. It recently conducted a contest for radio listeners concerning their knowledge about Turkey and Turkish life.

South Africa—By this time, SABC's commercial ("C") transmitters should be on the air under the call-sign "*Springbok Radio*"; *English* and Afrikaans will be used—depending on the sponsors; schedule will be 2345-1600, but there may be breaks in the s.w. service when frequencies are changed; it is believed the transmitters will work largely in the 40-, 60-, and 90-m. bands. I hope to have complete details next month.

Johannesburg, 9.523, noted in California 2345. (Moore)

Sweden—*Radio Sweden* hopes to be on the air with two new 100 kw. transmitter early in 1951. (Boice, Conn.) "*Sweden Today*" (*English*) noted 0815-0830 on SBT, 15.155, good signal. (Fargo, Ga.)

Switzerland—Berne's summer schedules are—To Europe, weekdays 0015-0140, Sundays 0155-0140, HER3, 6.165, HEI3, 7.210, HER4, 9.535; Monday to Friday 0500-0830, 1000-1700, Saturdays 0500-1700, Sundays 0245-1700, HER3, 6.165, HER4, 9.535. To Africa, daily 0115-0140 (Sundays from 0155), 0500-0730, 1000-1700, HER6, 15.305, HER8, 21.520, HER6, 15.305. To Australia, New Zealand, Far East, 0215-0440, HEI5, 11.715, HER5, 11.865, HER6, 15.305. To South-East Asia, 0745-0930, HER6, 15.305, HER7, 17.784, HER8, 21.520. To India and Pakistan, 0945-1130, HER5, 11.865, HER7, 17.784. To the Middle East, 1145-1330, HEU3, 9.665, HER5, 11.865. To the United Kingdom and Ireland, 1345-1530, HEU3, 9.665, HER5, 11.865. To Spain and Portugal and South America (first daily transmission), 1545-1715, HEU3, 9.665, HER5, 11.865. To North America 1730-1815 (first daily transmission) and 2030-2300 (second daily transmission), HER5, 11.865, HER6, 15.305,

STAR SPECIAL!

FAMOUS ASTATIC MICROPHONE



Model DN-HZ high impedance dynamic microphone. Flat response from 50 to 7000 cps with —55 db output. Rugged construction; suitable for PA, recording, ham and other uses. Beautiful opalescent gray and chrome finish. Includes 15-ft shielded cable, Amphenol 75-MIF standard mike connector AND an Astatic Model F desk stand. Everything brand new and fully guaranteed. List price \$31.00. COMPARE OUR LOW **\$12.95** PRICE!

Same fine mike with Astatic Model G desk stand. Has push-to-talk switch, 8-ft shielded cable and Amphenol mike connector.

List price \$35.00. Limited quantity; order promptly! **\$14.95**

COMPLETE STOCKS All Standard Brands Just off the press . . . **BIG BARGAIN BULLETIN**

STAR ELECTRONIC DISTRIBUTORS, INC.

Dept. RN 2-7736 S. Halsted, Chicago 20, Ill.

TV CHASSIS SPECIAL!

LIC. by RCA

10"-12½"-16"



A SET—NOT A KIT

• 22 Tubes
• Hi-gain Turret type Tuner **\$118.50** Fed. Tax Less CRT \$1.80

Completely wired, factory engineered, tested and guaranteed. Perfect for custom installation. F.O.B. Long Island City—20% deposit. Bal. C.O.D.

MACKAY TELEVISION CORP.

12-01 44th Ave., Long Island City, N. Y.

LEARN

Radio-Television, OR Electricity

IN THE GREAT SHOPS OF **COYNE**

COYNE 51st ANNIVERSARY
TRAIN QUICKLY!
OLDEST, BEST EQUIPPED SCHOOL of ITS KIND in U.S.
2 Opportunity Fields

Come to the Great Shops of COYNE in Chicago during our 51st Anniversary Year! Get quick, practical training in RADIO-TELEVISION or ELECTRICITY. G.I. Approved. Finance plan for non-veterans. Mail Coupon Today for complete details.

NOT "HOME-STUDY" COURSES!
You learn on real, full-size equipment, not by mail. Finest staff of trained instructors to help you get ready quickly for a better job, a fine future.

FREE BOOKS Clip coupon for big illustrated Coyne book on either ELECTRICITY or RADIO-TELEVISION. Both books sent FREE if you wish. No obligation; no salesman will call. Act NOW!

B. W. COOKE, Pres.
COYNE Electrical & Radio-Television School,
500 S. Paulina St., Chicago 12, Ill. Dept. A0-85H

Send FREE BOOK and full details on:

RADIO-TELEVISION ELECTRICITY

NAME.....

ADDRESS.....

CITY..... STATE.....

RADIO & TELEVISION NEWS

HER7, 17.784. To South America (second daily transmission), 1830-1900, HER5, 11.865, HER6, 15.305, HER7, 17.784. Has inaugurated several new features for the summer. An illustrated program schedule giving details is available on request to the Swiss Shortwave Service, Berne, Switzerland.

Syria—Damascus is reported using 16.750 daily *except* Sunday with news in Arabic 0940-0950. (Radio Sweden)

Bluman, Israel, says Damascus has moved from 11.750 back to 12.000, and that the former 41-m. channel has moved to 6.950; frequencies of 6.950, 6.000, and 12.000 are now in parallel. Pearce, England, lists Damascus on 6.910 instead of 6.950, heard 1530 with news, announces next *English* for 0610.

Uruguay—Radio Nacional, 6.035, noted for after 1900; listed CXA30 with 5 kw. (Stark, Texas) Location is Montevideo.

USA—Test transmission of AAH, Seattle, Washington, was heard around 1830-1930 on announced 14.867; stated, "This is AAH from Seattle, Washington, a station of the Alaskan Communications Commission, on 14.867 and 10.720"; the 10.720 channel was not audible in New York; played recordings with frequent announcements. (Leinbach)

USSR—Radio Moscow noted on 9.345 at 2000 with chimes; identified at 2035 after trumpet fanfare. (Stark, Texas) Soviet outlet noted on 11.87 in Chinese after 0600, good signal. (Balbi, Calif.)

Vatican—HVJ, 15.095, heard irregularly in Italian 0130-0145. (Balbi, Calif.)

Yugoslavia—Bellington, N. Y., received these detailed schedules of news periods from Radio Belgrade—"morning" session, 9.505, 2300 Bulgarian, 2315 Hungarian, 2330 Rumanian, 2345 French, 0000 German, 0015 Turkish, 0030 Spanish, 0045 Italian, 0100 Greek, 0115 *English*; "afternoon" session, 9.505, 0700 Russian, 0730 Czech, 0800 Bulgarian, 0830 Albanian, 0900 Hungarian; "evening" session, 6.100V, 1100 German, 1115 *English*, 1130 Slovak, 1145 Greek, 1200 French, 1215 Italian, 1230 Russian, 1300 Polish.

Last Minute Tips

ZNB, Mafeking, Bechuanaland, has moved from 5.900 to an experimental frequency of 8.130 in the 37-m. band. (Laubscher, South Africa)

Dilg, Calif., recently heard an unidentified station on approximately 7.245 between Bombay's 7.240 and Malaya's 7.250; came on 0800 and left around 0810; seemed to be in *English*; weak signal. Possibly *Radio Tibet*?

Since Israel is now on Summer Time, *English* newscasts should be at 0600 on 6.830 (Tel Aviv) and 8.170 (Haifa), and at 1415 on 6.830, 8.170, and 9.000 (Tel Aviv). (Pearce, England)

The Communist-Chinese outlet first on 6.100 and then on 6.090 has moved higher, back to approximately 6.10; signal only fair. (Balbi, Calif.) I have noted improvement lately in the 10.260 Peking outlet; has bad CWQRM but

June, 1950

SUMMER SPECIAL SALE VALUES LOWEST PRICES

PROP PITCH MOTORS



For your Beam Antenna:
20 Volt to 32 Volt, A.C. or D.C. 1/2 H.P. Motor;
1 1/4 RPM Gear Reduction,
7000 to 1.
ALL BRAND **\$14.95** ea.
NEW.

GYRO MOTOR UNITS

Dual Gyro Unit which was used in conjunction with Auto-Pilot equip. Both Gyro Motors mounted on a single base, wired in parallel for 12 or 24 Volt operation. One used as the Azimuth control and the other as an elevation control. When ordering these Units, specify 12 or 24 Volt.
Our price—Special **\$4.95** ea.

BC 1073 WAVEMETER

Resonant cavity tuning from 120 to 210 MCs. Complete with power supply for 110 Volt, 60 Cy. A.C., and 18 tubes.
Our low price **\$19.95** ea.

T.C.S. POWER SUPPLIES

12 Volt Dual Dynamotor Units
Input—12 Volt D.C.
Output—220 Volt D.C. @ 100 MA. **\$22.50** set
400 Volt D.C. @ 200 MA. **\$22.50** set
24 Volt D.C. Motor Generator Set complete with Two 24 Volt, 3/16 H.P. Motors driving two Generators, which put out following voltages:
225 Volts @ 100 MA. **\$35.00** set
400 Volts @ 200 MA. **\$35.00** set
12 Volt D.C. at 5 Amps.
Both above units, complete with mounted Filter Bases.

6 INCH WATERPROOF SPEAKERS

Plastic Cone V.C. Imp. 6-8 ohms. Ideal for all outdoor purposes. Limited Supply. Used but in excellent condition. Approx. wt. 15 lbs.
Our price ea. **\$4.95**

WILLARD 2 VOLT RADIO BATTERY



NEW. Uncharged (Appr. wt. 4 lbs.) **\$1.05**
TYPE 20-2. Each **\$1.05**
Complete set of three with Box and Connections to make a 6 Volt, 20 Amp. Hrs. Battery Uncharged (Appr. wt. 15 lbs.) **\$3.95**

C-1 SERVO UNIT

Part of C-1 Gyro. Contains 24 V. DC. Servo Motor Clutch 4 Relays which control rotation of motor and a set of differential gears which control speed of output shaft in either direction. Can be used by itself to rotate beam antenna or as a boat rudder control. Excellent condition.
Our price **\$4.95** ea.

R-14 HEADPHONES

Complete with rubber ear cups and cord with a P1-55 Plug. High Imp. (Appr. wt. 1 lb.) **Pair \$1.25**

HEINEMANN CIRCUIT BREAKER



15 Amp.—120 Volts AC **\$.97** Ea.
7 Amp.—24 Volts DC **\$.50** Ea.
ALL NEW (Appr. 1 lb. ea.)

BENDIX SELSYN MOTORS



110 V. 60 Cy. AC.
Brass Heavy Duty. (Appr. wt. 22 lbs.) **NEW, PAIR \$8.95**

3" TRIUMPH OSCILLOGRAPH

Complete Test Scope, with built in Wobulator, so as to be used on TV or FM servicing. Operates from 110 Volt, 60 Cy. A.C. Limited Supply. All in **\$39.95** ea.
excellent condition. A Real Buy.
ROTARY SWITCHES—4 Pos. Heavy Amp. **\$ 75** Ea.
6 Volt Vibrators—4 Pin. Non-Synch. **1.00** Ea.
Vacuum Condensers—MMFD. 5 KV. **1.00** Ea.

AN/APN4 INDICATOR SCOPES

ID6B, APN-4 complete with 25 tubes and 100 KC. calibrated crystal to time sweeps; and marker clips at 2, 20 and 100 KC. SCPI tube—easily converted to test scope. Greatest value ever—**\$29.95** Ea.
ALL BRAND NEW. Our price.
Approx. Weight 45 Lbs.

All Mail Orders Promptly Filled, F.O.B. San Francisco. . . All California Orders—Add 3% Sales Tax. . . Outside of California—No Sales Tax. Write for our free booklet listing our stock and prices on Radio, Electronics, Tools, Hardware, Motors, Wire, Meters, Batteries, Aluminum Sheets, etc. 20% Dep. on all C.O.D. orders. All items subject to prior sale.

STANDARD SURPLUS 1230 Market St., San Francisco 3, Cal. Telephone HEmlock 1-3106

When answering Advertisements please mention RADIO & TELEVISION NEWS

EASY TO LEARN CODE

It is easy to learn or increase speed with an Instructograph Code Teacher. Affords the quickest and most practical method yet developed. For beginners or advanced students. Available tapes from beginner's alphabet to typical messages on all subjects. Speed range 5 to 40 WPM. Always ready—no girls.



ENDORSED BY THOUSANDS!

The Instructograph Code Teacher literally takes the place of an operator-instructor and enables anyone to learn and master code without further assistance. Thousands of successful operators have "acquired the code" with the Instructograph System. Write today for convenient rental and purchase plans.

INSTRUCTOGRAPH COMPANY

4711 SHERIDAN ROAD, CHICAGO 40, ILLINOIS

BC-605 INTER-PHONE AMPS.



(See conversion of this Unit on Page 140 in April Issue—Radio-Telev. News). Ideal for Inter-Com; Office to office; airplane inter-com, etc.; Complete with Tubes, Diagram and Case. Easily converted. Uses DM 34 Dynamotor and all brand new.
Our low price, less **\$3.95** ea.
Dynamotor

MIDGET SELSYNS

AY type operates from 12 Volt 60 Cycl. Use as both transmitter and receiver. These compact little units draw almost no current and work fine for all remote position installing applications. OD 2 1/4 x 2 1/4 x 2 1/2".
All New (Appr. wt. 1 lb.) **Each 98c**

WATERTIGHT SWITCH BOXES

Contains 10 Toggles and 2 Terminal Boards. Completely wired up in a watertight case. Ideal for Control Circuits of all kinds. All New.
Special at **\$3.50** ea.

DYNAMOTORS

DM-512 Input 12 V. D.C. @ 3.8 Amps. Output—380 V. D.C. @ 100 MA. **\$3.95** ea.
DY-82—Input 28 V. D.C. @ 1.1 Amp. Output 250 V. D.C. @ 60 MA. **\$1.50** ea.

COMMAND RECEIVERS

190 KC to 550 KC (Appr. wt. 12 lbs.) **\$8.95** ea.
3 MC to 6 MC (Appr. wt. 12 lbs.) **6.95** ea.
All used but complete and in good condition.

COMMAND TRANSMITTERS

3 to 4 MCs **\$8.95** ea. 5.3 to 7 Meg. **\$4.95** ea.
Complete with Tubes and Crystals. Excellent condition.

BEACON RECEIVERS

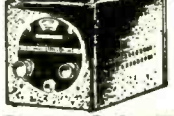

BC 1206C—200 to 400 K.C. (As illustrated). IF Freq. 135 KC. Complete with five Tubes. Ready to operate. Direct from 24 Volt D.C. **\$5.95** ea.
BC 1033—70 to 80 Megs. Complete with Tubes, operates off 24 Volt **\$3.95**

ELECTRIC MEGAPHONES



Complete with Amplifier, Horn and Carrying Case. Dry Cell Battery operated. Ideal for Coaches, Sports Events, Cheer Leaders, Fire and Police Dept., etc. Lightweight and portable. Approx. 10 watts output. All new. (Approx. wt. in use 38 lbs.)
Our Price **\$42.50** Set

CAPACITORS

Pyranol—C.D. Solar—New

1 Mfd. 500 V. DC.	\$.20
1 Mfd. 2000 V. DC.	1.00
2 Mfd. 4000 V. DC.	2.95
4 Mfd. 600 V. DC.	.49
10 Mfd. 600 V. DC.	.79
10 Mfd. 1000 V. DC.	1.49

LP 21 A LOOP ANTENNA



Used with BC 433 or R5/ARN 7. Radio Compass Receivers. Excellent condition. (Appr. wt. 15 lbs. ea.) **Each \$7.95**
LP 19 Loop Antennas **\$5.95**

METERS

Weston—2"; 0 to 30 VDC and 0 to 120 Amps. DC. **\$3.95** Ea.
Weston—2"; 0 to 30 VDC and 0 to 240 Amps. DC. **3.95** Ea.
(Both meters above are complete with a 50 M.V. Shunt)

MINE DETECTOR, AN/PRS-1

Easy to operate, easy to carry. Can be used for detecting ore deposits, both metallic and non-metallic. Now being used extensively by Miners, Prospectors, Beachcombers, and Explorers. These sets are brand new and come complete with Detector head with antenna; Reflector meter and housing and exploring rod; a bag for carrying equipment while operating and a wooden case for storing or transporting unit when not in use. These units contain Tubes, and instruction books. Shipping weight is 12.5 lbs. Weight when operating unit is 22 lbs. All New—Complete with Batteries and ready to operate **\$29.95**

LEARN DAY and EVENING CLASSES TELEVISION

ELECTRONICS-RADIO
Modern Laboratory Instruction in

- SERVICING
- BROADCAST OPERATING
- ELECTRONIC and TV ENGINEERING

G.I. APPROVED

WRITE FOR ILLUSTRATED CATALOG

ELECTRONICS INSTITUTE, Inc.

21 HENRY, DETROIT 1, MICH.

Now Available TAYLOR SUPER-MODULATION

TRANSMITTER KITS and TRANSFORMERS

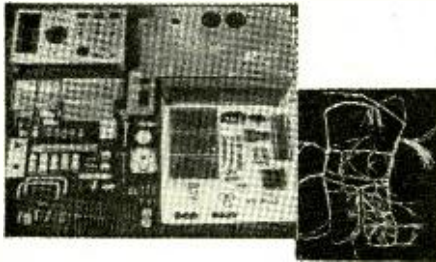

TSM-75K Super-Modulation Transmitter

A revolutionary new high power, compact, light weight amateur transmitter for stationary and mobile use. The "TALK-POWER OUTPUT" is approximately 3 times that of any other type of transmitter with the same power input. Maximum power input of the TSM-75K is approximately 75 watts.

The basic kit now available consists of all metal-work completely finished, and includes punched chassis, front panel, back panel, cabinet, and all brackets and special parts. Also included in the kit are the modulation transformer, meter shunts, special capacitors, and all other special parts. The major feature of the TSM-75K basic kit is the cable harness, which is completely pre-formed and laeod, and all wires are stripped, tinned, and numbered for easy assembly. The wires are placed in such a way that when the harness is laid into the chassis all leads are close to the parts to which they are to be attached. Complete assembly, wiring, and adjustment instructions are furnished, and a complete parts list is supplied. All parts not furnished are standard parts available from most jobbers. Tubes required are 1 - 3E29/829B, 2 - 6AK6, 2 - 6AQ5, and 1 - 6AU6.

The modulator is incorporated into the transmitter, and the only accessories required for operation on either phone or CW are a microphone and power supply. Coil data is supplied with the kit for 10 meter operation. Other data available on request. Coils are available at prices shown below.

TSM-75KB Basic Kit — Net.....\$79.50
Set of Matched Tubes — Net..... 20.40
Set of 4 Coils — Net..... 12.50

Super-Modulation Transformer



MODULATION TRANSFORMER for any Super-Modulation transmitter up to 500 watts, with data for proper use. Weight 13 oz. CS-3261 — Net..... \$7.50

Super-Modulation Transformer

MODULATION TRANSFORMER for any Super-Modulation transmitter up to 1000 watts, with data for proper use. Weight 27 oz. CS-3262 — Net..... \$9.50



All Prices F.O.B. Los Angeles
25% Deposit Required With All Orders.
Orders Accompanied by Full Payment
Shipped Prepaid.
California Sales Add Sales Tax.

The Gaertner Co.

3614 Maple Ave.
Los Angeles 11, Calif.

Licenses Under United States and Foreign
TAYLOR Super-Modulation Patents.

usually the *English* period 0830-0850 can be read.

At press time, the Communist-Chinese "wanderer" in the low end of the 15-megacycle band was "hovering" around measured 15.068-15.076 where it was overriding the BBC's 15.070 outlet, but with bad heterodyne from the BBC; has news 0830, at good strength; announces as "The Peking Radio," and gives a m.w. frequency, 10.260, and a 19-m. channel that "sounds" like 15.063. If this isn't direct from Peking, it may be a relay from Chungking.

AIR, New Delhi, just airmailed me these current over-all schedules for its s.w. outlets:

Delhi—VUD2, 7.290, 2045-2300; 9.630, 0200-0400; 7.290, 0630-0800; 4.960, 0815-1230. VUD3, 15.290, 2030-2145; 9.630, 2200-2230; 15.290, 0200-0240; 17.760, 0300-0400, 0730-0750; 11.790, 0830-0915; 6.010, 0930-1100; 9.590, 1130-1230. VUD4, 11.830, 2030-2230, 0220-0250, 0300-0320, 0340-0400, 0700-0750, 0830-1100, 1130-1230. VUD5, 15.160, 2030-2200, 2300-2330; 17.840, 0230-0330, 0600-0815, 0830-0915; 17.760, 1000-1040; 11.790, 1100-1230; 9.620, 1400-1500; 15.160, 1930-2015. VUD7, 11.760, 2030-2115, 2130-2200; 9.565, 2215-2310; 15.160, 0230-0330, 0430-0530, 0615-0730; 9.590, 0745-1045; 11.710, 1100-1330; 11.760, 1400-1500; 11.830, 1845-1900, 1945-2000. VUD8, 9.680, 2030-2230; 15.350, 0220-0250; 9.660, 0310-0320, 0340-0350; 9.680, 0700-0750, 0830-1330. VUD9, 11.790, 2030-2115; 7.275, 2130-

2230; 11.790, 0220-0240; 15.290, 0300-0400, 0730-0750, 0830-1330. VUD10, 7.225, 2030-2115, 2130-2200, 2215-2310; 17.780, 0230-0330, 0430-0530, 0615-0730; 7.225, 0745-1045; 17.760, 1100-1330; 7.240, 1400-1500; 15.290, 1845-1900, 1945-2000. VUD11, 17.780, 2030-2200, 2300-2330; 21.510, 0230-0330; 15.190, 0600-0815, 0830-0915; 15.210, 1000-1040, 1100-1230; 11.850, 1400-1500, 1930-2015.

Bombay—VUB2, 7.240, 2100-2230; 9.550, 0215-0400; 7.240, 0630-0845; 4.840, 0900-1230. VUB3, 9.550, 2100-2230; 7.240, 0215-0400; 9.550, 0630-0845; 7.240, 0900-1230.

Calcutta—VUC2, 7.210, 2030-2200; 9.530, 0200-0430; 7.210, 0630-0830; 4.880, 0845-1230. VUC3, 9.530, 2000-2200; 7.210, 0200-0430; 9.530, 0630-0830; 7.210, 0845-1230.

Madras—VUM2, 7.260, 2030-2230; 9.590, 0200-0430, 0530-0630; 4.920, 0700-1200. VUM3, 9.590, 2030-2230; 7.260, 0200-0430, 0530-0630, 0700-1200.

According to Magami, Tokyo, summer schedules of *Radio Ankara* are—TAQ, 15.195, 0430-0600, transmission from the Home Service; Thursday, 1530-1600, "Talks on Turkey" (*English*), including recorded music; Sunday, 1530-1600, "Mail Bag" (*English*), including recorded music. TAP, 9.465, daily, 1000 news in Urdu; 1015 recorded music; 1030 news in Arabic; 1045 news in Persian; 1100 transmission from the Home Service; 1130 news in Greek; 1145 news in Rumanian; 1200 commentary in Turkish from the Home Service; 1230 news in

SLIDE FOR LP

BY EDWIN W. HILL
Chief Eng., WDHL

THE LAST few inches of a long "transcription type" pickup arm seem to cost a great deal more than the first few inches do—at least that is a very easy conclusion to reach after comparing the prices of such arms with those of the more common shorter kind that cannot be used with records exceeding 12 inches in diameter.

Among one of his favorite possessions, the author has a two-speed turntable and arm assembly that does double duty as a record player at 78 r.p.m. and a transcription player at 33 $\frac{1}{3}$ r.p.m. Since the dual speed feature was already present, it was logical to want to convert the device to play LP discs also; this, of course, without interfering with its transcription playing ability. The simplest approach would have been the purchase of a pickup arm of the extra long type. However, the cost of those extra inches was such that it was felt that the investment would not be worthwhile.

The small GE UPX004 arm, with VR cartridge, is excellent for LP's and is also quite reasonably priced. However, if this arm were to be mounted in the conventional manner it would be so close to the turntable that the playing of 16-inch transcriptions would no longer be possible.

The problem was solved by drilling a hole in the motorboard according to the directions supplied with the arm and then extending this hole, away from the turntable, in the form of a slot about 2 $\frac{1}{2}$ inches long. The pickup arm is mounted in this slot and the

mounting nut tightened enough so that the arm can just slide back and forth in the slot. Two flat washers, one on each side of the motorboard, will make the sliding operation easier and smoother.

To play LP's the arm is pushed into position next to the turntable. To play transcriptions the arm is slid away from the turntable to the other end of the slot where it is out of the way when a 16-inch transcription is placed on the turntable.

This arrangement can be used with any pickup arm of the short type. The only precaution is that the turntable diameter should not be much greater than 12 inches.

—30—

Over-all view of the author's two-speed turntable which was converted for LP use.



RADIO & TELEVISION NEWS

Bulgarian; 1245 news in French; 1300 news in Serbo-Croat; 1315 news in Hungarian; 1330 news in German; 1345 news in *English*; 1400 home news in Turkish; 1415-1500 transmission from the Home Service.

Direct from Chang Shui-yu, head of the Service Section, Taiwan Broadcasting Station, the Central Broadcasting Administration, Taiwan Broadcasting District, Taipei, Taiwan, China, the *International Monitoring Service*, Calif., has received word that "there are about ten broadcasting stations in Taiwan" (presumably, most are m.w.). Stated further, "This station has two short-wave programs—one being 2300-0100 daily, call BED4, 11.725, beamed to the USA, and the other 0500-1100 daily, call BED7, 7.151." T. Y. Woo, long an official of the Central Broadcasting Administration, is now in Taipei as assistant manager of the China Broadcasting Corporation, Mr. Chang explained.

Summer schedules of *Radio Moscow's* transmissions to North America (*English*), as received from Moscow by the *International Monitoring Service*, Calif., are—1820-1930, 15.23, 11.88, 9.72, 9.67, 11.78, 7.31, 11.96; 2000-2100, 15.23, 11.88, 9.72, 9.67, 9.60, 11.78, 11.96; 2200-2300, 15.41, 15.23, 15.10, 11.88, 9.72, 9.67, 11.96, 11.78.

I have just received a copy of "OP-AID," described by the publishers as "essential data for efficient operation by the amateur radio transmitter or listener," direct from the amalgamated Short Wave Press, 57, Maida Vale, London, W.9, England; price is 25 cents. Topics covered include prefixes, block allocations; amateur prefixes, alphabetical; amateur prefixes, by country; call areas; radio zone boundaries; local time conversion (GMT); mileage table (from London); QSL bureaus of the world; international "Q" code; "Z" code; amateur codes; amateur abbreviations; international Morse Code; the amateur bands; amateur transmitting license; standard frequency transmissions; states and zones charts, and maps of USA and USSR call areas.

At the time this was written, Paris s.w. transmitters were reported off the air; however, Tubb, Texas, had just received word direct from the station that s.w. transmissions were to be resumed shortly.

Radio Scutari, 8.220, Albania, transmits 0700-0900, 1130-1500. (Patrick, England) PZC, 15.405, Paramaribo, Surinam, noted Sundays 1730-1800 with "Bringing Christ to the Nations" (*English*). (Cox, Dela.) *Radio Indonesia*, Makassar, Celebes, 9.550, at least some days has an *English* talk 0530-0535 directed to USA. (Lambach, Ill.)

To July 30, *Radio Sweden* is using these frequencies—1900-2030, 10.780, 15.155; 0015-0230, 6.065, 15.155; 0230-1015, 11.705, 15.155; 1015-1700, 10.780, 15.155; these times are *not exact* times of transmission, since usually there are intervals on weekdays at 0230-0600, 0900-1015; printed schedules are

SEE LEO FIRST . . . for THE BEST TRADE-IN DEAL



Ask the Fellow Who Deals with Me!

Leo I. Meyerson, WØGFO

Trade for a new HALLICRAFTER—I'll allow you more for your present equipment. WRL buys more equipment—WRL sells more equipment. Our large volume of sales means faster turnover, greater savings for you! We finance our own paper—no red tape!

LOW DOWN PAYMENTS—NAME YOUR OWN TERMS—LET'S GET ACQUAINTED!

Guaranteed Satisfaction From The World's Largest Distributor Of
Amateur Radio Transmitting Equipment

HALLICRAFTER SX-71 RECEIVER



Double Conversion sharp selectivity, plus built-in NBFM at moderate cost. 11 tubes plus voltage regulator and rectifier.

\$179.50
Low Down Payment

HALLICRAFTER NEW S-40 B RECEIVER



Frequency 540 KC to 43 MC. 8 tubes, rectifier, internal speaker. 3 watt output. One RF, 2 IF.

Only \$79.95
Low Down Payment



Deal with the "World's Most Personalized Radio Supply House". Send for your new complete WRL Catalog containing everything new in radio.

GIANT RADIO REFERENCE MAP



Just right for your control room wall. Approximately 28" x 42". Contains time zones, amateur zones, leading shortwave stations, monitoring stations. **25c**

FREE WRITE—WIRE PHONE 7795

WORLD RADIO LABORATORIES R-6
744 West Broadway
Council Bluffs, Iowa

Please send me: SX-71 Info
 Radio Map S-40B Receiver Info
 New Catalog List of Guaranteed Used Equipment
 List of Guaranteed Used Equipment

Name

Address

City..... State.....



World Radio Laboratories
LABORATORIES COUNCIL BLUFFS, IOWA

Read RADIO & TELEVISION NEWS Every Month

FREE TELEVISION FREE CATALOG FREE

OF

ALL T-V COMPONENTS EQUIPMENT • PARTS • KITS CABINETS • ANTENNAS, ETC.

NOW READY—BULLETIN J2—WRITE NOW

ARROW ELECTRONICS

INCORPORATED
82 CORTLANDT ST., NEW YORK 7, N. Y.

TELEVISION • ELECTRONICS

Learn Radio the Northwestern Way

- BASIC RADIO
- RADIO SERVICE
- COMMUNICATIONS
- INDUSTRIAL ELECTRONICS
- TELEVISION

Highly Trained Instructors • Modern Equipment
• Spacious Building and Grounds
G.I. and Rehab. Approved

NORTHWESTERN VOCATIONAL INST.



745 Grand Ave.
ST. PAUL 5
MINN.

RADAR, COMMUNICATIONS AND SONAR TECHNICIANS W-A-N-T-E-D For Overseas Assignments

Technical Qualifications:

1. At least 3 years practical experience in installation and maintenance.
2. Navy veterans ETM 1/c or higher.
3. Army veterans TECH/SGT or higher.

Personal Qualifications:

1. Age, over 22—must pass physical examination.
2. Ability to assume responsibility.
3. Must stand through character investigation.
4. Willing to go overseas for 1 year.

Base pay, Bonus, Living Allowance, Vacation add-up to \$7,000.00 per year. Permanent connection with company possible.

Apply by Writing to
D-4, P.O. Box 3575,
Philadelphia 22, Pa.

Men qualified in RADAR, COMMUNICATIONS or SONAR give complete history. Interview will be arranged for successful applicants.

CHANNEL CHIEF

High Gain Square Corner Radar Type T.V. Antenna. Broad Band response covers all High Band Channels but peak may be chosen to boost your weakest picture. "Mirror Focus" Beam Action increases Gain and decreases Ghosts and Naise. All Aluminum Construction for Durability and Quick Assembly.

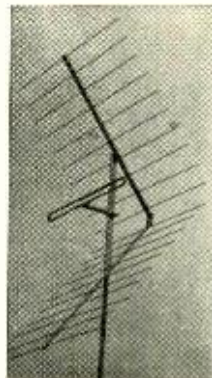

300 Ohm Impedance.
State Weakest Channel

ONLY

10.95 NET

(Mast Not Included)

ORDER DIRECT FROM
MANUFACTURER AND SAVE
25% Deposit with C.O.D. Orders.

CHANNEL CHIEF CO.
37 Mall Drive N. Plainfield, N. J.

TELEVISION

PREPARE FOR A GOOD JOB!
BROADCAST ENGINEER
COMMERCIAL OPERATOR (CODE)
RADIO SERVICEMAN

Television Servicing

(Approved for Veterans)
SEND FOR FREE LITERATURE
BALTIMORE TECHNICAL INSTITUTE
1425 EUTAW PLACE, BALT. 17, MD.

mailed on request from Radio Sweden, Stockholm, Sweden.

Reports in at press time from various parts of the world indicated that *Radio Damascus*, Syria, varies around 6.910 to 7.145 in parallel with its other current channels of 6.000, 12.000. *Radio Sweden* reports PSL, 7.935, and PSH, 10.220, Rio de Janeiro, are in parallel 1630-1700 sign-off. And that *Radio Italiana*, Rome, is now using a new channel of 17.820 around 0700-0900, 1300-1400; recently I heard a 16-m. outlet (seemed somewhat higher than 17.820) at 1340 with *Radio Italiana* news which must be the new outlet.

Lindahl, Calif., flashes that he is hearing YI5KG, 7.090, Baghdad, Iraq, around 1000-1515 but with weak signal.

* * *

Acknowledgement

Many thanks for the fine reports. Keep them coming to 948 Stewartstown Road, Morgantown, West Virginia, USA. KRB.

HAM FEST

THE Peoria Amateur Radio Association is holding its annual ham fest on June 11th at Pleasant Valley Park, located near Dunlap, Illinois, and 10½ miles from Peoria on Route 91.

Full details on the affair are available from H. C. Sever, W9FM, club secretary, 1018 W. McClure, Peoria, Ill.

★ ★ ★

Q.C.W.A. MEETS

THE Quarter Century Wireless Association will hold its sixth semi-annual dinner meeting on Friday, June 9th at the 71st Regiment Armory, 34th Street at Park Avenue in New York.

Famous hams of yesteryear will be guest speakers for the event. In addition, various types of entertainment have been planned. The dinner, which will begin promptly at 6:30 p.m., is \$3.50 per person. Reservations by non-members should be made with John DiBlasi, W2FX, 259 West 14th Street, New York.

★ ★ ★

ANNUAL PICNIC

THE annual picnic of the Indiana Radio Club Council will be held at Turkey Run State Park on Sunday June 18th.

One feature of the get-together will be the awarding of the 1950 plaque to the outstanding amateur of 1950 in Indiana.

★ ★ ★

RADIO CLUBS PICNIC

JULY 16th has been set as the date for the Fourth Annual Weldon Springs Picnic sponsored by the Cenosis Amateur Radio Club, Central Illinois Radio Club of Bloomington, Inc., Clinton Radio Club, Twin-Cities Radio Club, and the Sangamon Valley Radio Club.

This big ham event will be held at Weldon Springs State Park, 4 miles east of Clinton, Illinois. Families are invited to attend and are asked to bring their own picnic lunches. Soft drinks will be served free of charge. A "White Elephant" sale will be a feature of the event.

Full details are available from H. F. Lund, W9KQL, 3135 South Fifth, Springfield, Illinois.

-30-

RADIO & TELEVISION NEWS

BUILD 15 RADIOS ONLY \$14.75

- Absolutely No Knowledge of Radio Necessary.
- No Additional Parts Needed
- Excellent Background for Television.

The PROGRESSIVE RADIO EDU-KIT will help you, if you want an EDUCATIONAL AND INTERESTING HOBBY, or if you want to get into a WELL-PAYING BUSINESS, or if you want to INCREASE YOUR KNOWLEDGE OF RADIO.

Absolutely no knowledge of radio is necessary. The PROGRESSIVE RADIO EDU-KIT is the product of many years of teaching and engineering experience. The detailed instructions and quizzes are clearly written and illustrated, so that they can be understood by anyone between the ages of 12 and 80.

The PROGRESSIVE RADIO EDU-KIT is not merely a collection of radio parts accompanied by a radio diagram. IT IS PRACTICALLY A RADIO COURSE, offered at a mere fraction of its real value. You will be taught to build radios in a progressive manner. First, you will build a very simple 1-tube receiver. The next set is a little more advanced. Gradually you will find yourself constructing elaborate radio sets, and doing work like a professional radio technician. Every part is illustrated. EVERY STEP INVOLVED IN BUILDING THESE SETS HAS BEEN CAREFULLY PLANNED. YOU CANNOT MAKE A MISTAKE.

Each of the 15 radios you will build operates on 110-120 volts, AC or DC. These sets have been designed to teach you the PRINCIPLES OF RADIO. Therefore, you will build a variety of circuits. The PROGRESSIVE RADIO EDU-KIT is EXCELLENT FOR LEARNING THE PRINCIPLES OF RECEIVER, TRANSMITTER, AND AMPLIFIER DESIGN. It is used in many Radio Schools and Colleges in U.S.A. and abroad. It is used by the Veterans Administration for veteran training.

Quizzes are provided as part of the PROGRESSIVE RADIO EDU-KIT. They will be corrected by our staff at no extra cost.



FREE
1950 EXTRAS:

ELECTRICAL AND RADIO TESTER
SCREWDRIVER
BOOK ON TELEVISION
GENEROUS HANK OF WIRE

ELECTRIC SOLDERING IRON
ALIGNMENT TOOL
SPOOL OF ROSIN CORE SOLDER
MEMBERSHIP IN RADIO-TV CLUB

ORDER YOUR PROGRESSIVE EDU-KIT TODAY, OR SEND FOR FREE "KIT-KATALOG"
POSTAGE PREPAID ON CASH ORDERS. C.O.D. ORDERS ACCEPTED IN U.S.A.

PROGRESSIVE ELECTRONICS CO.

497 Union Ave., Dept. RN-34
Brooklyn 11, New York

Mac's Service Shop
(Continued from page 48)

be moistened by applying the acetone with long curved eye-droppers."

"Where do you get those?"

"You make them, or have someone else do it for you. Jennie, the girl who lives next door to us, works in a hospital laboratory, and she makes them for me by heating the end of a glass tube over a Bunsen burner and then drawing it out and curving it to agree with sketches I give her; but you can do the same thing in any gas flame.

"When acetone is properly applied through these droppers, it softens the spider and takes the side-pressure off the coil. Then I turn the infra-red heat lamp on the speaker and give the spider a quick drying. After it is thoroughly dry, the shims are removed; and almost invariably the coil is found to be perfectly centered. As a double check, though, I keep the radio playing at low volume—where the rubbing-voice-coil type of distortion is most apparent—while I again heat the speaker with the heat lamp. Then I turn the set off and let it cool down. If no rubbing shows up under either 'hot' or 'cold' conditions, I feel confident the job will be satisfactory."

"Don't you find some of them in which the voice coil is out of line—sort of cocked on the pole piece?"

"Yes, and they are the really tough ones. They are the cases where the front of the coil form touches the pole piece on one side and the rear of the form touches it on the opposite side. In that case I use my shims that have had one end dipped into varnish and allowed to harden so that the end of the shim is appreciably thicker than the rest of it. One of these thickened tips is worked into the space where the rear of the voice coil sleeve is resting against the center pole, and another is used to separate the front of the form from the pole. Straight shims are used at the other two quadrant positions. In addition to softening the spider, I also use acetone very cautiously to soften the union of the voice coil form with the cone proper, being very sure that none of the fluid runs down inside or outside the coil."

"That sounds like a good bit of trouble. Is it worth it?"

"I think so. In the telling it sounds more complicated than it is. I have kept a close check on these repair jobs, and less than four per-cent of them have given trouble again—which compares very favorably with new speaker installation jobs.

"Quite often installing a new speaker means that it must be ordered from a distributor with a consequent delay in getting the set back to the customer. The cost is much less, too. That is quite an item on those small sets. The cost of installing a new speaker is such a substantial percentage of the cost of the whole radio that the owner quite often decides simply to junk the set."

SAVE UP TO 95% SENSATIONAL SURPLUS VALUES!



BRAND NEW APS-13 WARNING RADAR

17 tubes as follows: 9—6AB5, 5—6J6, 2—2D21, and VR-105, 410 to 420 Mc, and 30 Mc. IF. Good deal for conversion and citizen band. With instruction book. Originally over \$100. **\$16.95**

COMMAND RECEIVERS

Tested Before Shipping
190-550 KC Used. Orig. \$40. Now. **\$9.95**
3-6 MC Used. Orig. \$30. Now. **4.95**
3-6 MC New. Orig. \$35. Now. **6.50**
6-19 MC Used. **7.95**
1.5-3 Meg. Used. Excellent. **14.95**
ARR-2. Used. 234-258 Mex. **9.95**



COMMAND XMITTERS

BC-459, 7-9.1 Mc. Excell. Cond. **\$8.95**
T-22ARC-5.7-9.1. New. Orig. \$50. Now. **12.75**
3-4 MC. Used. Orig. \$50. Now. **12.50**
5.3-7 MC. Used. Orig. \$30. Now. **3.95**
T-21 ARC-5.5.3-7. New. Orig. \$40. Now. **5.95**
4-5.3 MC. Used. Orig. \$30. Now. **3.49**
T-20 ARC-5. New. Orig. \$40. Now. **6.95**
2-1-3 MC. LN. Orig. \$40. Now. **9.95**

BC-474 FIELD TRANSMITTER RECEIVER

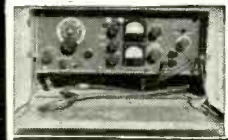

Receiver tunes from 2.3 megs. to 6.5 megs. using 1 RF stage. Power requirements 30 V and 1.5 V. Transmitter tunes from 3.5-6.3 megs., phone or CW using 6V6EC, 6V6PA, and 6V6 modulator. Uses 100 mil. plate meter and 0-1 amp. RF ammeter. Power requirements 300 V 100 mil. Excel. used cond. with tubes and dry battery. **\$39.95**

PE-103 DYNAMOTOR

6-12 volt input. 500 volt @ 160 MA output. Comes equipped with 2 10-volt input leads. Used but like new condition. **\$16.95**

PE-157 VIBRATOR PACK

Part of SCR 511 "Horsie-Talkie." Operates from 2 volt rechargeable battery which can be recharged from 6, or 12 volts DC, or 6.3 volts AC. Contains loudspeaker and mike transformer. Output: Receiver—1.5 filament V @ 355 MA, 67.5 plate V @ 20 MA. Transmitter: 1.5 filament V @ 490 MA, 105-125 plate V @ 50 MA. In excellent used condition. A real buy. **\$9.95**

PE-237 VIBRATOR POWER UNIT

6, 12, 24 volt input. Output: 515 V @ 160 MA, 105 V @ 40 MA, 95 V @ 17 MA, 1.4 V @ 45 Amp. Coupled with 6-foot power cord. Like new. **\$14.95**

SCR-522 VFH TRANSCEIVER

An all time favorite for all 2 meter ham operators. This unit consists of 2 chassis. BC-625 transmitter and BC-624 receiver, transmitter being hot controlled and having an am output of approx. 15 watts. Freq. range 100-156 meg. w/ Diagram. Used. Complete. Good cond. **\$29.95**
Xmitter or Revr. Separate. **\$14.95**

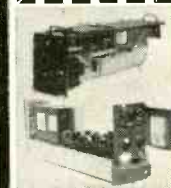

BC-1073 WAVEMETER
PWR. SUPPLY SECTION: 110 V 60 Cy, 330 V DC 85 MA 2 section filter. Also 15 tubes: 10-6NS7's, 1-5Y3, 1-6H6, 1-6SJ7, 1-6V6, 1-6SA7. Can be purchased separate at **\$9.95**
WAVEMETER SECTION: has high quality resonant cavity tuning from 150-210 MC, oscillator, heterodyne amplifier, electric tuning eye, precision milten gear drive and collapsible antenna. Built-in oscillator checks against cavity for proper frequency setting. Uses 9002, 6SF5 and 6E5 tubes. Used. **\$14.00**
PWR. SUPPLY AND WAVEMETER IN ONE **\$22.50**

WRITE FOR NEW 1950 CATALOG

V&H RADIO & ELECTRONICS SUPPLY
DEPT. R-10, 2033 37 W. VENICE BLVD.
LOS ANGELES 6, CALIFORNIA

100 WATT BENDIX TRANSMITTER TA-12

3—807 tubes, 4—12SK7's, 2' 5 amp. RF meter and separate master oscillators. Easily changed to cover 20-40-80 meters and using crystal 10 meters also. Thus giving you a complete coverage transmitter section and position switch changes ECO, IPA and output tank simultaneously. Comes with MP-28 Mod. & dynamotor. USED **\$29.50** NEW **\$45.00**



BC-611 "HANDIE-TALKIES"

FRED, 3-6 MC ATTENTION CONSTRUCTION MEN, BUILDERS, SURVEYORS! Perfect for short distance communication. Weights only 5 1/2 lbs. Hand held. Pre-set to your frequency. Push-button controlled. Transmitter and receiver in same case. 15 3/4" x 3 3/4" x 5 3/4" sturdy aluminum case. Complete with tubes, crystals, 1 set batteries. Extra batteries, accessories available. In good used condition. PRICE ON REQUEST.

BC-1068 RCVR

150-210 Meg. Contains 115 V AC 60 Cy. power supply. Inductance tuning for RF, Ant., DET. and OSC. Makes ideal FM or 2 meter rcvr. with few modifications. Has 14 tubes: 1—6SN7, 1—6H6, 3—6SH7, 3—6AC7, 2—6AB7, 1—6B5, 1—504G, 1—9006, 1—6E5 ind. **\$22.50**
Used. **\$38.95**
BOTH BC-1068 and BC-1072. **\$38.95**

BC-1072 XMITTER

157-187 MC. Input 117VAC 60 cy. Has parallel rod OSC using 2—826 PP, contains power supply, general radio variac 1.5A. 3 1/2" 0-5 kilovoltmeter, 10 tubes and loads of other parts too numerous to mention. **\$19.75**
With tubes. Less Blowers. Used.

815 TUBE. New. each **\$1.95**; **\$4.95** for 4.



WESTERN ELECTRIC AUDIO AMPLIFIER TYPE D-150300



An excellent mod. driver or PA system with hi-quality components and construction. Input stage consists of parallel 6L7's feeding parallel 6C5's. Impedance couple to 6L5's in PP parallel. Class A 40 W output 225 ohms output impedance. Power supply 110V 60 cyc. using 2-5T4's. Has built-in limiter and compression circuits. Maximum hinged and folds back for easy servicing in rack as shown. Excel. cond. COMPLETE WITH TUBES. **\$49.95**

SIMPSON #624 VOLT-OHM-METER

TS-291, part of I-56 Test Set. 0-30-300-600-volts/DC, 1000 ohms/volt. 0-500-10,000-100,000, 1 meg. ohms. In excellent condition. 5 1/2" x 3 3/4" x 2 3/8". **\$14.95**
TRIPLETT #1183-SC COMBINATION TUBE AND MULTI-TESTER
Checks tubes, AF output, measures AC, DC volts, direct current, resistance, cap. Can be used as free-point tester for measurements at tube sockets while radio is on, without removing chassis from cabinet. 0/10/50/250/500/1000 AC, DC volts. Ohms/volt: 10,000 DC, 2000 AC, DC MA. 0/1/10/50/250. Ohms: 0-500-15,000, 0-1.5 or 15 megs. Used good condition. Part of I-566 test set. 14 7/8" x 7 1/4" Weighs 5.2 lbs. **\$49.50**

LAYOIE VHF FREQ. METER. Type 105SM

Tunes from 375-725 MC. 1%. Brand new. Complete. **\$59.95**

BC-659 TRANSCIEVER

27-39 MC. FM. Crystal controlled. Complete with PE-120 Vibropack which operates on 6, 12, or 24 volts. This is an excellent buy and is in good used condition. **\$13.95**
AN29C ANTENNA for BC-659. Only **\$2.95**
DM-35D DYNAMOTOR
12 volt input. 625 volts @ 225 MA output. Continuous duty. A real bargain at this special low price. **\$5.95**
In good condition.

SPECIAL BUY! NEW IRC BLEEDER RESISTORS

50,000 ohms, 60 watts. Only 49c ea. or 10 for \$3.95.

IMPORTANT
NO ORDER LESS THAN \$5.00. Send 30% deposit on cost of item or full amount to save COD charges. Do not send shipping costs. It will be COD only. Shipments sent via railway express unless other instructions given. Merchandise subject to prior sale. Prices subject to change at any time.

TELEVISION RECEIVER—\$1.00

Complete instructions for building your own television receiver. 16 pages—11" x 17" of pictures, pictorial diagrams, clarified schematics, 17" x 22" complete schematic diagram and chassis layout. Also booklet of alignment instructions, voltage and resistance tables and trouble-shooting hints —All for **\$1.00**

CERTIFIED TELEVISION LABORATORIES
5507-13th Ave., Brooklyn 19, N. Y.

PEN-OSCIL-LITE

Extremely convenient test oscillator for all radio servicing; alignment • Small as a pen • Self powered • Range from 700 cycles audio to over 600 megacycles u.h.f. • Output from zero to 125 v. • Low in cost • Used by Signal Corps • Write for information.

GENERAL TEST EQUIPMENT
38 Argyle Buffalo 9, N. Y.

BLISS Electrical Training

Intensive 32 weeks' residence course in fundamentals of industrial electrical engineering, including radio and electronics. Extensive laboratory, shop work, drafting. Prepares for electrical technician and engineering

aides in communications, power, manufacturing, business machines, sales, service. G. I. approved. 57th year. Enter Sept. 5. Catalog. **7611 TAKOMA AVE. WASHINGTON 12, D. C.**

Lowest prices!



SYNCHRON MOTOR
Model 600, 1 RPM, 115 Volts, 60 cycles. Brand New.
Special Price \$2.45 each

C-1 AUTOPILOT SERVO UNIT—

Use to rotate beam antenna, actuate boat rudder control, etc. Contains 24 V. motor, clutch, relays, etc. Reversible. Size overall approx. 10 1/2" x 8 1/2" x 6 1/2". Ideal for light hoisting. Make your own garage door opener. Removed from new aircraft.

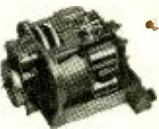

PRICE \$8.95

C-1 AUTOPILOT VERTICAL GYROS

May be used to conduct many interesting and amusing experiments. Operates from 24 V. DC or may be operated for short periods on 110 V. AC Gyro will run for approx. 15 minutes after actuating. Size—approx. 8" x 8 1/2" x 8 1/2". Less Amphenol Connector. Removed from new aircraft. Special.....



\$4.95

C-1 AUTOPILOT AMPLIFIERS

Three channel servo amplifier consisting of many valuable electronic parts including 6 relays, 7 tubes, etc. Unit removed from new aircraft.



Super Special \$4.95

12 V. DYNAMOTOR

WinCo Type 4156 input 13 Volts DC 13 amps. Total output 250 volts at .060 A and 300 volts 225 A. Ideal for boat or mobile use.

NEW at \$3.95 each



BEAM INDICATOR

I-82F Compass Indicator. 0-360°-5 in. dial. 26 v 400 cy. 8-12 v. 60 cy. Ideal position indicator. Brand new.

Price \$2.95 each

SAMPSEL PM MOTOR

Alnico Field
27.5 v. DC. 10,000 rpm. 1/100th hp. Ideal also as tachometer generator.

Price \$3.95 ea.

SERVO AMPLIFIER

Minneapolis-Honeywell Design G-403A1
115 v. 400 cy. Use with a-c error signal. Price. \$6.50 ea. USE WITH M.H. MOTOR G303AY2CA4. Built in gear reduction. 50 in/lb. torque.

Brand New—Special price \$6.75 ea.

Edison Time Delay Relay—s.p.s.t. nor. closed. 30 v. 7 sec. to open. Sealed. . . . 59c ea.
Neon Blown Fuse Indicator—110/220 v. AC or DC 39c ea.
Relay—6/12 v. DC. D.P.S.T. 69c ea.
Relay—6/12 v. DC. Makes one breaks one. (10 Amps.) 89c ea.
Contactor—Cutler Hammer 6041H30B. (50 Amps.) Special \$2.95 ea.
Tube Specials—7F7, 7N7, 7Y4 at 49c ea.

TERMS: 20% cash with order—balance C.O.D. Orders accompanied by payment in full must include sufficient postage, otherwise shipment will be made via Railway Express collect. Minimum order \$2.00.

Electro Devices
INCORPORATED
BOX NO. 1941 PATERSON, N.J.

Barney stretched until his muscles cracked and gave a prodigious yawn. "Man, am I sleepy," he said. "It was such a wonderful evening last night with such a big full moon that—"

"That you kept Margie out until the wee small hours explaining the wonders of observational astronomy to her," Mac interrupted.

"I was about to say," Barney continued with quiet dignity, "that I blew Mom to a drive-in picture show and then took her for a long ride afterward. In the future, Mr. McGregor, don't be so quick to jump to conclusions!"

—30—

Diode Applications

(Continued from page 65)

between 75 and about 115 volts for the 1N34.

In Fig. 7, a 1N34 diode is "back-connected" in series with a variable-voltage (zero to 120 v.) d.c. power supply and 100-ohm fixed resistor. The voltage is increased slowly by manual adjustment of the power supply to approach point "X" on the crystal conduction curve. As the voltage is raised, the reverse current increases slowly and non-linearly and is restricted to microamperes. The crystal accordingly "sees" almost the full supply voltage at each low-voltage point, because the voltage drop across resistor *R* is small. At the instant that the voltage corresponding to point "X" is reached, however, the crystal suddenly draws a much larger current (10 to 20 milliamperes). The increased current causes an appreciable voltage drop across the resistor, and this reduces the voltage across the crystal. The crystal then draws less current, and the resulting drop across the resistor decreases, increasing the crystal voltage. A repetitive process sets in. If the supply voltage is held in the vicinity of point "X" the crystal current accordingly will rise and fall rhythmically at a rate determined chiefly by the voltage at point "X" and the value of the fixed resistor. Thus, an oscillator containing only resistance ("R"-oscillator) is obtained.

The output waveform takes the shape of rather steep "spikes," as

Fig. 7. Germanium oscillator using resistance and voltage exclusively.

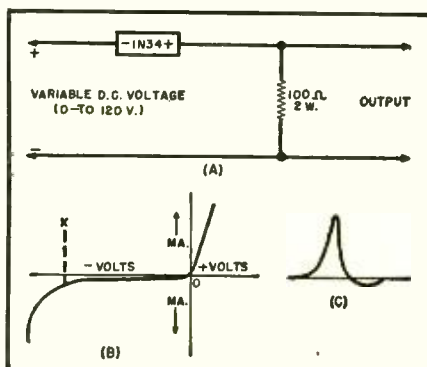

Telrex INC.
CONICAL "V" BEAMS
ASBURY PARK, NEW JERSEY

- THE SKILL TO DESIGN
- THE FACILITIES TO PRODUCE
- THE ABILITY TO DELIVER

MANUFACTURERS OF THE CONICAL "V" BEAM FOR TV AND FM RECEPTION

Available through Authorized TELREX Distributors

WRITE DEPT. R FOR CATALOG

LOOK!
BC-221
SUB-ASSEMBLY

Basic VFO Unit used in BC-221 Frequency Meter. Ideal for home building of:

BRAND NEW! \$4.95

Amateur Radio VFO; Portable Xmitter; Frequency Meter; and, for replacement in BC-221. Contains: 2 temp./humid. compensated coils; water switch; 3 var. condensers; resistors; silver-mica condensers. Mtd. on aluminum chassis, WIRED and ready for installation.

PRICE SLASHED!
150-WATT BC-375-E
RADIO TRANSMITTER

With all 7 Tuning Units (200 kc.-12.5 mc., except B-C band), Dynamotor, Ant. Tun. Unit, Connectors, Tubes, etc.

CUT TO \$69.95

Send for Circular! All items subject prior sale: F.O.B. N.Y.C.: 20% dep. on C.O.D.'s.

COMPONENTS SUPPLY CO.
161N Washington St., N. Y. 6, N. Y.

WANTED TO BUY

Large and small quantities of new or used electronic government or manufacturers' surplus tubes and equipment. Highest prices paid. State quantity, condition and best price in first letter.

Box 496, % RADIO & TELEVISION NEWS
185 N. Wabash Ave., Chicago 1, Illinois

WANTED

ELECTRONIC—RADIO PARTS IN QUANTITY

GOULD GREEN
252 GREENWICH ST., NEW YORK CITY 7

RADIO & TELEVISION NEWS

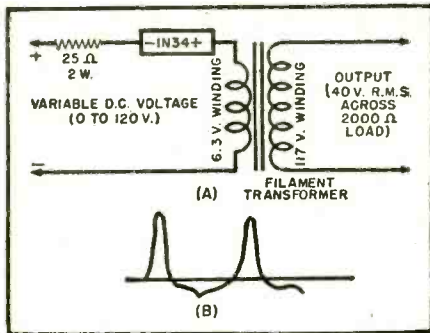

Fig. 8. Crystal interrupter. An input voltage of 85 to 110 volts d.c. will give an output of 1 to 400 c.p.s. at 40 volts r.m.s. across 2000 ohm load.

shown in Fig. 7. The frequency can be shifted over a range of several hundred cycles by adjustment of the input voltage slightly above point "X." Adjustment of the circuit is simple: A pair of headphones or a.c. vacuum tube voltmeter can be capacitance-coupled across the 100 ohm resistor, after which, simply adjust the d.c. supply voltage slowly until the circuit breaks into oscillation.

Signal voltage can be capacitance-coupled out of the oscillator from across the resistor.

Crystal-Diode Interrupter

The same principle explained in the preceding oscillator section is utilized in the circuit in Fig. 8. Here, the same type of oscillation is obtained by the combination of d.c. voltage, fixed resistor, and crystal conduction characteristic. The transformer winding, connected in series with the crystal, has negligible resistance.

As the current rises and falls in the crystal circuit, as a result of oscillation, a voltage is induced across the secondary winding of the transformer. The crystal thus acts as a non-mechanical primary-circuit interrupter.

With the combination shown in Fig. 8, an output of 40 volts r.m.s. was obtained across a pair of 2000 ohm headphones as a load. The frequency was adjustable between 1 and 400 cycles per second by varying the d.c. supply voltage between 85 and 110 volts. The higher frequency corresponds to the higher voltage. The waveform is "spiked," as shown in the pattern in Fig. 8.

-30-

TRANSVISION 19" KIT

\$104⁰⁰

less C.R. Tube*

Finest Quality

ANYONE can easily assemble the famous Transvision Kit. No technical knowledge or instruments required. Instruction sheet is simple (each part is packaged and numbered). ALL IF'S are wired and pre-tuned. Note: Kit comes complete with all parts except picture tube.

COMPLETE LINE: TV only ("A" line). Also TV-and-FM Radio ("D" line). 12 1/2", 16", 19". Choice of tuners includes famous DuMont Inputuner.
 *PICTURE TUBES: 16" all glass tube, fully guaranteed....net \$35.00
 19" all glass tube, fully guaranteed....net 62.00

WIRED TV CHASSIS

Completely Wired and Aligned
 Transvision "A" Chassis (TV only) comes completely wired, aligned and operating. Especially designed for fringe area reception. 23 tubes, AFC, AGC. Wired-in phono plug. Picture tube and speaker not included.
 Transvision "D" Chassis (TV-and-FM Radio) has famous DuMont Inputuner.
 PRICES: 16" TV Chassis ("A" line)net \$115.00*
 19" TV Chassis ("A" line)net \$122.00*
 *Picture tube and speaker are extra.

TV CABINETS

Newly styled complete line of beautiful hand-rubbed cabinets for 19" and 16" TV Chassis or Kits. Also CONVERSION CABINETS to convert any small screen set to a giant 16" or 19" size. WRITE FOR FOLDER.

INSTRUMENTS and PARTS

Transvision FIELD STRENGTH METER
 Improves installations; saves 1/2 the work. Model FSM-1, complete with tubes..... Net \$79.00
DEFLECTION YOKE..... Net \$2.95
FLYBACK TRANSFORMER
 Net \$2.95

TRANSVISION, INC., Dept. RN, NEW ROCHELLE, N. Y.

Branches:—Jamaica, L. I., 167-01 Hillside Ave. . . . Syracuse, N. Y., 622 N. Salina St. . . . Cleveland, O., 2001 Euclid Ave. . . . Columbus, O., 54 E. Long St. . . . Chicago, Ill., 4834 S. Ashland Ave.

ASK YOUR RADIO PARTS JOBBER! Representatives: Apply now for available territories.

Write for Folders on Complete TRANSVISION Line

Mass. Radio School

273 Huntington Ave., Boston 15, Mass.
 Offers Training Courses for Radio Technician (Pre-Television) and Licensed Radio Operator (All Types) including maintenance and operation of General Electronic Equipment. Over 20,000 Alumni and 30 years' radio-training EXPERIENCE. Courses approved for Training for Veterans.
 Send for Catalog
 Licensed by Commonwealth of Mass.
 Department of Education

COIN RADIOS

Buy Direct from Manufacturer & Save

- STEEL CABINET
- MODERN DESIGN
- COIN REJECTOR



\$39⁵⁰

List F.O.B. Factory

One-third Deposit. Balance C.O.D. Write, Wire, Call for Quantity Discount. Send for Full Story

Coin Radio & Television Co.
 500 W. 52nd St. Dept. R New York City

COLOR ON YOUR TELEVISION NOW

Simply attach TELECOLOR FILTER to front of your set, and enjoy favorite programs in a glorious color tone, instead of dull black and white. "TELECOLOR" Filter is one of the latest discoveries. Its special formula fluorescent coloring gives brilliant, pleasing color tone. Experience new happiness and enjoyment in life-like color depth, reduced glare, and eye strain. Everyone is talking about and waiting for 3 color Television costing hundreds of dollars. Now for a small sum you can enjoy new color toning. This filter is guaranteed to work on every make or size of set.

TELECOLOR FILTER is a wonderful gift. Children love it.

TRADE DISCOUNTS	10 inch tube	— \$3.00	Dept.
	12 1/2 "	— \$4.00	RN-6
	16 "	— \$6.00	

HARVARD LABORATORY
 659 Fulton St., Brooklyn 1, N. Y.

ALMO TV ANTENNAS

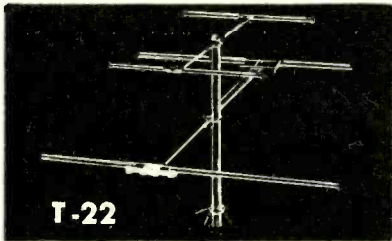

T-22 Straight dipole with reflector and matched HI-band adapter. All channels. Two mating 1 1/4" Dual-coated steel mast sections. 3/4" Aluminum alloy elements. 7 ft. erected. Guy ring included.
RA-22 Same as above, less pole and accessories.

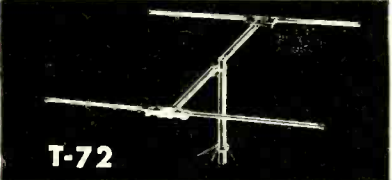

T-72 Channels 1-6. Lo-band array. Straight dipoles. 3/4" aluminum alloy elements. Complete with two mating 1 1/4" steel mast sections. 7 feet erected. With guy ring.
RA-72 Same as above, less masts.

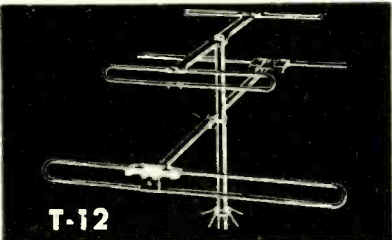

T-12 Folded dipole with reflector and matched HI-band adapter. All channels. HI-tensile 3/4" aluminum alloy elements. Two mating steel mast sections. 7 feet erected. With guy ring.
RA-12 Same as T-12, less pole and accessories.



TX Portable. 3-section telescopic dipoles. All-way orientation. All channels. Heavy cast base with crackle finish. Complete, with cable.

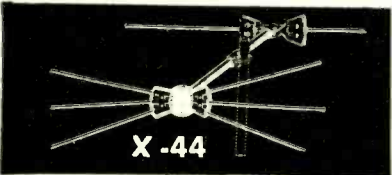

X-44 Array only. 3/4" aluminum elements. Includes mast clamp for use with poles to 1 1/4". A buy for installation crews supplying accessories.
X-33 Same as above with 6 interchangeable elements.

DEALER RESALE SCHEDULE—ALMO ANTENNAS

	1 to 5	6 to 11	12 to 24	25 or over
T-22	4.50	4.15	3.85	3.70
RA-22	3.75	3.50	3.25	3.00
T-72	3.95	3.50	3.25	3.00
RA-72	2.75	2.50	2.25	2.00
T-12	5.45	5.00	4.58	4.40
RA-12	4.25	3.85	3.58	3.40
TX	1.98	1.75	1.65	1.35
X-44	3.75	3.25	3.00	2.85
X-33	3.25	2.90	2.60	2.50

10% Cash With Order

ALMO RADIO CO.
 509 ARCH STREET • Philadelphia
 6205 MARKET STREET • West Phila.
 6th & ORANGE STS. • Wilmington
 4401 VENTNOR AVE. • Atlantic City

AFCA NEWS



This Association is a patriotic non-profit organization, with chapters in most of the larger cities, dedicated to developing and maintaining efficient personnel, commissioned, enlisted, civilian, for the supply (including design and development), installation, maintenance, and operation of communications and electronic equipment for Army, Navy, and Air Force and their supporting civilian activities. It publishes a magazine "SIGNALS" at its national headquarters in Washington. Every American interested in any way in communications is eligible and invited to join. Dues are \$5.00 per year. Application should be submitted to the secretary at 1624 Eye St., N. W., Washington 6, D. C., who will furnish details upon request.

AFCA CHAPTER NEWS

Baltimore

Two hundred members of the Baltimore Chapter visited the Glenn Martin aircraft plant on March 22nd, where they were guests of the Martin management for dinner and a discussion, illustrated with movies, on guided missile and rocket projects.

The Martin chief of electronics, John Pearce, welcomed the AFCA members and outlined the guided missiles program in general terms. Electronics takes a major part in all Martin special weapons developments, Mr. Pearce said, but it is a phase of operation which is all classified, leaving only broad details for discussion. In this vein the electronics chief said that it was confidently expected that a range of 4000 to 5000 miles would soon be made practicable for guided missiles, and that they would be heat or acoustic sensitive and capable of self-guidance to certain points.

Prior to movies shown of the Gorgon IV ramjet projectile and the Viking rocket these developments were described by R. W. Sanford and W. G. Purdy of the Martin engineering department. After the showing a question period was conducted by W. B. Bergen, chief engineer.

Kentucky

A tour of the U. S. Naval Reserve Training Station at Lexington was featured at the Kentucky Chapter's March 10th meeting.

Sixty-five members and guests attended dinner at Capps Coach House in Lexington and then went on to the training station where they were welcomed by Lieutenant Commander W. H. Bargeloh who had made the ar-

rangements for the chapter visit. At the conclusion of the inspection which covered all phases of the station's training facilities, two movies were shown—one on the subject of radar and the other on an atom bomb test.

A sub-chapter of the Kentucky Chapter has been organized in the Louisville area to be known as the Louisville-Fort Knox Sub-Chapter.

Captain Stephen A. Cisler, Jr., USMCR, vice-president of radio station WKYW, Louisville, was chosen to serve as the sub-chapter's first president. Perry W. Esten, chief engineer, radio station WGRC, Louisville, was elected secretary-treasurer.

New York

Brig. General Raymond C. Maude, Assistant Chief of the Air Force Development Division, was guest speaker at the March 22nd meeting of the New York Chapter at the 71st Regiment Armory. He discussed the mission and organization of the development division of the Air Force and reviewed some of the operations during World War II which led to the present emphasis on development activities in the Air Force.

"We feel that the one national resource in which we may maintain world superiority is in our technology and in the application of this technology to the national defense," General Maude said. "This technical superiority can only be maintained through the closest relationship of industry, research organizations and institutes, and the armed forces. We will always want to depend on scientific and research organizations such as our universities for the preponderance of basic research. In the field of applied research and development the armed forces must, however, play a leading role. The Air Force is responsible for establishing military requirements in terms of technical characteristics for

General Maude concluded his address with the following: "To a greater degree than ever before, we plan to solicit the active partnership of the civilian technical competence of this nation. You must provide the link between the needs of the uniformed services and the civilian scientific world. Your continuing awareness of the problems of national defense is the basic tool for creating the technical superiority we so sorely need. Officers in the military services can plan, study, analyze, and test weapons systems of tomorrow, become proficient in their application and provide operating personnel. But you, the aware and informed citizens, translating your technical competence into the application of technology to warfare and your social consciousness into political action which preserves an adequate force for national security, must furnish the broad base on which a modern Air Force is erected. Nothing less than this enlightened partnership of science and the military will suffice to uphold our way of life and our survival as a nation."

Chapter President Thompson H. Mitchell of *RCA Communications*, introduced a number of well-known members in the communications field. They included Maj. Gen. Harry C. Ingles, former Chief Signal Officer of the Army, and now President of *RCA Communications*; George W. Bailey, Executive Secretary of the IRE and President of the ARRL; Captain Roy W. M. Graham, USN, Chief of Staff of the Eastern Sea Frontier; Colonel Robert T. Yeager, USAF, Communications Officer of the First Air Force; Rear Admiral S. F. Patten of *Du Mont Television*; Dr. H. H. Beverage, radio engineer and inventor; D. F. McClure, Asst. Vice-President, *New York Telephone Co.*

The meeting concluded with the showing of three new Air Force training films. The first two, entitled "Air Power," showed the development of combat aircraft and its fire power. The story of atomic energy was depicted in the last film.

Philadelphia

The absolute dependence of all components of peace-time as well as war-time society upon communications was stressed in an address by Brig. General Hugh Hester before the Philadelphia Chapter on March 30th.

The business of the meeting was devoted to a discussion of the proposed agenda for the chapter presidents' conference to be held at the AFCA convention in May, which was submitted to each chapter by Col. George P. Dixon, AFCA Executive Secretary.

A film entitled "Industrial Mobilization" concluded the program for the evening.

Sacramento

The U. S. Geological Survey Photogrammetric Laboratory in Sacramento was the scene of the chapter's meeting on February 28th. In the layman's

HALF AS LARGE . . . TWICE AS GOOD!

DUAL & TRIPLE DANDEES with the NEW INSULATED-STUD TERMINALS

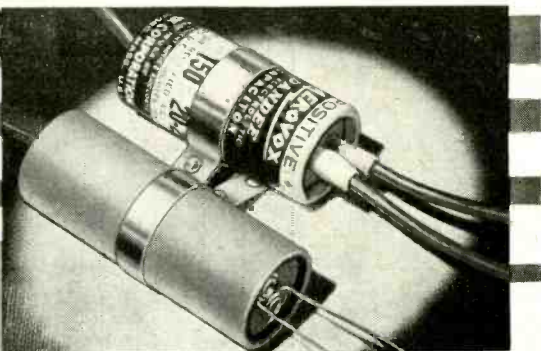

• Smaller — better. That's why the new Aerovox dual and triple midget-can electrolytics are a smash-hit with servicemen.

Stud terminals replace usual riveted terminals. Reduce tubular diameter 40%. Advanced electrolytic capacitor art further reduces bulk. Note comparison between usual dual and new Dual Dandee.

To top it all, insulated wire leads in place of bare wires! Also insulating sleeves over stud terminals. No danger of "shorts" even in tight spots.

GO AEROVOX!

For faster, easier, more-money servicing, ask your Aerovox jobber for these Dandees. Ask for latest Aerovox catalog—or write us.



FOR RADIO-ELECTRONIC AND INDUSTRIAL APPLICATIONS

AEROVOX CORPORATION, NEW BEDFORD, MASS., U. S. A.

Sales Offices in All Principal Cities • Export: 17 E. 42nd St., New York 17, N. Y. Cable: AEROCAP, N. Y. • In Canada: AEROVOX CANADA, LTD., Hamilton, Ont.

Leotone

SPECIAL — RADIO HARDWARE TREASURE! Full pound can of Nuts, Screws, etc.	49c
"POWER-PACKED" 2/5 HP UNIVERSAL MOTOR (GE/Emerson), 115 V. AC/DC. 3000 RPM, reversible, shaft 2 1/2" x 3/8". Over-all 7" x 4 1/2". Shpg. wt. 12 lbs.	\$5.95
4 WIRE CONNECTORS—PL-179 plug & jack.	.39
COAX ANGLE PLUG—8 1/2" (PL-179).	1.9c; 6/1.00
3 WIRE CABLE; rubber, 5/16" O.D. 5c ft.; 100'	3.49
"ALNICO MAGNET" KIT; powerful bar, block, ring, etc. Kit of 10 asstd.	1.98
RUBBER PHONE CUSHIONS, army type, pair.	.25
BATTERY CLIPS, 3 1/2" plated, ea.	9c; 15/1.00
3 MEG HEAR. AID PWR. & SW 3/4" deep.	.49
PILOT BULBS—621, 3 CP. 28V. 8 C. bay auto base ea.	9c; 15/\$1.00; 100/4.75
#3816, 13V. min. bay ea.	10/1.39
NE-48 NEON—115V. D.C. bay base.	19c; 10/1.98
T-30 THROAT MIKE, brand new.	ea. 39c; 6/1.98
CD-508 CORD & SWITCH for T-30.	ea. 49c; 6/2.49
T-32 DESK MIKE press-to-talk carbon.	NEW. 2.95
T-44 MAGNETIC MIKE.	NEW. 69c; 3/1.95
HANDY CARBON MIKE (RS-83). Prestalok.	.98
PORTABLE DC AMMETER (Boy #51) 0-15 Amps. 3 1/2" mirror scale. With 36" test leads & metal case.	3.95
50W-15 OHM RHEOSTAT (IRC) ea.	89c; 3/2.50
RADIO-AMPLIFIER STEEL CABINETS (made for RCA). CHROME GRILLE & SIDE TRIM, marine gray. 10 1/2" x 10 1/2" x 9 3/4"	1.98
DPDT TOGGLE (C-1). Bat. base. 30A/125V. tip. Spring return. 1 3/4" mtg. ea.	39c; 3/1.00
6V. BUZZER & KEY (W.E.). 1/2" bakelite base	1.25
HIGH FIDELITY CRYSTAL MIKE. Hi-imped. Rubber shock-mtd. 1 3/4" O.D. 1/4" deep. Less housing ea.	.98
ALUMINUM HOUSING for crystal mike	1.15
FREQ. METER TECH. MANUAL (TS-173)25
R-89/ARN-SA SCHEMATICS25
MS-53 MAST SECTIONS. 19" steel screw39
1/2" RED JEWEL ASSEMBLY—with 28V. min. bay. bulb ea.	29c; 4/1.00
05-400V. OIL CONDENSERS ea.	10c; 12/1.00
GENERATOR VOLTAGE REGULATOR (GE)—Navy—GBD—1-A-1B—24 cont. adj. relay.	1.75
50L6 OUTPUTS—single or P.P. ea.	29c; 4/1.00
MS-23 HEADSETS—4-in. dia. 3 1/2" cord & Plug.	1.69
"OUNCER" INPUT TRANSFORMERS—50 ohms to grid ea.	.75
3-P.E. MAGNET WIRE—400ft. roll.	19c; 6/1.00
GT TUBE SHIELDS—slip-on. ea.	5c; 24/1.00
1 MEG PRECISION RESISTOR—1%. IRC WW.	.69
NEW "JUMBO RADIO PARTS KIT"—17 POUNDS of New & Dismantled COILS, TRANSFORMER WIRE, SOCKETS, RESISTORS, ETC., ETC. Shpg. wt. 2 1/2 lbs.	2.95
BARGAINS IN KITS	
MOULDED BAKELITE CONDENSERS—00001 to 2md. 200-600 p.f. asstd.	2.49
DIAL SCALLES—Acetate & glass. 25 asstd.	2.95
DIAL ESCUTCHEONS—Kit of 25 asstd.	2.95
KNOBS—Spring, set screw. Kit of 25 asstd.	.98
WAFER SOCKETS—1 to 8 pin. 12 asstd.	1.25
SPEAKER CONES—4" to 12" moulded & freezed. Less voice coils. Kit of 12 asstd.	1.98
SPEAKER REPAIR KIT. Liberal assortment of Spiders, Mtg. Rings, Felt Strip, Leather Segments, V.C. Forms, Shims, Cement & Instructions. ALL FOR	2.49
SPECIAL BARGAIN OFFER—CONE & REPAIR KITS—BOTH FOR 20% deposit on all C.O.D.'s	3.95
Min. order \$2.00 Full remittance with foreign orders—Please add sufficient postage	

LEOTONE RADIO CO.
67 Day Street, New York 7, N. Y.

The ORIGINAL and Still the BEST LIGHTNING ARRESTER

for all weather conditions

will not absorb moisture

completely waterproof

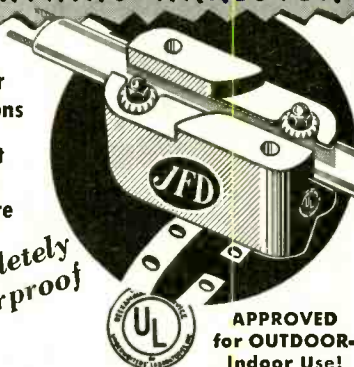

APPROVED for OUTDOOR-Indoor Use!

Protects Television Sets Against Lightning and Static Charges

JFD SAFE TV GUARD

Fits Any Type of Twin Lead

No. AT102 for Regular Twin Lead
No. AT103 for Oval Jumbo Twin Lead
No. AT103 Also for Tubular Twin Lead
BOTH Models Conform With Fire Underwriters and National Electrical Code Requirements for OUTDOOR installations.

\$225 EACH

SIMPLE TO INSTALL . . . For maximum efficiency arrester should be mounted outside window nearest to TV receiver, with ground wire attached to nearest grounded point. No stripping, cutting or spreading of wires necessary. Supplied complete with 4 ft. length of Ductile Aluminum Ground Wire for Wall Mounting, and Strap for Mast or Grounded Pipe installation.

JFD MANUFACTURING CO., Inc.
6127 16th Avenue, Brooklyn 4, N. Y.
First In Television Antennas & Accessories



**TOP TV
INSTALLERS**
say an
Eye-ful

**THE EYE-FUL
Home
TELEVISION
TOWER**

*Keeps your home
Beautiful...*

1. Invest **FIRST** in your outside installation, then determine the Television Set of your choice.
2. No built in antenna can give you as clear a picture as you will get in a proper outside installation.
3. The **EYE-FUL** all-aluminum tower will be installed to meet the most exacting demands of any **HOME OWNER**.



You can be the outstanding TV installer in your community with the new rapidly installed Eye-ful Home Television Tower. Demand is terrific wherever it is introduced. Start now and increase your sales.

THOMPSON & RUBY, INC.
BROWNSTOWN, INDIANA

THOMPSON & RUBY, INC.
BROWNSTOWN, INDIANA

I am interested in your EYE-FUL Tower as,

1. An installer
2. A sales representative
3. Both

NAME _____

ADDRESS _____

CITY _____ ZONE _____ STATE _____

language "Photogrammetry" is defined as the science of preparing detailed contour maps from aerial photographs. By the use of this process, the U. S. Geological Survey is presently engaged in the preparation of topographical maps of the United States and its possessions. The Sacramento laboratories perform that phase of the operation pertaining to the Western United States, Alaska, and Hawaii.

Approximately one hundred members and guests of the Sacramento Chapter were conducted through the photogrammetric laboratories in small groups of six or eight at a time, thus enabling them to view at close range the intricate processes involved in the piecing together of these gigantic jigsaw puzzles. Scientific production line methods are employed in the preparation of these valuable and minutely accurate maps.

Arrangements for this tour were made by Paul E. Shaad, program chairman for the Sacramento Chapter. The program was made possible through the courtesy of C. A. Ecklund, Pacific Regional Engineer, and D. H. Rutledge, Chief, Photogrammetric Section, U. S. Geological Survey.

San Francisco

The reorganization of the San Francisco Chapter was completed on March 31st with the election of new officers as follows: President—Harry E. Austin of *RCA Communications*; 1st Vice-President—George LeBlanc, *Pacific Tel & Tel*; 2nd Vice-President—Jackson Fairchild, *Westinghouse*; Secretary—C. L. Wickstrom, *Pacific Tel & Tel*; Treasurer—W. G. Damerow, *Pacific Gas & Electric*.

Among the new members signed up by the chapter is the *Lenkurt Electric Company* of San Carlos, manufacturers of carrier current equipment and components.

Seattle

The first 1950 meeting of the Seattle Chapter, held at the American Legion Hall on February 21st, also inaugurated the chapter's third year of activity as an AFCA unit.

Outgoing president Maurice F. Kerr opened the meeting by introducing various guests and then formally installed the newly elected officers as follows: President—Clarence D. Lawrence; 1st Vice-President—Marshall James; 2nd Vice-President—Hershal Wandling; Treasurer—Joe Gregory; Secretary—Clarence C. Bodine who was reelected for a second term.

President Lawrence then took over the chair and outlined plans for 1950. A general discussion followed as to the best suited programs for meetings. It was decided to arrange demonstrations of commercial equipment and to present talks on technical subjects so that non-technical members might become better informed.

STUDENT CHAPTERS

Texas Technological College
Lt. Col. Wayne P. Litz, Chief, ROTC Affairs Section, Office of the Chief

BRAND NEW! 99⁵⁰
GAS DRIVEN 120/240 VOLT
AC 60 CYCLE GENERATORS
300 WATT

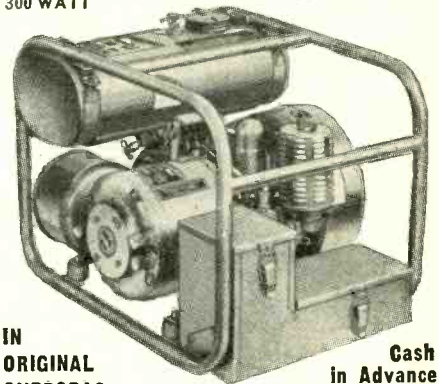

IN ORIGINAL OVERSEAS SHIPPING CRATES! Cash in Advance or 20% with Order, Balance C.O.D.

Net Weight 56 Lbs. Shipping Weight 102 Lbs.

FOR FULL DESCRIPTION WRITE TO THE MYTRONIC COMPANY
119 West Central Parkway, Cincinnati 2, Ohio

Approved

**MODEL A-710
12 TUBE
FM-AM
TUNER**

\$57⁵⁰

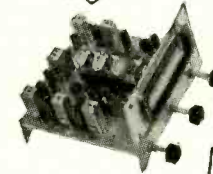

For the first time in radio history, there is really available a high quality FM-AM tuner, designed for drift-free, realistic high fidelity reception AT A PRICE THAT PLACES IT WITHIN EASY REACH OF THE CUSTOM BUILDER, SERVICEMAN, MANUFACTURER, EXPERIMENTER, ETC.

JOBBERS!

Write Dept. RN-M for New Catalog and Jobber Net Prices.

TUBES USED ON FM:
1—6AG5 RF Amp.; 1—6BE6 Mixer-Detector; 1—6J6 Os.-1—6AU6 IF Amp.; 2—6AU6 IF Amp.; 1—6AL5 Discriminator. TUBES USED ON AM: 1—6BA6 RF Amp.; 1—6BE6 Converter; 1—6BA6 IF Amp.; 1—6AT6 Diode (audio amplifier common to AM-FM).
Chassis dimensions: 8 1/2" x 5 3/4" high, 8" deep. Net weight: 3 1/2 lbs.

Power requirements: 170 V DC 20 MILS and/or 140 V DC 37 MIL. 6.3 V 4 AMP.

APPROVED ELECTRONIC INST. CORP.
142 Liberty St. N.Y.C.

POCKET RECORDER

Conferences
Reports
Dictation
Inventory
Sales Talks
2-Way Phone
Conversations
While Riding,
Walking, Sitting

WALKIE RECORDALL

Up to 4 hrs. of continuous uninterrupted permanent recording at a total cost of only 2 1/2¢ per hr. Concealed candid recorder picks up at a radius of up to 60'. Permanent play-back from same unit at no cost. Fully pat'd.

Size 4"x7"x7"
Weight 5 1/2 lbs.

MILES REPRODUCER CO., INC.
812 B'way Dept. RN N.Y.C. Spring 7;7670-1



GOLD PLATED CRYSTALS

2 FOR \$1.00 POSTPAID In the U.S.A.

All fundamental freqs. in Kilocycles
5910 6510 6690 7390
6360 6810 7270 7480
6370 6670 7350 7580
6470 6940 7380 9720

ELECTRONICRAFT, Inc.
5 Waverly Place, Tuckahoe 7, N. Y.

LAST CALL!

PRICES DRASTICALLY REDUCED ON THIS FINE SURPLUS EQUIPMENT TO CLEAR OUR WAREHOUSE FOR NEW MERCHANDISE

FM RECEIVERS & TRANSMITTERS

BC-603 RECEIVER, 20 to 28 MC for 11 meters, can be tuned to 10 meters or converted to receive up to 45 MC FM; superhet, BFC, squelch; 10 pushbuttons and manual tuning with all tubes, speaker, case, diagram, less dynamotor;

LIKE NEW \$17.95 USED \$13.95
Conversion instructions free with each instrument.



BC-604 TRANSMITTER, 20 to 28 MC for 11 and 15 meters; can be operated on 10 meters by use of proper xtal; 10 channel with all tubes, meter, diagram, case and covers, less dynamotor, crystals and drawer.

LIKE NEW \$15.95 A few repairable, w/tubes, less meter \$6.95

BC-684 TRANSMITTER, 27 to 38.9 MC, 30 watt 10 channel; with tubes, covers, meter, diagram, less dynamotor, crystals and drawer

USED \$23.95 A few repairable, w/tubes, less meter \$9.95

ACCESSORIES FOR ABOVE SETS
MOUNTING RACK FT-237 with all plugs. NEW \$8.95

PLUG PG-1; this is the Cannon connector which is on FT-237 rack; fits receiver or trans. 2.00

MAST SECTIONS MS-49 to MS-53, 3 ft sects. Makes mast up to 24 ft. long. BC-603, BC-604 require 3 sects.; BC-683, BC-684 require 2. Per section .50

PHANTOM ANTENNA A-62 for BC-604. NEW \$1.49

20 to 28 MC FM PORTABLE TRANSCEIVER
BC-620 for 11 and 15 meters; can be extended to 10 meters by adjusting IF's; similar to BC-659 but without speaker

NEW, original boxes \$14.95 GOOD USED \$9.95

POWER SUPPLY PE-120 for BC-620 & BC-659; operates from 6, 12 or 24 volts, with proper vibrator. With 12 or 24 v. vibrator, cable, plug and tubes

UNUSED \$9.95 GOOD USED \$6.95

HANDSET TS-13 w/PL-55 & PL-68; used, excel. \$3.95

HANDSET TS-9, NEW \$4.95; GOOD USED \$3.50

BELL, 24 volt AC or DC; 3" dia with self-contained ringer coils and hammer; easily mounted. New, boxed, BLACK, each 50c
CHROME PLATED, each .79c
ASK FOR PRICES IN LOTS OF 100 and 1000



TERMS: FREE CATALOG & FLYERS. Minimum order \$20, please. Check with order; 25% deposit for C.O.D.

ELECTRONIC SUPPLIES

219-R East 1st St. Tulsa 3, Okla.

Linearity Test

(Continued from page 67)

considerable variations in linearity and consequent tone color are possible. Other causes of nonlinearity may occur, but in any event they may be easily checked with the test setup previously described. In this case the attenuator on the output of the audio oscillator is varied from minimum to maximum and the diagonal scope trace observed for change of direction. Alteration of the axis indicates nonlinearity as illustrated by *N* and *O* of Fig. 2.

As mentioned at the first of this article, this scope technique may be used as an easy means of checking frequency response. This method was suggested by Goodell as a means of making rapid frequency checks with an audio oscillator having an uneven frequency output. If the equipment under test is flat then the direction of the trace will remain unchanged even though the length will fluctuate according to the signal generator variations. If frequency boost or attenuation is present in the equipment under test, then the axis of the trace will alter in a manner similar to that described in the previously mentioned linearity test. It should be noted however that this technique will lead to inaccurate results if appreciable nonlinearity is present in the equipment under test as any gain variation in the audio oscillator may be multiplied by any nonlinearity.

Although phase shift is often not considered of great importance, except in feedback loops and similar applications, there appears to be at least one instance in which it can assume significant proportions. This case is in the event that intermodulation distortion is present in the original signal and distortion of the same general nature is present in the reproducing amplifier. If no phase shift is present, then the characteristics of the input signal and the amplifier will tend to coincide and little further degradation of the signal will take place. However, if appreciable low frequency phase shift occurs, a previously undistorted section of the high frequency components may be now superimposed on the peaks of the low frequencies and undergo resultant modulation in the amplifier stages with consequent additional degradation of the reproduction. That situations of this nature are not uncommon is emphasized by the recent assertion that some conventional shellac recordings may contain up to thirty per cent intermodulation distortion.

In conclusion, the reader will undoubtedly find that the ability of the oscilloscope to graphically render input-output relationships provides a rapid and convenient means of observing a wide number of characteristics of audio equipment.

PHOTOFACT BOOKS HELP YOU 4 WAYS!

1. SAVE TIME 2. SAVE WORK

3. EARN MORE 4. LEARN MORE



PHOTOFACT TELEVISION COURSE

Gives you a clear understanding of TV principles, operation and practice. Complete coverage of all phases. 216 pages; profusely illustrated; 8 1/2 x 11". Used by thousands. Order TV-1 Only \$3.00

TELEVISION ANTENNAS

All you need to know about TV antennas—describes all types, tells you how to select, how to install, how to solve troubles. Saves time; helps you earn more. 192 pages; illustrated; handy pocket size. Order TAG-1 . . . Only \$1.25

TELEVISION TUBE LOCATION GUIDE

Accurate diagrams showing the position and function of all tubes in hundreds of TV receivers. Diagnose trouble and replace tubes, in most cases without removing chassis. Over 200 pages; pocket size. Order TGL-1 Only \$1.50



1948 RECORD CHANGER MANUAL

Covers 45 models made in 1948, including LP and dual-speed changers, plus leading wire recorders. Original data based on actual analysis of equipment. Over 400 pages; de luxe bound, 8 1/2 x 11". Order CM-2. Only \$6.75

AUTO RADIO MANUAL

Complete PHOTOFACT Service data on more than 100 post-war auto radio models. Complete, accurate, uniform information. Covers over 24 manufacturers. Makes auto radio servicing easier and more profitable. Over 350 pages. 8 1/2 x 11". Order AR-1 Only \$4.95

THE RECORDING & REPRODUCTION OF SOUND

A complete, authoritative treatment of the entire subject. Covers all phases of recording and amplification. 364 pages. 6 x 9", cloth binding. Order RR-1 Only \$5.00

NEW! DIAL CORD STRINGING GUIDE

New Volume 2, covering receivers produced from 1947 through 1949. The only book that shows you the one right way to string a dial cord in thousands of receivers. Handy pocket size. Order DC-2 Only \$1.00

HOWARD W. SAMS & CO., INC.

Order from your Parts Jobber Today, or write direct to HOWARD W. SAMS & CO., INC., 2201 E. 46th St., Indianapolis 5, Ind.

My (check) (money order) for \$ enclosed. Send the following books:

- TV-1 RR-1 AR-1 TGL-1
 TAG-1 CM-2 DC-2

Name

Address

City Zone State

BUY DIRECT SAVE!!

From Factory New Improved RCA Licensed 16"-630 Chassis

Complete with NEW, Electro-scope Magic-Eye Tuning Indicator—for perfect synchronization of video and radio trap circuits.

Completely wired and aligned by expert technicians.

Newly developed keyed automatic gain control.

Voltage doubler.

Latest type Standard Coil tuner for high sensitivity, UHF adaptation, and built-in booster action.

Not 21—not 30—but the full 31-tube circuit.

19"-630 Chassis—\$157.95 plus \$1.90 Fed. Excise Tax. (Less CRT)

All glass 16" C-R Tubes \$38.90

All glass 19" C-R Tubes \$73.25

No extra charge for rectangular or black tube

Regular RMA guarantee on all tubes and chassis

Beautiful cabinets for above—available

Terms: \$25.00 deposit on all orders—Balance C.O.D.

F.O.B.—N. Y. Factory

Prices subject to change without notice

IMMEDIATE DELIVERY Visit our showrooms

AD-RITZ MFG. CORP.

158 Grand Street New York, N. Y. Phone WO 4-6763

231 Centre Street New York, N. Y. Phone WO 2-5962

SAVE \$ ON \$UN SURPLUS AND STANDARD SPECIALS!

CRYSTALS Low Freq.

FT-241 A holder 1/2" pin spacing, for ham and general use, Xtal controlled Signal Generators, marked in army Mc harmonic frequencies—Directions for deriving fundamental frequencies enclosed. Listed below by fundamental frequency, fractions omitted.

412	426	442	475	493	504	515	372	381	390	401
413	427	443	477	494	506	518	374	383	391	402
414	429	444	478	495	507	518	375	384	392	403
415	431	445	481	496	508	519	376	386	393	404
416	433	446	483	497	509	522	377	387	394	405
418	434	447	484	498	511	523	379	388	395	408
419	435	448	485	503	512		380		396	409
420	436	452	487				381		397	411
422	437	458	488						400	
423	438	472	490							
424	440	473	491							
425	441	474	492							

49¢ each

each

400

each

39¢

each

79¢

each

450	531.944	Frequency	SPECIAL 200 kc
452.777	533.333	Standard	Xtals without holders
461.111	536.111	98.356 kc	21-32" x 23-32"
464.815	537.500	3-pr. holder	69¢ each
465.277	538.888		3 for.....\$2.00
526.358			
529.166			
530.555			

HAM CRYSTALS

FT-243 holders 1/2" pin spacing, for ham and experimental use. Fractions omitted.

4190	6140	6940	7973	3735	5825	6373	6706	7506
5030	6150	6973	7975	5305	5840	6405	6740	7540
5485	6173	7740	8240	5675	5850	6425	6806	7573
6006	6206	7773	8273	5677	5873	6440	7306	7640
6040	6208	7806	8306	5700	5875	6450	7340	7673
6073	6273	7840		5706	5900	6473	7373	7706
6075	6840	7873		5725	5906	6475	7406	7806
6100	6873	7906		5740	5925	6506	7440	8123
6106	6906	7975		5750	5940	6540	7473	8340
				5760	5973	6573		
				5773	5975	6606		
				5775	6273	6640		
				5806	6340	6673		

49¢ each

each

99¢

each

5910	6610	7580	2045	2260	2415	3215	3570
6370	7350	7810	2105	2282	2435	3237	3580
6450	7480	7930	2125	2300	2442	3250	3945
6470			2145	2305	2532	3322	3955
6507.9			2155	2320	2545	3518	3995
6522.9			2220	2360	2557	3520	
6547.9			2258	2390	3202	3550	

Payments must accompany order. Enclose 20¢ for postage and handling. Minimum order \$2.00 plus postage. Crystals shipped packed in cloth bags inasmuch as they are shock mounted. All shipments guaranteed.

Reduced for Clearance

BENDIX TA-12 Transmitter, 100 watt. 4 separate ECO's with tubes. 3-807, 4-12SK7. Complete instructions for converting to 10, 20, 40 and 80 meters supplied.

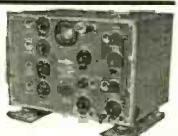

Like New Used
29.95 19.95

Replacement Filter Condensers

Capacity	DCWV	List Price	Your Cost
20x20	150	\$1.55	\$0.62
20x20	150	25	.88
20	25	2.20	.88
20x20	150	25	2.65
20	25	2.85	1.06
20x20x20	150	25	2.85
20	25	2.20	.88
40x20	150	25	2.30
20	25	2.30	1.02
40x30	150	25	2.35
20	25	2.40	.94
40x40	150	25	2.40
20	25	2.40	.96

Famous "Garrard" Record Changers

Single speed, reduced for clearance. Model RC 65, automatically mixes 10" and 12" records. High quality crystal pickup. REGULAR PRICE, \$69.50 REDUCED TO \$32.95, brand new.

Model RC 70, similar to above but slightly smaller and does not intermix. REGULAR PRICE, \$49.50 REDUCED TO \$24.95, brand new.

TERMS: All items F.O.B. Washington, D. C. All orders \$30.00 or less, cash with order. Above \$30.00, 25 per cent with order, balance C.O.D. Foreign orders cash with orders, plus exchange rate.

SUN RADIO
OF WASHINGTON, D. C.
938 F STREET, N. W. WASH. 4, D. C.

Classified

Rate 35c per word. Minimum 10 words

RADIO ENGINEERING

PANELS for electronic, nucleonic construction projects. Complete service for designers, custom builders. Circular upon request. Gilpin Instrument Works, P. O. Box No. 8, Mt. Clemens, Mich.

RADIO Engineering Broadcasting, Aviation and Police Radio, Servicing, Marine Operating and Electronics taught thoroughly. Expenses low. Write for catalog. Valparaiso Technical Institute, Dept. N, Valparaiso, Ind.

ADVANCED Practical-Engineering strikingly different new methods for radio-TV-electronics. High caliber correspondence, instruction. Simplified, streamlined, fast, practical methods for the practical man. Very reasonable rates. Write: Superior Procedures, Twenty-one Sixty-six Market St., San Francisco, Calif.

SALE

FIVE Element TV Yagi Beams. High Band \$6.75, Low Band \$8.50. Aluminum Tubing, etc. Willard Radcliff, Fostoria, Ohio.

COAXIAL Cable. Identical Characteristics as RG-58/U. Send dime for 3-foot sample. Harry H. Van Dick, Box 236, Little Falls, N. J.

FREE Listing Emerson Radio Tubes, 40% to 60% discount, also parts. Jos. Kase Electronics, 245 Echo Place, Bronx 57, N. Y.

BROOK 10C3 30 watt amplifier, \$170; Collins FM tuner, \$60, etc. All with original performance. Write for list. Robert W. Balluffi, 36 E. Montauk Highway, Lindenhurst, N. Y.

SEVERAL complete Mark III tank installation kits each complete with two complete transmitter and receivers, hundreds of spares. B. Arundel, 812 Robson St., Vancouver, B. C., Canada.

CODE Machine, new reasonably priced Model RCM-2. Phototube keying type, designed for efficient radiotelegraph code practice. Write: Ultradyn Electronics, Oswego, Ore.

RADIOS, small 4-tube battery portables, \$7; Philco, \$10; Olympic miniatures, \$10; small 3-way, \$12; Pada, \$17; Emerson miniatures, \$19; Suitcase 3-way, \$12; 5-tube desk clock radios, \$15; Horse statuette, \$19; Sonora table player combinations, \$20; Philco slide-in players, \$18; Clarion 6-tube wood chng. combinations, \$25. No C.O.D. Send needs. Smith, 46 Fisher Ave., Roxbury, Mass.

AMATEURS who own BC342, BC348, BC224, etc., may obtain high gain 10 meter performance with the use of our guaranteed RF243-tube 20-30 mc converters measuring only 5"x7"x10" and furnished with 3 spare tubes and adequate instructions, these units cost but \$16.00 each, postpaid. Write for yours today! Overbrook Co., Overbrook 81, Mass.

TRANSMITTERS: Dual triode audio oscillator MCW, 150 mile range, 500 kc, including key, tubes, 360 variable tuning condenser, pilot lights, new, only \$2.95. Wexpert, Box 8184, Birmingham, Ala.

COMPLETE new stock, parts, tubes, instruments, manuals of bankrupt shop. Late .410 repeating shotgun, new set National Encyclopedia. Sacrifice, \$600. Bentley's Radio, Paxton, Ill.

PHOTOFLASH Equipment! Ignition Transformer; 2V Storage Battery; Battery Charger. Each \$1.95. Modelectric Products, Asbury Park, N. J.

RECORD Changer Parts for leading makes. We ship everywhere. Friend's Wholesale Distributors, 106 N. 6th St., Philadelphia 6, Pa.

PHONOGRAPH Records, 15c. Catalogue free. Paramount, VE-313 E. Market, Wilkes-Barre, Pa.

BARGAINS. New and reconditioned Hallierafters, National, Collins, Hammarlund, RME, Meissner, other receivers, tuners, television receivers, transmitters, amplifiers, speakers, etc. Lowest wholesale prices. Terms. Shipped on trial. Liberal trade-in allowances. Write Henry Radio, Butler, Mo., and 11240 W. Olympic, Los Angeles, Calif.

LOWEST Prices Radio Tubes, parts. Bargain lists, 3c. Potter, 1314 McGee, Kansas City 6, Mo.

HOTTEST surplus list in the country. Electronics-Hydraulics, Aircraft-Gadgets. Dick Rose, Everett, Wash.

KYTENNA Television Balloon. Complete, unused, \$135. Glenn Simmons, Orleans, Ind.

COMPLETE parts including cabinet and panel to build an Oscilloscope, VTVM, combination only \$39.50. Cosmopolitan Electronics Co., Box 4, North Baldwin, N. Y.

NEW low voltage Geiger Counter \$35.00 complete. No C.O.D. Joseph O'Connor, 2304 S. Ogden St., Denver, Colo.

MAKE Offer! Exactly 300 complete BC-221 Frequency Meters, with tubes, crystal, calibration book. Splendid condition. Mail or wire your offer today to Box 505, % Radio & Television News, 185 N. Wabash Ave., Chicago 1, Ill.

RADIO Diagrams 50c; Record Changers, Recorders 60c; Television Diagrams with service data \$1.00 up. State Manufacturer and model number. Kramer's Radio Service, Dept. RX, 36 Columbus Ave., New York 23, N. Y.

WEBSTER Chicago record changer and wire recorder replacement parts. We ship everywhere! Friend's Wholesale Distributors, 106 N. 6th St., Philadelphia 6, Pa.

ALL Steel T.V. Towers which can be erected to 70' or more. Built to climb. Shipped direct from the factory at \$8.50 F.O.B. per 10' section. Weight 20 pounds per section. Write for more details. The Youngstown Steel Towers, 1316 Wilson Avenue, Youngstown 8, Ohio.

T.V. ANTENNAS. Deluxe, Conical, all channel, heavy duty aluminum, \$7.25. Double Bay, \$13.85. Super "X" Antenna Co., Manasquan, N. J.

GIGANTIC Surplus Equipment Mail Sale. Amazing values. Everything must go. Meters, burglar-fire alarms, telephones, transmitters, cathode ray tubes, thermostats, motors, electric drills, A-C generators, air compressors, relays, 110-volt elements, etc. Everything less than manufacturer's cost. We pay parcel post charges. Rush card for sale catalog. Burden Sales Co., 853 "O" St., Lincoln, Nebr.

SCOTT 800-B combination blonde mahogany cabinet like new, originally \$1375.00, sacrifice \$500.00. Edward I. Levy, 653 Main St., Buffalo, N. Y.

SURPLUS: BC221 Frequency Meters, clean and in perfect condition, \$39.50 each. Send orders to Monarch Electric Co., 411 Wood St., Pittsburgh 22, Pa.

COLOSSAL bargain in radio parts, over 150 assorted radio parts including resistors, condensers, controls, coils, etc. All new, \$75.00 value, guaranteed satisfaction or money refunded, postpaid in U. S. A., \$2.50. Write for catalog. Buyers Syndicate, 30 N. Taylor St., Springfield 3, Mass.

WILLARD BB54, 89c plus postage. List, 10c. Betz, 73 Caroline Ave., Yonkers 5, N. Y.

HEARING Aids. Zeniths, Western Electrics. Reconditioned. Make miniature transmitters or receivers. Complete with ear piece and cords, \$16.00 each. Gloria Davis, 2135 Caton Ave., Brooklyn, N. Y.

WANTED

SNIPERSCOPE & Snooperscopes wanted. Any type, any condition. Needed immediately. Box 495, % Radio & Television News, 185 N. Wabash Ave., Chicago 1, Ill.

COMPLETE Listings of Surplus Mica Condensers. Standard and Silver Micas. Postage stamp and half postage stamp size. Box RTN, 1652, 221 W. 41st St., New York 18, N. Y.

SUCCESSFUL small Jobber, excellent reputation among New Jersey trade. Want more lines for expansion. Harry Adelman's Circuit Electronics, 468 Broadway, Newark, N. J.

WANTED. RCA Magic Wave transformers Nos. 9849, 9814, 9813. Pay net plus 15% for postage. Norwest Radio, Shelby, Mont.

HELP WANTED

INSTRUCTORS in Electronics and Radio. Prefer former Navy Radio Technician instructors willing to locate in the Detroit, Mich., area. Write to Box 452, c/o Radio & Television News, 185 N. Wabash Ave., Chicago, Ill.

PATENT ATTORNEYS

HERMAN Lewis Gordon, Registered Patent Attorney. Patent Investigations and Opinions. Warner Building, Washington, D. C.

LANCASTER, Allwine & Rommel. Registered Patent Attorneys. Patent practice before U.S. Patent office. Validity and Infringement investigations and opinions. Booklet and form "Evidence of Conception" forwarded upon request. Suite 414, 815 15th St., N.W. Washington 5, D.C.

CORRESPONDENCE COURSE

USED Correspondence Courses and Books sold and rented. Money back guarantee. Catalog free. (Courses bought.) Lee Mountain, Pisgah, Ala.

USED Correspondence Courses and Educational Books bought, sold, rented. Catalog free. Educational Exchange, Summerville, Ga.

MISCELLANEOUS

"RADIOBUILDER" for Experimenters. 12 issues, \$1.00; 3, 25c. Catalog free. Laboratories, 578-H, San Carlos, Calif.

OSCILLOSCOPE Operators! Amazing device converts oscilloscope to precision voltmeter having enormous sensitivity and unequalled versatility for measuring A.C., D.C., & complex waveforms. Complete information, 10c, to cover mailing cost. Quono Enterprises, 1766 E. 26th St., Brooklyn 29, N. Y.

RADIO Telev. Sales and Service. Established. Low overhead. E. Weeks, 2209 1/2 Florida Ave., Tampa, Florida.

GOING to try for your Amateur Radio Operator's License? Check yourself with a written test similar to those used by the F.C.C. Complete coverage multiple-choice questions with answer key. Class B&C Test \$1.75. Class A Test \$2.00. Amateur Radio Supply, 1013 7th Ave., Worthington, Minn.

FOR Sale. Closing Radio Repair Department; Entire Stock of Parts, Rider Manuals (two sets) and test equipment must be sold. Write for list. Hodge Appliances & Furniture, Inc., 199 S. Main St., Liberty, N. Y.

QSL's, SWL's. Samples free! W1HJJ, Box 32C, Manchester, N. H.

YOU'LL never use pliers again to install F.P. condensers. Time-saving new tool loosens old lugs, tightens new ones. Slim, long reach for tightest places. Can't slip. One-hand operation. 69c post-paid in U.S.A. No stamps. Pays for itself on one tough job. Order today. K.D. Clayson, Box 1032, Bethlehem, Pa.

BIG Money, part-full time, Radio, Television, Electronics. Complete information free. R. Johnson, 326A Park Row Building, New York 7, N. Y.

RADIOMEN, Servicemen, Beginners. Make more money, easily, quickly, \$250 weekly possible. We show you how. Information free. Merit Products, 216-32R 132 Ave., Springfield Gardens 13, N. Y.

ANSWERS TO "MICROWAVE QUIZ"
PAGE 104

- | | | | | |
|------|------|------|-------|-------|
| 1. d | 4. a | 7. c | 10. a | 13. c |
| 2. d | 5. c | 8. b | 11. b | 14. c |
| 3. a | 6. a | 9. b | 12. c | 15. b |

SCORING TABLE

- | | | |
|-------------------|-------|-----------|
| 15 correct | | excellent |
| 13 to 14 correct | | very good |
| 10 to 12 correct | | good |
| 8 to 9 correct | | fair |
| 7 or less correct | | poor |

PHOTO CREDITS

Page	Credit
35 Ansley Radio Co.
37 North American Philips Company
38 Stewart-Warner Corporation
39 Allen B. Du Mont Laboratories, Inc.
46 Radio Corporation of America
58 Standard Coil Products Company
60 "Voice of America"
62, 63 T. F. F. Warren
66, 104 (Right) General Electric Company
81 MARS
83 Bell Telephone Laboratories
104 (Left) Raytheon Manufacturing Co.
155 Steven J. Stadler

ERRATA

The caption for the cover photograph, appearing on page 4 of the May issue, incorrectly referred to the kit Mr. Andrea was showing his daughter as a "Neutrodyne" kit. This is, of course, in error as the kit shown is one of the new Andrea "build-it-yourself" television kits. We are indeed sorry that this error occurred.

In Fig. 10 of the article "Simplified Ham TV Station," page 38 of the May issue, the parts list accompanying the diagram should show the wattage of resistors R₁₀ and R₁₁ as 2 watts instead of 1/2 watt.

An error appears in the article "The Mini-Rack Modulator" published in the April issue. In the diagram of Fig. 2, page 43, the shorting relay for the modulation transformer is incorrectly shown. The lead from the top of the modulation transformer secondary should go to R₁; as well as the relay contact. The lead from the plates of the 5R4GY should be connected to the relay arm instead of R₁₇.

There's a BIG Future for YOU in
TELEVISION
RADIO-ELECTRONICS

Builds Your Career in a Minimum of Time
Industry Needs More Trained Men Now
Day and Evening Classes Now Forming

GRADUATES of CREI Residence School are preferred by industry because of their *training and ability*. This recognition is the reason that CREI men quickly find good jobs. With 23 years of practical teaching experience in these highly technical fields, CREI offers an outstanding faculty, modern and complete laboratories, shops and equipment.

New students are accepted twice monthly and each may advance as rapidly as he is capable.

CREI is recognized as one of the country's leading technical institutes, offering college-calibre education for the young man who wants a practical career education that leads to a good-paying job in a minimum of time.



Approved for
Veterans' Training

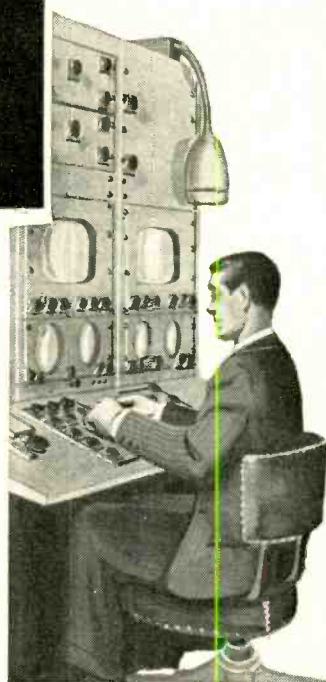

Mail Coupon for FREE Catalogue

CAPITOL RADIO
ENGINEERING INSTITUTE

Dept. 136-B, 16th & Park Rd., N.W.
Washington 10, D. C.

Please send me your illustrated catalog and complete details about the CREI Residence School.

NAME

AGE If in school, what term?

STREET

CITY ZONE STATE

I am entitled to training under G.I. Bill

Send information on Home Study Courses

TECH-MASTER
Blue Ribbon

TELEVISION KIT
featuring AGC

(Keyed automatic gain control)

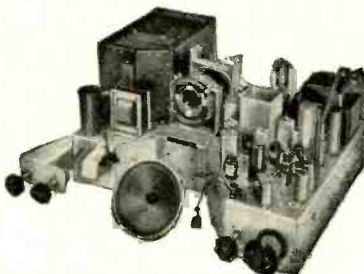

for 10" or 12" KINESCOPIES

Four-stage video IF—4Mc band width. Completely assembled . . . ready to wire. Factory tested parts of finest make. Trouble-free wiring diagrams permit wiring in a week-end.

Complete with all tubes, less Kinescope \$11995

At your distributor, or write Dept. RN-6 for literature



TECH-MASTER PRODUCTS CO.

443-445 Broadway, New York 13, N. Y.

More leading engineers and technicians have built Tech-Master for their own use than any other Television Kit.

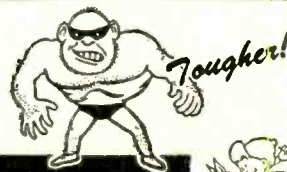

PHOENIX

Speed-Mounts
and
Speed-Tennas

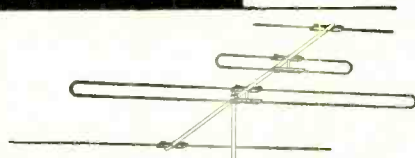

Phoenix IN-LINE SPEED-TENNA PAR-3

High gain consisting of director, high and low folded dipoles and reflector. Speed-rig. Lo Loss insulation. Complete with all hardware, less mast.

PHOENIX
ELECTRONICS, INC.
Lawrence, Mass.

AT LEADING JOBBERS
Write for folder V of complete line of television accessories.

DON'T MISS THIS MARKET—

DON'T MISS THESE PROFITS

DON'T MISS

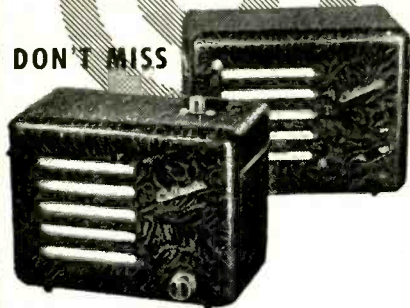

Callmaster

**ELECTRONIC
2-WAY COMMUNICATOR**

Right now, the moderate-price Communicator market is wide open . . . offers tremendous activity . . . continuing, excellent profits to merchandisers who promote it . . . with the **right** product, at the **right** price!

Callmaster meets every requirement of this rich market . . . it's **right**, it's **ready**, to help you get your share.

PRICE . . . \$39.95 complete set (above) . . . ready to connect . . . no "extras."

PERFORMANCE . . . perfect sound fidelity . . . even a whisper is received clear and true.

PROFIT . . . generous profit margin . . . quantity discounts.

SIZE . . . compact . . . 7"x5½"x3½" . . . less desk space than 'phone.

APPEARANCE . . . lustrous, mahogany-grain plastic cabinet . . . extra-thick, electric-shock proof. Bakelite control knobs.

PRECISION BUILT . . . engineered to rigid specifications. All components high quality. No "surplus" materials used.

INSTALLATION . . . easier to hook-up than standard door-bell system.

SERVICE . . . durable, rugged . . . doesn't have to be "babied." RMA warranty.

COMPLETE LINE. . . . Master and sub-station sets. Selective Masters for multi-sub-station operation. All-Master systems.

DEALERSHIPS . . . available.

DISTRIBUTORSHIPS . . . some still open.

WRITE TODAY . . . on company letterhead, for complete information.

WM. M. SMITH COMPANY
National Sales Office
20 FERGUSON AVE., BROOMALL, PA.

INDEX OF *Advertisers*

JUNE
1950

While every precaution is taken to insure accuracy, we cannot guarantee against the possibility of an occasional change or omission in the preparation of this index.

ADVERTISER	PAGE	ADVERTISER	PAGE
Acorn Electronics Corp.	155	LaPointe-Plascomold Corp.	20
Aero Products Company	108	Lectrolm, Incorporated	122
Ad-Ritz Mfg. Corp.	157	Leetronic Research Labs.	140
Aerovox Corporation	153	Leotone Radio Co.	153
Airex Radio Corp.	97	Long Island Radio	118
Allied Radio Corp.	9		
Almo Radio Co.	152		
Altec Lansing Corporation	102	Mackay Television Corp.	144
Alvaradio Supply Co.	110	MacMillen Co., The	100
American Radio Supply Co.	111	Mallory & Co., Inc., P. R.	4th Cover
American Television & Radio Co.	84	Mass. Radio School	151
Amperite Company, Inc.	161	Meissner Mfg. Division, Maguire Industries, Inc.	137
Amplifier Corp. of America	120, 141	Merit Transformer Corp.	98
Approved Electronics Inst., Corp.	154	Microscope & Lens Co.	82
Arrow Electronics, Incorporated	147	Miles Reproducer Co., Inc.	154
Arrow Sales, Inc.	141	Milwaukee School of Engineering	81
Art Radio Co., Walter	73	Multicore Sales Corp.	138
Astale Corporation, The	83	Murray Hill Books, Inc.	104, 142
Atlas Sound Corporation	128	Mytronic Company, The	154
		McGee Radio Company	85, 86, 87
Baltimore Technical Institute	148		
Bell Telephone Laboratories	17	National Company, Inc.	6
Best Vue Products	155	National Radio Institute	3
Blies Electrical School	144	National Schools	3rd Cover
Boyce-Roche Book Co.	116	Newark Surplus Materials Co.	124
Brook Electronics, Inc.	110	Newcomb Audio Products Co.	106
Buffalo Radio Supply	117	Niagara Radio Supply Corp.	107
		North American Philips Company, Inc.	10, 11
Candler System	122	Northwestern Vocational Inst.	147
Cannon Electric	112		
Capitol Radio Engineering Institute	29, 159	Offenbach & Reimus Co.	109
Centralab, Division of Globe-Union, Inc.	14, 15	Olson Radio Warehouse, Inc.	24, 25
Certified Television Laboratories	139	Opad-Green Company	105
Chancellor Chief Co.	148	Owl Radio Tube Company	139
Channel Master Corp.	12		
Chelsea Television Center, Inc.	74	Peak Electronics Co.	114
Chicago Industrial Instrument Co.	88	Penn Boiler & Burner Mfg. Corp.	18
Cincinnati Ventilating Co., Inc., The	88	Pernotlux Corporation	82
Circle-X Antenna Corporation	94	Pfaffenthal Chemical Co.	114
Cleveland Institute of Radio Electronics	5	Phoenix Electronics, Inc.	159
Coin Radio & Television Co.	151	Photocon Sales	125
Columbia Electronic Sales	161	Platt Electronics Corp.	130
Comet Electronic Sales Co.	103	Precision Electronics, Inc.	134
Communications Equipment Company	95	Premax Products	108
Components Supply Co.	150	Premier Radio Tube Company	90, 91
Concord Radio	32	Progressive Electronics Co.	148
Cornell-Dublier Electric Corporation	21	Pyramid Electric Company	26
Coyne Electrical & Radio-Television School	131, 144		
		Quam-Nichols Co.	141
DeForest's Training, Inc.	7		
		RCA Institutes, Inc.	133
Editors & Engineers Limited	28	Radio Corporation of America	30, 127, 2nd Cover
Eddie Electronics, Inc.	118	Radio Craftsmen Incorporated, The	72
Electric Spot, The	74	Radio Ham Shack, Inc.	113
Electro Devices, Incorporated	150	Radio Supply & Engineering Co., Inc.	120
Electro-Technical Industries	138	Rason Manufacturing Co.	143
Electronic Indicator Corp.	161	Ratlund Corporation, The	23
Electronic Instrument Co., Inc.	31	Raytron Mfg. Co.	139
Electronic Supplies	157	Reliance Merchandizing Co.	153
Electroncraft, Inc.	154	Rumph Co., Dave	127
Electronics Institute, Inc.	145		
Emmons Radio Supply	120	Sams & Co., Inc., Howard W.	156, 157
Esoge Sales Company, Ltd.	132	Sangamo Electric Company	33
Espey Manufacturing Company, Inc.	131	Schott Company, Walter L.	141
		Senco Radio, Inc.	126
Fair Radio Sales	99	Shaw Company, Joseph	108
Federated Purchaser, Incorporated	92	Smith, Wardell	82
Feiler Engineering Co.	122	Smith Company, William M.	160
French Telephone Systems	120	Spartan School of Radio and Electronics	125
		Sprague Products Company	16
G. L. Electronics	143	Sprabery Academy of Radio	19
Gaertner Co., The	146	Stahl, Inc., Michael	122
Garrard Sales Corp.	138	Standard Surplus	145
General Electric Company	13, 71	Standard Transformer Corporation	129
General Electronic Distributing Co.	93	Star Electronic Distributors, Inc.	144
General Test Equipment	149	Sun Radio of Washington, D. C.	158
Gold Green	150	Swedgal Radio, Inc.	94
Greenlee Tool Co.	110	Sylvania Electric	34
Harvard Laboratory	151	TAB	162
Harvey Radio Company, Inc.	22	Tech-Master Products Co.	159
Heath Company, The	76, 77, 78, 79, 80	Television Supply Co.	133
Henry Radio Stores	88	Telrex, Inc.	150
Henshaw Radio Supply	133	Thompson & Ruby, Inc.	154
Hollywood Sound Institute	74	Transvision, Inc.	151
Hollywood Technical Institute	94	Tri-State College	135
House of Plastics, The	94		
Hv-Grade Electronics, Inc.	134	V & H Radio & Electronics Supply	149
Hytron Radio & Electronics Corp.	27	Valparaiso Technical Institute	74
Indiana Technical College	143	Ward Products Corporation	133
Instructograph Company	145	Weller Manufacturing Company	8
Instrument Associates	134	Wholesale Radio Parts Co., Inc.	121
		Wind Turbine Co.	96
JFD Manufacturing Co., Inc.	153	Workshop Associates, Inc., The	115
Joseph Radio Parts, Inc., Irving	118	World Radio Laboratories Incorporated	147
Kato Engineering Company	135	YMCA Trade & Tech. Schools	82
Klein, Manuel	136		
Koenig Engineering	123	Ziff-Davis Publishing Company	119, 120

Mobile Antenna (Continued from page 63)

is quite handy and is very inexpensive to build. This "Blooper" is built in a plastic dish to show the parts. The calibration scale was scratched on the plastic and markings filled with ink. The frequency range is from 3.5 to 8.3 mc. This unit is a regenerative oscillator with the values of the grid leak and condenser chosen so that the oscillations are periodically interrupted. These interruptions are at an audio rate and result in an audio tone in the headphones. The action of the grid leak and condenser is that they charge up and bias the grid negatively enough to cut off the plate current. When the condenser discharges through the grid leak the plate starts to conduct again and the oscillations build up and charge the condenser and the process is repeated. When the grid inductance is coupled to a tuned circuit and the grid circuit of the "Blooper" is tuned through the frequency of the external tuned circuit, the audio tone in the headphones will stop. The tone stops because the power taken from the grid circuit by the external tuned circuit lowers the r.f. energy in the "Blooper" grid circuit and keeps the bias from reaching a high enough value to block the grid. The plate voltage of the 6J5 must be adjusted for proper operation. The adjustment should start at 0 volts and the voltage raised until the audio tone is audible in the phones. A potentiometer across 50 volts or so will do the trick very well. On the "Blooper" used here the plate voltage was only 5 volts.

The unit can be calibrated by listening to the output of the "Blooper" on a general coverage receiver. The receiver should have a short antenna and the "Blooper" signal kept as weak as possible. There will be several audible signals at the correct frequency due to the oscillations being interrupted at an audio rate.

The results with the "Blooper" were exactly the same as those with the grid dip meter.

After the antenna has been adjusted to the proper operating frequency with either the grid dip meter or the "Blooper" the antenna should be coupled through a low impedance line to the transmitter. At the transmitter a two- or three-turn link will be sufficient for coupling to the output stage. Use of transmitters with internal loading inductances is not recommended and these loading inductances are not necessary if the antenna has been adjusted to the correct frequency. It is best to pick out an operating frequency in the 75 meter band and cut your antenna for it. Moving from one end of the band to the other will require readjustment of the antenna length. Remember you are using low power and that radiating system must be efficient!

-30-

ARW3 10 Or 6 METER TRANSMITTER: Contains 12-12SH7, 3-12A6, 2-12SN7, 1-12SL7, 2-SR150, 1-807, keying relay, meter switch to read all stages of xmitr. Transmitter is composed of 12SL7 osc., 12SH17 quad., 12A6 quad., 12A6 dbl., 12A6 buffer, 12SH7 tone osc., and 807 final. 10-12SH7 are tone oscillators used to modulate xmitr to radio control airplane. 27V operation use 6V6's, 807, and you have the best little rig for 10 meters. Good cond. Complete with meter, tubes, dynamotor. Special: \$24.50

Columbia
GEM OF THE SURPLUS

BC 605 INTERPHONE AMPLIFIER: Converts nicely to intercom as on P-140 Apr/50 Radio News. New switch \$5.95

ARD3 UHF RECEIVER: Easily converted to 420 ham band. Contains 2-355, 3-6AC7, 2-6SN7, 1-6J5 and terrific tuner. Excel cond. \$14.95

PACKS: ARC-5 Dual Receiver. Excel cond. \$1.00
ART-13 Rack. Excel cond. 1.95
FL8 FILTERS: 1020 cycle, used. Ea. 75c
HS35 LOW Z HEADPHONES: Used. Ea. 98c
RECORD CHANGERS: 78 r.p.m. Standard brands. Near new \$14.95
PE218 INVERTER: 28 V in; 115V 1500 VA. 300-500 cy. out. Near new \$14.95
TU17 & 18 TUNING UNIT: For BC223 Transmitter. TU17 covers 2-3 mc; TU18 covers 3-4.5 mc. Excel shape \$1.95
EC456 274N MODULATOR: Complete less dynamotor. Used \$1.95
TN16 & 17 APR4 TUNING UNITS: TN16 covers 38-95 mc. with 30 mcs. out to IF. TN17 covers 74-320 mc. with 30 mc. out to IF. Excel cond. Ea. \$55.00

APN-4 Rack. Excel cond. \$1.50
ARN-5 Rack. Excel cond. 1.50

SCR522 RECEIVER-TRANSMITTER: 100-156 mc. This hot 2-meter rig is complete with all tubes and push-button control box. Excel cond. \$24.95

ACCESSORIES FOR 522 RECEIVER-TRANSMITTER
PE-98 12 V. Power Supply. Used. \$12.95
PE-94 24 V. Power Supply. Low price. 2.95
AN-104-A Antenna. Brand new. 1.95
Set of 7 plugs. New. 3.95
BC1303 MIKE ADAPTER & TEST UNIT. 5.00

ARC-5 TRANS-MITTERS COMPLETE
4-5.3 mcs. Used. excel cond. \$3.50
2.1-3 mcs. Excel. 5.3-7 mcs. Used. 3.50
for ship use. New. \$12.95
3-4 mcs. Used. 7-9.1 mcs. Used. 9.95
excel. cond. 9.95

ARC-5 RECEIVERS
3-6 mcs. excel cond. \$3.95
6-9.1 mcs., good cond. 5.95
190-550 kcs., excel. cond. 9.95
Command Receiver flex. cable 6'95
Command Receiver 28V dynamotor.79
Command knobs for Receiver. Ea.69

10 BP4 TV TUBES: Used but tested working cond. Ea. \$8.95

BC 375 TRANSMITTER: 150 W. Phone or CW. 2-211 tubes in final. Complete with all tubes but less tuning unit \$10.95

BC 191 TRANSMITTER: Same as BC 375 above but 12V operation. Excel. cond. \$19.95

BC 375 TUNING UNITS: TU-10, 10 to 12-5 mc.; TU-6, 3 to 4.5 mc.; TU-22, 350 to 650 kc.; TU-26, 200 to 500 kc. Excel cond. Ea. \$ 1.85
ORDER 10 FOR ONLY. 15.00

TCS MARINE RECEIVER & TRANSMITTER: Complete with all tubes and dynamotor. less crystals. 35 watts, 12V. operation. Excel. cond. \$169.50

FISHER MARINE TRANSMITTER & RECEIVER: Complete with 12V. supply. 25 watts, less crystal. Excel. cond. \$139.50

ART 13 TRANSMITTER: 813 final. 2-811 mod., 250 watts. Excel. cond. \$119.95

SIGNAL LAMP: Pistol grip. 12V. 6.6 amp. New \$2.95

BC1151 INDICATOR: Dual scope contains 2 of everything: 5Y7, 618, focus coil, deflection coil, intensity control, focus control, etc. Use 1 side and U will have enough room to build a scope, modulation monitor, etc. Excel. cond. \$10.95

BC433 COMPASS RECEIVER: 200-1750 kc. 115V 400 cy. input. Convert for home receiver or use as ADF. Complete with tubes. Excel. cond. \$12.95
S.O.S. BALLOONS: New Ea. \$1.95
12" BRASS ANTENNA: Shuts to 15". Used 2.75
CONICAL TV ANTENNA: New \$2.75

274N ANTENNA RELAY BOX
Contains RF meter plus 50 mmfd H. V. vacuum cond. and relay. New in carton. \$2.25
SAME but less vacuum cond., used, good cond.99

EE-8 FIELD TELEPHONE: Uses 2 flashlight batt. Has crank for ringing other phone. Ideal for use in field, mines, camp, house to lab. or garage, etc. Excel. operating condition. Each \$ 9.75
ORDER A PAIR FOR ONLY. 12.95

APN-1 ALTIMETER TRANSCIEVER
Operates approx. 420 MC. FM designed to give accurate height above ground. Unit can be revamped for the 420 mcs. ham or foundation for citizens' band. Contains 2-955, 2-9001, 5-12SH7, 2-12SJ7. A dynamic vibrating capacitance for producing FM signal. (Makes excellent unit for FM or TV sweep generators.) Many other useful parts. Excellent cond. With plugs. \$4.95
APN-1 DIAGRAM 1.00

IT'S FOR FREE! Come into our warehouse personally for your FREE SURPRISE GIFT! Just say: "I saw your ad."

COLUMBIA ELECTRONIC SALES
522 South San Pedro Street
LOS ANGELES 13, CALIFORNIA

It's
Copied
by everyone.

buy
the original

from
ELINCOR

Stocked in
all channels.
Send for literature

ELECTRONIC INDICATOR CORP.
259 GREEN STREET BROOKLYN 22, N. Y.



AMPERITE
Studio Microphones
at P.A. Prices

Ideal for
BROADCASTING
RECORDING
PUBLIC ADDRESS

"The ultimate in microphone quality," says Evan Rushing, sound engineer of the Hotel New Yorker.

- Shout right into the new Amperite Microphone—or stand 2 feet away—reproduction is always perfect.
- Not affected by any climatic conditions.
- Guaranteed to withstand severe "knocking around."

Models
RBLG—200 ohms
RBHG—Hi-imp.
List \$42.00

"Kontak" Mikes
Model SKH, list \$12.00
Model KKH, list \$18.00

Special Offer: Write for Special Introductory Offer, and 4-page illustrated folder.

AMPERITE Company, Inc.
561 BROADWAY • NEW YORK 12, N. Y.
Canada: Atlas Radio Corp., Ltd., 560 King St. W., Toronto



GIGANTIC "TAB" SALE!

TRANSFORMERS

115 Volt 60 Cye Input TV Pwr Supply for 7" to 20" Tubes. 115V/5000 20,000W (w/quadripler ckt). ALL Tubes, Plates & Fil Wndgs Divrg. 300VDC/275 Ma Full-Wave, 6.4V/10.3A, 5.4V/8A, 2.5V/3A, Hypersil Core Oil Impreg USN Spec by WECO. \$6.98
 1000vct/45Ma, 795vct/80Ma & 380vct/55Ma, 85V/3A, 6.3vct/1A, 6.3vct/0.3A Csd Hiv \$3.98
 900v/35Ma, 2x2.5v/2A Csd, Hivins. 2.98
 700vct/120Ma, 1.5v/100Ma, 2x6.3v/1A, 5v/2A Csd Hiv Ins. \$2.98
 420vct/120Ma, 6.3v/1.9A w/Inpta 6-12-24-115vdc/1.15/230vac. \$1.98; 10 for \$16.98
 3000v/10Ma, \$4.50; 2x10vct/10Ma, 98c
 Filament Transformers:
 2x5v/12A ea. wndg 12.5KV Ins. \$8.98
 24v/2A Csd \$1.59
 34v/6A Csd \$1.29
 12.6vct/1.25A Csd Hivins. 1.39
 7.5vct/1.2A Csd Hivins. 4.98
 6.3vct/0.6A Csd Hivins. 1.29
 6.3vct/4A (rud 6.5A) Csd Hivins. 1.69

FILTER CHOKES

8Hy/150Ma New UTC erckd T'bd. 2 for \$1.98
 12Hy/300Ma. 2 for \$3.95
 32Hy/400Ma/15KV. \$2.75
 50Hy/125Ma. Csd. \$4.95;
 10Hy/50Ma. 2 for \$1.98
 Dual 2Hy/300Ma. Csd. 2 for \$1.98

POTENTIOMETERS

200 ohms, "AB-J", 4 for \$1
 100,000 ohms, 1 1/2" shaft. 5 for \$1
 200,000 ohms, 1/2" shaft. 5 for \$1
 1 megohm, 1 1/2" shaft. 4 for \$1
 5K-30K dual, AD-J, 7/16" lg. 3 for \$1

RHEOSTATS

25 Watts-Slotted Shaft, 350, 500, 1000, 1500, 3500, 6000 ohms. 5 for \$1; 10 for 98c
 50 Watts, 20 ohms, Knob & Plate. 69c

FUSES—HOLDERS

3AG: 1/8, 1/4, 1/2 Amp. Ea. 2c; 100 \$3.98
 3AG: 1 1/2, 2, 3, 4, 5, 8, 10 Amps Ea. 3c; 100 \$2.49
 4AG: 1/2 Amp. Ea. 7c; 100 for 5.98
 4AG: 5, 10 Amp. Ea. 5c; 100 for 3.98
 5AG: 5, 10 Amp. Ea. 9c; 100/7.98
 5AG: 40 Amp. Ea. 5c; 100 for 3.98
 7AG: 0.2 Amp. Ea. 9c; 100 for 7.98
 3AG-4AG Clip Mtg. Ea. 12c; 10 for 1.00
 3AG-4AG Dual Clip. Ea. 20c; 6 for 1.00

INSULATORS

Thru-Panel, two 7/8" high x 1 1/4" dia. sections & ALL mtg hardware. 2 for 45c
 Cylindrical, Glazed, Tapped. 12c
 1 1/4hx1 1/2" dia. 10c
 1 1/2hx3/4" dia. 12c

KNOB—Popular Types

Polished black bakelite, 1/4" ID brass bushing with set screws, white position indicator.
 Fluted, 1 1/2" dia x 5/8" h. 12c; 10 for 98c
 Bar Knob, 1 1/4" lg x 7/8" dia. 10c; 12 for 98c

SOLDER LUGS

Meter Lugs—Asstd Bts No. 6, 8 & 12 SCRU. 300 for 98c

FL-5 FILTER

Range of Voice. Filters 1000 Hz. Exc for work. 89c

LINE FILTERS

10Amp/130vacdc Csd USN 0.1 to 100 Mc's. \$1.25
 30Amp/250vacdc Csd USN 0.1 to 1000 Mc's. \$3.98; 2/\$6.98
 100Amp/usable 110vacdc GE 2 for \$1.98

BUILD A BANTAM 1-WATT XMITTER

With this Bargain Foundation Unit, Free Instructions. Takes 2 plug-in Xtals, Coils, W/140mmf Cn'dr & Sockets. 2 for 49c
 Complete w/Xtals & Coil. 2 for \$1.95

HEADSETS

8000 ohms—New HS18, 2 Recvs w/PL546C073A, Less Band \$1.98
 250 ohms—HS30, 2 Recvs w/ Band & Cord. \$1.69
 U.S. HS50 as Sound Pwr Unit. 2 for 52.98

KITS

Silver & Mica Cndrs. 30 for \$1.50
 Controls, 500hm to 1Meg. 10 for 2.50
 Resistors, 1/2 & 1W, to 2Megs 100 for 2.50
 Vitreous Ww Resistors. 20 for 1.00
 Sockets, Ass'd, 8, 7, 4P, 25 for 1.00
 Rotary Switches, Ass'd. 6 for 1.75
 G-P Tube Caps, Ass'd. 50 for 1.49
 Coil Forms, TUBSIMP. 50 for 1.00
 Iron Core Slug & Screw. 50 for 1.00
 Elastic Stop Nuts, Ass'd. 50 for 1.25
 Knobs, Ass'd w/Insert. 25 for 1.00
 Spagetti Sleeving, Ass'd. 75 ft for 1.00
 Ceramic Cndrs, Ass'd. 15 for 1.00
 Grammets, Rubber, Ass'd. 100 for 1.00
 Resistors, 2W Ass'd. 100 for 3.50
 Tie-Point Lugs, Ass'd. 25 for .35

G-E SELSYN 2UJG1

400 cye Usable 24V or 110V/60cye Used, Tested, Ctd. w/4.49
 GE Liquid Level Transmitter. Approx Govt Costs \$100.
 GE T3 DC Selsyn for Remote Indication of Liquid present in Tank.
 New. 2 for 89c

UHF ANTENNA

12"/30cm AT5/ARRI convertible Citizen's Band, Th'd Coax Term Insult'd Slitw/Cont w/wpl Gask Flange & H'w. MOLLE mtr. BRAND NEW. 39c; 4 for \$1.00
 PL259 for above. 29c
 Whip Antenna Buys! \$1.69
 MS49to52, 16 ft. 2.49
 MS49to53 & extra 53, 19 1/2 ft. 3.99
 MS49to53, 53, 55, 56, 26 1/2 ft. 5.98

STORAGE BATTERIES

36 Volt WILLARD Mini-BRAND NEW: 5 oz. Desgnd Portable equip. Models. ONLY 98c; 4 for \$3
 2V/25AH G-E Portable Radio Battr. by Flis Ident. Space GE Radio 25-2. Leads Adaptable. \$5.49
 2V/27AH Willard B554 and \$4.98
 2 Volt Vibrator. \$1.98

DRY BATTERIES

SigCorps—BRAND NEW Tested—Shelf Dated.
 BA34 7 1/2 V 5/4 1/2 3/1 1/2 Neg Volts. 10 \$4.99
 BA35 1 1/2 V simBURGESS 4FH. 29c
 BA36 45.22V BURGESS 5308 3 for \$1.49
 BA37 1 1/2 V Walky-Talky. 1.49
 BA38 103 1/2 V Walky-Talky. 1.49
 BA39 150 1/2 V Burg-FUSA 100. 2 for 98c
 BA40 90 1/2 V Burg 4GBG. 1.19
 BA43 90/45 1 1/2 V. 98c
 BA51 87 1/2 V Minimax. 10 for 1.00
 45/30 Volt NEW 1949 Batty simBURGESS XX30E, 1x2 3/8 x 1 1/4". 89c

CIRCUIT BREAKERS

Heinemann Mgn Bkrs AMPS: 0.22, 3, 9, 15, 30. \$11.49; 100 \$1.29;
 Klaxon Thermal Push Button Bkrs 5, 15 Amps. Ea. 69c;
 Solid & CH AN Toggle Sw. Bkrs 5, 10, 25 Amps. Ea. 79c; 100 \$5.98; 100 \$4.99

COAXIAL CABLE

TWINEX, 100 ft. \$1.09; 1000 ft. \$8.75
 RG8/U, 100 ft. 98c; 100 ft. 9.98
 RG11/U, 100 ft. 1.09

16 mm FILM

BRAND NEW! 16mm PAN film CSAP Camera—SPECIAL! 54 rolls (1350 ft.) \$4.98

I-F TRANSFORMERS

456 Kc Double Slug Tuned. Shielded. 3 for \$1; 8 for \$2
 10 to 14 Mc PM&TV Double Slug Tuned. Shielded. 2 for \$1; 5 for \$2

TOGGLE SWITCHES

AH&H—6Amp/125V—UL Appvd Hi-Nickel Finish, Remov from Equip. Bkts Csd. CLEAN! A Real Buy! SPDT 5/31; DPDT. 4/51

MICROSWITCHES

SPNC 10A/WZ-RQ11. 69c
 SPNO 10A/1/2-TRTC, Pin. \$4c
 Plunger. \$5c
 SPNO 10A/G-TRST, Plunger. \$1.25
 SPNC/30A/B-1. Hi-ALT. Cased. \$1.25

ROTARY SWITCHES

Decks	Ckts	Pos	2	6	for \$1
1	3	2	5	2	for \$1
4	1	6	2	2	for \$1

RECTIFIERS

Precision BRADLEY Dbl Bridge. Balanced Current & Temp 1% from -40 to 88°C. Input to 4.5vac. Output to 3vdc/5Ma. Only 98c
 36V/100V/150Ma Selen w/ mtg flange. 2 units can connect in CT for Full Wave; 4 units usable as Full Wave Bridge. Ea. 36c; 2 for 60c; 4 for \$1
 100Ma Selen. 69c; 200Ma Selen. 98c
 Full Wave Bridge Selen for Relays or Pwr. Inpt 115 to 130vac; Output 115vdc/40Ma. Ea. 49c; 10 for \$4.49

TUBE SOCKETS

OCTAL, 8 pin & plate. 12 \$1
 LOCTAL, 8 pin & lock Mien B HF. 20 \$1
 4-PRONG Sealite, Johnson 866. 5 \$1
 7-Pin Mini, Bot Mtg Bkts sim Amp 147-500. 10 for \$1
 7-Pin Mini, Mtr. Top Mtg. 1/2 sh. 10 for \$1.79; 100 for \$15

MICA CAPACITORS

Postage & Micas: .003/.004/.006/.01 mfd, ea. 12 for 98c
 Lug Term: .006mfd/600v. 12 for 98c

Type	Mfd.	WV	Each
B	.006	600	\$0.25
B	.008	600	.25
B	.01	600	.30
B	.02	800	.45
B	.03	800	.58
B	.002	1200	.30
B	.01	1200	.50
A	.0004	2500	.35
A	.0005	2500	.75
A	.015	2500	1.30

Mfd Transmuting Micas Each
 .006 2500 \$1.35
 .00005 3000 .65
 .000 3000 .90
 .0007 3000 .90

BAKELITE CASED PAPER CAPACITORS

Deduct 10% Qts. 100
 Postage & Domino—400to600WVDC. Mfd: .01, .02, .05, .08. 15 for \$1

TUBULAR PAPER CAPACITORS

.1mfd/150v. .05mfd/400v. .0003mfd/600v. Each. 7c; 10 for 63c
 Metal Cased Tubulars—Oil Impreg. 2 for \$1
 .01mfd/400v. 12 for \$1
 .04mfd/600v. 10 for \$1

OIL CAPACITORS

Lowest Prices Ever!
 2x5mfd (10mfd) OILMITE to W.E. specs. 8976, 400wvdc —65to65°C. Gut/Usable 600wvdc. 2 for 98c
 2x1 mfd. 5 for \$1
 2x1mfd/2000v TOBE, Common OFF Ground. \$1.08; 2 for \$2.00
 Bathtub & Rectangular Choice
 300 WVDC
 1.2mfd 400 WVDC 7 for \$1
 1 mfd 600 WVDC 6 for \$1
 4 mfd 300 WVDC 3 for \$1
 2x1 mfd 5 for \$1
 3x1 mfd 4 for \$1
 1 mfd 500 WVDC 6 for \$1
 1 mfd 600 WVDC 6 for \$1
 5 mfd 4 for \$1
 2x.25 mfd 4 for \$1
 3x.05 mfd 8 for \$1
 3x.22 mfd 8 for \$1

1N34 CRYSTALS. ea. 67c

10 for \$6.50; 100 for \$63.00

TUBES BRAND NEW Tested—Guaranteed

25¢ Each	6C4	954	2X2
	12A6	955	3A4
	24G	956	6J5GT
	455/VT52	957	6J5GT
Unit Price...29c	VR92	7193/2C22	6J5GT
	WE215A/VT5	9006	26
			9001

45¢ Each	1U5	68A6	6K6GT	6W4GT	1258GT	2526GT
	3Q4	68E6	6K7GT	6X4	125A7GT	3585
	354	68H6	6P5G	6X5	125F5GT	35C5
	6B8J	68J6	6S47GT	7Y4	125F7GT	35W4
	6B8A	6C5GT	6D7GT	12AR6T	125J7GT	35Z5GT
	6A65	6F5GT	6F5GT	12AT6	125N7	5085
	6A65	6F6GT	6K7GT	12AU7	125Q7GT	50C5
	1A3	1T4	6H6	6S07GT	128A6	125L6GT
	1L4	1U4	6A6	6H6GT	6V6GT	128E6
						25Z5
						211/VT4C

55¢ Each	OD3/VR150	5U4G	68F6	65L7GT	128F6	35L6GT
	1H5GT	5Z3	6C86	7C4	128K8	REL36/6J4
	1N5GT	6AL5	6J7GT	7C5	12Q7GT	50L6GT
	1R5	6AR5	6K5GT	7F7	125K7GT	2051
	2V3G	6AV6	6Q7GT	12AX7	125L7GT	
Unit Price...59c	3V4	68A7	688GT	128A7	35/51	

65¢ Each	1A7GT	6A8GT	6J6	183GT	6L6G
	1LN5	12AT7	5T4	1X2	6T8
				3Q5GT	19T8

Lots of 50—Unit Price, 69c

75¢ Each	6AC7M	6V6M
	6AG7	1986G
	6AK5	117L7GT
	6BG6G	6L6M
	6L6M	117P7GT

Lots of 50—Unit Price, 79c

85¢ Each	OC3/VR105	25B06GT
	6AC5GT	32L7GT
	68A6	930
	6BQ6GT	

Lots of 50—Unit Price, 89c

99¢ Each	6AC7M	6V6M
	6AG7	1986G
	6AK5	117L7GT
	6BG6G	6L6M
	6L6M	117P7GT

Lots of 50—Unit Price, 1.09

THAT'S "TAB" THAT'S A BUY

DEPT. 6RN SIX CHURCH ST. NEW YORK 6, N.Y., U.S.A. - CORNER CHURCH & LIBERTY STS. ROOM 200

PRINTED IN U.S.A.

RADIO & TELEVISION NEWS

Phone Worth 2-7230



Get
Into

TELEVISION, RADIO ELECTRONICS

Master ALL Phases

Get Complete Training. You Receive and Keep All Tubes, Equipment, Parts and Lessons. No Extra Charges.

**GOOD PAY
and Unlimited Opportunities
in JOBS LIKE THESE:**

Business of Your Own. Radio Manufacturing. Sales. Service. Broadcasting Telecasting. Television Manufacturing. Sales. Service. Laboratories: Installation. Maintenance of Electronic Equipment. Electrolysis. Call Systems. Garages. Auto Radio Sales. Service. Sound Systems and Telephone Companies; Oil Well and Drilling Companies; Engineering Firms. Theatre Sound Systems. Police Radio.

And scores of other good jobs
in many related fields

**YOU CONDUCT MANY
EXPERIMENTS LIKE THESE!**

Checking action of condensers
Experiments with AF and RF amplifiers
Experiments with resonance
Producing beat frequencies
Calibrating oscillators
Experiments with diode, grid-bias, grid-leak and infinite impedance detectors
Practical experience in receiver trouble shooting
Application of visual tester in checking parts and circuits
Experiments with audio oscillators
Advanced trouble-shooting
and many, many others.

**Complete Training by Practical
Resident Trade School, Est. 1905**

The same highly trained faculty, instruction materials and methods used here in our large, modern resident school, are adapted to your training in your own home. Shop Method Home Training has been proved by hundreds of successful graduates.

**Both Resident and Home Study
Courses Offered**

**YOU
LEARN BY
DOING**

You receive special laboratory experiment lessons to show you how to build with your own hands various experimental units such as those shown at left, and how to conduct many tests.

You will find all lessons easy to understand because they are illustrated throughout with clear diagrams and step-by-step examples that you work out yourself. Every piece of the equipment and complete lesson material we send you is yours to keep and enjoy, including the multimeter, experimental equipment, all parts of the Superheterodyne, tube manual, radio dictionary, and complete, modern Television texts. All parts are standard equipment.

**Shop Method Home Training . . .
Earn While You Learn**

With our practical resident Shop Method Home Training, you study in your spare time. You receive Spare Time Work Lessons, which show you how to earn while you learn. Service neighbors' radios and TV receivers, appliances, etc., for extra money and experience. Many National students pay all or part of their training with spare time earnings!

**DON'T DELAY! The Radio-Television
Industry needs trained men NOW!**

**APPROVED
FOR
VETERANS!**
Check coupon below!

For quick action,
mail coupon
today and we'll
rush you full in-
formation.

Free!

**NEW, ILLUSTRATED
OPPORTUNITY
BOOK AND SAMPLE
LESSON SHOW YOU
HOW WE TRAIN
YOU . . . SEND FOR
THEM TODAY! NO
COST. NO
OBLIGATION.**



**YOU RECEIVE THIS
PROFESSIONAL MULTITESTER
YOU BUILD ALL THESE AND
MANY OTHER UNITS WITH
PARTS WE SEND YOU!**



Signal Generator

Audio
Oscillator

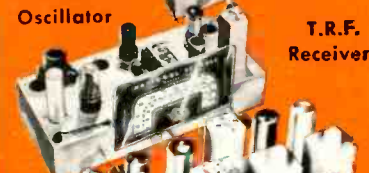

T.R.F.
Receiver

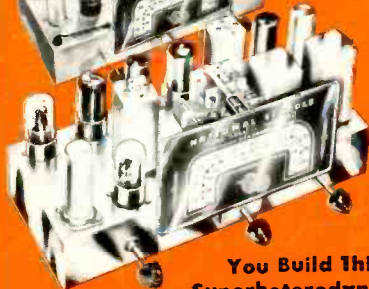

You Build This
Superheterodyne

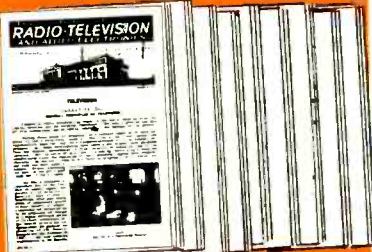

You Receive a Special Series of Modern Lessons in TELEVISION, all a part of your course: you master all phases.

NATIONAL SCHOOLS

LOS ANGELES 37, CALIF. • EST. 1905

FIND OUT NOW . . . MAIL COUPON TODAY

National Schools, Dept. RN-6
4000 South Figueroa Street
Los Angeles 37, California

Send me your FREE book "Your Future in Radio" and the sample lesson of your course. I understand no salesman will call on me.

NAME _____ AGE _____

ADDRESS _____

CITY _____ ZONE _____ STATE _____

Check here if Veteran of World War II

Mail in envelope
or paste on
penny postal.

New



Mallory Plascap*

... Made with Amazing Mallocene*!



World's First Completely Engineered Plastic Tubular Capacitor

Here's the plastic tubular that's years ahead of its time ... made possible *now* by Mallocene, amazing Mallory plastic development that gives you *four exclusive* performance firsts, leaves ordinary plastic tubulars far behind!

Gone is the old bugaboo of "call-backs" due to construction weaknesses beyond your control. For the Mallory Plascap is dependable. No oil leakage, no unsoldered leads, no off-center or deformed cartridges, no messy outside wax coating, no insulation problems. The Mallory Plascap makes your service job easier! See your Mallory Distributor.

The Secret of Mallocene . . .

There is only *one* logical way to build a molded type plastic tubular capacitor ... with a plastic that sticks to the metal leads! But with ordinary construction methods, this has been impossible, for such a plastic would stick to the metal mold!

Here's the secret of the Mallory Plascap. First, an extremely tough plastic shell is molded. The cartridge is carefully centered within this shell. Then, the cartridge is surrounded with Mallocene. When Mallocene hardens, it actually becomes part of the outer plastic shell, and *sticks to the metal leads!* Thus, Mallocene provides a solid plastic tubular capacitor with the *first* moisture-proof construction!



TRISEAL CONSTRUCTION—Sealed *three* ways —with moisture-free Mallotrol* ... tough outer plastic shell ... exclusive Mallocene!



DISTORTION-FREE WINDING — No flattened cartridges due to molding pressures ... no failures due to "shorts"!



FASTITE LEADS—Permanently fastened ... sealed with Mallocene ... unaffected by soldering-iron heat!



TRU-CENTER CARTRIDGE—Cartridge centered every time ... uniform insulation guaranteed at all points!

Plus these **Top Features**: Operates at 85°C ... No messy outside wax coating required ... Great mechanical strength ... Small in size ... Light in weight ... High dielectric strength ... Lead to outside foil clearly identified ... Handsome yellow case ... Legible part-numbers and ratings.

P. R. MALLORY & CO. Inc.
MALLORY
CAPACITORS ... CONTROLS ... VIBRATORS ...
SWITCHES ... RESISTORS ... RECTIFIERS ...
VIBRAPACK* POWER SUPPLIES ... FILTERS
*Reg. U. S. Pat. Off.
APPROVED PRECISION PRODUCTS

*Trade Mark

P. R. MALLORY & CO., Inc., INDIANAPOLIS 6, INDIANA